

**JAN.  
1962**

# tv horizons

## CATV

## IN

## EUROPE

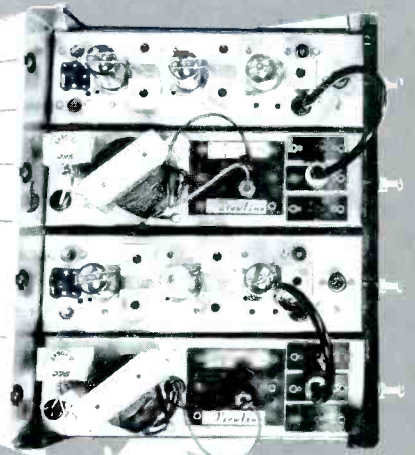

serving the television reception industry

A.G. Flanagan  
General Manager  
KCOP-TV  
915 N. La Brea  
Hollywood 38, Calif.



**Servicemen everywhere are saying:**



**brings in sharp**

**pictures where other electronic antennas fail**

It stands to reason that TACO would produce, in the T-BIRD ELECTRA, the world's best electronic antenna. Only TACO gives you the combination of the most rugged, highest-performance antennas plus the finest in antenna-mounted transistorized preamplifiers (designed by Jerrold).

So, with the T-BIRD ELECTRA you assure customer satisfaction, even in severest "problem" areas. Rigid chrome-alloy aluminum elements and

contacts eliminate the antenna "friction noise" and "signal flutter" inherent in some so-called "high-gain" antennas. There's a T-BIRD ELECTRA for every TV/FM home need, priced from \$79.75. And it's completely pre-assembled for your convenience.

Only TACO offers custom area-engineering on electronic antennas to help you solve any type of signal problem. For these special services, see your TACO distributor.

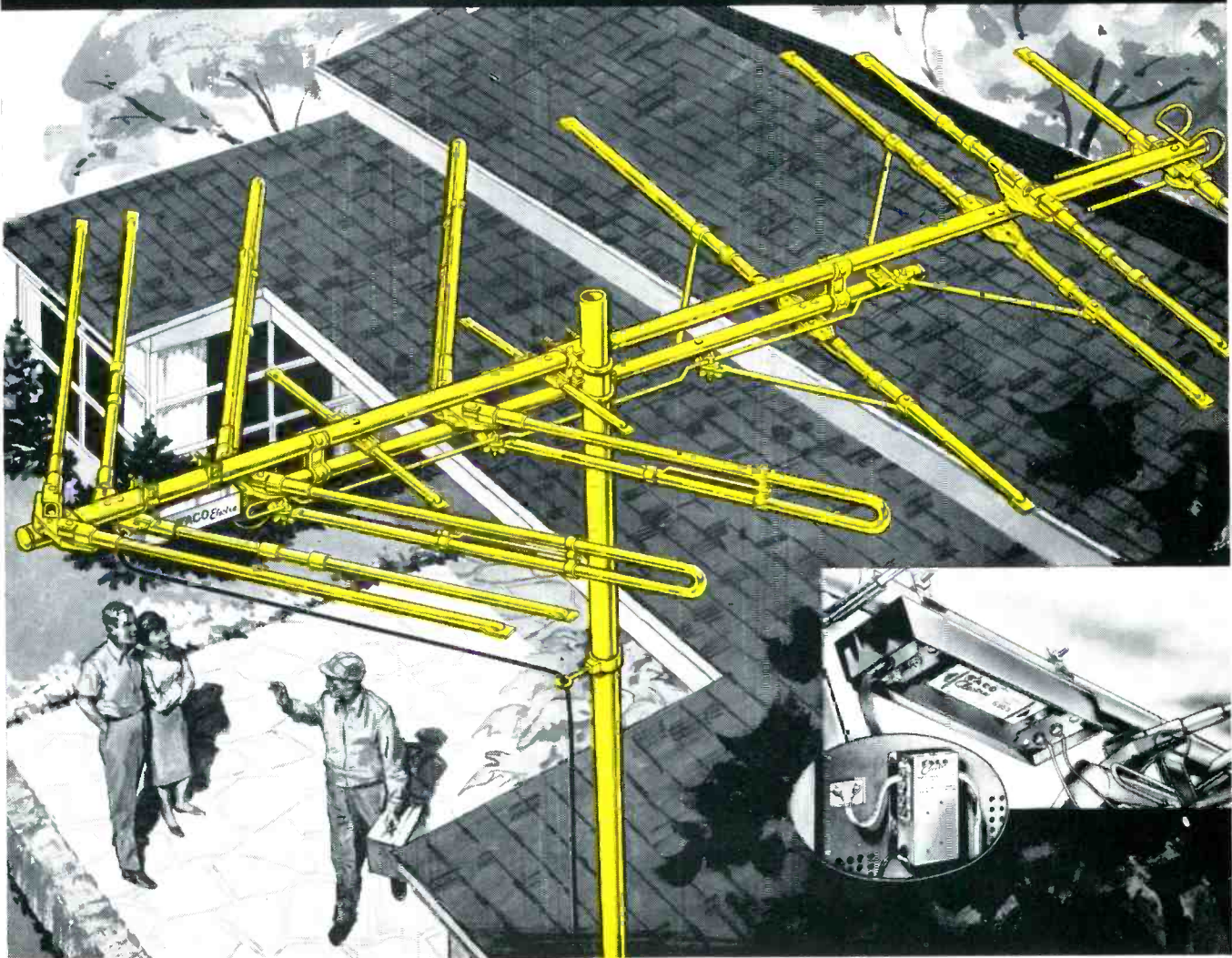

\*The TACO ELECTRA preamplifier is available separately at \$39.95 for use with any antenna

**TACO**

**TECHNICAL APPLIANCE CORPORATION**

Distributor Sales Division • Dept. JTD16, Sherburne, New York  
A Subsidiary of Jerrold Electronics Corporation



# Channel

# 1

## AMECO Becomes Separate Corporation

AMECO, formerly the manufacturing division of Antennavision, Inc., Phoenix, Arizona, became a separate corporation on December 1. Antennavision President Bruce Merrill picked the occasion to announce plans for an expansion of the AMECO plant facilities and a companion remodeling program of the company's headquarters building in Phoenix.

AMECO was begun as the manufacturing arm of Antennavision. Antennavision, one of the nation's largest operators of CATV systems, had found it advantageous to manufacture its own line of CATV equipment for use in the desert southwest region where its systems are located. Recently the company broadened its marketing approach to CATV, establishing a sales force across the country and molding a sizeable headquarters management force captained by ex-NCTA prexy Ed Whitney.



Architect's sketch of Ameco's remodeled plant and headquarters building.

A portion of the additional production space will be utilized for a number of new product lines, including recently perfected transistorized equipment. President Merrill stated he feels "immediate acceptance by the industry of AMECO's newly developed fully transistorized all band TV distribution equipment line has created the (pressing) need for this expansion."

AMECO construction crews are currently building community antenna systems in Alpine, Texas; Colorado City, Texas; Van Buren, Arkansas; Yuma, Arizona; Holtville, Imperial, El Centro, Calexico and Brawley in California. Systems under construction or recently completed utilizing AMECO equipment are located in Buffalo, Oklahoma; Laverne, Oklahoma; Waynesville, Missouri; Yates Center, Kansas; Oxford, New York; Mill Hall and Huntingdon,

CATV  
MATV  
Fringe TV  
ETV  
UHF-TV  
Associated  
Industries' News

Pennsylvania; Irran, Texas; Yuma Test Station, Arizona; Moab, Utah and Monterrey, Mexico.

## CCTV Firms Merge

Centry Sound, Inc., A Fort Wayne communications equipment distributor has recently announced a merger with Fountain Sound Equipment Company. The surviving firm will be Centry Sound, Inc., according to President Bill Dodenhoff. Centry Sound is a distributor for Dage Television, and Blonder Tongue. The firm is located at 7675 Bluffton Road, Fort Wayne, Indiana.

## Senor Raytheon

Raytheon has moved into the South American television market with an announcement of a long-term sales agreement whereby television components will be assembled into television receivers in Argentina by Visora, S.A.

Visorama has been formed by the merger of Establecimientos Nyska, S.R.L. and Motorama, S.A. Both firms are established manufacturers of television receivers for the Argentine. More than 770,000 video receivers are now in use in Argentina and the market is expected to increase considerably in the year ahead as thirty newly author-

ized government stations take to the airwaves.

## TVH To Sponsor Parametric Amp Test

I. Switzer, operator of Co-Ax Television Ltd, Estevan and Saskatoon, Saskatchewan, Canada recently contacted the Television Horizons engineering desk with a request that Horizons undertake a series of test appraisals of a new product recently announced for operation in the 750-1000 mcs. region. The product is a parametric amplifier, produced by Micromega Corporation, Venice, California. Micromega has been manufacturing the super low noise units for military scatter applications across the North Atlantic. However Mr. Switzer felt the units could be adapted to UHF television use in regions where the very last db of signal is necessary. The unit in question is a one-port reflection-type amplifier utilizing mechanical tunable ferrite circulators. Noise figure at 900 mcs. is 2.0 db.

Horizons authorized Art Brothers of Los Angeles to set up a testing program with Micromega, who in turn indicated considerable interest in developing the product for television off-the-air reception work. It appears the unit to be tested can be kept to 10 mcs. bandwidth with a response of plus or minus 1/2 db over a six megacycle segment. Sometime in the near future the unit will be tested on an 85 mile channel 83 hop in Arizona. A complete field engineering report, complete with photos of the off-the-air reception will be forthcoming in TVH if everything comes off on schedule.

## About the December Directory

The December Directory edition of Television Horizons contained a few errors, and a few listings which arrived after our editorial closing date did not get in as we had hoped they would.

Consequently, the February issue of Television Horizons will contain a Directory Addendum (corrections and mostly additions) which you will find of considerable value.

**The Winegard Company has brought to our attention that all Winegard listings showed list prices, not user net prices as quoted. Therefore please keep in mind that all Winegard Directory prices are list prices, not user net prices.**

# TELEVISION HORIZONS

PUBLISHED MONTHLY BY HORIZONS PUBLICATIONS  
POST OFFICE BOX 3207 • MODESTO, CALIFORNIA

## EDITORIAL

The translator has come a long way. Only eighteen months ago it was chased from the air by the vigilantes of the airwaves, the FCC. It was cursed, written harshly about and generally considered the illegitimate child of an "out-back public" craving for big city entertainment.

Then in early July, 1960, it was recognized as a possible adjunct to the broadcasting world. Rules and regulations allowing the V translator to take on a quasi-legal status were released by the FCC, and all past bad feelings about the VHF Booster monster were supposed to be forgotten, apparently overnight.

In the past year, in the best of American tradition, an industry has sprung up around the translator. It is a young-dynamic industry, still not quite sure which way to loft its sails . . . to the starboard, or to the port. From that industry have sprung a few young giants, men who eighteen months ago were either hiding their work for fear of government intervention, or carefully planning their future work cognizant of new horizons the legalizing of the monster would create.

Recently the translator industry won an important battle when the Supreme Court of Wisconsin ruled that it is constitutional in that state to use authorized public funds for the construction of municipally owned television translators.

Residents of Darlington, Wisconsin, in a referendum on April 5, 1960, had voted to spend money for a tower, and translators, which would repeat the signals of Madison UHF stations on channels 27 and 33. A taxpayer had filed suit challenging the constitutionality of the measure, contending that building the translators with tax money was improper use of such funds and would amount to another 'step forward toward the concept of the welfare state'.

The future of the translator device? Only the ingenious mind of man can say. RBC

## TABLE OF CONTENTS

### FEATURES

OFFICIAL FCC REPORT	
<i>VHF-UHF Field Strength Measurements . . . . .</i>	4
COVER STORY—NEW MONTHLY FEATURE	
<i>Our Man in Europe — Gordon J. King . . . . .</i>	8
FIND HELP FAST—NEW MONTHLY FEATURE	
<i>Department JJ . . . . .</i>	9
TVH EDITORIAL CHALLENGE TO THE CATV INDUSTRY	
<i>ETV and CATV . . . . .</i>	16
SPECIAL REPORT—CATV	
<i>The Microwave Question and CATV . . . . .</i>	16
LATE NEWS FLASH—CATV	
<i>FCC Outlines CATV Microwave Attack . . . . .</i>	18
HOW GOOD IS YOUR PUBLIC RELATIONS?	
<i>PR in CATV . . . . .</i>	24

### DEPARTMENTS

<i>News to Deadline from the Industry — CHANNEL ONE . . . . .</i>	1
<i>Comments from R. B. Cooper, Jr. — EDITORIAL . . . . .</i>	2
<i>As We See Others — OUR MAN IN EUROPE . . . . .</i>	8
<i>Help! — DEPARTMENT JJ . . . . .</i>	9
<i>The Future of Television — UHF TELECASTING REPORT . . . . .</i>	12
<i>New Products for Better Weak Signal TV — PRODUCT SHOWCASE . . . . .</i>	13
<i>News From the Cable TV World — CABLE DROP . . . . .</i>	17
<i>Technician's Special — MATV/CATV FIELD ENGINEERING . . . . .</i>	20
<i>Engineer's Special — JERROLD CATV BASICS . . . . .</i>	23
<i>System Manager's Special — PR IN CATV . . . . .</i>	24
<i>You Can't Tell the Players Without a Program — FCC IN REVIEW . . . . .</i>	28

### STAFF

**R. B. COOPER, JR., K6EDX**  
Publisher-Editor  
CARLYNE SILVA  
Associate Editor  
LES FAREY  
LON CANTOR  
MARV MITCHELL  
CHARLES WIGUTOW  
VIC NICHOLSON  
Contributing Editors  
GORDON J. KING  
"Our Man in Europe"  
STANLEY M. SEARLE  
Art Director  
BONNIE FANTER  
Circulation Manager

### OFFICES

1016 - 14th STREET  
MODESTO, CALIFORNIA  
U.S.A.  
LAmbert 4-7395  
P. O. BOX 1557  
OKLAHOMA CITY, OKLA.  
Central 2-6290

**ADVERTISING:** Television Horizons accepts commercial display advertising from bona fide manufacturers of electronics equipment and apparatus dealing with the CATV, MATV, fringe-TV, ETV and rebroadcast TV industries. Advertising rate card and circulation data upon request.

**CIRCULATION:** Television Horizons is circulated through the mails and in person on the 5th of each month to an average of 7,500 readers in the CATV, MATV, TV servicing, fringe-TV, ETV and TV broadcast (and rebroadcast) industries. Circulation is both paid and controlled. Detailed circulation breakdown, by reader occupation, is available upon request.

**SUBSCRIPTION:** Subscription rates in the United States and Canada \$5.00 per year. Subscription includes the Annual Directory edition, issued every December. Single magazine copies \$.50 each. Single Directory Editions \$1.00 each. Subscription remittances should be made by bank money order or check. Two year subscription rate U.S.A. and Canada—\$8.00. Subscriptions outside the U.S.A., Canada \$6.00 per year.

TELEVISION HORIZONS (title registered U.S. Post Office) entered as second class postage material December 30, 1960. Second class postage paid at Modesto, California. All rights reserved. Address of publisher in Modesto, California is 916 - 14th Street.

POSTMASTER: Send form 3579 to Television Horizons, P. O. Box 3207, Modesto, California.

TELEVISION HORIZONS . . . Serving an Industry



AVAILABLE FROM BLONDER-TONGUE

# The new Benco T-6 VHF Translator Is Priced at \$845<sup>00</sup>

(Suggested User price)

...It is

FCC Type  
Accepted

Rugged and  
Reliable

Available for  
Prompt Delivery

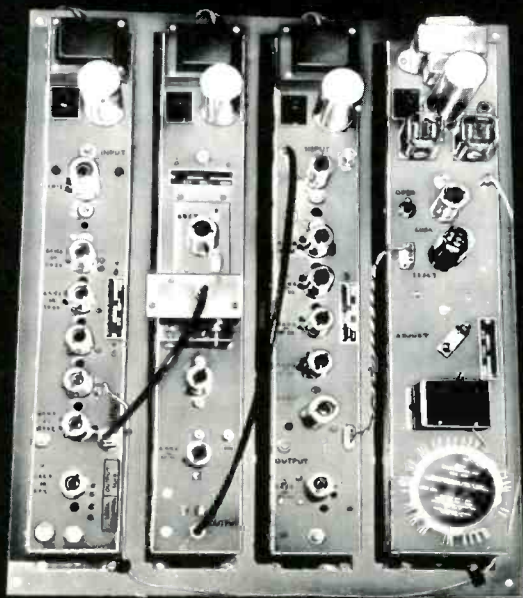

The Benco T-6 offers these advantages :

1. Meets all FCC specifications.
2. Provides constant output even in weak signal areas—preamp AGC activated by signals as low as 50 microvolts.
3. Automatic shutoff and identification.
4. Remote shutoff for any location up to 5 miles from the translator. (with RC-1).
5. Covers from 8 to 30 miles or more.
6. Prompt delivery to those who must have a low cost unit immediately to meet their 'on-the-air' time-schedule.

#### TECHNICAL SPECIFICATIONS

Primary Power Source	.....117 v $\pm$ 10% 60 c/s
Power Consumption	.....120 W
Temperature Ambient	.....-30°C to + 50°C
Overall Noise Figure	
Low Band	.....4 db $\pm$ 1 db
High Band	.....6 db $\pm$ 1 db
Recommended Input	.....50—4000 microvolts
Max. Permissible Power	.....1 Watt (Peak Power)
Frequency Stability	......02%
Gain (maximum)	.....105 db
Band Width	.....6 Mc (3 db points)
Dimensions (metal base)	.....18"x22½"
Weight	.....27 lbs.

#### BENCO VHF AND UHF TRANSLATORS FOR EVERY TYPE OF INSTALLATION

**MODEL T-1 VHF TRANSLATOR, FCC type-accepted.** 1 watt output for U. S. use • ideal for future expansion • meets all FCC specifications • noise-proof automatic shutoff • regulated power supply for stable operation, even at the end of poor quality power lines • under-rated output section for continuous service; weather-proof housing; quick easy coding of identification unit • built-in direct reading power meter.

**MODEL T-14 VHF-TO-UHF TRANSLATOR.** FCC type-accepted. 2.5 watts output. For U. S. use. Includes identification units with automatic "on/off," power indicator and voltage regulator. VHF input, channels 7-13.

**MODEL T-13 VHF-TO-UHF.** Same as T-14 except: VHF input, channels 2-6.

*If you're planning a translator installation, contact  
Blonder-Tongue. Free layout service and field  
engineering assistance are available at nominal cost.*

engineered and manufactured by

**BLONDER-TONGUE**  
9 Alling St., Newark, N. J.

Canadian Div.: Benco Television Assoc. Ltd., Toronto, Ont.  
Export: Morhan Export Corp., New York 13, N. Y.  
home TV accessories • UHF converters • master TV  
systems • Industrial TV systems

# THE FCC OFFICE OF THE CHIEF ENGINEER

## REPORTS ON VHF-UHF FIELD STRENGTH MEASUREMENTS

By  
George V. Waldo  
Jack Damelin

### Editor's Note:

While the Federal Communications Commission is busily engaged in signal measurements of off-the-air channel 31 in the New York City UHF test, a recent report compiled by the Commission on the subject of VHF versus UHF field intensity measurements over long periods of time, has been made available to Horizons Publications. The context of this report is long and detailed in that some thirty-two charts are presented showing diurnal, seasonal, and long term signal variations for over the horizon paths on frequencies in the VHF and UHF ranges. A number of these charts, the basis for the comparisons, and a short section of text from the report is reproduced here, with some of our comments on the wave propagation properties apparently exhibited by the charts.

### VHF-UHF FIELD INTENSITY MEASUREMENTS

#### INTRODUCTION

This report summarizes and presents the results of a considerable number of VHF-UHF field strength recording projects conducted at FCC monitoring stations. A large range of distances, transmitting antenna heights, and terrain variation is represented by these data which were collected over the continental U.S. Some of the projects are still active. Information is being presented in the form of graphs showing seasonal and diurnal variations of signals exceeded for various percentages of time. Time distributions of field strengths exceeded for several percentages of time over the entire periods of recording were also obtained in most cases, and are shown in the report.

#### ANTENNAS AND EQUIPMENT

All receiving antennas used for field strength recording were mounted thirty feet above ground. The VHF antennas were horizontal half-wave dipoles; the UHF antennas were half-wave dipoles with corner reflectors having gains of about 12 db relative to a simple half-wave dipole. Standard coaxial cables were used with direct (unbalanced) matched connections at the antenna and receiver terminations. The VHF antenna calibrations were made by techniques utilizing sweep frequency oscillator reflection measurements. The forward gain of each corner reflector antenna used for UHF was measured by the FCC Laboratory Division prior to installation. The terminal impedances of the antennas, receivers and signal generators, as well as transmission line losses, were checked periodically by reflection measurement techniques.

At most of the installations, the receivers on loan to the

FCC from the Central Radio Propagation Laboratory of the National Bureau of Standards, were specially designed for field strength recording purposes. The FCC Laboratory Division designed and built several of the UHF receivers. Some of the VHF receivers were BC 624 surplus military equipment modified for this purpose by the FCC Field Engineering and Monitoring Bureau.

#### METHODS OF FIELD STRENGTH DATA ANALYSIS

Since there is generally a considerable amount of rapid fading characteristic of tropospheric propagation in the VHF-UHF bands, it is not possible to analyze the registered traces of receiver output as obtained on standard graphical millimeters unless the chart paper is driven at an unreasonably high speed, or unless an "averaging" or "time constant" circuit is used to dampen the movement of the recorder pen. The use of "time constant" circuits was investigated, and it was found that such arrangements do permit a satisfactory display of recorded signals for analysis. It was further determined the adequate analysis accuracy could be achieved by sampling the signal thirty times per hour instead of recording signal traces continuously. Accordingly, recording samples were made taken at 2-minute intervals. A switching arrangement, activated by a synchronous clock motor, made the signal circuit of the recording receiver inoperative except for a period of about five seconds for each sample, allowing the pen to reach full deflection. The current supplied to the recording meter was a function of the AGC voltage in the receiver, so that the meter would mark deflections which were approximately proportional to the logarithm of the RMS, rf receiver input voltage for the 30 hourly samples. The recorder charts were analyzed by means of an electronic analyzer which counted automatically the number of signal samples exceeding each of the several calibration levels within the range of signal variation.

#### CONCLUSIONS

Evaluation and review of the several modes of data presentation, which constitute the main body of this report, tend to give additional weight and credence to the following general qualitative findings and conclusions arrived at by other investigations of propagation in the VHF-UHF frequency bands:

1. Fields are higher in summer than winter.
2. Fields are higher during nighttime hours than during daylight hours.
3. Greater variability is to be expected as the frequency increases.



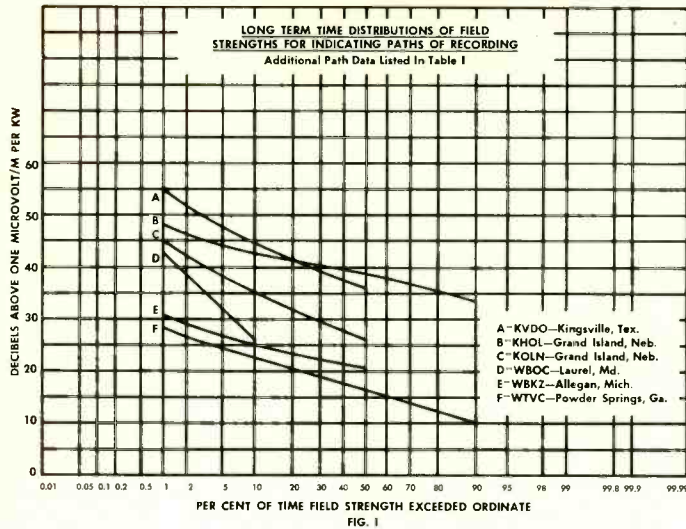

Grid lines A, D, E, are UHF while B, C and F are VHF. Paths covered vary from 38 miles for line A to 86 miles for line F.

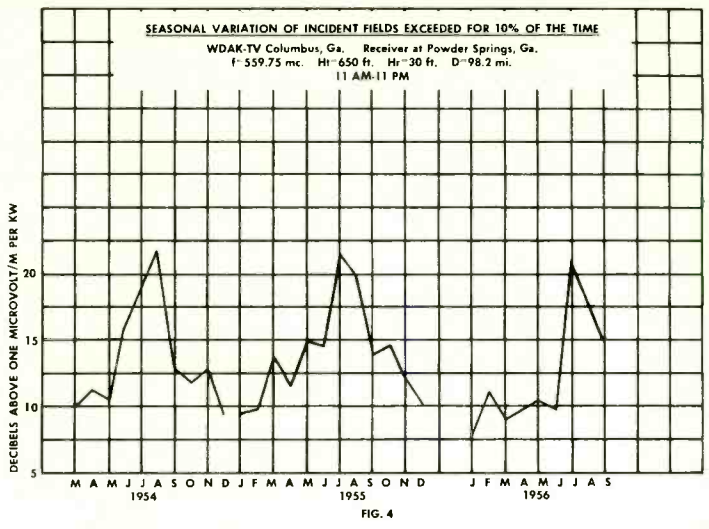

Summer time higher average signal strengths are verified during three year study of 559 mcs. signal of WDAK-TV, 98.2 miles from the receiving site.

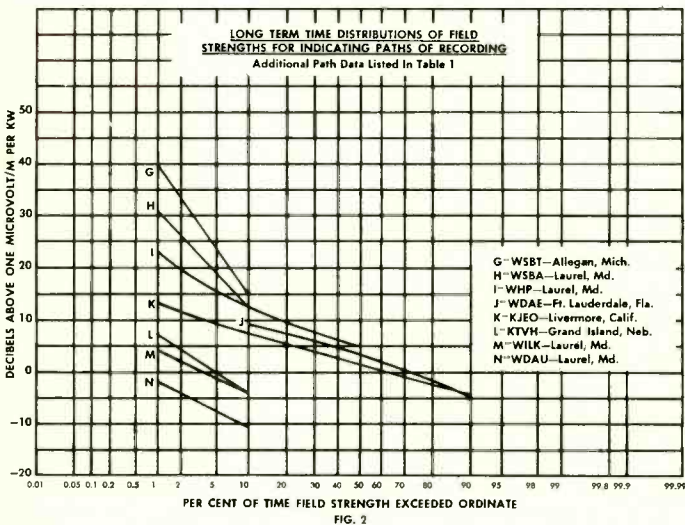

Frequency span of 100.7 to 673 mcs. is shown in this chart with line J being WDAE-FM (100.7 mcs.) and line K KJEO (673 mcs.). Note even distribution except for lines I (UHF WHP-TV) and K (UHF KJEO-TV). Affect of frequency on WDAE-FM (line J) is evident.

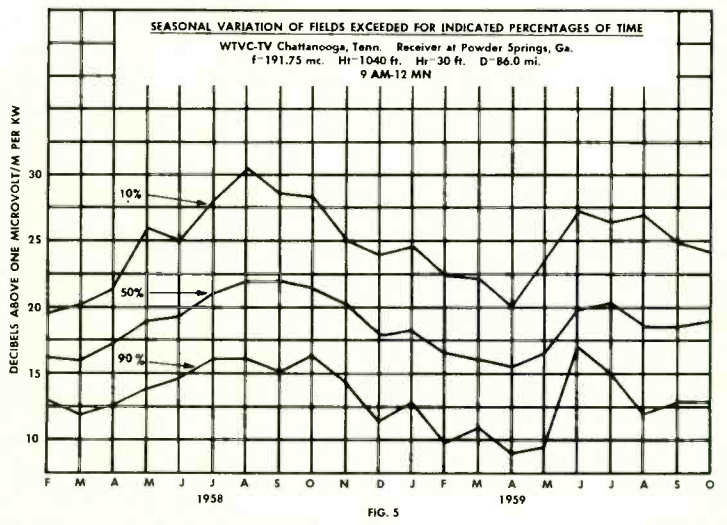

February, March, April period apparently is year's worst while June and July are best at VHF frequency 191 mcs. of WTVC over an 86 mile path.

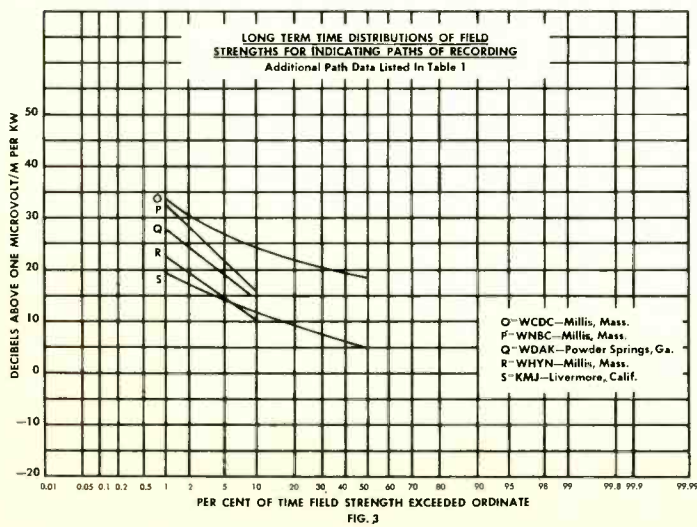

UHF variations over varying degrees of terrain. Paths vary from WHYN (line R) at 67.5 miles to KMJ (line S) at 153.3 miles.

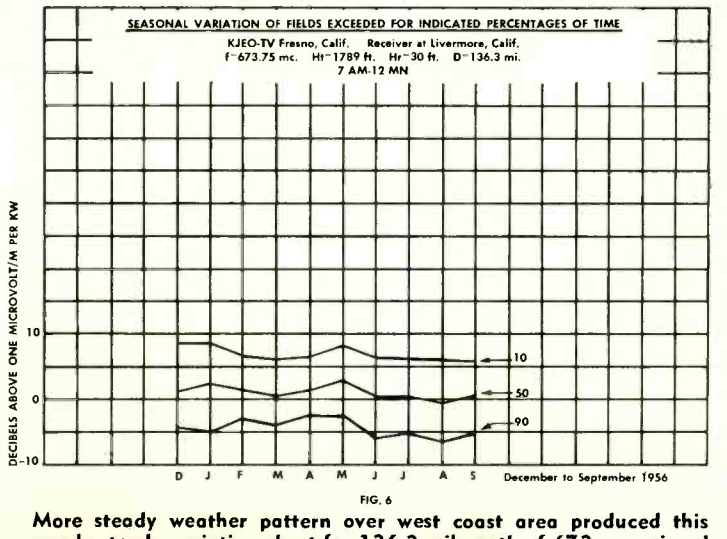

More steady weather pattern over west coast area produced this nearly steady variation chart for 136.3 mile path of 673 mcs. signal of KJEO-TV. Note apparent dip during summer months, the opposite of southeastern observations.

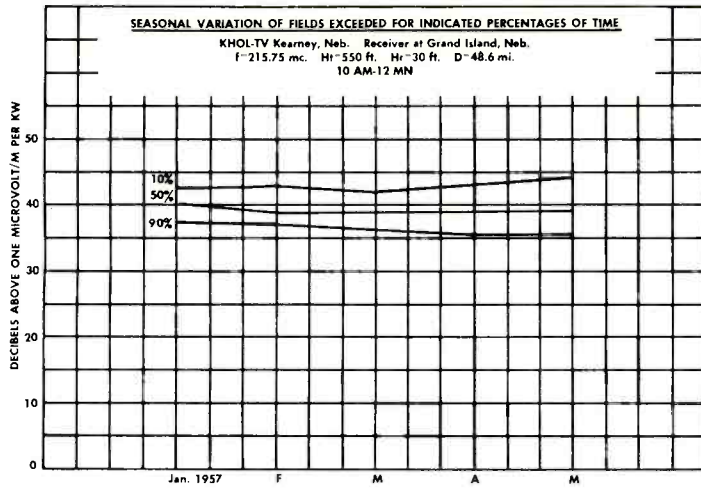

FIG. 7

Well within the Grade B coverage of KHOL on 215 mcs., this chart shows gradual increase of signal at end of observation period, in late May.

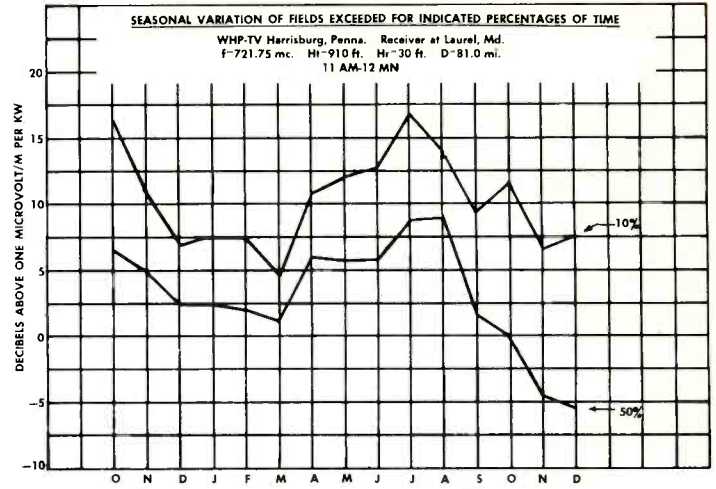

FIG. 8

Great variations in signal level mark this recording of microvolts taken at 721 mcs. with signal of WHP-TV. November through March declines seem apparent, although the summer-time higher signal level period apparently lasted well into October in 1957.

TABLE

Transmitter	Receiver	Call	Recording Period		D Distance (Miles)	f Frequency (Mc)
			From	To		
New Britain, Conn.	Millis, Mass.	WNBC-TV	8/57	2/59	84.2	571.75
Columbus, Ga.	Powder Springs, Ga.	WDAK-TV	3/54	9/56	98.2	559.75
Corpus Christi, Texas	Kingsville, Texas	KVDO-TV	5/57	8/57	38.1	523.75
Springfield, Mass.	Millis, Mass.	WHYN-TV	6/54	6/55	67.5	721.75
Lincoln, Neb.	Grand Island, Neb.	KOLN-TV	6/55	7/57	66.2	196.76
Adams, Mass.	Millis, Mass.	WCDC-TV	8/57	3/59	98.6	505.75
Salisbury, Md.	Laurel, Md.	WBOC-TV	3/55	9/56	85.4	487.75
Fresno, Calif.	Livermore, Calif.	KMJ-TV	6/55	9/56	153.3	535.75
Chattanooga, Tenn.	Powder Springs, Ga.	WTVC-TV	2/58	10/59	86.0	191.75
Kearney, Neb.	Grand Island, Neb.	KHOL-TV	11/56	7/57	48.6	215.75
South Bend, Ind.	Allegan, Mich.	WSBT-TV	6/58	5/59	69.4	523.75
Hutchinson, Kans.	Grand Island, Neb.	KTVH-TV	2/55	8/56	198.0	209.75
Scranton, Pa.	Laurel, Md.	WDAU-TV	2/59	8/60	173.0	523.74
Fresno, Calif.	Livermore, Calif.	KJEO-TV	12/55	9/56	136.3	673.75
Harrisburg, Pa.	Laurel, Md.	WHP-TV	10/57	9/58	81.0	721.75
Wilkes Barre, Pa.	Millis, Mass.	WBRE-TV	6/55	9/56	241.7	559.75
Wilkes Barre, Pa.	Laurel, Md.	WBRE-TV	3/55	7/56	150.0	559.75
Wilkes Barre, Pa.	Laurel, Md.	WILK-TV	12/55	9/56	147.8	595.75
York, Pa.	Laurel, Md.	WSBA-TV	8/53	9/55	53.8	649.75
Peoria, Ill.	Allegan, Mich.	WEEK-TV	8/54	9/56	230.8	649.76
Battle Creek, Mich	Allegan, Mich.	WBKZ-TV	1/54	3/54	42.0	775.75
Tampa, Fla.	Ft. Lauderdale, Fla.	WDAE-FM	10/55	3/56	184.6	100.7
Seattle, Wash.	Portland, Oregon	KING-FM	8/50	Continuing	144.8	98.1



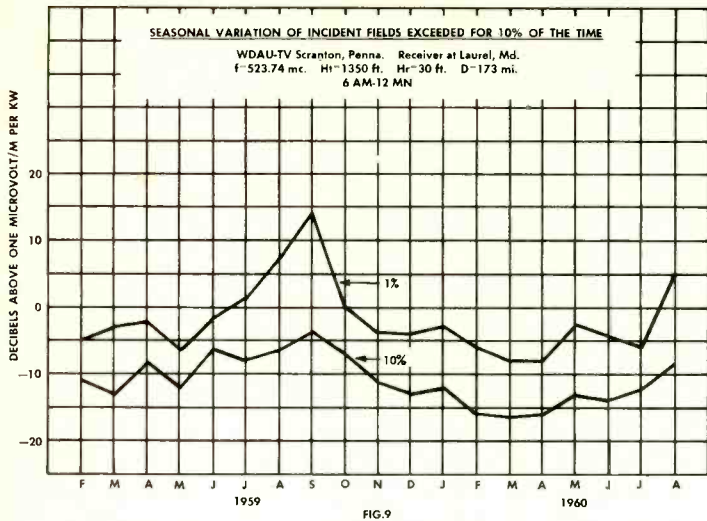

Long path reception of UHF WDAU on 523 mcs. (173 miles) shows marked impression of inversion season, which occurs normally from late June through mid September. Note peak in September 1959.

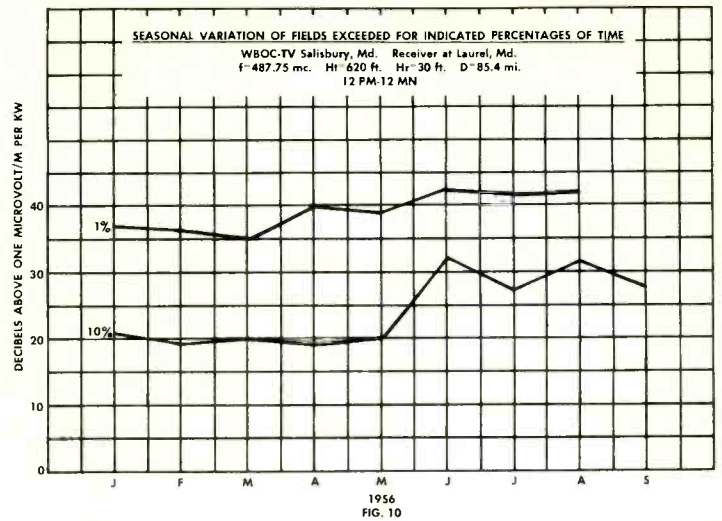

Short term variations in April 1956 stand out on the 1 percent line (top line) on this chart of 85 mile reception of WBOC-TV from FCC observation post in Salisbury, Maryland. June-July-August period shows more valid affect of long term (bottom line) signal level variation.

1

HT** Trans. Ant. (Feet)	HR Rec. Ant. (Feet)	D-DLS Miles	F 1% dbu/kw	F 10% dbu/kw	F 50% dbu/kw	F 90% dbu/kw	Hours
970	30	32.5	31.3	14.1			6AM-12MN
650	30	54.8	26.8	12.8	-4.5*		11AM-11PM
310	30	5.5	55.6	45.2	36.2		3PM-11PM
900	30	17.4	21.4	8.8	-6.5*		7AM-12MN
1000	30	13.8	45.9	35.6	26.1	18.0*	7AM-12MN
2120	30	25.9	32.5	23.1	17.2	13.1*	7AM-12MN
620	30	42.5	43.5	26.5	6.0*		12PM-12MN
2290	30	78.0	17.9	11.2	3.4		6AM-12MN
1040	30	32.8	28.8	22.5	16.5	9.5	9AM-12MN
550	30	7.8	48.1	42.8	39.0	33.6	10AM-12MN
540	30	28.8	40.3	15.5	-14.8*		8AM-12MN
810	30	150.1	7.5	-4.1	-18.3*		7PM-10PM
1350	30	113.4	-1.4	-10.6			6AM-12MN
1789	30	68.8	13.2	7.8	1.5	-4.2	7AM-12MN
910	30	30.7	23.6	12.6	5.0	-1.2*	11AM-12MN
1220	30	184.6	-10.0*				7AM-12MN
1220	30	92.9	8.6	-4.0	-18.2*		7AM-12MN
1095	30	93.4	4.5	-4.1	-14.3*		11AM-12MN
550	30	13.0	31.2	12.5	-10.5*		8AM-11PM
550	30	190.0	-11.8*				7AM-12PM
335	30	8.4	31.0	25.4	20.7		3PM-11PM
391	30			9.2	3.1	-4.9	7PM-10PM
410	30						

\*\* Average 2-10 mile height

\* Extrapolated



# OUR MAN IN EUROPE

**Gordon J. King**  
Assoc. Brit. I.R.E.  
Brixham, Devon, England

## EDITOR'S NOTE:

Horizons Publications considers this exciting new monthly column by Mr. King one of the outstanding examples of our ocean-spanning industry, "off-the-air video reception." In his early columns Mr. King will endeavor to bring the reader up-to-date on the basic Communal Aerial concept as practiced in Europe. In later columns he will begin to discuss legislative and regional problems found in Coaxial Relay Circuits in Great Britain. Mr. King will also endeavor to keep us informed of new products and circuitry as develops from time to time in his portion of the world.

As your European CATV reporter, I shall be bringing to you each month news of CATV activities over this side of the world. It will be my very pleasant task to reflect into these pages the state of the art in terms of the latest equipment, existing and new networks, operational problems and solutions and, in general, how we do it over here.

As a start it would not be amiss to introduce myself. Like most of you, I have been keenly connected with "piped television"—as it is often called over here—for many years. I engineered my first system way back in 1952, when there was not too much known about the practical side of coaxial distribution in my country.

From then on the "relay" bug really got me. I became involved with one of the largest networks in the U-K, that at Oxford. This well-known city has a population well in excess of 100,000, and the contract was to wire not only the whole of the city but also outlying areas, adding at least a further 50,000

population. We had problems, and problems still exist. These and their solutions I shall deal with later.

I next moved on to South West regions, namely Paignton in Devon and assisted in the launching of a system for 30,000 population. Likewise at Brixham, a little further round the coast, with 10,000 population. I have now established my headquarters at Brixham, and operate under the trade name RELAY TECHNIQUES. Here at Brixham we not only deal with system launching and engineering problems, but we also evolve new designs for relay equipment and improved methods for distribution.

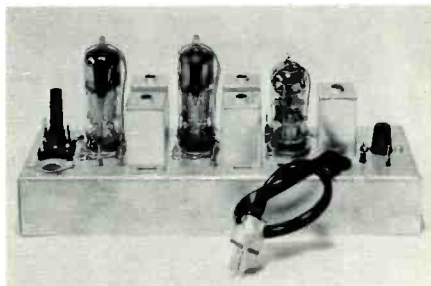

**A Band 1 Repeater Strip, marketed by View-line (Sales) Limited of Paignton. This is Band 1 wide and has a rising response over about 6 db for equalisation.**

## Basic Systems

Coaxial relay over here is relatively new. The original relays, which were in action before the war, were for sound-only distribution. Here a conductor circuit was required for each programme distributed. Large audio power amplifiers were set up at van tage points and the audio was distributed at fairly high level to each household. Each subscriber on the system had a loudspeaker "terminal unit" connected to the lines through a step-

down matching transformer and "programme selector switch."

Pioneers in that specific field are the well-known firms of Rediffuson and British Relay Wireless. Even before the war steps were taken to launch video on the already existing audio pairs, and several so-called "slave systems" were evolved, whereby most of the television set was at the sending end and each subscriber had a relatively inexpensive "display unit", the accompanying sound being taken care of by the audio part of the system.

Although the idea was good, and was pioneered quite a lot by EMI, it did not catch on. Rediffuson and BRW, however, undertook extensive developments on their own audio systems to provide for TV distribution. The video was modulated onto a relatively low-frequency carrier (3.7 to 12.0 Mcs. approximately) and introduced along with the audio on pairs of conductors. Special receiving units were produced which responded to the low-frequency video-modulator carrier, and ultimately several picture programmes were made available by multi-conductor cables and a system of switching at the receiving units—again, the sound being accommodated by the existing audio set-up.

Such systems are in use still today, giving a multiplicity of sound and vision programmes to connected subscribers. New systems of that nature are being erected, but in the main development is more and more towards coaxial relay.

Coaxial relay started essentially as communal aerial or, so-called, shared aerial and flat systems. This happened in earnest about ten years ago, and

(Continued on page 10)

## COVER STORY

This month's Television Horizons inaugurates regular reports from Gordon J. King, "Our Man in Europe" for CATV and MATV. Cover photo is two European repeater amplifier strips and their associated power supplies, minus outside case.



## DEPARTMENT JJ

In line with our editorial, appearing in the November issue of Television Horizons, we are inaugurating this new section of "free—no charge" classified listings, utilizing TVH assigned box numbers, for individuals seeking job placement or employees in the CATV-MATV field. All replies are held confidential, forwarded directly to the holder of the box number. Respondents should address inquiries to **Department JJ, Box X, (fill in number), Television Horizons Magazine, Post Office Box 1557, Oklahoma City, Okla.**

If you wish to use this free service of TVH to seek job advancement, or employees, direct your no-charge listings in care of Dept. JJ at TVH, Oklahoma City.

**ELECTRONICS TECHNICIANS—MATV systems.** The continuing expansion of this medium sized eastern CATV-MATV manufacturer has created a new growth position for a Technician experienced in the engineering layout and/or installation of master antenna systems. We prefer a person who has had additional background in the field of closed circuit television. Good starting salary and liberal company benefits, including college tuition payment plan. Write in confidence to Box 1.

**AVAILABLE—**Good man, capable of all phases of CATV, construction, technical, office management. Twelve years Bell System, FCC license. Microwave planning, installation, and maintenance. Cost conscious, dependable, needs no supervision. Write in confidence to Box 2.

**POSITION WANTED—**Cable TV technician with seven years experience wishes position with growing company. Experience includes installation, new construction, maintenance and alignment of broad-band amplifiers. Prefer position with opportunity to handle bench and learn microwave. Reply to Box 5.

### SPECIAL ANNOUNCEMENT

The February issue of Television Horizons, which may be reaching you a few days earlier than normal if you live in the mid-west and east (we will be mailing from our new Editorial Offices in Oklahoma City) will carry these special reports of vital interest to your TV operation.

- **Status Report — A Tunnel Diode Amplifier for UHF-TV**  
by Alfred Graydon  
Micro State Electronics Corp.
- **G-Line Transmission System for Remote Antenna Sites**  
A Report on Experimental Work by Engineers Archie Taylor and George Frese
- **Intec Service Bench**  
First of a series from Intercontinental Electronics Corporation—all about the ABB-9 and ABB-10 transistorized amps.

Servicemen everywhere say,  
**"OUTPERFORMS THEM ALL!"**

## NEW TRANSISTOR **JERROLD® POWERMATE**

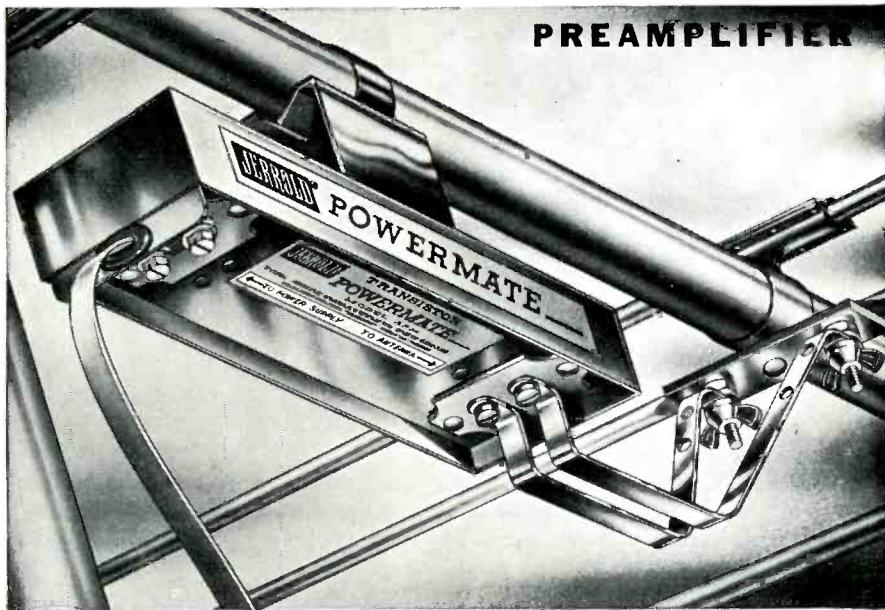

### offers highest gain, lowest noise figure

Here's the preamplifier for every TV antenna in your area, whether new or up for years! The exclusive universal bracket of the new JERROLD Transistor POWERMATE permits mounting directly on the antenna boom (for greatest boost before downlead losses) or at any other point—along the mast, on the wall or windowsill, behind the set—anywhere your best judgment dictates.

And look at this gain: An average of 13.9db at Channel 13 and 18.25db at Channel 2—by far the highest in the business! This remarkable gain gives any antenna system the lowest System Noise Figure obtainable—the key to better pictures.

See your distributor today, or write for special bulletin describing System Noise Figure.

*Only \$39.95 list, complete with power supply*

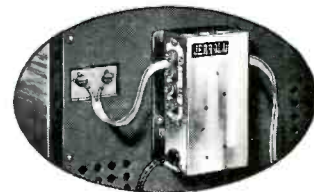
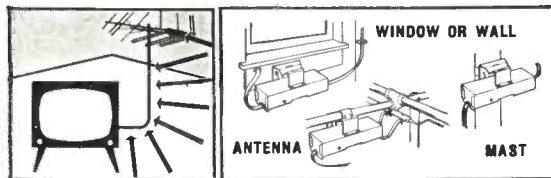

#### NO TUBES, NO BATTERIES, NO OSCILLATION, NO FEEDBACK

Mount it on the boom or anywhere along the downlead. Thoroughly neutralized against oscillation; output impedance balanced to prevent radiation back to antenna. Same 300-ohm lead that carries signal also carries 15 volts ac to POWERMATE. No tubes or batteries to replace.

#### REMOTE AC POWER SUPPLY OPERATES 1OR 2 TV OR FM SETS

Installs on or near receiver, draws less current than an electric clock. No polarity problems when attaching to lead, no danger of transistor damage.

**JERROLD® ELECTRONICS CORPORATION**  
Distributor Sales Division, Dept. IDS-205.  
The Jerrold Building, Philadelphia 32, Pa.

Jerrold Electronics (Canada) Ltd., Toronto, Ontario  
Export Representative: CBS International, New York 22, N.Y.

AMERICA'S LEADING MANUFACTURER OF TV-FM RECEPTION AIDS AND MASTER-ANTENNA-SYSTEM PRODUCTS  
TELEVISION HORIZONS — THE VOICE OF THE INDUSTRY 9

since then there has been speedy and progressive development. In the early days of coaxial relay there was only one television programme, and problems were few. It was then simply a matter of erecting a good aerial, connecting that to a good amplifier and feeding the output of the amplifier to the required number of outlets through suitable resistive pads.

Extension was possible by adding more amplifiers and more outlets, and provided a reasonable match was maintained throughout the coaxial system, quite good pictures were possible after four or five amplifiers.

### Programme Multiplicity

Coaxial relay caught on. Television dealers liked it because it allowed the use of ordinary "off-air" receivers; town councils liked it because it showed a promise of clearing the skyline of the mushroom growth of aerials; and viewers liked it because it gave them good quality, interference-free reception of the alternative programmes which were then coming on the air.

At the present time there are only two television bands operational in the U-K; Band I from about 40 to 70 mcs., containing five channels, and Band III from about 175 to 215 mcs., containing eight channels, with only seven operational. Band I is used exclusively by the BBC, and almost all of the country is covered by primary and secondary transmitters on a channel sharing basis. Band III is used exclusively by the ITA (Independent Television Authority), also using primary and secondary transmitters on a channel sharing basis.

On both services the major areas of the country are embraced by high-power stations, while the fringe areas are filled up by smaller stations and translators. Even so, there are still many locally shielded areas where reception is very poor, and it is into such areas where the signal is being piped by coaxial. Already the co-channel interference problem is severe, so it is unlikely that the smaller cut-off zones will be fed off-air on the existing bands. This may happen when UHF gets underway, depending on channel availability and keeping in mind the concentrated nature of the country.

### System Techniques

With coaxial relay rapidly expanding outside the bounds of shared aerial systems and being called upon to handle several television and sound programmes, a diversity of system techniques were established, but these have since been resolved to two basic arrangements.

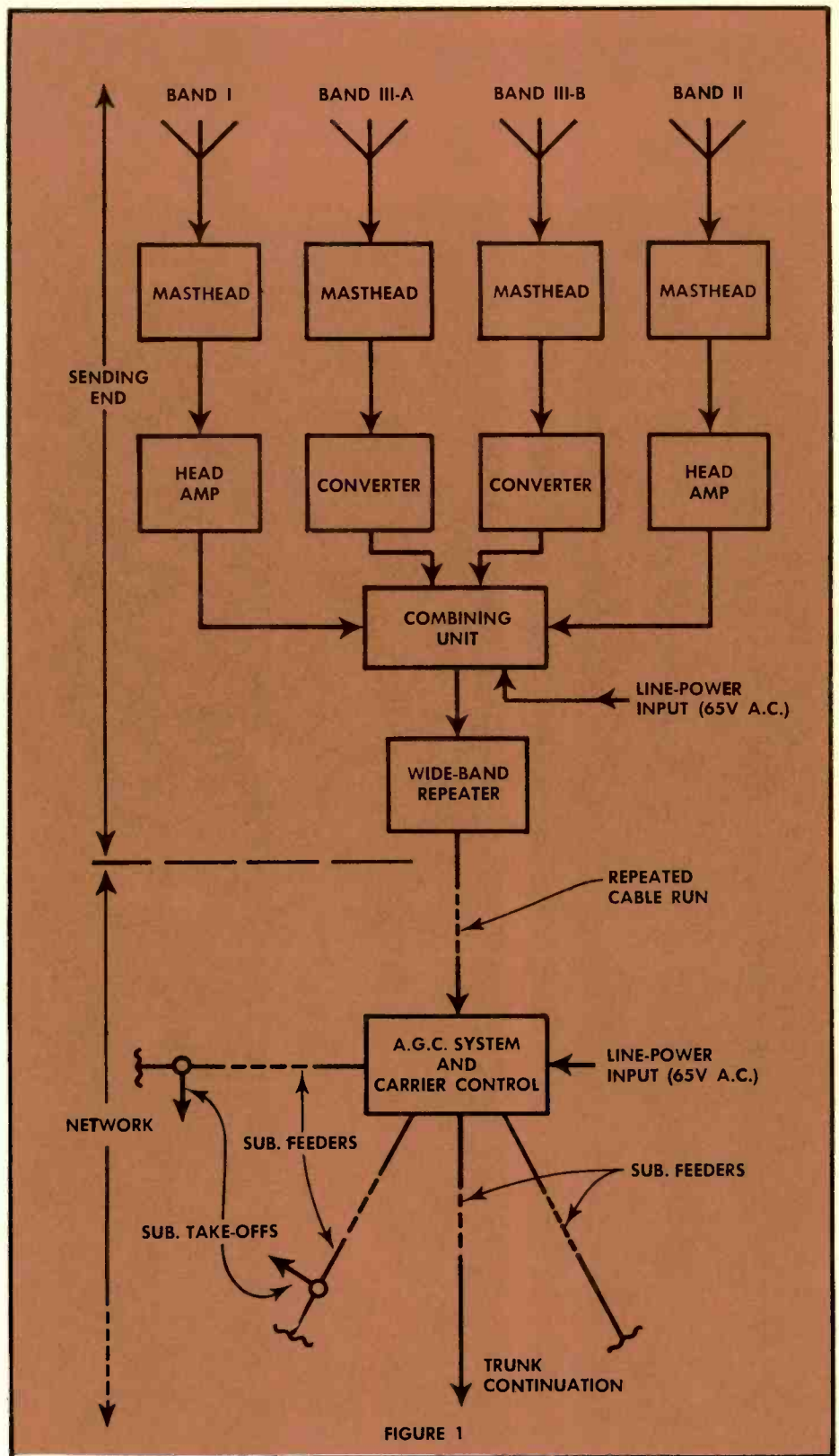

FIGURE 1 — Basic system layout as described in report.

The most popular is to distribute all television programmes in Band I and all sound-only programmes in Band II, the latter being known as the VHF-FM band, extending from around 85 mcs. to 95 mcs., and which is used to carry three off-air frequency-modulated programmes of the BBC. At the head end,

the Band III programmes are converted to an unused Band I channel, and all television programmes are then put into the system which is made responsive to the whole of Band I and the whole of Band II.

This is accomplished in two ways: one by the use of a "two-strip" re-



peater system, with one strip being wide over Band I and the other being wide over Band II, signal splitting and combining taking place at the input and output of each repeater system on the network; or two, by the use of a "distributed load" repeater system, covering from about 40 mcs. to 100 mcs. in a single swoop.

The second basic arrangement, and one which is used extensively in your areas, uses an ultra wideband repeater covering from about 40 mcs. (or below) to 200 plus mcs. This opens-up the network for neat distribution at carrier frequencies in Bands I, II and III, though in some cases it is still necessary to undertake channel conversion at the sending end. There are two reasons for that, which I shall deal with in subsequent reports, but fun-

damentally one is tied up with the adjacent channel selectivity of commercial receivers and the other with radiation.

Interposed at intervals in the "repeated" cable system are a.g.c. (automatic gain control) systems. These in some instances separate all the sound and vision signals, correct their responses, amplify them, introduce a.g.c. and re-combine them to line. Over extended cable systems such control has been found essential, firstly to iron-out network attenuation variations caused by temperature change, and secondly to provide for individual balancing of the multiplicity of carriers after a certain run of repeaters. A.g.c. systems also serve as feeder distribution points along an extended cable system.

Most repeaters to date embody tubes

as distinct from transistors, though there are one or two firms introducing transistorized equipment. Even with tube repeaters, power for operating them is often fed along the coaxial along with the signals. The power is around 65 volts a.c., and is introduced either at a.g.c. systems or at suitable points in the network.

In the main, subscribers are fed from the feeder cables through "resistive" take-offs. Reactive and transformer arrangements are not very popular over here, though work is in hand in my organization on the development of a miniature, wideband transformer take-off, embodying the latest ferrite materials. Most systems are engineered to provide subscribers with around 1 mV of vision and 0.5 mV of sound. (Continued on page 28)

**GUARANTEED FM AND  
FM STEREO RECEPTION  
FROM 200 MILES!**

# Winegard STEREO-TRON

World's Most Powerful FM Antenna!

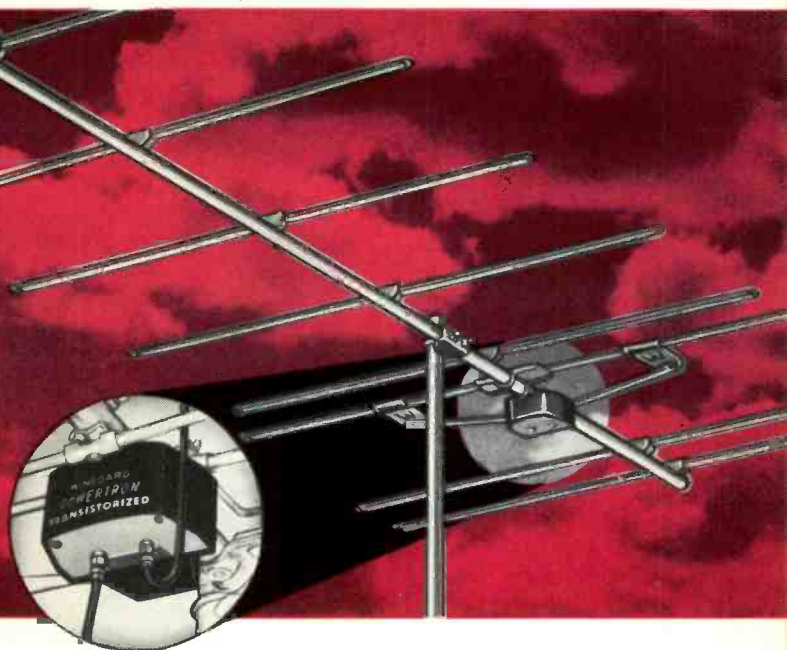

**NEW ELECTRONIC FM ANTENNA FOR LONG DISTANCE FM AND STEREO!** Now Winegard Guarantees unexcelled FM performance with the new Winegard electronic Stereo-Tron. Actually **GUARANTEES** your customer will receive 85% of all FM stations in a 200 miles radius over normal terrain with a rotor. Built in transistor amplifies signals, really gets L-O-N-G distance reception. Opens a new field of opportunity in the fast growing FM and FM stereo market.

**MODEL PF-8 FM STEREO-TRON YAGI—Gold Anodized!** This is the world's most powerful FM antenna. Because Multiplex requires an antenna with greater sensitivity and gain to offset the power loss of the carrier and subcarrier, Winegard's PF-8 is the best antenna you can install for Multiplex. When you hook up a PF-8, weak signals come in like "locals." Recommended for use where signals are under 10,000 microvolts. For strong signal areas, same antenna without amplifier, Model FM-8, is recommended.

The PF-8 has a minimum gain of 26 DB over a folded dipole with a flat frequency response of  $\pm 1/4$  DB from 88 to 108 m.c. It features a built-in TV-FM coupler and has eight elements with **EXCLUSIVE "TAPERED T"** driven element engineered

to perfectly match the powerful transistor, direct coupled, built-in amplifier. It is available two ways—Model PF-8 for 300 ohm twin lead or Model PF-8C for 75 ohm coax.

#### Important Features of Winegard Electronic FM Antennas

1. Transistor amplifier is designed as part of the "Tapered T" driven element (model PF-8) for unprecedented efficiency and signal-to-noise ratio.
2. At no extra charge, built-in FM-TV coupler allows you to use one power supply and down lead when used with a WINEGARD POWERTRON TV antenna.
3. Beautiful gold anodized permanent finish—100% corrosion proofed—all hardware irridized. This is the finest finish of any antenna—has richest appearance—meets U.S. Navy specifications.
4. The quality of craftsmanship and fine materials in these antennas tell their own story—perfect mechanical balance—100 m.p.h. wind tested.

Winegard makes a complete line of FM antennas. Write for information and spec. sheets. Also get **FREE**, Station Log and FM map of U.S.

**MODEL PF-4 FM ELECTRONIC TURNSTILE Gold Anodized!** Non-directional FM antenna with 16 DB gain in all directions over a folded dipole. Has Winegard offset mount and transistor amplifier with TV-FM coupler. Also available without amplifier, Model FM-3T.



# Winegard

**ANTENNA SYSTEMS**

3011-1D Kirkwood Avenue, Burlington, Iowa

## Two New Low Noise Units

Of prime news value to the UHF television industry this month are a pair of announcements concerning UHF low noise amplifiers which are in the laboratory stage of production. In the past all Ultra High Frequency amplifying equipment utilized in the TV band has been of tube design, or adapted from solid state military equipment. Now, however, two firms are making real headway with units which promise to create major noise figure breakthroughs shortly after the first of February. Micro-Mega Corporation is planning a series of parametric amplifier tests in Arizona as this is written (see separate story on page 1).

But of perhaps even more significant importance is word from Philco that their Coaxial Transistor type T-2351 is now priced down to \$60.00. This coaxially encapsulated unit is under actual circuit development by a west coast Philco laboratory (sorry — we promised to keep mum a bit longer as to who and where) as a mast mounted tuneable preamplifier to cover the entire UHF television band. While the \$60.00 transistor price tag is still a bit stiff, Philco people told Television Horizons the price would catapult downward as soon as a demand is created for the transistor. At the present time production of the unit is in small quantities. One west coast industrial electronics wholesale house took delivery on ten of the units December 4, so shipment and availability is underway.

Television Horizons has been promised first crack at a story when the mock-up amplifier is completed, and complete circuit information will be available in these pages, if all goes well. The unit will be tested in Northern California at an existing UHF translator site, and later in central California where a number of UHF off-the-air signals are available.

(Editor's note: For further information on what the FCC was told about coaxial transistors and their possible application to UHF television, see the May 1961 issue of Television Horizons).

## EIMAC Pledges Hi-Power UHF-TV Support

Eitel-McCullough, Inc., San Carlos, California, one of the world's leading manufacturers of electron power tubes, has endorsed the FCC's policies to promote and spread the usefulness of UHF television as a "sane and sound program." The California firm has announced "a major engineering pro-

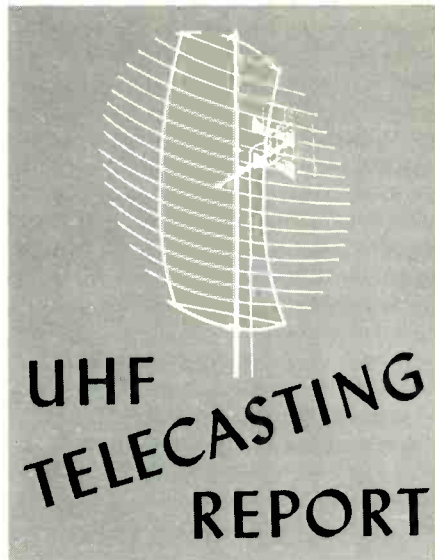

gram to apply the fruits of its military tube developments to remove some of the technical barriers to UHF-TV growth."

EIMAC heralded the Commission's fight to save UHF with an announcement that in its opinion, "Television allocations is one of the government's toughest problems. We feel the Commission is sanely and sensibly serving its responsibility to conserve the electro-magnetic spectrum in the best interest of the public, and is heading toward a new high level of responsible service."

EIMAC said its power klystron, "refined over more than ten years of development for worldwide military UHF communications and in European UHF-TV can give needed improvement to UHF television in the United States." The company said its engineering program has already produced klystrons for power outputs from 12½ to 50 kilowatts, and that it is ready to quote (prices on) klystrons of the same simplicity, reliability, efficiency and clean performance at power levels up to 250 kilowatts.

The announcement by EIMAC caught some of the established television equipment and tube manufacturers (General Electric, RCA, etc.) holding the bag. EIMAC has admitted to no interest to build complete high power UHF transmitters, and until some firm comes along willing to use their super power units in improved UHF-TV service, the offer of the company wags the engineering finger at the entire industry.

## JFK Gets Word on UHF

President Kennedy's Special Science Adviser, Dr. Jerome B. Weisner, has allied himself with the UHF-TV advocates in a way that leaves little doubt

he will recommend an all UHF system to the President whenever he has the opportunity.

In his remarks to the press, Dr. Weisner made his position on the UHF question very clear. He noted "I am not advocating anything. TV is a minor problem for me; I have others that are much more important."

However on the question of UHF, he did state that in his own opinion, should the New York City UHF test prove this medium feasible, he would recommend a complete re-evaluation of the spectrum between 25 and 890 megacycles.

He noted that major engineering and technology breakthroughs in the past two decades would appear to completely outdate the frequency allocations made shortly after the Second World War (these allocations established the 12 channel VHF system). He noted that the addition of UHF channels (70 in all) was done as a "stop-gap measure" without suitable thought to the future of the entire VHF-UHF field.

Dr. Weisner further defined his position by noting his feelings on UHF. (A) "The ultra high spectrum would appear to be the best hope for providing more stations in more communities, than the present 12 channel VHF system does.

(B) "TV can be made to work, and work well, on the UHF TV bands. This may require an extensive industry sponsored research and development program. He broke down his prime areas of R and D concern into:

- (1) Higher power transmitting tubes;
- (2) more sophisticated circuitry, such as employed in communications equipment in the 450-470 mcs. band;
- (3) high gain, directional antenna systems and
- (4) improved receiver design.

Dr. Weisner brought to the White House Science Advisory Board his many years of experience as Director of the Massachusetts Institute of Technology Electronics Research Lab.

He pointed out that should an all UHF system be put into effect, a transition or changeover period would definitely be in order.

Dr. Weisner noted that if such a move to UHF were to be made, a complete re-vamping of the basic technical factors in television transmission should also be incorporated in the move. He stressed the need for a complete color transmission medium, and improved higher definition pictures, apparently modeled after either the European 625 line system, or the French 819 line system.



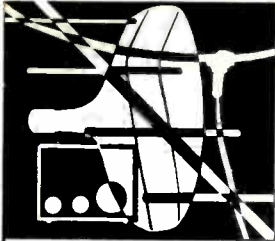

# Product SHOW CASE

Manufacturers of CATV, MATV, fringe TV, closed circuit TV and broadcast TV equipment are invited to submit product news releases to this column. Address all mailings to "New Products, Dept. C, Television Horizons, P. O. Box 1557, Oklahoma City 1, Okla."

ADLER • AMECO • AMPEREX • ARF • BENCO • BLONDER TONGUE • CAS • CECO • CHANNEL MASTER • COLLINS • COLUMBIA WIRE • CONRAC • CRAFTSMAN • DAGE • DYNAIR • EITEL • ELECTRON • EMCEE • ENTRON • FOTO-VIDEO • HOLT • INTEC • JAMPRO • JERROLD • KTV • MARS • MASTER VIDEO • MIRATEL • RCA • ROHN • SITCO • SKL • SUPERIOR CABLE • TACO • TELSON • TIMES WIRE-CABLE • TPT • VISUAL ELECTRONICS • WINEGARD

## Jerrold's New Audio-Trol

Jerrold has announced a new modulator which can replace an entire audio distribution system for hotels, motels or institutional use. Introduced by the company's Distributor Sales Division, the Audio-Trol (Model AT) lists for \$325.00. The unit provides for adding AM, FM, background music or public announcements to any TV distribution system. The unit eliminates the need for additional audio system equipment and installation by utilizing unused television channels of a standard TV receiver for audio reception.

The source feeding the equipment may be an FM tuner, an AM radio, Muzak, records, tape or microphone. Audio programming is piped from the head-end of the TV distribution system, where the Audio-Trol is installed, to any room or receiver location.

The new unit can feed five separate channels of audio, even in seven channel TV areas. Cross modulation will not occur between adjacent channels. The channel conversion is achieved by providing a crystal-controlled video carrier and FM sound carrier. The latter is held to precisely 4.5 mcs. separation from the video carrier. The Audio-Trol is designed for rack mounting, and it operates from 115 vac, 60 cycles.

## New INTEC Data Sheets

A new data sheet describing the INTEC model CV-1 VHF to VHF converter has been released by Intercontinental Electronics Corporation, 300 Shames Drive, Westbury, L.I., New York. Featuring signal gain at all conversions and low noise operation, the INTEC CV-1 converter is a crystal controlled unit. It includes a built-in power supply and matched input and output circuits.

## New CECO Bulletin

CECO (Community Engineering Corporation, State College, Pennsylvania) has released a new descriptive

brochure covering the firm's compact single channel "PRV" ultra-low noise preamplifier units. The units are available for any VHF channel, 2-13. The data sheets are available from the company.

## New Cut-Channel Powertron Yagis

The Winegard Company, Burlington, Iowa has announced a new line of fifteen cut-to-channel electronic Powertron antennas featuring transistorized amplifiers as an integral part of each antenna.

The Powertrons have a manufacturer's quoted gain of "28 db per channel with lowest possible signal-to-noise ratio." In the new line of antennas are six eight-element cut channel and broad band low band models, and eight twelve-element cut channel and broad band high band models, plus two FM amplified yagis.



Power consumption of each transistorized amplifier-yagi is .05 watts, and eight such antennas may be powered from a single power supply through a common down-lead.

All Powertron cut channel yagis have a permanent gold anodized finish and are designed for 75 ohm coaxial feed.

Winegard notes the new antennas are ideal for farm and home use, motel and hotel systems, and apartment buildings.

Winegard also announces a new line of Electronic FM antennas for fringe FM and stereo FM. Winegard guarantees the new Stereo-Tron Yagi will pick up eighty-five percent of all FM stations in a 200 mile radius from any location, over normal terrain.

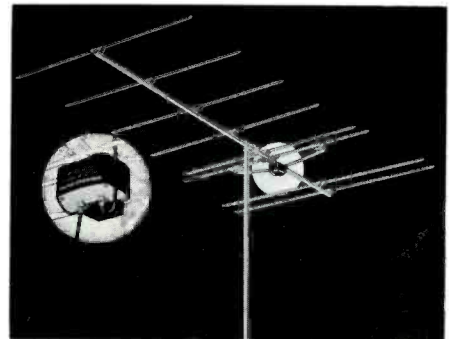

The PF-8 Stereo-Tron Yagi is gold anodized and has a minimum gain of 26 db over a folded dipole. The frequency response is flat within 1/4 db over the frequency range of 88 to 108 mcs. The unit is available in two models; Model PF-8 for 300 ohm twin lead or Model PF-8C for 75 ohm coax. Both models can be used with one power supply and down lead when used with a Winegard Powertron TV antenna installation.

## PROPOSAL FOR SHIFTING CHANNEL TO INDIANAPOLIS

By Notice of Proposed Rule Making, the Commission invites comments to a proposal by Sarkes Tarzian, Inc. (WTTV, Channel 4), Bloomington, Ind., to shift that channel to Indianapolis; also to determine whether more than three VHF commercial services are needed in the Indianapolis-Bloomington area and whether it would better serve the public interest and enable more effective use of VHF assignments in this area to reserve one of them for educational use. It deferred action upon Tarzian's request for issuance of an order to show cause why the authorization for WTTV should not be modified to specify operation on Channel 4 in Indianapolis instead of Bloomington, and denied its request for extension of time to reply to opposition pleading of WIBC, Inc. Commissioner Lee concurred in result.



# ACTUAL PHOTOS OF TV PICTURES RECEIVED UP TO 248 MILES AWAY

## PULLED IN BY A *Winegard* SUPER POWERTRON TV ANTENNA

We can't guarantee that everyone will get results like this but long distance reception performance is not unusual for the world's most powerful TV antenna.

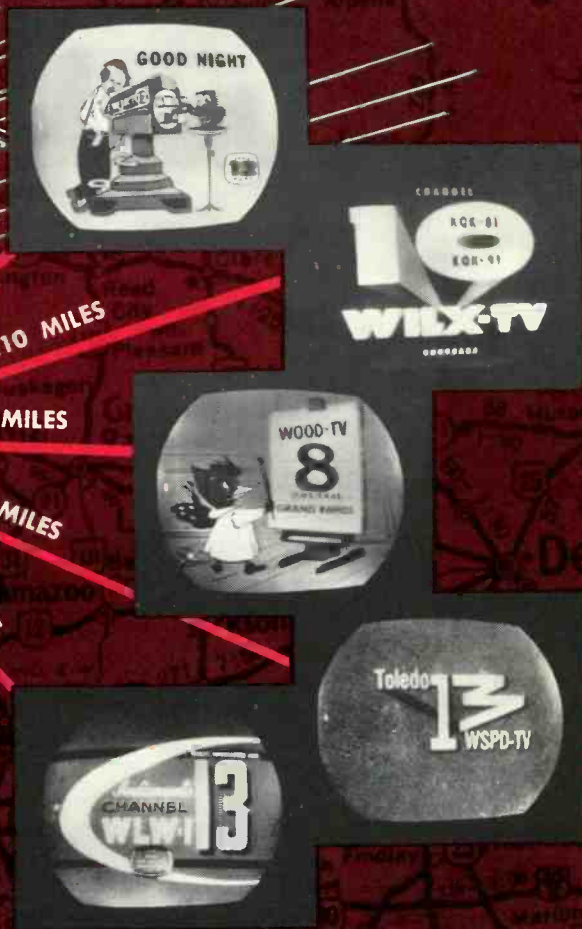

### Why the Winegard Super Powertron is the Most Effective Antenna Ever Designed—

 **IT CAPTURES MORE SIGNAL** than any other all-channel antenna ever made. Patented design, electro-lens director system, dual "TAPERED T" driven elements, 30 precision-tuned elements in all.

 **IT ELIMINATES ALL SIGNAL LOSS** that normally occurs between the driven element and the amplifier due to transmission and coupling mis-match.

 **IT'S THE ONLY TRUE ELECTRONIC ANTENNA.** Only the Winegard Powertron is built with the amplifier as part of the driven element—not an "add-on" attachment.

 **IT BOOSTS WEAK SIGNALS UP OUT OF THE SNOW** far better than any other antenna or antenna-amplifier combination made.

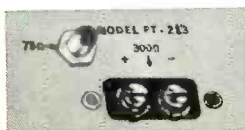

ONLY POWERTRON HAS BOTH 300 OHM TWIN LEAD AND 75 OHM COAX TERMINALS ON BUILT-IN AMPLIFIER.

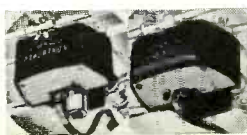

ONLY POWERTRON GIVES YOU YOUR CHOICE OF TRANSISTORS OR TUBES (TUBE MODELS 300 OHM ONLY).



ONLY POWERTRON HAS RANGE AND POLARITY CONTROL SWITCH TO PREVENT OVERDRIVING ON STRONG CHANNELS.



ONLY POWERTRON HAS AC PLUG-IN OUTLET FOR TV SET BUILT INTO THE POWER SUPPLY.

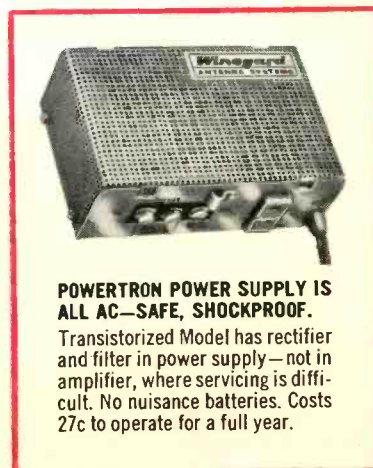

**POWERTRON POWER SUPPLY IS ALL AC—SAFE, SHOCKPROOF.** Transistorized Model has rectifier and filter in power supply—not in amplifier, where servicing is difficult. No nuisance batteries. Costs 27c to operate for a full year.



# Read what Charles J. Milton of Moyer TV, Milwaukee, has to say about the Winegard Super Powertron...

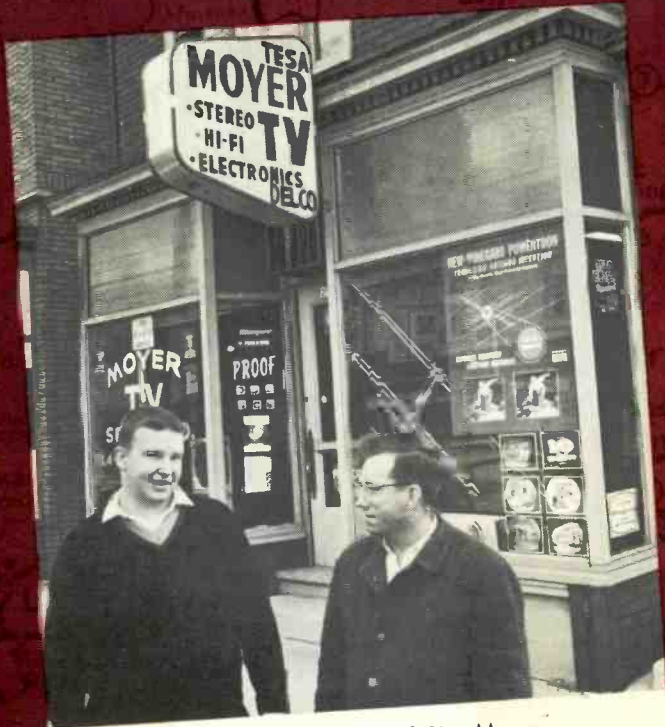

Charles Milton and Jim Moyer  
In front of Moyer TV

Of course, everyone can't get reception results like Charles Milton has experienced. Each area has its own unique reception characteristics and problems. But one thing we can promise, the Powertron will deliver more clean pictures on your TV screen than any antenna you can own.



**MOYER TV & RADIO SERVICE**  
3111 W. NORTH AVE. 2913 W. NORTH AVE.  
TESA-MILW. MILWAUKEE 8, WIS. Hilltop 4-0740

Winegard Company  
3000 Kirkwood  
Burlington, Iowa

Gentlemen:

I would like to thank the Winegard Company for building the Super Powertron SP-44X.

With this antenna, reception at the local station level is perfect in both black and white and color. At medium range, the Powertron outperforms all others. Channel nine from Chicago, about 90 air miles, comes in clear and regularly. This is the Cubs baseball station and the one Milwaukeeans are willing to pay big money to get.

When the "Big Winegard", as it is affectionately called around the shop, is on long range it probes the unknown alone. All other antennas have fallen far behind. I have picked up eleven stations over 100 air miles away. The farthest of these is WWJ, Channel Four, Detroit, an unbelievable 251 miles. I have included a few pictures that I took off the TV with a Rolliflex F 3.5 at one second using Verichrome Pan.

We use the pictures in a window display and I use a set of pictures to explain the advantages of a Winegard to prospective customers. Believe me the pictures work -- and so does the "Big Winegard."

Sincerely,

*Charles J. Milton*

**POWERTRON IS 100%  
CORROSION-PROOFED  
ANTENNA IS GOLD ANODIZED,  
ALL HARDWARE IMPR DIZED,  
AMPLIFIER HOUSING OF HIGH  
IMPACT POLYSTYRENE.**

## PHOTOGRAPH YOUR OWN TV STATION PICTURES AND SEND THEM IN!

If you own a Powertron, chances are you too are experiencing unusual results. Why not photograph the stations you receive and send them in to us. We are always interested in hearing from Winegard antenna dealers and owners. We will be glad to enlarge your camera shots so that you can make your own window or store display like Moyer TV has done. The photos make

great sales persuaders to prospects and can be used in many ways to sell more Powertrons.

If you have never tried a Winegard Electronic Powertron, give it a test and be agreeably surprised. Don't take our word for it—let your eyes and ears and field strength meter tell the story. For full details and spec sheets, ask your distributor or write.

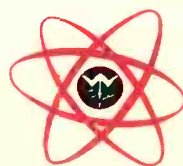

**Winegard**  
ANTENNA SYSTEMS

Winegard Co., 3011-1A Kirkwood St., Burlington, Iowa

Of Special CATV Interest. . .

## AN EDITORIAL CHALLENGE FROM TVH

The nation's CATV systems are grasping for recognition as public servants. CATV operators fear government regulation like the plague, as well they might.

To demonstrate that they do not need "the government stamp of approval," they have, in recent months, jumped upon the Educational TV bandwagon. A number of systems have "offered" to add ETV programming from existing ETV stations to their systems hoping, apparently, that this will show that they have the public interest at heart during a period of our history when everything bad is blamed on lack of educational awareness.

The NCTA has further offered the microwave relay circuits of its members to the "cause of civil defense" in case of national or regional emergency, again hoping that by so doing they will demonstrate an acute desire to be "good guys."

All of these efforts are superficial and not one is likely to sway Washington legislators who have the massive power of the nation's broadcasting interests on their backs, demanding CATV legislation.

Something remains to be done. Something must be done. We would like to suggest that something take the form of an industry-wide committee which would investigate an alliance between the nation's ETV network and the nation's CATV systems. All ETV programs are on kinescope. All such programs are made available to ETV stations at little or no cost. For the cost of transportation and possible duplicate kinescopes the nation's CATV systems could obtain enough ETV programming, properly balanced, to fill an entire day of ETV programming on a system channel. By making the programming, designed for both in-class instruction and in-home enlightenment available to the system viewers, the CATV system operators would indemnify themselves quickly with the educators of their served regions in such a way that no power on earth (not even Washington legislators) could force legislation passage. An industry wide

board, operating out of the NCTA office in Washington, could select the best programs for the appropriate daytime and nighttime programming hours. School officials would jump at the chance to bring these top flight ETV programs to their students. And school drops could easily be arranged on either a "system donation" or "per-cost" basis.

We believe that school officials, once made aware that the CATV system itself was footing the bill for the origination equipment, would be eager to go to bat with their school district officials to obtain funds needed to pay for the cable costs and at least meet the CATV operator half-way.

The entire nation is education conscious. FCC Commissioners such as Lee are exceedingly concerned for ETV, and nothing would make a bigger hit with them than a program such as we are outlining.

CATV systems are, as a rule, located in towns well out of range of ETV stations, and extremely conscious of their "out-back" locales. Bringing the youngsters (and oldsters) of these towns the very finest in ETV programming, on an industry wide basis, would do more for CATV goodwill in these areas than anything conceived to date.

Finally, the advantages of installing CCTV equipment on the CATV system should be obvious. As a long term investment, it will make your CATV system worth a great deal more on two fronts. Public goodwill will rise by an incalculable amount, and, the future addition of local-live programming featuring local personalities and events will seem just that much closer.

Such an ambitious program as we outline here cannot be undertaken by only a handful of systems. It will require the very best minds our industry has to offer. But in the years ahead it could well prove to be the most significant decision ever passed upon by this nation's CATV operators.

R. B. "Bob" Cooper, Jr.

Publisher—Horizons Publications

## THE MICROWAVE QUESTION AND CATV

- A SPECIAL REPORT -

One year ago the FCC announced the new availability of microwave frequencies above 10,700 megacycles in the Business Radio Service. While this announcement was only a small portion of a major re-apportionment of all frequencies above 890 mcs., it was particularly interesting to CATV operators who were utilizing microwave frequencies for relay between remote antenna sites and drop areas. The FCC Docket which concerned the new look for frequencies above 890 mcs. stipulated that present day users of 6 kmc. microwave frequencies (i.e., Common Carriers) would eventually have to be moved to the 12.7 kmc. band Business Radio Band, if they were not able to justify continued operation as a Common Carrier. It should be pointed out that to justify continued Common Carrier operation, your microwave system must also handle business from other users of microwave point-to-point communications. In other words, you must be in the microwave business as a business, not as merely an adjunct service to your CATV system.

Perhaps portions of our special report on microwave, which appeared in the December 1960 and January 1961 issues of the old DXing Horizons would not be amiss being repeated here. At that time Horizons sought answers on this very problem from the Commission. Acting Secretary Ben F. Waple told us. . . .

... In accordance with Section 11.551 of part 11, Industrial Radio Services, the following persons, when engaged in lawful activities, are eligible to hold licenses in the Business Radio Service.

(1) Any person engaged in a commercial activity.

(2) A subsidiary corporation proposing to furnish a non-profit radio communication service to its parent corporation or to another subsidiary of the parent where the party to be served is engaged in a commercial activity."

Our January 1961 report asked the question "Can the Safety and Special Services Bureau of the Business Radio Service institute hearings when a CATV system proposes to



## Recent Developments in Canada

Twenty-four CBC programs have been released for possible distribution to Canadian CATV systems. The actual regulations governing the release of these programs to isolated closed circuit systems were discussed in detail in the October issue of TVH, and will not be reviewed here at this time.

The CBC proposes a reel handling charge of \$8.00 per kinescope, in addition to transportation charges. Two problems have developed in releasing the Kinescopes to Canadian systems. Both involve labor units. The AFM (American Federation of Musicians) has notified the CBC that it requires clearance for all shows that involve its members. This affects all shows with live (studio) background music.

The Canadian Actor's Federation has also notified the CBC that it requires clearance for any shows on Canadian CATV systems.

The original ruling, of the CBC, that no editing, change or modification of any kind of the program may be effected by the CATV operator, still holds.

## A Really Large System

The Daniels & Associates Canadian Office Manager, Fred Metcalf, has announced the formation of Grand River Cable TV Ltd, which will build wired systems in the Ontario towns of Kitchener, Waterloo, Galt, Preston and Stratford, utilizing a common head-end located on Baden Hill, New Hamburg, Ontario. This is one of the highest points in southern Ontario. The area to be served will encompass an estimated 45,000 homes, with the system stretch-

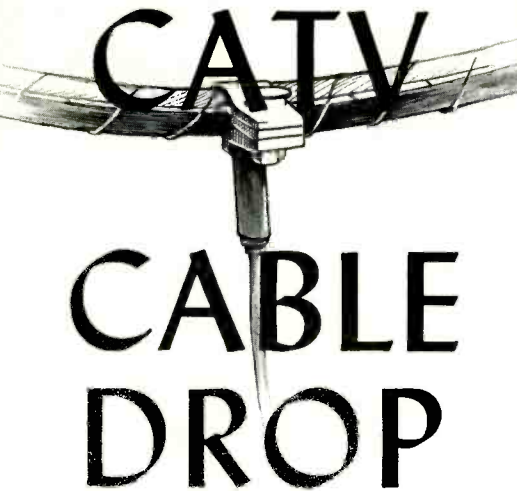

ing over a length of 32 miles from end to end. The Bell Telephone Company will complete the major portion of the wiring. Construction began October 1, and is scheduled for completion in October of 1962. The Grand River Cable TV Ltd. is owned by CKSO-TV, Kitchener, Neighborhood Television Ltd. of Guelph, and Famous Players Canadian Corporation.

Because of its great size, the eventual bounds of the system is expected to make it the largest in Canada, and one of the largest in North America.

## Canadian RCA Victor Enters CATV — Maybe

For some years the RCA Service Co. has stayed "out of CATV" in Canada, and the United States. In numerous

instances in the states the company has been vigorously opposed to local CATV operations which were installed in regions where some form of off-the-air reception was possible.

Recently however one of the suburbs of the "cablest city in the world" — Montreal, was treated to circulation of leaflets announcing RCA CATV system service. The system, proposed for the Pierrefonds district of Montreal, offers five channels of television with an initial connection charge of \$10.00, and a monthly contract charge of \$3.00 per during the initial contract year. There was written indication that monthly drop charges would be reduced to \$2.00 per year in the second and succeeding years.

Television Horizons contacted RCA Victor, Ltd. for a comment on the report. Their only comment was "no comment."

## Swinging From the Cable

A recent report in the NCATA (Canadian CATV Association) Bulletin noted that "section 273 of the Criminal Code of Canada has been modified to state that 'anyone who obtains cable television without being a bona-fide subscriber to such service commits a theft punishable by two to ten years imprisonment.'" Thanks for this amendment go to Armand Rousseau, a former President of NCATA.

The first prosecution under this amendment reportedly has already transpired in Verdun, Quebec.

To adapt an old adage, "Give a man enough cable and he will hang himself!"

microwave signals into a region served by a local TV Station?"

Our January 1961 answer from the desk of Acting Secretary Ben F. Waple read "The conditions under which the Commission will impose conditions of non-duplication on the CATV system of signals or programs carried by local TV stations will be handled on a case by case basis. The Commission proposes to limit the number of channels on each microwave system or circuit to the number which will best serve the public interest. It is expected that the granting of additional adjacent (microwave) channels will be very limited in view of the large number of individual users who will require private microwave facilities.

"At the present time there is no limit as to the distance over which a private microwave system could transport TV signals. In other words, there is no restriction in reference to distance between the TV pickup point and the CATV distribution system."

And we asked Mr. Waple "What will happen to expiring CATV microwave Common Carrier Licenses?"

"As Common Carrier CATV licenses expire, the Commission proposes to examine the records of each licensee to ascertain whether or not he is a bona fide Common Carrier

under the fifty percent rule. Those licensees who are performing a Common Carrier service should have no difficulty in obtaining renewal of their licenses, provided of course that all necessary obligations are met. Those licenses who are not performing a Common Carrier service might consider a private microwave system in the Business Radio Service."

This precedent setting report was published more than one year ago. And yet, for some reason, the question of Common Carrier service in microwave continues to plague the nation's CATV operators.

Let it be stated here that everything you need to know about Commission policy was said more than twelve months back, and printed in detail in this publication.

## Currently?

Has this early report born itself out in fact? Let the facts speak for themselves. Late in October of 1961 the Commission ordered license renewal hearings for fourteen microwave relay stations that are owned and operated by CATV companies, and which serve these companies only. The licensees were told that should they not wish to go through formal hearings on the question of their Common Carrier

(Turn Page)

operations, they could proceed with one of the following steps:

- (A) Dismiss the request for renewal and surrender the use of microwave radio facilities.
- (B) Make efforts to obtain customers for the services of the point-to-point microwave service who are not in any way related to the business of the licensee.
- (C) Consider seeking a license to operate the facilities as a private system in the Industrial Radio Services instead of as a Common Carrier, which by law must serve the public.

All of this raises a number of interesting points. On one hand it would appear that the CATV operator is being backed to the wall and told to legalize or else. Granted, Common Carrier operations that are not as far as the Commission is concerned operating in the public interest, should be made legal. However the first choice, "surrender existing 6 kmc. operations," is certainly not in the public interest if the Commission insists that such actions take place with such speed that the fourteen systems in question lose their microwave service and have no means of substituting service in the interim. Not only would such "speedy action" cause undue financial hardship on the CATV operators involved, it would mean temporary loss of television service to the viewers served by these systems.

Fortunately there is a bit of glimmering hope on the Commission. All of the Commissioners involved did not agree on the decision. Commissioner Cross issued the following dissenting statement:

"All of these parties whose applications are today being designated for hearing hold themselves ready and willing to

provide service to others, and some of them assert that not only did they intend to comply fully with the provisions of Section 21.709 of our Rules by obtaining additional customers not directly controlling or controlled by or under direct or indirect control with themselves, but that their considerable efforts in this regard were frustrated by subsequent actions of the Commission. In other words, after receipt of their original grants, and after they spent considerable sums in constructing their microwave systems, the Commission finalized its Report and Order rulemaking proceeding in Docket No. 11866 after which *inter alia* permitted practically all of their prospective customers to build and operate their own private microwave systems. Thus it is asserted that, since this subsequent action by the Commission made it difficult, if not well-nigh impossible, for these applicants to obtain customers other than themselves and thereby comply with our Rule 21.709, the same Commission should not now turn around, and, on the basis of their failure to comply with the rule, refuse to grant them a renewal of their license without a hearing.

"I am persuaded by these arguments and would therefore afford these carriers an additional five-year license period either to obtain new customers, or if none can be obtained, to permit them this additional period of time to salvage by amortization as much of their considerable investment as possible. In the interest of justice itself, a time honored legal maxim should apply here: *Impossibilum nulla obligatio Est.*

There is no obligation to do impossible things."

Television Horizons will keep readers informed of future developments in this seemingly impossible situation.

## LATE NEWS FLASH - FCC Outlines CATV Microwave Attack

On December 14th the FCC issued an order to its Opinions and Review staff to prepare a decision which may go down in CATV microwave annals as the first major defeat for CATV microwave users.

The hearing before the six man board (Commissioner Bartley was not present) involved an application by Carter Mountain Transmission Corporation to bring microwave signals into CATV systems already operating in

Riverton, Lander and Thermopolis, Wyoming.

Carter Mountains' original application with the Commission had been protested by local station KWRB-TV, Riverton. The Commission ruled in favor of Carter Mountain in the initial hearing stage, which brought the full force of the National Association of Broadcasters into the fight.

In deciding the KWRB-Carter Mountain case, it became apparent that the Commission felt it does have the power to weigh the "pros" of additional television service to these communities against the possible "cons" of the local station (KWRB-TV) leaving the air because of claimed "economic injury."

Strangely enough, the Commissioners did not reach their decision by agreeing with all of their staff members. For example during the course of the hearing, Common Carrier Chief Arthur Gladstone pointed out that as Carter Mountain is a bona-fide Common Carrier, the FCC has no authority to look at and decide against the final product of the Carter Mountain application, i.e., the CATV system which will be fed by the Common Carrier signal.

(Continued on page 23)

## Revolutionary NEW DESIGN

Type ST-4  
**SOLDERLESS  
TAP-OFF**



Unique patented ferrite core transformer design transfers energy to the branch line with a minimum of loss.

- No Pre-Drilling Required
- ST-4 Accepts Single or Double Shielded Cable
- Lowest Tap-Off Loss (down to 12 db.)
- Lowest Insertion Loss (ST-4/12 = 0.33 db.)
- Extended Frequency Range, 8-216 Mc/s
- Very Low Reflection Co-Efficient
- Separate Messenger Cable Clamp (if required) Minimizes Suspension Strain

**BENCO**

TELEVISION ASSOCIATES LTD.

27 TABER ROAD, REXDALE, ONTARIO

Available in the United States through Blonder-Tongue Distributors



# Introducing . . .

## VIKINGS ALL NEW STRIP COPPER SHIELD

- IMPROVED RADIATION CHARACTERISTICS
- IMPROVED ATTENUATION
- IMPROVED IMPEDENCE UNIFORMITY
- SAME O.D. ON SINGLE & DOUBLE SHIELDED TYPE CABLES
- USES STANDARD SIZE PRESSURE TAPS
- WEIGHT REDUCTION BY 20 TO 40%

WITH NEW  
STRIP COPPER SHIELD

LOW LOSS  
FULLY FOAM DIELECTRIC



## ALL NEW SUPERIOR STRIP BRAID CO-AXIAL CABLE

VK11 SINGLE SHIELDED & SINGLE JACKETED  
VKD11 DOUBLE SHIELDED & SINGLE JACKETED  
VK108 SINGLE SHIELDED & SINGLE JACKETED  
VKD108 DOUBLE SHIELDED & SINGLE JACKETED

SWEPT AND THOROUGHLY TESTED  
NON-CONTAMINATING JACKET

TYPE	O. D. (NOM.) Inner Cond.	O. D. (NOM.) Dielectric	O. D. (NOM.) Shield	D. D. (NOM.) 2nd Shield	O. D. (NOM.) Jacket	Attenuation Channel 6 (db/100 ft.)	Attenuation Channel 13 (db/100 ft.)	Shipping Weight Lbs/M Feet
VK11	.064	.285	.296	—	.407	1.31	2.2	64
VKD11	.064	.285	.296	.307	.407	1.31	2.2	73
VK108	.081	.373	.389	—	.460	1.01	1.6	89
VKD108	.081	.373	.389	.400	.460	1.01	1.6	101

**CALL US COLLECT**

FOR SPECIAL LOW QUANTITY  
PRICES ON ALL OUR ITEMS AND  
TO DISCUSS YOUR SPECIAL NEEDS.

New York, N.Y.  
**Whitehall**  
3-5793

Hoboken, N.J.  
**Oldfield**  
6-2020

# VIKING CABLE COMPANY

830 MONROE STREET • HOBOKEN, NEW JERSEY

MANUFACTURERS OF COAXIAL CABLE  
AND PRODUCTS FOR THE COMMUNITY TV INDUSTRY

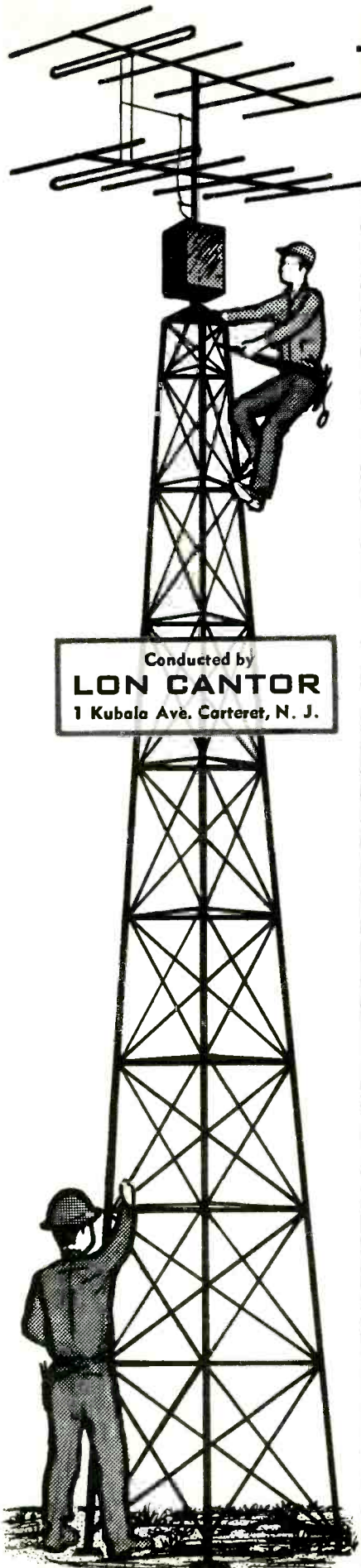

## HEAD END

Midtown Gardens, the huge new hotel loomed impressively in front of Hank and Bob. They were greeted so courteously by the doorman, they decided not to go around the back to the service entrance. Bob carried a Portable TV set with a variable antenna mounted on it. Hank carried a field strength meter.

"What does the installer say is wrong with the system?" inquired Bob. "Interference," replied Hank. "He says he's getting interference on all the low band channels. And Channel 10 is sometimes snowy."

"In other words, we'll have to figure out where the interference is coming from and what filters and traps we need to get rid of it, right?" asked Bob.

Hank was a little dubious. "I guess so. But there is interference and there is interference. Let's see what it looks like before we try to figure out how to cure it."

They stepped off the elevator on the top floor, walked up one short flight and found the head end. It consisted of four antennas combined by a 4-way hybrid splitter, feeding into an MLA-b amplifier (See Figure 1).

Hank connected the portable TV set to the monitor output of the MLA-b through a matching transformer and a variable attenuator (see Figure 2).

"It sure is distorted," exclaimed Bob, looking at the picture on channel 4 (see Figure 3). "What kind of interference do you call this?" he pointed to a dark line moving across the screen.

"That my friend," said Hank in a tone of self satisfaction, "is an excellent sample of what is known as 'windshield wiper' effect."

"I can see where they get the windshield wiper business," agreed Bob, "but what causes it? How can we find out what frequency it is? What kind of trap can we use?"

"Hold on a minute, Ace," remonstrated Hank drily, "Let me show you something." He switched the set to channel 2. "See, the same type of problem." Then he dialed channel 5 and the interference could still be seen.

"What frequency, or what kind of interference would you see on three different channels?" he asked. "That's right," pondered Bob. "The installer did say he got interference on all the low band channels. You got me. I don't know what it is."

"Well I do," grinned Hank. "But let me try something else, just to be sure." He disconnected the set from the output monitor and connected it to the input monitor of the MLA-b. Switching from channel to channel, they found that all pictures were excellent, except channel 10, which was snowy.

Bob was confused. "Wait a minute," he pleaded. "You're going too fast. What are you doing with that variable attenuator? How did you get rid of the interference? And how come channel 10 is worse than it was before?"

Hank grinned, "You've got to keep with it boy," he admonished, "But let's go over this thing step by step so you'll know what's happening. First, without talking about the attenuator — we looked at the picture at the output of the MLA and it was pretty horrible on the low band. Then we looked at the picture at the input of the MLA and the low band channels were fine. What does that tell you?"

"I get it," Bob exulted, "the trouble is caused by the MLA. There's something wrong with the MLA."

"Don't go jumping to conclusions. Actually, there's nothing wrong with the MLA. It just isn't being used right. What causes the 'windshield wiper' effect is cross modulation. And cross modulation is usually caused by overload. In plain language, we're putting so much signal into the MLA that the low band input tube is being driven too far. It's operating in the non-linear portion of the curve."

"I see. Most of the time the trouble is not enough signal. But we are so close to the transmitters here that we have too much signal."

Right," agreed Hank. "Now it's time you learned how to use this attenuator. When I connected the set to the output monitor, I wanted to see what the picture would look like at the TV sets furthest from the head-end.



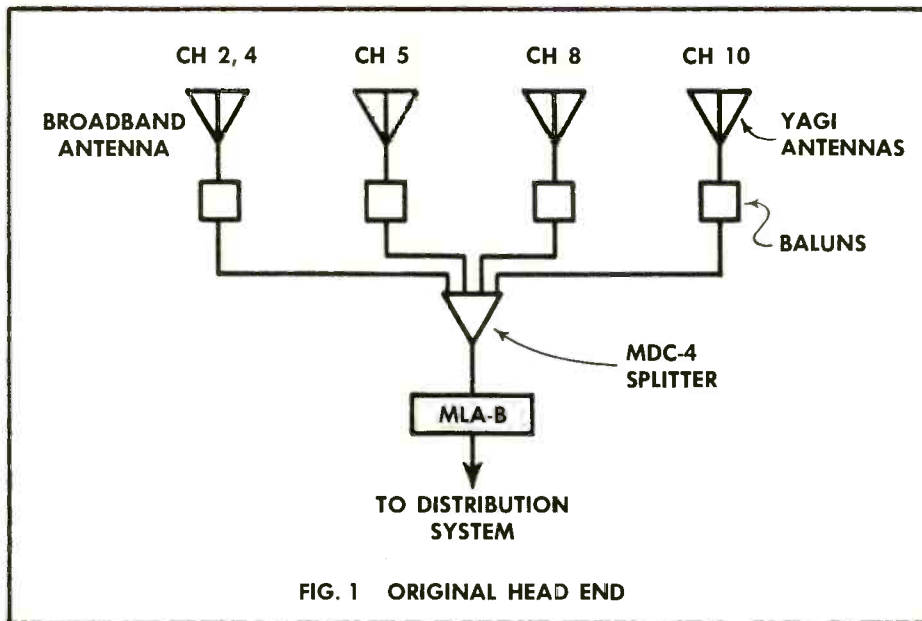

FIG. 1 ORIGINAL HEAD END

"The distribution system loss of this particular system is about 53 db.\* In other words, before the signal gets to some of the sets in this building it's attenuated by 53 db. The monitor output jack on this amplifier is 20 db down. That's so we can make these tests without disturbing the operation of the system. So all I do is switch in another 33 db with the variable attenuator and the picture looks pretty much as it would at the end of the line."

"That sounds easy enough," commented Bob.

"It is easy. When I monitored the input signal to the MLA, it was a different story. I wanted to see what the off-the-air signals were like. I switched out all of the attenuation on the variable attenuator, but the input jack is also 20 db down. That's why we got snow on channel 10."

"I understand," nodded Bob. "What do we do now?"

"We break out the old field strength meter," said Hank, suiting action to words. "We already have some indication of how strong the various channels are but let's not guess — let's find out for sure." With the aid of the field strength meter Hank made the following chart:

Channel	Picture Carrier	Sound Carrier
2	160,000 $\mu$ V	80,000 $\mu$ V
4	140,000 $\mu$ V	80,000 $\mu$ V
5	80,000 $\mu$ V	60,000 $\mu$ V
8	12,000 $\mu$ V	11,500 $\mu$ V
10	160 $\mu$ V	140 $\mu$ V

"Now," Hank said with satisfaction, "we know what we have."

\*EDITOR'S NOTE: See November issue for explanation of how to compute distribution system loss.

"How would you know without trying it out that those signals are strong enough to overload the amplifier?" inquired Bob.

"We'd have to know the characteristics of the amplifier. Of course I don't expect you to memorize all kinds of amplifier specs. Just look'em up on the manufacturer's spec sheets. They say that maximum input for the MLA is 0.2 volts per band. How strong a signal have we got?"

Bob added all the sound and picture carriers of channels 2, 4 and 5 and exclaimed "We're feeding in 0.6 volts on the low band."

"Your arithmetic is OK," corrected Hank, "but you forgot one thing — the signals are being mixed in a 4-way splitter. How much loss is there in a 4-way splitter?"

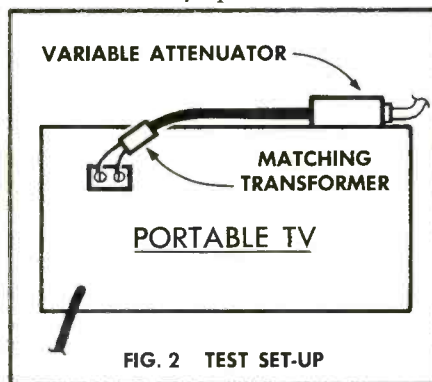

FIG. 2 TEST SET-UP

"Six db. Yeah, I get it. Six db is half the voltage so we're only feeding — let's see, half of 0.6 or 0.3 volts into the amplifier on the low band."

"Very good," agreed Hank. "That's still 1½ times as much as we should be feeding in. The question is, what are we going to do about it?"

"Put in an attenuator," replied Bob promptly. "All we have to do is

add about another 6 db of attenuation and the signal will be small enough."

"Well, that's a logical approach. Where would you put the attenuator?"

"Let's see," mused Bob. "I guess we'd actually need two attenuators. One in the line from the antenna picking up channels 2 and 4 and one in the line picking up channel 5. No, wait a minute! Channel 5 isn't so strong. I'd just use an attenuator in the 2 and 4 line."

"What size attenuator would you use?"

Bob figured it out. "We've got 240,000 microvolts on channel 2 and 220,000 microvolts on channel 4. That's 460,000 microvolts altogether. The splitter brings it down 6 db to 230,000 microvolts. Okay — after the splitter channel 5 would be 70,000 microvolts. How much did you say the MLA would take?"

"200,000 microvolts," supplied Hank.

"Yeah, well I'll subtract the 70,000 microvolt channel 5 signal from the 200,000 and I get 130,000 microvolts. In other words I have 130,000 microvolts to divvy up between 2 and 4, right?"

Hank agreed.

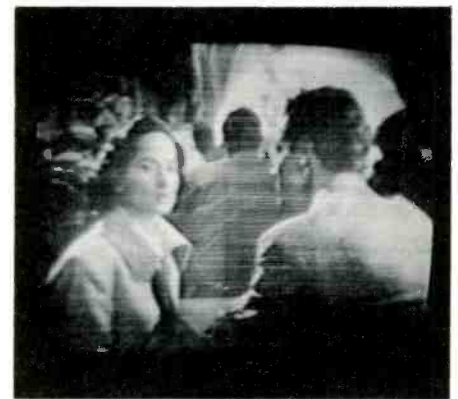

FIG. 3

"Boy," exclaimed Bob. "You have to be a mathematician in this business. So I should have 130,000 microvolts and I have 230,000 microvolts. All right. I'll put in 6 db and bring it down to 115,000 microvolts. How's that?"

"Pretty good," agreed Hank. "But what about channel 10? How are you going to get rid of the snow?"

"I don't know." I'd need some more amplification. That's it. Let's put a preamplifier between the antenna and the 4-way splitter. How does that strike you?"

"Well, I don't mind, if the FCC doesn't," was Hank's dry rejoinder. "Here's what you'd actually be doing: You'd be taking channel 10, amplifying

ing it and sending it out over all the other antennas. It's true that the splitter attenuates the signal some and the antennas are not cut to channel 10, but you still have an illegal transmitter. Ordinarily it wouldn't bother anybody. As a matter of fact, I've seen it done in a number of systems. But let's stick with good engineering practices. So you can't use a preamplifier in front of the splitter. How are you going to make channel 10 stronger?"

"I've made enough wild guesses," replied Bob. "You tell me."

"All right. If we were designing the system from scratch, we wouldn't use a broadband amplifier. We'd probably use single channel strips. Of course it's more expensive that way but with a system this size, it's well worth it, especially if you use strips with AGC. However, that's just idle conjecture. This installer has already used a broadband amplifier and I don't think we'd make him very happy suggesting that he take it out. What I would ask him to take out is the four way splitter. A hybrid splitter does make a good signal mixer, but sometimes you can't afford the 6db loss, and if any of the signals are amplified, it's probably illegal. Before the splitter, channel 10 is 300 microvolts. What is the standard minimum signal?"

"A thousand microvolts per channel across 75 ohms," responded Bob quickly.

"Right. We try to provide at least 1000 microvolts to every set in the system. Well 300 microvolts is about 10 db less than 1000 microvolts. Let's call it minus 10 db. The gain of the MLA is 40 db. We add the plus 40 db of the amplifier to the minus 10 db signal voltage and we get plus 30 db. However, the total distribution loss of this system is 53 db so we still need about 23 db. Therefore, we have to use an amplifier with at least 23 db gain. In fact, I think we should use a higher gain amplifier, to compensate for signal fading. I think I'll suggest the Benco UA-1 strip. That has a gain of 35 db.

"That's just what I said," protested Bob. "You still haven't told me how we're going to mix the signals without getting in trouble with the FCC."

"I was coming to that," Hank responded. "Instead of mixing with a splitter, all we have to do is use a mixer. The Benco unimix or the Jerrold AMN would be OK. But I think I'd recommend the new Blonder-Tonque MX. The difference between a mixer and a splitter is that a mixer is frequency sensitive. It actually consists of a number of tuned-to-channel filters whose outputs are mixed together. Since each filter attenuates all channels except the one to which it is tuned, radiation is no problem — unless you are using adjacent channels and there are ways to get around that too.

"Another advantage of a mixer is considerably less thru-loss. You can mix up to seven channels with only about 2 db thru-loss.

"The reason I'd choose the MX is that it is sort of a building block system. It consists of a number of tuned filters which are mixed in bases. The other mixers have inputs for up to seven channels but with the MX, you just order as many filters as you need. We'd only need five for this system so we'd save a little money. But the important thing is that the MX filters are pretuned. The installer can order a unit specifically for channels 2, 4, 5, 8 and 10 and when he gets it he doesn't have to touch the tuning. The other mixers would have to be tuned in the field — either roughly using a TV set as an indicator, or with a signal generator and oscilloscope or field strength meter. Frankly, I don't think this installer has the equipment to align a mixer properly."

"So we'll recommend the MX," agreed Bob. "How does it fit into the system?"

Hank drew it out (see Figure 4). "Since channels 2 and 4 are received by a single antenna, we'll use a splitter to get two separate lines. Channels 2, 4, and 5 are mixed on one MX base; 8 and 10 are mixed on another. Then the outputs of the two bases are mixed in and MX hi/lo mixer and sent to the MLA.

(Continued on page 26)

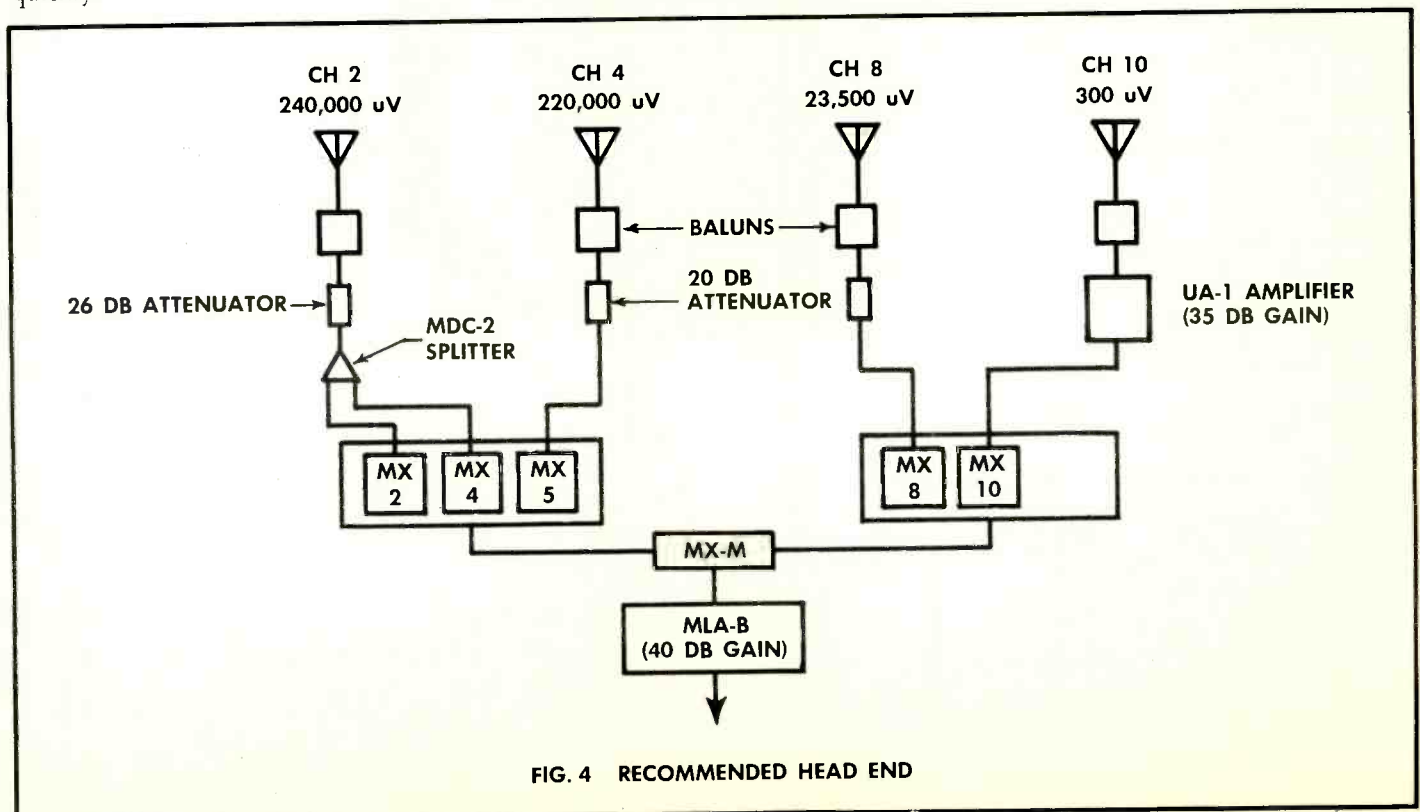



## Service Bench

By  
**Vic Nicholson**  
Jerrold Electronics Corporation

With the vast multitude of TV Master Antenna and closed circuit TV Distribution Systems in operation throughout the United States and Canada, Jerrold Electronics Corporation has, for a number of years, held special courses in its Philadelphia School on the service and maintenance of such systems. However, there are many who for one reason or another are unable to attend our School; for their benefit we shall, by courtesy of TV HORIZONS, publish here a number of articles giving certain service and maintenance procedures.

Although equipment maintenance is generally covered by a manufacturer's instruction sheets or manuals, the service hints and system maintenance procedures discussed here will offer time-saving short-cuts and suggest preventive measures that will keep a system in top operational condition.

The prerequisites for the proper upkeep of a system are:

### A. KNOW YOUR SYSTEM

To know one's system, a complete set of "as-built" records should be available, comprising;

1. Schematic Block Diagram of head-end or antenna site equipment.
2. The mechanical lay-out drawings of that equipment.
3. Lay-out of the entire distribution system, giving type and location of every amplifier, tap, splitter, cable splice, ect.
4. A chart showing the signal levels of both input and output of each piece of electronic equipment as measured at the final system check-out.
5. Operating and maintenance manuals for the equipment, including schematic circuit diagrams and replacement parts lists.

### B. TRAINING

The personnel responsible for maintenance must be familiar with TV receivers. Minimum requirements are that they should be able to accurately distinguish between

troubles caused within the distribution system itself and those within the receiver. The individual customer will have a justified grievance if told that his receiver is defective and pays for a serviceman's call only to find out that his set is OK and that the trouble is actually somewhere in the system. The system maintenance personnel must therefore be properly trained for this kind of work.

### C. TEST EQUIPMENT

However, the most competent technician loses most of his value unless he has all the test instruments and tools necessary to carry out his job.

One of the most important instruments is an accurate field strength meter (such as Jerrold Model 704B). With this, one can read signal levels, measure video carrier levels with respect to audio carrier levels (this being important for proper adjacent channel reception), one can measure and locate interfering signals, and one can feed the video detector output of the field strength meter into an oscilloscope for observation of the composite video and quantitative measurement of any defects.

A portable TV receiver and a good voltohmmeter are also necessary, to observe pix quality at various locations and to check whether lines are properly terminated.

Technicians, who are to maintain a number of small systems or a large one, should also have a broad-band sweep generator, a marker generator, a detector and a variable attenuator. These, and a good set of tools, will permit him to align all the equipment for response, measure match or VSWR, and when necessary repair a unit or entire system.

### D. MAINTENANCE RECORDS

Up-to-date records should be kept of the operation of each piece of equipment at its location. This will insure that the operational status of the system or parts thereof are readily available, even when maintenance personnel is changed.

Such records should also contain comparisons of signal quality for signals received directly off-the-air versus those received at the extreme end of the distribution line.

At the investigation of each trouble call, signal levels at the trouble spot should be measured with the field strength meter and results recorded. Any degradation in signals level should be corrected immediately. This simultaneously serves as a system check and will prevent degradation at this or other points in the system.

While checking all lines for D.C. resistance to ascertain whether they are properly terminated, also insure that each cable is correctly tagged as to its further terminus.

The foregoing is the basis for an adequate maintenance program oriented to make a system deliver high quality pictures over a period of many years.

Future articles will discuss in detail system standards, lay-outs, and test procedures.

### FCC OUTLINES ATTACK

(Continued)

On the other side of the fence, Robert Rawson, Chief of the Broadcast Bureau said the grant, if OK'ed for Carter Mountain, would have an adverse affect on the operation of KWRB-TV, and this is of direct and proper concern to the Commission.

Carter Mountain had sought to bring the signals of KOOK-TV and KGHL-TV (Billings, Montana); KTWQ-TV (Casper, Wyoming; and KID-TV (Idaho Falls, Idaho) to the trio of Wyoming towns. The Commission had originally OK'ed the application without any hearing in April of 1959. But a following protest from KWRB collected a stay of the grant for the station and the in-fighting has ensued since.

At press-time, it was not known if Carter Mountain will seek to appeal the case. It is thought likely that some form of appeal may be forthcoming since the entire future of microwave CATV in the wired TV industry would be at stake if the decision was allowed to stand, un-protested. — END —

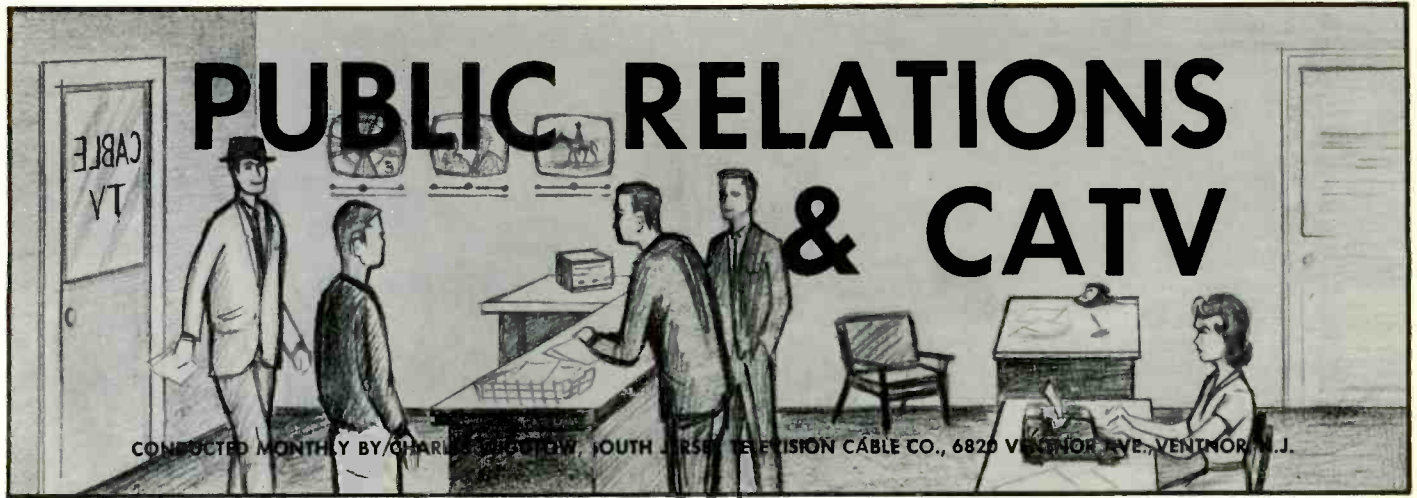

**Publisher's Note:**

The idea for this column was born out of the wide public acceptance of the February issue of the old **DXing HORIZONS**. That issue, of nearly a year ago, dealt with the public relations aspects of fringe area TV reception, whether it be via cable, re-broadcast TV or whatever.

Charles Wigutow is an excellent choice to manage this new monthly section in *Television Horizons*. At the present time he is Manager of the South Jersey Television Cable Company, Ventnor, New Jersey. Among his achievements, an Honorable Mention Award from the NCTA at the 1961 convention for his work in CATV advertising stands out. Wigutow was 1/2 owner in a large scale television service business for ten years, served as Manager for the Flagstaff Television and Cable Company, and specialized as a Management Consultant in Merchandising for a number of years.

Although located on the east coast, he continues to conduct a regular column on television programming for the *Arizona Daily Sun*. In the east he conducts a column on education for a suburban Philadelphia newspaper.

*Television Horizons* invites CATV system managers to take advantage of Wigutow's invitation to air your PR problems in print. He is interested in reporting on your successful programs, as well as your problem areas. It is hoped that through this regular feature your own knowledge of CATV system management problems and solutions will grow by the month.

R. B. Cooper, Jr.

Let's start with the idea that television is as important to people as the air they breathe, and through which the signals fly. Your job is to give the community the best and most television they can get for their money, otherwise you may expect them to think of other ways of getting reception.

The TV set has become many things to everybody. It is the quickest and most used source of world wide news; it is entertainment that meets every level and variety of taste; it is a form of education; it is a way of keeping up with the Jones's. It helps belong in a common community of interests and conversation, and is company in a home.

In addition, for those who live some distance from population centers, it has been the means of erasing the time lag in fashions, fads, and customs that used to exist between the big cities and remote spots. Newsworthy events are broadcast to all of the nation's population, wherever they are at the instant.

The television set has created an overnight revolution that has wiped out isolation. Universal quick transportation and television have done away with any concept of hinterland.

The set has become an absolute necessity. Herein lies both opportunity and danger. Subscribers will welcome the extras that you can provide. Four or five good solid channels on cable are well worth paying for and you need never have qualms about your product.

Television reception as purchased through the cable system conforms to rules that are no different than those that

govern major personal purchases. It is a well observed phenomenon among Americans that they will buy the best they can afford to get. This is true of cars, homes, and furniture. Why shouldn't it operate with television reception? In fact, it is more so with television. The set is not a passive object. The average person is absorbed by it for some five hours per day.

When there is such a degree of interest, inferior performance means frustration. There is hardly any question that people will pay for consistent quality, multi-channel television. This is where good service and good business meet on the same ground.

The cable manager must recognize that people look on television as being almost a natural right, like the right not to go hungry, or the right to be clothed and housed. So it is with television. Where there is a place for a cable system, it will be chosen for the advantages it brings. Danger can only come from failure to recognize the consuming place that television has come to occupy in the home.

The cable company must place its emphasis on the good things it is doing. If the system is bringing in a big attraction sports event, or a series of programs of great cultural interest that can only be seen by your subscribers, then that becomes your public relations prescription. Similarly, if you have given free cable service to the schools, be proud of it publicly in the press and the radio. These are newsworthy facts. You will find that the press is looking for just such news items of local interest.

If you manage a cable system, you should be interested in what comes off the air. A good working knowledge of what TV programming is about is as interesting and rewarding as any field of knowledge.

Ideally, you should be the person in your community who knows most about television, not necessarily the technical functioning, but about the controversial issues on the place of television in the home and in society.

Some excellent books on the meaning and effects of television have been published in recent years. These will give you the substance of some interesting talks that you can give at club luncheons, and also in schools.

Your cable system will enjoy the prestige of being identified with you as the focal point of television knowledge. And this is good.

"If ever there has been a business that has been steeped in public relations practices, it is the television cable business. It is the intent of this column to explore community relations policies that should be good for you and others in the community. If you have such a problem, or a solution, or have worked out something in the past, why not write to us? We will make this a regular monthly feature."



COMPLETE SUPPLY SERVICE  
FOR ALL LINE CONSTRUCTION

# JACK PRUZAN CO.

1963 - 1st Ave. South

Seattle 4, Washington

Specializing in materials for building TELEVISION CABLE SYSTEMS. We carry a complete stock of all items used on TV CABLE LINES and POWER and COMMUNICATIONS LINES.

POLE LINE HARDWARE

TOOLS & SPECIALTIES

MESSENGER & GUY STRAND

SAFETY EQUIPMENT & POWER SUPPLIES

CABLE LASHERS AND LASHING WIRE

CROSSARMS & BRACES

BARE & INSULATED WIRES

TAPES & SPLICING MATERIALS

**IMMEDIATE NATION-WIDE SHIPMENT**

CALL OR WRITE FOR JACK PRUZAN COMPANY ILLUSTRATED CATALOG-STOCK LIST



*"Pruzan has everything"*

CALL  
MAin 4-6505

(Well, Almost Everything)

ORDERS SHIPPED THE  
SAME DAY RECEIVED

## On-Channel UHF Boosters

Persistent UHF translator enthusiasts sent our Washington office staff to the FCC seeking answers to the question "What is holding up the processing of UHF On Channel Booster Application Forms?"

The Commission form in question has been dubbed "FCC Form 346-A," which is used to make application for authority to construct a UHF translator signal booster.

Acting Secretary Ben F. Waple advised our staff reporter, "Of necessity, considerable time has been expended in the drafting of the form, its submission to the Budget Bureau for approval, and subsequent preparation for printing. Upon receipt of the printed forms, which is expected in the very near future, they will be made available to the general public."

Horizons has been further promised that we will be advised immediately when the form is available for distribution. Keep in mind that type-acceptance is not required for UHF translator signal boosters, as spelled out in the Commission's Rules—Sections 4.701(e) and 4.733.

## FIELD ENGINEER

(Continued from page 22)

"It's good engineering practice to balance the signals fed into a broad-band amplifier. You see, it's not enough just to have enough gain. This job is a good illustration of the fact that the input signals can't be too strong or too weak. And there is one other important factor—the output capability of the amplifier.

"I'll show you what I mean. Maximum input on the MLA is 0.2 volts. Suppose we had a signal of 95,000 microvolts on channel 2; 95,000 microvolts on channel 4 and only 10,000 microvolts on channel 5. What would be the total low band input signal?"

"Uh—0.2 volts," calculated Bob.

"Right. In other words we would not run into cross modulation because of the input signal. A 10,000 microvolt signal is ten times as large as the standard minimum signal—how many db is that?"

Bob referred to his db to voltage slide rule. "Twenty db," he answered. "Right," Hank agreed again. "So if the gain of the MLA is 40 db, how many db more than the standard minimum signal (1000 db) is channel 10 at the output of the MLA?"

"Well, 20 db for the input signal, plus 40 db for the amplifier is—60 db," said Bob. "The distribution system loss is only 53 db so I don't see where we'd have any trouble on channel 5."

"That's exactly what I'm trying to explain," said Hank triumphantly. "I trapped you into that one. The gain of the MLA is 40 db with the gain control all the way up. If we had an input signal of 0.2 volts and amplified it

by 40 db (100) the output would be 20 volts. It takes one heck of an amplifier to give you 20 volts per band undistorted. Actually, in order to use 0.2 volts input, we have to turn the gain control way down. The manufacturer tells us that maximum output on the MLA is 2 volts per band. If the input is 0.2 volts, we only have to multiply it by ten times, which is 20 db to get 2 volts output.

"It is possible to tilt the response of the MLA a little with the tilt controls but let's forget about that. Generally it's done to compensate for long cable runs.

"Getting back to channel 5, if we amplify the 10,000 microvolts by only 20 db, we wind up with only 100,000 microvolts at the output of the MLA. That's only 40 db greater than the standard minimum signal. The distribution system loss is 53 db and we are in a lot of trouble."

"I get it," said the chagrined Bob. "That's why we have to equalize the signals."

"Exactly. Let's start with the output capability of the MLA. According to the manufacturer, it is about 2 volts per band. That 2 volts is divided in this case between channels 2, 4, and 5. So three channels into 2 volts is about 0.65 volts per channel. That's what we want to wind up with—about 0.65 volts on channel 2, 4, and 5. 0.65 volts is 650 times 1000 microvolts or about 57 db greater than the standard minimum signal. Therefore, if we get 0.65 volts per channel, the signals will be more than strong enough to overcome the 53 db distribution system loss.

"The easiest way to equalize the signals is to work with db. Channel 5 is 140 times 1000 microvolts so we'll call it plus 43 db. Channel 4 is 220 times 1000 microvolts so we'll call it plus 47 db. Channel 2 is 240 times the standard minimum signal, which is about plus 48 db.

"If we put in a 6 db attenuator before the channel 2 and 4 splitter (see Figure 4) all three channels would be about equal. However, we'd still be overloading the input of the MLA.

"Therefore, let's put a 26 db attenuator in the 2 and 4 line and a 20 db attenuator in the channel 5 cable. All three low band channels would go into the MLA at about 22 db. We could set the low band gain control for about 35 db to give us an output of 57 db."

"What about the high band?" asked Bob. "Shouldn't that be equalized too?"

"Sure it should," affirmed Hank. "But most broadband amplifiers, in-

cluding this one, have separate hi and lo band gain controls. So we can balance the high separately.

"The signal at channel 10 is 300 volts or—10 db compared with the standard minimum. We amplify it by 35 db and get plus 25 db. Channel 8 is 23.5 times 1000 microvolts or about plus 27 or plus 28 db. By coincidence, that's close enough so that we don't have to bother with it, although we could put a 3 db attenuator into the channel 8 line if we wanted to split hairs."

Three days later the installer stopped in to thank Hank and Bob. He had taken their advice and the system was working beautifully.

"I wasn't too surprised to hear you recommend a single channel amplifier," he said, "But that cross modulation was driving me bugs."

"We have DDT for bugs," grinned Bob.

The installer turned to Hank wryly. "Does he help with the solution or is he part of the problem?" he inquired.

Hank laughed. "Bob's only problem," he stated, "is how to get balanced signals with an unbalanced mind!"

## Questions and Answers

**QUESTION**—Recently I was out on a job where I had overload on a Benco Pacemaker. I put in two splitters to cut down the signal strength and the overload disappeared. Is this all right or will it cause trouble in the system?  
M.H.

**ANSWER**—That's a rather ingenious way of attenuating the signal but it's also a little expensive. No, it shouldn't cause any trouble in the system. I recommend that you take a variable attenuator and a supply of inexpensive fixed attenuators (such as the Blonder-Tongue FA unit) with you on every job. You can determine the proper amount of attenuation with the variable attenuator and then replace it with a less expensive fixed unit.

THE FIELD ENGINEER

**AUTHOR'S NOTE:** The Field Engineer will be glad to answer your questions on MATV, CATV and CCTV in this column. Address all questions to:

FIELD ENGINEER  
c/o TV Horizons  
Box 1557  
Oklahoma City, Oklahoma



# **MARS MAC 17**

## **VHF TRANSLATOR**

**FCC  
TYPE  
ACCEPTED  
1 WATT  
OUTPUT**



**ONLY MARS OFFERS:**

- ★ **ALL INDUSTRIAL TUBES**
- ★ **OPTICAL IDENTIFIER**
- ★ **LESS THAN 50 WATTS AC POWER**
- ★ **SINGLE UNIT CONSTRUCTION**
- ★ **100% VOLTAGE REGULATED**
- ★ **SMALLEST AND LIGHTEST TRANSLATOR**
- ★ **\$933.00 LIST PRICE**

## **MID-AMERICA RELAY SYSTEMS, Inc.**

A Subsidiary of Miratel Electronics, Inc.

918 Tilford Street, Sturgis, S.D.

Dealer, Distributor Inquiries Invited

# WANTED!

## EXPERIENCED ELECTRONIC TECHNICIANS

Our rapidly expanding sales and new product lines have created several positions for experienced electronic technicians in our engineering research department. Knowledge of R-F amplifier and antenna theory, plus experience in installation or maintenance of TV antenna distribution systems desirable.

New plant and laboratory facilities with latest equipment in pleasant city of 35,000 on beautiful Mississippi river. Centrally located between Chicago, St. Louis, Omaha and Minneapolis.

Write full details about yourself and your experience. Interviews will be arranged for selected applicants.

 **Winegard**  
ANTENNA SYSTEMS

3000 Kirkwood Ave., Burlington, Iowa

# FCC

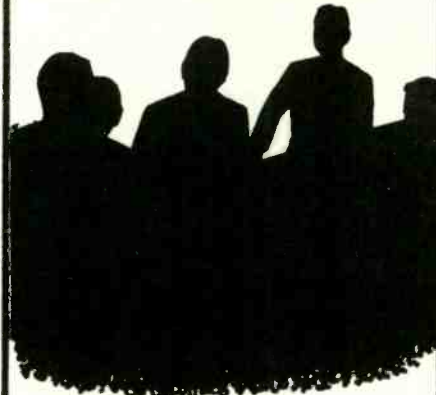

## IN REVIEW

### TRANSLATOR ACTIONS

Seligman Recreation Assn., Deer Lodge, Hyde Park, and Seligman, Arizona

Granted CP for a new VHF translator station (BPTTV-679, 680) with provision for multiple output amplifiers on Channel 7 to translate programs of KTVK (Channel 3) Phoenix, Ariz.; condition.

Granted CPs for the following new VHF TV translator stations: Upper Rosebud TV Club (BPTTV-696) on Channel 11, Upper Rosebud, Mont., to translate program of KOOK-TV, Channel 2, Billings, Mont., and Minersville Television Committee (BPTTV-839) on Channel 2, Minersville, Utah, to translate programs of KUTV, Channel 2, Salt Lake City, Utah, via intermediate translator station.

BLTTV-104 LAVA T-V Associa- K11CP  
tion, Lava Hot  
Springs, Idaho

License to cover construction permit (BPTTV-947, which authorized a new VHF Television Translator station) and to specify type of transmitter as TEPCO, TE-1B, 1 watt.

BLTTV-105 SAME AS ABOVE K13CO

License to cover construction permit (BPTTV-948, which authorized a new VHF Television Translator station) and to specify type of transmitter as TEPCO, TE-1B, 1 watt.

BPTTV-383 CITY OF BURWELL NEW  
AMENDED Burwell, Nebraska

Amended to change frequency to Channel 2, 54-60 Mcs; primary TV station to KOLN, Ch. 10, Lincoln, Nebraska via KGIN-TV, Ch. 11, Grand Island, Nebraska; and type of transmitter to Benco, T-1.

BPTTV-384 SAME AS ABOVE NEW  
AMENDED

Amended to change frequency to Channel 8, 180-186 Mcs, and make of transmitter to Benco, T-1.

BMPTTV-38 Rex M. Shirts K07AH  
Hailey, Idaho

Mod. of CP (BPTTV-209, which authorized a new VHF TV Translator station) to change type of transmitter to MARS, MAC-17, 1 watt.

BMPTTV-39 Harlowton T.V. K13BE  
Association  
Harlowton, Montana

Mod. of CP (BPTTV-537, which authorized a new VHF TV Translator station) to

change primary TV Station to KGHL-TV, CH. 8, Billings, Montana.

BMPTTV-40 Harlowton T.V. K10AX  
Association  
Harlowton, Montana

Mod. CP (BPTTV-538, which authorized a new VHF TV Translator station) to change primary TV station to KOOK-TV, CH. 2, Billings, Montana.

BPTTV-1106 Community Television NEW  
AMENDED System  
Gatlinburg, Tenn.

Amended to show name of applicant as Jerry Hays and Robert A. Conner d/b as Community Television System.

BPTTV-1150 Intermountain Television 13  
Limited  
Burney, California

KRON, CH. 4, San Francisco, California.  
BPTTV-1149 SAME NAME AS ABOVE 3  
Fall River Mills and  
Adin, California

SAME AS ABOVE.  
BMPTTV-46 Bert B. Williamson K07AB  
Belt, Montana

Mod. of CP (BPTTV-40, which authorized a new VHF TV Translator station) to change make of transmitter to TEPCO, TE-2A, 1 watt.

BMPTTV-43 Emery Town K09DJ  
Emery, Utah

Mod. of CP (BPTTV-929, which authorized a new VHF Television Translator station) to change type of transmitter to EMCEE, UHRV, 1 watt.

BPTT-651 Greater Rolfe Club NEW  
Rolfe, Iowa

Channel 72, 818-824 Mos. Primary TV  
Station: WOI-TV, CH. 5, Ames, Iowa.

### OUR MAN IN EUROPE

(Continued from page 11)

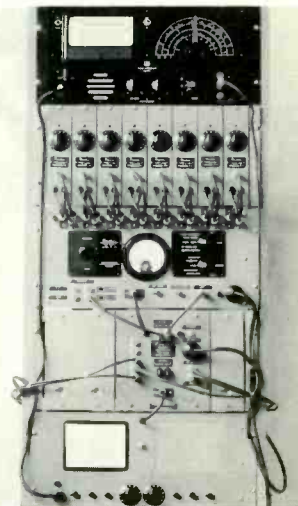

An a.g.c. system rack. Top to bottom: signal strength meter, bank of sound and vision a.g.c. strips, power supply and level monitor, automatic standby, video monitor.

At the head end, the aerial signal is first passed through a low-noise mast-head amplifier, and then on to pre-amplifiers (head amplifiers) or converters. A.g.c. is given to the aerial signals at the head amplifiers and converters and also, where the signal is prone to heavy fading, at the mastheads. The signals are combined either at high-level or low-level and then fed direct to line or to line via a repeater.

G.J.K.





## WHY JERROLD BUILDS MORE CATV SYSTEMS on a "turn-key"\* basis than all other manufacturing-contractors combined!

There's ample reason: Jerrord simply gives the owner more—takes every bit of responsibility along the way:

Check this typical Jerrord CATV "turn-key" package:

1. Antenna-site signal survey.
2. Pole-line survey (and assistance in dealing with utilities).
3. Complete systems engineering.
4. All equipment and materials, both construction and electronic—from the "antenna shack" to the "house drop".
5. Construction by the largest, most highly skilled force in the industry.
6. Activation of the new system.
7. Thorough checkout.
8. Training of your personnel in system operation and management.
9. Delivery of the fully operating system—on schedule.
10. COMPLETE FINANCING—on terms to meet your needs.

Small wonder, then, that system owners have found it simpler, faster—and cheaper—to rely on Jerrord from beginning to end rather than attempt to pull all the elements together themselves. Small wonder that Jerrord start-to-finish installations in 1960 alone added facilities to service over a quarter million new CATV subscribers in twelve states (see list below).

If you want the peace of mind that comes of dealing with a thoroughly integrated organization that knows your needs—leave it to Jerrord.

\*"turn-key": You order the system built—we turn the key over to you when it's running full-tilt.

### Some of the New CATV Systems Built by Jerrord in 1960

Chippewa Falls, Wisc.	Johnstown, Pa.	Ocala, Fla.
Eau Claire, Wisc.	Manhattan, Kan.	Roswell, N.M.
Escanaba-Gladstone, Mich.	Maysville, Ky.	Salisbury, Md.
Glasgow, Mont.	Mountain Home, Ark.	Somerset, Ky.
Haskell, Texas	Munising, Mich.	Stamford, N.Y.

**JERROLD**®

### ELECTRONICS CORPORATION

Community Systems Division 1SS-6  
 Headquarters Office, The Jerrord Building  
 Philadelphia 32, Pa. Telephone 215—BALDWIN 6-3456



# The **EMCEE** VHF TRANSLATOR



## THERE'S MANY A GOOD REASON WHY EMCEE IS FIRST CHOICE OF AMERICA'S LEADING TRANSLATOR ORGANIZATIONS

America's leading experts on television rebroadcasting have designed for you the EMCEE line of TV Translators. Every circuit in every unit is expressly designed for translators and carefully constructed of quality components. Only with EMCEE do you get "Integrated Design," essential for maximum performance and long trouble-free service. EMCEE has the widest line of translator products, has the most models accepted and approved to ensure you the

maximum performance and complete compliance with government regulations.

Our comprehensive field organization stands ready to supply you not only with the finest equipment, but with complete engineering back-up. Installation planning and service, back-up or routine maintenance, local stocks of repair parts, FCC liaison are all yours when you go EMCEE.

### VHF TRANSLATORS

- MODEL HRV – 1-Watt FCC Type Accepted • Multiple output available.
- MODEL U-HRV – same with UHF input.
- MODEL HRV-10 – 5-Watt Pedestal Level – Canadian DOT Accepted
- MODEL HRV-10X – 10-Watt Export
- MODEL TOA – 10-Watt. Amplifier For use where higher power is authorized.

**FREE**  
reprint of  
FCC rules  
covering  
translators

**EMCEE** suggests you compare...

LOOK AT THE SPECIFICATIONS!  
LOOK AT THE PERFORMANCE!  
LOOK AT THE CONSTRUCTION!  
LOOK AT THE PICTURE!

*over 100 field representatives are ready to show you the difference.*

Now serve several communities  
from a common site with a full watt to each.

MULTIPLE OUTPUT AMENDMENT TO FCC RULES ADOPTED!  
Model 4-MXA multiple amplifier chassis extends EMCEE quality performance – serves up to four communities. Write for detailed specifications, copy of rules amendment.

**E**LECTRONICS, **M**ISSILES AND **C**OMMUNICATIONS, INC.  
262 EAST THIRD STREET • MOUNT VERNON • NEW YORK

ELECTRONICS, MISSILES AND COMMUNICATIONS, INC.  
262 east third street • mount vernon, new york

Gentlemen:

- Please rush free planning package including data sheet, complete installation check list, coverage calculation form.
- Please send free reprint of FCC rules covering translators.
- UHF Input Data Sheet.
- Multiple Output Information

NAME \_\_\_\_\_

ADDRESS \_\_\_\_\_

CITY \_\_\_\_\_ STATE \_\_\_\_\_