

Practical Electrics

20 Cents

Over
100

Illustrations

Oct. 1923

EDITED BY H. GERNSBACH

PERPETUAL MOTION?!

See Page 545



"THE NATIONAL AUTHORITY ON WIRING FOR TWENTY-EIGHT YEARS"

Do Your Own Wiring and Save 50%

Anyone can become an expert wireman and secure a license by following the simple rules given in "Standard Wiring,"

Endorsed by the Wiring Department of the Joint Committee for Business Development in the Movement to "Electrify"

For twenty-eight years this book has been the acknowledged authority on electric light and power wiring and construction, and is in constant use by wiremen, contractors, and engineers throughout the United States and Canada. It is the only up-to-date book on the subject published.

Thousands of young men have become expert wiremen and electrical contractors by mastering the simple rules given in "Standard Wiring."

So simple that a school boy can understand, yet so complete and thorough that all the leading wiremen and contractors use it in preference to any other book.

This latest edition contains over twice the amount of useful information ever before published. The National Electrical Code explained and illustrated. New illustrated chapters on Outside Wiring and Inside Wiring for all systems for both direct and alternating currents; House and Residence Wiring, Garage Wiring, Theatre and Moving Picture House Wiring, Marine Wiring, Electric Sign Wiring.

How to install, operate and care for Generators, Motors, Storage Batteries, Meters, Electric Ranges and every kind of wiring device for light, heat and power. How to secure the proper illumination for every condition; latest Mazda lamp data; 250 electric terms and their definition and values; the complete Metric system; fifty-two of the latest tables on wires and wiring; all dimensions, weights and capacities of wires and cables for copper, brass and iron; tables; showing at a glance, and without any figuring, the right size of wire for power or lighting jobs for any capacity. New 1923 edition just out.

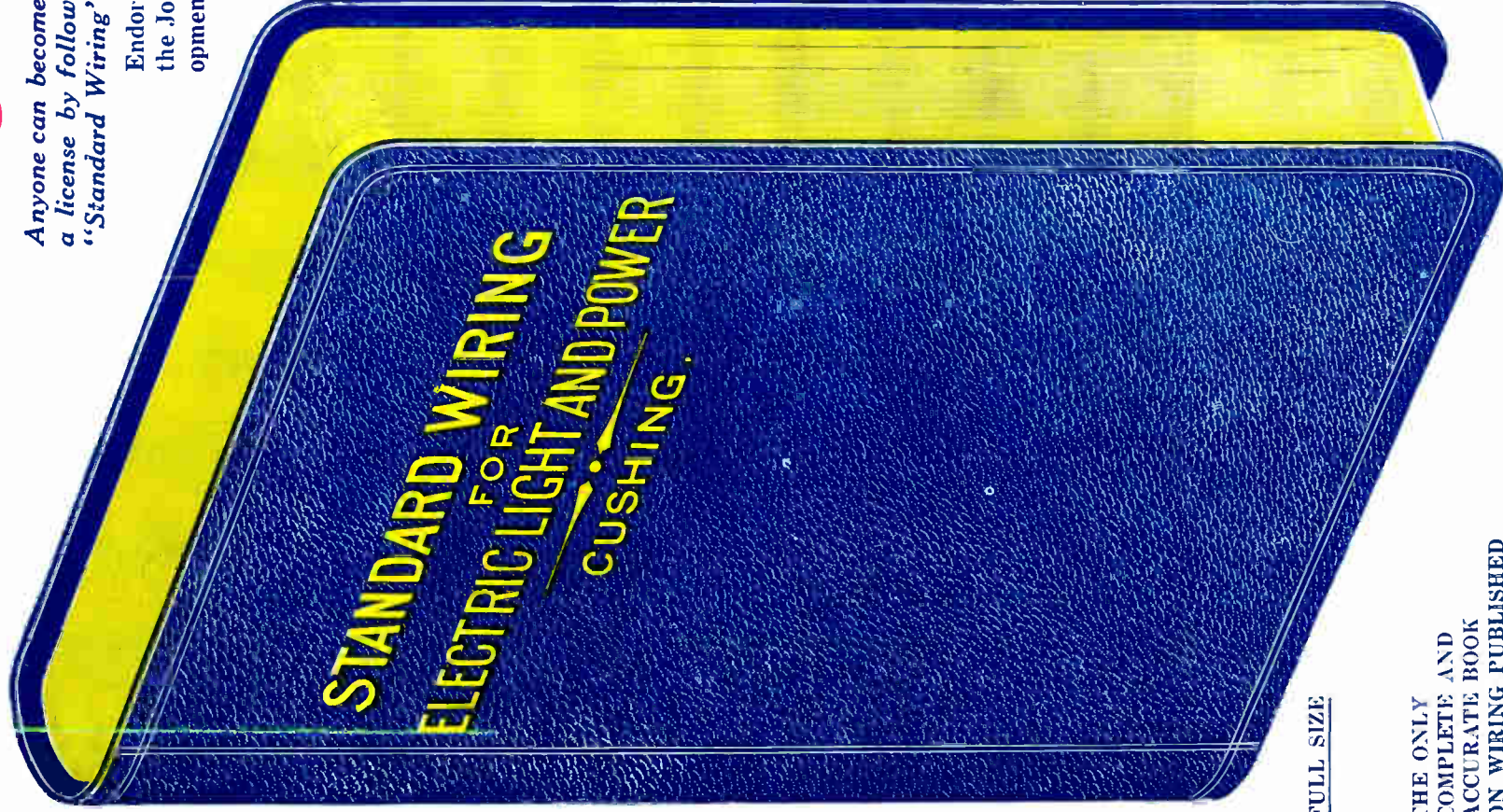

FULL SIZE

THE ONLY COMPLETE AND ACCURATE BOOK ON WIRING PUBLISHED

400 PAGES LEATHERETTE COVER GILT EDGES POCKET SIZE PRICE \$2.00

Sent postpaid to any address on receipt of price by

H. C. Cushing, Jr., 10 West 40th St., New York

Be a **Certificated Electrical Expert**

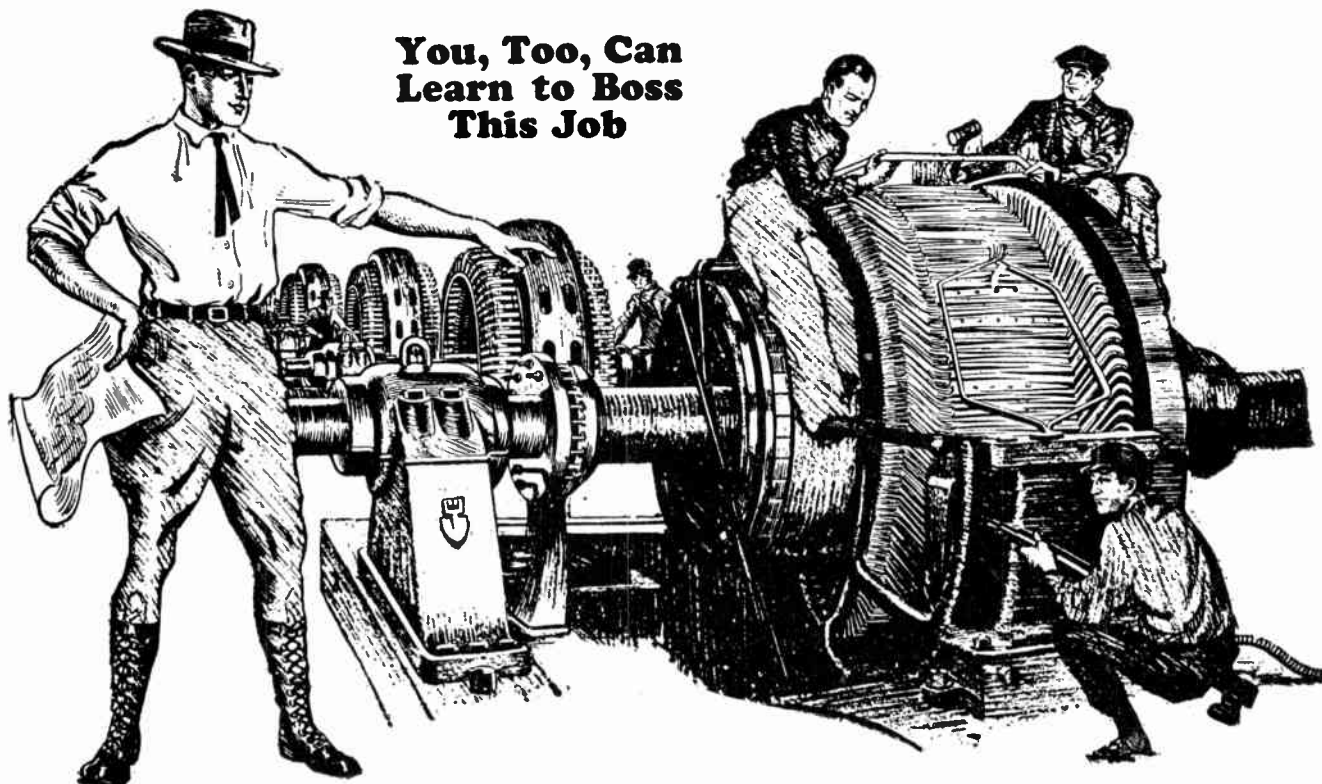

You, Too, Can Learn to Boss This Job

EARN \$3500 to \$10000 a Year

Trained "Electrical Experts" are in great demand at the highest salaries, and the opportunities for advancement and a big success in this line are the greatest ever known. "Electrical Experts" earn \$70 to \$200 a week.

Fit yourself for one of these big paying positions. In my twenty years of Electrical Engineering I have gathered some wonderful and interesting facts about this great industry—"Vital Facts." I will send them to you free.

Learn at Home to Earn \$12.00 to \$30.00 a Day

Today even the ordinary Electrician—the "screw driver" kind—is making money—big money. But it's the trained man—the man who knows the whys and wherefores of Electricity—the "Electrical Expert"—who is picked out to "boss" ordinary Electricians—to boss Big Jobs—the jobs that pay. You, too, can learn to fill one of these jobs—spare-time only is needed. Be an "Electrical Expert"—Earn \$70 to \$200 a week.

Age or Lack of Experience No Drawback

You don't have to be a College Man; you don't have to be a High School graduate. If you can read and write English, my course will make you a big success. It is

the most simple, thorough, and successful Electrical Course in existence, and offers every man, regardless of age, education, or previous experience, the chance to become, in a very short time, an "Electrical Expert," able to make from \$70 to \$200 a week.

Some Features of My Course That Make SUCCESS Certain

1. Practical Money-Making Instruction—no useless, high-sounding theory.
2. Free Electrical Outfit.—Finest outfit ever sent out for home experiment and practical use.
3. Free Employment Service. (Helps you get a good job.)
4. Free Consulting Service. (No chance to get stuck on anything, while studying or afterward.)
5. Free Engineering Magazine.
6. Free use of my Electrical Laboratory.
7. Extra Courses Free—Radio—Electrical Drafting.
8. Spare Time Work—Special earn-while-you-learn lessons.
9. Reduced prices on all Electrical Supplies.
10. Cash Refund Guarantee Bond.

These features are all explained in my big Free Book.

I Give You a Real Training

As Chief Engineer of the Chicago Engineering Works, I know exactly the kind of training a man needs to get the best positions at the highest salaries. Hundreds of my students are now earning \$3,500 to \$10,000 a year. Many are successful ELECTRICAL CONTRACTORS.

Your Satisfaction Guaranteed

So sure am I that you can learn Electricity—so sure am I that after studying with me, you too, can get into the "big money" class in electrical work, that I will guarantee under bond to return every single penny paid me in tuition if, when you have finished my course, you are not satisfied it was the best investment you ever made.

FREE—Electrical Working Outfit —FREE

I give each student a Splendid Outfit of Electrical Tools,

Materials and Measuring Instruments absolutely FREE. I also furnish them with all supplies, including examination paper, and many other things that other schools don't furnish. You do PRACTICAL work—AT HOME with this Outfit. You start right in after the first few lessons to WORK AT YOUR PROFESSION in a practical way.

Get Started Now—Mail Coupon

I want to send you the "Vital Facts" of the Electrical Industry including my Electrical Book, Proof Lessons, and a sample of my guarantee bond all FREE. These cost you nothing and you'll enjoy them. Make the start today for a bright future in Electricity. Send in the coupon—NOW.

L. L. COOKE, Chief Engineer

Chicago Engineering Works
Dept. 217 2150 Lawrence Ave., Chicago

Use this Free Outfit Coupon!

L. L. COOKE, Chief Engineer,
Chicago Engineering Works, Dept. 217
2150 Lawrence Ave., Chicago, Ill.

Dear Sir:—Send at once the "Vital Facts" containing Sample Lessons, your Big Book, and full particulars of your Free Outfit and Home Study Course—all fully prepaid, without obligation on my part.

Name.....
Address.....
City and State.....
Occupation..... Age.....

The "Cooke" Trained Man is the "Big Pay" Man

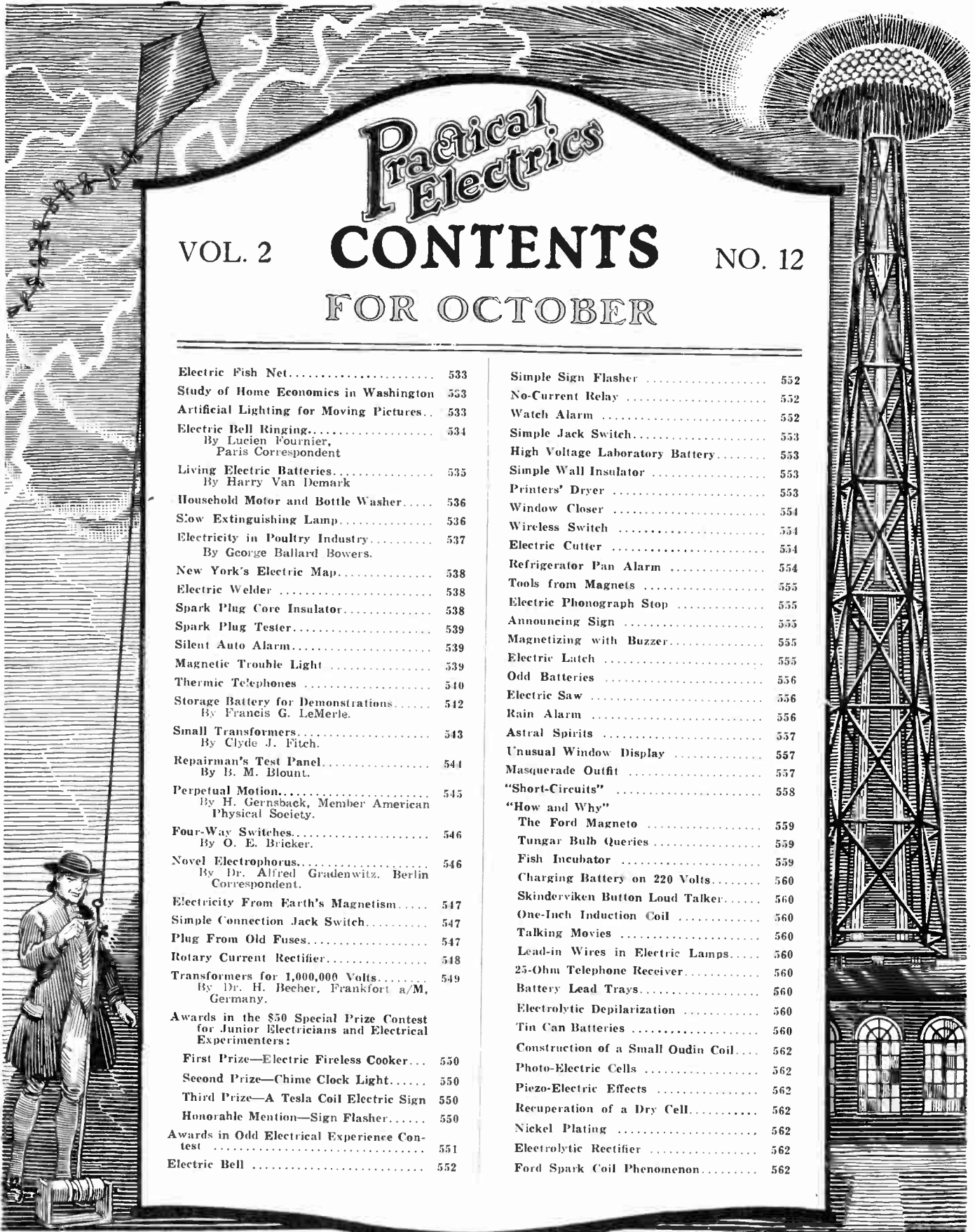

VOL. 2 **Practical Electrics** NO. 12
CONTENTS
 FOR OCTOBER

Electric Fish Net.....	533	Simple Sign Flasher.....	552
Study of Home Economics in Washington.....	533	No-Current Relay.....	552
Artificial Lighting for Moving Pictures.....	533	Watch Alarm.....	552
Electric Bell Ringing.....	534	Simple Jack Switch.....	553
By Lucien Fournier,		High Voltage Laboratory Battery.....	553
Paris Correspondent		Simple Wall Insulator.....	553
Living Electric Batteries.....	535	Printers' Dryer.....	553
By Harry Van Demark		Window Closer.....	554
Household Motor and Bottle Washer.....	536	Wireless Switch.....	554
Slow Extinguishing Lamp.....	536	Electric Cutter.....	554
Electricity in Poultry Industry.....	537	Refrigerator Pan Alarm.....	554
By George Ballard Bowers.		Tools from Magnets.....	555
New York's Electric Map.....	538	Electric Phonograph Stop.....	555
Electric Welder.....	538	Announcing Sign.....	555
Spark Plug Core Insulator.....	538	Magnetizing with Buzzer.....	555
Spark Plug Tester.....	539	Electric Latch.....	555
Silent Auto Alarm.....	539	Odd Batteries.....	556
Magnetic Trouble Light.....	539	Electric Saw.....	556
Thermic Telephones.....	540	Rain Alarm.....	556
Storage Battery for Demonstrations.....	542	Astral Spirits.....	557
By Francis G. LeMerle.		Unusual Window Display.....	557
Small Transformers.....	543	Masquerade Outfit.....	557
By Clyde J. Fitch.		"Short-Circuits".....	558
Repairman's Test Panel.....	544	"How and Why"	
By B. M. Blount.		The Ford Magneto.....	559
Perpetual Motion.....	545	Tungar Bulb Queries.....	559
By H. Gernsback, Member American		Fish Incubator.....	559
Physical Society.		Charging Battery on 220 Volts.....	560
Four-Way Switches.....	546	Skinderviken Button Loud Talker.....	560
By O. E. Bricker.		One-Inch Induction Coil.....	560
Novel Electrophorus.....	546	Talking Movies.....	560
By Dr. Alfred Gradenwitz, Berlin		Lead-in Wires in Electric Lamps.....	560
Correspondent.		25-Ohm Telephone Receiver.....	560
Electricity From Earth's Magnetism.....	547	Battery Lead Trays.....	560
Simple Connection Jack Switch.....	547	Electrolytic Depolarization.....	560
Plug From Old Fuses.....	547	Tin Can Batteries.....	560
Rotary Current Rectifier.....	548	Construction of a Small Oudin Coil.....	562
Transformers for 1,000,000 Volts.....	549	Photo-Electric Cells.....	562
By Dr. H. Becher, Frankfurt a/M,		Piezo-Electric Effects.....	562
Germany.		Recuperation of a Dry Cell.....	562
Awards in the \$50 Special Prize Contest		Nickel Plating.....	562
for Junior Electricians and Electrical		Electrolytic Rectifier.....	562
Experimenters:		Ford Spark Coil Phenomenon.....	562
First Prize—Electric Fireless Cooker.....	550		
Second Prize—Chime Clock Light.....	550		
Third Prize—A Tesla Coil Electric Sign.....	550		
Honorable Mention—Sign Flasher.....	550		
Awards in Odd Electrical Experience Con-			
test.....	551		
Electric Bell.....	552		



PRACTICAL ELECTRICS is published on the 15th of each month at 53 Park Place, New York City. There are 12 numbers per year. Subscription price is \$2.00 a year in U. S. and possessions. Canada and foreign countries \$2.50 a year. U. S. coin as well as U. S. stamps accepted (no foreign coin or stamps). Single copies 20 cents each. A sample will be sent gratis on request. Checks and money orders should be drawn to order of PRACTICAL ELECTRICS CO. If you change your address, notify us promptly, in order that copies are not misrouted or lost.

All communications and contributions to this journal should be addressed to: Editor, PRACTICAL ELECTRICS, 53 Park Place, New York. Unaccepted contributions cannot be returned unless full postage has been included.

Published by EXPERIMENTER PUBLISHING CO., INC.

All accepted contributions are paid for on publication. A special rate is paid for novel experiments; good photographs accompanying them are highly desirable. PRACTICAL ELECTRICS, MONTHLY entered as second-class matter October 14, 1921, at the New York Post Office under Act of Congress of March 3, 1919, Title registered at the Patent Office, Copyright, 1922, by PRACTICAL ELECTRICS COMPANY, INC., New York. The contents of this Magazine are copyrighted and must not be reproduced without giving full credit to the publication.

PRACTICAL ELECTRICS is for sale at all news stands in the United States and Canada; also at Brentano's, 37 Avenue de l'Opera, Paris.

H. GERNSBACK, President
 S. GERNSBACK, Treasurer
 General Advertising Department, 53 Park Place, New York City
 Western Advertising Representatives, Finucan & McClure, 720 Cass Street, Chicago, Ill.
 Kansas City Advertising Representative, George F. Dillon, Republic Building, Kansas City, Mo.
 Pacific Coast Advertising Representatives, A. J. Norris Hill Co., Hearst Building, San Francisco, Cal.

(Practical Electrics Co., Inc., owner)
 53 Park Place, N. Y. City
 R. W. DeMOTT, Secretary

Examine this Library for 10 Days Free

WE want to place these books in your hands for 10 days' Free Examination. No expense to you—we pay all the charges—take all the risk.

It is only by seeing them and actually trying them out in your work that you can judge the value of the books to you.

Fill in and mail the coupon below. The books will be sent to you by return mail.



Electrical Maintenance and Repair—

5 volumes—1736 pages—1818 illustrations—library binding

THESE five volumes contain the largest collection of practical methods for electrical repair and maintenance men ever put together in book form.

Every one of the books is jammed from cover to cover with good, sound, how-to-do-it information—the kind you have to have when anything goes wrong.

They cover every phase of electrical repair and maintenance work from armature winding to the correction of brush troubles. And the treatment is always from the practical man's standpoint.

Fundamental laws and rules are discussed when necessary but there is no hard-to-understand theory or discussion of design. All of the material presented in these five books has been obtained from actual experiences. The library outlines the practical remedies that have been applied by repairmen all over the country in the solving of puzzling electrical problems.

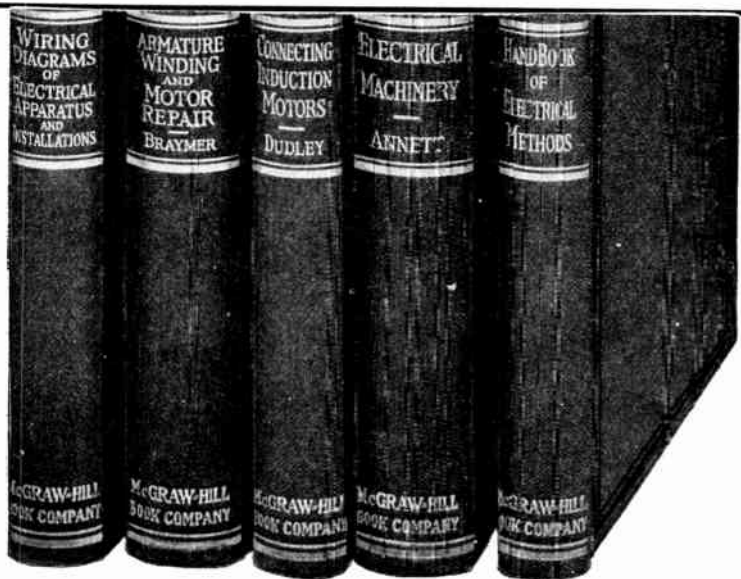

These books tell you

- How to replace commutator segments—
- How to connect an induction motor winding to meet any condition of voltage, phase, frequency and speed—
- How to check this reconnection to know if the motor will operate under the new condition—
- How to draw a diagram for any winding—
- Ten most common defects in windings—
- How to locate defects—
- How to figure a new winding for an old core—
- How frequency affects winding and r.p.m.—
- How performance is affected by a change in winding—
- How to find out what the trouble is when a motor or generator will not run—
- How to remedy the trouble—
- How to keep electrical machines in first-class operating condition—
- How to re-arrange a three-wire system to reduce voltage fluctuations—
- How to test meters—
- How to turn down a commutator—
- How to insert spare transformer in star-delta group—
- How to remove defective field coils—

And hundreds of other practical methods and kinks

Seven good reasons why you should have these books

1. The five books in this library discuss actual repair jobs and show you step by step what to do when anything goes wrong.
2. They show you how to locate and remedy motor and generator troubles.
3. They show you how to reconnect motors to meet any condition of voltage, phase frequency and speed.
4. They give you suggestions for preventing electrical machinery troubles.
5. They cover fully the rewinding of motors.
6. They present information that will help you get better service out of your electrical equipment.
7. They give you tables, data, kinks that you will find of priceless value every day on every job.

—no money in advance
—easy monthly payments

If you keep these books after looking them over send us \$2.00 in ten days. The balance may be paid in monthly instalments of \$2.00 until the price of the library—\$14.00—is paid. Send for the books today. Fill in and mail the coupon. No money down—no agents. You simply agree to return the books, postpaid, in ten days or remit for them on our convenient monthly payment plan.

McGraw - Hill
Book Co., Inc.,
370 Seventh Ave.,
New York.

Gentlemen:

Send me the LIBRARY OF ELECTRICAL MAINTENANCE AND REPAIR (shipping charges prepaid), for 10 days' free examination. If satisfactory, I will send \$2.00 in ten days and \$2 per month until the special price of \$14.00 has been paid. If not wanted, I will write you for return shipping instructions. (Write plainly and fill in all lines.)

Name

Home Address

City and State.....

Employed By

Occupation.....

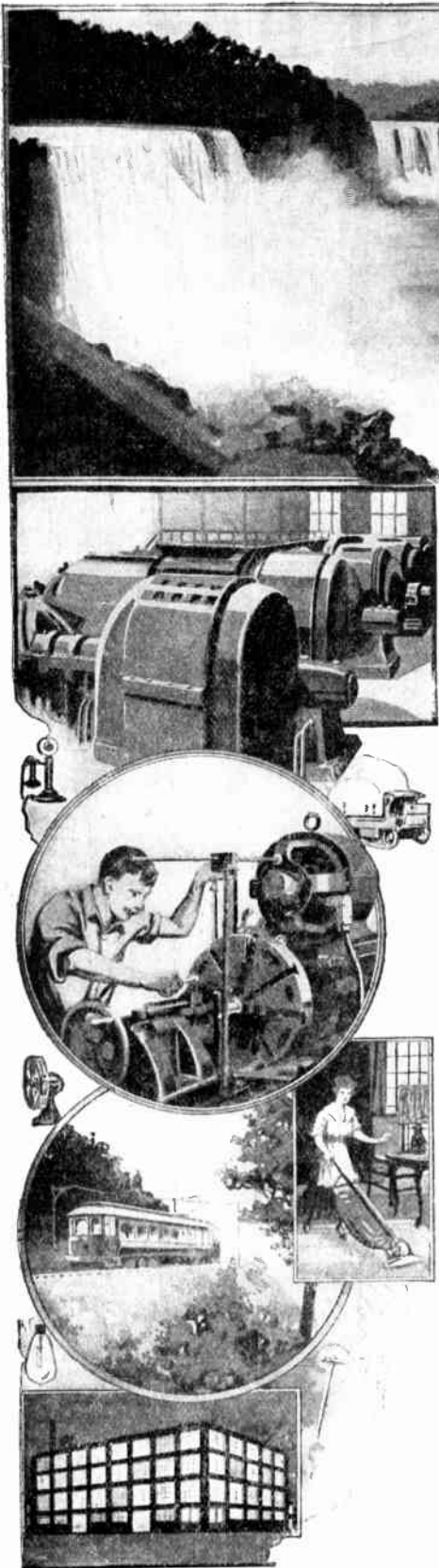

Master Electricity By Actual Practice

The only way you can become an expert is by doing the very work under competent instructors, which you will be called upon to do later on. In other words, *learn by doing*. That is the method of the New York Electrical School.

Five minutes of actual practice properly directed is worth more to a man than years and years of book study. Indeed, Actual Practice is the only training of value, and graduates of New York Electrical School have proved themselves to be the only men that are fully qualified to satisfy EVERY demand of the Electrical Profession.

The Only Institution of the Kind in America

At this "Learn by Doing" School a man acquires the art of Electrical Drafting; the best business methods and experience in Electrical Contracting, together with the skill to install, operate and maintain all systems for producing, transmitting and using electricity. A school for Old and Young. Individual instruction.

Over 8,000 Graduates are Successful Men in the Electrical World

No previous knowledge of electricity, mechanics or mathematics is necessary to take this electrical course. You can begin the course now and by steady application prepare yourself in a short time. You will be taught by practical electrical experts with actual apparatus, under actual conditions.

The N. Y. E. S. gives a *special* Automobile Ignition Course as an advanced training for Auto Mechanics, Garage Men and Car Owners. The course covers completely all Systems of Ignition, Starters, Lighting and other electrical equipment on automobiles, motor boats, airplanes, etc.

Let us explain our complete courses to you in person. If you can't call, send now for 64-page book—it's FREE to you.

New York Electrical School

31 West 17th Street, New York

New York Electrical School
31 W. 17th St., New York, N. Y.

Please send FREE and without obligation to me your 64-page book.

..... NAME
..... STREET
..... CITY STATE

H. Gernsback, Editor and Publisher

T. O'Connor Sloane, Ph.D., Associate Editor

Electric Fish Net

SOME things improve with time and others do not. A device which has not improved to any great extent is the fishing-net. This implement was used thousands of years ago.

The illustration shows a radical departure in fishing-nets. This net, practically invisible, is plainly shown in the picture. It is nothing more than a wall of electricity, in the shape of an inverted cone. The electric current passes from the metal ball at the apex of the cone to its base, a metal ring floated at the surface.

The ball is lowered to a suitable depth and is left there until the fish arrive.

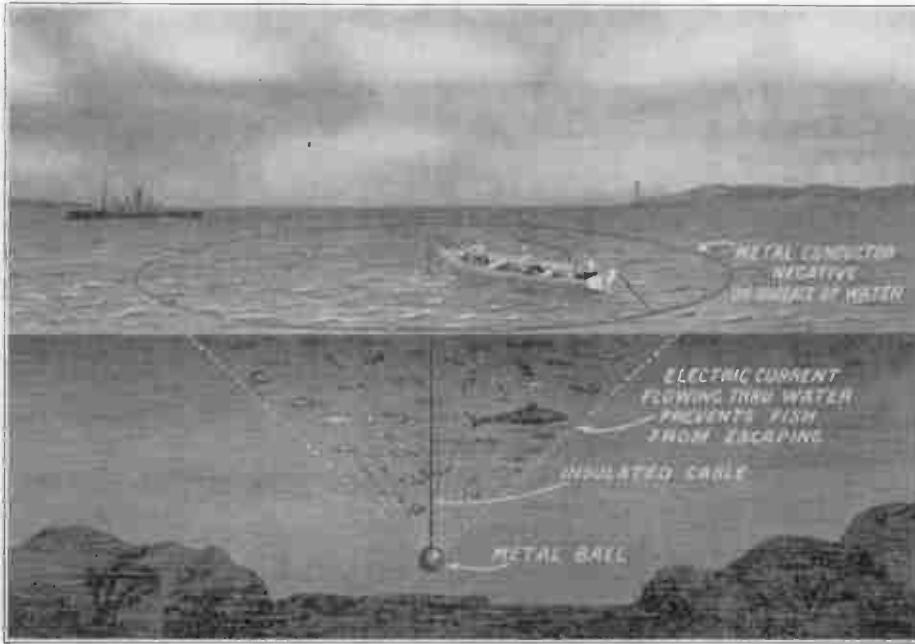

Then the electric current is turned on. The result is that all of the fish that are within the electric cone are surrounded by a wall of electricity, through which they will not attempt to pass. Now the ball

An electrical fish net. The problem is, whether the meshes are small enough to prevent fishes from escaping.

is slowly pulled up toward the surface, thus closing the net in on the fish and forcing them to the surface. The fish are either picked up with a scoop net and dropped into the boat, or the current may be increased until the shocks stun the fish and they float lifeless.

Study of Home Economics in Washington

Artificial Lightning for Moving Pictures

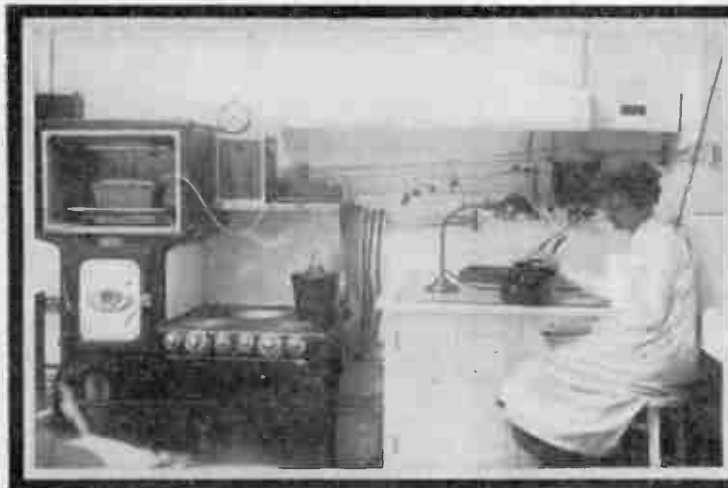

Above: What the United States is doing for the housewife, studying with electrical apparatus the making of bread. Right: A simple apparatus for producing sheet-lightning for use in moving pictures.

THE United States Department of Agriculture has organized a bureau or division of Home Economics. In this division technical investigation of the work of the home, of the housewife and housekeeper, is scientifically investigated and the results are applied to acquiring a more intelligent conception of these operations than has hitherto prevailed.

All the processes of cookery even today are accomplished principally on a rule of thumb basis, and it is the amount of personal ability of the operator rather than

any scientific carrying out of the process which governs the results.

Especially in studying the temperature question, electricity conduces to the formulation of methods, for the heat question is the all important one in bread making. Heat regulating affects the rising of the dough, whether yeast-raised or raised by baking powders, and also affects the relation of crust to crumb, a slow heat giving a lighter crust and a more evenly baked interior, while the strong, dark crust, with almost slack

baked material within, would be given by a higher heat suddenly applied. It is such points as these of the baking action which have to be determined and reduced to a basis, so that the baking of good bread will be a certainty in the household, and no longer a matter of chance, as unfortunately has been too often the case in the past.

OUR illustration shows a very simple apparatus for giving the effect of

sheet lightning in the photography of moving pictures.

We have already described the work done in the production of electric discharges at high voltage in the experimental laboratories of some of the great electric companies. But here we have a far different thing, not the "forked lightning" of the story tellers, but the general illumination due to the less startling discharge.

What is wanted for the moving pic-

tures is a great flash of light, and that is obtained by the production of a great arc at the desired instant. Referring to the picture, we see a bunch of carbons packed together and carried on the end of an upright post. A pivoted arm can be swung up so as to bring a single carbon which it carries into contact with the bunch of carbons on the fixed standard.

When one lead of the circuit is connected to the bunch of carbons on the standard, and the other to the single car-

bon carried on the pivoted arm, if the current is on, all is ready for the flash. To produce it, the pivoted arm is swung up so that the carbon comes in full contact with the bunch on the upright, and the current starts to go through. Then by releasing the pivoted arm the arc is drawn out and the brilliant flash is produced, giving the exact effect of sheet lightning. Pulling the cord swings the arm in towards the standard so as to make the contact.

Electric Bell Ringing

By Lucien Fournier

Paris Correspondent

(Abstract)

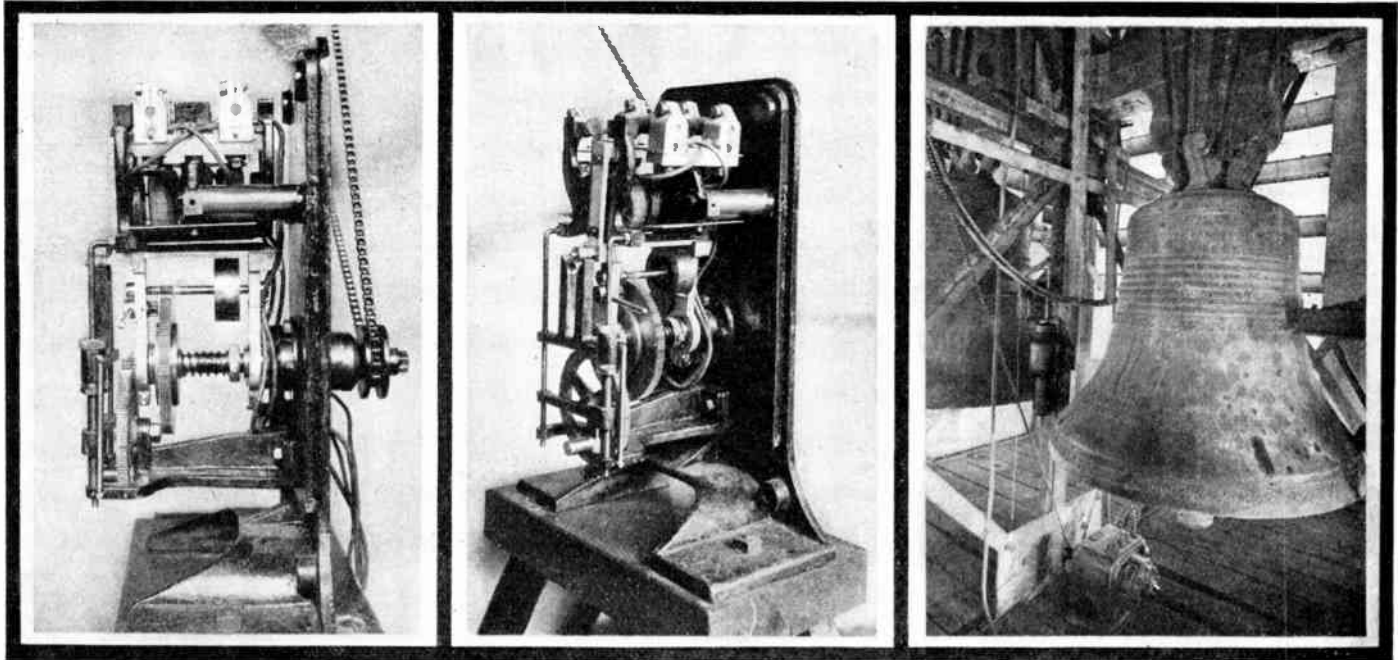

Electric machinery for ringing the large church and cathedral bells. They are rung by two methods; the one by swinging the bell itself, the other by causing a heavy hammer to impinge upon the bell at the proper place. The point of impact is of extreme importance, affecting the note given. It is all wholly operated by electricity; throwing the switch causes the chimes to peal out. The swinging bell is swung by an endless chain and another chain connection reverses the motor for the return stroke.

FOR what the French call ringing *en volée*, which means swinging a great bell to and fro, there is keyed on a shaft which carries the bell a large chain-gear pulley, and the chain belt connects it to an electric motor below. If the motor turns, it will swing the bell, direction depending upon its own direction of motion. Now the bell has to swing back and forward, therefore if it is to be operated by the one chain belt, it is obvious that the direction of the motor has to be reversed for each swing. Accordingly, there is a smaller pulley connected to the bell, and this, by a chain, operates a current changer which reverses the motor for each swing of the bell. As the bell swings, this chain causes a frame carrying four carbon brushes to oscillate, effecting two different contacts, one contact causes the motor to turn clockwise, the other causes it to turn in the reverse direction.

The bell pealing out notes acts as a commutating element or mechanism for the motor. It will be seen that the brush contact will not be for the entire time of a swing, but there will be a period when no current will pass. The effect of this is that the motor is not only supplied with current in constantly changing directions, but that part of the time it is left without any current at all. In this way a comparatively small expenditure of power keeps the bell ringing. When the bell is in fullest possible motion, going

each time to the end of its swing, this reduction and cutting off of the current is greatest in amount.

The bell need not be swung, for there is another way of giving a stroke which consists in striking the bell near its rim, with a special hammer or tongue. This will operate on a motionless bell—some are rung only in this way and never move. This last system the French term *en tintement*.

Both kinds of strokes can be given simultaneously, as we may express it, while the bell is ringing. In all great installations there are a number of bells, each with its own note, and some of the bells may be rung by external hammers; these can be governed by the same motor, which operates the swinging bell by a chain connection. The timing is so arranged that the stroke *en tintement* is given to the other bell, when the swinging bell is at the bottom of its course, so that the second stationary bell gives its sound by a stroke exactly half way between the two strokes of the swinging bell.

The connections for three bells may be so arranged that as the swinging bell reaches the lowest point of its course in one direction the one fixed bell shall be struck by its hammer, and on the return swing the other fixed bell shall be struck. This gives one ringing *en volée*, and two ringings *en tintement*, employing three bells.

Our author cites a case of tolling for

the dead with three bells, tuned to do, mi and sol. The do bell is arranged to swing, while the mi and sol bells are motionless and are struck each by its hammer. This will give, he says, the following succession of notes, carrying out the successive action we have just described. The swinging bell gives do; when its return swing is half completed the note mi is struck on its own bell; the swinging bell completes its stroke and gives do again. On the return swing in the reverse direction the sol bell is struck, giving that note. It will be seen that this succession will be repeated over and over again, as long as the motor runs. Each of the bells struck by the hammer blows has its own motor for actuating the hammer. These motors are brought successively into action as described above.

Our author remarks upon the certainty of the disappearance of the famous bell ringers of older times, who cannot compete with what he calls the fairy—electricity. He says that we will no longer see in our bell towers the traditional bell ringers pulling the bell ropes with all their power. A small electric motor will do the work as well, or even better. The parochial officials will thus be enabled to ring the bells in any desired way, from the sacristy or even from their homes. The turning of a switch will start the bells into action.

If the wire is cut the "curfew will not ring tonight."

Living Electric Batteries

By Harry Van Demark

Of all the wonders which have perplexed the wise men of the world, the origin of the mysterious electric current is probably the greatest. Sec-

The eel is not the only denizen of the deep to be safeguarded by powerful electric batteries. There is the torpedo ray, or skate, which looks like a three-cornered

kite with a long tail, equally dangerous to handle without rubber gloves. There are also several quite unrelated fishes which possess the extraordinary property

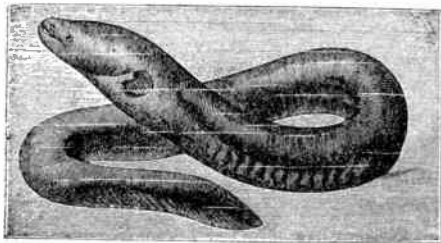

The Electric Eel of South America can give a most severe shock when fresh.

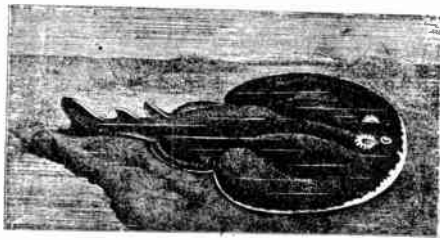

The Torpedo is very dangerous for bathers.

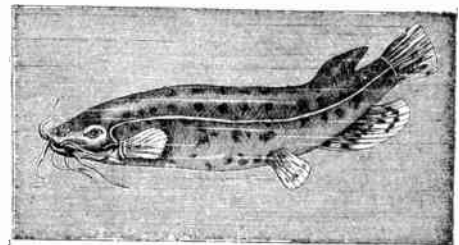

An Arabian fish found in the Nile, the Electric Catfish.

ond only to its baffling secret are the marvelous and astonishing living batteries of certain fishes which have the magical power of producing their own electricity at will and in quantities large enough to make them dangerous customers to meet.

These animated "induction coils" in the shape of fishes inhabit various parts of the seven seas, and although scientists have studied them assiduously for years, their secrets are still hidden in the microscopic cells of their electrical organs.

Foremost among these piscatorial dynamos is the electric eel of the brackish waters of South America. This eel is not unlike the common river eel familiar to everyone. It grows to the astonishing length of six and seven feet, but the average specimens of this species are about four feet long.

This eel is nothing more than a fish in an extended and elongated form, and possesses a powerful electric battery near the tail with which it stuns its prey and drives away its natural enemies. Few denizens of the deep, large or small, would relish a second encounter with an electric eel. When attacked it merely claps its "live-wire" caudal appendage against its enemy and presses the button.

The victim instantly gets a powerful shock of electricity which is strong enough to knock a man down.

Scientists who have dissected these eels to discover "the reason" have been defied. They found that the electrical organs consist of two pairs of longitudinal organs located between the skin and the muscles of the caudal region, composed of 240 cells and supplied by more than 200 nerves.

The eel can discharge current enough to kill an animal of considerable size, and can easily knock down a man or horse. After a few consecutive shocks the battery is exhausted and the eel has to retire to a nearby mud-bank to rest so that he can generate a new supply. In an hour or two he is ready for the next victim.

This eel is very good to eat, but no one cares to take them off the hooks, so the common way to catch them is to drive horses into the bayous where they are known to be plentiful. The eels attack the horses and quickly exhaust their batteries. When they are powerless to do any further electrocution they are speared by the natives. Not infrequently horses are lost in this manner of fishing.

\$12,000.00 IN PRIZES FOR PICTURES

SCIENCE AND INVENTION for the coming year will pay at the rate of \$1,000 in gold for pictures or suggestions for pictures each and every month, a total of \$12,000 for twelve months.

"Science and Invention," beginning with the October issue, will contain *three times as much matter* as heretofore, presented to you in entirely new manner.

Don't miss this big issue.

List of Electrical Articles in October "Science and Invention"

- Electric Power from the World's Largest Falls — Many times greater than that now obtained at Niagara.
- Electric Apparatus for Locating Icebergs.
- By Dr. Neuburger.
- Electric and Pneumatic Machinery Speeds Modern Building Construction.
- Sound from Airplane Attracts New Aerial Torpedoes.
- By Raymond F. Yates.
- Electricity from New Solar Power Plant.
- By Dr. Becher.
- New Suspended Electric Railway.
- Radio Controlled Torpedoes for Future Wars.
- By Graser Schornstheimer.
- Besides a Host of Radio Constructor Articles.

of communicating an electric shock to animals with which they come in contact.

In all cases the electric organs are modifications of muscular tissues, looking like a mass of closely packed prisms, each divided into a series of compartments filled with a gelatinous substance. The whole is like a group of voltaic piles.

The electric ray has its batteries located near the head. They are supplied with energy from large nerves proceeding from the brain. The ray is an ugly customer and can give as much trouble as the electric eel. A man receiving a shock from a large ray will remember it for a long time, if, indeed, it does not kill him outright.

Even the little rays can give quite a shock when molested. The electric ray is a member of the skate family, and most skates can produce more or less electricity, but the ray is the only one of this species which is dangerous to handle.

Then there is the electric catfish from the Nile, which carries around a powerful storage battery concealed under its skin next to the muscles. This battery is a layer or blanket of electric cells covering most of the body. The charge can be delivered at will, and is quite powerful, but, as the fish never attains large proportions, its shock is not dangerous to anything except small animals.

While all the fish mentioned above are capable of producing electricity for hunting and defensive purposes, not one of them utilizes the current for electric lighting. And yet, strange as it may seem, there are plenty of other fishes who do use electricity produced by themselves for this very purpose.

Not until the last eight or ten years has any attempt been made to investigate the

life of the deeper parts of the ocean. But the trawls and dragnets suspended a mile under the water, where it is necessarily total darkness all the time, reveal a multitude of small fishes each equipped with an electric light. Without this light they would, of course, be unable to see at all at that great depth where the sunlight can never penetrate. The nets bring up a host of these small fishes, and in nearly every case they are equipped with the brightest eyes and little individual lanterns to light their way along the dark pathways of the deep.

No man knows just how the electricity for this light is produced.

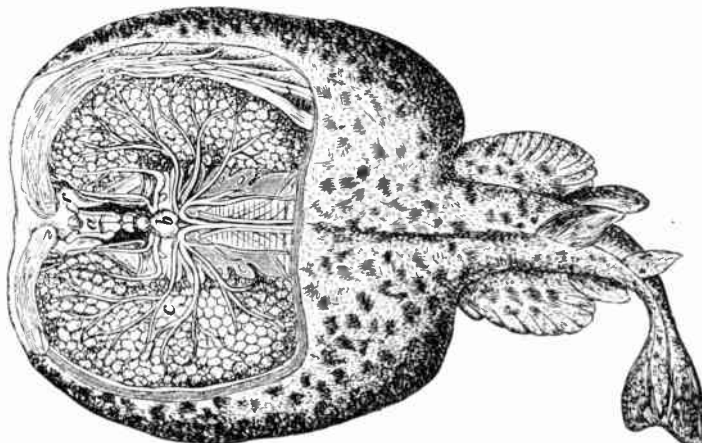

Electric shocking organs of the Torpedo. One of Nature's mysteries.



New Things Electric

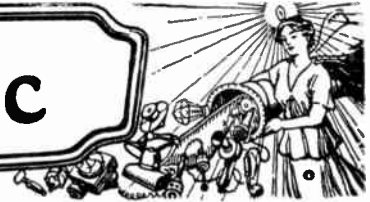

Household Motor and Bottle Washer

THE illustrations show a small motor for household use. As will be seen, there is connected to its shaft a brush for washing out milk bottles, Mason jars and the like. But, of course, by using various appliances, it can be adapted for different kinds of work.

One illustration shows the apparatus complete, while the second shows a rather interesting demonstration in which the motor with brush is immersed in an aquarium filled with water, in which it rotates. The action of the water on the filaments of the brush demonstrates its activity pictorially, because the reader will see how they are bent about by their rotation.

In using the apparatus for washing bottles and the like, the motor is mounted so that the brush will rotate over a tub or a sink. The bottle is filled about half full of water. The effect of the rapid rotation is to drive the water to the periphery of the brush by centrifugal force, so that as long as the motor is in action the water acts upon the interior of the bottle, giving absolutely positive cleaning. The process is much faster than hand work.

For small work a small motor is made. The larger one is a 1/4-horse-

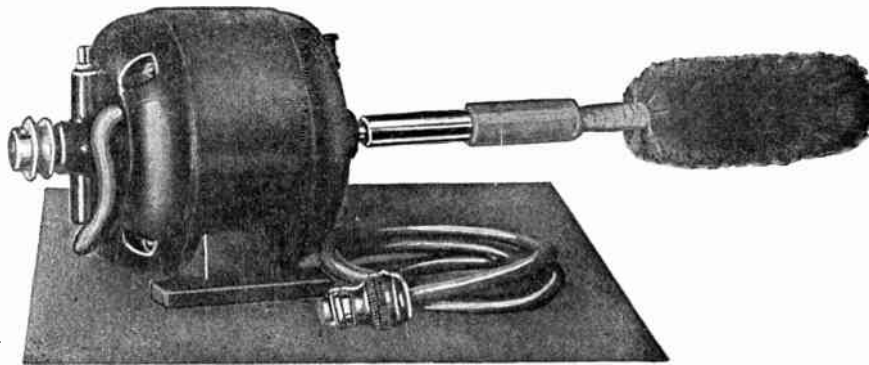

A motor carrying a horizontal brush, designed for washing milk bottles, preserve jars and the like. The apparatus is quite waterproof.

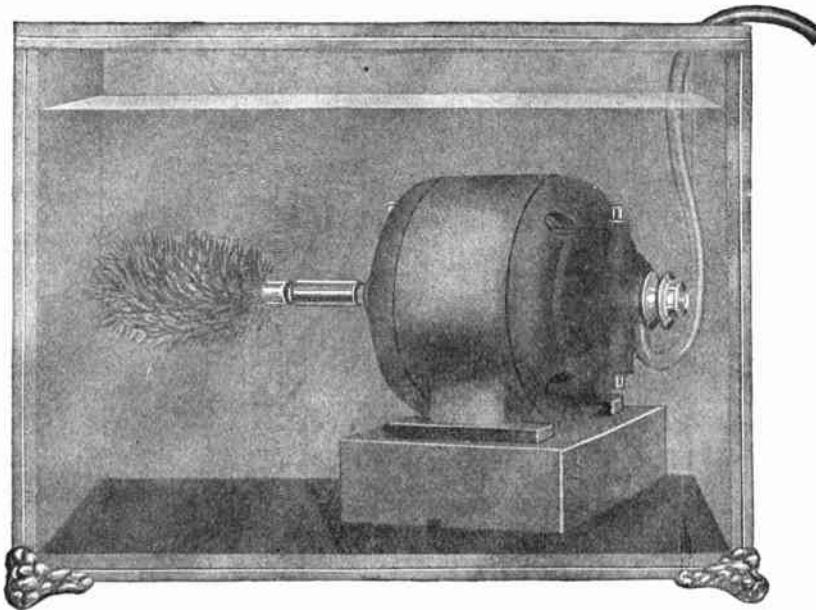

Demonstration of the waterproof quality of this motor, in which the whole apparatus is immersed in a tank of water and rotated therein at high speed.

power capacity, so that it represents a consumption of power between that used by one and by two 16-watt lamps. The waterproof feature is rather interesting, as of course in cleaning bottles water will be everywhere present, and a motor not waterproof would be quite unavailable for such purposes.

Sometimes for the adequate cleaning of bottles a more severe treatment than that of simple water or even soap and water is required. An old system was to shake lead shot along with water in the bottle and it will be seen that this brush can have its action greatly reinforced by the use of such adjunct to its operations. Great care must be exercised if lead shot are used, to see that every particle is removed so that no poisonous lead salt can ever be produced. Sand, which is perfectly safe, could be used for extreme cases. Other things than bottles have to be cleaned and for knives, more or less flat articles, a wheel made of discs of cotton or canton flannel can be attached to the spindle. Other uses in the household for such an apparatus may be left to the fertile imagination of the housekeeper, who is becoming quite adept in electricity.

Slow Extinguishing Lamp

TO cause a light to remain bright for a short period after the switch is turned off, the following device, involving the principle of the sand-glass or hour-glass, is suggested by a correspondent of one of our contemporaries, *Die Umschau*.

Upon the shaft of a switch (a, b, b), of standard construction, a container of hour-glass shape is mounted. It is made of some insulating material such as glass, and is partly filled with metal filings, small steel balls or some finely divided conducting material. Terminals are soldered or cemented into and through the glass. These may be ends of copper wires. There is no question of air-tight sealing. If these ends are in electrical contact with each other they will connect (e, c) and (f, g) even if the switch is turned off. The filings normally lie in the lower part of the container (d) when the switch is open or closed.

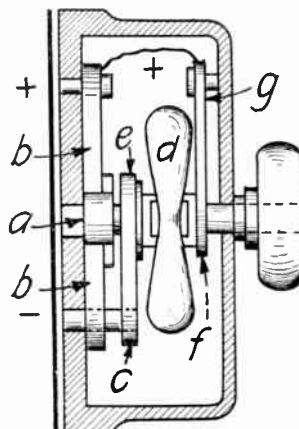

Suppose the switch to be closed and current passing. If it is turned off through 180 degrees, the container will be reversed and the filings will close the gap between the wire ends, and current will

Very ingenious slow-extinguishing lamp, operating on the principle of the well-known sand glass. The "sand" has, however, to be an electric conductor. Fine shot, carefully assorted steel filings, or the smallest size of steel ball may be used.

continue to pass. But the filings keep passing down in a stream into the lower division of the container, and as they finally pass completely down, the circuit is opened and the current is cut off.

By varying the proportions of the container, the delay in action of the switch may be made long or short as desired.

Electricity in Poultry Industry

By George Ballard Bowers and S. R. Winters

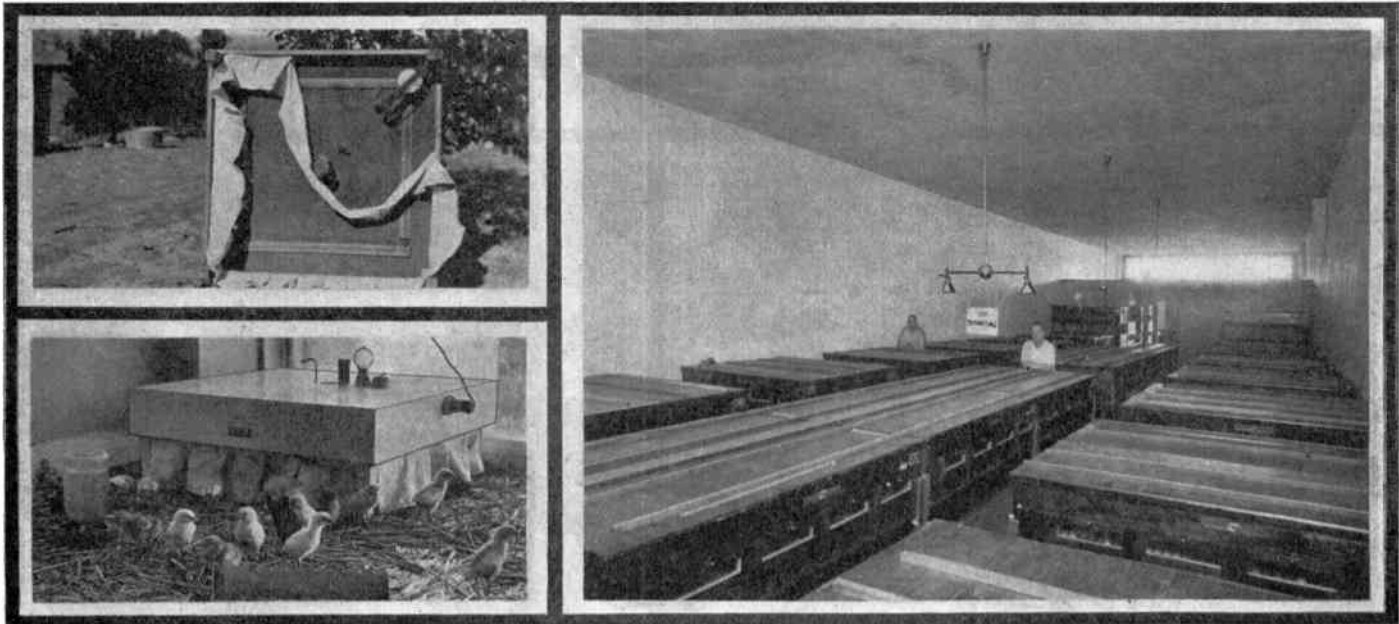

Electric poultry raising. Left, below is seen a brooder closed in with its curtains; left, above a brooder is raised on edge to show the interior. On the right are shown the great hatching incubators, operated by electricity like the brooder, putting the industry on a thoroughly electrical basis.

WHEREVER the poultry industry is engaged in as a livelihood, electricity has been found an indispensable aid. One reason for electricity being preferable in fuel systems is the reduced fire hazard.

Eggs are now most economically hatched in incubators heated by electricity. As a rule the large commercial hatcheries have incubators of 500-egg capacity, in order to eliminate the possibility of losing many eggs in case of accident to a regulator. The heat required to cause germination radiates from electrically heated coils over the eggs, controlled by an automatic thermostat. Incubators are opened daily to permit cooling and turning the eggs.

At intervals of a week the eggs are tested to determine their fertility or the vitality of the growing embryos. This operation is performed by means of a sort of periscope with an electric light within. The light rays penetrate the egg shell so as to disclose the interior, enabling the operator to determine at a glance which are the infertile eggs; those with dead germs are discarded. For this operation the eggs are not removed from the trays, as is necessary when "candled" by the old method. The entire tray is intersected in fifteen seconds. To forestall any interruption in the current the hatchery attendant has an alarm gong to warn him if the current fails, so repairs may be made, before the incubators have cooled.

Chicken eggs require three weeks to hatch. The baby chicks are not disturbed until they are at least 48 hours old, for it would be detrimental to give them either food or drink before that time has elapsed. As soon as the chicks are removed from the incubator, they are placed under an electrically heated brooder with an automatically regulated heat regulator such as that of the incubator.

a light under the brooder. This light is to be used to entice the chicks under. When night begins to fall the chicks seek light, and when they are under the brooder the light is turned off. This interior light is useful for inspecting chicks at night.

The brooder is started at 100 degrees F. and after the second day cut down gradually a degree each day.

The brooder is blocked up an inch after the first week and thereafter as needed.

Before leaving the brooder at night the pilot light should be unscrewed a trifle so that its light will not disturb the chicks under the hover of the brooder.

Six weeks old chicks no longer require the brooder but are not yet through with electricity if winter is on. The pullets must be brought to maturity and laying as quickly as possible. To accomplish this end the young pullets are fed frequently. In the winter, the young hens neither grow rapidly nor are in a laying mood, so electric lights are installed in the hen house and yards. If the house and yard grows light suddenly at four A. M., electric light being turned

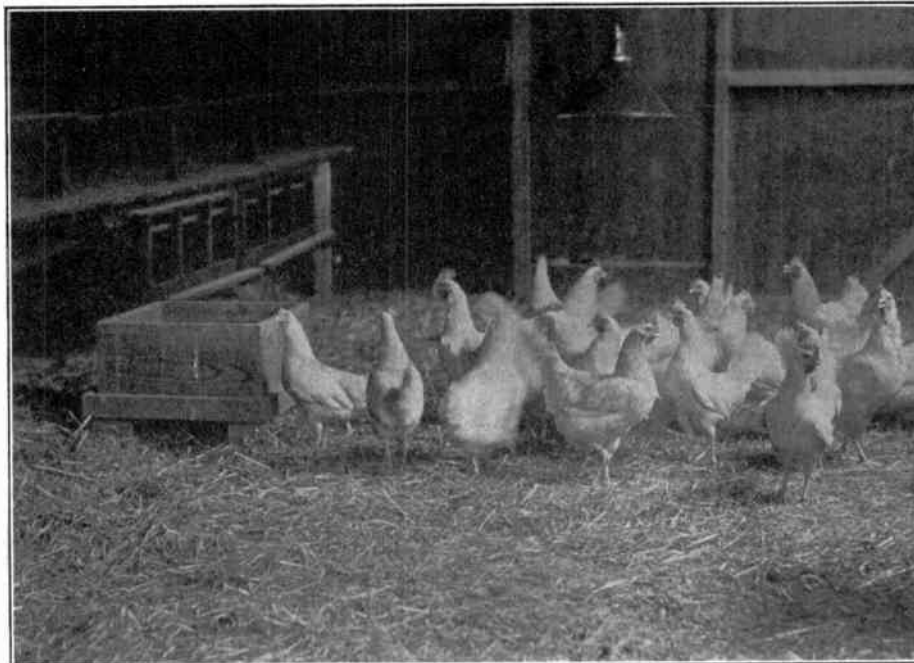

View of the Federal Government's experimental chicken house, in which the effects of electric light on poultry products is being tried out.

Some rules follow, as examples of instruction for inexperienced attendants. A pilot light on top of the brooder lights only when the brooder is heated to 100 degrees F. To increase the heat the handle is turned to the right; to decrease, to the left.

A switch on top of the brooder turns on

on by a clock, the stupid hens think it is daybreak and leave the roost to search for food.

At Beltsville, Maryland, approximately a dozen miles from the White House—the Federal Government, Department of Agriculture, maintains a 60-acre experimental chicken farm, containing a flock of poultry

varying in numbers from 4,000 to 4,500. Here, for the past two years, a flock of fifty pullets have had their waking hours extended by an electric light during the fall and winter months. These hens, responsive to this modern convenience, yield fifty dozen more eggs than the same num-

ber of pullets that went to roost and woke at normal hours. This increased contribution to the egg basket occurred during the first year of the experiment. In the course of the succeeding year the pullets in the electrically-lighted pen yielded sixty dozen more eggs than a like number of hens

whose pen was unlighted electrically. The above lighting system was in operation from November 1 to March 20. One 75-watt incandescent electric light bulb hung in the pen where these fifty pullets roosted. It was operated two and one-half hours daily for 140 days.

New York's Electric Map

Electric Welder

Spark Plug Core Insulator

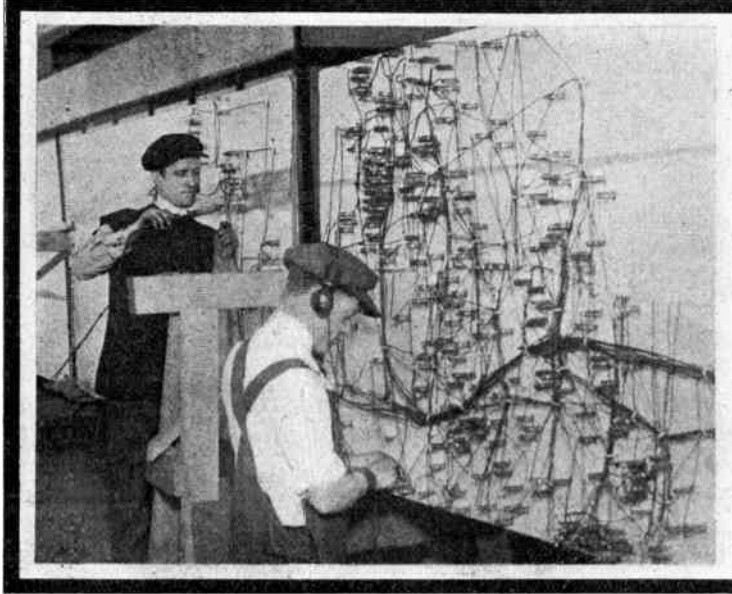

Above—Wiring up the great electric map of New York, which was seen and studied by so many at the Jubilee Exhibition of New York City.

Right—A lady electric welder, doing work of a type generally restricted to men; in our issue of January, 1923, will be found a very elaborate description of the art practiced by this representative of the trade.

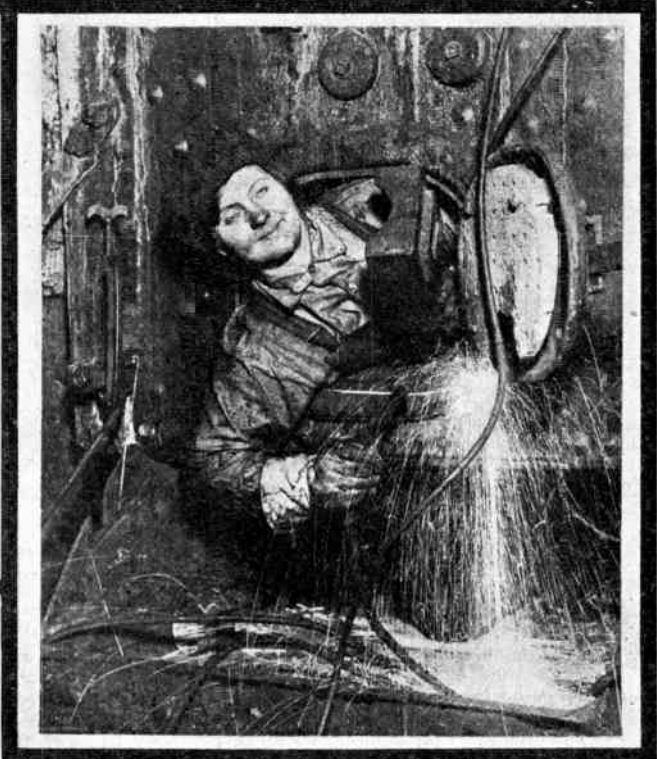

A JUBILEE of the great metropolis of America was opened on the 26th of May of the present year, and a most interesting feature undoubtedly is an exposition of the work of the different city departments, now very numerous and very elaborately organized, and comprising relics of the past as well as present achievements. Statistical exhibits of all kinds of apparatus used by the scientists of the different departments, sample exhibits from the Metropolitan Museum of Art, the American Museum of Natural History, and the like, are included.

Above is shown the preparation of the great map, one of the most elaborate exhibits presented. This map is laid out on a scale of 400 feet to the inch, and the structure was designed by Thomas W. Rochester, E.E., one of the city engineers, and was built by the Croker Electric Company of this city.

There are a multiplicity of small-sized electric lights distributed over the surface of the map, which are turned on and off by a flasher, while at the side there is a directory of some thirty titles. When the directory shows Health Department, lights are turned on, one for each of the buildings, offices or laboratories of that department. When these are extinguished, another series of lights appear; if they are for the Police Department, they are green, and show the exact location of each station house and building under the police jurisdiction. A number of red lights are flashed on in their turn, indicating the multiplicity of buildings of the Fire Department. Each set of lights is turned on for a very short period to give the observer a conception of our municipal government.

Our illustration shows the wiring of the board by the electricians.

THE welder we refer to is neither a man nor a machine, but is a member of the weaker sex, who irrespective of equal rights and universal suffrage, has shown the good that is in her and her true ability by becoming one of the best electric welders in the country.

Some assert that she is perhaps the very best of all, and it is claimed that she is called upon for jobs, which men have refused to take as being too difficult or too dangerous.

This exemplary person did her first and foremost duty to the world when at about seventeen years of age she married. This was in Denmark, where her husband had a garage, and there she used to assist him and learned the mechanic's trade. Her husband died and she became a stewardess on an ocean liner, but eventually settled in America.

Availing herself of her knowledge of machinery, she obtained some kind of a machinist's position in the Erie Railroad shops, and very naturally became attracted to electric welding, with its great possibilities. She now devotes all her time to electric welding, and the photograph which we present is supposed to show her at work. The remuneration for this class of work is sometimes very high. In boiler work and the like very small manholes have to be passed through and apparently inaccessible places have to be got at, and there is no doubt that part of Mrs. Nelson's success is due to her ability in getting at such difficult places.

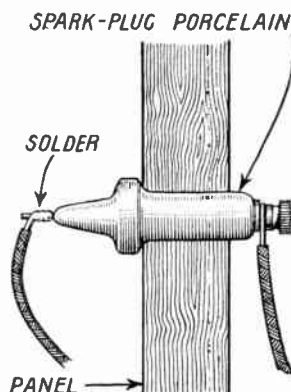

Porcelain core from an old spark plug is used to provide a well insulated entrance for an electric wire to a house. It is also suggested that it may provide a useful form of binding post.

THE porcelain core of an old spark plug contains one of the electrodes running through its axis or center. This is the universal construction. Such may be used as an insulator or binding post.

When an electric lead-in comes through the frame of the window, or some other place, one of these plug cores makes not only a very neat looking job, but leaves an air-tight construction. It is much better practice than to have the wire come through the window glass, because this is a hindrance when raising the window.

These cores also make excellent binding posts, particularly for the amateur doing high voltage work.

To mount the core, drill a hole a trifle smaller than the neck of the core into the panel. Then force the core in and up to the shoulder. Solder the wire to the sparking end of the electrode, and use the other end as a binding post.

Contributed by RAYMOND CARLSON.

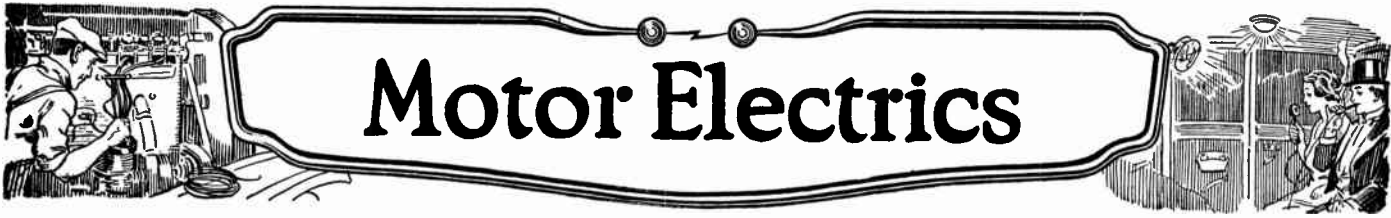

Motor Electrics

Spark Plug Tester

THIS spark plug tester, though simple in construction, will be found a handy instrument to have on the dashboard of any car.

A piece of wood 1 inch thick serves to mount the tester and selective switch upon. It can be cut in any desired shape or can be left square.

A hole (A) is drilled in the mounting block so that a spark plug tester of the Westinghouse type can be inserted therein. Next a hole is bored in the center of the lower circle of the board, with a bit having a radius of 1 3/4 inches. The edge of this hole should touch the bottom of hole (C) shown in the diagram.

A selective switch, 4, 6, 8 or 12 point, is mounted on the front of the block so that

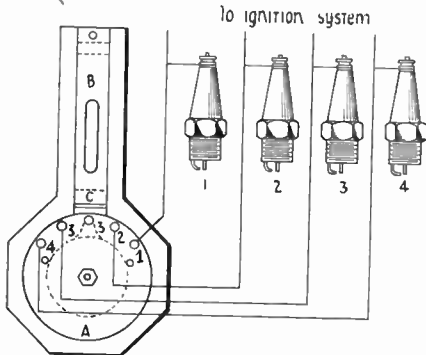

A neon or similar type of spark plug tester is mounted so as to be thrown into circuit with any desired plug to test its condition.

its center will come at the center of the large hole in the rear of the mounting block.

The diagram shows the wiring of the tester very plainly. The switch is placed on the point connected to a plug and the tester indicates whether the plug is in good condition and if it is connected.

Contributed by HOWARD E. EARL.

Silent Auto Alarm

By PHILIPPE A. JUDD

THE alarm herein described operates on the principle of the effect of a colored light upon a complementary color, and though the thief is unaware of the fact, it indicates to any observer that the car is stolen property.

The device consists of a metal reflector (1) (Fig. 4), on the front of which a frame (3) is hinged at (8). Two lamp receptacles (7) are mounted on the reflector.

The frame carries a glass plate (5) of the same dimensions as the license plate. The window thus formed is painted on the outside (Fig. 1), in duplication of the license plate, using a semi-opaque white for a background (A) and a transparent red for the figures (B). On the inside (Fig. 2) the letters "Stolen" (C) are painted with a transparent blue. The letters must be reversed so that they may be read from the outside. A piece of stiff spring wire is bent so that it will hold the glass in the frame (4) (Fig. 4).

A bolt (6) is soldered to the reflector to hold the door closed. The two lamps (2), only one being shown, one blue and one red, are placed in the receptacles (7). (They may be dipped in the paint used on the glass window.)

After painting the outside of the box to harmonize with the car, it is mounted in the place formerly occupied by the rear license plate.

One lead (G) (Fig. 5) from each lamp is grounded through the body of the car to the battery; the other two wires (R and B) are connected to a three-spring jack mounted on the dashboard. The third wire (S) from the jack completes the circuit to the battery through the ignition switch, lamp switch, or both. A thermo-flasher may be placed in the red lamp

circuit, so that it will attract more attention by flashing intermittently.

When the car is in use the plug is inserted in the jack, thus lighting the blue lamp and causing the license to appear as black figures on a blue field.

The plug is removed upon leaving the car, so that the would-be thief, upon closing the ignition or lamp switch, completes the circuit through the red lamp. The background becomes red; the red license numbers, being invisible on a red field, disappear, their place being taken by the word "Stolen" in large black letters.

Fig. 6 illustrates how the reflector and door are constructed. All joints should be soldered.

We Pay One Cent a Word

WE want good electrical articles on various subjects, and here is your chance to make some easy money. We will pay one cent a word upon publication for all accepted articles. If you have performed any novel experiments, if you see anything new electrical, if you know of some new electrical stunt be sure to let us hear from you. Articles with good photographs are particularly desirable. Write legibly, in ink, and on one side of the paper only.

EDITOR.

Magnetic Trouble Light

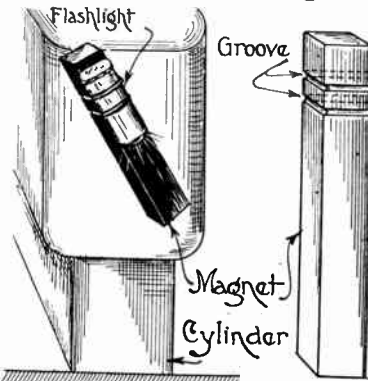

A bar-magnet carries a flashlight, battery and case so that it can be attached to any iron or steel part of an automobile to light up operations in the dark.

A TROUBLE lamp for use around an automobile is a practical necessity and its usefulness is increased by having an electromagnet attached to its base so that the lamp can be attached by magnetic attraction to any iron part of the car. This allows freedom of both hands for repairing. The usual fault encountered with a trouble lamp of this type is the long electric cord necessary, as considerable time is wasted in coiling and uncoiling the cord; this is especially annoying when the trouble happens to be only a loose nut to be tightened or other simple repairs.

The trouble lamp described in this article will not give as much light as the regular trouble lamp, but for illuminating close places is perfect. It is made by cutting two narrow slots, two or three inches apart, across a strong four or five inch bar magnet. To the bar magnet attach a very small flashlight by wrapping two short pieces of wire around both; the wires must lie in the slots, which are cut on the side of the magnet opposite the flashlight, so that the surface on that side will be smooth.

To use, lay the smooth side of the magnet against the iron parts of the car, directing the light where needed. The magnetism in a new bar magnet should be serviceable for several months, and then it can be remagnetized very easily. The flashlight, preferably, should be on the order of a fountain pen flashlight.

Another method of fastening the flashlight to the bar magnet is to use a springy U-shaped clamp which will allow the flashlight to be removed easily.

Contributed by H. P. CLAY.

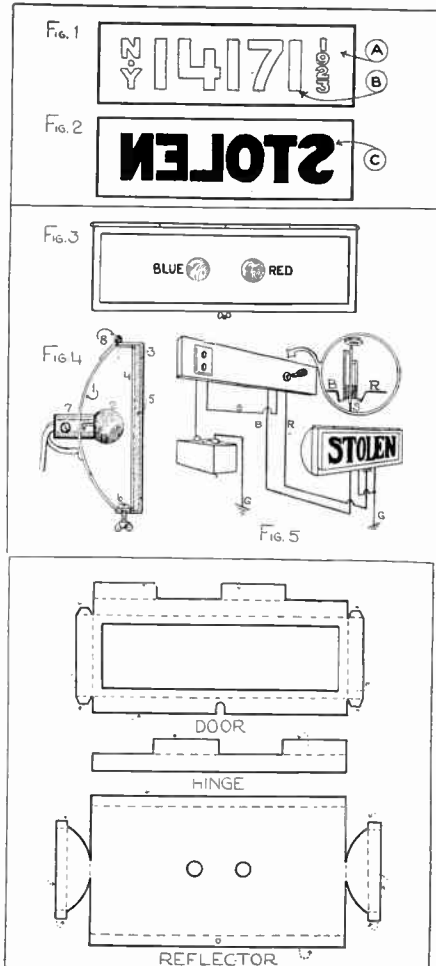

The general effect, the details of wiring and connections, and the lay-out of the case for a theft-preventive appliance for motor cars.



Thermic Telephones

THE experiments of Preece and Forbes have long ago proved that in changing the temperature of incandescent bodies, particularly of metallic wires, it is possible to produce

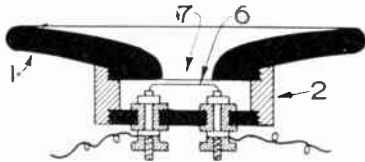

Fig. 1. A straight wire thermic telephone with outside ear-piece.

telephonic and microphonic effects in synchronism with acoustic vibrations; yet it is only lately that practical apparatus utilizing this phenomenon has been invented and constructed.

As the forerunner of modern apparatus, we may take the thermic telephone, invented by Abraham and Carpentier in

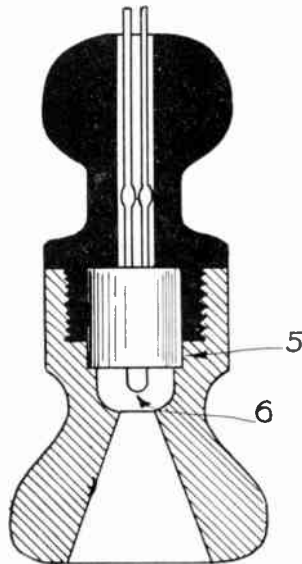

Fig. 2. Looped wire thermic telephone for the aural canal.

1907 (Fig. 1). The ear cap of ebonite (1), with an opening (7), which may be closed if desired by a membrane, is fastened to a metallic case (2), whose interior surface is nickel- or gold-plated. Two rods, insulated from the case and to

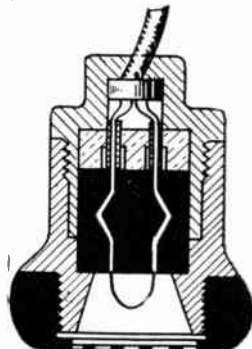

Fig. 3. A modification of the above, showing how the wires are secured.

which are connected the telephone lines, are connected within the case by an extremely thin wire (6), which is called

a Wollaston wire, or by a strip of gold leaf. To make a Wollaston wire a very thin wire of platinum is thickly silver-plated; this is drawn until extremely thin, and then the silver cylinder or coating is dissolved with nitric acid and disappears, leaving only the platinum core so thin as to be almost invisible.

The Wollaston wire (6), in alternately heating and cooling, communicates to the air or gas enclosed in the apparatus energy due to the speaking currents which pass through it; variations in the pressure of the gas are produced, and these variations are received by the ear as sounds.

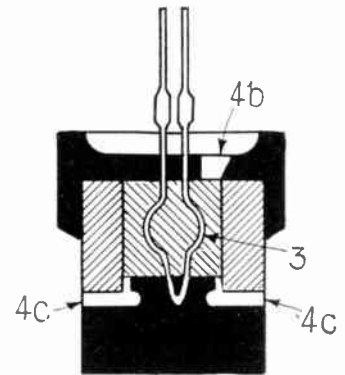
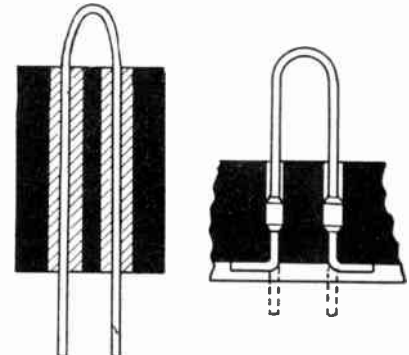

Fig. 4. The structure of the thermic telephone, showing the bends (3) which hold the wire in place.

intense currents would be emphasized over the feebler ones, outside of the repetition of simple sounds (vowels); consequently the different parts of a word would not be equally well produced.

To overcome these two troubles, it is necessary to pass through the thermic



Figs. 5 and 6. Two simple constructions of the thermic telephone, one using insulation.

receiver a constant current on which will be superimposed the speaking current. Here we find something analogous to the permanent magnet of an ordinary receiver. The arrangement is the following: A large storage battery produces a constant current whose circuit is connected to the terminals of the thermic telephone and which current keeps the wire incandescent; the transformer coil superimposes the speaking current upon the constant current.

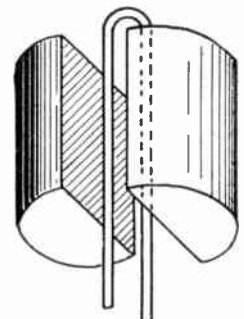

Fig. 7. The clamp method of constructing the telephone.

The cap (1) is dispensed with in another model of this apparatus, which is designed to be introduced into the audi-

ALL HEADLINERS

SIR OLIVER LODGE, D. Sc., L.L.D., F.R.S.
Dr. A. J. Fleming, M. A., D. Sc., F.R.S.

John Scott-Taggart, F. Inst. P.
Dr. Eugene Nesper.
Dr. Lee D. Forest, Ph. D.
Ellis Parker Butler.

All will appear in the big October issue of "Radio News."

Some of the Interesting Articles Appearing in the October Issue of "Radio News"

- Pioneer Work in Ether Waves. By Sir Oliver Lodge.
- Experiments with ST 100-Circuit. By John Scott-Taggart.
- Radio Frequency Amplification. By Louis Frank.
- Electrons, Electric Waves and Wireless Telephony. By Dr. J. A. Fleming.
- The Galena Amplifier. By Clyde J. Fitch.
- A Capacity-Coupled Receiver. By Paul G. Watson.
- Construction of Push-Pull Transformers. By H. N. Bliss.

These variations are due to the Joule effect, which is proportionate to the square of the intensity of the telephonic current. That is to say, at the crest of every wave, whether positive or negative, a sudden change in pressure of the air or of the gas is initiated. Assuming that every sound wave has two crests, one positive and one negative, it follows that the ther-

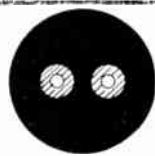

Fig. 5A. Section of Fig. 5, showing the wires surrounded by insulation.

mic receiver does not reproduce the voice of the original pitch, but an octave higher. There would be still a further inconvenience—the temperature produced varying with the square of the intensity, the more

tory canal. The thermic telephone which we have described possesses all the essential organs; it is the foundation of all later developments.

The German patent No. 242,831, of October 31, 1909, describes the making of the Wollaston wire in the form of a set of loops. For this construction to be possible with such extremely fine wire, its final form must be given to it before treating it with acid; then there must be applied to its terminals or ends an insulating material not attacked by acids, which will protect the two extremities of the wire and leave the active loops unprotected for stripping in the acid.

Fig. 2 shows a thermic receiver made to be introduced into the auditory canal; the thermic wire (6) projects from the insulating piece (5); the wire is connected

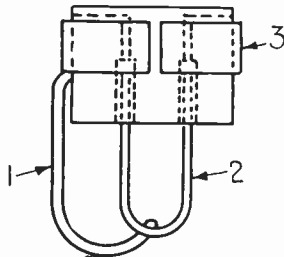

Fig. 8. How the loop can be supported at its center.

to the line wires by contact rods, as shown in Fig. 3. Fig. 4 shows the matrix used to make the insulating piece (5). The wire is shaped into the loop-form by means of pliers or otherwise; it is bent slightly, as is shown in Fig. 4 at (3), so that the wire can be more solidly held in place in the block. The wire is then placed in the matrix and the melted insulator is poured in by the opening (4b) of Fig. 4. (4c, 4c) are air vents; when cooled the block is taken out of the mould and the loop of wire is stripped by placing it in nitric acid. Following this process, it is clear that interchangeable parts can be constructed having the same length

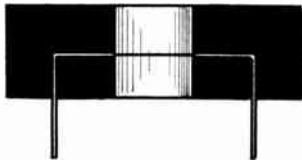

Fig. 9. A very simple construction this time, using a straight wire.

as the thermic wire. Fig. 5 from the patent 247,910 is a variation on the preceding system; the wire passes through two holes drilled through the block, which are afterwards filled with the melted insulator. Fig. 6 shows another method, patent 309,415: The wires and their prolongations are so placed as to retain themselves in the holes in the block. Fig. 7 (patent 247,911) shows how the wire can be placed between two half blocks, which

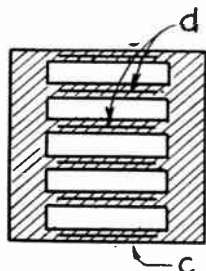
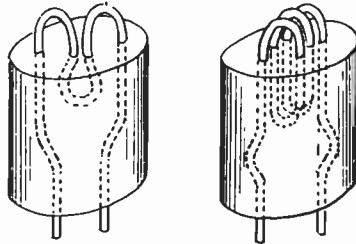

Fig. 10. Another departure, using a number of straight wires, side by side.

are then forced together and held in place by means of a collar.

When the thread is withdrawn from the nitric acid, great care is necessary

to avoid bending or twisting under the effect of the drops of liquid adhering to it. According to patent 316,402, January 17, 1918, the nitric acid must be contained in a recipient, so that the level of the liquid can be lowered after stripping, and the wire emerges without disturbances; evaporation removes the last trace of acid from the filament; aspiration or any equivalent method can be used in addition for removing the last traces of acid.



Figs. 11 and 12. Examples of multiple loop construction, the loops being in series.

Danger of deterioration of the wire loops is still further reduced if instead of using liquid acid, the vapor of nitric acid is employed (patent 296,134).

Finally, Fig. 8 (patent 342,902), a supporting arrangement (1) for the wire (2) can be used; before stripping, it is secured to the block by a collar (3). This keeps the wire rigid during the operation; when this is finished the supporting arrangement is carefully removed.

In Fig. 9 is shown another type of Wollaston wire (patent 245,897) with a support, which can be used in such apparatus as is not designed to be introduced into the auditory canal.

According to patent 254,274, there are

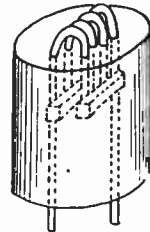

Fig. 13. Multiple loop construction with the loops in parallel.

other processes than the Wollaston system; such are electrolytic methods of making the thermic wire. A metallic plate of copper of proper form, as shown in Fig. 10, is covered with an insulating coating which is removed at the points (d), which later receive the thermic wire; consequently in these points the metal is bare and can receive an electrolytic deposit of platinum. Finally, the plate is surrounded by an insulating covering which only leaves exposed the parts which are to be attacked by the acid. The whole arrangement is placed in nitric acid,



Fig. 14. The thermic wires are here supported by little cylinders of insulating material.

which dissolves the metal hitherto employed as a support, and the thin wires electrically formed are left. This process can be expected to give thermic wires of rigidly identical structure.

For mechanical reasons the thermic wires have to be rather short—they have to be very thin to do their work properly—because the stirrup-shaped wire, fragile as it is, could easily break or buckle, especially if the receiver is handled carelessly. On the other hand, for the hearing or reception to be satisfactory, it is neces-

sary that the surface of the wire to be heated is not too small. This delicate problem receives various solutions; sometimes by one or another process the wire is supported which otherwise would be too long to sustain its weight; or again several short wires in parallel or in series may be used, or a combination of both methods.

Patent 247,152 describes a grouping in one block of several of the wires, connected either in series (Figs. 11 and 12) or in parallel (Fig. 13). Patents 247,912 (Fig. 14) and 247,914 (Fig. 15) describe another mounting of thermic wires. Supporting cylinders (8 and 9) of Fig. 14 supply the contacts effecting the connection with the telephonic circuit. In patent 247,913 enameled rods are used to

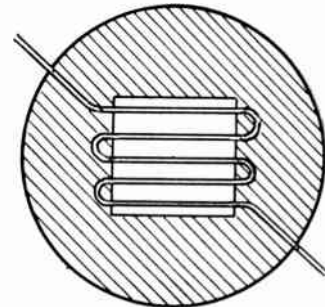
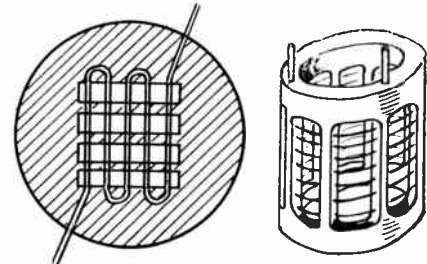

Fig. 15. In this construction the wires are brought close together to reinforce the action.

carry the wires, whose insulating surface makes it possible to mount the individual wires in series. To get a due number of these in a very small space, it is important to bring them close together, and to be certain that they do not touch each other when expanded by heat. This is why it is good practice to support the wires by means of several transverse supports; Figs. 16 and 17 are taken out of patent 249,192 which describes this sys-



Figs. 16 and 17. Here, again, the wires are brought close together, but are supported by insulating material at their intermediate points.

tem and others of the same kind. Fig. 18 from patent 283,703 describes the variation on the systems described in the previous patent. Here the wires are attached to the insulating block (1), and in the middle are soldered to a junction bar (8). This construction should be easy to carry out. In patent 259,961 the thermic wire which has the form of a ring, is carried by two little wires or bus-bars which connect alternately with one or the other,

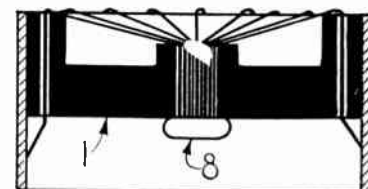

Fig. 18. A radial construction quite different from any of the others shown.

of the two bars, separated by an insulating substance. The current enters and leaves by these wires.*

(Concluded in November issue.)

*On receipt of stamped envelope we will send the name of manufacturers of Wollaston wire.

Storage Battery for Demonstrations

By Francis G. Le Merle

THE storage battery is really a wonderful piece of apparatus when one realizes how many chemical changes occur during the charge and discharge of a lead sulphuric acid cell.

The exact nature of these chemical changes is not yet fully established, but it has been conclusively shown that sulphate of lead ($Pb\ SO_4$) enters largely into the composition of the once active material on both elements in a discharged lead cell.

Lead storage cells fall into two classes; those in which the active material is formed from the substance of the element itself, either by direct chemical or electrochemical action, and those in which the chemical formation is accelerated by applying some easily reducible compound of lead to the elements in the form of a paste.

Elements that have the active material formed out of the elements themselves are known as the "Planté" type, and those that have an easily reducible lead compound applied to the elements in the form of a paste are known as the "Faure" or pasted type, Messrs. Planté and Faure being the respective inventors of the two different types of elements.

The illustrations show a very easily constructed storage cell of the "Planté" type which was made by the author and which will show the chemical changes made while the cell is being charged. This particular cell was made up with two pieces of thin lead foil, separated by two pieces of blotting paper, all of which were rolled up and placed in a small glass bottle as shown; it was charged at one-quarter of an ampere for ten minutes and the foil plate that was connected to the positive charging lead or terminal of the charging board was seen to turn a dark chocolate color, while the negative foil plate assumed a slate-gray appearance.

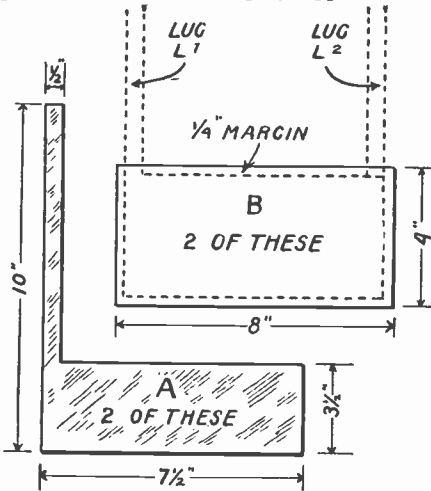

Patterns of the plates and separators, with dimensions, as required for the construction of the Planté battery.

Chemical analysis has shown that the surfaces of the elements in a new and fully charged storage cell of the "Planté" type consist of nearly pure peroxide of lead ($Pb\ O_2$) on the positive plate and spongy gray metallic lead (Pb) on the negative plate. During the discharge, or if the cell is allowed to remain at rest, the sulphuric acid ($H_2\ SO_4$) in the solution enters into combination with the peroxide of lead and the spongy gray metallic lead and partially converts them into lead sulphate. The acid being continually abstracted from the electrolyte as the discharge proceeds, the density of

the solution becomes less. This is termed sulphating when it is of injurious degree.

In the charging operation the action is reversed, as the reducible sulphates of lead which have previously been formed are apparently decomposed, the acids being returned to the electrolyte, and therefore causing an increase in its density.

This peculiar alteration or change in the density of the electrolyte enables us to



Complete Planté storage battery set up; one which can be made by the amateur and which will give excellent results for the lighter class of work.

ascertain at any time the state of charge or discharge and the general condition of the cell by simply finding the density or specific gravity of the liquid, which is accomplished by the use of an instrument known as a hydrometer.

The illustrations show the elements and give the dimensions for constructing a cell of this kind. (A) being one of the two lead foil plates and (B) one of the two blotters used to separate the plates, the dotted outline shows the position the two plates will occupy in respect to the two blotters before they are rolled up and held in position by the rubber band as shown in the view of the complete cell. In assembling the element a blotter is laid down and one of the foil plates is laid upon same as shown by the dotted lines with the lug (L_1) to the left; then the other blotter and on top of this the other plate with the lug (L_2) to the right; they are then rolled up and held in position by a rubber band; the element is then placed in the glass jar or bottle and dilute sulphuric acid is added to just cover the plates or element about one-quarter inch with the foil lugs hanging over the sides; the specific gravity of the acid to be 1.300, which can be ascertained by measurement with the hydrometer after the acid has been slowly poured into the water in sufficient quantity to bring the specific gravity nearly up to 1.300. As quite an appreciable amount of heat is generated while mixing the acid with the water the solution should be allowed to completely cool before finally testing the specific gravity and putting the elements in the cell.

The cell is now ready for charging and after charging for ten minutes at one-quarter ampere, as did the author, take out the elements and take same apart. The chocolate colored element, which is the positive one, is coated with nearly pure peroxide of lead, as chemical analysis will show. The other element, which is the negative one, will prove to be coated with pure metallic spongy gray lead. Replace the elements and charge again for ten minutes, disconnect and then connect a small flashlight bulb of two volts to same as shown, and it will

be seen to light up, which shows that a chemical action of some kind is going on in the battery which is thus causing a current of electricity to flow and light up the lamp. This chemical action is really the reverse of that which took place while the cell was charging.

The main object in constructing a cell of this kind is to enable one to get a large amount of plate area in as small a space as possible, as the larger the area of the plates the greater the ampere-hour capacity, and, further, the more the battery is charged and discharged the more the capacity will increase. Reversing the charging leads to the battery every time the battery is charged for about 25 times will materially increase the ampere-hour capacity or form the plates, after which the battery terminals are marked positive and negative and the charging leads connected accordingly for each and every charge thereafter.

The reason for this reversal of the charging leads is that there seems to be a greater amount of spongy gray lead and lead peroxide formed in a given time; that is, the chemical action seems to penetrate deeper into the plates, because the lead oxide on the positive plate after the cell has been discharged is changed into spongy gray lead on the next charge after the charging leads have been reversed, while the spongy gray lead is changed into peroxide of lead, and so on with each of the charges and reversal of the charging leads.

This method of reversing the charging leads every time the battery is charged is known as forming the plates and is only used on cells that are of the "Planté" type, but never on the "Faure" or pasted type. The charging leads are always connected to the same polarity of the battery as they are themselves in charging the pasted or "Faure" type of battery.

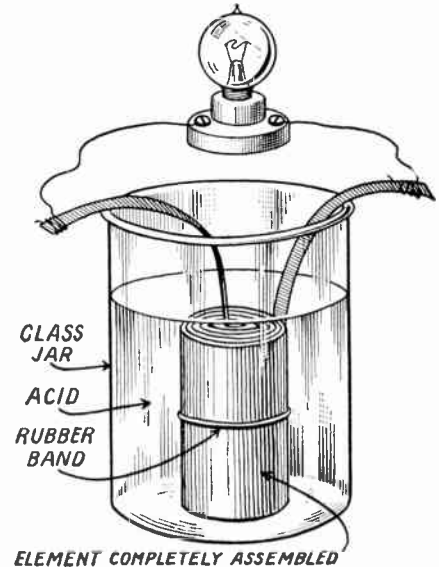
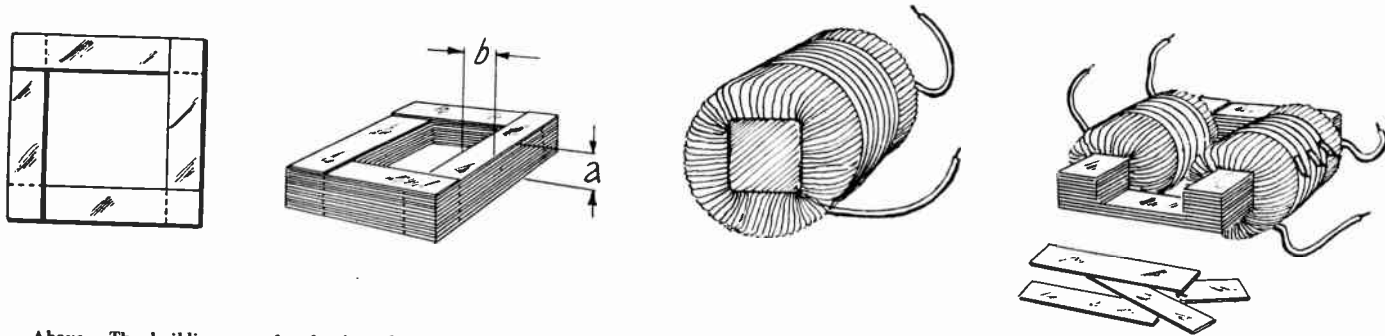

Diagram of assembly of the Planté cell, showing spiral construction of the plates. Note the rubber band for holding them together.

Any suitable source of direct current will do to charge these cells. A 23-watt lamp in series with a 110-volt direct current main, or a rectifier if the mains supply alternating current, and then a suitable resistance or lamp in series with the direct current side of the rectifier to limit the current to about one-quarter of an ampere; or if only one cell is to be charged, two standard dry cells in series can be used by connecting them directly to the cell.

Small Transformers

By Clyde J. Fitch



Above.—The building up of a laminated core out of straight pieces of iron, the simplest possible construction practicable; winding the coil on a wooden core; mounting the parts. The straight strips of iron are passed into the square opening the coil.

Below.—Other designs of laminated cores for a similar coil, which are somewhat more secure; final clamping of the completed core illustrated.

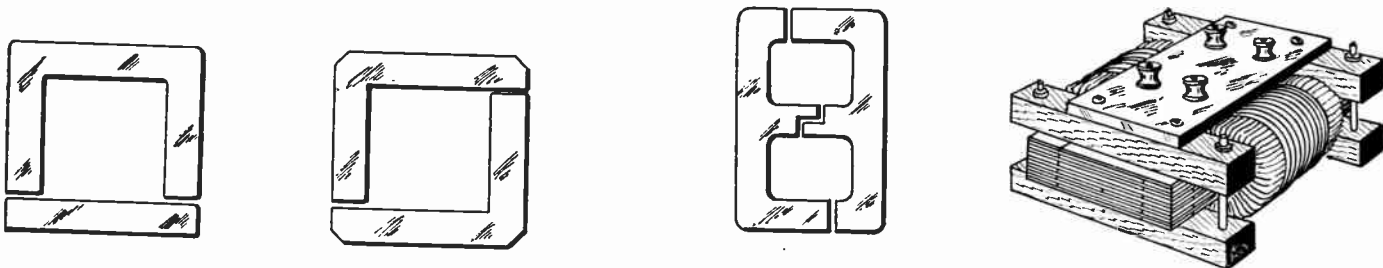

HARDLY a day passes that does not bring forth an inquiry regarding the construction and design of small transformers capable of stepping down 110 volts to 6, 8, 10 volts, etc. Should our staff attempt to answer all of these queries, we would be kept busy designing small transformers, and the **HOW AND WHY** department would be flooded with transformer data.

For this reason we give a very simple method for calculating the number of turns, size of core, etc., of small transformers up to 500 watts capacity, to be used on 60 cycle circuits. By this method any one with a knowledge of multiplication and division can calculate transformers of various sizes. The transformers so designed will be in accordance with standard engineering practice and will have an efficiency of from 80 to 90 per cent. No complicated formulas will be given for calculating the efficiency, as only small transformers will be considered, for which the losses, from a financial point of view, are negligible.

In the first place it is well to keep in mind that the wattage of a transformer has nothing to do with the number of turns of wire in either the primary or secondary coils and the cross-sectional area of the core. In other words, the coils would have the same number of turns, and the core would have the same cross-sectional area whether the transformer was designed for 3 watts or for 3000 watts. It is only the size of the wire that determines the wattage of the transformer. Therefore if we determine the size of the core and the number of turns in the coils, we can make the transformer good for any wattage by choosing the correct sizes of wire.

The core of the transformer should be made up of a good grade of silicon steel laminations, which may be purchased in thicknesses of about .014 inches. Ordinary stove pipe iron may be used, however, and will give good results. The difficulty in using stove pipe iron is that the laminations must be cut out by hand with shears, or cold chisel, which is a tedious job, whereas the silicon steel

laminations may be purchased already punched out to the desired size.

First the cross-sectional area of the core must be determined, as this is the element of the transformer whereby we will calculate the number of turns. The cross-sectional area of the core is the width of the laminations multiplied by the height to which they are stacked. It is the distance "a" times the distance "b" in the figure. We can choose any value we wish for these dimensions to start with. The dimensions should preferably suit the size of the steel laminations available. For example, suppose we choose a core having a square cross-sectional area of $1\frac{1}{4}$ inches by $1\frac{1}{4}$ inches, or 1.5625 square inches. A core of square cross-section is preferable to one of oblong and rectangular cross-section, as the length of wire in the coils for the same number of turns is less.

Now that we have decided on the cross-sectional area of the core, or 1.5625 square inches, we can determine by means of the curve the number of turns required in the coils. The core areas are marked off at the bottom of the graph. At the point 1.5625, we draw a vertical line to intersect the curve, which point is indicated at "a" in the figure. From "a" we draw a line horizontally to the left, where we find the number of turns required for a 1 volt winding, which is 4.81 turns.

We desire a transformer having one 110 volt coil for the primary, so that the required number of turns in the 110 volt coil will be 110 times the number of turns required in a 1 volt coil. This gives 110 times 4.81 or 530 turns. If the primary voltage is of any other value, say 115 or 130 volts, simply multiply that value by 4.81 and the product will be the correct number of turns.

Suppose we want a 16 volt secondary winding; multiply 16 by 4.81 and we have the correct number of turns for the 16 volt secondary, which is 77 turns. By this method we can determine the correct number of turns for any secondary voltage by simply multiplying the desired voltage by 4.81. This number, 4.81, is, of course, the turns required for a 1 volt winding on a

core having a cross-sectional area of 1.5625 square inches. The number of turns for a 1 volt winding on a core of a different cross-section may be obtained from the curve. If we desire to have a tap on the 16 volt secondary winding to obtain say 5 volts, multiply 5 by 4.81, which is 24. Then a tap on the 24th turn will deliver 5 volts.

For all practical purposes the core sizes within the limits of the curve may be used. The experimenter would do well to select two or three different sizes of core areas and then find the number of turns required for the various cores. In this way he can probably select a combination of core and wire that will suit the material on hand. Of course the larger the core is the less wire is required, and the cost of the transformer will be less. The disadvantage of using a large core is that the over-all dimensions and weight of the finished transformer will be greater than those of a transformer employing a smaller core and more wire.

Now we have the cross-sectional area of the core, which is $1\frac{1}{4}$ by $1\frac{1}{4}$ inches or 1.5625 square inches; the number of turns for a 110 volt primary, which is 530 turns, and the number of turns for the 16 volt secondary, or 77 turns. Next we must choose the capacity of wattage of the transformer, from which we can determine the size of wire from the wire table below. More extensive wire tables can be found in electrical handbooks.

Suppose, for example, we wish the transformer to have a capacity of 150 watts. The current or amperes flowing through each coil when the transformer is operating at full capacity will be the number of watts divided by the voltage of the coil. Therefore the 110 volt primary coil will have a current of 150 divided by 110, or 1.37 amperes. From the wire table we find that No. 16 B. & S. wire will safely carry 2 amperes, which is a good size for the wire of the primary coil, as it is better to use too large a wire than too small a one.

In the 16 volt secondary coil the current will be 150 divided by 16 or 9.4 amperes. From the table we find that No. 8 B. & S.

wire will carry 12.9 amperes, so we will use No. 8 for the 16 volt secondary winding. If we wish the 5 volt tap, we should be able to withdraw 150 divided by 5 or 22 amperes, so that the first 24 turns of the 16 volt winding should be of No. 5 B. & S. wire, which is good for 26 amperes. Either enamel and cotton, or double cotton covered copper wire should be used for all of the above windings.

Now that we know the number of turns and the size of wire in the coils, we can calculate the space occupied by the finished coils, and then determine the opening or window in the iron core. Knowing this, we can calculate the size of the steel laminations.

From the wire table we find that No. 16 D. C. C. wire winds 16.35 turns per inch. If we make the primary coil 2 inches long, we can wind 33 turns per layer, and 16 layers will give us the required 530 turns. The secondary coil can be calculated in the same way. By making a square window in the core, 2½ inches by 2½ inches, we will have ample room for the coils, and all of the punchings will be of the same size, or 1¼ by 3¼ inches.

The average length of each turn on the primary coil is nearly a foot, so that we will require about 500 feet of wire. From the table we find that there are 127.9 feet per pound, so that 4 pounds of wire will be sufficient. The amount of wire required for the secondary coils can be calculated in the same way.

The illustrations show very clearly the construction of the transformer. The coils are to be wound on a wooden form, 1½ inches square, and then, after removing the form, they should be bound with white cotton tape and impregnated with shellac. Three sides of the core are built up first and the coils placed on the core legs as

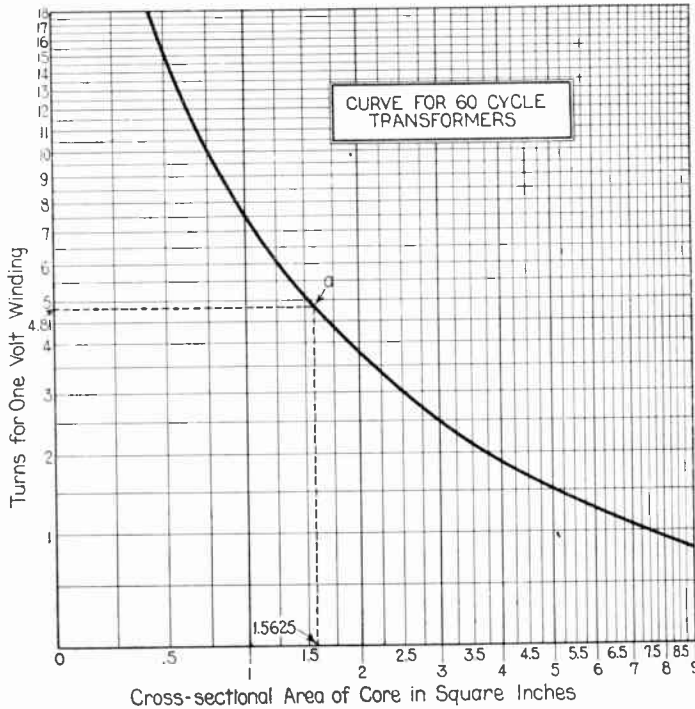

of advantage if any changes are to be made in the windings.

Those who wish to design transformers for different frequencies may use the following formula, from which the curve was obtained:

$$T = \frac{E \times 100,000,000}{4.44 \times A \times f \times F}$$

where T = turns in coil
 E = voltage of coil (for plotting the curve E was taken as 1).
 A = cross-sectional area of core in square inches.
 f = frequency in cycles per second of circuit.
 F = magnetic flux in lines per square inch in the core. This varies from 30,000 to 60,000 lines with different grades of iron. For plotting the curve 50,000 lines per square inch was taken.

WIRE TABLE

Size B. & S. Gauge	Ampere Carrying Capacity	Turns per Inch D.C.C.	Feet per Pound
0	82	2.65	3.13
1	65	2.99	3.947
2	52	3.36	4.977
3	41	3.80	6.276
4	32	4.28	7.914
5	26	4.83	9.980
6	20	5.44	12.58
7	16	6.08	15.87
8	12	6.80	20.01
10	8	8.51	31.82
12	5	10.60	50.59
14	3	13.10	80.44
16	2	16.35	127.9
18	1.2	19.50	203.4
20	.8	23	323.4
22	.5	28	514.2
24	.3	33	817.7
26	.19	39	1,300
28	.125	45	2,067
30	.0789	57	3,287
32	.0496	60	5,227
34	.0312	68	8,310
36	.01964	78	13,210
38	.01235	89	21,010
40	.007766	102	33,410

shown, after which the fourth leg is built up and the core is clamped. Connections are brought out to the terminals on the terminal board as shown.

Although the transformer may be made more compact by winding the primary coil directly over the secondary coil so that both windings will be placed on the same leg of the core, the coils are more accessible when placed on opposite legs, which is

Repairman's Test Panel

By B. M. BLOUNT

THE test panel described in this article is the outgrowth of several years of experiment and use in the shop of an electrical contractor-dealer.

A panel of wood or other non-conducting material about 16 by 20 inches is secured. The layout may be arranged to suit individual tastes and conditions, and either concealed or exposed wiring may be used—the former is neater, but the latter is easier to trace out, especially until the repair man becomes accustomed to using the test board. In the upper left corner is mounted a 30-ampere fused double-pole knife switch, such as are used for entrance switches.

At the right edge of the panel and about six inches from the top is mounted a small 10-watt test lamp or telltale. A few inches below is mounted a receptacle, which should be able to take attachment plugs of three classes—standard medium screw (Edison), parallel blades and tandem blades. Near the lower edge of the board are the test clips. These clips are on flexible cords about 3 or 4 feet long, and arranged so that the cords are pulled back behind the board by weighted pulleys.

The reader will note from the diagram that the circuit breaker, telltale, receptacle and test clips are all in series, and that each device except the circuit breaker is arranged to be short-circuited by a single-pole switch. When these three switches are all closed a "dead short" is formed; this

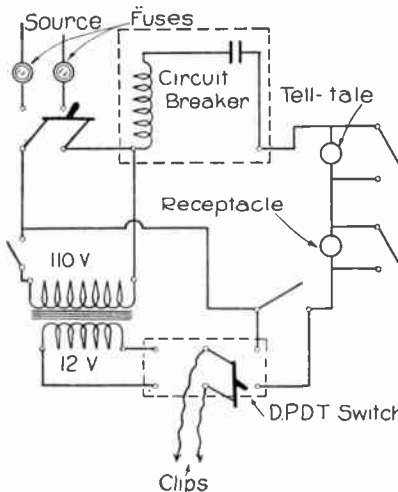

Complete plan of the circuit used on the repairman's test panel described in the article, one whose freedom from complication makes it particularly useful.

should be avoided, but will cause no damage, as the house circuit is protected.

A recent flood of repair work on toy electric trains accounts for the addition of the small bell-ringing transformer, and the double-pole double-throw switch enables the tester to use the same test leads for either 110 volts or 12 volts. The pri-

mary of the transformer may be connected directly to the main feeder switch, or may carry a switch in its leads if desired.

With this test panel an appliance may be tested for open or short circuit either with its cord and attachment plug or with the test clips, by opening or closing the proper by-pass switches. The appliance can then be tested under load by merely closing the by-pass switch to the telltale. Should the appliance be short circuited, the circuit breaker saves the main fuses, and since the cost is less than 20 cents' worth of new material, each time it "blows" half its cost is saved.

The solenoid has about 90 turns of No. 18 D. C. C. annunciator wire, wound on a piece of one-inch diameter brass tubing about 3½ inches long, whose ends were first split with a number of parallel cuts and spread to form a spool. The two levers are of ¼-inch brass rod, the springs from an old snap switch, the reset handle being a machine screw with a composition nut from a binding post. The armature is a piece of ½-inch square-head bolt, one side of the head being drilled and tapped to form a pivot where it fastens to the trigger lever. Since there is no dashpot, the action of the breaker is instantaneous. The contacts are of sheet copper and have a tendency to arc and pit, but not enough to warrant making carbon contacts. The whole breaker is mounted on an old slat switch base.

Perpetual Motion?!!

By H. Gernsback
Member American Physical Society
Lamp (dark)

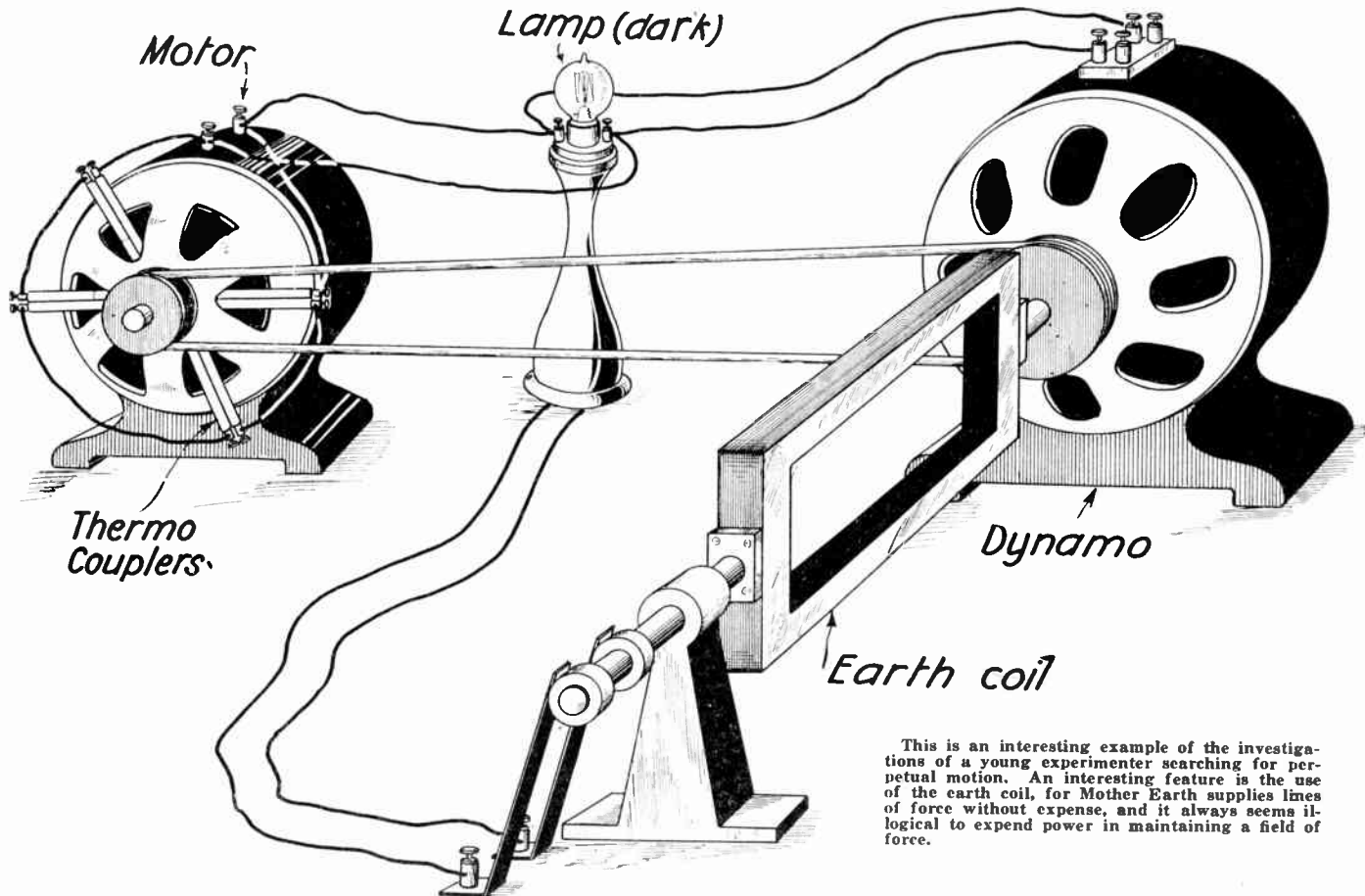

This is an interesting example of the investigations of a young experimenter searching for perpetual motion. An interesting feature is the use of the earth coil, for Mother Earth supplies lines of force without expense, and it always seems illogical to expend power in maintaining a field of force.

EVERY real experimenter worth his salt, at some period or another of his career, is struck by one of the most brilliant ideas in the universe. His age may be six or sixty, but sooner or later it will occur to him, and the mere contemplation of the idea will raise his blood pressure several dozen points. If he is a real live experimenter, he will not rest until he has tried out the scheme.

The brilliant thought is nothing less, nothing more, than hitching a dynamo to a motor electrically and also mechanically by means of a belt (see illustration). This scheme crops up regularly not less than three times a month, and the Editors have already encountered it ten times in a month.

The underlying idea is simply this:—The dynamo gives electric current. Suppose we connect the terminals of the dynamo to the motor. The dynamo, providing it runs, furnishes the current to run the motor. The motor, to return the compliment, if we connect it with a belt to the dynamo, will naturally feel obliged to run the dynamo in turn—a sort of dog trying to run after its own tail and keeping up its revolution.

The reason for failure is, first, that there is heat dissipation, and second, that no piece of machinery, no matter what its make or type, can render 100 per cent efficiency. Even if we had started the dynamo at full speed by an outside source, and then attached it electrically and mechanically to the motor, it would not run for two seconds, because the current developed by the dynamo would be just about 20 per cent less than the energy required to drive it. Then there are losses in the motor as well, so we can figure that

the actual losses in the transformation between the two machines will run over 35 per cent. In other words, you cannot lift yourself up by your own boot-straps.

When the Editor was a budding experimenter at the age of nine or ten, the big idea struck *him*, as it has hit many others. He tried the experiment, of course, and was very much crestfallen at its failure to work. Not possessing extensive knowledge of electrical and mechanical efficiencies at that tender age, he consulted with an older friend who was high up in knowledge of these matters, and this worthy of course laughed and explained just why the scheme was not feasible.

First of all, your young experimenter was informed that there were great heat losses in the bearings, and many other losses due to heating of the windings, friction at the bearings, and several other minor items, all of which tended to make the success of the experiment nil.

Nothing daunted, the writer believed that somehow or other he would foil nature in the end. So he rigged up the contrivance illustrated here and also shown on our cover. The scheme was very simple. The writer at that time had read about thermo-couples and knew that when you heated a metal junction you would get electric current. "So," said he, "why not put these thermo-couples on all the bearings, collect the heat and feed it into the circuit?" It seemed plausible, and accordingly, was done. But strange to say, even with about a dozen thermo-couples sprouting out all around the bearings, nature persistently refused to be thwarted, and the contraption did not become *mobile*, much less *perpetuum mobile*.

After this disillusion, we waded laboriously through several electrical textbooks

and finally stumbled across another hint that looked promising. It had to do with a so-called *earth coil*. The magnetism of the earth is there to be tapped. Now if you rotate or swing a square frame, on which there are wound many turns of fine wire, in the earth's magnetic field, this coil will generate electric current. So far, so good. Said we to our young selves, why not hitch one of these coils to the shaft of the motor, and as it revolves quickly it will cut sufficient magnetic lines and give a tremendous amount of current, which when fed into the main circuit will be enough to overcome all the losses of the combination, consequently the device must work!

The great day arrived and we started to crank her up. We worked fast and furiously for many hours, but somehow or other the moment we stopped cranking, the device would sink into a perpetually motionless state. Much hurt, we gave it up.

Our expert friend to whom we showed the great invention later had the time of his life. When he finally stopped laughing, he explained to the dispirited experimenter that the loss of transformation in a thermo-couple is much greater than in any other electrical instrument: in other words, out of 100 units of heat you obtain less than 3 per cent of electric power that you can use.

As to the rotating earth-coil inspiration, this was not quite so bad, but even here, the current of a quickly rotating earth-coil, although it may be a pretty big affair, is only microscopic. In other words, the electric energy that was recovered from the thermo-couples plus the earth coil was less than one-thousandth of one per cent.

Four-Way Switches

By O. E. Bricker

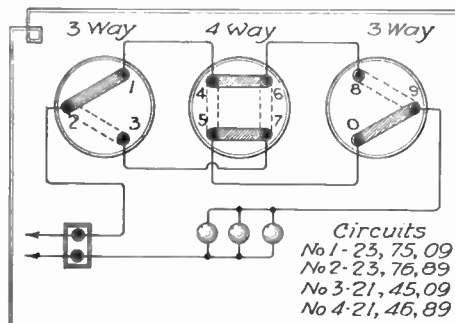

Fig. 1 - Lights controlled from 3 places

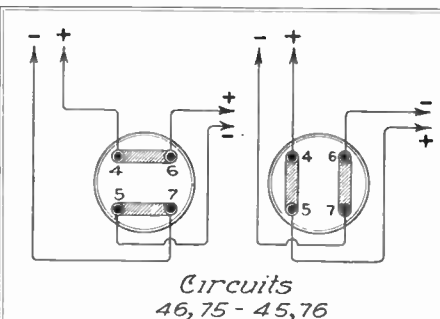

Fig. 2 - Polarity change

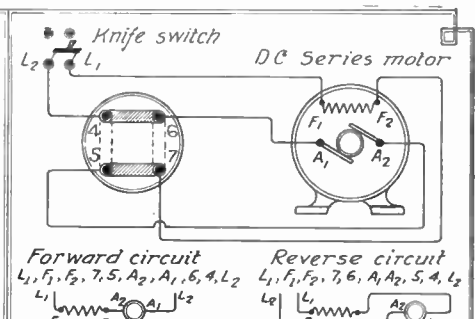

Fig. 3 - Series motor reversal

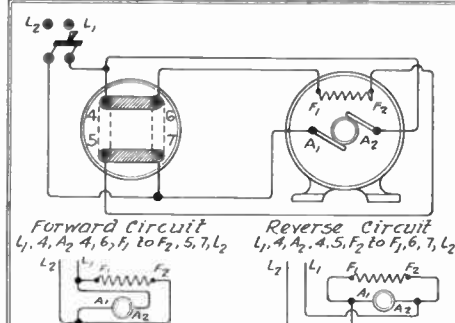

Fig. 4 - Shunt motor reversal

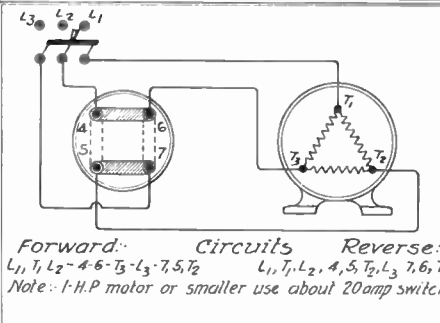

Fig. 5 Three phase A.C. motor or two phase three wire A.C. motor reversal

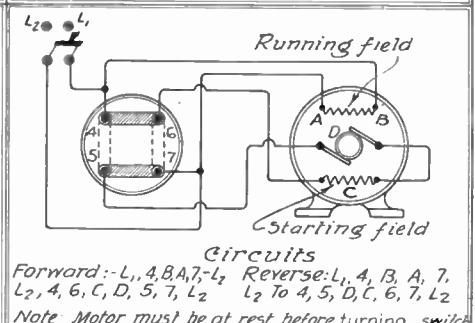

Fig. 6 - Single phase fractional H.P. motor reversal

Six interesting diagrams showing what can be done with four-way switches, each diagram having its own caption, which tells just what each switch is designed to effect.

SOME applications of four-way switches are described here.

Fig. 1.—This is a wiring diagram showing the general use of the switch to control a light or lights from three or more places. For more than three places add one 4-way switch between the 3-way switches for each number of places desired.

Fig. 2.—Having seen several different home-made switches in the column of PRACTICAL ELECTRICS for current reversing, I would suggest the single 4-way switch

as a convenient means of accomplishing this result.

Fig. 3.—Shows clearly the application of the 4-way switch as used to reverse a small series wound D. C. motor. The switch is so constructed that it has a quick mechanical break, making it very serviceable.

Fig. 4.—Shows the 4-way switch applied to a shunt wound D. C. motor.

Fig. 5.—We here have the same switch used to reverse a three-phase motor of the

induction type, or two-phase if a three-wire connection is made.

Fig. 6.—In this case we reverse with the 4-way switch the single-phase motor such as used on washing machines, small blowers, fans, etc. It will be seen that the switch changes the relation of the starting field to the running field. The motor, of course, must be at rest to reverse, as while running the starting field is open, due to the action of the centrifugal switch on the rotor.

Novel Electrophorus

By DR. ALFRED GRADENWITZ, Berlin Correspondent, PRACTICAL ELECTRICS

OUR readers are no doubt familiar with that simple apparatus called the "electrophorus," which, designed by Volta, in 1770, until the invention of the electro-static machine, constituted the most efficient means of generating static electricity.

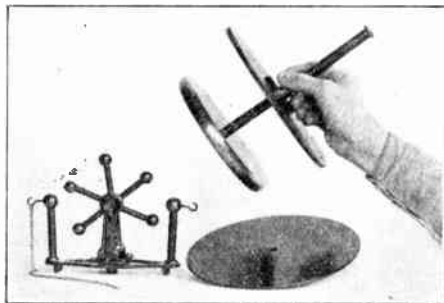

New type of electrophorus from Germany, which is said to have achieved very remarkable results in the use of the almost obsolete apparatus in improved form.

erating static electricity. In order to produce sufficient amounts of the electric fluid, its dimensions were made as great as possible, and one electrophorus on rec-

ord had a conductor 1.50 meter (nearly five feet) in diameter and required a set of pulley-blocks for moving it up and down. Since the advent of other and more powerful means of producing electricity, the electrophorus has been confined to a rather modest part in class rooms and scientific cabinets and has not undergone any alteration of shape or design.

A Berlin physicist, Dr. H. Wommelsdorf, the inventor of the condenser machine, which is an improvement on the familiar influence machine, is of the opinion that this time-honored device can be of active use in the laboratory. The writer has had the good fortune of acquainting himself with the new electrophorus just brought out by that inventor and had it photographed specially for the readers of PRACTICAL ELECTRICS. Fig. 1 will best illustrate the underlying principle.

The new electrophorus comprises a conductor (a) which, instead of being placed on a single insulating layer, is inserted between two such layers (b and c). A simple test, which consists of applying to the conductor first one, then both of the insulating layers, strikingly shows that

the spark length (ca) in the latter case is three times, and the voltage produced is twice as great as in the former. The disproportionate increase of spark length and voltage, of course, is due to the fact that the spark length, as the discharge potential rises, will grow considerably faster than the latter.

Moreover, the amount of electricity thus disengaged will correspond to a Volta

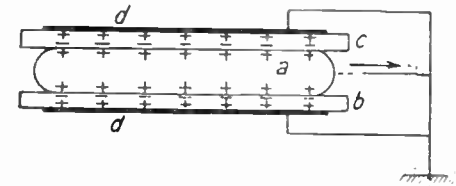

Sectional view of the new electrophorus, illustrating its operation and showing connections, the vertical lead going to a ground.

electrophorus with a much larger insulating layer without any corresponding increase in the diameter of the conductor.

In order to actuate the new electrophorus, both insulating layers are rubbed and, as seen from Fig. 1, placed on one another, when the electrons, on account of

the negative charges of the two layers (b and c), are energetically driven away from (a). If now the conductor (c) be touched with the finger, a wire, or the like, the electrons will flow off to the ground. On being next withdrawn, the conductor will be found to possess a free positive charge which can be utilized in any suitable manner, *e. g.*, for the charging of Leyden jars or for the operation of any convenient apparatus. The same phenomenon of electric influence can be repeated many times with a single rub-

bing of the insulating layers. A strip of tinfoil pasted on the upper insulating layer (c) enables the conductor to be earthed without any contact with the finger, so that the electrophorus can be operated simply by moving the insulating discs up and down.

The electrophorus represented in our illustration comprises two insulating discs of hard rubber. Dr. Wommelsdorf has, however, designed electrophoruses with such poor insulating layers, *e. g.*, of wood, paper and the like, as no longer to be

electrified by friction. These had to be operated by exciting the layers from outside and enabled the output of the little attachment to be raised considerably.

The new electrophorus is powerful enough, even with its discs only 15 cms., or 6 inches in diameter, to operate many large rotating apparatus, the spark length being 6 cms., 2½ inches, and the potential about 50,000 volts. It is thus a cheap and welcome substitute for a small influence machine, superior because of simplicity and its certainty of starting.

Electricity from Earth's Magnetism

EVERYONE knows that the earth is a huge magnet and that the lines of force surround the earth everywhere except at the magnetic poles. When a coil

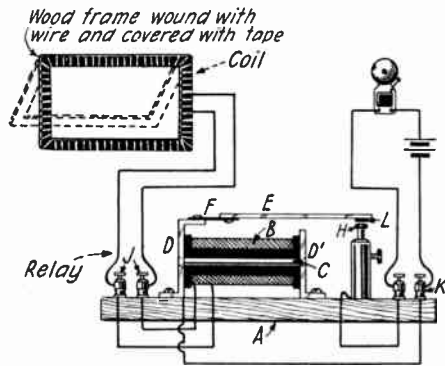

A simple method of carrying out this classic demonstration by using a sensitive relay.

of wire is moved so as to cut the lines of force of the earth a feeble electromotive force is produced and a current can be caused to flow if there is a closed circuit. In this experiment the current thus generated is used to operate a sensitive relay which in turn closes another circuit so as to produce a good effect.

The coil of wire used is wound on a thin rectangular wooden frame 24 by 18 inches in size. Two hundred turns of No. 22 or No. 24 gauge insulated or enameled copper wire are wound on it and taped. The ends of the coil are connected to an extension cord.

The complete relay is shown in the illustration. It should be finished as neatly as possible. The base of wood (A) is 6 inches by 3 inches and ½ inch thick. The wire of the electromagnet (B) is wound on a wooden bobbin. The bobbin can be turned out on a small wood turning lathe. The dimensions are given in the drawing. The core (C) is a Swedish charcoal soft iron bar 2½ inches long by ⅝ inch in diameter.

The brackets or angles (D and D'), and the armature (E) are also of the same metal. The armature is 3 inches long by ⅜ inch wide by 1/16 inch thick. It is connected with the bracket (D) by a piece of No. 28 gauge spring tempered brass (F). A hole is drilled down the center of the binding post (G). A small brass rod (H) with a contact point on it is

placed in the hole. It is adjusted and locked by a thumb-screw. A corresponding contact point is fixed to the armature as shown. The contact points can be taken from an old spark coil.

The bobbin is wound almost to the top of the sides with No. 34 gauge single silk covered copper magnet wire. Two binding posts are mounted and connected to the electromagnet. The binding posts (K, K) are mounted at the left-hand end and connected to the rod (G) and bracket (D).

A bell or similar apparatus and a battery are connected in series to the binding posts (K) and the coil is connected to binding posts (I). The contact points at (L) are adjusted until they are not more than one-sixteenth of an inch apart.

The coil is grasped loosely in the hands and swung to and fro, the bottom swinging in a semicircle, in a north and south oscillation, so as to cut the lines of force of the earth. A feeble current is generated which operates the relay and closes the external circuit. It will only be closed, however, when the coil is swung in one direction. The coil can be fixed so it can be revolved by turning a handle, thus generating a stronger current. A short-circuiting relay can be connected to close the circuit permanently if desired.

Contributed by ROY C. HUNTER.

BINDING posts do not make very satisfactory terminals on switchboards that carry rather high currents or voltages. To receive the heavy wires necessary to carry strong currents, binding posts must be very large and clumsy; but even then it is not easy to fasten the wires in place, and it is rather a nuisance where they have to be connected and disconnected often.

In the plug and jack system herein described, it is very easy to change connections, and, because of the large surfaces of the plug and jack which make contact, this system will carry a very heavy current. The dimensions given are for a jack and plug system which is very strong and also simple. The jack is designed to be mounted on a 1-inch marble panel. This system of connections is used in the electrical engineering laboratory of a prominent Los Angeles high school with complete success.

A 2½-inch length of threaded half-inch

Simple Connection Jack Switch

round brass rod is placed in a lathe and drilled through its entire length with a quarter-inch drill. The hole is reamed out with a taper reamer until the larger end of the hole is three-eighths of an

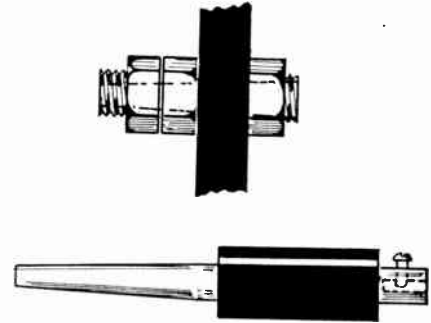

A solid construction of a plug or jack switch of wide applicability for experimenters.

inch in diameter. The jack is now done and is mounted on the panel with the large opening on the front of the panel and held in place with one nut on the front of the panel and two behind it. The wire lead is fastened to the jack by the two nuts at the back of the panel. The plug is made of a piece of three-eighths-inch round brass rod, 6½ inches long. It is placed in a lathe, and 2½ inches of it at the end tapered to correspond accurately with the tapering of the socket. There must not be the least shake.

A piece of wood three inches long is turned out in the lathe to a diameter of one inch, and a hole bored through it with a diameter to make it a driving fit over the untapered part of the brass rod. This is the handle. It is driven over the rod, leaving three inches of the rod projecting at the tapered end and one-half inch at the other end. The half-inch length of rod which projects from the handle is drilled to a depth of half an inch from the end by a 5/32-inch drill, and a hole for a set-screw is drilled and tapped in one side of the hole. This hole is to receive the connecting wire.

When a half dozen jacks have been connected to the different sources of power, and a corresponding number of plugs connected to the different electrical machines it is desired to run, we have a very versatile and easily-changed combination.

Contributed by CHARLES F. FILSTEAD.

Plug from Old Fuses

A PLUG which will fit any electric light socket can be made from an old burnt-out screw-type fuse.

Remove the mica and the brass ring that holds it. Then take a pair of pliers and pull out the end contact (if this cannot be done file it off). This will leave a hole large enough to insert a binding post screw through. Then pry loose the flange that holds the brass threaded portion and unscrew it.

The plug can now be connected up by

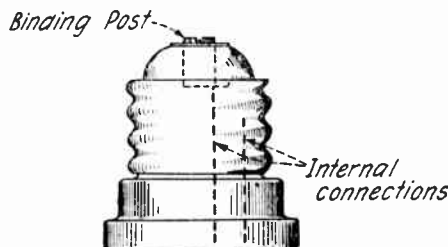

putting a binding post in the lower part of the plug, letting the head of the screw act as the contact, then lay the wire on

A plug made from an old blown-out fuse by slight alterations only.

the porcelain part and replace the screw bushing; screw it on, firmly gripping the wire, and the plug "est fini."

Contributed by HOWARD L. BARCOCK.

Rotary Current Rectifier

THIS apparatus is designed for the charging of storage batteries when alternating current from the service line is all that is available. The construction is very simple; the num-

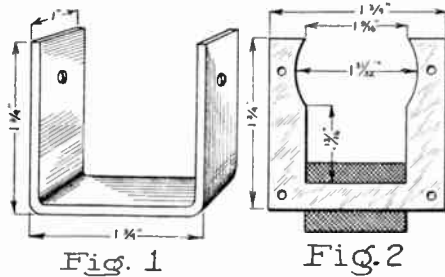

Fig. 1 represents the standard for the shaft of this apparatus. Fig. 2 gives the template for cutting out the field core laminations and also shows the windings.

ber of pieces should not frighten the amateur who would wish to construct it. We give the following figures:

Connected to a 110 volt, 50 cycle circuit, the potential is reduced to 25 volts. The apparatus requires 2 amperes for its rotation, and can give a useful rendition of 6 amperes at 10 volts. The efficiency is about 55 per cent. It is clear that if one has no transformer the efficiency will be lower. The choke coil is more economical than a rheostat for reducing the line voltage.

Principle of construction: Assume a synchronous motor, driving a reversing commutator; at each half turn the current will be reversed so that there will be two half periods in each revolution. Now, as the synchronous motor follows the periodicity of the exciting circuit, the current delivered by the commutator will always be in the same direction.

We will then have to construct a synchronous motor and reversing commutator.

The base will be made of wood, marble, or brass as desired, wood being the best. A plank of oak 8 inches by 3 inches and 3/4 inch thick will answer. On this are mounted the bearings and their support; the support will be made with .2 inch iron, 10 inches long, bent up into the shape of a letter U, preferably while heated. Four holes are bored in the bottom part as shown, .2 inch in diameter, and two other holes above, a trifle over .3 inch in diameter. The whole is shown in Fig. 1; the

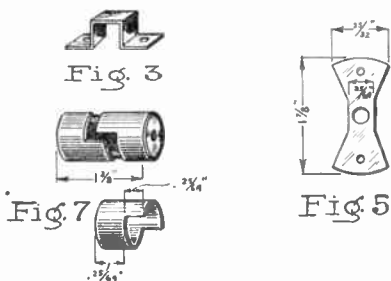

Fig. 3 is the strap for sustaining the magnet. Fig. 7 shows the commutator sections. Fig. 5 is the template for the rotor.

frame is supposed to be fastened on the support as shown in the other diagrams.

The field core is cut out of thin sheet iron, its thickness not being vital; 1/50th of an inch is a good thickness. Fig. 3 gives the profile by which the field core is to be cut. Twenty-five of these pieces are required. They are clamped together as accurately as possible and 1/4-inch holes are drilled as shown. They are then bolted together and a coarse file is used to finish them, and when the proper form is

reached the bundle is dismantled and all small asperities can be removed by a fine cut file. The pieces are then put together with thin paper between each pair of plates. The fine file gives the last finish.

The core now has to receive the field coil. The core is first wrapped with oiled silk or cloth and is then wound with 100 feet of No. 22 insulated wire, silk or cotton covered, or enameled. It is unnecessary to use insulating cloth between all of the layers, but such cloth should be used between every five layers. The completed field structure can now be secured to the base by a piece cut out of the same sheet iron as shown in one of the figures.

The only delicate part of the rotor is the shaft. It will be advantageous to have the shaft turned out by a regular machinist. The shaft must be of soft steel and of the form shown.

Bearings can easily be made of bronze or brass; a bronze bar 3/8 inch in diameter is cut to give two pieces each nearly 1/2 inch long, through whose centers quarter-inch holes are drilled. A second hole about .1 inch in diameter is drilled radially near one end of each.

The armature or rotor is made of 25 laminations of the same thickness of sheet iron used for the field core; the profile is shown in the illustration. The laminations

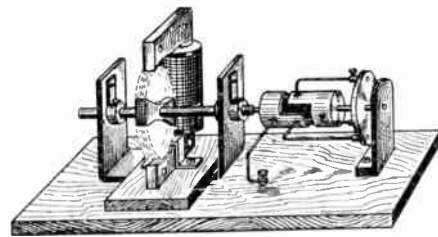

Perspective view of entire layout of rectifier, showing clearly the relation of all parts.

are put together exactly as described for the field core. There is no winding on the rotor.

Mounting. The frame carrying the bearings is screwed down on the wooden support and the bearings are thrust upon the axle ends. If the play is insufficient they can be reamed out with the tang of a file, or better yet, with a piece of hard wood supplied with emery paste, the wood being of such a size as to enter the hole without forcing. If, on the contrary, there is too much play, which can be avoided by having the axle turned up a little bit too large, other holes one-fiftieth of an inch smaller must be drilled in new bearings. At last when the shaft turns smoothly, the bearings are placed in the holes in the frame and are soldered in place, care being taken not to fill up the radial holes with solder. These holes are for oiling. When this much is done, the laminated core is slipped on the shaft. To do this it is best to prepare the bronze bearings like those used on other machinery, or to cut a thread in the radial hole. They will then act as collars to keep the rotor in place. To stop the rotor from turning independently of the shaft, two sheet iron angles are bolted to it as shown in the illustration, which in turn are bolted to the collars. A third collar is mounted on one side outside of the frame.

Now the field is put in place and held there by the piece of sheet iron shown. The field must be centered accurately and wedged in place with wood. It will be attached not directly upon the support, but will rest upon a piece of wood 3 1/2 by 2 1/4 by 1/2 inches cut out to accommodate the bearing frame. The thickness will be about 1/2 inch so that the field will be at the proper height. The centering will have to be done by experimenting. A

little filing may be required to give the last fine adjustment.

We now have to build the commutator, which is turned by the motor. A piece of round ebonite 1 1/4 inches by 3/4 inch is

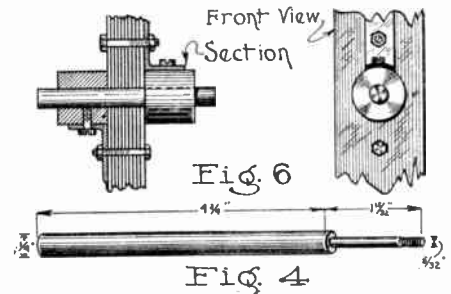

Fig. 6 shows section and front view of the rotor and its support. Fig. 4 is the shaft.

perforated by a 1/2-inch hole. Two special pieces of copper, which are to be described later, are put on with a driving fit. Finally, a brass washer is put against the shoulder, then the piece of ebonite, and the whole is secured by a nut upon the threaded part.

The commutator plates are made of a copper tube 3/4 inch inside diameter; two 3/4-inch pieces are cut off and a piece cut off the end of each. A transverse cut a little more than one-half the circumference in depth is made, and the larger piece removed by cutting parallel to the axis.

Having progressed thus far, to test the apparatus the terminals of the winding are connected to an alternating current circuit at about 25 volts. The apparatus is started by hand, which may be done by winding a string around the shaft, starting it top-fashion, or with a little motor. The apparatus is supposed to rotate at 3,000 turns per minute on a 50 cycle circuit. If a 60 cycle circuit is employed, the speed will be 3,600 r.p.m.

A certain amount of experience is necessary to succeed in starting the motor. If it does not start off in the first trials no discouragement need be felt.

When the motor is found to run well, the brushes are to be made. The following is the simplest construction:

One of the brushes makes contact with the complete circle of the commutator nearest the bend. A terminal that is screwed down on the base and a heavy copper wire .1 inch or more in diameter, is passed through the hole in the binding post which is set parallel to the axle. The

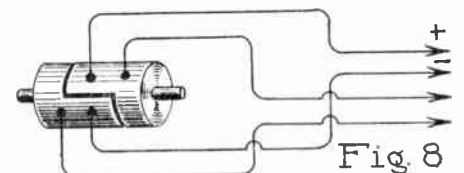

Fig. 8. This shows the commutator with its connections, for rectifying the current.

terminal is bent up so as to come within half an inch of the commutator. An eye is bent upon the end and filled with a brush of copper wire made from flexible cord stripped and doubled as required. The wire brush is soldered in the eye and the end is evened off. The brush presses against the commutator ring as adjusted by the binding post.

Three other brushes are held by a wooden disk carried by a prolongation of the shaft of the motor, and quite near the end. There are three binding posts attached to this disk, one is in contact with the outer end of the other half of the

commutator, the two others with the intermediate part, with the two brushes diametrically opposite each other. The pressure should be very light and the brushes should each be about 1½ inches long. The current is received by the ring shaped portion of the commutator and leaves by the intermediate brushes which

are in contact with the cut off portions of the commutators. The whole is explained in the drawing of the assembly. The apparatus has given great satisfaction to its constructor; it gives 6 amperes almost without sparking, and by setting the brushes one way or the other sparking can be almost completely pre-

vented. Some parts must be made by a machinist, but the cost will be very low. The whole bill came to about \$5.00 and the construction involved about twelve hours of work. The apparatus makes little noise and will operate as long as there is current to drive it.
M. ROUVIERE in *La Nature*.

Transformers for 1,000,000 Volts

By Dr. H. Becher

Frankfort a/M, Germany

IN the construction of transformers for very high tension considerable difficulties arise. A tension of 100,000 volts may discharge through air about 7½ inches between points, or about 1½ inches between spheres of 20 inches in diameter, while a tension of 500,000 volts discharges through an air distance of about 37½ inches between points and a tension of one million volts will discharge through 75 inches of air between points and 37½ inches between spheres of 20 inches diameter. One can imagine that even by using very good insulation and complete immersion of the transformer in oil it will still require considerable space between successive layers and between these and the iron core of the transformer to prevent disruptive discharge. The unavoidable consequence of a 500,000 or 1,000,000-volt transformer would seem to be extreme dimensions and high cost.

A German scientist, Dr. Friedrich Dessauer, has discovered a way of obtaining very high tensions with small and relatively low priced transformers. This idea was evolved at the very moment when it became necessary to have tensions of 200,000 volts and upwards for continuous working apparatus to be placed in the small rooms of hospitals for the purpose of producing extremely penetrating Röntgen rays, such as are used in the treatment of cancer.

The new system was based upon the following considerations: It is not difficult to construct a transformer for 100,000 volts, but for 200,000 volts about double the strength of insulation is necessary in every direction. This would amount to about eight times the volume even if two transformers, connected in series, are used, each of which would have to produce but half of the tension. If however, a group of transformers, connected as a whole, are utilized for the purpose, it is only necessary to insulate each of these transformers for a certain part of the entire tension. The electric energy thus transformed through a certain number of transformers will finally be brought to the full high tension in the so-called high-tension transformers to which it is delivered and the number of which may be taken at will. In this manner, it is possible to produce tensions of almost unlimited strength with a number of feebly insulated small transformers.

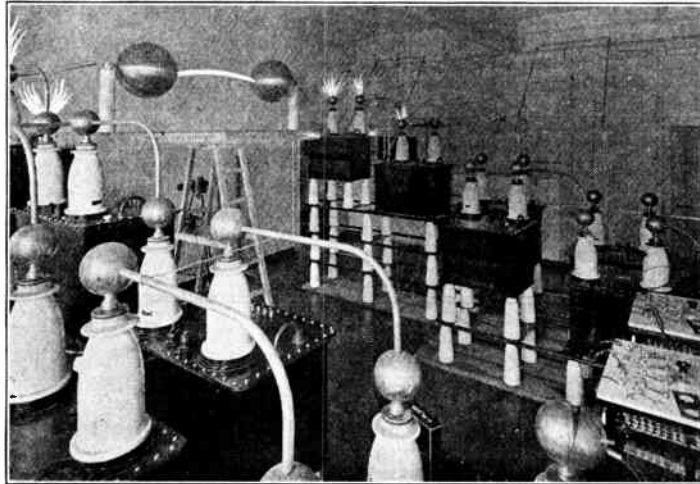

View of the great transformer set constructed in Germany for the development of a million-volt potential.

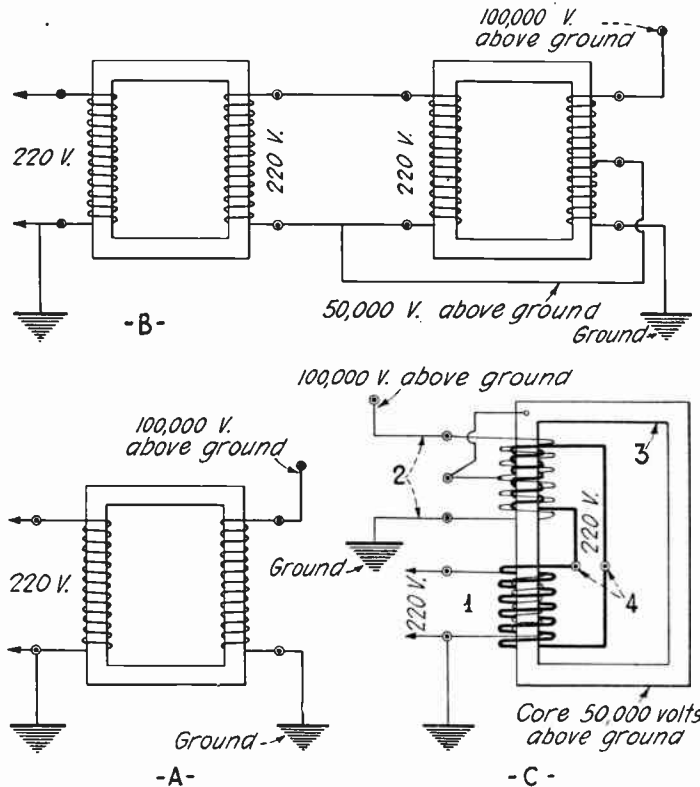

Explanatory diagrams of the connections of the induction coils, so as to avoid too high a difference of potential within near portions of their windings.

The arrangement and connections of a transformer of normal type are shown in the diagram (A). In one field of a closed iron core the winding for low tension is placed, over this the winding for high tension, the one end of which is grounded. The windings are shown on opposite legs of the core for clearness. Consequently the other end must be insulated from the low tension winding and from the iron core for the full tension of the 100,000 volts.

This means that the air space and material inserted must be sufficient to prevent even in continuous working any glowing or sparking. In comparison with this the arrangement of a transformer system according to the device of Professor Dessauer is shown at (C). In front of the high tension transformer an insulating transformer is placed which has to take upon itself part of the electric strain. The intermediate circuit is connected to the center of the high tension winding of the 100,000 volt transformer, thus placing this circuit 50,000 volts above ground potential. Each transformer now must be insulated for 50,000 volts, which is half of the entire tension. But even this arrangement may be still more simplified by combining the two transformers according to a device of Professor Petersen and Mr. Welter, engineers; this is shown in diagram (B). Here the low tension winding (1) and the high tension winding (2) are placed side by side upon the same iron core (3), which, by means of a connection with the center of the high tension winding, as in (B), now gets a tension of 50,000 volts above the earth. An equipotential winding (4), which is placed immediately on the iron core, operates to reduce the leakage. In this case, too, there is nowhere a tension above 50,000 volts for between any two adjacent parts of the outfit although a total of 100,000 volts is obtained.

A plant of this kind has been constructed by the Veifa works at Frankfort a/M for an institution in Japan, for the production of a tension of one million volts maximum value, which means 707,000 effective volts. It consists of two symmetrical halves, each containing four high tension transformers and two straining links. The high tension transformers, all of equal size, are immersed in oil tanks, each oil vessel being 23 inches in height, 27 inches in width and 23 inches in length. The insulators carrying the connections have a height of about 18½ inches, including the terminal balls. Each link produces a tension of 125,000 volts maximum value, but their insulation, according to the Dessauer principle, was calculated for only 62,500 volts. Thus all the four units of each side produce together 500,000 volts. The connection of both halves was grounded and the successive units were mounted step-fashion upon porcelain insulators.

Awards in the \$50 Special Prize Contest For Junior Electricians and Electrical Experimenters

<p>First Prize, \$25, Wilbur H. Yost, 742 Bowdoin St., Portland, Oregon.</p>	<p>Second Prize, \$15 Michael B. Cohan, 1009 Wolf St., Philadelphia, Pa.</p>	<p>Third Prize, \$10, Philo T. Farnsworth, 639 No. 6th West, Provo, Utah.</p>	<p>Hon. Mention, Lionel Nault, 80 Murray St., Sherbrooke, P. Q.</p>
---	---	--	--

First Prize

Electric Fireless Cooker

By WILBUR H. YOST

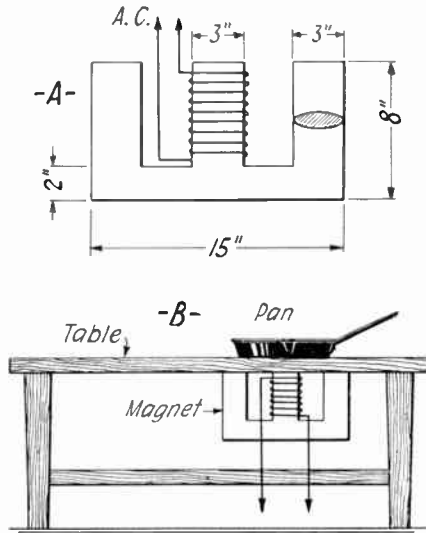

This apparatus by the action of an alternating current, produces heat sufficient for cooking. The currents induced in the core of the magnet do the work.

FIRST wind a powerful electromagnet with No. 6 or 8 cotton covered wire, on a frame of silicon steel, cut as in (A). Wind for 110 volts alternating current.

Mount this magnet underneath a wooden table as in (B). Leave top of table free. Connect the magnet coil with a concealed switch. Set an aluminum pan, over this magnet, on top of the table; and when an alternating current is turned on the pan will get hot enough to fry ham and eggs. This is due to the heating effect of the eddy currents set up in the pan.

Second Prize

Chime Clock Light

By MICHAEL B. COHAN

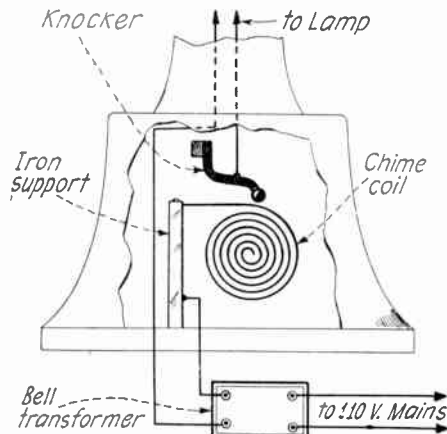

Attachment for a chime clock which causes a lamp to be lighted; each time the ring is given the contact between the hammer and the gong closes the circuit.

A NOVEL and somewhat mystifying light can be produced on a chime clock in the following manner:

First of all take the back of the clock off and look at the "works." Usually in a clock of this sort there is a heavy coil of steel, which is its gong, supported by an iron rod with the hammer above. Under the hammer head is a small piece of felt which should be removed. This is only placed there to give a softer ring to the chimes. A light (40 candlepower, 6-volt) which is supplied with current from a bell-transformer is concealed in the ornament.

\$50 IN PRIZES

A special prize contest for Junior Electricians and Electrical Experimenters will be held each month. There will be three monthly prizes as follows:

- First Prize \$25.00 in gold
- Second Prize \$15.00 in gold
- Third Prize \$10.00 in gold

Total \$50.00 in gold

This department desires particularly to publish new and original ideas on how to make things electrical, new electrical wrinkles and ideas that are of benefit to the user of electricity, be he a householder, business man, or in a factory.

There are dozens of valuable little stunts and ideas that we young men run across every month, and we mean to publish these for the benefit of all electrical experimenters.

If in any way possible, a clear photograph should be sent with the idea; but if that is not possible, a good sketch will do.

This prize contest is open to everyone. All prizes will be paid upon publication. If two contestants submit the same idea, both will receive the same prize.

Address all manuscripts, photos, models, etc., to *Editor, Electrical Wrinkle Contest*, in care of this publication.

The effect can be readily imagined. When the clock is about to strike, say ten, the knocker hits the gong, ringing it and also closing the circuit and lighting the lamp, once for each stroke of the hour.

Third Prize

A Tesla Coil Electric Sign

By PHILO T. FARNSWORTH

OF the many uses of the Tesla coil perhaps the most important is for advertising. It is at any rate a most effective means of advertising all electrical apparatus. The possibilities are endless. Almost every experiment performed with the Tesla coil serves for advertising purposes.

The construction is shown in the diagrams. Two sheets of bakelite about one-

eighth inch thick are coated on one side with tinfoil and shellacked together with the foil in the center. Figures are then painted on the outside to the outline of which fine wires are cemented. Many beautiful effects can be obtained in this manner, such as waves, aurora, and lightning. The coil can also be made to show various trade-marks, names of magazines, etc.

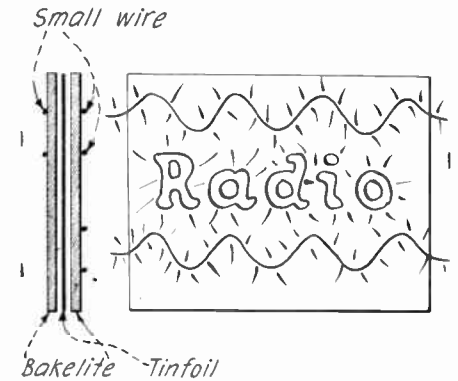

Electric sign which produces an effective display of letters or other desired description or design, utilizing high frequency current.

Wire ranging from No. 20 to No. 30 is used, depending upon the capacity of the Tesla coil.

Honorable Mention

Sign Flasher

By LIONEL NAULT

IN the illustration is shown a simple and practical way of making a sign flasher. Except for the two distributing posts (A) and (B) and the oscillating distributing

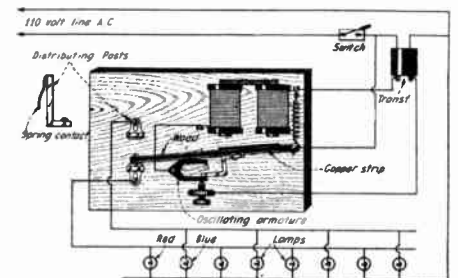

Sign flasher operating by an oscillating distributor actuated by an electro-magnet.

arm (C), the idea is the same as that of a slow ringing bell.

The arm (C) is of wood with a copper strip or even a copper wire run along the edge, free from contact with any other part. This is connected to the two screws on the ends of the arm. The distributing posts are easily made, either of metal or wood.

The apparatus works in the following manner: In turning on the current, the effect is the same as that of an ordinary door bell, but the current passing through the distributing arm is interrupted every time it leaves one distributing post to go to the other. By this movement, the lights are lighted and turned out in succession, and the action is repeated as long as the current is allowed to pass.

Awards in Odd Electrical Experience Contest

<p>First Prize, \$20 Arthur Flinner, Wichita Kansas</p>	<p>Second Prize, \$10 Arthur A. Kremer St. Cloud Minn.</p>	<p>Third Prize, \$5, Harold Hughes Worcester Mass.</p>	<p>Fourth Prize Ferral De Smith Richmond Mo.</p>
---	--	--	--

First Prize, \$20

Ball Lightning

By ARTHUR FLINNER



Ball lightning has been one of the world's meteorological mysteries, and this experience proves that there was a real electric discharge.

MY grandfather was sitting in the dining room of his house on a farm when lightning struck the house. A ball of fire as big as a man's two fists rolled across the room in front of him. The door leading outside was open and a dog was lying on the steps. The ball of fire killed that dog, then rolled down into the cellar, where it killed another one.

While there it split a heavy sill, making a bump in the floor. It also magnetized all the steel in the house. It seemed to have a grudge against dogs, because little else was harmed.

Second Prize, \$10

The Three-Brush Dynamo

By ARTHUR A. KREMER

IT was about a year ago, during the month of August, that I had an odd electrical experience. While the motor of our Dort car was running I thought that I might as well try to stop the motor by disconnecting the battery terminals. When I had disconnected them I found, to my surprise, that the engine did not stop.

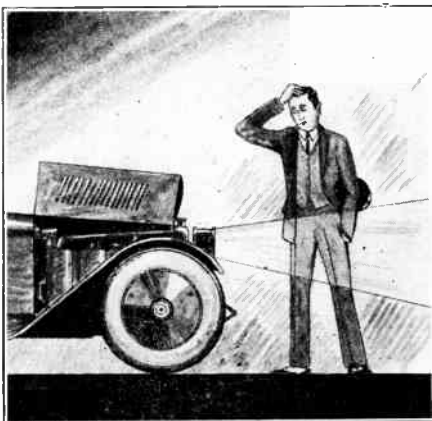

The third brush dynamo is known to be the source of various surprises. Here one of our readers tells one of his.

I next thought of turning on the electric lights. All the lights went on. I also turned on the dash lamp. But there was a difference in the lights. They all flickered, and were unusually bright.

Next I thought I could make the lights still brighter. So I opened the throttle of the engine a little more. But then all the lights went out; the current destroyed the filament.

From that time on I made up my mind never again to try that particular stunt.

I told him I did not know, so he sat in the seat, but was not affected in any way, and he asked me if I was fooling. I said no, and that I would show him how it happened; putting my feet on the heater

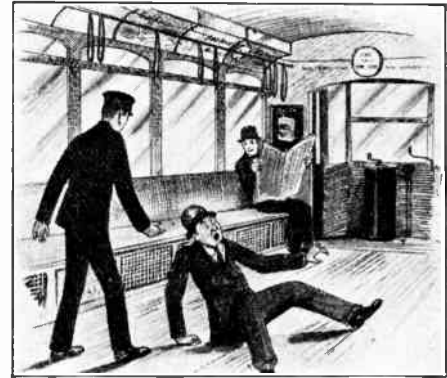

In one of DeMorgan's novels, "Somehow Good," a shock received in a trolley car, produces amnesia. Our contributor's memory was certainly not affected by the shock he received.

and one hand on the sill I was again thrown out into the aisle. I found out that the heater was grounded. The car was made of steel and was grounded by the track, so that when I put my hand on the window-sill I came between the heater and the grounded car.

\$37.50 IN PRIZES

We take pleasure in offering a series of prizes for letters giving odd and unusual electrical experiences.

First Prize \$20.00
 Second Prize \$10.00
 Third Prize \$5.00
 Fourth Prize \$2.50

Nearly every one of us has had an odd or unusual experience in electricity, sometimes humorous, sometimes pathetic, sometimes puzzling, and it would appear that our readers should let us have some of their personal experiences for the benefit of all.

The more unusual the experience, the more chance you have to win a prize.

Illustrations are not necessary, but the letter should be either type-written or written in ink. No penciled matter can be considered. Write only on one side of the paper.

If two contestants should send in the same winning experience, both will receive the same prize. In the event of two or more persons sending in the same as best, second best, etc., each tying contestant will receive the prize tied for.

Prize winning letters will be judged as follows: The first prize will be awarded for the letter giving the oddest or most unusual experience. The second prize to the one considered next best, and so on.

Communications to this department should be addressed *Editor, Odd Electrical Experiences, care PRACTICAL ELECTRICS, 53 Park Place, New York City, N. Y.*

Fourth Prize, \$2.50

Live Dead Wires

By FERRAL DE SMITH

WE had strung about a mile of No. 8 bare copper wire four feet below a transmission line of 33,000 volts. Our bare wire was well insulated from the cross-arms by 5,000-volt insulators, and was not connected at either end.

During the night a farmer called and said that the wires had set fire to a dead tree and embers were flying toward his haystack.

When I got there I found the supposedly dead wire would rub the limb and sparks would fly and the limb would blaze.

The trouble was only the induction from the transmission line above. After the supposedly dead wire was grounded all trouble ceased.

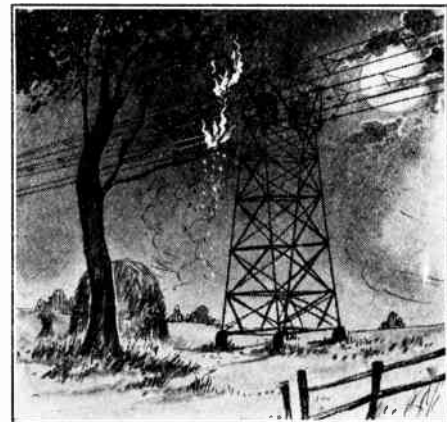

A presumably dead wire was the cause of a dangerous discharge when it touched a tree, so as to threaten the setting on fire of an adjoining hay stack. Grounding the wire did away with the trouble.

To burn out four lights at once was too much for me.

(Our readers are referred to Mr. H. Highstone's valuable article on the "Three-Brush Automobile Generator" in PRACTICAL ELECTRICS, June, 1923, p. 357.)

Third Prize, \$5

A Trolley Car Shock

By HAROLD HUGHES

THE following incident occurred about two years ago on an electric steel body car. One winter morning I took a seat in the car and as my feet were cold I put them on the heater and rested my hand on the window-sill. At once I was thrown out into the aisle. The conductor came over and asked me how it happened.

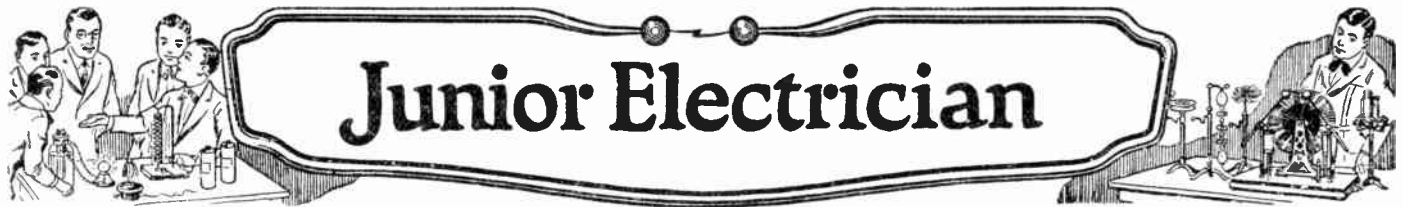

Junior Electrician

Electric Bell

A VERY simple single coil direct stroke bell is shown in the accompanying illustration.

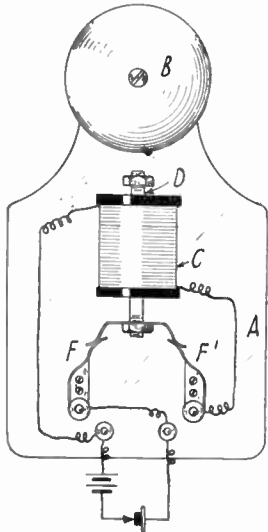

A direct-stroke bell of very simple construction, one which a junior electrician can build for himself.

The wooden base (A) is cut out as shown and the gong (B) is bolted to it. A solenoid (C) is fixed to the base about one-quarter inch from the gong. (D) is the solenoid core, which may be an iron bolt about three-quarters inch longer than the solenoid. A piece of spring brass is bent as shown and fixed to the lower end of the core. (F) and (F') are pieces of brass bent to make contact with this piece. Two binding posts are mounted on the base and the bell is connected up as shown.

When the circuit is closed the solenoid core is pulled up and strikes the gong, being raised by the attraction of the coil. When the core rises it breaks the contact at (F) and (F'), opening the circuit, allowing the core to fall and to make contacts at (F) and (F') again. This action is repeated as long as the external circuit is closed.

Contributed by ROY C. HUNTER.

Simple Sign Flasher

HEREWITH is a simple device which will control a number of lights, and

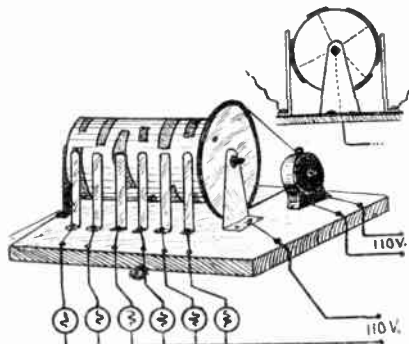

A sign flasher operated by the commutating drum principle, and turned by a miniature electric motor.

may be easily made from parts found lying around almost any shop.

A cylinder is made from insulating material such as wood or fiber, and is mounted on a shaft, which in turn is mounted on a wooden base. On the same shaft with the cylinder is placed a large pulley which is connected with a motor by a belt. On the cylinder are fastened a number of metal pieces (preferably copper or brass). These may be fastened with small wood screws. All the pieces of metal on the cylinder are connected together with wire and connected to the metal shaft. The shaft is supported by two metal pieces through which the current passes as shown by dotted lines, Fig. 1.

On the side of the cylinder are placed a row of metal pieces which serve as brushes, each being connected to one or more lights. If desired, two rows of the brushes may be used. The illustration shows how the connections are made.

Contributed by EVERMONT FISSEL.

WHEN this number will have reached the hands of our readers, the \$100 Spark Plug Contest announced in our September issue will be open for some time, as it does not close until October 15, 1923; the results will be published in our November issue.

We hope that this will have the same interesting and widely distributed response which has attended all our other contests.

The prizes have been already announced, and while the winners will be gratified by the reception thereof, they will also be interested in having their articles published by us, to be read by our many readers.

No-Current Relay

RECENTLY I had occasion to build a little charging board to "kick juice" into the radio battery and improvised a little no-current relay that might interest the great fraternity of wire twisters. As we all know, a storage battery works both ways; it takes stuff while the charging current is on, and should the charging current be cut off accidentally or otherwise, it kindly gives back all the current and then some, and has to be recharged.

A no-current relay prevents this nicely and one can readily be constructed from a bell or buzzer and a few odds and ends. As shown in the illustration a stiff arm is riveted to the armature of a buzzer. A strip of heavy brass bent at the end as shown does the trick. Two contacts are attached to a wood block in such a position that the bent part closes the circuit when raised into place. A small knob from a pot lid fastened to the end of the strips makes it look complete.

Now the winding must be suited to the current to be handled by the relay. Determine the amount of current to be used and allow 1,000 circular mils for each ampere and select the size of wire having this area from a wire table. Wind the coils full and connect the ends as shown in the wiring diagram.

The relay is simply connected in series with the source of current and the battery. When you want to charge push the

arm up into place and it will stay there. A break in the current lets it drop under the influence of the spring shown and the circuit is open and stays so. Be careful that the armature does not touch the poles of the coils when the relay is closed or it might stick and then Battery-Blooiie.

Contributed by M. R. McCABE.

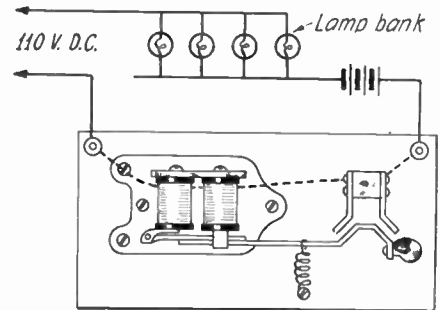

An apparatus called a no-current relay. It cuts off a storage battery from the charging circuit, when there is danger of its discharging itself through the same. The cessation of the charging current from any cause opens the circuit by electro-magnetic action.

Watch Alarm

A SIMPLE alarm can be made in the following way: Remove the glass, the minute and the second hand from a watch. Then take a strip of springy brass, a little longer than the diameter of the glass. Wind a few turns of insulated bell wire on this, removing the insulation from the ends and twisting them together. Bend the brass slightly and spring it into the groove originally meant for the glass. Bend the twisted ends of the wire downwards so that the hour hand will touch them on its way around. The watch is now placed in circuit with the bell and battery, as shown in the diagram, and the alarm is finished.

By turning the strip around in the groove the alarm can be set for any hour desired. The bell can be left out and a buzzer used instead. With this under one's pillow there is no disagreeable noise to waken the rest of the household.

Contributed by ERNEST FREDERICK, Berlin, Germany.

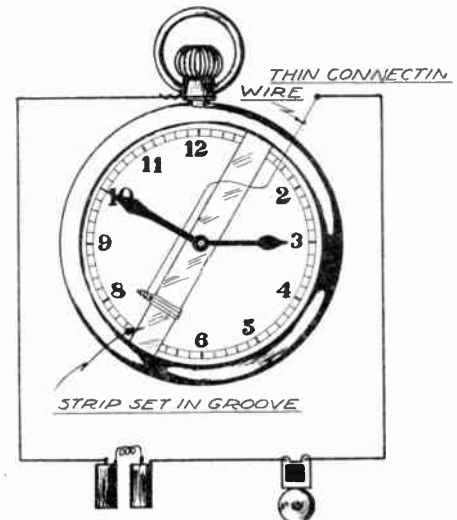

An ordinary watch arranged to close a bell circuit, so as to give an alarm for awakening the sleeper.

Simple Jack Switch

WHEN one possesses a small switch-board to control motors, testers, bells, etc., it is somewhat costly to use either snap-switches or knife-switches. However, this cost may be reduced a bit by the use of a small piece of mechanism which I am about to describe.

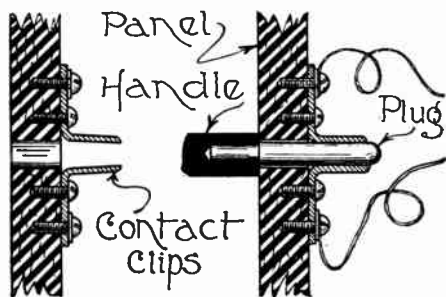

Very simple jack switch made out of every-day material, yet which, with a little taste, can be made to rival the purchased ones in appearance.

In the panel of the control board a hole about $\frac{1}{4}$ of an inch is made. On the back of the board two pieces of quite stiff brass or copper are placed, one just above and one just below the hole. They are placed as shown, and are about three-sixteenths of an inch apart. This can be termed a "jack." One wire is soldered to the one strip and the other wire is soldered to the remaining piece. Now it is necessary to make a plug. To do this, obtain a bright, long copper rivet just $\frac{1}{4}$ of an inch in diameter, and to the end where the head is, attach a neat-looking handle of some insulating material.

To make a connection, push the plug into the hole. It will come in contact with the two strips of metal and the current will flow through the plug to the other side.

This little connector can be made at a minimum cost, and is quite efficient. Of course, the greater the current the larger the jack and plug must be made.

Contributed by LLOYD L. CHAFFEE.

High Voltage Laboratory Battery

THE author has recently constructed a storage battery which has given very good results. It consists of ten cells giving over 20 volts and about 4 ampere hours. Due to the method of construction and materials used, the entire thing did not cost over \$1 in actual cash.

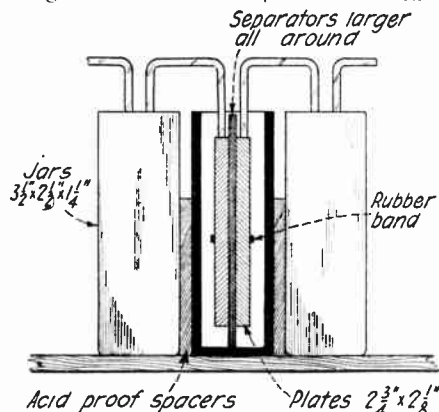

The making of a storage battery with small square jars designed to give high voltage rather than high amperage.

It will be noted that square jars are utilized. These are medicine bottles, all of the same size, with the tops cut off. The ones used were approximately $7\frac{1}{2}$ " high, $2\frac{1}{2}$ " wide, and $1\frac{1}{4}$ " thick. They were cut off $3\frac{1}{2}$ " from the bottom, giving jars $3\frac{1}{2}$ " by $2\frac{1}{2}$ " by $1\frac{1}{4}$ ".

Any method of bottle cutting may be employed, but the author secured good re-

sults by the following procedure: First, a file is moistened with turpentine and a fairly deep scratch is made where the bottle is to be cut. Then a piece of iron wire is heated to a red heat and held on the file mark in the direction that the cut is to go. The bottle will crack just where the hot wire was placed. This is repeated until a crack is made all around the bottle, after which the top will drop off. The sharp edges of the glass are smoothed with a carborundum slip or whetstone.

The jars are coated with paraffin at the top to prevent the acid from creeping.

The plates are cut from discarded automobile battery negative plates which can be obtained at any battery station for the asking. Pick out the best plates and a few good separators. The plates are cut into four pieces with large tin snips. The plates are $2\frac{3}{4}$ " high and $2\frac{1}{8}$ " wide to fit a jar of the size mentioned. Negative plates are used for both the negative and positive plates of the battery. This is the easiest and most satisfactory way as they form very quickly. It will be found that after about five hours at 1 ampere the battery will hold a good charge.

Lead strips about $\frac{3}{32}$ " thick, $\frac{3}{4}$ " wide, 3" long, are used to connect the cells. These must be "burned," not soldered, to the plates. A sort of half mould is used as shown. The connector and plate should be filed to a bright surface and then placed in the mould as indicated. A soldering iron is heated to nearly a red heat and then held on the joint just long enough so

Stagger connectors as shown

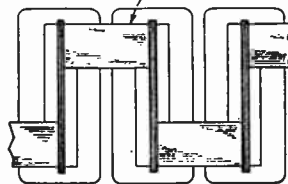

Connections for the storage battery illustrated in the preceding column, showing how the connections are to be staggered.

that the two ends melt and run together. The connectors can be cut from sheet material or moulded from scrap lead in a mould also shown. Two plates should be burned on the end of each connector except the end ones. Be sure to burn the connector on the corner of the original auto battery plate so that there will be some metal to melt upon the strip.

Sulphuric acid and water are mixed to give a specific gravity of 1.300 to provide the electrolyte. Be sure to pour the acid into water slowly and stir constantly. Enough should be put in each cell so as to cover the plates. Put it in when cold.

The plates are assembled by placing a separator between them, grooved side to the positive, and binding the pair with a rubber band. The separator extends further down than the bottom of the plates, so as to keep them from touching the bottom of the jar where sediment is likely to collect and short circuit the plates if it connects adjacent ones. The end connectors have binding posts as shown in the illustration.

The cells are kept in a box of proper size, which has been given a good coat of acid proof paint or varnish. The author used a cigar box, $7\frac{1}{2}$ " long, 5" wide and 2" high, inside measurements. The cover of the box was used as a cover for the unit, as individual covers would be too complicated.

Do not charge at a rate of over 1 ampere. An electrolytic rectifier provides a simple and cheap means of charging from an A. C. circuit.

If more than 20 volts is needed, extra cells can be made and hooked up in series. Twenty cells (40 volts) will easily run a small arc light. This is not a so-called

storage "B" battery as used in radio, this one being much larger and having greater capacity, although it may be used in radio work if desired.

Contributed by HARRY R. LUBCKE.

Simple Wall Insulator

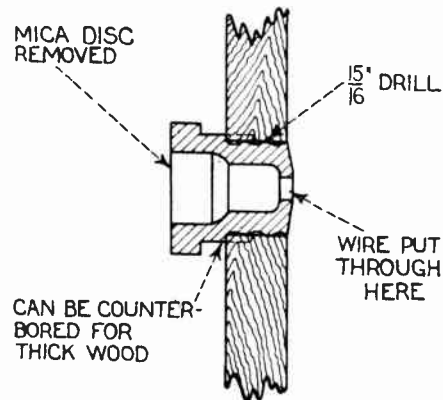

Wall insulators for passing a wire through a partition with perfect insulation, using an old plug fuse socket.

AN old plug fuse forms the base of a very simple and efficient wall insulator which can be made in a few minutes.

As will be seen in the diagram, it is only necessary to remove the mica disk and the brass connection at the bottom of the fuse. The fuse should also be cleaned of any fuse wire that might remain.

To install the insulator a fifteen-sixteenth inch hole is drilled at the desired place through panel or wall and the insulator is screwed in as if it were being screwed into a regular socket. The wire is put through the hole in the center.

This insulator has an advantage over the porcelain tube variety in that it is held solidly in the wall.

Contributed by HARRY R. LUBCKE.

Printers' Dryer

IN a job printer's shop I visited, the other day, I noticed that the printer had taken two open-coil flat-bed electric toasters or toaster stoves, and had mounted them upside down so that their heated surfaces were lifted about one inch above the table top.

Traveling across the table he had then arranged a wide cloth belt on which, at one side, he laid the "wet" cards or small sheets as they came from the press. As these cards were carried under the glow-

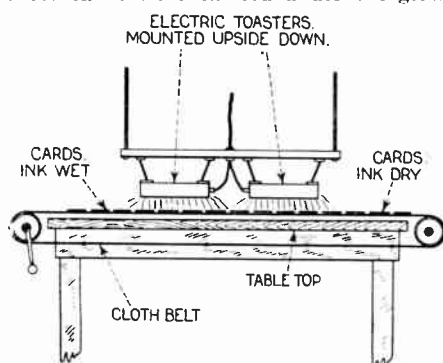

Two electric toasters inverted above a traveling band are used to dry pictures for printers or photographers.

ing toasters, the ink on them was quickly dried and they emerged at the far side, ready for use, without "offsetting."

This home-made electric drying outfit enables this printer to handle many rush jobs, which would otherwise take several hours extra to dry sufficiently to be handled.

It is evident that there are many operations to which this arrangement could be applied.—*Electrical Merchandizing.*

Window Closer

A WINDOW closer to be operated by an electric circuit, is shown here; the closer is always out of sight and allows the window to be raised to any height.

Fig. 1 (A) is a piece of india rubber fastened to the brass bar (B). (S) is a support on which (B) is pivoted. The spring (O) presses against (B) and holds (A) pressing against the window. An

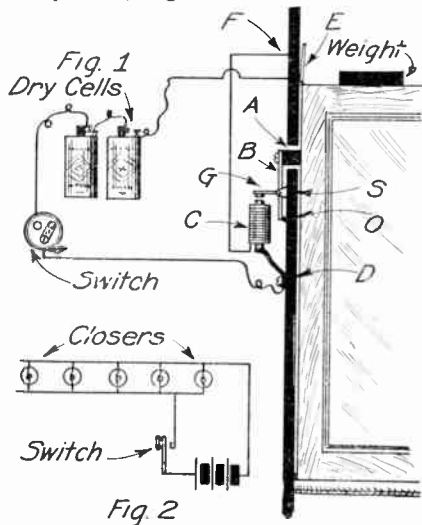

The above diagram shows a window closer. Fig. 1 shows the india rubber piece (A), which holds the sash up or down and when released the sash falls. Fig. 2 shows how a number of windows may be connected and operated from the one switch.

armature (G) is fastened in the middle of (B). The electromagnet is fastened under (G) so that when current passes (G) will be attracted. This draws the india rubber back and the sash is free to descend.

Fig. 2 shows the connection of five closers operated by one switch. The switch may be placed on the first floor of the house so that during a rain the windows may be closed all at once from the first floor; or it may be used in connection with a rain alarm. A weight is placed on top of the window sash so that it will descend.

Contributed by WILLIAM MEAGHER.

Wireless Switch

THE diagram illustrates a wireless switch which is operated by clapping the hands or producing other vibration.

The arm (A) is similar to the arm found in the Radio Rex, a toy dog which jumps out of his house when the hands

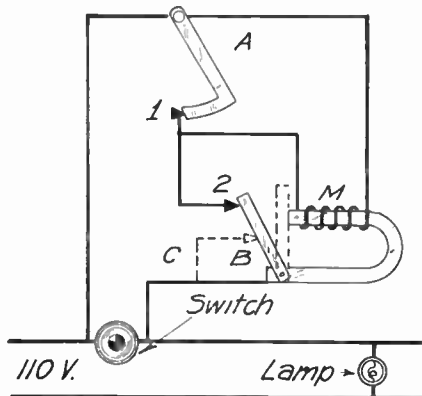

This switch is based upon the use of a delicately poised gravity connection such as utilized in the well-known radio-fox toy. Clapping the hands opens the switch. The magnet attracts its armature and the light is extinguished.

are clapped. (A) should be delicately suspended so that it makes a light contact with (1).

The main switch can be turned off and

yet the light burns as shown by the diagram.

Then after the person is, say, in bed, he claps his hands and out goes the light. The clapping vibrates (A), which opens that circuit and causes the current to flow through magnet (M). The said magnet then draws over its armature (B), thereby turning out the light. (B) is part of the magnetic circuit of (M).

Needless to say, the magnet (M) must be well insulated from the core so as to prevent the current from flowing through it, or the circuit can be arranged as shown by dotted lines (C).

The whole secret lies in the arm (A) and one must experiment to cause it to jump easily. It will help some to mount the apparatus on a sounding board such as a cigar box.

Contributed by WALTER LINDQUIST.

Interesting Articles to Appear In November Issue of Practical Electrics

Mercury Vapor Arcs.
By Allan R. Kenworthy.

Floating Needles and the Magnet.
By Dr. Albert Neuburger, Berlin.

Carbon Disc Rheostat.

Finding Positive Pole.

Thermic Telephones.
Concluded.

Little Known Methods of Producing Electricity. By Raymond B. Wailes.

Electric Cutter

THE electric cutter described here has been used with great success for cutting jars, bottles, large diameter glass tubing and gauge glasses, to any desired length.

The appliance consists of a high resistance wire strung between two upright supports mounted on a base. Fiber arms fastened to the tops of the supports and carrying binding posts hold the strung wire securely. A short length of nichrome, silchrome, kromore, or other high temperature nickel- or silicon-chromium resistance wire serves admirably for the cutting element. German silver wire cannot be used for any length of time, for it slowly oxidizes and breaks.

A resistance composed of several turns of the same resistance wire wound upon an asbestos or slate form is used in series with the wire cutter, the cutter and the resistance being inserted in series with the 110-volt A. C. or D. C. circuit. Enough wire should be wound upon the resistance so that when the current is passing through it and the cutting wire, an almost bright red heat is obtained on both. The resistance should be enclosed in a tin box containing asbestos so that fire danger is eliminated.

To cut a bottle or large diameter glass tube, file a mark half an inch long on the piece where the cut is to be made and in

the direction the cut is to follow. Now with the cutter wire heated apply the file mark to the wire and rotate the article. The crack produced can be easily led around the entire diameter by rotating the bottle, if a steady hand is used, always coming exactly even with the starting crack. The sharp edge of the article can be smoothed with emery paper, with a whetstone or on a plate of glass with turpentine and sand.

A small metal saddle fastened upon the

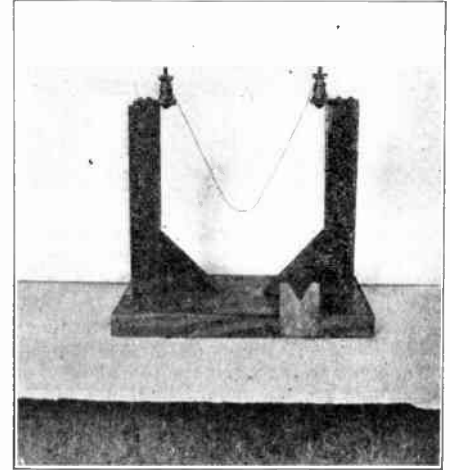

The apparatus shown is for the purpose of cutting bottles. It maintains a wire at red heat and when the bottle has a little scratch made upon it, it can be cut very accurately by the effect of the heated wire on the glass.

front of the electric cutter, as shown, enables very short lengths of tubing to be cut from glass tubing or rod. After filing a starting mark upon the tube, the tube is laid in the saddle, with the filed portion upon the metal saddle. A sharp rap with the file will break off the portion protruding upon the opposite side of the saddle.

Contributed by RAYMOND B. WAILES.

Refrigerator Pan Alarm

IN view of the inconvenience caused by refrigerator water overflow, the alarm illustrated herewith may interest many of our readers.

Being composed of a single unit standing on the floor, and designed to extend over the edge of the pan, the device can be pushed in and out as well as set to one side when emptying the water.

The diagram is fully explanatory; most of the necessary material, with the exception of the battery, is likely to be

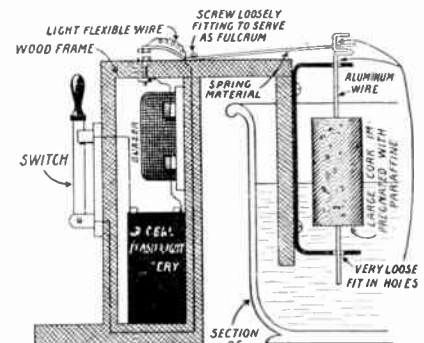

An elaborate water alarm which is supposed to be for a refrigerator pan, to warn of danger of overflowing, but will have numerous other applications. This apparatus can be adjusted for different levels.

found in the junk corner of nearly any workshop.

The device is adjustable as to the water level at which the contacts are closed, by sliding the cork up or down the float rod.

Contributed by JOHN W. KRONS.

Tools From Magnets

An old telephone magnet can be utilized in constructing this wrench. The ends of the magnet are to be forced together, so as to make it fit the smallest nut necessary. The magnetic force of the magnet helps to keep the magnet in place on the nut. Notches should be filed in

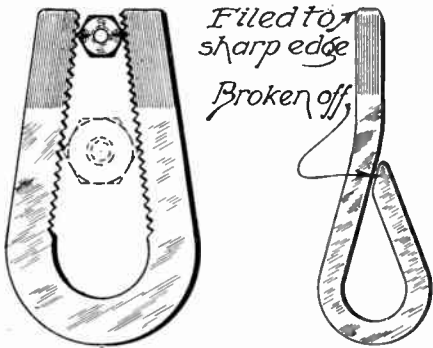

Magnetized screw-driver and wrench made out of discarded magnets; the quality of the steel and the magnetization of the tools given them value.

the magnet as shown in the illustration. A handy screw-driver can also be made from an old magnet by remodelling it in the manner shown in the next illustration. This is an ordinary magnet bought in a toy store. The force of the magnet helps to keep the tool's edge in the notch of the iron screw.

Contributed by DONALD JOHNSTON.

Electric Phonograph Stop

IS the top of the phonograph, (A) is the turntable, (C) the reproducer, (B) the stop.

A pair of bell magnets are mounted so that they will draw evenly on the handle of the regular stop. They are shown at (F) in the diagram.

A brass strip is next bent as shown in the small figure. Place it on the machine as shown at (D) and fasten one of the electric circuit wires to it.

Fasten a wire to the reproducer arm in series with a couple of dry cells and the magnet. Connect the wire from the brass strip to the other terminal of the magnet.

The operation is as follows: When the reproducer reaches the end of the record, it touches the brass strip and closes the circuit, exciting the magnet. The magnet draws the stop or brake arm, which stops the phonograph.

Contributed by FRED HALL.

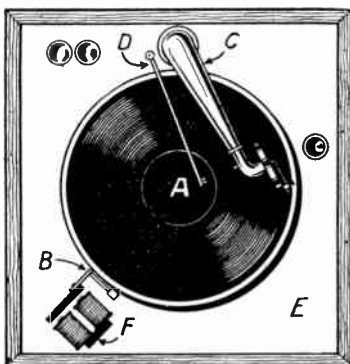

Very simple electric stop for arresting a phonograph when it reaches the end of the piece it is playing.

Announcing Sign

THE following materials are required to make this combination name-plate and "Not at Home" sign:

An old tin box about six inches long, four inches wide and one inch high, an electromagnet, a flashlight reflector and bulb, two binding posts (from a worn-out

dry cell), a piece of soft iron bent in the shape of the lever in the diagram (Figure 2), a piece of light metal (such as tin or aluminum) about five inches long and one and one-half inches wide, two pieces of tin about three inches long and one-half inch wide, enough screws to put the contrivance together and fasten it above the push-button.

First cut a piece of tin about three-fourths of an inch wide and five inches long from the front of the box, three-fourths of an inch below the top of the box. On the inside of the box put a piece of glass over the hole and fasten by bending about one-fourth of an inch of tin at each end of the slit, over it. After supporting the glass tight, procure an old electromagnet from a worn-out electric bell and fasten this to the bottom of the tin box, inside and about in the center.

Next put a bolt about three-fourths of an inch long in from the back of the box, and fasten it to the back by soldering. Put a nut on the screw, then the lever (which has a hole in the center) the screw, and then a second nut to keep the lever in place. One end of the lever has a piece of cardboard glued to the bottom to keep it from sticking to the electromagnet

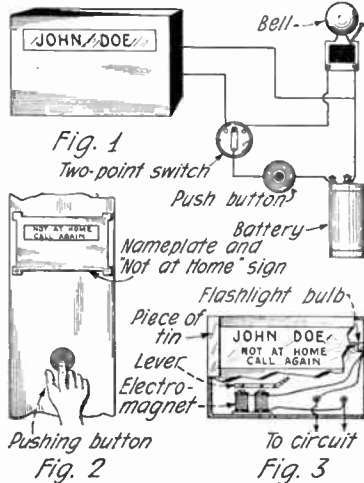

Door sign operated by electricity, so as to indicate when the occupant is out or when he will return, and to give any other information of that character by the touching of a button.

when the current is off, and is placed so that it is about three-eighths of an inch above the electromagnet. The other end of the lever is fastened with a bolt or rivet to the center of the bottom of the long piece of tin. This lever is so pivoted that when the magnet pulls the armature end down three-eighths of an inch, the end fastened to the piece of tin will rise three-fourths of an inch. On the lower three-quarters inch of this piece of tin are printed the words "Not at home, Call Again." On the upper three-quarters inch is printed the name of the person residing at the house.

Two small pieces of tin are bent so as to form a vertical groove to guide the large piece of tin when being raised by the electromagnet or lowered. The flashlight bulb in the reflector is placed at the side and in the front of the box, out of sight, but so that it will throw light on the large piece of tin when the button is depressed. The electromagnet and flashlight bulb are connected in series and the wires go to the insulated binding posts at the back of the box.

The combination name-plate and "Not at Home" sign is then connected as shown in the diagram with the bell, push-button, battery and two-point switch.

When you are at home, and the button is depressed, the bell will ring, but the name-plate will show your name only.

When you are not at home, and the two-

point switch is turned to the other side, and the button is depressed, the bell will not ring, but will raise up the piece of tin high enough by means of the electromagnet to show the words "Not at Home, Call Again." When the button is released, the piece of tin will fall again so as to show only the name.

Contributed by JOE CLEVELAND.

Magnetizing With Buzzer

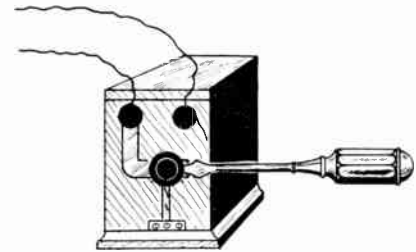

Magnetizing a screw-driver with a buzzer or electric bell—a rather interesting experiment and one which is easily tried.

THE blade of a knife or the end of a screwdriver can be magnetized quickly by using a spark coil and four dry cells, or, better yet, a 6-volt storage battery. One or the other of these is to be found in most homes or workshops.

When the battery is connected to the spark coil the buzzer will operate; then hold the handle with a piece of rubber, run the blade between the two points of the buzzer several times, and it will be magnetized. The blade is to be held so as to barely touch the contact points, so that they can be working constantly.

While it is hard to believe that anything can be magnetized in this way, one can easily be convinced by trying it.

Contributed by EDWARD HILBERT.

Electric Latch

BY placing this contrivance on the door of my laboratory, I am enabled to leave or enter by simply stepping on a button and pushing the door open with my foot. This, of course, is a convenience when both arms are occupied.

(C) is an iron rod pivoted at (A), so it can work freely up and down; (B) is a spring; (D) is a stop; (E) is the hasp; (A) is an electromagnet. The wires from the electromagnet connect in series with a push-button and battery.

When the button is pressed, the electro-

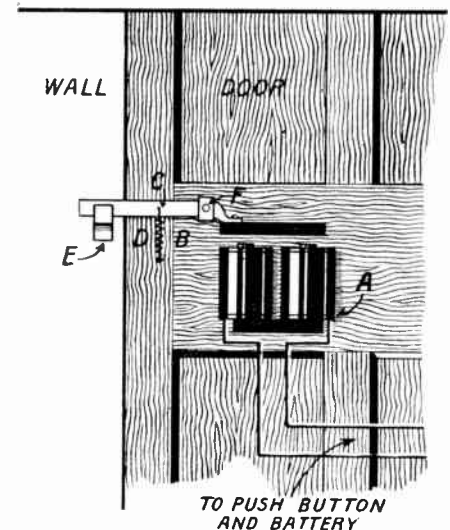

Electric door latch which is released by closing an electric circuit, either by an ordinary button or a concealed key.

magnet is excited and pulls the iron bar (C) down, thereby lifting its other end from the hasp. The door may then be pushed open.

Contributed by FRED HALL.

Odd Batteries

There are numerous places about the house where the electrical experimenter possessing a radio head set can find or produce minute currents of electricity. It is quite well known that a dime and a copper cent separated by a small corner

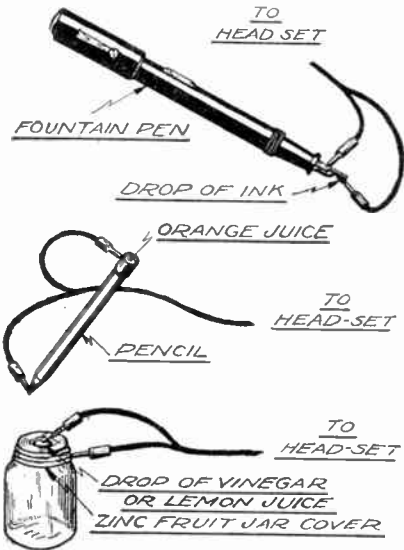

Three examples of the production of currents of electricity from unusual sources, such as a fountain pen, a lead pencil, or the cover of a fruit jar, which class of experiments can be extended to many other objects.

of wet newspaper constitute a miniature battery, and will produce enough current to make a very audible click in a telephone receiver. The sensitive radio head set will detect the current in quite a number of other places or arrangements.

A thimble partly full of salt water may be set on one terminal and a click will be heard whenever the other terminal of the head set is plunged in the water.

A fountain pen containing ink is also a battery. Shake out a big drop to the end of the pen and touch one terminal to the drop and the other terminal to the metal pen above the drop. A click will be heard in the receivers.

A lead pencil with metal ferrule and rubber eraser gives another element for a battery. Remove the rubber eraser from its holder and squeeze a drop of orange juice into the recess left on the pencil top. One terminal touched to the metal of the holder, and the other to the lead at the point, will be followed by a click in the receivers.

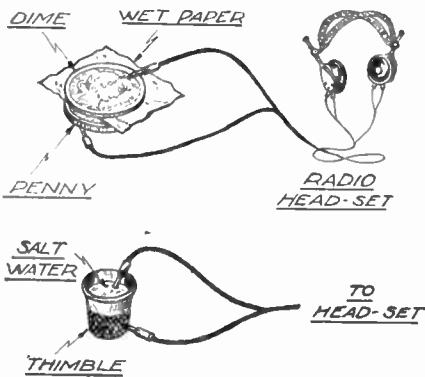

A thimble, with salt water, are elements in one little battery; the upper figure shows a coin battery, and the general way in which the miniature batteries are connected to the head-set.

A zinc fruit jar will also yield a wee bit of electric current. A drop of lemon juice is placed on the zinc cover. A small piece of copper wire wrapped around one terminal of the receivers and held in the drop of lemon juice, but not

touching the cover, is the first requirement. Rasping the other terminal on the zinc cover will produce a corresponding rasping sound in the receivers. This experiment is equally successful using the zinc lining to the refrigerator and a drop of vinegar as the electrolyte.

In connection with the short list of experiments I have outlined, I am wondering if some of the readers of PRACTICAL ELECTRICIANS would not find it possible to find a number of other places about the house where minute currents can be produced, using simple materials.

Contributed by B. W. CURRY.

Electric Saw

At first glance the electric saw described in this article appears to be nothing more than a novelty. But despite its looks it is really a very useful device for certain classes of work.

This apparatus operates by the utilization of a heated wire; the wire, maintained at a red heat, burns its way through anything inflammable, or possessing a low melting point. Although best adapted for light work such as cardboard, hard rubber or other similar substance, bristol board, thin wood like cigar boxes and the like, it has under test cut an inch square piece of hard wood in two. A slight sawing motion makes it cut several times faster.

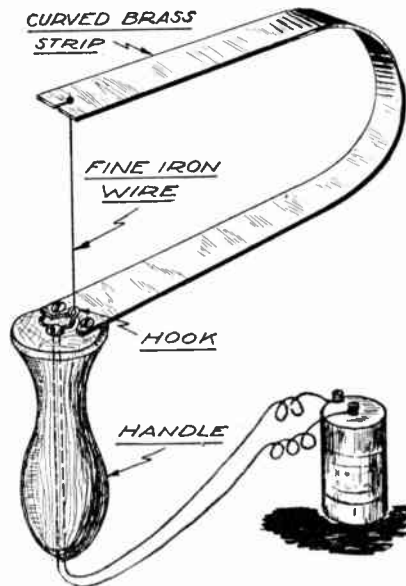

An electric saw, a very interesting and in many cases exceedingly useful article, for cutting wood and similar materials by a hot wire.

The surface of the material cut has a brown, highly polished look, due to the heat, but a rub with fine sandpaper will remove this. The feature that makes it practical is that the frailty of the substance to be severed is no hindrance to smooth cutting. The saw "eats" its way through without the harmful pressure and motion of the regular toothed saw. As an example of the delicate work possible the fact may be cited that as a "trick" I was able to cut a match stick into four parts lengthways.

It takes but a few minutes to construct. The materials necessary are a 10-inch strip of brass or tin, a wooden handle and two or three dry cells for current. As shown in the illustration the metal strip is bent double and at one end a fine slot one-fourth inch long is cut, while the other end has a slot a half inch long and one-fourth inch wide cut out. The end with the large slot is fastened on the end of the handle with two small screws.

Next a hole is bored through the handle at a slight slant so as to miss the end of the strip. A tiny screw hook or small bent nail is driven in the wood at the end of the handle exactly in the center of the slot or opening in the strip. Two wires from the dry cells are brought through the hole in the handle and then one wire is soldered to the strip and the other to the hook. Heavily insulated wire is best to prevent a short circuit. A thin piece of iron wire (a piece of screen wire will serve excellently), one-inch long has a small loop at one end and a knot at the other. The loop is slipped over the hook and the knot is pushed into the small slot so that it is held straight by the springiness of the metal strip.

When the current is turned on from the batteries the iron wire will glow at red heat, if the current is strong enough; a rheostat should be placed on the circuit to regulate the current. I have found that the best temperature for use at all times is not a full red heat, but where the wire is just on the point of becoming red, while still black in color.

Contributed by H. P. CLAY.

Rain Alarm

A very simple and efficient rain alarm can be made from an old burnt-out incandescent lamp.

A 75- or 100-watt incandescent lamp is obtained. It should be an old style tungsten lamp. The top is cut off as shown in the illustration. The filament is then taken out and the wires that are connected to it are broken off even with the glass inner stem. The inside of the bulb is filled with plaster of Paris, as shown. This is in order that the first few drops of rain that fall within the bulb will run down and close the circuit between the two wires.

For a super-sensitive alarm, cover the ends of the wires in the bulb with table salt. To use the device, place the bulb in a socket and put it outside where the first few drops of rain will fall upon it. The wires from the socket are connected in series with a battery and bell or any other kind of alarm.

Contributed by ROY C. HUNTER.

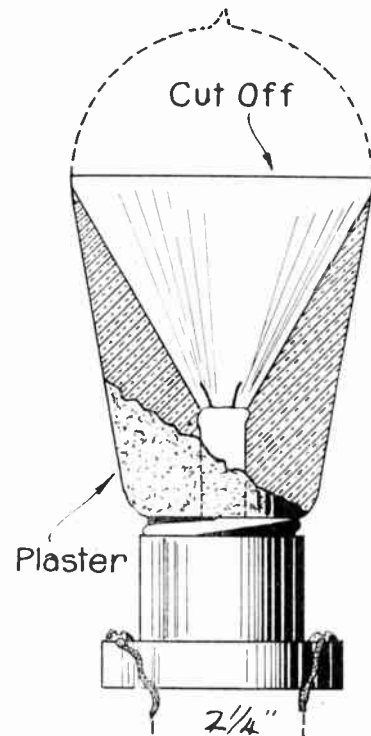

An incandescent lamp after the top is cut off is partly filled with plaster of Paris and acts as a sensitive rain gauge.



Elec-Tricks



IN this department are published various tricks that can be performed by means of the electrical current. Such tricks may be used for entertaining, for window displays, or for any other purpose. This department will pay monthly a first prize of \$3.00 for the best electrical trick, and the Editor invites manuscripts from contributors. To win the first prize, the trick must necessarily be new and original. All other Elec-Tricks published are paid for at regular space rates.

Astral Spirits

THE magician calls attention to a large, unprepared wooden frame, to which he affixes a piece of white paper. He then sets this frame in a clamp, which in turn he attaches to the

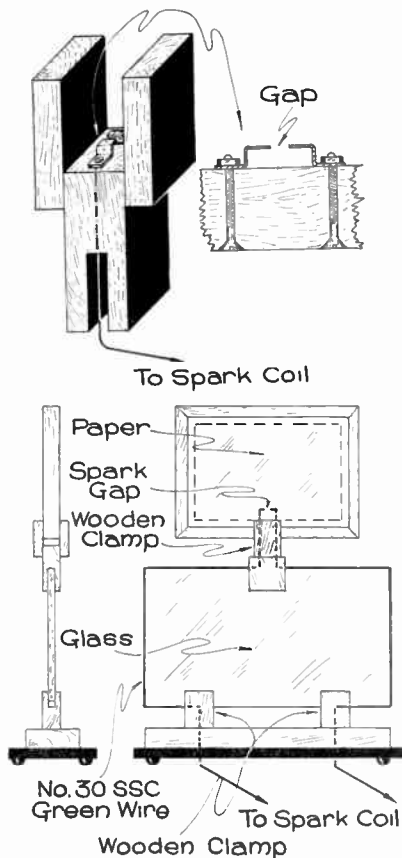

A mysterious production of the name of a card chosen by one of the audience upon an apparently disconnected sheet of paper carried on the edge of a glass pane to suggest insulation.

top of a sheet of glass held in a vertical position. He then emphasizes the fact that the glass rests on a wooden base entirely insulated.

He now shows the audience a pack of ordinary playing cards and requests that some one in the audience will kindly come up and choose a card. He announces that by the aid of spirits and divers other things known only to men of his profession, he will have the name of the chosen card written in letters of fire on the piece of paper, which is fastened to the wooden frame and faces the audience, and immediately the astounding thing takes place. The audience sees the name of the chosen card appear written in letters of fire that light up the whole room with a weird, ghost-like glow upon the paper. The explanation is:

The card chosen is "forced," that is to say, it is a card which the operator in the well known adroit manner causes the person to choose without his design being detected. The name of the card to be forced has been written on the piece of paper with a solution of six measures of

potassium nitrate and one-half measure of gum arabic in enough water to dissolve them. It is applied with a camel's hair brush. This writing when dry will be invisible, but when a flame or spark is touched to any part of the writing the rest will ignite instantly and will produce the letters in sparkling effect. The ignition is produced by means of a one-half inch spark coil.

The electrical current is carried to the frame through a concealed arrangement of contacts and breaks as illustrated. The wire connects with ends of a No. 36 green silk covered wire which is glued to the edge of the glass. The wiring at the double clamp is arranged to make contact with the wire on the frame. The spark occurs at the ends of the wires in the frame and at this point it would be well to place a tiny piece of flash paper to insure quick results. If care is taken so that the spark will not touch the paper outside the letters, there will be no danger of the rest of the paper catching fire. However, to be positive that the fire will not spread from the writing, it would be well to paint the area bordering the letters with water glass or sodium phosphate solution. The writing is done in huge letters, making sure that they are all joined together, also that the spark is produced upon the part of the paper written on. A larger conductor may be used to surround the glass, such as a ribbon of copper, and instead of the spark, a short piece of thin wire may be ignited to start the letters to forming.

Contributed by HOWARD HUGHES.

Unusual Window Display

A WINDOW display which gives a rather mysterious effect has recently attracted attention.

A two-wheeled truck on which a fan has been fastened is pivoted with a rod to the center of a metal plate. The rod is insulated from both the truck and the metal plate. One wire from the fan motor is run underneath the truck and fastened. The other wire is fastened to the rod. All wires are concealed. The fan acts as a propeller and causes the truck to move around very rapidly.

A small lamp socket is fastened to the fan's guard frame and connected in the circuit. A colored lamp is put in the socket. When the display is operated at night with no other illumination a very good effect is produced.

Contributed by ROBERT E. PARKER.

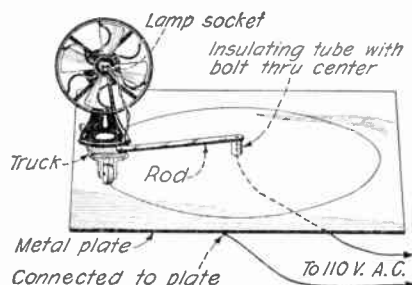

A fan mounted on a circular railroad as long as it whirls around follows the track as long as current is maintained; a very attractive window display.

Masquerade Outfit

BESIDES furnishing amusement for the wearer, the masquerade outfit shown here often secures the prizes in competitive masquerades.

An ordinary half-mask or domino is fitted with flashlight bulbs, one to each eye. The method of securing the bulb in the mask is clearly shown in the sectional view. Small circles of light cardboard are

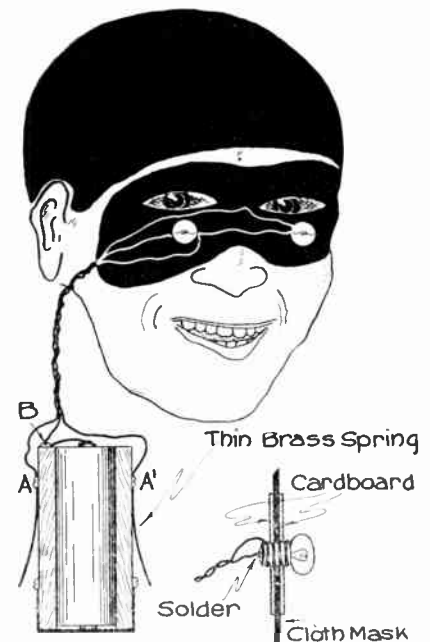

This mask in a dark room presents the appearance of two mysterious burning eyes. To make it still more odd one eye can be lighted at a time, a sort of electric winking.

perforated in the center and made to fit tightly around the threaded end of the globe, thus eliminating the use of sockets.

Three strands of very light silk covered wire are twisted together and fastened to the ends and sides of the bulbs with single drops of solder. The proper wiring of the globes to the battery case is obtained by trials; when finished, switch (A) should light globe (A); (A') should light (A'), and pressing (A) and (A') simultaneously should light both bulbs at once.

The battery receptacle should accommodate two cells of a dry battery. The case is made of wood and is open on both ends. The battery is held in place by the two pieces of spring brass shown in the diagram.

After connecting to the mask the wires are run over the left ear and down through the lining of the coat into the side pocket, where they are attached to the battery. A slight pressure of the arm against the side causes either globe to light up at will, while heavier pressure causes them to light simultaneously.

If dipped in solutions of different colors and dried, the appearance of the globes will be rendered still more effective.

Contributed by HAROLD FUSGARD.



Short-Circuits

THE idea of this department is to present to the layman the dangers of the electrical current in a manner that can be understood by everyone, and that will be instructive too. There is a monthly prize of \$3.00 for the best idea on "short-circuits." Look at the illustrations and then send us your own particular "Short-Circuit." It is understood that the idea must be possible or probable. If it shows something that occurs as a regular thing, such an idea will have a good chance to win the prize. It is not necessary to make an elaborate sketch, or to write the verses. We will attend to that. Now, let's see what you can do!



Here beneath this flower
Rests Master John Brown.
He climbed an electric tower
And never climbed down.
—GEORGE C. REED.



RAT STOPS OPERATIONS AT TWO BIG COLLIERIES

Rodent Gets Into Fatal Mix-Up With High Tension System.

A Mauch Chunk, Pa., special of April 13 says: A monster rat crawling into the circuit breaker at Nesquehoning some time during the night caused a short circuit of the high tension system between the Hauto plant and the Nesquehoning colliery of the Lehigh Coal & Navigation Company. By means of the failure of the system to function both the Nesquehoning and Hauto operations were compelled to remain idle all day yesterday.

These are the bones
Of Mrs. Nosey Rat.
There was a flash when
On the breaker she sat.
—As Reported by W. B. KENNEDY.



This grave holds
Marmaduke Slaughter,
While carrying a line
He stepped in the water.
—HAROLD J. CLARK.



Here lies the remains
Of Abdullah Norman,
Who thought he'd monkey
With the electric fan.
—N. DEL VECCHIO.

**LEFT FATAL BARE WIRE;
IS HELD FOR KILLING**

Stanley Sanders, a Pittsburgh Worker, Accused of Manslaughter in Mrs. Smith's Death.

Special to The New York Times.
PITTSBURGH, Aug. 8.—Stanley Sanders, an electrician employed by the Duquesne Light Company, will face a jury in the Criminal Court on a charge of manslaughter growing out of the death of Mrs. Katherine Smith, who was electrocuted at her home several weeks ago. Sanders was held by a Coroner's jury today.

It developed at the inquest that Sanders had been called to the Smith home to do some electrical repair work. Before he could finish the work, according to the story he told, he was ordered away on an emergency job and left several wires carrying the usual house current without insulation in the basement of the home.

Several days later Mrs. Smith was doing laundry work in the basement and slipped on the damp floor, falling and touching the bare wires. She died almost instantly. Stanley said that while he left the wires bare he told Mrs. Smith that it would be dangerous for her to go near them.



Lies sleeping here
Jeremiah Klein.
He sprayed the tree,
Also the line.
—GORDON CALLENDER.



? How and Why ?

THIS department is conducted for the benefit of everyone interested in electricity in all its phases. We are glad to answer questions for the benefit of all, but necessarily can only publish such matter as interests the majority of readers.

1. Not more than three questions can be answered for each correspondent.
 2. Write on only one side of the paper; all matter should be typewritten, or else written in ink. No attention can be paid to penciled letters.
 3. Sketches, diagrams, etc., must always be on separate sheets.
 4. This department does not answer questions by mail free of charge. The editor will, however, be glad to answer special questions at the rate of 25 cents for each. On questions entailing research work, intricate calculations, patent research work, etc., a special charge will be made. Correspondents will be informed as to such charge.
- Kindly oblige us by making your letter as short as possible.

The Ford Magneto

(321)—G. W. Wise, Strafford, Mo., writes:

Q. 1.—Please publish a diagram of the armature winding of the generator which is standard equipment on Ford cars at this time. I wish to know how the armature coils are connected to the commutator, how spaced, and the number of turns.

A. 1.—The illustration shows a very ingenious type of dynamo which is used on Ford cars only. Sixteen permanent magnets attached directly to the fly wheel of the engine produce a revolving magnetic field which acts upon as many coils attached to a fixed plate supported by the engine base.

This forms a magneto having a revolving field and a fixed armature. As the coils are stationary, no commutator or brushes are required, as the current can be taken from the fixed coils by a direct connection. Although this type of a magneto is not as efficient as the conventional design because more metal and wire are required to produce the same power, this disadvantage is not serious when used as in the Ford car, as the magnets which form the greatest weight are joined to the fly wheel, which can be correspondingly lighter. The advantages of not having a commutator and brushes to cause trouble are apparent.

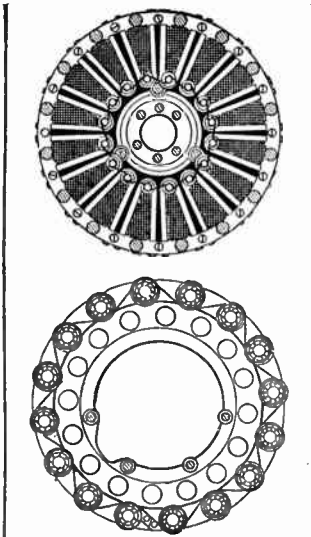

The rotor and stator of the Ford magneto are shown in the diagram above. The 16 permanent magnets shown are attached to the flywheel and revolve therewith exciting the stationary coils.

Tungar Bulb Queries

(322)—We have received inquiries from several sources regarding the Home Battery Charger employing a Tungar bulb which appeared in the March issue of PRACTICAL ELECTRICS.

Q. 1.—I have constructed the battery charger according to directions and find that the bulb gets very hot. How hot can it get without burning out?

A. 1.—The bulb does get very hot when operating under normal conditions, but

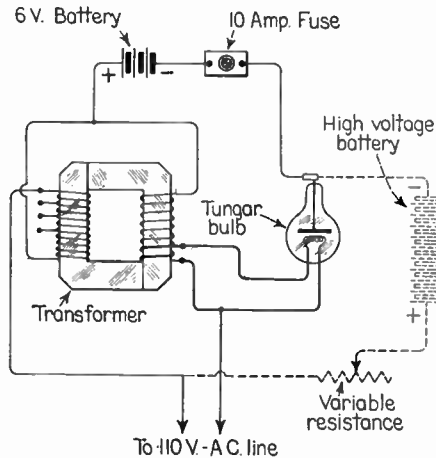

The diagram shows a connection for a Tungar rectifier which by means of a transformer is arranged for charging high and low voltage batteries.

just how hot it gets, under such conditions, we do not know. The manufacturers of these chargers place the bulb in a well ventilated metal box, to allow free circulation of the air as well as protection from mechanical injury. The best way to determine if the bulb is not overloaded is to connect a D. C. ammeter in series with the battery being charged. If the current flowing is not over six amperes, there is no danger of the bulb getting too hot. The bulb should then be removed and an A. C. voltmeter should be connected to the filament winding. This should indicate 2½ volts, or less. If the voltage is over 2½ the life of the bulb will be shortened.

Q. 2.—Are there different sizes of Tungar bulbs? The electric company here asks me what size outfit the bulb is for.

A. 2.—There are several sizes of Tungar bulbs. This charger was designed for use with Tungar bulb Cat. No. 189048, manufactured by the General Electric Company.

Q. 3.—Will you show a diagram whereby I can charge ten 6-volt batteries with the same bulb.

A. 3.—This connection was clearly shown in the original article, the diagram of which we are reproducing here. For charging the ten 6-volt batteries the connections shown in dotted lines should be used. In this case the transformer is used merely to light the filament of the bulb, and the 6-volt battery, shown in the diagram, is, of course, removed. The ten 6-volt batteries are connected as shown in dotted lines with a resistance in series, which may be a large lamp bank. This resistance need not be very high but should safely pass 6 amperes. Transformer steel laminations of various shapes may be purchased from almost every large electrical supply house, especially from those who manufacture small transformers.

Q. 4.—The drawing calls for 73 turns of No. 8, 6 turns of No. 6, and 197 turns

of No. 10 B. & S. gage magnet wire, while in the text 73 turns of No. 10, 6 turns of No. 6, and 197 turns of No. 14 are called for. Which is correct?

A. 4.—The smaller sizes of wire, as called for in the text are correct. The weights given in the text are also correct for the smaller sizes of wire. The larger sizes may be used, of course, and will give a little higher efficiency than the smaller wire.

Q. 5.—The drawing of the core shows the core legs butted up against each other in two corners. Shouldn't the laminations be interleaved at all corners?

A. 5.—If you will carefully read the text you will find that the laminations used in the transformer shown in the reproduced photograph are "L" shaped, and not rectangular as you probably assumed. If four rectangular shaped laminations were used in place of two "L" shaped laminations they should interleave at the four corners as you say. The "L" shaped laminations form a dove-tailed joint at the two corners and build up in a solid core, of excellent magnetic joints.

Fish Incubator

(323)—Walter A. Cohen, Bronxboro, N. Y., writes:

Q. 1.—Will you please show me how I may use a thermostat and electric heater for heating and maintaining the temperature of an aquarium for tropical fish?

A. 1.—This apparatus may be obtained

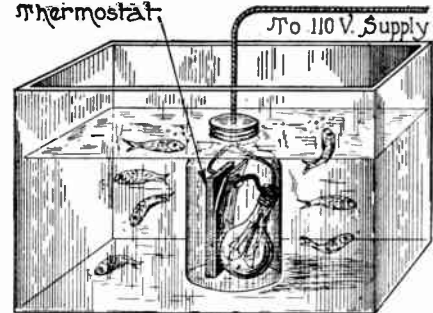

An incandescent lamp in a water-tight vessel is used to keep up the temperature of water in an aquarium to any desired degree.

from concerns who manufacture electrical incubators. A small aquarium may be kept warm by simply immersing a lamp globe hermetically sealed in a glass fruit jar in the water. A suitable thermostat may be placed in the jar with the lamp and connected in the lamp circuit for controlling the temperature. The jar should be painted black on the inside so that the light from the lamp will not affect the fishes and also the black coating will absorb the light and produce heat. By experimenting with different sizes of lamp bulbs the correct one can be determined. The lamp cord running from the 110-volt socket through the water to the lamp in the jar should be thoroughly insulated so that the water will not soak into the copper wires. The illustration shows the arrangement of the parts.

Charging Battery on 220 Volts

(324)—L. King, Corning, Ark., asks:

Q. 1.—How many 50-watt 220-volt lamps must I use in a 220-volt D. C. circuit to reduce the current to charge a 6-volt storage battery?

A. 1.—This depends upon the ampere carrying capacity of the 220-volt circuit and the time within which you wish to charge the battery. If you wish to charge the battery at a 6-ampere rate you will require enough 50-watt lamps in parallel to pass 6 amperes at 220 volts. Six amperes at 220 volts represents 1,320 watts. 1,320 divided by 50 is 26.4, or 27 lamps as by Ohm's law. If the 220-volt line will not carry 6 amperes you will have to use less in the circuit. We do not advise charging a u-volt battery on a 220-volt circuit, as the efficiency is less than one-half of 1 per cent.

Q. 2.—How many lamps will I have to use to charge a 24-volt "B" battery?

A. 2.—The charging rate of a "B" battery is about one-quarter ampere. As one 50-watt lamp on a 220-volt circuit will pass about .227 amperes, one of these lamps in series with the "B" battery will be sufficient. We are assuming, of course, that the 50-watt lamps you are using are designed to be operated on 220 volts, and not 110.

Q. 3.—How many lamps should be used on a 110-volt A. C. line with an electrolytic rectifier or on a 110-volt D. C. line without the rectifier, for charging a 6-volt battery at a 5-ampere rate?

A. 3.—Twelve 110-volt 50-watt lamps connected in parallel and the whole connected to the line in series with the battery and rectifier if used on an A. C. line will allow for charging at about the 5-ampere rate.

Skinderviken Button Loud Talker

(325)—J. Malakin, Scranton, Pa., asks:

Q. 1.—Tell me how I can make a loud talker to transmit phonograph music using the Skinderviken button to collect the sound waves.

A. 1.—You may use a Skinderviken transmitter button to transmit phonograph music by attaching the same to the tone arm of the phonograph. The button may then be connected in series with two dry cells and the primary of an induction coil, and the secondary connected to an ordinary radio loud talker.

A small induction coil may be made as follows: Form a core of soft iron wires 3 inches long by $\frac{1}{4}$ inch in diameter. Insulate this with tape or Empire cloth. Next wind two layers of No. 23 S.S.C. wire, which composes the primary, and slip over this an insulating tube with a one thirty-second-inch wall. Tape or Empire cloth may be substituted for the insulating tube. Over this wind $\frac{1}{4}$ pound of No. 34 wire in even layers.

Q. 2.—How can I make a simple induction coil?

A. 2.—If you wish to use this induction coil with a vibrator, build up a condenser composed of 30 tinfoil sheets 4 inches long by 2 inches wide. This is to be connected across the vibrator. Using a primary voltage of 3, this coil will give a $\frac{1}{8}$ -inch spark. If you wish to use this coil in connection with the Skinderviken button above mentioned, the vibrator and condenser will not be necessary.

One-Inch Induction Coil

(326)—J. K. Moore, Andover, Mass., asks:

Q. 1.—How can I make an induction coil that will give a 1-inch spark?

A. 1.—We are giving you herewith data on a 1-inch spark coil as requested by you. Six to eight volts will be necessary for the operation of this coil. The core is composed of a bundle of iron wires, $8\frac{1}{2}$

inches long by $\frac{1}{2}$ inch in diameter. This is covered with several layers of Empire cloth or a hard rubber tube. On this is wound two layers of No. 16 D.C.C. wire, over which are placed several more layers of Empire cloth or another hard rubber tube. On this wind the secondary, which is composed of two pounds of No. 34 S.S.C. or enameled wire.

The winding of the secondary coil is a very tedious job and we suggest that you purchase this coil already wound.

The condenser for use across the vibrator of this coil contains 120 sheets of tinfoil 5 x 7 inches.

Talking Movies

(327)—Harold Williams, Detroit, Mich., asks:

Q. 1.—How is it possible to accurately record sound waves on a moving picture

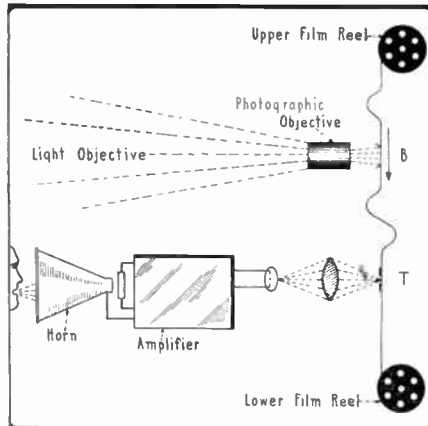

Photographing the voice on a moving picture film. The film moves continuously.

film when the film is passing by the objective lens in jerks?

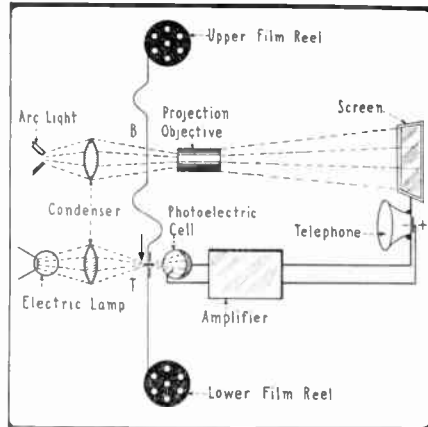

Projecting the voice sounds from a moving picture film. In both cases the speaking film moves continuously.

A. 1.—Although the film is passing by the lenses in jerks, it does not necessarily pass by the sound recording or reproducing apparatus in jerks. As shown in the illustration, the film is slack both above and below the photographic objective. The slack is sufficient to allow for a uniform motion by the portion of the film recording or reproducing the sound, although it is passing by the photographic or projecting objective, as the case may be, in jerks. The recorded sounds will be not really a few feet in advance of the pictures, but as they were photographed in the way described, the reproduced sounds will always be in synchronism with the reproduced pictures.

Lead-in Wires in Electric Lamps

(328)—H. J. Linkins, Springfield, Ill., asks:

Q. 1.—Of what metal are the wires that support the filament in nitrogen lamps?

A. 1.—The wire originally used for the leads from the filament of an electric light bulb was platinum at the point where it passes through the glass stem. However, there has lately been found a combination of metals known as Dumet, which has the same coefficient of expansion as glass, and this metal is now being used.

25-Ohm Telephone Receiver

(329)—Harry J. Kelly, Lowell, Mass., asks:

Q. 1.—Where can I obtain a 25-ohm receiver for use with a microphone button?

A. 1.—We believe that an ordinary 75-ohm receiver will function very well with your microphone button. We do not know of any concern manufacturing a 25-ohm receiver, consequently an ordinary receiver would have to be rewound to satisfy your demands. We would suggest that you use a small induction coil in series with the transmitter button, stepping up the voltage and employing a 75-ohm receiver in series with the secondary of this transformer.

Battery Lead Trays

(330)—C. A. Kemnitz, Eldorado, Wis., asks:

Q. 1.—Where can I obtain lead trays for constructing the battery shown on page 353 of the July, 1922, issue of PRACTICAL ELECTRICS?

A. 1.—The lead trays to which you refer in your recent communication would have to be built by yourself. The simple mold of clay or plaster, or even wood, could be employed for that purpose. If you have sheet lead on hand, a die could be built for pressing or beating up the trays out of the sheet material. A wooden mallet such as plumbers use will be best for heating up the sheet lead.

Electrolytic Depilatorization

(331)—J. E. Duffy, Sawtelle, Cal., asks:

Q. 1.—How can I make an electric needle for the purpose of destroying superfluous hairs?

A. 1.—Make up a sharp gold needle out of fine wire; mount this in a suitable holder, and connect to the negative side of a six-volt storage battery with a variable resistance in series. A sponge electrode is connected to the positive side of this battery. The method of manipulation is as follows:

The needle is inserted into the hair follicle; the patient then grasps the sponge electrode until a small trace of bubbles exudes from the hair follicle. The patient releases the sponge electrode, and the needle is then withdrawn. A pair of tweezers easily removes the hair without pain. If the operation is painful, the gold needle has not been inserted properly.

Tin Can Batteries

(332)—M. F. Corbett, Syracuse, asks:

Q. 1.—Please show how to make sal ammoniac voltaire cells out of tin cans.

A. 1.—For making wet batteries out of tin cans you should first clean the latter thoroughly inside and fill within one inch of the top with a concentrated solution of sal ammoniac. Provide a wooden cover for the can and through the center of the latter drill a hole of sufficient size to introduce an ordinary No. 6 dry cell carbon.

The cell will then be ready for use. It will give from 1.1 to 1.6 volts. The amperage, however, will not be very great, but will serve for experimental purposes. In using the cells, they should be placed in such a position that they will not cause injury to any surrounding objects if they should happen to leak. You will find a tin can copper sulphate cell described in PRACTICAL ELECTRICS, September, 1923, page 514. The illustration shows clearly the construction of either cell.

10,000 Trained Men Wanted in the Electrical Field

The World Technical Institute methods of training men at home are a revelation. "I am amazed at the manner in which you cover the most difficult subjects in electricity without resort to higher mathematics," says one of the leading vocational educators of America.

Salaries of \$72 to \$200 Per Week

The World Technical Institute agrees to give you a better training than any other similar Institution, or refund your money.

The highest salaries in the history of the electrical industry are now paid. Nearly one billion dollars per year is being spent on extensions, materials, apparatus, maintenance.

There are 14,000,000 old houses and thousands of new ones under construction to be wired. Trained men are at a premium. Salary, bonus and overtime have brought about undreamed of earnings.

Manufacturers of electrical machinery are operating to their fullest capacity. Scores of great hydro-electric projects are planned.



WAYNE C. ROBINETTE
PRESIDENT
WORLD TECHNICAL INSTITUTE

YOU! Young man and old—are you looking for independence? Are you helping yourself?

Now is your chance. The opportunity to make good, to do credit to yourself and family, is here. Don't waste any more valuable time in thinking and talking about what you want to do, what you would like to do. Your success in the electrical game is sure.

As-In-Practice Training at Home

Take the short-cut to big pay. The World Technical Institute's improved methods of training men of all ages are ten years ahead of anything of the kind.

No Matter About Your Age, Experience, or Previous Education

The World Technical Institute Offers You What No Other School Can Offer—

- (1) Complete, practical, simplified instruction in every phase of electricity, including:
- (2) Power plant management, maintenance, installation.
- (3) Wiring, armature winding, batteries, motors, generators.
- (4) Illumination, signs, motion picture operating.
- (5) Ac and dc machinery of every description, repairs.
- (6) Contracting, merchandising, telephony, telegraphy.
- (7) Train lighting, farm lighting, welding, meters, instruments.
- (8) Automobile ignition, lighting and starting.
- (9) Complete instruction in wireless.
- (10) Real working outfit, presented free.
- (11) A real employment service.
- (12) Information which will enable you to become an expert draftsman.
- (13) Reviews of your work by an electrical engineer.
- (14) Personal instruction by an electrical engineer.
- (15) Money-back guarantee bond.
- (16) Consulting service until you are earning \$100 per week.
- (17) All the advantages of our Key-sheet System.
- (18) Information which will enable you to procure a license in any State or town where required.
- (19) Instruction which will help you to begin earning money in a few weeks after you enroll.
- (20) A diploma which means that you have completed the most practical course of training in existence. (All explained in the Free Book.)

If you can read and write, if you can add, subtract, multiply and divide, we can make of you an expert. We will help you to make more money than you have ever dreamed of earning. Our course outclasses all others in simplicity, accuracy, modernity and thoroughness.

Free Tools, Instruments, Material

You will be supplied with a real working outfit, consisting of a motor and over eighteen standard articles. Superior to the working outfit of any other school. It is yours to keep. No strings attached to it.

Free Employment Service

We render a real employment service to students who wish to avail themselves of the same. We give real time and energy to placing students in satisfactory positions.

Money-Back Guarantee

You run no risk whatever in enrolling with us. The risk is all ours. We give you a Bond which guarantees satisfaction.

Mail Free Coupon Now

Our great free electrical book, and all particulars in regard to the most remarkable offers ever made by any school will be mailed to you free and postpaid upon receipt of coupon.

WORLD TECHNICAL INSTITUTE

Fuller Bldg., Jersey City, N. J.

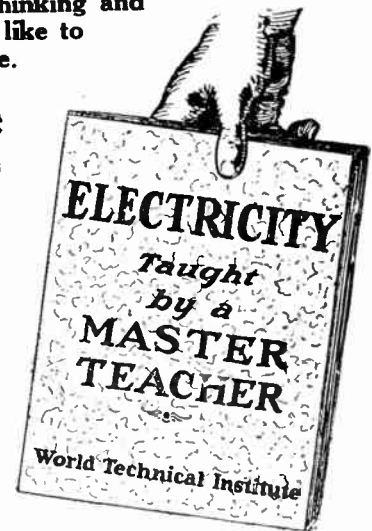

Absolutely Free. This 56-Page Book

This book, which cost \$2,500 to produce, is yours for the asking. It will tell you hundreds of vital facts about the world of electricity which you should know. It also reveals the startling truths about the latest method of preparing men for big positions.

Your Future Lies in This Coupon

WORLD TECHNICAL INSTITUTE,
Fuller Bldg., Jersey City, N. J.

Gentlemen:—Send to me postpaid, and without obligation, your valuable illustrated book entitled, "Electricity Taught by a Master Teacher," also full particulars in regard to your course and the remarkable offers you are making to students.

Name.....

Address.....

P.E., 10-23



NOW

IS THE TIME TO BUY A



Storage Battery

BE SURE TO READ BELOW
SPECIAL OFFER
LIMITED TO
RADIO NEWS READERS ONLY

We Save You
50%
and you get a
**WRITTEN 2YR.
GUARANTEE**

"WORLDS OF PERFORMANCE"

We maintain the same high quality material and workmanship found on the most expensive batteries and still are able to allow our remarkably low sale price by greatly reducing our overhead and sale costs.

Thousands of users enjoy the dependable qualities of our battery. World battery owners "tell their friends." This is our best proof of performance.

COMPARE THESE PRICES
SPECIAL 2 VOLT STORAGE BATTERY for W. D. 11
\$5.00

Will Run 200 Hours on One Charge
Rechargeable

6-Volt	60 Amps.....	\$10.00
6-Volt	80 Amps.....	12.50
6-Volt	100 Amps.....	14.50
6-Volt	120 Amps.....	16.00

SEND NO MONEY

We ship C. O. D. subject to inspection. Or, if you prefer, send money order, check, etc. and take 5% discount. Shipment made same day order is received. Save 50% on your next battery and get better service and longer life. Our written 2-year guarantee is your proof of satisfaction. Order today—Now.

WORLD BATTERY CO.
DEPT. 15

1219 So. Wabash Ave., Chicago Ill.

Just clip this ad, mail in with order, and we will include one Ever-ready "B" Battery, free of charge. Accept this liberal offer now before it is withdrawn.



How and Why?

(Continued from page 560)

Construction of a Small Oudin Coil

(333)—Arthur E. Newlon, New Lexington, Ohio, asks:

Q. 1.—Will you please give details of the construction of a small Oudin coil?

A. 1.—We would suggest that you build an Oudin coil as follows:

On a cardboard tube 18 inches long and 3½ inches in diameter, wind one layer of No. 32 single silk covered wire, each turn being separated from the preceding turn by a space of one-sixteenth of an inch. This is mounted upright on a base. On another drum about 10 inches in diameter, wind 11 turns of No. 2 aluminum wire, or copper wire may be employed. If wire is unobtainable, tubing or ribbon may be used. The turns on this coil are separated one-half inch from each other. A ½ to 1 kw. transformer is used to excite this Oudin, or a 3-inch spark coil may be so employed. Connect up the apparatus, as shown in the accompanying illustration.

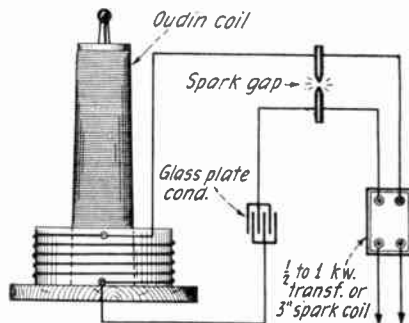

Diagram of connections of an Oudin coil, giving general hook-up and disposition of parts.

Photo-Electric Cells

(334)—O. C. Williamson, Mountain View, Cal., writes:

Q. 1.—Please give data on a photo-electric cell which is instantaneous in its action and will pass absolutely no current when no light is directed upon it.

A. 1.—Photoelectric cells are almost absolutely instantaneous, and pass such an infinitesimal amount of current at a high voltage when not affected by light that the amount may be assumed to be negligible. This refers to the Kuntz and other rubidium screen cells, not to selenium cells.

Piezo-Electric Effects

(335)—C. G. Taylor, Rochester, N. Y., asks:

Q. 1.—What solution is used in growing Rochelle salt crystals for piezo-electric effects?

A. 1.—Rochelle salt crystals are grown from a supersaturated solution of Rochelle salt in distilled water.

In making these crystals, Rochelle salt is added to boiling water until no more of the salt will dissolve. The solution is then placed in a container and allowed to cool; during the cooling process it must neither be shaken nor otherwise disturbed in the least degree. Crystals will form within ten or twelve hours.

Another solution is then similarly made or else the first solution is again used but some of the crystals are removed, and the rest dissolved in the hot liquid. Several of the crystals obtained during the first growth are then placed upon an inverted tumbler in the solution just prepared, after the same is cooled to about 12 degrees above room temperature. These crystals will then grow larger.

The same method is repeated until a crystal 1 to 1½ inches long and about 1 inch across is obtained. Long hexagonal crystals or triangular crystals are the best. The crystal must be employed while still fresh.

Recuperation of a Dry Cell

(336)—Dale Pollack, Weehawken, N. J., writes:

Q. 1.—I have a 2-cell, 3-volt flashlight with a 2½-volt bulb. This was in use until the battery was completely worn out and the bulb failed to light. After standing idle for several days I noticed that the battery would light the bulb up brightly again. Will you explain this?

A. 1.—The cause of the action you have noticed in connection with your flashlight battery is due to the recuperating powers of dry cells. During use the cell becomes polarized, and if the use is kept up long enough, the cell ceases to give any current. However, upon standing, the cell depolarizes, and can be used over again for short periods.

Nickel Plating

(337)—Martin Johnson, Cook, Minn., asks:

Q. 1.—How can I nickel-plate small articles, using a 6-volt automobile battery?

A. 1.—Nickel plating with a 6-volt storage battery may be accomplished in a small jar made of glass or earthenware. The solution used should consist of 1 gallon of water, 14 ounces of nickel ammonium sulphate double salt, and 2 ounces of boric acid. The resulting solution should show a hydrometer reading of 7 degrees Baumé. The anode should consist of 99 per cent pure nickel bar or plate and the cathode is the article to be plated.

It will be well to insert a rheostat in series with your battery, for nickel plating requires a quite careful regulation. A heavy current will result in a coarse crystalline deposit which will crack and peel readily.

Electrolytic Rectifier

(338)—F. G. Cameron, New York City, inquires:

Q. 1.—Will you kindly give me details for constructing an electrolytic rectifier for charging storage batteries from alternating current?

A. 1.—We are giving herewith the method of making a rectifier for charging batteries.

Four plates of aluminum and four of lead, each 4½ inches by 6 inches, are separated a distance of 1 inch by means of wooden blocks. They are suspended in a saturated solution of ammonium phosphate, Rochelle salts or slightly acidulated water. A resistance is placed in series with the same, this generally being a lamp bank. The circuit diagram has been often given by us.

Ford Spark Coil Phenomenon

(339)—J. D. Lassiter, Picher, Okla., inquires:

Q. 1.—By placing the lead-in wire and the ground wire of a radio aerial near the secondary terminals of a Ford spark coil I find that a spark will jump from each. As the aerial is well insulated from the ground, how can they form a circuit?

A. 1.—The reason that a spark jumps from your Ford spark coil to the aerial and ground terminals is because of the fact that both act as the plates of a condenser, the air between the aerial and the ground being the dielectric. Consequently, you are charging your aerial, and at the same time causing waves to be radiated into space, which waves are called Hertzian waves.

"BUILD YOUR OWN" WITH "RASCO" PARTS!

THE Radio Specialty Company—"RASCO" for short—now in its third year, is unquestionably the oldest and most unique radio parts supply house in the United States, if not in the whole world. This Company makes a specialty of small orders. No order is too small to get immediate and prompt attention. The reason is simple: 80% of our orders are small. The reputation of this house was built upon service. Ask any of your radio acquaintances what they think of "RASCO" service. "RASCO" promptness. Thousands of unsolicited testimonials are in our files, to prove that we serve the public as it has never been served in radio merchandise before. Be sure to get our great 84-page catalog, containing over 500 different parts. Catalog contains over 300 illustrations. "WE CAN ONLY DISAPPOINT YOU ONCE." Try us with a 50c. order and make us prove what we say. Prices include delivery to your door.

Order direct from this page. We pay all transportation charges. All goods sent prepaid in 24 hours.

NOTE BIG PRICE REDUCTIONS THIS MONTH Money refunded if goods do not satisfy



LOOP AERIAL
The loop aerial you have been waiting for. Made entirely of well seasoned hard wood. Complete with all parts and base; No. 22 enameled wire used. Total height, loop 36", 2 feet on the side; loop is 10 convolutions. Can be put together by anyone in less than 5 minutes. Satisfaction guaranteed.

R-2600, Two foot loop aerial, complete...\$1.15

STORAGE BATTERIES

New! New! New!

Two volt, 40 ampere hour storage battery for use with WD-11, 12, and P.V. 199 tubes. Don't keep on buying dry cells continuously. This storage battery will pay for itself in two months. Only best materials used. Guaranteed for 2 years. You can connect up to 6 dry cell tubes on a single one of these batteries. Can be recharged for a few cents. Hard rubber container encased in impregnated wood case. Due to low price and large weight of batteries, shipped express collect.

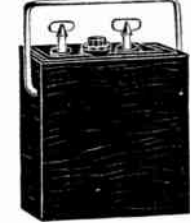

R-2400, Two volt, 40 ampere hour storage battery, size 2 1/4"x8x9".....\$4.25
R-640, Six volt, 10 ampere hour storage battery, size 4 3/4"x7 1/4"x9"..... 8.75
R-660, Six volt, 40 ampere hour storage battery, size 6x7x9 3/4"..... 11.00

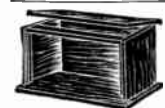

WOOD CABINETS
Highest grade mahogany cabinets made. Best hand rubbed finish. Top is hinged. Front of cabinet rabbetted to fit panel. Price delivered to your door; no panel included in these prices. Entire cabinet made of 1/2" well seasoned stock.

R-714, Wood cabinets, panel size 7"x11".....\$3.35
R-718, Wood cabinets, panel size 7"x18"..... 3.60
R-724, Wood cabinets, panel size 7"x24"..... 4.40
R-710, Wood cabinets, panel size 7"x14"..... 2.60
R-712, Wood cabinets, panel size 7"x12"..... 3.00
R-721, Wood cabinets, panel size 7"x21"..... 3.90

CARDBOARD TUBING

Only seamless tubing made in United States. Perfectly seasoned. Heavy wall. I.D.—Inside Diameter. O.D.—Outside Diameter. L.—Length.

R-6600, 3" I.D., 3/4" O.D. x 7" L.\$3.30
R-6601, 3 1/2" I.D., 3/4" O.D. x 7" L.35
R-6602, 3 3/4" I.D., 3/4" O.D. x 5" L.25
R-6603, 3 1/2" I.D., 3/4" O.D. x 5" L.27
R-6604, 4" I.D., 3/4" O.D. x 5" L.33
R-6605, 2 1/2" I.D., 3/4" O.D. x 2 3/4" L.15



"RASCO" BEZELS
The finest Bezel on the market. Best brass mesh used. The Bezel comes entirely nickel plated. Will improve looks of your panel 100 per cent. Outside diameter 1". Can be used on 3/8" or 3/16" panel.

R-1700, Rasco bezel.....\$1.15
R-1701, Bezel 1 1/2" diam..... .20

FORMICA PANELS Clearance Sale.

This sheeting is positively the best grade on the market. High Finish on both sides. Too well known to require much explanation. Due to the fact that we are discontinuing these particular sizes, this material is now offered practically at cost. Prices are about 40 per cent lower than our catalogue list. Note also that we ship these panels prepaid. This alone amounts to a considerable saving.

R-350, 6"x12"x3-16" thick, each.....\$1.50
R-351, 6"x18"x3-16" thick, each..... 1.60
R-352, 9"x18"x3-16" thick, each..... 1.75
R-353, 12"x18"x3-16" thick, each..... 4.00
R-354, 6"x19 1/2"x3-16" thick, each..... 1.90
R-355, 6"x7 1/2"x3-16" thick, each..... .85
R-356, 6"x11"x3-16" thick, each..... 1.60
R-357, 6"x4"x3-16" thick, each..... .65

RASCO 180° VARIOCOUPLER

This Coupler while extremely low in price will do anything and everything that the more expensive ones accomplish. Silk Wire wound on 1/4" bakelite tubes. There are six taps. Wave length of coupler is from 150 to 600 meters. Coupler is made for panel mounting, 3/4" shaft. Your money refunded if it does not do all that we claim for it.

R-3100 Variocoupler, prepaid.....\$1.50



MELOTONE LOUD SPEAKER
The best popular loud speaker on the market. Has tuned feature the same as all "Rico" phones. Fibre horn, heavy metal base, five foot nickel gooseneck. Greatest tuned loud speaker. Compares favorably with most expensive speakers. Size overall 11 1/2"; horn length 11 1/2"; bell 6 1/2"; total height 9".

R-255, Melotone Speaker.....\$4.90

RICO TUNED RECEIVERS

No better phones made. Supersensitive. Awarded Radio News Laboratories Certificate of Merit. The only tuned phone on the market. Can be tuned for any intensity and sensitivity. Magnetic pole of phone is in mathematical center of diaphragm. "Turn the cap to tune."



R-2020, 2000 ohms, double head set.....\$4.45
R-3030, 3000 ohms, double head set.....\$5.50

"RASCO" VERNIER

Cleverest vernier made. Can be used with any dial. Soft rubber ring engages dial. Does away with vernier condenser. We guarantee results. All metal parts moulded in best black composition. Nothing to come apart. Biggest hit of the season.

R-1450, Vernier.....\$3.30

"RASCO" POSTS

R-650, Post made entirely of best black composition—8/32" screw—each.....\$0.08
R-202, Post has nickel-plated bottom part, each..... .90
Dozen, each style..... .08



"RASCO" SWITCH POINTS
Nickel-plated and polished. The following have been found the most popular.
R-301, 3/4"x3/4", 6/32" thread, doz.....\$1.18
R-302, 3/16"x3/4", 6/32" dia., 6/32" thread doz..... .18
R-303, 3/16"x3/16", 4-36" thread, doz..... .18
R-304, 1/4" dia., 1/4" thick; slant 6/32" doz..... .18
R-305, 1/4" dia., 3/16" thick; shank 4/36" doz..... .18
R-306, 3/16" dia., 3/16" thick; shank 4/36" doz..... .18
R-307, 3/16" dia., 1/4" thick; shank 4/36" doz..... .18
R-375, Switch Stop, 1/2" long, 4/36" thread, complete with nut, each..... .18

"RASCO" SOCKETTES

Substitute for Vacuum Tube Socket. Four of these take one Vacuum Tube. Grasp tube firmly. Best contact possible. Take less room. Are better.
R-1550, Sockettes, nickled, set of 4.....\$2.25
R-1551, Sockettes, nickled, set of 4 (to take WD-11 Tube)..... .25
Note: Set of 4 sufficient to hold 1 Tube.

COPPER FOIL

Thinnest copper foil made. .001" thick. Comes 1" wide.
R-5025, Copper Foil, per ft. \$1.10
10-ft. length..... .80

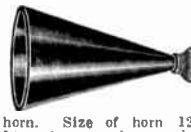

PHONEHORN
This is a new and distinct unit. Base consists of R-1310 Phonodapter described on this page into which fits a fine enameled fibre horn; bell 6 1/2". Slip horn. Size of horn 12". Phonodapter end on a single telephone receiver and you have the lowest priced loud talker ever made. Mounted in your set or hung in corner of room it will bring sound all over the room. A most useful article. Welcome by all radio fans. R-1321 Phonehorn, prepaid.....\$1.45

R-1100, A.F. Transformer, ratio 4 1/2 to 1.....\$2.00
R-1150, A.F. Transformer, ratio 6 1/2 to 1.....\$2.00

AUDIO FREQUENCY TRANSFORMERS

No better Transformer on the market. Highest class materials. Impregnated coils. Silicon steel stampings used. Save 50 per cent by assembling it yourself.
R-1100, A.F. Transformer, ratio 4 1/2 to 1.....\$2.00
R-1150, A.F. Transformer, ratio 6 1/2 to 1.....\$2.00

RADIO FREQUENCY TRANSFORMERS

The best Radio Frequency Transformer developed so far. Designed for us by Mr. R. E. Lucas, Assoc. Editor of RADIO NEWS. Air core. Guaranteed to do the work. This Transformer brings in the long distances.
R-2800, Radio Frequency Transformer, ratio 1 1/2"x2 1/2".....\$1.50

RHEOSTATS AND POTENTIOMETERS

Highest grade Rheostat made. High heat dielectric composition base. Wound with best non-corrosive resistor wire. Comes with tapered, knurled knob. Diameter, 2 1/2". Complete with pointer.
R-4310—6 ohms, each \$4.50
R-4311—30 ohms, for 301a and 201a tubes, each.....\$6.50
R-4312—Potentiometer, 200 Ohms each.....\$8.50

SPIDER WEB FORMS

At last! Fine forms to wind your spider webs. Made from hard, well seasoned fibre, 1-16" thick, center and side holes for wiring. 3200 has 13 slots, 3201, 11 slots, both 5" diameter. 3201 has projection for mounting.
R-3200—Spider web form, each.....\$2.25
R-3201—Spider web form, each.....\$2.25

BRASS RODS

Sold in 6" lengths only
R-6032, Brass Rod, 8/32" thread, per length.....\$0.08
R-6032, Brass Rod, 6/32" thread, per length..... .06
R-1425, Brass Rod, plain 1/4" round, per length..... .06
R-3616, Brass Rod, plain 3/16" round, per length..... .10

"RASCO" NAME PLATES

The circular plate is our new Binding Post Name Plate. Diameter, 3/4". These denominations: PHONES, GROUND, OUTPUT, BATTERY, LOUD SPEAKER, GRID, 1G5, CATHODE, AERIAL, INPUT, A. I. T. TERY—RATT L— LOOP, TICKLER, PLATE, "C" RATT L, FILAMENT.
R-6000 to 6019, Binding Post Name Plates, each denomination.....\$0.03
Dozen..... .30



REINARTZ SPIOERWEB COIL
Here is a very fine induction for Reinartz circuit, 200-600 meters, 19 taps. Size 4 1/4" diameter; 1 1/2" center opening. Can be used in nearly all new circuits. Construction: duo-spider-web throughout. Coil is firm and will not fall apart as is case with many inferior makes. A few of these coils will work wonders in your set.
R-2550 Spider-web Reinartz coil.....\$1.15

PHONODAPTER

The Phonodapter will fit any phone. Metal tube fits any standard phonograph. Make your phonograph a loud talker. Fits Columbia, Victor and Sonora phonographs. Is made entirely of pure soft rubber with brass tube inserted.
R-1310 Phonodapter.....\$5.56

DOUBLE PHONODAPTER

The Double Phonodapter fits all phonographs and will take any standard double head set, thereby making your phonograph a loud talker. Made of cast metal, nickel plated and highly polished. Has three generous soft rubber bushings.
R-1320 Double Phonodapter.....\$6.55

RASCO TELEPHONE PLUG

This is the plug that is sold from 75c. to \$1.00 everywhere. Has hard rubber composition shell and patented cord tip holder. Must be seen to be appreciated. Finest workmanship throughout.
R-1030—Rasco Telephone Plug, each.....\$3.35

LITZ WIRE

R-323, equals No. 25 B&S, per foot.....\$0.02
R-890, equals No. 28 B&S, per foot..... .01
R-891, equals No. 21 B&S, per foot..... .03
R-892, equals No. 20 B&S, per foot..... .04
Discounts of 10 percent in 100-ft. lots.

UNIVERSAL BEARING

The bearing to hold variometer and varicooper rotors. Total length of bearing 2 1/4". Outside shaft, 1 1/4". Length of thread 1 1/4".
R-1375, Bearing.....\$2.25

PANEL MOUNTING VARIABLE CONDENSERS

This condenser presents the latest word in precision mechanics. Plates, washers, and all other parts are accurately machined. Positively no better condenser on the market. Shafts 1/4". Save from 10% to 60% by assembling condenser yourself. A child can do it in a few minutes spare time. Capacities guaranteed.
R-1411 11 plate condenser, .00025 mfd.....\$1.10
R-2121 21 plate condenser, .0005 mfd..... 1.22
R-4343 43 plate condenser, .001 mfd..... 1.50

The "Rasco" Catalog
CONTAINS 75 VACUUM TUBE HOOK-UPS, 350 ILLUSTRATIONS No. 10
550 ARTICLES, 84 PAGES

All Armstrong Circuits: These important circuits are explained clearly, all values have been given leaving out nothing that could puzzle you. Just to name a few of the Vacuum Tube circuits: The V.T. as a detector and one-step amplifier; Armstrong circuits; one-step radio frequency amplifier and detector; three stage audio frequency amplifier; short wave regenerative circuits; 4-stage radio frequency amplifiers; radio and audio frequency amplifier; inductively coupled amplifier; Armstrong superautodyne, etc. Catalog mailed only upon receipt of 15 Cents in Stamps or Coin.

Radio Specialty Co.
98S Park Place - New York City
Oldest and Original Exclusive Radio Parts House in U. S.
Factories: Brooklyn, N. Y. Elkridge, Md.

DEALERS
Get Our Special Proposition



The Sure Way To Bigger Pay

Big salaries are paid in the electrical field for expert knowledge. The man who knows electricity in all of its many phases—the man who has completely mastered the subject from A to Z—can pick his own job and name his own salary. The only way you can earn more is to learn more. Small knowledge means small pay. Learn the way to bigger pay. Become an expert. Croft will show you how.

The Croft Library of Practical Electricity

Everywhere the Croft Library is acknowledged as the standard—the leader—in practical electrical training. Go into the home or shop of any man who has made a success in electricity and nine times out of ten you will find somewhere a well-thumbed set of Croft. Croft and success go hand in hand. If your electrical training is obtained from these great books you are certain to win your way to the top.

Do not confuse these books with other sets. Croft is different. A good thing is always worth doing right, so seven years were spent in getting the library ready. The books stand alone—offering to the ambitious student the utmost in electrical training for the least in money. They are for the man who wants the best—who wants something that will actually help him to fill a bigger job.

The Croft Library at its present low price is a bargain in electrical training. A correspondence course of equal value would cost you \$100, or more. Books equal to those in the Croft set, needless to say, cannot be obtained at any price. The Croft Library is the most popular as well as the lowest-priced high-grade electrical home-study course published.

We'll gladly send you these books for ten days' Free Trial. No money needed—no obligation to buy. Use them—test them out any way you please. If you don't think they'll help you, send them back. If you keep them, you pay only \$1.50 in ten days and \$2.00 a month for nine months.

MAIL THIS COUPON

McGraw-Hill Book Co., Inc.
370 Seventh Avenue, New York.

Gentlemen:—Please send me the Croft Library of Practical Electricity (shipping charges prepaid) for 10 days' free examination. If satisfactory, I will send \$1.50 in ten days and \$2.00 a month until the special price of \$19.50 has been paid. If not wanted I will write you for return shipping instructions. (Write plainly and fill in all lines.)

Name

Home Address

City and State

Employed by

Occupation P.E.F.—10-23

Tidal Power

IN a Paris message dated December 30th, Reuter states that the French Chamber has passed without discussion a Bill for the erection of an experimental tidal electric-power station at Aber-Wrach (Finistere). It is proposed to build a barrage of 150 m. across the estuary, the top of which will be level with the land at either end and 4 m. above the spring tides high-water mark.

The barrage is to be constructed of hollow reinforced concrete blocks. The center block will be 35 m. long and 22 m. broad, and will contain the turbines and alternators; on the right hand side of the barrage a lock will be constructed to allow the fishing craft to pass. It is thought that, according to the height of the tide, the barrage will retain from 2,000,000 to 3,000,000 cub. m. of water. The turbines will work on difference in level between the water inside and outside the barrage, and will act whether the tide is flowing or ebbing, except for a short time when the water is nearly the same height on both sides. A difference of 70 cub. m. or so (it is stated) is all that is necessary to set them in motion.

Four turbines will be used, and the two alternators attached to them will furnish a current at 1,500 V. Owing to the fact that the turbines will each furnish from 75 to 1,200 horsepower, according to the state of the tide, it has been necessary to evolve some scheme for making the power obtained less irregular. It is proposed to build across the river Diouris, above tide level, a dam which will store 12,000,000 c. m. of river water, and which, even at high water will give the river a fall of 8 m., and at low water a fall of 29 m.

It is estimated that a maximum of 4,800 horsepower will be furnished by the installation and the regular production will be 1,600 horsepower. It is hoped that the annual output of the power station will be 11 million kilowatt. The expenditure will probably amount to 20 million francs.

Electric Drive on Ships

THE following comes from the commander of the U. S. S. "Maryland," Captain Sellers:

"The storm proved the value of the electric drive. That is automatically regulated, so that no matter what seas we plow into the speed of the ship is maintained. During the storm we sometimes brought up against seas as if they were brick walls, but the 'Maryland' went right through them.

"The engineer officer told me that at one time when we ran up against seas that checked our course there was 8,000 more horsepower generated to bring the speed up to the normal of 18 knots and keep it there. The automatic governor takes care of that, and all that is necessary is to set the motors at the desired number of revolutions and they keep that speed."

Electric Power Development

By M. H. AYLESWORTH,
Executive Manager, National Electric Light Association

WITH an output of approximately 51 billion kilowatt hours and with over \$750,000,000 raised for refunding, new construction, extensions and betterments, the electric light and power companies of the country during 1922 continued the same steady march of progress and growth maintained by them for the past 15 years.

While the appropriations for new construction in 1922 made a new record, the industry is in reality only on the threshold of a great comprehensive and complete development era.

The harnessing of the nation's water powers alone and the contribution of their energy to the productive wealth and prosperity of the country will require vast sums of money every year for the next decade or two. Already applications are on file with the federal power commission involving 17,692,000 primary horsepower and projects aggregating 2,500,000 primary horsepower are now under construction. The estimated capital involved in the projects granted preliminary or final permits and licenses is \$778,000,000, and the transmission, distribution, and ultimate utilization of the electricity generated by them will involve an additional expenditure approaching five billion dollars.

But 2,500,000 horsepower is only a small part of the whole. The total hydro-electric horsepower awaiting development is 54,000,000, and it is expected that in the ordinary course of events all of the 17,692,000 horsepower applied for will be in operation by 1930, with many new projects under construction or in contemplation.

While much of this hydro-electric energy will be used to replace the electricity now generated in coal-burning power stations, there will be no let-up in the erection of huge steam turbine stations, particularly in the great industrial centers in the East. Here there is only water power enough to supply a small part of the available load, and the great bulk of electricity will have to be generated as it is at present, in large, modern, coal-burning power houses. The tendency, however, will be to replace the many small stations, by a few larger ones and to locate these whenever possible close to the coal mines. This in turn will give impetus to the construction of high-tension transmission systems

STANDARD RADIO GOODS AT REDUCED PRICES

DeForest, D-7A reflex receivers.....	\$99.50
Grebe CR9	102.50
3-circuit receiver and 2-step, list \$70.....	51.75
Detector tubes, 200	3.90
Jacks, four-prong53
Plugs47
Mesco fones, 2,000-ohm.....	4.10
Murdock's fones, 3,000-ohm.....	4.20
W. E. fones, 2,200-ohm, reg. \$12.....	8.95
New type W. E. loud speaker.....	17.95
Storage batteries, 6 volts, 100 amp.....	12.25
Valley Battery Charger for A and B batteries, list \$18	15.10

Add postage or express to above. Write for prices on any standard apparatus you need.

HICKS RADIO, MARION, ILLINOIS

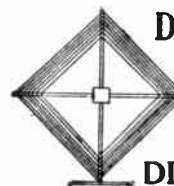

DIETZEN PORTABLE LOOP

Complete, ready to assemble; set up in few minutes. Works as well as the most expensive made. By mail 10c extra. Jobbers and dealers write for proposition.

DIETZEN, Inc., 71 Cortlandt St. New York

1.25^c By MAIL

QUESTIONS and ANSWERS

AIDS TO ELECTRICAL DIAGNOSIS (QUESTIONS and ANSWERS)

Electricians' Examinations
Diagrams, symbols, tables, notes and formulas for preparation for license.

READE PUB. CO.
296 Broadway, N. Y. City

Learn at Home

LEARN AT HOME DURING SPARE TIME

Write for book, "How to Become a Good Penman," and beautiful specimens, free. Your name on card if you enclose stamp.

F. W. Tammlyn, 441 Ridge Bldg., Kansas City, Mo.

with potentials ranging as high as 220,000 volts.

As to the possible market for all this electricity, there is every indication that it will develop faster than the facilities for supplying it can be brought into operation. The field of railroad electrification has hardly been touched, and opportunities equally attractive are to be found in the industrial world. There is approximately 65,000,000 horsepower in steam locomotives on the railroads of the United States which will eventually be displaced by electric equipment, and there is 26,000,000 horsepower awaiting conversion in the manufacturing industries. Then there are the millions of homes still to be reached with electric service and the tens of millions that are potential users of electric washing machines, vacuum cleaners, refrigerating machines, electric ranges and numerous other labor-saving and convenience devices.

A New Electric Furnace

THE electrical home has arrived—and the electrical factory is on the threshold. Surprising accomplishments have come to light with the entrance of electricity more and more fully into industry. The most recent is the appearance of a new and particularly efficient style of electric furnace for melting non-ferrous metals. This furnace is of the induction type. The first installations have revealed possibilities in the melting of brass that have never before been realized with the old style of crucible and oil-fired furnaces. Actual operation has demonstrated that whereas it costs \$16 per ton to melt brass in a coal-fired furnace, and \$14 in an oil-fired furnace, the cost with the new electric furnace is only \$8 per ton, or .4 cents per pound.

Metal is also saved, for this electric furnace, working tests show, melts brass with a distinct reduction of zinc waste; and at the same time the product turned out is finer in quality than was the case when the old-style furnaces were used.

Laymen no doubt may fail to grasp the significance of all this. If so, it is only necessary to glance at the findings just published by the United States Bureau of Mines after an investigation of brass furnace practice in the United States. This statement proclaims that if electric furnaces were substituted entirely for the old types, the saving in the brass melting industry would run to between two and three million dollars a year.

"If all the brass made in the country could have been melted electrically in 1917 and 1918," the Bureau adds, "the war expenses of the country would have been reduced some \$20,000,000."

The secret is that with the old-style furnaces there are certain serious wastes, which are practically done away with in the electric furnace. These wastes include enormous losses of zinc by vaporization.

Possibly as much as 6 per cent of the metal is lost in making brass castings, and 10 per cent is lost in making wrought brass. At the brass casting shops of one large plant, it is estimated, 7500 pounds of zinc pass from the stacks into the atmosphere every day in the form of zinc oxides—literally vanish into thin air.

Electric furnaces for brass melting, the Bureau of Mines estimates, would mean that six thousand tons less of metal would be required, releasing labor and railroad rolling stock for other needs. The health and safety of the workmen is incidentally increased by the cooler and cleaner character of the work.

Lectures for the Deaf

A GOOD deal of attention has been devoted in late years to the development of the telephone transmitter and receiver.

No Matter What Your Vocation

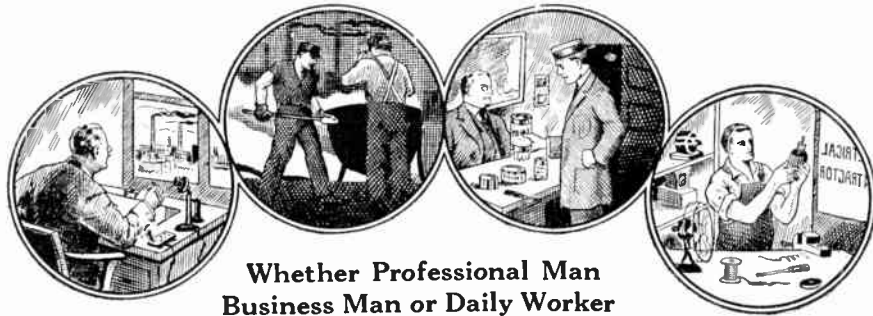

Whether Professional Man
Business Man or Daily Worker

A Thorough Training In CHEMISTRY Will Help You To Get Ahead

TO be successful today is to know Chemistry! Every line of business, every branch of industry depends upon Chemistry in some form. You may not realize it, but your own proficiency in whatever work you are doing would be increased by a knowledge of Chemistry. In many lines such knowledge is absolutely essential. In others it is a guarantee of promotion and more money.

The keen competition that exists in every commercial activity today requires that a man know all there is to know about his vocation. If you have something to sell—no matter what—Chemistry enters into its make-up. The salesman who knows the chemical composition of his article can talk about it more intelligently than the one who lacks this information, and his sales are proportionately larger. In the building trades Chemistry is of prime importance. The mason, electrician or painter who knows something about Chemistry can do better work and command more money than the one who does not. Through Chemistry a shop-keeper learns how to attract the most trade, and even in clerical positions one can capitalize his chemical skill.

Chemistry should be as much a part of your mental equipment as the ability to calculate or to write correct English. The world is paying a thousandfold more for ideas than for actual labor. The big rewards go to the man who can show how to turn out a little better product at a little lower cost. And Chemistry will give you the ideas that will save money for yourself or your firm in the very fundamentals of your business. There is nothing remarkable about this; it is going on every day. If you have not heard of it before, it is because the general public has been slow to recognize the tremendous value of chemical training. People have been content to leave Chemistry in the hands of a few trained chemists who could not possibly develop the subject to anywhere near its greatest extent.

Now we are on the eve of a great awakening. Our heritage from the World War has been an intense development of the chemical industries in the United States and a tremendous interest in all the applications of Chemistry. People are taking up the subject merely for the good it will do them in their own line of business.

It is no longer necessary to enter college in order to learn this fascinating science. Our Home Study Course trains you just as thoroughly, and with the same assurance of success, as those who took the longer way. And our methods are so simple that we can teach you no matter how little previous education you may have had. Many of our graduates now hold responsible positions or have materially increased their incomes from private enterprises as a result of taking our course. Hundreds of letters from students testifying to the benefits they have derived from our training are here for your inspection.

Remember, that you do not need to study Chemistry with the idea of actually practicing as a chemist, although a great many of our students are taking our course with this object in view. If you want to know more about what Chemistry will do for you, if you want to know what our home study course offers, sign and mail the coupon today for FREE BOOK "Opportunities for Chemists."

Chemical Institute of New York, Inc.

Home Extension Division 10

66- B West Broadway, New York City

DR. T. O'CONNOR SLOANE Will Teach You Chemistry In Your Own Home

The Chemical Institute of New York, of which Dr. T. O'Connor Sloane is Educational Director, was founded to fill the need of ambitious, far-sighted men who realize and recognize the splendid future Chemistry offers them, but who cannot spare either the time or the money to attend college. Dr. Sloane, a foremost authority on Chemistry, will teach you and will give you any individual help you may require. He will personally go over your papers, correct them, point out your faults, teaching you in a practical and interesting way. No special education required other than the ability to read and write English. One student has characterized our lessons as "The course that takes the mystery out of Chemistry."

Read What One of Our Recent Graduates Reports

"I thought I would let you know of my success. I finished your course about two months ago and now have a fine position as chemist at the DuPont Dye Works. I am getting along fine with my work and like it very much. It was through your course alone that I have been so successful. It is wonderful and I hope you have great success with it."

(Name and Address on request).

Easy Monthly Payments

You do not have to have even the small price of the course to start. You can pay for it in small monthly payments—so small that you won't feel them. The cost is very moderate, and includes everything, even the Laboratory Equipment—there are no extras to buy with our course. Our plan of monthly payments places a chemical education within the reach of everyone.

Laboratory Equipment Given To Every Student Without Additional Charge

We give to every student without additional charge his chemical equipment, including forty-two pieces of laboratory apparatus and supplies, and seventeen different chemicals and reagents. These comprise the apparatus and chemicals used for the experimental work of the course.

Special 30-Day Offer

For a short period we are making a special offer that will be worth your while to take advantage of. Write for particulars, using the coupon below or simply a postal card. This will not obligate you in the least. Do not wait until tomorrow. Send the coupon now while you think of it.

Sign and Mail the Coupon for FREE BOOK

CHEMICAL INSTITUTE OF NEW YORK, Inc.
Home Extension Division 10,
66-B —West Broadway New York City.

Please send me at once without any obligation on my part, your Free Book "Opportunities for Chemists," and full particulars about the Laboratory Equipment furnished to every student. Also please tell me about your plan of payment and your special 30 day offer.

NAME

ADDRESS

CITY

STATE

P.E.,10-23

BE AN AUTOMOTIVE Electrical Expert

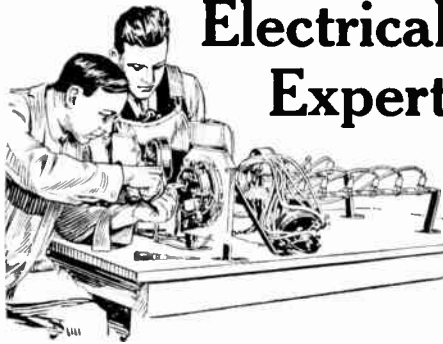

A Great New Field of Highly Paid Specialists

Experts in Electric starting, lighting, ignition and storage batteries earn \$150 to \$300 a month and more. You can qualify quickly for a big paying position as electrical expert on automobiles, motor trucks, tractors, motorcycles, aircraft, farm lighting plants, etc. Trained men are needed everywhere by manufacturers, service stations and garages. Our Free Employment Bureau helps you to a good position.

Experts Train You

Come to America's greatest institution of electrical education. Learn by practical work in our big electrical laboratories under expert instructors.

In Three Months

thirteen weeks' intensive full time training makes you a master of all types of electrical equipment—starting, lighting, ignition and storage batteries—or you can earn your own way by half time work. We find you a position. Low tuition fee.

Big Book Free

Write for handsome, illustrated book, telling about the great opportunities for trained Automotive Electrical Experts. Our quick method of training you.

SPECIAL

Personal instruction offered by mail to those who cannot come to Milwaukee now.

ENDORSED

By the Automotive Electrical Association of Wisconsin.

Ask for Details—Mail Coupon Today.

School of Automotive Electricity Inc.

415 Marshall St., Dept. P.E. 9, Milwaukee, Wis.

SCHOOL OF AUTOMOTIVE ELECTRICITY, Inc.,
415 Marshall St., Dept. P.E. 9, Milwaukee, Wis.
Gentlemen:

I would like to know more about how to become an Automotive Electrical Expert.
Send me FREE catalog and details regarding

- 3 months' day course
- 6 months' half day course
- 9 months' evening course
- Home Service Training

Name Age

Address City State



The requirements of radio operators have brought forward new receivers and special ones have been devised for the deaf. A sensitive microphone is part of the apparatus, the speaker stands well back of the microphone case, so that he can lecture with comparative ease, and not feel any annoyance due to the impression that he is talking through a contracted microphone. He can hold himself back from the transmitter and speak exactly as if he were addressing a hearing audience, with the certainty that his words are reaching every person present.

The improved microphone transmitters of the present day and the sensitive receiver specially designed for the deaf have made this system of lecturing to the deaf possible and practical.

Electric Locomotive Repairs

IN the *American Machinist* Mr. Frank C. Hudson states that the electric locomotive brings entirely new problems to the railway repair shops, involving the need of men who understand electric motor work, such as winding armatures, caring for commutators, and the like. But electric motors require much less attention than their steam-driven predecessors, and a general overhaul can be made in about one-third the time formerly required. This is partly attributable to the absence of reciprocating parts in the transmission of power. The substitution of rotary motion eliminates the pound on the wheel bearings and entirely does away with the wear on main and side rod bearings. Another noticeable effect is the reduced wear on driving box thrust-plates and hub-liners, the life being increased from 50 to 100 per cent over that of the steam locomotives.

Static Spark and Gasoline Tanks

IN a recent inquiry at Bridgeport into the death of an occupant of a closed automobile by fire resulting from the explosion of a gasoline tank, the explosion was due to static electricity induced by the flow of gasoline into the tank.

The tank was being filled at the time of the accident and until experts testified before the coroner the cause of the explosion was a mystery. The expert witnesses gave it as their opinion that a static electrical discharge was the cause of the explosion.

The flow of gasoline from the hose into the tank was sufficient to set up static electrical potential, they said, and a spark leaping from the nozzle of the hose to the metal tank would ignite the gasoline vapor, causing the explosion.

It was recommended, however, that occupants of closed automobiles, whose gasoline tanks are in the body of the car, leave the vehicle while the tank is being filled. It was suggested also that a chain be fastened to the gasoline tank of such a car which could be lowered to the road when the tank is being filled, thus grounding any current that might be set up.

Joseph Bazatta, it was learned after the hearing, was severely burned this morning in Westport in an unexplained explosion that occurred while the tank of his automobile was being filled.

Two members of an automobile party from Watertown, N. Y., were burned to death and three others were injured when the gasoline tank exploded while being refilled.

Great carelessness prevails in garages in the handling of gasoline. The wonder is that more accidents do not happen. Cigarettes are smoked by those about the cars and this action involves lighted matches. It therefore is no wonder that the fortunately rare static spark is forgotten until it does its work. This article is valuable in pointing out the danger.

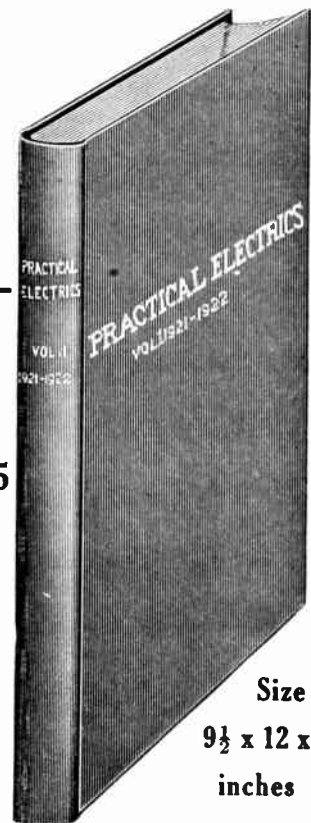

\$
1.75

528
Pages

Size
9½ x 12 x 1½
inches

BOUND VOLUME NO. 1

NOV. 1921 TO OCT. 1922

Bound in blue cloth
Gold Stamped

Over 900 original articles by
the best writers in the Elec-
trical field.

Over 2000 illustrations.

Everybody interested in Elec-
tricity should have this bound
volume on his shelf.

PRICE \$1.75

Express collect

PRACTICAL ELECTRICS COMPANY,
53 Park Place, New York, N. Y.

Enclosed please find \$1.75 for which
send me by express, collect, Volume
No. 1 of PRACTICAL ELECTRICS.

Name

Address

Town..... State.....

SEND NO MONEY

THE WILD CAT
Regular
Swing-Out
Hand-Ejecting
Left-Hand
Wheeler
Revolver
\$3.30 or 38 Cal.
6 Shot.....



\$14.50

A powerful six shot gun; made specially for Hunters, mountaineers and men working in unprotected places, requiring a safe and efficient weapon. Quick as a flash, with great penetrating power and true marksmanship. Carry this gun with you and you will feel fully protected. Made of best blue steel, rifled barrel. Hammer with safety. Fires regular 32.20 or 38 caliber ammunition.

20-SHOT AUTOMATIC PISTOL



\$9.50

20-SHOT—32 CAL.

The biggest bargain ever offered. Built of best blue steel, checkered grip, safety. Every one brand new and inspected. Shoots all standard 32 cal. cartridges, 10 shot, with extra magazine, making 20 quick, hard and straight shots. Buy several while they last, at our unheard price \$9.50 (regular \$35). Pocket size, 35 cal., 7 shot, \$7.80; 32 cal., 6 shot., \$9.30.

SEND NO MONEY: Pay on arrival, our bargain price, plus few cents postage. Satisfaction guaranteed, or money back. Order today. NOW.

THE PRICE CUTTING CO., Desk 221, 55 Broadway, New York



SAVE MONEY



You positively can do wiring and re-pairing of bells, lighting, garages, irons, vacuum cleaners, washing machines, etc., without previous experience, when you own our new book **ELECTRICAL KINKS**. Most complete book on everything electrical in the HOME. **SEND NO MONEY**, just your name and address. Pay postman \$1.00 plus a few cents postage when delivered. (Or send a dollar bill with your order. TODAY. Money back if not satisfied. Circular Free.

HOMEBOOK CO., 388BM Arcade Bldg., Cleveland, Ohio

Sell Shirts

Sell Madison "Better-Made" Shirts, Pajamas, and Nightshirts direct from our factory to wearer. Nationally advertised. Easy to sell. Exclusive patterns. Exceptional values. No experience or capital required. Large steady income assured. Entirely new proposition. **WRITE FOR FREE SAMPLES.**
MADISON SHIRT CO., 803 B'way, N.Y. City

Earn \$10.00 a Day

Selling a household necessity, one to a dozen in each home; big seller, good repeater. Write for Free sample and particulars to

"STICK-ON" COMPANY
16-22 HUDSON STREET, NEW YORK

Earn \$50 a day

Selling men's gas-mask

GOODYEAR RAINCOATS

\$1.90 each, in dozen or gross lots. Sample sent upon receipt of \$2.15. Agents wanted. (Write for our six best sellers.)

GOODYEAR RUBBER M'FG CO.
Dept. P 34 E. 9th Street, N. Y. C.

SEX BOOKS Practical information all sex matters. Send 10c today, stamps or coin, for remarkable illustrated catalog. Nothing else like it in this country.
Dept. 185, Counsel Service, 257 W. 71st St., New York

ARE YOU SELF-CONSCIOUS?
Embarrassed in company, lacking in self-control? Let me tell you how you can overcome these troubles.
E. VERITAS, 1400 Broadway, New York City

In our issue of June, 1923, page 356, we described the grounding of gasoline tanks, where in handling the fluid on the large or commercial scale danger of conflagration from the static spark was anticipated.

Electro-Photograph of Anxiety

A WOMAN patient was being examined in the office of a heart specialist. The test at the moment under way consisted of the taking of what is known as an electro-cardiogram—a photographic record of the electrical currents generated by the heart beat.

The patient sat motionless in a chair at one end of a long room. At the other end of the room a man was looking at a little spot that danced about on a screen. The man's back was toward the patient. Apparently he was disregarding her altogether, yet presently he said:

"Madam, you are worried about something. What is it?"

And the patient replied, rather shamefacedly: "Why, I left my purse, with my rings, in the dressing room, and I just heard steps in the hall as if someone were going that way. I was a little afraid the jewels might not be safe."

The physician directed an assistant to get the purse. Then he proceeded with the electric test.

"Ah, that is quite different," he said presently. And when the negative was printed, it plainly revealed that the electrical conditions of the heart were modified when the patient had been worried even in that small degree.—*New York American.*

Electric Hay Curing in Germany and Austria

THE green crop is placed in large containers built up of reinforced artificial stone of an insulating nature both as regards electricity and heat. The walls are varnished on the inside to prevent current leakage. The capacity of a container varies greatly—some being as small as five cubic yards and others as large as 175 cubic yards. The floor electrode of the container is formed of galvanized sheet iron or of a grid of iron rods. The crop is spread out uniformly and trodden down, and is then covered by a metal-built lid acting as the second electrode. Alternating current at 220 to 500 volts is employed—the higher the voltage the shorter the time taken for the curing process. Neither the current nor the voltage requires any regulation during the treatment. Investigation has shown that as soon as the current is applied, a sort of paralysis or suspension of organic life takes place in the mass of material, and it is due to this fact that no deleterious effects are set up tending to lessen the food value of the product. It is especially advantageous as regards the albumen content.

A change of resistance occurs at or about the temperature of 50 degrees Centigrade (122 degrees Fahrenheit), which, as stated above, is also the temperature of sterilization. At this temperature the plant cells and bacteria collapse, and the whole mass sinters together, and most of the internal air spaces disappear. After this, very little further heat is generated because of the low resistance of the material, and in this way the process is practically self-regulating. As soon as the whole mass is found to have reached about 122° Fahrenheit, the current can be switched off.

Experiment has shown that about 23 kwh are required per ton of green material treated. Before the actual curing process can be commenced, the crop must be subjected to a preliminary treatment to give it the necessary conductivity.

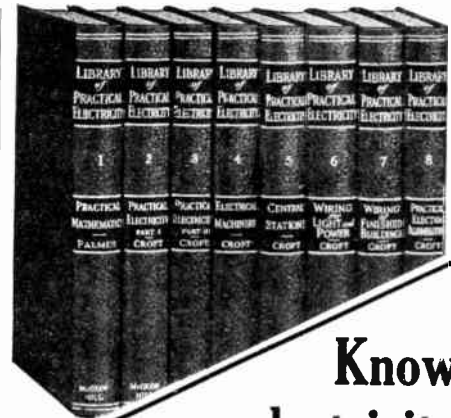

Know electricity as experts know it and get an expert's pay

Electricity holds out today the greatest imaginable future. Technically trained electricians are earning big salaries. New opportunities appear every day to those who are acquainted with up-to-date methods. Now is the time to take advantage of these opportunities. The Croft Library will aid the beginner as well as the expert. It is written in a non-technical manner, yet its accuracy and thoroughness are known to more than forty thousand Croft followers.

The Croft Library

A combined reference library and home-study course in practical electricity

No course, no set of books, offers a quicker, surer method of mastering electricity than the Croft Library. It is a complete electrical educator. It is founded on practice—on work as it is actually done. It is jammed from cover to cover with the kind of hard-headed facts you want. Written so that the beginner can easily understand it, yet so sound, so thorough, that it is the daily guide of thousands of highly paid electrical workers and engineers.

Craft and success go hand in hand. If your electrical training is obtained from these great books you are certain to win your way to the top.

Free Examination—no money down—only \$1.50 in ten days and \$2.00 a month until paid

Fill in and mail the coupon attached and we will send you the entire set of eight volumes for ten days' Free Examination. We take all the risk—pay all charges. You assume no obligation—you pay nothing unless you decide to keep the books. Then \$1.50 in ten days and the balance at the rate of \$2.00 a month. Send the coupon NOW and see the books for yourself.

Free Examination Coupon

McGraw-Hill Book Co., Inc.
370 Seventh Avenue, New York.

Gentlemen:—Please send me the Croft Library of Practical Electricity (shipping charges prepaid) for 10 days' free examination. If satisfactory, I will send \$1.50 in ten days and \$2.00 a month until the special price of \$19.50 has been paid. If not wanted I will write you for return shipping instructions. (Write plainly and fill in all lines.)

Name

Home Address

City and State

Employed by

Occupation P.E.B.—40-23



**Leading
Electrical Concerns
Join America's
Foremost School in
Practical Electricity
to Develop
Trained Men**

To meet the extraordinary present-day demand for trained electrical men, a number of big Milwaukee Industrial Concerns have taken a step without precedent or parallel. They have entered into a contract with the School of Engineering of Milwaukee to give their students part-time employment at practical electrical work during their entire course of study.

This gives you an opportunity absolutely unique in the history of technical education—the opportunity to secure a sound, through-and-through training in both the "book" and the "dollar-and-cents" sides of

**Commercial and
Electrical Engineering**

You can earn your living expenses while pursuing your studies. Mornings—lectures and laboratory work at school; afternoons—actual practice in the work rooms of the industrial companies. What better start in life could you ask than this chance to acquire a complete job-insuring, technical training under actual wage-earning, working conditions, giving you confidence in yourself and a feeling of security in holding your job?

**A Permanent Job
For Every Graduate**

Feeling the tremendous need for more men with the sound, technical training afforded by this school, these same concerns have agreed to employ all our duly qualified graduates at good salaries the moment they receive their diplomas.

To meet this demand, we offer the following courses to students with fourteen high school units:

Commercial Electrical Engineering.....1 year
Electrical Engineering, B.S. Degree3 years

Students with only a common school education may take Electrotechnician Course in 1 to 2 years; Practical Electricity in 6 months to 1 year; Armature Winding in 3 months; Wiring and Testing in 3 months; and Automotive Electricity in 3 months.

Established eighteen years ago, the School of Engineering of Milwaukee stands absolutely alone in the field of electrical and commercial engineering. Has the emphatic and unqualified endorsement of all leading engineering industries. Write at once for full particulars. New classes now organizing.

**SCHOOL OF ENGINEERING
of Milwaukee**

P.E.-10-415 Marshal Street, Milwaukee, Wis

Fill out this coupon and return now for full information.

SCHOOL OF ENGINEERING, P.E.-10
415 Marshall St., Milwaukee, Wis.

Gentlemen: Please send me complete details regarding your Earn-While-You-Learn proposition and theCourse. (Fill in the course most interested in.)

Name
Address
City State

Freshly-reaped, undamaged crops offer a very high resistance to the passage of a current owing to the protective covering of hairs, waxes, gums, etc., on the outer surface. For instance, a mass of such material 20 inches thick required the application of nearly 8,000 volts before any appreciable current would pass. It is the inner, juicy portions of the plant which conduct well, and the best and simplest way of exposing these parts to the action of the current is found to be by chopping up the material. This chopping is in any case desirable in material intended for cattle food, and it also greatly facilitates the handling throughout. After treatment, the hay is left carefully covered up in the containers until wanted for use.

The chief advantages claimed for the process are:

- (1) The whole hay crop becomes independent of weather conditions.
- (2) The crop can be treated at almost any stage of ripeness, and is not liable to damage through rain, dew or frost. Also such very juicy materials as turnip leaves, turnip tops and coarsely-chopped turnips, potatoes, carrots, etc., can be stored indefinitely without deterioration after the treatment.
- (3) Independence of weather conditions allows more crops to be raised from a given area. The crops can be cut when in their most nourishing stage (just before flowering).
- (4) The retention of the protein in the hay makes clover and leguminous crops serve as real sources of albumen throughout the winter, and it has been found in practice that very satisfactory milk returns have been obtained by the use of the process. The cured crop has been found very suitable for horses, sheep, goats and fowls—in fact, all animals like it because of its aromatic taste.
- (5) The process enables better use to be made of the available labor on the farm, and so leads to economies which more than cover the cost of the electricity.
- (6) The load is a desirable one from the power-station point of view, because it is, to a large extent, an all-night load—the work of transporting the crops and loading the containers being done in the daytime, and the current being allowed to do its part at night.—*Elektrotechnik und Maschinenbau.*

Storage Battery Repairs

A COMMITTEE of the Associated Advertising Clubs of the World have investigated the repairing and charging of storage batteries for automobile owners and others. We quote:

"The automobile owner is at the mercy of a battery station in the matter of having his battery charged, changed, rebuilt or repaired, for the reason that it is impractical to disassemble a battery and identify the parts.

"If the owner wants the repair parts put out by the maker of his battery, he is entitled to receive them, even though there may be repair parts made by others which could be used just as efficiently. Substitution under such circumstances constitutes a fraud upon the public and jeopardizes the good will and reputation of the battery manufacturer which the service station purports to represent."

The committee states that complaints have come to it from many sources to the effect that the motoring public is being imposed upon from time to time by unscrupulous concerns which offer a remedy for all battery troubles through the medium of pastes, fillers, solutions and other compounds to take the place of regular electrolytes. Tests and analyses of several of these "dope" solutions indicate that, while they apparently give a battery greater momentary "kick," they oftentimes

**How to Hook-Up A
Transmitter Button to
Make an Efficient
Loud Talker**

A Transmitter button with a few dry cells and a telephone receiver will make a remarkably simple and efficient loud talker. A Microphonic amplifier of this type is just the thing for use with a radio set. The weak music and signals may be amplified many times their original value. It is possible to entertain a large audience with a simple radio equipment if a transmitter button is used in the circuit as explained in diagram A.

The cost is extremely low, and the results are comparable with those produced by highest grade of expensive loud talkers.

As may be seen in the diagram, two dry cells or a small storage battery are connected in series with the transmitter button and a 4 to 75 ohm telephone receiver. The transmitter button is secured to the diaphragm of the telephone in the radio receiving set. To accomplish this properly, scrape off the enamel (if diaphragm is enameled) on the face of the diaphragm and solder the small hexagon nut supplied with the button to the exact center. Care should be taken that the thin diaphragm is not bent or otherwise harmed. The transmitter

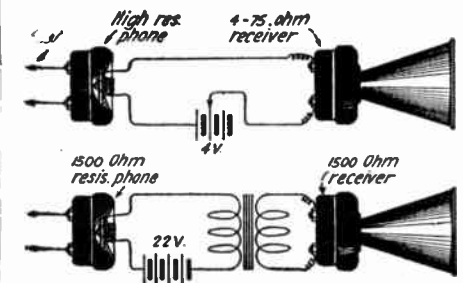

button is then screwed into place. Connections, as shown in the diagram, are made with flexible wire. A horn may be placed over the low resistance receiver if desired. When the radio set is properly tuned and signals are being received, the transmitter button is operated by the vibration of the diaphragm of the receiver. As the receiver diaphragm vibrates, the mica diaphragm on the transmitter button also vibrates. The carbon grains are compressed at varying pressure; the current flowing through the local battery circuit is thus varied and results in an amplification of the sounds in the low resistance telephone loud-talker.

Diagram B, which includes a step-up transformer, is to be used with loud talking receivers of high resistance. The primary of the transformers should have a resistance of about 75 ohms. An ordinary telephone induction coil will serve as the transformer in this circuit.

You can get the above-described transmitter button FREE in subscribing to PRACTICAL ELECTRICS Magazine at \$2.00 per year (12 months). Send your subscriptions today.

Make all remittances payable to Practical Electrics Co., 53 Park Place, New York City.

—Adv.

Standard Spanish ARMY

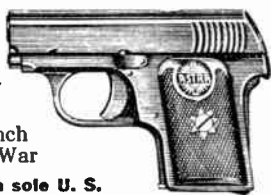

Used by French During World War

Buy direct from sole U. S. importers and SAVE 1/2 on this

GENUINE ASTRA AUTOMATIC

Your chance to have the finest European pistol--the equal of any similar American gun--at about 1/2 the price. Order direct at these special prices.

- \$7.75 25 calibre—7 shot—C. O. Q. Automatic.
- 8.95 25 calibre—7 shot—Astra Automatic.
- 9.95 25 calibre Astra with triple safety.
- 10.95 32 calibre—10 shot Astra, extra magazine.
- 16.95 32-20 and 38 cal. swing-out cyl. revolvers.

We guarantee every gun against defective workmanship; brand new; of Drop Forged Steel Throughout. Before buying any weapon **INSIST** on this guarantee. **SEND NO MONEY** unless you wish. State model desired—pay postman on delivery plus postage. Satisfaction guaranteed or money refunded. Write for new firearms catalogue.

CALIFORNIA TRADING CO.

Dept. 2410 Terminal Bldg., Los Angeles, Cal.

A Wonderful Book on Finger Prints FREE to YOU!

Full of Thrilling, True Stories of crime mysteries solved through Finger Print Evidence by some of America's greatest Finger Print Experts. Gripping illustrations. Greatest book ever published on the subject. Send for your FREE copy today.

Big Money to Experts!

You can learn the Finger Print Profession easily at home in spare time. Great demand for Experts. Professional fees are high. This book pictures the wonderful opportunity awaiting you. **Big Special Offer** open now. Write at once. Get full details. Big surprise in store for you. A splendid field for professional work never dreamed of.

UNIVERSITY OF APPLIED SCIENCE

Dept. 15-76 1920 Sunnyside Ave. Chicago, Ill.

HOW TO BECOME A PROFESSIONAL PHOTOGRAPHER



EARNING \$35 TO \$125 A WEEK

An interesting illustrated booklet (free) on choosing a vocation, and the exceptional opportunities Photography offers you.

MOTION PICTURE — COMMERCIAL — PORTRAITURE

Three to six months' course. Modern equipment. Day or evening classes. Easy terms. Ask for Catalog No. 57. **N. Y. INSTITUTE OF PHOTOGRAPHY**
NEW YORK CHICAGO BROOKLYN
141 W. 36th St. 630 So. Wabash Ave. 505 State St.

MATHEMATICS



can be easily mastered with the Midget 5 in 1 slide rule. With this calculator you can instantly add, subtract, multiply and divide any combination of decimals, fractions, whole and mixed numbers. Also obtain all roots, powers, Logs, and Trig. Functions.

It is used at all colleges, 200 at Harvard, 300 at Cornell, etc. The Engine-Divided Scales are on white celluloid, mounted on aluminum and

are grease and waterproof. Diameter 4 inches. Price with instruction book \$1.50. Leather Case 50c extra. Catalogue Free. Your money back if you are not satisfied.

GILSON SLIDE RULE CO., Niles, Mich.

No matter who or what you are, whether you are too thin or too fat—or unable to sleep and eat properly, you need a

RESIBELL

Ask your dealer or send your name and address for particulars.

Address **HAIMS 932 East 140th St., Cleveland, Ohio**

FREE Drafting Lesson

Not a penny to send for this Free Trial Lesson which shows how easily you can learn Drafting by mail under Chicago "Tech" experts. Prepare now for paying positions. Draftsmen earn \$60 to \$150 weekly. Big jobs are waiting. Send today for the Free Lesson, catalog, terms, etc.

CHICAGO TECHNICAL COLLEGE
1068 Chicago "Tech" Bldg., CHICAGO

contain ingredients which are absolutely ruinous to the plates and separators, thereby shortening the life of the battery from 50 to 75 per cent.

Purchasers are warned to inquire carefully regarding such solutions, and assure themselves that the substitute they are procuring has real merit and will not damage the battery, before placing their orders.

Another misleading and sometimes fraudulent feature attends the manner in which many so-called "dry batteries" are advertised, the committee says. Some of these are exploited as "new and wonderful" inventions that "never need to be taken to a service station," that "require no water" nor added charge "no matter how long in use," "cannot freeze," etc.

Elaborate Lighting Spectacles Planned for Illuminating Engineering Society Meeting

DETAILED plans for the special features which will mark the 1923 convention of the Illuminating Engineering Society meeting at Lake George, N. Y., September 24 to 28, are nearing completion and promise to surpass in spectacular effect and all-around interest anything yet attempted by the society.

A battery of great searchlights forming a scintillator of moving colored beams will be the big event of the convention. This scintillator, it is announced, will be located on the wharf in front of the Fort William Henry Hotel, convention headquarters, and will send a multitude of powerful rays into the sky in a fan-like formation. By means of colored slides the beams will be constantly changed in colors, one blending into another to give a startling and beautiful rainbow effect.

An elaborate program of fireworks is another feature, a high point of which will be the explosion of the largest bomb used in such displays. A jeweled emblem of the society, illuminated in various colors by floodlights, is another thing of interest on which the committee is working. This will be placed on the grounds near the hotel.

Large, beautifully colored lanterns will dot the groves and walks surrounding the hotel and water's edge, while negotiations are on for securing a special battery of the largest searchlights, about 60 inches in diameter, which will cross in the sky in front of the headquarters from strategic points on the hills surrounding the southern end of the lake.

W. D.A. Ryan, chairman of the general convention committee, under whose direction the lighting effects are being worked out, believes the illumination features of this meeting will compare favorably with the largest spectacles of the kind. The scintillator of colored searchlight beams is patterned after that used with such wonderful effect during the Panama Pacific International Exposition.

The officers of the convention committee consist of Mr. Ryan as chairman, Henry W. Peck, vice-chairman, and H. E. Mahan, secretary.

Gases Liberated by High-Voltage Insulator Testing Apparatus

By G. W. JONES and W. P. YANT,
U. S. Bureau of Mines

DURING the testing of porcelain insulators with a 60-cycle flash-over apparatus, gases are liberated having an odor greatly resembling that of ozone. Since the two main constituents of normal air are nitrogen and oxygen, and high voltages (approximately 90,000 volts) are used during the tests, the conditions are favorable for the production

I Pay Your Railroad Fare



B. W. COOKE, President

to the Great Shops of **COYNE**

Chicago

The Electrical Center of the World

We pay your railroad fare to Chicago—the Electrical Center of the World—from any place in the United States. Grasp the opportunity to see the country at our expense. Come to Coyne—learn electricity in 3 months. The largest electrical school in the country specializing in electrical instruction only. Get a complete training so you can make big money as Power Plant Operator, Superintendent, Telephone man, Construction worker, auto, truck or tractor electrician, battery man, radio expert, or you can go into business for yourself as electrical contractor, dealer, auto ignition or battery expert and make from \$3,000 to \$20,000 a year. Hundreds of our graduates today are making big money and you can do the same if you grasp this opportunity—act now.

Learn Electricity In 3 Months

No books or useless theory. You are trained on \$100,000 worth of electrical equipment. Everything from door bells to power plants. You work on motors, generators, house-wiring, autos, batteries, radio, switch-boards, power plants—everything to make you an expert ready to step right into a position paying from \$45 to \$100 a week.

Radio Course FREE

We include the following free with the regular course:

- (1) A complete course in auto, truck and tractor electricity and storage batteries. Greatest outlay of auto, electrical and battery equipment in the country.
- (2) Course in Radio—the marvel of the age. Constructing, installing and operating. You can build your own wireless telephone set.
- (3) A life scholarship in the Coyne school. You can stay as long as you wish and return for further training at any time in the future.

Earn While You Learn

We help students to secure jobs to earn a good part of their expense while studying.

Send Coupon Now

Don't delay a minute—send that coupon in right now for our big free catalog and full particulars of Free Railroad Fare offer. Act now!

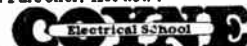

Endorsed by Electrical Industry
1300-1310 W. Harrison St., Dept. 15-77

B. W. Cooke, Pres., Coyne Electrical School,
Dept. 15-77 1300-1310 W. Harrison St., Chicago, Ill.

Dear Sir: Please send me free your big catalog and full particulars of your special offer of Free Railroad Fare and two extra courses.

Name.....

Address.....

Build Your Own Radio Apparatus

As Easily as a Woman Makes a Dress!

"CONSOLIDATED" PATTERNS

are designed by the foremost radio engineers and by our novel method of construction anyone can easily make efficient apparatus to receive all wave lengths. All Patterns are Full Size, printed on heavy Blue-Print paper and put up in attractive packet of heavy manila, 9x12". Each one is fully illustrated by photographs.

Every packet contains complete instructions for the construction of these circuits including the tools required, parts needed, directions for drilling, mounting and wiring and most important of all, full instruction on how to tune the circuit. Sets constructed from these plans have been thoroughly tested and pronounced perfect.



How to Make a Cockaday Receiver

The Cockaday four-circuit tuner is one of the latest advancements in radio. Its main advantage lies in the fact that the set can be adjusted to the highest point of regeneration, and tuning accomplished over a wide band of wave-lengths without the necessity for readjusting the regeneration control. The set described in our folder was designed and built at our own shop. All dimensions, size of components, number of turns, etc., are given, leaving nothing to the imagination.

50c.

How to Make a Reflex Receiver

The plans for the reflex receiver were gotten out only after considerable research work by our engineers. Most people have trouble with reflex receivers. It takes an expert to build one that will work satisfactorily. The trouble lies in the values of condensers, etc., in the circuits. If they are incorrect, the set is a dismal failure. The constructional details of a reflex receiver, contained in this folder, are the results of their successful efforts.

50c.



How to Make a Reinartz Receiver

The original Reinartz Receiver is the most popular type of set in existence today. It gained its popularity through its simplicity of operation and capability of long-distance reception. Full directions for building this receiver are given in this folder. The construction of the coil—the most difficult part—is made easy with the concise instructions we furnish. The connections of the set are shown plainly, so that the novice will have no trouble in following them.

50c.

Twenty Radio Phone Diagrams and Hook-Ups With Supplements of Latest Hook-Ups

These diagrams show how to get the best possible efficiency from the instruments you make or purchase. They cover hook-ups from the simplest to the most complicated, in a way that any amateur can understand and follow without difficulty. Printed on heavy paper, 8 1/2 x 11 1/2 inches, and together with KEY CHART OF SYMBOLS and pamphlet "HOW TO READ DIAGRAMS", are contained in a heavy two-color envelope.

50c.



All About Aerials and Their Construction

These blue prints were made after practical erection of each aerial, and point out how simple it is to erect not only the proper aerial for your particular need, but how to erect this aerial in the most practical manner and at the least expense. Consists of 12 blue prints 8 1/2 x 11 inches and one four-page instruction pamphlet 8 1/2 x 11 inches.

50c.

14 Radio Formulae and Diagrams

With this packet of radio knowledge you need never worry about schematic wiring diagrams, measurements and radio tables. All formulae and diagrams are printed on heavy paper in black and blue, and contained in two-color printed envelope, 9x12 inches.

50c.



How to Make a Short Wave Regenerative Receiver

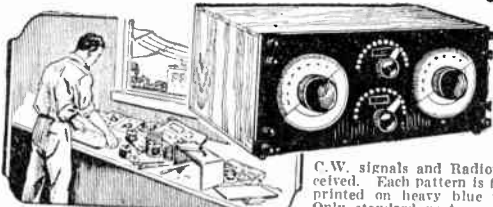

Easy to build. No machine shop needed. One of the foremost Radio engineers constructed this set for us; it's simple to follow our patterns and assemble the parts comprising this set with which spark, C.W. signals and Radiotelephony may be received. Each pattern is full size and printed on heavy blue print paper. Only standard parts are used.

50c.

How to Make Detector and Amplifier Units

Can be built anywhere in your house; no machine shop needed. May be used with any type of Regenerative Receiver or short wave set, with which spark, C.W. Signals and Radiotelephony may be received. We've tested these patterns by actually building the outfit—they're perfect! Only standard parts used in making the outfit.

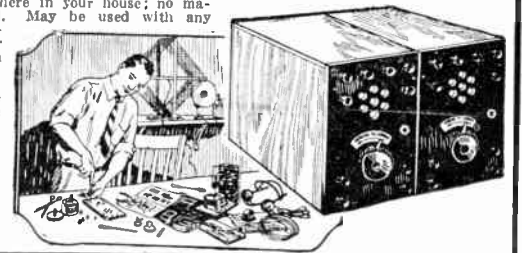

50c.

The Consrad Co
INC.
Formerly The Consolidated Radio Call Book Co.

Order from dealers whose names appear on page 572

If your dealer cannot supply you, order from us, giving his name and address

233 Fulton Street, New York City

Publishers of Consolidated Patterns and Sales Agents for E. I. Co. Books

GOLD SEAL HOMCHARGER
The World's Most Popular Battery Charger
 —silently and efficiently charges your radio or automobile battery over night for a nickel! No stopping—no sticking—no muss—no fuss—no trouble. Self-polarizing—high charging rate—finished in mahogany and gold—approved by Underwriters. Price \$18.50 complete with ammeter (\$25.00 in Canada)—no extras to buy.

LOOK FOR and INSIST on the GOLD SEAL
 WRITE FOR FREE BOOKLET
THE AUTOMATIC ELECTRICAL DEVICES COMPANY
 155 W. THIRD ST.
 CINCINNATI

LOUD SPEAKING CRYSTAL SET At Last

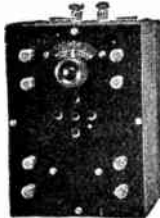

You can add a loud speaker to any crystal set by using the STEINMETZ Amplifier costing only \$8.50. Guaranteed to operate on any kind of crystal set regardless of what type it is, or we will refund your money.

By using your crystal set with this amplifier music is brought in as clear as a bell, and can be heard all over the room. Amplifier uses dry cell tube. Write for our complete catalog and also information on a highly efficient detector and two-stage amplifier at \$22.50

STEINMETZ WIRELESS MFG. CO.

Manufacturers and Engineers

5705 Penn. Ave. Pittsburgh, Pa.

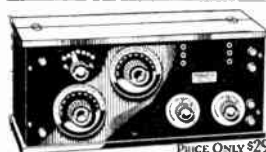

PRICE ONLY \$29.50

At the low prices shown below you get the efficiency of sets costing three times as much. These radio frequency receivers—pick up stations over 1500 miles away under good conditions—everywhere. Operate either on DRY CELLS or storage battery. Cabinets of solid mahogany and workmanship the finest throughout. Order direct or send for bulletin.

For tube outfit, as shown above, headphones only \$29.50
 Four tube outfit for loudspeaker or headphones \$4.50

DEALERS write for proposition quickly—it's a AGENTS winner.

THE MIDWEST RADIO COMPANY

816 Main Street, Cincinnati, Ohio

LEARN RADIO

Here's your opportunity. Radio needs you. Win success in this fascinating field. Trained men in demand at highest salaries. Learn at home, in your spare time.

Be a Radio Expert

I will train you, quickly and easily, to design, construct, install, operate, repair, maintain, and sell all forms of Radio apparatus. My new methods are the most successful in existence. Learn to earn \$1,800 to \$10,000 a Year

FREE Wonderful, home-construction, tube receiving set, of latest design. Write for "Radio Facts" free. Engineer Mohaupt, American Electrical Association, Dept. 1810 4513 Ravenswood Ave., Chicago

DIETZEN VACUUM TUBES

1 VOLT Operates on single dry cell with or without "B" battery. Instructions and wiring diagram FREE. Send for your tube today. Socket 46C, extra. Add 15c. for parcel post.

Dealers—Jobbers—Write for Proposition.

DIETZEN INC. 22 CORLAND ST. New York

INSTALL AN ELECTRIC LIGHT IN YOUR HOME

It costs only a few cents a day. You can install, quickly, with a Midget Marvel electric light outfit. No matter how far you are from a power plant this new discovery gives you a dazzling flood of electric light at the touch of the switch. You recharge your battery with a 10c powder obtained from your drugist. With ordinary use one charge supplies light 7 to 10 days. Outfit will last for years. Sent complete ready to install, including 50 feet wire, staples, switch, completely wired fixture with shade, guaranteed Mazda lamp, battery system, battery charger and instructions. Postpaid for \$2. Agents Wanted. Send today for complete outfit and wholesale terms. No circulars or C. O. D. Your \$2 returned if not satisfied.

ELECTRIC LIGHT OUTFIT

B. B. IRVING ELECTRIC CO., 1636 S. Lawndale Ave., Chicago

of ozone or oxides of nitrogen, and perhaps both simultaneously.

The presence of these gases is only noticeable during the testing period. They soon disappear after the test is over. No fatalities have ever resulted from these gases at the plant visited, nor are there any records of any of the men who worked on the tests being confined to their homes from this cause. New employes sometimes complain of a depressed feeling and shortness of breath, which is most noticeable after leaving work and getting into fresh air, but they soon become accustomed to it and no ill effects are noticed.

In view of previous work which the Bureau of mines has done on oxides of nitrogen in connection with mine gases and problems in gas analysis, tests were made at the plant of the Westinghouse High Voltage Insulator Company at Derry, Pa., to determine the kind and amount of gases liberated.

Before the insulators are shipped from the plant, each is tested for its insulating properties in the above-mentioned 60-cycle flash-over apparatus. The insulators are placed on specially constructed racks or tables of such size that 150 units can be tested at one time. The racks form a terminal of the source of power, while the other terminal is connected by chains or other metallic connectors to the other side of the insulators. When the insulators have been prepared for testing, safety gates are closed, and from 90,000 to 100,000 volts are impressed on the insulators for five to seven minutes. If any one of the insulators fails, this is quickly shown by a current flow across a spark gap above that particular insulator. During the testing there is continual sparking about the insulators which causes a rather deafening noise. The workmen are exposed to the gases mainly while the test is in progress, after the test when the insulators are being removed, and while a new supply is being prepared for testing.

Oxides of Nitrogen.—Samples of the gases were taken during testing periods in one-liter evacuated sample tubes, and several additional samples were obtained by aspirating five liters of the gas during testing through dilute caustic potash solutions. These were tested for oxides of nitrogen by the diphenolsulphonic acid method.

Ozone.—Five-liter samples of the gas were aspirated through potassium iodide, and analyzed by the method of titrating both the iodine liberated and the KOH formed.

The quantity of oxides of nitrogen was never greater than 0.2 part per million, the limit of accuracy for the method. It is doubtful whether any oxides of nitrogen were present at all. If they were present, even in amounts several times that shown by the tests, these would still be well within the safety limit, because Lehman found that as high as 39 parts per million of oxides of nitrogen can be tolerated by many individuals for many hours; 78 parts can be borne for only a half hour, while 117 to 156 parts are directly dangerous.

For ozone, the maximum concentration will be noted as 10 parts per million, and then only when the samples were taken directly over the rack during testing, when the maximum quantity of ozone was being liberated. A sample taken on the windward side over the rack showed only 2 parts per million. When the insulator tests are completed the concentration falls quickly as shown by the disappearance of odor.

There is some question as to the physiological effects of ozone in concentrations such as found in these tests. Some tests

Let an Experienced Newspaper Man Show You How to Break Into the Newspaper Field



NEWSPAPER work offers countless opportunities for the young man or the young woman who really wants to amount to something. The history of Journalism shows innumerable instances where bright young reporters have been graduated from newspaper staffs to high places in the industrial and political world. Ex-President Harding was an old newspaper man. Thomas W. Lamont, one of the senior partners of J. P. Morgan & Company, was a reporter on the New York Tribune. Senator Walter E. Edge of New Jersey was, and is, an editor; so is ex-Senator James K. Vardaman of Mississippi. Augustus Thomas, America's foremost playwright, was a reporter on the St. Louis Post Dispatch. Arthur Hopkins and Brock Pemberton, theatrical producers, were newspapermen. Arthur Woods, ex-police commissioner of New York, was a reporter. Newspaper work, in itself, is a field that offers unlimited opportunity—and it often leads to better things.

FASCINATING WORK

Salaries of \$40 to \$125 a week

There isn't any profession that offers the thrill that Journalism does and there is always room for a live, wide awake young fellow in this exciting field. Regular Reporters earn from \$10 to \$125 a week. Good deskmen on a daily paper are paid from \$60 to \$100 a week. A "Star" Reporter can command his own salary.

Part Time If You Prefer

Hundreds of ambitious men and women make extra money by corresponding for newspapers or writing for magazines in their spare time. Many of the most successful reporters of today started in this way. If you have the ability to write, there is always a market for your efforts.

We Will Teach You Journalism At Home

Henry J. Brockmeyer, Assistant City Editor of the New York Evening Post, will give you a thorough training in Journalism in six short easy lessons. Mr. Brockmeyer is well qualified to teach you. He has trained hundreds of men and women, many of whom have, under his guidance, developed into front rank reporters or feature writers.

Mr. Brockmeyer's course in Practical Journalism will teach you what it would take months of actual newspaper work to learn. The course is complete, authoritative, easy to understand. In it Mr. Brockmeyer has incorporated everything that his long experience of over thirty years in the newspaper field has taught him. It shows not only the way a newspaper is run, giving a detailed explanation of the reportorial and administrative staffs, with the duties of each, but it trains the student in every phase of Journalism, instructing him how to develop a "nose for news", how to write, how to prepare his copy and edit it for publication and drills into him the development of style, with countless references and actual examples.

The complete course comprises six comprehensive lessons just brimful of everything a reporter or correspondent must learn. And it's all interesting reading—more fascinating than any novel. You won't want to stop studying once you start.

Five Days Trial

To actually prove to you the merits of the course we will send it to you on five days' trial. If at the end of that time you do not feel that you have received more than your ten dollars' worth (the price of the complete course is only \$10) you may return it to us at our expense and your money will be immediately refunded. We won't even ask you for an explanation—we guarantee to refund your money in full within twenty-four hours after receiving the lessons back.

Just pin a check, money order or ten dollar bill to the coupon below and mail it to us. Then take five days after the course arrives to decide whether you want to keep it or not. You, alone, will be the judge. We know that you will find the course worth many times its price.

THE PRESS GUILD, Inc., 66-B-W. B'way, N. Y.

THE PRESS GUILD, Inc., 66-B West Broadway, New York City.

Enclosed find \$10 for which you are to ship me at once, prepaid, Henry J. Brockmeyer's complete course in Practical Journalism with the distinct understanding that if I return the course in five days my full \$10 will be refunded and no questions asked.

(Name)
 (Address)
 (City) (State)

THESE DEALERS CARRY

"Consolidated" | E.I. Company

Patterns | and | 25c. Books

See Full Page Ads on Pages 570 and 576

Abilene, Kans. Union Elec. Co.
 Albany, Ga. Lonsbergs Book House
 Akron, O. Radbort Supply Co.
 Albany, N. Y. Havens Elec. Co.
 Lefflon Service Supply Co
 Cooper & Hotchkiss
 Kimball Bros.
 Peoples Radio Store
 Standard Elec. Co.
 Wanger Bros.
 Amsterdam, N. Y. Anderson Elec. Co.
 Allentown, Pa. Hess Bros.
 Buchanan Book Store
 Altoona, Pa. Altoona Elec. Supply Co.
 Anthony, Kans. Lefflon Highbanks Rad. Co.
 Astoria, L. I. Astoria Radio Shop
 Atchison, Kans. Low & Blythe Co.
 Atlanta, Ga. Capital Elec. Co.
 Millers Book Store
 Atlantic City, N. J. Paramount Radio Co.
 Eastern Hdwe. & Sup. Co.
 Sport Shop
 Just Elec. Co.
 Sea Coast Radio Co.
 Auburn, Me. G. L. Pons
 Baltimore, Md. Jos. A. Becker
 Jos. M. Zamoiski
 Wilbur Elec. Co.
 Barbara's Razin Co.
 W. W. Hentzehl
 S. B. Berkowich
 Joel Gutman
 Herdas Elec.
 Little Jones Dept. Store
 C. D. Kellert
 J. Meyer
 Murdoch Co.
 E. I. Rosenfeld & Co.
 Batavia, N. Y. H. F. Smith
 Bethlehem, Pa. Lehigh Radio Co.
 Billings, Mont. Targerson Bros.
 Birmingham, Ala. Interstate Elec. Co.
 Bluefield, W. Va. Burgess Elec. Co.
 Boston, Mass. Atlantic Radio Co.
 Cutter & Wood Supply Co.
 Seth Fuller Co.
 International Radio Corp.
 Lewis Elec. Supply
 F. D. Pitts Co.
 Williams Book Stores
 J. B. Hunter & Co.
 James H. Jones, Inc.
 Samuel J. Berkwith
 Chandler & Farguhar Co.
 A. P. Merchant Co.
 Eugene Proctor Co., Inc.
 Radio Sales & Service Co.
 Farrington & Clark
 Herman Radio
 Bridgeport, Conn. Merison Radio-Phone Parts
 Flynn & Power
 Conn. Radio Supply Co.
 Brooklyn, N. Y. Ekllyn Radio Serv. Co.
 O. Olsen
 Toller Elec. Co.
 Ekllyn Radio Center
 Robs Radio Service
 Bklyn Elec. Lamm & Nov.
 Globe Radio & Bat. Shop
 Haug & Vinco Co.
 G. Kleinteleh
 C. G. Rosewall
 J. Street
 Denmark
 American Phon. Exch.
 Arlington Radio Service
 Barneys Radio Shop
 Reno Elec. Co.
 J. D. Cunningham
 Delta Elec. Co.
 H. A. Dietz
 Duckmans Music Store
 Kelley & Feist
 Halpern Elec. Co.
 Kensington Radio
 E. C. & H. B. Lagerholm
 G. Moskowitz
 G. Scharff Sons

H. Schur & Son
 Victor Radio Sport Shop
 Walker Elec. Co.
 Breuer Bros.
 20th Century Radio Co.
 M. Ulrich
 R. Haupt
 David M. Isaac
 Star Radio
 Buffalo, N. Y. McCarthy Bros. & Ford
 Robertson Cataract
 O. Ulrich Co.
 Burlington, N. J. Burlington Elec. Co.
 C. H. Monte
 Montana Elec. Co.
 Cambridge, Mass. Clapp-Eastman Co.
 University Book Store
 Canton, Ill. Frank White & Bros.
 Camden, N. J. Neisner Bros.
 Carrollton, Mo. Carrollton Radio Shop
 Centerville, Ia. H. E. Lathie
 Champagne, Ill. H. C. Starnell & Son
 Charlestown, W. Va. John R. Koch
 Charlestown, S. Car. S. C. Radio Shop
 Charlotte, N. C. Smith Neavoy Elec. Co.
 Carolina Radio Co.
 Chester, Pa. Neisner Bros.
 Chicago, Ill. Harry Alter & Co.
 Barawk Co.
 Beckley-Ralston Co.
 Chicago Radio App. Co.
 Elec. Appliance Co.
 Inland Elec. Co.
 Marshall-Field & Co.
 A. C. McClurg & Co.
 Montgomery Ward & Co.
 Newark Elec. Co.
 Henry Paulson & Co.
 Sears-Roebuck & Co.
 Chicago Cut Rate Book
 Community Book Store
 Jenstark Radio Co.
 Pollett Book Co.
 McArthur Elec. Co.
 P. O. News Co.
 Max Stein
 E. J. Stringos
 Fireside Radio Co.
 Cincinnati, O. Midwest Radio Co.
 Minor Elec. Co.
 Reuter Elec. Co.
 Cleveland, O. Radio Electric Shop
 Radio Eng. & Sales Co.
 H. Lesser & Co.
 O'Brien & Schroeder
 Radio Sales & Rep. Co.
 Columbus, O. Hall Elec. Co.
 Coraopolis, Pa. T. C. O'Donovan
 Cumberland, Md. J. A. Patten & Co.
 Dallas, Texas Huey & Philip Hdwe. Co.
 Southwest Radio Sup. Co.
 Radio Equip. Co.
 Denton, Tex. Evers Hdwe. Co.
 Denver, Colo. Electrical Auto App. Co.
 Peatt Book Store
 Reynolds Radio Co.
 Des Moines, Ia. H. W. King
 Iowa Radio Co.
 Detroit, Mich. Federal Elec. Supply Co.
 Twentieth Century Radio Co.
 Crowley Miller Co.
 McChulay Bros.
 Detroit Elec. Co.
 Wolverine Radio Co.
 Northwestern Radio Co.
 Duluth, Minn. Kelley Duluth Co.
 Easton, Pa. F. & W. Grand Stores
 E. Drange, N. J. Essex Radio Shop
 United Radio & Sport Shop
 Elizabeth, N. J. H. Richmond & Son
 Elizabeth Elec. Sup. Co.

Eureka, Ill. Kham Radio Co.
 Fergus Falls, Minn. Grand & Sether
 Far Rockaway, L. I. Dunlap Spts. Goods Co.
 Selenfile Radio Co., Inc.
 Flushing, L. I. The Electric Shop
 Ft. Worth, Tex. H. C. Mearham Co.
 Galveston, Tex. Galveston Wireless Sup. Co.
 Gardner, Mass. Gardner Hdwe. Co.
 Gloucester, N. J. Lemm's Variety Store
 Granite City, Ill. Rosenberg Dept. Store
 Great Bend, Kans. Great Bend Radio Co.
 Greensburg, Pa. E. Hamilton
 Hamilton, O. Radio Co.
 Hartford, Conn. Elec. Sup. & Equip. Co.
 F. & W. Grand Stores
 G. Fox & Co.
 Havana, Cuba Diamond News Co.
 Litteria de Jose Albello
 Helena, Mont. Van Blaricom Co.
 Hoboken, N. J. International Book Store
 Hoagans Radio Co.
 Holyoke, Mass. Haskell Elec. Co.
 Independence, Mo. The Melodian Co.
 Hackensack, N. J. Wurtz & Fields
 Jacksonville, Fla. Southern Elec. Co.
 Holt Elec. Co.
 Jamestown, N. Y. Willis Switch & Inst. Co.
 Jamaica Plain, Mass. Conrad Radio Co.
 Jamaica, L. I. Scientific Radio Co., Inc.
 Merrick Elec. Co.
 Jersey City, N. J. Arrow Elec. Co.
 M. Schlein
 Guarantee Elec. Co.
 Johnson City, Tenn. Bishop Elec. Co.
 Johnstown, Pa. W. T. Grant Co.
 Joliet, Ill. Joliet Book & Sta. Co.
 Kansas City, Mo. Vulcanizers Supply Co.
 Donaldson Radio Co.
 Lancaster, Pa. Radio Outfit & Sup. Co.
 Lawrence, Mass. Schwarzenberg, W.
 Leo L. Meisberg
 Los Angeles, Cal. S. California Elec. Co.
 West Radio Elec. Co.
 Radio Concert & Equip.
 Nattlek Book Store
 Broad Elec. Co.
 Lewiston, Montana Chas. Williams
 Lock Haven, Pa. Burkett Bros.
 Louisville, Ky. Sutcliffe Co.
 Lowell, Mass. G. A. Hill Co.
 Lyons, Kans. R. L. Case
 Macon, Ga. J. W. Burke Co.
 Memphis, Tenn. Street Elec. Co.
 McKeesport, Pa. F. C. Wampler & Son
 Milwaukee, Wis. Julius Andrae & Co.
 Dewey Sport Goods Co.
 Badger Radio Co.
 Minneapolis, Minn. Jaosh Andressen Co.
 Findley Elec. Sup. Co.
 Nasell Hdwe. Co.
 Reinhard Bros. Co., Inc.
 Sterling Elec. Co.
 Peerless Elec. Co.
 Missoula, Mont. Missoula Elec. Sup. Co.
 Montgomery, Ala. Alabama Radio Mfg. Co.
 R. P. Reeves

Nashville, Tenn. Zilbert Bros.
 Newark, N. J. Hamberger & Co.
 Bassett Radio Sup. Co.
 Davis Elec. Co.
 Ediles Wireless Ex.
 Bannister & Pollard
 Easton Mfg. Co.
 W. T. Grand Co.
 United Elec. Sup. Co.
 Friedmann Music Shop
 Mt. Vernon, N. Y. Stephens Shop
 New Brunswick, N. J. Schneider Bros.
 The Elec. Shop
 New Orleans, La. Interstate Elec. Co.
 Newport, R. I. Geo. H. Chase
 New Haven, Conn. W. W. Gale & Co.
 New York City Penn & Co.
 Frank Radio Co.
 Fremont Radio Co.
 J. J. Kelleher
 David Killoch & Co.
 Radio Radio Co.
 R. H. Macy & Co.
 Chamberlain Elec. Sup.
 Overland Radio & Equip Co.
 Peerless Light Co.
 Radio Specialty Co.
 Stanley & Patterson
 Viking Radio Co.
 The Winchester Store
 Army & Navy Dist. Co.
 Chamberlain Elec. Co.
 Economy Radio
 Elec. Service Eng. Co.
 Goldfinger Bros.
 Gluebel Bros.
 R. G. Haslinger
 Herbert & Huesgen
 Allied Radio Co.
 J. H. Bunnell & Co.
 Butler Bros.
 Carnahan & Dalzell, Inc.
 Bway. Radio Corp.
 P. M. Dreyfuss Co., Inc.
 Delta Elec. Co.
 Portland Radio Spec. Co.
 F. & W. Grand Stores
 J. L. Lewis & Co.
 Lowe Motor Sup. Co.
 Iova Radio Stores
 Live Wire Elec. Co.
 Marks Radio
 Models—8 Stores
 Phillips Sport Shop
 Philadelphia, Pa. A. & A. Elec. Co.
 Acme Radio Co.
 Ann. Elec. Tech. App.
 Atlas Elec. Supply Co.
 Atlas Radio Co.
 Bergmaier Bros.
 Franklin Radio Shop
 J. Gabler
 Globe Radio Shop
 Hygrade Elec. Co.
 International Radio Store
 J. Kelleher
 Marlen Hdwe. Co.
 Nassau Radio Co.
 Times Sq. Auto Sup. Co.
 Triguers
 Ace Elec. Co.
 A. & P. Radio Co.
 Baker & Taylor Co.
 Borough Elec. Co.
 Combia Elec. Co.
 J. Buelsen
 Keystone Battery Service
 S. S. Kresge & Co.
 Lanagers Radio Store
 A. Marcus
 G. H. Masten & Co.
 Mentz Store
 Millbro Radio & Elec. Co.
 Radio & Merch. Trad. Corp.
 Radio Parlor
 Radiohome Equip. Co.
 New Eng. Elec. Spec. Co.
 Rialto Elec. Shop
 St. Marks Radio Co.
 K. R. Schuilstron
 F. E. Silverman
 Woolter
 M. Workman
 Perfection Radio
 Cortland Radio
 James Gear
 A. J. Goldman

W. Eaton & Co.
 Cross Radio Co.
 Progressive Book Store
 S. Astor
 M. & T. Elec. Co.
 Borough Elec. Co.
 Marvel Elec. Sup. Co.
 O. R. B.
 A. E. Zimmerman
 Sam Astor
 Davidson Radio Co.
 Van Auto Supply Co.
 Mogul Elec. Co.
 Brunswick Supply Co.
 Stuyvesant Radio Co.
 Oscars Radio
 Fordham Sup. Co.
 Int. News Co.
 M. H. Elec. Co.
 The Heights Radio Sup. Co.
 Echipse Elec. Co.
 Fordham Radio Co.
 Crescent Radio Co.
 Terminal Rad. & Mus. Shop
 United Anchor Tire Co.
 Inter City Radio Co.
 Josephson
 Redifon Corp.
 Greenwich Radio Co.
 H. Goldstein
 Isador Pajinas, Inc.
 Grand Radio
 M. Rubin
 Hannes & Co.
 Madison Hdwe. Store
 American Radio Co.
 Electrical Eng. & Con. Co.
 Niagara Falls, N. Y. H. Messersmith & Sons
 Norristown, Pa. E. M. Law
 Oakland, Cal. E. M. Sargent Co.
 Omaha, Nebr. Wolfe Elec. Co.
 Onset, Mass. W. C. Spring
 Passaic, N. J. J. L. David
 Simon Bros.
 Passaic Radio Shop
 Perth Amboy, N. J. Smerling, J.
 Amboy Lighting Co.
 Amboy Radio
 Paterson, N. J. Federal Radio & Elec. Co.
 Pawtucket, R. I. Debaney Feltch & Co.
 Peoria, Ill. Peoria News Stand
 Philadelphia, Pa. Gluebel Bros.
 H. C. Roberts El. Sup. Co.
 Sayre Level Radio Co.
 Goetz Music Stores
 F. & W. Grand Stores
 E. P. Noll & Co.
 G. W. Snell Co.
 Neisner Bros.
 Schimmel Elec. Co.
 Radio Sales Co.
 John Wanamaker
 Phoenix, Ariz. Nielson Radio Sup. Co.
 Poughkeepsie, N. Y. C. E. Raymond
 Pittsburgh, Pa. Goldsmith & Son Co.
 Ludwig Hommel & Co.
 Gain-a-Day Elec. Co.
 Liberty Incan. Sup. Co.
 Pitus Radio & App. Co.
 U. S. Radio Co. of Pa.
 Doubleday Hill Co.
 Pittsfield, Mass. W. T. Grant Co.
 Plainfield, N. J. H. E. Gayle Hdwe. Co.
 Plattsburgh, N. Y. H. E. Atwater
 Portland, Me. Chisholm Bros.
 Portland, Ore. E. L. Knight Co.
 Hynson Elec. Co.
 Hylands Oil Book Store
 Pottstown, Pa. Pottstown Radio Sup. Co.
 Princeton, N. J. Princeton Cycle Shop
 Providence, R. I. B. & H. Supply Co.
 The Shepard Co.

R. I. Elec. Equip.
 The Outlet Co.
 Boston Store
 Reading, Pa. F. & W. Grand Stores
 Rochester, N. Y. Hickson Elec. Co.
 Rochester Elec. Sup. Co.
 Wheeler Green El. Sup. Co.
 Eastern Radio Co.
 R. Schmidt & Co.
 E. C. Skyes & Co.
 Neisner Bros.
 Miller Drug & Elec. Co.
 Ridgewood, L. I. Ridgewood Radio Shop
 Rock Island, Ill. H. E. Gollart & Co.
 Boardley Specialty Co.
 Vaile Co.
 St. Joseph, Mo. Empire Elec. Co.
 Mannsbroeks Book Stores
 St. Louis, Mo. The Benwood Co.
 Linze Elec. Supply Co.
 Foster Book & Cigar Co.
 St. Paul, Minn. North-West Elec. Eq. Co.
 Premier Radio Mfg. Co.
 Pioneer Elec. Co.
 St. Paul Book & Sta. Co.
 Crest Book Shop
 San Francisco, Cal. Hecht, Grand
 Schenectady, N. Y. Albany St. Radio Store
 Seattle, Wash. F. B. Wilson
 Stamford, Conn. Athora
 Stillwater, Okla. Stillwater Elec. Shop
 Syracuse, N. Y. Grant's Alexander Sons
 Hughes Radio Corp.
 M. H. Salmon Elec. Co.
 Toledo, O. Kuebler Radio Co.
 W. J. Nagel Elec. Co.
 Trenton, N. J. Fleorn & Son, Inc.
 Radio Chain Stores
 Troy, N. Y. L. H. Cooney & Son
 Tyler, Tex. R. E. Bryan
 Union Hill, N. J. N. W. Friedman
 Uniontown, Pa. Frederick Piano Co., W. F.
 Utica, N. Y. Dent. Co., M. F.
 Olds Book Store
 Utica Elec. App. Co.
 Utica Elec. Sup. Co., Inc.
 Waco, Tex. Jackson's Radio Eng. Lab.
 Washington, D. C. Continental Elec. & Sup. Co.
 Radio Auto Sup. Co.
 Warrertown, Wis. D. & F. Kusel Co.
 Watertown, N. Y. F. A. Empsall & Co.
 W. Hoboken, N. J. The Heron Exchange
 W. New York, N. J. W. N. Y. Heron
 Wheeling, W. Va. Gee Electric Co.
 Wapakoneta, Ohio Helne & Nagel Elec. Co.
 Waunaca, Wis. Waunaca Radio Sales Co.
 Wausau, Wis. Janke, Korh Co.
 Wilkes-Barre, Pa. Foster Radio & Elec. Co.
 Wilmington, Del. J. P. Moore
 Wilmington Elec. Spec. Co.
 Worcester, Mass. Neisner Bros.
 Williamsport, Pa. Wilhelm Book Store
 Yonkers, N. Y. Knepper, F.
 Westchester Elec. Eq. Co.
 York, Nebr. Bullocks
 Youngstown, Ohio Robert F. Phillips



Order direct from these dealers. If your dealer cannot supply you, send us his name and address

233 Fulton Street, New York City

Publishers of Consolidated Patterns
 Sales Agents for E. I. Co. Books

RADIO CATALOG
CONTAINING
LATEST HOOK - UPS
14 Up-to-Date Hook-ups and List of
STANDARD QUALITY PARTS
AT REDUCED PRICES
SEND 10c. TO COVER COST OF MAILING
SERVICE AND QUALITY GOODS
BUILT THIS HOUSE
GREAT LAKES RADIO CO.
136 W. LAKE ST., Dept. X, CHICAGO, ILL.

CATALOG E19-112
PAGES FREE
EVERYTHING IN RADIO
One of the largest complete stocks in the world. 40 diagrams of latest Hookups.
DEALERS ALL OVER THE U.S.
Making big profits handling our supplies. 24-hour service. Goods shipped same day order received.

AMERICAN RADIO Mfg Co
QUALITY AND SERVICE
WHOLESALE RADIO DISTRIBUTORS
Dept. Q 107 E. 13th St. Kansas City, Mo.

INVISIBLE AERIALS
for better reception
Many Special Features
Special invisible alloy bronze wire that cannot be seen 20 feet away.
Ten times stronger than copper.
Will not corrode, nor snap.
Excellent for use as indoor aerials, assuring better reception of signals. Comes in rolls of 150 feet.
Sent Prepaid to any address in \$1.00
U. S. or Canada upon receipt of
A. B. C. LABORATORIES
100 Lawrence St. (West 126th St.) New York City

Don't let exaggerated stories of summer "static" keep you from enjoying Radio. On most summer nights receiving is as good as at any time of the year—if it's **SIGNAL** apparatus.
Send for catalog.
SIGNAL ELECTRIC MFG. CO., 1923 Broadway, Menominee, Mich.

YOU DON'T NEED Tubes to get out of town. Even in the summer I hear Omaha, Kansas City, Fort Worth and Davenport on my crystal set without amplification. Works over 1,000 miles in winter. Send self-addressed envelope for further information or \$1.00 for complete copyrighted drawings and instructions. Everything clearly explained. Satisfaction GUARANTEED.
Leon Lambert, 543 South Volusia, Wichita, Kan.
\$27.50 Brings You a Genuine
100 R3 MAGNAVOX
EASTERN RADIO EQUIPMENT COMPANY
2013 Boston Road New York City

"B" BATTERIES
Depleted "B" Batteries are usually the cause of your troubles in receiving. Eliminate it! Buy your "B" Batteries fresh tested from our Laboratories, guaranteed in every respect to be equal to any standard make.

	Large	Medium	Small
22½ Volt plain	\$1.25	\$1.00	\$0.70
22½ Volt variable	\$1.38	\$1.13	\$0.75
45 Volt plain	\$2.50	\$1.75	—
45 Volt variable	\$2.75	\$2.00	—

Any other type of battery made to order—send Money Order (include postage) or order for C. O. D.
With any order for \$5.00 of batteries we will send you a standard voltmeter 0-50 Volt, listed at \$2.75, for \$1.87.
ROSENDAL & CO., 2 Stone Street, New York

reported by Hill and Aeberly may be of interest. They found, using a testing chamber, that 3 parts per million in normal air caused smarting of the eyes and nose, and finally a coughing spell, which compelled the subject to leave the chamber after 10 minutes' exposure. In another test, a subject remained for 12 minutes in the chamber containing from 3 to 6 parts per million. Operating a pump for taking samples caused frequent coughing, which continued for some time after leaving the chamber. No lasting ill effects were experienced after the immediate effects had disappeared. In conclusion, they state that 6 parts per million causes coughing after moderate exercise. Jordan and Carlson found that 10 parts per million for a 15-minute exposure caused sore throat, and that exposure for two hours to 20 parts (Hill and Flack) may prove fatal.

No mention is made by Hill and Aeberly of any serious after-effects resulting from exposure to ozone in concentrations of 10 parts per million or less.

Hindoos Using More Electricity

A RAPID increase is reported in municipal installations in small towns of Madras Presidency, India. General increases in the use of electricity throughout this presidency are shown by the last report of the electrical engineer to the Madras Government reviewing the Administration of the Indian Electricity Act of 1922, says Consul H. A. Doolittle in a report to the U. S. Department of Commerce. The number of both private and municipal installations in the smaller towns is rapidly growing and a greater interest is being shown in electrical projects in all areas. The superiority of electric fans to the hand-pulled punkah and of electric lights to coconut oil lamps in the hot, humid climate of India is rapidly overcoming the conservatism of India, which has operated against the adoption of these modern improvements.

At the end of the fiscal year 1922 there were 169 private installations in Madras City, 76 in outside districts, and 20 municipal electric plants. There were also 138 privately-owned power stations in operation. This is an increase of some 125 plants over the number in operation in 1918 and 1919.

New Power Station for Johannesburg, Africa

RECOMMENDATIONS contained in the report of the independent consulting engineers, appointed to investigate the question of Johannesburg's electric power needs, indicate the possibility of a 10,000-kilowatt generating set being installed within the next two years. A further installation involving two 10,000-kilowatt sets is contemplated between 1925 and 1927, Consul G. K. Donald, Johannesburg, reports to the Department of Commerce.



Take This Short Cut to Accomplish Your Ambition

The field of electrical engineering offers wonderful opportunities for trained men to direct and carry out great industrial and commercial projects. Get a thorough and practical training here in our course of

ELECTRICAL ENGINEERING
with B. S. Degree in 3 years

A faculty of specialists is leading hundreds of ambitious young men to sure success. Why not you? If you are lacking some preparatory studies you can make them up here as you go along. This is an exceptional opportunity to become an electrical engineer in the shortest possible time.

ELECTROTECHNICS

From 1 to 2 years in this course makes you a completely trained electrotechnician—prepared to fill such positions as general plant superintendent, director of construction, superintendent of maintenance, chief draftsman, etc. The Electrotechnician is the man between the Electrical Engineer and the Electrician—a well paid position and a stepping stone to higher executive work. A grade school diploma or equivalent admits you without examination. New term opens every 6 weeks.

COMMERCIAL ELECTRICAL ENGINEERING
in 1 Year

Unparalleled opportunities for brilliant, successful careers in the new field of Commercial Electrical Engineering. To meet the extraordinary present-day demand for trained electrical business men, consulting and efficiency engineers, we offer this thorough, condensed and very practical training, especially adapted to high school graduates.

PRACTICAL ELECTRICITY

In this complete 6 months' Electrical Course—8 hours daily—you can learn house, factory and theatre wiring, testing and meter work, A.C. and D.C. Armature Winding and all necessary mathematics.

A 3 months' course in A.C. and D.C. Armature Winding, or a 3 months' Course in Light and Motor Wiring and Testing is offered to those with limited time and means.

AUTOMOTIVE ELECTRICITY

Electrical specialists who instinctively diagnose and locate automotive electrical troubles command high positions and are well paid. Specialize in starting, lighting, ignition and storage batteries and command a big job at a big salary.

"EARN WHILE YOU LEARN"

We agree to provide, for a limited number of worthy young men, half-time jobs at good wages, and permanent positions with unlimited prospects to all duly qualified graduates. Here is the opportunity of your life to acquire a thorough, practical training for big-paying profession that is in urgent need for trained men.

ESTABLISHED 17 YEARS AGO

The S. of E. stands absolutely alone in the field of thorough, practical electrical education and in commercial and electrical engineering.

NO NEED OF YOUR BEING WITHOUT AN S. OF E. TRAINING

It does not matter how old you are or what schooling you have had. Students from 16 years up to 50 are in attendance here.

Fill out the following coupon and mail it to-day.

SCHOOL of ENGINEERING of Milwaukee

SCHOOL OF ENGINEERING OF MILWAUKEE
P.E.-10, 415-17 Marshall Street, Milwaukee, Wis.

Without obligating me in any way, please mail free 72-page illustrated book "Electricity and the One Best Way to Learn It" and particulars regarding the course I have marked with an X.

- Electrical Engineering.
- Electrotechnics.
- Commercial Electrical Engineering.
- Automotive Electricity.
- Armature Winding.
- Light, Motor Wiring and Testing.
- Practical Electricity.
- I am interested in your "Earn While You Learn" Plan.

Name Age

Address

City State

Education

OPPORTUNITY AD-LETS

You can place your ad in these columns for only 4c a word. It will pay you to read and investigate the offerings made from month to month in these columns, by reliable firms, dealers and individuals from all over the country. You are reading them now—others will read yours. Ad-lets for the December issue must reach us not later than October 20th.

The Circulation of Practical Electricians is more than 55,000

Practical Electricians Company, Inc., 53 Park Place, New York, N. Y.

Agents Wanted

Sell Madison "Better Made" Shirts direct from our factory to wearer. No capital or experience required. Easily sold. Big profits. Write for Free Samples. Madison Mills, 503 Broadway, New York.

We Want Salesmen and Agents, either whole or side line, to sell our low priced radio books to the trade. Excellent proposition for live wires. The E. I. Company, Publishers, 233 Fulton St., New York City.

Big Money and Fast Sales.—Every owner buys Gold Initials for his auto. You charge \$1.50; make \$1.35. Ten orders daily easy. Write for particulars and free samples. American Monogram Co., Dept. 226, East Orange, N. J.

Books

Diseases and Their Innate Healer. Book 25c. A. J. Stevens, Wauseon, Ohio.

Diseases and Their Innate Healer. Treats on anemia, apoplexy, appendicitis, asthma, bronchitis, cankers, constipation, consumption, convulsions, debility, gallstones, headache. Book 25c. A. J. Stevens, Wauseon, Ohio.

Send for New Illustrated Catalog of Books on Mechanical Subjects Free. Spon & Chamberlain, 122 E. Liberty St., New York.

"Lights, Colors, Tones and Nature's Finer Forces," including Vibrations; Electromagnets; Odic-auras; Radio; Coldlights; Coming Inventions; Marvelous opportunities; 260 pages; Satisfaction Guaranteed; \$2.00; Table Contents Free. P. E. Stevens, Publisher, 242 Powell, San Francisco.

The Amateur Electrician explains "The How and Why" of Electricity with plans for making and Operating Wireless, Telephones, Electric Bells, Toys, Novelties, etc.; over 70 illustrations; 64 pages only 10c. Chemical wonders, secrets and mysteries fully explained, only 10c. Catalog 2c. Henry E. Collins Co., 197 Fulton Street, Brooklyn, N. Y.

Experimental Electricity Course in 20 Lessons. By S. Gernsback and H. W. Secor, E.E. A course of the theory and practice of Electricity for the Experimenter. Every phase of experimental electricity is treated comprehensively in plain English. New experiments are described and explained, and nearly every application of Electricity in modern life is given. 160 pages—400 illustrations. Flexible cloth cover, 75c postpaid. Stiff cloth cover, \$1.25 postpaid. Experimenter Publishing Co., Book Dept., 53 Park Place, New York City.

The How and Why of Radio Apparatus, by H. W. Secor, E.E. This newest book on radio matters fulfills a distinct gap in wireless literature in that, while the treatment is made as understandable and as free from mathematics as possible, it at the same time incorporates a wealth of technique and instruction for the Radio Amateur—the Radio Operator—the Installation and Designing Expert—as well as teachers and students of the subject in general. A very broad field has been covered by the author, at the same time giving a great deal of information not found in other text books. If you are engaged in any branch of the Radio or allied arts at all, you will surely need this latest contribution to radio literature, which is destined to be found on every radio man's book shelf before long. A glance at the following list of chapters gives but a very scant idea of the extensive and useful radio knowledge provided in its text: The Induction Coil; The Alternating Current Transformer; Radio Transmitting Condensers; The Spark Gaps; Radio-Transmitting Inductances; Radio Receiving Tuners; Radio Receiving Condensers; Detectors; Telephone Receivers; Radio Amplifiers; Construction of a Direct Reading Wavemeter and Decimeter; Antenna Construction; The Calculation and Measurement of Inductances; Appendix containing very useful tables, covering all subjects treated in this very unusual book. This newest of Radio Works, cloth bound in Vellum de Luxe, Gold Stamped and Hand Sewed, has 160 pages. Size of book, 6x9 inches. The How and Why of Radio Apparatus. Postpaid, \$1.75. Experimenter Publishing Co., Book Dept., 53 Park Place, New York City.

For Boys

Everyboy's Magazine—Published Monthly, 35c. per year; sample copy, 4c. Sandelin Publishing House, Dept. W. Laurium, Michigan.

Business Opportunities

Sell Us Your Spare Time. You can earn Fifteen to Fifty dollars weekly writing showcards at home, no canvassing; pleasant, profitable profession, easily, quickly learned by our simple graphic block system; artistic ability unnecessary; we instruct you and supply work. Wilson Methods, Limited, Dept. J, Toronto, Canada.

Big Profits in Tire Repairing with Haywood Vulcanizing and Retreading Plants. Sold complete with full equipment, materials and Home Instruction Course at \$97.50 up. Easy payments if desired. Write quick for our big proposition. Haywood Tire Equipment Co., 1300 South Oakley, Chicago.

Be a Broker, buy and sell Currencies and Bonds, make 100 to 300% profit. Write for interesting information. George Grigoleit, 20 E. Jackson, Chicago.

Chemistry

"Popular Chemistry" magazine. "The Experimenter's Monthly." Six months' Trial—45c. B. Wright Laboratory, Caldwell, New Jersey.

Boys—A real Chemistry outfit with regular chemical apparatus, to perform fascinating chemical experiments; not a toy. Also Electric Toy outfit, complete to make over 25 different electrical apparatus. Send for descriptive literature. A. Urie, 333 W. Manhattan Blvd., Toledo, Ohio.

Learn Chemistry at Home—Dr. T. O'Connor Sloane, noted educator and scientific authority, will teach you. Our home study correspondence course is a real short cut. You can learn in half the usual time. Gives you the same education as you would get at a college or university. See our full page ads on pages 565 and 571 of this issue for special 30-day offer. Chemical Institute of New York, 66 W. Broadway, New York City.

Correspondence Courses

Degrees earned by correspondence study in Engineering, science, law, theology, medicine, etc. 700 courses. Catalog free. Oriental University, 1702 Oregon Ave., N. W., Washington, D. C.

Help Wanted

We Want Salesmen and Agents, either whole or side line, to sell our low priced radio books to the trade. Excellent proposition for live wires. The E. I. Company, Publishers, 233 Fulton St., New York City.

Make Money in spare time mailing letters. Rare opportunity now. Men send addressed envelope for special plan. Normande R., 147 W. 23d St., New York.

Detectives Earn Big Money. Excellent opportunity. Travel. Great demand everywhere. Experience unnecessary. Particulars free. Write American Detective System, 1968 Broadway, N. Y.

Stop Daily Grind. Dependable plans free. Easy silvering mirrors, tableware, headlights, etc. Clarence Sprinkle, Dept. 87, Marion, Indiana.

Languages

World-Romic System. Masterkey to All Languages. Primers, 23 languages, \$1.94 each language; Arabic, Cantonese, Danish, Dutch, English, French, German, Italian, Japanese, Latin, Polish, Portuguese, Russian, Spanish, Swedish. Pronunciation-Tables, 101 languages, 30c each language. Languages Publishing Company, 8 West 40th St., New York.

Miscellaneous

Buy Your Cigars Direct. 50 Aromor prepaid, \$1.50. Money back if dissatisfied. Agents wanted. Havana Smokehouse, Homeland, Ga.

Moon-O-Light Radium Light shines in darkness; 25c. per bottle. Gray & Bretey Co., Dept. 45, 1463 St. Lawrence Ave., Bronx, N. Y.

Spark-Plug. Cleans like a pipe, outright or royalty. Box 100, Worth, N. C.

Bicycles and Supplies, stamps, coins, curios, novelties, etc. Cheap. Send stamp for list. Ask for approvals if interested. Henry Verzke, Lindsey, Wisconsin.

For Advertisers

I Write Letters, folders, booklets, complete follow-up for manufacturers mail-order dealers. Long experience. Write for details. L. Taylor, Box 44P, Freeport, Illinois.

Advertising. One inch placed in 140 co-operative magazines; 3 months for \$5.00. Sample 10c. A. Barnes, Box E734, Helena, Ark.

For Men

Enjoy Life, Smoke "Old Field Tobacco." Sample 10c. Hast Mailing Company, Paducah, Ky.

Health

Christians Red Food Salt. Greatest Natural Aid for Nutrition, \$1, \$2 sizes. Guaranteed Vegetarian Food Co., St. Louis, Mo. Literature free.

Patent Attorneys

Patents Procured. Send sketch or model today for examination, prompt report and advice. No charge for preliminary advice. Write for free booklet and blank form on which to disclose your idea. Highest references. Promptness assured. Clarence A. O'Brien, Registered Patent Lawyer, 960 Southern Building, Washington, D. C.

Patents—Send for form "Evidence of Conception" to be signed and witnessed. Form, fee schedule, information free. Lancaster and Allwine, 288 Ouray Bldg., Washington, D. C.

H. F. Lowenstein, Registered Patent Attorney, Radio Expert, 825 McLachlen Building, Washington, D. C.

Personal

150 Funny Parodies on Latest Songs, 25c. P. Collins Co., 32 Liberty Street, Hastings, Brooklyn, N. Y.

Exchange Letters With New Friends everywhere. Pleasant pastime, particulars free. Smith, Box 1167-Y, Denver, Colorado.

Exchange Cheery Letters With New Friends. Write Betty Lee, Inc., 4254 Broadway, New York City. Stamp appreciated.

Lonesome! Make New and True Friends. Write Dolly Gray Club, Box 186N, Denver, Colorado.

Wireless

Tested Recipes. Transmitter Button Hook-Ups. Amplification. Loud Speakers. Free Circular. K Electric Co., 15 Park Row, New York City.

Radio! It's New—Panel shielding. Applied without removing instruments. Price 35c. H. & M. Specialty Co., Box 66, Brighton, Mass.

!!! Very Special Radio Sale !!! \$142.50 Westinghouse Radiola RC Radio Set, \$106.88. This set comes complete all ready to install. Your money will be refunded if you are not pleased with the set. !!! Another Big Special !!! \$55.00 Crosley Model X Radio Set, \$45.00; \$20.00 Leich Battery Charger, \$15.00; \$8.00 Radiotron UV-202 Power Bulbs, \$6.50. Dealers write for special proposition. The Cole Radio Company, Willard, Ohio.

One Thousand Agents Wanted

Whether You are Fifteen or Fifty This is a Good Proposition

We want one thousand agents to sell subscriptions to RADIO NEWS, SCIENCE and INVENTION and PRACTICAL ELECTRICIANS during their vacations. We will pay a generous commission for this work and help you in every way. Our three publications are leaders in their fields, ready sellers and this is an offer well worth your while. A few spare hours a day will bring you a handsome return. Write regarding our proposition at once and be the first one to get started in your vicinity.

Experimenter Publishing Company
HERBERT H. FOSTER, Sales Manager
53 Park Place New York

Each a Leader In Its Field



Science & Invention

Is one of the most interesting magazines published. It is more interesting than fiction.

It is profusely illustrated and covers in word and picture the latest achievements in the sciences—in Invention, Astronomy, Physics, Chemistry, Electricity, Mechanics, etc.

It has a large section devoted exclusively to Radio.

SCIENCE & INVENTION has the distinction of being more often quoted than any other magazine in the world.

More than 100 large pages—with over 300 illustrations, drawings, etc.

Special prize contests are offered each month.

On all newsstands, 25c a copy.

Subscription Prices

Science & Invention

Radio News

One Year
12 Issues
\$2.50
Each

(Add 50c to the cost of each magazine for Canada or Foreign)



Radio News

"The 100 Per Cent Wireless Magazine"

The Largest Radio Magazine in the World is read by more than a million Radio enthusiasts each month.

Its position as the leader of all Radio publications is universally recognized by dealers, radio manufacturers and every branch of the radio industry and its pages reflect their confidence.

RADIO NEWS contains more articles by Radio Experts—more specific information—detailed drawings—illustrations and news—than is published in any other magazine.

More than 200 large pages monthly. Profusely illustrated.

On all newsstands, 25c a copy.

You can easily earn any of the premiums shown on this page, in subscribing for one of our magazines. The articles given away as Rewards are absolutely free and will be sent to you postpaid. Other premiums are shown in the New Premium List just off the press. A copy of this list will be sent to you free if you ask for it.

For Descriptive Details of Rewards See our Premium Catalog which is forwarded free of cost on receipt of your Postal Card to our Premium Dept.
Experimenter Publishing Co., Inc., 53 Park Place, New York, N. Y.

NEW 25c BOOKS

That Every Novice or Amateur Needs

100 Radio Hook-ups

By M. L. MUHLEMAN

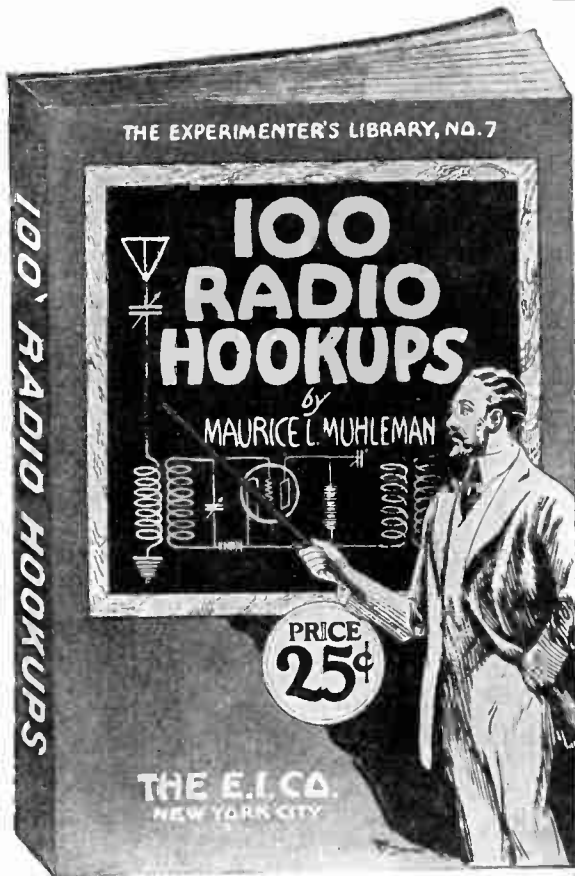

A book for both the novice and advanced radio amateur containing a varied selection of hook-ups from the simple crystal to the more elaborate circuits, with a circuit for every requirement. Crystal hook-ups, combined crystal with radio and audio frequency amplifiers, non-regenerative, and regenerative vacuum tube circuits with and without radio and audio amplifiers. Amplifier units, with straight jacks, filament and switching arrangements, power amplifiers, choke coil, resistance coupled and transformer coupled radio frequency amplifiers.

Includes all of the latest, one and multi-tube hook-ups including the numerous types of Reflex, super regenerative, super-Heterodyne, Neutrodyne, Reinartz, Flewelling, and Bishop. The values and constants of all apparatus employed in the hook-ups are given. A list of radio symbols is included, which are of material help to the reader in determining the meaning of the conventional hook-up diagrams. The text includes much helpful information.

52 Pages—Two-Color Cover **25c.**



This book covers in comprehensive form, the fundamental principles of tuning. The characteristics of radio waves are fully described and illustrated. Illustrations are used so that the non-technical reader can easily understand the identical actions as applied to radio. Several chapters are devoted to the use and functions of all radio apparatus. The book describes how to tune such sets as the Reinartz, Flewelling, Neutrodyne, radio frequency amplifier receivers and other.

52 pages,
25 Illustrations
Prepaid **25c**

A non-technical book for the beginner. Gives complete constructional data on the building of a complete Crystal Detector Set, Tuning Coil, Loose Coupler and a Single Audion Tube Set with Amplifying Units. It furnishes all dimensions and working drawings of every part that must be constructed by the amateur. Written in plain, simple language that anyone can understand. The opening chapter gives a complete description of the theory of radio and tells what it's all about, teaching the principles of wireless so that the constructor knows what he is doing.

48 Pages, 26 Illustrations
Bound in Beautiful Two-Color Cover. Size, 5½ x 7½ in. Prepaid **25c**

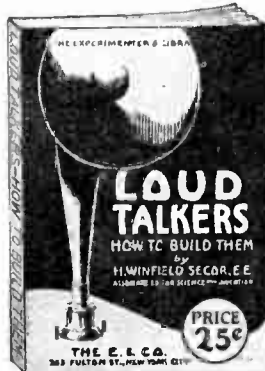
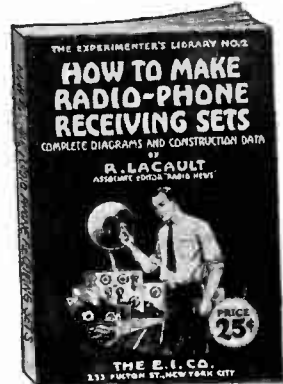

This book describes and gives complete data for building two distinct types of loud talkers. One chapter deals with improvised loud talkers, and gives complete instructions on how to build suitable horns for use in loud receivers of the Baldwin and other types. In preparing these designs, the point has been constantly kept in mind to use the simplest parts possible, so that anyone can build a successful loud talker, equivalent to the commercial types, costing \$40.00 or more.

48 pages, Profusely Illustrated
Prepaid **25c**

This book is for the more advanced amateur, showing the construction of the Radio Frequency Amplifying Transformer and giving complete constructional data. It shows the application of Radio Frequency to amplifying units that the amateur may already possess and gives 15 hook-ups showing practically every use Radio Frequency Amplifying Transformers can be put to.

32 Pages, 15 Illustrations
Bound in Beautiful Two-Color Cover. Size, 5½ x 7½ in. Prepaid **25c**

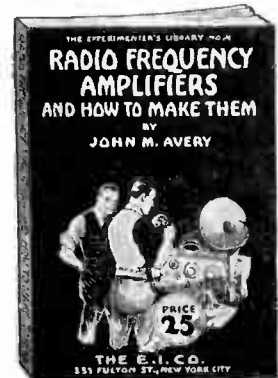

A complete list of dealers carrying these books will be found on page 572

If your dealer cannot supply you—order direct from us—giving dealer's name and address.

THE E. I. COMPANY (THE CONRAD CO.) 233 Fulton St., N. Y. City
Selling Agents

Let These Guides

Solve Your Problems

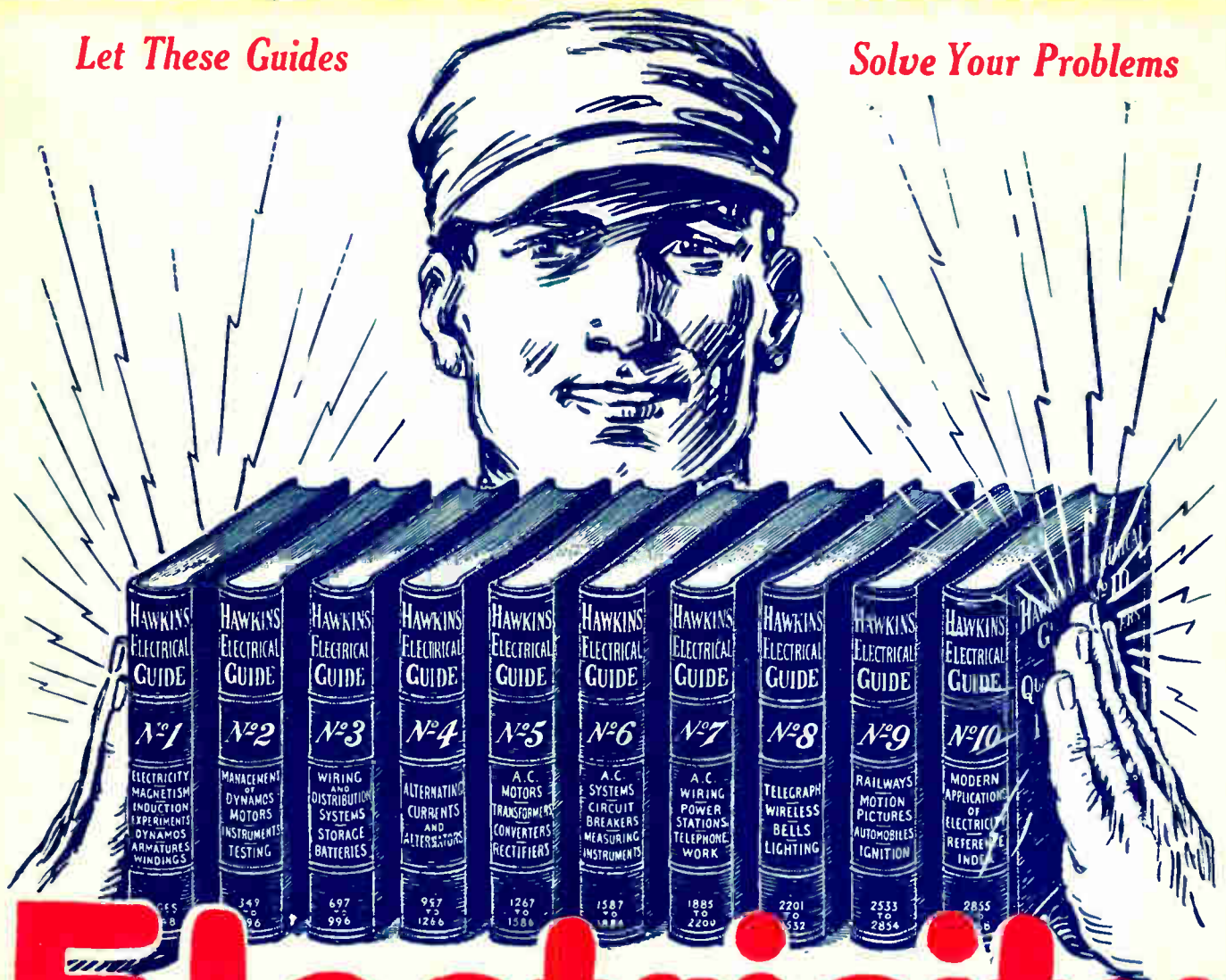

Electricity at your finger ends

HAWKINS ELECTRICAL GUIDES IN TEN VOLUMES

3500 PAGES
4700 PICTURES

\$1 A VOLUME
\$1 A MONTH

SEND NO MONEY—SEND ONLY THIS COUPON

Know the facts in Electricity. They mean more money and better position for you. Hawkins Guides tell you all you need to know about Electricity. Every important electrical subject covered so you can understand it. Easy to study and apply. A complete, practical working course, in 10 volumes. Books are pocket size; flexible covers. Order a set today to look over.

LEARN ALL ABOUT

Magnetism—Induction—Experiments—Dynamometers—Electric Machinery—Motors—Armatures—Armature Windings—Installing of Dynamometers—Electrical Instrument Testing—Practical Management of Dynamometers and Motors—Distribution Systems—Wiring—Wiring Diagrams—Sign Flashers—Storage Batteries—Principles of Alternating Currents and Alternators—Alternating Current Motors—Transformers—Converters—Rectifiers—Alternating Current Systems—Circuit Breakers—Measuring Instruments—Switchboards—Wiring—Power Stations—Installing—Telephone—Telegraph—Wireless—Bells—Lighting—Railways. Also many Modern Practical Applications of Electricity and Ready Reference Index of the ten numbers.

SHIPPED FREE

Not a cent to pay until you see the books. No obligation to buy unless you are satisfied. Send Coupon now—today—and get this great help library and see if it is not worth \$100 to you—you pay \$1.00 a month for ten months or return it.

THEO. AUDEL & CO.,
72 Fifth Ave., New York City

Please submit me for free examination, HAWKINS ELECTRICAL GUIDE (Price \$1 a number). Ship at once prepaid, the 10 numbers. If satisfactory, I agree to send you \$1 within seven days and to further mail you \$1 each month until paid.

Name

Occupation

Employed by

Home Address

Reference

P. E. Oct.

Let me Prove that I Can teach you how to dance in One Evening



If you can do the step illustrated on this page there is no reason why you cannot quickly master all of the latest dances through my new method.

Arthur Murray.

GOOD dancers always have plenty of friends and are welcomed everywhere because they add considerable to the fun of the party. You, too, can add to your popularity by quickly becoming an expert dancer through my teaching methods.

Arthur Murray guarantees to make you a fine dancer if you will carefully follow his new diagrams and simple instructions. All that you need to do is to first read over the few written instructions, then place your feet as shown in the diagrams, and take the steps as illustrated in the direction plainly pointed out by arrows. Practice the steps a few times until you have them fixed in your memory, after which there is no reason in the world why you should not be able to dance them perfectly on any floor, to any kind of music and with the best dancer in your set.

In the beginning you don't need either music or partner. You can step right into the privacy of your own room, close the door and practice all alone until you have gotten the idea. After you have this Murray foundation to your dancing you will be able to quickly master any new steps or dances just as quickly as they are invented—just as soon as you have seen a few of the steps.

Good Dancers Always Have Perfect Poise

Dancing gives poise to the carriage. It helps one overcome self-consciousness when in the presence of strangers. It teaches perfect mental and physical control—helps one

overcome timidity and awkwardness.

The way others have learned to dance you can learn. The method is so simple that it's easy for you to quickly master every dance now in vogue.

Learn From America's Foremost Dancing Instructor

Arthur Murray is recognized as

America's foremost authority on social dancing. Such people as the Vanderbilts, ex-Governor Locke Craig, of North Carolina, and scores of other

socially prominent people have chosen Mr. Murray as their dancing instructor. In fact, over ninety thousand people have learned to dance through Arthur Murray's amazing methods of teaching

—by mail—and about five thousand people a month are becoming perfect dancers through his wonderfully easy methods. The lessons have been so simplified that even a child can learn directly from them—as very many children do learn. And just as soon as you have the Murray foundation to your dancing you can quickly pick up any new dance after seeing only a few of the steps.

A Generous Limited Time Offer

Arthur Murray is so sure that you will be delighted with his methods of instructions—he is so sure that you won't have the slightest difficulty in mastering all of the steps in each dance that he is perfectly willing to send you an introductory sixteen-lesson course for your five days' free personal trial. Through these sixteen lessons you will learn the Correct Dancing Position—How to Gain Confidence—How to Follow Successfully—The Art of Making Your Feet Look Attractive—The Correct Walk in the Fox Trot—The Basic Principles in Waltzing—How to Waltz Backward—The Secret of Leading—The Chasse in the Fox Trot—The Forward Waltz Step—How to Leave One Partner to Dance with Another—How to Learn and Also Teach Your Child to Dance—What the Advanced Dancer Should Know—How to Develop Your Sense of Rhythm—Etiquette of the Ballroom. You receive all of these 16 lessons for only \$1.00.

Private instruction by Mr. Murray in his own studio costs \$10 per lesson. But through his new, simplified methods of teaching, you receive the very same high class instruction at a ridiculously low price. And if you aren't positively delighted the instruction doesn't cost you one cent.



Send No Money—Not One Cent

It isn't necessary to send one cent in advance in order to convince yourself that you can quickly become a popular dancer

through Arthur Murray's teaching methods. All that you need to do now is to fill in and mail the coupon—or a letter or postcard will do—and the special course will be promptly sent to you. Then, when your own postman hands the introductory 16-lesson course to you simply deposit with him only \$1.00 plus the few cents postage, and the course is yours without any further payments of any kind. Keep the course for five days. Practice all the steps—learn everything each lesson teaches, because that is the only way you can prove to your own satisfaction that Arthur Murray fulfills every one of his promises. It is the only way that you can prove that you have found the quickest, easiest, and most delightful way to learn to dance in a socially correct manner, and to be expert in all of the steps.

But if, within five days, you are not perfectly satisfied with the 16 lessons, you may return the course and your deposit will be promptly refunded to you without question or argument.

Remember, Your Satisfaction Is Guaranteed

Positively, you take no risks of any kind. If, after reading over the instructions and practicing the steps of this new 16-lesson course, you are not satisfied in every particular, Arthur Murray will refund every cent you have paid.

You have always wanted to learn to dance—you have always promised yourself that you would learn. Here is your opportunity, and it isn't necessary for you to even leave the privacy of your own room to become a perfect dancer.

If you are to take advantage of this liberal offer you must send the coupon today.

ARTHUR MURRAY
Studio 864

290 Broadway New York

ARTHUR MURRAY, Studio 864
290 Broadway, New York

To prove that you can teach me to dance in one evening at home you may send the sixteen-lesson course and when the postman hands it to me I will deposit \$1.00 with him (plus a few cents postage) in full payment. If within five days I decide to return the course I may do so and you will refund my money promptly and without question.

Name

Address

City State

Would you like to teach dancing? Outside U. S. A.—must send cash with order. Residents of England write to 150 Southampton Road, London.

Try This New Picture Method—Simply Follow The Footsteps

FIRST PART OF FORWARD WALTZ

