

Practical Electrics

20 Cents

Over
100
Illustrations

July 1922

EDITED BY H. GERNSBACK



How to Make a
PHONOGRAPH LOUD TALKER
See Page 354

"Electrical Progress in Plain English"

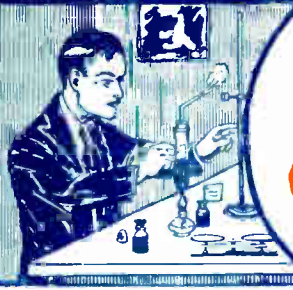

Dr. T. O'Connor Sloane will teach you **CHEMISTRY** Right in your own Home



Good Chemists Command High Salaries



DR. T. O'CONNOR SLOANE,
A.B., A.M., Ph.D., Ph.D.
Noted Instructor, Lecturer, and
Author. Formerly Treasurer American
Chemical Society and a practical
chemist with many well known
achievements to his credit. Not
only has Dr. Sloane taught chemistry
in the classroom but he was
for many years engaged in com-
mercial chemistry work.

Industrial firms of all kinds pay tempting salaries to get the right men. Salaries of \$10,000 to \$12,000 a year are not unusual for chemists of exceptional abilities. Chemistry offers those who are ambitious and willing to apply themselves conscientiously the greatest opportunities of any vocation. Why be satisfied with small pay and hard, thankless work—learn the profession of Chemistry and your salary will depend only upon your own efforts and your own abilities.

The work of the chemist is extremely interesting. If you are fond of experimenting, if you like exciting and intensely interesting work, take up Chemistry. To the man who is dissatisfied with his present job, to the young man just deciding on his life work, Chemistry holds alluring charms, and countless opportunities. If you want to earn more money, the way is open through our course in Chemistry.

Now Is The Time To Study Chemistry

Never before has the world seen such splendid opportunities for chemists as exist today. The war has awakened the United States to the need of trained chemists and chemical engineers. Everywhere the demand has sprung up. In factories, mills, laboratories, electrical shops, industrial plants of all kinds, chemistry plays a vital part in the continuation and expansion of the business. In every branch of human endeavor the need for chemists has arisen. No profession offers such alluring opportunities and the next ten years are going to show the greatest development in this science that this country has ever seen. Those who have the foresight and ambition to learn chemistry now will have the added advantages and greater opportunities afforded while the chemical field is growing and expanding.

ten years are going to show the greatest development in this science that this country has ever seen. Those who have the foresight and ambition to learn chemistry now will have the added advantages and greater opportunities afforded while the chemical field is growing and expanding.

You Can Learn At Home

Dr. Sloane will teach you Chemistry in a practical and intensely interesting way. Our home study course written by Dr. Sloane himself is practical, logical and remarkably simple. It is illustrated by so many experiments that are performed right from the start that anyone, no matter how little education he may have, can thoroughly understand every lesson. Dr. Sloane teaches you in your own home with the same individual and painstaking care with which he has already taught thousands in the class room. And, Dr. Sloane personally examines and corrects all examination papers, pointing out your mistakes and correcting them for you. He will, in addition, give you any individual help you might need in your studies. This personal training will be of inestimable value to you in your future career.

Experimental Equipment Furnished to Every Student



We give to every student without additional charge, this chemical equipment including forty two pieces of laboratory apparatus and supplies and eighteen different chemicals and reagents. The fitted heavy wooden box serves not only as a case for the outfit but also as a laboratory accessory for performing countless experiments. Full particulars about this special feature of our course are contained in our free book "Opportunities for Chemists."

What Well-Known Authorities Say About Our Course

From Hudson Maxim,
"Dr. Sloane has done a much-needed work in a much better way than anything of the kind has, heretofore, been done."

"Dr. Sloane has a remarkable faculty of presenting Science for self-instruction of the student in such a clear and understandable way as to be most readily grasped and assimilated."
"I, therefore, unreservedly recommend and place my highest indorsement on his work."

From Dr. W. W. de Kerlor,
"I can not recommend your course too highly and I congratulate both you and Dr. Sloane on same."

From John A. Tennant,
"This is something which has long been needed. Your long experience in the teaching of chemistry... assurance that the course will be practical as well as plain to the untutored students."

What the Students Say:

"Your course has been worth \$50,000 to my concern."

"This is just like reading some fascinating fiction story."

"I have just been made Assistant Chemist of my concern."

"Your course is just what a person wants to start in the wonderful science of Chemistry."

"I find that your course is very interesting. I wait patiently for the next lesson."

"I find the study of chemistry more and more interesting at every lesson and you may be sure that I am getting into smoking habit even more than I ever did even in my school days."

"I am well pleased with your course and I think, from the way it starts out, I have found a good teacher and school."

"Your course is quite wonderful, easy to understand, and so well laid out. I like it immensely."

"The lessons are fine and I like them."

"I have written to different people about your course and they speak very highly of same."

"If I don't learn it isn't your fault for I find that your lessons contain a whole lot."

(Names and addresses on request)

Easy Monthly Payments

You don't have to have even the small price of the course to start. You can pay for it in small monthly amounts—so small that you won't feel them. The cost of our course is very low, and includes everything, even the chemistry outfit—there are no extras to buy with our course. Our plan of monthly payments places a chemical education within the reach of everyone. Write us and let us explain our plan in full—give us the opportunity of showing you how you can qualify for a highly trained technical position without even giving up your present employment.

SPECIAL 30 DAY OFFER

Besides furnishing the student with his Experimental Equipment, we are making an additional special offer for a short while only. You owe it to yourself to find out about it. Write today for full information and free book "Opportunities for Chemists." Send the coupon right now while it is fresh in your mind. Or just write your name and address on a postal and mail it to us. But whatever you do, act today before this offer is withdrawn.

**CHEMICAL
INSTITUTE
OF NEW YORK**
Home Extension
Division 7
140—B Liberty St.,
New York City

Please send me at once, without any obligation on my part, your free Book "Opportunities for Chemists," and full particulars about the Experimental Equipment given to every student. Also please tell me about your plan of payment and your special 30 day offer.

NAME

ADDRESS

CITY..... STATE.....

Don't Wait—Mail the Coupon NOW!

CHEMICAL INSTITUTE of NEW YORK, Inc.

140—B LIBERTY ST.

Home Extension Division 7

NEW YORK CITY



Go after the big-pay job!

"Know electricity as experts know it and get an expert's pay"

DONT be satisfied to worry along in little jobs with little pay. Master the finer points of electrical practice and bring the big pay job within your reach. Croft will show you how. Through his famous books he will teach you electricity as experts know it and put you in line for an expert's pay. The Croft books take you out of the crowd and fit you for more responsible positions—they give you a short cut to **SUCCESS** in the electrical field. Thirty thousand men are using these books to step ahead.—**WHY NOT YOU?**

The Croft Library of Practical Electricity

A Combined Home Study Course and Reference Library
8 volumes — 3000 pages — 2100 illustrations — flexible Keratol binding

NO method of teaching electricity offers a quicker, surer way to success than the Croft books.

Starting right in with the ABC's of modern electrical practice, Croft takes you through his books in easy steps. He gives you the secrets of success in electricity in plain words, figures and illustrations. Nothing is left to the imagination—there is no guesswork.

Thos. A. Edison said: "Croft's method of explaining by analogy with things everyone knows, and the simple illustrations, make his work one of the best that I have yet seen."

Croft teaches you electrical practice complete—inside and outside work—central stations and the whole subject. He takes you in quick, easy steps from the simplest principles to the complete and economical operation of a great central station.

He tells you things you need to know about motors, generators, armatures, commutators, transformers, circuits, currents, switch-boards, distribution systems—electrical machinery of every type, installation, operation and repair—wiring for light and power—how to do it mechanically perfect, in accordance with the National Electrical Code—wiring of finished buildings—Underwriters' and municipal requirements—how to do the complete job, from estimating it, to completion—illumination in its every phase—the latest and most improved methods of lighting—lamps and lighting effects, etc.

The Croft Library is the last word in practical electrical education. No man who wishes to achieve success in the electrical field can afford to be without it.

**WAS
\$27.50
NOW
\$19.50**

**YOU
SAVE
\$8
AND HAVE
10
MONTHS
TO PAY**

**FREE
EXAMINATION**

**NO
MONEY
IN
ADVANCE**

The Sure Way to Bigger Pay

Big salaries are paid in the electrical field for expert knowledge. The man who knows electricity in all its many phases—the man who has completely mastered the subject from A to Z—can pick his own job and name his own salary. The only way you can earn more is to learn more. Small knowledge means small pay. Learn the way to bigger pay. Become an expert.

Practical Electricity Taught By An Expert

Croft has had an almost sensational climb. Beginning as an apprentice lineman, he went through the various stages of wireman, draftsman, etc., until he attained the position of electrical engineer with one of the great electrical manufacturing companies. Now he heads his own consulting company with a large and successful practice, and his name is known in every corner of the electrical world.

Croft gives you only the boiled-down records of every-day electrical practice. His knowledge of electricity has been obtained through actual shirt-sleeve practice, and because he knows your problems he is able to tell you in clear, understandable language the best way to solve them.

Free Trial The proof of all we have said is in the books themselves, and it costs you N-O-T-H-I-N-G to examine them. There are no charges of any kind to pay. We pay everything. We send the books to you for 10 days' examination and let you be the sole judge as to their value.

Easy Payments We have clipped \$8.00 off the price of this popular electrical library—made it \$19.50 instead of \$27.50, a reduction of about 30 per cent. And more than that, we are offering the easiest terms we have ever made on the Croft books. You now pay, not \$5 a month, nor even \$3 a month, but the sum of \$1.50 in ten days and the balance at the rate of only \$2 a month. This gives you ten full months to complete your payments.

Just Send the Coupon

Your set is packed, ready for shipment to you. The minute we receive your shipping instructions we will forward the books to you, all charges prepaid. Just fill in and mail the coupon. No money necessary.

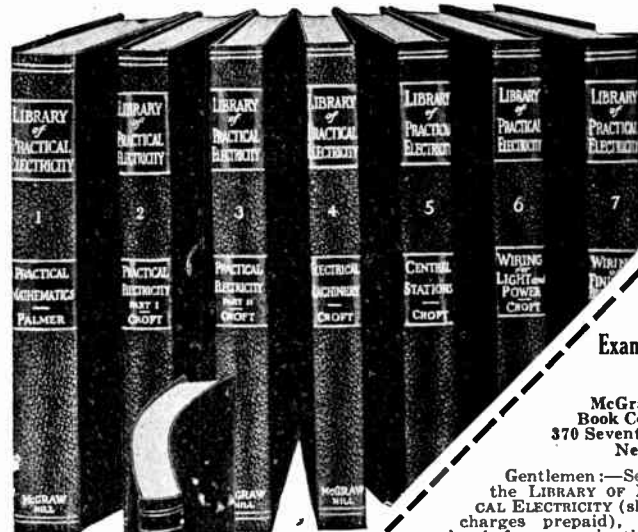

**FREE
Examination
Coupon**

McGraw-Hill
Book Co., Inc.,
370 Seventh Ave.,
New York

Gentlemen:—Send me the LIBRARY OF PRACTICAL ELECTRICITY (shipping charges prepaid), for 10 days' free examination. If satisfactory, I will send \$1.50 in ten days and \$2 per month until the special price of \$19.50 has been paid. If not wanted, I will write you for return shipping instructions. (Write plainly and fill in all lines.)

Name.....
Home Address.....
City and State.....
Employed by.....
Occupation.....

PE-7-1-22

McGraw-Hill Book Company, Inc.
370 Seventh Ave., New York

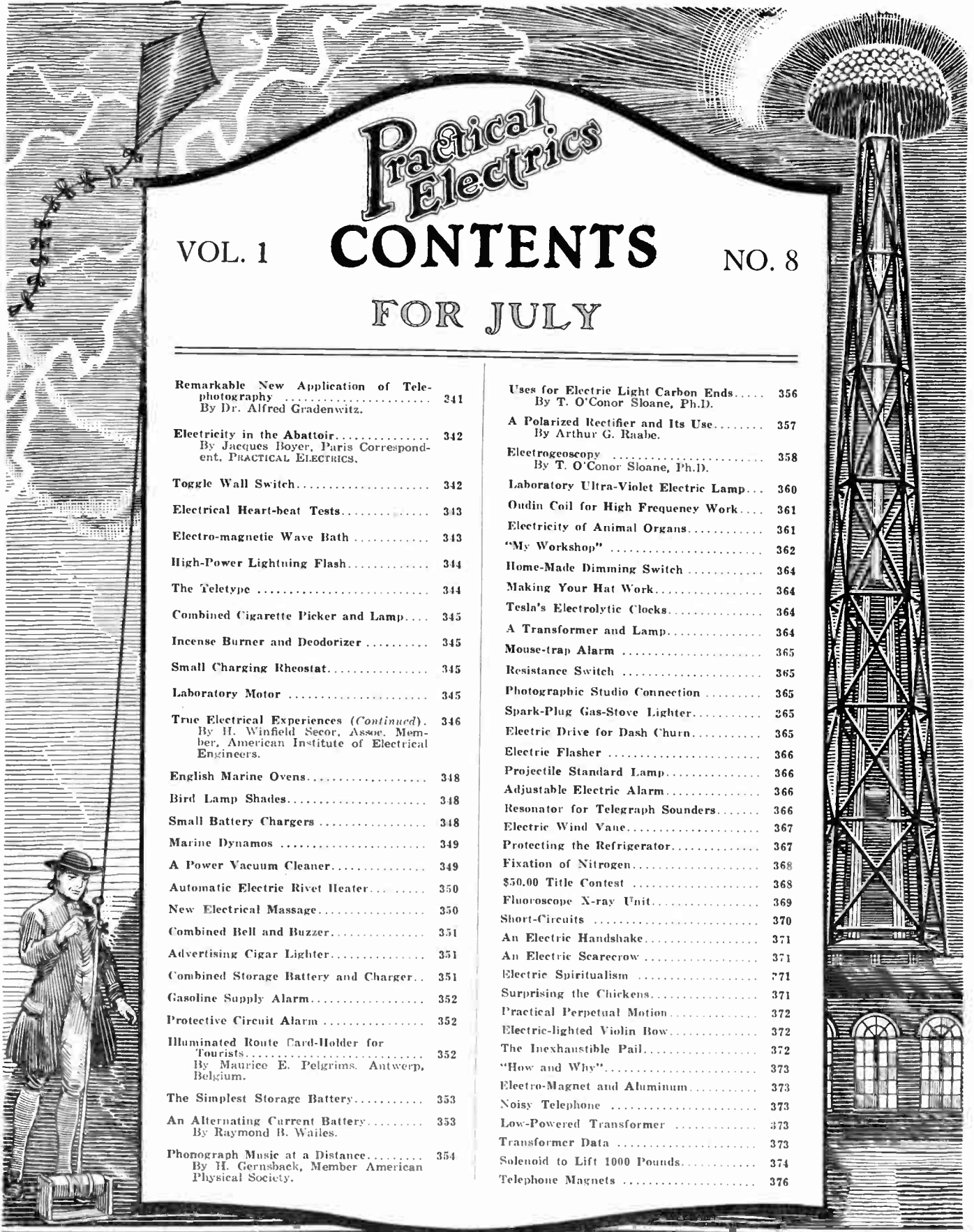

**Practical
Electric**
VOL. 1 CONTENTS NO. 8
FOR JULY

Remarkable New Application of Tele- photography By Dr. Alfred Gradenwitz.....	341	Uses for Electric Light Carbon Ends..... By T. O'Connor Sloane, Ph.D.....	356
Electricity in the Abattoir..... By Jacques Boyer, Paris Correspond- ent, PRACTICAL ELECTRICS.....	342	A Polarized Rectifier and Its Use..... By Arthur G. Raabe.....	357
Toggle Wall Switch.....	342	Electroscopy By T. O'Connor Sloane, Ph.D.....	358
Electrical Heart-beat Tests.....	343	Laboratory Ultra-Violet Electric Lamp.....	360
Electro-magnetic Wave Bath.....	343	Oudin Coil for High Frequency Work.....	361
High-Power Lightning Flash.....	344	Electricity of Animal Organs.....	361
The Teletype.....	344	"My Workshop".....	362
Combined Cigarette Picker and Lamp.....	345	Home-Made Dimming Switch.....	364
Incense Burner and Deodorizer.....	345	Making Your Hat Work.....	364
Small Charging Rheostat.....	345	Tesla's Electrolytic Clocks.....	364
Laboratory Motor.....	345	A Transformer and Lamp.....	364
True Electrical Experiences (Continued). By H. Winfield Secor, Assoc. Mem- ber, American Institute of Electrical Engineers.....	346	Mouse-trap Alarm.....	365
English Marine Ovens.....	348	Resistance Switch.....	365
Bird Lamp Shades.....	348	Photographic Studio Connection.....	365
Small Battery Chargers.....	348	Spark-Plug Gas-Stove Lighter.....	365
Marine Dynamos.....	349	Electric Drive for Dash Churn.....	365
A Power Vacuum Cleaner.....	349	Electric Flasher.....	366
Automatic Electric Rivet Heater.....	350	Projectile Standard Lamp.....	366
New Electrical Massage.....	350	Adjustable Electric Alarm.....	366
Combined Bell and Buzzer.....	351	Resonator for Telegraph Sounders.....	366
Advertising Cigar Lighter.....	351	Electric Wind Vane.....	367
Combined Storage Battery and Charger.....	351	Protecting the Refrigerator.....	367
Gasoline Supply Alarm.....	352	Fixation of Nitrogen.....	368
Protective Circuit Alarm.....	352	\$50.00 Title Contest.....	368
Illuminated Route Card-Holder for Tourists..... By Maurice E. Pelgrims, Antwerp, Belgium.....	352	Fluoroscope X-ray Unit.....	369
The Simplest Storage Battery.....	353	Short-Circuits.....	370
An Alternating Current Battery..... By Raymond B. Wailes.....	353	An Electric Handshake.....	371
Phonograph Music at a Distance..... By H. Gernsback, Member American Physical Society.....	354	An Electric Scarecrow.....	371
		Electric Spiritualism.....	371
		Surprising the Chickens.....	371
		Practical Perpetual Motion.....	372
		Electric-lighted Violin Bow.....	372
		The Inexhaustible Pail.....	372
		"How and Why".....	373
		Electro-Magnet and Aluminum.....	373
		Noisy Telephone.....	373
		Low-Powered Transformer.....	373
		Transformer Data.....	373
		Solenoid to Lift 1000 Pounds.....	374
		Telephone Magnets.....	376

PRACTICAL ELECTRICS is published on the 15th of each month at 233 Fulton Street, New York. There are 12 numbers per year. Subscription price is \$2.00 a year in U. S. and possessions. Canada and foreign countries \$2.50 a year. U. S. coin as well as U. S. stamps accepted (no foreign coin or stamps). Single copies 20 cents each. A sample will be sent gratis on request. Checks and money orders should be drawn to order of PRACTICAL ELECTRICS CO. If you change your address, notify us promptly, in order that copies are not miscarried or lost.

All communications and contributions to this journal should be addressed to: Editor, PRACTICAL ELECTRICS, 53 Park Place, New York. Un-accepted contributions cannot be returned unless full postage has been in-cluded. All accepted contributions are paid for on publication. A special rate is paid for novel experiments; good photographs accompanying them are highly desirable. PRACTICAL ELECTRICS, MONTHLY Entered as second-class matter October 14, 1921, at the New York Post Office under Act of Congress of March 3, 1879. Title registered at the Patent Office, Copyright, 1922, by PRACTICAL ELECTRICS COMPANY, INC., New York. The contents of this Magazine are copyrighted and must not be reproduced with- out giving full credit to the publication.

PRACTICAL ELECTRICS is for sale at all news stands in the United States and Canada; also at Brentano's, 37 Avenue de l'Opera, Paris.

(Practical Electric Co., Inc., owner) 53 Park Place, N. Y. City
S. GERNSBACK, Treasurer R W. DeMOTT, Secretary
General Advertising Department, 53 Park Place, New York City.
Western Advertising Representatives, Finucan & McClure, Hartford Bldg., Chicago, Ill.
Pacific Coast Advertising Representatives, A. J. Norris Hill Co., 1014 Hearst Bldg., San Francisco, Cal.

PRACTICAL ELECTRICS is published on the 15th of each month at 233 Fulton Street, New York. There are 12 numbers per year. Subscription price is \$2.00 a year in U. S. and possessions. Canada and foreign countries \$2.50 a year. U. S. coin as well as U. S. stamps accepted (no foreign coin or stamps). Single copies 20 cents each. A sample will be sent gratis on request. Checks and money orders should be drawn to order of PRACTICAL ELECTRICS CO. If you change your address, notify us promptly, in order that copies are not miscarried or lost.

All communications and contributions to this journal should be addressed to: Editor, PRACTICAL ELECTRICS, 53 Park Place, New York. Un-accepted contributions cannot be returned unless full postage has been in-cluded. All accepted contributions are paid for on publication. A special rate is paid for novel experiments; good photographs accompanying them are highly desirable. PRACTICAL ELECTRICS, MONTHLY Entered as second-class matter October 14, 1921, at the New York Post Office under Act of Congress of March 3, 1879. Title registered at the Patent Office, Copyright, 1922, by PRACTICAL ELECTRICS COMPANY, INC., New York. The contents of this Magazine are copyrighted and must not be reproduced with- out giving full credit to the publication.

PRACTICAL ELECTRICS is for sale at all news stands in the United States and Canada; also at Brentano's, 37 Avenue de l'Opera, Paris.

(Practical Electric Co., Inc., owner) 53 Park Place, N. Y. City
S. GERNSBACK, Treasurer R W. DeMOTT, Secretary
General Advertising Department, 53 Park Place, New York City.
Western Advertising Representatives, Finucan & McClure, Hartford Bldg., Chicago, Ill.
Pacific Coast Advertising Representatives, A. J. Norris Hill Co., 1014 Hearst Bldg., San Francisco, Cal.

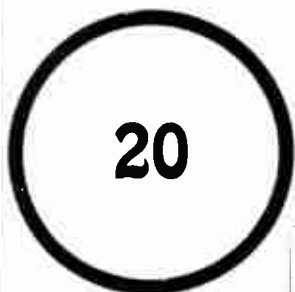

TWENTY RADIOPHONE DIAGRAMS

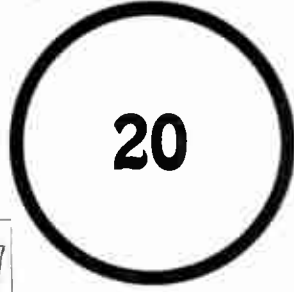

The most complete selection of diagrams and hook-ups for **RADIO AMATEURS** enabling anybody to rig-up a wireless



telephone outfit from the simplest crystal detector circuit, to the most ultra-modern regenerative and amplifying radio set.

TITLES of DIAGRAMS

1. Single Slide Tuning Coil with Crystal Detector.
2. Double Slide Tuning Coil with Crystal Detector.
3. Loose Coupler with Crystal Detector.
4. Regenerative set, using 2 slide tuner.
5. Plain Audion Detector Circuit.
6. Feed-back Circuit with a Loose Coupler.
7. Armstrong Feed-back Circuit.
8. Standard Short Wave Regenerative Set.
9. Honey-comb coil Receiver for all wave lengths.
10. Short wave regenerative set, with 2 step Amplifier.
11. Combination Circuit for Long and Short Waves.
12. Detector and Two stage Amplifier with automatic Filament control Jacks.
13. Single Circuit Regenerative Tuner.
14. Circuit for elimination of induction from power lines.
15. Loop Aerial Receiver.
16. Radio and Audion frequency amplifier.
17. Circuit of a C.W. Transmitter for low power.
18. 5 Watt Radio-phon.
19. 10 Watt Phone and C.W. Transmitter.
20. High Power C.W. Transmitter.

COMPLETE SET OF 20 RADIOPHONE DIAGRAMS

consisting of twenty blueprint diagrams, size 8 1/2 x 11 1/2 inches and one four page direction—pamphlet 8 1/2 x 11 1/2 inches, containing: Illustrated Symbol Key Chart, Direction How to Read Diagrams, How to Follow Circuit, etc. and explanation of each diagram. All contained in heavy, two color printed envelope size 9 x 12 inches.

PRICE - 50c FOR THE COMPLETE SET OF 20, SHIPPED PREPAID

Either Direct from us or for sale by the following responsible Dealers:

- | | | | |
|---|---|---|---|
| Alamo Sales Corp. Indianapolis, Ind. | Fenno Co., R. F. N. Y. City | Mevberg Co., Leo J., San Francisco, Cal. | Rose Radio Supply New Orleans, La. |
| Am. Electric Tech. App. Co., N. Y. City | Zanesville, O. | Milnor Elec. Co. Cincinnati, Ohio | Roy News Co., Fre'k J. Toronto, Can. |
| American Hdw. Stores, Bridgeport, Conn. | Findley Electric Co., Minneapolis, Minn. | Mohawk Elec. Sup. Co., Syracuse, N. Y. | Sands Electric Co. Wheeling, W. Va. |
| Andrae & Sons, Julius, Milwaukee, Wis. | Fleron & Son, M. M. Trenton, N. J. | Montgomery-Ward & Co. Chicago, Ill. | Sayre-Level Radio Co. Phila., Pa. |
| Andrae & Sons, Julius, Mason City, Ia. | Fuller Co., Seth W. Boston, Mass. | Morehouse-Martens Co. Columbus, Ohio | Schmidt & Co., R. Rochester, N. Y. |
| Anthracite Radio Shop Scranton, Pa. | Ganday Elec. Co. Pittsburgh, Pa. | Natl Radio Institute, Washington, D. C. | Sears, Roebuck & Co. Chicago, Ill. |
| Associated Merchandising Corp., N. Y. C. | Galveston W'less Sup. Co., Galveston, Tex. | New England Motor Sales Co., Green-
wich, Conn. | Shotton Radio Mfg. Co. Scranton, Pa. |
| Atlantic Radio Co. Boston, Mass. | Greene, Jos. E. Boston, Mass. | New Era Shop Milwaukee, Wis. | Smith Novotay Elec. Inc., Charlotte, N. C. |
| Bamberger & Co., L. Newark, N. J. | Gurd & Co., Wm. London, Canada | Newman-Smyth Co. Cleveland, O. | So. California Elec. Co., Los Angeles, Cal. |
| Banister & Pollard Co., Newark, N. J. | Hall Electric Co., Wm. Dayton, O. | Nichols Radio Sup. Co., Big. Green, Ky. | Southern Elec'l Sup. Co., San Diego, Cal. |
| Beckley-Ralston Co., The Chicago, Ill. | Hartford Elec. Sup. Co., Hartford, Conn. | Nola Radio Co. New Orleans, La. | Southwest Radio Sup. Co., Dallas, Tex. |
| Benwood Specialty Co. St. Louis, Mo. | Hartfield Electric Co., Indianapolis, Ind. | Noll & Co., E. P. Philadelphia, Pa. | Sprout-Shaw Schl. Vancouver, B. C. |
| Bluebird Electric Shop, Jersey City, N. J. | Houston, A. E. Fitchburg, Mass. | Northern Radio & El. Co., Seattle, Wash. | Standard Drug Co., The., Detroit, Mich. |
| Brode Electric Co. Los Angeles, Cal. | Hickson Electric Co. Rochester, N. Y. | Northwest Radio Serv. Co., Seattle, Wash. | Steiner Elec. Co. Chicago, Ill. |
| Brown, J. Edw. Glenbrook, Conn. | Hiro Wireless Sup. Co. Marion, Ind. | N. S. W. Bookstall Co., Sydney, Australia | Steinman Hardware Co., Lancaster, Pa. |
| Bunnell & Co., J. H. New York City | Holt Electric Util. Co., Jacksonville, Fla. | Pearlman's Book Shop, Washington, D. C. | Sterling Electric Co., Minneapolis, Minn. |
| California Elec. Co., San Francisco, Cal. | Hommel-Ludwig & Co. Pittsburgh, Pa. | Penn Radio Apparatus Co., Reading, Pa. | Stubs Electric Co. Portland, Ore. |
| Capital Radio Sup. Co., Indianapolis, Ind. | Hook Drug Co. Indianapolis, Ind. | Penn. Marconi Wireless Schl. Phila.
Pettingill-Andrews Co. Boston, Mass. | Sunbeam Elec. Sup. Co. N. Y. City |
| Carter Electric Co. Atlanta, Ga. | Huey & Philip H'dware Co., Dallas, Tex. | Pitts. Schl. of Wireless Tele., Phila., Pa. | Tuska Co., C. S. Hartford, Conn. |
| Central Radio Co. Independence, Mo. | Hughes Elec'l Corp. Syracuse, N. Y. | Pioneer Electric Co. Ashville, N. C. | Union Elec. Sup. Co., Providence, R. I. |
| Chase, Geo. H. Newport, R. I. | Iowa Radio Corp. Des Moines, Iowa | Pitts. Co., F. D. Boston, Mass. | United Elec. Stores Co., Braddock, Pa. |
| Chesapeake Elec. Co. Baltimore, Md. | Jenkins, Lester I. New Bedford, Mass. | Pitts. Radio & App. Co., Pittsburgh, Pa. | United Elec. Sup. Co. Pittsburgh, Pa. |
| Chicago Radio Ap. Co. Chicago, Ill. | Keaselman-O'Dris'oil Co., Milwaukee, Wis. | Post Arthur Radio Lab., Port Arthur, Tex. | U. S. Radio Co. Pittsburgh, Pa. |
| Cleveland Co., L. W. Portland, Me. | Keubler Radio Co. Toledo, O. | Post Office News Co. Chicago, Ill. | Virginia Novelty Co., Martinsburg, W. Va. |
| Cloud & Son Macy, Ind. | Killoch Co., David New York City | Precision Equipment Co. Cincinnati, O. | Warner Bros. Oakland, Cal. |
| Con. Radio & Elec. Corp. N. Y. City | King Radio Co. Pittsburgh, Pa. | Quaker Light Sup. Co., The, Phila., Pa. | Western Radio Co. Kansas City, Mo. |
| Continental Elec. Sup. Co., Washington,
D. C. | Klaus Radio Co. Eureka, Ill. | Radio Distributing Co. Newark, N. J. | West'n Radio Elec. Co., Los Angeles, Cal. |
| Daily Battery & Equipment Co., Pitts-
burgh, Pa. | Kluge, Arno A. Los Angeles, Cal. | Radio Electric Co. Pittsburgh, Pa. | Westmore-Savage Co. Boston, Mass. |
| Delancey-Felch & Co. Detroit, Mich. | Knoxville Radio Co. Knoxville, Tenn. | Radio Equipment Co. Boston, Mass. | Wheeler Green Electric Co., Rochester,
N. Y. |
| Delancey-Felch & Co. Pawtucket, R. I. | Kusel Co., D. & F. Watertown, Wis. | Radio Equip't & Mfg. Co., Minneapolis
Radio-Electric Shop Cleveland, O. | Whitall Elec. Co. Springfield, Mass. |
| Detroit Electric Co. Detroit, Mich. | Lehigh Radio Co. Bethlehem, Pa. | Ray-Di-Co. Chicago, Ill. | Whitall Elec. Co. Westerly, R. I. |
| Devev Spitz, Goods Co., Milwaukee, Wis. | Liberty Incandescent Sup. Co., Pitts-
burgh, Pa. | Reynolds Radio Denver, Colo. | Williamson Elec. Co. Seattle, Wash. |
| Doubleday-Hill Elec. Co., Pittsburgh, Pa. | Liberty Radio Sup. Co. Chicago, Ill. | Renter Electric Co. Cincinnati, O. | Wilmington Elec. Spec. Co., Wilmington |
| Dreyfus Sales Co. New York City | Linze Elec'l. Sus. Co. St. Louis, Mo. | R. I. Elec. Equip't. Co., Providence, R. I. | Wilson Co., Harold K., Grundy Center,
Iowa. |
| Duck & Co., Wm. B. Toledo, O. | Litscher Elec. Co., C. J. Grand Rapids,
Mich. | Riverside Laboratory Milwaukee, Wis. | Winner Radio Co. Aurora, Colo. |
| E. S. & E. Co. Hartford, Conn. | Ludwig Hommel & Co., Pittsburgh, Pa. | Robertson-Cataract El. Co., Buffalo, N. Y. | Wireless Mfg. Co. Canton, O. |
| Electro Importing Co. N. Y. City | Luther, H. E. Centerville, Ia. | | Wolfe Electric Co. Omaha, Neb. |
| Elite Electric Shop El Paso, Tex. | Manhattan Elec. Sup. Co. Toledo, O. | | Zamojski Co., James M., Baltimore, Md. |
| Eric Book Store Erie, Pa. | Marshall-Gerken Co. Toledo, O. | | Zibart Bros. Nashville, Tenn. |
| Farley & MacNeill Boston, Mass. | McCarthy Bros. & Ford, Buffalo, N. Y. | | |
| Farrington & Clark Boston, Mass. | McMillan Bros. Pittsburgh, Pa. | | |
| Federal Elec. Sup. Co. Detroit, Mich. | Merchant, A. P., & Co. Boston, Mass. | | |

Consolidated Radio Call Book Co., Inc., 98 Park Place, New York City

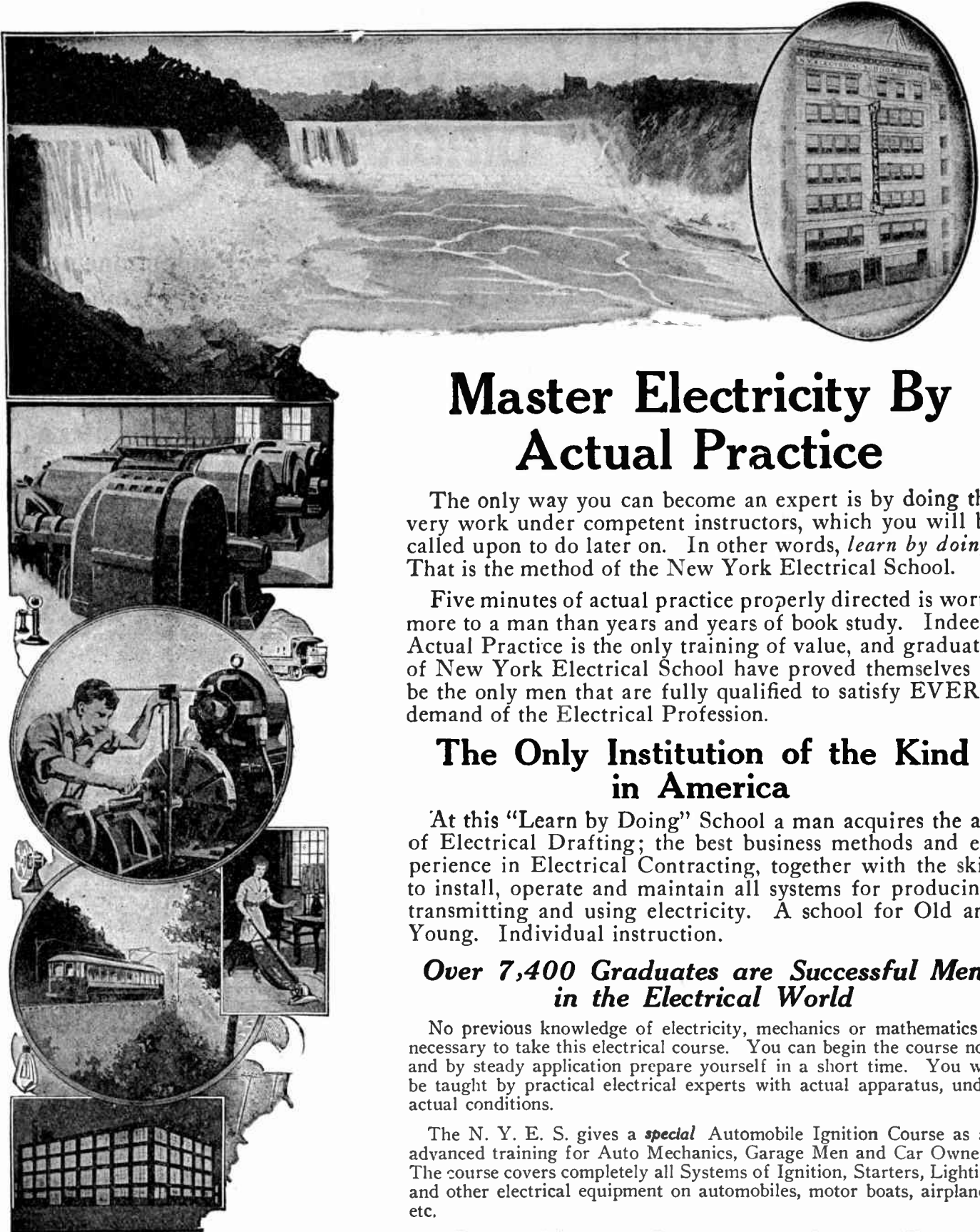

Master Electricity By Actual Practice

The only way you can become an expert is by doing the very work under competent instructors, which you will be called upon to do later on. In other words, *learn by doing*. That is the method of the New York Electrical School.

Five minutes of actual practice properly directed is worth more to a man than years and years of book study. Indeed, Actual Practice is the only training of value, and graduates of New York Electrical School have proved themselves to be the only men that are fully qualified to satisfy EVERY demand of the Electrical Profession.

The Only Institution of the Kind in America

At this "Learn by Doing" School a man acquires the art of Electrical Drafting; the best business methods and experience in Electrical Contracting, together with the skill to install, operate and maintain all systems for producing, transmitting and using electricity. A school for Old and Young. Individual instruction.

Over 7,400 Graduates are Successful Men in the Electrical World

No previous knowledge of electricity, mechanics or mathematics is necessary to take this electrical course. You can begin the course now and by steady application prepare yourself in a short time. You will be taught by practical electrical experts with actual apparatus, under actual conditions.

The N. Y. E. S. gives a *special* Automobile Ignition Course as an advanced training for Auto Mechanics, Garage Men and Car Owners. The course covers completely all Systems of Ignition, Starters, Lighting and other electrical equipment on automobiles, motor boats, airplanes, etc.

Let us explain our complete courses to you in person. If you can't call, send now for 64-page book—it's FREE to you.

New York Electrical School

31 West 17th Street, New York

New York Electrical School
31 W. 17th St., New York, N. Y.

Please send FREE and without obligation to me your 64-page book.

..... NAME
 STREET
CITYSTATE

H. Gernsback, Editor and Publisher

T. O'Connor Sloane, Ph.D., Associate Editor

Remarkable New Application of Tele-Photography

By Dr. Alfred Gradenwitz



Left—The inventor, Dr. A. Korn, of the Berlin Engineering College, standing back of his instrument.

Right—A reproduction of a bank draft, whose design was sent by Dr. Korn's instrument over a long distance telephone line, complete in twelve minutes.



original check. Just fancy the possibilities included in these wired drafts (shortly even to be supplemented by wireless ones)! The whole banking practice may be revolutionized by this innovation, the more so as signatures are in the same manner transmitted and checked over the telephone wire.

Other possibilities are illustrated—the tele-photographic reproduction of a fingerprint, intended to identify a criminal. Professor Ottolenghi of the University of Rome, director of the Scientific Police School, takes the greatest interest in this new development by which the tracing and capturing of criminals will be made much more effective than heretofore. When it is realized that the portrait of

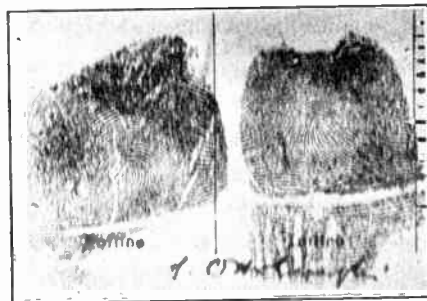

An example of thumb or finger prints, illustrating the value of this invention for the capture of criminals.

any suspected person, along with his or her finger-prints, can, within a few minutes, be transmitted to any distance, it will indeed be understood that the police of a near future will have much more efficient methods at its disposal than those of the present time and that the criminal's chance of escaping the avenging arm of Justice is becoming more and more precarious. This is to be more developed,

as wireless methods will soon allow portraits, signatures and finger-prints to be transmitted broadcast in all directions.

The method used in connection with our illustrations is a *telautographic* one, i. e., a method intended for the transmission, not of shades as in a photograph, but of points and lines as in a drawing or half-tone. The original picture is reproduced on a zinc or copper sheet on which the drawing is made with some electrically non-conductive ink, and is wound on the metallic cylinder constituting the most conspicuous part of the transmitter. A metallic stylus follows a helical course, like that of a phonograph needle on its cylinder. The cylinder rotates and advances in a parallel direction to its axis, so that the stylus traveling over the whole surface of the cylinder, passes a current to the receiver every time the stylus touches a metallic point of the original picture. In order to reconstitute the picture at the receiving end by means of the currents coming from the transmitter, an apparatus of similar disposition is required, viz., a rotating cylinder on which the photographic paper destined to receive the reproduction is wound, and a recording device. The latter is of remarkable rapidity and sensitiveness and mainly consists of a string galvanometer opening or closing, as the case may be (according as to the passage or otherwise of any current from the sending station), a slot through which the light from a Nernst lamp is allowed to strike a given element of the photographic paper, thus reproducing one by one, the various "elements" of the original picture. Up to 2,000 elements per second can thus be reproduced so that any photograph, sketch or drawing can be transmitted in a few minutes. A photograph must, previous to being transmitted by the telautographic method, be converted into a half-tone by printing through a fine grating.

TELE-PHOTOGRAPHY, i. e., the art of transmitting photographs, drawings, etc., to a distance in a manner similar to that employed for transmitting words by telegraphy, had, immediately before the war, reached a stage justifying its ultimate development on a commercial scale to be foreseen for the near future. For obvious reasons connected with the state of war and because all long-distance telegraph and telephone lines were taken into possession for purposes of more immediate necessity, the tele-photographic press service installed between several European capitals, e. g., between Berlin and London, London and Paris, Copenhagen and Stockholm, as well as all experimental work in the field, had to be temporarily abandoned.

However, the pioneer of that art, Dr. A. Korn, professor at the Berlin Engineering College, has just returned from Italy, where his tele-photographic methods—both those used in connection with the pre-war press service and some new ones developed in the meantime—have on the Government's initiative, been submitted to a series of conclusive and most successful tests. In a recent interview the writer received from him some interesting information on new applications of tele-photography tested in this connection.

The check represented in one of the illustrations is the tele-photographic reproduction of an original draft transmitted in 12 minutes over one of the Italian long-distance telephone lines. It is clear enough and shows sufficient wealth of details to be a perfect substitute for the

Electricity in the Abattoir

By Jacques Boyer

Paris Correspondent, PRACTICAL ELECTRICIANS



Left—An electric abattoir-knife, whose blades whirling at high rapidity secure speedy removal of hides from carcasses without injury.

Below—A butcher, holding the knife at the end of its flexible shaft.

Right—The knife at work, stripping the skin from an animal, with a very small percentage of injuries to the hide.



THE French are inclined to admit that in model abattoirs the United States, the Argentine, Australia and two or three other countries were in advance of their own. But recently they have been attempting to bring some of their slaughter houses quite up to date.

The illustration shows the use of an electric knife; it seems that hitherto, using the ordinary knives of the old-time butchers, great skill was required on the part of the operative, so that competent specialists in butchery were very rare.

It is claimed that in the use of the older

methods only 15 per cent of the hides were exempt from damage by the knife. The electric knife we illustrate, called the Perco apparatus, enables even a practically inexperienced man to do first-class work. The illustration shows the instrument in the hands of a workman. It has three wings, each carrying at its end three branches with a sharp disk on each one. These are held between two disks some four inches in diameter; a handle about a foot in length is provided for its manipulation.

A quarter-horsepower electric motor with a flexible shaft drives the knife, the

wings rotating at a speed of 2,800 turns per minute. The manipulation is simplicity itself; in removing the hide from the animal the instrument is placed flat against the flesh and pushed forward, between hide and flesh, separating the skin perfectly without any damage. It works so quickly that after a few days' apprenticeship a butcher can skin the largest animal in twenty minutes. This is not considered much of a gain in time, but when it is remembered that the old-style knife injured 85 per cent of the hides, a strong point is made for its introduction in advanced establishments.

Toggle Wall Switch

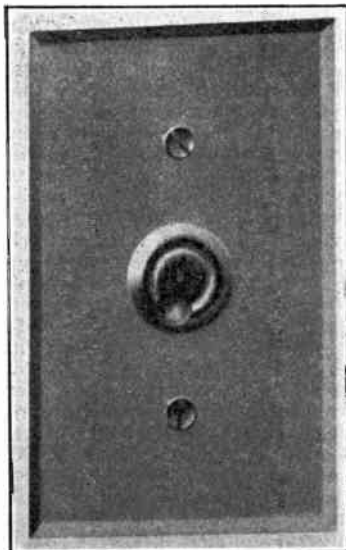

A wall switch of a very compact description, which is opened and closed by moving the fingers across its face and sweeping the little knob up or down as the case may be.

THE switch illustrated herewith is an interesting innovation on the ordinary type of button switch, where pressing one button inwards lights the lamp and pressing another button, also inwards, extinguishes it.

This switch is constructed on the toggle principle, and its action depends on the swinging of the little projecting knob from top and bottom of the circular aperture in the wall-plate through which it protrudes. The hand is simply swept up or down, as the case may be, over the plate; the finger touches the button and it swings across the opening, lighting or extinguishing the lamp, according to the connection. If so placed that swinging it down will light the lamps, swinging it up will extinguish them.

It can, of course, be placed horizontally, providing for a horizontal motion of the hand. It makes an exceedingly neat fixture, and the good construction of it, the substantial way in which it is put together and the effectiveness of the installation are brought out in the illustration showing the interior.

There are bronze auxiliary contacts which take any arc that may possibly

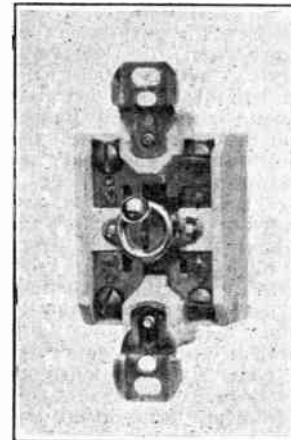

Interior, showing the construction of the toggle wall switch.

form, the idea being to protect the main contacts. The whole switch and plate and finger piece lies very close against the wall, the protuberance of the little knob being very slight—just enough for the finger to catch.

Electrical Heart-Beat Tests

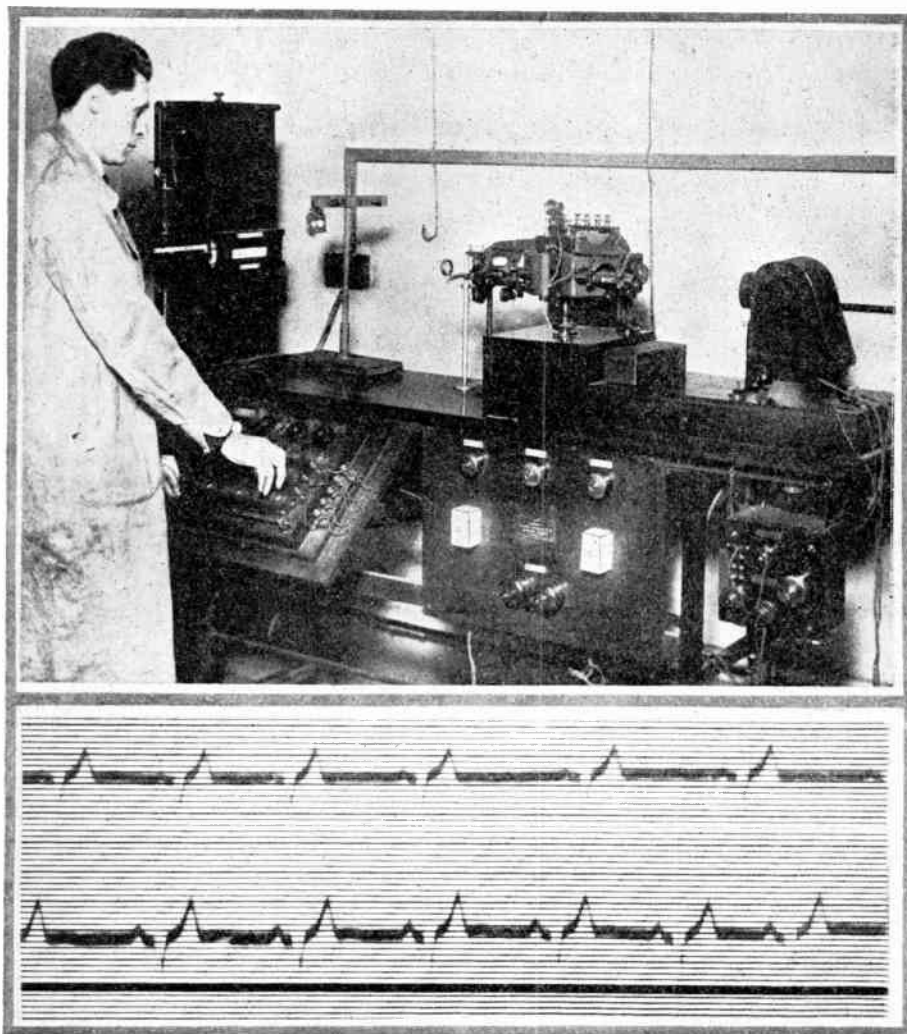

An apparatus used in the great English hospital, the National Hospital for Heart Diseases, London. The apparatus is shown with the operator standing near it, while below are reproductions of the traces of heart action as produced by the apparatus.

A VERY elaborate apparatus for registering the trace describing the action of the heart has been installed in one of the great English hospitals, The National Hospital for Heart Diseases, London. The electric cardiograph is taken to the ward or room where the diagnosis of a patient or applicant is to be obtained.

Here the instrument does its work and the interesting feature is that the heart action as interpreted by the electrical instrument is telegraphed to any desired place in the hospital. In the illustration the electric cardiograph proper is supposed to be three floors removed from the registration instrument, so while the patient is having his heart action tested, it is in a room three stories below that the recording instrument, actuated by the heart beats telegraphed to it, receives the traces of a stylus on a paper strip, so that the patient knows nothing about the story told, or of the history of his case, which is often a desirable situation.

It will be seen that in this way the records of a great hospital may all be taken in one room and the information for the diagnosis is placed there on file.

Another advantage of the system is that the permanent records produced are all kept filed away so that the changes from time to time and new developments can always be watched for.

Electro-Magnetic Wave Bath

THE two illustrations show a patient being treated by what is known as the "wave bath." It is said to give heat, light and electrical treatment simultaneously. In this apparatus the patient's body never is in direct contact with an electrode, but all the action comes from the excited conductors through space, not by direct conduction.

It is said that the machine takes the place of five large-sized pieces of apparatus formerly used in succession, one after the other, to give the same treatment, which is here given at one time and in one process.

The patient shown in the picture, who certainly does not look like an invalid, is Miss Florence Macbeth, famous soprano. From all appearances she is enjoying the treatment and we hope she is receiving benefit too.

It often happens that electricity as applied in therapeutics, is quite disagreeable. The electrodes give the tingling effect which is not tolerated by everyone, but here we seem to have a milder system of applying the electric discharge, which appears to be tolerable by delicate patients, the discharge being of course modified by its distance from the surface on which it is operating. The different positions which

the patient can take, open up quite a range of possibilities. The patient in the illustration is really an invalid, although her appearance would belie any such assertion.

It is rather interesting to see on this page two typical applications of electricity,

the one to diagnosis, registering heart action permanently for future reference during the treatment of a case,—the other the purely healing application of the electric agent, to effect a cure where perhaps an electrical diagnosis has indicated what the ailment of the patient is.



Above—Electrical wave treatment received by a patient in a recumbent position.

Right—The patient sitting up in a chair receiving wave treatment in a different position.

High-Power Lightning Flash

WE reproduce the photograph of a very wonderful lightning flash which was taken shortly after midnight in a Western city.

Those who know the Northwest will see in the horizon line of trees a feature identified with much of the scenery there. Visitors to Vancouver will recognize this feature, the background of the Canadian Pacific terminal, which is crowded with trees, most of them denuded of foliage by forest fires, forming a characteristic setting for the houses.

The high degree of illumination produced by the discharge is a very remarkable feature, because a photograph of a lightning flash rarely shows so much of the country and so much of the foreground as well portrayed as we find it here. The reader will notice that even the letters on the advertisement signs can be read.

It brings out, too, another interesting feature of the lightning flash—the accepted artist's reproduction of the lightning flash is a zigzag, whereas actually the line taken by lightning is strictly



A wonderful lightning flash, with luminosity sufficient to bring out the advertising signs on the building in the foreground; a unique photograph.

sinuous, the zigzag being practically unknown, as all photographs of these dis-

charges demonstrate. The power of this discharge must have been incalculably great. It would be a curious speculation if the lightning discharge lasted for a minute, or even for a second, to determine the full energy. The shortness of its discharge, a minute fraction of a second, goes to indicate that the electric energy in the clouds is not anything great. It is the potential only that is enormous.

One of the latest developments in the way of a lightning arrester provides an air gap for the discharge to spring across to the ground. On one side of the air gap is what is known as a flash rod, connected to the line, and providing a great number of minute gaps. Then there is a main discharge gap to the ground. The flash rod is ready with the increase of voltage or frequency to induce a discharge across this gap. When the surge comes it forms an arc, and at each end of the flash rod and gap there are horns diverging at the top, which catch the arc and dissipate it.

The Teletype

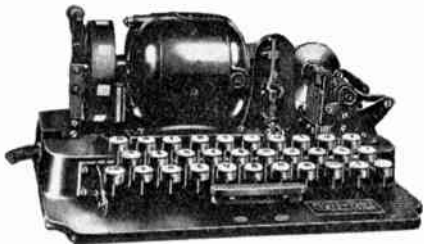

A transmitter which sends a telegraph message to a receiving station and caused it to be printed there by the receiving instrument.



The combined receiving and transmitting instruments; the keyboard is used for sending and is copied from the standard typewriter keyboard.

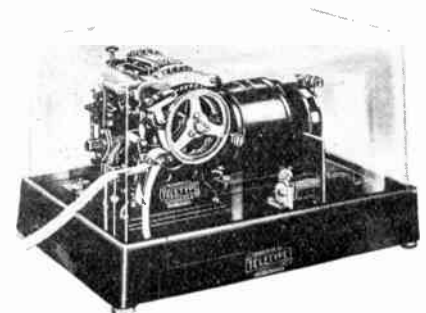

The receiving instrument; the message is printed on the tape, which is seen emerging from the left of the instrument.

THE illustrations show an interesting printing telegraph, which by real mechanism actuated electrically, prints a message on a tape. The electric signals sent to it over the wire are translated into printed characters and are impressed on a tape from a type wheel, somewhat as the too-familiar stock ticker prints its all-important story on the tape in Wall Street.

A station may be fitted with a keyboard transmitting machine, with a keyboard similar to that of a typewriter, on which the letters are arranged in the same standard order—so that a typist is at home with the machine. An electric motor drives it, and the message it transmits may go to several receiving stations at once. At the receiving stations there is a printing machine, the receiving organism, also operated by an electric motor,

which prints the message as it comes in. The receiving and transmitting machines can be entirely distinct, or can be built into one. If the latter arrangement is carried out, the receiver not only receives messages from distant points, but it prints the message sent out by the transmitter from the home station, and in this way a record is kept of the message sent.

interval, or in any two variously spaced, and so on for three and four intervals until current is transmitted into all five, or current may be transmitted in none. If this be followed out it will be found that 32 combinations can be made in this way. These 32 take care of the alphabet with one series, and of numbers and varying signs in the corresponding parallel series, like the shift in the typewriter.

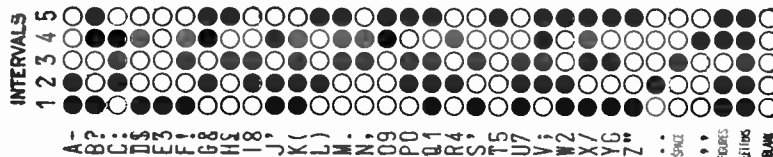

A diagram illustrating the five-interval system on which the Teletype is based.

The signalling code which transmits the character is the five-unit code. If a given unit of time is divided into five intervals, current may be transmitted in any one

It is out of the question for us, within the limits of our space, to describe the exact mechanism. Of course, in any machine of this sort the problem of synchronizing comes up. The way this is regulated is somewhat similar to that used in the transmission of pictures by telegraph. The receiver shaft, the shaft of the distant receiving instrument, is made to rotate slightly faster, 14 per cent is the figure, (Continued on page 379)

Combined Cigarette Picker and Lamp



A cigarette holder at the base of a lamp, with a stork which, when the finger presses a key, automatically picks up a cigarette for the expectant smoker.

THIS appliance is a very nice addition to the cigarette smoker's table. A rectangular box holds cigarettes and from the box a lamp standard arises, carrying an electric lamp. Towards the edge of the box there is a plunger, which, when

depressed by the finger, opens the lid of the compartment containing the cigarettes and makes a little bird bob over and pick up a cigarette from the selection below. On releasing the plunger it springs up, the bird goes back to its position, the lid closes, and the smoker has a cigarette at hand, ready for use, presented to him by the bird.

The combination is a most attractive one, and, as the illustration shows, the decorations of the box show an oriental strain, in accordance, we presume, with the bird. The Japanese are wonderful draftsmen when it comes to drawing birds. They are specially fond of storks and it will be seen that the birds on the box have all the life given them that one anticipates from the Nipponese artists.

A VERY prettily designed incense burner and deodorizer for the smoking room and for the boudoir in the present day, when ladies smoke cigarettes, is presumably highly to be desired. Here we have a young lady seated at the base of the lamp, the function of which base is to hold a burner which disseminates incense or a special vapor which will effectively cope with the odor of tobacco.

We have already illustrated a number of electrical incense burners, which are really getting to be a quite attractive phase in the application of electric current.

The incense burner proper is contained within the base of the lamp, which accounts for the large size of the base. The lamp burning in the shade above it pro-

Incense Burner and Deodorizer



A lamp arranged to distribute perfume through a room or to kill by its emanations the odor of tobacco left in an apartment by a smoker.

duces an up-draft, so that as the smoke or perfume issues from the base it will be caught in the air currents due to the lamp and disseminated through the upper part of the room.

This quick dissemination of the perfume is one of the improvements claimed for the combined apparatus.

Small Charging Rheostat

THE illustration shows a very compactly constructed resistance box to be used in charging storage batteries from direct current sources such as power or light lines, generators such as are used on farm equipment, or other isolated plants.

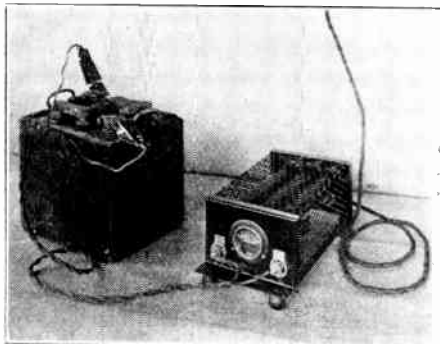

A rheostat for charging small batteries, mounted in a network case so as to be perfectly cooled; change of temperature, changes the resistance of most metals.

It consists of a series of resistance coils, which are arranged to be connected in series or parallel, or in other arrangements, so as to modify the resistance as required. The illustration shows that the coils are very well ventilated, which avoids overheating, and the whole apparatus is only 5 by 7 by 9 inches and weighs but ten pounds.

The general idea of the different types made is to give a charging rate varying from a very low figure of only 2 or 3 amperes, up to as high as 12 amperes, and they are constructed for three voltages.

One voltage is 32, which is the potential generated in the standard farm plant. Another one operates at 110 volts, and yet another at 230 volts, thus taking care of the standard lighting circuit.

A minor feature is the handle, by which it can be lifted about, and shifted around as desired—making a very convenient piece of apparatus, and one which is adapted to take care of the conditions encountered in every-day practice.

WE have had frequent occasion to describe in our columns applications of the fan motor for doing various things about the house or laboratory. The fact that a number of suggestions of this nature have reached us indicates that there is really a field for a small motor adaptable for many requirements. The one we illustrate is a most convenient piece of mechanism which has been developed for laboratory and amateur workshop use and for experimental work. One of its uses is for experimenting with centrifugal and rotating apparatus.

Much work is to be done in this line. The attainment of kinetic and dynamic balance in rapidly rotating machinery is still to a certain extent a desideratum. To the scientific lecturer, too, a whirling apparatus is of use for his demonstrations in centrifugal and rotary phenomena.

The motor is cylindrical in shape, 3 1/4 inches in diameter and 4 3/16 inches long. The shaft, 1 1/4 inches in diameter, extends out 1 inch from each end. The motor is carried by a pedestal. To the top of the upright of the pedestal it is at-

Laboratory Motor

tached by a swivel joint, by which it is possible to tilt it in any direction. A thumb-screw fixes it in the desired position. The support contains two sockets, one vertical and one horizontal, which still further increases the range of posi-

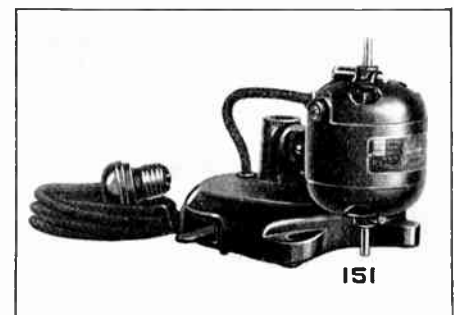

A very neat and compact little laboratory motor which will find uses for many purposes, even in ordinary household work. It can be inclined at different angles for all requirements.

tion which is possible with the motor.

The base of the pedestal contains a speed regulator by which a very complete variation of speed can be obtained.

The motor is wound for a 110-volt circuit, and worked on either direct or alternating current, whose frequency may vary from 25 to 60 cycles. Its maximum no-load speed is approximately 10,000 revolutions per minute. In the full load the speed drops down to 6,000 revolutions per minute, and the motor then develops about 1/30th of a horsepower, or not far from 25 watts. Its weight is about eight pounds.

True Electrical Experiences

Including Description of Some Electric Problems Encountered in Practice, and Their Solution

(Continued)

By H. Winfield Secor

Associate Member, American Institute of Electrical Engineers



An accident which might have been a very serious one, due to the fact that the electrician stood upon a wet support. A very bad shock was received.

IN the June issue of this journal, the writer described in his article entitled "True Electrical Stories," some rather unusual experiences, and in the present paper, he will endeavor to explain a few practical problems which he has faced in his experience, with their solutions, which may be of value to the electrical student.

Some years ago when the writer was a "trouble-shooter" for an electrical repair shop in Philadelphia, he was sent to a fish market to repair a chandelier, which lighted several large marble slabs or tables on which oysters were opened. For several reasons, it was hardly possible to cut off the current from the electric light circuit and so, as was often the case, the defective lamp socket had to be repaired with the parts alive. As shown in Fig. 1,

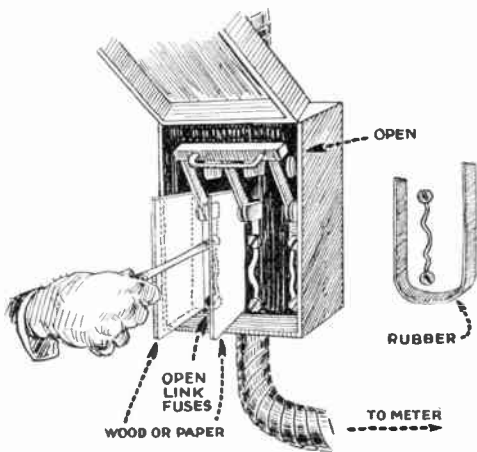

How to work safely with a screw-driver in a switchbox when replacing burnt-out fuses.

an amusing incident occurred, that is, the recollection seems amusing now. As the marble slabs were wet with salt water, it was deemed advisable that a dry box or other piece of dry wood should be used to stand on. A couple of apparently dry boxes were procured, but when "yours

truly" mounted the boxes and touched one of the live parts of the socket—Zowie!—there was "something doing" right away.

The reason was that these boxes, although apparently dry, were actually damp with brine, and served to conduct the current which passed through the body down through the wet marble and the leg of the table to the ground. This trouble was finally overcome by purchasing several copies of a morning newspaper and standing on them, which proved to be a first class insulator.

The diagram given illustrates how a shock is obtained by standing on the ground or anything that forms a conductive path to the ground, on a three-wire system, the neutral or central wire of the system being grounded at periodic intervals. If one touches either outside wire, he receives a 110 volt shock, via the neutral ground wire.

Replacing burnt out fuses is not always the sinecure that one might think, and a burned hand or injured eyesight may easily result, if certain precautions are not taken in performing the operation. Cartridge fuses are of course, fairly easy to replace, but even then the sensible electrician will always see what he is standing on before he touches a fuse, unless both fuse terminals are rendered absolutely dead by suitable cut-out switches. Usually, however, one side of

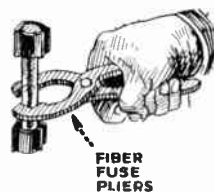

How to handle fuses safely with insulating pliers.

the fuse terminals is left alive, and care must be taken to see that you do not stand on damp ground or on any metal object, such as a register, which may be grounded through a heating or other system, as an unpleasant shock may be obtained when the screw driver or the fingers of one hand touch the live side of the fuse.

Small cartridge fuses can be plucked from their spring clips straight outward, and should be inserted the same way. Large cartridge fuses invariably have to be removed by pulling first one end out and then the other. Removing cartridge fuses is greatly facilitated by employing a pair of pliers made of fibre or bakelite, after the design shown above. In removing link fuses more care has to be exercised than in the case of cartridge fuses, as when the screws are loosened, the fuse may loosen and fall across to the metal fuse box or to another terminal, and cause a short circuit which may melt the wire with a terrific flash and injure the eyesight or burn the hand.

It is a good idea to place a piece of rubber packing, cloth, fiber, cardboard or any good insulator like this, at least between the link fuses, and preferably around both sides of the bottom of the box, so that the screw driver cannot touch the live fuse terminal and the metal box. It is surprising how frequently otherwise, one will drop a screw driver or

a pair of pliers across terminals, so as to make contact with one live terminal and the grounded conduit box, causing more havoc.

Did you ever connect up a long string of lamps for a lawn festival or picnic, and

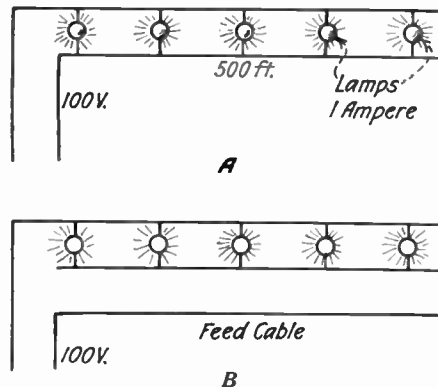

The proper way to connect lamps to a feed cable to equalize the potential received by near and distant lamps.

when you threw in the main switch, find that the lamps toward the far end of the circuit were burning much more dimly than those nearest the switch end of the circuit? The writer remembers a case like this, and no doubt it has happened to many readers. Referring to diagram, you will see clearly what is meant; at A the 500-foot circuit with lamps spaced say 10 feet along it, is fed from one end, and the solution of this problem so as to give an equal potential to each lamp, is to connect one of the feed wire cables to the opposite end, as shown in B. By tracing the circuit through the lamps at either extreme of the run, it becomes evident that the length of circuit through the feed wires and any lamp is practically equal, thus equalizing the voltage distribution among them. Another way of more equally dividing the voltage drop on such a long circuit, is to connect the feed wire cable at the center, instead of at one end.

What would you think of the following electrical conundrum? Suppose you were called in to look at a dynamo, and it was

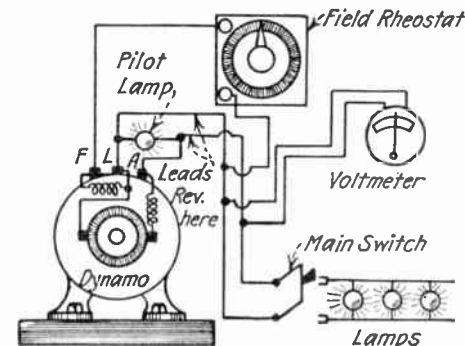

A case of dynamo operation which puzzled the electrician when he first observed it; the diagram and text gives the explanation.

explained that when the dynamo was started up and brought to normal speed, the voltmeter on the switchboard indicated full voltage, while the pilot lamp on the machine also glowed brightly; but when the lamp load was connected to the

dynamo by throwing in the main switch, the voltage immediately dropped, and the belt on the machine invariably flew off. This proved a puzzle, especially after the circuits had been tested and were found to be complete through the field and armature; but by mental deduction and a little questioning of the engineer in charge of the plant, it was suspected that some of the wires had been transposed with regard to their connection to the dynamo and the switchboard. Especially did this seem probable when he mentioned that the dynamo had been upset from its base in the morning, due to the fact that some change in the driving arrangement had

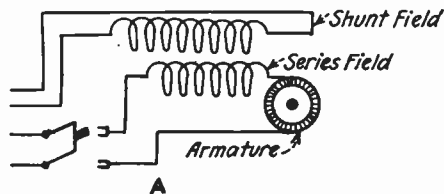

A good and practical way of determining polarity in the field, with simple appliances.

been effected, and the nuts had not been put in place before the engine was started. The result of this was that the wires had been ripped loose from the terminal connections on the dynamo connection block, and while they looked as if they were in their proper places—the answer was that they distinctly were not—and the diagram clearly shows that two of the wires were transposed. With the aid of a series field, and the natural residual magnetism in the iron field frame, the machine would build up and register approximately full voltage; but as soon as the load was thrown on, the shunt field winding being short-circuited on itself, there was not sufficient field strength to take care of the load, and so the voltage fell off rapidly. When this fact was ascertained, and the lead wires replaced in their proper positions, that is, simply transposed, the dynamo took care of its load without trouble.

The testing of compound wound dynamos and motors is not one of the easiest things, especially when shop testing conditions involving scarcity of instruments are such that the correct polarities of the series and shunt field poles cannot be determined. One of the members of our old

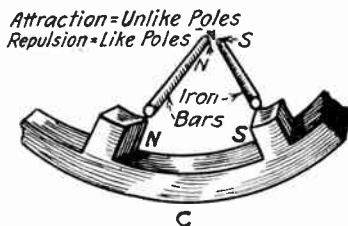
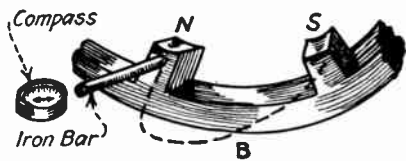

Another simple method of determining the polarity of adjoining poles of a stator.

“trouble shooting” staff used to have a trick way of determining whether or not the shunt and compound fields were magnetizing the poles in unison or differentially. Usually, it should be stated, the shunt and compound or series field windings act in unison, that is, each magnetizes one end of the pole north or south,

as the case may be; in the differentially connected machine, the series field windings “buck” the shunt field windings, for reasons which do not have to be explained here, but both of these types of connections are fully described in dynamo and motor text books.

In making shop tests, the polarity of the field poles due solely to the series or heavy windings, is determined by passing a fairly heavy current through them from a rheostat connected in series. Then a second test is made with the shunt field, checking up the polarities in both cases with a compass needle or otherwise.

The trick we refer to, of making these tests in the field when no rheostats or other apparatus was available, such as a storage battery or a lamp bank to permit of passing sufficient current to magnetize it for testing, resolved itself simply into operating the machine as a series motor (even if it was a dynamo), by quickly opening and closing a switch connecting a 110 volt supply with the series field and armature connected as shown here at (A). If the armature spun in the right hand direction, let us say, viewed from the pulley end of the machine, then this was checked with a second test, wherein the shunt field winding was connected in the usual way, and the direction of the rotation of the armature noted. If the armature rotated in the same direction

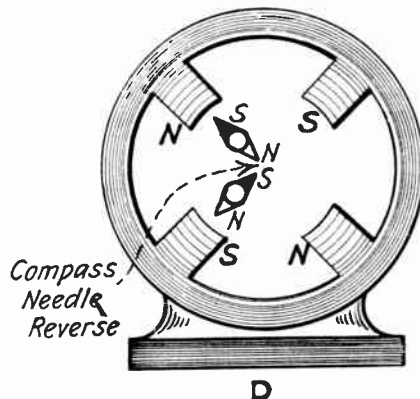

The action of a compass in a four-pole field, illustrated, and what it tells the electrician.

in both tests, the fields were connected in unison or aided each other; if the armature rotated oppositely in each test, then the shunt fields were bucking or acting differentially. Usually it will be found feasible to connect a lamp bank or other resistance in series with the armature circuit, shown at (A), as the fuses are liable to pop when this trick is tried, unless the series field has a relatively high resistance. In making the test as a shunt machine with the series field cut-out, i.e., the second test referred to above, the usual connections for any shunt machine should be followed, the resistance being cut out of the armature circuit gradually, to allow the machine to accelerate. If you try to connect the 110 volt supply circuit directly across the armature and shunt field, the low resistance of the armature will be very likely to cause it to be burned out, and in any event will blow a string of fuses clean back to the power station.

A few words on the testing of north and south polarities of the field poles of dynamos and motors may not be amiss. An ordinary pocket compass, the smaller the better, is moved slowly from pole to pole, as indicated by the dotted line, and then moving it toward the second pole as in (B), the two alternate poles, if they are north and south polarity, will attract opposite ends of the compass needle.

With powerful fields, or for other reasons, it is not always desirable or possible to bring the compass needle up close to the poles, which may cause it to be demagnetized and remagnetized and cause confusion and a mistake in the test. To prevent overpowering the compass needle therefore, it is a trick among experts to use a screw driver or piece of iron bar, one end of which is placed in contact with the pole face or shoe under test, and the

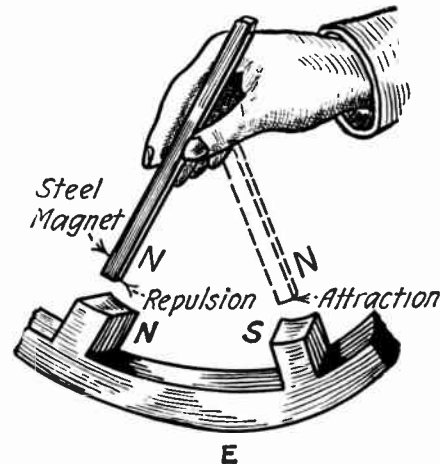

A permanent steel magnet, used to determine the polarity of different parts of a field—like poles repelling, the unlike poles attracting.

compass needle is then brought near to the outer end of the iron bar. This makes a very excellent method of accurately determining the field pole polarities. If both poles attract the same end of the compass needle, then they are of the same polarity and the terminals of the coil at one of these poles should be reversed in order to correct the polarity.

A compass needle is not always at hand and some other method of testing field poles is always welcome; (C) shows well how two iron bars (files or screw drivers) have been used) may be employed to determine the polarity of two field poles. If the two poles are of opposite polarity, that is north and south, the free ends of the two iron bars will be strongly attracted as you hold them in your hands; if the two field poles are of like polarity, then

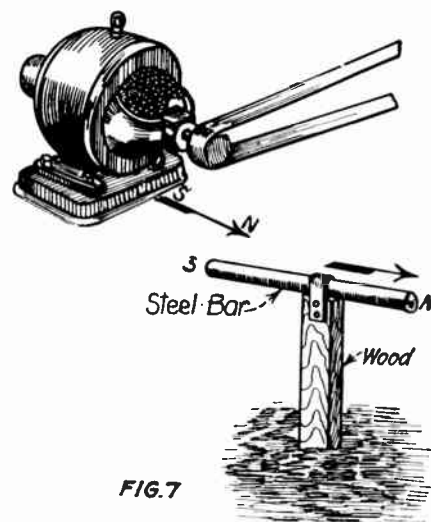

The influence of the earth's field upon an electric generator; the influence of position upon starting the generator into action.

there will be practically no attraction between the free end of the iron bar. At (D) are shown the relative polarities, (Continued on page 378)



New Things Electric

English Marine Ovens

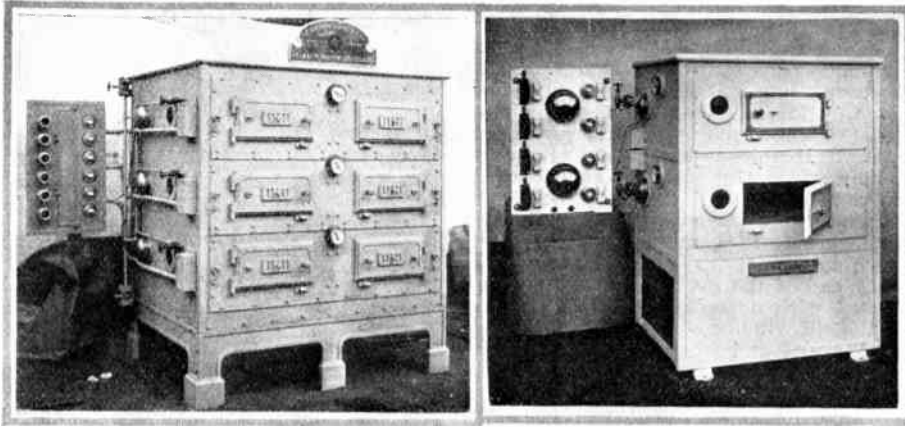

Two views of an English electric oven, designed especially for marine use; the left hand view showing the oven divided into six compartments, the right hand view showing another type with fewer divisions.

OUR illustrations show electric ovens manufactured by an English firm, and especially designed for use on shipboard. They are constructed of steel plate with

several ovens. In some there are heating elements above and below so as to secure any distribution of heat, and as each set of elements is controlled by its own

switch, any effect may be produced in the oven, in the way of top or bottom heating as may be required.

The ovens are provided with a window in the front, and a light at the back, so that the interior can be inspected at any time without opening the door—which would seem to be quite desirable. The doors are secured in different ways; in one construction the rotating of a central handle shoots out four bolts, above and below and to both sides. In another oven a simple connection at the opening end is used.

A steam boiler with glass water gauge, safety valve and automatic water feed is a part of one type of oven. In this oven there are several compartments, and provisions are made for steam heating. Thus, two widely different types of oven are produced. There are steam jets provided for each oven, in order to secure steam cooking.

The total loading ranges from 10 to 30 kilowatts; for cooking cannot be done without heat, and heat resolves itself into power.

Bird Lamp Shades

Small Battery Chargers



A lamp shade in the shape of a bird, a very pretty and suggestive design which can be modified and worked up readily.

FROM our English cousins comes the very pretty lamp shade illustrated here, of which quite a series is manufactured. The series are all reproductions of birds, the bodies made of cork and silk-covered. The spread wings of silk as well as the body and expanded tail, are hand-colored, so as to produce certainly a very life-like effect and really an ornamental one.

It is quite the fashion now to avoid absolutely direct illumination, and these pretty little birds, hung as shown in front of the bulb, prevent light rays from reaching the eyes of the observer directly, while light is disseminated through the apartment. The birds are supplied in all colors, which appears to be an improvement on Mother Nature, who seems to make each kind of her birds the same color, as a general practice. They are supplied with three forms of fittings, so as to be adapted for lamps, high or low, the angle, of course, having to be changed according to the level of the burner.

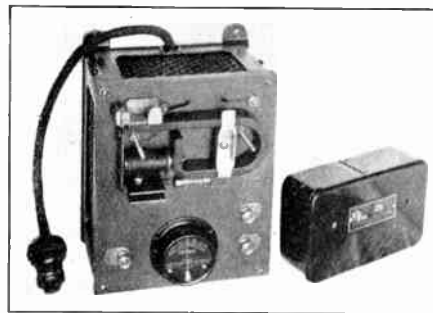

A small battery charger, rectifying a house current for charging small batteries. The movable parts are shown exposed in the illustration, but are to be enclosed by the case in practice.

The illustration speaks for itself, and the shields, as they are called, or shades, as we would call them, are supposed to be adapted for theatres and restaurants as well as for private houses. We presume that for Maeterlinck's use, a bluebird lamp-shade would be in order.

IN charging a small battery, the great points to be attained are simplicity and adaptability to the every-day circuit. Of course, in a large establishment with its own plant, where heavy work is to be done, all sorts of requirements in the direction of high efficiency are expected and exacted. But for small work, the great desideratum is simplicity.

We illustrate two examples of compact little chargers, which take care of the voltage of a house circuit and also rectify half the current. In one of the chargers, one which has the ammeter on its face, there will be observed three binding posts near the base. The one on the left

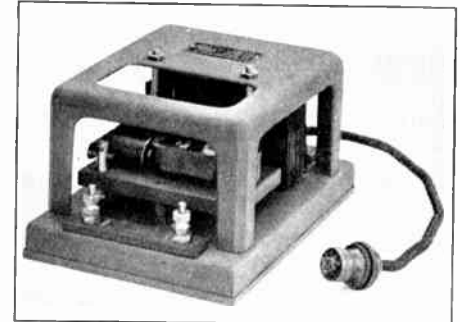

Another version of the small battery charger, this time with a case partially open to vision, the open panels being filled with glass.

is the negative, for connection to the negative pole of the storage battery, and the other two on the right are positive connections, one for 6 volts and one for 12. The way in which the 12- and 6-volt connections are arranged is quite simple.

The machine contains a transformer, which cuts down the voltage of a lighting circuit to a maximum at the terminals of the secondary, of 12 volts. From one terminal of the secondary a wire goes to the 12-volt binding post. From the center of the secondary another wire goes directly to the 6-volt positive post. As the central connection makes only half the secondary active, the possible terminal voltage of 12 is cut in two.

The electro-magnet coil is in parallel with a 6-volt division of the circuit. The other terminal of the secondary passes through the armature of the magnet. At the lower end of the armature is an adjustable contact, so that a make-and-break is established here. When attracted, the

(Continued on page 379)

Marine Dynamamos

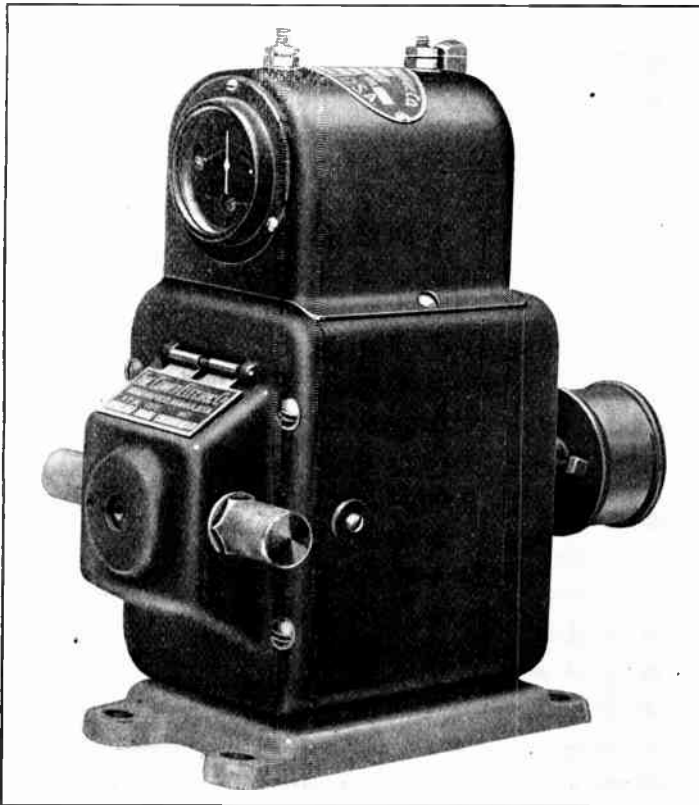

A marine dynamo, with all parts enclosed as far as possible, protecting it from moisture incident to marine conditions. The lay-out is a model of completeness and compactness.

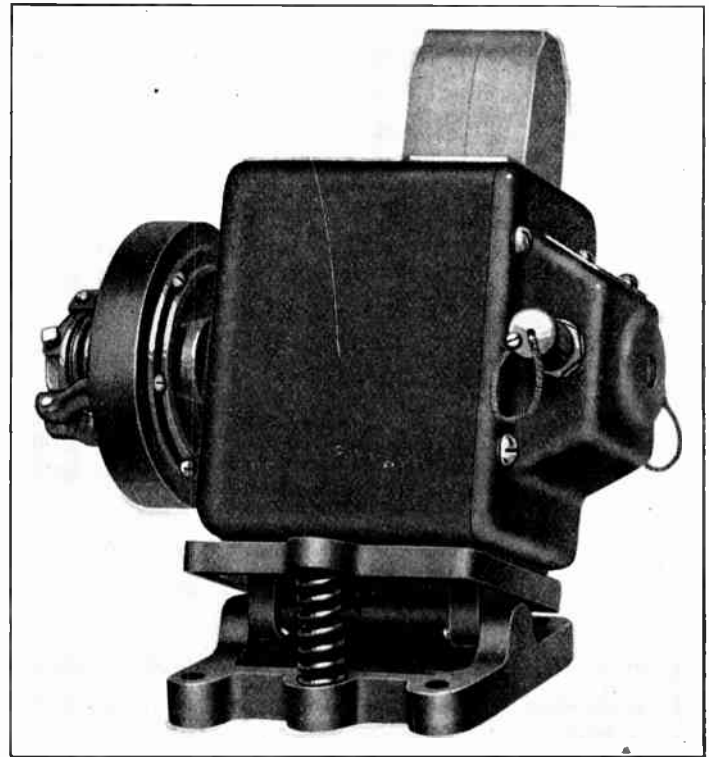

Another view of the dynamo, showing how by tipping it on its frame the belt tension may be regulated, this being a substitute for the ordinary system of slide-rest.

THE dynamos illustrated by us are designed for marine use, for supplying the lighting circuit and charging storage batteries. The description of the machine implies two qualities—that they are constructed on conservative and established lines, not on anything novel, and that the best materials are used so as to secure high efficiency.

Soft electric iron is used for cores of field and armature to secure the best results in establishing a field of force. The armature is laminated, of course, and made up of punchings, in accordance with the usual practice. The armature slots are insulated with fibre, and the armature windings are double insulated, while the

field windings are nude up, taped, and baked before being inserted into their place in the field. The commutator is often a source of trouble, and in this case is made of special copper; the mica insulation between the leaves of the copper is supposed to wear away at an equal rate with the copper. Such, at least, is the statement of the manufacturers.

The generators are all small sized and are given ball bearings which are very reliable for light machinery. Storage batteries may be floated on the line, in which case an automatic control connects and disconnects the battery, according to the voltage, so that when the battery voltage runs down, the generator is automatically

thrown into circuit to recharge it. Zinc plating, so-called galvanizing, is used where required, and the general finish of the apparatus is a baked enamel. It may be regarded as well protected against rust—a great trouble on the salt water.

Some of the generators are adapted for charging Edison storage batteries in motor boats. The Edison battery can be charged with a very heavy current, and these machines will give it.

Another feature of this machine is that the adjustments are done away with—all positions of parts being fixed.

The pivotted tightening base is shown in one of the illustrations.

A Power Vacuum Cleaner

THE vacuum cleaner was one of the great household improvements, due to what may be called the domestication of the electric current. When first introduced into homes, electricity was only for lighting, or occasionally for motors, until little by little other appliances entered into the field. It is fair to say that the vacuum cleaner, up to the present time, is one of the most important accessions to the electric home that has yet been invented.

For cleaning large buildings and large floor areas the ordinary vacuum cleaner is hardly enough. Its operation is too slow, as it only takes in a small width at each passage. Again, in a large building, where the ordinary type of large vacuum cleaner is used, piping has to be installed, with sufficient outlets to enable the floor area to be covered by the machine in its travel.

To install a complete central station vacuum-cleaning plant in a large building is a matter of considerable expense. To

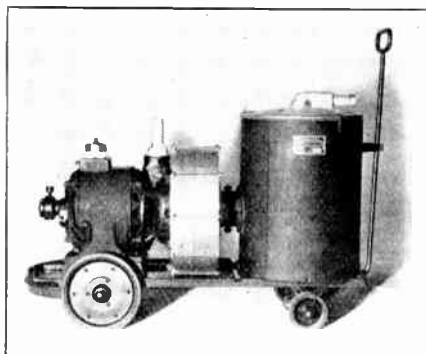

A vacuum cleaner, of large dimensions, operated by a centrifugal fan blower, and carried on a four-wheeled base so as to be moved about as required.

give power and speed to the vacuum cleaner, and also to enable it to cover the largest room without the use of pipes, and the annoyance of coupling and uncoupling them perpetually, a magnified

self-contained vacuum cleaner has been placed upon the market.

A four-wheeled car carries a 1½-horsepower motor, wound to match the house circuit. This operates a series of centrifugal fans, with a speed of 3,500 revolutions per minute, which arrangement gives 44 inches' water gauge vacuum, and passes 130 cubic feet of air per minute. The dust separator, it is claimed, is so perfect that the exhaust of the machine can be used for blowing purposes while the vacuum end is cleaning. In some cases this gives the cleaning a double speed, both ends working at once. The whole, including motor, fans and dust receiver, with its case, are carried on a channel-iron frame with ball-bearing wheels.

As the illustration shows, most of the weight of the apparatus is on the left of the center; so the wheels on the left end, whose axle is under the motor, are of large diameter, while those in front, which have only comparatively little weight to

(Continued on page 379)

Automatic Electric Rivet Heater

By Maurice E. Pelgrims

Antwerp Correspondent PRACTICAL ELECTRICS

THE present high cost of fuel and labor demand the employment of efficient labor-saving devices in order to keep down the cost of production and successfully meet competition. One of the most novel of labor-saving devices is, no doubt, the present electric rivet heater, which has just made its appearance in England.

The furnace is of the resistance type, to be operated either on single-phase or direct current circuits, the rivets being heated by conduction and radiation in practically a non-oxidizing atmosphere. There being no products of combustion to be dealt with, the rivets are heated under ideal metallurgical conditions. They are fed into the furnace with the shank end foremost, and are automatically discharged at the other end of the furnace at the correct temperature for riveting. The rotation of the cylinder effects the travel of the rivets through the furnace, the speed of rotation being adjusted to give the output of rivets required per minute. In the event of the rivet being fed into the furnace with the head instead of shank foremost, the rivet is automatically discharged at the feed end of the furnace, making the apparatus fool-proof against incorrect feeding.

Rivets smaller in diameter than the maximum size for which the furnace is constructed, are automatically heated and discharged at a proportionately increased output, although the speed of rotation of the furnace may remain constant. The time taken for a rivet to travel through the furnace is dependent on the speed of rotation, the size of the rivet, and the ratio between the length and diameter of the rivet. As an example, when heating rivets of the same diameter but of unequal length, the heavier rivet takes longer time to travel through the furnace, thus automatically obtaining the longer time ele-

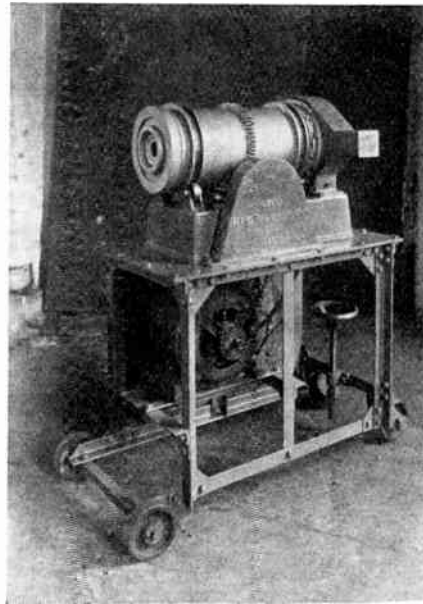

The European solution of the problem of heating rivets. This is an English machine working automatically, and which seems to embody the intelligence of a rivet boy.

ment required for heating a large mass of metal to the same temperature, and vice versa, when heating small rivets.

These unique features enable this rivet heater to operate at practically full load with maximum efficiency, irrespective of the size of the rivets which are being heated. The electrical gear for controlling the motor and current input to the furnace is mounted on a panel conveniently situated for easy control. The motor and heating circuit are electrically connected in parallel, so that when the motor is stopped the current is automatically cut

off from the heating circuit. Tests made with the type of machine illustrated demonstrated that 150 rivets, three-quarters inch in diameter and two inches long, were heated with current consumption of 5 B.O.T. units, inclusive of the current required for driving the motor. The time required for the rivet heater to reach its maximum temperature from the first opening of the switch is approximately 25 minutes. The heating chamber is of special refractory material, capable of standing temperatures up to 1,600° Centigrade without softening or distortion. The heating element consists of a winding of special alloy wire and the method of winding adopted is one which eliminates all electrical joints, providing ample provision for expansion and contraction due to thermal effect.

Recently we illustrated a rivet heater of widely different construction in which the principle of the electric welder was utilized for heating each rivet individually. In its use the attendant had to put in each rivet individually and according to the width of the machine more or less rivets could be heated simultaneously—the idea, of course, being to heat them just as rapidly as the attendant would take them from the clamps and replace them one by one. But in the machine, which represents the English version, the automatic feature appears, and it really would seem to be exempt to a great extent from the danger of overheating, which is at least suggested by the incandescent system utilized in the other machine. It hardly appears natural to find our cousins across the sea surpassing us in the introduction of the automatic feature into a mechanism.

It would certainly seem a great advantage to be free from such detail as the placing of the rivets one by one with at least some degree of accuracy in the clamps.

New Electrical Massage

THE Montefiore Hospital in New York has been giving a great deal of attention to the use of electrically driven apparatus for treating certain types of diseases. This development is somewhat in the line of massaging by machinery.

One of our illustrations shows a patient having the muscles of the back massaged by a rotating apparatus, which carries a series of rollers, mounted in cylindrical contour, which is turned around, while pressed against the back. The object is to restore muscles to their proper strength and flexibility. Other cylindrical surfaces than the roller arrangement can be applied to the back, so that, by the use of different rotators, any variety of massage can be given.

Another illustration depicts the treatment of the feet by a foot-vibrator. The patient is having the soles of the foot acted on by the rotating cylinder shown. This illustrates a vigorous massaging applied to the soles of the feet, probably more intense than could be done by hand.

The results of these mechanical appliances the authorities at the hospital seem to have found very beneficial.

The main object in all this treatment is to restore the use of atrophied muscles.

Our readers will recognize in this massage apparatus an excellent substitute for the "Daily Dozen," of which we hear so much now. It is incontestable that such massaging as here produced would be most beneficial to the patient, and it certainly is a great point that it can be done

by the all-adaptable electric current, without requiring the assistance of the professional masseur or masseuse.

There are, of course, innumerable other

rollers could be connected to a source of static electricity, so that a continuous discharge would accompany the massaging action—giving it a double effect. It is not



Application of electrical massage to the soles of the feet, the position and pressure being governed by the appliances shown, as actuated by the patient.

Massaging the back by the rotation of a cylinder made up of rollers arranged around its periphery.

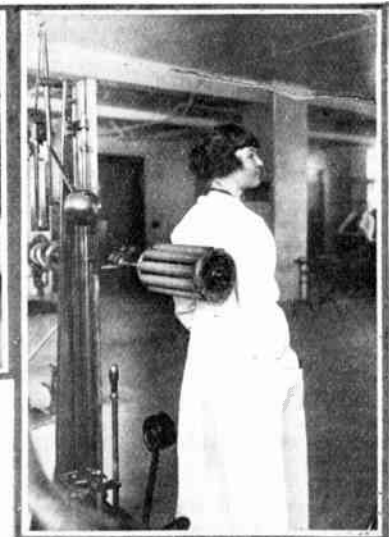

applications which could be carried out in this line, for electricity lends itself to every possible variety of treatment. In both the cases illustrated here the degree of pressure is left to the judgment of the patient herself.

It is evident that this apparatus would lend itself to electric excitation along with the mechanical massage, that the

always thought prudent to permit a patient to apply electric treatment to himself to any extent that may appeal to him, but this apparatus certainly suggests the possibility of applying most efficacious electrical treatment.

Combined Bell and Buzzer

Advertising Cigar Lighter

THIS appliance, containing what may be termed a three-armed horseshoe magnet, although any resemblance to a horseshoe would seem to be eliminated by the central coil, is constructed to give two distinct signals, one that of a bell and the other that of a buzzer.

The idea is to use one signal placed where it can be heard by the occupants of the house in any usual place, to have one connection to the front door and one to the back, with the usual push buttons on the door jambs.

On pushing one of the buttons, the bell rings, and on pushing the other, the buzzer sounds. In this way a visitor announces by his signal, ring or buzz which door he is at. A single apparatus does the work. When one button is pushed, which may be at the front door, the bell signal may ring; then the button at the other door when pressed will cause the buzzer to sound, and the reverse arrangement can be brought about by shifting the connection. It is a sort of two-in-one apparatus, for ordinarily there would be a buzzer for one door and a bell for the other.

Electric bells have a mysterious way of getting dirty. The appliance we describe is so completely enclosed, bell and all, that there is no chance for dirt to get in.

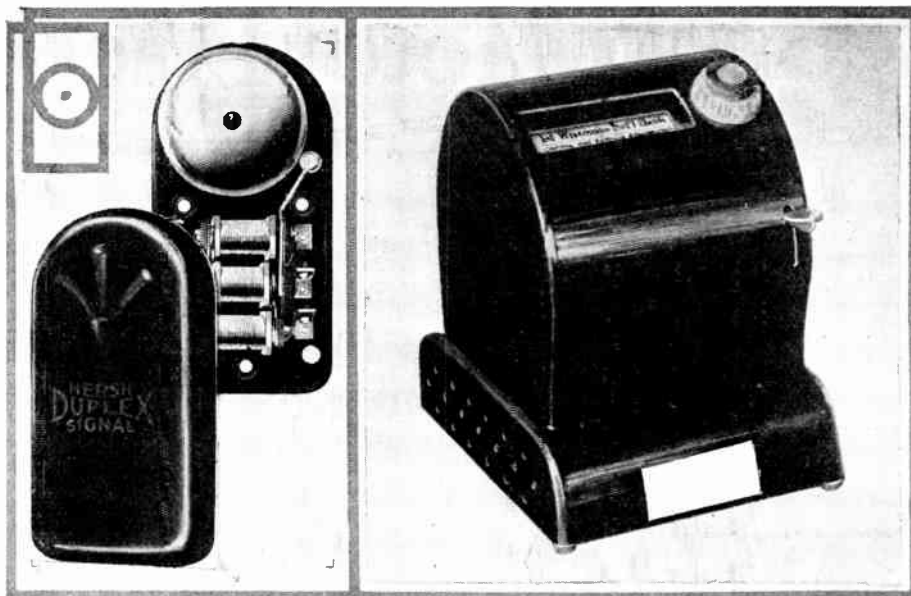

A combined bell and buzzer, employing a three-voil electro-magnet—a suggestive construction. There are two push buttons to operate it, placed in different positions, as at the front and rear doors of a house, one sounding the buzzer and the other the bell.

A cigar lighter—this not only lights your cigar, but tells you where to buy various things as advertised upon a moving strip seen through an open panel on the top, and constantly changing.

WE have all heard of the Wisconsin idea. This term is applied often to some of the many new ideas in politics, and the administration of law originating among the inhabitants of this progressive State. Now we have their idea of how to light a cigar and study an advertisement simultaneously.

Within the case shown there is a reel

which carries 17 different advertisements. As the reel turns, the advertisements are shown, one by one, through the window in the top of the case. Alongside the window is a cigar lighter, and below is a switch handle. When the switch is depressed, the cigar lighter becomes hot

and ready to light the cigar. To its left, an advertisement, one of the 17 varieties, is displayed for the contemplation of the smoker.

The current is supplied from the regular service line, so that no battery is needed; the machine takes care of itself.

Combined Storage Battery and Charger

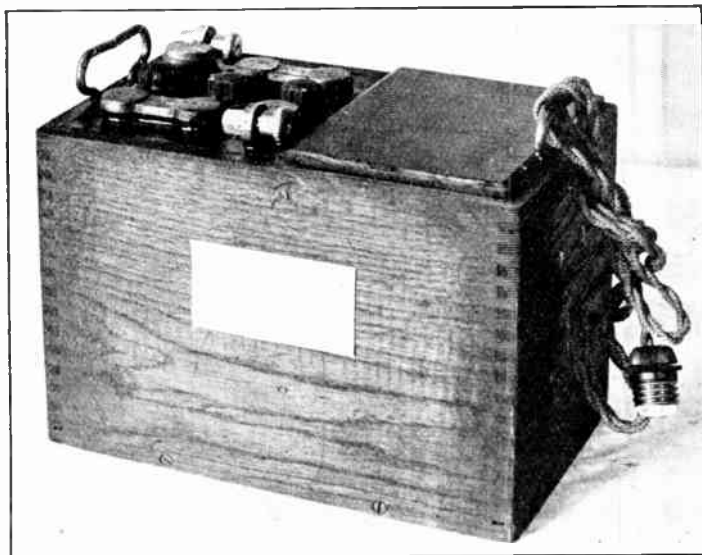

A storage battery enclosed in a wooden case which it half fills. The other half of the case contains a rectifier, so that there is a complete battery and rectifying plant provided. The battery is seen on the left and the rectifier is on the right of the case.

WE illustrate a very interesting example of a storage battery enclosed in an oak case and provided within the case with connections for charging it. Ordinarily, to recharge a battery the charging leads are connected specially to the terminals and the current sent through, but in this combination, all that is necessary for recharging is to plug in the connection to a lamp socket.

The one we illustrate contains three cells, giving the typical $7\frac{1}{2}$ volts, or thereabouts, which we are so familiar with.

The right-hand compartment, as we look at the battery, contains a rectifier, so that an alternating current lamp socket can be used for charging. The combination of the whole thing in one case and the arrangement by which for charging nothing is necessary except to tap the every-day lamp socket, constitutes a most convenient battery.

One of the interesting points about the storage battery on an automobile is that it is constantly being automatically charged. No one gives any attention to it, and

here we certainly approach the automatic principle, for the moment one notices the voltage being somewhat low, or finds the electrolyte falling in specific gravity below the proper amount, a few seconds connects it to the house circuit, and the charging operation begins, and is completed in one night.

We add to this description the following items from "Things Worth Knowing About a Storage Battery," which we are sure will interest our readers:

- That a battery receives its life acid at its birth and should receive no more.
- That a battery will freeze at zero, when half charged.
- That a battery can stand 90 degrees below zero when fully charged.
- That a battery that has been frozen once, never regains its former strength.
- That it is very injurious to a battery to let it stand in a discharged condition.
- That it is as injurious to over charge a battery as it is to have it stand in a discharged condition.
- That a fully discharged battery requires from 24 to 36 hours to recharge.
- That a fully charged battery should read $2\frac{1}{2}$ volts when connected to a 5-ampere charging line.

The reason why overcharging may injure a battery is because it is liable to become heated, and this injures the plates.

It is little less than astonishing, however, to realize the abuse which storage batteries will stand. This is seen on automobiles which start badly, and where a battery has its charge drawn upon far in excess of the proper maximum.

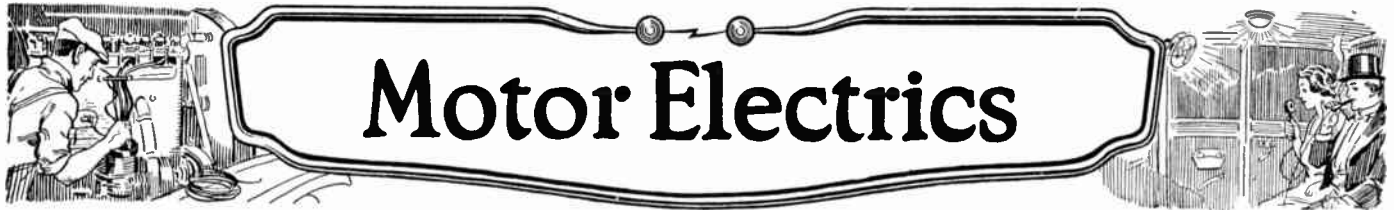

Motor Electrics

Gasoline Supply Alarm

THIS description and diagram is of an automatic gasoline supply alarm which can be used on any make of automobile. Near the bottom of the tank is connected a small cylindrical chamber in which is laid a wooden float with a thin strip of

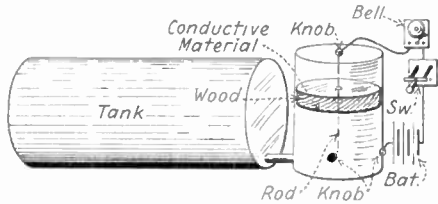

An electric alarm for notifying the automobilist when he is getting close to the bottom of his gasoline tank. It can be adjusted to ring at any desired point, when only a gallon of gasoline is left, or when two gallons are left, or any other quantity.

conductive material, copper, fastened to the lower side. Upon each end of the rod which passes through a hole bored in the float are two knobs, one of which is on a level with a similar one in the side of the chamber. The circuit is made up of an electric bell, a lever switch for breaking the circuit when not needed and the battery, either storage or dry cell. As the gas is being used, and as its level sinks, the float reaches the bottom of the side chamber, closes the circuit by touching the two knobs and rings the bell, which warns the driver that his gas supply is low.

Contributed by HOWARD J. STOVER.

Protective Circuit Alarm

THE ordinary automobile generator, when connected in circuit with the starting battery, delivers between six and seven volts. Should the circuit be opened while the generator is in operation the generator voltage will immediately rise to approximately twenty-four volts.

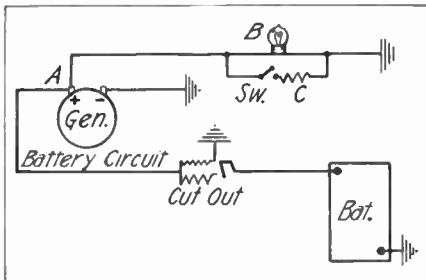

An arrangement for taking care of an annoying accident that sometimes burns out lamps and does other injuries on an automobile.

The generator designed with low resistance for the six volt circuit will have enough amperage forced through the internal circuit by the higher voltage to cause excessive heating. As a result, the shunt field will be burnt or the solder will be melted and thrown out of the commutator by centrifugal force.

The burning out of generators, accompanied in many instances by the burning out of all lights on the car, from this cause, happens frequently as automobile electricians well know. The reason for the increase in voltage requires no lengthy explanation. The battery circuit, having

lower resistance than the field circuit, takes most of the current delivered by the armature. Upon opening the battery circuit, the shunt field coils, receiving the current that formerly went to the battery, build up the field magnetism, the increased strength of the field flux in turn building up the armature voltage until the results mentioned obtain.

An attachment to prevent damage to the electrical equipment is herewith described. One side of a twenty-four volt lamp (B) is connected to the positive terminal (A) of the generator. The other side is connected to a ground or the negative generator terminal depending on whether the car has a grounded or two-wire system. A resistance (C) which is approximately of the same value as the resistance of the battery, is shunted around the lamp in series with a single pole switch of any type. This switch is normally left open.

In operation, when the battery circuit is closed, the six volts generated are not sufficient to cause the bulb to light up. The small current which leaks through the lamp is negligible. However, in case of an accidental open circuit in the main line the rise in voltage will cause the lamp to light. When the lamp lights, the switch is to be closed, throwing the resistance in the circuit, the resistance then taking the place of the battery in holding down the voltage. The lamp will then go out again, and it will be safe to continue driving until an opportunity presents to get to a service station, where the trouble may be remedied.

The globe and switch are to be mounted on the instrument board, where the lighting up of the globe would immediately come to the attention of the driver.

It would, of course, be possible to close the switch automatically by means of a cut-out such as is used in the battery circuit, but that would defeat the purpose of the arrangement, which is to draw the operator's attention to the fact that trouble exists.

Contributed by ARTHUR C. BONN.

Illuminated Route Card-Holder for Tourists

By MAURICE E. PELGRIMS
Antwerp, Belgium

MOTORCYCLISTS and automobile owners who enjoy long journeys on the road will welcome this illuminated map and route card-holder, which can be easily

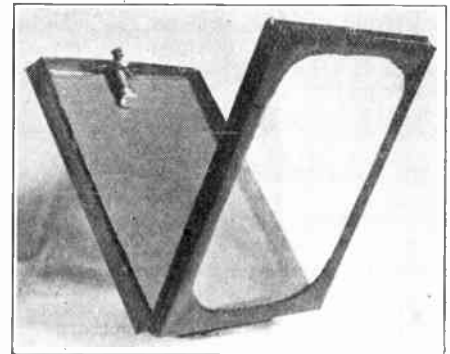

Reproduction of a photograph of a chart holder; this holds the route card safe from wind and rain and in full sight of the chauffeur.

fitted to handlebar or steering wheel. The device is entirely self-contained and has a transparent front which moves on hinges to allow the map or card to be inserted.

The map is illuminated by a flashlight bulb carried inside at the top. Affixed to the back is a switch and an ordinary flashlight battery is enclosed. One wire is led to the bulb, while the other terminal (the negative) is grounded to the holder. The holder may be readily clipped to the handlebar of the motorcycle or attached to the steering wheel or dashboard of the car, as the case may require, and the position of the switch is such that it is easily manipulated while riding.

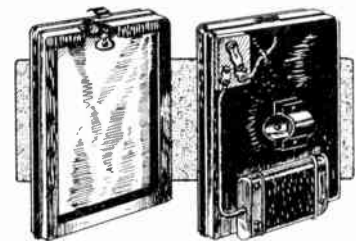

Back and front view of the illuminated route card holder, showing the battery switch and connections.

Some of the Interesting Articles Appearing in the July Issue of Radio News

- Portraits Radiated Through the Ether. By Dr. Alfred Gradenwitz.
- The Development of Radio on Airplanes in France During and Since the War. By the Paris Correspondent of Radio News.
- How Time Signals Are Broadcast by Radio. By S. R. Winters.
- A Celestial Audion. By H. Gernsback.
- Construction of an Audio Frequency Amplifier. By Paul G. Watson.
- An Efficient Audio Frequency Transformer. By D. R. Clemmons.
- Construction of a Tungar Rectifier. By Cecil W. Guyatt.
- Practical Information on the Reception of Radio Signals. By A. F. Van Dyck.



The Simplest Storage Battery

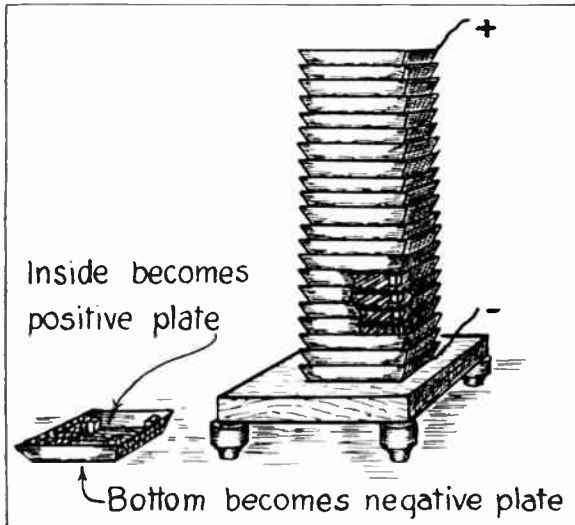

Left—A storage battery built up of lead trays, the bottom of each tray is corrugated and becomes the positive plate; the bottom becomes the negative plate. Non-conducting separators are placed in the trays.

Right—The battery set up in its frame, and the interior is shown where it is cut away. Notice the corrugated bottom of the tray at the left.

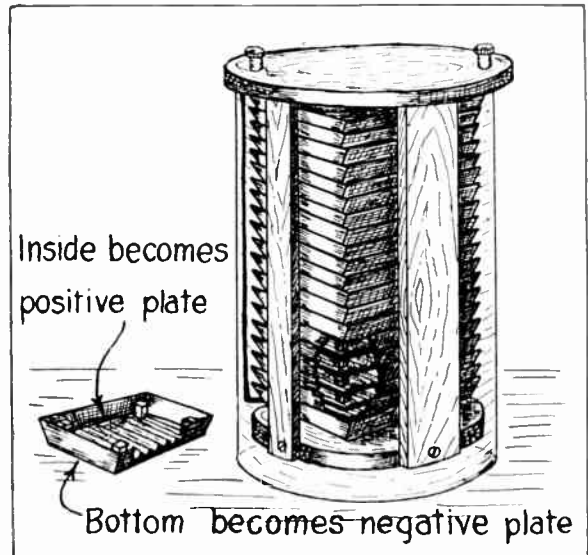

FROM a French contemporary we take the following description and illustrations of a very ingenious and simple storage battery, whose construction is so obvious that the illustrations alone almost tell the story. We translate the following description from *La Nature*:

The new battery which we present here solves some of the troublesome problems where the private person wants a high potential storage battery. Instead of using, as is the custom, battery jars of glass or celluloid, one alongside the other and connecting each element to its neighbor, by a small conductor, for getting the requisite voltage, the battery jars are here piled up, one on the other, exactly like a Voltaic pile, built up with discs of copper and zinc.

But that which constitutes the originality of the system is that these plates in the form of trays, are made of lead, and are at once negative electrode on one side of the metal, and positive on the other. The metal of the tray acts as the conductor between the two poles, little blocks of insulating material between the trays maintain their proper separation, and it is enough to fill the tray with acidulated water of the storage battery strength, to constitute a battery answering all small requirements.

The standard model is contained in a glass jar and gives a potential of 40 volts. The use of a glass-enclosing vessel makes it possible to carry the battery about without danger of spilling the acid on the floor or on one's clothes.

On the other hand, it is possible to construct these batteries of any desired potential in individual installations, at little expense—a very interesting feature.

Charging can be accomplished very easily, and at a high rate, without any danger, from any source of direct current or rectified current, as long as the voltage of the circuit used is greater than that of the battery.

The filling is very simple; finally, in case of accidental sulphation, due to neglect of maintenance, it is easy to take down the battery completely, to wash off each electrode, and to obtain, after a somewhat prolonged charge, a completely new battery, so that the duration of these little batteries is almost unlimited. The bottom of each tray is corrugated.

An Alternating Current Battery

By Raymond B. Wailes

WE generally think of a cell, whether wet or dry, as giving out a direct current of electricity. A small cell which actually produces an alternating current can be assembled by the experimenter.

Two sheet iron electrodes are required. They must be brightly polished and free from grease. These electrodes when placed in a chromic acid solution constitute an alternating current cell. The chromic acid solution is made by mixing 1 part of sulphuric acid with 5 parts of water and allowing to cool. A strong or saturated solution of sodium (or potassium) dichromate is now made, and equal quantities of the dichromate and the acid solution are mixed and placed in the battery jar or other container.

It is best to use an indicating instrument of fair sensitiveness, and one that has its pointer or needle in the middle of the scale, so that different flowing currents produce a different needle deflection. If an instrument of this type is not available, the needle should be moved, by means of

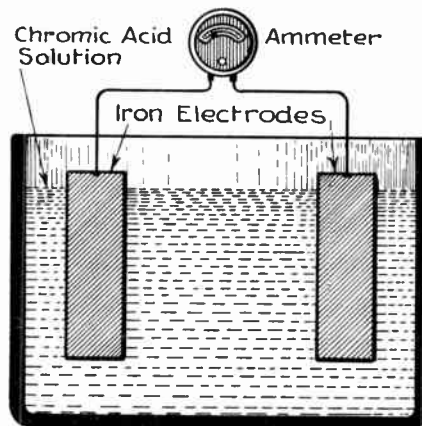

An interesting experiment in which a primary cell produces an alternating current.

the adjusting screw, from zero to a point near the center of the scale.

When the electrodes are immersed, the pointer or needle will move in one direction, sway and then return to the zero point, then pass it and go to the other side of the scale. After this, the needle comes again to zero and swings to the initial side as before. The deviation will continue for some time.

It is thought that the action of the oxygen in the chromic acid electrolyte has a bearing upon the alternating current which is produced. Probably the acid causes the iron to become passive, with the production of an electric current, this production being gradually influenced by another passive-phase, generating a counter-current.

When iron is made passive, it sometimes assumes a condition when strong acid will not attack it; immersion in nitric acid has this effect, and it is sometimes accounted for on the theory that magnetic oxide of iron is formed, coating the metal. This principle has been applied in making iron rust-proof.

Phonograph Music at a Distance

By H. Gernsback

Member American Physical Society

IT is sometimes desirable to project the music from a phonograph to a distant location. Such occasions arise frequently. For instance, the phonograph dealer in the summer time may find business dull and in order

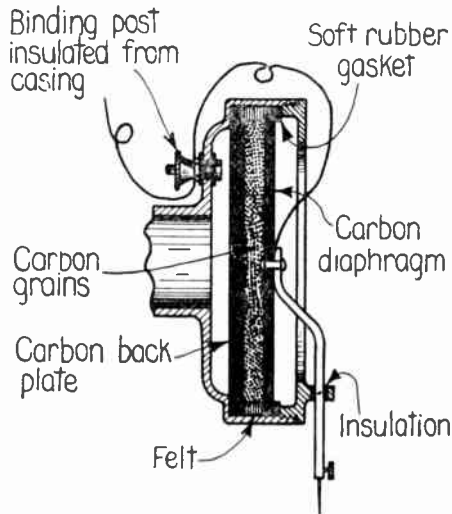

Cross-section of the microphone, with its loose carbon granules, diaphragms and connections for transmission of phonograph music.

diaphragm in such manner that there will be no rattling.

In the back of the sound box a carbon plate is placed. This carbon plate takes up the entire back, and is of course circular. Inasmuch as no sound passes through the tone arm, the carbon plate should be solid and usually measures about 2½ to 3 inches in diameter, while the thickness may be 1-16 of an inch or thereabouts. In case no carbon plate can be obtained, use a metal plate against which you place a carbon diaphragm. The metal plate is simply to stiffen the back diaphragm and keep it from vibrating.

The space between the back carbon and the front diaphragm should be ½ of an inch in thickness. A felt washer keeps the diaphragm away from the back plate, and the resulting space is filled up loosely with highly polished carbon grains secured from any electrical specialty house. It is necessary to experiment a little here, because if too much carbon grain is used, the microphone will not function well. It is rather better to use a little less than too much.

When the microphone is in its vertical position, the grain chamber should not be entirely full. From 90 per cent to 95 per cent capacity will do. This will leave the grain rather loose, which is satisfactory.

Between the outer carbon diaphragm and the clamping ring we use a soft rubber gasket which is usually supplied with a sound box.

Some sort of insulation must of course be placed between the back carbon plate and the front carbon diaphragm. One connection is taken from the front diaphragm and the other from the tone-arm, as the latter is grounded to the back diaphragm. It should, of course, be understood that the front carbon diaphragm from which the one connection is taken is well insulated, as otherwise there will be a short circuit.

When the microphone is entirely finished, it should be tested out, which is done by means of an ordinary two cell

battery and a 75 ohm receiver. When operating the phonograph, the music should be reproduced loudly in the telephone receiver, as a matter of fact, so loudly that it hurts the ear. This shows



The phonograph disc, reproducer and microphone, showing the microphone and the electric connections to the microphone.

to attract prospective customers, is at times forced to place his phonograph near the door of his shop. This does not always produce much sound outside, and a much better way would be to project the music outside of the store by means of a loud talker, as shown on our front cover. Then there are many other uses as when we have a lawn fête and do not wish to transport the phonograph from the house outdoors. Our young electricians will wish to have the music out on the lawn or garden and it can readily be accomplished.

When you have a phonograph stationary in the house, but wish to have the music in another room as, for instance, in case of sickness, for children, or if you wish to dance to the phonograph music in another place, all this can be accomplished without moving the phonograph at all. Nor is it difficult to do this, and any wide awake young man who is handy with tools should be able to build the few instruments necessary to accomplish it.

In the first place, we must build a microphone, which is the keynote of the apparatus. If you do not wish to spoil the sound box on your phonograph, it would be best to pick up a second-hand one, and make the sound box into a sensitive microphone, which can be tuned very easily as shown in our illustration. The sound box is simply opened up and the mica diaphragm taken off. A carbon diaphragm, which may be bought from any electrical specialty house, is then attached to the arm that carried the needle. A screw and a nut usually hold this arm to the mica diaphragm and the same screw and nut can be used to fasten it to the carbon diaphragm. It is important, however, that when the screw and nut have been fastened, a small drop of hot sealing wax be applied on the front of the diaphragm, which will secure the lever and the

that the microphone transmitter is well built.

We now come to the loud talker, which can be constructed readily at an expense that is not high. The original loud talker has actually been built by Mr. F. R. Kingman, of Bremerton, Washington, to whom the author is indebted for the simplified construction. This loud talker, which works on the same principle as a Magnavox, can also be used for radio by making slight changes.

In connection with radio, the loud talker must of course be used with a two or three stage amplifier, and the results will be excellent.

The following tells how to construct a loud speaker that operates on the magnavox principle, but instead of using powerful electro-magnets, permanent ones are used, thus doing away with a storage battery.

This type of loud speaker is, perhaps, a little larger and more bulky, but its difference in size is of no great disadvantage so long as it operates as effectively as other types of loud speakers.

In building this loud speaker the writer used the magnets of an old magneto. The over-all length of the longest magnet was a little over six inches and the width of the short one was four inches. There appears an article in the October, 1920, number of *RADIO NEWS* on the construction of a loud speaker, by H. W. Secor. This article will give you a good idea on the construction of a loud speaker using *electro-magnets*.

In building a loud speaker using permanent magnets, the exact size of the instrument will depend upon the size of the magnets used. For best results the diaphragm should be about three inches in diameter and should be made out of sheet mica or spring sheet phosphor bronze. The moving diaphragm coil should be about one-half by three-fourths of an inch over-all size.

The size of the coil will vary as to the resistance to which it is wound; however, the coil should be about the size shown in the drawing. For a 50 ohm winding, an adequate length of No. 35 enameled wire is

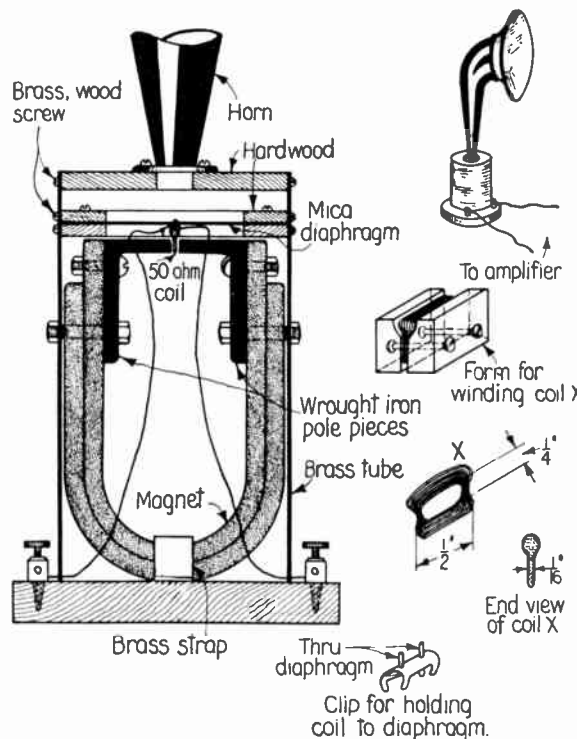

Details of the reproducer with its permanent magnet, diaphragm, horn and connections.

required. The method of winding the coil is shown in the drawing; the thickness of the thin part of the coil is one-sixteenth of an inch.

After the coil has been wound the upper part is to be tied with silk thread, and is then impregnated with shellac. A way to make the thin part of the coil hold its form until the shellac is dry, is by clamping the narrow part of the coil between two flat plates.

The wrought iron pole pieces can be made of soft iron, tool steel or tungsten steel. If the steel has been fitted on, it can be taken off, hardened and magnetized, thus increasing its strength.

The horn can be constructed out of heavy paper, cardboard or wood. The writer recommends a wooden horn or at least some kind of a wooden sound box constructed of spruce or cedar, for best results.

A telephone induction coil can be used, as shown in the drawing; however, one can make a transformer. A modulation transformer can be used. Data on the construction of a transformer for this type of loud speaker may be had from the radio department of SCIENCE AND INVENTION for August, on page 408.

The outside case of the loud speaker can be made out of a piece of brass tubing. The base of the instrument should be of hard wood and covered with felt to eliminate all vibration.

The permanent magnets should be magnetized to their full capacity before assembling them. The diaphragm should be of the proper thickness, otherwise the instrument will be sluggish in its action and will not

reproduce distinctly. For mica the thickness should be about .006 of an inch. Magnets of an old magneto vary in size, but the large ones having an over-all length of not less than six inches should be used.

The distance between the poles should be one-sixteenth of an inch. If the builder wishes, however, to vary the magnetic field between the pole pieces, he can place some kind of a magnetic shunt across the pole pieces so as to control the strength of the field. It is like varying the strength of an electro-magnet by changing the current strength.

There are a number of ways of fastening the moving coil to the diaphragm; the best way is by making a clip as shown in the drawing. The builder can construct several of these coils of different resistances, as he will find that coils having a greater number of turns will prove more effective at times than one having only a 50 ohm winding. For radio work a three stage amplifier and a 50 ohm winding are probably most suitable.

The principle on which this loud speaker works is patented and it must not be built to sell.

After building the loud talker, and after it has been tested, the connections are made as shown in our diagram. A four or six volt storage battery should be used for best results.

A rheostat is put in series with the circuit, and has the function of either increasing or decreasing the loudness of the music. When too much battery is used it will be noted that the transmitted music is harsh and disagreeable.

It should be understood that the line that runs between phonograph and loud talker must be of sufficiently low resistance, particularly where the distance is great. If the distance is more than 100 feet, it will be necessary to have an induction coil near the loud talker, and another induction coil near the microphone transmitter. In that case, a rather high resistance line can be used, as for instance, a No. 20 or No. 22 wire. Where

the distance is less than 100 feet, the wire should not be less than No. 16 B. and S. gauge, otherwise there would be too much loss in transmission.

It should be understood that in a scheme of this kind we could also dispense with the loud talker and use a great number of telephone receivers, should we so desire. When using a high resistance telephone receiver, such as one of 1000 ohms, a great number of people can listen in to the phonograph music by placing all the receivers in series or series parallel as found best by experiment.

There are many uses for such an instrument that will readily suggest themselves to all.

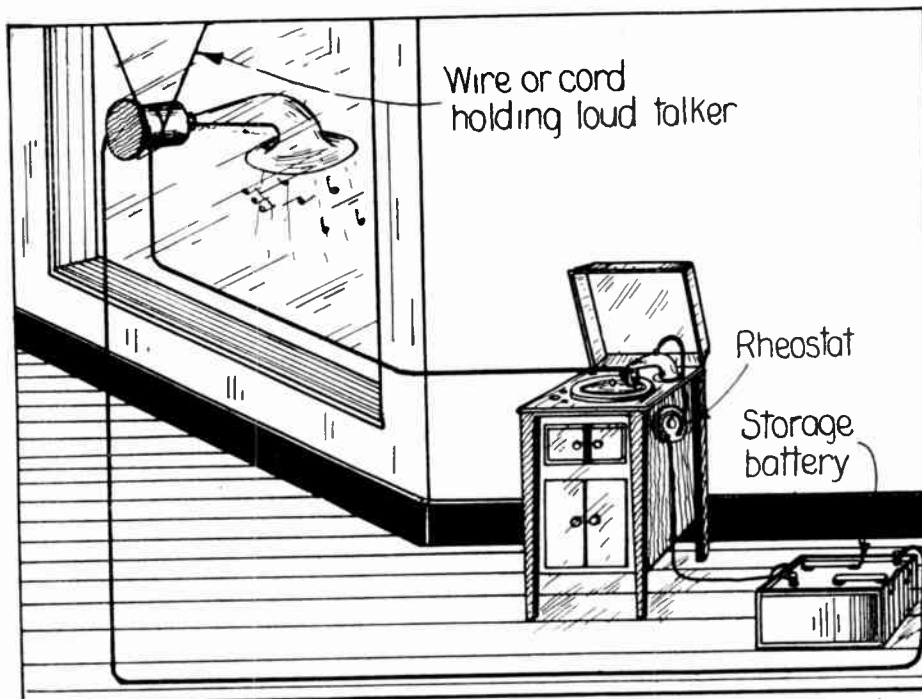

The disposition of phonograph and loud-speaker with the storage battery, circuit and connections.

Conduit Box Switch



A neat and compact switch for use on a house conduit.

WE illustrate a conduit box switch. This switch is one which is opened and closed by successive pulls of a pendant, and is so arranged that it can be quickly installed on new or old work.

Automatic Extension Reel

It will be observed that there are two knurled thumb nuts; one is seen in the illustration directly above the apparatus, and that, of course, is connected to the fixture. The other is to connect it to the conduit box. A short chain and six or more feet of cord, with terminal ball, complete the equipment, so that it can be used from no matter what height the ceiling may be.

The claim is made that it replaces, as regards its work, four or five other switches, so that the one device takes the place of four upon the dealer's shelves.

THE illustration shows a spring reel, one which winds up automatically, coiling up around its drum as it does so a flexible cord. At the end of the cord there is an electric lamp, and the lamp when the cord winds up fits into a holding socket on the nozzle of the coil, so as to have a rigid place. It is especially designed for use on automobiles.

The flexible cord is connected to the electric system, grounded or not grounded as the case may be; and for the inspection of any part of the car in the dark, the reel feeds out all the flexible cord re-

quired up to a length of 12 feet. The reel presumably being connected to the dashboard, 12 feet of conductor is more than enough to reach any part of the car.

The same system, of course, can be used

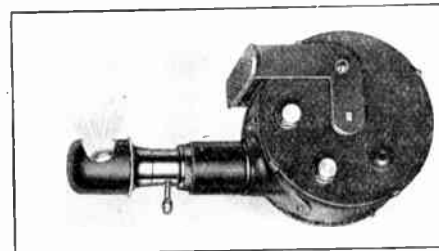

An automatic spring reel for carrying the flexible cord for a trouble lamp.

for carrying electric power to portable drills and other small machinery, and it would really seem to be quite an interesting addition to a car. Considerable annoyance with the ordinary trouble lamp is involved in the care and disposition of the loose coil of wire ordinarily used, for which there is no place specifically provided.

Uses for Electric Light Carbon Ends

By T. O'Connor Sloane, Ph.D.

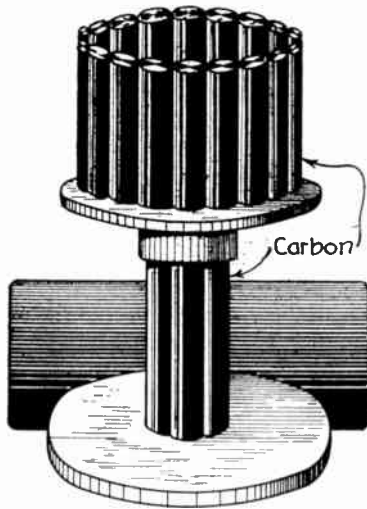

A vase made by soldering copper coated arc lamp carbons together and mounting them as shown on a circular base.

WE suppose many electricians, especially the younger ones, have picked up electric carbons from the ground where they have been thrown by the lamp trimmer. It always seems as if some use could be made of them.

They form excellent carbons for batteries. A good way of arranging them for a small battery is to have a wooden cover for the jar, with a rebate around it, so that when in place it cannot shift sideways. Through this holder holes are bored of size to receive the carbons tightly. As each carbon is inserted, a wire is put in to extend perhaps barely through the thickness of the wood; but if the carbons are copper coated, each wire may be twisted around its carbon very near the top and soldered there. The effect of this last arrangement will be that the carbons can only go through the wooden cover of the battery jar until the wire ring comes in contact with the top. The copper should be removed from the lower ends of the carbon, although in the battery it is fair to assume that this will take place anyhow. Other holes in the cover receive the zincs, which wires also are soldered; round Leclanché zincs are excellent for this purpose. Of course, by following out these lines all sorts of arrangements of carbon and zincs can be made.

To obtain a flat carbon battery plate, as many carbons as desired may be placed parallel to each other, and pressed together by an improvised clamp, and soldered, first on one side and then on the other. An inch of soldering will suffice to hold them, and the rest of the copper

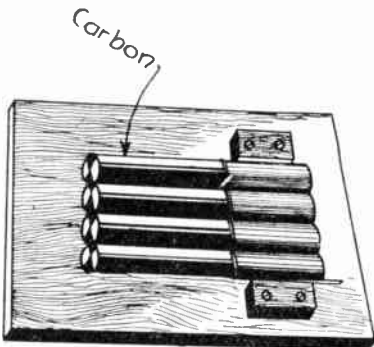

A battery plate is made by soldering several carbons together at their upper ends, the copper is removed from the ends entering the solution.

may be removed by nitric acid or left to the mercies of the battery.

It is easy to see that all sorts of changes may be rung on this basis; the carbons may be soldered into a hollow cylinder, to receive the zinc in the middle.

The carbons can be used, however, in other ways and for other purposes than for the making of battery carbons; they may be fastened around a piece of dowseling or a piece of pipe; they must fit in the sense that while against the pipe each carbon will come in contact with the other one, and can then be soldered. Before doing this, the tapering ends must be cut off. Above these carbons there comes another set, and so on until the whole pipe is enclosed. Where they join, a brass hook or band will be placed tightly around them, so as to hide the joint. This gives

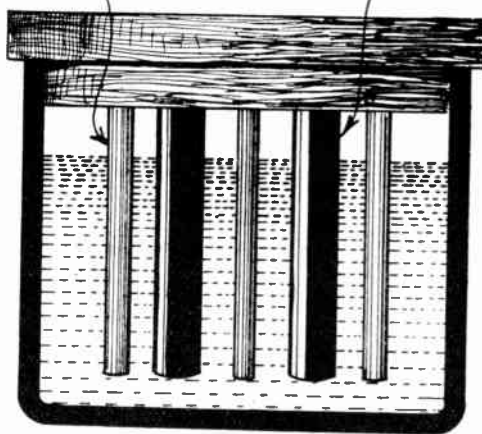
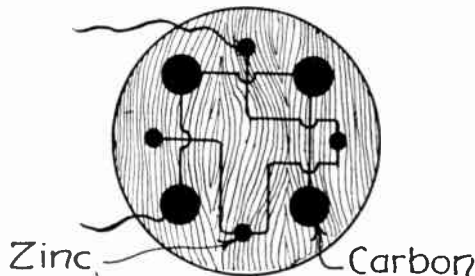

A battery made with arc lamp carbons; a rebate is turned on the circular top to prevent the elements from touching the sides of the jar.

a very pretty standard for a lamp, and is shown in one of the illustrations.

We have spoken of soldering them in a hollow cylinder for use in a battery; by carrying out this idea, a cylindrical vessel is made, in which case, of course, the soldering extends the entire length of the copper. By picking out carbons, whose points are practically identical, the body for a vase may be produced, with a sort of picketed top, possibly suggesting cigars. The bottom may be of plate copper, also secured by soldering. By bunching half a dozen carbons around a piece of dowseling and soldering them, a stem for the vessel can be made, whose upper end goes into a socket soldered to the brass or copper bottom already referred to, and whose lower end enters the hole in a solid base of wood.

All sorts of changes can be made along these ideas, and the illustrations are intended to suggest to our readers how they may try their ingenuity. If the carbons are not copper coated, the electrician can easily give them an electrolytic deposit himself, and after the soldering is completed it is a simple thing to give them a plating of silver or nickel.

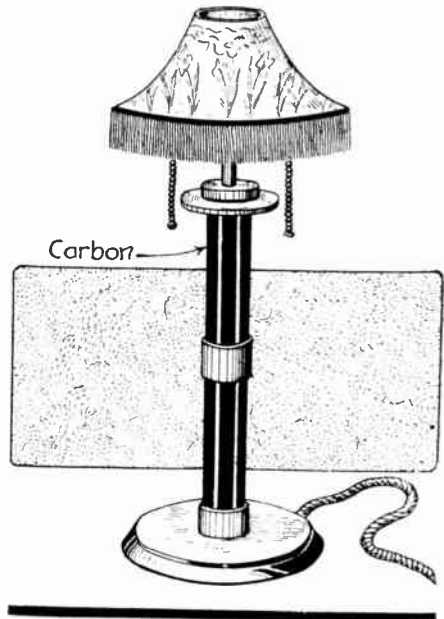

An electric lamp mounted on a standard with electric light carbons surrounding the supporting central piece, a tube or piece of dowel stick.

Too much reliance must not be placed upon the strength of the carbons, except in cases where solder is applied for the entire length; if this is done, it will, of course, fortify them greatly. It may be advisable also to shellac or varnish them to prevent any dust coming from the surface. Our readers can exercise their ingenuity in evolving other designs, and we shall hope to hear from them. Carbon ends are not so common as they used to be, as the tungsten lamps gradually replace the arc lamps, but they can always be procured.

It is to be noted that the vases and other articles depend for their strength on the adhesion of the copper to the carbon. This may not be very great. Therefore, where strength is essential, the system of soldering a brass or copper ring around the bunch of carbons must be resorted to, and the interstices between this ring and the carbons can be filled with solder. The end of the opening to be thus filled should be stopped up with kneaded bread crumb, and the copper on the carbons and of the band or ring should be tinned in advance. Heavy copper plating may be experimented with as a substitute for soldering.

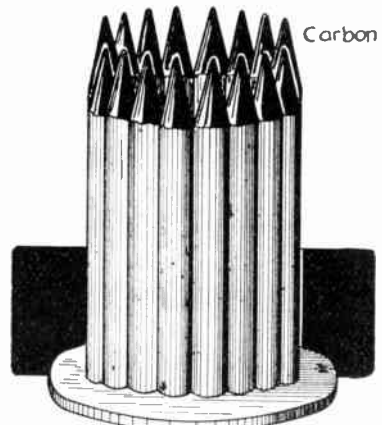

A simple cup made with pointed carbons, suggesting a bunch of cigars; they are soldered solidly together.

A Polarized Rectifier and Its Use

By Arthur G. Raabe

ALTERNATING current is the type of current now generally supplied by electric companies. This makes it impossible to recharge storage batteries, to electroplate, or perform experiments requiring direct current, unless

obvious, as an immediate short circuit will result if the insulation breaks down and the screw comes in contact with the armature.

Arrange contact post and adjust the same, according to Fig. 3, so that the moment the insulated contact spring touches contact joints (E) or (G), the distance between the armature and contact points (D) or (F) shall be equivalent to the thickness of two business cards. The moment the armature touches contact points (D) or (F) the distance between the armature and the core of the attracting coil should also be equal to the thickness of two business cards. This method of adjustment causes the circuit to open or close at contact points (D) or (F), thereby bringing the arc caused by this action close to the magnetic field, which has a tendency to quench the arc. If platinum or tungsten contacts are desired, they need only be placed on points (D) and (F).

The principle of the apparatus is this: A permanent magnet lying parallel with

If the rectifier is not receiving its alternating current from a step-down transformer delivering from 66 to 10 volts, it will be essential to insert a 5-ampere fuse

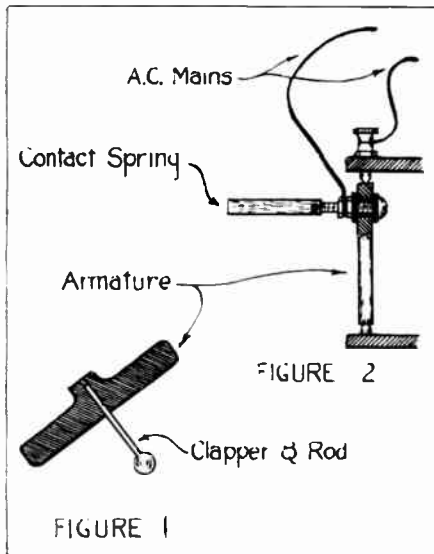

Construction of the contact spring attached to the armature of the magnet used in a rectifier.

one purchases an expensive rectifier, a mercury arc or motor-generator set, or makes one himself.

The necessity of purchasing one can be obviated, following these instructions, for constructing one:

Procure a telephone ringer of about 1,000 ohms resistance. Remove the bell-clapper and rod from the armature (Fig. 1), fastening an insulated contact maker (Fig. 2), consisting of fiber washers and bushing for insulation, nuts and a screw which is filed down on one side. The screw is insulated perfectly from the armature and a brass contact spring is soldered neatly to the flat side of the screw, as shown. Flexible leads bring the A. C.

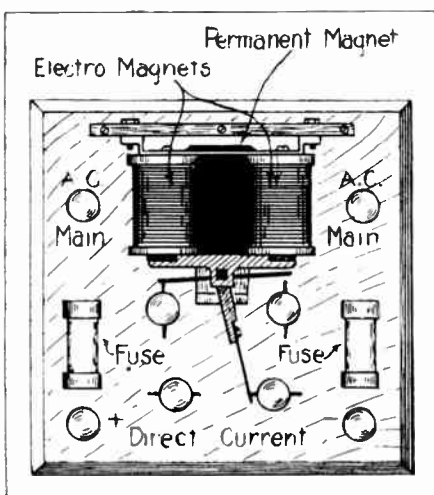

Fig. 4. The rectifying apparatus mounted on a panel, showing the fuses, double contacts, and permanent polarizing magnet.

current to the contact spring and the armature, which are held in their respective positions by nuts, according to Fig. 2. The importance of neat workmanship is

EXPERIMENTERS and amateurs, we want your ideas. Tell us about that new electrical stunt you have meant to write up right along, but never got to. Perhaps you have a new idea, perhaps you have seen some new electrically arranged "do-funny"—we want these ideas, all of them. For all such contributed articles that are accepted, we will pay one cent a word upon publication. The shorter the article, and the better the illustration—whether it is a sketch or photograph—the better we like it. Why not get busy at once?
EDITOR.

the coils maintains the armature magnetized with the same polarity—south, for example. As the current passes, the armature is attracted by the north pole of the electro-magnet and closes the circuit, making (D) positive and (E) negative. As the A. C. current drops to zero, the armature is released. The current is reversed. The armature, being then attracted in the opposite direction, closes the contacts (F) and (G). Since the current has already been reversed, (F) and (G) now have the same polarity as originally, and a direct current is delivered at the terminals (P) and (N).

Now, knowing that direct current is obtainable at terminals (P) and (N), the next step is to determine which is positive and which is negative. This can be readily done by attaching a strip of lead to a wire from terminal (P) and likewise from (N). Place the two lead strips in a clean tumbler containing a little storage battery solution, keep the lead strips from touching each other, even for a second, and turn on the current for a few minutes. The strip of lead attached to the positive wire will turn brown on the end that is immersed in the solution. Mark the terminals so that you will know which is positive and negative in order that you need not perform the above test every time you desire to know the polarity of terminals (P) and (N). Should you have taken the solution from one of the cells of your storage battery, you should return the same solution after the test, to preclude any fear of endangering the cell.

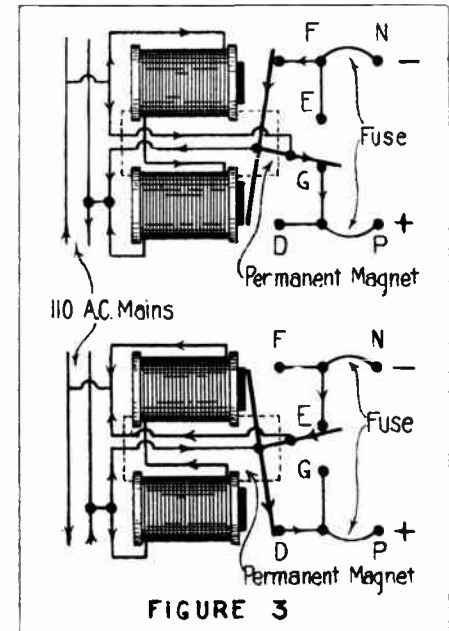

Two diagrams illustrating the action of this rectifier in producing an earth current and avoiding an arc at the contact.

between (P) and its feeders, (D) and (G); also between (N) and its feeders, (F) and (E). This means, should you accidentally short circuit the wires leading from terminals (P) and (N), a fuse will blow. Be careful and you will save fuses.

It will be desirable to regulate the flow of current in recharging storage batteries. This can be accomplished with a rheostat, or lamp resistance. Lamp resistance is the preferred method, consisting of lamps strung in parallel, as in Fig. 5. When charging by this method, use the rate given on the name-plate of the battery.

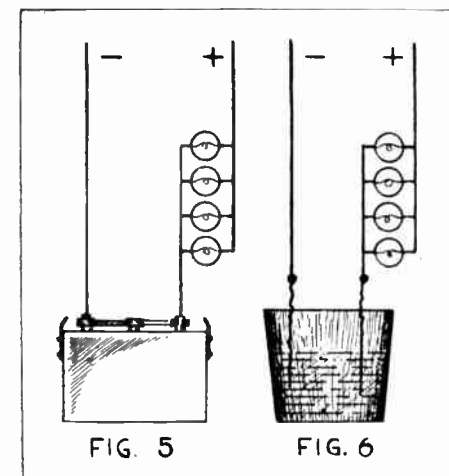

Connections for charging a storage battery, in which a bank of incandescent lamps is used as a resistance.

This rate determines the number of lamps to be used, as follows:

One 32-candlepower carbon filament, or 100-watt Mazda for resistance, gives one ampere.

(Continued on page 381)

Electrogeoscoping

By T. O'Connor Sloane, Ph.D.

CONSIDERABLE attention has been given recently to the exploration of the subterrain by use of electricity. In SCIENCE AND INVENTION, some months ago, a Hughes balance was illustrated, which was constructed to locate metals deposited under ground, such as pipes or treasure—as

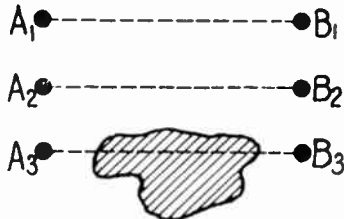

Testing for the presence of a mineral deposit by measuring the resistance of the earth circuit between various points equally distant from each other, the mineral deposit decreasing the resistance.

some sanguine souls believe there is a probability of finding buried gold.

But this balance is of very questionable utility for such purpose, though it can be made of great sensitiveness. This was really one of the first attempts to scientifically explore the underground regions of our earth, and it was based on the modification of the magnetic field, and diversion of its lines of force by the presence of an electric conducting mass, even though one of high resistivity.

One of our Italian contemporaries, *L'Audion*, has published quite an elaborate article on the subject of finding and defining mineral deposits by electricity.

During the war it is said that the Germans used the induction balance. It is believed that they could detect distant vessels—of course, the advantage here being that there was no question of an imperfectly conducting mass of mineral matter, but of a particularly good conductor of iron and steel. It is said to be useful in finding buried unexploded shells.

Again keeping to the elementary attempts, the use of the compass, horizontal or dipping, is to be cited. This, of course, applies only to magnetic deposits, such as pyrite and magnetite. For such it is quite practical and useful.

The density of rock beneath the surface, and not too far removed therefrom, affects the period of oscillation of the pendulum and this gives a clue to a non-electric method of finding minerals.

One form of portable induction balance consists simply of two coils wound at right angles to each other, and an alternating current from a battery-actuated induction coil is passed through them; a

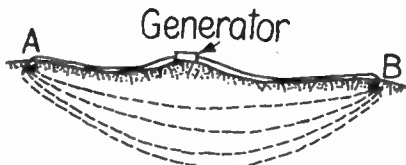

The passage of a current through the earth, illustrated diagrammatically; it will be seen that the current reaches a considerable depth below the surface.

telephone in circuit discloses any unbalancing attributable to minerals or metals in the vicinity. Curiously enough, the subject was not treated by our contemporary without allusions to studies by a German physicist, Hoppe, on the subject of raddomancy—which is nothing but the old divining rod.

The Germans seem always to retain an affection for the ancient divining rod, and Hoppe has tried to prove also that a human body can act as a detector of electricity in the air. We know that the divining rod is moved entirely by conscious and unconscious muscular effort of the manipulator; it is therefore evident that an unconscious movement might be produced due to his electrification. We may even go to the extreme of assuming that his electrification would be changed by the presence of mineral deposits, and thus try to inject some meaning into the divining rod. It is absolutely certain that water, oil, metals and minerals have no direct effect upon the hazel twig.

The serious and scientific method of determining the presence of ores by electricity in modern practice is based on various phases; the first to be considered is the measurement of the resistance of the soil. Two contacts with the soil may be made at a distance apart of 500 feet or more, and with the Wheatstone bridge the resistance between the points is determined. Keeping the same distance apart of the earth contacts, they are moved about until a decrease in resistance or an increase occurs. This indicates a mass of matter of some conductivity beneath the surface, and it is to be presumed that it will lie between points where the least resistance is developed. Thus, referring to the diagram, the resistance between A1 and B1, A2 and B2, we may take as identical. But as between

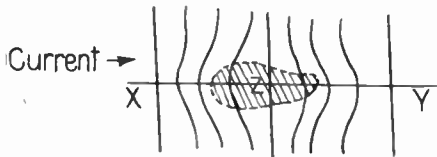

A mineral deposit causes an increased distance to be produced between points of equal resistance, following out Ohm's law.

the point A3 and B3, a mass of mineral matter occurred; the resistance there will be cut down and the deposit will be indicated.

When the earth operates as a conductor, the current spreads, so that a large section of the earth may be concerned in its transmission. The effect of this will be that this system will be impaired, because, to carry it out, we must assume that the current takes a straight and limited path—instead of which, it really spreads out to an indefinite extent, spindle-fashion.

The contacts may be made by burying spheres in the earth or by driving pointed iron bars down to a good depth.

A more advanced system is the equipotential system. In connection with this work the principal magnetic minerals have been tabulated, and while the conductivity of each of them is but one-one hundred thousandth that of a copper conductor, the conductivity of these minerals is at least a thousand times as great as that of barren rock. Then, all sorts of complications are introduced by the gangue, which, if interpolated so as to enclose grains of the metal-bearing material, may modify greatly the resistance of masses of ore. Other minerals have their resistance reduced by the imbibing of water. The whole subject of resistance of wet soils has been elaborately studied and the specific resistances and inductive capacity have been tabulated.

Suppose that a generator is placed on a line whose ends are connected to earth

plates or other form of earth contact, and the current is produced; it is a simple matter to explore around with a delicate galvanometer and determine any number of equal-potential points. On connecting these points, a curved line will be produced, which will be practically symmetrical if the soil is all of uniform resist-

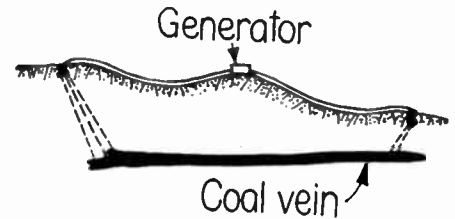

How a vein of coal affects an earth current.

tance, which means if the soil contains no metallic deposit or is all metallic deposit. Of course, the case which interests us is one where an isolated deposit is to be found or a vein to be located. By carrying out this process, a series of lines resembling contour lines on a topographic map will be produced. The effect of a mass of material of less resistivity than the barren rocks will, by the elementary laws of the conduction of currents, practically, by Ohm's law, operate to push apart the equal-potential lines as shown in the sketch—and it will be under such portions of the lines that we must look for a mass of material of superior conductivity. It will be seen that this is quite an elegant method of identifying such deposits—carrying out Ohm's law perfectly.

In one of the diagrams, the application of a telephone instead of a galvanometer is shown. Here an alternator maintains currents through the earth by means of two series of contacts, at the end of straight and parallel lines, each series of contacts connected by a conductor. The telephone is provided with two contact spikes, and these are driven into the earth at various points, and where no difference of potential exists, the telephone will be silent. These two points are located on the chart. In this way equipotential lines are determined for the whole area, with the result shown in the diagram, provided there is no disturbing deposit of mineral matter beneath. If there is a mass of conducting material, the lines will be spread apart, following out Ohm's law to the letter. Some interesting examples of equal-potential lines are given in some of the illustrations.

A vein of ore is seen crossing the equipotential line; the ore being a good con-

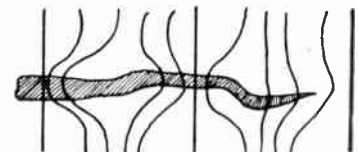

The effect of a mineral vein on resistance in the earth's circuit, equipotential lines being spread apart where the vein acts upon the passage of the current.

ductor, the ohmic resistance between the potential lines where the vein crosses them is much less for an equal length of vein than in sterile ground. So, as before stated, by simply following out Ohm's law, it will be seen why the potential lines are bowed out where they overlie the vein of good conducting material. The vein in this case was one of hematite, red

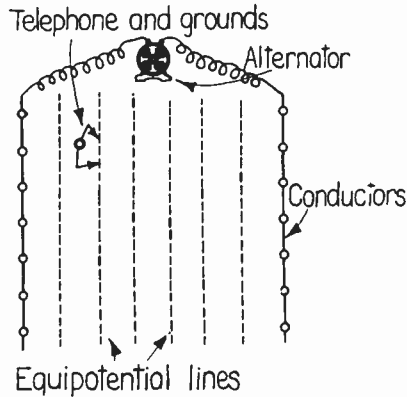

An apparatus layout, using a telephone for determining lines of equal potential; where the telephone produces no sound on its two terminals being connected to the earth while the alternator is running, the potential difference is zero.

iron sesqui-oxide, and it is a very good example because hematite is not a good conductor, but is far superior, of course, to granite, schist, or any ordinary country rock. Some twelve equi-potential lines determined the location of the vein.

Another interesting illustration is a mass of copper pyrite found in France, which pyrite was mixed with a certain amount of other minerals, 40 per cent of silica alone. The general elliptical form measures 200 meters in length by 100 in width. It is interesting to see how closely the lines follow the contour of the deposit.

A more direct and quicker method has been entitled the "zone of silence system." From what has been said before, it will be understood that if a discharge of alternating current is maintained in an area, the telephone connected with the area, as long as the current is passing, will produce a sound due to the frequency of the current. But if there is a mineral deposit there, it will have the effect of concentrating to a certain extent the current in itself, robbing, as it were, the country rock thereof, so that the telephone will be silent. This phenomenon leads to another method of research.

The great difference in conductivity already spoken of is the basis of this method, which is illustrated in diagram. A central point is established and an insulated conductor is stretched across it of equal length on each side. A generator, which must be of some power, or else an induction coil operated by a storage battery, excites the circuit. Earth contacts are placed at each end of the conductor. In homogeneous soil if the telephone is connected at two points, as already described, keeping to the line of the conductor or following a line parallel thereto, the telephone will give a sound. If there is a mineral mass this will have the general effect of concentrating the current within itself; so that to all intents and purposes the current will abandon the surface, and the telephone will be silent. The area un-

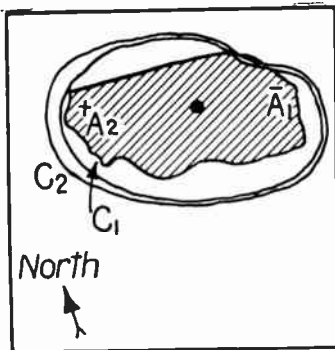

Equi-potential lines surrounding an ore deposit—an actual instance of plotting out the unseen.

derlaid by the deposit is determined by rotating the straight conductor around the central point and continuing the tests. There is something more direct in this system than when equi-potential lines have to be drawn, but this gets at the direct determination of the outline of the deposits.

Another way of carrying out this system is to lay out the straight conductor from A to B, the other pole of the generator being connected directly to the earth. An operator with a reel of in-

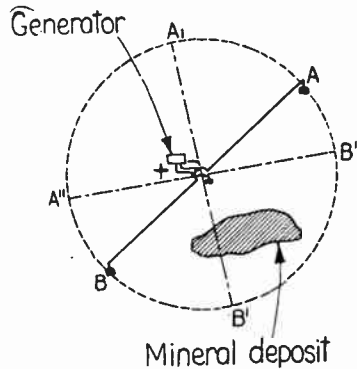

Another system of applying the alternating generator and exploring telephone to detecting ore deposits.

ulated wire connected to the extremity B makes contact with the earth at points representing in a general way the prolongations of radii from the point A. The operator with the telephone makes his own private contacts parallel with the radial lines thus determined, or on such lines, until if there is a mineral deposit the telephone will cease to sound. In this method, as the zone of minerals is ap-

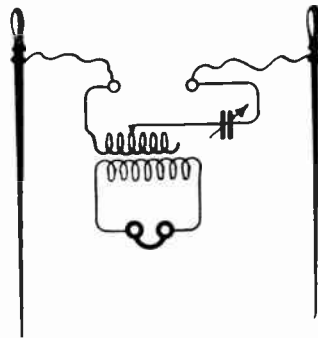

The telephone with induction coil, condenser, the latter adjustable, and the two pointed bars for earth contact for carrying out the investigations by the "zone of silence" method.

proached, the sound of the telephone will grow weaker. This system gives greater facility of research in rough ground than the resistance method, and can be carried out within the interior of mines, and is a considerable advance over the resistance method. As a test of this process, a plate of copper was buried, and its location and size determined by the silent method, with the result that its area was given with wonderfully close approximation. This was a crucial test.

The general disposition of the apparatus is shown in the illustration; the reels carrying the insulated wire are shown terminating in the points to be driven in the ground, while the head-piece carrying the telephones with the two contact points is also there.

An interesting modification of the process is carried out sometimes by the telephone operator having plates of metal attached to his shoe with points to penetrate the soil, and his telephone wires are connected to these plates.

Finally, the Hertzian discharge is made the basis of a similar system. It is

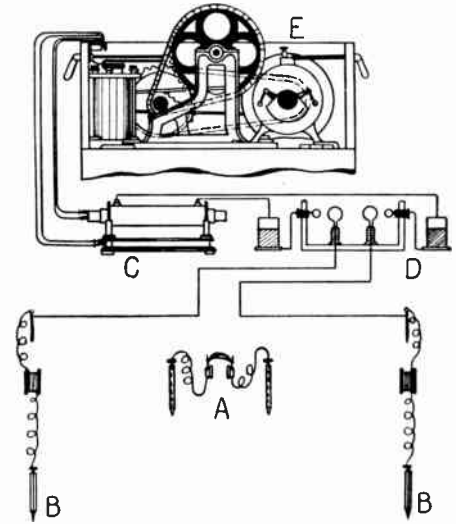

Diagram of the full outfit for elaborate investigation, including reels of wire, contacts BB, induction coil C, spark gap with Leyden jars D, and alternator E. A is the telephone apparatus.

known that the Hertzian spark will cause the detector to answer through a stone wall, but that a metal plate will cut the effect off. A deposit of a mineral mass, it is found, will act in the same way; so by proper location at a distance from each other of the Hertz discharger and of the detector, lines are determined through which the discharge takes place readily, and others where it is interfered with. Those where the interference occurs pass through mineral masses. The illustration, which speaks for itself, shows the Hertzian method applied in a mine; by shifting about the discharger and detector, the shape of the deposit can be very accurately found.

Recently an attempt at treasure trove by an alleged effective detecting apparatus has been made in Canada. A legend of a chest of gold articles which fell into a river some centuries ago induced a party to go there with the apparatus mentioned, and with it the inventor or operator claimed to have located the chest. Dredging and sounding operations were commenced, and a hard object was encountered, which they believed to be the treasure chest. A diver descended and found that the hard object was nothing but a rock, so according to the last account the search resulted in nothing.

The amount of fraud which has been perpetrated in the past by alleged treasure finders, inclines one to discredit even serious work in this field. But what is described here is a purely scientific attack on the problem, the application of absolutely correct methods, all of which is certified to by the fact that good results have been attained.

The Germans and English have been considerably victimized by the divining rod, but what we have described here is serious scientific exploration.

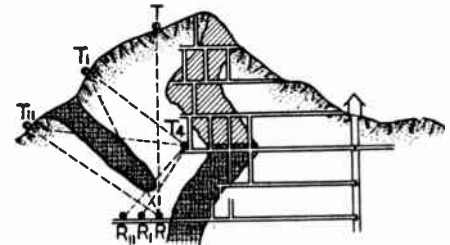

Exploration of a mine, this time using the Hertz rays, and detecting by systematic change of position the locality of ore deposits; the presence of such interferes with the production of the Hertz spark.

Laboratory Ultra-Violet Electric Lamp

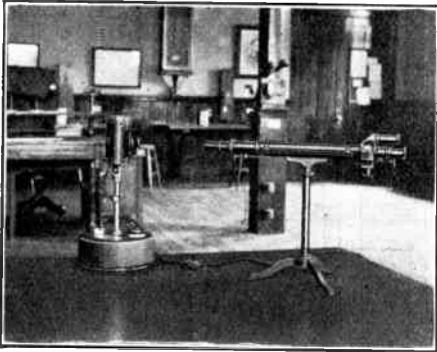

The ultra-violet laboratory lamp, used in polarization work as in sugar houses, where sugar is analyzed by the polariscope.



The lamp applied to spectroscopic work in the investigator's laboratory.

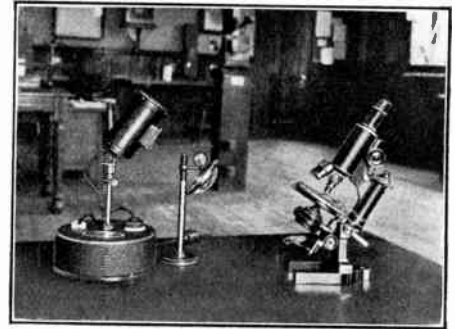

The same lamp is used here as an illuminant for microscopic work, giving a very pure, almost monochromatic light.

THE ultra-violet light was described at considerable length some months ago in *SCIENCE AND INVENTION*. Ultra-violet rays have long been known to physicists, and it is fair to say that any white light radiates more or less of them. In a general way they are present in greater proportion as the light is hotter. Thus the light of the sun before it reaches the earth's atmosphere must be very rich in these rays, but they are sifted out to a great extent by the air surrounding the earth. Otherwise the light of the sun would be quite unendurable, on account of the intense effect of these rays in producing sunburn.

Travelers in high regions are liable to be troubled by the ultra-violet rays, and one of the fears which has been expressed about the climbing of Mt. Everest in the Himalayas is based on the intense sunburning effect to be encountered there, because at such great altitudes there will be so little air between the earth and the sun that the ultra-violet rays will get through in great quantity. To protect themselves, mountain climbers often blacken their faces.

But the ultra-violet rays are daily acquiring new technical uses. They bring about chemical and physical changes. In a short time they will fade inferior dye on fabrics, which gives them value in testing dyes, and their usefulness for absolute chemical investigations has by no means been brought to its full development. They are used in treating oils to get rid of the bloom, as it is called, and to improve them in quality. A considerable amount of experimentation in the commercial utilization of them for manufacturing purposes is going on from day to day. Little is being said about them, but more and more will be heard about them in the near future.

X-ray operators suffer sometimes from what is called X-ray burns. It took many years and some deaths to show how dangerous the exposure to the X-ray is. The patient who is only subjected to its action for a few seconds, escapes quite scot free, but the operator working at it day by day, unless adequately shielded by lead screens, which may aggregate a ton or more in weight, will be very seriously injured. The writer knew of one physician whose hand, first on the finger-tips, showed the effect of X-rays like a bad case of sunburn. It gradually became worse; he was a physician who had been identified with X-ray practice. After a while amputation began, one of his fingers being cut off above the knuckle, and later the effects began to show just in front of the shoulder, and death ensued. This was a case personally known to the writer and is by no means the only one where fatal injuries resulted from incautious manipulation of the X-ray tubes.

The ultra-violet rays produce acute sunburn, and if applied to an area infected by X-ray burns, they will cause the skin to peel off, and it is not impossible that in this application a cure for X-ray burns may be found.

We are all familiar with the mercury vapor arc. Everyone has seen the tubes, three or four feet long, illuminated by a rather ghastly blue light, but one of considerable intensity, and which has a very extensive use in photographing plays for moving pictures. In the mercury vapor arc, which is seen in these tubes, there is a large percentage of ultra-violet rays. But they are cut off almost entirely by the glass, so that the mercury vapor arc is a very safe light to work under and, despite its peculiar appearance, has been found to be very good for the eyes, although it is fair to say that it has not improved the complexion, as seen under its radiations. The face and hands appear ghastly, but this is only while the light shines upon them, as no permanent effect is produced, the light being quite innocuous.

If for the glass tube a quartz tube is substituted, a most intense illumination is produced, particularly charged with ultra-

violet rays, exposure to which of the unprotected skin, is quite injurious, because transparent quartz does not sift out the ultra-violet rays.

Hitherto, the quartz tube lamp has been one of very high candlepower, so much so that it has been used for illuminating railroad yards and similar large areas. When used for such purposes it is installed on the top of a high pole, and the hundred feet or more of air, which the light has to penetrate, takes out the ultra-violet ray and the illumination is perfectly safe.

From all that is said, it will be seen that a considerable interest attaches to the ultra-violet ray from the practical standpoint, for in our brief category only a hint has been given of what it does in the technical field.

We illustrate with this article a very small ultra-violet lamp which is produced for laboratory uses. The large lamp requiring considerable power, and giving a candlepower running up into the thousands, is far too powerful for laboratory work.

The tube which contains the mercury vapor arc is perfectly transparent fused quartz. When quartz is melted into a glass it is pretty nearly exempt from the effects of sudden changes of temperature. It can be made white hot and dipped into cold water without cracking. Glass cooking utensils are made of glass very rich in silica, which in a sense approaches the composition of melted quartz, and they stand the fire almost as well as metal.

The laboratory arc lamp we are describing has an effective area or light source of $1\frac{3}{4}$ inches long, and one-quarter inch wide; the arc is enclosed in a metal casing, to protect the observer. Its spectrum has been worked out with considerable care and the quality of the radiations can be affected by the use of screens. Mica is a material which absorbs the very "far" or extreme ultra-violet rays, when they are not needed. On removing the screen, some 25 ultra-violet lines are admitted again with the radiations. Various filters are used for as nearly as possible isolating special lines. Of course, there is no possibility of isolating a single line, but very nearly monochromatic light can be obtained, which is peculiarly advantageous for polarimeter work. A vast quantity of such work is done in sugar houses for the determination of the percentage of sugar, and there are many other uses for it.

The United States Bureau of Standards has adopted the mercury green line as the official spectrum line for polarimeter measurements. Frequently a sodium flame is used for monochromatic light, which it approaches very closely in quality; but when the light is maintained for any con-

(Continued on page 381)



A view of the lamp on its standard, showing how compact and well designed a structure it is.

Oudin Coil for High Frequency Work

AN experimenter who possesses a spark coil can make use of it to operate an Oudin coil. With the latter piece of apparatus many interesting experiments in high frequency current may be performed.

On a cardboard tube six inches long and three inches wide wind one layer of No. 30 double cotton covered magnet wire. It is well to space the turns, for insulation, by winding on a piece of string at the same time as the wire is wound. Shellac the tube and turns well, and, while the shellac is still wet, unwind the cord, leaving the wire alone, and being careful not to dislodge it. After the shellac has dried, apply another coat to be sure that the wire stays in place. Two coil ends should be turned up and fastened in the ends of the tube with glue. One end of the wire should be led to a binding post in the base of the instrument. The other end should be connected to a metal ball at the top, as in the figure. An old brass bed is often a source of small brass balls suitable for the discharge balls of Oudin and Tesla coils, Leyden jars, and other apparatus.

The tube should be fastened to a suitable hardwood base by screws passed through the base and into the coil ends. In a circle concentric with the secondary coil six one-quarter inch dowels are to be installed. The diameter of the circle is to be four and one-half inches. Around these dowels twelve turns of No. 10 copper wire should be wound and evenly spaced. This is to be the primary, and as such will be referred to hereafter. The lower end of the primary turns is to be connected to the

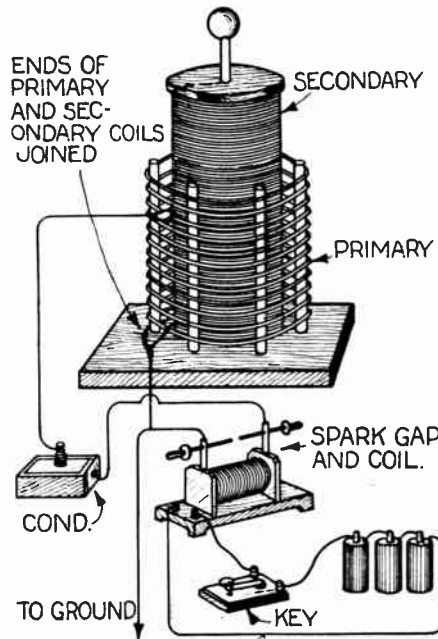

A very clear diagram of the popular Oudin coil used for demonstrative experiments in high frequency electricity is here given in detail. The effect is produced by the inherent frequency of the spark discharge at the spark gap shown.

same binding post with which one end of the secondary is connected. The other end of the primary is left free.

A wire should be run from the binding

post referred to above, to any convenient ground. An adjustable clip should be provided to make contact with the turns on the primary. For the sake of convenience in connecting and disconnecting the different pieces of equipment used in connection with the Oudin coil, the clip may be connected by a flexible cord to a second binding post in the base.

A wire is to be connected from the adjustable clip, through a condenser, to one of the secondary terminals of an induction coil. A second wire must be connected from the other binding post, referred to above, to the other terminal of the induction coil secondary. A spark gap should be shunted across the secondary binding posts to the induction coil. If the induction coil is now operated, long streamers of bluish fire should appear around the ball at the top. If none appear, stop the coil, and vary the position of the clip on the primary of the Oudin coil, or close or open the spark gap electrodes. After a few trials the desired effect will be observed. A piece of metal held in the bare hand and brought close to the ball will cause long sparks to leap to the metal. No harm will be done whatever. The writer has observed that when the metal is grasped tightly there is no sensation felt, but when the metal is held loosely there is quite a pronounced tingling feeling. This latter effect is also observed when the hand is insulated by a layer of cloth or paper. Interesting stunts may be tried by placing plates of glass and other substances in the path of the spark.

Contributed by FRED O. RODGERS.

Electricity of Animal Organs

ACCORDING to general opinion, the production of electric current depends on atomic changes by which various constituents of the muscles are oxidized. This can be shown experimentally.

Claude Bernard has shown that, when oxidation processes of the body are checked by ether, electric current is reduced or brought down to zero. The anaesthetic operation of ether expends itself not only on the nerves and muscles, but on the living substance in the cells—on the protoplasm.

If an elementary organism, the ferment of beer, is placed in a vessel with sugar an electric current is produced. But this phenomenon ceases and reaches zero when the protoplasm is exposed to the action of ether; and if a muscle is put out of action by ether, the same annihilation of the current appears.

Among all the muscles, the heart is especially interesting. It is a well known fact that every heart beat is accompanied by an electric impulse. Dr. Walter, in London, has published interesting observations on this electro-motive power of the heart. He used in his observations Lippmann's mercury electrometer. Concerning this instrument all that need be said here is that it shows by the rising and falling of a column of mercury the intensity and polarity of an electro-motive force actuating a current passing through it. This instrument made it possible to observe the electro-motive force of the heart, even in a living subject.

If one immerses both hands in a vessel of water, into which two wires of an electrometer are also dipped, then every heart-beat shows the electro-motive force

of the heart by the change in height of the mercury columns. These experiments prove also that it is not immaterial which sides of the body are connected to the electro-meter. If one selects, for instance, two parts of the body upon the two feet, or upon one foot and the left hand, or upon the right hand and on the head, the mercury does not move. But if the right hand or one of the feet, or, as already mentioned, both hands are connected to the electrometer, the electro-motive force of the heart is at once shown. As

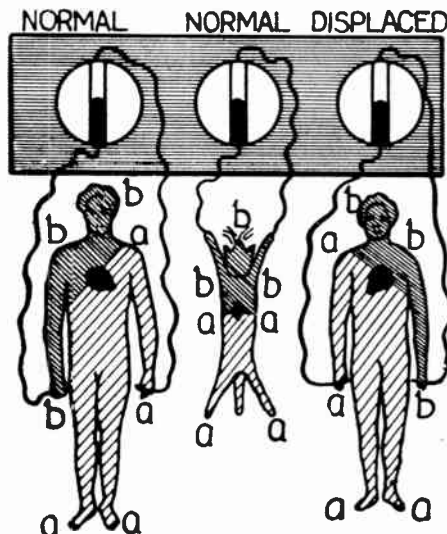

The electricity evolved by the human system, and how the current is affected by different connections and different positions of the heart.

we all know, the heart in the normal subject is on the left side of the body, and the vertical axis of the heart is inclined to the left. By the experiments alluded to in the text, it is shown that a plane perpendicular to this axis and passing through the heart divides the human body into two unequal parts, with the result that any particular point (a) on one side, connected with the electrometer, simultaneously with the point (b) on the other side, causes a movement in the mercury column, while connection with points (a) and (a), or (b) and (b), each pair lying in the same division of the body, occasion no movement of the mercury.

It is proved that the position of the separating plane is determined definitely by the position of the heart, because the plane takes the opposite position, if the heart is inclined in the other direction, which occurs in many cases of sickness, as well as by the experimenting with the body of an animal such as a cat or dog, in which the heart is more symmetrically placed, and gives therefore a symmetrical position of the two divisions of the body.

From these experiments it follows that the contractions of the four chambers of the heart do not occur all at once, but that there is a progressive movement. In warm-blooded animals this movement begins at the lower extremity of the heart and progresses towards its top, while the contraction of the cold-blooded hearts progresses from the top to the lower end. If, on the other hand, all the chambers contracted simultaneously, synchronous impulses would go out to both portions of the body, so that there would be no electric current, and the mercury in the electrometer would not move.



THIS department is open to all readers, whether subscribers or news-stand readers. We aim to show here for the benefit of others the best photographs of amateur work shops and laboratories. Nearly every experimenter has his own work shop, and we would like to receive photographs of all these. Photos are judged for best arrangement, and novelty of the apparatus, neatness of lay-out and assortment, etc. The prize does not necessarily go to the shop containing most apparatus and instruments.

In order to increase the interest in this department, we make it a rule not to publish photographs unless accompanied by portraits of the owner. We prefer dark photographs to light ones. Prize photographs must be on prints not smaller than $5 \times 4\frac{1}{2}$ inches. It is impossible to reproduce pictures smaller than $3\frac{1}{2} \times 3\frac{1}{2}$ inches. All pictures must bear name and address written in ink on the back. A letter of not less than 100 words with full description of the shop must accompany the picture.

PRIZES: One first monthly prize of \$3.00; all other published pictures will be paid for at the rate of \$1.00 each. Pictures and photographs will be returned upon request.

Johnstone Laboratory

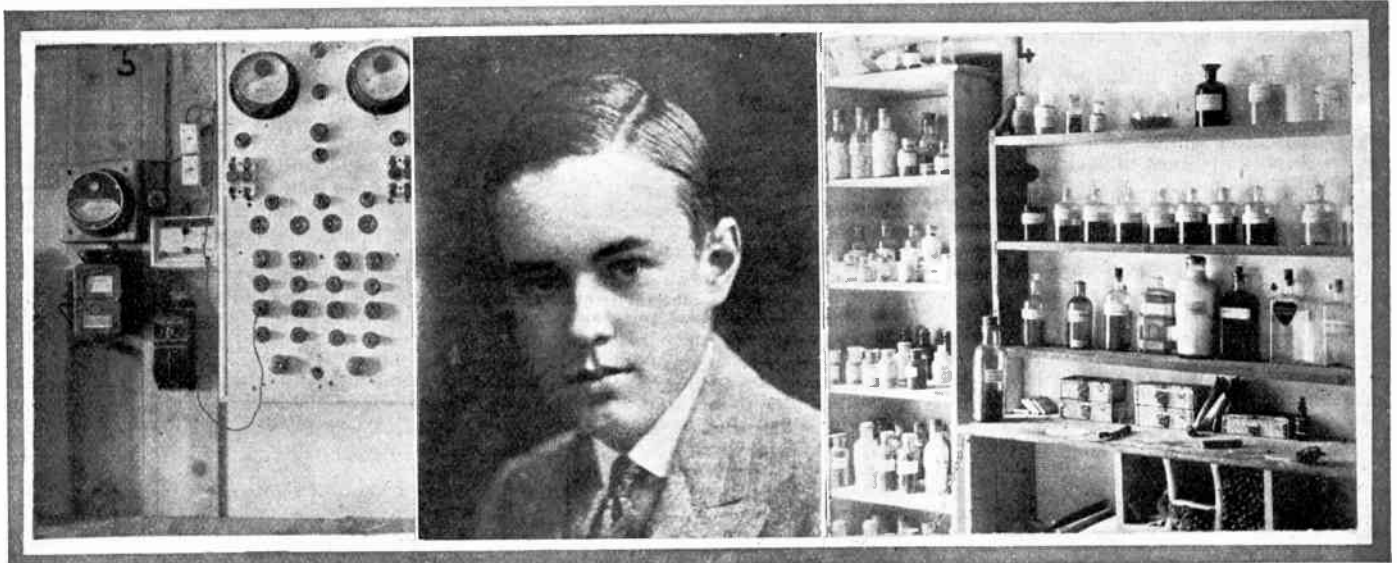

FROM A. S. Johnstone of Groombridge, Kent, England, we have the following account of his laboratory, which in the electrical portion, as well as chemical, seems to be very complete and is an interesting example of what is being done in England:

"My laboratory is divided into two parts—electrical and chemical. In the electrical division I have a very complete range of voltages from 25 to 440 D. C. and from 50 to 20,000 A. C. The various voltages up to 440 A. C. and D. C. are taken from the lamp sockets on the main switchboard, the high voltage of 10,000 to 20,000 volts being taken from the terminals on the left-hand side. The transformers and potentiometers for varying

the voltages are set into the wall behind the main board, all of which I have made myself. I am now constructing a radio set, but the restrictions over here are still very severe.

"In the chemical half I have a very complete set of all the ordinary reagents, 286 solid and 68 liquid; I have done quite some analysis work of alloys used in electrical machinery, and have made a fair study of the various grades of oils, both for power and lubricating.

"I am now making a study of the commoner aniline dyes, and have made quite a number of them.

"A quantity of the apparatus is kept in cupboards below the reagents' shelves."

This description of Mr. Johnstone's laboratory is of particular interest to us, as it shows what our English workers are doing, and there is a certain difference, we think, to be observed between the technique of the English student and experimenter as contrasted with the same individual in our country. Mr. Johnstone's laboratory with its quite efficient appearance, does not suggest as much of the rough and ready, as will be observed from our American students'.

His list of reagents is quite impressive, aggregating nearly 350, which he modestly terms "all the ordinary reagents." We certainly think the description is very modest, and he must have a wonderfully equipped laboratory.

Weiss Laboratory

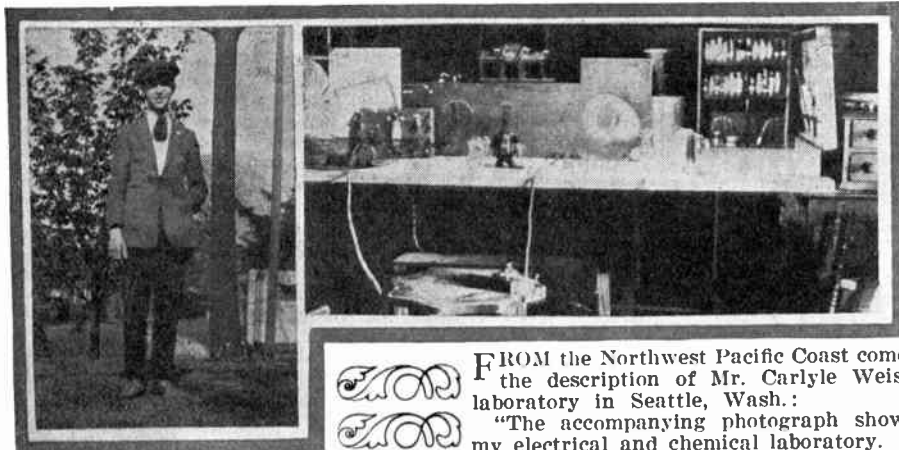

FROM the Northwest Pacific Coast comes the description of Mr. Carlyle Weiss' laboratory in Seattle, Wash.:

"The accompanying photograph shows my electrical and chemical laboratory.

I have a wireless receiving set, employing an audion for detector.

I perform many interesting experiments with my Tesla high frequency coil and my large spark coil. The Tesla coil is shown in the photograph. I have three motors, each of a different kind, besides much other electrical apparatus.

My chemical outfit is composed of about sixty different chemicals, test-tubes, delivery tubes, gas generator, alcohol lamps, mortars and pestles, and much other chemical paraphernalia."

In view of what is said above, this seems to be a very practical, every-day workshop, and it is quite interesting to have on the same page the typical laboratory of English and American workers. We only wish that the American laboratory was represented by a view which would do it fuller justice.

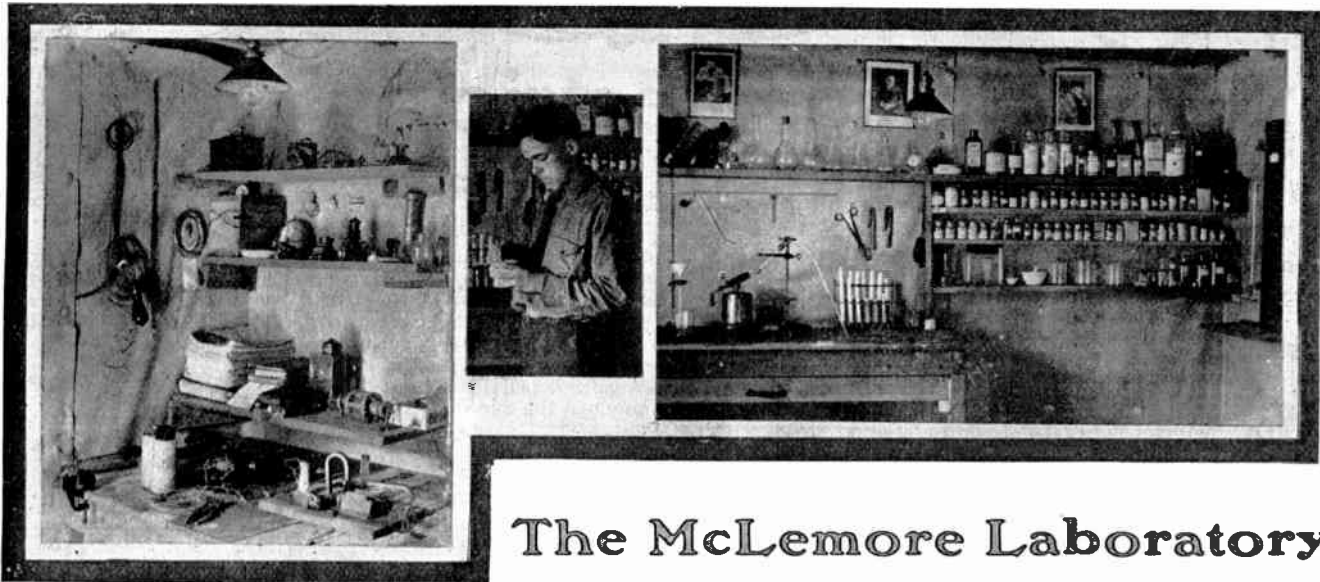

The McMormore Laboratory

MR. JOYCE R. McLEMORE of Wise, Va., writes us as follows in regard to his workshop:

"My laboratory building is eight by ten feet and was built by myself of one-inch lumber and two by four inch framing. It has a rubber roof, large double windows, and there are honeysuckle vines growing over it, which enhance the appearance and help keep it cool on a hot day.

"Strung between two high trees above the building is a two-wire aerial about 75 feet long. This aerial is used only for experimental work, because of the lack of the proper instruments to listen to the big government stations. With a one and one-half inch spark coil, a telephone receiver and galena detector I have talked a distance of about three-quarters of a mile to

a small field set. I use my chemical laboratory for quantitative and qualitative analysis, food testing, water testing (for mineral salts in solution), chemical magic and almost everything a laboratory can be used for.

"The chemicals and apparatus were selected with care, with the result that almost any experiment possible with the average laboratory, can be performed.

"It contains Florence and Erlenmeyer flasks, all sizes of beakers and test-tubes, gas generators, mortar and pestle, alcohol lamps, gasoline blow-torch, wash bottles, balances with complete set of weights, ring stands, thistle-tubes, funnels, graduates, and numerous other apparatus, besides the chemicals.

"My electrical laboratory is used for

constructing apparatus, for repairing toys and apparatus and for experimenting in everything electrical in its scope.

"I use a step-down transformer for all the experiments which it will do. I have also experimented with a rectifier.

"Under the workbench is a set of drawers and shelves which are very convenient to keep tools, screws, bolts, wire instruments, etc., in.

"Among the apparatus I have constructed are the following, for which I found the directions in my copies of the ELECTRICAL EXPERIMENTER and your other magazines. (Have every copy since May, 1915, which I value very highly.) Electric arc searchlight, Geissler tubes, detectors, Tesla coil, condensers, galvanometers, motors and telegraph instruments."



The Lawlor Laboratory

MR. JOHN D. LAWLOR of New Bedford, Mass., thus tells of his work:

"Enclosed you will find some 'shots' of my electro-chemical laboratory, and one view of yours as per usual. I have about 300 different chemicals, acids, reagents, mixtures, compounds, etc., and all the paraphernalia necessary for the conducting of a large number of experiments. Florence and Erlenmeyer flasks, test tubes, retorts, graduates, scales and all the rest of the junk necessary to and usually found in such a hangout. I have also a home-made Liebig condenser that would make old man Liebig himself wonder what it was for, but it works. At times the results of my many experiments are most astonishing, to say the least.

"The electrical end has three switchboards, one large and two small ones. The large one is the main source of sup-



ply, 110 V. A. C., and contains all the switches to the lighting circuits, trans-

former, etc. One of the smaller ones gives from 3 to 30 V. A. C., by means of a step-down transformer, and is used in the main to run small motors, buzzer system, 14 V. electric lights, etc. The other small one is a D. C. one, giving from 4 to 40 V. D. C. by means of an electrolytic rectifier described in a previous issue of 'E. E.' This is used for experimental purposes mostly, as it is not as reliable as it might be, and is doing duty chiefly with my Audion 'A' and 'B' batteries. There are six small motors and two large ones, electric fan, soldering iron, induction coils, choke coils, retardation coils, resistances, buzzers, bells, ammeters, voltmeters, galvanometers, etc.

"I have also established telephonic, telegraphic and buzzer communication with a friend next door. All the apparatus is home-made and installed.

"The mechanical end includes a complete list of tools for every purpose."

Junior Electrician

Home-Made Dimming Switch

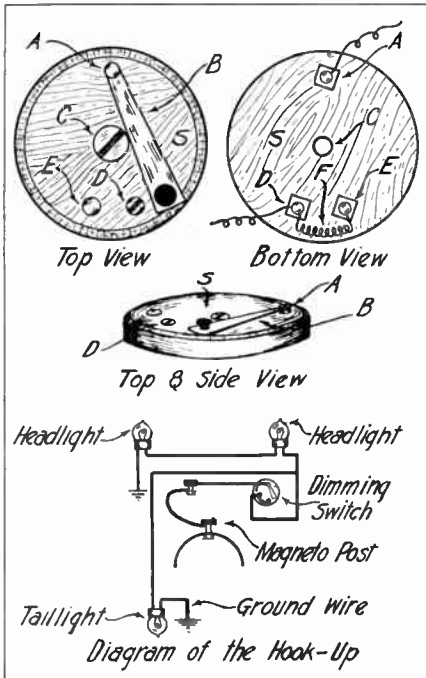

A dimming switch, of very simple construction, which may be used wherever a light is to be reduced in brightness, and can be applied very nicely to automobiles.

A VERY good dimming switch can be made with little work and at small cost by following these directions:

Purchase a small wooden-base switch (about 10 cents) and line with sheet asbestos. With a stove-bolt make an extra binding post with the nut on the under side. Take a short piece of German-silver wire and make a short coil, or, better still, use a short length of heating filament from an old electric iron or toy rheostat and connect one end to the regular binding post and the other end to the extra post. The feed wire is connected from the magneto (or battery) to the regular binding post at the top of the switch and the wire to the lights from the other regular post. Tapping in the tail light does not affect the head lights, although the tail light is dimmed with the head lights.

Contributed by FRANK H. AMBERS.

Making Your Hat Work

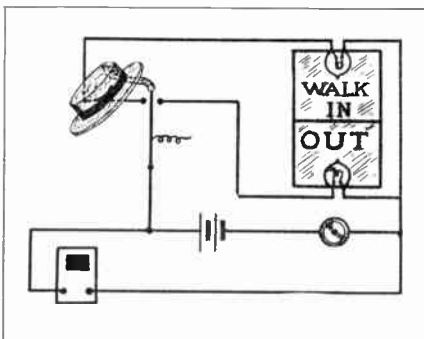

A switch operated by the weight of your hat; when you hang your hat up, the switch is made to operate an "enter" sign at your door, and when you take it off the hook, the switch is ready to operate an "out" sign.

THE piece of card board that hangs by a string to your door knob to announce your presence or absence in the office is nearly always turned the wrong way. However, if the automatic device hereinafter described is used, it will be found to be much more dependable, and in addition, will announce the arrival of a client.

To make the Announcer procure a cigar box. From the lid of the box, make a partition to be fastened across the middle, so that it lacks about one-half inch of reaching the top of the box. Tack narrow strips of wood around the inside, even with the top of the partition. Place two miniature electric lights in the box, one on each side of the partition, and run the connecting wires out at some convenient place. Fit a piece of glass into the top of the box. Place your sign over the top of the glass so that the words "Walk In" will be on one side of the partition and "Out," on the other. This sign must be of thin paper so that the light will shine through. Over this place a mirror having only a thin coat of silver and no paint on the back. Plain glass with a thin white paper pasted on the back will answer the purpose. Now secure the glass in place with putty and your announcer is complete.

To make the hat switch, take a piece of wood about 1"x4"x8", a strip of brass 1/2"x1/8"x12". Bend one end of the strip about a long brass screw to form a hinge. Then screw it into one edge of the board near one end. Near the other end, and on the same edge, screw two more brass screws, placing the brass strip between them so that it will have only about one-quarter inch play. Now bend the projecting end out so that it will accommodate a hat. Across the side, at about the middle of the block, cut a groove about one-half inch deep. Into this fasten a spring so that it will hold the strip against the back screw when not in use. Now wire to a push button and buzzer as shown in the diagram.

When a client pushes the button the buzzer will sound. If your hat is on the rack, the words "Walk In" will appear, if not, the word "Out" will appear on the announcer.

Tesla's Electrolytic Clock

THE main part of this clock is a copper disk perfectly balanced in a solution of copper sulphate and sulphuric acid. The disk is fastened on an axle, the latter being horizontal and free to rotate.

On both sides are copper electrodes connected to a battery. In electro-plating, metal is taken from the anode and deposited on the cathode.

Therefore from the anode electrode copper is deposited on the side of the wheel nearest it, unbalancing the wheel. From the other side of the wheel copper is deposited on the cathode electrode and the wheel is dissolved slightly, still further unbalancing it. This causes the wheel to rotate slowly. The speed is controlled by a rheostat.

This instrument measures time. Another electrolytic instrument for measuring current consumption was used by Edison on his first power line in New York.

This consisted of a zinc sulphate bath with zinc electrodes. From time to time the "zincs" were weighed and the weights recorded. The difference in weights determined the consumer's bill. This

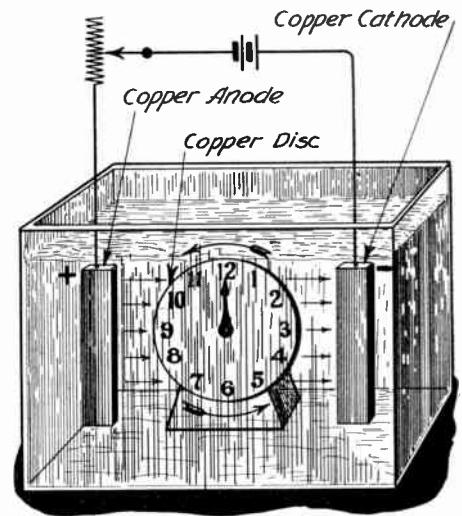

A very interesting experiment which is readily performed, due to Nicola Tesla; a clock operated electrolytically by deposition and solution of copper on a rotating disc.

arrangement is replaced by our present day electric meters.

The Edison electrolytic meter proved very troublesome. Water had to be constantly added to it, and in winter it froze. Consumers complained about the fumes arising from the meter and some could not understand "how they figured" their light bill, as of course there was no indicating dial or dials.

Contributed by E. MOEN.

A Transformer and Lamp

A DESCRIPTION of a transformer which will light a 3-volt lamp brilliantly, and can easily be made, is given below:

To construct this transformer an old 30-ohm magnet taken from a telephone ringer and about 20 feet of No. 24 S. C. C. wire are required. The wire on the magnet will be used as the primary of the transformer and the secondary can be made by winding the No. 24 wire in even layers on the outside of the primary wire. Attach a circuit of 110 volts A. C. to the primary and attach a 3-volt light to the secondary leads, and the light burns brightly.

Contributed by PAUL BOTSFORD.

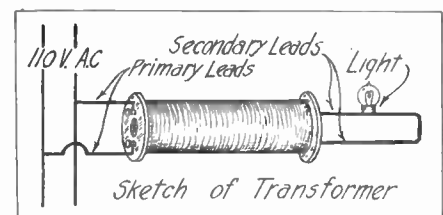

Operating a lamp with a transformer, from a 110-volt alternating current circuit, a very effectual and easily arranged connection.

Mouse-Trap Alarm

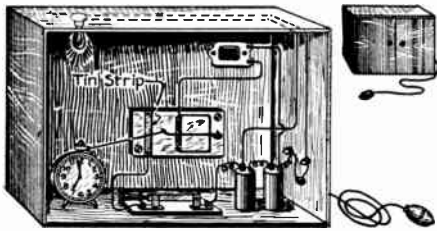

An alarm operated by a clock in which the connection is made by the tripping of a mouse trap; the whole is contained in a neat case, and a small lamp is lighted at the specified time so as to show the face of the clock.

A MOUSE-TRAP alarm, operated by an alarm clock, one which has given good service for a considerable time, is shown in the accompanying diagram, and possesses the desirable quality of making the sleeper arise to shut it off, providing it is placed at a reasonable distance from the bed. The whole outfit is enclosed in a wooden box having two doors in front, making a neat, cabinet-like affair.

The bell is removed from the clock so that the hammer is exposed. The mouse-trap is screwed to the back of the box in such a position that the trigger is in line with the hammer of the clock.

A strip of tin is tacked across one end of the trap and a wire connects this to one side of the switch fastened to the floor of the box. Another strip of tin, bent hook-shape, is connected by means of a string to the trigger of the trap and is placed around the hammer.

The tin should be carefully bent to an "L" shape, and the string must be of just sufficient length, so that when the clock alarm begins to go off the hammer will jerk the string and release the trigger and at the same time throw the tin hook off the hammer. This prevents the string from being broken every time the trap is sprung.

A miniature light for seeing the time during the night, without getting out of bed, is placed above the clock and an extension of suitable length is run through the side of the cabinet, at the end of which is connected a push button. The connections are shown in the diagram.

Contributed by JOHN W. KNIGHT.

Resistance Switch

AN ordinary knife switch, whose resistance is zero, can be transformed by the appliance shown here into a resistance switch, to cut down the current to any extent desired.

A piece of fibre or hard rubber rod is wound with resistance wire of any desired size and resistance. This wire must be calculated for the voltage of the circuit so that it will not become dangerously heated when such voltage is permitted to force a current through it.

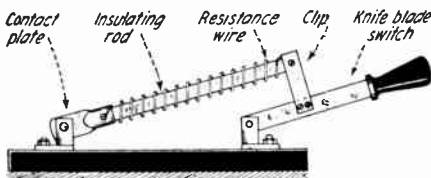

A knife-switch converted by a resistance coil wound on an insulating bar into a resistance switch, reducing the current as desired.

The rod is provided on both ends with plates; these represent the knife blade contacts of the switch, which it will be seen is of the familiar knife blade type. These enter, one into a clip above the

switch, and one into a special clip attached to the middle point of the blade of the switch bar. The illustration shows the whole arrangement; the ends of the wire are riveted and soldered into the plates at the end, or may be attached thereto by screws and in any case it is well to solder them.

If a zero resistance connection plug is wanted, the resistance coil is discarded and the switch bar is swung into position into the upper clip in the normal way. If resistance is required, the switch bar is swung down and the resistance element is inserted in the clip as shown in the illustration.

A number of such resistance pieces may be provided to cover different contingencies.

Contributed by H. L. SMELTZER.

Photographic Studio Connection

THE illustration shows a switch with connections for dark-room use by the photographer. In the dark room there has to be a ruby lamp properly shielded, and in a room where enlargements are to be made, which is presumed to be the case in this instance, where bromide exposure and development is in question, there is a constant change required from white to ruby lamps.

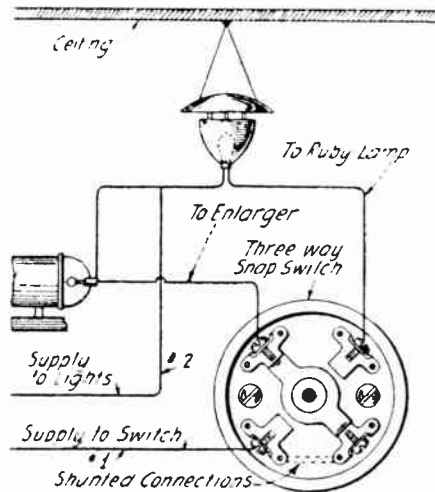

How to connect a ruby lamp and the powerful enlarging lamp in a photographer's studio to a single switch, so that any light desired can be produced from that one point.

For every enlargement, five or six trips from ruby lamp to enlarger are required for each picture made.

The connections shown provide for turning on either lamp as required, with the same switch. The ruby lamp will be noticed high up, with perhaps a conical screen, made of what the photographers call envelope paper, surrounding it. Then the powerful white light required for enlargement is connected to the same switch. The arrangement is certainly most convenient, and very suggestive for workers in the enlargement room.

Contributed by LLOYD RINGER.

Spark-Plug Gas-Stove Lighter

A GAS STOVE can be lighted with a common automobile spark plug, as shown in the sketch, and the use of matches is eliminated.

Make a handle of rubber or some non-conducting material, drill out a hole about one-half inch deep in one end, and then solder a plug terminal head to the top of a wood screw as shown. Twist the wood screw into the end of the handle

and thread the porcelain shank of the plug into it firmly.

Tap the shell of the plug for one wire and carry a second wire to the central terminal; these are to be led to the secondary terminals of a spark coil, and then

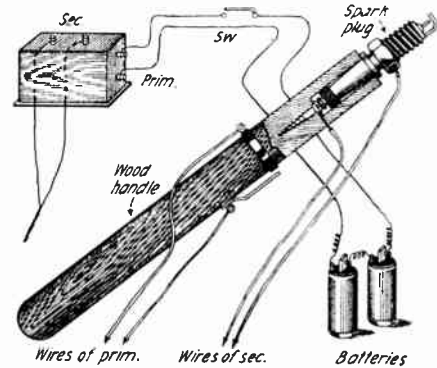

A spark plug, such as used in automobiles, is mounted on an insulating handle and connected to the secondary of an induction coil, so as to operate as a gas stove lighter.

attach four dry cells by a second pair of wires to a simple brass switch on the handle of the lighter and lead from there to primary terminals of spark coil.

Thus, by holding the lighter over the gas and pressing down on the switch, a spark jumps the plug gap and ignites the gas.

By touching plug points to paper or tinder any fire can be started by this lighter.

Contributed by WILLIAM WEBBER.

Electric Drive for Dash Churn

IT is a simple matter to connect an electric motor by belt or gear to any appliance which needs to be rotated. In the case of the modern churns, where the dashers are turned by hand, it is a simple matter to remove the crank, put on a belt wheel, connect the motor and let electricity do the work.

When we come to the old-fashioned dash-churn, however, in which the dasher is moved up and down vertically, within the barrel-shaped churn, on its face at least it is not so simple a matter to connect an electric motor. By utilizing a stand of an old sewing machine, the old-fashioned churn can be operated to great effect by a motor.

All accounts of former days tell us that no work was more distasteful than churning with the dash-churn, but by the appliance illustrated, all one has to do is to turn an electric switch and the universal servant does the rest. For such is the title which electricity has won.

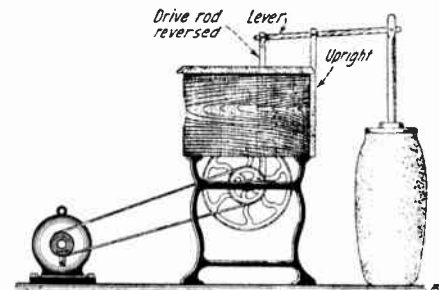

An old sewing machine table with flywheel and connecting rod is here used as the mechanism for operating the dash churn by electricity.

As a means of transmitting power to an ordinary old-fashioned stone jar milk churn, the mechanism of an old sewing machine serves as a mediator between mo-

tor and churn, in a novel manner, as shown in the accompanying illustration.

The head of the machine is removed and the drive rod disconnected from the treadle and reversed so as to protrude through the opening in the table. An upright is bolted to the frame of the machine to provide a fulcrum and a two-by-one lever placed across this from the rod to the churn dasher. The motor is then connected to the drive wheel by means of the sewing machine belt and the butter is churned in the "good old-fashioned way." The machine's legs are blocked around to prevent it from being moved from the vibration of the apparatus, the churn is also enclosed by blocks of wood nailed to the floor to hold it in position. The housewife is thus at liberty to proceed to other chores while the milk is being churned.

Contributed by L. M. JORDAN.

Electric Flasher

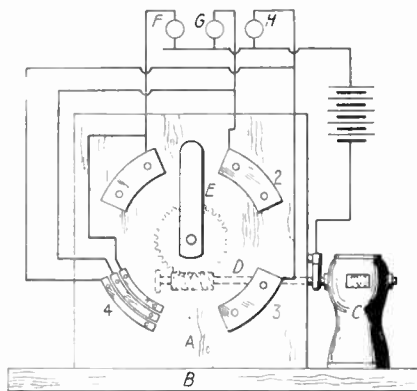

An electric flasher; a switch operated by a motor, which turns on and off a bank of lamps or each lamp singly, thus producing a definite flashing effect which can be modified as desired.

IN the construction of an electric sign, I was confronted by the problem of having three lamps flash singly and then together. A flasher of the following construction accomplishes this very nicely:

A board, about three inches by three inches by one-half inch, is mounted in an upright position on a base (B). On this board are arranged four contacts, three being single plates, while the fourth is in three segments. A lever (E) is secured to a shaft which passes through a bearing in the upright block of wood and is attached on the other side to a small gear. A worm gear, attached to an extended motor shaft, meshes with the gear attached to the lever and serves to revolve this lever slowly.

When the lever comes in contact with segment No. 1, the current from the batteries or other source flows through the lamp (F), contact to the lever being made through the motor shaft. The lamps (G) and (H) are lit in succession, and when the lever comes to the fourth contact, which is composed of three independent segments, all three lamps are connected in parallel.

Contributed by PAUL G. EDWARDS.

Projectile Standard Lamp

A PLAN of my shell lamp, which I made from a relic of the war, is submitted herewith. I am using it daily and find it works very satisfactorily.

The regulation plug (E) is turned down, as per sketch, and provided with four rubber plugs and four contact pins (BB) and also holds the pipe (K), which is a holder for the shade as well as for the lamps (FF and G). The top (D) is turned to the same shape as an ordinary fuse and rests on the plug (E), and turns around the pipe (K). The top (D)

is provided with one rubber bushing, holding contact spring (C), which is to bridge the contacts (B) either to the right or

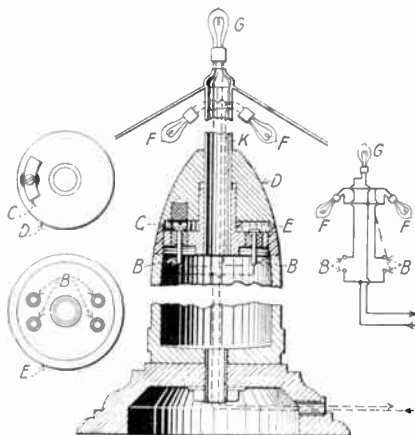

A projectile from the great war, utilized as the standard for carrying an electric lamp, making a memorial of something which, if it were possible, should be forgotten.

left in order to light the lamps (FF) under the shade, or the lamp (G) over the shade. All the lamps are extinguished by a quarter turn.

Contributed by O. E. JOHNSON.

Electrical Articles in August Science and Invention

- Perpetual Motion—Is It Possible? By H. Gernsback.
- Automatic Airplane Stabilizer. By G. H. Daly, D.S.M., Late of the Royal Flying Corps.
- Ship Fire Detector and Extinguisher. By Robert G. Skerrett.
- Motion Pictures Transmitted via Radio. By S. R. Winters.
- New Vacuum and Compressed Air Railway.
- Truth Enforced by Electric Machine.
- Home-Made Carousel.
- The Oracle—Question and Answer Box.
- Latest Patents.
- Patent Advice.

Adjustable Electric Alarm

Alarm Clock

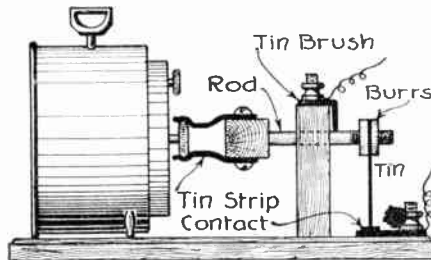

An alarm clock which will ring an alarm at any time within the hour; its uses are restricted to cases where intervals of less than 59 minutes are in question. It cannot be used as an alarm clock to wake you in the morning, however.

TO construct this alarm a board is to be obtained—as wide as the clock and twice as long. About an inch from one end mount a piece of wood (higher than the center of the dial). A 1/8-inch hole is drilled in the line with the axle, on which the minute hand of the clock is fastened. The drawing explains the rest.

A spark-plug rod with two burrs is put in position, as shown, through the hole

in the wooden upright. Be sure it is free to turn. On the unthreaded end of the rod a tight-fitting block of wood is fastened. On the block are fastened two tin or brass arms, one-half inch wide, which grasp the knob on the center of the back of the clock. A tin arm is fastened on the other end of the rod by the burrs.

Connections go to a brush that rubs on the rod and to a piece of tin that touches the tin arm once for every revolution of the arm.

This alarm can be adjusted from one-half to 59 minutes, and will prove a boon to the cook or anyone who takes the care to adjust the contraption. It will do for timing the boiling of eggs or other culinary operations.

No doubt it can be put to a great many uses. It could be modified by fastening a small paddle-wheel, to be turned by the tin arm. Thus the clock could be set to ring inside of several hours—or to open a closed circuit such as an illuminated window display.

Contributed by ESTEN MOEN.

Resonator for Telegraph Sounders

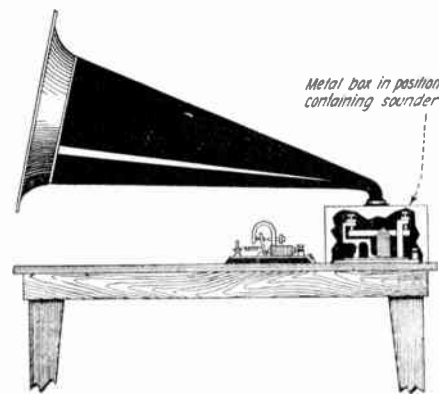

A phonograph horn used as a resonator for increasing the range of action of the telegraph sounder, as well as directing the sound waves in any desired distance.

IN telegraph offices, especially where there are a large number of instruments crowded together, the sounders, if they are close together, are often heard only with difficulty. To magnify the sound, they are often mounted in wooden resonating boxes.

The phonograph horn mounted on a box enclosing the sounder, may be used for the magnification of the sound, and also to some extent as a directional appliance, sending the sound out in the line of its axis.

To increase the volume of sound produced by the telegraph sounder, and direct the waves to the ears of the operator, serving the same purpose as the factory constructed resonator, the horn of an old phonograph is attached to the sounder as shown in the illustration.

A small rectangular, sheet metal or tin box is mounted on the telegraph table and contains the sounder, completely enclosing the same, but provided with a lid to be opened for adjusting the sounder bar, etc. Attached to the upper edge of this metal box, centrally, is the neck of the horn, over a small hole cut through the box, through which pass the waves of the instrument. This attachment is accomplished by soldering. The box is secured to the table's leaf from the inside. The horn may be turned to several positions as when on the phonograph, to meet with the operator's possible changes of position. The flare of the horn extends near the operator's ears and the transmission is much clearer and more efficient than is produced without a resonator, or with the factory constructed device.

Contributed by L. M. JORDAN.

Electric Wind Vane

ALLOW me to submit an article on the construction of an electrically recording wind vane, which I hope will appeal to the readers of your fine magazine.

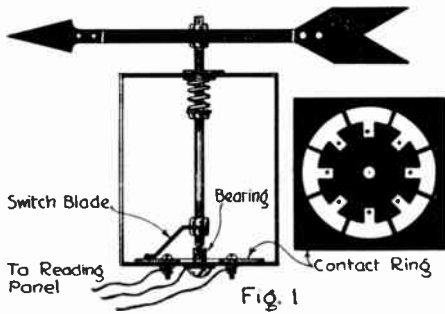

The mounting of a wind-vane, with its switch blade, contact ring and eight-point connection, to show the direction of the wind in a room or hallway of a house.

The vane was made of thin tin taken from a cracker box. The point was triangular in shape. The wing was 5 inches wide and 8 inches long; the strip is made from an old yardstick cut in two, and the tin wing and point clamped between the pieces by two 3/16-inch stove bolts. The balance of the vane is then found, and a rod threaded at one end is placed between the strips and a nut at each side holds the vane straight.

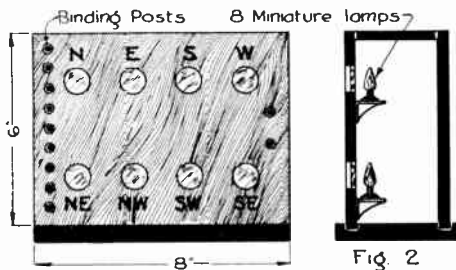

A lamp board, with eight lamps corresponding to eight points on the wind vane; whichever lamp is lighted, indicates the direction of the wind as shown.

The switch box was a common school chalk box; in one end a hole was drilled in the center just large enough to let the rod pass freely. A larger hole was drilled in the other end corresponding with the first hole and a 3/16-inch by 1/2-inch stove bolt was drilled with a countersink at the end which forms the bearing for the rod.

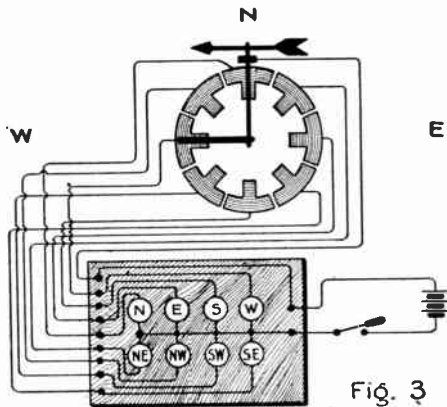

Full diagram of connections between the wind vane and the lamp board; as the wind changes a different lamp is lighted, one for each of the eight principal points.

The rod is filed to a point to fit the bearing. This end is threaded all the way to the bearing and a small spring

and a nut are placed on the rod to prevent the rod from slipping out of the bearing in a strong wind. The top bearing was a strip of half-inch copper drilled large enough to take the rod.

At the bottom of the rod a strip of spring brass, fastened between two nuts, formed the switch.

The contacts (eight in number) were made as follows:

A circle was cut out of sheet copper 3 inches in diameter; a 2 1/2-inch circle was marked inside the larger; the whole marked into eight sections and cut like small Ts; these were then bolted to the bottom of the box forming a circle. Be sure they don't touch each other. The bolts should be long enough to put an extra nut on them. These are the connecting posts. The bearing is the ninth binding post.

The box is given a coat of paint and when dry rubbed with wax, which makes it waterproof; the top should fit tight enough so as not to admit any water. Several holes are drilled in the bottom to let out any water that may leak through the top bearing.

The recording panel was made from a piece of half-inch oak, 6 inches by 8 inches, and is drilled as in the diagram. Eight small miniature lamp sockets are mounted on two shelves back of the holes. A s. p. s. t. switch is mounted on the panel so as to disconnect the battery when desired.

The two binding posts at the right are connected to the battery, the nine posts on the left are connected to the vane. The wiring diagram is self-explanatory.

After the apparatus is finished the vane is mounted on a chimney or any clear place where the wind will strike it from any direction. It is advisable to mount it close to the room where the recording panel is located, to save wire, but it must be in an exposed place.

A single drop of oil on the bearing is sufficient. Both bearings should be connected by a piece of wire for the current to pass through the rod to the switch blade.

The instruments are then wired as in the diagram; the lamps are marked on the panel as shown.

Contributed by BELGRAVE F. GOSTIN.

Protecting the Refrigerator

ABOUT this season of the year the youths of the neighborhood become afflicted with a propensity for making excursions to nearby refrigerators and relieving them of "goodies" and most tempting food. This is a costly and dangerous sport that should be discouraged, as it often results in serious injury to the mischievous youths and expense to the victim of the robbery.

This is the electrical age and there are very few problems that cannot be solved by electricity. These young robbers, alley cats as they are called, can be effectually discouraged without serious injury by the proper use of electricity.

The refrigerator is shown on the back porch in Fig. 1. In order to open the refrigerator door the handle (H) must be lifted, which causes the lever (L) to rise out of its socket, forcing the rod (R) up to the insulated wire (K), making a connection of the primary circuit of a small induction coil. The secondary terminals are led to the lock (J) and the socket; when the primary circuit is completed the victim receives a severe, though not serious shock.

In order that the housewife will not be exposed to the unpleasantness of an electric shock, an automatic switch (S) is fixed on the kitchen door. A brass strip is nailed on the side of the door and when the door is closed the brass strip closes

the circuit, but when the door is open the circuit is broken. All the housewife has to do is to remember to keep the kitchen door open when she goes to the refrigerator.

Diagram 2 shows another attachment to

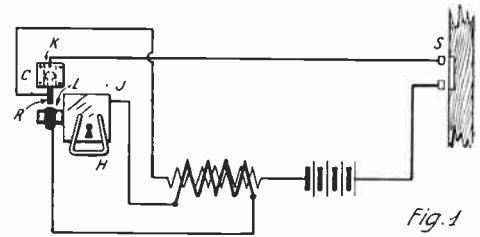

The connections for protecting a refrigerator so that a shock will be given to anyone attempting to open it.

use on the refrigerator for chasing intruders. The same switch (S) is used on the kitchen door and an electric bell is placed in the circuit. On the refrigerator door there is a switch (S¹), shown in detail in Fig. 3. The essential difference between this switch and switch (S) is the position of the door when the switch completes a circuit. When the refrigerator door is closed the circuit is broken, but just as the door is pulled open the brass strip comes in contact with the ends of the wires, closing the circuit and causing the warning bell to ring.

The third plan is to connect the elec-

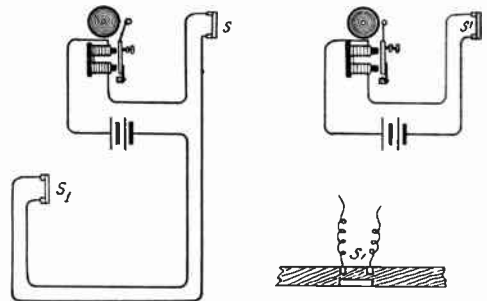

Two alternative connections to protect the refrigerator, this time by ringing a bell.

tric bell so that it will ring as the screen door on the back porch is being opened. The switch (S¹) is fixed on the door and as the culprits slyly open the door they are greeted by the loud ringing of the bell.

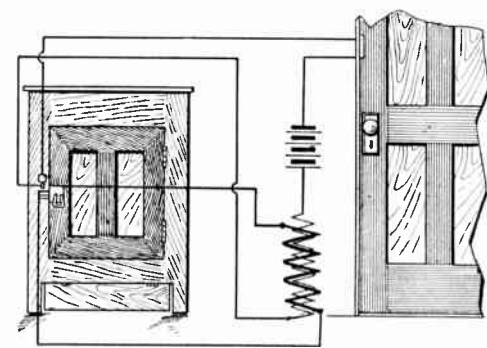

The entire connection in elevation between door and refrigerator for carrying out the protection by shock.

Any one of these three plans will safeguard the contents of your refrigerator and save you many times the cost of the materials used in the construction of your silent sentinels.

Contributed by EDWARD L. FRIEDMAN.

Fixation of Nitrogen

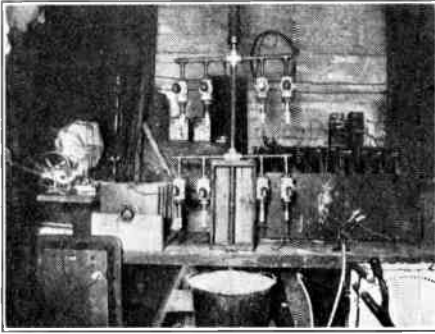

View of the apparatus with which the fixation of atmospheric nitrogen was accomplished.

THE illustrations show an inventor's workshop, in which the fixation of atmospheric nitrogen is being studied.

The process applied is the well-known arc process, in which air is passed through a flaming voltaic arc. The arc of the electric light is employed, except that it is much longer, on account of the electrodes being widely separated. When air is passed through the flame of such an arc, the high temperature reacts upon the oxygen and nitrogen of the air, bringing about a combination of nitrogen and oxygen, forming oxides of nitrogen, which, by absorption in water and subsequent oxidation, give nitric acid.

A great deal has appeared in the newspapers of late on the subject of Mussel Shoals, and the proposal for the utilization of the water-power there, which has

been presented to the Government, are generally supposed to include the fixation of atmospheric nitrogen as one of the principal objects. This gives special interest to any serious work in this direction.

The laboratory we illustrate is in Cincinnati and the inventor of the process being worked out there is Charles H. Buettner. In the one photograph are seen four combustion chambers, within each of which an arc is maintained, and through which air at atmospheric pressure and temperature passes. The large bottle seen above the four combustion chambers is used for further oxidation. The gases are then passed through water, which, absorbing the oxidized nitrogen, forms nitric acid, and final passage through a bottle containing an alkaline or alkaline earth hydrate absorbs any that may escape the water, forming a nitrate of the base employed.

Everything, of course, in the laboratory is done on the miniature scale; in the next photograph we find the oxidizing chamber dispensed with, and a vertical tube, representing an absorbing tower, filled with gravel, over which water trickles, used to absorb the gas.

When it is remembered that the world is largely dependent for its supply of nitric acid and nitrates on the natural deposits of far-off Chile, and that the consumption of the derived chemicals is constantly on the increase, it will be seen how important an industry is involved in this synthesis.

In old times potassium nitrate produced on a very small scale, comparatively

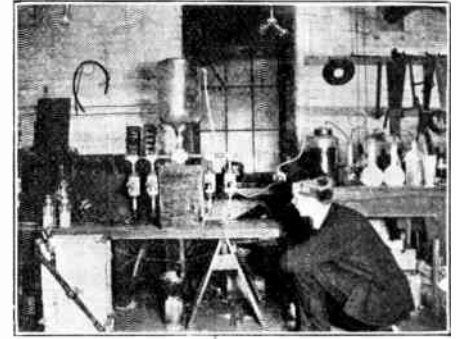

The inventor in his laboratory carrying out his work on the action of the electric arc on air.

speaking, by a natural decomposition and recombination, gave the world its "villainous saltpetre," whose principal use was then the manufacture of gunpowder. The introduction of artificial fertilizer and the development of the chemical industry, especially in the production of dyes, all accomplished in quite recent times, have given a great impetus to the industries based on nitric acid. The old artificial nitrate beds, in which the potassium nitrate was slowly produced, have sunk into utter insignificance, and the great deposits of Chile will soon be supplemented on a very large scale by the fixated nitrogen of the air.

It was the fixation of nitrogen which enabled the German powers to prolong the war, giving them the requisite nitrogen oxides for their high explosives.

\$50.00 Title Contest

IN our issue of March-April we announced a \$50.00 prize contest for the best title of our cover. A picture of that cover is reproduced herewith. Close upon 4000 letters suggesting various titles were received, this contest seemingly having interested people in every civilized country of the world and all walks of life. There were entries from electricians, stock brokers, automobile manufacturers, publishers, merchants, radio enthusiasts, and hundreds of others. Sometimes a whole family participated and some of the contestants were not backward in submitting a long list of titles. Ten to twenty different titles was the average run, while one contestant from the Pacific coast actually submitted forty-five titles.

Of course there were many hundreds of duplications, running as follows: "Trouble for the Receiver," "The Lucky and Unlucky Receiver," "Practical Electrician," "Necessity is the Mother of Invention," "The Unlucky Horse Shoe," "The Electrical Experimentor," "Science Must Be Served," "The End Justifies the Means," "The Young Edison," "Necessity Knows No Law," and hundreds of other similar ones. Most of these were duplications and did not show any ingenuity.

We stated that we desired the title to be descriptive and to explain the picture in short and crisp terms. In awarding the first prize to Mr. B. Halpern, we believe that his title possesses these qualifications. We believe that the title "Applied Practical Electrician" is the most meritorious submitted. The others were selected on account of their ingenuity.



THE PRIZES

FIRST PRIZE—"Applied Practical Electrician," submitted by B. Halpern, 251 Clifton Pl., Brooklyn, N. Y. \$25.00.

SECOND PRIZE—"Phoney Business," submitted by Henry C. Fitzpatrick, 39 Winthrop Street, Brockton, Mass. \$15.00.

THIRD PRIZE—"In the Hands of the Receiver," submitted by A. W. Jeffs, 6 Hudson St., Worcester, Mass. \$5.00.

FOURTH PRIZE—"The Scientific American," submitted by Homer J. Jones, No. 6 Fire Station, Canton, Ohio. \$3.00.

FIFTH PRIZE—"Impractical Electrician," submitted by M. P. Daniel, Liberty, Texas. \$2.00.

We were pleasantly surprised at the avalanche of titles received, and the interest displayed in this contest urges us to soon stage another. We thank our contestants for the trouble taken, and trust that all will be satisfied with the selection of the prize winners. So much interest has been taken in this contest that we reproduce the cover design for the benefit of our readers. They can see how well the titles fit the subject, not only the prize winners but the others also.

Detecting Counterfeit Banknotes

IN recent times banknotes have been so often skillfully counterfeited that their detection becomes increasingly difficult for the average man, and is often absolutely impossible for him to achieve. Even the expert is often deceived. Many attempts have been made to detect counterfeits in some infallible way, in order to separate the good notes from the counterfeits quickly and with certainty. A new invention in this line is to be noted in which the X-ray has been called into service.

This invention, patented in Germany, is a process of printing the notes with colorless material mixed with the ink, which material strongly absorbs X-rays and does not permit their passing through. Such, for example, are the salts of heavy metals, and these of course are impressed in the form of the letters on the banknote, the figures and the signature. By subjecting such notes to the X-ray the figures come out clearly upon the sensitized electric plate after development.

Fluoroscope X-Ray Unit

By Charles W. Geiger

A VERY complete X-ray apparatus, which takes up less than 20 square feet of floor space, and which operates satisfactorily on the standard 110-volt alternating current available at any lamp socket, is now offered to the medical

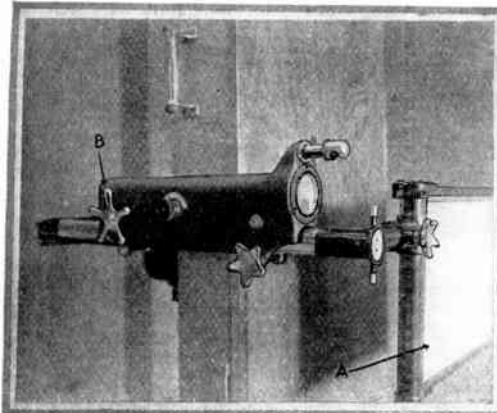

A fluoroscope, through which the observation of a patient is made by the physician. This is mounted on a standard carried by the apparatus shown, so as to be adjustable for all requirements of position.

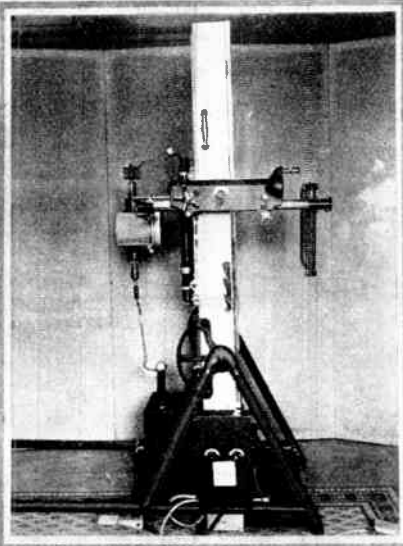

The apparatus in a vertical position; the fluoroscope can be seen in this illustration, extending across the frame just above the center.

plant for repairs and another unit is connected to the transformer by a 7-point slotted plug so that the connection is always made in the proper position.

There is a foot-switch for fluoroscopic work and a pull-switch which is used in radiography. Five milliamperes suffice for fluoroscopic work and 30 milliamperes for radiography. For bringing the current up to 30 milliamperes the operator merely pulls a string (on the pull-switch) and holds same until the exposure is made, and then releases the pull-switch. The instant this switch is released the current is automatically shut off and the machine remains set for fluoroscopic work.

One of the desirable features of this equipment is the fact that the Coolidge tube is enclosed in lead shields as shown by the arrow at (A) in the photograph. This provides protection to the operator from any vagrant X-rays that might escape from the Coolidge tube. These lead shields cut off most of the X-rays except those used for the examination and exposure. The Coolidge tube is enclosed in lead glass painted black, thus eliminating all light from the machine, making it possible to keep complete darkness in the room at all times, as this darkness is absolutely necessary for the best fluoroscopic work.

The entire outfit can be easily moved from one room to another.

The X-ray may fitly rank with one of the miracles of modern electricity, although we now accept it as a matter of course, refusing to be astonished at anything less than the 3000-mile transfer of sound waves by radio. But what the physician would do today without the X-ray is hard to say. He would feel as if he were deprived of his first assistant.

The operator is also adequately pro-

profession by Mr. Frank Rieber of San Francisco.

The Rieber fluoroscopic unit is shown in the accompanying photos, and is a complete X-ray plant—everything from the transformer to the tube and the screen, mounted as one unit.

It can be set up and used independently in a large X-ray plant—or it may be used to handle the entire X-ray work itself, and may be used wherever current and darkness are available. It operates without noise, inconvenience or distracting adjustment.

The equipment is provided with a finely balanced examination table—a touch tilts it from vertical to horizontal, and beyond. By means of this facility an operator can examine any part of a patient instantly and effectively, with a maximum of comfort to the patient and to the operator.

At the pressure of the foot of the operator on a foot-operated control switch a brilliant X-ray image on the screen, with or without extreme contrast, is produced.

A combination fluoroscopic screen and photographic plate holder, centered with the X-ray tube, is held in place in front of the examination table by a metal arm, adjustable along a line parallel with the direction of the rays.

The X-ray tube, fluoroscopic screen, and photographic plate holder are attached to a transverse carriage which also supports the screen shutter control, the meter and filament control. A special feature of this machine is that the tube and fluoroscopic screen and plate holder are always the same distance apart and directly in line. The advantage of this arrangement is that results are always uniform, because the screen is always at the same distance from the tube.

The transverse carriage is supported on a perpendicular carriage which operates on a track fastened to the inside of the table, the entire assembly being carried by chains and counterbalanced; it has an up and down movement of 26 inches, a cross movement of 18 inches, and a back and forward range of 8 inches to accommodate stout or thin patients.

The examination table is counterbalanced by the weight of the transformer, which is firmly attached to the lower part of the table and can be removed in less than half a minute.

In front of the transformer is an electrical unit containing a 4-wire conductor under tension, which can be quickly removed. This will prove an advantage in the event that it becomes necessary to make repairs, as the conductor can be lifted out and the entire unit sent to the

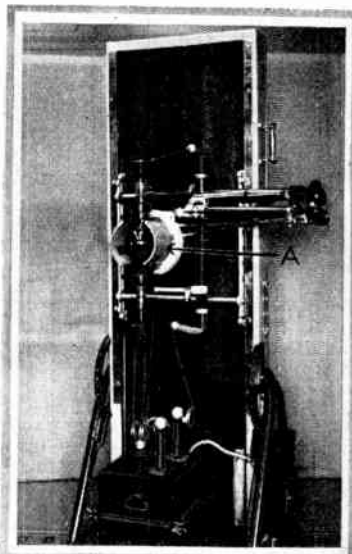

Another view of the apparatus, this time also in a vertical position. In this and the other illustrations of the apparatus, the handles for manipulating it can be seen at the side of the frame.

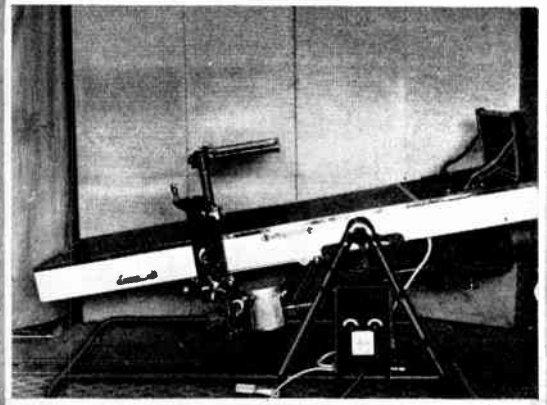

The apparatus in a nearly horizontal position. The patient can thus be placed at any desired angle of inclination, according to the necessities of the case.

We Pay a Cent a Word

WE want good electrical articles on various subjects, and here is your chance to make some easy money. We will pay one cent a word upon publication for all accepted articles. If you have performed any novel experiments, if you see anything new electrical, if you know of some new electrical stunt, be sure to let us hear from you. Articles with good photographs are particularly desirable.

EDITOR.

ected; as stated above, the X-ray tube is shielded by lead glass. As the apparatus is intended for fluoroscopic work and not for radiography, provision is made for having the room dark, by painting the lead glass, which encloses the Coolidge tube, black. It is absolutely necessary to preserve the sensitiveness of the eye of the operator where he has to depend entirely upon what he sees, and where he obtains no permanent photographic record of the interception of the rays. He has to see the silhouette in greatest perfection.

The apparatus shown with all the details for manipulation as described in the article, indicates an important advance in the science.

Short-Circuits

THE idea of this department is to present to the layman the dangers of the electrical current in a manner that can be understood by everyone, and that will be instructive too. There is a monthly prize of \$3.00 for the best idea on "short-circuits." Look at the illustrations and then send us your own particular "Short-Circuit." It is understood that the idea must be possible or probable. If it shows something that occurs as a regular thing, such an idea will have a good chance to win the prize. It is not necessary to make an elaborate sketch, or to write the verses. We will attend to that. Now, let's see what you can do!

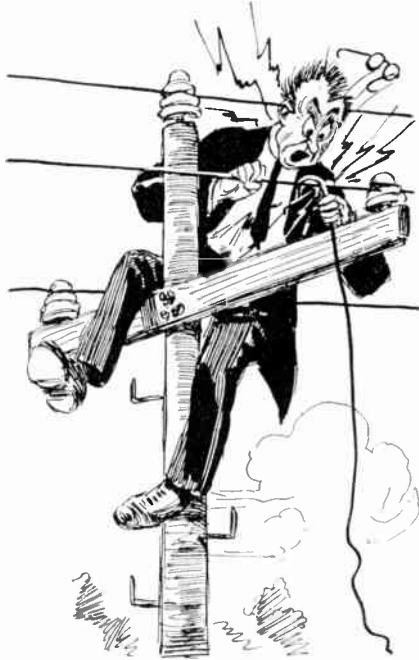

Beneath these clouds
Lies Walter Penn.
He thought 2200
Was 110.

—W. H. ENGLAND.



Lie sleeping here,
Joe and Mrs. McLife.
He didn't think
When he asked for his knife.

—L. HUNT.



Beneath this stone rests
Farmer Julius Lenz.
He didn't look,
When he touched the fence.

—ERNEST PARIS.



In peace here lies
Mrs. Miriam Hughes.
She grabbed the pipe
While fixing the fuse.

—NELSON HALL.

ELECTROCUTED IN BATH TUB IN HOME

Daughter of Edward B. Clark,
Newspaper Writer, Killed
In Omaha, Neb.

Omaha, Neb., March 3.—Death of Mrs. Frances Devereux, 29, Omaha society woman, who was electrocuted by an electric heater in a bath tub of her home here yesterday was accidental and no inquest would be necessary, the coroner announced today. Mrs. Devereux was the daughter of Edward B. Clark, Washington correspondent of the Chicago Evening Post.

The heater, according to Dr. J. H. Henske, was found on a wet towel which was wrapped around her feet. There was no water in the tub and the heater is believed either to have fallen into the tub or to have been placed there by Mrs. Devereux to warm her feet.

Mrs. Devereux was heard to scream, but the bathroom door was locked and her two small children and a servant summoned a locksmith.

The above article reproduced from a daily newspaper shows that our "Short Circuits" comic as they are, have a sad basis in fact. The Latin poet says, "What prohibits a laughing man from telling the truth?"



This simple grave
Holds Tommy Wade.
He stood near a leader
When lightning played.

—HAROLD GULICK.



Elec-Tricks

IN this department are published various tricks that can be performed by means of the electrical current. Such tricks may be used for entertaining, for window displays, or for any other purpose. This department will pay monthly a first prize of \$3.00 for the best electrical trick, and the Editor invites manuscripts from contributors.

To win the first prize, the trick must necessarily be new and original. All other Elec-Tricks published are paid for at regular space rates.

An Electric Hand Shake

A SKETCH of an electric shocker which I think might interest the readers of Elec-Tricks in PRACTICAL ELECTRICS, is submitted herewith.

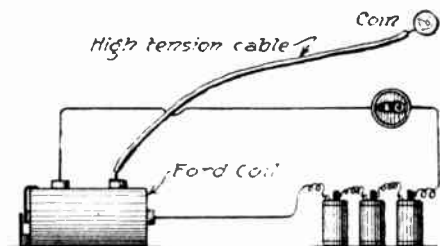

A very clever trick, in which the performer gives an electric shock to the person attempting to shake hands with him.

It is composed of a Ford coil, three two volt flash-light batteries and five feet of high tension cable, and a switch. The coil is connected with the batteries as shown in sketch. The high tension cable connected with coil runs under the owner's coat and down his sleeve into his hand. The end in his hand is connected to a coin. By wearing a rubber glove he may offer the coin to a person. When the victim tries to take the coin he turns on the switch and he receives a shock. He may place his hand on a metal object which others are in contact with and give them all a shock. This is not half the fun possible with this electric shocker which may be constructed at a very moderate cost. Another idea is to place the device in a small bag or satchel to hang at the owner's side under his coat.

Contributed by W. S. CHESNEY.

An Electric Scarecrow

THIS plan should prove a great help to farmers and town folks whose fruit trees are depleted by birds.

First make a wooden frame in the shape of the toy called a Jumping Jack, but do not attach the arms to the body until you are ready for them. After you have

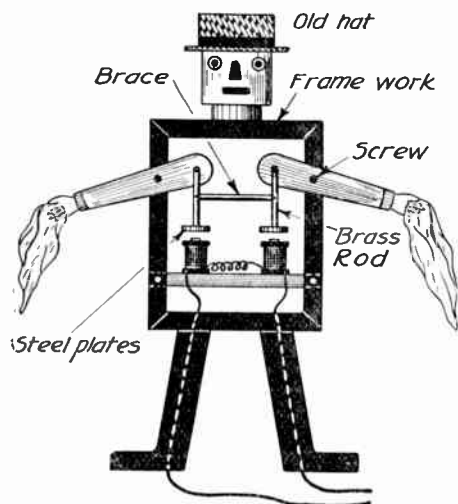

An electric jumping-jack, designed as a scarecrow, but quite available for window display and similar purposes.

made the framework, put a piece across the body from side to side to hold two large electro-magnets. Two powerful electro-magnets go on the cross-piece and are fastened firmly.

Next make the arms and pivot them to the framework of the body by means of large screws, leaving about six inches on the inside for each arm. Next bore two small holes for a brass rod in each. One end of these rods you must secure to the holes in the arms, and at the remaining ends fasten thick round pieces of iron plate as armatures for the magnets.

Next place a brass or wooden brace between the two rods to keep them in line. The wires pass down from the magnets to a key or automatic circuit breaker and batteries in the distance.

Place a canvas covering over the framework and paint the features of a person on it, and also put a piece of cloth in each hand. Your device is now ready to work when placed among the branches of a tree where the birds are eating the fruit.

When the circuit is closed the electro-magnets pull the iron plates down, which then pulls the arms up, and when opened the arms fall down, which scares the birds.

Contributed by HAROLD MCVICKER.

Important Articles Appearing in the August Issue of Radio News

- Radio Telephotography. By Dr. Alfred Gradenwitz.
- The Electron Theory Simplified. By Edward T. Bicak.
- The Armstrong Super-Regenerative Circuit.
- How to Build a Loud-Speaker. By Paul G. Watson.
- The Construction of an Ideal Short-Wave Receiver. By Edmond S. Smith.
- Practical Information on Reception of Radio Signals. By B. Bradbury.

Electric Spiritualism

JUST think! all the spiritual messages you want for about fifteen cents and a codfish box!

Punch a small hole (about 3/16 inch) in the top of a codfish box and directly under it and in the center of the box fasten a small porcelain socket; miniature base type. Remove the battery from your flashlight and pack the battery in the box so that it will not roll and make any noise. Bend a piece of No. 18 copper wire and pass it through a small hole in the box to make contact with a piece of tinfoil, as shown. A piece of S. C. C. No. 24 wire is soldered to this and the battery; or it may be held to the battery by a couple of feet of tape securely wrapped around it. The tinfoil must be cemented down and connection may be made to it by a tack through it, by winding the wire around the tack and then pounding it down. Now cover the whole box with a colored silk

rag if possible; and practice turning the light off and on by the concealed switch under the cover a few minutes till you have it always under control.

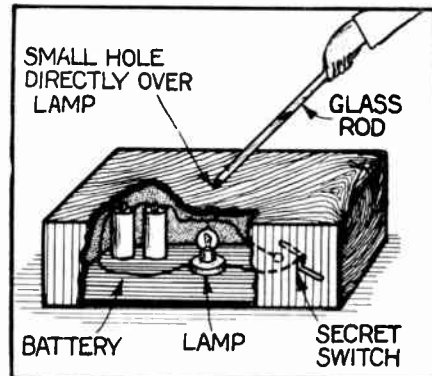

Spiritualism as perpetrated by a simple electric appliance, but which by its very simplicity will mystify the audience.

The next thing to do is to purchase a small towel rack for about 15 cents, and remove the glass rod (it must be a glass one). The end of the rod must be broken off at about 45° in order to work. A file or grindstone will smooth the surface, although a break is not so apt to arouse suspicions.

To operate you enter the dark room amid many magic words and place the box on a small stand; seat yourself behind it; take the glass rod by the unbroken end in your left hand and place it exactly over the hole (a little practice and you won't miss the hole). Be sure the broken part is towards the guest for best results. At least always have it at back or front, never sideways. Touch the switch and just the broken part will be filled with light. If your friend is a radio bug perhaps the spirits will use the International Code. But the best is, they will not see the manipulation. In case the rest of the rod does light up, slightly dilute the light with more silk rag.

Contributed by RICHARD PITT BALLON.

Surprising the Chickens

MUCH amusement can be obtained with the aid of an old telephone magnet. Connect it up to a pan or water trough.



An elec-trick, this time for the benefit of chickens; the electrician may try the effect of either grounding or insulating the water trough.

If the magneto is weak, get two horse-shoe magnets from an automobile magneto and fasten them on the outside of the magneto. Then watch the chickens.

Contributed by AUGUST W. GUSTAFSON.

Practical Perpetual Motion

THIS system, unique in design and very deceptive, is not only a wonderful advertising novelty, but can be used in magical entertainments and exhibitions. A lattice-work stand, the height

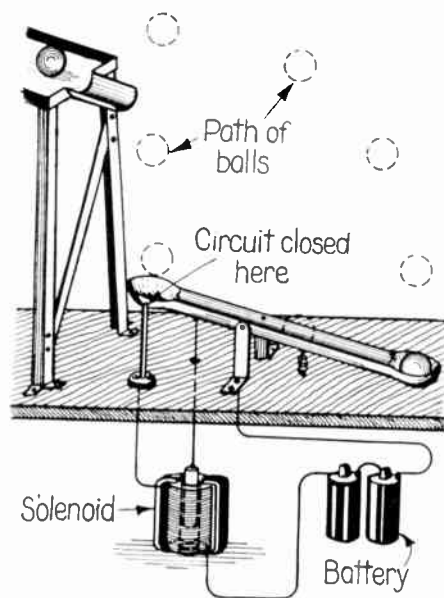

A puzzling trick supposed to represent perpetual motion; the power, of course, comes from the concealed battery and solenoid.

of which is determined after the other parts of the apparatus have been built, holds a tray, into which steel balls drop. This tray can be made out of wire or aluminum, shaped as shown in the accompanying illustration. A lip extending from it is slightly curved, so as to direct the ball to the proper landing position in a seesaw device located below. This see-saw device is a deeply grooved metallic cradle, closed at both ends. It presents on cross-section a half cup, or half ball view. It is pivoted near its upper third. Scarcely one-eighth of an inch below this seesaw, which may be likened to a catapult, is a brass strip so arranged that when the shorter end of the catapult is depressed but slightly, the brass strip will make contact with the sides of the grooved channel of the catapult along its entire course, clear down to the bottom. The effect is as follows: One ball is inserted into the lower end of the catapult, and another into the tray at the top. The ball in the tray now rolls downward because the tray is so inclined, and passes along the lip. It then drops with considerable force upon the upper end of the catapult. This drop seemingly causes the ball in the lower end of the catapult to be hurled upward into the air and caught by the tray again. The spring now draws the larger end of the catapult downward, permitting the ball which has just dropped to roll to the opposite end and take the place of the one just tossed into the air. This action continues (at least to all intents and purposes of the bystanders) indefinitely, but it is not perpetual motion by any means when one knows the secret.

Upon close observation, it will be seen that a very thin cord attached to the upper end of the catapult passes through the board in the base. This is secured to the plunger of a solenoid. The construction of the solenoid is as follows: The core is one-half inch in diameter, a pipe slightly larger and three inches long is wound to a full outside diameter of two and a half inches with No. 18 B. & S. gauge single cotton-covered wire. When complete, the solenoid is connected as shown in the diagram, in series with a 6-volt storage battery, with the catapult

and with the brass contact. The action is as follows: When the ball drops from the tray above to the catapult, there is a slight jar. This jar is sufficient to close the circuit between the catapult and the spring-brass brush alongside of it, energizing the solenoid. The solenoid, therefore, draws down its core, tossing the ball at the lower end of the catapult back into the basket. By decreasing the angle of the incline at the top of the frame, the speed of the balls and the action of the machine may be regulated.

In building the apparatus, it is best to proceed with the catapult at first. Then procuring two balls, place one in the lower end of the seesaw arrangement, and drop the other from a distance of two feet or more. Determine the height to which the ball in the lower end of the catapult will be thrown. Then construct a basket slightly below this point; the higher the device, the more effective are the results. A placard stating that the force of the dropping ball is multiplied by the leverage action, causing the other ball to be tossed upward, enhances the idea of mystery.

Electric-Lighted Violin Bow

THE electrically-lighted violin bow, as shown in our illustration, is a contribution to patriotism in the sense that the lights are red, white and blue, showing the three colors which have been appropriated by so many nations for their standards, each country seeming to regard them as their own private property.

The description follows:

Three 2.9-volt bulbs are needed, one at the tip, one at the middle and one at the frog of the bow. As the illustration shows, these bulbs are connected in parallel with a battery of three flashlight cells, also connected in parallel.

I fastened these in a metal container to fit in the hip pocket of the violinist—all zincs being grounded to the container. Then, of course, all carbons are connected to one wire, the other wire connecting to the zinc of the containers. The ends of the battery wires have little hooks or clasps to fasten into the eyes on the bow where they connect.

The wire from the battery in the hip pocket should be flexible—long enough not to bind the arm or cause any side pull on the bow while playing. The battery is first put in the pocket, then take in the hand the wire that goes into the coat sleeve. As the arm slips through the sleeve, the wire is also taken through.

By coloring the bulbs, a pretty effect is obtained by playing the instrument with this bow in a dark room. The red, white and blue bulbs are effective especially on our national airs. By using the parallel

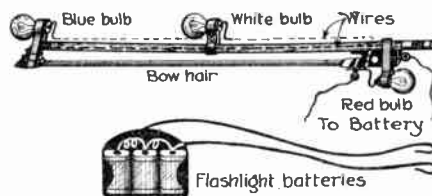

An illuminated violin bow, to be used in playing the violin in a dark room, giving a beautiful electric effect.

connections, one light out has no effect on the others. The sockets are made of any light metal and so constructed that the little bulbs can be screwed in. This is accomplished by drilling a small hole through the bow where the bulb comes; then a copper wire is put through and over the top of the socket, as shown. It is then twisted up to the proper tension.

The battery may be carried in the pocket. The hooks on the wires may be fastened to the sleeve.

Contributed by ANSON K. PEARCE.

The Inexhaustible Pail

SOME months ago we described an inexhaustible bottle. This bottle was a very neat illusion, and produced a very good effect. On the same order is the inexhaustible

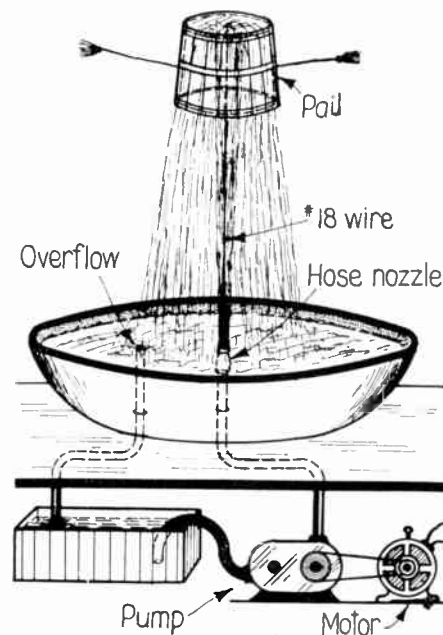

A pail, mysteriously sustained in air, over a jet of water.

tible pail. Its method of construction is fairly simple.

An ordinary wooden bucket has had its handle removed. Into the bottom of this bucket a screw-eye is fastened. A large pan is then mounted in the base of a window or in the room. Two holes have been drilled into the bottom of this pan or shallow dish, into one of which a pipe is inserted and soldered 5 inches from the bottom; the other is merely a 1/2-inch pipe fitting provided with a screw thread for the reception of a garden hose nozzle. Both of these pipes project through the floor base of the window or through a table top, and hose are fitted to them. One of these hose passes downward through a tank containing water. This hose connects to the pipe cut off 5 inches above the bottom of the dish. The other hose communicating with the garden spray nozzle is connected to the output side of a rotary water pump, which pump is fed by a supply of water taken from the tank. This pump is electrically driven. A five- or six-foot piece of bare No. 18 copper wire is soldered to the hose nozzle, and then passes upward to the screw-eye in the bottom of the pail. When the pump is started, the water forces the pail into the air to a height predetermined by the length of the copper wire. Here the water divides and separates, falling from the pail in a continuous stream.

Neither the water passing upward nor the wire is ever noticed, particularly if the device is illuminated by brilliant nitrogen lamps. Several tassels fastened to the inverted pail and extending laterally therefrom greatly enhance the effect. If the hook in the bottom is replaced by a swiveled joint and several blades to deflect the water stream are secured to the very bottom of the pail, the pail will rotate in the air. Several flashlight batteries fastened to the top of the pail may be connected in series, with miniature colored lights surrounding the base. This addition will make the device very effective for demonstration at night. It is advisable to use a rheostat in series with the motor, operating the rotary pump so that the power may be reduced gradually, the pail lowering itself slowly without any appreciable splash when it strikes the pan.



THIS department is conducted for the benefit of everyone interested in electricity in all its phases. We are glad to answer questions for the benefit of all, but necessarily can only publish such matter as interests the majority of readers.

1. Not more than three questions can be answered for each correspondent.
 2. Write on only one side of the paper; all matter should be typewritten, or else written in ink. No attention can be paid to penciled letters.
 3. Sketches, diagrams, etc., must always be on separate sheets.
 4. This department does not answer questions by mail free of charge. The editor will, however, be glad to answer special questions at the rate of 25 cents for each. On questions entailing research work, intricate calculations, patent research work, etc., a special charge will be made. Correspondents will be informed as to such charge.
- Kindly oblige us by making your letter as short as possible.

Electro-Magnet and Aluminum

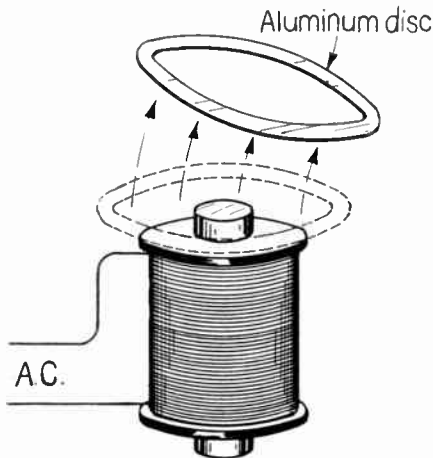

This illustration shows how an aluminum ring or disc is affected by an alternating current passing through a coil over which the disc is placed.

(120)—F. W. Ehret, Erie, Pa., asks:
O. E.—Is there any electro-magnet which will attract aluminum?

A. 1.—There is no electro-magnet which will lift a bar of aluminum—aluminum being one of the non-magnetic metals. A ring of aluminum is repelled by an A. C. electro-magnet, but not attracted.

Electric currents in the same direction attract each other; those in the reverse repel, and it is the action of the alternating current in producing oppositely directed currents in the aluminum which cause it to be so mysteriously repelled. The repulsion, however, is not to be considered as any more remarkable than the attraction of iron through space by a magnet, although the experiment when shown always excites great interest.

Noisy Telephone

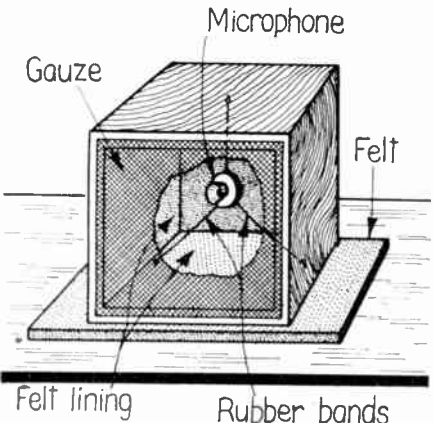

A suggested silencing box to be used on the telephone system to prevent noise in the receiver.

(121)—Russ A. Dano, Herrin, Ill., asks:
Q. 1.—The operation of a one-wire telephone system, which I have installed at my office, cannot always be depended upon. I am located in a railroad yard, where

the electric locomotives, which I use to haul coal, make transmission and reception very noisy. Is there any way in which I can eliminate this noise?

A. 1.—There are many reasons why your phone is noisy. It may be that the vibration due to the trains causes the wire of the circuit to tremble. A portion of this wire may have been bared and touched some grounded projection; consequently, short-circuited your telephonic system intermittently. Artificial electrical disturbances, such as those set up by the locomotives, may cripple the lines temporarily, in much the same manner as local atmospheric disturbances. The most probable cause, however, is the shaking of the microphone due to the vibrations set up by the trains, which tends to agitate the carbon granules in the microphone around. The best way to reduce this vibration is to suspend the microphone within a wooden box lined on the inside with felt, from three rubber bands, as shown in the accompanying illustration. The back and the front of the box is then covered with several layers of voile or cheesecloth, and the whole is placed upon a thick pad of felt. This will greatly limit extraneous vibrations.

We would also suggest that you place the mouthpiece of the microphone against your chest or larynx when talking, holding it closely to the body. Now talk in the ordinary manner, you will find that the speech is transmitted as distinctly through the chest as ordinarily, and air currents or other vibrations have practically no effect on the microphone.

Transformer Data

(122)—George W. Zoll, Lead, S. D., asks:

Q. 1.—I have a sheet-iron core size 5¼ inches by 4¼ inches by 1 inch. Please give windings for a ½-kilowatt 10,000-volt transformer, with 110 volts on the primary.

A. 1.—We would advise that you wind 150 feet of No. 18 double cotton covered wire, as the primary on your iron core. The secondary of the 10,000-volt transformer should contain 13,500 feet of No. 40 cotton covered wire wound in pies or sections; 27 pies to 500 turns each are enough.

Fuse Blowing

(123)—George F. Frazier, Comb, Mass., asks:

Q. 1.—Why do I always blow out fuses when using the electrolytic rectifier on a house current.

A. 1.—The electrolytic rectifier you have constructed is correctly designed. We would advise, however, that you use a saturated solution of ammonium phosphate.

The reason your fuses blow is because the resistance of the liquid is not great enough. A lamp bank may be used to cut down the current. This comprises 5 lamps all arranged in parallel and in series with one of the conductors to the A. C. mains. The lamps should preferably be of the 100-watt type.

Low-Powered Transformer

(124)—James H. Dalgleich, St. Catharines, Ont., Canada, writes:

Q. 1.—Please give me the data for the construction of a low-powered transformer capable of delivering current at 6 and 30 volts potential, respectively.

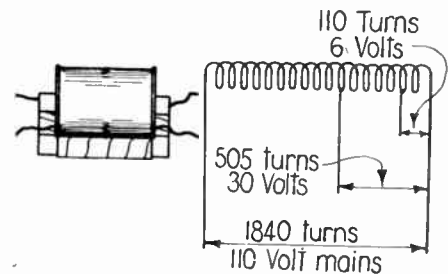
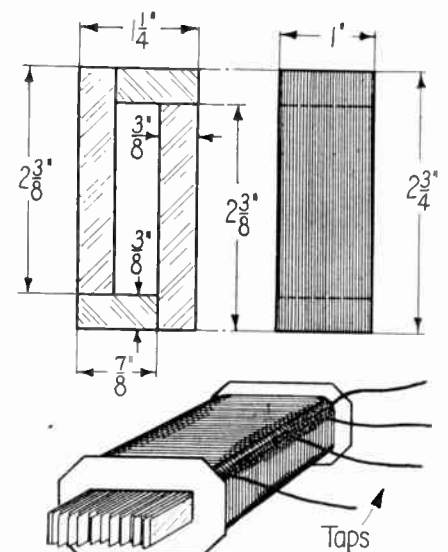

Diagram of the layout of a transformer for delivering current at different potentials. This illustrates the connection and general construction.

A. 1.—The core of this transformer is made up of very thin iron laminations, measuring ¾ inch by 2¾ inches for the long legs, and ¾ inch by ¾ inch for the shorter parts of the yoke. One of these legs is built up to a thickness of 1 inch, staggering the laminations, so that alternate iron strips are placed ¾ inch from the others. Two cardboard flanges are then glued in place about 1¼ inches apart, and the core wrapped with a layer of insulating tape. Soldering a piece of lamp cord to No. 34 silk or enameled wire, the winding is started at one end. When 110 turns have been wound, a tap is taken off,



Details of the core and winding of a transformer with intermediate taps, showing how the core is built up and how the winding is held in place.

and the winding is continued. At 505 turns from the beginning of the winding another tap is taken off, and the winding is continued to a total of 1,840 turns.

Large Ozonator

(125)—Gordon G. Logan, Prairie, Mont., asks:

Q. 1.—What is the construction of an electric air purifier or ozonator?

A. 1.—An ozonator consists of a step-up transformer capable of delivering approximately 50,000 volts in a secondary circuit. Within a box are mounted a series of flat aluminum plates connected alternately to the two leads of the step-up transformer. These are separated just far enough to prevent a discharge in the form of a spark, but between which a silent discharge having a bluish radiance constantly takes place, particularly noted in a dark room. Air is gently wafted between the plates, which may measure as much as ten inches square. The oxygen of the air turns in part into ozone.

Melting Iron

(126)—George Conway, Elk City, Okla., asks:

Q. 1.—How much current is required to melt or weld iron?

A. 1.—Methods of making arcs capable of melting or welding iron or steel differ widely. Ordinarily an arc furnace consuming ten amperes will melt iron. For welding by incandescence any number of amperes, at a pressure of 10 to 12 volts, may be used.

Q. 2.—What are the four kinds of electricity?

A. 2.—There are only two kinds of electricity, current electricity or electricity in motion, and static electricity or electricity at rest.

Electromagnet Query

(127)—Julius E. Thieler, Newark, N. J., says:

Q. 1.—An electromagnet with a density of 20,000 lines having a traction of 16.22 kilograms, having a wrought iron plunger $\frac{3}{8}$ inch in diameter, with a winding space of 2 inches in length and $1\frac{1}{4}$ inches in diameter; the voltage being 6 or 8 and amperage from 60 to 80 from dry cells or storage battery: the plunger is to travel one inch. Kindly advise the size of wire to use and the number of turns.

A. 1.—With reference to your calculations, we would state that the size of wire necessary for carrying a load of 80 amperes, which would be the amount of current needed in your particular type of magnet, is No. 3 wire (A. W. G.). This is .299 inch, or nearly a quarter of an inch in diameter, and so little could be done with it within the dimensions of the coil you give that it would be useless to calculate any further. The high amperage needed would necessitate the use of fairly large sized storage batteries and the large storage batteries and the long travel of your plunger will diminish the minimum pull which we believe must be the basis of your work.

Resistance to Cut Down 32 Volts

(128)—Henry C. Herold, Eagle River, Wis., asks:

Q. 1.—How can I make a resistance to cut down 32 volts to 6 volts D. C. for charging a storage battery?

A. 1.—It is not necessary to reduce the voltage of the 32-volt direct current farm lighting generator in order to charge a 6-volt storage battery. Simply use the hook-up in which a lamp bank is employed. Five to eight lamps will be sufficient, and each should be capable of passing one ampere. In other words, 32-volt lamps if used on this circuit should have a rating of at least 32 watts. Lamps supply a convenient and known resistance.

Mysterious Third Rail

(129)—Walter Hayward, Omaha, Neb., asks:

Q. 1.—If a trolley pole jumps off the wire and there is no guide to pull it on again, would it be possible to climb on top of the car and place the pole on the wire without danger of shock?

A. 1.—If the operator's feet were particularly well insulated from any grounding action which the car may give, no shock would result.

Q. 2.—By connecting an electric motor and dynamo, could perpetual motion be secured?

A. 2.—No. Inasmuch as the efficiency of a motor is about 90% and the efficiency of the generator 90%, the combined efficiency of the two will be only 81%, and, therefore, for every 100 watts which the motor will use in its turn, only 81 watts could possibly be produced by the generator. Transmission losses are not considered.

Solenoid to Lift 1,000 Pounds

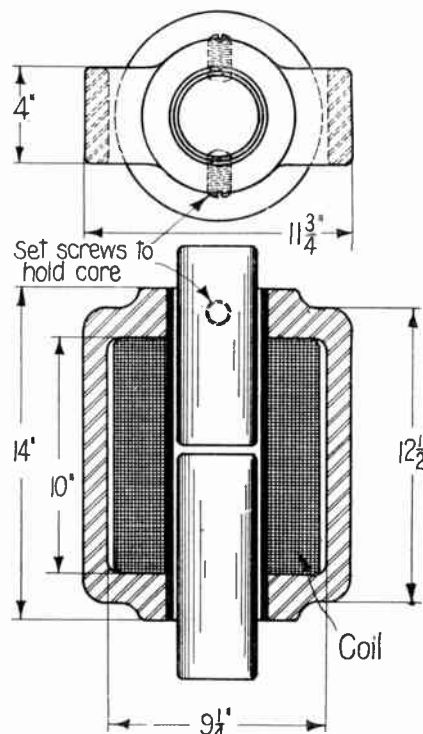

Diagram of the powerful solenoid, the data of which are given in the answer to the query. The jacketing of the coil and the two cores will be noted.

(130)—L. Dutton, Milwaukee, Wis., asks:

Q. 1.—Please give me data on the construction of a power solenoid to lift a weight of more than 400 pounds a distance of one-half inch.

A. 1.—Sketch is given herewith of solenoid for 110-volt D. C. circuit. This solenoid will exert a pull of 1,000 pounds on a $\frac{1}{4}$ -inch stroke, and 600 pounds on a $\frac{1}{2}$ -inch stroke, which pull decreases proportionately as the stroke becomes longer. Power consumption is 300 watts.

Exploring Coil

(131)—Wm. C. Merrill, Somerville, Mass., inquires:

Q. 1.—I have a cable buried about 12 inches underground. This is grounded and I do not know the direction of its passage through the earth. How can I build an exploring coil to locate this, and what is the method of exploring to employ?

A. 1.—We would advise you to construct an exploring coil as follows: Wind a coil about 18 inches in diameter with approxi-

mately 300 turns of No. 28 wire. Connect the two ends to a telephone receiver, and you are ready to begin your hunt. By connecting the loose end of the buried cable to one side of the 110-volt A. C. mains, and grounding the other side of the main, it will be possible to trace the direction of the wire by means of the coil described above. It is best to ascertain if A. C. lines are already grounded, as you must ground the side of the circuit already grounded. Starting at the point where the current is connected to the cable, and holding the exploring coil in the hand, it will be possible to trace the course of the cable by means of the humming sound heard in the telephone receiver. When the humming sound stops, you will find that this is probably the point at which your cable is broken or grounded.

Electrolytic Rectifier

(132)—Chas. A. Miller, Carbon Co., Pa., writes:

Q. 1.—Give me three solutions to use in an electrolytic rectifier.

A. 1.—The following are three formulae for electrolytic rectifying solutions: No. 1, a neutral solution of ammonium phosphate in water; No. 2, a saturated solution of sodium bicarbonate in water; No. 3, a 1 to 2% solution of pyrogallie acid in ammonium citrate.

Making Storage Battery Plates

(133)—P. Crouch, Cleveland, Ohio, asks:

Q. 1.—How is the paste for a storage battery plate made?

A. 1.—The paste for the positive plate is made by mixing red lead with sulphuric acid diluted with distilled water to a specific gravity of 1.275. On the negative plate litharge is preferably used. You will find a very elaborate description of the construction of storage batteries in PRACTICAL ELECTRICS for May, 1922, page 262.

In the forming process the red lead is oxidized and forms the binoxide and the litharge is reduced to metallic lead. Of course, the oxidation in the one case and the reduction in the other may not be complete, but the more complete it is the better.

Q. 2.—What else is done to a plate before it is finished, aside from applying the paste?

A. 2.—The paste is allowed to harden; it sets somewhat as plaster of Paris does, and then the plates are formed by successive charging and discharging, all of which you will find described in the article referred to.

Speed of Electric Motor

(134)—Henry Crimm, Lafayette, Ind., writes:

A and B are having an argument. A perfectly flat disc, two inches in diameter, is to be mounted on the shaft of a fan motor. This is to be replaced later by a 30-inch disc.

A says that the smaller disc will go faster than the 30-inch disc.

B says it will not. The motor is powerful enough to drive both easily.

Q. 1.—Which is correct?

A. 1.—There will be a difference of speed because of the friction of the air upon the larger disc and because of the expenditure of energy in driving the air outwards by centrifugal force as the actuating cause. It is quite likely that the difference would not be perceptible if the speed were slow, but at anything like a high speed of rotation the difference would be appreciable and would increase at a rapid ratio to the increase of speed.

"RASCO HAS IT!"

THE Radio Specialty Co.--"Rasco" for short--is probably the most unique supply house in the United States, if not in the world to-day. This company makes a specialty of small orders, no order being too small to get immediate and prompt attention for the simple reason that most of our orders are small.

The reputation of this house was built upon service. Ask any of your acquaintances what they think of Rasco goods, Rasco service, Rasco promptness! Thousands of unsolicited testimonials on file to prove that we serve the public best! Be sure to get our great catalogue, containing several hundred different parts, which is illustrated below.

ORDER DIRECT FROM THIS PAGE. ALL GOODS SENT PREPAID IN 24 HOURS

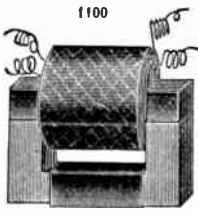

"RASCO" AUDIO FREQUENCY TRANSFORMER

We have compared many of the present transformers on the market but have finally decided upon a type that is the most efficient one we have seen so far. The best amplifying transformer is that in which the impedance of its primary is equal to or exceeds the impedance of the plate-to-filament circuit of the tube in which it is connected.

We guarantee this transformer to equal any one on the market. No. 1100 "Rasco" Audio Frequency Transformer (not assembled) each prepaid.....\$2.65

ANTENNA CONNECTOR

This antenna connector is made entirely of aluminum, is light and will not rust. The only connector of its kind. The 4 antenna wires go to the upper holes; the lower hole takes the lead-in. Don't solder your aerial, don't have loose connections. Dimensions 2" high, 1 1/4" wide, 3/8" thick. No. 999, Connector, each.....\$0.35



9.9



PANEL KNOBS

No. 6241 is well made and has a good corrugation. Its dia. is 1", height is 1/2", hole 5/32". The shank is 1/4" high.

No. 6241, Knob, each.....\$0.08
 Has a central hole of 5/32" and seat to hold the screw, dia. is 1/4", height 3/4".
 No. 838, Marconi Knob, each.....\$0.15



838



RASCO POSTS

These are our very own patterns, from our own designs and look mighty handsome on any instrument. The top knobs are of composition, the bottom parts brass nickel plated polish.

No. 202 is nickel plated at bottom part. "Rasco" Binding Post, 8/32 thread, each, \$0.10; doz., \$1.00. No. 202, Post, each.....\$0.08
 Nos. 650 and 651 made entirely in composition with a hexagonal brass nut in center. No. 650 has 8/32 machine screw. No. 651 has bottom wood screw. No. 650, Post, each.....\$0.08
 No. 651, Post, each.....\$0.08
 Dozen, each style.....\$0.90



030

029



650

651

BRASS NICKEL POSTS

No. 029, Binding Post, each.....\$0.05
 No. 030, Binding Post, each.....\$0.04



RASCO SWITCH POINTS

Nickel plated and polished. The following have been found the most popular.

No. 1 1/4" x 1/4", 6/32 thread, ea., \$0.03; doz., 35c
 No. 2, 3/16" high, 1/4" dia., 6/32 thread, ea., \$0.03; doz., 35c.
 No. 3, 3/16" x 3/16", 4-36 thread, ea., \$0.03; doz., 35c.
 No. 4, 3/8" dia.; 1/8" thick; stem 6/32, ea., \$0.03 1/2; doz., 40c.
 No. 5, 3/8" dia. 3/16" thick; stem 4-36, ea., \$0.03 1/2; doz., 40c.
 No. 6, 3/16" dia.; 1/8" thick; stem 4-36, ea., \$0.03 1/2; doz., 40c.
 No. 7, 3/16" dia.; 1/8" thick; stem 4-36, ea., \$0.03 1/2; doz., 40c.
 No. 75, Switch Stop, 3/8" long, 4-36 thread, complete with nut, ea., \$0.05; doz., 50c.
 No. 76, New style Switch Point, to be pressed into bakelite panels with forced fit. Wire is soldered to pin end. Head 3/4"; dia., 1/16" thick, ea., \$0.03 1/2; doz., 40c.
 No. 77, same as above, but head is 1/4" dia. x 3/16" thick, ea., \$0.03 1/2; doz., 40c.



THE RASCO BABY DETECTOR

In presenting this little Detector, we feel sure that it fills a place never taken before by any small detector. It does a variety of things and does them all well and better than position. Mounted on same is a nickel holder and binding post which holds a fluted hard rubber knob with its sliding rod member. The outstanding part of the Detector, is the patented nickel detector cup and binding post. The knurled cap unscrews and you place the Galena Crystal in the cup, then replace the knurled cap and the galena crystal is held secure. The circular hole in the cap exposes enough of the crystal for ordinary purposes. No. 1898, Rasco Baby Galena Detector. Price, prepaid.....\$0.50
 No. 1899, Rasco Baby Detector with Galena and Radiocite Crystals. Price, prepaid.....\$0.75

PANEL SWITCH LEVER

New style switch lever with lock fork. It is impossible for this lever not to make positive contact at all times. The blade radius is 1 1/4". Blade is nickel plated and polished. Fork is phosphor bronze. The lock fork holds the screw (in which it rotates), securely. A loose contact is impossible. No. 200, Switch Lever, complete as illustrated.....\$0.30



200



LITZ WIRE

This wire is recognized as the only thing for winding coils for Radio Instruments. Particularly recommended with our No. 343 Variocoupler Rotor, for vario-couplers, banked windings, etc. No. 323, Litz Wire, 20 No. 38 strands, enameled double silk wire, per foot, \$0.02; per 100 feet, \$1.15
 No. 890, Litz Wire, 10 strands No. 38 wire, per foot, \$0.01; per 100 feet, \$0.75
 No. 891, Litz Wire, 16 cables of three strands No. 38 wire, per foot, \$0.03; per 100 feet, \$2.25.

NOTE: This page contains only a few of our 300 specialties.

PANEL KNOB

This is a very distinctive knob and can be used on dials, panels, switches, condensers, etc. It is exceptional and well made. Dia. 1 1/16"; height 1/16"; comes with 8/32" bushing. No. 815, Knob, each.....\$0.18



815



VARIOCOUPLER ROTOR

This rotor is used by all up-to-date amateurs. It is accurately turned of hard wood and is used as a secondary coil. It takes any finish, either shellac or stain and can be drilled readily for any size hole. Large hole 2" dia. Width of spool is 2". Total dia. 3 3/4". No. 343 Variocoupler Rotor, each.....\$0.75



"RASCO" NAME PLATES

Our name plates are of brass with a black background. Letters are polished nickel. Order by name and number.

807 "Phones".....\$0.05	810 "Ground".....\$0.05
809 "Aerial".....\$0.05	812 "Primary".....\$0.05
811 "Secondary".....\$0.05	814 "Detector".....\$0.05
813 "Audion".....\$0.05	816 "On".....\$0.05
865 "Off".....\$0.05	840 "Increase Current" (Right).....\$0.10
839 "Increase Current" (Left).....\$0.10	834 "Series".....\$0.05
813 "Vacuum Tube".....\$0.05	830 "Receive".....\$0.05
831 "Transmit".....\$0.05	820 "2nd Step".....\$0.05
821 "3rd Step".....\$0.05	827 "Tickler".....\$0.05
819 "1st Step".....\$0.05	825 "Plate Variometer".....\$0.05
826 "Grid Variometer".....\$0.05	835 "B Battery".....\$0.05
823 "Secondary".....\$0.05	817 "Output".....\$0.05
836 "A Battery".....\$0.05	824 "Primary Condenser".....\$0.05
818 "Input".....\$0.05	828 "Parallel".....\$0.05
829 "Telephone".....\$0.05	837 "A".....\$0.05
833 "Detector Tube".....\$0.05	841 "(Blank) (takes pen or pencil writing).....\$0.05
822 "Coupling".....\$0.05	
808 "Load" Coil.....\$0.05	

Price of all of our name plates in dozen lots, 50c, with the exception of the two "Increase Current"

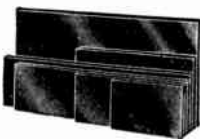

BAKELITE PANELS

We list below six panels, the sizes of which have been selected after carefully checking up many dimensions of the most popular radio apparatus on the market. Note particularly that our prices are anywhere from 25 to 50% lower than those quoted by most other concerns. The reason is that we buy these panels in very large quantities, and we do not cut sheets to order. Remember always that when sheets are cut to order they cost you at least 50% more than our prices, because you must pay for the cutting and the necessary waste. Note also that we ship these panels prepaid. This alone amounts to a considerable saving.

No. 350	6" x 12"	x 3/16" thick,	each.....\$1.90
No. 351	6" x 18"	x 3/16" "	" " " " 2.85
No. 352	9" x 18"	x 3/16" "	" " " " 3.00
No. 353	12" x 18"	x 3/16" "	" " " " 5.65
No. 354	6 1/2" x 19 1/2"	x 3/16" "	" " " " 3.50
No. 355	6" x 7 1/2"	x 3/16" "	" " " " 1.20

"RASCO" LUBRICATED PANEL SWITCH

A radio switch that has two nuts at the end is a monstrosity, for the reason that it will never stay put. Our patent spring fork holds the switch handle always under uniform tension, at the same time it insures the best contact possible. New wiping contact, which covers every point of the switch point. Another new improvement is the lock fork, which can assume three different positions to accommodate the switch to various thicknesses of panels. No. 1921 "Rasco" Switch, as illustrated, each \$0.50.



1921



KNOBS

These knobs are favorites with all experimenters. The size of both is: dia. 1 1/2", height 3/4". No. 445 comes with 8/32 and 10/32 bushing. No. 4451, Knob, each.....\$0.06
 No. 199 (screw length 3/4") Knob, each.....\$0.10



4451

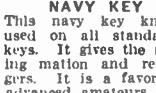

NAVY KEY KNOB

This navy key knob is now used on all standard wireless keys. It gives the right swinging motion and rests the fingers. It is a favorite with all advanced amateurs. Once used always used. The screw is 8/32 and will fit all keys. No. 748, Key Knob, each.....\$0.28



748

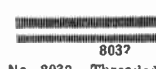

THREADED BRASS ROD

We carry two styles, 6/32 and 8/32 thread. Only 6" lengths sold. No. 8032, Threaded Brass Rod 8/32 thread, per 6" length.....\$0.08
 No. 6032, Threaded Brass Rod, 6/32 thread, per 6" length.....\$0.06

THE "RASCO" CATALOG

CONTAINS 50 VACUUM TUBE HOOK-UPS

Complete hook-ups of all important vacuum tube circuits are given in clear diagrams with complete explanation. Just to name a few:—The V.T. as a detector and one-step amplifier; regenerative circuit; De Forest autrodion; V.T. to receive undamped and spark signals; Armstrong circuits; one step radio frequency amplifier and detector; three stage audio-frequency amplifier; short wave regenerative circuits; V.T. radio telephone; 4-stage radio frequency amplifiers; radio and audio frequency amplifier, inductively coupled amplifier; Armstrong superautodyne; radio frequency amplifier and crystal detector; etc., etc. The catalog contains 200 illustrations. On account of its great cost, it cannot be distributed free of charge. Mailed only upon receipt of The catalog contains 200 illustrations. On account of its great cost, it cannot be distributed free of charge. Mailed only upon receipt of



15c in stamps or coin.



98 S PARK PLAGE, NEW YORK CITY

This business was originated with the sole purpose to cater to the amateur who has small orders. ALL OF OUR ORDERS ARE SMALL and that is why your small order will never be side-tracked by us. A trial order will make you a life customer. Order from the above illustrations. "We can only stick you once." Try us with a 50c order. ALL GOODS PREPAID.

DEALERS
 Get Our Special Proposition

Factories
 Brooklyn, N. Y.—Elkridge, Md.

MAKE SOLDERING EASY BY USING A POST STYLOLECTRIC



Radio's Most Valuable Asset

Perfect attunement is impossible without perfectly soldered connections. With this simple invention the making of perfect connections, soldering any loose parts, is as easy as writing a short sentence with a fountain pen.

A FEW OF THE MANY USES OF "STYLOLECTRIC"

Soft Soldering

- | | |
|-------------------|------------------|
| Bakelite Products | Leather Articles |
| Luggage | Wooden Novelties |
| Sporting Goods | French Ivory |
| Fibre Products | Glass and China |
| Redmanol Products | Formica |

With this Pen you can write or design in any color—gold—red—blue—silver, etc. The various colors are produced by using special Transfer paper. This paper is included Free with each outfit.

WORKS ON ANY CIRCUIT

Attains maximum heat in 45 seconds

Price \$7.50 Fully Guaranteed

Attractive proposition to Dealers

The Post Electric Co.

30 East 42nd St., New York, N. Y.

"ELECTRO-CONDITE"

STARTLES THE WORLD

Thousands of people are marveling at the wonderful performance of the "Electro-Condite" Converter. Clarifies, purifies, sterilizes, matures and mellows most kinds of beverages. Makes hard water soft, etc. May prevent poisoning.

Send \$5.00 for device with 5 days' trial money-back guarantee or ask for circular.

Best grade Proof Hydrometers, \$1.00 each, prepaid.

A-B-C LABORATORIES CO.
Dept. E. 200 West 72d St., New York

MAKE MONEY AT HOME

YOU can earn from \$1 to \$2 an hour in your spare time writing show cards. Quickly and easily learned by our new, simple "Instructor-graph" method. No canvassing or soliciting; we teach you how, guarantee you steady work at home no matter where you live, and pay you cash each week.

Full particulars and Booklet free
AMERICAN SHOW CARD SCHOOL
46 Ryrie Building Toronto, Canada

FREE Drafting Lesson

Not a penny to send for this Free Trial Lesson which shows how easily you can learn Drafting by mail under Chicago "Tech" experts. Prepare now for paying positions. Draftsmen earn \$60 to \$150 weekly. Big jobs are waiting. Send today for the Free Lesson, catalog, terms, etc.

CHICAGO TECHNICAL COLLEGE
766 Chicago "Tech" Bldg., CHICAGO

CUSTOM TAILOR MADE

TO FIT YOUR INDIVIDUAL CAR

Made in our custom shops after your order is received. We ship ordinarily in 2 or 3 days. Perfect fit guaranteed when correct name, year and model of car is given. You can easily apply it yourself.

\$4.40 and up

Parcels Post Paid

We furnish instructions and all necessary tacks, welts and fasteners. Our Catalog No. 10 with samples is free for the asking.

LIBERTY TOP & TIRE CO., Dept. R-5, Cincinnati, O.

A Solenoid Question

(135)—J. Overup, Martinez, Calif., writes:

Q. 1.—I have a D. C. circuit of 7-volt minimum, 1.1-volt maximum, and from .27A to .3A, with a resistance of 13.22 ohms (intern. resistance of source). In this circuit I wanted to insert a solenoid with a plunger of 5/8-inch diameter, whereas the spool has an outside diameter of 25/32 inches, which would be the inside diameter of the winding. I have a few hundred feet of No. 13 B. and S. cubic wire S. C. C., which I should like to use if practical. The solenoid may be as long as eight inches if necessary. How should I wind this solenoid? What can I do to make it as sensitive as possible? What is the actual pull of the plunger?

A. 1.—The solenoid which you desire data upon could not possibly exert much attraction with the low current and the low pressure which you intend to supply. Such a solenoid, regardless of how carefully constructed, would not even lift the weight of the core, using your data as the basis of the design.

Telephone Magnets

(136)—George Deprey, New York City, asks:

Q. 1.—How can I adjust a telephone magneto so that it will light three or four miniature 4-volt flashlight bulbs?

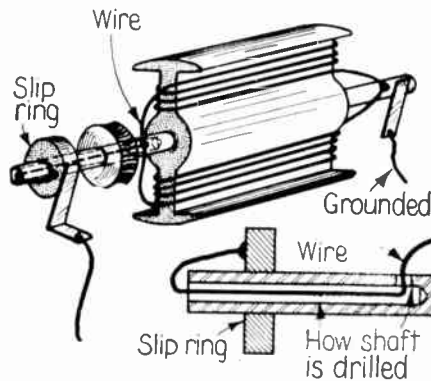

The telephone magneto armature arranged to give a greater current at lower potential than with its regular winding.

A. 1.—The way in which to change the magneto so that it will light 3- or 4-volt miniature bulbs is to rewind the armature of the same with No. 22 single cotton-covered wire, and to mount a pair of slip rings upon the shaft, and then you must connect brushes with these slip rings, as shown in the accompanying sketch.

Gold Electro-Plating

(137)—J. E. Divine, Lordsburg, New Mexico, asks:

Q. 1.—Please publish the formula for a solution for gold plating and the general method of procedure.

A. 1.—For gold plating, use a gold anode and a battery giving a pressure of from 1½ to 4 volts. The correct voltage will have to be determined by experiment. The following solution is used:

- Water 1 gallon
- Potassium cyanide 10 ounces
- Gold chloride 3 ounces

The potassium cyanide is dissolved in warm distilled water. To this solution is added the gold chloride. The quantity of potassium cyanide needed may be varied to secure the desired color. The article to be plated is first cleaned with caustic soda and water, after which it must be handled by tongs or wire, and must never be touched by the hands. It is then im-

mersed in the bath and the current allowed to flow through the electro-plating solution. It is shortly removed and slightly scratch-brushed, whereupon it is again immersed and left until the coating is completed. It is desirable to mount the cathode (that is the article to be plated) in such a way that it will allow for considerable swinging movement, and the article to be coated should be kept in motion in order to obtain a uniform deposit.

Motor as Generator

(138)—A. Bender, Meriden, Conn., says: I would like to run a motor as a generator. It now runs at 3,400 revolutions per minute and consumes about 9 amperes at 220 volts potential.

Q. 1.—At what speed should this be run to deliver 9 amperes?

A. 1.—The output of the motor if run as a generator will be about 94 per cent of its current consumption when run as a motor. Therefore, this motor should be driven at a speed a trifle above 3,600 revolutions per minute in order to give a 9-ampere current at the same pressure—viz., 220 volts.

Decreasing Direct Current

(139)—George W. Beck, Mather Field, Mills, Calif., writes:

I have a D. C. generator giving 1 ampere at 25 volts.

Q. 1.—Is it possible to make a coil which will cut down the voltage and increase the amperage? I do not want to change the windings. I must decrease the voltage, however.

A. 1.—There is one simple method of doing what you desire, and that is to cut down both the voltage and the amperage by connecting a resistance in series with your apparatus or coil. Of course, you cannot increase the amperage and lower the voltage in this manner; both amperage and voltage will be affected at the same time.

If the requirements were not for so small a current, a motor generator in which your circuit would run the motor while the generator would give you approximately the same wattage at any desired voltage, according to the windings, would accomplish the result.

Another way to do it is to charge a storage battery in series and discharge it for use in parallel.

A Three-Inch Spark Coil

(140)—Floyd Cotton, Black Hawk, Indiana, asks:

Q. 1.—Please give all dimensions of a 3-inch spark coil.

A. 1.—Here are the dimensions of a 3-inch spark coil: the length of iron core is 12½ inches; diameter of iron core, 1¾ inches. This core is made of soft iron wire about No. 20 size and is packed into a fiber tube one-eighth of an inch thick. This tube is then wound with two layers of No. 14 D. C. wire.

The secondary is wound in 16 pies and 8 pounds of No. 32 wire, B. and S. gauge, is used. The condenser contains 120 sheets of tinfoil, 9 by 7 inches, which are separated by waxed paper. Current at a pressure of 12 volts is used in the primary circuit.

Q. 2.—Is it practical for an amateur with limited appliances to construct so large a coil?

A. 2.—It is certainly practical, yet it is rather a large coil to start with. You should have the best winding and testing facilities, so as to watch the progress of the work. All will go much smoother under such conditions. We wish to encourage the amateur, but would it not be better to start with a smaller unit?

NOW READY! The Fourth Edition of the **Consolidated Radio Call Book** NOW READY!

Very Greatly Enlarged With Seven Two-Color Radio Maps

280 pages (88 pages more than the 3rd edition), better paper, stiff covers, etc.
25,000 Copies

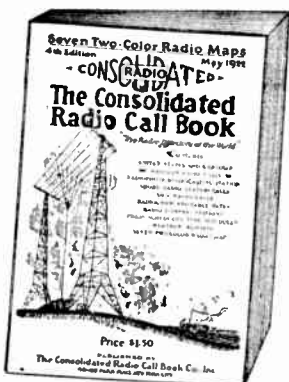

Some of the special information contained in the new book: All Amateur Radio Calls of the United States and Canada; Every Vessel, Coast Station, and Radio-Compass Station in the World; Radiophone Broadcasting Stations of the United States; Every High-Power Station in the World; Special Land Stations of the United States; Time Signals, Hydrographic and Weather Reports of the United States and Principal Foreign Countries; International Abbreviations; Assignment of International Calls; Press Schedules; Radiogram Rates; Cable Rates; International Morse Code and Continental Signals; and Complete General Information covering Distress Calls, International Safety Signal, Use of 800-Meter Wave Length, Amendments and Changes in Various Governmental Regulations, How to Determine Charges on Radiograms, Free Medical Advice by Radio to Vessels, and much other useful information.

The Consolidated Radio Call Book is the only book in print officially listing all the Radio calls as issued by the Bureau of Commerce. Every vessel and land station in the world is represented and listed alphabetically, according to name of vessels or land stations, and according to call letters. The New Radiophone Broadcast Section is particularly complete and gives all available information concerning Calls, Wave Lengths, Programs, etc.

Every Amateur Call in the United States and Canada Is Listed

SPECIAL RADIO MAP SECTION

Contains Five Two-Color Continental Maps showing All Stations thruout the World Handling Commercial Traffic with their Calls; a Two-Color Map showing the Amateur Radio Districts of the United States and the Principal Radiophone Broadcasting Stations with their Calls; and a Map of the United States Weather Forecast Zones.

The third edition of 10,000 copies was exhausted in two weeks. The fourth edition is selling just as quickly. Don't wait until it is all gone. Order at once, either direct from us or from your favorite dealer.

Price \$1.50 Prepaid

Order Direct from us or for sale by the following responsible Dealers:

- | | | | | | | | |
|--|--------------------|--------------------------------|---------------------|---|---------------------|-----------------------------|----------------------|
| Alamo Sales Corp. | Indianapolis, Ind. | Fernco Co., R. F. | N. Y. City | Meyberg Co., Leo J. | San Francisco, Cal. | Rose Radio Supply | New Orleans, La. |
| Am. Electro Tech. App. Co., N. Y. City | | Fergus Elec. Co. | Zanesville, O. | Milnor Elec. Co. | Cincinnati, Ohio | Roy News Co., Frank J. | Toronto, Can. |
| American Hdw. Stores, Bridgeport, Conn. | | Phidley Electric Co. | Minneapolis, Minn. | Mohawk Elec. Sup. Co. | Syracuse, N. Y. | Saids Electric Co. | Wheeling, W. Va. |
| Andrea & Sons, Julius, Milwaukee, Wis. | | Fieron & Son, M. M. | Trenton, N. J. | Montgomery-Ward & Co. | Chicago, Ill. | Satre-level Radio Co. | Phila., Pa. |
| Andrae & Sons, Julius, Mason City, Ia. | | Fuller Co., Seth W. | Boston, Mass. | Morehouse-Martens Co. | Columbus, Ohio | Schmidt & Co., R. | Rochester, N. Y. |
| Anthraxite Radio Shop, Scranton, Pa. | | Galinday Elec. Co. | Pittsburgh, Pa. | National Radio Corp. | Atlanta, Ga. | Sears, Roebuck & Co. | Chicago, Ill. |
| Associated Merchandising Corp., N. Y. C. | | Galveston Wireless Sup. Co. | Galveston, Tex. | Natl Radio Institute, Washington, D. C. | | Shotton Radio Mfg. Co. | Scranton, Pa. |
| Atlantic Radio Co. | Boston, Mass. | Greene, Jos. E. | Boston, Mass. | New England Motor Sales Co., Green- | wich, Conn. | Smith Radio Lab. | Sarnia, Ont., Canada |
| Bamberger & Co., I. | Newark, N. J. | Gurd & Co., Wm. | London, Canada | New Era Shop | Milwaukee, Wis. | Smith Novotay Elec. Inc. | Charlotte, N. C. |
| Banister & Pollard Co., Newark, N. J. | | Hall Electric Co., Wm. | Dayton, O. | Newman-Stern Co. | Cleveland, O. | So. California Elec. Co. | Los Angeles, Cal. |
| Beckley-Ralston Co., The | Chicago, Ill. | Hartford Elec. Sup. Co. | Hartford, Conn. | Nichols Radio Sup. Co., | Big Green, Ky. | Southern Elec'l Sup. Co., | San Diego, Cal. |
| Benwood, Specialty Co. | St. Louis, Mo. | Hathfield Electric Co. | Indianapolis, Ind. | Nola Radio Co. | New Orleans, La. | Southwest Radio Sup. Co., | Dallas, Tex. |
| Bluebird Electric Shop, | Jersey City, N. J. | Heistis, A. E. | Pittsburg, Mass. | Noll & Co., E. P. | Philadelphia, Pa. | Sprott-Shaw Schl. | Vancouver, B. C. |
| Brosie Electric Co. | Los Angeles, Cal. | Hickson Electric Co. | Rochester, N. Y. | Northern Radio & El. Co., | Seattle, Wash. | Standard Drug Co., The | Detroit, Mich. |
| Brown, J. Edw. | Glenbrook, Conn. | Hiro Wireless Sup. Co. | Marion, Ill. | Northwest Radio Serv. Co., | Seattle, Wash. | Steiner Elec. Co. | Chicago, Ill. |
| Bunnell & Co., J. H. | New York City | Holt Electric l'hl. Co., | Jacksonville, Fla. | N. S.W. Bookstall Co. | Sydney, Australia | Steinman Hardware Co. | Lancaster, Pa. |
| California Elec. Co., San Francisco, Cal. | | Hommel-Ludwig & Co. | Pittsburgh, Pa. | Paramount Radio Sup. Co., | Atlantic City | Sterling Electric Co., | Minneapolis, Minn. |
| Capital Radio Sup. Co., Indianapolis, Ind. | | Hook Drug Co. | Indianapolis, Ind. | Penn Radio Apparatus Co., | Reading, Pa. | Stubbis Electric Co. | Portland, Ore. |
| Carter Electric Co. | Atlanta, Ga. | Huey & Phillip H'dware Co., | Dallas, Tex. | Penn. Marconi Wireless Schl. | Phila. | Sunbeam Elec. Sup. Co., | N. Y. City |
| Central Radio Co. | Independence, Mo. | Hughes Elec'l. Corp. | Syracuse, N. Y. | Pettingell-Andrews Co. | Boston, Mass. | Tuska Co., C. S. | Hartford, Conn. |
| Chase, Geo. H. | Newport, R. I. | Iowa Radio Corp. | Des Moines, Iowa | Phila. Schl. of Wireless Tele. | Phila., Pa. | Union Elec. Sup. Co. | Providence, R. I. |
| Chesapeake Elec. Co. | Baltimore, Md. | Jenkins, Lester I. | New Bedford, Mass. | Piedmont Electric Co. | Asheville, N. C. | United Elec. Stores Co. | Bradford, Pa. |
| Chicago Radio App. Co. | Chicago, Ill. | Kesselman-O'Driscoll Co., | Milwaukee, Wis. | Pioneer Electric Co. | St. Paul, Minn. | United Electric Stores | E. Pittsburgh, Pa. |
| Cleveland Co., I. W. | Portland, Me. | Kaubler Radio Co. | Tokelo, O. | Pitts. Co., F. D. | Pittsburgh, Pa. | U. S. Radio Co. | Pittsburgh, Pa. |
| Cloud & Son | Macy, Ind. | Killoch Co., David | New York City | Pitts. Radio Sup. Co. | Pittsburgh, Pa. | Virginia Novelty Co., | Martinsburg, W. Va. |
| Con. Radio & Elec. Corp. | N. Y. City | King Radio Co. | Pittsburgh, Pa. | Pitts. Radio & App. Co., | Pittsburgh, Pa. | Warner Bros. | Oakland, Cal. |
| Continental Elec. Sup. Co., | Washington, D. C. | Klaus Radio Co. | Eureka, Ill. | Port Arthur Radio Lab., | Port Arthur, Tex. | Western Radio Co. | Kansas City, Mo. |
| Daily Battery & Equipment Co., | Pitts- | Knoxville Radio Co. | Knoxville, Tenn. | Post Office News Co. | Chicago, Ill. | West'n Radio Elec. Co., | Los Angeles, Cal. |
| burgh, Pa. | | Kusel Co., D. & F. | Waterstown, Wis. | Precision Equipment Co. | Cincinnati, O. | Wetmore-Savage Co. | Boston, Mass. |
| Delancey-Felch & Co. | Detroit, Mich. | Lehigh Radio Co. | Bethlehem, Pa. | Quaker Light Sup. Co., | The Phila., Pa. | Wheeler Green Electric Co., | Rochester, N. Y. |
| Detroit Electric Co. | Detroit, Mich. | Liberty Incandescent Sup. Co., | Pittsburgh, Pa. | Radio Distributing Co. | Newark, N. J. | Whitall Elec. Co. | Springfield, Mass. |
| Dewey Spig. Goods Co. | Milwaukee, Wis. | Liberty Radio Sup. Co. | Chicago, Ill. | Radio Electric Co. | Pittsburgh, Pa. | Whitlauer Elec. Co. | Westerly, R. I. |
| Doubleday-Hill Elec. Co. | Pittsburgh, Pa. | Linze Elec'l. Sup. Co. | St. Louis, Mo. | Radio Equipment Co. | Boston, Mass. | Williamson Elec. Co. | Seattle, Wash. |
| Dreyfuss Sales Co. | New York City | Litscher Elec. Co., C. J. | Grand Rapids, Mich. | Radio Equip't. & Mfg. Co., | Minneapolis | Wilmington Elec. Spec. Co., | Wilmington, N. C. |
| Duck & Co., Wm. B. | Toledo, O. | Ludwig Hommel & Co. | Pittsburgh, Pa. | Radioelectric Shop | Cleveland, O. | Wilson Co., Harold K., | Grundy Center, Iowa. |
| E. S. & E. Co. | Hartford, Conn. | Luther, H. E. | Centerville, Ia. | Ray-Di-Co. | Chicago, Ill. | Winner Radio Co. | Aurora, Colo. |
| Electro Importing Co. | N. Y. City | Manhattan Elec. Sup. Co. | Toledo, O. | Reynolds Radio | Denver, Colo. | Wireless Mfg. Co. | Canton, G. |
| Elite Electric Shop | El Paso, Tex. | Marshall-Gerken Co. | Toledo, O. | Reuter Electric Co. | Cincinnati, O. | Wolfe Electric Co. | Omaha, Neb. |
| Eric Book Store | Eric, Pa. | McCarthy Bros. & Ford, | Buffalo, N. Y. | R. I. Elec. Equipt. Co. | Providence, R. I. | Zamolski Co., Jas. M. | Baltimore, Md. |
| Farley & MacNeill | Boston, Mass. | McMillan Bros. | Pittsburgh, Pa. | Riverside Laboratory | Milwaukee, Wis. | Zilbarr Bros. | Nashville, Tenn. |
| Farrington & Clark | Boston, Mass. | Merchant, A. P. & Co. | Boston, Mass. | Robertson-Cataract El. Co., | Buffalo, N. Y. | | |
| Federal Elec. Sup. Co. | Detroit, Mich. | | | | | | |

Published by

Consolidated Radio Call Book Co., Inc.

96-98 Park Place, New York City

Radio Detector Tubes \$1.00

While they last we offer A & P or Cunningham Licensed Detector Tubes at \$1.00 with each purchase of Kellogg 2400 ohm Head Phones at \$12.00.

- Sliders for Slide Tuners.....\$0.15
- Eisemann Magneto Corp. Phones.... 6.75
- Rubber Top Binding Posts..... .04
- Glass Enclosed Detectors..... 1.00
- Howard Potentiometers..... 1.50
- Switch Levers (nickel plated)..... .25
- Rubber 3-in. Dials..... .55

Henry I. Leviton

138 No. LaSalle St. Chicago, Ill.

"ELECTRICITY Taught by a MASTER TEACHER"

is the name of a valuable 56-page booklet which should be in the hands of every boy and man in the United States who is interested in electricity or electrical engineering. It is FREE. Send for your copy today. It tells the facts about the greatest industry on earth, and contains an astounding offer.

DEPT. 10B
World Technical Institute, Jersey City, N. J.



The Midget "FIVE-IN-ONE" Slide Rule is a combination Mannheim, Log-Log, Add and Subtract, Poly-phase and Binary Slide Rule. It will instantly add, subtract, multiply and divide any combination involving whole numbers, fractions, decimals and mixed numbers. Gives every possible root and power of every quantity. The graduations are printed on metal coated with white celluloid and are grease and waterproof. While

it is the most versatile calculator ever invented, its operation is simple and easily understood. Diameter 4". Price with 16-page Instruction Book, \$1.50. Leatherette carrying case 50c extra. Catalog free. Your money back if you are not satisfied.

Gilson Slide Rule Co., Niles, Mich

Electrical Engineering men with training are in demand. For more than a quarter of a century, this school has been training men of ambition and limited time, for the electrical industries. Condensed course in Electrical Engineering enables graduates to secure good positions and promotions. Theoretical and Practical Electricity, Mathematics, Steam and Gas Engines and Mechanical Drawing. Students construct dynamos, install wiring and test electrical machinery. Course with diploma complete

In One Year



Over 2000 men trained. Thoroughly equipped fireproof dormitories, dining hall, laboratories, shops. Free catalog. 30th year begins Sept. 27, 1922. BLISS ELECTRICAL SCHOOL 409 TAKOMA AVE., WASHINGTON, D.C.

SAVE MONEY



Anyone with the aid of ELECTRICAL KINKS can do wiring and repairing of bells, burglar alarms, lighting, garages, irons, vacuum cleaners, washing machines, etc., everything for the HOME. For a limited time this new book is ONLY \$1.00 postpaid, or C. O. D. Send today. Satisfaction guaranteed.

HOME BOOK CO. 388 BA Arcade Bldg., CLEVELAND, OHIO

Ultralens Microscopes Give High Magnification at Low Cost. Something new. Model with magnification gradually variable from 2,500 to 62,500 times for \$1.60. Others from 100 up to 250,000 times. A new method of lens construction on which patents are pending enables us to produce microscopes of extremely high power at prices that place them within the reach of all. Circular PE free on request. SPECIALTY MFG. CO., MILTON, PA.



"BOW LEGS and KNOCK-KNEES" UNSIGHTLY

SEND FOR BOOKLET SHOWING PHOTOS OF MEN WITH AND WITHOUT THE PERFECT LEG FORMS. PERFECT SALES CO., 140 N. Mayfield Ave., Dept. 59 Chicago, Ill.

TELEGRAPHY

(Morse and Wireless) and RAILWAY ACCOUNTING taught thoroughly. Big salaries; great opportunities. Oldest, largest school. Endorsed by Telegraph, Railway, Radio, and Government officials. Expenses low—opportunities to earn large portion. Catalog free. DODGE'S INSTITUTE, 28th Street, Valparaiso, Ind.

Tesla and Oudin Coils

(141)—H. A. Walsh, London, England, asks:

Q. 1.—What is wrong with my Tesla or Oudin coil? I cannot get more than an inch spark from the same, using a 6-inch spark coil to excite it.

A. 1.—The reason that you did not obtain very good results from your Tesla or Oudin coil was undoubtedly due to the fact that your condenser in the secondary circuit was not of the proper capacity for this outfit. The cost of constructing an Oudin coil is very reasonable. We would suggest, therefore, that you build one according to the following specifications:

On a tube 3 feet long and 4 inches in diameter wind No. 32 single silk-covered wire, separating the turns at least one-sixteenth of an inch from each other. This is mounted on two uprights at either end, or attached vertically to a base. No screws or nails are used anywhere in the construction. The primary will then consist of 11 turns of No. 0 or larger B. and S. gauge copper tubing or brass tubing, or aluminum wire of equivalent size. This wire may be wound on a wooden or rubber cage 12 inches in diameter and located centrally, if the coil is mounted horizontally. This primary may be slidably mounted, so that the apparatus can be made to conform with either an Oudin or a Tesla coil in a moment's notice; or the cage may be placed at the base if the coil is mounted in a vertical position. We would then suggest that you employ a pointed spark gap, and that Leyden jars be used in the circuit instead of glass plate condensers.

We believe that those coils you have built would have given satisfaction if proper condensers had been used in the circuit. It is possible, however, that your 6-inch spark coil is delivering very little energy from the secondary binding posts.

In Which Direction Does an A. C. Motor Run?

(142)—B. Cheney, Phoenix, Ariz., asks:

Q. 1.—In which direction does an alternating current induction motor run?

A. 1.—The direction in which an alternating current motor will run depends entirely on the winding, if it is of the induction type. The simplest forms of induction motors will travel in either direction, dependent on the direction in which they are started.

Hydro-Electric Development in Remote District

A new reservoir for the city of Bradford, England, is, according to the *London Electrician*, about to be built in the remote fastnesses of the Yorkshire moors, and all the motive power for the machinery of building is to be derived from a hydro-electric plant whose wheels will be turned by water conveyed in a pipe line from an existing reservoir. In addition, this plant will provide lighting and make possible a motion-picture show in the village which will be erected for the workmen near the reservoir site. Nor will the development be merely temporary. The colony that will remain around the reservoirs will be far from an industrial area and the district is poorly served by rail. It is hoped therefore that the hydro-electric plant will solve the fuel problem of the village and give it permanently the most modern heating, cooking and lighting facilities.

Electric Furnace for Reducing Chloride Volatilization Fume

In the work of the Intermountain Station of the Bureau of Mines at Salt Lake City, Utah, on the reduction of chloride

volatilization fume, particularly that from copper ores, difficulty has been encountered due to excessive losses of copper and chlorine. It has been suggested that electric furnace melting could be carried on without such losses. Work along this line, to be undertaken by the Bureau of Mines at Seattle, will consist of (1) calculating the costs of the operation using the electric furnace to compare with that using fuel-fired furnaces; (2) designing a suitable furnace; and (3) carrying on actual reduction tests determining the efficiency and recovery of metals and chlorine. The point involved is that metallic chlorides are volatile, and in their volatilization occasion considerable losses of metal.

True Electrical Experiences

(Continued from page 347)

when a compass needle is placed near the field poles of a four-pole machine. At (E) we show another trick of the practical electrician for determining polarities of dynamo and motor field without a compass needle. A permanent steel magnet of the bar or other type, is used for this test. With the field excited, an end of the steel magnet is brought toward one of the poles, and the fact noted as to whether repulsion or attraction takes place. If the two field poles are magnetized north and south, as they should be, attraction will result between the end of the steel magnet and one of the poles, while repulsion will result between the same end of the steel magnet and the second pole, as becomes evident.

The test at Fig. 6 (C) is sometimes used in the simplified form, by placing a bar of iron across the two poles. If they are magnetized correctly, that is, north and south, the iron bar will be attracted equally at both poles; but if they are of like polarity, there will be very little or no attraction between one of the poles and one end of the iron bar.

A very peculiar problem arose in a certain power plant where a reserve dynamo was only used occasionally or about once a week. Every time this dynamo was started up, it refused to generate or "build up." Experts were finally consulted regarding this dynamo, which was a large one, and the opinion seemed to be that it had lost its residual magnetism and would not retain sufficient magnetism to build up on, due to the fact that it was standing with its axle facing east and west. It was reported that the machine acted properly after it had been rotated on its base 90 degrees, so that its shaft or the axis of its field faced north and south. This point is brought out in an experimental way by one of the simplest experiments in electro-physics, which involves the magnetizing of a steel bar by placing it in a north and south direction for a short time. If the steel bar is placed facing east and west, it will not become magnetized; but when pointing in the direction of the earth's magnetic field, that is, north and south, it will be found to have become magnetized.

Once in carrying out a test on the electrocution chair, a side of beef was placed in the chair and connected with the cap and ankle electrodes respectively, as usual. The assistant electrician became over-ambitious and nearly touched the piece of meat before all of the tests were completed; luckily, the chief in charge observed his action and warned him barely in time, as the current had been turned on for the third contact. Eighteen hundred to two thousand volts potential were applied to these tests, and if the young man had touched the carcass of beef, he would undoubtedly have been electrocuted.

A Power Vacuum Cleaner

(Continued from page 349)

carry, in the shape principally of the dust separator, are of small diameter, mounted on a swivel axle, and when turned under the car permit a very short turning. It is from this end that the car is manipulated, with a handle by which it is pushed and pulled about as required. The apparatus is 44 inches in length, and its highest part is 28 inches above the floor. Its weight is 250 pounds.

Six different tools are supplied for connection to the hose, including a blowing tool for use in inaccessible places, which can be used to aerate pillows, mattresses, etc. Nothing here is needed but the electric wire or flexible cord plugged into a burner socket on the wall, which is certainly a great improvement on the heavy hose with special piping to supply connections in the case of other large-type cleaners.

The Teletype

(Continued from page 344)

than does the transmitter. When the receiving instrument has completed a revolution, it has gone a little bit ahead of the transmitter, and at this instant is brought to rest. Meanwhile the transmitter is catching up with it, and when it has covered the 14 per cent advantage gained by the receiver, a starting impulse is sent out by it, which really signals a completion of one revolution by the transmitter.

A starting impulse as this revolution is

completed causes the receiving instrument's shaft to start revolving, and again it completes its rotation slightly ahead of the transmitter, stops and is started only when the transmitting shaft has executed its full rotation.

The usual type of motors are for 110 volts and 220 volts direct current, and 110 volts alternating current, the frequencies varying from 25 to 85 cycles. If voltages run too high they may be reduced by rheostats. The apparatus as installed is encased very neatly, so that it really resembles a magnified typewriter. It can send at the rate of 40 words per minute, and if there is no one at the receiving instrument it makes no difference, as the message is printed there. Its great field of use, it is said, is for inter-department communication in large business establishments.

Small Battery Charger

(Continued from page 348)

armature closes the circuit, and immediately opens it for the other cycle of the alternating current received. The lead then goes from this contact at the foot of the armature, through a safety fuse, to the ammeter, and thence to the positive binding post. A cover is provided to enclose the magnet, leaving exposed the ammeter and binding posts beside it.

The other type of charger is built on the same lines, but with certain variations, and is designed especially for charging radio batteries. The latter charger designed for radio purposes charges a 6-volt battery, a 24-volt battery and those of higher voltage. The case is glass-paneled.

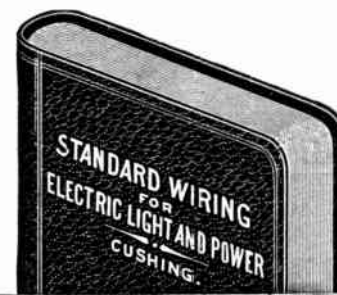

**DO YOUR OWN WIRING!
AND SAVE 50%**

400 PAGES
ILLUSTRATED

Anyone can become an expert wireman and secure a license by following the simple rules given in "Standard Wiring"

The National Authority for 28 Years

All the necessary rules, tables and illustrations needed for every kind of inside and outside wiring and construction for both direct and alternating currents, in accordance with the Underwriters' rules. The most complete and accurate book on wiring published. Twenty-eighth Edition just out.

Leather Cover. Gilt Edges. Pocket Size. \$2.00
Sent on receipt of Price

H. C. CUSHING, Jr.
10 WEST 40th STREET, NEW YORK

WONDERFUL NEW INVENTION BRINGS RADIO RECEPTION OVER YOUR ELECTRIC LIGHT WIRES

Super-Antenna



THIS wonderful unit has been developed by the country's foremost engineers, making possible radio reception over your electric lighting circuits. No power current is used when operating a "Super-Antenna." It operates on any electrical circuit from 22 to 120 volts, D.C. or A.C. Light plug can be turned either "ON" or "OFF."

The "Super-Antenna" is shock proof, will not blow fuses, and will not damage a receiving set in any way. During the many months of development of this unit, all practical circuits were protected. Beware of imitations. They are expensive to experiment with.

No Outside Aerial Necessary

This unit does away with the dangers of stringing antenna over power and lighting wires, where great danger results when antenna touches live wires caused by storms, etc. The "Super-Antenna" eliminates all troubles and dangers incident to the erection of the antenna. Most convenient for using receiving set anywhere. You just insert plug in any electric light socket and connect binding post to your receiving set.

TESTED BY LARGEST EXPERIMENTAL STATIONS

The "Super-Antenna" has been tested by many Radio Experimental Stations and found to give marvelous results. Stations twelve hundred miles distant may be readily copied with the ordinary installation, and in the majority of circuits it tends to reduce static effects.

ORDER TODAY

\$280

The demand for this "Super-Antenna" is taxing our supply to the limit, so get your order in early. Dealers everywhere are stocking them. If your Radio Dealer cannot supply you with the "Super-Antenna" order direct and send us his name.

Enclose check or Money Order. West of Rockies \$3.00, Canada \$3.70. **Dealers and Jobbers** Be first in your territory to stock this wonderful unit.

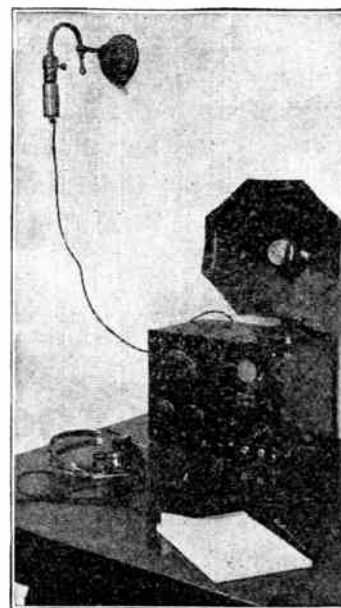

LOOK FOR ORIGINAL
BEWARE OF IMITATIONS

- Safe--Efficient
--Convenient**
- NO POWER CURRENT NECESSARY
 - ELIMINATES DANGERS
 - SHOCK PROOF
 - WILL NOT DAMAGE RECEIVING SET
 - WILL NOT BLOW FUSES

SUPER-ANTENNA COMPANY, Dept. 37, Quincy, Ill.

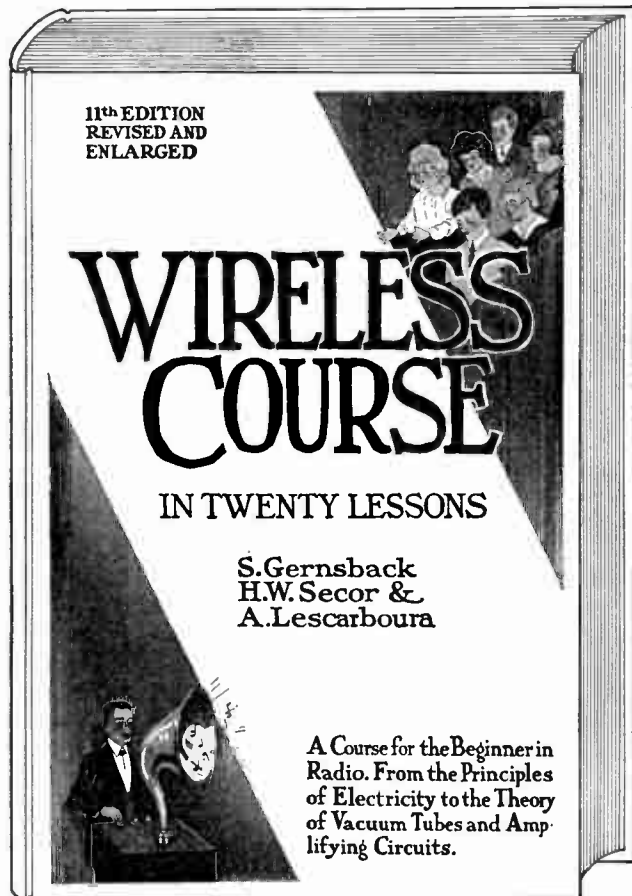

WIRELESS COURSE

in 20 Lessons

By

**S. GERNSBACK, H. W. SECOR,
A. LESCARBOURA**

Beautifully Stiff Bound
 in Red Cloth
 Gold Stamped
 Size 7 x 10 inches
 160 Pages
 20 Lessons
 360 Illustrations
 30 Tables
 Price \$1.75 Prepaid



Exactly the Same Book
 But Soft Bound,
 and not Gold Stamped
 Price \$1.25 Prepaid

THIS Course has been considerably revised in order that it meet some of the many important changes which have occurred in Radio Telegraphy and Telephony within recent years. Much valuable data and illustrations concerning the Vacuum Tube has been added. This comprises the theory of the Tube as a detector and as an amplifier, and in addition has been included modern amplification circuits of practical worth. Incidentally, space has also been devoted to the development of the Radio Compass as operated and controlled by the United States Navy with its consequent great aid to present-day navigation.

The beginner and general student of radio will find this Course of great value in securing the necessary fundamentals of a most fascinating and instructive vocation, or avocation—as the case may be. Radio holds out considerable inducements as a career.

THE PUBLISHERS

The Experimenter Publishing Co., Inc.

53 PARK PLACE
NEW YORK, N. Y.

The Experimenter Publishing Co., Inc.
53 Park Place, New York, N. Y.

Enclosed find \$1.75 for which send me one copy of
 stiff \$1.25
 soft bound WIRELESS COURSE, Postpaid.

Name

Town

Address

State

P.E. 7-22

Laboratory Ultra-Violet Ray Electric Lamp

(Continued from page 360)

siderable period, the vapor of the sodium salt is diffused through the atmosphere in a disagreeable way and it operates to make fine instruments dirty. It is really an unpleasant thing to have in the laboratory.

In ordinary microscopy, the mercury arc is found to give very fine results, but what is more interesting are its uses in photo-microscopy, where the great actinic power of the ray gives very short exposure results. The optical system to use the ultra-violet rays must be built up of quartz lenses and flourspar lenses. Such lenses are now available. The pity of it is that flourspar is one of the softer minerals, and the greatest care has to be exercised in using it, to avoid deterioration of its surface.

The laboratory arc places at the disposal of the chemist and physicist a most convenient source of ultra-violet rays, and in the production of which little power is required; yet whose uses are very many, and are going to increase continually. It is found that the full-size mercury vapor quartz tube lamp will burn continuously for many months before giving way, so that it is probable that the laboratory ultra-violet lamp will last still longer, as, of course, its use is intermittent.

One interesting feature of the construction of this class of lamp is the connection of glass tubes to the quartz tubes. This is done by a graded system; thus pyrex, the material for cooking vessels, which is very difficultly fusible and which has a very high percentage of silica, is used as the intermediate gradation between quartz of the lamp proper and glass proper for the rest of the lamp. It is quite possible that there may be more than one gradation; several steps have been used by several glasses succeeding each other in order to avoid the bringing together and melting into one of glasses of highly differing coefficients of thermal expansion.

A Polarized Rectifier and Its Use

(Continued from page 357)

One 16-candlepower carbon filament, or 50-watt Mazda lamp for resistance, gives one-half ampere.

For example: A battery whose finishing rate is 3 1/2 amperes requires three 32-candlepower, or 100-watt lamps, and one 16-candlepower, or 50-watt lamp.

The time required for charging depends upon the number of ampere hours (product of amperes and hours) in the battery. This can be determined by the hydrometer readings which give the specific gravity of the electrolyte (battery solution). The following table shows the discharged condition of the battery for various gravity readings:

- Specific gravity, 1.150; battery empty.
- Specific gravity, 1.180; battery three-quarters discharged.
- Specific gravity, 1.215; battery, one-half discharged.
- Specific gravity, 1.250; battery one-quarter discharged.
- Specific gravity, 1.280; battery full.

Example: Suppose you have a battery rated with a capacity of 40 ampere hours. The hydrometer records the gravity at 1.250. According to the above table, this means the battery is one-quarter discharged, which is one-quarter of 40 ampere hours, or 10 ampere hours were discharged from the battery. This amount will be required to bring the battery to full capacity; however, the recharge is not 100 per cent efficient. Therefore, it

will be advisable to multiply the ampere hours required in all cases by a coefficient of 1.2. Referring to the example: Twelve ampere hours will be required for a 40-ampere hour battery one-quarter discharged, i. e., one ampere for 12 hours, or three amperes for four hours, etc.

It is advisable to charge for a long period of time at a low rate of amperage, because this will eliminate many battery troubles.

Repairing Iron Electrolytically

When some iron or steel part of machinery becomes badly worn it will now be possible to restore its usefulness by giving it a coat of iron, applied by electricity.

David G. Kellogg, research engineer of the Westinghouse Electric and Manufacturing Company, describes the successful development of commercial electrolytic deposition of iron at the meeting of the American Institute of Mining and Metallurgical Engineers in New York.

A worn motor shaft repaired with a coat of iron applied by his new method gave as satisfactory service as a new one, Dr. Kellogg said. Cast iron as well as steel can be electroplated, and this is expected to prove useful in repair work of special machine parts. Dr. Kellogg's work is an improvement on the war methods of the British army repair shops, which used the electrolytic method in repairing about 6,000 steel and iron machine parts. Electro deposition of iron has been practiced for years, but earlier work was undertaken only for the production of metallic iron.

Vulcano Radio Torch

Self-Heating Soldering
Iron, blow torch combination.

Postpaid for
\$2.50



Latest
Device

Big Hit

with electricians and mechanics. Points on Radio soldering FREE. Certificate of honorable mention from Radio Inst. of the N. Y. Evening Mail.

AGENTS WANTED
NATIONAL RADIO SALES CO.
32e UNION SQ., N. Y. C.

Send To-day for the "Electrical Worker's Friend"

An electrical book of 66 motor drawings with complete instructions for rewinding and reconnecting A. C. motors. Special at **\$4.00**
Or write for full particulars of this valuable book.

SMITH & SMITH PUBLISHING CO.
Dept. C., 7428 Hermitage St., Pittsburgh, Pa.

VIKING RADIO PRODUCTS

Viking Vernier Condensers

These Vernier Condensers may be used in conjunction with any type condenser, making sharp tuning possible. Invaluable in accurate wave meter work. Will also make an excellent grid condenser.

Price **\$1.50** each

Viking Vario-Couplers

Here is the Viking Vario-Coupler that has given so much satisfaction to "fans" making their own sets. It is a well finished article of excellent workmanship and design. Wave length range, 150 to 800 meters. It is so constructed as to be adaptable for use in the Short-Wave Regenerative Receiver described in the Consolidated Radio Call Book Co.'s Pattern No. 1.

PRICE **\$5.00** EACH



Zeta Radio Frequency Transformers

These Radio Frequency Transformers are invaluable in loop antenna, underground aeriels and concentrated antenna. As many stages of amplification as desired may be employed with our R F T and remarkable signal strength obtained when a detector and 2 stages of audio frequency amplification are employed, in addition to as many steps of radio frequency as desired.

PRICE **\$6.00** EACH



Ideal Variable Condensers

Variable Condensers of the better kind at reasonable prices. Bakelite Plates, Excellent Construction and Finish.

- 43 Plate - - **\$4.75** each
- 23 Plate - - **\$3.75** each
- 11 Plate - - **\$3.00** each

ALSO ON HAND FOR IMMEDIATE DELIVERY: Genuine 2-Fil. Audiotron Tubes \$6.00
Adapters (for above) 1.50
Metal Dials 3 1/4" diam. 1/4" shaft. 90
Moulded Phone Condensers, .002 mfd. 75
Ducon Aerial Plugs. 1-50

Dealers will find it worth their while to write for attractive discounts on these articles and others we carry in stock

Viking Radio Company 26 CORTLANDT ST., New York City
453 WASHINGTON ST., Boston, Mass.



10c. Charges Radio & Auto Batteries At Home F-F Booster

Which is a Full Wave Automatic Magnetic Rectifier for 105-125 Volt 60 Cycle A. C. A Complete Compact Self-Contained Conveniently Portable Automatic Charging Unit. Adjustable Renewable Infusible Carbon Electrodes Rectify Current Uninterruptedly. AMMETER eliminates All Guess Work. No Skill is Required. They last a Lifetime. Leave Battery in Car. Screw Plug in Socket; Snap Charger Clips on Battery Terminals. Turn Switch, lock garage door, knowing Your Battery will be Charged in the Morning. Starting Car Quick, requires Fewer New Batteries. Boosters thus Save more than their Cost. Is It Not Gratifying to Feel Your Batteries are Ready for All Radiophone Music & News? Don't think Your Battery is dead & worn out simply because it will not start Your Car. Buy a Booster & Fill it With Life. It Saves You 90c a Charge. **REDUCED PRICES** Type charges 6 volt Battery at 6 amperes \$15 Type 12 charges 12 volt Battery at 5 amp \$15 Type B charges 2 to 100 volt Radio Batteries \$15 Type A-B charges Both A & B batteries \$20 Type 16 charges 6 volt Battery 12 ampere \$24 Type 16 12 charges 12 volt Battery 7 amp \$24 Type 16 2 is Combination of Types 16 & 12 & Charges Both 6 & 12 volt Batteries \$36 The Larger Types are recommended for heavy Batteries, or where time is limited. Shipping Weights Complete with AMMETER & BATTERY CLIPS, 11 to 15 lbs. Order from Your Dealer, or Mail Check for Prompt Express Shipment; include Postage & Insurance Charges for Parcel Post Shipment, or Write us to Ship Type desired C. O. D. **F-F ROTARY RECTIFIER** For **GROUP CHARGING** Full Wave Automatic 12 Battery Size \$135. Free Descriptive **ROTARY Bulletin 25A** Order Now or Write Immediately for Free Descriptive **BOOSTER Bulletin 25** **France Manufacturing Co.,** Cleveland, Ohio, U. S. A. Canadian Representative: Battery Service & Sales Co., Hamilton, Ontario, Canada.

OPPORTUNITY AD-LETS

You can place your ad in these columns for only 2c a word. It will pay you to read and investigate the offerings made from month to month in these columns, by reliable firms, dealers and individuals from all over the country. You are reading them now—others will read yours. Ad-lets for the September issue must reach us not later than August 1st.

The Circulation of Practical Electrics is more than 33,000.

Practical Electrics Company, Inc., 53 Park Place, New York, N. Y.

Aeronautics

Model Aeroplanes that fly. Buy your complete outfit, scale drawings, fittings, compressed air motors and all-best model aeroplane supplies from the Wading River Manufacturing Co. Established 1900. Our new 52-page catalog illustrated, 24 latest models and designs. Send 5c. for your copy. Wading River Manufacturing Co., 672K Broadway, Brooklyn, N. Y.

Agents Wanted

We wish representatives in every community to secure subscriptions for Practical Electrics, Radio News, and Science & Invention. This is a wonderful opportunity for Amateur Radio Enthusiasts to make big money quickly. Write Experimenter Publishing Co., Inc., 53 Park Place, New York City.

Books

Radio building books 25c. Amateur Electrician, 10c; ToyMaker Books, 10c; 64 pages each; 150 kinds mechanical puzzles leader and catalog, 10c. Western Puzzle Works, 15 Saint Paul, Minn.

Back issues of all magazines supplied by Boston Magazine Exchange, 109 Mountfort Street, Boston, Mass.

Experimental Electricity Course in 20 Lessons. By S. Gernsback and H. W. Secor, E. E. A course of the theory and practice of Electricity for the Experimenter. Every phase of experimental electricity is treated comprehensively in plain English. New experiments are described and explained, and nearly every application of Electricity in modern life is given. 160 pages—400 illustrations. Flexible cloth cover, 75c postpaid. Stiff cloth cover, \$1.25 postpaid. Experimenter Publishing Co., Book Dept., 53 Park Place, New York City.

How to Make Wireless Receiving Apparatus. 100 pages—90 illustrations. Only strictly modern radio apparatus are described in this book and the illustrations and descriptions are so clear and simple that no trouble will be experienced in making the instruments. Paper covered, 35c postpaid. Experimenter Publishing Co., Book Dept., 53 Park Place, New York City.

How to Make Wireless Sending Apparatus. 100 pages—88 illustrations. Written and published entirely for the wireless enthusiast who wants to make his own radio apparatus. Contains more information on "how to make it" than any other book we know of. Paper bound, 35c postpaid. Experimenter Publishing Co., Book Dept., 53 Park Place, New York City.

Business Opportunities

Make big money opening safes and setting combinations. Wayne Strong, Box 1430, Los Angeles, Calif.

Men—Make money in spare time mailing letters; unusual opportunity offered. Send stamped addressed reply envelope. R. Normande, 147 West 23d St., New York.

Chemistry

Learn Chemistry at Home—Dr. T. O'Connor Sloane, noted educator and scientific authority, will teach you. Our home study correspondence course is a real short cut. You can learn in half the usual time. Gives you the same education as you would get at a college or university. See our full page ad in this issue for special 30-day offer. Chemical Institute of New York, 140-B Liberty Street, New York City.

For Inventors

Inventors—If you have an idea, before spending unnecessary money for a patent, write Inventors & Engineers Consulting Co., P. O. Box 344, Washington, D. C.

Health

Pyorrhea (Riggs Disease, Bleeding or Swollen Gums). Hundreds have been helped by "Pyorrdent," the successful home Pyorrhea treatment. Purifying, healing, preventative. Full month's treatment, consisting of a very beneficial massage paste and an antiseptic tooth-cleansing paste to be used in place of your ordinary dentifrice, together with full directions for treatment. \$1 postpaid. Or write for free Booklet "P," Pyorrdent Mfg. Co., 439 Seventh St., Brooklyn, N. Y.

Help Wanted

Wanted—Men—Women over 17; get U. S. Government Life Jobs. Commence \$95 to \$132 month. Quick raise. Steady work. No layoffs. Paid vacation. Short hours. Common education sufficient. Pull unnecessary. List positions free. Write immediately. Franklin Institute, Dept. F111, Rochester, N. Y.

Detectives Make Big Money. Travel and be independent. Learn this fascinating profession by home study. We show you the way. Write today for free booklet. American School of Criminology, Scherer Bldg., Detroit, Mich.

Detectives Earn Big Money. Excellent opportunity. Travel. Great demand everywhere. Experience unnecessary. Particulars free. Write, American Detective System, 1968 Broadway, N. Y.

Instruction

How to Swallow Swords. Secret exposed; be popular, surprise friends. Instructions, 25c. H. Johnson, Box 54, San Mateo, Calif.

Insects Wanted

Spent Spring, Summer, Fall, gathering butterflies, insects. I buy hundreds for collections. Send for 25c (not stamps) for illustrated Prospectus. Sinclair, Dept. 33, Ocean Park, California.

Languages

World-Romic System, Masterkey to All Languages. Six textbooks, \$1.73. French Chart, 87c; Spanish, 37c; Speech-Organs, 37c. Pronunciation-Tables, 79 languages, 30c each. Languages Publishing Company, 8 West 40th Street, New York.

Mailing Lists

2075 Farmers, Every Nebraska County, \$3.00. Jeston's Service, Box 769, Omaha, Nebr.

Mail Order Business

\$25,000.00 made with a small mail order business home evenings. I made it, started with \$3.00. Booklet for stamp tells how, or send 25c for sample of article and plan. Alpece Scott, Cohoes, N. Y.

Miscellaneous

Luminous Paint, Bottle 20c. Laboratories F, Box 316, Portland, Oregon.

Patents

Get your own Patent \$35 complete. Application blanks and full instructions \$1. Theodore Cutting, Cooper Bldg., Campbell, Cal.

Patents for Sale

Patent for Sale—Foldable screened rocking chair, adapted for porches, country places, hospitals, seashore. Address, Strausky, 200 Greenway, Darby, Pa.

Patent Attorneys

Patent application filed on partial payment plan. Trade-marks, copyrights, etc. Milo B. Stevens & Co., 694 F Street, Washington, D. C. Estab. 1864.

Personal

Success or Failure. Which is your destiny? Scientific information. "Success" pointers and personality sketch for 10c and birthdate. Thomson-Heywood, Dept. 590, Chronicle Bldg., San Francisco, California.

Exchange cheery letters with new friends! Send stamp. Betty Lee, 28 East Bay, Jacksonville, Florida.

\$1 buys Industrial Alcohol Book. Catalog Free. Pure Copper Cans, Tubing, Testers, Carax. Box 2571, Boston.

Stamps and Coins

Boys, don't buy stamps until you have seen our approvals and prices. Approvals sent on request. Send dime for sample packet. Squan Novelty Co., Manasquan, N. J.

Telegraphy

Telegraphy (Morse and Wireless) and Railway Accounting taught thoroughly. Big salaries. Great opportunities. Oldest, largest school. All expenses low—can earn large part. Catalogue free. Dodge's Institute, 29th St., Valparaiso, Indiana.

Wanted to Buy

Old Gold, Silver, Platinum, broken and discarded jewelry, stamp and coin collections. Walters Co., 1540 North 58th Street, Philadelphia, Pa.

Used Correspondence Courses wanted. All schools; all subjects. Courses bought, sold, exchanged. Bulletin 1071 free. Instruction Correspondence Exchange, 1966 Broadway, N. Y.

Wanted—Platinum Magneto Points, old or new. We pay full value, mail or express. Packages returned if our offer is not satisfactory. Highest cash prices paid for old Gold, Silver, Watches, Platinum, Crowns and Bridges, Diamonds, War Bonds and Stamps. United States Smelting Works (The Old Reliable), Dept. 12, Chicago, Ill.

Wireless

No Amateur's room, or Radio Club complete without the Radio-Thrill. A compact instrument in itself, affording a great deal of amusement in the home. Price, \$5.00. Postpaid to you. Write, Thos. Ensall, 1208 Grandview Ave., Warren, Ohio.

Genuine Rusonite Crystals, tested and guaranteed. Mounted crystals postpaid, 50c. Trade discounts to dealers, manufacturers. H. J. Davis, 200 Ridgewood Ave., Brooklyn, N. Y.

The How and Why of Radio Apparatus, by H. W. Secor, E.E. This newest book on radio matters fulfills a distinct gap in wireless literature in that, while the treatment is made as understandable and as free from mathematics as possible, it at the same time incorporates a wealth of technique and instruction for the Radio Amateur—the Radio Operator—the Installation and Designing Expert—as well as teachers and students of the subject in general. A very broad field has been covered by the author, at the same time giving a great deal of information not found in other text books. If you are engaged in any branch of the Radio or allied arts at all, you will surely need this latest contribution to radio literature, which is destined to be found on every radio man's book shelf before long. A glance at the following list of chapters gives but a very scant idea of the extensive and useful radio knowledge provided in its text: The Induction Coil; The Alternating Current Transformer; Radio Transmitting Condensers; The Spark Gaps; Radio-Transmitting Inductances; Radio Receiving Tuners; Radio Receiving Condensers; Detectors; Telephone Receivers; Radio Amplifiers; Construction of a Direct Reading Wave-meter and Decimeter; Antenna Construction; The Calculation and Measurement of Inductances; Appendix containing very useful tables, covering all subjects treated in this very unusual book. This newest of Radio Works, cloth bound in Vellum de Luxe, Gold Stamped and Hand Sewed, has 160 pages. Size of book 6x9 inches. The How and Why of Radio Apparatus, Postpaid, \$1.75. Experimenter Publishing Co., Book Dept., 53 Park Place, New York City.

OFFICIAL RADIOPHONE
BROADCAST

MAP

10 CENTS EACH

Size 16 x 11½"

Now Ready for Distribution

In two colors ready to be mounted to
hang over your radio set

Map also includes names, call letters
and location of all broadcasting stations
in the United States

EXPERIMENTER PUBLISHING CO., INC.
53 Park Place, N. Y. C.

ELECTRICAL EXPERIMENTERS!!

SKINDERVIKEN TRANSMITTER BUTTON

MOST SENSITIVE MICROPHONE

YOU can easily make a highly sensitive detectophone by using a Skinderviken Transmitter Button to collect the sound waves. You can build your own outfit without buying expensive equipment.

Think of the fun you would have with such an instrument! It's very simple, too, and inexpensive.

You can install an outfit in your home and hear the conversation being held all over the house. You can connect up different rooms of a hotel. *This outfit was used by secret service operatives during the War. It is being used on the stage.*

So much for its commercial adaptations! You can procure apparatus of the same type.

One of the main advantages of the Skinderviken Transmitter Button lies in its ultra-sensitiveness. You can place it in any position you like. It is the greatest invention in micro-phones and has won recommendations from men of high standing in the scientific world. It is being used all over the world. You can mount it most anywhere. Card board boxes, stove pipes, stiff calendars and hundreds of other places will suggest themselves to you. The buttons cannot be seen by any one in the room as they are so small and light. Only a small brass nut is exposed to the view.

The only instruments needed to complete a detectophone outfit, in

AS A PREMIUM

MR. H. Gernsback, editor of this magazine, who is the dean of electrical experimenters, said: "In the writer's opinion, obtained by actual elaborate tests, the Skinderviken Transmitter Button is probably the most efficient device of its kind on market today, due to its simplicity and other outstanding features. Should have a great future."

The same circuit connections apply to all experiments, regardless of how the transmitter button is mounted.

The Skinderviken Transmitter Button operates on one or two dry cells. It often happens that two cells produce too

much current and the sounds are deafening. We recommend either one fresh cell or two worn out cells.

We have acquired a limited amount of these Transmitter Buttons and offer same free to our subscribers as a Premium, with a one year subscription to PRACTICAL ELECTRICS. These Buttons sell everywhere for \$1.00 and are worth it. We send you one prepaid upon receipt of the coupon below and the subscription price of our magazine. Do it today.



Actual size.

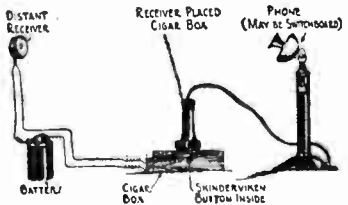
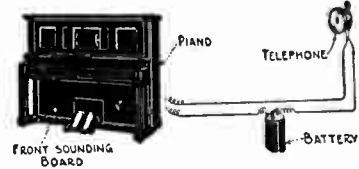
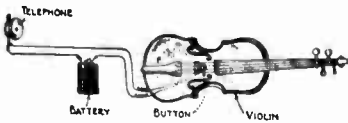

addition to a Skinderviken Transmitter Button are a receiver, battery, and, if desired, an induction coil.

PRACTICAL ELECTRICS COMPANY

53 PARK PLACE
New York, N. Y.

USE THIS COUPON

PRACTICAL ELECTRICS COMPANY
53 Park Place, New York, N. Y.

Gentlemen:

Enter my order for one year's subscription, and send me as special premium, free of charge, one Skinderviken Button. Enclosed find \$2.00 (Canadian and Foreign \$2.50.)

Name.....
Address.....
Town.....
State.....

LEARN ELECTRICITY

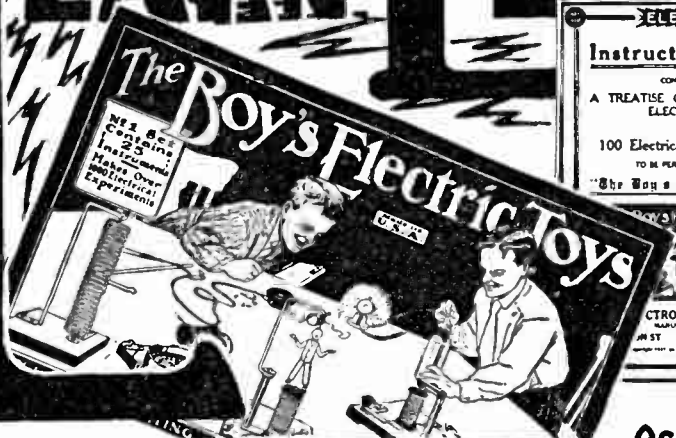

The BOY'S ELECTRIC TOYS

As Shown
\$7.50
Complete

Teaches you all the principles of electricity by the "Learn by Doing" Method. Entertaining, Instructive, More Fascinating than any game. The most complete electrical experimenters' outfit that has ever been put on the market.

Valuable Electrical Instruction Book With Each Outfit

With each outfit we furnish free a very comprehensive book of electrical instruction. All the fundamentals of this fascinating science are clearly explained so even a layman can understand every word. Profusely illustrated. The instructions for building the apparatus are given in such a simple and easily grasped manner that anyone can make them without the least trouble. Over a hundred experiments that can be performed with the outfit are listed in the instruction book, nearly all of them illustrated with superb drawings.

A Sample of What You Can Do With This Outfit

This illustration, made from an actual photograph, shows only a very few of the many instruments that can be made with the Boy's Electric Toys: Electric Pen and Lin. Electric Telegraph, Current Generator, Electric Dancing Spiral, Galvanometer.

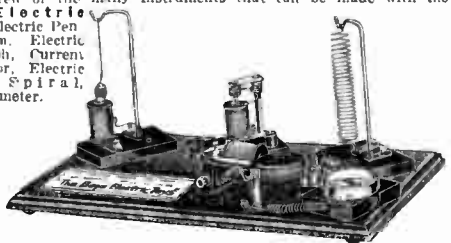

The outfit contains 114 separate pieces of material and 24 pieces of finished articles ready to use at once. Among the finished material are included: Chromic salts, lamp socket, mercury, core wire, iron filings, three spools of wire, carbons, machine screws, flexible cord, wood bases, glass plate, paraffine paper, binding posts, screw-driver, etc., etc.



Teaches You How To Build Electrical Apparatus

THE BOY'S ELECTRIC TOYS' contains enough material to make and complete over twenty-five different electrical apparatus without any other tools, except a screwdriver furnished with the outfit. The box contains the following complete instruments and apparatus which are already assembled:
Student's chromic plunge battery, compass-galvanometer, solenoid, telephone receiver, electric lamp. Enough various parts, wire, etc., are furnished to make the following apparatus:
Electromagnet, electric cannon, magnetic pictures, dancing spiral, electric hammer, galvanometer, voltmeter, hook for telephone receiver, condenser, sensitive microphone, short distance wireless telephone, test storage battery, shocking coil, complete telegraph set, electric riveting machine, electric buzzer, dancing fishes, singing telephone, mysterious dancing man, electric jumping jack, magnetic geometric figures, rheostat, erratic pendulum, electric butterfly, thermo electric motor, visual telegraph, etc., etc.

Shipment guaranteed within 24 hours.

SEND NO MONEY

We have so much confidence in this set that we desire to ship it to you C. O. D. with the privilege of inspection. It does not cost you one cent to take a good look at the outfit, and see if it comes up to your expectations. If it does, pay the postman \$7.50, plus shipping charges. If it does not, you need not accept it, and we will pay the return charges as well.

THE ELECTRO IMPORTING CO.
231 Fulton St., N. Y. City

ELECTRO IMPORTING CO.,
231 Fulton St., N. Y.

As per your advertisement, ship to me at once, C.O.D., the Boy's Electric Toys with privilege of inspection. It is understood that if I do not like the outfit I can refuse it.

Name

Address

City..... State.....

Let These Guides

Solve Your Problems

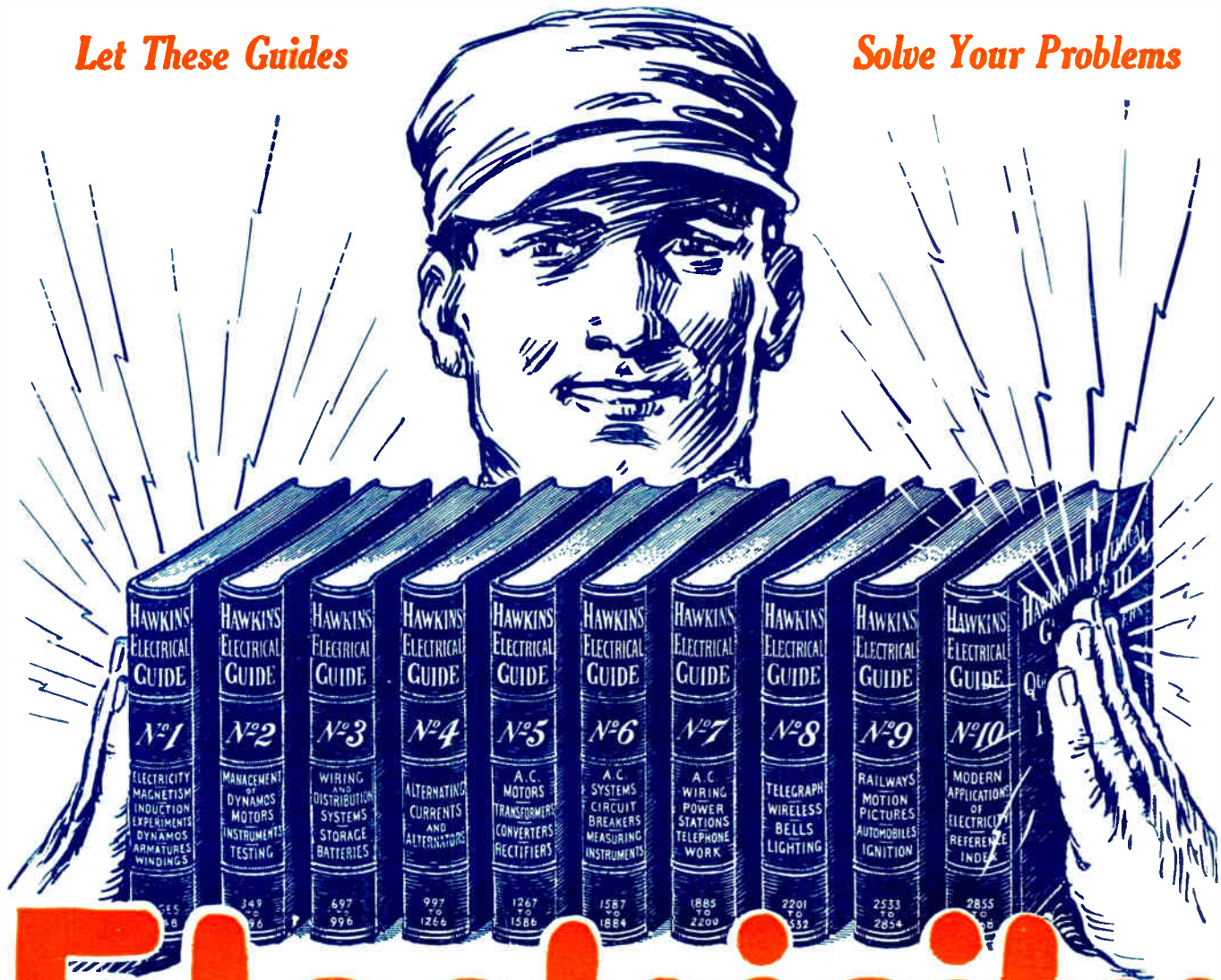

Electricity at your finger ends

HAWKINS ELECTRICAL GUIDES IN TEN VOLUMES

3500 PAGES
4700 PICTURES

\$1 A VOLUME
\$1 A MONTH

SEND NO MONEY—SEND ONLY THIS COUPON

Know the facts in Electricity. They mean more money and better position for you. Hawkins Guides tell you all you need to know about Electricity. Every important electrical subject covered so you can understand it. Easy to study and apply. A complete, practical working course, in 10 volumes. Books are pocket size; flexible covers. Order a set today to look over.

LEARN ALL ABOUT

Magnetism—Induction—Experiments—Dynamos—Electric Machinery—Motors—Armatures—Armature Windings—Installing of Dynamos—Electrical Instrument Testing—Practical Management of Dynamos and Motors—Distribution Systems—Wiring—Wiring Diagrams—Sign Flashers—Storage Batteries—Principles of Alternating Currents and Alternators—Alternating Current Motors—Transformers—Converters—Rectifiers—Alternating Current Systems—Circuit Breakers—Measuring Instruments—Switchboards—Wiring—Power Stations—Installing—Telephone—Telegraph—Wireless—Bells—Lighting—Railways. Also many Modern Practical Applications of Electricity and Ready Reference Index of the ten numbers.

SHIPPED FREE

Not a cent to pay until you see the books. No obligation to buy unless you are satisfied. Send Coupon now today—and get this great help library and see if it is not worth \$100 to you—you pay \$1.00 a month for ten months or return it.

THEO. AUDEL & CO.,
72 Fifth Ave., New York City

Please submit me for free examination, HAWKINS ELECTRICAL GUIDE (Price \$1 a number). Ship at once prepaid, the 10 numbers. If satisfactory, I agree to send you \$1 within seven days and to further mail you \$1 each month until paid.

Name

Occupation

Employed by

Home Address

Reference

P. E. July

RADIO TELEPHONY and TELEGRAPHY

SIMPLY EXPLAINED

By JOSEPH G. BRANCH, B. S., M. E.

*Complete Instructions for Wireless Communication
Fully Illustrated, Handsomely Bound, Complete Index*

:-: TABLE OF CONTENTS :-:

Static Electricity
Dynamic Electricity
Mechanical and Electrical Power
Types of Cells and Connections
Magnetism
Conduction and Induction
Mechanical Generation of Currents
The Magnetic Circuit
High Frequency Currents
Inductance Coils and Oscillation Transformers
Transmitter Equipment
Receiving Equipment
Vacuum Tube Detectors and Amplifiers
Simple Radio Circuits
Undamped Wave Circuits
Types of Aerials
Long Distance Transmitting Stations
Long Distance Receiving and Relay Stations
Radio Measurements

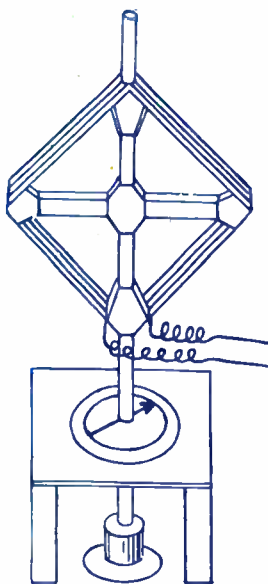

Nature of Electricity and of the Medium Ether
The Electric Current
Ether and Ether Waves.
Electromagnetic Induction
Induction Coils and Interrupters.
Transformers
Electric Oscillations
Resistance, Inductance, Capacity
Simple Transmitting Circuits
Aerials and Grounds
Tuning. Electric Resonance
Oscillation Detectors
Tuned and Untuned Receiving Circuits
Radio Telephony
Sustained Wave Generators
Vacuum Tube Oscillators
Modulation Control
Government Laws and Regulations
Index

Complete correspondence Courses in Electrical Engineering and Radio Engineering.

WRITE FOR INFORMATION

The JOSEPH G. BRANCH
Institute of Engineering
DEPT. F-164 BRANCH BUILDING, CHICAGO, ILL.

Gentlemen:-

Please send me at once your Jos. G. Branch's book as described on this page, including complete Tesla Coil Specification. I enclose herewith value of \$2.00, for which you are to send the book prepaid at once, Dept. F-164

Name
Address
City State

THE JOSEPH G. BRANCH
INSTITUTE OF ENGINEERING
DEPT. F-164
BRANCH BUILDING
CHICAGO
U. S. A.

This book will prepare you to obtain your First Grade Commercial U. S. GOVERNMENT LICENSE.

and

is used as a Text-Book in the Branch Institute of Engineering. Published both in English and Spanish.