

# RADIO & TELEVISION

FORMERLY  
**SHORT WAVE & TELEVISION**

*In This Issue —*

**LOWELL THOMAS** tells  
How to Listen to "War" News

Map of Radio War "News Centers"

A 2-tube Receiver for the S-W Fan  
— **Harry D. Hooton, W8KPX**

DeLuxe Portable Transmitter and  
Receiver — **Howard Earp, W7CHT**

Latest Television News

90 Miles on 1 Meter

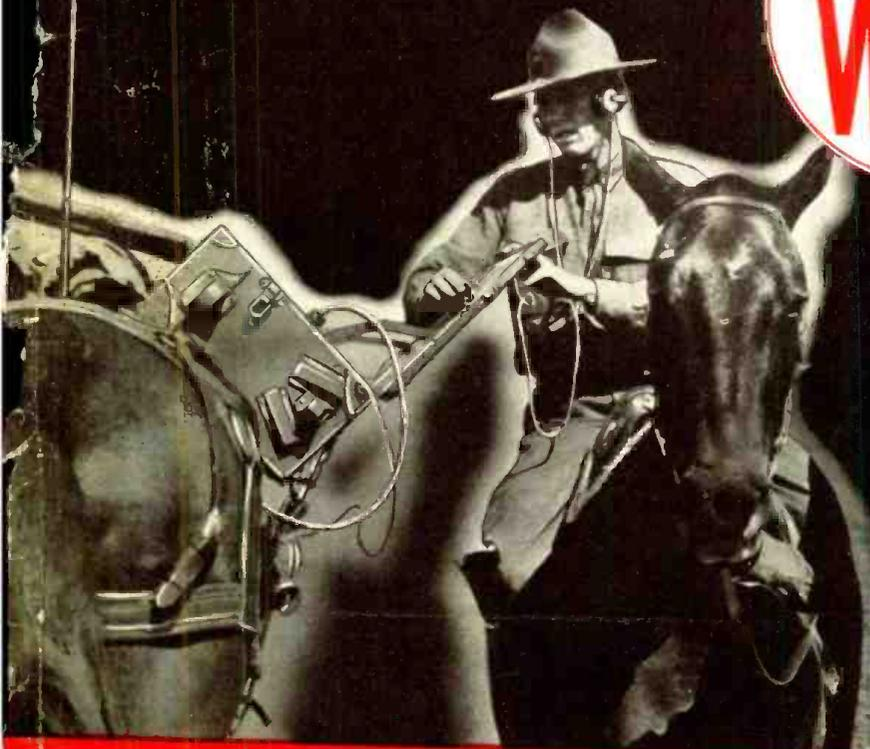

**HUGO  
GERNSBACK**  
EDITOR

**RADIO EXPERIMENTING  
AMATEUR RADIO**

**25¢**  
IN U.S. AND  
CANADA

**NOV.  
1939**

TRULY-FLEXIBLE ISOLANTITE  
COUPLINGS



1939-40



**JAMES  
MILLEN**

MANUFACTURING COMPANY, INC.

*Radio Engineers and Manufacturers*  
6 PLEASANT STREET • MALDEN, MASS.

HIGH VOLTAGE  
STEATITE SOCKETS



SAFETY TERMINALS



DIALS TO MATCH METERS

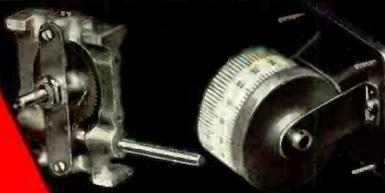

NEW DEVELOPMENTS  
IN TRANSMITTING  
CONDENSERS

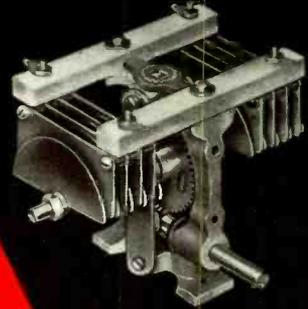

COMPACT  
NEUTRALIZERS



"CONVENIENT TO USE"  
EXCITER TANKS



QUARTZ Q

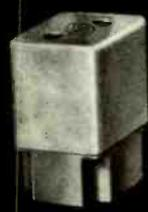
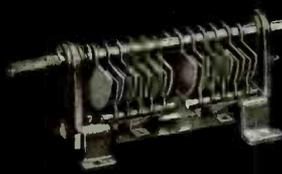

**YOUR DEALER HAS YOUR COPY!**

# Read what happened



**YES!**

I'll take your training. That's what S. J. Ebert said. He is making good money and has found success in Radio.

to these  
two men

when I said:



**NO!**

I'm not interested. That's what this fellow said. Today he would be ashamed if I told you his real name and salary.

## I will Train You at Home in Spare Time for a GOOD JOB IN RADIO

These two fellows each clipped and sent me a coupon, like the one in this ad. Both were interested in getting a good job in Radio—a field with a future. They got my book on Radio's opportunities, found out how I trained men at home to be Radio Technicians. S. J. Ebert, 104-B Quadrangle, University of Iowa, Iowa City, Iowa, saw Radio offered him a real chance. He enrolled. The other fellow, whom we will call John Doe, wrote he wasn't interested. He was just one of those fellows who wants a better job, better pay, but never does anything about it. Now, read what S. J. Ebert writes me and remember that John Doe had the same chance: "Upon graduation I accepted a job fixing Radio sets, and within three weeks was made Service Manager of a Radio store. This job paid me \$40 to \$50 a week compared with \$18 I earned in a shoe factory. Eight months later I went with Station KWCR as operator. From there I went to KTNT. Now I am Radio Engineer with WSUI. I certainly recommend N.R.I. to all interested in the greatest field of all, Radio."

### Why Many Radio Technicians Make \$30, \$40, \$50 a Week

Radio broadcasting stations employ engineers, operators, station managers and pay well for trained men. Radio manufacturers employ testers, inspectors, foremen, servicemen in good-pay jobs with opportunities for advancement. Radio jobbers and dealers employ installation and servicemen. Many Radio Technicians open their own Radio sales and repair businesses and make \$30, \$40, \$50 a week. Others hold their regular jobs and make \$5 to \$10 a week fixing Radio in spare time. Automobile, police, aviation, commercial Radio; loudspeaker systems, electronic devices, are newer fields offering



"I WANT TO HELP YOU. If you are earning less than \$30 a week I believe I can raise your pay. However, I will let you decide that. Let me show you what I have done for others; what I am prepared to do for you. Get my book, read it over, and then decide."

J. E. Smith.

good opportunities to qualified men. And my course includes Television, which promises to open many good jobs soon.

### Many Make \$5 to \$10 a Week Extra in Spare Time While Learning

The day you enroll, in addition to my regular Course, I start sending you Extra Money Job Sheets which start showing you how to do actual Radio repair jobs. Throughout your training I send plans and directions which have helped many make \$200 to \$500 a year in spare time while learning. I send special Radio equipment; show you how to conduct experiments, build circuits. This 50-50 training method makes learning at home interesting, fascinating, practical.



### I Also Give You This Professional Servicing Instrument

Here is the type of instrument Radio Technicians use — an All-Wave Set Servicing Instrument. It contains everything necessary to measure A.C. and D.C. voltages and current; to check resistances; adjust and align any set, old or new. It satisfies your needs for professional servicing after you graduate—can help you make extra money fixing sets while training.

### You Are Trained for Television Also

With N.R.I. you take up Television principles right along with Radio principles—the correct method—since Television receivers combine both sight and sound. You also get more than ten text books devoted entirely to Television.

### Sample Lesson and 64-Page Book Free

Act today. Mail coupon now for Sample Lesson and 64-page Book. They're FREE. They point out Radio's spare time and full time opportunities and those coming in Television; tell about my course in Radio and Television; show many letters from men I trained, telling what they are doing and earning. Read my money back agreement. Find out what Radio offers you. Mail coupon in envelope or paste on penny postcard—NOW!

J. E. SMITH, President  
Dept. 9MB3, National Radio Institute  
Washington, D. C.



**MAIL THIS NOW**

### FOR FREE BOOK OF FACTS ABOUT RADIO

J. E. Smith, President, National Radio Institute  
Dept. 9MB3, Washington, D. C.

Without obligating me, send your Sample Lesson and 64-page Book FREE. I will particularly appreciate the branch of Radio checked below.

- |   |  |
|---|--|
| <input type="checkbox"/> Radio Service Business of My Own     | <input type="checkbox"/> Loud Speaker Systems, Installations and Service |
| <input type="checkbox"/> Spare Time Radio Repair Work         | <input type="checkbox"/> Auto Radio Installation and Service             |
| <input type="checkbox"/> Service Technician for Retail Stores | <input type="checkbox"/> Television Station Operator                     |
| <input type="checkbox"/> Broadcasting Station Operator        | <input type="checkbox"/> Commercial Radio Station Operator               |
| <input type="checkbox"/> Aviator's Radio Technician           | <input type="checkbox"/> All-around Servicing Technician                 |

If you have not decided which branch you prefer—mail coupon now, for information to help you decide.

Name ..... Age .....

Address ..... 14X1

**SAMPLE LESSON FREE**  
I want to prove my Training gives practical, money-making information, that it is easy to understand—what you need to master Radio. My sample lesson text, "Radio Receiver Troubles—Their Cause and Repair," covers a long list of Radio receiver troubles in A.C., D.C., battery, universal, auto, T.R.F., superheterodyne, all wave, and other types of sets. And a cross-reference system gives you the probable cause and a quick way to locate and remedy these set troubles. A special section is devoted to receiver check-up, alignment, balancing, neutralizing, tuning. You can get this lesson Free by mailing the coupon.



Please say you saw it in RADIO & TELEVISION

# RADIO & TELEVISION

*The Popular Radio Magazine*

November — 1939  
Vol. X No. 7

HUGO GERNSBACK, Editor  
H. WINFIELD SECOR, Manag. Editor  
ROBERT EICHBERG, Assoc. Editor

**FREE**  
**Television**  
**Course**

See Page 421

## In This Issue

### GENERAL FEATURES

How to Listen to War News—Lowell Thomas, famous NBC commentator .....	389
Radio and Television in War—H. W. Secor .....	390
World-Wide Radio Digest .....	392
90 Miles on One Meter—Arthur E. Bent .....	394
Hear the Heart-Beat of WAR! .....	395
International Radio Review .....	396
Practical Radio Ideas .....	400

### CONSTRUCTION

Adding 3" C-R Tube to Low-Cost Television Set—Peter Scozzari .....	399
How to Electrify the "Twinplex"—Allan Stuart .....	400
The "Loktal" Preselector Becomes a 2-Tube Receiver—Harry D. Hooton, W8KPX .....	403
De Luxe Portable Transmitter and Receiver—Howard W. Earp, W7CHT .....	404
ECO-Xtal Power Supply and Modulator—Herman Yellin, W2AJL .....	414

### CONDENSED FEATURES

Ceramic Tubes .....	392
Square C-R Tubes .....	392
WMCA War News Tangle .....	393
Telepickup Comparison .....	396
Projecting Television Images .....	396
Volume Expander .....	396
Baffle Design .....	397
A.C.-D.C. S-W Converter .....	397

Three-Inch C-R Tube Television Receiver—Peter Scozzari .....	399
Free Television Course .....	421

### MISCELLANEOUS

Map of Radio "War News" Centers .....	395
Radio Construction "Shorts" .....	400
Conversion Chart for ALL Frequencies .....	402
World Short Wave Stations .....	406
Where to Listen In on War News .....	407
Second Plaque Award for Best Ham Station Photo .....	409
What Do YOU Think? .....	411
Short Wave League—"DX" on the HAM Bands—Elmer R. Fuller ..	413
Radio Kinks .....	416
Book Review .....	417
Question Box .....	418
New 18-Tube Hammarlund Receiver for Ham and SWL .....	420
Free Television Course .....	421
New Millen Radio Apparatus .....	422
Autodyne S-W Converter—G. H. Browning and C. H. Day .....	423
Newest Radio Apparatus .....	387, 424

### INSTRUCTION

The Radio Beginner—Martin Clifford, W2CDV .....	398
Question Box .....	418

### TELEVISION

Television in War .....	390
Gold C-R Tubes .....	392
Square Television Tubes .....	392
Color Television .....	393
Telepickup Comparison .....	396
Television Image Projector .....	396
Secret Television System .....	396

Cover composition by H. Gernsback and Thos. D. Pentz. Photos courtesy U.S. Army Signal Corps. See article, "Radio and Television in War," page 390.

**RADIO & TELEVISION**—Published monthly on the tenth of the month. Entered as second-class matter Feb. 15, 1938, at the post office at Springfield, Mass., under the act of March 3, 1879. Trademarks and copyrights by permission of H. Gernsback. Text and illustrations are copyright and may not be reproduced without permission. Subscription price \$2.00 a year in the United States and possessions and Canada, \$2.50 in foreign countries. Make all subscription checks payable to Popular Book Corporation.

Published by Popular Book Corporation, Publication Office—29 Worthington St., Springfield, Mass. Editorial and Executive Office—89 Hudson St., New York, N.Y. HUGO GERNSBACK, President; H. W. SECOR, Vice-President; EMIL GROSSMAN, Director of Advertising; European Agents: Atlas Publishing and Distributing Co., Ltd., 18 Bride Lane, Fleet St., London, England; Brentano's—London and Paris. Australian Agents: McGill's Agency, 179 Elizabeth St., Melbourne.

Copyright 1939 by H. Gernsback

## In the December Issue

- Forty Years of Radio—Lee de Forest, Ph.D.
- A 3" Tube Television Receiver—Ricardo Muniz, E.E.
- "Tiny Tim"—A 2-Tube Receiver for the Short-Wave Beginner.
- A 5 and 10 Meter Transmitter—Milton Meyrowitz.
- A Low-Cost Transceiver—Harry D. Hooton, W8KPX.
- Home Diathermy Apparatus—Allan Stuart.
- Hints on "Trouble-Shooting"—Harry G. Cisin, M.E.

### Certified Circuits



When you see this seal on a set it is a guarantee that it has been tested and certified in our laboratories, as well as privately in different parts of the country. Only constructional—experimental sets are certified.

You need not hesitate to spend money on parts because the set and circuit are bona fide.

This is the only magazine that renders such a service.

# NEWEST RADIO APPARATUS

## 100 Mc. and 5 Kw. Tubes

● THROUGH the research and design of Bell Telephone Labs., Western Electric has introduced the 357A tube which has a rating of 350 watts plate dissipation and full voltage rating up to 100 mc. The first application of this new tube will be in the new high efficiency W.E. one

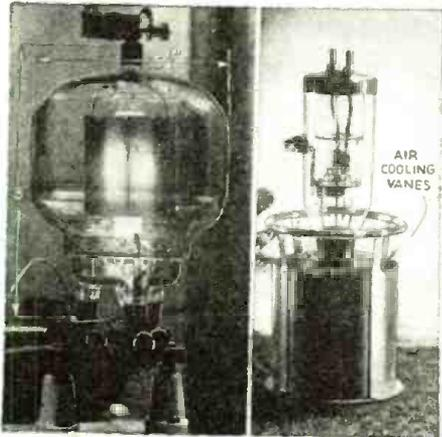

Left, the 100 mc. tube. Right, the air-cooled 5 kw. tube.

kilowatt broadcast transmitter, which is intended for use in medium power broadcasting and high quality police service. The transmitter is designed primarily for 1000 or 500 watt operation but may be reduced when less power is necessary.

In addition to broadcasting and police work, it is believed that the tube will find considerable application in aviation and marine installations. Because of its high amplification factor, it requires relatively low biases for high voltages. Despite its great output, the tube measures only 5 1/2" in diameter and 8" high overall. Its electrodes are supported independently on their own short heavy leads. Some of the outstanding characteristics of the tube follow: Filament voltage, 10; filament current, 10 amps. At plate current of 5 amp., the amplification factor is 30; transconductance 9000 micromhos. Interelectrode capacities: G-P 4.25 mmf.; G-F 9.25 mmf.; P-F 2.5 mmf. Maximum direct plate voltage 4000; maximum direct plate current 500 ma. Maximum direct grid current 100 ma.

The tube may be used as a class B audio amplifier or in a 2-tube modulator circuit, as a class B radio frequency linear amplifier, as a class C radio frequency oscillator or power amplifier, or as a class C radio frequency amplifier.

Also new in the Western Electric line is the 343AA tube. Designed for operation in the new 5 kw. transmitters, this tube is air-cooled and is said to combine all the advantages of previous water-cooled and air-cooled tubes, while having none of their drawbacks. This tube will doubtless find considerable use in medium power broadcasting stations where high efficiency is a requisite, and which would find the facilities required for using the previous water-cooled types of high power tubes inaccessible or inconvenient.

The characteristics of this tube should also make it valuable for high power marine installations and for field installations where large output is essential.

## New Radio Tube Testers

● TWO new tube testers which will check the performance of every standard radio receiving tube type now available, and which have built-in adaptability for new types likely to be introduced in the future, have been announced by the RCA Manufacturing Company. These instruments are being introduced under the new "Minimized Obsolescence" policy of the company.

The new testers are identical except for the case, one being a counter type and the other a portable model.

Provision has been made for testing Loktal-base tubes and the new miniature base tubes, in addition to pilot lamps, Christmas tree bulbs and flashlight bulbs. Each has two spare sockets to provide for new types, and additional chart space to insert data on new tubes as they are introduced. Tubes with filament voltages up to 120 volts may be tested.

The testers are operated with one finger, with the buttons released or retained automatically as required for testing. Line voltages up to the instant of the actual tests are shown, making it unnecessary to set the line voltage before inserting



the tube in the socket. Four-prong and octal-base ballast tubes may be tested for noisy welds and opens, as may the voltage drop on all types of gas tubes. They test magic eye tubes for brilliance and the opening and closing of the eye. All tests are made according to RMA standards.

## 1.7 to 60 Mc. Transmitter

● THE latest addition to the Hallcrafters line of amateur and commercial transmitters is the Model HT-6 phone and telegraph transmitter which provides 25 watts output and operates at any desired frequencies, amateur or commercial, within the range of 1.7 to 60 megacycles.

Among its features is the provision for instantaneous switch selection of any three desired bands, each of the three distinct channels being set up by means of appropriate plug-in units and all circuits except the final tank pre-tuned to the desired operating frequencies. Thereafter to shift from one band to another requires only a flip of the selector switch and retuning of the final tank by means of the single tuning control on the front panel.

It utilizes eight tubes with an 807 or RK39 in the power-amplifier stage. Front panel controls include a dual-range meter with 4-position switch, c.w. phone switch, 3-position band selector switch, tank tuning knob, master off-on switch, modulator off-on switch, and stand-by switch with provision for simultaneous control of antenna relay and receiver stand-by circuit.

(Continued on page 424)

New 1.7 to 60 Mc. Transmitter



Please say you saw it in RADIO & TELEVISION

ACTUAL WORK ON  
ACTUAL ELECTRICAL  
MACHINERY

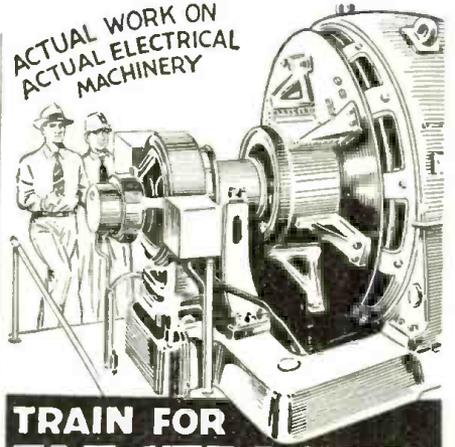

## TRAIN FOR ELECTRICITY 12 WEEKS SHOP TRAINING

### PAY TUITION AFTER GRADUATION

Are you out of a job? Are you working long hours at low pay in a job you don't like? Are you wondering where you can find a job that will give you steady, interesting work with better pay? If this applies to you and if you are between 16 and 40, then read every word of this message.

Get into a field where the opportunities are great and better salaries are paid. The huge billion dollar Electrical Industry is full of opportunities for men and young men. Build the foundation for yourself by training for 12 weeks in these fascinating, bigger-pay branches of Electricity—Power Plant work, sub-station operation, electrical maintenance, refrigeration and air conditioning, Diesel Electricity, construction work and many other branches.

#### GET A PRACTICAL TRAINING IN FAMOUS CHICAGO SHOPS

You must be trained to get ahead. The famous Coyne Shops in Chicago can train you for a start in Electricity in only 12 weeks—not by home study but right here in Chicago where you "Learn-by-Doing" on real equipment.

You don't need previous experience—you don't need advanced education. At Coyne you are trained on real motors, dynamos, generators. You wind armatures, do house-wiring, operate switchboards, work on electric refrigeration and air conditioning equipment, farm lighting plants, automobile ignition and many other branches of Electricity.

**MANY EARN WHILE LEARNING**  
**Employment Help After Graduation**  
A lot of my students work part-time to help with their living expenses. If you need this assistance my employment department will give it to you and after graduation you will get valuable employment and consultation service.

**If You Are Short of Money My "Pay After Graduation" Plan Will Help You**  
I have a plan to help ambitious fellows who are short of money for their tuition. On this plan you can get your training with only a small down payment. Then, you pay the rest of your tuition in small, monthly payments starting 60 days after graduation and extending over a period of one year. Mail the coupon for the facts.

**MAIL COUPON TODAY**  
You can't make the start to a better future unless you do something about it. Act now to make your dreams come true. The first step is simple. SEND THE COUPON FOR MY BIG FREE CATALOG AND ALL THE FACTS—TODAY!

H. C. LEWIS, President  
**COYNE ELECTRICAL SCHOOL**  
500 S. Paulina St., Dept. 89-82, Chicago

H. C. LEWIS, President  
COYNE Electrical School  
500 S. Paulina St., Dept. 89-82, Chicago, Illinois

Dear Sir: Please send me your big free catalog and all the facts about your "Pay After Graduation" plan as well as other details of your plans to help a fellow get ahead.

NAME .....

ADDRESS .....

CITY.....STATE.....



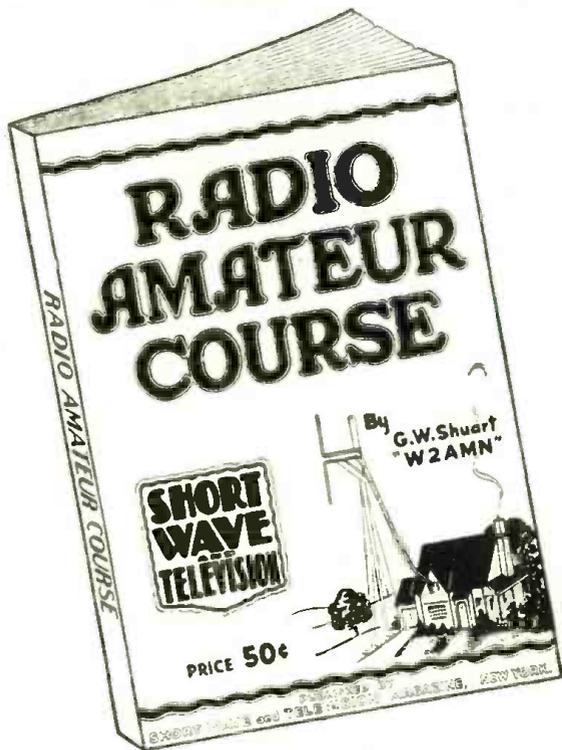

*Your Money Back —*

**IF THE RADIO AMATEUR COURSE DOES NOT REPRESENT THE GREATEST BOOK VALUE EVER OFFERED TO THE RADIO "FANS" FOR 50c**

**T**o convince you that there isn't a better book buy today, the publishers of the RADIO AMATEUR COURSE make the sensational offer of a money-back guarantee on such a low-priced book. Stop in at any of the many dealers listed at the right and examine this volume. See for yourself if the RADIO AMATEUR COURSE isn't just the book you've always wanted.

Printed on the finest coated paper—well illustrated attractive 4-color cover—complete with radio information you must have. It contains a step-by-step program for obtaining a short-wave radio education.

Written by George W. Shuart, W2AMN,  
foremost short-wave authority

**148 PAGES**  
6¼ x 9½ INCHES

**OVER 150 RADIO DIAGRAMS  
and TECHNICAL PHOTOGRAPHS**

**RADIO AND TELEVISION**  
99 Hudson Street, New York, N. Y.

**NEW 1939 EDITION!**

*All Prominent* **RADIO DEALERS**  
**Ready to Show You This Big Book!**

- ARIZONA**  
Sam's Cigar Store,  
127 N. First Ave., Phoenix.
- CALIFORNIA**  
Scott Wholesale Radio Co.,  
344 E. Fourth Street, Long Beach.  
Offenbach Electric Co., Ltd.,  
1452 Market Street, San Francisco.  
Zack Radio Supply Co.,  
1426 Market Street, San Francisco.
- COLORADO**  
Auto Equipment Co.,  
14th at Lawrence, Denver.
- CONNECTICUT**  
Radio Inspection Service Co.,  
207 Asylum Street, Hartford.  
Stern Wholesale Parts, Inc.,  
210 Chapel St., Hartford.
- GEORGIA**  
Radio Wire Television, Inc.,  
465 Peachtree St., N. W., Atlanta.
- ILLINOIS**  
Allied Radio Corporation,  
853 West Jackson Blvd., Chicago.  
Newark Electric Company,  
226 W. Madison Street, Chicago.  
Radio Wire Television, Inc.,  
801 W. Jackson Blvd., Chicago.
- INDIANA**  
Van Sickle Radio, Inc.,  
54 West Ohio Street, Indianapolis.
- MASSACHUSETTS**  
Greater Boston Distributors,  
40 Waltham St., Boston.  
H. Jappe Co., 36 Cornhill, Boston.  
Radio Wire Television, Inc.,  
110 Federal Street, Boston.  
Springfield Radio Co.,  
397 Dwight Street, Springfield.  
H. Jappe Co.,  
37 Mechanic Street, Worcester.
- MICHIGAN**  
Rissl Brothers, Inc.,  
302 Hamilton Ave., Detroit.  
Rissl Brothers, Inc.,  
413 S. Division St., Detroit.
- MISSOURI**  
Modern Radio Company,  
409 No. Third Street, Hannibal.  
Burstin-Applebee Co.,  
1012-14 McGee Street, Kansas City.  
Van Sickle Radio Co.,  
1113 Pine Street, St. Louis.
- NEBRASKA**  
Radio Accessories Company,  
2566 Farnam Street, Omaha.
- NEW JERSEY**  
Arco Radio Co.,  
227 Central Avenue, Newark.  
Radio Wire Television, Inc.,  
24 Central Avenue, Newark.
- NEW YORK**  
Radio Wire Television, Inc.,  
542 E. Fordham Rd., Bronx.  
Radio Wire Television, Inc.,  
90-08 166th Street, Jamaica, L. I.  
Llan, The Radio Man, Inc.,  
64 Dey Street, New York City.  
Eagle Radio Co.,  
84 Cortlandt Street, New York City.  
Federated Purchaser, Inc.,  
25 Park Place, New York City.  
Harrison Radio Co.,  
12 West Broadway, New York City.  
Sun Radio Co.,  
212 Fulton Street, New York City.  
Terminal Radio Corp.,  
80 Cortlandt Street, New York City.  
Thor Radio Corp.,  
60 Dey St., New York City.  
Try-No Radio Co., Inc.,  
85 Cortlandt Street, New York City.  
Radio Wire Television, Inc.,  
109 Sixth Avenue, New York City.  
Radio Parts & Equipment Co.,  
244 Clinton Avenue No., Rochester.
- M. Schwartz & Son,  
710-712 Broadway, Schenectady.
- NEW HAMPSHIRE**  
Radio Service Laboratory,  
1187 Elm Street, Manchester.
- OHIO**  
News Exchange,  
51 So. Main Street, Akron.  
Canton Radio & Supply Co.,  
1140 Tuscarawas Street, W., Canton.  
United Radio, Inc.,  
1103 Vine Street, Cincinnati.  
The Hughes-Peters Electric Corp.,  
178-180 N. Third Street, Columbus.  
Standard Radio Parts Co.,  
135 East Second Street, Dayton.
- OREGON**  
Portland Radio Supply Co.,  
1300 W. Burnside Street, Portland.
- PENNSYLVANIA**  
Radio Distributing Co.,  
1124-26 Market Street, Harrisburg.  
M. & H. Sporting Goods Co.,  
512 Market Street, Philadelphia.  
Cameradio Co.,  
963 Liberty Ave., Pittsburgh.
- RHODE ISLAND**  
W. H. Edwards Co.,  
32 Broadway, Providence, R. I.
- TEXAS**  
Amarillo Electric Co.,  
111 East 8th Avenue, Amarillo.
- UTAH**  
O'Loughlin's Wholesale Radio Supply,  
315 South Main Street, Salt Lake City.  
Radio Supply, Inc.,  
46 Exchange Place, Salt Lake City.
- WASHINGTON**  
Spokane Radio Co., Inc.,  
611 First Avenue, Spokane.
- WISCONSIN**  
Radio Parts Co., Inc.,  
536-538 W. State Street, Milwaukee.
- AUSTRALIA**  
McGill's Agency,  
183-184 Elizabeth Street, Melbourne.
- CANADA**  
The T. Eaton Co., Ltd.,  
Winnipeg, Manitoba.  
Canadian Electrical Supply Co., Limited,  
285 Craig Street W., Montreal, Que.  
Metropolitan News Agency,  
1248 Peel Street, Montreal, Que.
- CUBA**  
The Diamond News Co.,  
Palacio Asturiano, Por San Jose,  
Habana.
- ENGLAND**  
Gorrings's American News Agency,  
9a, Green Street, Leicester Square,  
London, W.C.2.
- HOLLAND**  
Radio Peeters, Van Worstraat, Amsterdam, Z.
- INDIA**  
Empire Book Mart,  
Box 631, Bombay.
- MEXICO**  
American Book Store, S. A.,  
Avenida Madero 25, Mexico City.  
Central De Publicaciones,  
Avenida Juarez, 4, Apartado 2430,  
Mexico, D. F.
- NEW ZEALAND**  
To Aru Book Depot, Ltd.,  
64 Courtenay Place, Wellington.
- SOUTH AFRICA**  
South African Radio Publications,  
40 Trust Bldgs., Cor. Fox and Loveday Sts.,  
Johannesburg.  
Technical Book Co.,  
5, Strand Street, Cape Town.

If this book is not at your dealer's, send your order directly to us. We will credit your dealer with the sale of this book. To order your copy of RADIO AMATEUR COURSE, fill in coupon below and mail.

RADIO AND TELEVISION, 99 Hudson St., New York, N. Y.  
Gentlemen: I enclose herewith my remittance of Fifty Cents (50c) for which please send me POSTPAID, my copy of the RADIO AMATEUR COURSE. (Remit by check or money order; register letter if you send cash or unused U. S. Postage Stamps.)

Name .....

Address .....

City ..... State ..... R&T-11-39

## How to Listen to War News

Lowell Thomas

Famous NBC Commentator

THE other evening on the air I ventured to propound what I considered a few useful rules for listening to war news—and reading it, for that matter. I want to expand them. It's the same way with all wars—what to believe and what *not* to believe. Everyone who has got along as far as middle life will remember the deluge of World War propaganda that was poured upon us Americans—cunningly designed falsehoods, bits of fact exaggerated and warped out of all semblance to truth. Both the Allies and the Kaiser's Germans made lavish use of the weapon of fraudulent information to affect American public opinion—the one side trying to get us into the war, the other side trying to keep us out. All wars have been affairs of propaganda, increasingly so in modern times. The present struggle in Europe, more than any clash in the past, is a *contest of misinformation*. The World War had no radio to spread propaganda by the immense medium of broadcasting. The radio alone makes today's European war a climax of misrepresentation.

A couple of years ago in Rome I talked to the Italian Foreign Minister, Count Ciano, and he told me that the war to come would be largely a *radio war*. Nations would use the weapon of propaganda to strengthen their own people, weaken the morale of the enemy and affect neutrals. It would be a battle of opposing forces, until those exposed to both of the opposing propaganda assaults wouldn't know what to do. Mussolini's son-in-law shrugged his shoulders, Italian style, and gave the opinion that the war of radio would in the end produce complete confusion of fact and falsehood—an anarchy of misinformation.

What is a radio listener to do, the American radio listener who is the great neutral and a supreme target of propaganda? What, for that matter, is an American radio commentator to do? The questions are a good deal alike. A commentator is in the same position as the listener—only very much more so. His job puts him right in the maelstrom of propaganda as it streams off the wires. His first task is to try to sift the truth from the falsehood and decide *what to believe* and what *not* to believe. The listeners of the radio audience are next in sequence, with the same problem of truth and falsehood. Much of the time a commentator can't tell what's true and what's false. It's his honest function to present the elements to the listeners with the implication: *Judge for yourself if you can!*

American radio, under the guidance of the Federal Communications Commission, has resolved not to be used as an instrument of foreign war propaganda. We of the National Broadcasting Company are instructed to use the coolest and most impartial



Lowell Thomas of NBC, known to millions of radio listeners, is generally conceded to be the leading interpreter and reporter of the day's news. Here he tells you how to analyze the radio reports—direct or indirect—which you hear from the powers engaged in the present World War. He explains how to separate the truth from the propaganda.

caution in trying to weed out the falsehood and get at the *truth* of the war news. I, for one, have always tried for an unbiased attitude toward the news, with not a little wary skepticism.

The very first day of the present war brought the inevitable shower of contradiction and perversion of fact—so reminiscent of the conflicting claims, affirmations and denials, and opposing proclamations of victory during the World War. Every succeeding day has increased the confusion. Past radio experience in past wars had already indicated some general ideas for disentangling fact from fraud, and these are expanded and elaborated by the conflict of the war dispatches now pouring in from Europe. In this case, what's sauce for the radio commentator is sauce for the radio audience, and I would like for the listeners to do what I myself do. So here are some rules for listening to war news—and reading it:—

Be dubious and skeptical of tidings favorable to the nation from which they come. Everything is censorship and propaganda. If a nation in the war reports anything that sounds good for its own cause, it may be the honest truth—but it's more likely to be exaggerated, colored or simply invented. I recall that during the Spanish Civil War the Franco people announced the capture of Teruel several times—and days

before the Nationalist army actually took the city. Those false war bulletins were strictly propaganda to bolster up the courage of the people on the Franco side of the line—and vice-versa. During the Ethiopian war there were Addis Ababa dispatches affirming that Haile Selassie's tribesmen were driving into the Italian provinces at Eritrea, conquering the home grounds of Mussolini's invaders. This was designed to encourage pro-Ethiopian public opinion in Europe.

About victories on battlefields of land, sea or sky, it is safe to believe them when both sides agree—the *winners* and the *losers*. When Barcelona was captured both Franco and the Republicans said so. There was the same kind of unanimity when Nanking fell to the Japanese in the China war. When the winner claims a glorious success and the loser admits a minor set-back, then the truth is somewhere between the two. When the attacking army announces a decisive advance, and the defenders declare they executed a successful strategic retirement, the chances are that the retirement was probably strategic, but because of necessity.

When both sides issue diametrically opposite war bulletins, you can sometimes guess the truth from geographical locations. If they both claim victory at a certain point within an invaded country, you know the invaders have got that far. If you find an army reporting a

(Continued on page 419)

Thirty-third of a series of  
"Guest" Editorials

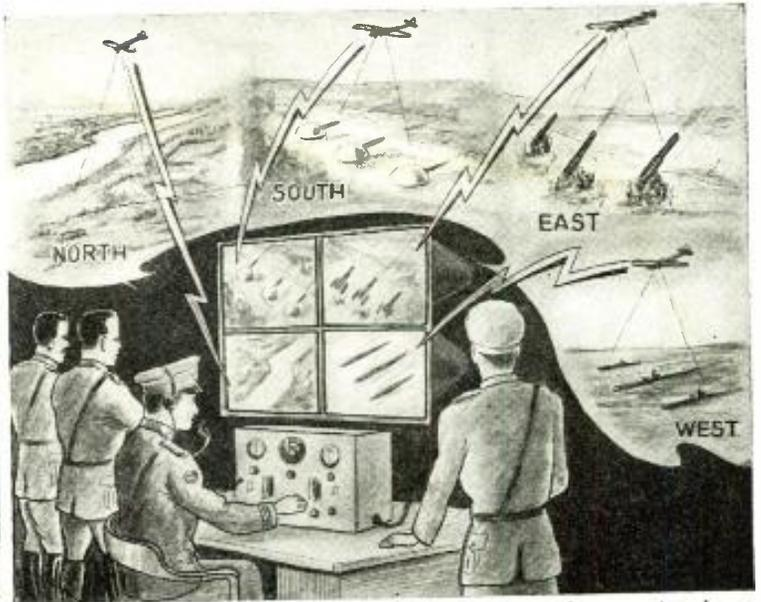

Left—Radio waves direct modern war planes and tanks\*. Right—H. Gernsback's invention—airplanes pick up scenes of enemy terrain on television cameras and flash them back to headquarters for study by the strategy experts. (\*U. S. Army photos.)

# Radio and Television

## Cover Feature

Short waves and television are playing a most important role in present war activities. Short waves carry propaganda speeches across the borders from one country to another—5-meter "pack" sets keep groups of soldiers in touch with their fellows—airplanes find their bearings by radio, while facsimile and television bid fair to do their part.

● MILITARY and naval operations owe a big part of their success to radio communication. A merchant vessel may be attacked by an enemy submarine, but before the ship is sunk, a radio message can have been dispatched from the steamer, and there is a good chance that naval destroyers will dash over the horizon to rescue the ship's passengers and drop depth bombs on the submarine. A group of soldiers in the thick of battle may be cut off from the main body of troops, but thanks to the 5-meter "pack" sets now in use, such a situation may be instantly radioed back to headquarters and help dispatched at once.

One of the most important uses for short-wave communication is that of transmitting information from observation planes flying over enemy territory to artillery commanders. A plane can flash back the news as to where the shells are falling in respect to the target, so that necessary corrections can be quickly made by the gun pointers.

One of the most ingenious applications of short-waves and ultra short-waves lies in the control of "crew-less" tanks, planes or ships loaded with high explosives. Radio engineers have experimented ex-

tensively, especially in military and naval laboratories, with various forms of radio control, and today it is easy to construct a simple control mechanism so that by sending a series of properly timed radio signals, a tank or ship can be made to move forward, turn to right or left, etc. Mass bombing attacks tomorrow will undoubtedly be carried out by means of large crew-less planes directed by radio waves.

While the older types of sound wave airplane detectors, fitted with huge horns, are still in use in the various armies, there is a newer type of ultra short wave airplane locator which gives great promise. This new type of locator has an advantage over the acoustic or sound wave type, in that it is much more accurate, as sound waves may be deflected or refracted due to moving air currents of differing density. Connect one of these super-sensitive airplane locators to anti-aircraft guns, and you have a *self-aiming* gun from which it would be almost impossible for the plane to escape.

The British navy is reported to be using a new super-sensitive sound detector for locating submarines. Here is a thought for our radio experimenters;

why not develop a new *ultra short wave* system for locating submarines?

Aside from the everyday use of radio communication to tie together various sections of the army in a military operation, we have numerous other uses for radio waves. They may be used, for example, to explode mines previously placed in the enemy territory, and they can also be used to explode mines anchored under water in harbors, etc.

One of the leading American business machine companies has perfected the *short wave typewriter*; in one test messages were typed successfully by short waves over a distance of several thousand miles.

Short wave *facsimile* apparatus has been used for some time by the Signal Corps for transmitting weather and other maps, and in war time the rapid extension of the facsimile system can well be expected. The army experts also find many uses for the *teletype*, but these are usually operated on wire circuits, or a circuit comprising one wire and a ground return; in emergency radio waves might be used.

When a large number of tanks attack the enemy, as recently happened in Poland, radio communication with the leading tanks is important and is readily carried out.

In airplane attacks, the commanding plane can check with a ground station and also communicate with other planes in the attacking group. Submarines can pick up signals from their home stations over distances of several thousand miles, even though they have to rise to the surface (possibly at night) to do so.

"Death rays" are forever capturing the imagination of the public, and it should be

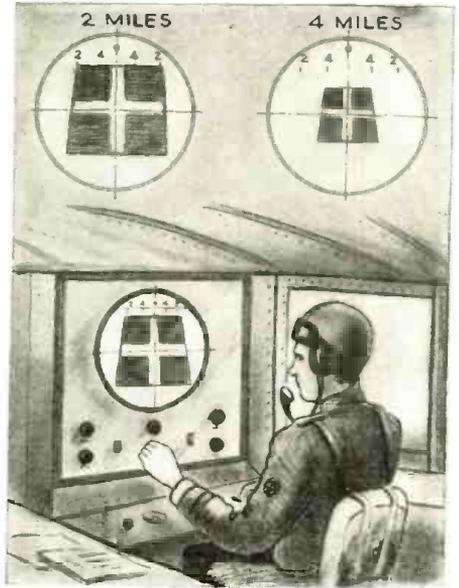

Above—Radio goniometer for locating enemy stations\*; short-wave cavalry\* set; right—new television range-finder, invented by Dr. Alfred N. Goldsmith, in which size of image indicates distance from transmitter.

# in WAR

H. W. Secor

said that to the best of our present knowledge, there are no successful death rays which can be aimed at enemy planes or tanks and cause them to be put out of commission.

One of the theories on these so-called death rays is that we generate a beam of sufficiently powerful ultra short waves that might cause the ignition systems of gasoline engines to burn out—but, so far, the amount of energy which can be projected in this fashion is far too small to cause any such disturbance.

Don't forget also, embryo "death ray" inventors, that Diesel oil engines are being used more and more and that these engines do not use delicate electrical coils to ignite the gas mixture.

## Television

Television promises a number of military uses—one of the newest inventions, that of Dr. Alfred N. Goldsmith, describes a new television range-finder. In his invention the size of the image depends on the distance of the receiver from the transmitter; thus it becomes an easy matter to calibrate the screen of the receiver so that an airplane can tell how many miles it is from a landing field. Many other applications of this invention will, of course, suggest themselves, such as its use in range finders for artillery, etc.

As Dr. Goldsmith says in his patent, this new television range indicating system is particularly applicable to guiding aircraft and ships into airports or harbors where, due to bad weather conditions or to darkness, a direct and accurate view of the ultimate point of destination cannot be obtained.

Those familiar with the ordinary television receiver know that the size of the image has nothing to do with the distance of the receiver from the transmitter, and they may wonder how the inventor of this newest range-finder brings about such a result.

In the first place, it is assumed that the television image transmitter is carefully supervised so far as the strength of the radiated signal is concerned. The next important point is that at the receiver, a special circuit is employed whereby the strength of the image signal applied to the cathode-ray tube is varied in exact accordance with the strength of the received signal. Furthermore, the size of the spot on the screen of the cathode-ray tube is varied likewise, according to the strength of the incoming signal.

From the foregoing, it will be quite clear that at a distance of say a mile from the transmitter, the image will be a certain size on the screen of the tube; at a distance of half a mile, the image will be proportionately larger, and by placing suitable calibration scales on the end of the picture tube, the operator can quickly determine the approximate distance of

(Continued on page 438)

Second photo above—Multi-wave radio transmitter and diversity receivers (day and night channels) of the type used on big bombing planes. Lower photo—5 meter "pack" set suitable for use in front lines (transmits and receives speech). Other portable sets are available for code (telegraph) transmission. (U. S. Army Photos.)





**SHORT WAVE STATIONS** throughout U. S. changed their call letters in most instances a few months ago. Above, Veronica Layden, a decorative damsel, is shown changing W2XAD to WGEA on a microphone of General Electric's international short wave station in Schenectady. The station has been on the air since 1926 and its old call letters, the "2" meaning second radio district and the "X" standing for experimental, are among the most famous in the radio world. The station operates on 9.550, 15.330 and 21.500 mc. The other long range Schenectady short wave station has been changed from W2XAF to WGEO.

**CONNECTING A RADIO** antenna to a tomato plant is said to increase the yield about 450%, according to *Associated Press*. Archibald Dickson of Sacramento, Calif., the experimenter, also uses a mysterious "accumulator."

**CERAMIC ENVELOPES** are now used on some German tubes, instead of the glass or metal envelopes as formerly employed. Shielding is accomplished by spraying metal onto the inside of the envelope.

**CRIME DETECTION** can make use of television, as was proven in a recent test when an enlargement of a finger print was transmitted from the Don Lee studio to a police department and identified in a few seconds. In the picture herewith, shown left to right, are Thomas S. Lee, station executive, and Lieut. Otto Faulkner and Supt. L. E. Christiansen of the Long Beach (Calif.) police. Other eminent police executives, such as Supt. Gerald S. Morris of New York, have also shown much interest in the use of television



to combat crime. An article on this subject, by Supt. Morris, appeared as a Guest Editorial in the June issue of *RADIO & TELEVISION*.

Televising police line-ups to local precinct houses would make it far easier for victims of a crime to inspect suspects. Supt. Morris pointed out.

**LATIN-AMERICA** is now getting 3½ more hours daily of American programs since W3XAL has increased its schedule. The new 21.630 mc. frequency with directional beam antenna is now carrying on a series of programs previously beamed exclusively on Europe. These consist of one hour each of English, Italian and German, and a half hour of French.

**A NEW PATENT**, awarded to two Englishmen and assigned to RCA, is said to improve the brightness of cathode-ray receiving tubes by utilizing a thin layer of gold on which to deposit the fluorescent material, willenite, on the screen. The gold is said to increase the intensity of the c-r beam. Increased brilliance makes it possible to use the apparatus in well-lighted rooms, and apparently improves the visible detail.

**HIGH ASH HILLS** surrounding the radio towers at North Beach Airport, New York, will have to be removed in order to make transmitting and receiving conditions effective, according to the United States Army District Engineer. Some of the five sets of towers, each of which occupies two acres, are surrounded by ash peaks up to 80 feet high—and the towers are but 40 feet, according to the engineer's check.

# WORLD WIDE

**DETAILED CHECKS** of television transmission and reception are made by means of the chart shown herewith. The card, being held by Miss Mary Murray, is placed in front of the iconoscope which scans it. If full detail is shown without distortion and with accurate rendition of the half tones, transmitter and receiver are functioning adequately.

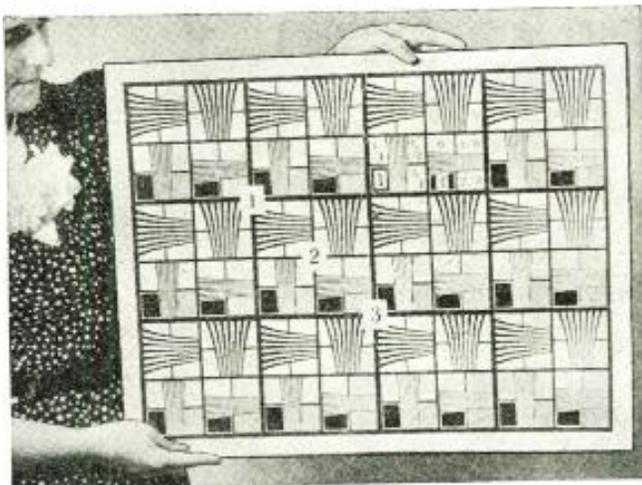

Unlike the familiar NBC chart, previously illustrated in *RADIO & TELEVISION*, this one is favored by General Electric engineers. It is, however, a standard chart used by television engineers generally to check the quality of resolution, definition and lineation in images. When lines making up the small ends of the wedges are seen, 441-line detail is had.

**SQUARE TUBES** have been devised by German engineers for use in their standard television receivers sold in that nation. The tube pictured herewith requires 6,000 volts on the anode and produces a picture approximately 5" x 7". The entire

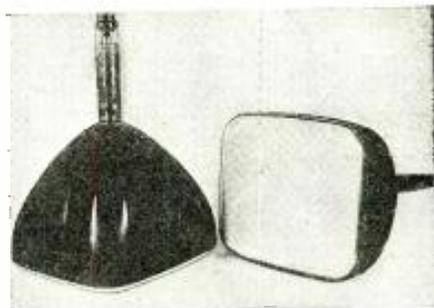

set measures only 25 x 14 x 10" and employs but 15 tubes. Its price has recently been reduced to around \$250.00. It has been made only in limited quantities thus far.

**STATION WCAU** of Philadelphia wants to add a new decoration to the hat of the statue of William Penn which tops the city's City Hall. Planning to install a television transmitter, station officials said they wish to place the antenna in the crown of Mr. Penn's hat.

**EMPLOYEES** of the British Broadcasting Corporation have received written requests asking them to install suppressors on the ignition systems of their cars. Television set owners are annoyed by ignition interference which causes "snowstorms" on television screens, and figure the staff is a good place to start interference elimination.

**HEARING AIDS** for bone conduction or air conduction are nothing new, but the engineers of the Western Electric Co. have recently invented an extremely efficient and compact unit. In this apparatus, the transmitter element is about 2 inches in diameter and under 1/2 inch thick. It feeds into an amplifier which consists of a closely-coupled receiver and microphone unit. This in turn feeds the bone conduction reproducer. Speech amplification is from 15 to 20 db. for the air conduction unit which does not use an amplifier, and from 40 to 45 db. for the bone conduction job with amplifier. The frequency range is from 200 to 2500 cycles, which is ample for speech.

# RADIO DIGEST

**SCHOLARSHIP AWARD** of \$1,000 to provide two years' study in advanced radio engineering and television was won by 16-year-old Robert Barkey, right, in a competition sponsored by the Veteran Wireless Operators' Association. Young Barkey is



the first winner of this Marconi Memorial Scholarship. Presentation was made to him by J. R. Poppele, center, representing the VWOA, and Robert T. Pollock, President of the American Institute, which sponsored Barkey's entry. The award was made in the auditorium of the Westinghouse Exhibit at the New York World's Fair, where the Institute has displays showing outstanding scientific and engineering accomplishments of ingenious high school boys and girls.

**GERMAN LAWS** forbid reception of other than German stations in the Reich, with penalties running up to capital punishment. A drive to keep the foreign waves out is being made by *jamming* foreign broadcasts with jazz music.

To further this end, powerful stations in Germany are reported "jamming" the news broadcasts in German which are radiated by England, France, the United States and other democracies. The jamming consists of broadcasting loud music on the same wavelength as that being employed by the station which the Reich's propaganda ministry wishes to block out.

Timely at press time, this may be obsolete on publication, should peace come.

**AN ENTHUSIASTIC** wire from the Baird Television Corporation in England announces that a color photograph of King George was received in full color and with perfect definition on a large screen, using a new Baird system. This is said to be the first time television in colors has been received on a cathode ray tube, although mechanical scanners have often been used.

**HISTORY MADE** today is being preserved for the students of tomorrow by means of large phonograph discs, as shown herewith. In this picture, Eugene Darlington, manager of General Electric's international short wave stations WGEA and WGEO, is seen holding one of the new records. All steps in the outbreak of the current World War, including the speeches of the heads of many of the nations involved, have been thus recorded. General Electric's short wave stations recorded them.



**SCOOP!**

SAID GEORGE ROSS IN THE NEW YORK WORLD-TELEGRAM THURSDAY, AUGUST 31st

AND BEN GROSS IN THE N.Y. DAILY NEWS

— and we respectfully refer you to the FRONT PAGES of the following New York newspapers that generously credited WMCA for important international news scoops:

Daily Mirror	August 28 and 30	Herald-Tribune	August 28
Journal-American	August 28	Daily News	August 29
New York Post	August 28		

**WMCA**  
TOP OF THE DIAL  
IN NEW YORK

**BETWEEN THE DEVIL** and the deep blue sea was where station WMCA found itself shortly after running an advertisement in *Radio Daily*, which is reproduced above. In this ad, the station quoted radio columnist Ben Gross, who said "... WMCA added to its record of sensational crisis scoops by airing an intercepted British Admiralty code message ordering the closing of the Mediterranean." Broadway columnist George Ross was also quoted as saying that WMCA flashed the British Admiralty orders and the secret German naval orders before these became public knowledge. Ross explained that to do this, the station hired an expert on naval code who stationed himself near a short wave receiver to decode and report secret messages for rebroadcast.

Called to task by the F.C.C. for allegedly broadcasting secret material, WMCA executives explained that the ad was the work of an over-enthusiastic promotion man; that the station had never transmitted secret material; that all its news transmissions were obtained from the *Herald-Tribune*, *Daily Mirror*, and the *International News Service*.

# Short Waves Above the CLOUDS

Arthur E. Bent

Mt. Washington Observatory, N. H.

One-meter waves leaped 90 miles, a record distance, from the top of Mt. Washington to Exeter, N. H. Both super-regenerative receivers and super-het converters were used. Some peculiar effects with this high-frequency transmission were observed.

● HIGH up in the clouds, 6288 feet above sea level, is the Mount Washington Observatory on the summit of Mount Washington, highest peak of the White Mountains of New Hampshire. Here in their small building anchored to the bare rocky summit far beyond the shelter of the forest four men live through the year making scientific observations of different kinds. Here the greatest wind velocity ever officially recorded by instruments, 231 miles per hour, was observed and the record minimum temperature is 40.5 below zero! Last winter during the 182 days from October through March, the wind exceeded hurricane force, or 75 miles per hour, on 111 days. The Observatory is primarily interested in the weather, and reports are sent to the United States Weather Bureau seven times each day. Observations and studies relating to other scientific matters are also carried on, such as solar radiation, geology, botany, and radio.

As a result of its commanding position so high above the surrounding country, Mount Washington has always been a favorable place to experiment with the ultra-high frequencies and the Observatory has pioneered in the study and use of very short radio waves over long distances. A number of records for long distances have been made during the march to high frequencies of the past few years. In 1932, a record of



The Mount Washington Observatory, 6,288 feet above sea, atop New England's highest peak. Note the ultra short-wave antenna cross-arms covered with ice.

125 miles was established on five meters, and three years later a record of 142 miles



Wind-blown observer removing frost from wires on Mount Washington.

was set up on two and a half meters. Last winter a transmission of 92 miles was made on 225 megacycles, or about a meter and a third.

Interest in high frequencies at the Observatory arose from the need for communication facilities. Early attempts to use long waves were not satisfactory because of the difficulty of maintaining antenna structures outside. Wires become coated with frost and ice, which increases the wind resistance, causing the wires to break under the strain of high velocities. Ultra-high frequency antennas could be placed inside, thus eliminating a serious problem. Antennas can, of course, be designed for these unusual strains as shown by the ninety-foot turnstile antenna of the Yankee Network, which organization maintains an experimental 41 megacycle (7.3 meter) station at the Observatory. There are no power lines at the Observatory and electricity for the experiments is generated by gasoline driven equipment. Ten thousand gallons of gasoline are stored in tanks under the rocks to operate the ten kilowatt generator. In fact all supplies for the long winter months must be taken up the mountain by truck in the fall, and planning for the needs of the Observatory is like providing for an ex-

(Continued on page 444)



Mount Washington observatory with turnstile antenna of Yankee network station in midwinter.

Picture at right shows how one-meter signals were successfully sent a distance of 90 miles between the transmitter atop Mount Washington and Exeter, N. H.

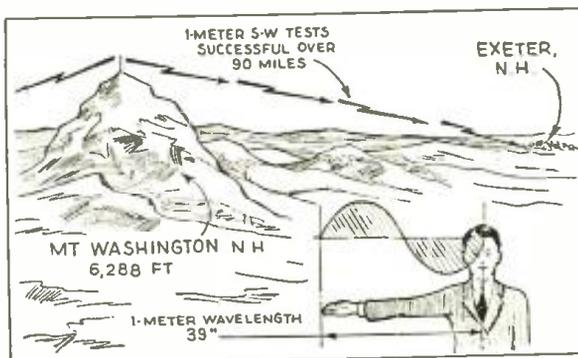



FIG. 3

If it is desired to dispense with the comparatively costly power transformer and A.F. choke, the unit may be powered from any radio receiver with which it is to be used. It can also be employed in a public address system with a phonograph, or for any other similar applications which one desires.

The plate voltage used is approximately 450, and in the drawing shown, the power transformer affords 270 volts on each side of the center tap, to allow for voltage drop in the choke.

The unit's designer, Paul Heusser, states that it reproduces music with singular brilliance and naturalness, giving due emphasis to the fortissimo passages.

### Baffle Design

**5** SOME new ideas for increasing the length of baffles without getting a percussion effect, are given in *Radio Revista* of the Argentine. Fig. 5A illustrates one simple system in which the baffle path is increased by adding a false baffle, as shown by the heavy line. This increases the path which the sound waves must take in order to reach the opening, which should measure 4" x 20".

In Fig. 5B, another means of increasing the length of the path is shown. In this system, plates of non-resonant material are installed to give the effect of large baffle area, even when only a moderate size cabinet is available.

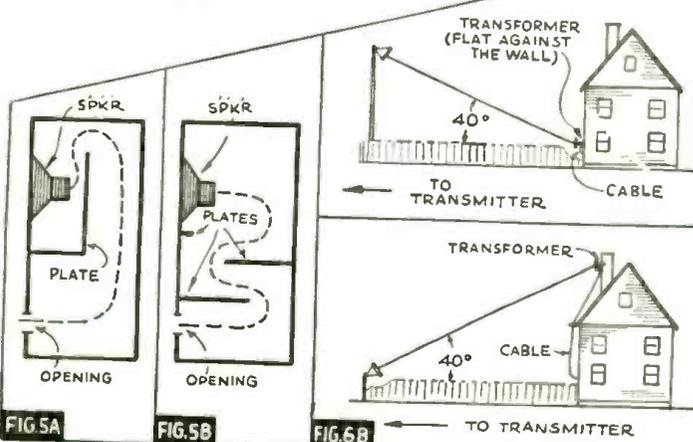

FIG. 5A

FIG. 5B

FIG. 5C

### New Television Aerial

**6** A TILTED wire system for television reception has been described in *Wireless World* of Great Britain. In this system, the antenna may be erected as shown at either Figs. 6A or 6B. The former is for use when a mast is available; the latter, when only a low point is convenient.

Recently patented by E. C. Cork, J. L. Pawsey, and M. B. Manifold, of E.M.I., it is said to have a gain of about 3 db. over the single dipole usually used.

The aerial terminates in a resistance of approximately 250 ohms to secure good matching, and the device at its end, which resembles a spreader, has a pair of coil windings with a total length of three feet acting as a compressed dipole. The second compressed dipole is arranged at the point marked "transformer" in the diagram, as is an impedance matching transformer.

### A.C.-D.C. Short Wave Converter

**7** A SELF-CONTAINED short-wave converter, powered by A.C. or D.C. lines, has been described in *Practical and Amateur Wireless* of England. Fig. 7 gives the complete schematic diagram with all values. The coils are of the plug-in type to be used in 6-prong sockets, and are wound on standard 6-prong plug-in coil forms.

The line voltage dropping resistance may

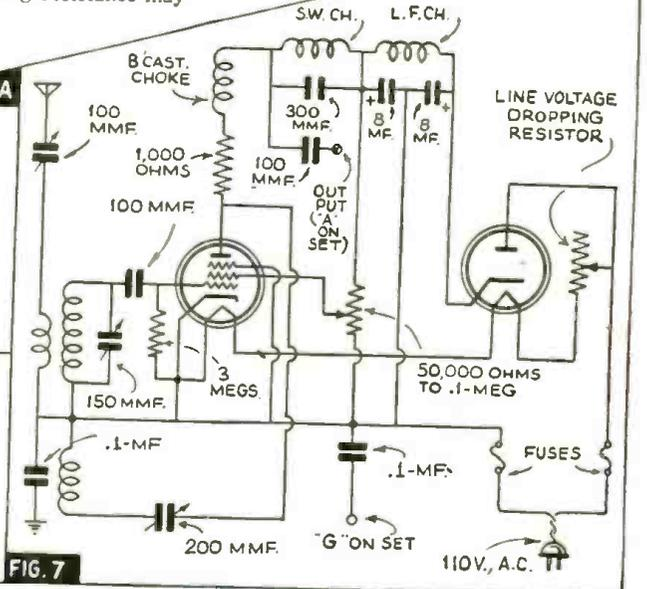

FIG. 6A

FIG. 7

be built in the line cord and in this case is, of course, not variable. If it is not a line cord resistor, it can be placed on top of the chassis in order to secure adequate cooling.

The converter is connected to the receiver in the usual way, the output terminal being connected to the antenna of the radio receiver, and the ground terminal going to the ground post of the set, if any is employed. As will be seen, the converter incorporates regeneration control by means of the .0002 mfd. condenser, and further control of oscillation is had by means of the potentiometer.

### War-Time Rules for Hams

● IN order to aid in the preservation of American neutrality, the American Radio Relay League has suggested certain rules to its members. The proposed rules are as follows:

1. All contacts between "hams" in different nations are to be devoted to experimental and incidental topics only.
2. No intelligence of any sort is to be transmitted from one country to another.
3. "Hams" are not to discuss any happenings which might have any military significance whatsoever.
4. "Hams" are not to express private opinions of an unneutral nature or to discuss the war or allied matters.

# The RADIO BEGINNER

Martin Clifford, W2CDV

## Lesson 11—

## Ultra High Frequency Receivers

AS we approach the very high frequency bands, radio waves seem to take on some of the physical properties of light waves. This is not unexpected, since light waves have a very high frequency. Thus, the transmitted range of ultra high radio frequencies appears to be only slightly more than our *line of sight*; that is, as far as we can see. It is true that communication has been established for much greater distances on the high frequencies, but such communication is fairly uncertain, and is perhaps controlled by atmospheric or solar conditions. For short-range communication, however, the ultra high frequencies present numerous advantages. Antennas become very short, the use of directors and reflectors is facilitated, and substantial gains in power and directivity are obtained. Then again, ultra high frequency receivers and transmitters may be made very compact and represent an excellent answer to the problems of space limitation or portability. Finally, the ultra high frequencies present to the pioneering ham or short wave listener unlimited opportunities for economical and interesting experimentation.

### Action of Regeneration

Before we can understand the operation of one of the major groups of ultra high frequency receivers, we should briefly consider the phenomenon of *regeneration* or *feed-back*. In previous articles we studied the problem of detector action as exemplified in a typical circuit such as that shown in Fig. 1. In the plate circuit of this receiver, the radio frequency bypass condenser, marked C, serves to provide an easy path for the return of radio frequency currents. Instead of wasting these currents, they can be fed back into the grid circuit and consequently undergo further amplification. In Fig. 2 we have such an arrangement. In this circuit, the radio frequency currents appearing in the plate circuit are fed through coil L2 so placed that magnetic induction can

occur between it and coil L1. The radio frequency current flowing through L2 creates a moving magnetic field whose lines of force cut L1. By induction, a similar magnetic field is induced around coil L1. This moving magnetic field induces a current in L1, connected to the grid of the vacuum tube. In this way a tremendous increase in sensitivity and amplification is secured.

### Two Types of Receiver Used

Today, two types of receivers are being used on the *ultra high frequencies*; the *super-regenerative* receiver and the *superheterodyne*. In the regenerative circuit shown, the coil in the plate circuit is so placed that there is magnetic interaction between it and (Continued on page 442)

Fig. 5—Adding stage of tuned R.F. to super-regenerative set; Fig. 6—U.H.F. converter circuit; Fig. 7—The transceiver; it uses the same tube for transmitting and receiving.

Diagrams below show, respectively: Simple non-regenerative detector; Regenerative detector; Super-regenerative receiver, with separate oscillator, and, in Fig. 4, a "self-quenched" hook-up.

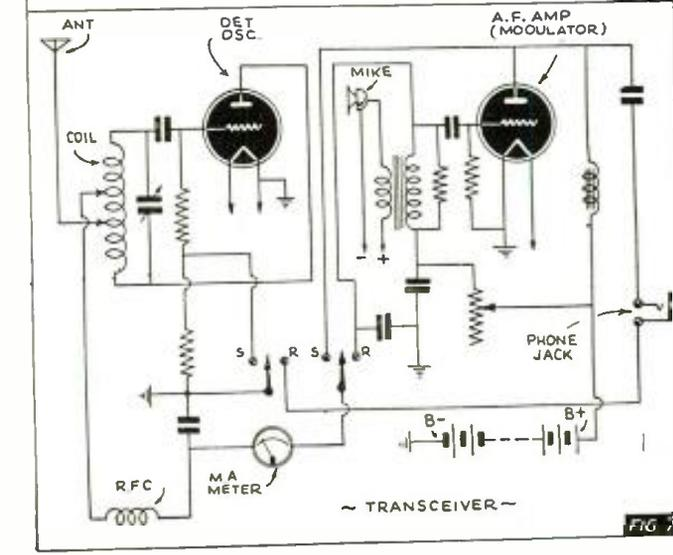
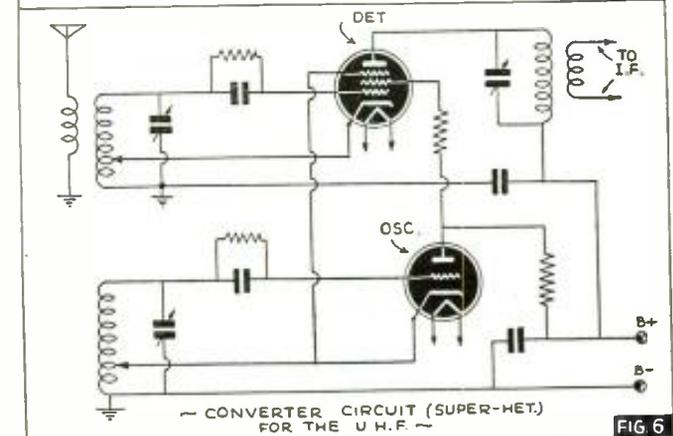
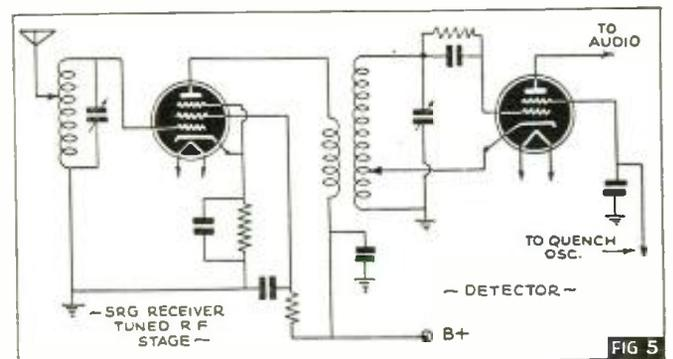
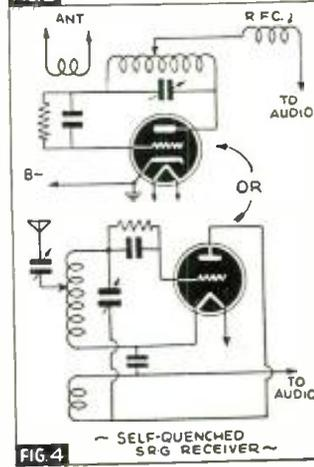
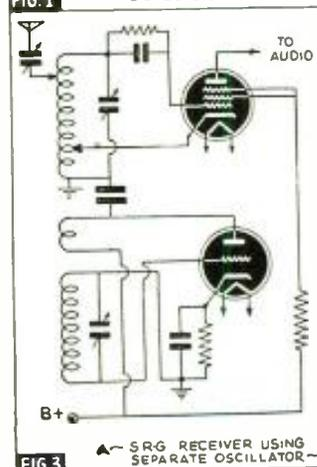
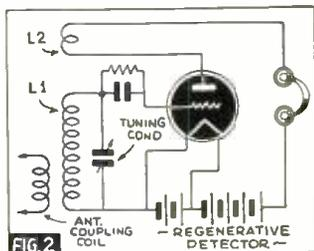
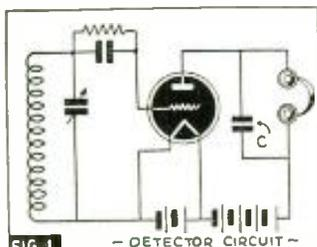

# Adding 3" C-R TUBE to Low-Cost Television Set

Described Last Month

Simple changes in home-made Television receiver more than double picture area, when 3" C-R tube is used.

Peter Scozzari

● THE design of a television receiver that will meet the requirements of the beginner presents some problems which differ from those encountered in commercial practice.

The high definition television in use today is inherently very complex. In order to obtain the full fidelity of the transmitted picture, approximately 225,000 picture elements must be reproduced on the screen of the cathode-ray tube. This means that the band width required to give maximum picture detail must be approximately 4 megacycles wide and must be maintained thus from antenna to cathode-ray tube. These requirements are met in commercial practice by the use of the superheterodyne circuit with a specially designed intermediate frequency system that will pass the desired band width. However, this is not the solution from the experimenter's point of view. While the superheterodyne has very desirable features, it is difficult to align, and requires an elaborate array of alignment instruments in order to do the job properly.

The T.R.F. (Tuned Radio Frequency)

due to its ease of construction and low cost has everything to recommend it. This circuit, if properly designed, will have sufficient band-pass for the smaller cathode-ray tubes.

It must be remembered that the resolution (dot size relative to screen area) of these small tubes does not permit the high order of definition of which the larger tubes are capable. Therefore, a 2 megacycle band-pass is sufficient.

In the October issue of RADIO & TELEVISION, a 2" tube television set was described by the writer. This produced very good images and had many desirable features. It was felt, however, that an improved model would be wanted by the advanced experimenter. Therefore, the original set was redesigned to utilize the new 906-14 3" diameter cathode-ray tube, which provides a black and white picture instead of having the greenish hue which is characteristic of the oscilloscope type tube. This set also retains the desirable features of the previous model.

Constructional data will be given for those desiring to rebuild the 2" tube model to

accommodate the 3" tube. Those who wish to build this model are referred to the October issue for constructional details.

The power supply is rebuilt first. The high voltage power transformer is removed and the new one, supplying 1,200 volts, is installed, together with the high impedance choke and the 2,000 volt filter condensers.

Automobile ignition wire should be used in wiring the high voltage circuit. It should be noted that, unlike the previous circuit, the negative of the high voltage supply is grounded, because of some circuit changes in the main chassis. Particular attention should be paid to the 3 megohm bleeder resistor which is shunted across the output of the high voltage. This resistor discharges the high voltage filter condensers in a few seconds and is a measure of protection in the event that the voltage divider in the main chassis opens or the plug connecting to the power supply is not attached. It cannot be repeated too often that the greatest care must be exercised in handling these voltages. Whenever possible the re-

(Continued on page 439)

Diagrams below show simple changes and few new parts added to the 2" television receiver to convert it for operation with 3" black and white C-R tube. The entertainment value of the set is increased a hundred-fold.

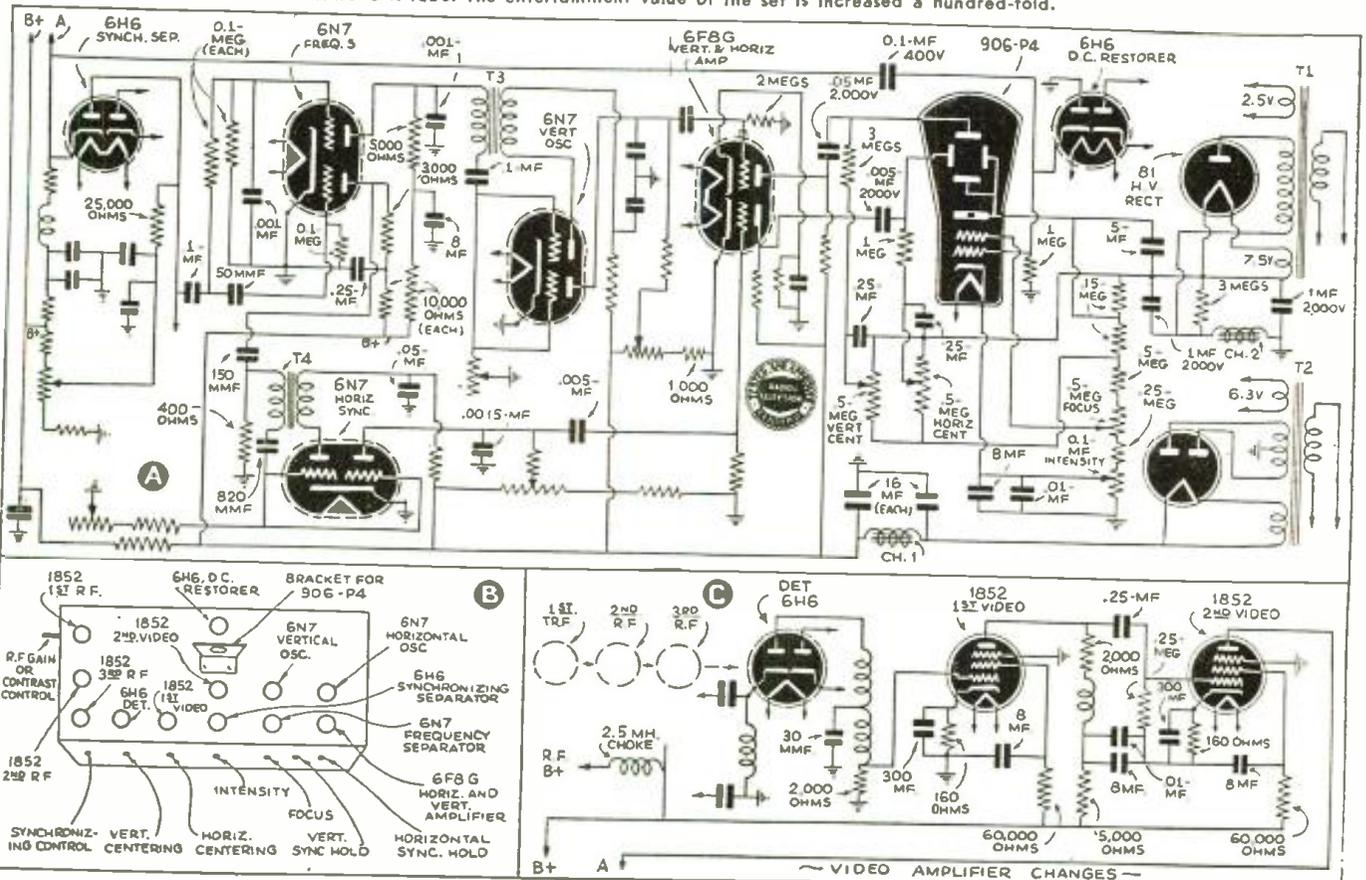

# Practical

This is YOUR department and you can help to make it a very "live" one by sending your favorite radio "idea" to the editors. Photos are welcome, but pencil or pen and ink sketches will do—our draftsmen will remake all drawings. Just write a simple but accurate description of the idea and keep it within 500 words.

## How to Electrify

Allan Stuart

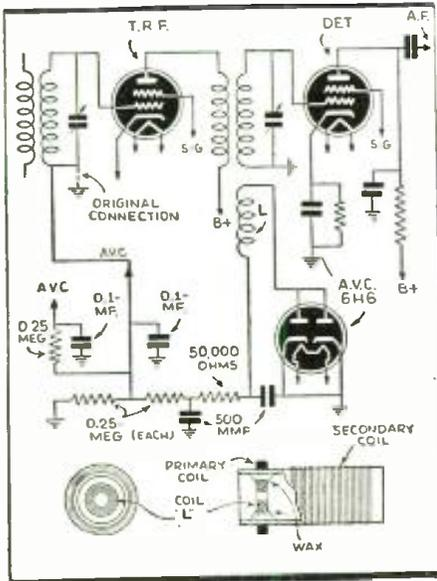

Circuit for adding AVC to T.R.F. set.

### AVC from Any T.R.F. Receiver

● THIS is a hookup which I use for obtaining AVC on any screen-grid T.R.F. receiver. This always minimizes troublesome fading which is characteristic with T.R.F. receivers. The AVC tube (6H6) is coupled to the detector by coil "L" which is fitted inside the detector R.F. coil and fastened by paraffine wax as shown by the accompanying diagram. The coil should consist of from 50 to 100 turns of fine insulated wire. Any ordinary universal-wound R.F. choke of convenient size will do. The diagram also shows an AVC tap for another R.F. stage. The receiver should be realigned after the changes are made.—CLARENCE H. CRAMER.

### Wind-Driven Dynamo

● FREE electricity from the wind can be obtained by driving a Ford or other type automobile generator by means of a propeller (or series of propeller blades) as the illustration shows. To swing the wind vane into the wind, the tail of the apparatus is swung around into the wind by pulling on the cord shown. Although not illustrated here, one of the American commercial devices of this type utilizes a latch which will lock the director or tail blade in position when the cord is pulled once. When the cord is jerked again, the detent or latch is released and allows the spring to pull the tail and the wind vanes back out of the wind. The whole unit revolves on ballbearings and one side of the circuit is carried through a spring and contact ring, as the drawing shows.—*Courtesy Radio Revista.*

### Construction details of wind-driven charger.

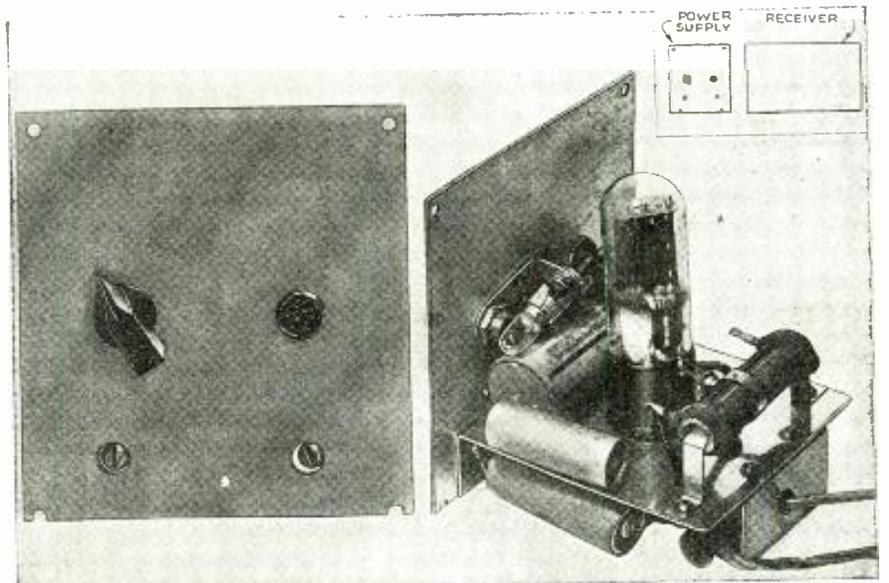
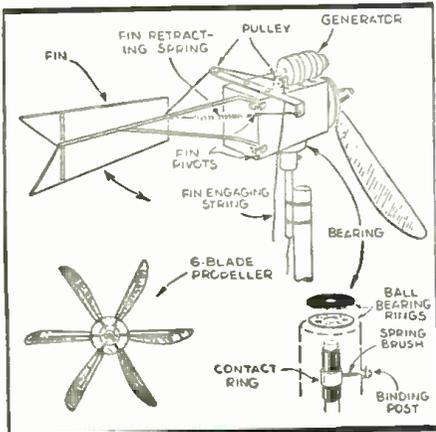

Front and rear views of the power supply unit for electrifying the "Twinplex" described in this department last month. The cost of the parts is small, and the convenience afforded will repay the builder many times over.

● HERE it is, as promised—a simple power supply for electrifying the "Modernized Twinplex." A few resistors and condensers, a single rectifier tube, a pilot light, switch and line cord comprise the entire unit. Yet, simple as this may sound, problems similar to those confronting heavy duty power packs designed for 6.3 volt tubes were encountered. Well-filtered "B" power had to be provided not only for the plate of the receiver tube but for the filament too, since the 1G6-G tube, used in the "Twinplex" described last month is of the 1.4 volt battery type. Further, as the "Twinplex" is a short-wave receiver, it is sensitive to the presence of even small amounts of hum, especially at the point of regeneration.

The old time "A" eliminators had to use heavy-duty dry-disc or gaseous rectifiers, combined with about 2000 mf. capacity in order to supply ripple-free filament current. However, since the current requirement of the 1.4 volt series of tubes is extremely low, we can use an ordinary rectifier tube to supply both "A" and "B" currents. In the case of the "Twinplex", the filament consumption is 100 milliamperes and that of the plate approximately 3 milliamperes; and since the rectifier tube which

we use is capable of furnishing a maximum of 120 milliamperes, we even have a little current to spare. This rectifier tube, recently developed, is a full-wave job and has a filament which operates directly from the 117 volt line, either A.C. or D.C. Hence, neither a ballast tube nor a voltage-dropping resistor is required. Incidentally, the filament has a center tap, which, when used, requires a potential of only 58.5 V. The current consumption, however, is doubled. We use 117 volts with a filament consumption of .075 ampere.

As shown in the illustrations, this power supply is on a chassis all its own, but of such dimensions as to match the front panel of the "Twinplex." The purpose of this separate construction is to permit the use of this power supply with other battery receivers using the 1.4 V. tubes—such as the battery portables which are so popular today.

Since we are not dealing with any high-frequency currents, the components may be mounted in any position to suit the convenience of the constructor. There is one exception, however, and that is the 2500 ohm wire-wound semi-variable resistor. Inasmuch as this unit gets quite hot in operation, it should be mounted on top of the

# Radio Ideas

All articles accepted by this department will be paid for at regular space rates. Each month the editors will select the best article and it will receive a special price—double the usual space rates.

Address all articles, photos and diagrams to the Editor, *Practical Radio Ideas*, c/o RADIO & TELEVISION, 99 Hudson Street, New York, N. Y.

## the "Twinplex"

This Month's Feature

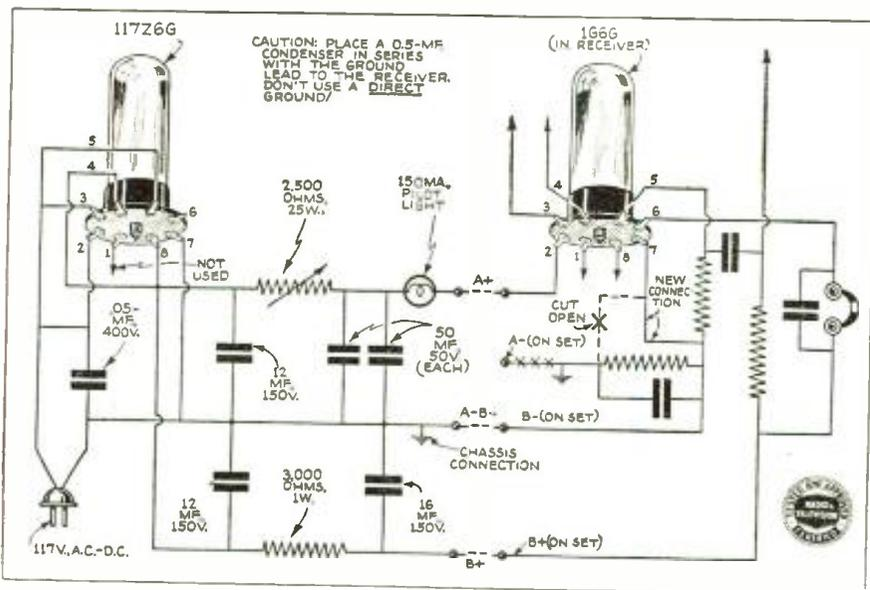

As the diagram shows, the hook-up of the parts for the power supply unit is very simple. Note the new connection between B- and A- in the receiver itself; also that the circuit is to be cut open at X.

sub-panel. Another precaution is to wire the electrolytic condensers correctly, according to polarity. A 150-ma. pilot light is wired in series with the rectified "A" power to indicate when the power pack is supplying current to the receiver. Since a 10 mil pilot light is not available this 150-mil-bulb was used but will not glow at full brilliance.

After the power supply has been com-

pleted, point of highest resistance down until the milliammeter reads exactly 100 ma. This, of course, has to be done with all other connections between the power supply and set completed so that the power pack is properly "loaded."

Caution: Always connect the set to the power supply first before turning on the line power. If the power pack has been turned on first and the set then connected to it,

Many readers have expressed their pleasure at seeing the famous "Twinplex" modernized, as described in the last issue. Here is a 110 volt A.C.-D.C. power supply unit which eliminates all batteries.

pletely wired, according to the diagram shown, one adjustment to the semi-variable resistor must be made. Once adjusted however, it remains fixed unless the pack is to be used with a receiver having other filament requirements. To adjust this resistor for the correct current when used with the "Twinplex," insert a 100 ma. (or more) milliammeter in series with the filament circuit and slowly move the slider from the

high surge current flowing through the reduced resistance of the cold filament of the receiver tube will cause it to blow out. Another precaution is never to attach a ground wire directly to the chassis of either the receiver or the power supply. Use an isolating condenser of at least 1/2 mf. (That is the condenser is to be connected in series with the ground, if one is used.)

(Continued on page 422)

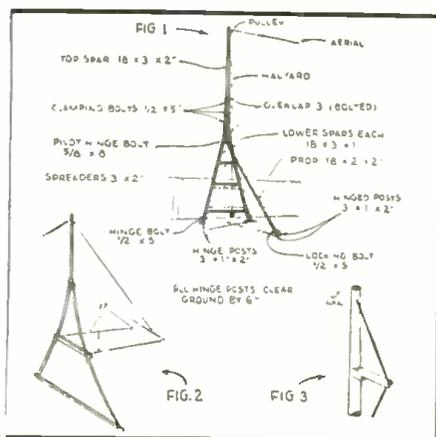

A simple but very sturdy aerial mast is here illustrated. It can easily be raised into position and anchored.

### Simple Aerial Mast

● MANY different types of aerial masts have been tried by radio amateurs and fans but the accompanying illustration shows one of the simplest and strongest we have seen in quite a while. It was recently described in *Practical and Amateur Wireless*. The size of the wooden members used in building the mast will depend a great deal, of course, upon the height of the structure, and one of the features of the mast here shown is that it may be arranged with two bolts or pivots at the base, so that the mast can be pulled up into position by means of a rope, or else simply pushed up into a vertical position in the same way that you raise a heavy ladder. Once in position, suitable guy wires are attached. A mast of this type may easily be built from pipe and pipe fittings. In any event, if made of wood or metal, the mast should be treated to several coats of paint to preserve it against the weather.

### Cathode-Ray Indicator

● THIS simple signal strength indicator may be arranged on the average receiver with little difficulty. The strength of the signal is indicated by the width of the shadow on the end of the magic eye tube. In the position of no signal, the shadow area is greatest, and as the signals are tuned in, the shadow area decreases. With a very powerful signal, the light area may spread or overlap so that there is no shaded portion, says W. J. Delaney in *Practical and Amateur Wireless*, London. As the carrier input affects the amount of shadow, we see that a control may be fitted which will regulate the input and thereby control the indications on the eye tube. The R.F. gain control on the receiver may be used for this purpose. A dial or an indicator is fitted on the knob of the control and various points marked off to indicate the "R" values from 1 to 9.

A "signal strength" indicator is readily built, using a "magic eye" tube as the indicator.

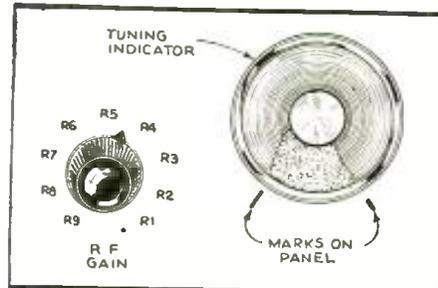

# Conversion Chart for ALL Frequencies

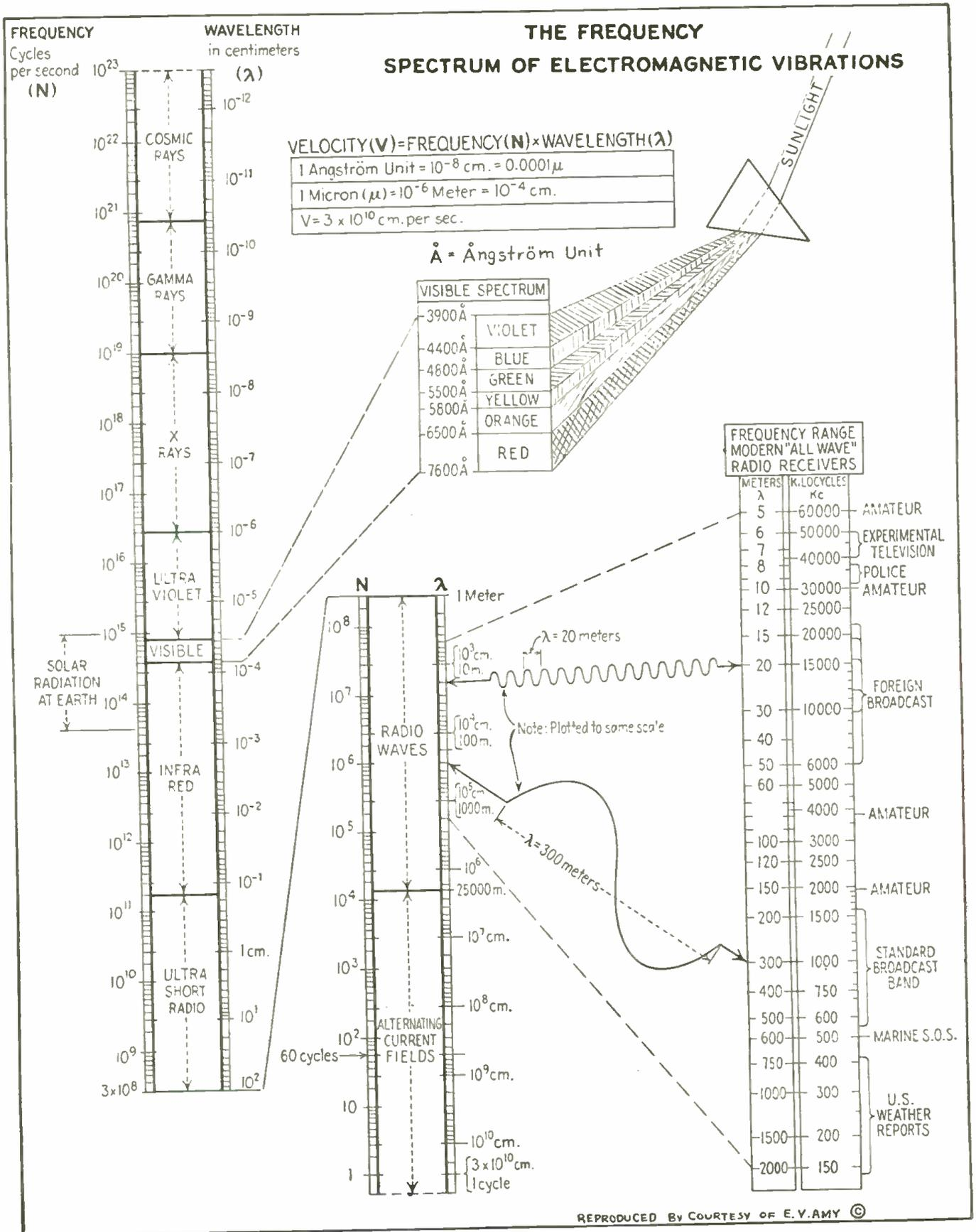

The conversion chart above not only shows the relationship between frequency in kilocycles and wave length in meters, but gives a complete picture of the electromagnetic wave spectrum. It shows the relative

length and frequency of cosmic rays, gamma rays, X-rays, ultra-violet, visible light, infra-red, ultra-short radio waves, short waves, broadcast waves, long waves, and alternating current fields.

# That DX-Grabbing "LOKTAL" Preselector becomes a 2-Tube Receiver



Harry D. Hooton, W8KPX

Many readers have asked how the "Loktal" 1-tube preselector on page 291 of the September issue may be used as a receiver. Here is the data for changing the preselector into a simple 2-tube regenerative "all-wave" receiver.

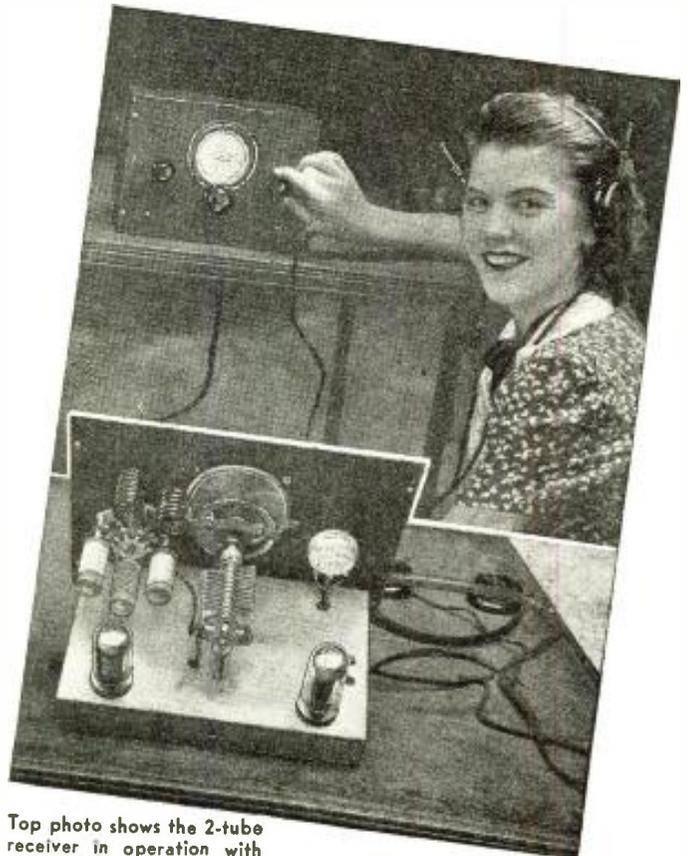

Top photo shows the 2-tube receiver in operation with Brush crystal headphones. Lower photo—rear view of the receiver.

● AS Fig. 1 and the photographs show, only a few minor changes are required. A 100 mmf. mica condenser and a 3 megohm fixed resistor are placed in series with the lead between the fixed plates of the tuning condenser and the control grid of the 7B7 tube. The 300 ohm cathode bias resistor and its associated .05 mf. bypass condenser are removed from the circuit, the cathode of the tube being connected directly to the switch arm as indicated. The ter-

minial of the 250 mmf. mica condenser which originally connected to the output (antenna) post is grounded to the chassis. These are the only changes required to convert the preselector into a simple receiver. As can be seen, little cost is involved.

It's easy to build this flexible 2-tube receiver, with the aid of the simple diagrams given below.

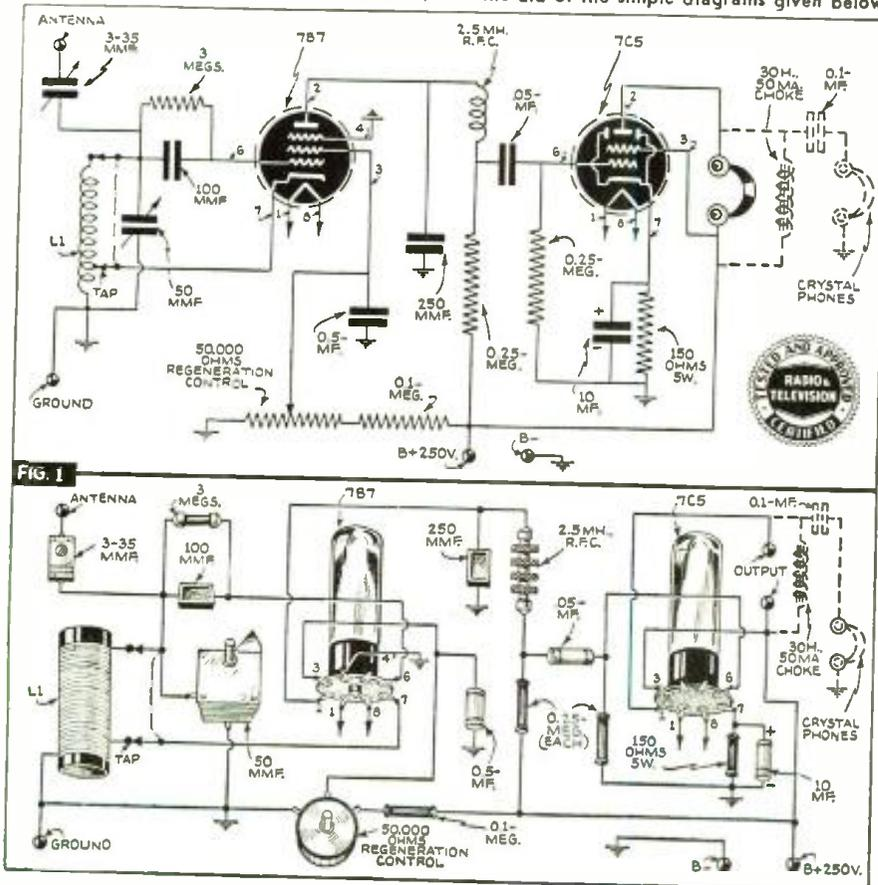

**Stage of Audio Added:** In order to obtain a more comfortable degree of headphone volume, especially on the weaker signals, a stage of audio amplification was considered desirable. Fig. 1 shows the additional parts necessary for the 7C5 audio circuit. The 7C5 tube itself is similar to the older 6V6 but is much smaller in size. Its high amplification factor gives plenty of volume on most stations.

The construction of the receiver is similar to that of the preselector. Keep the wiring, especially the leads from the "hot" grid and cathode circuits, to the coil switch, the coils and the tuning condenser, as short and direct as possible and solder each joint carefully with a clean, well-tinned iron and rosin-core solder. Do not permit the rosin to run down over the contacts of the waveband switch and do not heat the insulation of the switch to such an extent that the impregnating material is melted out of the bakelite insulation. If these precautions are not observed, losses may take place, especially on the higher frequency bands, which will reduce the efficiency of the little set considerably. The coils may be home-made according to the data given at the end of this article, or they may be purchased ready-wound and mounted on the switch. The switch used is a special short-circuiting type which "shorts" out all of the coils except the one in actual operation.

**Hints on Operation:** The operation of the little receiver is simplicity itself. Attach a power supply (an A.C. power pack or a 6-volt storage battery and three or four 45  
(Continued on page 437)

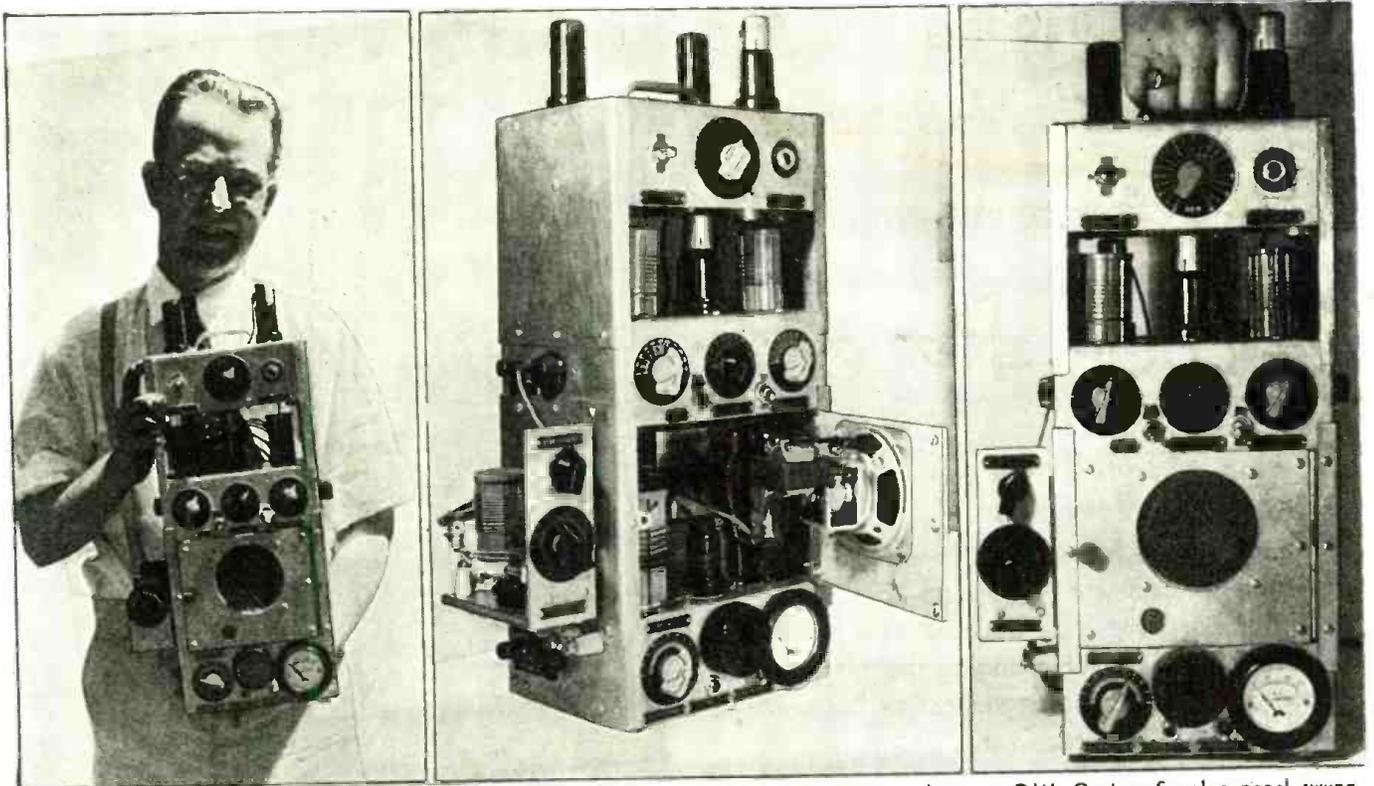

Left—This portable transmitter and receiver, weighing but 25 lbs., rates 20 to 25 watts on phone or C.W. Center—Speaker panel swung out, showing tank coil, Pierce oscillator and 83 rectifier. Right—Close-up of the complete portable.

# De Luxe Portable

## TRANSMITTER AND RECEIVER

Howard W. Earp, W7CHT

University of Portland, Portland, Oregon

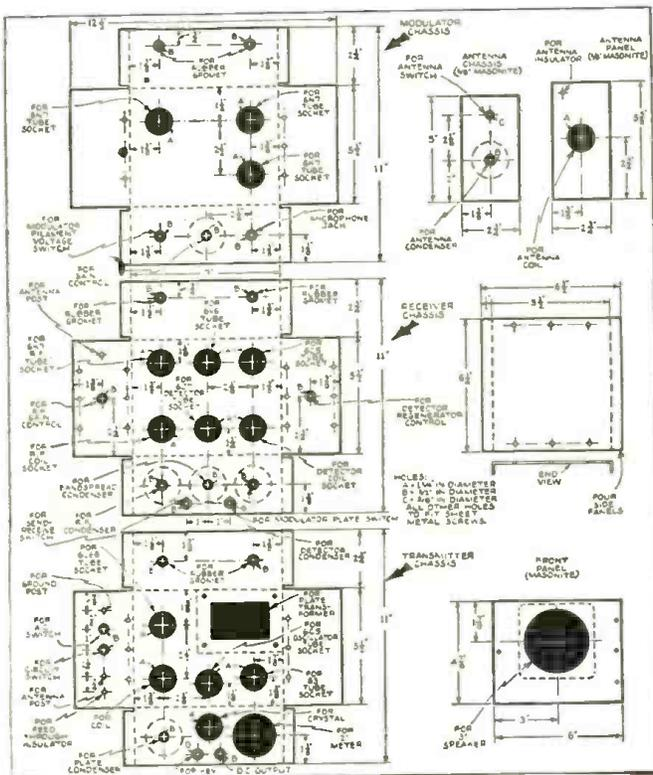

Above—Diagrams showing the dimensions of the chassis.

● ONE compact unit, containing a receiver, two stage transmitter, modulator, and power supply—in short, a complete phone and C.W. amateur radio station that was easily portable—that was the idea behind the construction of this outfit. After considerable experimentation it was finished, weighing 25 pounds, and measuring overall  $6\frac{3}{4} \times 10 \times 19\frac{1}{4}$  inches, which allows it to fit into a small suitcase. Its compactness, light weight, and versatility have made portable operation a real pleasure, while as an *auxiliary* and *emergency* unit it also holds an important place alongside the regular higher power station equipment.

**TRANSMITTER:** The transmitter was designed for phone and C.W. operation with about twenty watts output from 160 to 20 meters. Three circuits are available instantaneously at the turn of switch S1, a novel arrangement which adds considerably to the utility of the unit. This switch is a four-circuit, ganged, three-position rotary type. In Number One position the circuit consists of a 6L6G tri-tet oscillator, used for 20 meter C.W. and phone with a 40 meter crystal. The cathode circuit gives sufficient buffer effect for stable low power phone operation. The cathode coil L5 and trimmer condenser C16 are tuned once and set for maximum output. This is accomplished at approximately 10,000 kc.

In Number Two position the circuit consists of a Jones regenerative 6L6G oscillator, used mainly on 40 and 80 meter C.W. This circuit gives the most output of the three employed. In Number Three position, the 6C5 Pierce oscillator is switched in, driving the 6L6G amplifier and providing a stable R.F. section for 75 and 160 meter phone. Crystal current as indicated by the 60 ma. bulb remains a safe value on all circuits, but is highest on the tri-tet.

Transmitter designed for phone and C.W. operation from 20 to 160 meters. Receiver employs T.R.F. stage, regenerative detector, two audio stages with 6V6 beam power output tube. An ideal auxiliary and emergency unit for the Ham; it weighs but 25 lb. complete.

A number of combinations are possible from this arrangement, such as 40 and 80 meter tri-tet operation, 40 meter 6C5-6L6G operation, etc. It also gives an opportunity for comparing the efficiency of these standard circuits.

Only two tuning adjustments are required for each band, the plate tank condenser C25, and the antenna condenser C27.

**RECEIVER:** The conventional circuit uses a 6K7 T.R.F. stage, a 6J7 regenerative detector, a 6C5 audio stage, and a 6V6 beam power output tube to a 3" permanent magnet speaker. Two plug-in coils are used for each band. Winding the detector coil in the opposite direction from the R.F. coil reduced the interlocking effects caused by their proximity and by the absence of external shielding which, despite the crowding of parts, is unnecessary in the completed receiver. R4 regulates R.F. volume, while R7 controls volume and regeneration of the detector for C.W. Band-spread is accomplished by paralleling a 25 mmf. condenser with the detector band-set condenser. Broadcast coils increase the receiver's usefulness on vacation trips.

**MODULATOR:** The modulator consists of a 6K7 pentode stage, followed by a 6N7 connected in parallel, driving a 6N7 stage in Class B, and provides sufficient gain for a crystal microphone. The filaments of the modulator tubes are wired to a switch, (Continued on page 433)

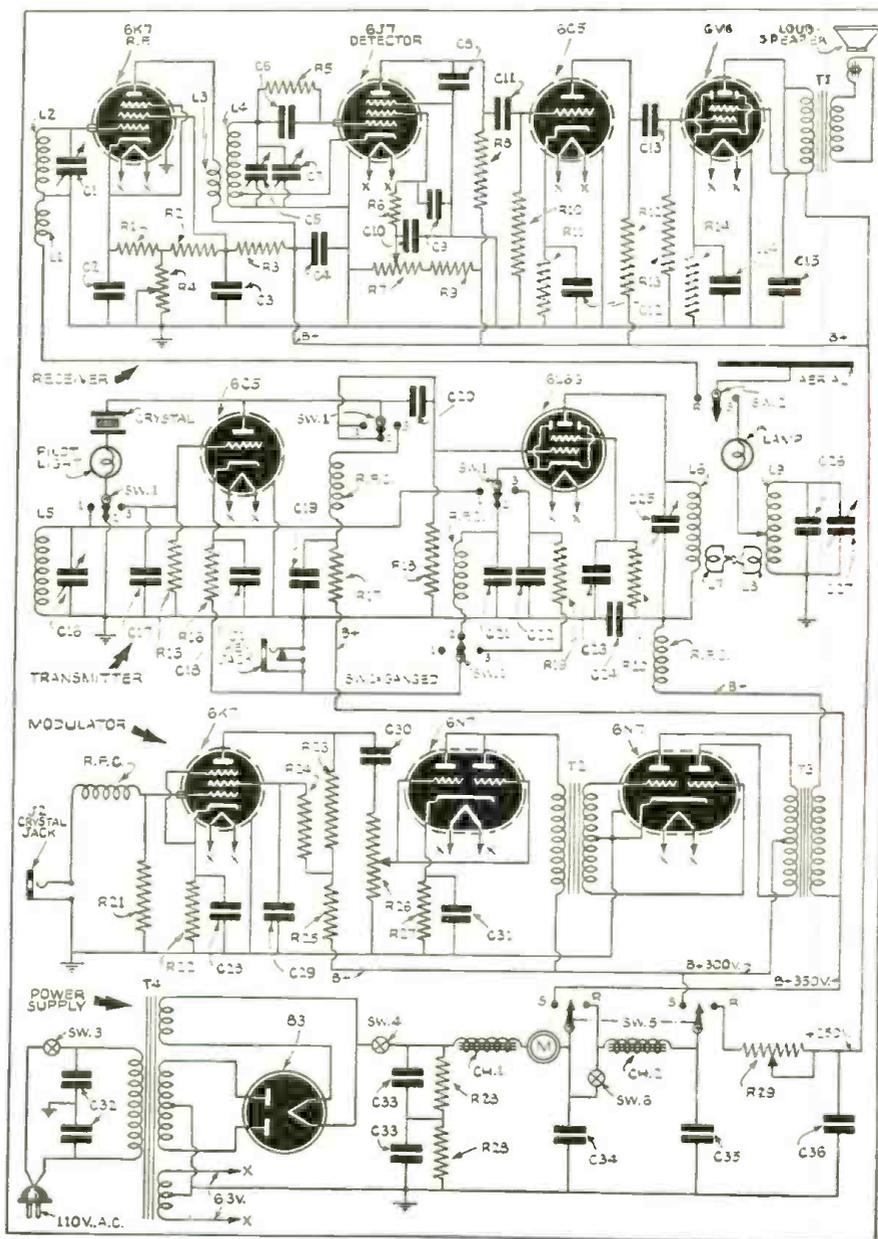

Above—Complete wiring diagram of the transmitter and receiver.

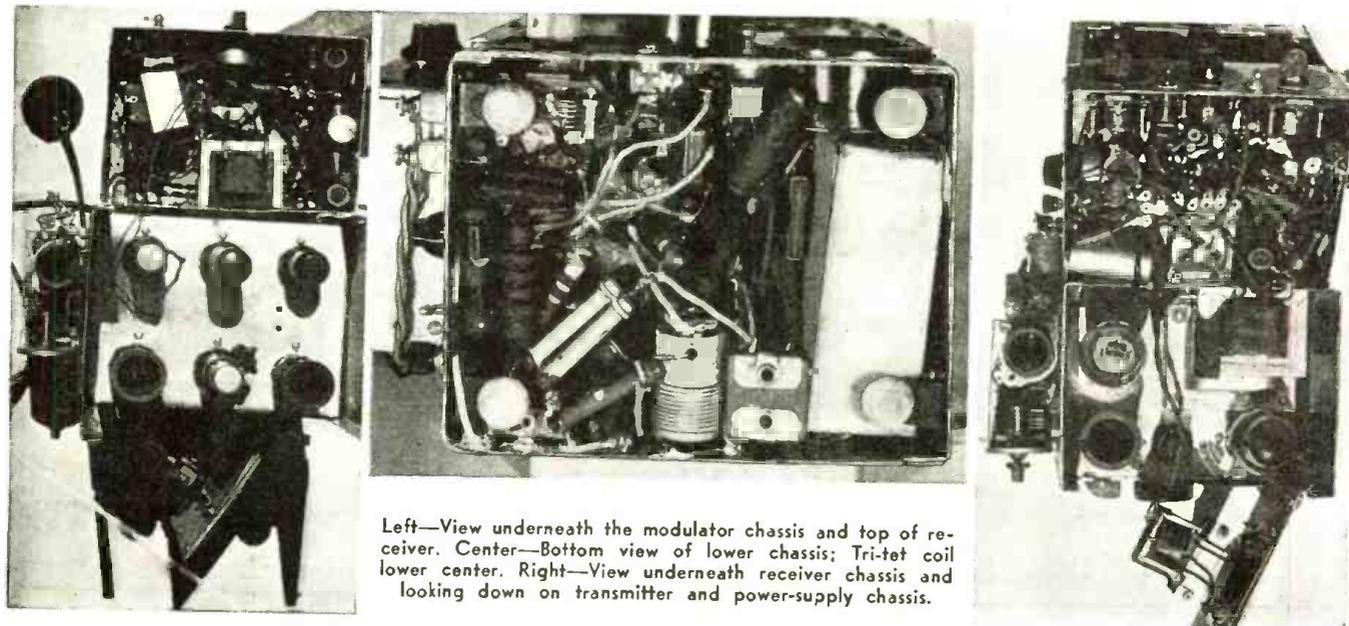

Left—View underneath the modulator chassis and top of receiver. Center—Bottom view of lower chassis; Tri-tet coil lower center. Right—View underneath receiver chassis and looking down on transmitter and power-supply chassis.

# World Short Wave Stations

*Revised Monthly*

Complete List of SW  
Broadcast Stations

Reports on station changes are appreciated.

Mc.	Call	Address	Mc.	Call	Address	Mc.	Call	Address
31.600	WIXKA	BOSTON, MASS., 9.494 m., Addr. Westinghouse Co. Daily 6 am.-1 am., Sun. 8 am.-1 am. Relays WBZ.	21.550	GST	DAVENTRY, ENG., 13.92 m., Addr. (B.B.C., London) 5.45 am.-12 noon.	17.310	W2XGB	HICKSVILLE, L. I., N. Y., 17.33 m., Addr. Press Wireless, Box 296. Tests 9.30-11.30 am. except Sat. and Sun.
31.600	WIXKB	SPRINGFIELD, MASS., 9.494 m., Addr. Westinghouse Co. Daily 6 am.-1 am., Sun. 8 am.-1 am. Relays WBZ.	21.540	WPIT	PITTSBURGH, PA., 13.93 m., Addr. Grant Bldg. Relays KDKA 5:30-8 am.	17.280	FZEB	DJIBOUTI, FRENCH SOMALI-LAND, 17.36 m. Test XMSN 1st Thurs. each month 8-8.30 am. Next B.C.S. Oct. 5 & Nov. 2.
31.600	W3XEY	BALTIMORE, MD., 9.494 m., Relays WFBZ 4 pm.-12 m.	21.530	GSJ	DAVENTRY, ENG., 13.93 m., Addr. (See 21.550 mc.) 5.45-10:15 am.	15.550	CO9XX	TUINICU, ORIENTE, CUBA, 19.29 m., Addr. Frank Jones, Central Tuinicu, Tuinicu, Santa Clara. Broadcasts irregularly evenings.
31.600	W2XDV	NEW YORK CITY, 9.494 m., Addr. Col. Broad. System, 485 Madison Ave. Daily 6-11 pm.; Sat. and Sun. 1.30-6, 7-10 pm.	21.520	WCAB	PHILA., PA., 13.94 m., Addr. Col. Broad. Syst., 485 Madison Ave., N. Y. C. 12 n. to 6 pm.	15.510	XOZ	CHENGJU, CHINA, 19.34 m. Daily 9.45-10.30 am.
31.600	W9XHW	MINNEAPOLIS, MINN., 9.494 m. Relays WCCO 9 am.-12:30 am.	21.510	2RO16	ROME, ITALY, 13.94 m. 9-9.55 am.	15.370	HAS3	BUDAPEST, HUNGARY, 19.52 m., Addr. Radioabor, Gyalai Ut 22. Sun. 9-10 am. Daily 8-9 pm.
31.600	W3XKA	PHILADELPHIA, PA., 9.494 m. Addr. NBC. Relays KYW 9 am-10 pm.	21.500	WGEA	SCHENECTADY, N. Y., 13.95 m. General Electric Co., 8-11 am.	15.360	DZG	ZEESEN, GERMANY, 19.53 m., Addr. Reichspostzentralamt. Tests irregularly.
31.600	W5XAU	OKLAHOMA CITY, 9.494 m., Sun. 12 n.-1 pm., 6-7 pm. Irregular other times.	21.480	PHI3	HUIZEN, HOLLAND, 13.96 m., Addr. N. V. Philips, Hilversum. Irregular, 6.10-9.35 am.	15.360	—	BERNE, SWITZERLAND, 19.53 m. Irreg. 6.45-7.45 pm.
31.600	W9XUY	OMAHA, NEBR., 9.494 m. No sked. known.	21.470	GSH	DAVENTRY, ENG., 13.97 m. (See 21.550 mc.) 5.45-8.50 am., 9 am.-noon. To Africa.			
31.600	W4XCA	MEMPHIS, TENN., 9.494 m. Addr. Memphis Commercial Appeal. Relays WMC. 10 am.-6 pm.	21.460	WSLR	BOSTON, MASS., 13.98 m. Addr. University Club. Sun. 9-11.30 am., Tues. 10-11 am.			
31.600	W8XAI	ROCHESTER, N. Y., 9.494 m., Addr. Stromberg Carlson Co. Relays WHAM 7.30-12.05 am.	21.450	DJS	BERLIN, GERMANY, 13.99 m., Addr. Broadcasting House. 12.05-7.55 am. To Asia.			
31.600	W8XWJ	DETROIT, MICH., 9.494 m., Addr. Evening News Ass'n. Relays WWJ 5 am.-11.30 pm. Sun. 7 am.-11 pm.	19.020	HS6PJ	BANGKOK, SIAM, 15.77 m. Mondays 8-10 am. See 15.23 mc.			
31.600	W9XPD	ST. LOUIS, MO., 9.494 m., Addr. Pulitzer Pub. Co. Relays KSD.	18.450	HBF	GENEVA, SWITZERLAND, 16.26 m., Addr. Radio Nations. Fri. 8.45-10.45 am.			
31.600	W5XD	DALLAS, TEXAS, 9.494 m., 11.30 am.-1.30 pm. Ex. Sat.-Sun.						
26.500	W9XTA	HARRISBURG, ILL., 11.32 m. 1-4 pm.						
26.450	W9XA	KANSAS CITY, MO., 11.33 m., Addr. Commercial Radio Eqpt. Co. 10 am.-1 pm., 3-7 pm.						
26.400	W9XAZ	MILWAUKEE, WIS., 11.36 m., Addr. The Journal Co. Relays WTMJ from 1 pm. to midnight.						
26.150	W9XUP	ST. PAUL, MINN., 11.47 m. Rel. KSTP 8 am.-1 am.						
26.100	W9XJL	SUPERIOR, WIS., 11.49 m. Relays WEBC daily. 10 am.-8 pm.						
26.050	W9XTC	MINNEAPOLIS, MINN., 11.51 m. Relays WCTN 10 am.-9 pm.						
26.050	W9XH	SOUTH BEND, IND., 11.51 m., Addr. South Bend Tribune. Relays WSBT-WFAM 2.30-6.30 pm. exc. Sat. and Sun.						
25.950	W6XKG	LOS ANGELES, CAL., 11.56 m., Addr. B. S. McGlashan, Wash. Blvd. at Oak St. Relays KGFJ 24 hours daily. DX tips Mon., Wed. and Fri. 2:15 pm.						
25.950	WBXNU	CINCINNATI, OHIO, 11.56 m., 7 am.-1 am. Sun. 8 am.-1 am.						
25.500	W2XQO	NEW YORK CITY, N. Y. 11.76 m. Noon-9 pm.						
25.300	W2XJI	NEW YORK, N. Y. 11.86 m., Addr. Bamberger Broad. Service, 1440 Broadway. Relays WOR 12 n.-6 pm.						
21.640	GRZ	DAVENTRY, ENG., 13.86 m. Addr. B.B.C., London. Unused at present.						
21.630	WRCA	BOUND BROOK, N. J., 13.8 m., Addr. N.B.C., N. Y. C. 8 am.-4 pm. to Europe.						
21.570	WCBX	NEW YORK CITY, 13.91 m. Addr. CBS, 485 Madison Ave. Irregular.						
21.565	DJJ	BERLIN, GERMANY, 13.92 m., Addr. Broadcasting House. Irreg.						

## 16 Met. Broadcast Band

## 19 Met. Broadcast Band

End of Broadcast Band

(Continued on page 408)

All Schedules Eastern Standard Time

# Let's Listen In on WAR NEWS

Lyle M. Nelson

Covers the Pacific Coast!

(All times are P.S.T.)

● WITH the current European crisis many Pacific Coast short wave listeners are tuning daily to stations located in the capitals of the countries involved for the latest news—direct from the front.

Favorite among the news broadcasts are those from Daventry at 4:45 p.m. over GSE and GSD; at 8 p.m. from GSD, GSC and GSB and at 10:30 p.m. from GSF, GSD and GSB. Of these stations, GSD on its 11.75-megacycle frequency is usually the best received here.

Not to be forgotten are the German news bulletins over DJD, 11.77 mc., at 7:30 p.m. nightly. These bulletins give the latest German attitude on current questions.

Paris has several English news programs, the best of which is the 7 p.m. broadcast over stations TPA4 on 11.72 and TPB11 on 11.89 megs. Occasionally the English news broadcast for the Far East is heard here at 4 a.m.

Rome's attitude is voiced daily during the North American program. Several listeners, including C. F. Burns of Vancouver, Wash., report 2R04, 11.81 mc. and 2R06 on 15.30 mc. with excellent reception.

Kendall Walker of Yamhill writes that RKI on 15.04 mc. is well received here with the special English broadcast from 6 to 7 p.m. daily. This broadcast is also carried by RNE on 12.00 and RAN on 9.60 mc., but these stations are rarely heard here.

Evening reception from South and Central America has continued to pick up during the past month, and with the approach of winter many of the Spanish speaking broadcasters will begin coming in with the volume of locals. Several of the more powerful stations on the 19 and 25 meter bands can be tuned as early as 3 p.m. but the majority begin coming in well about 5:30 or 6 p.m.

Mr. Walker reports that station CD1190 of Valdivia, Chile, now has a new beam for North America with the result that it is heard here with excellent strength. This station broadcasts on 11.90 mc. daily from 4 to 7 p.m. but does not become audible here until about 6 p.m.

CXA8 of Colonia, Uruguay, now is booming through on 9.64 mc. with good volume. John Cavanagh, of Oregon City, reports. The station is on the air from 6 to 8 p.m. and on Saturday nights until 10 p.m. Mr. Cavanagh says.

Slightly above CXA8 on the dial can be heard LRX of Buenos Aires on 9.66 mcs. LRX has long been a favorite here on the coast and is regularly received daily from 5:30 to 7 p.m. Several listeners have reported this station irregularly as late as 8 p.m.

Various listeners including Mr. Walker and Mr. Cavanagh have reported W2XAF testing on 9.53 mc. with their new transmitter. Broadcasts as yet are irregular, the station has informed Mr. Walker.

Considerable controversy has arisen over HNF of Baghdad, Iraq. Many listeners claim that this station is now off the air, while others report reception. Jack McCliment, of Portland, and T. S. Hite, of Los Angeles, report a station announcing as HNF on 9.68 mcs. from 5 to 6:30 a.m. daily.

**ROUND UP ABOUT—From listener's reports.**  
New Swedish station heard on 15.16 mcs. Wednesdays and Saturdays from 5 to 6 p.m. . . .  
RV15 of Khabarovsk, U. S. S. R. occasionally heard here on 4.27 mc. in early mornings. . . .  
GSE heard on 15.14 mc. with English news at 5 and 8 a.m. daily. . . .  
COCH of Havana, continuing to hold forth on 9.43 mc. from 5 to 9 p.m. daily. . . .  
Best Spanish broadcaster at present. . . .  
TG2X of Guatemala City is excellently received on 5.94 mc. every Saturday night from 7 to 10 p.m. . . .  
Japanese attitude is reflected during nightly "overseas broadcast." English news is heard at 9:05 p.m. . . .  
HVI of Vatican City heard from 7:30 to 7:45 a.m. on 15.11 mc. . . .  
Nationalist government of Spain is planning a new 50,000 watt station for Madrid. . . .  
COCM of Havana heard at present near 9.82 mc. . . .  
TIPG of San Jose now on 9.62 mc. from 5 to 8:30 p.m. . . .  
Station CB1185 heard on 11.85 mc. from 5 to 8 p.m. daily. . . .  
New Mexican station reported on 11.82 mc. irregularly near 9 p.m. . . .  
ZP14 of Villarica, Paraguay, occasionally heard here near 5 p.m. on Sundays. . . .  
MTCY of H-sinking is now operating daily on 11.77 mc. from 10:30 to 11:20 p.m. . . .  
DJJ on 11.883 mc. now broadcasting simultaneously with DJD on North American program. . . .  
HS8PJ of Bangkok heard daily except Monday from 5 to 7 a.m. on 9.51 mc.

● **THRILLING** as are the reports broadcast by the American news commentators, and authoritative as are their opinions of what is going on in Europe, they cannot afford the thrills one receives when listening in on the voices of men who are actually at the scene of battle—men who are in Warsaw, Berlin, Moscow, London and Paris.

The short waves are crammed with reports and propaganda, all of which is of vital interest to those of us in America who wish to know what is really going on in Europe—to those of us who hope that America will follow her honored traditions and hew to the paths of peace.

A reference to the list of short wave stations in this issue will show the frequencies and schedules of the stations in the centers of war. The 13, 16 and 19 meter bands are best received during the daylight hours, but after dusk falls, the short wave listener will generally obtain better results by tuning to the 25, 31, 40 or even the 49 meter bands. As many of these stations are beamed directly at North America, the average good multi-band radio receiver will pick up their signals with clarity and volume. However, do not expect to get first-rate results with a second-rate antenna—an efficient aerial is essential, if you wish

to hear Europe without too much background noise.

Generally speaking, the most efficient antenna for reception of foreign short wave stations is a doublet of a half or quarter the wavelength of the station that one desires to receive. However, as many bands are to be received, any standard short wave doublet should prove effective. If the lead-in is a good twisted pair, designed for radio use, there will be little loss of energy picked up by the antenna and very low pick-up of man-made static, provided the antenna is erected sufficiently high.

While a good bit of the material emanating from the foreign stations is in the native language of the country of its origin, there are many broadcasts in English, designed to influence thought in the United States.

The guest editorial appearing in this issue of RADIO & TELEVISION, by Lowell Thomas, generally considered America's foremost news commentator, tells how to analyze what you hear from Europe and to give it true evaluation.

We suggest that you keep Mr. Thomas' words in mind when listening to the voice of war-torn Europe.

Amateurs must be especially careful during (Continued on page 429)

## Get Your VAC Certificate?

### Rules for VAC Certificates

● **RADIO & TELEVISION Magazine** has prepared a hand-some VAC (Verified All Continents) certificate which will be issued to all short-wave listeners submitting adequate proof of verification from all continents. To secure a VAC certificate the listener must send in a verification card from each of the continents. The VAC certificate will only be issued for verifications of radio-telephone stations, not C.W. stations. The certificates will be signed by the DX Editor, and Hugo Gernsback, Editor-in-Chief of RADIO & TELEVISION.

It is advisable that the cards be sent in a neat

package and insured for safe delivery. All cards submitted will be returned. The listener should enclose return postage.

A nominal charge of twenty-five cents (25c) will be made for the certificate to cover the cost of handling and printing.

The DX Editor will be the judge as to whether the verifications submitted are bona fide.

A special notation will be made on the certificate in the event that a listener has more than one complete set of verifications from all continents.

All entries should be made to the VAC Editor, RADIO & TELEVISION, 99 Hudson Street, New York, N. Y.

**VAC**  
VERIFIED ALL CONTINENTS  
**RADIO & TELEVISION**  
MAGAZINE

This is to certify that  
*Frank Gordon*  
is admitted to Membership in the VAC CLUB,  
having submitted adequate proof of his reception  
of Radio Phone Signals from each of the six Continents.

*H. Gernsback*  
*Joe Miller*

Mc.	Call	Mc.	Call	Mc.	Call		
15.240	YUG	BELGRADE, YUGOSLAVIA, 19.68	14.440	—	RADIO MALAGA, SPAIN, 20.78 m.		
15.230	HS6PJ	BANGKOK, SIAM, 19.7 m. Irregularly Mon. 8-10 am.	14.420	HCIJB	Relays Salamanca 5.45-7.30 pm. Sometimes 2-4 pm.		
15.230	OLR5A	PRAGUE, BOHEMIA, 19.7 m. Addr. (See OLR4A, 11.84) Daily 6.55-9.15 pm.	14.460	HCIB	QUITO, ECUADOR, 20.80 m. 7-8.15, 11.30 am.-2.30, 4.45 pm.-10.15 pm. Exc. Mon.		
15.220	PCJ2	HUIZEN, HOLLAND, 19.71 m. Addr. N. V. Philips' Radio Hilversum, 7.40-8.45 am. (Sun., Mon., Thur. to 9 am.), Tue. 1-2.30 am., Wed. 9.30-11 am.	14.166	PIIJ	DORDRECHT, HOLLAND, 21.15 m., Addr. (See 7.088 mc.) Sat. 12 n.-12.30 pm.		
15.210	WPIT	PITTSBURGH, PA., 19.72 m., Addr. (See 21.540 mc.) 8 am-1 pm.	13.997	EA9AH	TETUAN, SPANISH MOROCCO, 21.43 m. Apartado 124, 5.15-6.15 pm., 6.30-7.30 pm., 9-10 pm. Relays Salamanca from 5.40 pm.		
15.200	DJB	BERLIN, GERMANY, 19.74 m., Addr. (See 15.280 mc.) 12.05-11 am., 4.50-10.50 pm. Also Sun. 11.10 am.-12.25 pm.	13.635	SPW *	WARSAW, POLAND, 22 m.		
15.200	XGOX	CHUNGKING, CHINA, 19.74 m., 5.30-11 am., 2-6.20 pm., 9-10.45 pm.	12.862	W9XDH	ELGIN, ILL., 23.32 m. Press Wireless, Tests 2-5 pm.		
15.195	TAQ	ANKARA, TURKEY, 19.74 m., 5.30 7 am.	12.486	HIIN	TRUJILLO CITY, DOM. REP., 24.03 m. 6.40-10.40 am., 5.10-10.10 pm.		
15.190	OIE	LAHTI, FINLAND, 19.75 m. Addr. (See OFD, 9.5 mc.) 1.05-4 am, 9 am.-5 pm.	12.460	HCJB	QUITO, ECUADOR, 24.08 m. Daily exc. Mon. 7-8.15, 11.30 am.-2.30, 5-10.30 pm.		
15.190	ZBW4	HONGKONG, CHINA, 19.75 m., Addr. P. O. Box 200. Irregular. 11.30 pm. to 1.15 am., 3-10 am.	12.310	VOFB	ST. JOHNS, NEWFOUNDLAND, 24.37 m. 5.30-7.30 pm.		
15.180	GSO	DAVENTRY, ENG., 19.76 m., Addr. (See 17.79 mc.) 9.10-11 am., 4.20-6 pm.	12.235	TFJ	REYKJAVIK, ICELAND, 24.52 m. Works Europe mornings. Broadcasts Sun. 1.40-2.30 pm.		
15.180	RV96	MOSCOW, U.S.S.R., 19.76 m. Daily 11.55 pm.-2, 3-4 am. Mon., Wed., Thurs. 7-9.15 pm.	12.230	COCE	HAVANA, CUBA, 24.53 m.-8 am.-11.30 pm. Sun. noon-11.30 pm.		
15.170	TGWA	GUATEMALA CITY, GUAT., 19.77 m., Addr. Ministere de Fomento, Daily 12.45-1.45 pm.; Sun. 12.45-5.15 pm.	12.200	—	TRUJILLO, PERU, 24.59 m., "Rancho Grande." Address Hacienda Chiclin. Irregular.		
15.166	LKV	OSLO, NORWAY, 19.78 m. 6.40 am.-5 pm.	12.000	RNE	MOSCOW, U.S.S.R., 25 m. 6-6.30, 10-10.30 am., 1-1.30, 3-5.30, 8.30-10 pm., Sun. 6-10 am., 1-6, 9-10 pm.		
15.160	JZK	TOKYO, JAPAN, 19.79 m. 12 m.-1.30 am. to Canada & Hawaii, and Pacific U.S. 8-9 pm. to Eastern U.S. 7-9.30 am. to China and 2-4 pm. to Europe.	11.970	CB1180	SANTIAGO, CHILE, 25.06 m. 7-11 pm.		
15.160	XEWW	MEXICO CITY, MEXICO, 19.79 m., 12 n.-12 m., irregular.	11.970	H12X	CIUDAD TRUJILLO, D. R., 25.07 m., Addr. La Voz de Hispaniola. Relays HIX Tue. and Fri. 8.10 10.10 pm. Sun. 7.40-9.40 am.		
15.155	SBT	MOTALA, SWEDEN, 19.80 m. 1-4.15 pm. Wed., Sats. 8-9 pm.	<b>25 Met. Broadcast Band</b>		11.940	T12XD	SAN JOSE, COSTA RICA, 25.13 m. La Voz del Pilot. Apartado 1729. 7.30 am.-noon, 4-10 pm.
15.150	YDC	BANDOENG, JAVA, 19.8 m., Addr. N. I. R. O. M. 6-9 pm. ex. Sat., 10.30 pm.-2 am., Sat. 7.30 pm.-2 am., daily 4.30-10.30 am.	11.910	CD1190	VALDIVIA, CHILE, 25.19 m., P. O. Box 642. Relays C869 10 am.-1 pm., 3-6, 7-10 pm.		
15.140	GSF	DAVENTRY, ENG., 19.82 m., Addr. (See 17.79 mc.) 5.45 am.-8.50, 9 am.-noon; 4.20-6: 6.20-9.15 pm.	11.910	—	HANOI, FRENCH INDO-CHINA, 25.19 m. "Radio Hanoi", 11.45-1.15 am., 7.30-9.30 am., 150 watts.		
15.135	JLU3	TOKYO, JAPAN, 19.82 m., 8-9.30 am. to China.	11.900	XEW1	MEXICO CITY, MEXICO, 25.21 m., Addr. P. O. Box 2874. Mon., Wed., Fri. 3-4 pm., 9 pm.-12 m. Tues. and Thur. 7.30 pm.-12 m., Sat. 9 pm.-12 m., Sun. 12.30-2 pm.		
15.130	TPB6	PARIS, FRANCE, 19.83 m., Addr. "Paris Mondial," 98 Bis Blvd. Haussmann, 1-4 am.	11.900	XGOY	CHUNGKING, CHINA, 25.21 m., 5.30-7.10 am. to North Asia, 7.15-7.55 am. to Japan, 8-10.30 am. to South Asia. 11-11.45 am. to U.S.S.R. 4-6.30 pm. to Europe.		
15.130	WSLR	BOSTON, MASS., 19.83 m., Addr. World-Wide B'cast'g Foundation, University Club, 2.30-5.30 9-10 pm. ex. Wed., Sat., Sun., 2.30-3 pm.	11.895	2RO13	ROME, ITALY, 25.23 m. Irregular 6-9 pm.		
15.120	SP19 *	WARSAW, POLAND, 19.84 m.	11.885	TPB11	PARIS, FRANCE, 25.24 m., 8.30-11 pm. beamed to U.S.		
15.120	HVJ	VATICAN CITY, 19.84 m., 10.30-10.45 am., Tues., Sun. 1-1.30 pm.	11.885	TPB12	PARIS, FRANCE, 25.24 m. (See 15.245 mc.) 6-8.15 pm. Beamed to S. A.		
15.120	CSW4	LISBON, PORTUGAL, 19.84 m., 6-8 am., irreg.	11.880	VLR3	MELBOURNE, AUSTRALIA, 25.25 m. 3.30 pm.-midnight.		
15.110	DJL	BERLIN, GERMANY, 19.85 m., Addr. (See 15.280 mc.) 12.10-2, 8-9 am., 10.40 am.-4.25 pm.	11.870	WPIT	PITTSBURGH, PA., 25.26 m., Addr. (See 21.540 mc.) 1-10 pm.		
15.100	CB1510	VALPARAISO, CHILE, 19.87 m. Testing near 7.30 am.	11.870	VUM2	MADRAS, INDIA, 25.26 m. M.W.F. 3.30-4 am. Irregular.		
15.100	2RO12	ROME, ITALY, 19.87 m. Testing irreg.	11.865	—	BERNE, SWITZERLAND, 25.28 m. Irreg. 8-9 pm. to No. Amer.		
15.080	RKI	MOSCOW, U.S.S.R., 19.95 m. Works Tashkent near 7 am. Broadcasts in English. Daily 7-9 pm.	11.860	GSE	DAVENTRY, ENG., 25.30 m., Addr. (See 11.75 mc.) 6 am.-12.45 pm.		
<b>End of Broadcast Band</b>			11.855	XMHA	SHANGHAI, CHINA, 25.31 m. 5-11 am.		
14.960	RZZ	MOSCOW, U.S.S.R., 20.05 m., Thurs. 6 pm. Dutch program.	11.855	DJP	BERLIN, GERMANY, 25.31 m., Addr. (See 15.200 mc.) 12.05-2 am., 4.50-10.50 pm.		
14.930	PSE	RIO DE JANEIRO, BRAZIL, 20.09 m. Broadcasts 6-7 pm., Wed. 4-4.10 pm., Thurs. 3-3.30 pm.	11.850	CB1185	SANTIAGO, CHILE, 25.32 m. Sat. 6-11 pm. and irreg.		
14.920	KQH	KAHUKU, HAWAII, 20.11 m. Sats. 7.30-8 pm., Sun. 9-9.30 pm.	11.850	OAX2A	TRUJILLO, PERU, 25.32 m. Testing on this freq. (See 12.200).		
14.795	IQA	ROME, ITALY, 20.28 m. 4.30-5 am. In Arabic.	11.840	KZRM	MANILA, P. I., 25.35 m. Addr. Erlanger & Gallinger, Box 283. 9 pm.-10 am. Irregular.		
14.600	JVH	NAZAKI, JAPAN, 20.55 m. Works Europe 4-8 am. Rel. JOAK Irr. after midnight.	11.840	C5W	LISBON, PORT., 25.35 m. Nat'l Broad. Station. 11.30 am.-1.30 pm. Irregular.		
14.535	HBJ	GENEVA, SWITZERLAND, 20.64 m. Addr. Radio Nations. Broadcasts Tues. 6.45-8.15; 8.45-10.00 pm.					
* Operation subject to hostilities of war.							
11.840	OLR4A	PRAGUE, BOHEMIA, 25.35 m., Addr. Czech Shortwave Sta., Praha XII, Fochova 16. Daily 6.45-9 pm.	11.830	WCBI	CHICAGO, ILL., 25.36 m., Addr. Chicago Federation of Labor. Irregular 7 am.-6 pm.		
11.830	WCBX	NEW YORK CITY, 25.34 m., Addr. Col. Broad. System, 485 Madison Av., N.Y.C. 9-11.30 pm.	11.826	XEBR	HERMOSILLA, SON., MEX., 25.37 m., Addr. Box 68. Relays XEBH. 9.30-11 am., 1-4 pm., 9 pm.-12 m.		
11.810	ZRO4	ROME, ITALY, 25.4 m., Addr. E.I.A.R., Via Montello 5. Daily 4.30-8.45 am., 10 am.-2.30 pm., 6-9 pm.	11.805	OZG	SKAMLEBAK, DENMARK, 25.41 m. Addr. Statsradiofonien. Irreg.		
11.800	COGF	MATANZAS, CUBA, 25.42 m., Addr. Gen. Betancourt 51. Relays CMGF. 2-3, 4-5, 6 pm.-Mid.	11.800	JZJ	TOKYO, JAPAN, 25.42 m., Addr. Broadcasting Co. of Japan, Overseas Division 7-9.30 am., 2-4 pm.		
11.795	DJO	BERLIN, GERMANY, 25.42 m. Addr. (See 15.280 mc.) Irreg.	11.790	WSLR	BOSTON, MASS., 25.45 m., Addr. (See 15.250 mc.) 2.30-5.30 pm. Sat., 2-6.30 pm.		
11.780	—	LUXEMBURG, LUXEMBURG, 25.47 m. Radio Luxemburg. Heard 8.30-10 pm.	11.780	HP5G	PANAMA CITY, PAN., 25.47 m., Addr. Box 1121. Noon-1 pm., 6-10 pm.		
11.780	OFE	LAHTI, FINLAND, 25.47 m. Addr. (See OFD, 9.5 mc.) 1.05-3 am., 5-6.20, 10 am.-12.30 pm.	11.775	MTCY	HSINGKING, MANCHUKUO, 25.48 m. Addr. Central Broadcasting Station. 1.30-2.15 am.		
11.770	DJD	BERLIN, GERMANY, 25.49 m., Addr. (See 15.280 mc.) 11.30 am.-4.25 pm., 4.50-10.50 pm.	11.760	TGWA	GUATEMALA CITY, GUAT., 25.51 m. (See 17.8 mc.) Irregular 10-11.30 pm. Sun. 6-11.30 pm., irregular.		
11.760	XETA	MONTEREY, MEX. 25.51 m., Addr. Box 203. Relays XET, n.-3.30 pm. and evenings.	11.760	OLR4B	PRAGUE, BOHEMIA, 25.51 m. Addr. (See 11.840 mc.) Daily exc. Sun. 8.25-10.05 am.		
11.760	OLR4B	PRAGUE, BOHEMIA, 25.51 m. Addr. (See 11.840 mc.) Daily exc. Sun. 8.25-10.05 am.	11.750	GSD	DAVENTRY, ENG., 25.53 m., Addr. B.B.C., London, 1.30-3.45 am., 12.25-4, 4.20-6, 6.20-9.15, 9.40-11.30 pm.		
11.740	SP25 *	WARSAW, POLAND, 25.55 m.	11.740	SP25 *	WARSAW, POLAND, 25.55 m.		
11.740	HVJ	VATICAN CITY, 25.55 m. Tues. 8.30-9 am.	11.740	HVJ	VATICAN CITY, 25.55 m. Tues. 8.30-9 am.		
11.740	CR6RC	LOANDA, ANGOLA, 25.55 m., Tues., Thurs., Sat. 2-3.30 pm.	11.735	COCX	HAVANA, CUBA, 25.57 m. P. O. Box 32. Daily 8 am.-12 m. Sun. 8 am.-1 am. Relays CMX.		
11.735	LKQ	OSLO, NORWAY, 25.57 m. 4.30-6.40 am., Sun. 2.30-6.40 am.	11.735	LKQ	OSLO, NORWAY, 25.57 m. 4.30-6.40 am., Sun. 2.30-6.40 am.		
11.730	PHI	HUIZEN, HOLLAND, 25.57 m., Addr. N. V. Philips' Radio.	11.730	PHI	HUIZEN, HOLLAND, 25.57 m., Addr. N. V. Philips' Radio.		
11.730	WSLR	BOSTON, MASS., 25.58 m., Addr. World-Wide B'cast'g Foundation, University Club. Daily 6.30-8.30, 8.45-10 pm., Sat., Sun. 1.30-5 pm.	11.725	JVW3	TOKYO, JAPAN, 25.57 m. Now on regular schedule from 1.15 am. daily on, and irregular from 4-7.30 am.		
11.720	CJRXX	WINNIPEG, CANADA, 25.6 m., Addr. James Richardson & Sons, Ltd. Daily 6 pm.-12 m., Sat. 6 pm.-Sun. 4 am.	11.720	ZP14	VILLARICA, PARAGUAY, 25.60 m. Mon. to Fri. 5-8 pm., Sat.-Sun. 11 am.-6 pm.		
11.718	CR78H	LAURENCO MARQUES, PORTUGUESE E. AFRICA, 25.6 m. Daily 12.05-1, 4.30-6.30, 9.30-11 am., 12.05-4 pm., Sun. 4-7 am., 10 am.-2 pm.	11.715	TPA4	PARIS, FRANCE, 25.61 m., (See 15.245 mc.) 6-3.15, 8.30-11 pm. to No. America.		

(Continued on page 410)

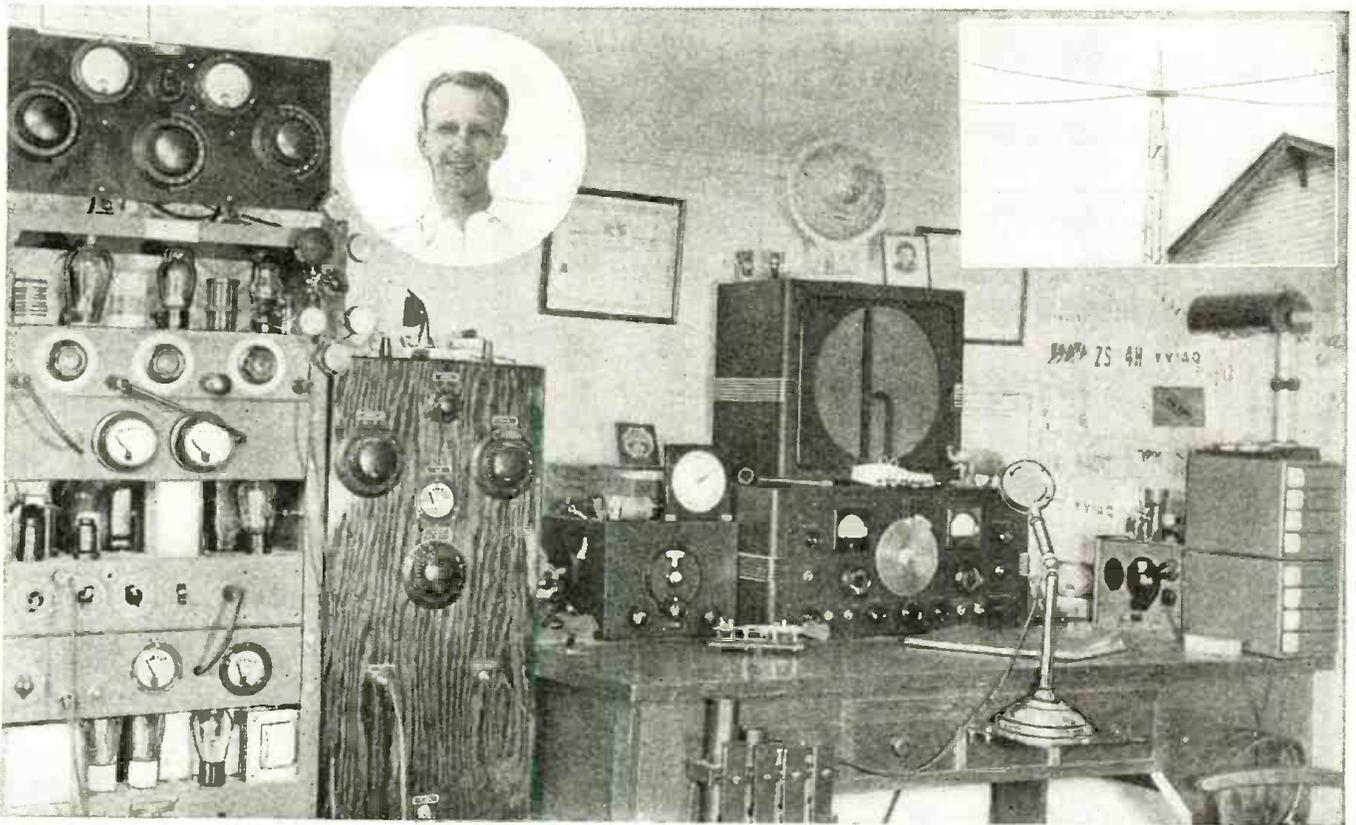

One of the best designed "ham" stations we have seen. Inset are Mr. Wiley's antenna and his portrait.

## New "Award of Honor" PLAQUE

Given Monthly for the Best  
*Amateur Station*  
PHOTO

2nd Plaque Award Goes to  
*W. B. Wiley, W9QDD*

● HERE is a picture of my radio station which is at present operating portably in the 5th call area at Watonga, Oklahoma. The home QTH of this station is Washington, Indiana. Other photos show myself and the antenna.

The rig is a Gross CB55 with a few added features. A third power supply has been added which delivers 800 volts to the final, giving an input of 120 watts on phone. An overmodulation indicator has also been built into the rig, which is capable of operation on all five bands, 160 through 10 meters, but is only used on 40, 20 and 10. About 90 per cent of the work is on 20 meter phone. A total of 36 countries has been worked on 20 meter phone, and all continents but Asia.

The tube lineup is as follows: Modulator—6C5, 6N7, 6C5s, to 6L6s. The modulator has separate power supply with an 83. R.F. Section is a 42, a 6L6, and two T20s. The power-supply for the oscillator and buffer stage uses an 83, while that for the T20s uses 866 Jrs.

The antenna coupler is a series-parallel affair containing an antenna change-over relay. A crystal-switching arrangement containing 6 crystals is used, and 3 bands are worked with each crystal. The mike is a D104. Break-in is employed, it being necessary to manipulate only one switch to transmit or receive.

(Continued on page 429)

**RADIO & TELEVISION**

**THIS**  
*Award of Honor*  
Presented to

*W. B. Wiley, W9QDD*

*by*

**RADIO & TELEVISION**  
**MAGAZINE**

for the  
**Best**  
**PHOTOGRAPH**  
of an  
**AMATEUR RADIO STATION**

Submitted in the monthly  
**Amateur Station Photo Contest**

*H. Gensback, Editor*

Here is the new "Award of Honor" Plaque which measures 5" x 7" in size. It is handsomely executed in colors on metal, and is framed, ready to hang on the wall. The letters appear in gray against a beautiful black background, and we are sure that our amateur friends who are awarded one of these new "badges of merit" will be more than pleased with it. The name of the winner will be suitably inscribed.

Mc.	Call	Station	Time
11.710	YSM	SAN SALVADOR, EL SALVADOR, 25.62 m., Addr. (See 7.894 mc.) 1-2.30 pm.	
11.710	—	SAIGON, FRENCH INDO-CHINA. 25.62 m., Addr. 80y-Landry, 17 Place A Foray. 7.30-9.45 am.	
11.705	SBP	MOTALA, SWEDEN, 25.63 m., 1-4.15 pm. Sun. 3 am.-4.15 pm. Wed and Sat. 8-9 pm.	
11.700	HPSA	PANAMA CITY, PAN., 25.64 m. Addr. Radio Teatro, Apartado 954. 10 am.-1 pm., 5-10 pm. Sun. 6-10 pm. 7-8.30 am.	
11.700	CBI170	SANTIAGO, CHILE, 25.65 m. Addr. P.O. Box 706. Relays CB89 10 am.-2 pm., 3.30-11 pm.	
<b>End of Broadcast Band</b>			
11.676	IQY	ROME, ITALY, 25.7 m. 5.20-5.40 am. ex. Sun., Daily 12.07-12.56, 1.50-2.30 pm.	
11.535	SPD*	WARSAW, POLAND, 26.01 m. Addr. S Mazowiecka St. 6-9 pm.	
11.402	HBO	GENEVA, SWITZERLAND, 26.31 m., Addr. Radio Nations. 1st Sun of mo. 12.45-2.30 am., 1.45-2.30 pm. Mon. 6.45-8.15 pm., 8.45-10.15 pm., Tues. 12.45-2.45 pm. Sun. 8.45-10 pm.	
11.040	CSW5	LISBON, PORTUGAL, 27.17 m., Addr. Nat. Broad Sta. 11 am.-4.30 pm. Sun. 10 am.-4.30 pm.	
11.000	PLP	BANDOENG, JAVA, 27.27 m. Relays YDB, 6-9 pm., 10.30 pm.-2 am., 4.30-10.30 or 11 am. Sat. until 11.30 am.	
10.950	—	TANANARIVE, MADAGASCAR, 27.40 m., Addr. (See 9.38 mc.) 12.30-45, 10-11 am., 2.30-4 am.	
10.670	CEC	SANTIAGO, CHILE, 28.12 m. Irregular.	
10.660	JVN	NAZAKI, JAPAN, 28.14 m. Broadcasts daily 1.50-7.40 am. Works Europe irregularly at other times.	
10.535	JIB	TAIHOKU, TAIWAN, 28.48 m. Works Japan around 6.25 am. Broadcasts, relaying JFAK 9-9.55 am., 1-2.30 am. Sun. to 10.15 am.	
10.400	YSP	SAN SALVADOR, EL SALVADOR, 28.85 m., 1-3, 6.30-11 pm.	
10.360	EAJ43	TENERIFE, CANARY ISL., 28.96 m., 3-4.30, 5-7, 7.45-8.45, 9-10 pm.	
10.350	LSX	BUENOS AIRES, ARG., 28.98 m., Addr. Transradio International. Tests irregularly.	
10.330	ORK	RUYSELEDE, BELGIUM, 29.04 m. Broadcasts 1.30-3 pm. To Belgian Congo. Works OPM 1-3 am., 3-5 pm.	
10.260	PMN	BANDOENG, JAVA, 29.24 m. Relays YDB 6-9 pm., 10.30 pm.-2 am., 4.30-10.30 or 11 am., Sat. to 11.30 pm.	
10.220	PSH	RIO DE JANEIRO, BRAZIL, 29.35 m., Addr. Box 709. Broadcasts 6-7 pm., Mon. 8-8.30 pm., Fri. 7-7.30 pm.	
10.100	—	DEUTSCHE FREIHEITS SENDE, 29.70 m., loc. in Germany, under-cover, 4-5 pm.	
10.050	TIEMT	SAN JOSE, COSTA RICA, 29.85 m., 4.30-8 pm.	
10.050	DZC	ZEESEN, GERMANY, 29.16 m., Addr. (See 15.360 mc.) Irregular.	
10.042	DZB	ZEESEN, GERMANY, 29.87 m., Addr. Reichspostzentramt. Irregular.	
9.985	COBC	HAVANA, CUBA, 30.05 m. Addr. P. O. Box 132. Relays CMBC 6 am.-12 mid.	
9.925	JDY	DAIREN, MANCHUKUO, 30.23 m. Relays JOAK daily 7-8 am. Works Tokyo occasionally in early am.	
9.892	CPI	SUCRE, BOLIVIA, 30.33 m., 11 am.-n., 7-9 pm.	
9.855	EAQ	MADRID, SPAIN, 30.45 m., Addr. P. O. Box 951. 7.30-8, 8.40-9 pm. 3.45-4.05, 4.45-5.05 am., also.	
9.830	IRF	ROME, ITALY, 30.52 m. Works Egypt afternoons. Relays 2RO, 12-12.25 pm. Thurs. Daily 12.40-1, 1.50-2.30, 6-9 pm.	
9.815	COCM	HAVANA, CUBA, 30.57 m. Addr. Transradio Columbia, P. O. Box 33. 8-1 am. Relays CCMC.	
9.785	HH3W	PORT-AU-PRINCE, HAITI, 30.66 m. Addr. P. O. Box A117. 1-2, 7-9.15 pm.	

Mc.	Call	Station	Time
9.755	ZRO	DURBAN, SOUTH AFRICA, 30.75 m. Addr. S. A. Broadcasting Corp., P. O. Box 4559, Johannesburg. From Nov. 1, daily exc. Sat. 11.45 pm.-12.50 am. Daily exc. Sun. 5.30-7, 9-11.15 am. Sun. 5.30-7.	
9.740	CSW7	LISBON, PORTUGAL, 30.80 m. Addr. Nat. Broad. Sta. n-2 p.m., 6-9 pm. for No. Amer.	
9.730	CB970	VALPARAISO, CHILE, 30.83 m., 6.30-11.30 pm., or mid.	
9.708	COCQ	HAVANA, CUBA, 30.90 m. Addr. 25 No. 445, Vedado, Havana, 7-1 am. Sun. 6.55 am.-1 am.	
<b>31 Met. Broadcast Band</b>			
9.705	—	FORT DE FRANCE, MARTINIQUE, 30.92 m., Addr. P. O. Box 136. 6-8.10 pm. Irr. to 9.30 pm.	
9.695	JIE2	TYUREKI, TAIWAN, 30.95 m. 9.05-10.20 am.	
9.690	T14NRH	HEREDIA, COSTA RICA, 30.96 m., Addr. Amendo C. Marin, Apartado 40. Mon. to Thur. 6-9 pm., Fri. 4-9 pm., Sat.-Sun. 5.40-9.40 am.	
9.690	LRAI	BUENOS AIRES, ARG., 30.96 m., 6-9 pm. Mon-Thur., 4-9 pm. Fri., 7-9 pm. Sat.	
9.690	—	TANANARIVE, MADAGASCAR, 30.96 m., 12.30-1.45, 3.30-4.30, 10-11 am., Sun. 2.30-4 am.	
9.690	ZHP	SINGAPORE, MALAYA, 30.96 m. Sun. 5.40-9.40 am., Wed. 12.40-1.40 am., Mon.-Fri. 4.40-9.40 am., Sat. 12.25-1.40 am., 4.40-9.40 am., 10.40 pm.-11.0 am. (Sun.)	
9.690	GRX	DAVENTRY, ENGLAND, 30.96 m., Addr. See GSC, 9.58 mc. 1-6, 6.20-9.15 pm.	
9.685	TGWA	GUATEMALA CITY, GUAT., 30.96 m. Daily 10-11.30 pm.; Sun. 7-10.45 pm.	
9.683	HNF	BAGHDAD, IRAQ, 30.98 m. 6 am.-3 pm.	
9.680	TPB	PARIS, FRANCE, 30.99 m. "Paris Morcial" 6-11 pm.	
9.675	—	SAIGON, INDO-CHINA, 31.01 m., Addr. 17, Place A. Foray. "Radio Boy-Lar-dry." 7.30-9.45 am. Irreg.	
9.675	DJX	BERLIN, GERMANY, 31.01 m., Addr. (DJD, 11.77 mc.) 10.40 am.-4.25 pm. To Africa.	
9.670	WRCA	BOUND BROOK, N. J., 31.03 m. Addr. NBC, N. Y. C. 6 pm.-1 am.	
9.665	2RO9	ROME, ITALY, 31.04 m. 12.40-1, 1.37-5.30 pm., 6-6.30 pm.	
9.660	LRX	BUENOS AIRES, ARG., 31.06 m., Addr. El Mundo, Relays LRI, 6-6.45 am.-9.15 am.-10 pm.	
9.660	HVJ	VATICAN CITY, 31.06 m. Sun. 5-5.30 am.	
9.650	WCBX	NEW YORK CITY, 31.09 m. (See 21.570 mc. for addr.) Irregular.	
9.650	CS2WA	LISBON, PORTUGAL, 31.09 m., Addr. Radio Colonial. Tues., Thurs. and Sat. 4-7 pm.	
9.650	IABA	ADDIS ABABA, ETHIOPIA, 31.09 m., 3.55-4.05, 4.15-4.45, 11 am.-noon, 1-3 pm. Surs. 3.30-3.55 am.	
9.645	JLT2	TOKYO, JAPAN, 31.10 m.	
9.640	CXA8	COLONIA, URUGUAY, 31.12 m., Addr. Belgrano 1841, Buenos Aires, Argentina. Relays LR3, Buenos Aires 5 am.-10.45 pm. Sat. to 1 am.	
9.635	2RO3	ROME, ITALY, 31.13 m., Addr. (See 11.810 mc.) 12.07-3 pm., 5.30-9 pm., also Mon. 3.50-4.05 pm., Fri. and Sat. 4-4.20 pm.	
9.630	JFO	TAIHOKU, TAIWAN, 31.15 m. Relays JFAK. 4-10.30 am.	
9.620	CXA6	MONTEVIDEO, URUGUAY, 31.19 m., Rel. CX 6 to 9 pm.	
9.610	LLG	OSLO, NORWAY, 31.22 m., 3-6, 8-9, 11 pm.-mid.	
9.610	DXB	BERLIN, GERMANY, 31.22 m. 6-10.50 pm. irreg. to No. America.	
9.606	ZRL	KLIPHEVAL, SOUTH AFRICA, 31.23 m., Addr. P. O. Box 4559, Johannesburg. Daily, exc. Sat. 11.45 pm.-12.50 am. Daily exc. Sun. 3.20-7.20, 9-11.45 am., Sun. 3.30-4.30 or 4-5, 5.30-7, 9-11.45 am.	
9.600	RAN	MOSCOW, U.S.S.R., 31.25 m. Daily exc. Sun. 6-10 pm. Sun. 6-7, 9.15-10 pm.	

Mc.	Call	Station	Time
9.600	CB960	SANTIAGO, CHILE, 31.25 m., 8-11.30 pm.	
9.600	GRY	DAVENTRY, ENG., 31.25 m., Addr. See GSC, 9.58 mc., Irreg. 12.25-6 pm.	
9.595	—	MOYDRUM, ATHLONE, EIRE, 31.27 m., Radio Eireann. 12.30-4.30 pm. Irreg.	
9.595	HBL	GENEVA, SWITZERLAND, 31.27 m., Addr. Radio Nations. Irregular.	
9.590	HPSJ	PANAMA CITY, PANAMA, 31.28 m. Addr. Apartado 867. 12 n. to 1.30 pm., 6.30-10.30 pm.	
9.590	VUD2	DELHI, INDIA, 31.28 m. Addr. All India Radio, 1.30-3.30 am., 7.30 am.-12.30 pm., 8.30-10.30 pm.	
9.590	PCJ	HUIZEN, HOLLAND, 31.28 m., Addr. (See 15.220 mc.) Sun. 2-3, 7.15-9.25 pm. Tues. 1.45-3.30, 7-8.30, 8.45-10.15 pm., Wed. 7.15-8.40 pm., Fri. 8-9 pm.	
9.590	VK6ME	PERTH, W. AUSTRALIA, 31.28 m., Addr. Amalgamated Wireless of Australasia, Ltd. 6-8 am. exc. Sun.	
9.590	VK2ME	SYDNEY, AUSTRALIA, 31.28 m., Addr. Amalgamated Wireless of Australasia, Ltd., 47 York St., Sundays only—Oct., 12.30-2.30, 4.30-8.30, 9.30-11.30 am.; Nov. 1-3, 4.30-8.30, 9-11 am.	
9.590	WCAB	PHILADELPHIA, PA., 31.28 m. (Addr. See 21.52 mc.) Mon., Thurs. & Sat. 6.30 pm.-2 am., Wed. 9 pm.-2 am.	
9.580	GSC	DAVENTRY, ENGLAND, 31.32 m., Addr. 8, 8, C., Portland Pl., London, W. 1., 12.25-4, 4.20-6, 6.20-9.15, 9.40-1.30 pm.	
9.580	VLR	MELBOURNE, AUSTRALIA, 31.32 m. Addr. Box 1686, G. P. O. Daily exc. Sat. 3.30-7.15 pm., Sat. 5-10.30 pm. Daily exc. Fri., Sat. 9 pm.-8.30 am., Fri. 9 pm.-9 am. (Sat.), Sat. 12 m.-7.30 am. (Sun.)	
9.570	KZRM	MANILA, P. I., 31.35 m., Addr. Erlanger & Galinger, Box 283, Wkdays 4.30-6 pm. m. tof. 5-9 am., Sat. 5-10 am., Sun. 4-10 am.	
9.570	WBOS	BOSTON, MASS., 31.35 m., Addr. Westinghouse Electric & Mfg. Co. 7-1 am., Sun. 8 am.-1 am.	
9.566	OAX4T	LIMA, PERU, 31.37 m., 7-8, 11.30 am.-1.30 pm.	
9.560	XGAP	PEKING, CHINA, 31.38 m. Addr. S. Yoshimura, Dir. Peking Central Sta., Hsi-chen-an-chieh, Peking. 4-9 am.	
9.560	DJA	BERLIN, GERMANY, 31.38 m., Addr. Broadcasting House. 6.30-10.50 pm.	
9.550	HVJ	VATICAN CITY, 31.41 m., Sun. 5-5.30 am., Wed. 2.30-3 pm.	
9.550	TPBII	PARIS, FRANCE, 31.41 m. Addr. (See 15.245 mc.) 11.15 am.-7 pm., 9.30 pm.-mid. Irreg.	
9.550	WGEA	SCHENECTADY, N. Y., 31.41 m., General Electric Co., 5.15-8.15 pm. to So. Amer.	
9.550	OLR3A	PRAGUE, BOHEMIA, 31.41 m. (See 11.840 mc.) Irreg. 4.40-5.10 pm.	
9.550	XEFT	VERA CRUZ, MEX., 31.41 m. 10.30 am.-4.30 pm., 10.30 pm.-12.30 am.	
9.550	YDB	SOERABAJA, JAVA, 31.41 m., Addr. N.I.R.O.M. Daily exc. Sat. 6-7.30 pm., 10.30 pm.-2 am.-4.30-10.30 am. Sat. 7 pm.-2 am.	
9.550	VUB2	BOMBAY, INDIA, 31.41 m., Addr. All India Radio. 9.30-10.30 pm., 1-3.30 am. 5-6 am. also.	
9.540	DJN	BERLIN, GERMANY, 31.45 m., Addr. (See 9.560 mc.) 12.05-2.30, 9.30-11 am., 4.55-10.50 pm. to So. Amer.	
9.538	VPD2	SUYA, FIJI ISLANDS, 31.46 m., Addr. Amalgamated Wireless of Australasia, Ltd. 5.30-7 am., exc. Sun.	
9.535	SBU	MOTALA, SWEDEN, 31.46 m. 4.15-5.05 pm.	
9.535	ZJI	TOKYO, JAPAN, 31.46 m. 4.30-5.30 pm.	
9.535	—	SCHWARZENBURG, SWITZERLAND, 31.46 m., 1-2 pm. 6.45-7.45, 8-9 pm.	
9.530	KGEI	SAN FRANCISCO, CAL., 31.48 m., Addr. Gen. Elec. Co., 12 m.-3 am., 7 am.-12 n. to Asia.	

(Continued on page 412)

All Schedules Eastern Standard Time

# What Do YOU Think?

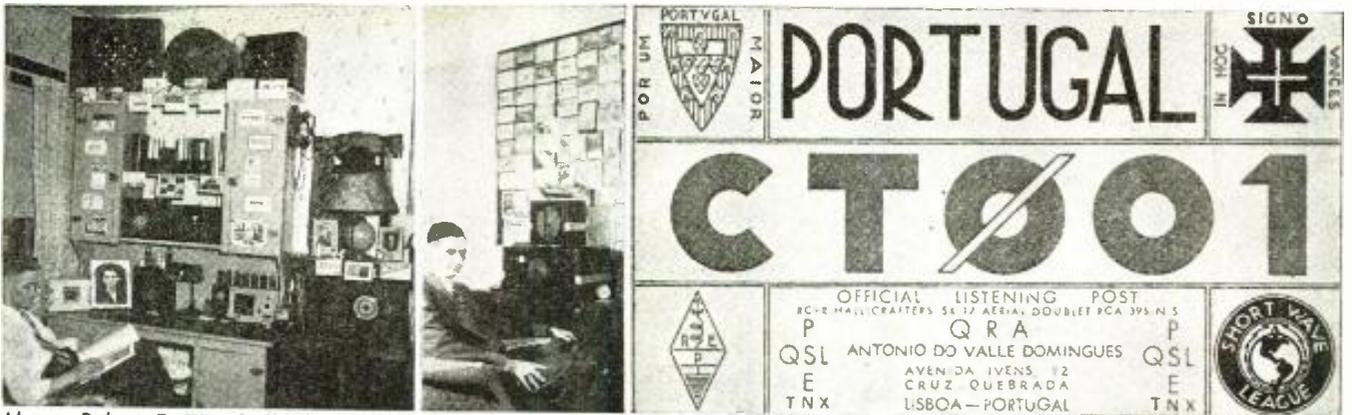

Above—Robert F. Clough (left) with his FB listening post; All but one of the sets were built from "R. & T." circuits. Harold G. Seixas (center) has pulled in 68 veris with his post. Handsome red and green card (right) from Lisboa, Portugal, carries a good-will message from Antonio Do Valle Domingues, CT001.

## What He Likes

Editor:

Joe Miller's column and "What Do YOU Think?" are very interesting to me. The "What Do YOU Think?" section gives us a chance to meet other people and to learn their opinions on general topics.

Of course, Joe Miller's column gives us an easy way of getting in touch with other stations throughout the world.

Wishing R. & T. increased sales, I remain,  
NORMAN E. WHITON,  
76 Green St.,  
Greenwood, Mass.

## How SWL's Should Report!

Editor:

I have just read Mr. Gordon's reply to "SWL Punks." I agree with him full-heartedly. If the SWL's would be more careful and complete in their reports, they wouldn't have to crab so much. Every report should contain the following information:

(1) Name of station. (2) Frequency or band. (3) QSA, R, T. (4) Date. (5) Time. (6) Programs heard. (7) QRN (fading, static, etc.) (8) Calls of interfering stations. (9) Local weather. (10) Receiving equipment used.

I have been SWL'ing for quite a while and have never had to crab. Here's hoping that R. & T. never changes its style. Good luck to all of you.

73 and 88,

DON GARDNER,  
9 Temple Court,  
Waterville, Me.

## "R. & T." Like Gold on His Bookshelf!

Editor,

I have been buying RADIO & TELEVISION since 1937 and I consider it to be a fine magazine—the finest magazine in the world, I think. The "Joe Miller" column is sure a hit, also the World S.W. Station list. The S.W. circuits I'm mostly interested in. The more the merrier, I say, and I'm sure listeners will agree with me. Anyhow, you know how to produce a fine S.W. magazine over there. The magazines here in England are not worth a button—(that's honestly speaking). I have about 30 of your magazines and they are like gold upon my book-shelf. I prize them greatly, so keep up

## The War and QSL's

Now that the world burns once more in the flame of war, veris from Europe and elsewhere may be more difficult. Watch your daily papers for lists of belligerent countries; it will do you little good to seek veris or Ham contacts from most of them. When conducting "letter swaps," remember that there will be rigid censorships in most warring nations; therefore, do not discuss anything of a military nature in such communications, but confine yourself to radio and personalities.

the exceedingly splendid work.

By the way, the magazines I pick up over here are back numbers, but they are worth waiting for.

E. W. SMITH,  
60, Frampton Park Road,  
Well Street, Hackney Eq.,  
London, England

## We Cover "Everything!"

Editor,

I have tried several other magazines to see which would be the better to buy and when I purchased RADIO & TELEVISION for my first time (the August issue), I decided on R & T because it covered everything that would be needed in various types of work, such as service men, amateurs, experimenters and SWL's. Your list of S-W stations I believe is a very fine one. I greatly enjoy reading "What Do YOU Think?" as well as the many other features you have.

I think a certificate, such as the V.A.C. given for veris from all countries in either South or North America would be a good idea.

With best of luck and 73

DICK EVANS,  
State Center, Iowa

## Antonio Has Nifty QSL Card

Editor,

I am a constant reader and subscriber of RADIO & TELEVISION, and as a good member of the Short Wave League I have gotten up a QSL card. I am forwarding one of these to you for publication in your magazine, if you believe it suitable. (It appears herewith.—Editor)

With my sincerest thanks for all the fine articles you publish and with best wishes to the Short Wave League and RADIO & TELEVISION, I beg to remain,

ANTONIO DO VALLE DOMINGUES CT001,  
Ave. Ivens 72 Cruz-Quebrada,  
Lisboa, Portugal

## But Are the Images Polarized?

Editor,

I have just finished reading the article by Bohke of R.C.A. on *Television Antennas*. I found it very interesting and instructive. But, to get down to "brass tacks", I've just got an idea from the article on a method for three dimensional television. Enclosed is a stamped envelope for an answer on its possibilities. You may print it, in fact I would like to see it in your magazine.

Here is my brainstorm!

Fig. 3 of the article shows a multi-path signal. The article states that the "ghost" may be as strong as the original image or so faint that it is barely visible. The ghost in the case given in the article was  $\frac{5}{8}$  inch to one side. These are bad conditions for present day television. My plan will use them.

My antennas shall be placed so that I get a ghost as strong as the original and between a half and one inch to the side of the original. I shall turn on my "teleeceiver" and don a pair of polarized glasses. The images through the glasses will be in three dimensions. This is the same principle as the movies shown at the Chrysler Building at the New York World's Fair. Of course I have to have the luck to have a building so placed that it will reflect the radio waves to make the ghost. I believe that if a building is not available, some type of directional or reflecting antenna can be devised.

WM. H. GREENBAUM,  
13 N. Central Ave.,  
Elmsford, N. Y.

(Continued on page 435)

Mc. Call		Mc. Call		Mc. Call	
9.530	WGEO	SCHENECTADY, N. Y., 31.48 m., Addr. General Electric Co. 3-11 pm.	9.188	HC2AB	ECUADOR, 32.65 m., nightly to 10 pm.
9.530	VUC2	CALCUTTA, INDIA. 31.48 m. Addr. All India Radic. 2.06-4.06 am. 10 pm.-2 am.	9.170	HCIGQ	QUITO, ECUADOR, 32.72 m., Mon. Wed., Sat. 9-9.55 pm.
9.526	XEDQ	GUADALAJARA, GAL., MEXICO, 31.49 m., N.-4.30 pm., 7 pm.-mid- night.	9.125	HAT4	BUDAPEST, HUNGARY, 32.88 m., Addr. "Radiolabor," Gyali-ut, 22. Daily 7-8 pm., Sat., 6-7 pm.
9.526	ZBW3	HONGKONG, CHINA, 31.49 m., Addr. P. O. Box 200. 5-10 am., 11.30 pm.-1.15 am. Sun 5-9.30 am.	9.124	HC2CW	GUAYAQUIL, ECUADOR, 32.88 m., 11 am.-1, 7-11 pm.
9.525	OQ2AA	LEOPOLDVILLE, BELGIAN CON- GO. 31.49 m. 5.25-7 am.	9.100	COCA	HAVANA, CUBA, 32.61 m. Addr. Galiano No. 102. Relays CMCA Noon-1.15 am. Irreg. to 3 am.
9.525	LKC	JELOY, NORWAY, 31.49 m., 4.30- 10.30 am., Sun. 2.30-10.30 am.	9.091	PJCI	CURACAO, D. W. INDIES, 33 m., 6.36-8.36 pm., Sun. 10.36 am.- 12.36 pm.
9.523	ZRG	ROBERTS HEIGHTS, S. AFRICA. 31.5 m., Addr. (See ZRK, 9.606 mc.) Daily exc. Sun. 5-7 am.; Sun. 5.30-7 am.	9.030	COBZ	HAVANA, CUBA, 33.32 m., Radio Salas Addr. P. O. Box 866. 7.45 am.-1.15 am. Sun. 7.45 am.-12 m. Relays CMBZ.
9.520	OZF	SKAMLEBAK, DENMARK, 31.51 m., Addr. Statsradiofonien, Heib- ergsgade 7, Copenhagen, 8-9.30, 6-9.05 am., and 8.30 pm.-2.40 am.	8.965	COKG	SANTIAGO, CUBA, 33.44 m. Addr. Box 137, 9-10 am., 11.30 am.-1.30 pm., 3-4.30, 5-6, 10-11 pm., 12 m.-2 am.
9.520	YSH	SAN SALVADOR, EL SALVADOR 31.51 m., Addr. (See 7.894 mc.) Irregular 6-10 pm.	8.960	TPZ2	ALGIERS, ALGERIA. 33.48 m. Tues. 12.30-1.30 pm.
9.520	RV96	MOSCOW, U.S.S.R. 31.51 m., 1-3, 4-7 pm., and irr.	8.841	HCJB	QUITO, ECUADOR, 33.5 m. 7-8.30 am., 11.45 am.-2.30 pm., 5-10 pm., except Mon. Sun. 12 m.- 1.30 pm., 5.30-10 pm.
9.510	GSB	DAVENTRY, ENGLAND, 31.55 m., Addr. (See 9.580 mc.—GSC) 12 m.-2.15 am., 6.20-9.15, 9.40 11.30 pm.	8.830	COCQ	HAVANA, CUBA, 33.98 m., 6.55 am 1 am.
9.510	—	TANANARIVE, MADAGASCAR, 31.55 m. Addr. Le Directeur des PTT, Radio Tananarive, Adminis- tration PTT. 12.30-12.45, 10-11 am., 2.30-4 am.	8.700	HKV	BOGOTA, COLOMBIA, 34.46 m. Tues. and Fri. 7-7.20 pm.
9.510	HS8PJ	BANGKOK, SIAM, 31.55 m. Daily Ex. Mon. 8-10 am.	8.645	COJK	CAMAGUEY, CUBA, 34.64 m., Addr. Finlay No. 3 Altos. 11.30 am.-12.30 pm., 3.30-6, 8-9 pm.
9.510	—	HANOI, FRENCH INDO-CHINA. 31.55 m. "Radio Hanoi", Addr. Radio Club de L'Indochine. 12 m.-2 am., 6-10 am. 15 watts.	8.665	W2XGB	HICKSVILLE, N. Y., 34.64 m., Addr. Press Wireless, Mon. to Fri. News at 9 am. and 5 pm.
9.503	XEWV	MEXICO CITY, MEX., 31.57 m. Addr. Apart. 2516. Relays XEW. 7-45 am.-12.30 am.	8.580	YNPR	MANAGUA, NICARAGUA, 34.92 m. Radiodifusora Pilot. 12.45-2.15, 6.45-10.15 pm.
9.501	PRF5	RIO DE JANEIRO, BRAZIL, 31.58 m., 4.45-5.55 pm. Ex. Suns.	8.572	—	BUCHAREST, ROUMANIA, 35.02 m., 8.15-10.30 am., 4-7 pm.
9.500	VK3ME	MELBOURNE, AUSTRALIA, 31.58 m., Addr. Amalgamated Wireless of Australasia, 167 Queen St. Daily except Sun. 4-7 am.	7.894	YSD	SAN SALVADOR, EL SALVADOR, 37.99 m., Addr. Dir. Genl. Tel. & Tel. 7-10.30 pm.
9.500	XGOY	CHUNGKING, CHINA, 31.58 m., 5.30-11.30 am., 2-6.20 pm., 9-10.45 pm.	7.870	HCIRB	QUITO, ECUADOR, 38.1 m. La Voz de Quito. 8.30-11.30 pm.
9.500	OFD	LAHTI, FINLAND, 31.58 m., Addr. Finnish Brst. Co., Helsinki. 12.15- 5 pm.	7.854	HC2JSB	GUAYAQUIL, ECUADOR, 38.2 m. 11 am.-2, 4-11 pm.
9.497	KZ1B	MANILA PHIL. ISL., 31.59 m., 6-9.05 am. and 8.30 pm.-2.40 am. Irreg.	7.797	HBP	GENEVA, SWITZERLAND, 38.48 m., Addr. Radio-Nations.
<b>==== End of Broadcast Band ====</b>					
9.465	TAP	ANKARA, TURKEY, 31.70 m., 11.30 am.-5 pm.	7.614	CR6AA	LOBITO, ANGOLA, 39.39 m., Mon., Wed., Sats. 2.30-4.30 pm. Also 7.177 mc.
9.445	HCODA	GUAYAQUIL, ECUADOR, 31.77 m., 8.15-10.15 pm., exc. Sun.	7.520	KKH	KAHUKU, HAWAII, 39.89 m., Fri. 9-10 pm., Sat. 1-1.30 am., 9.30-10 pm.
9.437	COCH	HAVANA, CUBA, 31.8 m., Addr. 2 B St., Vedado. 8 am.-11 pm. Sun. 8 am.-10 pm.	7.490	EAJ43	TENERIFE, CANARY ISL., 40.05 m., 8-9.30 pm. and Irreg.
9.390	OAX5C	ICA, PERU, 31.95 m., Radio Uni- versal, 7-11.30 pm.	7.450	T12RS	SAN JOSE, COSTA RICA. 40.27 m. "Radioemisora Athena". 7-11 pm.
9.355	HC1ETC	QUITO, ECUADOR, 32.05 m., Addr. Teatro Bolivar, Thurs. un- til 9.30 pm. 8-11 pm. Sats.	7.440	FG8AH	POINT-A-PITRE, GUADELOUPE, F.W.I., 40.32 m., 6-7.10 pm., also 9-10.30 pm. Irreg. P. O. Box 125.
9.350	COCD	HAVANA, CUBA, 32.08 m., Addr. Box 2294. Relays CMCD 10 am.- 11.30 pm. Sun. 10 am.-9 pm.	7.410	HCJ84	QUITO, ECUADOR, 40.46 m., 7- 9.30 pm. irregularly.
9.345	HBL	GENEVA, SWITZERLAND, 32.11 m., Addr. Radio Nations. Sun. 7-7.45, 8-8.45 pm. Mon. 6.50-8.15 pm.	7.380	XECR	MEXICO CITY, MEX., 40.65 m., Addr. Foreign Office. Sun. 6-7 pm.
9.340	OAX4J	LIMA, PERU, 32.12 m., Addr. Box 1166, "Radio Universal." 12 m.- 3 pm., 5 pm.-indefinite.	7.310	VIG	PORT MORESBY, PAPUA, 41.01 m., 2nd & 4th Sats. each month. 3-5 am.
9.295	H12G	CIUDAD TRUJILLO, D. R., 32.28 m., 6.40-8.40 am., 11.40 am.-2.10 pm., 3.40-4.40 pm.	7.295	JIE	TYUREI, TAIWAN, 41.13 m. 9.05- 10.20 am.
9.280	LYR	KAUNAS, LITHUANIA, 32.33 m. Daily 12-12.40 am., and 2.30-3 pm. Sun. 1.30-2.15, 6-7.45, 11.30 am.-1.15 pm., 2-3.30 pm.	7.280	TPB12	PARIS, FRANCE, 41.21 m., 10.15 am.-5.15 pm.
9.200	ZMEF	SUNDAY ISLAND, 32.61 m., Confs. ZILS, N.Z. 1.45-2.15 am. Irreg.	7.260	CSW8	LISBON, PORTUGAL, 41.32 m., addr. Emisora Nacional de Ra- diodifusao, rua do Quelhas. Tue., Thurs., Sat. 4.05-5 pm.
9.200	COBX	HAVANA, CUBA, 32.61 m. Addr. San Miguel 194, Altos. Relays CMBX 8 am.-11.30 pm.	7.260	GSU	DAVENTRY, ENGLAND, 41.32 m. Irregular.
			7.250	YDA	TANDJONGPRIOK, JAVA, 41.3P m., Addr. N.I.R.O.M., Batavia, 10.30 pm.-2 am.; Sat. 7.30 pm.- 2 am.
			7.230	GSW	DAVENTRY, ENGLAND, 41.49 m. 6 am.-12.45 pm. To Europe.
			7.220	YDX	MEDAN, SUMATRA, N. E. I., 41.55 m. Daily exc. Sat., 10.30 pm.- 2 am. Sat. 7.30 pm.-1.30 am. Irreg. to 9 am.
			7.200	Y15KG	BAGHDAD, IRAQ, 41.67 m., 7.30 am.-4 pm.
			7.200	YNAM	MANAGUA, NICARAGUA, 41.67 m. Irregular at 9 pm.
7.177	CR6AA	LOBITA, ANGOLA, PORT. WEST AFRICA. 41.75 m., Mon., Wed., and Sats. 2.45-4.30 pm. Also see 7.614 mc.	6.712	YN3DG	LEON, NICARAGUA, 42.09 m., 2-2.30, 8.30-9.30 pm. ex. Suns.
7.100	FO8AA	PAPEETE, TAHITI, 42.25 m., Addr. Radio Club Oceanien. Tues. and Fri. 11 pm.-12.30 am.	6.700	XPSA	MERIDA, YUCATAN, 42.89 m., Addr. Calle 59, No. 517, "La Voz de Yucatan desde Merida." Irregular.
7.088	PIIJ	DORDRECHT, HOLLAND, 42.3 m., Addr. Dr. M. Hellingman, Techni- cal College. Sat. 11.10-11.50 am.	6.977	XBA	TACUBAYA, D. F., MEX., 43 m. 9.30 am.-1 pm., 7-8.30 pm.
6.990	XEME	MERIDA, YUCATAN, 42.89 m., Addr. Calle 59, No. 517, "La Voz de Yucatan desde Merida." Irregular.	6.970	XPSA	KWEIYANG, CHINA, 43.05 m., 5.30, or 6-11 am.
6.970	XPSA	MERIDA, YUCATAN, 42.89 m., Addr. Calle 59, No. 517, "La Voz de Yucatan desde Merida." Irregular.	6.960	ZZB	WELLINGTON, N. Z., 43.10 m., Mid-7 am.
6.880	XOJD	HANKOW, CHINA, 43.60 m., 6-8.30 am.	6.880	XOJD	HANKOW, CHINA, 43.60 m., 6-8.30 am.
6.805	HI7P	CIUDAD TRUJILLO, DOM. REP., 44.06 m., Addr. Emisora Diaria de Comercio. Daily exc. Sat. and Sun. 12.40-1.40, 6.40-8.40 pm. Sat. 12.40-1.40 pm. Sun. 10.40 am.- 11.40 am.	6.805	HI7P	CIUDAD TRUJILLO, DOM. REP., 44.06 m., Addr. Emisora Diaria de Comercio. Daily exc. Sat. and Sun. 12.40-1.40, 6.40-8.40 pm. Sat. 12.40-1.40 pm. Sun. 10.40 am.- 11.40 am.
6.790	PZH	PARAMARIBO, SURINAM, S.A. 44.16 m., Addr. P. O. Box 18. Sun. 8.40-10.40 am. Tues. & Fri. 5.40- 8.40 pm. 1st & 3rd Thurs. monthly 6.40-8.40 pm.	6.790	PZH	PARAMARIBO, SURINAM, S.A. 44.16 m., Addr. P. O. Box 18. Sun. 8.40-10.40 am. Tues. & Fri. 5.40- 8.40 pm. 1st & 3rd Thurs. monthly 6.40-8.40 pm.
6.775	HIH	SAN PEDRO DE MACORIS, DOM. REP., 44.26 m. 7-9.40 pm. Sun. 5.20-6.40 pm.	6.775	HIH	SAN PEDRO DE MACORIS, DOM. REP., 44.26 m. 7-9.40 pm. Sun. 5.20-6.40 pm.
6.730	HI3C	LA ROMANA, DOM. REP., 44.58 m., Addr. "La Voz de la Feria." 12.30-2 pm., 5-6 pm.	6.730	HI3C	LA ROMANA, DOM. REP., 44.58 m., Addr. "La Voz de la Feria." 12.30-2 pm., 5-6 pm.
6.720	PMH	BANDOENG, JAVA, 44.64 m. Re- lays N.I.R.O.M. programs. 4.30-11 or 11.30 am. Also Sat. 9.30 pm.- 1.30 am.	6.720	PMH	BANDOENG, JAVA, 44.64 m. Re- lays N.I.R.O.M. programs. 4.30-11 or 11.30 am. Also Sat. 9.30 pm.- 1.30 am.
6.690	TIEP	SAN JOSE, COSTA RICA, 44.82 m., Addr. Apartado 257, La Voz del Tropico. Daily 7-11 pm.	6.690	TIEP	SAN JOSE, COSTA RICA, 44.82 m., Addr. Apartado 257, La Voz del Tropico. Daily 7-11 pm.
6.675	HBQ	GENEVA, SWITZERLAND, 44.94 m. Addr. Radio-Nations. Sun. 1.45- 2.45 pm.	6.675	HBQ	GENEVA, SWITZERLAND, 44.94 m. Addr. Radio-Nations. Sun. 1.45- 2.45 pm.
6.660	H15G	TRUJILLO CITY, D. R., 45.05 m., to 8.40 pm.	6.660	H15G	TRUJILLO CITY, D. R., 45.05 m., to 8.40 pm.
6.635	HC2RL	GUAYAQUIL, ECUADOR, 45.18 m., Addr. P. O. Box 759. Sun. 5.45- 7.45 pm., Tues. 9.15-11.15 pm.	6.635	HC2RL	GUAYAQUIL, ECUADOR, 45.18 m., Addr. P. O. Box 759. Sun. 5.45- 7.45 pm., Tues. 9.15-11.15 pm.
6.630	HIT	CIUDAD TRUJILLO, D. R., 45.25 m., Addr. "La Voz de la RCA Victor." Apartado 1105. Daily exc. Sun. 12.10-1.40 pm., 5.40-8.40 pm.; also Sat. 10.40 pm.-12.40 am.	6.630	HIT	CIUDAD TRUJILLO, D. R., 45.25 m., Addr. "La Voz de la RCA Victor." Apartado 1105. Daily exc. Sun. 12.10-1.40 pm., 5.40-8.40 pm.; also Sat. 10.40 pm.-12.40 am.
6.625	PRADO	RIOBAMBA, ECUADOR, 45.28 m. Thurs. 9-11.45 pm.	6.625	PRADO	RIOBAMBA, ECUADOR, 45.28 m. Thurs. 9-11.45 pm.
6.610	YNLG	MANAGUA, NICARAGUA, 45.39 m. Emisora Ruben Dario. 1.30- 2.30, 6-10.15 pm.	6.610	YNLG	MANAGUA, NICARAGUA, 45.39 m. Emisora Ruben Dario. 1.30- 2.30, 6-10.15 pm.
6.600	H16H	TRUJILLO CITY, D. R., 45.45 m., 7.40-8.40 pm.	6.600	H16H	TRUJILLO CITY, D. R., 45.45 m., 7.40-8.40 pm.
6.565	H15P	PUERTO PLATA, D. R., 45.70 m., 5.40-7.40, 9.40-11.40 pm.	6.565	H15P	PUERTO PLATA, D. R., 45.70 m., 5.40-7.40, 9.40-11.40 pm.
6.558	H14D	CIUDAD TRUJILLO, D. R., 45.74 m., Addr. Apartado 623. 12.30-2, 6-8 or 9 pm. Except Suns.	6.558	H14D	CIUDAD TRUJILLO, D. R., 45.74 m., Addr. Apartado 623. 12.30-2, 6-8 or 9 pm. Except Suns.
6.550	XBC	VERA CRUZ, MEX., 45.8 m. 8.15-9 am.	6.550	XBC	VERA CRUZ, MEX., 45.8 m. 8.15-9 am.
6.550	TIRCC	SAN JOSE, COSTA RICA, 45.8 m., Addr. Radioemisora Catolica Costarricense. Sun. 11 am.-2 pm., 6-7, 8-9 pm. Daily 12 m.-2 pm., 6-7 pm., Thurs. 6-11 pm.	6.550	TIRCC	SAN JOSE, COSTA RICA, 45.8 m., Addr. Radioemisora Catolica Costarricense. Sun. 11 am.-2 pm., 6-7, 8-9 pm. Daily 12 m.-2 pm., 6-7 pm., Thurs. 6-11 pm.
6.540	YNIGG	MANAGUA, NICARAGUA, 45.87 m., Addr. "La Voz de los Lagos." 1-2.30, 8-10 pm. Except Sundays.	6.540	YNIGG	MANAGUA, NICARAGUA, 45.87 m., Addr. "La Voz de los Lagos." 1-2.30, 8-10 pm. Except Sundays.
6.490	TGWB	GUATEMALA CITY, GUAT., 46.2 m. La Voz de Guatemala, Daily 7.45-9 am. 12.45-3.45 pm., 7.30 pm.-12.15 am. Sun. 10.30 am.-5.15 pm., 7 pm.-12 m.	6.490	TGWB	GUATEMALA CITY, GUAT., 46.2 m. La Voz de Guatemala, Daily 7.45-9 am. 12.45-3.45 pm., 7.30 pm.-12.15 am. Sun. 10.30 am.-5.15 pm., 7 pm.-12 m.
6.480	H11L	SANTIAGO DE LOS CABALLEROS, D. R., 46.28 m., Addr. Box 356. 9.40-11.40 am., 7.40-9.40 pm.	6.480	H11L	SANTIAGO DE LOS CABALLEROS, D. R., 46.28 m., Addr. Box 356. 9.40-11.40 am., 7.40-9.40 pm.
6.470	YNLAT	GRANADA, NICARAGUA, 46.36 m., Addr. Leonidas Tenorio, "La Voz del Mombacho." Irregular.	6.470	YNLAT	GRANADA, NICARAGUA, 46.36 m., Addr. Leonidas Tenorio, "La Voz del Mombacho." Irregular.
6.455	H14V	SAN FRANCISCO DE MACORIS, D. R., 46.44 m., 11.40 am.-1.40 pm., 5.10-9.40 pm.	6.455	H14V	SAN FRANCISCO DE MACORIS, D. R., 46.44 m., 11.40 am.-1.40 pm., 5.10-9.40 pm.

(Continued on page 445)

# The Short Wave League DX on the Ham Bands

(with the "Listening Post" Observers)

Edited by

Elmer R. Fuller



## HONORARY MEMBERS

Dr. Lee de Forest  
D. E. Repogle  
John L. Rehnitz  
Hugo Gernsback, Executive Secretary

Manfred von Ardenne  
E. T. Somerset  
Holt's Battery

The antenna system used  
by Everett E. Worrell, Jr.,  
Observer for Virginia.

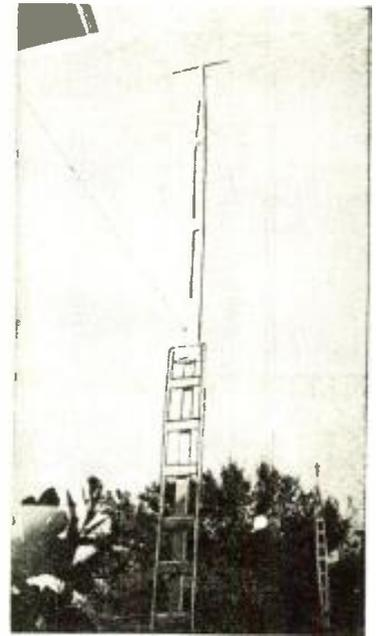

## DX on the Ham Bands

● ANOTHER month has come and gone, and yet our DX is no better than it has been for the past several months. Conditions have been very poor, only at times has any good DX come through. A few more Asiatics were reported than last month, but the others have fallen off sharply. The five meter band seems to have gone out entirely, at least we did not receive any reports from our special observers for this band.

W. C. Post, Observer for Minnesota, reports hearing KHCTB on 12.32 megacycles. This is the call used by the airplane "Guba" of the Archbold Expedition. It was near Australia when heard by Post.

A station in the 14 megacycle band understood to be EL7AS, was reported by James Kavanaugh, Observer for Indiana. This is the only report of this ham being heard in this country.

What the effect of the new war in Europe will have upon the DX situation cannot yet be determined. However, it is already showing us that several of our old DX standbys will not be with us this winter. The number of Europeans coming in has already been decreased several fold. In just what countries, if any, the rights of the amateurs have been suspended, it has been impossible to determine. Sometimes we hear one thing, and then something different. One cannot tell which story to believe, if either.

Last month reports were received from the following observers:—

Alabama ..... Jack Well-  
Arizona ..... Lester Fuller  
Connecticut ..... Howard G. Kemp  
District of Columbia ..... A. J. Hall  
Florida ..... Major Lester

## TEN BEST DX CATCHES

Name	Station	Freq.	R	S	Miles
Everett Worrell	PK4KS	280°E1	4	4	12,300
Bob Taglauer	PK1AS	14.09	5	7-8	12,000
R. B. Fleming	VS2AK	14.02	5	4-5	11,800
Burns E. Hegler	VQ8JM	14.1	5	7	11,600
Kenneth Walker	PK4KS	14.06	5	8	11,500
W. C. Post	VK0MW	14.1	3-4	5-6	11,300
Burns E. Hegler	PK1ZL	14.3	4	5-6	11,300
Dick Mannheimer	PK3W1	14.045	4	5	11,300
James Kavanaugh	VK5RN	14.1	4	6	11,200
Everett Worrell	VQ8JM	13.1	5	5	11,200

State	Name	Call	Freq.	R	S	Heard In
Indiana	James Kavanaugh	J7CB	14.110	4	7	Ariz.
Iowa	Dick Mannheimer	J8CI	14.103	4	6	Ariz.
Kansas	Burns E. Hegler	VS1AE	14.05	4	6	England
Kentucky	Bob Taglauer	VS2AK	14.02	4	4-5	Mo.
Michigan	Vernon Gabriel	VS2HA	14.06	5	8	Ariz.
Minnesota	W. C. Post	VS2AL	14.	4	7	West Australia
Missouri	R. B. Fleming	VS7RG	13.09	4	5	Va.
Nebraska	William Dean Noyes	VS7RA	14.	4	6-7	West Australia
New Jersey	John Fitzpatrick					
New York	Charles H. Fuller					
North Carolina	Roger Poole					
Oklahoma	Kenneth Walker					
Rhode Island	George F. Baptiste					
South Carolina	Roy Halliday					
Texas	Edward C. Slaughter					
Virginia	Everett E. Worrell					
Wisconsin	Lyssa Dana Wheaton					
England	Kenneth Spencer					
West Australia	Roy Matthews					

## AFRICA

Call	Freq.	R	S	Heard In
CN8BB	14.11	5	5	Ind.
CT2BP	14.134	4	7	Minn., Ky., Ind.
EK1AF	14.1	4	7	Minn., N. C., Ont.
VQ8WP	13.107	4	5	Va.
VQ8JM	14.1	5	7	Kan., Ind.
ZS2AZ	14.08	4	6	Kan., Tex.
ZS4H	14.046	3	5	Nehr.
ZS5Q	14.03	5	8	Tex., Ont., Nehr.
ZS5DA	14.11	6	6	Ariz.
ZS6FD	14.06	5	7	Kan., Tex.

From Asia we have the following stations reported:—

Call	Freq.	R	S	Heard In
J5CW	14.085	4	5-6	Kan., Ala., Tex., Ia.
J7CR	14.009	5	9	Okl.

(Continued on page 431)

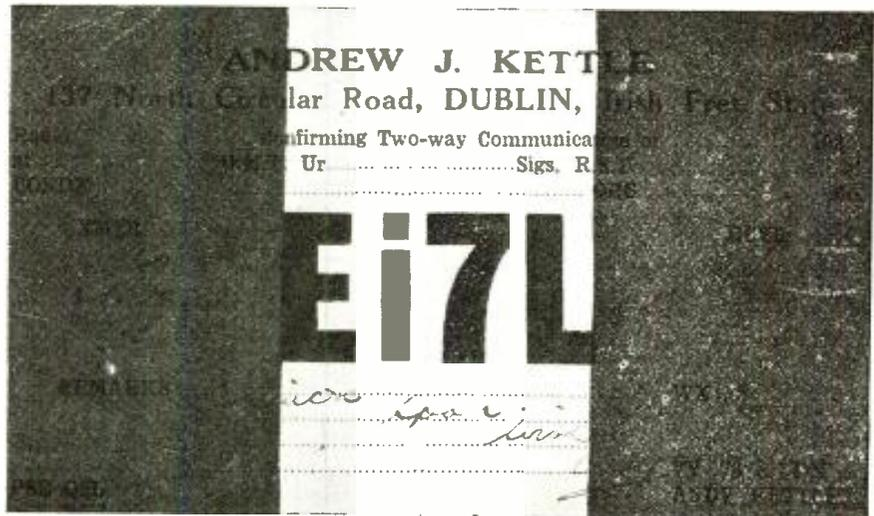

Left—A close-up of Everett E. Worrell, Jr., who captures DX for the Short Wave League in the Virginia area. Above—Card received by Jack Wells, Observer for Alabama, from Andrew J. Kettle in Dublin, Ire.

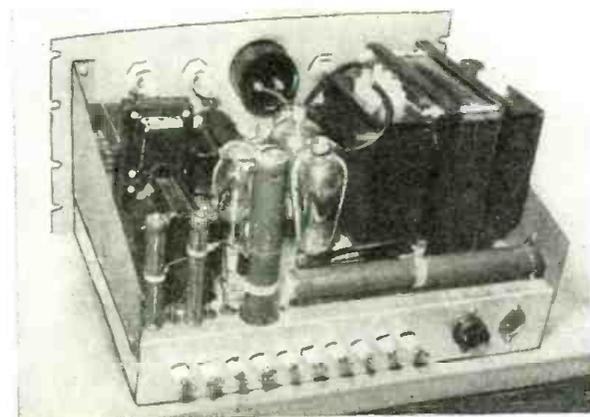
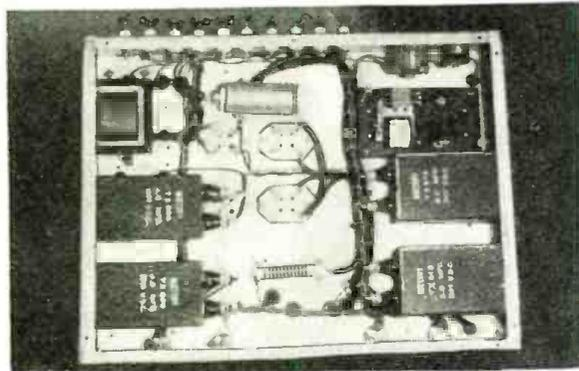
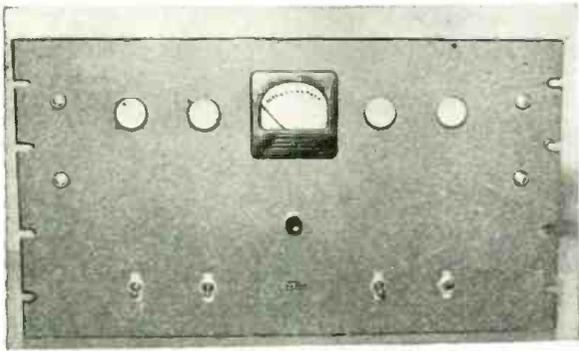

▲ Above—Front, bottom and rear views of the Power Supply

➤ Right—Circuit diagram of the ECO-XTAL Power Supply.

● THE power supplies necessary for the transmitter were all mounted on a single large chassis, 13" x 17" x 3", fastened to a 10½" relay rack panel to match the transmitter panel. Because of the great weight of the various transformers and chokes, it was found necessary to use a pair of panel brackets to keep the chassis from parting with the panel.

There are three separate power supplies controlled by an interlocking switching arrangement, designed for safety and convenience.

The high voltage supply for the HK-54 employs a pair of 866 tubes followed by a single section choke input filter. Two 2 mf. filter condensers in parallel were used as a single 4 mf. unit was not available. The 75,000-ohm, 200-watt bleeder resistor is of the slider type so that it is possible to vary the D.C. voltage. The plate transformer T-4 has a tapped secondary, allowing either of two voltages to be applied to the rectifier

# Power Supply and Modulator for the ECO-Xtal TRANSMITTER



Herman Yellin, W2AJL

Final touches to put the ECO-XTAL transmitter in operating condition. Now you can take the air!

tubes. For supplying plate voltage to the oscillator and buffer, a single power supply using an 83 rectifier, was employed. With a two section, choke input filter, there was no trace of ripple. The 30,000-ohm divider, R4, has two sliding taps, one each for the oscillator and buffer stages. In the bias power supply, we have an 80 rectifier followed by a single section filter. Notice that the two sections of the double 8 mf. filter condenser are connected in parallel. Here we have two voltage dividers connected together across the output of the power supply, allowing the grid bias for each stage to be separately adjusted without any interaction between them. The bias voltage dividers have been so designed that the resistance between the slider and ground will be the correct value of grid leak used for the tube. If, for any reason, the bias voltage should fail, the tube would still have the proper grid leak bias. However, keying in the oscillator would not then be possible, since with the oscillator key in the "up" position, no excitation would be supplied to the following tubes, resulting in abnormal plate currents.

It will be noticed that all filament voltages, both in the power supply and transmitter, are supplied by two separate filament transformers. In this way, the transmitter as a whole can be kept in a stand-by condition with all tubes warm and plate voltage off, ready for instant operation with the flick of a single switch (SW-2). This is especially helpful in testing and tuning up.

(Continued on page 432)

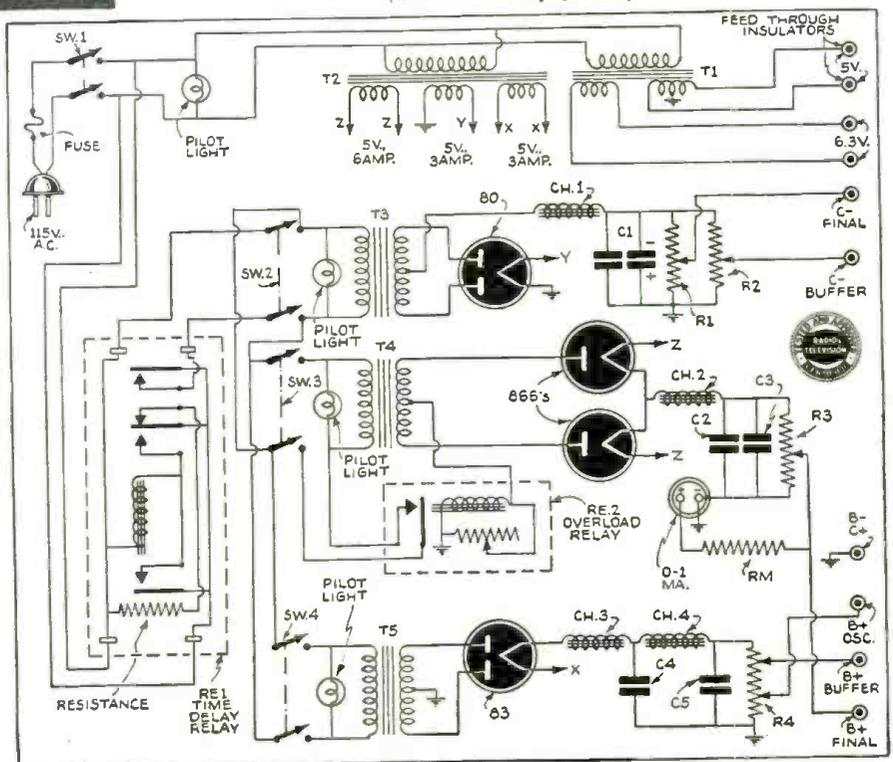



DEALERS!



SERVICE MEN!



AMATEURS!



P. A. SPECIALISTS!



BUILDERS!

# THEY SAY: *It's The Greatest Radio Catalog Ever!*

## 204 PAGES, EXCLUSIVELY RADIO!

### EVERYTHING IN RADIO AT LOWEST PRICES!

### Greater Selection, Bigger Values Than Ever Before! 5 Big New Sections!

Good news spreads fast . . . and Everyone in Radio is sending for this new 1940 ALLIED Catalog! Don't miss it—bigger, better, more complete than ever before, it places every radio need at your finger-tips, shows you **EVERYTHING** in RADIO at **LOWEST PRICES**. 5 complete new sections, for Dealers, Servicemen, Amateurs, Sound Specialists, and Builders—showing the newest Sets, Kits, P.A., Recording Equipment, Ham Gear, Test Equipment, books, tools, and more than 15,000 parts, all organized conveniently for quick and easy reference, and every item an outstanding value. Send for ALLIED's 1940 Catalog today!

Remember, ALLIED'S business is exclusively radio supplies; it has but one policy, one effort, and one interest: that of fulfilling your radio needs in the most satisfactory, speedy and most economical manner. You'll find it always pays to buy at ALLIED.



### Send For Your FREE Copy Today!

**60 NEW SETS**



Greatest set values in ALLIED's history! 60 new Knight models, 4 to 12 tubes, featuring built-in Air-Magnet Aerials and new Push-Button Tuning. New lower-priced portables—1 1/2-volt models. AC-Battery, strap-type, etc.—new plastic cabinets, etc.—sets for every purpose—and phonograph (1-tube electric, etc.)—phono-radios (5, 7, 11 tube) — new recorder-phono-radio combination cabinets, complete phono accessories — they're all in ALLIED's new catalog at lowest prices. Send coupon today.

**P. A. 3 NEW LINES**



Now, "Economy," "Standard" and "De Luxe" lines—11 new systems, portable, mobile, permanent,—6-65 watts. New beauty in utility. New systems for 110 volts AC-DC, battery, 32 volts, etc.—20-watt with built-in phono. new Power Stages, etc. Also new Knight "mikes," complete recording equipment and P.A. accessories, new low-priced discs, etc. Hearing Aid, and other specialties.

**New Time Payment Plan**  
Lowest carrying-charge, easiest terms. See ALLIED's 1940 Catalog.

**Allied Radio CORPORATION**  
For Retail Radio Distribution  
833 W. Jackson Blvd. Chicago, Ill.

**A MESSAGE TO EVERYONE IN RADIO**

The 1940 ALLIED Catalog is the largest we have ever published. Its 204 pages offer a wider selection of radio equipment for everyone in Radio -- for Serviceman, Dealer, Amateur, Builder, Dealer and Sound Man. Most important of all -- our prices have never before been so low. This larger catalog is the symbol of ALLIED's determination to give constantly better service to its many radio customers. Against a background of 17 years, ALLIED has consistently specialized in radio -- it is our 100% interest -- our one and only goal, in which we can do, we feel, the only way in which we continue to give you at all times the ALLIED high standard of service and value you have come to expect. I am proud, on behalf of all of us here at ALLIED, to bring you our new 204-page 1940 Catalog -- devoted exclusively to radio -- for everyone in Radio. I sincerely believe that you will find it the most complete and value-packed, money-saving catalog you have ever used.

Sincerely yours,  
*A. A. Adams*  
President  
ALLIED RADIO CORPORATION

**HAM GEAR!**  
**ALL LEADING LINES**



The largest Ham Section ever published! — every receiver, transmitter, transceiver from every leading line, spread before your eyes at lowest prices! All newest receivers, Sky-riders "Defiant," Television equipment, Rotary Beam equipment, etc. 20,000 Amateurs buy from ALLIED, because ALLIED knows Ham problems, needs, desires. Get this big new Catalog today!

**New Time Payment Plan**  
Lowest carrying-charge, easiest terms. See ALLIED's 1940 Catalog.

**PARTS! BIG NEW SECTION**



See the latest new type tubes—110, 117 volt, etc.—thousands of exact duplicate and replacement parts for every need. Dozens of new kits, Beginners' 1, 2, and 3 Tubes, New Television Kit, Wire-less Phono, 1 1/2 volt, etc.—Free Parts Lists. Complete section of latest Test Equipment from every leading manufacturer. Complete line of latest accessories. New Big Parts section — and over 15,000 quality items. "Everything in Radio at lowest prices" in one big book. Send for a FREE Catalog today!



### And a Big New Bargain Section Where Prices Meet their Waterloo!

Specials, every one!—the country's biggest radio bargains, in the special color section. Don't miss these values!

ALLIED Radio Corporation,  
833 W. Jackson Blvd.,  
Chicago, Ill. Dept. 3-L-O

**FREE**  
SEND  
COUPON

Send your FREE 204-page Radio Catalog.

Name .....

Address .....

City ..... State .....

**ALLIED RADIO CORPORATION**  
833 W. JACKSON BLVD. CHICAGO



# BOOK REVIEW

**MAGIC DIALS**, 147 pages including index, size 9 1/4 x 12 inches, by Lowell Thomas, with illustrations by Anton Bruehl. Published by Lee Furman, New York, N. Y.

Every one who has listened to a radio broadcast knows Lowell Thomas, whose news comments have made him one of the most popular figures on the air. Now Mr. Thomas, author of innumerable best sellers, has produced a book called *Magic Dials*, the sub-title of which is "The Story of Radio and Television".

In this book, Mr. Thomas begins with a short history of the development of radio, follows it with a brief discussion of how programs have developed, and then leaps into that newest of all megacycle magic—television. He then reverts to a short explanation of what goes on when programs are broadcast and follows this with a discussion of his own particular branch of radio entertainment—news. After this there is a brief survey of how programs are built, an outline of the fantastically rapid growth of the radio industry, and a discussion of how order is maintained on the crowded megacycles. The mystery of network broadcasts also comes in for a share of Mr. Thomas' attention, as does the sponsorship of radio broadcasting by advertisers—the American system. He concludes his book with a short discussion of station operating technique and program costs.

The book is profusely illustrated with photographs in both black and white and color, taken by ace lensmen Anton Bruehl. Of particular interest to those with whom photography is a hobby is a special appendix in the back of the book which tells what equipment, film, developer, exposure, stop and lighting were used in making every picture.

Mr. Thomas and Mr. Bruehl have collaborated in putting out a most attractive book which should be intensely interesting to every radio listener as well as to those more seriously engaged in the art.

**SPARKS, LIGHTNING, COSMIC RAYS**, by Dr. Dayton C. Miller, contains 192 pages, size 5 1/4 x 8 1/2, illustrated, and is published by The Macmillan Company, New York.

Dr. Dayton Clarence Miller, who is Professor of Physics at the Case School of Applied Science, has given thorough coverage of the basis of electricity. In simple, readable language, as given to young people at the Franklin Institute, he describes "Sparks" from the beginnings of electricity to high potential electrostatic generators. His section on "Lightning" runs from the beginnings of the study by Benjamin Franklin all the way up to the law of inverse squares. In discussing "Cosmic Rays," he commences with the oscillatory discharge and Hertzian waves, which marked the inception of radio, and carries through to the world-wide cosmic ray surveys.

This book is of great interest to anyone who would like a better understanding of the background of electricity. Not only is it educational, but highly interesting as well.

**AERONAUTIC RADIO** (a manual for operators, pilots and radio mechanics) has 502 pages including index, size 5 3/4 x 8 1/4, and is published by The Ronald Press Company, New York.

Lieut. Myron F. Eddy, author of this book, is not only U.S.N. retired, but is Chief Instructor in aircraft radio at the Stewart Technical School and is a member of the I.R.E. Lieutenant Eddy's book considers the subject from beginning to end, not only on communications—radio as applied to aviation, but also discussing beacons, direction finders, instrument landing systems, radio traffic control, etc., in 16 chapters. Two appendices explain the graphical symbols generally employed in radio diagrams, and define the terms used in radio engineering. A comprehensive index gives further help to those who use this highly valuable volume.

**RADIO SERVICE TRADE KINKS** contains 269 pages including the index, size 9" x 11 1/4". Published by the McGraw-Hill Book Company, New York and London.

Lewis S. Simon, the author of this book, certainly should know his subject, for he is the manager of the Rexall Radio Stores in Brooklyn, N. Y. The contents of this book are arranged alphabetically under manufacturers' names and subdivided further under model numbers. It tells the troubles that are not infrequently encountered in various sets, how to check for them, and then what to do to correct them.

## Radio Interference Manual

THE new Sprague Manual of Radio Interference Elimination tells the reader how to locate noise-making devices, then how to determine exactly what units are required before any filters are bought or any permanent installation made. Described and illustrated are the correct filter circuits and parts needed and the procedure for connecting them to electrical devices such as single or polyphase motors, D.C. generators, alternators, switches, thermostats, sign flashers, arcing devices, oil burners, gas engines, vibrating contacts, mercury vapor lamps and many others. In practically every case, the procedure entails filter installations directly at the electrical device, as long experience has proved this is the only means by which radio noises can be eliminated satisfactorily.

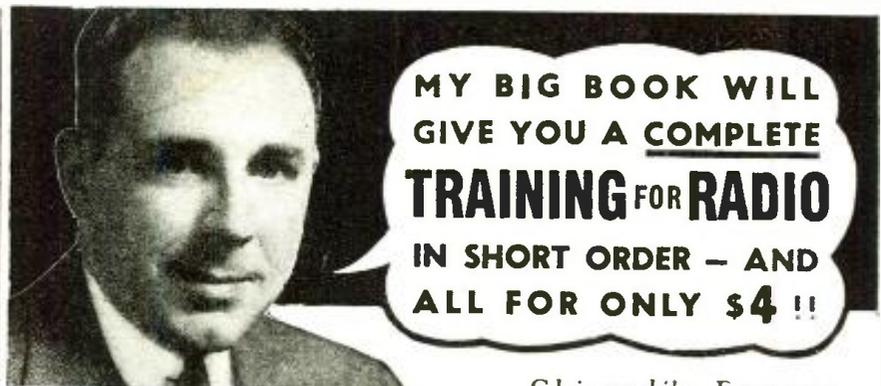

**MY BIG BOOK WILL GIVE YOU A COMPLETE TRAINING FOR RADIO IN SHORT ORDER - AND ALL FOR ONLY \$4 !!**

**A Fascinating Career Lies Before You - LET ME HELP YOU GET STARTED NOW!**

Ghirardi's Famous Short-Cut Home-Study Course will fit you Quickly for a Good Job in RADIO

**AT LAST!**—Your start in Life! No longer need you be held back from the Radio Career you've dreamed about. No longer is lack of money an obstacle. The opportunity you have been waiting for is here! Ghirardi is ready to give YOU every advantage that he has already given to thousands of men who have made successful careers in all branches of Radio work. Now you may get just as good a training in radio as they did, for they too studied the easy but thorough "Ghirardi Way." Today many of these men are making good money . . . they're going ahead . . . and they are happy in their work! What they have done, you, too, can do! No matter what your previous education and experience has been, Ghirardi's course has been written so that you can master the subject easily and quickly, by yourself in your own home!

**All here COMPLETE in 1 Big Book —Your Practical Training in Radio**

Sit in your easy chair in your own home and let Ghirardi train you for whatever type of radio work you want to do. Yes, it's as simple as that! Just plan to spend a few minutes a day of your spare time reading this interesting book. You'll find it hard to put down, for it makes the subject so absorbing. Specially Ghirardi will take you step by step from the very first principles of Electricity right on up through Radio, Television and other great electrical sciences of today.

### TELEVISION MADE EASY, TOO!

Each step of your study, each section of the course is complete in itself—and just as plain and easy to understand as your primer. The Television section is by itself a whole course in the basic fundamentals of this exciting new profession. As for Sound Engineering, you get up-to-date instruction in Public-Address Systems, Sound Recording, Phonograph Pickups, Sound Motion Pictures, etc.—a great group of specialized new sciences, each of them offering you a promising future. So with Photo-electric Cells and Cathode-Ray Tubes—one of these days you may be very glad that you let Ghirardi explain to you the principles and applications of the "Electric Eye." Yet all this, and much more besides, is given to you in addition to the thorough training in Radio itself—broadcasting, receiving, short-wave, high fidelity, testing and repairing, auto-radio, police radio, airplane radio, etc. Everything essential is here—nothing is omitted—nearly a thousand illustrated pages full of practical knowledge for you to make your own!

### USE IT 5 DAYS—OUR RISK!

You take no chances with Radio Physics Course. Send for it today—read it for 5 days—then, if not satisfied in any way, you may return it in good condition and get your money back immediately. Our guarantee protects you fully. You will never know how much this book will do for you until you get it and see for yourself. That's why we take all the risk. So now it's up to you. Do you want to learn radio quickly, thoroughly, inexpensively? If you do, there's just one thing to do—fill out the coupon on this clip and mail it without delay—right now!

### 36 Volumes in One

Radio, Electricity and Sound Complete. Plus Many Other Valuable Special Features are covered in these 36 big Chapter-Sections. 972 Pages. 508 Schematic Diagrams, Charts and Photos. 856 Review Questions.

- |  |  |
|--|--|
| 1. Radio Broadcasting System.                          | 19. Construction Features of Vacuum Tubes.             |
| 2. Sound, Speech and Music as Related to Broadcasting. | 20. Vacuum Tube Detector and Amplifier Action.         |
| 3. Electron Theory, Electric Current.                  | 21. Radio Frequency Amplification.                     |
| 4. Electrical Units, Ohm's Law, Resistance.            | 22. Superheterodyne Receivers.                         |
| 5. Electrical Circuits, Batteries.                     | 23. Design of R.F. Amplifiers and Tuning Coils.        |
| 6. Magnetism.  | 24. Audio Amplification.                               |
| 7. Electromagnetism.                                   | 25. Loud Speakers.                                     |
| 8. Electromagnetic Induction.                          | 26. The Battery Operated Receiver.                     |
| 9. Inductance and Inductors.                           | 27. The Power Supply Unit.                             |
| 10. Capacitance and Condensers.                        | 28. Electric Receivers.                                |
| 11. Alternating Current Circuits.                      | 29. Automobile and Aircraft Receivers.                 |
| 12. Electric Filters.                                  | 30. Phonograph Pickups and Public Address Systems.     |
| 13. Electrical Measuring Instruments.                  | 31. Short Wave Reception.                              |
| 14. Electromagnetic Radiation.                         | 32. Vacuum Tube Applications and Photo-electric Cells. |
| 15. Radio Transmission, the Broadcasting System.       | 33. Television.  |
| 16. The Receiving Station, Detection with Crystals.    | 34. The Antenna and Ground.                            |
| 17. Elementary Study of the Vacuum Tube.               | 35. Testing and Servicing.                             |
| 18. Vacuum Tube Characteristics.                       | 36. Sound Motion Pictures, Charts, Tables, etc.        |

**—972 Pages**

**Get Started - RUSH THIS COUPON NOW!**

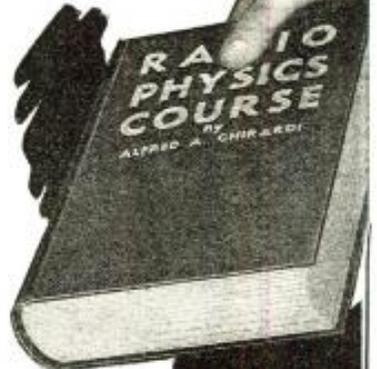

**Only \$4.00**

**No Further Payments**

### A Marvel of Clearness

Ghirardi has an amazing genius for making the most intricate problems of Radio crystal-clear. In plain, everyday language he explains every topic with equal clarity. Hundreds of illustrations—schematic diagrams and photos—picture for you graphically the points he describes so vividly. When you have finished reading this great book you will have a solid grasp of radio fundamentals that will stick by you for life. Once Ghirardi tells you—you'll never forget it!

### A Miracle of Condensation

How is it possible, you ask, to boil down a complete radio education into one single book? Truly it's almost unbelievable the amount of information that is packed in between the two covers of this book. Actually you get the equivalent of 36 different radio books in one inexpensive volume. Think of it—your basic training for a lifetime career—all for only \$4. Read over the section titles at the left—just see what you get!

### "Price Insignificant!"

writes Ghirardi Enthusiast

"I have never seen a text book so complete, as easy to understand, and as helpful as this one. The price I paid for the book is insignificant in comparison to the value of the knowledge gained. I feel it is my duty to tell you that this book should be more widely advertised for the good of all those concerned and for the cause of the science of radio, physics and electricity."—Tom W. Danielson, Lockland, Ohio.

## MAIL COUPON TODAY

Books Shipped Postpaid Anywhere!

**RADIO & TECHNICAL PUBL. CO.**  
55 Astor Place, New York  
Dept. R.E.T.-9

Enclosed find \$1 (\$4.50 foreign) for my copy of Ghirardi's "RADIO PHYSICS COURSE," with your 5-day Money-Back Guarantee.

NAME .....

ADDRESS .....

CITY ..... STATE .....

Please send me free descriptive literature about "RADIO PHYSICS COURSE."



## How to Listen to War News

LOWELL THOMAS

(Continued from page 389)

triumph at some point surprisingly deep in its own territory—then you know the triumph is to be taken the other way around. I remember in the first World War, and more recently in the Spanish war, how the scene of defensive victories changed progressively. One day you'd have a bulletin—"We have utterly repelled the enemy at Such-and-Such a place." The next day—"We have checked the enemy with heavy losses at still some other place." And the map would show that place Number Two was twenty or thirty miles in the rear of place Number One—that would tell the story. All the repelling and checking meant a *fast retreat*. This was spectacularly true of the Russians in the first World War, at the time of Mackensen's great drive. The Czar's army won a series of victories all the way from the German border to a line a few hundred miles in the rear! So said the Russians.

In addition to censorship and propaganda there's the exciting business of steaming up stories, exaggerating little or nothing into something huge and startling—just scaring up headlines. Keep a lookout for the facts, if any, on which great flashing rumors are based. Immediately after France declared war the other day we had the exciting news that the French army from the Maginot Line was storming the German Siegfried Line, and there was *hand-to-hand fighting!* All this was based on a brief statement by the French Command that a contact with the enemy had been established. The military term contact was interpreted to mean the physical contact of soldier to soldier, whereas in a military sense it might mean, "We've sighted the enemy with our most powerful binoculars." The truth was that the contact was nothing more than both sides taking up advanced positions, digging trenches in No Man's Land between the Siegfried and Maginot Lines. Another headline was "French Army Invades Germany!" This in point of literal fact was quite true. The border between France and Germany runs through the belt of No Man's Land between the two fortified lines, and at one place the French established their advance patrol positions a short distance over the line. It was technically an invasion of Germany, but it hardly deserved a headline.

All of this must make many a one in the radio audience ask, "So what's the use of listening to or reading this war news, anyway?" Well, there's a lot of truth in the flood of dispatches from Europe, immense world-shaking truth, along with and in spite of censorship, propaganda, and scare headlines. We want to know what's happening. We must know. So let's be as keen as we can, both radio commentator and radio audience. Let's do our level best to pick out the facts and toss out the falsehood, and thereby keep ourselves aware of the tremendous events that are now occurring on this mad globe.

(Note: Where the phrase "first World War" has been used in the foregoing editorial, the word "first" has been added by the editor.)

### Radio WAR News

#### First—

All the latest news—where to tune for the "foreign" S-W war communique; new radio war inventions; activities of the Radio Amateur stations, etc.

Here it is —

The NEW SUPER PRO



#### FEATURES

- ★ Two Stages TRF
- ★ Three Stages IF
- ★ Variable Crystal
- ★ Noise Limiter
- ★ New "S" Meter

FOR years the "SUPER-PRO" has been an outstanding receiver in commercial and amateur fields. This new and improved "Super-Pro" is a deluxe communications receiver, complete in every detail. Selectivity is variable from 16 kc. to better than 100 cycles. The crystal filter has five ranges permitting its use for phone reception as well as CW. Exceptionally high sensitivity is obtained with two stages of tuned R.F. and three stages of I.F. The two R.F. stages provide maximum image rejection and a very high signal-to-noise ratio.

The new noise limiter in the "Super-Pro" performs beyond expectations. It will reduce many types of noises to a minimum without distorting the signal. The "Super-Pro" "S" meter is adjustable over wide limits. It is no longer necessary to give inaccurate reports. Besides the many new features, the new "Super-Pro" has the time-

proved tuning unit with multiple section condensers and individual coils. The main dial is accurately calibrated and the band spread dial provides full scale spread on all amateur bands and continuous spread throughout the entire range of the receiver.

Other features include, AVC, beat oscillator, send-receive switch, phone and phonopickup connections, relay terminals, beautiful metal cabinet, and 16 watts of audio. Available in two standard ranges, 15 to 560 meters and 7½ to 240 meters. This new 18-tube "Super-Pro" is the last word in receiver engineering.

#### MAIL COUPON TODAY!

HAMMARLUND MFG. CO., INC. RT-11  
424 West 33 St., N. Y. City

Please send new "Super-Pro" folder.

Name .....

Address .....

City ..... State .....

Canadian Office: 41 West  
Av., No. Hamilton, Ont.



# HAMMARLUND

### BUILD THE BROWNING AUTODYNE CONVERTER AND PRESELECTOR



Make any receiver a short-wave set, tuning from 5 to 185 meters. (uses 1852 tube) **\$13.50**  
Available in kit form .....

Laboratory wired and tested, \$16.50 (uses 1852 tube)  
Cabinet: Black or Grey crackle finish.

**BROWNING LABORATORIES, INC.**  
750 MAIN STREET WINCHESTER, MASS.

### BAND SWITCH ASSEMBLY

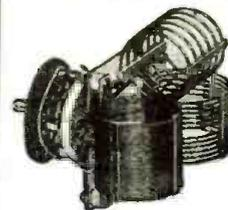

**COMPACT EFFICIENT 10 to 160 METER OPERATION**

No. OCS-1 Band Switch Assembly is made for pentode oscillator and buffer circuits with inputs up to 50 watts. Your net cost only \$3.30.

For Catalogue No. RT 119 giving full description, write to

**BUD RADIO, INC.**  
5205 Cedar Ave. Cleveland, Ohio

Right—Front view of new 18-tube Communications receiver. A model for the S-W Fan covers the short-wave bands and the broadcast bands as well.

Below—Top view of the receiver. Note the excellent workmanship.

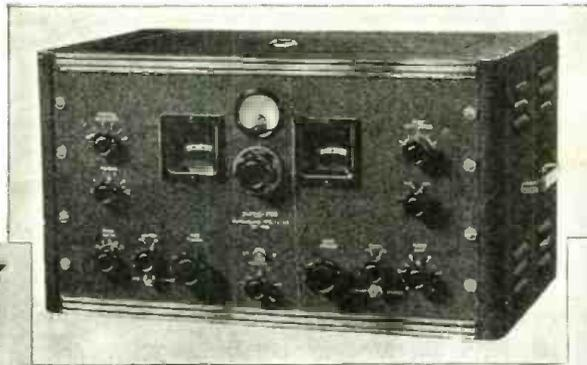

Below—Rear view of the new receiver. Superior selectivity, excellent band-spread and an improved noise-limiter are just a few of the features.

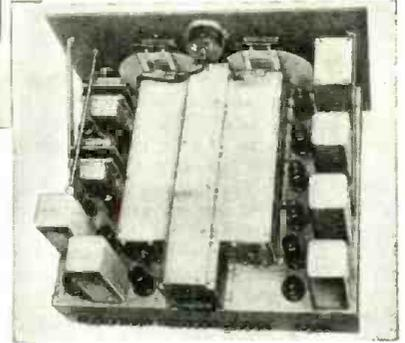
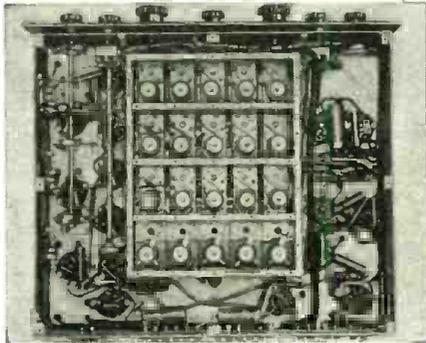

# A New 18-Tube Receiver for the Ham and S.W.L.

● A NEW communications type receiver, available in two tuning ranges—15 to 560 meters and  $7\frac{1}{2}$  to 240 meters—has been announced by the Hammarlund Manufacturing Co.

The new set, which has 18 tubes, utilizes all the developments which made the original "Super-Pro" so popular with Hams and SWL's. In addition to these are a number of improvements, such as the variable selectivity crystal filter, first introduced in the Hammarlund HQ-120X; a new and improved noise limiter and an entirely new "S" meter. The new crystal filter has as its main features variable selectivity, constant gain, and simplicity of operation. Three of the five selectivity ranges are for voice and music, and the other two for C.W.

Hams and short-wave Fans will welcome this new "Super-Pro". Available in two ranges: 15 to 560 meters and  $7\frac{1}{2}$  to 240 meters. Features new "S" meter, variable selectivity crystal filter, improved noise limiter, super-selective tuning, 16 watts output, band-change switch, etc.

The manufacturers claim that it effectively doubles the width of crowded phone bands. The new "S" meter has a single variable control which can be adjusted to compensate for variations in antenna and locations.

The tubes used in this new "Super-Pro" include two 6K7's as first and second T.R.F.; a 6L7 as first detector; a 6J7 H.F. oscillator; a 6K7 as first I.F. stage; two 6SK7's as second and third I.F. stages; a 6H6 second detector; a 6N7 noise limiter; a 6SJ7 B.F.O.; a 6SK7 A.V.C. amplifier; a 6H6 A.V.C. and meter rectifier; a 6C5 first A.F.; a 6F6 second A.F.; and two 6F6's as the push-pull output stages. The power supply uses two rectifiers—a 5Z3 for high voltage, and an 80 low voltage rectifier.

(Continued on page 429)

Diagram of the new Hammarlund "Super-Pro" receiver.

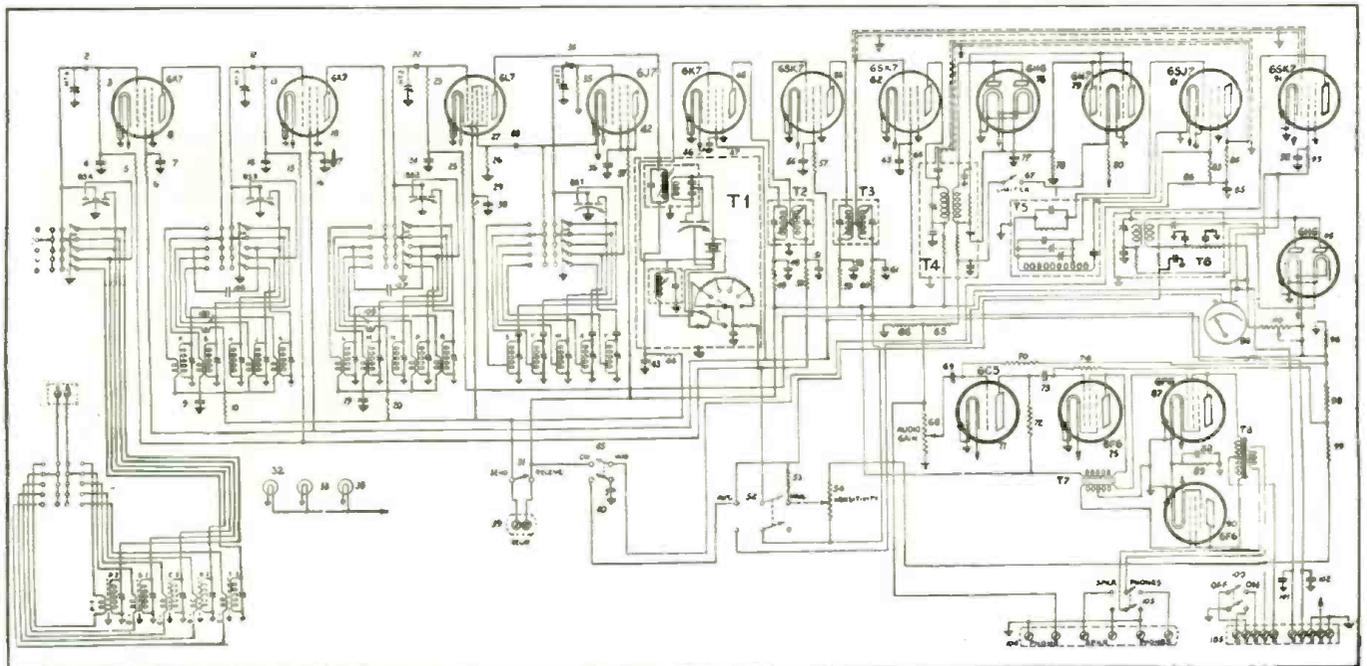

# FREE TELEVISION COURSE

All you have to do is write a 250-word letter on the subject:

*"Why I Want To Become A Television Expert"*

● THE editors are pleased to announce that they have arranged with the National Radio Institute of Washington, D. C., to provide a Correspondence Course in Television which will be given free of all cost to the successful contestant.

Here is all that you have to do. Write a 250-word letter on the subject, *"Why I Want to Become a Television Expert."* The letter should be typewritten or neatly written in ink. No pencilled manuscripts will be considered.

To give you some idea of what the letter may cover, you may discuss such subjects as the *future of television; the commercial possibilities of television; the opportunities for television engineers, servicemen, script writers, etc.*

You do not have to be a reader of RADIO & TELEVISION Magazine in order to enter this contest. In the event of a tie, equal prizes will be given to each contestant so tying.

The judges will be the editors of RADIO & TELEVISION.

The closing date for this Television Letter Contest is December 1st and the name of the successful contestant will be published in the February, 1940, issue.

Address all entries for this contest to—Editor, Television Letter Contest, RADIO & TELEVISION, 99 Hudson St., New York, N. Y.

This Television Course which is offered free for the best letter on *"Why I Want to Become a Television Expert,"* covers present day television as described below.

## SYNOPSIS OF CONTENTS OF N. R. I. COURSE IN TELEVISION

● THE first lessons in this course give a thorough training in the fundamental principles of television. Subjects covered include the behavior of tuned circuits under various conditions, methods used for coupling together television circuits, radio tubes and cathode-ray tubes used in television equipment, voltage amplifier, oscillator, frequency converter, detector, power amplifier, power rectifier, automatic volume control and automatic C bias circuits, peak and band-pass tuning circuits, methods of keeping signal circuits in desired paths, and methods used for amplifying signals at ultra-high frequencies, intermediate frequencies and at the low frequencies associated with the sound and picture signals. The highly important super-heterodyne receiver principle employed in practically all television receivers is covered in detail. You learn what a radio wave is, how it is produced, how it travels through space, why it sometimes fades, and how it can best be picked up by receiving antennas.

With the fundamental principles mastered, you take up the technical requirements of a complete modern electronic television system and trace the signals from the "camera" in the television studio through the transmitter, through space to the receiver, and through the receiver to the screen of the television cathode-ray tube.

The optical features of a television system now receive attention. Topics studied include the nature of light, characteristics of the human eye, how light rays travel, how mirrors, prisms and lenses can be used to reflect, refract and bend light rays, how electronic lenses can be used to bend electron beams, how mirror-wheel, lens-disc and vibrating-mirror scanning systems work in mechanical television systems, and how images on television receiver screens can be reflected or enlarged.

In connection with television transmitters, you learn how a scene is scanned line after line and frame after frame by the pick-up tube in the electron camera, to produce the picture signal. The methods used for generating the line, frame and equalizing impulses with special saw-tooth sweep oscillators and for adding these impulses to the picture signal are covered, along with movie film scanners and various types of pick-up cathode-ray tubes, including the RCA iconoscope and the Farnsworth di-selector.

Before considering circuits of actual television receivers in detail, you are given a bird's-eye view of a typical complete television receiver, with a general analysis of a typical circuit for each important section. The changes which occur in the television signals as they pass through the receiver are given particular attention.

The essential elements in the cathode-ray tube, such as the electron gun with its cathode, control electrode, first anode and second anode, the electrostatic deflecting plates or the electromagnetic deflecting coils, and the fluorescent screen are studied. The focus, spot brilliance, contrast and size controls associated with the television cathode-ray tube circuits are taken up.

The R.F. amplifiers which handle both the sound and sight signals in a television receiver are now studied in detail, with special attention being given to automatic push-button and manual tuning arrangements, to band width requirements and to the special single-end vacuum tubes needed for efficient ultra-high frequency amplification, and to conversion of the ultra-high frequency carrier signals into lower-frequency video I.F. and sound I.F. signals.

The sound portion of the television program is followed through the sound I.F. channel, the sound second detector and the audio amplifier to the loud-speaker. The special requirements of the sound I.F. channel to minimize the effects of oscillator frequency drift are discussed in detail, along with various means for using ordinary radio receivers to reproduce the sound portion of a television program.

Returning to the picture signal, the band width and amplification requirements of the video I.F. amplifier are now taken up in detail, along with various typical circuits. The half-wave and full-wave diode detectors used for demodulating the video I.F. carrier signal come next, followed by a study of automatic gain controls as used to compensate for fluctuations in the strength of the television signal reaching the receiving antenna.

The video amplifiers which boost the strength of the picture signal itself are taken up in detail, since they have considerable effect upon the definition of the reproduced image. Subjects such as stage gain, high trans-conductance, phase delay, time delay, D.C. restoration, positive and negative picture phase and elimination of distortion are discussed.

The highly important problem of synchronization is taken up next. You learn how the line and frame synchronizing impulses are separated from the picture signal in what is called the *clipper stage*, how the line impulses are then separated from the frame impulses in the frequency separator stage, and how each impulse is then made to control the frequency of its own saw-tooth sweep generator circuit. The horizontal and vertical sweep channel output circuit requirements for both electrostatic and electromagnetic deflecting systems are covered.

Television receivers generally have at least two power packs, one producing the extremely high voltage for the television cathode-ray tube and the other producing the lower voltages required by the various other vacuum tubes in the receiver. The design, construction and maintenance of these power packs is taken up.

You are taught how to acquire a safe and efficient television receiver servicing technique for each type of receiver trouble. Dead receivers are treated separately from improperly operating receivers. Instructions are given for handling interference complaints, and complaints of poor image definition. You learn how to adjust the pre-set controls, how to tune in a television program properly.

(Continued on page 435)



This 188 Page Money Saving 1940 Catalog FREE

on everything you buy!

### COMPLETE STOCK OF PARTS

Including items out of manufacture. All the nationally advertised brands. The world's greatest stock of parts. Consult your Lafayette catalog—save time and money.

### COMPLETE IN TEST EQUIPMENT

All the leading makes, all latest types. Every instrument accurately described. Here's the book that will enable you to keep up-to-date economically!

### COMPLETE P. A. SELECTION

Three complete lines — DeLuxe, Standard and Economy — for every purse and purpose. All systems — permanent, portable and mobile have the advantage of Lafayette advanced engineering. Amplifiers from 5 to 100 watts.

### COMPLETE LINE OF RADIOS

All the wanted features in portable, mantle, and phono-combination models. Beautiful style. Brilliant performance. Challenging the field in quality and low price.

### COMPLETE HAM SECTION

Greatest array of amateur receivers, transmitters, ham equipment we've ever assembled. Over 30 pages packed with merchandise—every item packed with value!

### PLUS A COMPLETE

line of 1940 auto radios, record players, tubes, tools, new books—all at lowest prices. Save money with the book that has everything in radio! Send for a copy today. It's packed with profits. And it's FREE! Mail coupon now.

Radio Wire Television Inc. formerly WHOLESALE RADIO SERVICE, INC.

**LAFAYETTE RADIO**

Sales Office in NEW YORK 100 Sixth Avenue ATLANTA 245 Peachtree St. CHICAGO 921 W. Jackson Rd. Boston - Newark Bronx - Jamaica

Radio Wire Television Inc. Dept. 4L9—100 Sixth Ave., New York, N. Y. Rush FREE 1940 Radio Catalog No. 78

Name.....  
Address.....  
City..... State.....

PASTE COUPON ON PENNY POSTCARD



# Autodyne Short-Wave Converter

G. H. Browning and C. H. Day

Efficient reception of short waves from 5 to 185 meters is made possible by the new Browning Autodyne converter which may also be employed as a *high-gain* preselector. Cost of parts, including cabinet, is nominal.

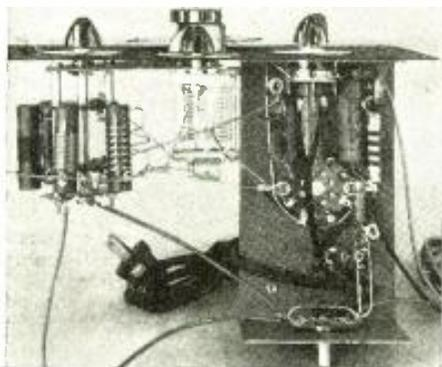
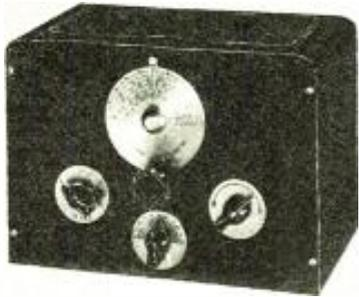

Top view shows converter housed in attractive cabinet. A calibrated dial with vernier drive is provided; vernier band-spread condenser facilitates tuning.

● MORE and more, radio fans are becoming interested in *short-wave* reception which covers two-way police communications, short-wave broadcast stations, airplane transmission, etc. Many of these listeners do not have all-wave receivers, and even if they do have general-coverage sets, the reception is usually not satisfactory below 10 meters. It is believed that there is a very substantial demand for an inexpensive converter covering a wide band of frequencies which may be attached to any A.C. broadcast receiver and thus make possible receiving signals the frequencies of which are between 5 and 550 meters (0.55 to 62.0 mc.). After considerable contemplation of this problem, a simple inexpensive *autodyne* converter was tried out and, to the amazement of even the writers, its performance proved to be exceptional.

It is well known that an autodyne type of converter is extremely simple to build and operate; and, with the advent of the new high-gain tubes, such as the 1852, surprising reception may be obtained.

An autodyne converter depends for its operation on a single oscillating tuned circuit. The incoming signal is fed to this oscillating circuit and the two frequencies (incoming frequency and oscillator frequency) mixed in the 1852 tube so that in the plate circuit, the *difference* between the frequency of the incoming signal and the frequency of the oscillating circuit appears. The set to which the converter is attached then acts as an intermediate frequency amplifier and audio system.

The converter to be described employs a *band-switching* tuner with 5 bands, the first band covering from 25 to 62 mc., the second band from 16 to 38 mc., the third band from 7.5 to 18.0 mc., the fourth band from 3.5 to 7.5 mc. and the fifth band from 1.7 to 3.8 mc. As will be noted from the above data, all frequencies are covered from 62 mc. to 1.7 mc. with generous overlaps from band to band. A Kenyon transformer has been used in the converter so that no external filament connections are necessary. An antenna throw-over switch is incorporated for convenience in changing an antenna from the converter to the broadcast receiver. Thus, the converter may be left connected to the broadcast receiver ready for instant operation and the broadcast receiver used in its normal manner. The power supply for the converter is conveniently obtained by means of a special connector which clips under one of the tube prongs of the receiver. The additional current drain is negligible.

The sensitivity of the converter when used with a broadcast set whose sensitivity at 550 kc. is approximately 5 microvolts is as follows: 60 mc. sensitivity, 5 microvolts; 28 mc. sensitivity, 5 microvolts; 11

The converter is laid out to keep all R.F. and by-pass leads short. A bus is used for grounding the components.

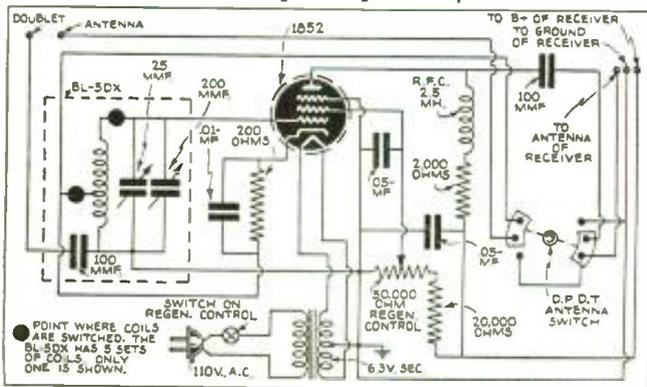

mc. sensitivity, 10 microvolts; 9 mc. sensitivity, 15 microvolts; 6 mc. sensitivity, 30 microvolts; 2 mc. sensitivity, 100 microvolts.

(Continued on page 427)

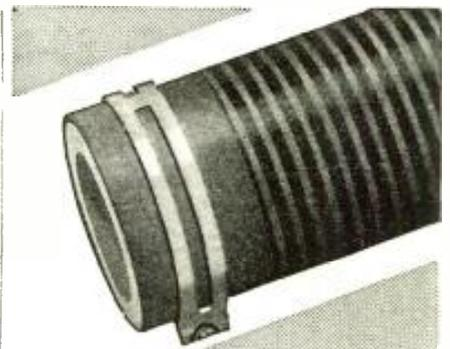

## MILLION VOLT RESISTORS...

Maybe you don't need million volt resistors . . . yet it is worth knowing that the same famous IRC Metallized resistance principle, best known in the little 1/2-, 1- and 2-watt Insulated Resistors for radio use, has now made possible outstanding advances in both high voltage and ultra high frequency resistors for advanced scientific research purposes.

10,000 ohms at 1/2 watt—100,000 volts at 150 watts—1,000 megohms at 150 volts . . . regardless of the need, the IRC Metallized element can supply them all, dependably and economically.

"Metallized" Resistors are made under IRC patents in eight countries. The Metallized type of element is the most adaptable yet produced. No other resistance material holds such an outstanding record of past success. None holds such broad possibilities for future development. Whatever your need—insist on the best!



"They Stay Put"



INSULATED  
*Metallized*  
RESISTORS

TYPE BT  
INTERNATIONAL RESISTANCE CO.

401 N. Broad St., Phila., Pa.

## DOERLE MODEL BS-6 BAND SWITCH RECEIVER

A powerful sensitive, and selective short wave and broadcast receiver covering 12 to 550 meters in 5 steps. No plug-in coils to change. Simply turn the wave band selector switch and enjoy reception on any wavelength within these limits.



Uses two 6K7G, one 6C5G one 43, one K42A ballast and one 25Z5 rectifier tubes, screen-grid RF amplifier, screen-grid electron coupled regenerative detector—powerful 2 stage audio frequency amplifier with pentode output stage—rectifier and complete built-in power supply. Hum free in operation.

Beautiful, heavy, black crystal finished metal chassis, panel, and cabinet. Illuminated, large, vernier type aeroplane dial. Smooth and effective regeneration control. Highly efficient electron-coupled oscillator of good stability.

Built-in high quality dynamic loudspeaker. Automatic headphone jack permitting the use of phones if desired.

\*Operates from your regular 110 volt house current.

\*Delivers good loudspeaker volume on all short wave and broadcast stations under fair conditions.

\*Simple and efficient bandswitching system.

\*Dimensions are approximately 14" x 7 1/4" x 7". Shipping weight is 18 pounds.

### KIT OF ALL PARTS

Including pre-wired coil circuit, otherwise unwired less tubes, but including Dynamic Speaker, Beautiful Cracked Cabinet, Drilled & Assembled Chassis, Airplane Dial.

### AMATEURS:

Model BS-6-AB has same specifications as BS-6 except that it has special band-spread circuit for 20-40-80-160 M bands and is equipped with plate voltage cut-off switch. Add \$1.00 to above price.

# 13<sup>50</sup>

Wired and tested, complete with tubes, ready to use, nothing else to buy .....\$17.50  
Note: Also available in battery model at same price upon special order.

### 3-Tube Electric

● DESIGNED for the short-wave "fan" who wishes to construct an inexpensive yet highly efficient set which will produce excellent results, this compact short-wave receiver uses a minimum of parts in a time-tried circuit. The entire set may be constructed for only a few dollars and will give excellent results.



Kit with all necessary parts, including assembled metal chassis, all five coils less tubes .....\$3.50

Wired, complete, ready to use with tubes \$6.50

## EILEN RADIO LABS.

297 DeKalb Ave., Dept. 11 Brooklyn, N. Y.

# Newest Radio Apparatus

## Beat Frequency Oscillator

M. N. Beitman

● THE Beat Frequency Oscillator unit is especially useful in tuning in weak stations. Without such a unit, it would be necessary in tuning to listen closely for the actual signal; with such a unit, however, when a phone station is tuned in and the B.F.O. unit is on, a louder beat note will be heard. This note indicates that the station is present at about this point on the dial; then the B.F.O. unit is switched off and the signal can be tuned in more accurately. For the reception of code transmission, the B.F.O. unit is kept in operation and is adjusted to the most pleasing, easiest-to-read pitch.

The beat frequency oscillator kit described here has been especially designed to meet the demand for an easily built unit which may be added to any existing superheterodyne receiver. The choice of a 58 or a 6D6 tube will depend on whether your present receiver uses 2.5 or 6.3 volt tubes. The transformer supplied with the kit is intended for an I.F. frequency of 456 kc. and is adjustable approximately 20 kilocycles up or down. If your radio set uses some other intermediate frequency, not within the range mentioned, the required transformer may be substituted.

assembles his own kit, and may also be used as a general guide for the wiring. In general, however, the wiring should be done by following the schematic diagram. The output wire is loosely coupled to the radio set and provides sufficient

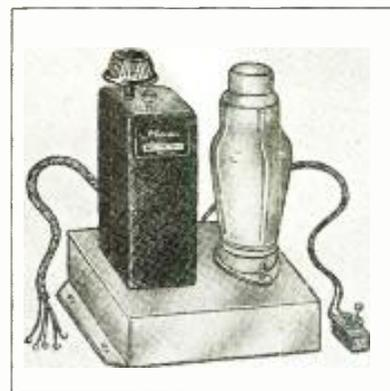

Neat and compact new Beat Frequency Oscillator gives great help in tuning in DX stations.

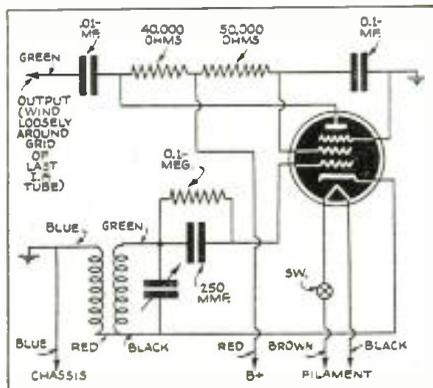

Hook-up of Beat Frequency Oscillator.

The unit obtains its filament and plate voltages directly from the radio set. Ordinarily, home type radio sets have sufficient excess power to handle this additional requirement. In the A.C. type of radio receiver, the filament connections of the beat frequency oscillator are made in parallel with one of the other tubes of the radio set.

In the A.C.-D.C. type of receiver having series filament connections, one of the connections is broken and the 6D6 tube which is needed is wired in series with the remaining tubes.

The necessary plate voltage may be obtained from the power tube screen-grid prong. This will afford high positive filtered potential. In addition, the chassis base of the beat frequency unit must be connected to the chassis of the receiving set.

The entire unit is easily assembled on the punched and drilled chassis base supplied with the Allied Radio kit. The pictorial diagram may be followed in the placing of parts if the constructor

signal to beat with the incoming signal. The actual intensity is easily controlled by making the coupling closer or looser. The pitch of the signal is controlled with the adjustment of the I.F. transformer.

The beat frequency oscillator may be turned on or off at will by means of the switch which is incorporated. This switch can be mounted wherever it is most accessible, but the B.F.O. unit itself is to be placed inside the radio set cabinet. Of course, in midjet type radio sets, the unit must be mounted separately since it will not fit into ultra-compact cabinets.—Courtesy Allied Radio Corporation.

### Complete Kit—List of Parts

- 1—Oscillator coil, 450-525 kc.
- 1—6-prong socket
- 1—.1 mf. 400 volt condenser
- 1—.01 mf. 400 volt condenser
- 1—.00025 mf. mica condenser
- 1—100,000 ohm. 1/4 watt resistor
- 1—50,000 ohm. 1/4 watt resistor
- 1—40,000 ohm. 1/4 watt resistor
- 2—Terminal lugs
- 1—Tube shield
- 1—3-foot 5 conductor cable
- 1—3-foot cord
- 1—S.P.S.T. switch
- 1—8-foot shielded cable
- 1—Chassis 3" x 4" x 1" drilled
- 1—Grid cap
- 1—Hardware kit, consisting of:
  - 12 6-32 1/2" screws
  - 12 6-32 nuts
- 1—Type 6D6 Raytheon tube for sets using 6.3 volt tubes, or
- 1—Type 58 Raytheon tube for sets using 2.5 volt tubes

### New 1 Kw. Transmitter

● "MORE accessible than a breadboard model" is what engineers are stated to remark upon first viewing the interior of the new Western Electric 1 kw. broadcasting transmitter.

As the photograph of the model with the doors open shows, all apparatus which generates heat has been mounted nearest the top. This insures cool operation. The set uses the famous high efficiency Doherty amplifier and a stabilized feedback circuit. Economical in operation, it is said to draw less than 50% of the operating power generally required by units of 1 kw. capacity. In the open view, the lower group of 5 rectifier tubes supplies the plate, screen and biasing potentials for the entire transmitter. Behind and below these tubes are most of the associated filters, transformers and control circuits. The second group of tubes includes audio monitoring rectifier, feedback rectifier and first and second audio stages. The R.F. oscillators and three amplifiers are on the next shelf, while the top shelf contains the final stages. The closed view shows how two doors cover the control knobs at right and left of the rack. A blower in back of the unit provides high speed air-cooling.

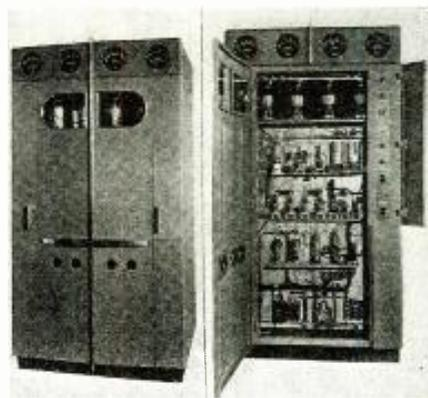

### Tilt Type Television Antenna

• THE new J.F.D. arrays represent an idea in television tilt antennae. With reversible directivity, they will cover all compass points vertically and horizontally and, being designed especially for low-angle horizontally polarized waves, minimum noise and maximum signal pickup should result.

The ball and socket universal joint is easily tilted for best reception, such orientation of the di-pole increasing the signal pickup and greatly reducing the noise and reflected signal (ghosts) pickup.

The J.F.D. rods are made of sturdy 3/8" brass tubing, nickel plated, giving a flat response over a broader band or range of frequencies and permitting efficient reception over a 6 megacycle spread. For other than one channel reception, the

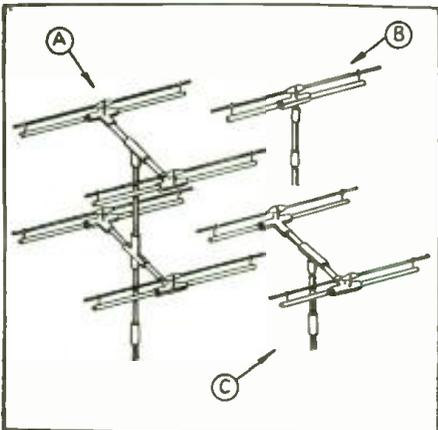

A—Dual Doublet Array with reflectors. B—Single Doublet. C—Doublet with reflector.

rods are ruled and stamped for two other channels, namely 45 ins for 66-72 mc. and 38 in. for 78-90 mc.

All standards and cross arms are of hard wood, lacquered and all metal parts such as the brackets and ball and socket are of cast aluminum, thus achieving a strength combined with lightness not heretofore presented. Insulators are porcelain.

All parts of the J.F.D. television antennae are clearly marked and easily understood instructions make assembly and installation a simple matter. They are available in single and double di-pole types with and without reflectors.

### Improved Microphone



• AMERICAN MICROPHONE CO. is offering a new dynamic microphone which has many interesting features. A choice of non-directional or semi-directional characteristics are obtained by tilting the microphone at various angles to the incident sound. Improved electrical and acoustical design have increased its output efficiency several decibels. Its sensitivity is 48 db. below 1 V/bar. and it covers a frequency range of 60 to 7,000 cycles. It is available in 30, 50, 200, 500 and 38,000 ohms impedance.

### Oil-Filled Condensers

• SOLAR MANUFACTURING CORPORATION, makers of capacitors, presents to radio amateurs a new type of oil-filled filter capacitor for general transmitting use. This unit, available in all standard values, is called Solarex Type O. It is built of paper sections which are oil-impregnated



under high vacuum and the assembly is rigidly held in round metal cans, oil-filled and hermetically sealed. Terminals are high quality porcelain stand-off insulators. Mounting is accomplished by detachable rings. The units may be upright or inverted.

### Mike and Oscillator

• A NEW low-cost carbon microphone and oscillator-modulator have been produced by RCA Manufacturing Co., Inc., for use with any radio receiver for home broadcasting. The microphone is of the single-button type and is claimed to equal many more expensive models in general purpose performance. It is the lowest priced carbon microphone in the history of RCA. The oscillator-modulator is also a low cost unit with usual RCA efficiency.

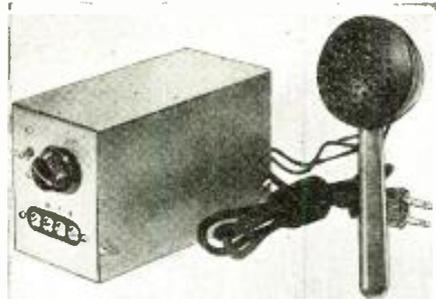

### Two Guthman Innovations

• THERE are two new items in the Guthman line. First among these is the Keystone, type U-35—an audio frequency oscillator having choice of four tone pitches, any one of which is made audible through a built-in loud-speaker.

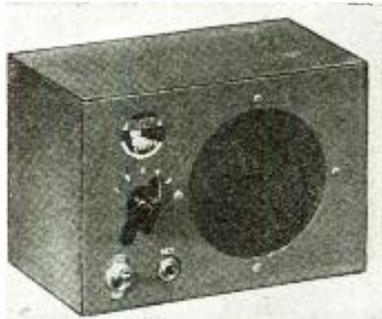

Designed to serve as a code practice instrument and as a source of tones for testing amplifier systems, it can be operated from 105-125 volts, 25-60 A.C. or from D.C. The control knob has four positions, and a jack is provided so that a key may be plugged in. The unit requires but a single 70L7GT tube in order to be complete and ready for operation.



The other new item on this manufacturer's list is the new U-42 high-gain Pre-Selector, which may be connected between the receiving antenna and any receiver to improve gain, selectivity and signal-to-noise ratio. It operates on five bands from 490 kc. to 46 mc. and is calibrated over 324 degrees. The tuning knob has a 5 to 1 vernier. Amplification is controlled by a regenerative control knob, and when the set is oscillating, it will serve as a heterodyne frequency meter. A phone jack is provided to permit monitoring phone or C.W.

### New Brush Products

• THE Brush Development Co.'s type BJ headphones are especially designed to meet the requirements of dependability, ruggedness, light weight, sensitivity and the ability to withstand adverse climatic conditions. A soft rubber jacket encases the cartridge and a hermetically sealed aluminum cartridge construction protects the phones against adverse climatic conditions. Another feature popular with communications men is the yokeless cord design. The headband is adjustable.

The new Brush US microphone has a very high output level with good fidelity (-44 db.), approximately 1/2 volt for close speaking. It is especially designed for mobile transmitters and for communications work where highest sensitivity is desired. It is light and rugged and not highly priced.

Other new Brush microphones are the Model QO and QOM. The QO has a fidelity of response 30 to 9,000 c.p.s. For close speaking the output is sustained in the lower register without booming. Its output level is minus 54 db.

The QOM has the same characteristics as the QO. The only difference in the two microphones is the case.

# I'LL SHOW YOU HOW TO MAKE REAL MONEY IN RADIO AND TELEVISION



New Practical HOME TRAINING fits you quickly

YOU GET PROFESSIONAL TEST EQUIPMENT plus EXPERIMENTAL OUTFITS!



146 RADIO PARTS RADIO TOOLS All-Purpose, All-Wave ANALYZER

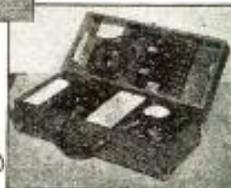

I'LL PROVE THAT YOU CAN HAVE

A GOOD JOB IN RADIO . . . OR A BUSINESS OF YOUR OWN

I offer you a new and altogether different type of practical training for a money-making career in Radio and Television. No matter if you desire to BE YOUR OWN BOSS in your own business, or hold down a good job in Radio, my Personalized Training will give you the useful knowledge to win success.

### EASY TO LEARN—EARN FROM THE START

YOU DO PRACTICAL EXPERIMENTS with real Radio Equipment . . . with your own hands. Thus the principles of Radio become crystal-clear to you. The valuable spare-time BUSINESS BUILDERS I supply will show you how to put this knowledge to work in handling profitable Radio service jobs while learning.

### NO PREVIOUS EXPERIENCE NEEDED

It makes no difference what your education has been. My Training starts at the beginning of Radio, covers in a simple understandable style all essential subjects including Television, Electronics, Facsimile Radio, Radio Set Repair and Installation.

### READ WHAT THIS STUDENT SAYS "Earned \$250. Since Starting Course"

"I have only completed one third of the Sprayberry Course and I find it very interesting, which makes it easy to learn. By devoting several hours spare time daily to studying and servicing I have made about \$250 gross since starting the course." Earl W. Hostetter, R. No. 4, Lebanon, Pa.

### SERVICEMEN

I offer Advanced Training for those already in Radio. Get complete details in my FREE 52-page Book.

REMEMBER—THE SPRAYBERRY COURSE IS SOLD UNDER A MONEY-BACK AGREEMENT



RUSH THIS COUPON FREE for BIG FREE BOOK

DON'T DELAY! ACT NOW!

SPRAYBERRY ACADEMY OF RADIO  
F. L. Sprayberry, Pres.  
245-L University Place, N.W., Washington, D. C.

Please send me FREE copy of "HOW TO MAKE MONEY IN RADIO."

Name . . . . . Age . . . . .

Address . . . . .

City . . . . . State . . . . .

Tear off this coupon, mail in envelope or paste on penny postcard. Servicemen—Check here

# WRITE ME!

I will help you get the right receiver and see that you are 100% satisfied. We stock all receivers—more than 25 models of all makes—and know all about them. Write for full information.

You can buy on 6% terms financed entirely by myself so you buy with less cost—more convenience—quicker delivery.

You get maximum trade-in for your receiver—describe it and I will tell you its trade-in value—and you can pay the balance on my 6% terms. You get ten-day free trial—you don't buy unless you are satisfied.

You get prompt shipment from the world's most complete stock of communications receivers. Shipment from factory if you wish.

Model	Cash Price	Down Payment	12 Monthly Payments
HQ-120X	\$129.00	\$25.80	\$9.11
SX-24	69.50	13.90	4.90
Sky Buddy	29.50	5.90	2.08
RME-70	138.60	27.72	9.79
NC-44	49.50	9.90	3.49
NC101XA	129.00	25.80	9.11
Howard 460	79.95	15.99	5.64
Breting 6	32.40	6.48	2.28

Similar terms on all other receivers.

*Bob Henry*  
**W9ARA**  
**HENRY RADIO SHOP**  
 Butler, Missouri

**JFD**

## TILTING TELEVISION ANTENNA

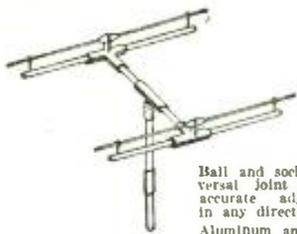

Ball and socket universal joint permits accurate adjustment in any direction.

Aluminum and hardwood construction achieves a strength combined with lightness not heretofore presented.

Made in single dipole and single dipole with reflector.

Send for complete details.

**J. F. D. MANUFACTURING CO.**  
 4111 Ft. Hamilton P'kway, Brooklyn, N. Y.

**SOLAR**  
 WAX-MOLDED  
**Sealdite**  
 Tubular Paper Capacitors molded in hard wax... no moisture can enter... much longer life... buy from your jobber in factory-sealed cartons.  
 Write for Catalog  
**SOLAR MFG. CORP. Bayonne, N. J.**

## Wireless Microphone Unit

● NOW comes a miniature broadcasting device that plugs into any electric socket and transmits to nearby receivers without the use of wires. It is called "Mystic Mike," and is made by the Olson Mfg. Company.

The unit consists of a modulated oscillator with tube and microphone. It will operate on

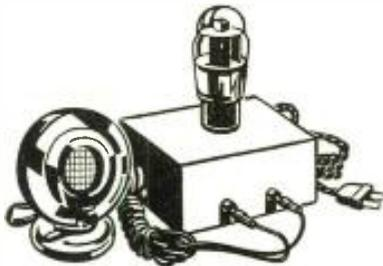

A.C. or D.C. The unit, with variable frequency control, radiates a signal within tuning range of all types of broadcast receivers.

The makers suggest its use for home entertainment or as a public address system. It is convenient for many purposes in offices and stores, as well as for auditions, rehearsals, etc. The chief feature is the fact that no inter-connecting wires are needed.

## New Crystal Mike

● A NEW Turner crystal microphone, with tilting head adjustable over full 90 degrees range for semi- and non-directional pick-up, has just been put on the market by the Turner Co.

The new microphone is satin chrome plated all over, in streamline, modernistic design, which allows the cable set to be removed and changed without opening the mike. It has a range of 30-7000 cycle high level -52 db. and is fully shielded and protected for the ham rig, yet rugged enough for the toughest P.A. jobs.

## New RCA Tubes

● SEVERAL new model tubes have been announced by the Radio Corporation of America. Among these are:

**1T5-GT Beam Power Amplifier.** This tube, designed for use in Class A1 single-tube amplifiers, has a filament voltage of 1.4, drawing a current of .05 amp. Maximum plate and screen voltages are 90 with -6 on the grid. The plate current is 6.5 ma., and the transconductance 1150 micromhos. The tube has a maximum signal power output of 170 milliwatts.

**6P5-G Detector Amplifier Triode.** to be used as a Class A1 amplifier. Its characteristics are: Heater voltage 6.3 A.C. or D.C., heater current .3 amp., grid voltage -13%, amplification factor 13.8, transconductance 1450 micromhos, plate current 5 ma.

**6V6-GT Beam Power Amplifier,** to be used as a single-tube Class A1 amplifier or as a push-pull Class AB1 amplifier. Its heater voltage is 6.3 A.C. or D.C., heater current .45 amp. When used in a single-tube circuit, maximum plate and screen voltages are 250, and the grid voltage is -12½ max. The transconductance is 4100 micromhos and the maximum signal power output 4.25 watts. When used in a push-pull amplifier, the maximum plate and screen voltages are 300, the grid voltage -20 and the maximum signal power output 13 watts for two tubes.

**7AP4** is a 7" kinescope of the magnetic-deflection type with a white phosphor screen and short bulb. The approximate size of the image reproduced on this screen is 4½ inches by 6 inches or slightly larger. The tube's overall length is 13½". A maximum of 1000 volts is used on the focusing electrode (anode No. 1). The grid (control electrode) is kept in a negative potential, and a maximum of 3500 volts is used on the high voltage electrode (anode No. 2).

A very interesting pamphlet telling the applications and characteristics of this tube, together with a circuit diagram for its voltage supply and sweep circuits, has been issued by the manufacturer.

**1898 Monoscope.** This is a 3" electrostatic-deflection type tube, used for demonstrating the principles of television. It contains an electrode on which is printed a picture of a girl's head. In operation, an electron beam scans this picture and, as a result of the secondary-emission effect thus produced, the tube generates a video signal representing the picture. It thus provides a convenient source of picture signals which is available independently of television broadcasts.

The tube requires a maximum of 1300 volts on the pattern electrode, 1200 volts max. on the focusing electrode (anode) No. 2, and 500 volts max. on focusing electrode anode (No. 1).

A booklet describing this tube and its uses also contains circuits for its high-voltage supply unit, the vertical deflection circuit and video amplifier, etc.

## How To Improve Your Bridge Play

Do not try to pit your skill against that of occasional players because they cannot offer you any competition.

Nor can you learn the fine arts of bidding and play from those who know little about the game.

### TOM THUMB INTERNATIONAL BRIDGE GAME

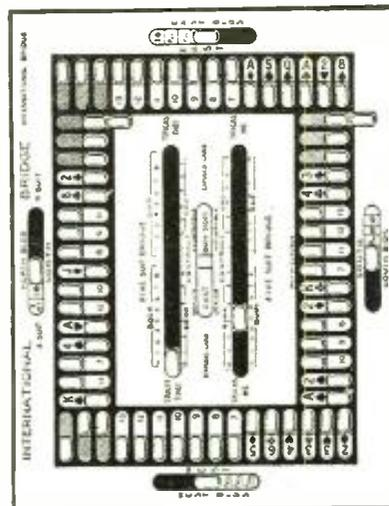

which is an ingenious mechanical device, you play with an expert as a partner against two other experts.

You not only improve your bidding and play, but you learn how to play bridge the way experts play, while you are amusing yourself with the most exciting game of solitaire ever devised.

If you are a beginner, this Tom Thumb International Bridge Game will start you on the right track to becoming a good bridge player.

Bidding and play explained by experts on each sheet under the board.

Large metal board with 24 deals in envelope **\$2.00**

Smaller " " " 12 " " **\$1.50**

24 extra deals in envelope .....50c

P.P. PREPAID to any part of the U.S. and Canada

**GOLD SHIELD PRODUCTS**

350 Greenwich St., Dept. R&T, New York City

## EASY—SIMPLIFIED—PRACTICAL

# ELEMENTARY MATHEMATICS

A book for the Technician and Craftsman, explaining and answering every meaning with illustrations. A real study-course in mathematics for the student or the man who wants to brush-up on his knowledge.

Special Chapter on Radio problems calculation.

### CONTENTS OF BOOK

**I. ARITHMETIC:** Addition, Multiplication, Division, II. Factoring and Cancellation, Fractions, Decimals, Percentages, Ratio, and Proportions, III. The Metric System, IV. How to Measure Surfaces and Capacity (Geometry), V. POWERS: Involution—ROOTS: Evolution, VI. Mathematics for the Manual and Technical Craftsman, Thermometer Conversions, Graphs or Curve-Plotting, Logarithms, Use of the Slide-Rule, VII. Special Mathematics for the Radio Technician, VIII. Commercial Calculations, Short-cut Arithmetic, Interest, Discounts, IX. Weights and Measures, Useful Tables.

**ONLY 50c POSTPAID**

Stamps, Cash or Money Order

## TECHNIFAX

Division RT-1139

1915 S. State St.

Chicago, Ill.

## WHAT STRANGE POWERS

Did The Ancients Possess?

WHERE was the source of knowledge that made it possible for the ancients to perform miracles? These wise men of the past knew the mysteries of life and personal power. This wisdom is not lost—it is withheld from the masses. It is offered freely TO YOU, if you have an open mind. Write for free sealed book. Address: Scribe CPA.

**The ROSICRUCIANS**  
 San Jose (AMORC) California

## Controls Are Improved

● CONSOLIDATED WIRE & ASSOCIATED CORPS. has just announced important changes in its volume and tone controls. The overall diameter and the overall thickness of the units has been reduced and at the same time the efficiency has been improved. Instead of the irregularly spaced groovings formerly used on the shafts, the present units have three-inch shafts grooved at quarter inch intervals from the end of the shaft. These units come in five types with resistances ranging from 1,000 to 2,000,000 ohms.



## Browning Autodyne Short-Wave Converter

(Continued from page 423)

It will be noted by the above data that the sensitivity increases at the higher frequencies which is indeed fortunate, for they will be generally used rather than the lower frequencies which, in some cases, may be covered by the receiver itself.

The apparatus described may be constructed in about two hours as the circuit is not at all complicated. The Browning 5DX tuner which is the band-switch tuner employed, comes completely wired and assembled so that only 3 connections need be made between it and the associated apparatus. However, as these connections carry RF current, No. 16 bare wire should be used and the connections should be made as directly as possible. (Refer to chassis view of converter.) It will be noted from the picture that the five coils on the tuner are rigidly mounted on a band-switch and that the 200 mmf. main tuning condenser and the 25 mmf. band-spread condenser are mounted together with the coil assembly to form an integral unit. The main 200 mmf. tuning condenser is controlled by means of a calibrated laboratory type vernier dial. The 25 mmf. condenser was designed to be used as a band-spread condenser on the amateur bands. However, as the tuning of the converter is extremely sharp, it is advisable to remove all but one stator plate and one stator from this 25 mmf. condenser and employ it as a vernier. This is especially necessary on the 5-meter band. The plates on this condenser can be readily removed by means of a pair of pliers, leaving a lone stator and rotor plate.

It will be noted that all parts are grounded to a common ground bus and that the chassis is not employed for this purpose. It is important that the leads to by-pass condensers be as short as possible. Very short connections are obtained by mounting these, as shown in the under-chassis view of the converter.

The following procedure is necessary to connect the converter to any receiver:

1. Connect the antenna to the antenna post of the converter. If a doublet antenna is not used, be sure that the antenna is attached to the antenna terminal strip which makes connections to the tap on the 5DX tuner.

2. Connect the output of the converter to the antenna post of the receiver.

3. If the receiver is equipped with provisions for a doublet antenna, one of the receiver's antenna terminals should be connected to ground. The correct antenna terminal to be grounded is usually designated in the instructions accompanying the receiver. Connect the ground of the pre-

(Continued on following page)

# NEW RADIO CATALOG

- ✓ **AMATEUR** A complete line of Nationally Advertised receivers, transmitters, mikes, keys, parts, etc.!
- ✓ **SERVICE** Compare all the important makes of test instruments, side-by-side, for the first time in any catalog!
- ✓ **SOUND** equipment for every purpose. From the new one-piece "Orator" to the largest 100-watt sound system for stadiums!

## MONTGOMERY WARD

9 Great Mail Order Houses More than 600 Retail Stores

### TIME PAYMENTS

Easy terms on Everything!

### COMPLETE STOCK

One of the largest in existence!

### SAME DAY SERVICE

Your order goes through immediately!

### MONEY-BACK GUARANTEE

You take no chances when you order from Wards!



MONTGOMERY WARD & CO.  
Dept. SW-31 Chicago, Illinois  
Please RUSH me your FREE  
Radio Equipment Catalog.

Name.....

Address.....

City..... State.....

## COMPLETE RADIO COURSE \$1.95

### Regular RADIO TECHNICAL INSTITUTE Training



#### A SPECIAL OFFER

A limited quantity of R.T.I. \$39.00 radio courses have been reprinted and are offered to you at only \$1.95. These are the latest courses, complete in every detail, and exactly the same as the originals.

Radio is the present-day opportunity field. Hundreds of men with no special talents have studied Radio Servicing for a short time and are now making twice and three times as much money. R.T.I. unique radio training brings rich rewards; you can get ready quickly, inexpensively, easily, and in your spare time for a good job in radio.

#### ACCEPTED BY INDUSTRY

Forty large radio manufacturers have helped to prepare the R.T.I. course. Just think what this backing by the radio industry means to you. R.T.I. practical training will give you facts and real data you will need on the job. Hundreds of diagrams and illustrations will help you. You will pass quickly from lesson to lesson and in a surprisingly short time will be ready to do real radio servicing.

#### COMPLETE IN ALL DETAILS

No special previous education or experience is needed. R.T.I. course will give you all the training you need. The lessons are clear, interesting, easy to master and use. Fellows who knew nothing about radio before taking a radio course are now the leading servicemen in their communities. This is your chance to obtain R.T.I. excellent course for only \$1.95.

From the very start you are introduced to practical servicing equipment and practice. You are told how to open your own shop or radio store. Lesson 15, "The Radio Servicing Business," will give you many practical ideas and hints. The course is so planned that you will be able to earn spare-time money before you have reached your tenth lesson. The special \$1.95 price of the complete course can be earned in a single hour's work of radio servicing.

#### YOUR GUARANTEE

You are completely protected. We guarantee these courses to be exactly as the original \$39.00 Radio Technical Institute courses. Money back guarantee. References: Liberty National Bank, Chicago, Dun & Bradstreet, or any magazine publisher.

#### 3 COURSES IN 1

R.T.I. course is really three complete essential courses combined. You get training in (1) Practical and Applied Radio; (2) Fundamentals of Radio Principles; and (3) Advanced Specialized Training. This is the training that will place you above the average radio servicemen—and you get this training for only \$1.95.

There are over 37,000,000 radio sets in use. The R.T.I. easy practical course will pave the way to your success in Radio work.

#### TELLS HOW TO USE INSTRUMENTS

The training is complete. Everything from simple facts to complex alignment problems. Many servicemen have found that R.T.I. training is excellent for brush up and study of modern servicing methods. This is the best buy in a radio education. Take advantage of the bargain price today.



#### LATEST DATA

Yes, in the R.T.I. course you will find a complete explanation of A.V.C. bow to use an oscilloscope, sound feed-back, resonance phenomenon... every possible fact you must know to be the best serviceman. You get a real radio training. One of the BEST radio courses is yours for only \$1.95.

#### LIMITED QUANTITY

Hurry your order to us today. There is but a small quantity of the courses left at the special price. You are completely protected with our guarantee. Postal money orders, checks, currency, unutilized stamps accepted. Answer today.

**SUPREME PUBLICATIONS,**  
3727 W. 13th St., Room 206,  
Chicago, Illinois

Please send the complete R.T.I. radio course at the special \$1.95 price. I am to be protected with your money back guarantee.

- I am enclosing \$1.95, send prepaid.  
 Send C.O.D. I will pay mailman \$1.95, plus a few cents postage.

NAME.....

ADDRESS.....



# SWINGS INTO ACTION

Primarily the aim of the Association is to return to the Distributor, the Dealer and the Serviceman the profits which are legitimately HIS! This can only be accomplished by raising the standards of ethics of merchandising within the Industry.

Names of Member Jobbers in your territory will be supplied if you will address the Executive Secretary of the Association.

**TEMPORARY OFFICE OF THE EXECUTIVE SECRETARY**  
5 West 86th Street New York, N. Y.

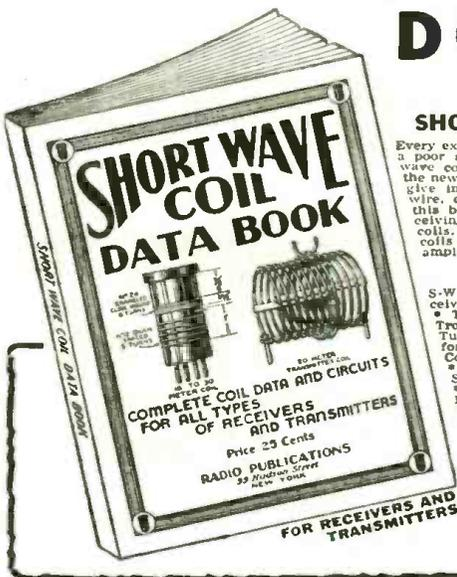

## DON'T FAIL TO GET THIS

### SHORT WAVE COIL DATA BOOK

Every experimenter knows that the difference between a good and a poor radio set is usually found in the construction of short-wave coils. Coil winding information is vitally important and in the new coil book all "dope" appears. There're illustrations which give instructions on how to wind coils, dimensions, sizes of wire, curves and how to plot them. Every experimenter needs this book—it also contains complete data on all types of receiving coils, together with many suitable circuits using these coils. Also complete data on various types of transmitting coils with many transmitting circuits such as exciters and amplifiers using the various coils described.

#### Contents Briefly Outlined

S-W Tuning Inductance Charts • Coil Data for T. R. F. Receivers • One Tube Oscillodyne • Two Tube Handspreader • The Mono-Coil • 2-Tube Old Reliable • 2-Tube Globe Trotter • 2 Winding Coils—10-500 Meters • Doerle 3-Tube "Signal Gripper" Electrified • 3-Tube Bandspreader for the Ham • General Coverage Coils on Ribbed Forms • Coil Data for Superhet or S-W Converter • Ultra S-W Coils • Switch Coils for S-W Superhets • Experimental Coils • S-W Antenna Tuner • Most Popular S-W Tuning Circuits • Self-Supporting Transmitting Circuits Employing Coils Described • All Band Antenna Tuner for Transmitting • Plug-in Coils for Exciters • Frequency-Wavelength Conversion Chart.

**PRICE 25c PREPAID**

For a copy of this handy book, send 25c in U.S. Coin or stamps to

**RADIO PUBLICATIONS**  
39 HUDSON STREET NEW YORK, N. Y.

(Continued from preceding page)

selector to the ground terminal of the receiver.

4. Connect the +B lead of the converter to the +B of the receiver. The voltage used on the converter should be between 180 and 300 volts. In practically all receivers, connections may be made to the screen grid of the receiver's output tube by means of a special connector which connects to the tube prong and thus eliminates the necessity of any soldered connections to the receiver's B supply.

#### Tuning the Converter

1. The broadcast receiver to which the converter is attached, should be tuned to some place on the low frequency end of the band where no stations will be picked up, near 550 kc.

2. Turn the antenna throw-over switch in the rear of the converter to position 2. (This connects the antenna to the converter and the output of the converter to the antenna post of the receiver).

3. Advance the regeneration control until the circuit associated with the 1852 tube is oscillating. (Turn 50,000 ohm potentiometer clockwise.)

4. Set the converter band switch on the desired frequency range. The tuning may then be done with the main tuning dial of the converter and vernier adjustments made as required. The volume of the received signal is regulated by the volume control of the broadcast receiver to which the converter is attached. Tuning will be found to be very sharp, and consequently it is advisable to rotate the dial of the converter slowly in order not to pass desired stations.

#### Using the Autodyne Converter as a High-Gain Preselector

The autodyne can be also readily used as a high-gain preselector by changing the mode of operations as follows: The apparatus is connected to the receiver as previously described. The antenna throw-over switch on the preselector is turned to position 1 and a short-wave station tuned in on the receiver in the ordinary manner, after which the antenna throw-over switch on the converter is thrown to position 2, the band switch set at the desired frequency range, and the regeneration control so retarded (turned counter-clockwise) that the circuit associated with the converter is not oscillating. Tune the converter carefully to the signal and at the same time advance the regeneration control. By carefully adjusting the regeneration control, tremendous gains may be obtained. Increase in signal strength of from 30 to 70 DB on all bands may be had, according to the amount of regeneration used. It will be found that incoming noise is materially reduced by using the converter as a preselector.—Data supplied by courtesy of Browning Laboratories, Inc.

#### Parts List—Available as Kit

**BROWNING LABORATORIES**  
5 DX Tuner  
7" x 10" x 6" cabinet

**KENYON**  
6.3 volt filament transformer

**MISCELLANEOUS**  
50,000 ohm potentiometer with A.C. switch  
2.5 mh. R.F. choke  
Double-pole, double-throw switch  
2—.05 mf. tubular 600 volt condensers  
1—.01 mf. tubular 400 volt condenser  
1—200 ohm, ½ watt resistor  
1—20,000 ohm, ½ watt resistor  
1—50,000 ohm, ½ watt resistor  
1—DXD vernier drive dial  
4—Pointer knobs  
4—Escutcheons  
1—Tube socket  
1—Chassis  
Miscellaneous hardware, wire, etc.

**IT'S LIKE HAVING YOUR OWN BROADCASTING STATION**

Now! This perfected M-stic Mike Wireless Outfit, with variable frequency control, enables you to do your own broadcasting from any part of your home, office or store WITHOUT the use of any interconnecting wires. Simply plug this unit into any AC or DC electric socket, speak or play music into the microphone and your voice, or the music, will be picked up by ANY radio ANYWHERE within the same building. Use it at home, office or store, for entertaining, rehearsals, auditions, as a public address system. Hundreds of uses.

**FREE BULLETIN RT-11** WRITE FOR **MONEY BACK GUARANTEE**  
**OLSON MFG. CO., 362 Wooster Ave., Akron, Ohio**

## MYSTIC MIKE WIRELESS Outfit

COMPLETE SET, WITH MICROPHONE and TUBE

**\$3.95** NET PRICE

Tear out this ad. write name and address in the margin, mail \$3.95 or order C.O.D. and we will send outfit at once.

**RADIOS.. SAVE UP TO 50%**

DEAL DIRECT — FACTORY PRICES... Many models to choose from at wholesale prices. AC DC midrange \$4.99. Portable and battery sets \$8.98 up. Car sets \$11.75 up. Also consoles, all-wave, etc. Samples at 50% off. Send for FREE 1940 bargain catalog giving details of 10 day FREE trial and agent's location and discounts. No obligation, write today.

**R.C.A. 495** EACH (in 1939)

**10 DAY TRIAL**

**Free Catalog**

**GOLDENTONE RADIO CO., DEPT. RT., Dearborn, Mich.**

**PRE-SELECTOR**

Self-powered, 490 to 48,000 K.C. Greatly increases gain and selectivity. Price only \$16.50 net. Kit \$19.80 wired. Cabinet \$2.40. Tubes \$1.38. Buy from your jobber or direct.

**EDWIN I. GUTHMAN & CO., INC.**  
400 SO. PEORIA ST., CHICAGO, U. S. A.

## Let's Listen In

(Continued from page 407)

ing this period of international antagonisms. Elsewhere in the magazine there appears a digest of rules suggested by the A.R.R.L. for the conduct of its members. More recently the F.C.C. has taken action against two amateur radio operators for violation of the Radio Law. The Commission, according to *Associated Press*, has issued a warning that "unauthorized activities by amateur stations during the period of the European war may tend to bring about curtailment of the short wave operations of amateurs generally." All of the nation's 60,000 amateurs have been urged to take all appropriate steps to protect their own standing.

It's an old saying but a good one—*A word to the wise is sufficient!*

## New Plaque Award

(Continued from page 409)

To the right of the Gross rig is a small portable emergency CW rig equipped for either "B" battery or power-supply operation. The tube line-up is a 6C5 crystal oscillator to a T21 final with 30 watts input. An 83 tube supplies the power for home work, while a supply of "B" batteries are on hand at all times in case of an emergency. One crystal is used to work both the 80 and 40 meter bands.

The receiver is a Hallcraft's Super Skyrider SX17, and to the left of this is a National SW3 which operates from either power-supply or "B" batteries, and is used as a preselector at the home station and as a receiver for emergency work. To the right of the SX17 is a two stage monitor.

The antenna is the "Poor Man's Rotary Beam" of the 8JK type, constructed on 4 bamboo fish poles at a total cost of \$4.50.

I would also like to add that I find many valuable articles in your magazine, and look forward each month to its arrival.

Yours very truly,

W. B. WILEY, W9QDD/5,  
Watonga, Oklahoma.

## New 18-Tube Receiver

(Continued from page 420)

ner for the "C" bias supply.

The gain in the first R.F. stage is said to be sufficient to override noises originating in the other tubes used in the circuit, and the gain in the first tuned circuit is claimed to be great enough to definitely establish a high signal-to-noise ratio even on weak signals. The antenna coil will operate with a low impedance lead-in system to reduce the possibility of noise pick-up. A multi-section cam-operated knife switch with silver-plated contacts is used for band changing. As no moving parts in the switch carry current, the chances that it will cause noise or introduce instability are small. Band width changes in the I.F. are secured by mechanically varying the coupling between the primary and secondary of the I.F. transformers. Three stages of I.F. using special transformers are employed.

The output of the receiver, with its three stages of audio, is approximately 16 watts. The set has all the more desirable features, such as A.V.C., SEND-RECEIVE switch, phone and phono connections, etc. The manufacturers have taken every precaution to make the receiver electrically sound and mechanically suited to years of exacting service.

for November, 1939

# WHAT IS IT?

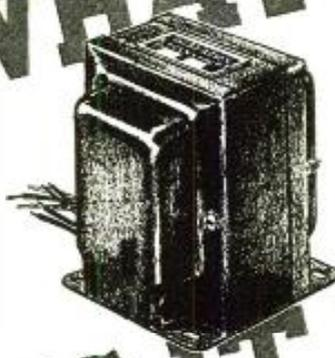

It is the largest-selling Plate Supply Transformer in the world—the THORDARSON T-19P56! Ten pounds of the most scientifically engineered iron and copper—built with the ruggedness of Gibraltar, to give amateurs dependable service for years. Your favorite Parts Jobber has just the THORDARSON transformer you need for any purpose—transmitter or receiver. Ask your Parts Jobber for Catalog 400-D.

## THORDARSON

Elec. Mfg. Co., Chicago

"THERE IS 44 YEARS OF EXPERIENCE BUILT INTO EVERY THORDARSON TRANSFORMER"

### TELEVISION SLANG

LESS HEADROOM . . . means to raise the person in the picture by tilting the television camera downward.

MORE HEADROOM . . . means to make more margin from the top of the actor's heads to the top of the picture. Accomplished by tilting camera head upward.

TRUCK BACK . . . action by the camera when it is moved back for a long shot. TRUCK UP . . . is the movement forward for a closeup.

BLIZZARD HEAD . . . a blonde woman or man television actor.

DARK ANGEL . . . a brunette because they televise easily, hence "angel" and their dark tresses cause a studio light "halo," whereas a BLIZZARD HEAD also causes a "halo" but a troublesome one difficult to control.

GHOST . . . a disturbing result of signal reflection which appears as part of the television image.

SECOND MIKE . . . means swing a boom microphone into place but out of picture range. This occurs when camera trucks back for a long shot and takes FIRST MIKE with it. FIRST MIKE being attached to camera dolly.

And here are some shortwave definitions as compiled by the Edgware Short-Wave Society of Great Britain:

SPOUT . . . an imaginary tube leading from the shack out into the free ether.

SOUP . . . the almost equally imaginary RF which is either "banged" or "sucked" up the spout.

BINGE . . . a delicate way of expressing large audio output.

PACKET . . . a mysterious parcel which arrives with commendable alacrity on touching HT transformer secondary, the final anode or other verboten places.

WALLOP . . . applied indiscriminately to both audio and RF power.

SPITCH . . . a harsh gurgling sound that interferes with the reception of CW on Amateur bands.

CW . . . a lousy chirping sound that spoils telephony reception on amateur bands. Dimly remembered by many amateurs as having been in some remote way connected with the obtaining of the license.

10 WATTS . . . a magic figure arrived at by multiplying Final Plate Volts by Final Plate Current—but of course there are meters AND meters.

PIRATE . . . an AA license-holder who yields to temptation, in a weak moment, to use the "spout."

## CONSOLIDATED CONDENSERS

Insist on Them for  
**QUALITY at LOW PRICE**



Dry-Electrolytic

By-Pass

Special Assortments

Shown at Left  
Inverted Type Dry-Electrolytic in Metal Container with Lock-Nut Mounting

There is a Consolidated Condenser for your every need—or a special assortment of these condensers to take care of your most frequent requirements. Save money with these top quality condensers at low prices.

See Them at Your Parts Jobber's Today!

**CONSOLIDATED**  
WIRE AND ASSOCIATED  
**CORPORATIONS**  
528 S. PEORIA ST. CHICAGO, ILL.

Please say you saw it in RADIO & TELEVISION

429

# A New Ultra High Frequency Receiver

Range 27 to 62 mc. (11.1 to 4.83 meters). Superhet has 11 tubes, A.V.C., C-W Oscillator, Noise Suppressor and Limiter.

● A SPECIALIZED communication receiver, utilizing a superheterodyne circuit, has just been announced by the National Company, Inc. Known as Type "NHU", this receiver covers the range from 27 to 62 megacycles (11.1 to 4.83 meters) in three ranges, each calibrated on a direct reading

after which is a pair of 6C8G's—one used as an infinite-impedance diode detector and noise limiter, the other as first audio and carrier-off noise suppressor. Two 6SJ7's are used for the C.W. oscillator and the A.V.C., which is both amplified and de-layed. A 6V6G is employed in the output.

70 to 1. Coils are mounted radially in a cast aluminum turret which is turned into position by means of a convenient control. Directly above this turret is the three-gang SLF tuning condenser. The R.F. circuit and tubes are within the condenser frame, thus affording the shortest possible leads. A

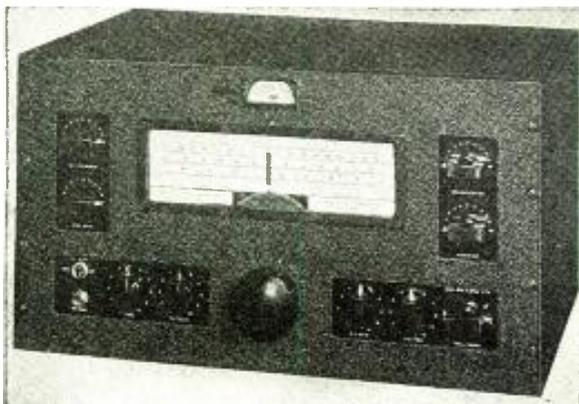

Right — Close-up view of the new 11-tube Ultra Short-Wave Receiver, showing the 3 Acorn tubes.

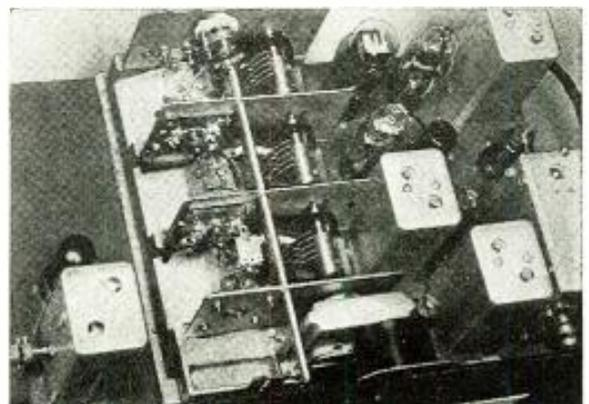

Left — Note the professional appearance of the new National "NHU" Communications Receiver.

full-vision dial. Three acorn tubes are used as follows: 956 as R.F., 954 as first detector and 955 as oscillator. This is followed by three 6K7's as the I.F. stages,

A single large knob on the panel is used both for the tuning condenser and the range-changing system. Tuning is of the inertia type with a ratio of approximately

wide range crystal filter and other standard features are also included. Many other features of great convenience to the operator are built into this well engineered receiver.

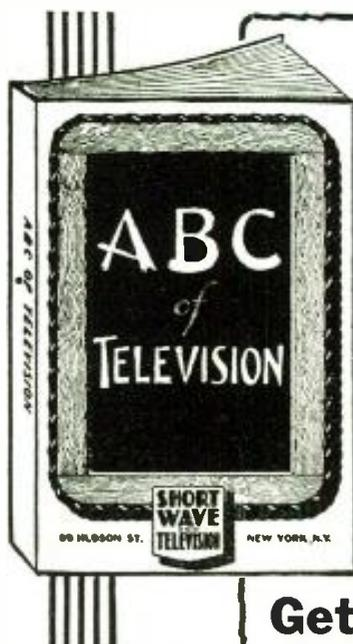

## TELEVISION'S Stride Today Makes It Essential for You to Read—"ABC of TELEVISION"—

WITH important progress being made in Television every day—and with developments satisfactory to Television engineers that consistent programs will be broadcast shortly, it is important that principles be understood quite thoroughly.

The publishers of RADIO AND TELEVISION give you the opportunity to add "ABC OF TELEVISION" or two other books to your technical library. They make the offer even more attractive by giving these books to you absolutely FREE. A subscription to RADIO AND TELEVISION for seven months at the cost of One Dollar gives you a choice of either of the three books shown in this advertisement. For Two Dollars you receive RADIO AND TELEVISION for fourteen months and you receive any two books of your choice absolutely FREE. To get all three books FREE, enter your subscription for twenty-one months for only Three Dollars. ANOTHER SAVING FOR YOU—THE PUBLISHERS PAY POSTAGE ON THE BOOK OR BOOKS YOU CHOOSE.

### Partial Contents of ABC of Television

- CHAPTER 1—The simplest television receiver; how the eye sees; its likeness to television equipment.
- CHAPTER 2—Theory of scanning; the Nipkow disc and its relation to television; the photo-electric cell; neon lamps; brief description of several modern mechanical systems.
- CHAPTER 3—Need for a large number of picture elements; need for broad channel width in transmission of high-fidelity television signals.
- CHAPTER 4—The use of the cathode ray tube in television receivers; necessary associated equipment used in cathode-ray systems.
- CHAPTER 5—How a television station looks and how the various parts are operated.

- CHAPTER 6—The Iconoscope as used for television transmission in the RCA system.
- CHAPTER 7—The Farnsworth system of television transmission.
- CHAPTER 8—The future of television; probable cost of receivers; some expressions of opinion by prominent men; list of present television transmitters.

64 PAGES—100 ILLUSTRATIONS  
Stiff, Flexible Covers, 5¼x8¼ INCHES

Get One or All of These Books

**FREE!!**

RADIO AND TELEVISION, 99 Hudson Street, New York, N. Y.

R&T-11-39

Gentlemen: Enclosed you will find my remittance of \$..... for which enter my subscription to RADIO AND TELEVISION as checked below; also send me, postpaid, the book or books which I have marked below:

- ABC OF TELEVISION
- S. W. RADIO QUIZ BOOK AND KINKS
- SHORT WAVE GUIDE

- 7 months—\$1.00—choice of any one of three (3) books. (Canadian and foreign—\$1.30)
  - 14 months—\$2.00—choice of any two (2) of the three (3) books. (Canadian and foreign—\$2.60)
  - 21 months—\$3.00—all three books. (Canadian and foreign—\$3.90)
- If you are a subscriber now, we will extend your present subscription.
- New subscriber       Old subscriber

Name..... Address.....

City..... State.....

Send your remittance by check or money order. If you send cash or unused U.S. postage stamps, please be sure to register your letter for your own protection.



**SHORT WAVE GUIDE**  
Covers hundreds of short-wave questions and answers; illustrates popular short-wave kinks; gives explicit instructions for building simple short-wave receivers; instruction on the best type of antenna installation; diagram and construction details for building transmitters.

### S. W. RADIO QUIZ BOOK

This book covers questions and answers on transmitters, short-wave receivers, ultra short-wave receivers; practical kinks, wrinkles and coil winding data; novel hook-ups for experimenters; how to "hook-up" converters, noise silencers, power supplies, modulators, heat oscillators, antennas, pre-selectors and 5-meter receivers.

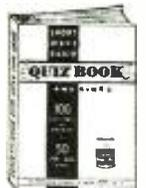

# On the "HAM" Bands

(Continued from page 413)

Call	Freq.	R	S	Heard In
ZS6AJ	14.07	5	7	Tex., Va.
ZS6DJ	14.06	5	7	Tex.
ZS6DW	14.075	5	6	Ariz.
ZS2AZ	14.08	4	6	Kan., Tex.
ZS4H	14.046	3	5	Nebr.
ZS5Q	14.03	5	8	Tex., Ont., Nebr.
ZS5DA	14.11	5	6	Ariz.
ZS6FD	14.06	7	7	Kan., Tex.
ZS6AJ	14.07	5	7	Tex., Va.
ZS6DJ	14.06	7	7	Tex.
ZS6DW	14.075	5	6	Tex.
ZS6BS	14.08	5	5	Ariz.
ZS6ED	14.1	4	5	Ariz.

## NORTH AMERICA

CO2LY	14.174	3	6	Wis.
K4FAY	14.25	5	9	N. J.
K4FKC	14.12	5	9	Ont.
T2RC	14.055	5	9	Ky., Mich., Ont.
VE3HI	14.01	4	7	Fla.
VE5KN	14.175	3	4	Wis.
VP6YY	14.12	5	5	N. Y.
VP6TR	14.3	4	8	Fla.
W1FH	14.	5	8	West Australia
W2XJH	14.	4	7	West Australia
W2AKZ	14.	4	7	West Australia
W2AKZ	14.	4	7-8	West Australia
W4ECF	14.	5	7-8	West Australia
W4AIT	14.	4	8	West Australia
W4PW	14.	5	9	West Australia
W5AKZ	14.	4	8	West Australia
W5CCB	14.	5	8-9	West Australia
W5CFO	14.	4	7	West Australia
W6NZS	14.	4	6	West Australia
W6BHO	14.	4	7	Wis.
W7PX	14.23	5	9	England
W7BVO	14.22	5	9	England
W8LW	14.	4	8	West Australia
W8MOV	14.	4	7	West Australia
W8CUE	14.	4	7-8	West Australia
W8DST	14.	5	7-8	West Australia
W9VXV	14.	5	8-9	West Australia
W9HOI	14.	3-4	6	West Australia
W9IAS	14.	5	8-9	West Australia
W9IZ	14.	5	9	West Australia
W9RUP	14.	5	9	West Australia
W9NTY	14.	5	8	West Australia
XE1PB	14.047	5	7	N. Y.
YN1IP	14.09	5	7	N. Y.

## SOUTH AMERICA

CE3DW	14.15	5	8	England
CE3CG	14.055	4	5	Conn.
CE3CO	14.19	4	5	Ont.
CE4AC	14.15	5	8	England
LU1HI	14.06	4	5	Conn.
LU2AW	14.2	5	9	Mich., Ont.
LU3HA	14.055	4	4	N. Y.
LU5PZ	14.17	4	9	Dist. of Col.
LU8AB	14.15	5	7	Okla., Dist. of Col.
OA3B	14.12	4	7	Fla.
OA4C	14.157	5	7	Ont.
OA4AI	14.15	5	8	Fla.
PY2BH	14.16	5	9	Mich., Ont.
PY2AC	14.062	5	9	Nebr.
PY7AI	14.17	5	5	Ont.
YV1AP	14.16	5	9	Mich.
YV1AV	14.027	4	6	Conn.
YV4AE	14.05	5	8	Ky.
YV6AB	14.08	4	6	Conn.
YV5ABF	14.15	5	7	Ont.
YU5AG	14.16	5	7	Ont.

## EUROPE

CT1OG	14.195	5	8	N. J.
CT1OR	14.185	4	6	N. Y.
CT1PA	14.09	5	5	N. C.
F3OX	14.095	4	8	N. J., N. C.
F8NT	14.125	4	8	Dist. of Col., Fla.
F8KI	14.	5	7-9	Dist. of Col.
F8UE	14.	4	7-8	Dist. of Col.

Too many G's were reported to list all. They were reported by observers in Oklahoma, Kansas, New Jersey, North Carolina, New York, District of Columbia, Michigan, Connecticut and Florida. GM's were reported by Listening Posts in Kansas, Minnesota, New Jersey, North Carolina, Connecticut and Florida.

GW5PH	14.205	5	9	N. J.
HB9J	14.04	4	5	Conn.
ON4RU	13.303	5	4	Va.
ON4NZ	14.	-	-	Dist. of Col.
ON4NK	14.	-	-	Dist. of Col.
PA0NN	14.095	3	4-5	Minn.
SM4JG	14.1	5	6-7	Kan.
K6BMR	14.27	5	8	Okla.
K6OJI	14.152	5	8	Okla., Minn., N. Y.
K6NYD	14.	5	8	Okla.
K6NYV	14.24	5	7	Minn.
K6LUD	14.23	5	6	Ky.
K6LW	14.24	4	6	England
K6PTW	14.34	4	8	Fla.

KA's were also very numerous last month, as were the PK's. Reports on the Philippines were received from our Observers in Oklahoma, Missouri, Virginia, Indiana, Kansas, Minnesota, West Australia, England, Alabama and Iowa.

# SUPERIOR KEYS FOR SUPERIOR WORK

STANDARD OF THE WORLD FOR CLARITY....SPEED....SENDING EASE

## DEMAND VIBROPLEX SEMI-AUTOMATIC KEY

The new "CHAMPION" is an inexpensive key having exceptional sending qualities—clarity . . . speed . . . sending ease, which will appeal alike to amateurs and professional operators. Chrome and cadmium plated and mounted on black base. Standard size and equipped with Standard contact points same as the more expensive models. Practically rust-proof. If your dealer cannot supply you write us for full particulars.



The "CHAMPION" ONLY \$9.95

Experienced operators—over 100,000 of them, have put their stamp of approval on VIBROPLEX

keys for clarity, speed and sending ease. They have learned from actual experience that the Vibroplex really does make sending a lot easier and better, and that it develops a higher degree of sending skill than the average hand sender can hope to attain.

Press Lever—Vibroplex Does the Rest  
If you can send on the regulation key—you can send better, faster and with half the effort with a Vibroplex. Its simplicity, mechanical perfection, machine speed and sending ease enables any operator with a little practice, to send with the skill of an expert. Simply press lever—Vibroplex does the rest. Heed the advice of experienced operators and demand the Genuine Vibroplex. Accept no substitute. Only the Genuine has "THE BUG" trade mark. Look for it on the bug you buy. You will always be glad you did.

### IMPROVED ORIGINAL VIBROPLEX \$13.75

Needs no introduction being known the world over for its smooth, easy, rhythmic sending. In high favor with experienced operators everywhere. Polished finish bright parts. Equipped with circuit closer, cord & wedge.

### A Winner "LIGHTNING BUG" \$13.75

This is the same Great New Easy-action Vibroplex which formerly sold for \$17.00—the same fine instrument that is preferred for its ease of handling, fine quality signal and all round superior performance. Polished finish bright parts. Equipped with circuit closer, cord & wedge.

## THE VIBROPLEX CO., Inc.

832 BROADWAY

J. E. ALBRIGHT, President

NEW YORK, N. Y.

Reports on the PK's were had from Oklahoma, Virginia, Kansas, Texas, Iowa, Missouri, New Jersey, South Carolina, Arizona, Kentucky, West Australia, Indiana and Nebraska.

As is the usual case at this time of the year, many VK's are heard, and more of these were reported than any other country. They were heard by nearly every observer. The Aussies were reported from Missouri, Virginia, Michigan, Alabama, Texas, Iowa, North Carolina, England, Nebraska, Kansas, Arizona, Minnesota, Florida and New Jersey.

Two lone ZL's were heard and reported last month by our observers in Arizona and Rhode Island. These were both on the 10 meter band and were the only ones reported on this band. In the near future this band should be picking up again. It has been a long time since it has produced any real good DX, hi.  
ZL1MI 28.32 5 9 Ariz.  
ZL3AY 28. 4 5 R. I.

### Don't Ask the F.C.C.

DO not request official lists, logs or call books of amateur radio stations in the United States, or in particular States, territories or other localities from the Federal Communications Commission. Such lists or call books are not now available from the F.C.C., either with or without charge.

Although an official amateur call book was formerly published by the Commission, such a book has not been put out since 1931. It is no longer available nor accurate, and there is no plan to resume its publication. However, various private publications giving such information are available on the newsstands and in libraries.

If, however, a listener wishes to identify a specific amateur station and can give the station's call letters or the name of the licensee, or the precise location of the transmitter, the station's identity can be obtained from the Commission's record.

### Short Wave "Spy Catchers"

A SOURCE close to the White House has disclosed that approximately 4,000 licensed amateur radio operators are planning to organize a watch on the short waves. Their purpose is to listen-in and check up on broadcasts so that they may report any un-American activities or espionage taking place in these bands. The unit plans to report its observations to the United States Government.

### All Wave Club, Lancaster, Calif.

This is to notify you about the organization of the All Wave Club. The All Wave Club has been organized for short wave listeners all over the world. Members of the club receive a monthly club bulletin. Further information about the All Wave Club may be obtained by writing to David Herbert, Jr., Box 709, Lancaster, Calif.

## FACTORY-TO-YOU SAVES YOU UP TO 50%

EASY TERMS



FOREIGN RECEPTION  
Here's our big 20th Anniversary radio special . . . the 14-tube 1940 Television-Adapted Midwest Brilliant performance . . . and exciting foreign reception!  
30 DAYS TRIAL  
Absolute satisfaction guaranteed on money-back basis. Catalog also shows 14-tube cabinet console for only \$29.95 complete!

See Midwest's Answer To TRADE-INS  
SEND IN POSTCARD FOR FREE 1940 CATALOG SHOWING COMPLETE LINE  
USER-AGENTS MAKE EXTRA MONEY!

MIDWEST RADIO CORPORATION  
Dept. 1433 Cincinnati, Ohio

## PERSONAL SERVICE By Bill Harrison

### HAMS! SWL's!

It will pay you to visit or write to me whenever you want to buy anything in Radio or Photography. I am authorized factory distributor of all Amateur Receivers, Transmitters, Kits, Parts, etc.

I guarantee to give you a fair and square deal with most liberal trade-in allowance and, above all, complete satisfaction!

Since 1925, more and more men in all parts of the world are being satisfied with my prompt Personal Service, and my low prices. You will be, too!

Bill Harrison, W2AVA  
EASY TIME PAYMENTS ON EVERYTHING!

HARRISON RADIO CO.  
12 WEST BROADWAY - NEW YORK CITY

# RADIO INSTRUCTION

## NOW READY!

Includes up to date technical information and illustrations on

## TELEVISION



**TO WHAT EVERY RADIOMAN SHOULD KNOW**  
**JUST PUBLISHED—1939**  
 —All the latest information on the new developments in Radio & Television. Explains Repairs, Servicing & Building of Sets for pleasure or profit—Easy to read & understand. Gives all the important phases of Modern Radio, Electricity & Sound. Handy reference guide. A real Helpful, Easy Way to secure authentic data on Radio Troubles—Static Elimination—Broadcasting—Antennas—Electronic Television—Repairs—Service—Short Wave—Auto Radios—Including Questions and Answers—34 Chapters—Over 400 Diagrams & Illustrations. Handy Size, Sturdy Flexible Binding. A Good Investment for Servicemen—Experimenters—Electronic Television Students—Aviation & Marine Radio Operators and all others. Get this practical information in handy form for yourself. Fill in and mail coupon today.

**4 COMPLETE • PAY ONLY \$1 A MO.**

**THEO. AUDEL & CO., 49 West 23rd Street, New York**  
 Mail AUDELS NEW RADIOS MANS GUIDE for free examination. If O. K., I will send you \$1 in 7 days; then remit \$1 monthly until price of \$4 is paid. Otherwise, I will return it.

Name \_\_\_\_\_  
 Address \_\_\_\_\_  
 Occupation \_\_\_\_\_  
 Reference \_\_\_\_\_  
 .....G

## EASY TO LEARN CODE

It is easy and pleasant work to learn the modern way—with an INSTRUCTOGRAPH CODE TEACHER. Ideal for the beginner or advanced student. Many tapes available ranging from alphabet for beginners to typical messages on all subjects. Speed range 5 to 40 WPM. Always ready, no GRM, beats having someone send to you.



**FOR SALE OR RENT**  
**STANDARD** with 10 tapes and book of instructions . . . \$20.25  
**JUNIOR** with 3 tapes and book of instructions (not rented) . . . \$12.00  
**RENTAL** Standard with 10 tapes and book of instructions \$3.00 first month, \$2.25 each additional month. All rental payments may be applied on the purchase price should you decide to buy the equipment.

Write for details today  
**INSTRUCTOGRAPH COMPANY**  
 Dept. SW, 912 Lakeside Place, Chicago, Ill.  
 Representatives for Canada:  
 Radio College of Canada, 863 Bay St., Toronto

## BOOKS 1/2 PRICE

1. RADIO SERVICING SHORT-CUTS
  2. PUBLIC ADDRESS HANDBOOK
  3. TELEVISION FACTS, By Beitman
  4. MATHEMATICS OF RADIO
  5. REFRIGERATION MANUAL
- Any of the above books **25¢**
- SUPREME PUBLICATIONS 3727 West 13th Street, Room 116, Chicago, Ill.**

# RADIO ENGINEERING

broadcasting, aviation and police radio, servicing, marine radio telegraphy and telephony, Morse telegraphy and railway accounting taught thoroughly. 48 weeks' Engineering course equivalent to 3 years of college radio work. All expenses low. Catalog free. School established 1874. **Dodge's Institute, Turner St., Valparaiso, Ind.**

# Power Supply and Modulator for the ECO-Xtal Transmitter

(Continued from page 414)

The switching system and relays used make the unit as foolproof as can be desired, at the same time giving a maximum of operating convenience. Reference to the diagram will show that there are 4 double-pole toggle switches. SW-1 is the main power switch and furnishes line voltage to the two filament transformers and the time delay relay. This relay consists of a thermostatic element controlling a relay, thus delaying the application of plate voltage to the 866 tubes until their filaments have been heated. A delay of twenty seconds is sufficient. SW-2 is fed from the time delay relay and controls the bias supply and also the high voltage and medium voltage transformers through their individual switches. SW-3 and SW-4 respectively. It is thus seen that unless the bias switch is on, neither of the other two supplies will be furnished with line voltage. Also, plate

As the photos show, all the transformers and tubes, and most of the chokes, are mounted on top of the chassis. Underneath are mounted the filter condensers, time delay relay, bias choke, and meter multiplier. The voltage dividers are mounted at the rear of the chassis where they are not so accessible to prying fingers.

The 1 milliamper meter has a 3 megohm multiplier so that its full scale reading is 3000 volts. Originally it had been planned to switch the meter across the different output voltages, but safety considerations resulted in its permanent placement across the high voltage supply, since this is of greatest interest to the operator.

If it is desired to modulate the transmitter, the cheapest and simplest method is to employ grid modulation of the HK54. Using this system, only a few watts of audio are necessary. The writer used the

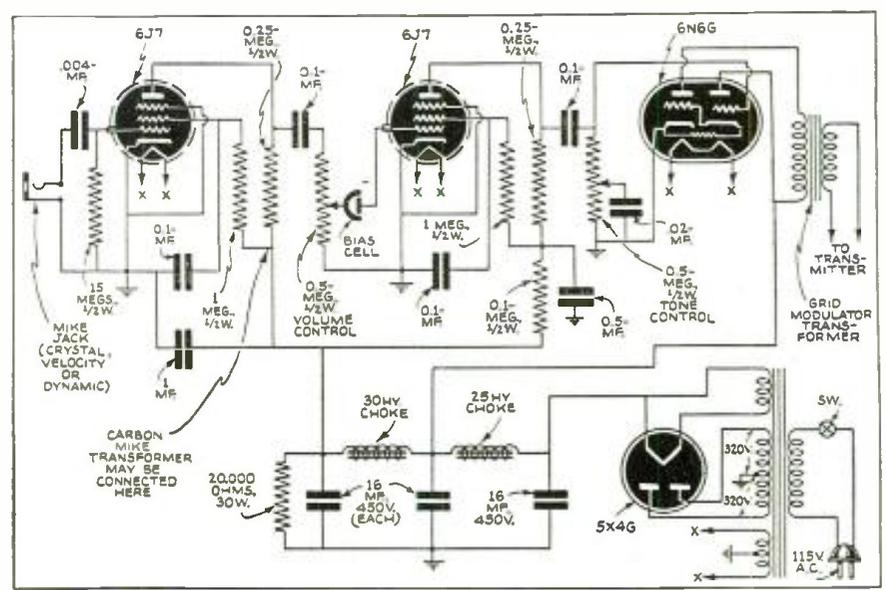

Diagram of Modulator.

voltage cannot be applied to any of the rectifier tubes until after the 866 filaments have warmed up. Individual switches to the medium and high voltage supplies allow either or both to be turned off for testing and tuning purposes. An adjustable overload relay has been incorporated in the high voltage supply and consists of a relay coil in series with the center tap of T-4, adjusted so that when the HK54 draws more than its normal plate current a pair of contacts in series with the transformer primary will open, disconnecting the plate voltage until the cause of the overload can be eliminated. The relay re-set button is mounted on the front panel.

The four pilot lights are wired across the primaries of the transformers so that one can tell at a glance which of the transformers is "hot" and be guided accordingly. However, too much reliance should not be placed on them as warning signals, since there is always the chance that one may have burned out. Whenever working on the power supply or transmitter unit, always make sure that the switches are off or, better yet, pull out the power supply line cord from the outlet. Remember that the voltages encountered are more than sufficient to inflict fatal injuries!

small 5 watt amplifier described on Page 230 of the August, 1938, issue of this magazine, with the addition of a stage of pre-amplification so that a dynamic mike could be used; but if a carbon mike is employed, the original amplifier is sufficient, with the addition, however, of a mike transformer. Fig. 2 shows the amplifier diagram with the addition of the preamp. stage for use with low-level mikes.

A grid modulation transformer will be needed to couple the amplifier to the transmitter. The secondary of this transformer is connected in series with the final amplifier grid bias supply. No more than 1500 volts should be applied to the HK54. Bias voltage should be 1 1/2 times cut-off. Somewhat tighter antenna coupling will be necessary than when using CW telegraph, and the excitation should be varied for best results. Use of an oscilloscope will greatly facilitate adjustments.

### Parts List

- STANDARD TRANSFORMER CORP.**  
 1—2000-2000 volt transformer, No. P-6154 (T-4)  
 1—600-600 volt transformer, No. P-3699 (T-5)  
 1—675 volt transformer, No. P-948 (T-3)  
 1—5 volt, 3 amp.; 5 v. 3 a., 5 v., 6 a. transformer, No. P-3032 (T-2)

(Continued on page 436)

# De Luxe Portable Transmitter and Receiver

(Continued from page 405)

which does not appear in the diagram, so that they can be turned off during C.W. operation.

**POWER SUPPLY:** The transformer T4 is specified to furnish 350 volts at the center tap under a load of 125 ma. current. Three different voltages are obtained from the power supply, controlled by the SEND-RECEIVE switch S5; 350 volts on the R.F. amplifier, 300 volts on the modulator, and 250 volts on the receiver. S6 is opened for C.W. operation to protect the following filter condensers from peak voltages when the key is open. The line condensers C32 cured trouble from tunable hum which appeared on the higher frequencies.

**ANTENNA:** An 80 meter Hertz antenna is used, tapped by the feeder one-third from one end for efficient harmonic operation. Other types, however, may be coupled to the antenna link. Taps near the ground end of L9 allow the antenna to be attached at a point of correct impedance. The ground connection to the chassis is optional and its effectiveness depends somewhat upon the length of the lead to actual ground. A little experimenting will determine the best circuit for any location. The antenna condenser C27 is double-spaced, and a fixed mica condenser, C26, is added in parallel to give an adequate L-C ratio and also to allow two hand coverage with the same coil. S2 switches the antenna to Receiver or Transmitter.

**CONSTRUCTIONAL DETAILS:** The transmitter, modulator, and receiver are wired in separate chassis, each measuring 7 x 5½ x 2¼ inches. Four side panels, 5½ x 6¼ inches, mounted with machine screws, support the receiver above the transmitter and the modulator above the receiver.

**LAYOUT:** Refer to the diagram and pictures. These should be self-explanatory.

**TUNING UP:** The switch S1 is set at the circuit desired. Switch S6 is tuned on a few seconds after S3 to allow the filament of the mercury vapor 83 to warm up. The SEND-RECEIVE switch is next turned. When C25 is tuned to resonance the crystal bulb lights indicating oscillation. Should the crystal current become too high because something is out of adjustment, the bulb will burn out before the crystal is damaged. Adjustment of spacing and turns of L6 will permit one coil to be used for two bands. The antenna condenser C27 is tuned to resonance for maximum current in the antenna bulb. For C.W. operation the note should be checked with a monitor and frequency meter to insure stable, clean keying of the crystal. Monitoring, of course, is also required for phone operation. *No trouble was experienced from frequency*

modulation, using the Pierce oscillator—6L6G combination, and the 6L6G does not need neutralization. Slight adjustments of the link coupling to the antenna will match the Class C load to the 5000-ohm impedance of the Class B transformer, and cause proper upward modulation. This results when the amplifier plate current is 70 ma. at 350 volts.

## Earp Transmitter and Receiver Parts List

### NATIONAL CO.

- 1—(C1) 140 mmf. var. EX-140 with Isolantite insulating strip
- 1—(C5) 140 mmf. var. EX-140 with Isolantite insulating strip
- 1—(C7) 25 mmf. var. EX-25
- 1—(C25) 100 mmf. var. EX-100 with Isol. insulation
- 1—(C27) 140 mmf. var. EX-140 (double-spaced) with Isol. insulation
- 1 RFC—R-100 2½ mh. choke

### SPRAGUE PRODUCTS CO.

- 1—(C2) .1 mf. paper 400 v.
- 1—(C3) .1 mf. paper 400 v.
- 1—(C4) .1 mf. paper 600 v.
- 1—(C9) .1 mf. paper 400 v.
- 1—(C10) .5 mf. paper 400 v.
- 1—(C11) .1 mf. paper 400 v.
- 1—(C15) .008 mf. paper 600 v.
- 1—(C18) .01 mf. paper 600 v.
- 1—(C19) .01 mf. paper 600 v.
- 1—(C22) .01 mf. paper 600 v.
- 1—(C23) .01 mf. paper 600 v.
- 1—(C30) .1 mf. paper 400 v.
- 1—(C31) 10 mf. 35 v. electrolytic
- 1—(C32) .01 mf. paper 600 v.

### SOLAR MFG. CORP.

- 1—(C6) .0001 mf. midget mica MW
- 1—(C8) .0005 mf. mica midget MW
- 1—(C12) 10 mf. 35 v. electrolytic T211
- 1—(C13) .001 mf. mica MW
- 1—(C14) 25 mf. 35 v. electrolytic ET-335
- 1—(C17) .00025 mf. mica MW
- 1—(C20) .00025 mf. mica 600 v. MW
- 1—(C21) .00015 mf. midget mica MW
- 1—(C28) 10 mf. 35 v. electrolytic
- 1—(C29) 4 mf. 450 v. electrolytic
- 1—(C33) 8 mf. 450 v. electrolytic
- 1—(C34) 8 mf. 450 v. electrolytic
- 1—(C35) 8 mf. 450 v. electrolytic
- 1—(C36) 8 mf. 450 v. electrolytic

### MEISSNER MFG. CO.

- 1—(C16) 15-50 mmf. mica trimmer

### SANGAMO ELECTRIC CO.

- 1—(C24) .002 mf. mica 1000 v. A-10
- 1—(C26) .0001 mf. mica 1000 v. A-10

### CONTINENTAL CARBON CO.

- 1—(R1) 400 ohm, 1 w. carbon
- 1—(R2) 50,000 ohm, 1 w. carbon
- 1—(R3) 50,000 ohm, 1 w. carbon
- 1—(R8) 50,000 ohm, 1 w. carbon
- 1—(R9) 25,000 ohm, 1 w. carbon
- 1—(R10) 250,000 ohm, ½ w. carbon
- 1—(R11) 2000 ohm, 1 w. carbon
- 1—(R12) 20,000 ohm, 1 w. carbon
- 1—(R13) 100,000 ohm, 1 w. carbon
- 1—(R14) 400 ohm, 2 w.
- 1—(R15) 30,000 ohm, 1 w. carbon
- 1—(R16) 1000 ohm, 1 w. carbon
- 1—(R17) 12,500 ohm, 2 w. carbon
- 1—(R18) 25,000 ohm, 1 w. carbon
- 1—(R19) 250 ohm, 10 watt
- 1—(R20) 10,000 ohm, 2 w. carbon
- 1—(R22) 1000 ohm, 1 w. carbon
- 1—(R23) 25,000 ohm, 1 w. carbon
- 1—(R24) 100,000 ohm, 1 w. carbon
- 1—(R25) 30,000 ohm, 1 w. carbon
- 1—(R27) 2000 ohm, 1 w. carbon

Coils	20	40	Meters	80	160
1.1	5 turns No. 24	( 8 turns	Same Coil)		15 turns
1.2	8 turns No. 24	(25 turns	Same Coil)		45 turns
1.3	3 turns No. 24	( 4 turns	Same Coil)		10 turns
1.4	9 T. tapped ½ T. for Cathode	(25 T. tapped ½ T. for Cath.)			45 T. tapped at 1 turn

(RECEIVER COILS—1¼" diameter form)

1.5	10½ turns No. 18 on 1" form				55 turns No. 18
1.6	7 turns No. 18	(27 turns No. 18 on 1½" form)			
1.7, 1.8	Two turn link				
1.9	12 turns No. 18 Approximate tap 5 turns	(26 turns No. 18) Approximate tap 5 turns			55 turns No. 18 Approximate tap 8 turns

(TRANSMITTER COILS—1½" diameter form)

## RADIO INSTRUCTION

### ARE YOU TRYING TO



## INSURE YOUR FUTURE with CREI Home-Study Training in Practical RADIO & TELEVISION ENGINEERING

• Don't get stuck! The great field of radio offers amazing opportunities for men in the expanding fields of radio and television engineering. But it takes ABILITY to earn good money in the good jobs. You can improve your present position by training in your spare time. CREI courses in Practical Radio and Television Engineering have equipped other ambitious radiomen to insure their futures in radio by being prepared for the good jobs open to trained men. Our students and graduates are now employed in over 300 U. S. broadcasting stations—proof that CREI training pays!

### NEW BOOKLET—Just released!

Write for Free copy of "The CREI Tested Plan"

48 interesting pages with scores of photographs and complete outline and description of CREI radio and television courses.

### CAPITOL RADIO Engineering Institute

Dept. ST-11, 3224-16th St. N. W., Washington, D. C.

## LEARN TO SEND AND RECEIVE CODE

Learn to send and receive code signals, like operators on ships at sea and at commercial and amateur land stations. Intercept distress signals, news flashes, bulletins, and dozens of other kinds of interesting radio communications.

**MASTER TELEPLEX** teaches you to receive code exactly the way the world's best operators do—by sound. A heavy waxed paper tape, running through a machine, operates an automatic key which sends messages to you, at any speed you desire. As you improve in speed, the machine sends faster, gradually preparing you for top speed amateur and commercial signals. With the new All Electric MASTER TELEPLEX you learn to send by sending and the signals you send are repeated back to you, exactly as you sent them, thus enabling you to correct your own errors. We furnish a complete course, lend you the improved All Electric MASTER TELEPLEX and give you personal instruction with a MONEY BACK GUARANTEE. Send for TELEPLEX FOLDER #11 today. IT'S FREE!

**TELEPLEX COMPANY**  
67-69 Park Place, New York  
In Canada write: CANADIAN ELECTRONIC INST., TORONTO, ONT.

## RADIO plus TELEVISION

—mastered by pre-tested training

No matter where you are or what you do, National has a complete training plan for you—to fit your circumstances. National's plan is for those seeking immediate shop-training as well as for those who cannot give up present employment and income. Mail coupon below.

### NATIONAL SCHOOLS

NATIONAL SCHOOLS, Dept. 11-RT  
4000 So. Figueroa St., Los Angeles, Calif.

Please send free Literature and full details.

NAME \_\_\_\_\_  
ADDRESS \_\_\_\_\_  
CITY \_\_\_\_\_ STATE \_\_\_\_\_

## RADIO INSTRUCTION

### LEARN CODE THE QUICK, EASY CANDLER WAY!



Code is easy to learn—the Candler way! You can avoid the hours upon hours of unproductive practice that the average beginner goes through. With the Candler System you start right, with the proper fundamentals—you learn sound consciousness, and, in a short time, you find yourself reading and sending code with the same unconscious ease that you read print. It's amazing, how quickly you make real progress. A few weeks of Candler training is equivalent to months of undirected practice.

Learn about the Candler System, if you are just beginning or if you want to make real speed on the air. There is an advanced course as well as the beginner's course. Send for the FREE Book of Facts, that will tell you how Candler trained thousands of operators and made champions like Ted McElroy, World's Champion Operator and L. R. McDonald, W8CW, 1937 ARRL Champion. Write for your copy today!

### CANDLER SYSTEM CO.

Dept. S-11 Box 331, Asheville, No. Carolina.

## RADIO ENGINEERING



RCA Institutes offer an intensive course of high standard embracing all phases of Radio and Television. Practical training with modern equipment at New York and Chicago schools. Also specialized courses and Home Study Courses under "No obligation" Plan. Catalog Dept. RT-39.

### RCA INSTITUTES, INC.

A Radio Corporation of America Service

75 Varick St., New York, 1154 Merchandise Mart, Chicago

## BE A RADIO SERVICE EXPERT



Modern receivers require men with modern training for service work. **LEARN AT HOME** Our home instruction method and service equipment offer starts you earning money almost at once. Up to \$3 an hour easy in a short time. Write for free book. Radio Training Ass'n of America Dept. RT-119 Chicago 4525 Ravenswood Ave., Chicago

## RADIO COURSES

New Fall Classes Now Starting  
RADIO OPERATING—BROADCASTING

- RADIO SERVICING — practical course
  - RADIO AMATEUR CODE — TELEVISION
  - ELECTRONICS—1 yr. day course 2 yrs. eve.
- Day and Evening Classes. Booklet Upon Request.  
New York Y.M.C.A. Schools  
4 W. 64th Street New York City

## LEARN RADIO TELEVISION

500 LICENSED graduates placed in past 7 years in shipping, broadcasting, aviation, police, etc.; we also teach radio servicing and repairing; new beginners' class now forming; 60-page catalog free; oldest, largest and best equipped.

### MASS. RADIO SCHOOL

18 BOYLSTON ST., BOSTON Est. 1899

## AMATEUR RADIO LICENSES

Day and evening classes in code and theory  
**Home Study Courses**

Hundreds of students now on the air. Results guaranteed. Reasonable, efficient and thorough.

### AMERICAN RADIO INSTITUTE

1123 BROADWAY NEW YORK, N. Y.

## De Luxe Portable Transmitter and Receiver

### CLAROSTAT MFG. CO.

- 1—(R4) 50,000 ohm pot. M44
- 1—(R7) 50,000 ohm pot. M44
- 1—(R26) .5 megohm pot. M60

### INTERNATIONAL RESIST. CO.

- 1—(R5) 2 megohm, 1/2 w.
- 1—(R6) 50,000, 1/2 w.
- 1—(R21) 5 megohm, 1/2 w.
- 1—(R28) 5 megohm, 1/2 w.

### WARD LEONARD ELECTRIC CO.

- 1—(R29) 2000 ohm Adjustohm 10 w., set at 1650 ohms

### P. R. MALLORY & CO.

- 1—(J1) closed circuit key jack, 1789
- 1—(J2) open circuit, 89, microphone jack

### OXFORD-TARTAK RADIO CORP.

- 1—(T1) speaker trans., 1254
- 1—(S) 3" permanent magnet speaker, 3ZMP

### THORDARSON ELEC. MFG. CO.

- 1—(T2) Class B input
- 1—(T3) Class B output
- 1—(T4) 700 v., 125 ma. CT, 5 v.—2 amp., 6.3 v., 2 A.
- 1—(CH2) 30 hy., 60 ma. choke

### YAXLEY MFG. CO.

- 1—(S1) 4-circuit, 3-position rotary switch, open type, 3243-J
- 1—(S2) single pole, double throw, rotary switch, 3222-J

### HART & HEGEMAN ELEC. CO.

- 1—(S3) toggle switch
- 1—(S4) toggle switch
- 1—(S5) double-pole, double-throw toggle switch
- 1—(S6) toggle

### HALLDORSON CO., INC.

- 1—(CHI) 23 hy., 110 ma. choke, EA-1030

### HOYT ELEC. INSTR. CO.

- 1—(M) 0-150 D.C. ma. meter, type 566

### ASTATIC MICROPHONE LAB.

- 1—Microphone

### BRUSH DEVEL. CO.

- 1—Pair crystal headphones

### BLILEY ELEC. CO.

- 1—40 meter crystal and holder
- 1—75 meter crystal and holder

### RAYTHEON PROD. CORP.

- 2—6K7 tubes
- 1—6J7 tube
- 1—6V6 tube
- 1—6L6G tube
- 2—6C5 tubes
- 2—6N7 tubes
- 1—83 tube

### AMERICAN PHENOLIC CO.

- 7—Octal wafer sockets
- 2—5-prong wafer sockets
- 2—4-prong wafer sockets
- 2—Octal isolantite sockets
- 1—5-prong isolantite socket
- 1—4-prong isolantite socket

### PAR-METAL PRODUCTS CORP.

- 3—Chassis, 5 1/2 x 7 x 2 3/4"
- 4—Side panels, 5 1/2 x 7 1/2 x 6 3/4"

### MISCELLANEOUS

- 8—Pointer knobs
- 6—Dial plates
- 13—Name plates
- Ground Send-Receive
- A.C. Input Receiver
- Antenna Microphone
- Antenna D.C. Output
- 3—Metal tube shields
- 6—Rubber grommets
- 4—Rubber feet pads
- 4—Angle brackets
- 2—Stand-off antenna feed-through insulators
- 1—Metal handle
- 20—Sheet metal screws
- 1—Key
- 1—Microphone plug
- 1—Key plug
- 1—Filament switch for Class B Modulator toggle
- 3—S. grid clips
- 5—Feet shielded microphone cable
- 3—5 1/2" prong coil forms
- 5—4 1/2" prong coil forms
- 3—1 1/2" 5-prong coil forms
- 180—Feet stranded antenna wire
- 4—Airplane type insulators
- 1—Antenna clip
- Regeneration Class B Mod. Transmitter Modulator Plate

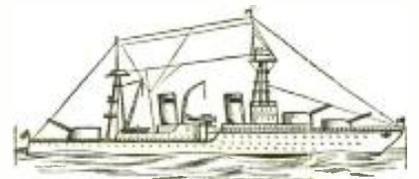

## Model Warship Prints

Get our Descriptive List  
Radio Control Print—See Below

## DATAPRINTS SHOW YOU HOW!

20c Each in Order for 10

### TESLA-LOUDIN HI-FREQ. COILS

- (Data and Drawings only)
- 36" Sp'k Tesla-Oudin Coil.....40c (1 K.W. Exc. Trf. Data, Included FREE!)
  - 8" Sp'k Tesla-Oudin Coil.....40c (1/2 K.W. Exc. Trf. Data Included FREE!)
  - 3" Sp'k Oudin; 110 Vt. "Kick Coil" type.....40c
  - 3" Sp'k Tesla Works on Ford Sp'k Coil.....40c
  - 1" Sp'k Violetta Hi-Freq. Coil.....40c
- FREE with order for \$1.00 or more—20 Tricks with Hi-Freq. Coils! (40c separate)

### Television Hook-ups "Sight & Sound" . . 40c

### 20 ELECTRIC PARTY AND LODGETRICKS! AND LODGE TRICKS! Loads of Fun!



How to Shock 'em!.....40c  
Order with other prints; see special Price below and save.

### Solenoid & Magnet Data—Get Our List!

### 20 Telephone Hook-ups—Build Your Own . . 40c

### GET OUR LIST OF MODEL SHIP PRINTS



### S-W DIATHERMY (Artificial Fever)

Dataprint giving Constructional data for Small, Medium and Large size App. (All 3)...40c

### 20 ELECTRIC PARTY AND LODGETRICKS! How to Shock 'em! Loads of Fun!.....40c

### RADIO CONTROL FOR MODEL BOATS, PLANES, Etc.

Circuit data 40c. Get our List of Model Ship prints.

## You NEED these DATAPRINTS !! 40c Each.

- 20 A.C. Problems and their Solutions.
  - 20 Simple Bell Circuits. Welding Trans. 2 K.W.
  - 1/2 Meter Transm. & Rec. Rewinding Armatures.
  - 20 Telephone Hook-ups. Eintheven String Galv.
  - 5 Meter Superheli. Wheatstone Bridge.
  - 100 Mechanical Movements. Model Ships—get list.
  - 20 Motor Hook-ups.
- Special Prices: 4 prints \$1.00; 10 for \$2.00; 40c each, single orders. Get New List 100A.

### The DATAPRINT Co.

Lock Box 322A

RAMSEY, N. J.

## Greatest Slide Rule VALUES ever offered!

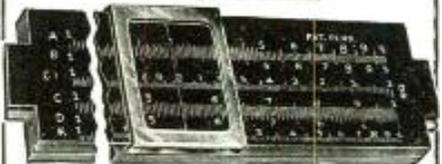

8 inch slide rule in case 25c

Eight inch, white wood, accurate slide rule with A, B, C, D, CI and K Scales, a 20-page Book of Instructions, How to Use a Slide Rule, a 36-page Book of 300 Examples and Answers, a two-color facsimile of the Declaration of Independence, suitable for framing, and an 8-page catalog illustrating and describing indoor games and many unusual items, all five prepaid anywhere in the United States and Canada for \$1.00

### 10 inch enameled slide rule, only 35c

10 inch enameled slide rule, made of kiln dried genuine mahogany wood, has auxiliary removable magnifier with pins to fit (cursor) runner. This rule has inch, millimeter, sine, log and tangent scales. Packed in individual carrying case. This rule is equal in performance to a \$10.00 rule. Our special price, P.P. prepaid anywhere \$1.00

## GOLD SHIELD PRODUCTS

Dept. RT-119 350 Greenwich St. New York

## What Do YOU Think?

(Continued from page 411)

### Suggests S.W.L. "Card Swappers" Club

Editor,

To All S.W.L. "Card Swappers": I have been reading RADIO & TELEVISION for a long time and haven't noticed any news or letters from any Erie boys, so I will try and make up for this.

I had a brain-storm the other night, so thought I would write my idea. Here it is: How about a S.W.L. Card Swappers' Club? There are probably a lot of these clubs, but I mean a big one—one that will be able to give a card to a SWL who swapped all continents or all states. Something like a SAC (Swapped All Continents) or SAS (Swapped All States). I'd be willing to get some attractive cards printed and anyone who could furnish proof that he swapped all continents or states would have one sent to him for a three cent stamp. Then at the end of each month the SWL who sent the best list would get an honor card with gold or silver letters. Then we could get some foreign SWL's to supply us with lists of foreign SWL swappers. And if this FB mag or I get a very big response from you SWL's, maybe we could get this mag to furnish us with a corner of a page to print lists of SWL swappers and winners of each month. Let's get some ideas on this.

STANLEY KASPER,  
933 E. 30th St.,  
Erie, Penna.

### He Indexes Q. & A. from R. & T.

Editor,

My intention in writing this letter is to tell you how much I enjoy reading RADIO & TELEVISION which, unfortunately, I obtain at very infrequent intervals. I have just finished reading the March issue, and found every page of interest.

I think the best department in the magazine is the Question Box. I cut out all circuits which are of interest and keep a scrap book of them and find this method most useful when required to refer to any particular circuit.

At present I am using a battery Detector and 2 A.F. which, unfortunately, does not give me the results I require, although I have logged all the well-known American Broadcast Short Wave Stations such as W2XAD, W2XAF, W3XL, W2XF, etc., besides many American Hams, all at good strength—from R7/9 on fones.

With best wishes for the continued success of your F.B. Magazine, and looking forward to reading many more copies,

L. ROFFEY,  
135, Hertford Road,  
Dalston,  
London, N.1.  
England

### Wants More 1- and 2-Tube Sets! Do YOU?

Editor,

I have been an ardent reader of your FB publication for the past four years. Although most of my copies have been picked up from the news stand I figure that no matter whether I subscribe to it or not it will be good.

These guys that throw brick-bats at RADIO & TELEVISION ought to be taken out and shot. I have read magazines from quite a few foreign countries and none in my opinion come anywhere near touching RADIO & TELEVISION. I not only speak for myself but I have in past times written to a few fellows abroad and they all say the same

as I. So you will see that I am not just talking through my hat, hi.

I think that Joe Miller's page is ace as far as I am concerned and the construction articles are swell too. The Radio Kinks, Question Box, and for instruction you can't beat the Radio Test Quiz.

I would like to see some more one and two tube sets published on your pages. I would also like to make a suggestion. Why not get pictures of some of the better known listening posts and put them on your covers?

ROMNEY MILLER,  
43½ Elm Street,  
Newport, R. I.

### More About Hams and QSL's

Editor,

I am an ardent reader of your FB magazine, RADIO & TELEVISION. I have just finished reading the letters written by other SWL's about Hams QSLing to SWL's. I agree with some of the things that have been written, but on the other hand, I disagree with other things.

I have been a SWL for more than two years, and have logged about 278 amateur stations but have received only 54 answers. I even sent International Reply Coupons and return postage to them with my SWL cards, but some of them never answered. Yet I have found several mighty fine Hams who QSL without hesitance.

I think there are two angles from which to consider the situation. Taking it from the SWL's point of view, if a SWL does not appreciate a QSL from a Ham enough to send return postage, I don't think he or she should expect one because most Hams aren't millionaires and it takes quite a tidy sum to build and operate a transmitter. (I don't always send return postage.)

On the other hand, if a Ham doesn't appreciate the reports from the SWL's enough to send a QSL, I think he should make it known that he doesn't QSL with SWL's. I think that the SWL's do the hams a great service by giving reports and by way of appreciation the Hams should QSL with those SWL's who really show that they deserve it. (I have even found one ham who *doesn't* QSL with other hams.)

In making out my reports to hams, I try to be as conscientious as one can be. I try to give them what they deserve, and yet not any more than what they deserve. In the checking of such reports, I think that the hams should be just as conscientious.

I am open for criticisms and would be glad to hear from other SWL's and hams, expressing their opinions. 73 Bst DX es Cul,

NOEL E. KURTZ,  
Nenia, Illinois

Member of the Short Wave League

### Free Television Course

(Continued from page 421)

how to align the tuned circuits in both the sight and sound channels of a television receiver, and how to set up push-buttons for tuning. Test equipment used in servicing television receivers is then taken up. An elaborate television trouble-shooting chart is given which lists, in a convenient manner for easy reference, the various types of trouble which may be observed in a television receiver, the probable causes for each trouble, and the remedies in each case.

Throughout this television course, the importance of effect-to-cause reasoning is emphasized, particularly in connection with high-voltage circuits where tests under operating conditions might be dangerous. The student is taught to read the story which is told by the image appearing on the receiver screen, so that after a certain amount of practical experience he will be able to determine the position of a defective part merely by studying this image and possibly making a few simple tests.

Built by CORNELL-DUBILIER

Capacitor Analyzer  
for the Service Shop and Lab.



**NOW**—radio servicemen, amateurs and experimenters! Get the Capacitor Analyzer built by Cornell-Dubilier. Take advantage of precision engineering, extra quality at no extra cost, and the broadest experience in the capacitor field. C-D Model BF 50 measures quickly and accurately all important characteristics of all types of capacitors. Special "visual eye" enables you to determine exact condition of capacitor under test. Only instrument providing complete test for all capacitors. Use it also to check continuity, capacity between circuits, insulation of transformer windings and other type coils. It's a honey for the money!  
Model BF 50 Capacitor Analyzer **\$24.90**  
Net Price (less tubes)

**NOW!** Mail coupon for FREE catalog No. 175A describing complete C-D line of capacitors, Quietone Interference Filters, and Capacitor Test Equipment. Product of the world's oldest and largest manufacturer of capacitors.

**CORNELL-DUBILIER**  
ELECTRIC CORPORATION  
1027 Hamilton Boulevard, South Plainfield, New Jersey

CORNELL-DUBILIER ELECTRIC CORPORATION. R&T-117  
SOUTH PLAINFIELD, NEW JERSEY  
Please rush Catalog No. 175A today.

Name \_\_\_\_\_  
Address \_\_\_\_\_  
City \_\_\_\_\_ State \_\_\_\_\_

**PRICES REDUCED**

**BLILEY**  
TYPE VFI  
VARIABLE FREQUENCY

**CRYSTAL UNITS**

40 - 80 METERS

now **\$6.60**

Get your copy of Circular A7  
from your Bliley Distributor

Now!  
**BALLAST REPLACEMENT**  
made  
**AMAZINGLY SIMPLE!**

Only 4 standard types of Amperite AC-DC Regulators will replace 90% (over 100 types) of AC-DC Ballast Tubes now in use!  
WRITE FOR CHART A-1.

New Low Price \$1.00 List

AMPERITE Co. 361 BROADWAY, N. Y.

**AMPERITE** AUTOMATIC REGULATORS



# 2 NEW 10c BOOKS

## Now Added to Gernsback Series!

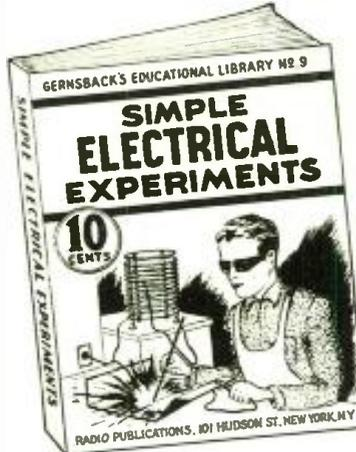

**RADIO FANS EVERYWHERE**  
—these fine ten cent text books give you an excellent foundation for the study of radio. They are clearly written, profusely illustrated and contain over 15,000 words in each book. You'll be amazed at the wealth of information these books have. Handy for review or reference. **Your money back if you are not pleased!**

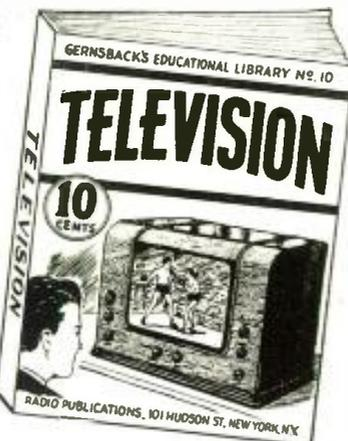

### NO. 9—SIMPLE ELECTRICAL EXPERIMENTS

Over 100 interesting and practical electrical experiments are described in this book, covering every branch of electricity—from simple experiments with magnets to high frequency "stunts". Among the experiments, all of which are clearly illustrated with special drawings, we find: Experiments with Magnets, Static Electricity, Transformers, Induction, Motors, High Frequency Motors, Switches and Lamps, Polarity Experiments, Buzzers, etc. All of the experiments described can be carried out with simple apparatus, most of which can be found about the home. Further, anyone can make them and thus this book becomes at once not only instructive but highly entertaining as well.

### NO. 1—HOW TO MAKE FOUR DOERLE SHORT WAVE SETS

Literally thousands of radio fans have built the famous DOERLE Short Wave Radio Receiver. No insistent has been the demand for these receivers, as well as construction details, that this book has been specially published. Thousands of copies of this book have been bought by short-wave fans. Contains EVERYTHING that has ever been printed on these famous receivers. These are the famous sets that appeared in the following issues of SHORT WAVE CRAFT: "A 2-Tube Receiver that Reaches the 12,500 Mile Mark," by Walter C. Doerle; "A 3-Tube 'Signal Gripper,'" by Walter C. Doerle; "Doerle '2-Tube' Adapted to A.C. Operation," by Walter C. Doerle; "The Doerle 3-Tube 'Signal-Gripper' Electrified," and "The Doerle Goes 'Band-Spread'."

### NO. 2—HOW TO MAKE THE MOST POPULAR ALL-WAVE 1- and 2-TUBE RECEIVERS

This book contains a number of excellent sets, some of which have appeared in past issues of RADIO-CRAFT. These sets have been carefully engineered. They are not experiments. To mention only a few of the sets the following will give you an idea:  
• The Megadyne 1-Tube Pentode Lojacker Set, by Hugo Gernsback. • Electrifying The Megadyne. • How To Make a 1-Tube Loud-Speaker Set, by W. P. Cheney. • How To Make a Simple 1-Tube All-Wave Electric Set, by F. W. Harris. • How To Build A Four-In-Two All-Wave Electric Set, by J. T. Bernisley, and others.  
Not only are all of these sets described in this book, but it contains all of the illustrations, diagrams, etc.—each book is up-to-date.

### NO. 5—BEGINNERS' RADIO DICTIONARY

Are you puzzled by radio language? Can you define Frequency? Kilocycle? Tetrad? Screen grid? Buffer? Anode? Triode? Pole? Ionization? Joule's Law? Harmonic? Gravity Cell? If you cannot define these very common radio words and dozens of other more technical terms used in all radio magazines and instruction books, you need this book in your library. It's as modern as tomorrow—right up to the minute. It tells you in simple language just what the words that puzzle you really mean. You cannot fully understand the articles you read unless you know what radio terms mean. This is the book that explains the meanings to you. Can you afford to be without it, even one day longer?

### NO. 6—HOW TO HAVE FUN WITH RADIO

Stunts for parties, practical jokes, scientific experiments and other amusements which can be done with your radio set are explained in this fascinating volume. It tells how to make a newspaper call-show to produce silent music for dances—how to make visible music show to make a "silent radio" unit, usable by the deafened—how to make toys which dance to radio music—sixteen clever and amusing stunts in all. Any of these can be done by the novice, and most of them require no more equipment than can be found in the average home. Endless hours of added entertainment will be yours if you follow the instructions given in this lavishly illustrated book. Get a copy today by using the coupon below—mail it today.

### NO. 10—TELEVISION

Every one is asking the question—How does television work? This book explains all of the different systems of television from the simplest to the most complex. It describes in A-B-C style just how the image is scanned, how the scene is picked up by the television camera and broadcast to your home. Various types of television receiving systems are described in easily understood language, and the book is very completely illustrated with dozens of special drawings. The book tells how the accompanying sound for television images is picked up and transmitted and answers hundreds of other questions which the student and layman ask daily.

### NO. 3—ALTERNATING CURRENT FOR BEGINNERS

This book explains the beginner a foothold in electricity and Radio. Electric circuits are explained. Ohm's Law, one of the fundamental laws of radio, is explained; the generation of alternating current; sine waves; the units—volts, amperes, and watts are explained; Condensers, transformers, A.C. instruments, motors and generators.  
Here are some practical experiments to perform at home. Simple tests for differentiating between alternating and direct current; how to light a lamp by induction; making a simple electric horn; demagnetizing a watch; testing motor armatures; charging storage batteries from A.C. outlet; testing condensers with A.C. making A.C. electro magnets; frying eggs on a cake of ice; making simple A.C. motors; many others.

### NO. 4—ALL ABOUT AERIALS

This book explains the theory underlying the various types of aerials; the inverted "L," the Doublet, the Doublet, etc. It explains why transposed leads are used. It gives in detail the construction of aerials suitable for long-wave broadcast receivers, for short-wave receivers and for all-wave receivers. Various types of aerials for the amateur transmitting station are explained. It eliminates, once and for all confusion about the type of aerial to choose for best broadcast and short-wave reception. For the thousands of radio fans who wish to know just what type of antenna they should use and why, this book has been published. Experts in radio have found valuable information in this book.

### NO. 7—HOW TO READ RADIO DIAGRAMS

All of the symbols commonly used in radio diagrams are presented in this book, together with pictures of the apparatus they represent and explanations giving an easy method to memorize them. This book, by Robert Eichberg, the well-known radio writer and member of the editorial staff of RADIO-CRAFT magazine, contains two dozen picture wiring diagrams of simple radio sets that you can build. Every diagram is completely explained in language which is easily understood by the radio beginner. More advanced radio men will be interested in learning the derivation of diagrams, and the many other interesting facts which this book contains. It is also helpful in solving many of the problems of servicemen.

### NO. 8—RADIO FOR BEGINNERS

Hugo Gernsback, the internationally famous radio pioneer, author and editor, those famous magazines, RADIO AND TELEVISION, and RADIO-CRAFT are read by millions. Scores another (trillion) of radio fans who read it will get a thorough ground work in radio theory, clearly explained in simple language, and through the use of many illustrations. Analogies are used to make the mysteries of radio as clear as "2-2 is 4". It also contains diagrams and instructions for building simple radio sets, suitable for the novice. If you want to know how transmitters and receivers work, how radio waves traverse space, and other interesting facts about this modern means of communication, this is the book for you!

### — BOOKS ARE ALL UNIFORM

Every book in the GERNSBACK EDUCATIONAL LIBRARY has 32 pages—with illustrations varying from 30 to 86 in number. Each title volume contains over 15,000 words. Positively radio's greatest book buys! If you do not think these books worth the price asked, return them in 24 hours and your money will be instantly refunded.

## RADIO PUBLICATIONS • 101 HUDSON STREET • NEW YORK, N. Y.

RADIO PUBLICATIONS Dept. RT-1139  
101 HUDSON STREET, NEW YORK, N. Y.  
( Gentlemen: Please send immediately, POSTPAID, the book numbers circled below. I am enclosing ..... cents —each book being 10c.

1	2	3	4	5	6	7	8	9	10
								NEW	NEW

Send FREE listing of 48 new 10c publications.

Name ..... Address .....

City ..... State .....

Remit by check or money order—register letter if you send cash or unused U. S. postage stamps.

**MAIL COUPON TODAY!**

## Power Supply and Modulator

(Continued from page 432)

- 1—5 v., 6 a.; 6.3 v., 6 a. transformer, No. P-4022 (T-1)
- 1—250 ma., 15 henry choke, No. C-1412 (CH-2)
- 1—20 henry, 175 ma. chokes, No. C-1411 (CH-2)
- 1—30 henry, 110 ma. choke, No. C-1001 (CH-1)
- 1—Grid modulation transformer, No. A-3322

### P. R. MALLORY & CO.

- 2—2 mf., 2500 volt condensers, type TX-813 (C-2, C-3)
- 2—4 mf., 1000 volt condensers, type TX-806 (C-4, C-5)
- 1—8 x 8 mf., 525 volt electrolytic condenser, type RM-262 (C-1)
- 1—75,000 ohm, 200 watt re-sistor, type 20AV75000 (R-3)
- 1—30,000 ohm, 100 watt re-sistor, type 10AV30000 (R-4)
- 1—15,000 ohm, 50 watt resistor, type 5AV15000 (R-1)
- 1—30,000 ohm, 50 watt re-sistor, type 5AV30000 (R-2)

### RCA RADIOTRON

- 2—86n tubes
- 1—83 tube
- 1—80 tube

### GUARDIAN ELECTRIC CO.

- 1—Adjustable overload relay, No. X-100
- 1—Time delay relay, No. T-100

### HAMMARLUND MFG. CO.

- 4—4-prong sockets, No. S-4

### BUD RADIO, INC.

- 4—Double-pole toggle switches, No. 1269 (SW-1, SW-2, SW-3, SW-4)
- 11—Cone style Feed-Thru Insulators, No. 435
- 2—Midget stand-off insulators, No. 1493

### DRAKE MFG. CO.

- 4—110 volt pilot light assemblies, No. 75

### PAR-METAL

- 1—13" x 17" x 1/2" cadmium-plated chassis, No. 15215
- 1—10" x 7" gray steel relay rack panel, No. 66605
- 1—Pair panel brackets, No. SB713

### BIRNBACH

Radex hook-up wire

### TRIPLETT

- 1—1 milliampere 5" meter, No. 327 (M)
- 1—3 megohm multiplier (RM)

### HK54 Tube Used in "Final"

Following the buffer stage we have the final R.F. stage, which uses an HK54 tube and is quite conventional except for the manner of connecting the tuning condenser which results in keeping the total voltage (D.C. & R.F.) across it at a low value. All leads should be kept as short as possible with the various components placed in such a position as to afford the shortest possible lead lengths. This is very important if efficient 10 and 5 meter operation is desired.

It will be noted that a single 1 milli-ampere meter in conjunction with a 2 pole, 3 position switch (SW-2) can be switched to either the oscillator plate circuit or the grids of either the 807 or HK54 stages. Individual shunts have been permanently wired into these circuits and the meter is switched across any one of them, thus allowing a single meter to perform several functions.

Although not shown in the photo, a keying relay was used for keying the oscillator. A relay is not strictly necessary, since the method of keying the oscillator permits the use of long keying leads. However, where break-in is used and a separate relay is employed to silence the receiver, it is necessary to use a relay at the transmitter also, since a single key cannot control two circuits.

In tuning the completed transmitter, it is primarily necessary to remember what

(Continued on page 441)

# FREE- REAL ELECTROPLATING OUTFIT



## Now You Can ELECTROPLATE Easily with a BRUSH!

SOMETHING new for amateurs, fans, set builders—something which gives you the opportunity with which to experiment. Here's an ELECTROPLATING KIT amazingly simple to operate—you just Electroplate with a Brush! Requires only one single dry cell.

### NOT A TOY

You can electroplate for profit, hundreds of things in the household—admirals, fixtures, water faucets, worn brack-ets, dog leashes, musical instruments, jewelry and silver-ware and other articles. It's an indispensable piece of equipment to you for plating articles in hotels, apart-ments, office buildings, medical and dental offices, fac-tories, schools, laboratories, etc. Exactly the same outfit (but larger) is used professionally by electricians, radio ser-vice men, automobile repair shops, etc. And for radio work, you can electroplate tarnished receiver parts, chassis, contacts, worn radio parts and accessories.

Put this REAL ELECTROPLATING KIT to use immediately—make it the most useful article in your lab or work bench. And, you can get it absolutely FREE (except for slight mailing cost).

Send your subscription today to RADIO AND TELEVISION for One Year (12 Issues) and receive absolute-ly FREE one of these REAL ELECTROPLATING KITS. New subscribers are accepted or you may extend your present subscription another twelve months under this offer. Mail your remittance of \$2.50 (plus 10¢ for ship-ping charges on kit) to the publishers of RADIO AND TELEVISION (Canada and foreign \$2.85.) You will promptly receive your FREE REAL ELECTROPLATING OUTFIT by return mail. Use the coupon below to order your subscription.

#### RADIO AND TELEVISION

99 Hudson Street New York, N. Y.

#### RADIO AND TELEVISION

99 HUDSON STREET, NEW YORK, N. Y.

Gentlemen: Enclosed you will find my remittance of \$2.50 for which enter my subscription to RADIO AND TELEVISION for One Year (12 Issues). Send me promptly my FREE REAL ELECTROPLATING OUTFIT. (Canada and foreign \$2.85.) In U.S. add 10¢ additional to cover shipping charges on kit.

NEW SUBSCRIBER  
 EXTEND PRESENT SUBSCRIPTION

Name .....

Address .....

City .....

State .....

Send remittance by check, money order or unused U. S. Postage stamps. Register letter if you send cash or stamps.

RT-11-39

## 2-Tube Receiver

(Continued from page 403)

volt "B" blocks) to the proper leads as shown in Fig. 1. If magnetic phones are used, these will be connected directly in series with the plate circuit of the 7C5 output tube as shown; if crystal headphones are desired, an output choke and condenser of the values indicated should be used. Make certain that the .1 mf. blocking condenser is of good quality. A condenser with even a very small amount of D.C. current leakage will soon damage the crystal elements beyond repair. Connect an antenna and a good ground to the input terminals, adjust the 50,000 ohm regeneration control until a slight hissing sound is heard in the phones. Rotate the dial for a signal. If nothing is heard, check the detector for oscillation by touching the fixed plates of the tuning condenser with the tip of a finger. If the circuit is operating properly, a sharp click should be heard in the phones when the contact is made and another when it is broken. If no click is heard, unscrew the antenna trimmer until the detector oscillates with the regeneration control advanced about three-fourths way full on. The greatest sensitivity will be obtained when the detector is operated just below the point where oscillation begins. It may be necessary to readjust the antenna trimmer slightly for each individual band, striking a "happy medium" which will give good results on all five bands. If peak efficiency is desired, a good quality variable condenser of about 35 mmf. capacity may be used in place of the trimmer. In this case the condenser would be placed on the front panel where it can be reached for frequent adjustments.

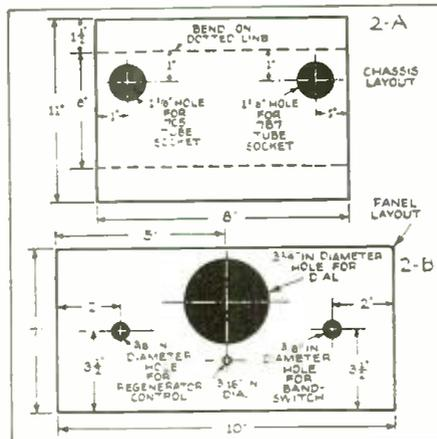

Details of Chassis.

#### Parts List

##### HAMMARLUND (Condenser and Choke)

- 1 .50 mmf. tuning condenser, double spaced, type MC-50-MX
- 1 Midget R.F. choke, 2.5 mh., type CHX

##### I.R.C. (Resistors)

- 2 250,000 ohm metallized resistors, 1/2 watt
- 1 3 megohm metallized resistor, 1/4 watt
- 1 100,000 ohm metallized resistor, 1 watt
- 1 150 ohm wire wound resistor, 5 watts
- 1 50,000 ohm potentiometer, with A.C. switch

##### CORNELL-DUBILIER (Condensers)

- 1 .100 mmf. (.0001 mf.) mica condenser, type 1W
- 1 .250 mf. (.00025 mf.) mica condenser, type M1
- 1 .05 mf., 600 v. tubular condenser, type DT
- 1 .5 mf., 600 v. tubular condenser, type DT
- 1 10 mf. 25 volt dry electrolytic condenser, type EDJ

##### BRUSH

- 1 Pair type A crystal headphones

Please say you saw it in RADIO & TELEVISION

# SPRAGUE ATOMS

"Mightiest Midgets of All"

## NO OTHER MIDGET BRINGS YOU SO MANY FEATURES



More honest-to-goodness features—smaller sizes—at the lowest possible cost! That is the story of Sprague ATOMS, the amazing midget dry electrolytic condenser development.

ATOMS are the smallest midgets on the market. They build up to higher surges than any similar units. They have lower leakage and power factor. They're unconditionally guaranteed against blow-ups. They're made in more capacities, more voltages plus a complete line-up of dual capacity units with common negative leads. Self-supporting. You mount 'em like paper tubulars. You use 'em for any replacement where you want real efficiency, smallest size, lowest cost.

#### HANDY KITS

Sold singly or in handy kits of 6 or 12 condensers. Write for complete Sprague Condenser Catalog.

SPRAGUE  
450 VOLTS

SPRAGUE  
PRODUCTS CO.  
North Adams, Mass.

## CRYSTAL MICROPHONE C 6

Compare These  
Advantages:

PRICE \$16.50

Swivel Mounting  
Plug at Microphone

High Output, -44  
Long Cable (250') May Be Used

See Technical Bulletin No. 33

Licensed by Brush Devel. Co. and ERP1

AMERICAN MICROPHONE CO., INC.  
LOS ANGELES



#### ALL YOUR RADIO NEEDS

Here in this one big book you will find everything you need in radio... sets, parts and supplies... public address systems... amateur equipment... testers and kits... your nationally known favorites at lowest possible prices. Write today for this valuable catalog and save money.

FREE  
CATALOG

PROMPT SERVICE

BURSTEIN-APPLEBEE COMPANY  
1012-14 MCGEE STREET, KANSAS CITY, MISSOURI



## NEW CATALOGUE

Of Radio, Electrical and Television parts and accessories. Available to Manufacturers, Jobbers, Dealers and Servicemen. Write on your business letterhead to:

INSULINE CORP. OF AMERICA  
30-50 Northern Blvd.  
Long Island City, N. Y.



# PRICED FOR CLEARANCE!

## Rockbottom Prices on Overstocked New and Rebuilt Merchandise

When prices are low we buy! They're low now—**LOWER THAN THEY EVER WILL BE**—hence this sale. Most of the merchandise is new—never used; some of it reconditioned. 100% satisfaction on each transaction or your money refunded. **ORDER FROM THIS PAGE.** Use the convenient coupon below. Be sure to include sufficient extra remittance for parcel post charges, else the order will be shipped express, charges collect. Any excess will be refunded. C.O.D. shipments require a 20% deposit. If full remittance accompanies order deduct 2% discount. Send money order—certified check—new U. S. stamps. No C.O.D. to foreign countries.

**ORDER TODAY QUANTITIES LIMITED PROMPT SHIPMENTS ASSURED**

### WESTINGHOUSE WATTHOUR METER

Completely overhauled and ready for immediate service. Designed for regular 110 volt, 60 cycle 2-wire A.C. circuit. Servicemen use it in their shops to check current consumption of sets, soldering irons, etc. Keeps costs down. If dismantled the parts alone would bring the price. The elaborate gear train could be used as a counter on machines of various kinds. Simple to install; 2 wires from the line and 2 wires to the load. Sturdily constructed in heavy metal case. Size: 3 1/2" high, 3 1/4" wide, 5" deep, overall. Shp. Wt. 1 1/2 lbs.



ITEM NO. 33  
Your Price ..... \$4.50

### PORTABLE TELEGRAPH AND BUZZER FIELD SETS



Made for military use by Western Electric. A wonderful buy if only for the parts it contains. Never been used. Good for code practicing, signaling, communications, etc. Contains 2-tone, high-frequency buzzer with platinum contacts, telegraph key, telephone switches, earphone, condenser, transformers, chokes, etc. A \$50 value easily. Complete in wooden case with diagrams and instructions. Shp. Wt. 12 lbs.

ITEM NO. 16  
Your Price ..... \$5.45

### SERVICEMEN!—EARN MORE MONEY

#### Electrifying Domestic Sewing Machines

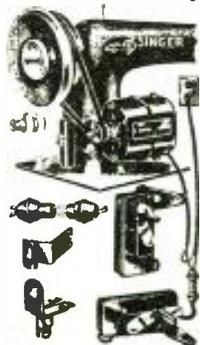

While you're repairing that radio suggest electrification of the old sewing machine. The cost is amazingly low. Every "foot-treadle" housewife is a likely prospect. Only one hole drilled to mount the entire assembly. Labor cost low, profit high.

#### COMPLETE EQUIPMENT SUPPLIED

Nothing else to buy. Kit includes motor, bracket to fit any machine (mention name) cord, pulley and rheostat for knee or foot control. Motor is 1/20 HP, 110 volts AC or DC, 25 or 60 cycles, 5,000 RPM variable, double 3/4" shaft for either rotation, flat-sided case to permit use on drop-head machines. Size 5" x 3" x 2 1/4". Shp. Wt. 1 1/2 lbs.

ITEM NO. 37  
Your Price ..... \$8.65

### WESTON MODEL 562 A.C.—D.C. AMMETER

Designed by Weston for the Eastman Kodak Co. Range, 0 to 6 Amps. It is a precision-built magnetic-vane type ammeter which, with suitable shunts, can be made to measure heavier currents too. It is 2" in diameter and designed for panel mounting. Bakelite base and black-enamelled cover. Shp. Wt. 2 lbs.



ITEM NO. 35  
Your Price ..... \$1.25

### 1/20 HP 2-SPEED AC-DC MOTOR

Double-Shaft, 5000 and 230 RPM

Brand new back-geared motor. Never been used. Steel worm and fibre driven gears. The 230 RPM shaft is at right angles to main shaft and delivers power up, down, right or left by moving gear train. A suitable-sized rheostat may be used for controlling the speed. Shaft is 3/16". For 110-volt A.C. or D.C. 25 or 60 cycles. Servicemen and others will find the double speeds useful for grindink, buffink, winding coils. Shp. wt. 12 lbs.

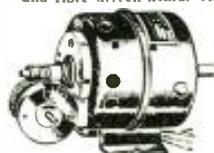

ITEM NO. 40  
Your Price ..... \$5.25

### 1/100 HP AC MOTOR

Excellent for experimenting, mechanical toys, dynamic window displays, etc. Develops 1750 RPM. Has 2-sided shaft with fan blade on one end for cooling the motor. Housed in sturdy case with attached mounting bracket. Shp. Wt. 5 lbs.

ITEM NO. 41  
Your Price ..... \$1.49



### MOTOR-SPEED REDUCER

Reduces the speed of electric motor, 12 1/2 times. The gears are totally enclosed in a steel case. Shaft, 1/2", sleeve bearings, 25", shaft extension 3 1/2", base to shaft centers 7". High speed shaft on top. Mounting bolts 3/16" x 2 1/2". Shp. Wt. 3 lbs.

ITEM NO. 42  
Your Price ..... \$4.72



### BUD

- 1—Steel cabinet 7x10x6 inches, type 993
- 1—Steel panel, 7x10 inches
- 1—Steel chassis, 1 1/2 x 5 x 8 inches

### RAYTHEON (Tubes)

- 1—Type 7B7 "loktal" tube
- 1—Type 7C5 "loktal" tube

### SIGMON RADIO SUPPLY

- 1—Coil and switch assembly
- 1—Special calibrated dial

### Coil Winding Data

Band	Turns	Tap	Spacing	Wire
160	115	9	Close	34 E.
80	45	4	Close	28 E.
40	16	2 1/2	7/8"	22 E.
*20	9	2	13/16"	16 E.
*10	5	1 3/4	1"	14 E.

E=Enamelled copper wire.

The coils for the 160, 80 and 40 meter bands are wound on 3/4 inch diameter, 1 1/2 inch long forms. The 20 and 10 meter coils are air-wound and self-supporting.

\*These coils may be stretched or compressed to bring the bands to the center of the dial scale.

### WELDING! BRAZING! SOLDERING!

#### 3-IN-1 PORTABLE ELECTRIC TORCH

WORKS FROM 110 VOLTS A.C. OR D.C. LINE

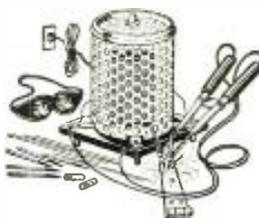

This electric torch is not a gadget or a toy but a sturdily built outfit using the finest materials. With it you are able to do professional type of welding, brazing and soldering work, regardless of whether or not you've had previous experience. It will do a thousand and one jobs; fender welding, auto body repairs, humpers, cylinders, tanks and industrial repairs—ideal for steel fitters, plumbers, sheet metal jobs, engineers, maintenance men, radio and bicycle repair men, etc. Works on aluminum, brass, copper, iron, steel and other metals.

The 3-in-1 electric torch is so simply constructed that even a boy can operate it after reading the simple and concise instructions furnished with the unit. Not necessary to know how to strike an arc. All you do is plug the torch into the light socket, adjust the carbons per instructions, and presto!—you have an intense, blazing flame, ready for work. The outfit comes complete with power unit, electric cord, electrode holder, carbons, welding rods, blazing rods, solder flux, goggles, and instructions.

Save money! Do your own repairing. Earn money by doing repairing for others. Simple, practical, durable and safe to handle—that's why the price is amazingly low. Don't delay—order one today. Shp. Wt., 3 lbs.

ITEM NO. 50  
Your Price ..... \$6.95

## Radio and Television in War

(Continued from page 391)

the plane or ship from the transmitter.

The size of the spot on the cathode-ray screen is varied by utilizing an additional focusing coil around the neck of the tube; any increase or decrease in the current flowing through this focusing coil produces a greater or lesser electro-magnetic field and controls accordingly the concentration of electrons passing through the electron gun assembly.

Television cameras or pick-up apparatus mounted in planes or balloons may be used to transmit views on enemy territory to suitable receivers located behind the lines.

A war-television invention by Hugo Gernsback is shown in one of the accompanying pictures—here airplanes, fitted with television transmitters and cameras, pick up scenes in the north, east and other sections of the battlefield, and these images are flashed back on ultra short waves to general headquarters. There the officers see the actual scenes of the enemy country flashed on large television screens and can quickly and more accurately make their own decisions before issuing orders for attack.

In Mr. Gernsback's plan for picking up television scenes of the enemy terrain and flashing them back to headquarters, each television image would be transmitted on a different frequency channel, and a receiver tuned to each respective channel employed to pick up the image behind the front lines. The large television images thrown on the screen at headquarters can be produced either by means of high voltage cathode-ray projectors or by means of revolving mirror drum apparatus, such as the Scopophony.

## HUDSON SPECIALTIES CO. - 40-T West Broadway - N. Y. C.

### IT'S EASY TO ORDER CLIP COUPON—MAIL NOW

HUDSON SPECIALTIES CO., 40-T West Broadway, New York, N. Y. RT-1139

I have circled below the numbers of the items I'm ordering. My full remittance of \$..... (include shipping charges) is enclosed.

OR my deposit of \$..... is enclosed (20% required), ship order C.O.D. for balance. (New U.S. stamps, check or money order accepted.)

(Circle item No. wanted: 16 33 35 37 40 41 43 50)

Name ..... Address .....

City ..... State .....

Send remittance by check, stamps or money order; register letter if you send cash or stamps.

### In the Next Issue!

More Constructional  
Articles for the  
HAM, S-W FAN  
and  
Television Set Builder

# NEW!

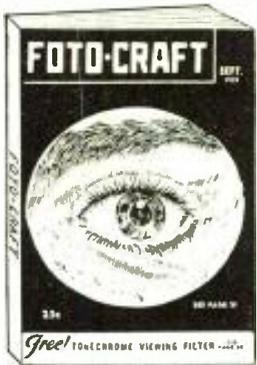

A NEW  
GERNSBACK  
PUBLICATION

The  
Constructive Photo  
Magazine

ON ALL  
NEWSSTANDS

FOR serious-minded amateur photographers, here's a photo magazine, FOTO-CRAFT, vastly different from any you've read. It tells you how and why to do things—it's a constructive publication which shows what can be done with the equipment you have, and how to make handy, photographic accessories. FOTO-CRAFT, with its broad editorial features, covers such important branches of photography as—New Scientific Researches; Developing; Printing; Enlarging; Duplicating; Cropping; Photomicrography; Color Photography; Amateur Movies; How to Make It Items.

A Few of the Articles in the Current Issue  
What Makes a Good Photograph—Making Photos Without a Camera—A One-Eye Stereoscope—A Color Transparency—Scope—Pistol or Gun Grip for Your Camera—Edge and Border Designs—Making a Scene Selector—Permanent Retouching Desk—Building a Focus Magnifier—Motor Driven Film Tank—Stamp Photos—Color in Photography—Film and Print Drier—Ventilated, Dustless Garage Dark-room—Making a Dial-Type Film-Tank Thermometer—Combination Spot and Floodlight—Home-Made Pan and Tilt Tripod Head—Home-Made Emergency Changing Bag—Creator of Illusions—Photo Quiz—Use Your Enlarger for Copying—Most Bizarre Photo Content—Hints and Kinks—Questions and Answers—What's New.

Foto-craft—Now Combined with Photo Review  
And another Free Gift—Tonechrome Viewing Filter.  
BIG OPPORTUNITY! Get a FOTO-CRAFT Press Card today—with it you can get permission to take photos which might be difficult to obtain. PRESS CARDS are sent FREE to subscribers of FOTO-CRAFT. Enter your subscription for Seven Months for \$1.00—and get your PRESS CARD immediately.

**FOTO-CRAFT**

99-T HUDSON STREET, NEW YORK, N. Y.

## U. S. ARMY SIGNAL CORPS LAMPS

The Lamp of 100 Uses

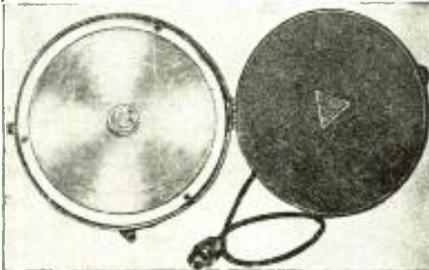

- Scout Signalling
- Night Bowling Alleys
- Trailer Lamp
- Night Motor Boat Races
- Auto, Truck and Trailer Camps
- Tractor Light
- Camp Light
- Barnyard Lighting
- Night Fishing
- Radio Shacks
- Bungalows
- Picnics, etc.



Scouts Signalling

Large size—12 1/2" wide, 5 1/2" deep, 1 1/2" high including socket, fitted with 10" silver plated reflector (no glass, nothing to break). Packed in portable wooden carrying case, with hinged cover, hump and handles. Every case contains weatherproof extension cord and plug, 2 extra bulbs, telegraph signalling key and 16 page U.S. Army Instruction Manual. Shipping weight 18 lbs. Price **\$3.95**

SPECIAL FOR 30 DAYS ONLY F.O.B. N. Y.

Same size lamp without wooden case or extra fittings **\$1.50**  
Small lamps, 6" **\$1.00**

Send for catalog containing full descriptions of this and many other interesting items.

**GOLD SHIELD PRODUCTS**

Dept. RT-11-9 350 Greenwich St. New York

## Adding 3" C-R Tube

(Continued from page 399)

istance method of testing is recommended.

The balance of the power supply (the low voltage and heater supply for the main chassis) remains intact. The main chassis is modified in several respects.

The R.F. choke in the detector circuit, if changed to a 10,000 ohm resistor, improves the detail immensely.

The second video stage employs another 1852 instead of the 6F6 and is cathode biased with a 100-ohm resistor plus a high capacity condenser, thereby eliminating the dry cell previously used for biasing. The same arrangement is used for the first video stage.

The next circuit change made by the writer is in the frequency separator, which utilizes a 6N7 instead of the 6F7. This also eliminates the synchronizing potentiometers, R30—R34. While this change is not absolutely necessary, it does simplify the circuit. Those who are rebuilding the set need not alter the original 6F7 circuit.

Potentiometers R65—R63 are removed and the 100,000-ohm unit (R63), which was the focusing control, is used for the intensity control, and a .5 meg. potentiometer is used for focusing the 906-P4. As can be seen in the wiring diagram, the intensity control is in the cathode circuit of the 906-P4; this is necessitated by the fact that grid No. 1 is returned to ground through a 1.0 meg. resistor in order to make use of a D.C. restorer circuit.

A medium 7-prong socket should be mounted on the bracket to accommodate the 906 cathode-ray tube.

An 8-prong socket is also installed on the chassis close to the cathode-ray tube bracket to accommodate the 6H6 D.C. restorer.

### Revised Parts List for 3" C-R Tube

NATIONAL UNION RADIO COPP. (Tubes)

5—1852	3—6N7
3—6H6	1—80
1—6F8G	1—81
	1—906-P4

RCA MFG. (Transformers)

- 1—Hov. oscillation trans., No. 3,899
- 1—Ver. o-sc. trans., No. 3,898

THORDARSON ELEC. MFG. CO.

- 1—(T2) T13R15
- 1—(CH1) T75C49

KENYON TRANSFORMER CO.

- 1—(T1) T-208
- 1—(CH2) T-158

INTERNATIONAL RESIST. CO.

(Potentiometers)

- 3—100,000 ohm
- 1—50,000 ohm
- 2—150,000 ohm
- 1—.25 meg.
- 3—.5 meg.

(Resistors)

- 3—1,500 ohm
- 1—150 ohm
- 5—5,000 ohm
- 5—60,000 ohm
- 5—250,000 ohm
- 2—175 ohm
- 1—1,500 ohm
- 2—2,000 ohm
- 4—1 meg.
- 1—40,000 meg.
- 3—.5 meg.
- 2—3 meg.
- 1—2 meg.
- 1—30,000 ohm
- 2—5,000 ohm
- 2—3,000 ohm
- 1—1,000 ohm
- 6—100,000 ohm
- 1—400 ohm
- 2—10,000 ohm
- 1—600,000 ohm
- 1—2,000 ohm, 10 watt
- 1—50 ohm, center tap, 20 watt
- 1—100,000 ohm, 1 watt
- 2—160 ohm

(Continued on page 441)

## PEAK EFFICIENCY

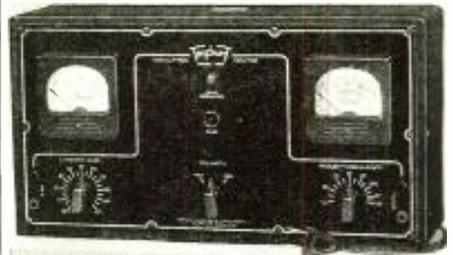

get more out of your  
power with **TRIPOLET**

### MODULATION MONITOR

... AT A PRICE!

• Usable On All Amateur Bands • Permits Compliance With Federal Regulations • 110 Volt AC 60 Cycle Operation • Two Meters—One for Carrier, One for Per Cent Modulation • Calibrated Modulation control for neon flasher from 50% to 120%. Polarity switch permits checking positive and negative peaks. Tip Jacks for Phone Connection • Uses Vacuum Tube Rectification • RED • DOT Lifetime Guaranteed Meters ...

In Metal Case ... DEALER NET **\$33.00**

PRICE ...

Also available as rack panel mounting unit ... Dealer Net Price ... **\$33.67**

WRITE FOR CATALOG

Section 2811 Harmon Avenue

TRIPLET ELECTRICAL INSTRUMENT CO.

Bluffton, Ohio

## Headset Headquarters



### CANNON-BALL

Phones have kept in the lead for over twenty years through real performance. Write for folder T-11 illustrating complete line of rugged, unusually sensitive, dependable Cannon-Ball Headsets.

Scientifically Built Heavy bar magnets greatly increase their efficiency.

C. F. CANNON COMPANY  
SPRINGWATER, N. Y.

## THE NEW "RCP"

RADIO CITY PRODUCTS  
"DEPENDABLE"  
TEST EQUIPMENT

Model 432 Trouble Shooter	Net \$5.83
Model 456 Multitester	Net \$7.79
Model 702 Signal Generator	Net \$22.49
Model 308-P Tube Tester	Net \$18.58

NOW IN STOCK FOR IMMEDIATE SHIPMENT

**CAMERADIO**

963 LIBERTY AVE. 30 TWELFTH ST.,  
PITTSBURGH, PA. WHEELING, W. VA.

Established 1919



### UNIVERSAL

Grasp-to-talk in single and double button, crystal and dynamic models. Streamlined, rugged, compact, lightweight. Hand grab-closed circuit. For police cars, fairs, window demonstrations, p. a., amateurs, call systems, sports event, etc. Incl. 6 ft. cord.

Universal Microphone Co., Ltd.  
424 Warren Lane, Inglewood, Calif., U.S.A.

# ... THESE OUTSTANDING SHORT WAVE BOOKS ARE Now Available AT YOUR DEALER!

YOU buy parts, tubes, kits, accessories from your local radio dealer—that's what countless thousands of short-wave fans do. Now through a nation-wide distribution service our numerous books are available at your favorite radio dealer—right where you buy other radio equipment. It's more convenient, saves time and you can inspect the books before you buy. Ask your dealer to show you all the books advertised on this page—they're always in stock.

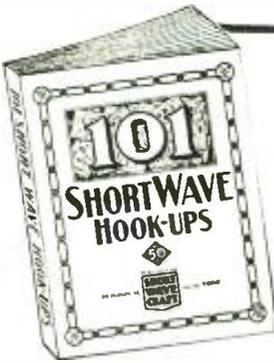

**101 SHORT WAVE HOOK-UPS**  
Compiled by the Editors of RADIO & TELEVISION  
Here is a worthwhile book that every short wave listener, every short wave fan, and every short wave amateur has wanted for a long time. It gives you the 101 best short wave hook-ups which have appeared heretofore.  
100 Illustrations 50c  
72 Pages

**HOW TO BUILD AND OPERATE SHORT WAVE RECEIVERS**  
This is the best and most up-to-date book on the subject. It is edited and prepared by the editors of RADIO & TELEVISION and contains a wealth of material on the building and operation, not only of typical short wave receivers, but short wave converters as well.  
150 Illustrations 50c  
72 Pages



**HOW TO GET BEST SHORT WAVE RECEPTION**  
M. HARVEY GERNSBACK tells you everything you have ever wanted to know about short wave reception. The author, a professional radio listener and radio fan for many years, gives you his long experience in radio reception and all that goes with it.  
40 Illustrations 50c  
72 Pages

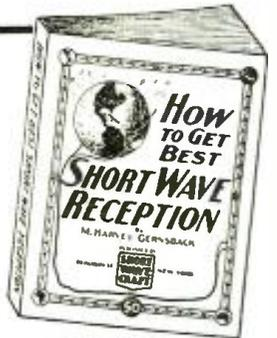

**HOW TO BECOME AN AMATEUR RADIO OPERATOR**  
By Lieut. Myron F. Eddy, whose experience in the amateur field has made him pre-eminent in this line.  
If you intend to become a licensed code operator, if you wish to take up phone work eventually—this is the book you must get.  
150 Illustrations 50c  
72 Pages

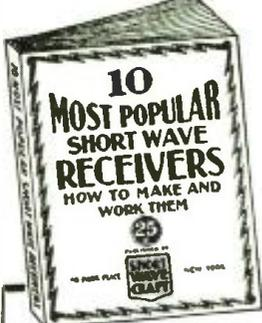

**TEN MOST POPULAR SHORT WAVE RECEIVERS**  
HOW TO MAKE AND WORK THEM  
The editors of RADIO & TELEVISION have selected ten outstanding short wave receivers and these are described in the new volume. Each receiver is fully illustrated with a complete layout, pictorial representation, photograph of the set complete, hook-up and all worthwhile specifications.  
75 Illustrations 25c  
40 Pages



**THE SHORT WAVE BEGINNER'S BOOK**  
Here is a book that solves your short wave problems—leading you in easy stages from the simplest fundamentals to the present stage of the art as it is known today. It is the only low-priced reference book on short waves for the beginner.  
75 Illustrations 25c  
40 Pages

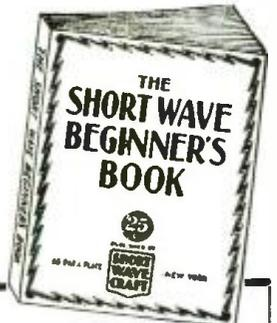

## LOOK FOR YOUR NEAREST DEALER

For convenience the publishers list below dealers in all parts of the world where our books are available. On your next shopping trip be certain to examine these volumes. You're sure to want them for your technical library.

- ALABAMA**  
Walther Bros., Montgomery
- ARIZONA**  
Sam's Cigar Store, Phoenix
- CALIFORNIA**  
Electric Supply Co., Oakland  
Radio Supply Company, Los Angeles  
Radio Television Supply Co., Los Angeles  
Pacific Radio Exchange, Inc., Los Angeles  
Western Auto Supply, Los Angeles  
Zack Radio Supply Co., Los Angeles  
Vroman's Book Store, Pasadena  
Western Radio & Elec. Co., San Diego  
Offenbach Electric Co., San Francisco  
Technical Book Co., San Francisco  
Zack Radio Supply Co., San Francisco  
Radio Specialties Co., San Jose
- COLORADO**  
Auto Equipment Co., Denver  
Interstate Radio Supply, Denver
- CONNECTICUT**  
The Edward P. Judd Co., New Haven
- DELAWARE**  
Wilmington Elec. Spec. Co., Inc., Wilmington
- FLORIDA**  
Radio Accessories Co., Orlando
- GEORGIA**  
Radio Wire Television, Inc., Atlanta
- ILLINOIS**  
Allied Radio Corporation, Chicago  
Walter C. Braun, Inc., Chicago  
Chicago Radio Apparatus Co., Chicago  
A. C. McClurg & Co., Chicago  
Midwest Radio Mart, Chicago  
Newark Electric Co., Chicago  
Sears, Roebuck & Co., Chicago  
Max Stein & Co., Chicago  
Montgomery Ward & Co., Chicago  
Radio Wire Television, Inc., Chicago

- INDIANA**  
Van Sickle Radio, Indianapolis
- MASSACHUSETTS**  
DeWolfe & Fiske Co., Boston  
The Personal Book Shop, Boston  
Radio Wire Television, Inc., Boston  
Library Book House, Springfield  
Tremont Elec. Supply Co., Boston
- MICHIGAN**  
Rlist Brothers, Detroit
- MINNESOTA**  
St. Paul Book & Stat. Co., St. Paul
- MISSOURI**  
Burstin-Appelke Co., Kansas City  
Radio Labs., Kansas City  
Walter Aabe Radio Co., St. Louis  
Van Sickle Radio Co., St. Louis
- NEW JERSEY**  
Radio Apparatus Co., Newark  
United Radio Co., Newark
- NEW YORK**  
Fort Orange Radio Dist. Co., Albany  
Radio Wire Television, Inc., Bronx  
Radio Wire Television, Inc., Jamaica, L. I.  
Harrison Radio Co., New York City  
American News Co., New York City  
Baker & Taylor Co., New York City  
Blair, the Radio Man, New York City  
David Bogen & Co., New York City  
Federated Purchaser, Inc., New York City  
Radio Circuit Co., New York City  
G. E. Stechert & Co., New York City  
The Stiefel Co., New York City  
Sun Radio Co., New York City  
Thor Radio Corp., New York City  
Try-Mo Radio Co., New York City  
Van Riemsdyck Book Stores, New York City  
Radio Wire Television, Inc., New York City  
H. W. Wilson Co., New York City  
Radio Parts & Equipment Co., Rochester  
M. Schwartz & Son, Schenectady
- OHIO**  
College Book Exchange, Toledo

- OREGON**  
J. K. Gill Co., Portland
- PENNSYLVANIA**  
Radio Electric Service Co., Philadelphia  
Cameradio Co., Pittsburgh
- WASHINGTON**  
Seattle Radio Supply Co., Seattle  
Wedel Co., Inc., Seattle  
Spokane Radio Co., Spokane
- WISCONSIN**  
Radio Parts Co., Milwaukee
- ARGENTINA**  
Radio Revista, Buenos Aires
- AUSTRALIA**  
McGill's Authorized Agency, Melbourne
- BELGIUM**  
Emil Arenis, Brussels
- CANADA**  
T. Eaton & Co., Winnipeg, Man.  
Electrical Supplies, Ltd., Winnipeg, Man.  
Wholesale Radio Supply, Winnipeg, Man.  
Canadian Electrical Supply Co., Ltd., Toronto, Ont.  
Radio Trade Supply Co., Ltd., Toronto, Ont.  
Canadian Electrical Supply Co., Ltd., Montreal, P. Q.
- BRAZIL**  
Agencia Soave, Sao Paulo
- CHINA**  
China News Co., Shanghai  
International Booksellers, Ltd., Shanghai
- CUBA**  
Diamond News Co., Havana
- ENGLAND**  
Goring's Amer. News Agency, London
- FRANCE**  
Toute La Radio, Paris
- GERMANY**  
Rehr G.M.B.H. SW15, Berlin NW No. 7

- HOLLAND**  
Radio Peeters, Amsterdam; Z.
- INDIA**  
Empire Book Mart, Bombay
- MEXICO**  
American Book Store, Mexico, D. F.  
Central De Publicaciones, S. A., Mexico, D. F.  
Jaquea Nairo, Mexico, D. F.
- NEW ZEALAND**  
Johns, Ltd., Auckland  
James Johnston, Ltd., Dunedin  
Te Aro Book Depot, Ltd., Wellington
- SOUTH AFRICA**  
Technical Book Co., Cape Town  
Central News Agency, Johannesburg  
International House, Johannesburg  
South African Radio Publications, Johannesburg

IF YOUR DEALER DOES NOT CARRY THESE BOOKS, ORDER DIRECT FROM US. FILL OUT COUPON BELOW. SHIPMENT WILL BE MADE IMMEDIATELY.

**POPULAR BOOK CORP.** R&T-II-39  
99 Hudson Street, New York City.

Gentlemen: I enclose herewith my remittance for . . . for which please send me the following books:

.....

.....

Name .....

Address .....

City .....

State .....

(Send remittance in form of check or money order. If letter contains cash or unused U. S. postage stamps, register it.)

POPULAR BOOK CORPORATION • Publishers • 99 HUDSON STREET • NEW YORK, N. Y.

# G.E. PHONOGRAPH MOTOR

Formerly Sold for \$15.00



Only \$4.95

**VARIABLE** speed induction type self-starting, 110 volt, 25 to 60 cycle, A.C. with speed control, plug and cord. Speed range from 5 to 200 R.P.M. Can be installed in place of old-fashioned, hand-winding speed motor. Also ideal for display turn table, and a hundred other uses. These General Electric Motors are brand new, in original factory cartons. **\$4.95**  
G. E. Electric Phonograph motor as described

Shipping Weight—12 lbs.

## MICROPHONE and RECEIVER

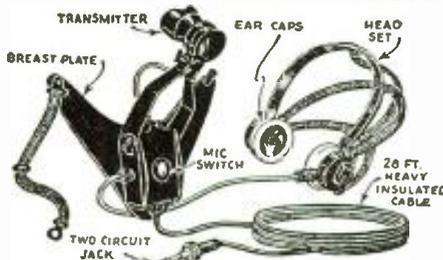

This Microphone and telephone headset outfit was built especially for the U. S. Navy Aviation Corps. The Holzer-Cabot Electric Company constructed the outfit to Government specifications. The outfit consists of low-impedance carbon microphone (transmitter), securely fastened to a metal breast-plate, and a set of heavy-duty, low-impedance earphones. A specially constructed switch on the back of the breast plate controls the microphone circuit. The earphones are U.S.N. Utah type, attached to adjustable headband. Twenty-eight feet of very heavy weather and waterproof conductor cable is furnished. Current of not more than 10 volts should be used. A storage battery is the most satisfactory current supply. **\$4.95**  
U. S. Navy Airplane-type Microphone and Receiver as described.....  
Shipping Weight—9 lbs.

We will forward Shipments by Express Collect if sufficient postage is not included.

**WELLWORTH TRADING COMPANY**  
1915 S. State Street Dept. RT-1139 Chicago, Ill.

## EXTRA MONEY FOR YOU! NOW ONLY 10¢

NEW 1940 EDITION

66 PAGES

300 WAYS TO MAKE MONEY

Successful tested schemes—actual experiences of men who have started on a shoestring—with less than \$10 capital. Money-Back Guarantee. "CASH IN" contains only tested ideas covering every type of full- or spare-time enterprise—it's a "masterpiece" in business ventures. 10 CENTS per copy. Sent **POSTPAID** anywhere upon receipt of 10 cents U.S. stamps or coin.

**NATIONAL PLANS INSTITUTE**  
246-T FIFTH AVENUE NEW YORK, N. Y.



**"JIFFY" Magazine Binders**  
Sturdily built and covered with black fabricoid. Has two stamped metal ends with 12 spring wire separators. Magazines can be inserted and removed in a jiffy. No fuss—no lost time—no labor.

- No. 1. 12"x9 1/4", with 2-inch back for H.&T., Radio-Craft, Radio News, etc. **\$1.00**
- No. 2. 10 1/2"x7 1/2", with 3-inch back for QST, Radio, Popular Mechanics, etc. **\$1.00**
- No. 3. 8 1/2"x6 1/2", with 3-inch back for Reader's Digest, etc. **\$1.00**

P.P. Prepaid in U.S. and Canada. Send for catalog containing full descriptions of many other interesting items.

**GOLD SHIELD PRODUCTS**  
Dept. RT-11-9 350 Greenwich St. New York

## Adding 3" C-R Tube

(Continued from page 439)

**CORNELL-DUBILIER CORP. (Condensers)**

- 3—16 mf., 450 v.—JR-516
- 5—8 mf., 450 v.—JR-508
- 3—.05, 400 v.—DT-485
- 1—.005, 400 v.—DT-615
- 1—.0015 mica, 1 w.—5D15
- 14—.01, 400 v.—DT-451
- 5—.25, 400 v.—DT-4P25
- 5—1 mf., 400 v.—DT-4P1
- 1—.5, 400 v.—DT-4P5
- 1—10 mf., 25 v.—BR-102
- 4—150 mmf., mica—3L-5T15
- 1—80 mmf., mica—1W-5T8
- 1—50 mmf., mica, 5 w.—5Q5
- 2—.001 mica, 1 w.—5D
- 1—.05, 2,000 v.—DT-16S5
- 1—.005, 2,000 v.—DT-16D5
- 2—1 mf., 2,000 v.—TQ-20010

**SOLAR MFG. CO. (Condensers)**

- 6—100 mf., 25 v.—M-0100
- (3—In parallel to make 300 mf.)

## Power Supply and Modulator

(Continued from page 436)

the various switches control. The oscillator grid tuning unit coil switch selects any one of five coils having the following frequency ranges—875-1000 kc., 1.7-2 mc., 3.5-4 mc., 7-7.5 mc., and 14-15 mc. Since the oscillator plate circuit is always tuned to the second harmonic of the grid circuit, output is available on all bands from 160 to 10 meters. The grid and plate coil switches are ganged together so that the proper plate coil is automatically selected. The 807 plate tuning unit, like the 89 plate unit, contains coils from 160 to 10 meters.

### 4 Bands on 1 Crystal

The 807 plate circuit can be operated either on the same frequency as the oscillator plate or on the second harmonic. Operation as a quadrupler will result in lower output so that maximum output from the final will not be possible. The final stage can be operated as a doubler, but this is not so desirable. Using crystal control, the same crystal can furnish either fundamental or second harmonic output in the plate. The buffer operating straight through doubling; and with the possibility of doubling in the final, we can operate on four bands with a single crystal.

Actual tuning is simple and straightforward. When using the ECO, the oscillator grid is tuned to the desired frequency by listening-in on the station receiver. The 807 plate tuning condenser is then tuned to resonance as indicated by a dip in plate current and the HK54 plate condenser is also tuned to resonance. Antenna adjustment will depend on the type of antenna used. As part of the final plate coil jack base, there is a three turn link coil, hinged to provide variable coupling. A 72 ohm feeder can be connected directly to this link coil. The screen voltage to the 807 should be adjusted to provide not more than about 25 milliamperes of grid current to the HK54.

Neutralizing the final is accomplished by adjusting the neutralizing condenser (NC) until, when swinging the plate condenser (C9) through resonance, there is no variation of the HK54 grid current. Once adjusted, it should require no readjustment for any other band. If the plate coils are home-made, extreme care should be taken so that the center tap is in the exact center of the coil.

More Television Construction Data Next Month

# OXFORD

**SPEAKERS THAT VITALIZE SOUND**



2 Inch to 14 Inch

Oxford Speakers have special appeal to amateurs and experimental engineers due to pioneering of new speakers with top-efficiency performance. Oxford was the first to introduce the 3" Electro-Dynamic (for compact AC-DC and Portable Sets) which was followed by the 3" Permag Dynamic and then the sensational Little General 2" Permag Dynamic.

For Speakers That Vitalize Sound — See Your Local Oxford Dealer or Send Coupon — NOW.

**MAIL THIS COUPON NOW**

Please Send Full Information on Oxford Speaker at Once.

Name .....

Address .....

City .....

Dept. V

**OXFORD-TARTAN RADIO CORPORATION**  
115 W. VAN BUREN ST. CHICAGO, U.S.A.

## NEW RADIO AND ELECTRONIC DICTIONARY Containing 3,800 Definitions

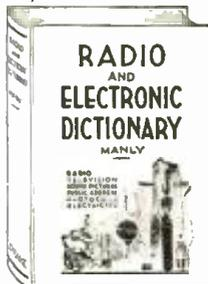

THIS RADIO AND ELECTRONIC DICTIONARY, written by Harold P. Manly, explains the meaning of 3,800 words used in radio, electronics and other closely allied fields. It includes new terms used in radio transmission, sound pictures, television, public address, aviation radio, navigation and industrial control, photo-electricity, photocell application, telephotography, etc. This dictionary permits learning every new expression whether you hear it or read it. Alphabetically arranged for quick reference. 350 illustrations augment definitions in the text.

The book is recommended for students, instructors, engineers, service men, experimenters, salesmen and everyone in any way associated with radio. **ONLY \$2.50**  
The RADIO AND ELECTRONIC DICTIONARY is new, authentic and printed in a single volume of 300 pages, 6 x 9 inches. The book weighs two pounds, and bound in durable cloth. **SHIPPED ANYWHERE \$2.50 IN U. S. A. POSTPAID** . . . Price

Mail remittance by check or money order to **RADIO PUBLICATIONS**  
99 HUDSON STREET NEW YORK, N. Y.

The Only Low Price Mike with Tilting Head and Removable Cable Set

## New TURNER 22X CRYSTAL MICROPHONE

Equal to Many \$25 Mikes, at **\$16.50** List

Here's the microphone that brings you crisp, clear performance and professional styling with satin-chrome plating all over. Fully protected and shielded for the amateur; rugged enough for the toughest P.A. job. Head range full 60 degrees. The low-cost way to pep up your equipment.



Send for Free Details  
**The TURNER CO.** Complete with 7-Ft. Cable Set.  
911 Seventeenth St., N.E. Range 30-7000 cycles High level.  
CEDAR RAPIDS, IOWA 52DB  
Lic. Under Patents of The Brush Development Co.

# COMMERCIAL NOTICES 10¢ A WORD

Under this heading only advertisements of a commercial nature are accepted. Remittance of 10¢ per word should accompany all orders. Copy should reach us not later than the 10th of the month for the second following month's issue.

## AGENTS WANTED

300% PROFIT SELLING GOLD Leaf Letters for Store Windows; Free samples. Metallic Co., 446 North Clark Chicago.

## CORRESPONDENCE COURSES

CORRESPONDENCE COURSES and educational books, slightly used. Sold, Rented, Exchanged. All subjects Satisfaction guaranteed. Cash paid for used courses. Complete details and bargain catalog Free. Send name Nelson Company, L-210 Manhattan Building, Chicago.

## INSTRUCTION

\$120.00 ELECTRICAL ENGINEERING Course; 60 cloth-bound lessons

books, Good condition. \$18.00. Harry Ackerson, Box 322, Ramsey, N. J.

## PATENT ATTORNEYS

INVENTORS — PROTECT YOUR rights before disclosing your invention to anyone. Form "Evidence of Conception"; "Schedule of Government and Attorneys' Fees" and instructions sent free. Lancaster, Allwine & Rommel, 435 Bowen Building, Washington, D. C.

## QSL—CARDS—SWL

100 NEAT SWL CARDS PRINTED with your name and address sent postpaid for \$1. Bunch of samples and ENY Chart for five cents in stamps. W1BER, 78 Warren St., Springfield, Mass.

QSL AND SWL CARDS, SAMPLES on request. Gilhe, P. O. Box 465, Albany, N. Y.

SWLs (QSLs ONE COLOR 75c 150, two colors \$1.00 150, samples, W3DEE, Maple Shade, N. J.

## RADIO DIAGRAMS

ANY RADIO DIAGRAM 25c. SPECIFY manufacturer, model. Radio magazine free. Supreme Publications, 3727 West 13th, Chicago.

## TELEVISION

TELEVISION — TUBES, DISKS, Motors. Arthur Pohl, 4929 Merritt, Detroit, Mich.

# FOR SALE (NON COMMERCIAL) 3¢ A WORD

Under this heading we accept advertisements only when goods are offered for sale without profit. Remittance of 3¢ per word should accompany all orders. Copy should reach us not later than the 10th of the month for the second following month's issue.

McMURDO SILVER MASTERPIECE IV, nineteen tubes five band, twin Jensen speakers in console, cost over \$400 sacrificed \$65. Charles Ardito, 118 Holland St., Somerville, Mass.

DON'T BUY A RECEIVER UNTIL you get my free list of reconditioned, guaranteed Receivers! Practically all models at money saving prices. Trade-ins, Time Payments. Send for list. W2AVA, 12 West Broadway, New York.

FINE WATSON GUITAR, GOOD condition, \$7.00. Hansen, 325 S. 4th, Aurora, Ill.

NC100X \$79.00, NC100 \$69.00, NC80X \$69.00, AGS \$49.00, RME-69 \$39.00, RME-9D \$49.00, Hretling 14 \$39.00, Hretling 15 \$49.00, SX-16 \$79.00, SX-18 \$54.00, Sky Champion \$39.00, Sky Chief \$24.00, Sky Buddy \$15.00, All Star \$15.00, FB7 \$19.00, SW3 \$9.00, many other receivers. All shipped on ten day free trial. List free. Terms. W9ARA, Butler, Missouri.

FOR SALE—HALLICRAFTER SKY Chief, 1938, in good condition with earphones, \$24.00, Louis Aranor, 1599 Lincoln Place, Brooklyn, N. Y.

SACRIFICE! ACE "DO-ALL" Deluxe Six tube T.R.F. Receiver, 24 to 3000 meters. Dynamic speaker. Complete \$9.50 (cost \$26.25 new). Sangamo Warthour (electric light) meters. Used perfect \$2.70. Robert Lang, 227 Greenwich Street, New York City.

NATIONAL SW3—WITH TUBES, 5 sets coils and National 5890 power pack with tube. Price complete \$22.50. New condition and of latest type. Shipping charges extra. Ensign Courier, Monmouth, Oregon.

# EXCHANGE FREE!

NO ADVERTISEMENT TO EXCEED 35 WORDS, INCLUDING NAME AND ADDRESS

Space in this department is not sold, it is intended solely for the benefit of our readers who exchange anything in the Radio and Television fields for Radio and other merchandise. As we receive no money for the announcements, we cannot accept responsibility for any statements made by the readers. Use these columns freely. Only one advertisement can be accepted from any reader in any one issue. All dealings MUST be above board. Remember you are using the U. S. Postal Laws. Describe anything you offer accurately and without exaggeration. Treat your fellow men the way you wish to be treated. We welcome suggestions that will help to make this department interesting and helpful to our readers. Copy should reach us not later than the 10th of the month for the second following month's issue.

WANT TO BUY A LOW PRICED 150 meter phone and c.w. xmt. Earle Miller, Box 6618, East Worcester, N. Y.

WILL SWAP SEVEN 01A, TWO 01AA and two 20 tubes in fine shape for five 30 tubes. I will swap four variable condensers for Wilbur Lemmons, Steamham, Colorado.

HAVE 8 SHOT CLIP 22 REPEATING rifle, Western Electric hand-set, cash, radio parts. Want 5-10 meter transmitter and receiver, mounted crystals, meters, xmitting tubes, xmitting parts. R. E. Murphy, 7311 Georgetown Rd., Bethesda, Md.

—PHILCO 048 TESTER, —JEWELL low range D.C. meter, 1 Weston 0-140 V. D.C. meter for 5 or 6 tube S.W. receiver good condition complete. Robert Newman, 1700 E. 15 St., Brooklyn, N. Y.

HAVE PHILCO BC RECEIVER (9 tube chassis) and Atwater Kent converter. Will trade for 50-200.00 hrs. Want Sky Buddy or Howard receiver. Fred Mark, 405 Alleshony Street, Huntingdon, Penna.

WANT TO SWAP C.W. XMT. HAS worked 70 states on 90 meters since June 9, 1939 using a 135 ft. ant., 20 ft. high. Complete except xtal is power. Call letters answered. Radio W3MIO, 819 West 4th Street, Mount Carmel, Ill.

HAVE COMPLETE 8 MM CAMERA and Proj. and exposure meter, film splicer, two reels and cans, two lens F3.5, F5.6. Exchange for transmitting equipment. All answered. Emory Pettigrew, Itawilla, Wyo.

SWAP: 3-BAND KIT; RADIO parts; test equipment; service manuals; new '39 Corning militer; Mini-Cam; S-W magazines; study-courses; Scott album, stamps. Want: Sky-Buddy, electric shaver, John Vilkas, 1515 So. 49th Court, Cicero, Ill.

WANT GOOD RADIO PARTS, OLD radios and books on radio. Have new ping pong set, 15 magazines for boys, 8 Geographic Magazines, 3 baseball bats and 4 male model airplane. Ross Mamam, Millington, Tenn.

TRADE—RADIO, AMPLIFIER, mike, speaker, phono motor, pickup, books, sporting goods, Radiolect, projector, cameras. Want 16mm films, etc. M. Epstein, 2953 Ruckle St., Indianapolis, Ind.

HAVE MOTOR GENERATOR WITH filter, input 110 V, D.C. output 110 V, 160 watts A.C. What have you? Vincent Iavarone, 807 Mace Ave., N.Y.C.

WILL TRADE 6 TUBE SHORT wave set for some used test equipment. Set is complete less cabinet. Also have other used radio parts to trade. Abe Ochstein, 35 E. Lewis St., Fort Wayne, Ind.

WANT HIGH VOLTAGE VIBRA-Dack or dynamo. Have old N.R.I. course, 8" P.M. dynamic spkr., power transformer, milk case, 0-1 mill Weston meter. Write Ora Reed, W9QVF, Route 1, Mt. Carmel, Ill.

HAVE YOU 6 FOOT TRUMPETS and 6 volt units? Also 1 to 10 battery charger? Also writer's manuals. Will pay cash or exchange. Budin, 11821 Kinsman Rd., Cleveland, Ohio.

HAVE NEW CRYSTAL RADIO AND Brandy head phones. Hamilton Beach sewing machine motor and foot rheostat. Spanish guitar. Want rifles, fine camping equipment. C. Moore, 211 East 108 Street, Los Angeles, Calif.

WANT 24 TO 5 METER TRANSMITTER or receiver, have 4 power Lyman target scope with micrometer clicks and 370 page book on short waves. George T. Hine, Grassy Hill Rd., Orange, Conn.

HAVE TRIPLETT 1505 ANALYZER, Weston 660 analyzer, Par-Met Cabinet 18"x21"x10" Ham. dual 69011 cond., Need xtal filter, XPS's 4 prongs, receivers. Correspond with SWLA Stanley Garner, 29 W. Chestnut St., Norristown, Pa.

SWAP: 5-550 METER SET, TUBE tester, typewriter, blank chassis, panels, cabinets, radio parts, for trumpet, cornet, good 5 meter receiver, transmitter, transmitter tubes, parts, William Rosner, 667 Union St., West Springfield, Mass.

WANTED TEST EQUIPMENT, Rider or similar manuals, swap 160 meter parts and etc., or will offer cash. Please describe equipment and what you want for it. Morris Rosen, 525 West 144 St., New York City, W2KNI.

WHAT KIND OF RECEIVER WILL you trade for assorted radio parts and audio oscillator in good cond. Also stamps and Chem-Traft outfit worth \$20, alone. Chaplin, Box 216, Westford, Mass.

SWAP VALUABLE STAMPS OF Iraq and surroundings, complete sets, used and un., old and new; also many dupes. Swap for small sets, xmt., receiver, radio course, books. E. Behnan, Port Moresby, Basrah, Iraq.

WANTED 6 TUBE SKY BUDDY; will swap 22 tube GHZ motor, 9 tube R.C.A., 16 mm movie projector. Also want transmitter any kind. John Long, 9346 Georgia Ave., Silver Spring, Md.

SWAP 6L6 XTAL CW XMITTER with power supply both in metal cabinets. Can use folding camera, enlarger, photographic supplies, radio, typewriter, wrist watch, Stan., 2748 Meade St., Detroit, Mich.

SWAP: 20 HOMING PIGEONS AND 40 meter crystal and holder for a Hallicrafter or some other good SW receiver. F. E. Campbell, Jr., 405 E. 4th St., Berwick, Pa.

SWAP "ELECTRONICS" APRIL '36 to May '37; 20 issues "Broadcast News" and 2 lightning switches, for photographic equipment or anything of value. Herman Yellin, W2AJL, 351 New Lots Ave., Brooklyn, N.Y.

WANTED—ANY KIND OF A GOOD transmitter, have good single shot bolt action rifle and cash for best offer. Julius Teleheart, 1404 Benton Ave., Owensboro, Ky.

WANTED: A.C. SHORT WAVE RECEIVER, 2 tubes or more. Have magazines, tennis racket and many other things. Send description of radio and what you want for it. Jack Towne, 1519 California St., Redding, Calif.

HAVE TRUMPET OSCILLOSCOPE, Model 77, has internal sweep and wobbulator, almost new. Will trade for good recording head. Arthur M. Hart, New Smyrna, Fla.

SWAP—FREQUENCY METER, monitor, audio amplifier, 5 meter transreceiver, SW-3 parts, tubes, coils and hundreds of valuable parts, for a good receiver, metal turning lathe or good movie camera. C. Whiter, 30 West, Illon, N.Y.

HAVE A&B BATTERY ELIMINATOR, A-1 condition. Trade for Sky Buddy worth \$18.50. Also have 2 50 watt power tube sockets for hi-powered xmitter. Gordon C. Johnson, 2908 E. 6th Street, Superior, Wis.

## The Radio Beginner

(Continued from page 398)

the grid coil. Because of this arrangement, there is a *feed-back* of energy from the plate to the grid circuit, the additional electromotive force supplied thus, increasing the amplitude of the voltage applied to the grid of the detector tube. These voltages on the grid build up to a point just before the tube goes into self-oscillation.

As the name implies, the *super-regenerative* receiver carries the regenerative principle a step further. The principle is simply that the voltages on the grid are increased to a much greater amplitude before the receiver goes into self-oscillation, in this way increasing the sensitivity (or the amplification) of the receiver. In Fig. 3 we see the circuit of a *super-regenerative* receiver. The circuit is so designed that maximum regeneration is obtained, but self-oscillation is automatically prevented. Such a receiver is hard to control, is very critical in its adjustment, and tunes very broadly. In this circuit we see that we have coupled a local generator of energy, or an *oscillator*, to a standard regenerative receiver. The frequency of the local oscillator should be of a fairly low value, about 15,000 or 20,000 cycle. It should be noted that these oscillations are of super-audibility. That is, their frequency is higher than the frequency of sound waves. One of the factors governing the selectivity of the super-regenerative receiver is these local oscillations; the higher this frequency, the broader and more un-selective the receiver.

### Quench Frequency—What It Does

Maximum regenerative amplification is secured only up to the point of self-oscillation, since there is no further amplification the moment such oscillation begins. The super-regenerative receiver takes advantage of this fact to *interrupt* the oscillations, and allows the signal to build up to a very high value. The frequency used to interrupt the detector oscillations is known as the *quench* or *interruption frequency*. "Quench" is so-called, since it quenches or stops the detector's self-oscillation.

In the super-regenerative circuit described, use is made of a separate oscillator in order to produce the desired quench oscillation, which is fed to the detector as shown. Although super-regenerative receivers using separate oscillators to produce the interruption frequency are easier to adjust and get operating, a *self-quenched* detector may be used. See Fig. 4. While the self-quenched super-regenerative receiver is more difficult to adjust, the elimination of the extra tube and associated parts for the separate oscillator make the receiver more popular for portable use.

We have already mentioned that super-regenerative receivers tune fairly broadly. In addition, such a receiver is capable of radiating a strong wave. An effective remedy for both of these operating characteristics would be the addition of a *tuned radio frequency amplifier*. Such a circuit is shown in Fig. 5. In adding a radio frequency amplifier to the super-regenerative receiver, attention should be paid to the amount of coupling between the amplifier and the detector. The detector of the super-regenerative receiver operates best when under heavy load. However, with the coupling too tight the radio frequency selectivity will be somewhat reduced. The coupling should be adjusted until the best operating conditions are obtained. Shielding between the radio frequency and detector stages should be used in order to prevent interaction between

them. The radio frequency stage also makes the detector easier to handle and smoother in operation. The tubes should be operated with as low plate voltage as possible to limit the emission of a modulated signal and avoid interference.

One reason for the great popularity of the super-regenerative receiver for the ultra high frequencies, lies in the fact that the early transmitters emitted waves that covered wide bands of frequencies, with the result that high selectivity in a receiver did not then constitute a desirable asset. With refinements in transmitter practice, the use of the crystal oscillator, and the MOPA (master oscillator-power amplifier) types of transmitter, the need was felt for increased receiver selectivity. The radio frequency stage ahead of the detector in the super-regenerative receiver was a partial answer to that problem, but the trend today is toward an increasing use of the *superheterodyne*.

### Superhet. Wave Selective

Because of its inherent selectivity, the *superheterodyne* receiver presents a decided advantage over the super-regenerative receiver, even when the latter has a radio frequency stage to improve its selectivity. If a regular superheterodyne receiver covering the broadcast or short wave bands is owned, a *converter* can be attached to the set for ultra high frequency reception. In such a case the converter changes the received wave to a lower frequency, the regular receiver being used as the intermediate frequency amplifier, detector and audio stages. Such a converter is shown in Fig. 6.

As research progressed toward the higher frequencies, it was found that the ordinary type of receiving tube presented physical limitations. For example, the use of such tubes meant unnecessarily long leads to the tube elements. In addition, the spacing between the elements meant that there was an appreciable time for the passage of electrons from filament to plate. This led to the development of the *acorn* tube, so called because of its small shape and size resembled an acorn. The small size of this tube greatly reduced the time element in the passage of electrons and also provided shorter leads. While ordinary receiving tubes can and are being used on the ultra-high frequencies, the acorn type, because of its very small size and short leads, becomes the superior tube for this type of work.

### Transceivers

Until the advent of the new FCC regulations prohibiting modulated oscillators and requiring frequency stability on wavelengths of five meters, *transceivers* were used on that band extensively. Now they find application on still higher frequencies. They are ideal for portable work, since the same tubes can be used for both transmission and reception. Such a circuit is shown in Fig. 7. The first tube acts as the usual super-regenerative detector feeding into the audio circuit when the switch is in the "receive" position. When the switch is in the "send" position, the tube that ordinarily acts as an audio amplifier now becomes a modulator, the detector functioning as a transmitting oscillator. Such a circuit is *taboo* on five meters because of FCC regulations, but can be used on 2½ meters. (See article on 2½ meter transceiver in Aug. 1939 issue, page 226.—*Editor*)

The antenna for the ultra high frequency receiver is usually of the half wave type (the doublet being popular) fed to the receiver through a tuned feeder line. It should be remembered that ultra short waves lend

(Continued on following page)

## BARTER and EXCHANGE FREE ADS (continued)

I WILL PAY CASH FOR USED HAM-69, HRO or SX-17. E. Pavlida, 139 W. 7th Ave., Conshohocken, Pa.

WANTED: PRINTING PRESS, transmitter, receiver. Swap LES radio course, crystal pickup, turntable, 10 watt amplifier, magnetic speaker and D.B. microphone. Ask for my swap list, Stanley Kasper, 933 E. 30th St., Erie, Penna.

WILL PAY CASH FOR SKY BUDDY or similar short wave receiver. 1939 model preferred but other considered. Address replies giving full details as to model, condition, etc. to Clinton Slusher, 906 Stewart Ave., Roanoke, Va.

WANT ARGUS, DETROLA, SIMULATED camera, enlarger, photo equipment. Have Peak Pat. Radio 1800 meter Clipper, transmitter, mike and power supply, Columbia portable photo-radio, typewriter, all complete and operating. H. Haver, Box 111, Janulu, Calif.

WANTED: MOTION PICTURE equipment, candle cameras, transmitter, receivers, model airplane gas kits and engines, electric trains. Have low powered transmitters, transceivers, short wave and broadcast receivers, etc. Johnny Newsome, Box 725, Wake Forest, N. C.

HAVE: POPULAR MECHANICS '36-'38 inclusive. Valuable tailoring books, piecion and poultry literature, non-fiction and semi-fiction aviation magazines. Want: three tube working SW receiver. Edw. V. Svredra, 225 School St., Stoughton, Mass.

TRADE 325 VOLT PWR SUPPLY, Corona portable typewriter for SW rev. not less than four tubes. Q.R.A.: David Guthrie, South Hill, Virginia.

HAVE PRACTICALLY NEW 8MM camera and projector with cases and extra F. 5.6. Also selling outfit. Valued at \$36.00. Want 1939 Sky Buddy or Howard SW receiver. Answer all letters 100%. Richard Walker, 2351 Champlain St., N.W., Washington, D.C.

NEW 8MM. MOVIE CAMERA AND projector to trade for 16mm equipment or what-have-you? Want Rider's manuals and Teleplex. Describe all items fully. Jack Fry, Box 151, Denver, Colo.

WILL TRADE ONE 22 RIFLE IN A1 condition or one complete taxi/erny course from Northwestern School of Taxidermy for what you especially radio. Ted Gromala, 270 Elm St., Meriden, Conn.

4 H.P. MOTOR—D.C.—110V. series wound Al, also radio parts etc. My list for yours. For what have you—anything usable. All inquiries answered 100%. Gerald Lautenschlager, Castorland, N.Y.

WANTED:—OUTBOARD MOTOR RIFLES, car radio, typewriter, car tires 29x3.50-19, metal row boat, binoculars, Gust Spink, Route 50, Muskegon, Mich.

SWAP 6-TUBE TRF RECEIVER, 5 pair National coils, Jensen speaker, headphones, 2-tube receiver, key, 2-gang tuning condenser, parts, equipment, for candid camera, high-grade record player, O. F. Mypur, 211 Sixth East St., Salt Lake City, Utah.

HAVE A HAND-DRIVEN 16 MM movie projector. Cost \$15 when new. Has not been used much, like new. Want a Doerle S.W. set, T. Wesley, 51 Van Nostrand Ave., Great Neck, N.Y.

SWAP: WIRELESS PHONO-OSC. bug, tube tester, 1.500V 2 and 4 conf., 80M crystals, wanted: 3000V 2 mfl., 800 meters, 7500 KC. Secut., .005 mica 5000V., 100-100 4000V tank cond. Dawson, 1508F The Dalles, Oregon.

HAVE COMPLETE ASSORTMENT of darkroom supplies, pans, 35mm tank, trimmer, printer, etc. Want small, late model A.C. radio in good condition. Five or more tubes. Charles D. Rice, Bentonville, Ark.

HAVE PRECISION MULTIMETER 840, 20 watt phone rig and receiver 110AC or 6 volt, portable Victrola records, lots of radio parts. What have you? Charles Hoffman, BB5, Box 300B, Terre Haute, Ind.

HAVE: GUITAR, COURSES, BOOKS, sporting goods, radio, telescope, rifles, etc. Want: rifles, printing press, camera. J. James Sharpe, 415 S. 22 St., Middleshoro, Ky.

SWAP ELECTRIC 12 RECORD phonograph. Plays 50-106-25¢ cost \$275, perfect order, for 12-15 tube all band communications receiver. Prefer 6 bands, 540-81,000 KC, inclusive, F. Simonian, 1 Pleasant St., Lynn, Mass.

WANTED TYPEWRITER, PRINTING press, good duplicator, mimeograph or crystal mike. Have two public address systems, radio parts, cheap radios in exchange. Earle Harriman, 52 Bridge St., Berwick, Me.

TRADE USED PAINT SPRAYING outfit with motor, instructograph complete, new 6N7, 6J7, 6E8, 6I3, signal lamp, B63. All for good bench type band or circle saw, power and hand tools. Carl Gale, Marissa, Ill.

HAVE A NEW PACKARD LKTRON shaver. Would exchange for a small 3 or 4 tube A.C. receiver. Benigno Fernandez, Allen No. 2, San Juan, P.R.

OFFER OVER 700 STAMPS, 100 mfd. 2 gang variable condensers with trimmer and other radio parts for S.W. receiver or a meter transceiver or smitler. All letters answered. James Whitte, 24 Garden St., Meriden, Conn. N.Y.

HAVE 50 STORY, PICTURE, RADIO, aviation, outdoor, mechanics magazines, 2 new books "Seven League Boots", "Epic of America", \$1.00 fishing reel. Want 1939 Calhook, world globe. Leonard Fuerst, Orland, Calif.

WANTED:—200-800 WATT AC GENERATOR. Also 1 1/2-3 HP gasoline engine for driving same. Will pay cash or what do you want? Don Thompson, Alpha Tau Omega House, Lawrence, Kansas.

HAVE ALL-STAR SENIOR; FIVE tube G.E., two band; Gilbert hand-halter; electric trains; Want Sky Buddy \$199; Howard 430; camera 14.5 lens. Tom Cullen, 22 Simpson Ave., Wallingford, Conn.

WANTED: "AA" AND "BB" COILS 500-3600 meters "C" coils 35-90 meters for Leutz type 9-AA116 receiver—in good condition. Schoonover, Oakland, N.J.

PAY CASH OR TRADE COMET 4-tube A.C.-D.C. and Truetime 4-tube superhet. Auto radio for Howard 430 or Sky Buddy. Name your offer. All letters answered. Don Lovett, 189 Bonnie Brae N.E., Warren, Ohio.

HAVE 4 TUBE 5 AND 10 METER receiver in crackle finished cabinet. Want portable typewriter, Teleplex, test equipment. Have 2 tube 5 and 10 receiver, speakers, tubes, etc. Jerry Samkofsky, 213 S. 3rd St., D'Almy, N.Y.

HAVE A.C. AND D.C., A.C. SETS, tubes, electric Phonograph and records, technical magazines and books. What have you? M. S. Woikoff, 724 Race St., Rear 12, Phila., Pa.

WISH TO BORROW, RENT OR purchase copy of Radio Station Log printed by Cincinnati Times-Star about 1927-1929. Desire information from this log, contact by mail. Robert Jones, 1273 East Vine Street, Coshocton, Ohio.

WILL PAY CASH FOR RIDER manuals 4-5-6-7. Send best offer. B. G. Taylor, 1804 Prospect St., Racine, Wis.

WANTED: MODERN RADIO SERVICING book by Ghirardi and service manuals trade or cash. I have for trade: Majestic Generator, Superior meter, signal generator and other meters. Thomas Tadler, Box 45, Owings, W. Va.

WANT RADIO MAGAZINES. COMPLETE R.I.A. radio and television course, radio parts, for complete low power phone-xmitter, P.A. system, or s.w. receiver. Send full particulars. Ray Braun, Rt. 6, Box 21, Olympia, Wash.

SWAP ONE R-522 STERLING portable tester. Want Rider's Trouble Shooters Manuals. Henry Diaz, 622 E. Jersey St., Elizabeth, N. J.

WANT—CRYSTAL MIKE, MAGNETIC pickup, phono-oscillator, good 22 rifle, mike stand or? Have Raco A.C. 3 short wave receiver, iny electric radio developing and printing outfit. Wayne Wenger, Wellman, Iowa.

WILL SWAP A GOOD VIOLIN with case and bow or Agfa box camera (120) little used—good condition—for used Candier coil course or what have you in radio. T. Sarvana, Box 237, Ramsay, Mich.

SWAP PHILCO MAGNETIC PICKUP, G.E. model IH' Induction Phonograph motor for crystal pickup and smaller motor (any type). Both in A-1 shape. Will buy cheap record player. Ted Brown, Bedford, Penna.

WANTED—USED POCKET VOLT-ohm-ma. meter. W91T, E. Rice, Hatton, N. Dak.

WANTED NATIONAL OR HALLICRAFTERS receiver or camera. State price or trade. Wm. E. Sampson, Jr., 4801 Stuart Ave., Richmond, Va.

WHAT WOULD YOU LIKE TO trade your radio parts for? I have equipment. Have a developing drum for movie film, will hold about 175' of 16 mm film. Loboy, 3111 N. Drake Ave., Chicago, Ill.

WILL EXCHANGE ALEXANDER Hamilton Modern Business Course for radio course or what have you. E. S. Barnett, P. O. Box 616, South Boston, Va.

HAVE—TWO INTERVOX MASTERS, Hixt eleven station, Ten watt amplifier. Hundred watt modulator parts, power supply. Want Oscilloscope, manuals, etc. Frank Mills, 1911 Central West, R. 1, Great Falls, Mont.

OFFER 32 VOLT 1250 WATT DELCO plant and batteries, Kato 32 volt 150 watt 110 volt A.C. converter. Want radio, refrig, radio, refrigerator manuals. Send swap list. Gottfried Streckert, Chilton, Wis.

SWAP ABOUT 20 SAT. EVE. Postals, 30 pulp magazines, sundry novels, some Pop. Science, etc., radio parts, sets, over 1000 stamps, microscope, for car radio or most anything useful. R. Hower, Rural 3, Bloomsburg, Pa.

WANTED: TWO VARIABLE CONDENSERS about 30 mm. 2.5, 300 volt power trans. for parts or cash. Jack Heffernan, 36-15 108 St., Flushing, N. Y. W2MKY.

WANT USED CORRESPONDENCE course on learning the code. Have 110 volt loudspeaker, 10 used radio tubes, receiver type and used radio parts. Accept first good deal. Cash also paid. James Carson III, Oneida, Tenn.

HAVE TYPEWRITERS, SUFER Chipper, violins, banjo, radio parts, rifle, etc. Want Midwest, small lathe. B. Tracy, 52 So. 3rd Ave., Mount Vernon, N. Y.

RADIO PARTS and 6V GENERATORS with pulleys for trade. Want 6V, 300V Vibrapack. Will answer all letters. Hienhold Ansbach, VELAMO, Insa, Alberta, Canada.

OFFER RADIO PARTS, RADIO AND television course, skate mtr. Want mtr parts, short wave radio battery model, Edison batteries, 32 volt generator, outboard motor, bone grinder, tent, rifles. L. B. Sneden, Bluffton, Alberta, Canada.

WANTED—SMALL RECEIVER AT least 3 tubes. In good condition or what have you? Have four commercial law books, chemical supplies No. 16 battery, magnet wire. Irwin Schor, 47-12 46 St., Woodside, N. Y.

SWAP 1-CYL., 1/2 h.p. GASOLINE motor for photo enlarger. Have radio parts to trade for photographic equipment. Let's exchange lists. W. Grimm, Jr., 1709 Rosedale St., Baltimore, Md.

WANT PORTABLE RADIO, TYPEWRITER, old radio mags., record player and tube tester. Have sets, parts and tubes of all kinds. All letters answered. Write Paul E. Kirkwood, P. O. Box No. 44, Crownwell, Iowa.

WANT USED CRAWLER JUNIOR Code Course with the Simplified Technical Course. State condition, year and price. John J. Grant, 10043 Baltic Rd., Cleveland, Ohio.

TRADE: LARGE R.C.A. H10V A.C. phonograph induction motor—complete Phonograph (minus pickup head), 1/30 h.p., W.E. teletype motor, R.C.A. filter unit 5 amp, 250 V. Want: Sky Buddy, tubes, Chas. Wilkins, 110 Huntington Rd., Atlanta, Ga.

WANT 24, 33, 16MM PACK OR CUT film camera, 8mm, movie camera and projector, Ghirardi's Modern Servicing, Rider's manuals, tube tester. What do you need? W. J. Closson, 295 8th St., Troy, N. Y.

WANTED LARGE STAMP ALBUM of U.S., general and precancel stamps. Have all kinds of radio parts to trade. C. Kowalski, 1239 Kinsmoor Ave., Fort Wayne, Ind. W9KIC.

WANTED—5 METER CONVERTER for communications receiver. Have phonographic equipment to trade. Vert Mandelstamm, 738 S. Park St., Saginaw, Mich.

HAVE THORDARSON ALL-STAR, all-wave, 7 tube, superheterodyne, communications receiver, employing electrical band-spread. Tubes are 2A7; 2-58's; 56; 2-53. Want other radio equipment. Earl W. Keller, Box 213, Hughesville, Pa.

WANTED—2 1/2 and 5 mtr. receivers. Will pay cash. State condition. Also power transformers wanted. Donald D. Warnock, Converse, Indiana.

WANT ACSWS, USED TEST EQUIPMENT, crystals, binoculars, candid camera, Radio Physics course, Radio Home course. Write for list of radio parts. Anthony Pusateri, 1101 Fleming St., Corazopolis, Pa.

HAVE 6 TIRE HOME BUILT regen. set, complete with built in power supply, speaker; coils and tubes for camera with 7.5 or 4.5 lens or? Jack Klein, 1983 Bryant Ave., Bronx, N. Y.

HAVE 8" DYNAMIC SPEAKER, 20 tubes, 3 pushpull transformers, a three canned vacuum tube amplifier, 149 mfm. 5 tunable r.f. coils, am interested in s.w. receiver. Address: 1433 Windsor Pl., Jacksonville, Fla. Maurice.

WANTED—RADIO AND TRANSMITTING tubes prior to 1921 including Moorehead, Audiotron, Marconi, DeForest, Bartley, Sodiou, etc. State price and condition. R. C. Hinselmann, 1753 W. Congress, Chicago, Ill.

SWAP DEV. EQUIPMENT—DARK room lites, printing frames, trays, stirring rods, graduate, ferrotype plate, roller, thermometer, fialion developer, clearing bath, etc.; elect. phono pickup; s.w. set or radio parts. E. Ahtl, 2111 Glenwood, Minneapolis, Minn.

WANT LATE MODEL HALLICRAFTERS receiver, test equipment. Have All Star Jr. super, new RCA portable radio, new Wilcox Gay wireless record player, new tubes. Fred Morcom, 302 W. Grand Ave., Highland Park, Mich. (Continued on following page)

# BARTER and EXCHANGE FREE ADS (continued)

**OFFER FOR TRADE 1 3/5 KELSEY** printing press and outfit for used, any make, 6 or 8 tube radio, 3 band, in working order. George J. Wertel, 126 2nd St., Wymond, Pa.

**CRYSTALS, 400-6000**, power supply, 6L6, 10, 83 tubes, many smitling, receiving parts, transformers, pu speakers. Want test equipment, meters, good working condition, keys, bugs. Cash for printing press. W88BP, Blanchester, Ohio.

**HAVE 8 POWER FRENCH BINOCULARS**, Hammerlund Pro with special speaker, other items. Want an ADR National Super-Pro or similar radio or testers and all wave oscillator. C. Pollock, Chanute, Kans.

**WILL EXCHANGE ONE 8 TUBE** communications receiver and a large assortment of auto mechanic tools valued at \$200.00, for radio service equipment. Alvin Deo, 50 S. Stadium Dr., Winston-Salem, N. C.

**I WANT 1937-38 SKY BUDDY OR** FB or SW. State your lowest price, some parts, some cash. J. Stiles, 139-22 125 St., Jamaica, N. Y.

**COMPLETE LIONEL TRAIN, NO. 252** locomotive, No. 81 rheostat, Type "A" transformer, perfect condition. Want A.C.-D.C. S.W. receiver, 4 or 1 1/2 h.p. motor, "Handie" grinder, drill, Press, etc. Paul Duster, 151 Seaman St., New Brunswick, N. J.

**150 WATT PHONE AND CW** complete transmitter, all band operation. Need motorcoat. H. G. Gwinn, Anderson, Indiana.

**SWAP 616 KODAK SPECIAL P.17** in Compur-rapid, range finder, Jewell 199 tube tester and analyzer. Packard Lektro-slaver, lots of radio magazines for Kodak Bantam Special or any fine miniature. Leslie Bureman, Buckner, Missouri.

**HAVE WESTON MODEL 201, 50-650** ohmmeter, Mazda 300 watt projection bulb. Want 150 volt D.C. meter or key, or what have you. Francis Bildlerack, Durand, Wis.

**WANTED: COMPLETE SKY BUDDY** in good operating condition. State price, model, condition, etc. Have some radio parts and stamps. Will also pay cash. J. S. Shino, 300 Main St., Vancouver, B. C., Canada.

**TRADE RACK AND PANEL HIGH** fidelity theatre 20 watt amplifier with meters and switches, furnishes voltage for 2 sound heads, for portable record player and high fidelity velocity or crystal mike. John Arnold, Bluffs, Ill.

**HAVE SKY BUDDY FOR SWAP.** Will pay cash for used communications rev. Sam Eaton, 7712 Jennette St., New Orleans, La.

**243 P.A. SYSTEM, CRYSTAL, 2** holders, 3 pwr. transformers, 2 6L6, 8-101 audio coupler. Want motorcycle, bug, gas engine or C. Steidtmann, Jr., 1421 Hillary, New Orleans, La.

**SWAP - PORTABLE UNDERWOOD** typewriter, very good condition, for Rider's Manual, etc. Have some offers. Eugene Sontos, 33 Hinchman Ave., Dover, N. J.

**WANT RIDERS MANUALS 1 TO 5**, new or used tubes, parts, Tungar 6 amp. bulb, reply all. Send descriptions and prices or wants to Robert H. Fleming, 722 N. James, Rome, N. Y.

**SWAP ALL KINDS METERS,** parts, milks, tubes, 5 meter low power CW rig 20 W-100 meter CW rig, 25 watt phone rig, used test equipment for what have you. Stanley Bartleman, Box 271, Grottinger, Iowa.

**TRADE 6L6 XMTR 25 WATTS OUT-**put, built-in pwr supply complete with 6L6 and rect., coil and forty n xtal for used Sky Buddy or similar rev. E. Schultz, 45-12 Bourne St., Flushing, N. Y.

**WANTED: GOOD SW AC-DC** receiver. Offer 1 tube battery set, 8 H, Couch mike, radio parts, tubes, high freq. buzzers, Amplion loud speaker cost \$65.00 when new. Thornton Lyford, 260 Woodlawn Ave., Hubbard Woods, Ill.

**WANTED: MINIATURE CAMERA,** camera accessories, plate camera. Have 5x7 plate camera, violin, radio parts and tubes. Send your list for mine. W80CP, Wayne Store, Beecher, Ill.

**SWAP-AI SUPER WAMP '47** final, Peerless BCL radio, 2-300V power supplies, 2-71 DeForest aud. tubes, French binoculars, camera. Want Howard, Hallcrafters, receivers, or Wallace Balla, 251 Flax Hill Road, South Norwalk, Conn.

**HAVE COMPUTING SCALES, PLAT-**form scales, radio parts, tubes. Want Supreme 551 analyzer, Nat. SW3, Sky Rider. Swap list for yours. W. S. Cronks, Box 13, Stow, Ohio.

**UNDERWOOD PORTABLE TYPE-**writer to trade radio equipment also interested in recorders. C. W. Philpot, 315 W. Main St., Laurens, S. C.

**HAVE RACER TUBE SKATES SIZE** 12 good used, hockey tubes size 6 new, telescope, 1000s of good stamps, covers, radio parts, Dayrad set tester. Want PA equipment, meters, trade stamps. Hasco, Roseburg, Oregon.

**HAVE TWO 1918 NAVY XTAL AND** one 1928 Coast Guard receiver, old Western Electric amplifier. Send for list of new equipment, meters, radio books and magazines. C. I. Vander Meer, 298 South Greene, Spokane, Wash.

**I HAVE 8" MAGNETIC, 8" DYNAMIC** speakers, condensers, audio transformer, choke, resistors, some cash. Want 6.3v transformer. Universal Model-AV mike, HY113 tube, phono deck-out. Daniel Platek, 225 Division Ave., Brooklyn, N. Y.

**HAVE DE LUXE BIRMINGHAM RAZOR** (new), Schick Elec. razor, perfect RCA phono-radio, record player, K11 art flash gun to fit Argus C. Trade for film pack camera, miniature, enlarger. Wayne Guest, 221 Central Park, Houston, Tex.

**SWAP: RME 510N CONVERTER,** 2-50 MC., 70 MC. for RME 1B20 or 200 Triplam. Quigley, 102 Ave. S., Brooklyn, N. Y.

**WANTED 50 TO 100 WATT GUTPI** transmitter factory built for 2118 and 2738 KC 110 volt AC supply or Marine transmitter. Dr. Young, WPGY, Minneapolis.

**WANTED - HALSTON RADIO CODE** Course, also Radio Physics Course by Alfred A. Ghirardi. What do you need. Edwin Davenport, Pittsford, N. Y.

**HAVE VISITING PHOTO, ELEC.** tube coil, 2-82, 1-81, 1F4, 1-19, 1-30, 1-1H6G, 1-1C7G, 1-12A7, 1-2A7, 1-58, 1-26, Hammarlund 10M, coil 2 windlug, 3 tube S.W. DC receiver. Robert C. Dole, 10 Clinton Ave., Rutland, Vt.

**SWAP ASSORTMENT NEW AND** slightly used RCA metal and glass tubes, Pilot Super Wamp rev., DC 2 tube tubes, motor cycle speedometer, 100V transformer C.T., used 2 V.A. battery, B eliminator for? Walter Blumer, Jefferson, Wis.

**WANTED STANDARD PORTABLE** typewriter A-1 condition for commercial 24-watt booster amplifier, black cane cover, uses 2-6B5's, 83. Requires +15 DB at 500 ohms input. Request for 2 speakers, 1 minimal set for 2-8-15-500 ohms output. J. F. Prestia, c/o Fourth Ave. Sta., Pittsburgh, Pa.

**WANTED: SKY BUDDY IN GOOD** condition. Have 1938 Roadmaster bicycle in A-1 shape with horn and generator light. Also have a Stewart Warner converter, 19-300 meters, Wills Allen, Jr., 121 Lakefront Ave., East Cleveland, Ohio.

**WILL TRADE 150 VOLT GENER-**ator for four tube A.C. short wave receiver or small transmitter, state condition. W. T. McNeil, R.R. Box 16, 4718b, Texas.

**DISMANTLING SERVICE BENEFIT.** Swap Clough Brendle signal generator model 93. Excellent test instrument for retinalizing or experimenting. Utilizes alternating current. Want candid camera, portable typewriter, manuals, or Irving Goldstone, 352 Alabama Avenue, Brooklyn, N. Y.

**WANTED RIDERS MANUALS AND** other radio books, a so interested in any other radio merchandise, meters, etc. Will pay cash or trade. Give full information and price. L. Mueller, 314 East Market St., Aberdeen, Wash.

**HAVE 9 TUBE TRANSCEIVER, 2 1/2** to 4000 meters, transmits 2 1/2 and 5 meters, complete. French telephone. Majestic 7 tube auto radio, speaker and steering post control. What have you? John J. Snyder, 71 Oswood Ave., Stapleton, S. I., N. Y.

**HAVE ONE SIGNAL GENERATOR,** 1 Rider Manual Servicing Superbers 1 Stewart Warner converter, all good condition. Want good short wave receiver 110 volts, 60 cycle. All mail ans. Gordon Temple, 12 Cross St., Westboro, Mass.

**WANTED: RIDER MANUALS** State condition and give price. Emerick J. Sepic, 2510 Harrison Ave., Eureka, Calif.

**WANT HAND OR POWER WOOD** or metal working tools, C clarinet, accordion, 18 inch bike. Have any size power supply or modulator or transformer for same. W9TDD-W19Z, 615 East State Blvd., Ft. Wayne, Indiana.

**HAVE INTHTOGRAPH SR., 10** American Morse code tape, an oscillator. Trade for a bug key. A. H. McKenzie, Wisner, Nehr.

**RADIO SERVICE MEN AND EX-**perimenters. Swap: 8-Journal of the Institute of Radio Service Men: 24-Battery Man: 2 vol. R.T.I. Correspondence Course Noel E. Kurtz, SWL-9, Xenia, Ill.

**TRADE - TRIMM FEATHERWEIGHT** phones like new. Want snare drum, F. Vieweger, 1411 S. 17th St., Manitowoc, Wis.

**HAVE ONE AND TWO TUBE RA-**dio, treasure finder dials, etc. Want old U.S. stamps and coins, Indian relics. John Hayes, Doe Run, Missouri.

**RADIO PARTS, RIFLES, 10,000** varieties obsolete stamps, old money and coins for your duplicates. S. P. Hughes, Auburn, Nebr.

**HAVE 1/2 DYNAMIC SPEAKER** for 245 will output transformer complete in cabinet, new 6A6, HY60, and 100 grided modulator classis. Want 100 ma. per section medium power split-stator cond. Rudy J. Tichy, 2009 Tate Ave., Cleveland, Ohio.

**HAVE JOWETT PHYSICAL** course, Short Wave Craft and Popular Science magazines, 250V factory built power supply, scout equipment and radio parts. What have you? H. Patches, 25 Grand St., Sidney, N. Y.

**SWAP PHOTOGRAPHIC EQUIP-**ment, radio parts for power supply or "B" eliminator. Write for my list and send description of your power supply. All inquiries answered. Rex W. Detrick, Box 65, Clarksfork, Idaho.

**HAVE 1939 KC X-CUT XTAL AND** 250 ma. medium power transmitting Cardwell condenser. Want forty meter coil in 83M form or what do you want? AT cut preferred, also crystal pickup. Julius Mosonics, Jr., 7715 Newport Ave., Parma, Ohio.

**WANTED: ANY "O" GAUGE** track, trains, switches, cross-overs, transformers, etc. Have unused 3c stamps (48.00) radio parts, tubes, meters, used 83M film or what do you want? Dickson Wiltman, 41 Peters Place, Red Bank, N. J.

## SWL EXCHANGE

UNITED STATES

MIGUEL ANGELO, WH124, 318 East 70 St., New York City.

JOHN ANTONIO, Box 32, Elkland, Penna.

JAMES ARP, 421 Mulberry St., Williamsport, Pa.

LEONARD N. BARRETT, 1701 Barnard Avenue, Waco, Texas.

CHAS. E. BANA, 2673 N. Halsted St., Chicago, Ill.

MILTON BENSON, 1 No. Main St., No. Hadley Falls, Mass.

PHILIP BRADY, Box 67, McComb, Miss.

F. E. CAMPBELL, JR., 405 E. 4th St., Berwick, Pa.

DONALD CHISHOLM, 18 Mountain Ave., Wakefield, Mass.

FRANK DIRASAL, JR., 301 N. Castle St., Baltimore, Md.

JOHN PETER GAWEL, 96 Jewett Park, Parkersburg, W. Va.

DAVID GUTHRIE, South Hill, Virginia.

HENRY F. HECKERT, 910 Coolbaugh Street, Red Oak, Iowa.

DAVID HERBERT, JR., Box 709, Lancaster, Pa.

LARRY HILKOWITZ, 31 Post Ave., New York City.

BOB JOHNSON, P. O. Box 146, Logan, W. Va.

GORDON C. JOHNSON, 2908 E. 6th St., Superior, Wis.

LLOYD KATNEY, Fayette, Ohio.

BOB LARSON, 618 North June Street, Hollywood, Calif.

JOHN LONG, 9406 Georgia Ave., Silver Spring, Md.

VEIT MANDELSTAMM, 738 S. Park St., Saginaw, Mich.

MERT MEADE, 819 W. Jadotte St., Kansas City, Mo.

JOHN T. MEHAN, 242 Governors Ave., Medford, Mass.

themselves to the optical effects previously mentioned and that reflection of the wave from buildings and natural elevations will take place. The antenna should be placed in an open space and as high as possible. The static disturbances that are so annoying on lower frequencies are negligible on the ultra short waves, but serious interference from motors and ignition systems may occur in the region between 5 and 10 meters. If the aerial is sufficiently high above the ground, this noise level will be reduced.

As we continue to increase the frequency of our radio waves, we get into the field of the ultra-ultra short waves or the *micro-wave*. This field at present consists of waves from about 1 meter down to about 20 centimeters in length. The usual method of securing oscillations on the lower frequencies is not applicable. Since with present circuits it is extremely difficult to get anything approximating stability of frequency, we find that micro-wave receivers must tune broadly. The broad tuning of the super-regenerative circuit makes it particularly useful on these wavelengths. Micro-waves definitely show the approach to light waves, since the wavelengths are short enough to permit the use of solid reflectors.

## Short Waves Above the Clouds

(Continued from page 394)

pedition. Life at the Observatory is good training for expedition work and one of our observers, Dave Arenberg, has just left for the Antarctic by Byrd.

### 1 Meter Tests

Our one meter tests began about a year ago and were carried on by the Observatory staff, officers, and associates. A compact and stable transmitter of special design recently developed to use the "door knob" tube, or Western Electric 316-A, was carried on skis to the mountain and listening tests were made at Exeter and Brentwood, New Hampshire, at distances of *slightly over ninety miles*. The transmitter and antenna were placed outside the Observatory on a frost covered wooden trestle in order to avoid possible obstruction to the signal by the building. The Brentwood listening point is in optical *line-of-sight* to the mountain but the Exeter position is slightly below the horizon. The signal was first received faintly at the writer's amateur station in Brentwood, and a few days later was heard at Exeter.

Reception of the signals was with super-regenerative receivers using simple half-wave antennas, employing single-wire fed transmission lines. Acorn tubes should be checked carefully before use at such high frequencies because those still giving fair results on such a "low" frequency as 60 megacycles, may be in poor condition for use at 225 megacycles. Tone modulated transmissions were used for listening tests and observation of signal changes. Voice was used successfully for communication. Later, during our tests, converters on the superheterodyne principle were developed which gave results comparable to those secured with the other type of receivers. The stability of transmissions on these frequencies is not yet sufficient to justify the use of the most selective receivers.

A number of characteristics of signals on these frequencies were observed as a result of our experiments. Marked interference patterns are set up on these frequencies with the result that *moving the transmitting or receiving antennas over a foot or two changes signal strength greatly*.

### CANADA

CHARLES TAYLOR, 4 Water St., St. Catharines, Ont.

### ENGLAND

ERNEST J. LOGAN, BSWL-2, 4 Fanshawe St., Bengeo, Hertford.

Physical obstructions to the signal appear more harmful than on the lower frequencies and it was observed that, when the antenna was indoors, the signal was weaker than when it was in the open. A simple two-element directive antenna was used at the transmitter and, due to the small size of directive antennas at these frequencies, there will no doubt be great progress in improving signals by this means. Under normal conditions, the signal at the writer's station was strong enough to give about thirty percent suppression of superregenerative noise by the distant carrier. Fading characteristics of these frequencies appear rather similar to those on other ultra-high frequencies and are probably the result of changes in atmospheric refraction. Several distinct types of change in signal strength have been noted, the difference being largely in the time element involved. There are marked changes in signal strength over the longer periods from hour to hour and from day to day. At one period a relatively good signal may be received while in a few hours the signal may be barely audible. Whether there is a definite diurnal change is not yet established. Over short periods the signal is characterized at times by a rising and falling from minute to minute. Relatively large changes in amplitude may take place in a few minutes. Still another type of fading has a very short period of a second or so and here again there may be relatively great changes in amplitude.

These interesting changes in signal strength indicate that there is a wide field for study of the propagation characteristics of these high frequencies. The long range of transmission secured suggests that with proper design of equipment, especially antennas, these frequencies may be used to signal over substantial distances. Amateurs and experimenters should look upon this as a fruitful field in which to delve as there is still little known of the practical use of frequencies above two hundred megacycles (1.5 meters.)

## November, 1939 RADIO-CRAFT

Converting a 5-inch Telly Kit for Receiving a 9-inch Image—Part I

How to Add 1 to 14 Modern Features to the All-Push-Pull Direct-Coupled 30-Watt Amplifier

How to Build a "Junkbox" Electric Guitar A Combination DX Directional Receiving Aerial

"Fade-Ometer"—A New Instrument for Servicemen

Making Milliammeter Multipliers

**New Catalog by Allied Radio**

• THE new Allied Radio catalog is one of the handiest this company has ever produced. It contains 200 pages packed full of items that the Ham and experimenter will find very useful. A large section in the front of the book is devoted to Knight radio receivers, after which are tubes, test instruments, public address systems, phono apparatus, antennas, speakers, etc. Large sections are likewise devoted to volume controls, resistors and fixed condensers, Ham apparatus, too, comes in for its share of attention. The usual small parts, tools and set components, are also included, and at the back of the book is a bargain section giving some excellent values in apparatus that every one can use.

## RADIO'S MOST COMPLETE LOW-PRICED TECHNICAL LIBRARY EACH VOLUME ONLY 50c



THE RADIO-CRAFT LIBRARY SERIES (each volume fifty cents)—a most complete and authentic set of Volumes—treats individually, important divisions of radio, refrigeration and air conditioning. Each book has been designed to give you the opportunity to learn one or more branches of the fields mentioned. The authors of the books are well-known to everyone. Each is an expert—an authority on the subject—each is thoroughly familiar with the field which he represents.

ALL BOOKS ARE UNIFORM—The volumes in the RADIO-CRAFT LIBRARY SERIES measure 6 x 9 inches. Each book contains on an average of 50 to 120 illustrations. The books are printed on an excellent grade of paper which makes the type easy reading.

### Here Are the Titles - - -

- |  |  |   |
|--|--|---|
| No. 2. MODERN VACUUM TUBES               | No. 16. PRACTICAL RADIO CIRCUITS             | No. 20. THE CATHODE-RAY OSCILLOSCOPE    |
| No. 4. BRINGING ELECTRIC SETS UP-TO-DATE | No. 17. SERVICING WITH SET ANALYZERS         | No. 21. BREAKING INTO RADIO SERVICING   |
| No. 13. ABC OF AIR CONDITIONING          | No. 18. POINT-TO-POINT RESISTANCE ANALYSIS   | No. 22. NEW RADIO QUESTIONS AND ANSWERS |
| No. 14. POCKET RADIO GUIDE               | No. 19. PRACTICAL RADIO KINKS AND SHORT CUTS | <b>NEW</b>                              |
| No. 15. ABC OF REFRIGERATION             |  | No. 23. PRACTICAL PUBLIC ADDRESS        |

### RADIO PUBLICATIONS • R&T 11-39 • 99T Hudson Street, • New York, N. Y.

I have circled below the numbers of books in the RADIO-CRAFT LIBRARY SERIES which you are to send me. I have included my remittance in full, at the price of 50c each. (Stamps, checks or money orders accepted).

2   6   13   14   15   16   17   18   19   20   21   22   23

Name ..... Address .....

City ..... State .....

All books are sent postage prepaid

# SPECIAL OFFER

## 6 COPIES R & T FOR 50c

For a limited time only, and as long as they last, we will send you six back numbers of RADIO & TELEVISION assorted, your choice, for 50 cents.

The usual price for six copies would be \$1.50, and most publishers charge a higher price for back numbers over one year old.

We can supply *only* the following back numbers: Dec., 1930; Feb., April, June, Sept., Oct., 1931; July, Oct., 1932; Jan., April, Oct., Nov., 1933; Jan., Feb., Mar., May, June, July, Aug., Sept., 1934; 1935—All issues except January, February and March; 1936, 1937, 1938—all issues; 1939—all issues to date.

If you do not specify copies, we will send assorted numbers to fill your order. Note, we cannot exchange the copies for ones that have been sent to you.

Every copy of RADIO & TELEVISION contains information which you should have. Here is a chance to get those copies.

As only a small supply of back numbers on hand, this offer will be withdrawn as soon as they have been sold.

We accept U. S. stamps, U. S. coin, or money order. Rush your order today.

### RADIO & TELEVISION 11-39

99-101 Hudson Street, New York, N. Y.

Gentlemen: I enclose herewith 50c, for which you are to send me six back number copies of RADIO & TELEVISION as follows:

.....

Name .....

Address .....

City ..... State .....

**James Millen Mfg. Co.**

• JAMES MILLEN MANUFACTURING CO., INC., has just issued a new 1939-40 catalog, and a handsome job it is. Not only does it show many of the standard parts used by most Hams and SWL's, but it also includes pictures and descriptions of many parts not heretofore obtainable. Some of the lesser known items are: Geared transmitting condensers, universal joint remote couplings, special neutralizing condensers, antenna kites, "pre-wired" foundation units, etc. The catalog contains 12 pages crammed full of information.

## World S-W Stations

(Continued from page 412)

Mc.	Call	Location	Mc.	Call	Location
6.420	HIIS	SANTIAGO, D. R., 46.73 m., 5.40-7.35 pm. Ex. Surs.	6.335	OAXIA	ICA, PERU, 47.33 m. Addr. La Voz de Chiclayo, Casilla No. 9. 8-1 pm.
6.400	TGQA	QUEZALTENANGO, GUATEMALA, 46.88 m., Mon.-Fri. 9-11 pm. Sat. 10 pm.-1 am. Sun. 1-3 pm.	6.324	COCW	HAVANA, CUBA, 47.4 m., Addr. La Voz del Radio Philco, P. O. Box 130, 6.55 am.-12 m. Sun. 9.55 am.-10 pm.
6.388	HI9B	SANTIAGO, D. R., 46.95 m., Mon. 6-6.45, 8-8.45 pm.	6.310	HIZ	CIUDAD TRUJILLO, D. R., 47.52 m. Daily except Sat. and Sun. 11-10 am.-2.25 pm., 5.10-8.40 pm. Sat. 5.10-11.10 pm. Sun. 11.40 am.-1.40 pm.
6.384	ZIZ	BASSETTERRE, ST. KITTS, W. INDIES, 46.99 m. 4.4.45 pm., Wed. 7-7.30 pm.	6.295	OAX4G	LIMA, PERU, 47.63 m., Addr. Apartado 1242. Daily 7-10.30 pm.
6.357	HRPI	SAN PEDRO SULA, HONDURAS, 47.20 m., 6-7.30 am., 2-4 pm. & Irreg. to 10 pm.	6.280	HIIG	TRUJILLO CITY, D. R., 47.77 m. 7.10-9.40 am., 11.40 am.-2.10 pm., 3.40-9.40 pm.
6.340	HIIX	CIUDAD TRUJILLO, D. R., 47.32 m., Sun. 7.40-10.40 am., daily 12.10-1.10 pm., Tues. and Fri. 8.10-10.10 pm.			

(Continued on following page)

# FREE CATALOGS and INFORMATION

By carefully reading the advertising columns, you will find many offers to furnish literature containing valuable technical information that will help you in your work. Use this list freely.

Firm	Business	Offer	No.	Cost	Adv. Page
Allied Engineering Institute	Set & Kit Mfr.	Circulars		Free	422
Allied Radio Corp.	Mail Order	1940 204-page Catalog		Free	415
American Microphone Co.	Parts Mfr.	Technical Bulletin	33	Free	437
American Radio Institute	Radio School	Booklet		Free	434
Amperite Co.	Parts Mfr.	Chart	AR	Free	435
Audel, Theo., & Co.	Book Publisher	Information		Free	432
Bliley Electric Co.	Parts Mfr.	Engineering Bulletin	E-6	10c	435
		Circular	A-6	Free	
		Bulletin	E-7	Free	
		Circular	A-7	Free	
		Bulletin		Free	419
Browning Labs., Inc.	Kit & Parts Mfr.	Catalog	RT-119	Free	419
Bud Radio, Inc.	Parts Mfr.	Catalog	56	Free	437
Burstein-Applebee Co.	Mail Order	1940 Catalog		Free	439
Cameradio Co.	Mail Order	1939 Catalog		Free	434
Candler System Co.	Code Course	Book of Facts		Free	439
Cannon, C. F., Co.	Parts Mfr.	Folder	T-11	Free	433
Capitol Radio Eng. Inst.	Radio School	48-page Booklet		Free	429
Consolidated Wire & As. Co.	Parts Mfr.	Information		Free	435
Cornell-Dubilier Elec. Corp.	Parts Mfr.	Catalog	175A	Free	387
Coyne Electrical School	Trade School	Electrical Catalog		Free	432
		Radio Catalog		Free	424
Dodge's Institute	Radio School	Catalog		Free	428
Eilen Radio Labs.	Set & Kit Mfr.	Circular		Free	428
Goldentone Radio Corp.	Set Mfr.	1940 Bargain Catalog		Free	419
Guthman, Edwin I., & Co.	Set & Parts Mfr.	Catalog		Free	431
Hammarlund Mfg. Co.	Set & Parts Mfr.	"Super-Pro" Folder		Free	426
Harrison Radio Co.	Mail Order	Information		Free	437
Henry Radio Shop	Mail Order	Information		Free	432
Insuline Corp. of America	Parts Mfr.	New Catalog		Free	448
Instructograph Company	Code Machine	Information		Free	423
International Corres. Schools	Corres. School	Booklet		Free	426
International Resistance Co.	Parts Mfr.	Literature		Free	434
J.F.D. Manufacturing Co.	Parts Mfr.	Information		Free	431
Mass. Radio School	Radio School	60-page Catalog		Free	434
Midwest Radio Corp.	Set Mfr.	1940 Catalog		Free	431
Millen, J., Mfg. Co., Inc.	Parts Mfr.	1939-40 Catalog		Free	I.F.C.
National Company, Inc.	Set & Parts Mfr.	Catalog	300L	Free	I.B.C.
National Radio Institute	Radio School	64-page Book		Free	385
National Schools	Radio School	Literature		Free	433
New York Y.M.C.A. Schools	Trade School	Booklet		Free	434
Olson Mfg. Co.	Set Mfr.	Bulletin	RT-11	Free	428
Oxford-Tartak Radio Corp.	Parts Mfr.	Information		Free	441
Radio & Technical Publ. Co.	Radio Textbooks	Circulars on each Book		Free	417
Radio Corp. of America	Radio & Telev'n	Literature		Free	B.C.
Radio Train. Assn. of Amer.	Radio School	Book		Free	434
Radio Wire Television Inc.	Mail Order	1940 Radio Catalog	78	Free	421
Radolek Co., The	Mail Order	1940 Radio Profit Guide		Free	447
RCA Institutes, Inc.	Radio School	Catalog		Free	434
Rosierucians, The	Fraternal Society	Book		Free	426
Sigmon Radio Supply	Set Mfr., Dealer	1939-1940 Catalog		Free	448
Solar Mfg. Corp.	Parts Mfr.	General Parts Catalog	9S	Free	426
		Transmitting Catalog	2X	Free	
		Condenser Testers Cat.	CBCC-1	Free	
Sprague Products Co.	Parts Mfr.	Condenser Catalog		Free	437
Sprayberry Acad. of Radio	Radio School	52-page Book		Free	425
Supreme Publications	Publisher	Information		Free	427, 432
Telex Co.	Code Machine	Folder	S-11	Free	433
Thordarson Elec. Mfg. Co.	Parts Mfr.	Catalog	400-D	Free	429
Triplett Electrical Inst. Co.	Parts Mfr.	Catalog		Free	439
Turner Co., The	Parts Mfr.	Information		Free	441
Universal Microphone Co.,	Parts Mfr.	Information		Free	439
Vibroplex Co., Inc., The	Code Machine	Information		Free	431
Ward, Montgomery & Co.	Mail Order	Radio Equip. Catalog		Free	427

## World S-W Stations

(Continued from preceding page)

Mc.	Call	Station
6.243	HIIN	CIUDAD TRUJILLO, D. R., 48 m., Addr. "La Voz del Partido Dom- inicano," 12 n.-2 pm., 6-10 pm.
6.296	HRD	LA CEIBA, HONDURAS, 48.12 m., Addr. "La Voz de Atlantida," 8-11 pm.; Sat. 8 pm.-1 am.; Sun. 4-6 pm.
6.210	---	SAIGON, INDO-CHINA, 48.28 m., Addr. Radio Boy-Landry, 17 Place A. Forey, 4.30 or 5.30-9.15 am. 11.45 pm.-1 am.
6.200	H18Q	CIUDAD TRUJILLO, D. R., 48.36 m. Irregular.
6.190	JLK	TOKYO, JAPAN, 48.47 m. 8-9.30 am.
6.190	HVJ	VATICAN CITY, 48.47 m., Mon., Wed., Thur., Sat. 2-3.30 pm., Tues., Fri. 2-3 pm. Thur. also 3-3.30 pm.
6.190	T02	GUATEMALA CITY, GUAT., 48.47 m., Addr. Dir. Genl. of Electr. Commun. Relays TGI Mon.-Fri. 6-11 pm., Sat. 6 pm.-3 am. Sun. 7-11 am., 3-8 pm.
6.185	H11A	SANTIAGO, D. R., 48.5 m., Addr. P. O. Box 423. 7 am.-5 pm.

## 49 Met. Broadcast Band

6.170	WC8X	NEW YORK CITY, 48.59 m., Addr. Col. B'cast System, 485 Madison Ave., 12 m.-2 am.
6.163	H15N	MOCA CITY, D. R., 48.75 m. 6.40- 9.10 pm.
6.150	HJDE	MEDELLIN, COLOMBIA, 48.78 m., 9.30 am.-1 pm., 5-11.30 pm.
6.180	CJRO	WINNIPEG, MAN., CANADA, 48.78 m., Addr. (See 11.720 mc.) Daily 6 pm.-12 m., Sun. 5-10 pm.
6.180	ZP14	VILLARRICA, PARAGUAY, 48.78 m. 4-6 pm.
6.148	ZTD	DURBAN, SOUTH AFRICA, 48.8 m. Addr. (see ZRO, 9.753 mc.) From Nov. 1: Daily 11.20-3.45 pm., Sat. till 4 pm., Sun. till 3.20 pm. Until Nov. 1: Daily ex. Sat. 11.45 pm.-12.50 am. Daily ex. Sun. 5.30-7, 9-11.15 am.
6.147	Z88	BULAWAYO, RHODESIA, S. AFRICA, 48.8 m. Mon., Wed., and Fri. 1.15-3.15 pm.; Tues. 11 am.-12 n.; Thurs. 10 am.-12 n. Sun. 3.30-5 am.
6.140	WPIT	PITTSBURGH, PA., 48.83 m., Addr. Westinghouse Electric & Mfg. Co. Relays KDKA 10 pm.-12 m.
6.140	OQ2AA	LEOPOLDVILLE, BELGIAN CON- GO, 48.83 m. Sun. 5.35-7 am.
6.140	SP48*	WARSAW, POLAND, 48.83 m., 3- 5.30 pm.
6.137	CR7AA	LAURENCO MARQUES, PORT. E. AFRICA, 48.87 m. Daily 12.05-1, 4.30-6.30, 9.30-11 am., 12.05-4 pm., Sun. 5-7 am., 10 am.-2 pm.
6.130	VP8B	GEORGETOWN, BRIT. GUIANA, 48.94 m. 9-10 am., 2.15-6.30 pm., Sun. 5.30-11.30 am., 3-5 pm.
6.130	T18M	SAN JOSE, COSTA RICA, 48.94 m. "El Mundo", Apartado 1049. 11 am.-11 pm., Sun. 10 am.-6 pm.
6.130	CHNX	HALIFAX, N. S., CAN., 48.94 m., Addr. P. O. Box 998. 7 am.-11.15 pm. Sat. 8 am.-11.30 pm. Sun., Noon-11.15 pm. Relays CHNS,
6.130	HS4PJ	BANGKOK, SIAM, 48.94 m. Daily Ex. Mon. 8-10 am.
6.130	LKJ2	JELOY, NORWAY, 48.94 m. Noon- 6 pm.
6.126	CX44	MONTEVIDEO, URUGUAY, 48.98 m., Addr. Radio Electrico de Montevideo, Mercedes 823. 8 am.-Noon. 2-10 pm.
6.122	HP8M	PANAMA CITY, PAN., 49 m., Addr. Box 1045. 10 am.-1 pm., 5-11 pm.
6.122	FK8AA	NOUMEA, NEW CALEDONIA, 49.00 m., Radio Noumea, Addr. Charles Gavaeu, 44 Rue de l'Al- ma., Wed. & Sats. 2.30-3.30 am.
6.120	WC8X	NEW YORK CITY, 49.01 m., Addr. See 6.170 mc., 12 m.-1 am. in October and December.
6.117	XBUZ	MEXICO CITY, MEX., 49.03 m., Addr. 5 de Mayo 21. Relays XEFO 9 am.-1 pm., 7 pm.-2 am.
6.116	---	SAIGON, FR. INDO-CHINA, 49.05 m., 6 or 7 to 9.30 am., 11-11.30 pm.
6.115	OLR3G	PRAGUE, BOHEMIA, 49.05 m. (See 11.40 mc.)

Mc. Call  
**6.110 XEGW** MEXICO CITY, MEX., 49.1 m.,  
 Addr. La Voz de Aguila Azteca  
 desde Mex., Apartado 8403. Re-  
 lays XEJW 11 pm.-1 am.

**6.105 HJAB** MANIZALES, COL., 49.14 m., Addr.  
 P. O. Box 175. Dly. 5:30-10 pm.  
 Sat. to 11 pm. Sun. 2:30-5 pm.

**6.100 YUA** BELGRADE, JUGOSLAVIA, 49.18  
 m. 1-3, 6:30-8:30 am., Noon-6:30  
 pm.

**6.100 W9XF** CHICAGO, ILL., 49.18 m., 4-6:50  
 pm. (Sat. to 5:30 pm.) 1-2 am.

**6.100 WNBI** BOUND BROOK, N. J., 49.18 m.,  
 Addr. Natl. Broad. Co. 9 pm.-  
 12 m.

**6.097 ZRK** KLIPHEUVEL, S. AFRICA, 49.2 m.,  
 Addr. S. African Broad. Co.,  
 Johannesburg. Daily 12 n.-4 pm.,  
 Sun. 12 n.-3:20 pm.

**6.097 ZRJ** JOHANNESBURG, S. AFRICA, 49.2  
 m. Addr. S. African Broad. Co.  
 Daily exc. Sat. 11:45 pm.-12:50  
 am.; Daily exc. Sun. 3:15-7,  
 9-11:30 am. (Sat. 8:30-11:30 am.)  
 Sun. 3:30-4:30 or 4-5 am., 5:30-7,  
 8:40-11:30 am.

**6.095 JZH** TOKYO, JAPAN, 49.22 m., Addr.  
 (See 11,800 mc., JZJ.) Irregular.

**6.090 ZNS** NASSAU, BAHAMAS, 49.26 m.,  
 Addr. Dir. of Tel. East St.,  
 Nassau. 1:30-2, 8-9 pm.

**6.090 CRCX** TORONTO, CAN., 49.26 m., Addr.  
 Can. Broadcasting Corp. Daily  
 6:45 am.-4 pm., Sun. 9:30 am.-  
 11 pm.

**6.090 ZBW2** HONGKONG, CHINA, 49.26 m.,  
 Addr. P. O. Box 200. Irregular.

**6.090 ZHJ** PENANG, FED. MALAY STATES,  
 49.26 m., 6:40-8:40 am., except  
 Sun., also Sat. 11 pm.-1 am.

**6.083 VQ7LO** NAIROBI, KENYA, AFRICA, 49.31  
 m., Addr. Cable and Wireless,  
 Ltd. Mon., Fri. 5:30-6 am., 11:15  
 am.-2:15 pm., also Tues. and  
 Thurs. 8:15-9:15 am.; Sat. 11:15  
 am.-3:15 pm.; Sun. 10:45 am.-  
 1:45 pm.

**6.080 WCB1** CHICAGO, ILL., 49.34 m., Addr.  
 Chicago Fed. of Labor. Relays  
 WCFL irregular.

**6.080 CRY9** MACAO, MACAO, 49.34 m., Tues.  
 8:30-10 am.

**6.080 HP5F** COLON, PAN., 49.34 m., Addr.  
 Carlton Hotel. 7-9 pm.

**6.079 DJM** BERLIN, GERMANY, 49.34 m.,  
 Addr., Broadcasting House. Ir-  
 regular.

**6.077 OAX4Z** LIMA, PERU, 49.35 m. Radio Na-  
 tional 7 pm.-1:30 am. Except  
 Sun.

**6.075 VP3MR** GEORGETOWN, BRI. GUIANA,  
 49.35 m. Sun. 7:45-10:15 am.;  
 Daily 4:45-8:45 pm.

**6.070 CFRX** TORONTO, CAN., 49.42 m. Relays  
 CFRB 6:30 am.-11 pm., Sun. 9 am.-  
 11 pm.

**6.070 VE9CS** VANCOUVER, B. C., CAN., 49.42  
 m. Sun. 1:45-9 pm., 10:30 pm.-  
 1 am.; Tues. 6:30 pm., 11:30  
 pm.-1:30 am. Daily 6-7:30 pm.

**6.069 —** TANANARIVE, MADAGASCAR,  
 49.42 m., Addr. (See 9.51 mc.)  
 12:30-12:45, 3:30-4:30, 10-11 am.,  
 Sun. 2:30-4:30 am.

**6.065 SBO** MOTALA, SWEDEN, 49.46 m. Re-  
 lays Stockholm 4:15-5 pm.

**6.060 —** TANANARIVE, MADAGASCAR,  
 49.5 m., 12:30-12:45, 3:30-4:30, 10-  
 11 am.

**6.060 YDD** BANDOENG, JAVA, 49.5 m., 5:30  
 am. on.

**6.060 WLWO** CINCINNATI, OHIO, 49.5 m.,  
 Addr. Crosley Radio Corp. Re-  
 lays WLW Sun. 7 am.-6:30 pm.,  
 Mon., Tues., Thur. 5:45-11 pm.,  
 Sat. to 10 pm. Other days to 10:30  
 pm.

**6.060 WCAB** PHILADELPHIA, PA., 49.5 m. Tues.,  
 Wed., Fri. 5:30-6:15, 6:30-11 pm.  
 Sat. 11 pm.-1 am. Sun. 6:30-11  
 pm.

**6.054 HJAA** PEREIRA, COLOMBIA, 9 am.-Noon,  
 6:30-10 pm.

**6.050 GSA** DAVENTRY, ENGLAND, 49.59 m.,  
 1-6, 6:20-9:15 pm.

**6.045 XETW** TAMPICO, MEXICO, 49.6 m. Ir-  
 regular 7-11 pm.

**6.043 WDJM** MIAMI BEACH, FLA., 49.65 m.  
 1-3 pm., 9 pm.-2 am., Sun. 4-6  
 pm. Relays WIOD.

**6.040 WSLR** BOSTON, MASS., 49.65 m., Addr.  
 University Club. 7-9 pm. exc.  
 Sat. & Sun. Sun. 2:30-6 pm.

**6.033 HP5B** PANAMA CITY, PAN., 49.75 m.,  
 Addr. P. O. Box 910. 10:30 am.-  
 2, 6-10 pm.

Mc. Call  
**6.030 CFVP** CALGARY, ALTA, CAN., 49.75 m.  
 Thur. 9 am.-1 am.; Sun. 12 n.-  
 12 m.

**6.030 RW96** MOSCOW, U.S.S.R., 49.75 m. 1-3,  
 4-7 pm.

**6.030 OLR2B** PRAGUE, BOHEMIA, 49.75 m. (See  
 11,875 mc.) Off the air at pres-  
 ent.

**6.023 XEUW** VERA CRUZ, MEX., 49.82 m., Addr.  
 Av. Independencia 98. 10 pm.-  
 1 am.

**6.020 XEXA** MEXICO CITY, MEX., 49.83 m.,  
 Addr. Dept. of Education. Daily  
 8-11 am., 2:30-4 pm., 7:30 pm.-  
 12:45 am. Sun. 1:30 pm.-12:45 am.

**6.020 DJC** BERLIN, GERMANY, 49.83 m.,  
 Addr. (See 6.079 mc.) 11:30 am.-  
 4:30 pm.

**6.017 H13U** SANTIAGO DE LOS CABALLEROS  
 D. R., 49.84 m. 7:30-9 am., 12 n.-  
 2 pm., 5-7 pm., 8-9:30 pm.; Sun.  
 12:30-2, 5-6 pm.

**6.015 PRA8** PERNAMBUCO, BRAZIL, 49.85 m.,  
 Radio Club of Pernambuco. 4-9  
 pm.

**6.010 OLR2A** PRAGUE, BOHEMIA, 49.92 m.  
 Addr. (See OLR, 11,84 mc.) Irreg.

**6.010 COCO** HAVANA, CUBA, 49.92 m., Addr.  
 P. O. Box 98. Daily 7:55 am.-  
 12 m., Sun. until 11 pm.

**6.010 VK9MI** S. S. KANIMBLA, 49.92 m. (Travels  
 between Australia and New Zea-  
 land). Sun., Wed., Thurs. 6:30-  
 7:30 am.

**6.010 CJCX** SYDNEY, N.O.W. SCOTIA, 49.92 m.  
 Relays CJC8 7 am.-12:30 pm.

**6.007 XYZ** RANGOON, BURMA, 49.94 m.,  
 6:30-10 am., 9-11 pm., Sat. 9:30-  
 11 pm.

**6.007 ZRH** ROBERTS HEIGHTS, S. AFRICA,  
 49.94 m., Addr. (See ZRK, 9.606  
 mc.) Daily exc. Sun. 9:30 am.-  
 3:30 pm. (to 4:45 pm. Sat.). Sun.  
 8:40 am.-12 n., 12-15:30 pm.  
 Daily exc. Sat. 11:45 pm.-12:50  
 am.

**6.005 HP5K** COLON, PAN., 49.96 m., Addr.  
 Box 33. La Voz de la Victor. 7-9  
 am., 10:30 am.-1 pm., 5-11 pm.

**6.005 CFCX** MONTREAL, CAN., 49.96 m., Can.  
 Marconi Co. Relays CFCF 6:45  
 am.-12 m.; Sun. 8 am.-10:15 pm.

**6.005 VE9DN** DRUMMONDVILLE, QUE., CAN.,  
 49.96 m., Addr. Canadian Mar-  
 coni Co.

**6.002 CXA2** MONTEVIDEO, URUGUAY, 49.98 m.  
 Addr. Rio Negro 1631. Relays  
 LS2, Radio Prieto, Buenos Aires  
 5:30-10:30 pm.

**6.000 XEBT** MEXICO CITY, MEX., 50 m.,  
 Addr. P. O. Box 79.44. 10 am.-  
 1:45 am.

**5.990 ZEA** SALISBURY, RHODESIA, S. AFRICA,  
 50.08 m. (See 6.147 mc., ZEB)  
 Also Sun. 3:30-5 am.

==== *End of Broadcast Band* ====

**5.977 CS2WD** LISBON, PORTUGAL, 50.15 m.,  
 Addr. Rua Capelo 5. 3:30-6 pm.

**5.975 OAX4P** HUANCAYO, PERU, 50.16 m. La  
 Voz del Cerro del Peru. 9-11 pm.

**5.968 HVJ** VATICAN CITY, 50.27 m. Off the  
 air at present.

**5.950 HH2S** PORT-AU-PRINCE, HAITI, 50.37  
 m., Addr. P. O. Box A103. 7-9:45  
 pm.

**5.940 OAX2A** TRUJILLO, PERU, 50.51 m., Tue.  
 Thu., Sat., Sun. 7-10 pm.

**5.900 ZNB** MAFEKING, BRI. BECHUANA-  
 LAND S. AFRICA, 50.84 m. Addr.  
 The Govt. Engineer, P. O. Box  
 106. 6-7 am. 1-2:30 pm. Ex. Surs.

**5.900 TILS** SAN JOSE, COSTA RICA, 50.85 m.  
 6-10 pm.

**5.885 H19B** SANTIAGO, D. R., 50.95 m. Irreg-  
 ular 6-11 pm.

**5.875 HRN** TEGUCIGALPA, HONDURAS, 51.06  
 m. 1:15-2:16, 8:30-10 pm.; Sun.  
 3:30-5:30, 8:30-9:30 pm.

**5.855 H11J** SAN PEDRO DE MACORIS, D. R.,  
 51.25 m., Addr. Box 204. 11:40  
 am.-1:40 pm., 6:10-8:40 pm.

**5.825 TIGPH** SAN JOSE, COSTA RICA, 51.5 m.,  
 Addr. Alma Tica, Apartado 800.  
 11 am.-1 pm., 6-10 pm. Relays  
 TIX 9-10 pm.

**5.813 TIGPH2** SAN JOSE, COSTA RICA, 51.59  
 m., Addr. Senor Gonzalo Pinto,  
 H.

**5.810 VONG** ST. JOHNS, NEWFOUNDLAND,  
 51.6 m., Add. Broad. Corp. of  
 Newfoundland.

**5.790 TGS** GUATEMALA CITY, GUAT., 51.75  
 m. Casa Presidencial, Senor J. M.  
 Caballero. Irregular.

*Save Money!*  
 With the  
**RADOLEK RADIO  
 PROFIT GUIDE!**

**164  
 PAGES**

**EVERYTHING IN RADIO  
 AT LOWEST PRICES!**

**OVER 15,000 REPAIR PARTS**

The world's most complete stock  
 of radio repair parts and exact  
 duplicate replacements. All lead-  
 ing brands. All guaranteed. Low-  
 est Prices!

**COMPLETE TUBE SELECTION**

All types RCA, Sylvania, Ray-  
 theon, Philco, etc. Includes Keel-  
 loc, special Majestic types and  
 transmitting tubes. Complete se-  
 lection.

**NEWEST TEST INSTRUMENTS**

The most complete line ever dis-  
 played in any catalog. All leading  
 makes. Latest improved models at  
 lowest prices.

**GREATEST RADIO VALUES**

A huge selection of money-saving  
 set bargains! New Phono-Radio  
 combinations. Automatic tuning  
 sets. Beautiful cabinets. New  
 "Ham" receivers and equipment.

**EVERYTHING FOR AUTO RADIO**

Complete auto radio section. In-  
 cludes vibrator replacement guide,  
 how auto aerials, custom panel  
 control plates for all autos, new-  
 est Auto sets.

**COMPLETE P. A. SELECTION**

New 200 public address ampli-  
 fiers from 5 to 100 watts. Com-  
 plete P. A. Systems for perma-  
 nent, portable and portable instal-  
 lations. Best values.

**NEW ELECTRICAL APPLIANCES**

Extra Profits for you! Standard  
 Brand Electric Irons, Stoves,  
 Heaters, Percolators, Waffle Irons,  
 Vacuum Cleaners, Trains, Clocks,  
 Mixers, etc., at lowest prices.

**FREE!**  
*Mail Coupon Catalog!*

**The RADOLEK Co.**  
 601 W. Randolph, Chicago,  
 Dept. T-35

Send the 1940 Radolek Radio Profit Guide  
 FREE!

Name .....

Address .....

Service man?  Dealer?  Experimenter?



# RADIO— MANY OPPORTUNITIES STILL AHEAD

• The radio industry has hit its full stride! The future, with Television, presents great opportunities—for the trained man! The I. C. S. Radio Course, prepared by experts in practice as well as theory, is constantly revised to meet new developments. This Course can make you a trained man — prepare you for promotion and a trained man's salary! Send for free booklet.

## INTERNATIONAL CORRESPONDENCE SCHOOLS

Box 2891-F, Scranton, Penna.  
Send me—free—information on subject checked:  
 Radio  Radio Service Man  
 Radio Operator  Electrical Engineer  
Name.....  
Address.....

## HAMS, EXPERIMENTERS!

Before you buy parts for that new transmitter, receiver or antenna, write for Sigmon's low prices. We carry a complete line of the latest Amateur and Service Supplies and guarantee to save you money on all your purchases. Write for our new Catalog or send us a list of your needs and we will quote our lowest delivered price, and all kinds of amateur and communications equipment designed and built to your specifications.  
**SIGMON RADIO SUPPLY COMPANY**  
"CUSTOM-BUILT RADIO HEADQUARTERS"  
104 Washington St., East, Charleston, W. Va.

# Westinghouse Power Generator

Manufactured for U. S. Signal Corps  
200 Watt. 110 V. AC

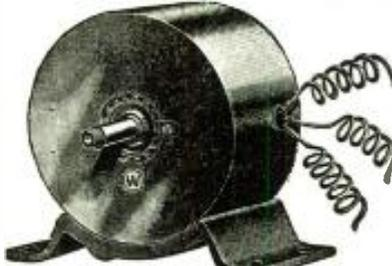

## A. C. ELECTRICAL POWER

from a Windmill, from available Waterpower, from your Automobile, from your Motorcycle, from your Bicycle, Foot-pedals or Handcrank (for transportable Radio Transmitters, Strong Floodlights, Advertising Signs); do you want to operate AC Radio sets from 32 V. DC farm light systems; operate two generators in series to get 200 V. AC; obtain two phase and three phase AC, etc., etc.

There Are Over 25 Applications  
Some of which are:

A.C. Dynamo lighting from eight to ten 20 Watt 110 Volt lamps. Short Wave Transmitter supplying 110 Volts AC for operating "Ham" transmitter. Operating 110 V. AC 60 Cycle Radio Receiver in 10' districts. Motor Generator. Public Address System. Electric Sirens on motor boats, yachts, etc. Camp Lighting. Short Wave artificial "fever" apparatus. Television. Pelton Waterwheel for lighting or other purposes. Airplane: for lighting strong searchlights or electric signs. Laboratory work, etc., etc. ½ to ¾ H.P. needed to run generator.

BLUE-PRINT 22 x 28 in. and Four-Page  
8½ x 12 in. INSTRUCTION SHEETS  
FREE with Generator.

Generator, as described, including Blue-print and instructions **\$7.90**  
Send \$2.00 deposit, balance C.O.D.  
Shipping weight 18 lbs.  
MONEY-BACK GUARANTEE

**WELLWORTH TRADING COMPANY**  
1915 S. State Street, Dept. RT-1139, Chicago, Ill.

Mc. Call	5.735 HCIPM	QUITO, ECUADOR, 52.28 m. Irregular 10 pm.-12 m.
5.460 YNOP	MANAGUA, NICARAGUA, 52.40 m., 8.30-9.30 pm. Sun. 2-3 pm.	
5.300 ZIK3	BELIZE, BRIT. HONDURAS, 56.6 m., Tue., Thurs., Sat. 1.30-2, 8.30-9 pm.	
5.145 OKIMPT	PRAGUE, BOHEMIA, 58.31 m., Addr. (See OLR, 11.84 mc.) Irregular.	
5.145 PMY	BANDOENG, JAVA, 58.31 m. 5.30-11 am.	
5.040 YV5RN	CARACAS, VENEZUELA, 59.52 m., 4-11.30 pm., Sun. 8.30-11.30 am., 3.30-10 pm.	
5.020 YV4RQ	PUERTO CABELLO, VENEZ., 59.76 m., testing nightly. Off 9.20 pm.	
5.010 YV5RM	CARACAS, VENEZ., 59.88 m., 3.30-10 pm., Sun. 8 am.-10.30 pm.	
4.990 YV3RX	BARQUISIMETO, VENEZ., 60.12 m., 10 am.-11 pm.	
4.970 YV1RJ	CORO, VENEZ., 60.36 m., Irreg.	
4.960 VUD2	DELHI, INDIA, 60.48 m., Addr. All India Radio. 7.30 am.-12.35 pm.	
4.960 YV5RS	CARACAS, VENEZ., 60.48 m., Irreg.	
4.950 YV4RO	VALENCIA, VENEZ., 60.61 m., Noon-1, 6-10 pm.	
4.940 YV5RO	CARACAS, VENEZ., 60.73 m.	
4.930 YV4RP	VALENCIA, VENEZ., 60.85 m. Irreg.	
4.920 YV5RU	CARACAS, VENEZ., 60.98 m., 6.30-7.30, 10.30 am.-1, 3.30-10 pm.	
4.920 VUM2	MADRAS, INDIA. 60.98 m. Addr. All India Radio, 6.30 am.-12.10 pm.	
4.910 YV1RY	CORO, VENEZ., 61.10 m., 6.30-9.30 pm., ex. Sundays.	
4.905 HJAG	BARRANQUILLA, COLOM., 61.16 m., 11 am.-11 pm., Sun. 11 am.-8 pm.	
4.900 YV6RT	BOLIVAR, VEN., 61.22 m. Signs off at 9.30 pm.	
4.900 HJCH	BOLIVAR, VENEZ., 61.22 m., Signs-off at 9.30 pm.	
4.900 HJCH	BOGOTA, COLOM., 61.22 m., 11.30 am.-2, 6-11 pm.	
4.890 YV1RX	MARACAIBO, VENEZ., 61.35 m., 10.30 am.-1.30, 4.30-10.30 pm.	
4.890 HJGD	BUCARAMANGA, COL., 61.35 m., 5.45-6.30, 11.30 am.-1 pm., 6-11 pm.	
4.885 HJDU	MEDELLIN, COLOM., 61.42 m., 8 am.-2, 6-11 pm.	
4.880 YUB2	BOMBAY, INDIA, 61.48 m. Addr. All India Radio, 7.30 am.-12.30 pm.	
4.880 YV6RU	BOLIVAR, VENEZ., 61.48 m., 6.30-9.30 pm. except Sundays.	
4.875 HJFH	ARMENIA, COLOM., 61.54 m., 8-11 am., 6-10 pm.	
4.865 HJBJ	SANTA MARTA, COLOM., 61.67 m., 5.30-10.30 pm.	
4.860 YV1RL	MARACAIBO, VENEZ., 61.73 m., 11 am.-1 pm., 4.30-10.30 pm.	
4.855 HJCF	BOGOTA, COLOM., 61.80 m., 7 pm.-mid, ex. Sundays.	
4.850 YV1RZ	VALERA, VENEZ., 61.88 m., 11.30 am.-1, 5.45-8.45 pm.	
4.845 HJCD	BOGOTA, COLOM., 61.92 m., 6-11.30 pm.	
4.840 VUC2	CALCUTTA, INDIA, 61.98 m. Addr. All India Radio. 6.30 am.-12 n.	
4.840 YV4RX	MARACAY, VENEZ., 61.98 m., 6-11 pm. ex. Sundays.	
4.835 HJAE	CARTAGENA, COLOM., 62.05 m., 7 am.-6, 7-11 pm.	
4.830 YV5RH	CARACAS, VENEZ., 62.11 m., 5-9.30 pm. (Sun. to 10.30 pm.)	
4.825 HJED	CALI, COLOM., 62.17 m., 7-11 am. ex. Sundays.	
4.820 YV3RN	BARQUISIMETO, VENEZ., 62.24 m., 11.30 am.-1.30, 5.30-9.30 pm.	
4.815 HJBB	CUCUTA, COLOMBIA, 62.31 m.	
4.810 YV1RU	MARACAIBO, VENEZ., 62.38 m., 10.45 am.-12.45 pm., 4.30-10.30 pm.	
4.800 YV1RY	MARACAIBO, VENEZ., 62.50 m., 10.45 am.-12.45 pm., 4.30-10.30 pm.	
4.795 HJDX	MEDELLIN, COLOMBIA. 62.57 m. 9.30-10.30 pm.	
4.795 HJFC	PEREIRA, COLOM., 62.57 m., 9 am.-noon, 6.30-10.30 pm. ex. Sun.	
4.790 YV5RY	CARACAS, VENEZUELA, 62.63 m., 5.30-8 pm.	
4.785 HJAB	BARRANQUILLA, COLOM., 62.69 m., 4.30-10.30 pm. ex. Sundays.	
4.772 HJGB	BUCARAMANGA, COLOM., 62.87 m., Nightly to 10.45 or 11 pm.	
4.745 HJCX	BOGOTA, COL., 63.23 m., Addr. Aparado 26-65, 12 n-2 pm., 5.30-11 pm., Sun. 6-11 pm.	
4.560 HC2ET	GUAYAQUIL, ECUADOR, 65.79 m., Wed. & Sat. 8-10 pm.	

## Index to Advertisers

A	
Allied Engineering Institute	422*
Allied Radio Corporation	415
American Microphone Co., Inc.	437
American Radio Institute	434
Amperite Co.	435
Audel, Theo., & Co.	432
B	
Barter & Exchange Free Ads	442-444
Bliley Electric Co.	435
Browning Laboratories, Inc.	419
Bud Radio, Inc.	419
Burstein-Applebee Co.	437
C	
Cameradio Co.	439
Candler System Co.	434
Cannon, C. F., Co.	439
Capitol Radio Engineering Institute	433
Commercial Notices	442
Consolidated Wire & Assoc. Corps.	429
Cornell-Dubilier Electric Corp.	435
Coyne Electrical School	387
D	
Dataprint Company	434
Dodge's Institute	432
E	
Eilen Radio Labs.	424
F	
For Sale Ads	442
Foto-Craft	439
G	
Goldentone Radio Corp.	428
Gold Shield Products	426, 434, 439, 441
Guthman, Edwin L., & Co., Inc.	428
H	
Hammarlund Manufacturing Co., Inc.	419
Harrison Radio Co.	431
Henry Radio Shop	426
Hudson Specialties Company	438
I	
Instructograph Company	432
Insuline Corp. of America	437
International Correspondence Schools	448
International Resistance Co.	423
J	
J. F. D. Manufacturing Co.	426
M	
Mass. Radio School	434
Midwest Radio Corporation	431
Millen, James, Mfg. Co., Inc.	Inside Front Cover
N	
National Company, Inc.	Inside Back Cover
National Plans Institute	441
National Radio Institute	385
National Schools	433
New York Y.M.C.A. Schools	434
N.R.P.D.A.	428
O	
Olson Mfg. Co.	428
Oxford-Tartak Radio Corporation	441
R	
Radio Amateur Course	388
Radio & Technical Publ. Co.	417
Radio Corporation of America	Back Cover
Radio Publications	428, 436, 441, 445
Radio Training Assn. of America	434
Radio Wire Television, Inc.	421
Radolek Co., The	447
RCA Institutes, Inc.	434
Rosicrucians, The	426
S	
Sigmon Radio Supply	448
Solar Mfg. Corp.	426
Sprague Products Co.	437
Sprayberry Academy of Radio	425
Supreme Publications	427, 432
T	
Technifax	426
Teleplex Co.	433
Thordarson Electric Mfg. Co.	429
Triplet Electrical Instrument Co.	439
Turner Co., The	441
U	
Universal Microphone Co., Ltd.	439
V	
Vibroplex Co., Inc., The	431
W	
Ward, Montgomery, & Co.	427
Wellworth Trading Company	441, 448

(While every precaution is taken to insure accuracy, we cannot guarantee against the possibility of an occasional change or omission in the preparation of this index.)



## A NEW AC MODEL **NC-44A**

Three models of the NC-44 are now available. The newest is the NC-44A, an AC model employing a transformer-type power supply. The transformer has been specially designed to insure effective shielding. The NC-44B is a new model for 6-volt battery operation.

The two newer models retain the fine performance characteristics of the original AC-DC NC-44. All have outstanding ability throughout their range from 550 KC to 30 MC. All have the same price \$49.50 net, complete with speaker and tubes. They are described in detail in the new 25th Anniversary Catalogue No. 300L which has just been issued.

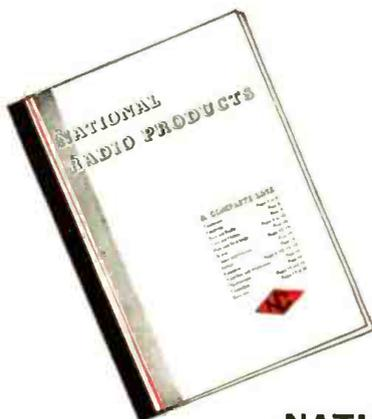

**NATIONAL COMPANY, INC., MALDEN, MASS., U.S.A.**



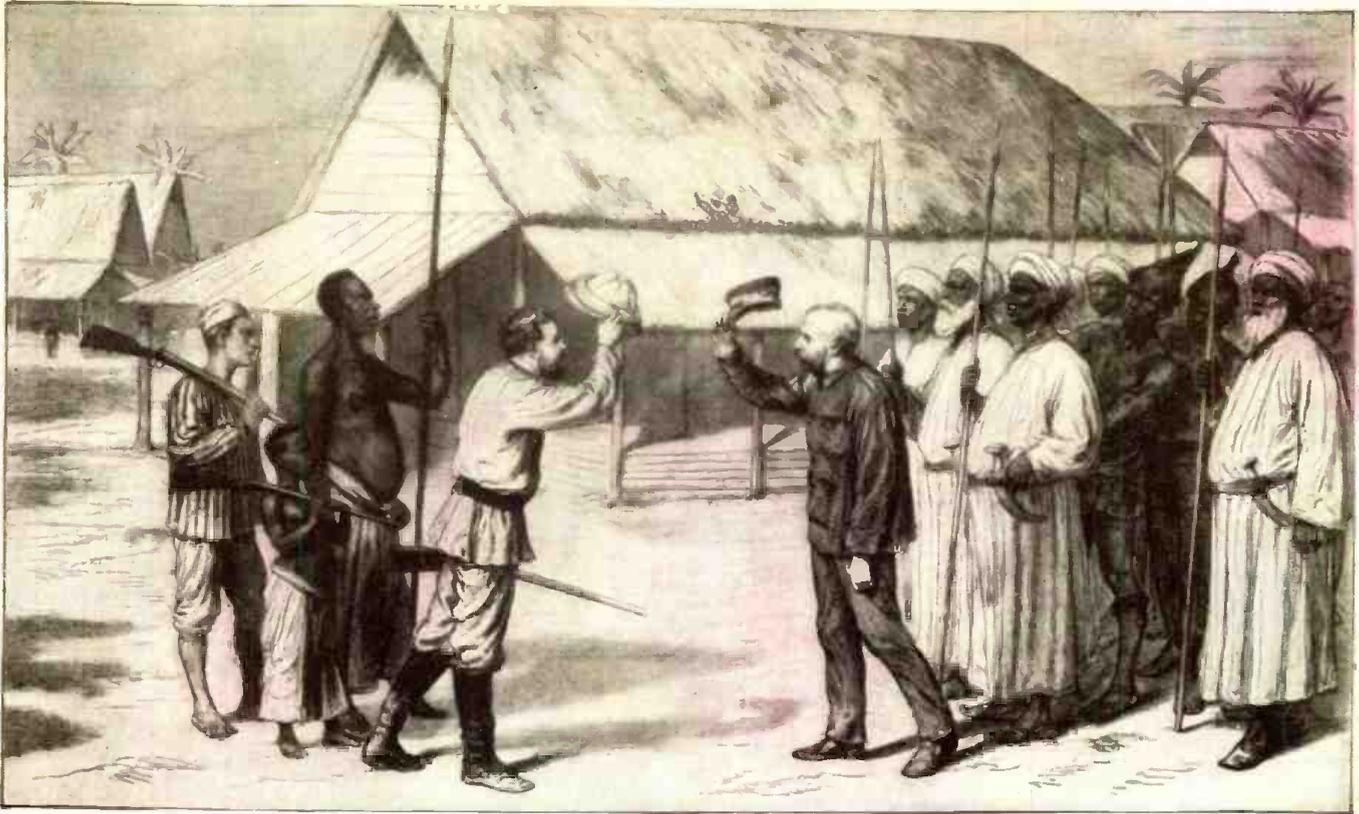

## IN 1939 RADIO WOULD FIND LIVINGSTONE

and save Stanley 8 months of hardships in Darkest Africa



**CALLING DR. LIVINGSTONE... CALLING DR. LIVINGSTONE**

Ujiji in the interior of Africa, where Stanley met Dr. Livingstone in 1871 after eight months of desperate and difficult searching, is now but a fraction of a second via radio from the great cities of the world. Only about seven years elapsed between Stanley's famous "Dr. Livingstone, I presume?" and the beginning of the experiments of Heinrich Hertz which first unlocked the secret of wireless waves. Since then, within the life span of the average man, radio has become one of the most vital forces controlled by man.

And in that remarkable development the Radio Corporation of America has played a major role.

Motivating factor in all that RCA does is research in RCA Laboratories. From here come the developments which the various members of the family of RCA utilize in making radio serve the world.

R.C.A. Communications provides communication to and from 43 countries and among leading cities of the United States. The National Broadcasting Company offers entertainment, information, news, and enlightenment

to millions. The RCA Manufacturing Company makes RCA Victor Radios, RCA Victrolas, Victor and Bluebird Records, and every kind of radio equipment for broadcasters, laboratories, airplanes, police departments, and for virtually every other known application of radio.

RCA activities are portrayed in RCA exhibits at the New York World's Fair and the San Francisco Exposition. You are cordially invited to visit these exhibits for a more intimate understanding of the ways you can cash in upon the services of RCA.

Trademarks "RCA Victor," "Victor" Reg. U. S. Pat. Off. by RCA Mfg. Co., Inc.



# RADIO CORPORATION OF AMERICA

RADIO CITY, NEW YORK

RCA MANUFACTURING COMPANY, INC. RADIOMARINE CORPORATION OF AMERICA RCA LABORATORIES  
NATIONAL BROADCASTING COMPANY R. C. A. COMMUNICATIONS, INC. RCA INSTITUTES, INC.