

RADIO & TELEVISION

FORMERLY
S SHORT WAVE & TELEVISION

In This Issue —
World-Wide Radio Digest
Best S-W Station List
Directory S-W Hams
Building A Television
Receiver
Radio Test Quiz
S-W Listening Tips
Receiver Construction

SEE PAGE 454

**HUGO
GERNSBACK**
EDITOR

**RADIO EXPERIMENTING
AMATEUR RADIO**

25¢
IN U.S. AND
CANADA

**DEC.
1938**

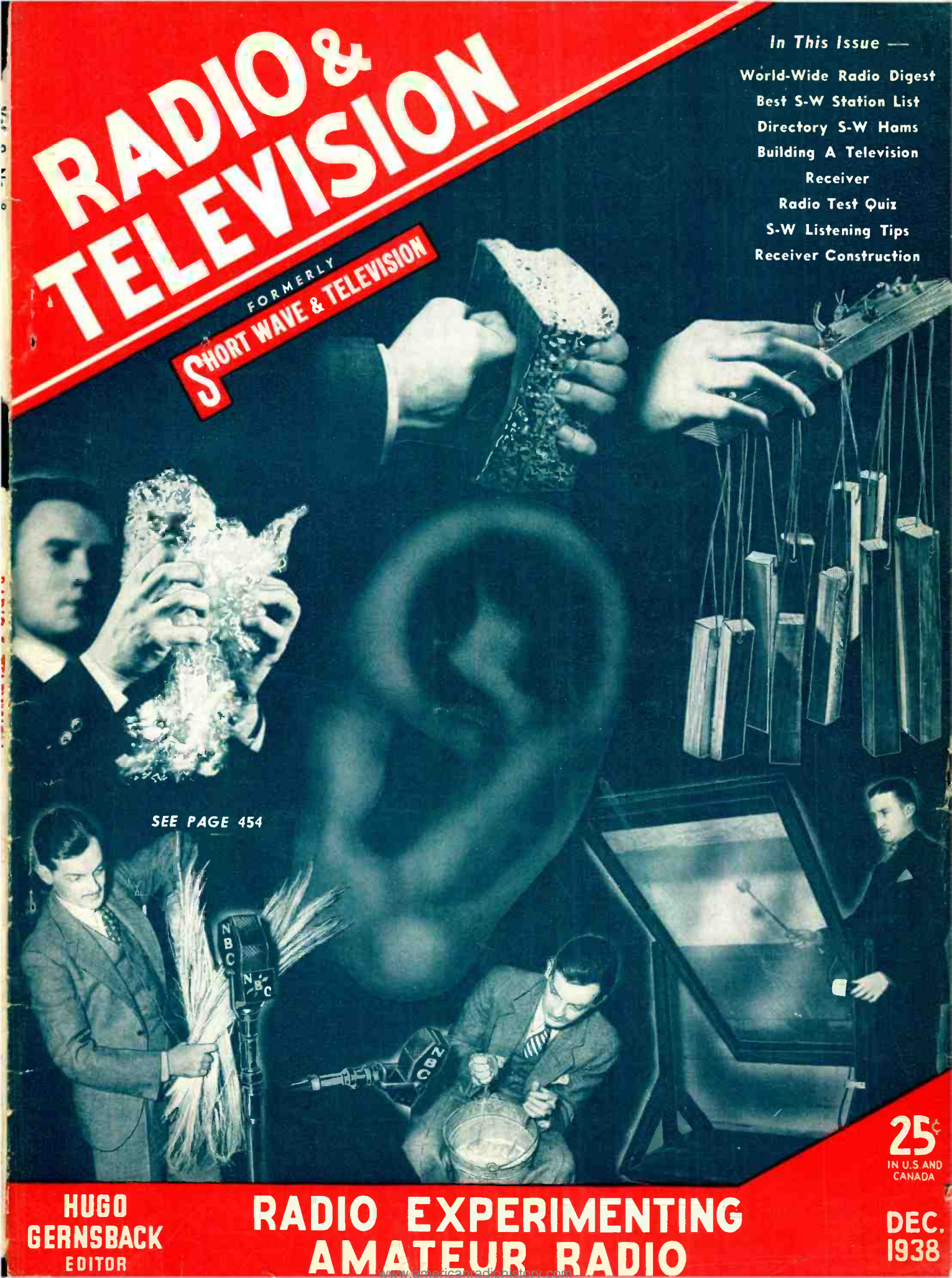

You can't lose! A money-back guarantee protects you!

THE RADIO AMATEUR COURSE REPRESENTS THE GREATEST BOOK VALUE EVER OFFERED TO RADIO "FANS" FOR 50c

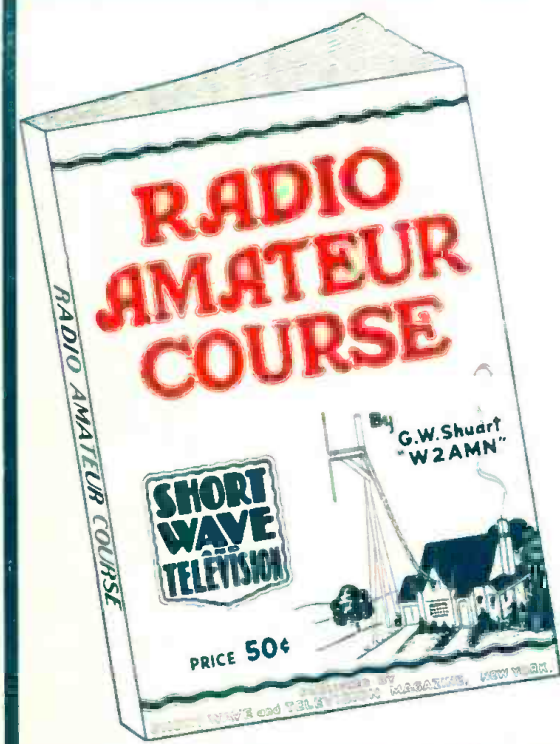

To convince you that there isn't a better book buy today the publishers of the RADIO AMATEUR COURSE make the sensational offer of a money-back guarantee on such a low-priced book. Stop in at any of the many dealers listed below and examine this volume. See for yourself if the RADIO AMATEUR COURSE isn't just the book you've always wanted.

**148 PAGES • • • 6 1/4 x 9 1/2 INCHES
OVER 150 DIAGRAMS AND PHOTOGRAPHS**

Printed on the finest quality paper—well illustrated attractive 4-color cover—complete with radio information you must have. It contains a step-by-step program for obtaining a short-wave radio education.

Written by George W. Shuart, W2AMN, foremost short-wave authority

ON SALE AT THE FOLLOWING DEALERS

- ARIZONA**
Sam's Cigar Store,
127 N. First Ave., Phoenix.
- CALIFORNIA**
Scott Wholesale Radio Co.,
340 E. Fourth Street, Long Beach.
Offenbach Electric Co., Ltd.,
1452 Market Street, San Francisco.
Zueck Radio Supply Co.,
1426 Market Street, San Francisco.
- COLORADO**
Auto Equipment Co.,
44th at Lawrence, Denver.
- CONNECTICUT**
Radio Inspection Service Co.,
297 Asylum Street, Hartford.
Stern Wholesale Paris, Inc.,
210 Chapel St., Hartford.
- GEORGIA**
Wholesale Radio Service Co., Inc.,
130 W. Peachtree St., N. W., Atlanta.
- ILLINOIS**
Allied Radio Corporation,
825 West Jackson Blvd., Chicago.
Newark Electric Company,
226 W. Madison Street, Chicago.
Wholesale Radio Service Co., Inc.,
901 W. Jackson Blvd., Chicago.
- INDIANA**
Van Sickle Radio, Inc.,
54 West Ohio Street, Indianapolis.
- MASSACHUSETTS**
Greater Boston Distributors,
40 Waltham St., Boston.
H. Jappe Co., 46 Cornhill, Boston.
Wholesale Radio Service Co., Inc.,
110 Federal Street, Boston.
Springfield Radio Co.,
397 Dwight Street, Springfield.
H. Jappe Co.,
37 Mechanic Street, Worcester.
- MICHIGAN**
Rissl Brothers, Inc.,
5027 Hamilton Ave., Detroit.

- MISSOURI**
Modern Radio Company,
409 No. Third Street, Hannibal.
Burstein-Appelbee Co.,
1012-14 McGee Street, Kansas City.
Van Sickle Radio Co.,
1113 Pine Street, St. Louis.
- NEBRASKA**
Radio Accessories Company,
2566 Farnam Street, Omaha.
- NEW HAMPSHIRE**
Radio Service Laboratory,
1187 Elm Street, Manchester.
- NEW JERSEY**
Aero Radio Co.,
227 Central Avenue, Newark.
Wholesale Radio Service Co., Inc.,
219 Central Avenue, Newark.
- NEW YORK**
Wholesale Radio Service Co., Inc.,
542 E. Furtham Rd., Bronx.
Wholesale Radio Service Co., Inc.,
90-08 160th Street, Jamaica, L. I.
1 Man. The Radio Man, Inc.,
64 Dey Street, New York City.
Eagle Radio Co.,
84 Cortlandt Street, New York City.
Federated Purchaser, Inc.,
25 Park Place, New York City.
Harrison Radio Co.,
12 West Broadway, New York City.
Sun Radio Co.,
212 Fulton Street, New York City.
Terminal Radio Corp.,
80 Cortlandt Street, New York City.
Thor Radio Corp.,
65 Cortlandt St., New York City.
Try-N Radio Co., Inc.,
55 Cortlandt Street, New York City.
Wholesale Radio Service Co., Inc.,
100 Sixth Avenue, New York City.
Radio Paris & Equipment Co.,
24 Clinton Avenue No., Rochester.
M. Schwartz & Son,
710-712 Broadway, Schenectady.

- OHIO**
News Exchange,
51 So. Main Street, Akron.
Canton Radio & Supply Co.,
1100 Tuscarawas Street, W., Canton.
United Radio, Inc.,
1103 Vine Street, Cincinnati.
The Hughes-Peters Electric Corp.,
178-180 N. Third Street, Columbus.
Standard Radio Paris Co.,
135 East Second Street, Dayton.
- OREGON**
Portland Radio Supply Co.,
1300 W. Burnside Street, Portland.
- PENNSYLVANIA**
Radio Distributing Co.,
1124-26 Market Street, Harrisburg.
M. & H. Sporting Goods Co.,
642 Market Street, Philadelphia.
Cameradio Co.,
963 Liberty Ave., Pittsburgh.
- RHODE ISLAND**
W. H. Edwards Co.,
32 Broadway, Providence, R. I.
- UTAH**
O'Loughlin's Wholesale Radio Supply,
315 South Main Street, Salt Lake City.
Radio Supply, Inc.,
46 Exchange Place, Salt Lake City.
- WASHINGTON**
Spokane Radio Co., Inc.,
611 First Avenue, Spokane.
- WISCONSIN**
Radio Paris Co., Inc.,
536-538 W. State Street, Milwaukee.

- TEXAS**
Amarillo Electric Co.,
111 East 6th Avenue, Amarillo.
- AUSTRALIA**
McGill's Agency,
183-184 Elizabeth Street, Melbourne.
- CANADA**
The T. Eaton Co., Ltd.,
1140, Winnipeg, Manitoba.
Canadian Electrical Supply Co., Limited,
285 Craig Street W., Montreal, Que.
Metropolitan News Agency,
1248 Peel Street, Montreal, Que.
- CUBA**
The Diamond News Co.,
Palacio Asturiano, Por San Jose,
Habana.
- ENGLAND**
Gorringe's American News Agency,
94, Green Street, Leicester Square,
London, W.C.2.
- HOLLAND**
Radio Peeters, Van Wovstraat, Amsterdam, Z.
- INDIA**
Empire Book Mart,
Box 631, Bombay.
- MEXICO**
American Book Store, S. A.,
Avenida Madero 25, Mexico City.
Central De Publicaciones,
Avenida Juarez, 4, Apartado 2430,
Mexico, D. F.
- NEW ZEALAND**
Te Aro Book Depot, Ltd.,
64 Courtenay Place, Wellington.
- SOUTH AFRICA**
Technical Book Co.,
117 Longmarket Street, Cape Town.

Be sure to see all future copies of RADIO AND TELEVISION for additional listings of dealers handling the RADIO AMATEUR COURSE.

RADIO AND TELEVISION

99 HUDSON ST., NEW YORK CITY

If this book is not at your dealer's, send your order directly to us. We will credit your dealer with the sale of this book. To order your copy of RADIO AMATEUR COURSE, fill in coupon below and mail.

RADIO AND TELEVISION, 99 HUDSON STREET, NEW YORK, N. Y.
Gentlemen: I enclose herewith my remittance of Fifty Cents (50c) for which please send me POSTPAID, my copy of the RADIO AMATEUR COURSE. (Remit by check or money order; register letter if you send cash or unused U.S. Postage Stamps.)

Name

Address

City State

R&T-1238



Be a Radio Expert

Many make **\$30 \$50 \$75** a week

I will train you at home for many Good Spare Time and Full Time Radio Jobs

J. E. SMITH, President, National Radio Institute
Established 1914

The man who has directed the home study training of more men for the Radio Industry than any other man in America.



Set Servicing

Fixing Radio sets in spare time pays many \$5, \$10, \$15 a week extra while learning. Full time repair pays as much as \$30, \$50, \$75 a week.



Broadcasting Stations

Employ managers, engineers, operators, installation and maintenance men for fascinating jobs and pay up to \$5,000 a year.



Loud Speaker Systems

Building, installing, servicing, operating public address systems is another growing field for men well trained in Radio.



HERE'S PROOF THAT MY TRAINING PAYS



\$50 Monthly in Spare Time

"I work on Radio part time, still holding my regular job. Since enrolling seven years ago, I have averaged around \$50 every month." JOHN B. MORISSETTE, 809 Valley St., Manchester, N. H.



Makes \$50 to \$60 a Week

"I am making between \$50 and \$60 a week after all expenses are paid, and I am getting all the Radio work I can take care of, thanks to N. R. I." H. W. SPANGLER, 126 1/2 S. Gay St., Knoxville, Tenn.



Operates Public Address System

"I have a position with the Los Angeles Civil Service, operating the Public Address System in the City Hall Council. My salary is \$170 a month." R. H. HOOD, R. 136, City Hall, Los Angeles, Calif.

Lesson on Radio Servicing Tips—FREE
I want to prove that my Training Gives practical, money-making information, is easy to understand—is what you need to master Radio. My sample lesson text, "Radio Receiver Troubles—Their Cause and Remedy" covers a long list of Radio receiver troubles in A.C., D.C., battery, universal, auto, T. R. F., superheterodyne, all-wave, and other types of sets. And a cross reference system gives you the probable cause and a quick way to locate and remedy these set troubles. A special section is devoted to receiver checkup, alignment, balancing, neutralizing and testing. Get this lesson FREE. No obligation. Just mail coupon.



Radio offers you many opportunities for well-paying spare-time and full time jobs. And you don't have to give up your job, leave home or spend a lot of money to train to get those jobs—to become a Radio Expert.

Get Ready Now for Jobs Like These

Radio broadcasting stations employ engineers, operators, station managers and pay up to \$5,000 a year. Fixing Radio sets in spare time pays many \$200 to \$500 a year—full time jobs with Radio jobbers, manufacturers and dealers, as much as \$30, \$50, \$75 a week. Many Radio Experts open full or part time radio sales and repair businesses. Radio manufacturers and jobbers employ testers, inspectors, foremen, engineers, servicemen, and pay up to \$6,000 a year. Automobile, police, aviation, commercial Radio and loud speaker systems are newer fields offering good opportunities now and for the future. Television promises to open many good jobs soon. Men I trained have good jobs in these branches of Radio. Read how they got their jobs. Mail coupon.

Why Many Radio Experts Make \$30, \$50, \$75 a Week

Radio is young—yet it's one of our large industries. More than 28,000,000 homes have one or more Radios. There are more Radios than telephones. Every year millions of Radios get out of date and are replaced. Millions more need new tubes, repairs. Over \$50,000,000 are spent every year for Radio repairs alone. Over 5,000,000 auto Radios are in use; more are being sold every day, offering more profit-making opportunities for Radio experts. And RADIO IS STILL YOUNG, GROWING, expanding into new fields. The few hundred \$30, \$50, \$75 a week jobs of 20 years ago have grown to thousands. Yes, Radio offers opportunities—now and for the future!

Many Make \$5, \$10, \$15, a Week Extra in Spare Time While Learning

The day you enroll I start sending Extra Money Job Sheets; show you how to do Radio repair jobs. Throughout your training I send plans and directions that made good spare time money—\$200 to \$500—for hundreds, while learning. I send you special Radio

equipment to conduct experiments and build circuits. This 50-50 method of training makes learning at home interesting, fascinating, practical.

I Also Give You This Professional Servicing Instrument



Here is the instrument every Radio expert needs and wants—an All-Wave, All-Purpose Set-Servicing Instrument. It contains everything necessary to measure A.C. and D.C. voltages and current; to test tubes, resistance; adjust and align any set, old or new. It satisfies your needs for professional servicing after you graduate—can help you make extra money fixing sets while training.

Money Back Agreement Protects You

I am so sure I can train you to your satisfaction that I agree in writing to refund every penny you pay me if you are not satisfied with my Lessons and Instruction Service when you finish. A copy of this agreement comes with my Free Book.

Find Out What Radio Offers You

Act Today. Mail the coupon now for "Rich Rewards in Radio." It's free to any fellow over 16 years old. It points out Radio's spare time and full time opportunities and those coming in Television; tells about my training in Radio and Television; shows you letters from men I trained, telling what they are doing and earning. Find out what Radio offers YOU! MAIL COUPON in an envelope, or paste on a postcard—NOW!

J. E. SMITH, Pres., National Radio Institute
Dept. 8NB3,
Washington, D. C.

THIS FREE BOOK HAS HELPED HUNDREDS OF MEN MAKE MORE MONEY



This Coupon is Good for One FREE Copy of My Book

J. E. SMITH, President, Dept. 8NB3
National Radio Institute, Washington, D. C.

Dear Mr. Smith: Without obligation, send me free the Sample Lesson and your 64-page Book, "Rich Rewards in Radio," telling about spare time and full time Radio opportunities, and how I can train for them at home in spare time. (Please write plainly.)

NAME _____ AGE _____

ADDRESS _____

CITY _____ STATE _____ 14-X1

HUGO GERNSBACK, Editor
 H. WINFIELD SECOR, Manag. Editor
 ROBERT EICHBERG, Assoc. Editor

New! Exclusive!
Roster of
New HAMS
 See Page 493

In This Issue

GENERAL FEATURES

Ultra Short Waves and Television— Dr. Greenleaf Whittier Pickard.....	453
Can You Recognize These Sound Effects?.....	454
Television Eye Pierces Fog.....	455
World-Wide Radio Digest.....	456
Aviation's Newest and Biggest Radio Rig—C. L. Stong.....	458
C.B.S. "Sets The Stage" for TELEVISION.....	460
With The YL's.....	461
Radio Directs Making of a Feature Movie—J. M. Goldby.....	464

CONDENSED FEATURES

Super-Imposing Television Images.....	455
World-Wide Radio Digest.....	456
Radio Altimeter for Planes.....	456
Whale Wired for Sound.....	456
New Laws for "Hams".....	456
Television Airplane Beacon.....	457
Ireland Rushes Transmitter.....	457
Television Promised in Spring.....	457
Radioddities.....	459
International Radio Review.....	462
"C" & "R" Meter.....	462
Experimental 1/4 Meter Sets.....	462
New Television Aerials.....	463
Short Waves on the SS. "Nieuw Amsterdam".....	466
Radio Talks from a Jungle.....	466

INSTRUCTION

Radio Beginner's Course— Martin Clifford, W2CDV.....	465
Radio Test Quiz—Robert Eichberg.....	467
Shooting Trouble on the Ham Trans- mitter—Alvin Abrams, W2DTT.....	468
Question and Answer Department.....	482

Cover composition by H. Gernsback and Thomas D. Pentz. Pho-
 tos: Courtesy National Broadcasting Company (see page 454).

RADIO & TELEVISION—Published monthly on the tenth of the month. Entered as second-class matter Feb. 15, 1938, at the post office at Springfield, Mass., under the act of March 3, 1879. Trademarks and copyrights by permission of H. Gernsback. Text and illustrations are copyright and may not be reproduced without permission. Subscription price \$2.50 a year in the United States and possessions and Canada, \$3.00 in foreign countries. Make all subscription checks payable to Popular Book Corporation.

Published by Popular Book Corporation, Publication Office—29 Worthington St., Springfield, Mass. Editorial and Executive Offices—89 Hudson St., New York, N.Y. HUGO GERNSBACK, President; H. W. SECOR, Vice-President; EMIL GROSSMAN, Director of Advertising. European Agents: Atlas Publishing and Distributing Co., Ltd., 18 Bride Lane, Fleet St., London, England; Brentano's—London and Paris. Australian Agents: McGill's Agency, 179 Elizabeth St., Melbourne.

Copyright 1938 by H. Gernsback

CONSTRUCTION

New Experiments with Radio Apparatus.....	469
Radio Kinks.....	477
T.R.F. 441-Line Television Receiver—Henry Townsend.....	478
3-Tube A.C. Receiver—J. T. Wilcox, W2CLS.....	480
Economical 25 Watt Xmitter Kit.....	480
1-Meter Waves with Ordinary Tubes—Nelson G. Haas and Carl A. Erbacher.....	484
Build This 4-Tube HAM Beginner's Receiver— Harry D. Hooton, W8KPX.....	486
110 Volt D.C. Transmitter, Part II—Conclusion Herman Yellin, W2AJL.....	502

TELEVISION

Television Eye.....	455
"Television in the Spring"— Sarnoff's Promise.....	457
C.B.S. "Sets the Stage" for Television.....	460
T.R.F. Television Receiver —How To Build.....	478

MISCELLANEOUS

Radioddities.....	459
Radio Test Quiz.....	467
Short Wave League—"On the Ham Bands"—Elmer R. Fuller.....	470
Local HAM Gossip.....	471
What Do YOU Think?.....	472
Silver Trophy Award for Best Station Photo.....	473
World Short Wave Stations.....	474
Let's Listen In with Joe Miller.....	475
Radio Kinks.....	477
Question Box.....	482
Directory of Newly Licensed Amateurs.....	493
New Radio Apparatus.....	499

Next Month

- Television—Tomorrow's Big Opportun-
ity—William Dubilier.
- Two-Stage Preselector for Use with
Communications Receiver—H. G.
McEntee, W2FHP.
- Good One-Tube Receiver for a Short
Wave Listener—Herman Yellin,
W2AJL.
- An Emergency Ham Transmitter—Her-
man Yellin, W2AJL.
- Ultra Short Wave Aerials, Including
Television Types.
- Zworykin's Automatic U.H.F. Relay
System.
- And All Your Favorite Departments.

Certified Circuits



When you see this seal on a set it is a guarantee that it has been tested and certified in our laboratories, as well as privately in different parts of the country. Only constructional—experimental sets are certified.

You need not hesitate to spend money on parts because the set and circuit are bona fide.

This is the only magazine that renders such a service.

TRAIN FOR RADIO IN 12 WEEKS

BY MY QUICK, EASY "LEARN BY DOING" METHOD



Prepare today to enter a real money-making field by my quick, easy way to learn Radio. Here in my school you are trained in 12 weeks for your start for a better job and a real future. You do actual work on a great outlay of Radio equipment. The remarkable "Learn-By-Doing" methods used in the great Coyne Shops train you in **Radio, Television** and sound equipment servicing. Not by books . . . Not by Correspondence . . . But all under the individual guidance of skilled instructors, and only on similar kind of work you will meet out on a real job. My methods make it easy to learn—First you are told how to do a thing—then you are shown how to do it—then you do the work yourself. WHERE ELSE CAN YOU FIND SO QUICK AND EASY A WAY TO GET PRACTICAL TRAINING IN THIS GIANT INDUSTRY?

I'LL FINANCE YOUR TRAINING

DON'T LET LACK OF MONEY keep you from sending in the Coupon TODAY. Learn how you can get training first and take more than a year to pay for it after graduation. Make your first payment 60 days after your regular 12 weeks' training period ends. Then take over a year to pay the balance of your tuition in easy monthly payments. Hundreds of ambitious fellows have used this method to get Coyne Training. **FILL IN THE COUPON AND MAIL IT TODAY.** It will bring you the details of this amazingly quick and easy way to get your start towards a good pay job.



H. C. Lewis

Radio—Television—Sound Equipment

Your training at Coyne is in wonderful, modern daylight shops on the finest kind of RADIO, TELEVISION and SOUND EQUIPMENT. Television is sure to come as a commercial industry, whether this year or next. Talking Picture and Public Address Systems offer opportunities for the trained man. Everything possible has been done to make your stay at Coyne happy and healthful as well as profitable.

Electric Refrigeration Training Included at No Extra Cost

This combination Training (Radio and Refrigeration) can be of great value to you. Whether you go into business for yourself or get a job working for a Radio Sales and Service organization, the fact that you are trained in servicing Electric Refrigerators should be profitable to you. Many Radio Manufacturers also make Electric Refrigerators and men with this combination training are much more valuable to these employers. You can NOW get this training without extra cost.

No Advanced Education or Previous Experience Needed

If you can read and write simple English and are ambitious you can be trained the Coyne way—by actual experience on a wide variety of up-to-date Superheterodyne sets, oscillators, analyzers, and test instruments. You learn how to operate television receiving and transmitting equipment and how to install, test and service public address systems and sound picture equipment. Coyne training also helps prepare you to qualify for a government license examination as Amateur Broadcast or Telegraph Radio Operator and to know Code and Department of Commerce rules. Send coupon for all details.

Part Time Work While Learning Employment Service after Graduation

If you need part time work to help pay living expenses while training, my Employment Department will help you get it. They will also give you Lifetime Employment Service after you graduate.

Mail Coupon Today I'll Send You All the Facts

Get the new "Coyne Opportunity Catalog," giving all facts about Coyne Training. Photographs of Shops showing students at work on modern radio equipment under the personal supervision of Coyne Expert Instructors. Also details of my Part Time Employment Offer, Pay After Graduation Plan and Graduate Employment Service. Yours without cost. Simply Mail the Coupon.



H. C. LEWIS, President,
Radio Division, Coyne Electrical School,
500 S. Paulina St., Dept. 98-2K, Chicago, Ill.

Send me your big FREE Book about Coyne Training and give me all details regarding your "Part Time Employment Offer" and "Pay After Graduation Plan" of easy, monthly payments.

NAME.....AGE.....

ADDRESS.....

CITY.....STATE.....

H. C. LEWIS, President RADIO DIVISION Founded 1899
COYNE ELECTRICAL SCHOOL
500 S. Paulina St., Dept. 98-2K Chicago, Ill.

..... THESE OUTSTANDING SHORT WAVE BOOKS ARE Now Available AT YOUR DEALER!

YOU buy parts, tubes, kits, accessories from your local radio dealer—that's what countless thousands of short-wave fans do. Now through a nation-wide distribution service our numerous books are available at your favorite radio dealer—right where you buy other radio equipment. It's more convenient, saves time and you can inspect the books before you buy. Ask your dealer to show you all the books advertised on this page—they're always in stock.

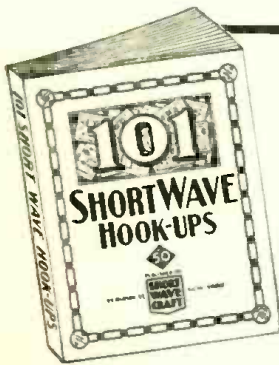

101 SHORT WAVE HOOK-UPS

Compiled by the Editors of RADIO & TELEVISION

Here is a worthwhile book that every short wave listener, every short wave fan, and every short wave amateur has wanted for a long time. It gives you the 101 best short wave hook-ups which have appeared heretofore.

100 Illustrations 50c
72 Pages

HOW TO BUILD AND OPERATE SHORT WAVE RECEIVERS

This is the best and most up-to-date book on the subject. It is edited and prepared by the editors of RADIO & TELEVISION and contains a wealth of material on the building and operation, not only of typical short wave receivers, but short wave converters as well.

150 Illustrations 50c
72 Pages



TEN MOST POPULAR SHORT WAVE RECEIVERS

HOW TO MAKE AND WORK THEM
The editors of RADIO & TELEVISION have selected ten outstanding short wave receivers and these are described in the new volume. Each receiver is fully illustrated with a complete layout, pictorial representation, photographs of the set complete, hook-up and all worthwhile specifications.

75 Illustrations 25c
40 Pages

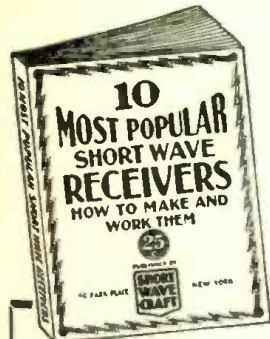

HOW TO GET BEST SHORT WAVE RECEPTION

M. HARVEY GERNSBACK tells you everything you have ever wanted to know about short wave reception. The author, a professional radio listener and radio fan for many years, gives you his long experience in radio reception and all that goes with it.

50 Illustrations 50c
72 Pages

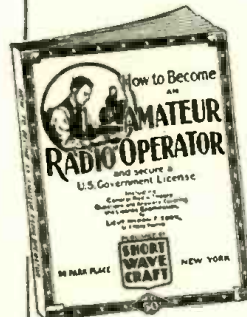
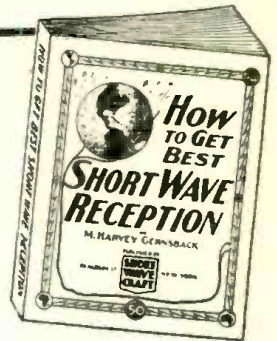

HOW TO BECOME AN AMATEUR RADIO OPERATOR

By Lieut. Myron F. Eddy, whose experience in the amateur field has made him pre-eminent in this line.

If you intend to become a licensed code operator, if you wish to take up phone work eventually—this is the book you must get.

150 Illustrations 50c
72 Pages

THE SHORT WAVE BEGINNER'S BOOK

Here is a book that solves your short wave problems—leading you in easy stages from the simplest fundamentals to the present stage of the art as it is known today. It is the only low-priced reference book on short waves for the beginner.

75 Illustrations 25c
40 Pages

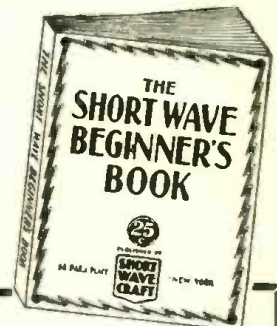

LOOK FOR YOUR NEAREST DEALER

For convenience the publishers list below dealers in all parts of the world where our books are available. On your next shopping trip be certain to examine these volumes. You're sure to want them for your technical library.

- ALABAMA**
Walther Bros., Montgomery
- ARIZONA**
Sam's Cigar Store, Phoenix
- CALIFORNIA**
Electric Supply Co., Oakland
Radio Supply Company, Los Angeles
Radio Television Supply Co., Los Angeles
Pacifica Radio Exchange, Inc., Los Angeles
Western Auto Supply, Los Angeles
Zack Radio Supply Co., Los Angeles
Vroman's Book Store, Pasadena
Western Radio & Elec. Co., San Diego
Offenbach Electric Co., San Francisco
Technical Book Co., San Francisco
Zack Radio Supply Co., San Francisco
Radio Specialties Co., San Jose
- COLORADO**
Auto Equipment Co., Denver
Interstate Radio Supply, Denver
- CONNECTICUT**
The Edward P. Judd Co., New Haven
- DELAWARE**
Wilmington Elec. Spec. Co., Inc., Wilmington
- FLORIDA**
Radio Accessories Co., Orlando
- GEORGIA**
Wholesale Radio Service Co., Inc., Atlanta
- ILLINOIS**
Allied Radio Corporation, Chicago
Walter C. Braun, Inc., Chicago
Chicago Radio Apparatus Co., Chicago
A. C. McClurg & Co., Chicago
Midwest Radio Mart, Chicago
Newark Electric Co., Chicago
Sears, Roebuck & Co., Chicago
Max Stein & Co., Chicago
Montgomery Ward & Co., Chicago
Wholesale Radio Service Co., Inc., Chicago

- INDIANA**
Van Sickle Radio, Indianapolis
- MASSACHUSETTS**
DeWolfe & Fiske Co., Boston
The Personal Book Shop, Boston
Wholesale Radio Service Co., Inc., Boston
Library Book House, Springfield
Tremont Elec. Supply Co., Boston
- MICHIGAN**
Rissl Brothers, Detroit
St. Paul Book & Stat. Co., St. Paul
- MINNESOTA**
Burststein-Appelbee Co., Kansas City
Radio Labs., Kansas City
Walter Ashe Radio Co., St. Louis
Van Sickle Radio Co., St. Louis
- MISSOURI**
Radio Apparatus Co., Newark
United Radio Co., Newark
Wholesale Radio Service Co., Inc., Newark
- NEW YORK**
Fort Orange Radio Dist. Co., Albany
Wholesale Radio Service Co., Inc., Bronx
Wholesale Radio Service Co., Inc., City
Harrison Radio Co., New York City
Yamalen, I., New York City
Baker & Taylor Co., New York City
Blum, the Radio Man, New York City
David Bogen & Co., New York City
Federated Purchaser, Inc., New York City
Radio Circular Co., New York City
Sun Radio Co., New York City
Thor Radio Corp., New York City
Try-Mo Radio Co., New York City
Van Biemdyck Book Stores, New York City
Wholesale Radio Service Co., Inc., New York City
H. W. Wilson Co., New York City
Radio Parts & Equipment Co., Rochester
M. Schwartz & Son, Schenectady

- OHIO**
College Book Exchange, Toledo
- OREGON**
J. K. Gill Co., Portland
- PENNSYLVANIA**
Radio Electric Service Co., Philadelphia
Cameradio Co., Pittsburgh
- WASHINGTON**
Seattle Radio Supply Co., Seattle
Weiel Co., Inc., Seattle
Spokane Radio Co., Spokane
- WISCONSIN**
Radio Parts Co., Milwaukee
Radio Revista, Buenos Aires
- ARGENTINA**
McGill's Authorized Agency, Melbourne
- AUSTRALIA**
Belgium
Emil Arens, Brussels
- CANADA**
T. Eaton & Co., Winnipeg, Man.
Electrical Supplies, Ltd., Winnipeg, Man.
Wholesale Radio Supply, Winnipeg, Man.
Canadian Electrical Supply Co., Ltd., Toronto, Ont.
Radio Trade Supply Co., Ltd., Toronto, Ont.
Canadian Electrical Supply Co., Ltd., Montreal, P. Q.
- BRAZIL**
Agencia Soave, Sao Paulo
- CHINA**
China News Co. Shanghai
International Booksellers, Ltd., Shanghai
- CUBA**
Diamond News Co., Havana
- ENGLAND**
Gorrings's Amer. News Agency, London
- FRANCE**
Toute La Radio, Paris
- GERMANY**
Behr G.M.B.H. SW15, Berlin NW No. 7

- HOLLAND**
Radio Peters, Amsterdam, Z.
- INDIA**
Empire Book Mart, Bombay
- MEXICO**
American Book Store, Mexico, D. F.
Central De Publicaciones, S. A., Mexico, D. F.
Jaques Salvo, Mexico, D. F.
- NEW ZEALAND**
Johns, Ltd., Auckland
James Johnston, Ltd., Dunedin
Te Aro Book Depot, Ltd., Wellington
- SOUTH AFRICA**
Technical Book Co., Cape Town
Central News Agency, Johannesburg
International House, Johannesburg
South African Radio Publications, Johannesburg

IF YOUR DEALER DOES NOT CARRY THESE BOOKS, ORDER DIRECT FROM US. FILL OUT COUPON BELOW. SHIPMENT WILL BE MADE IMMEDIATELY.

POPULAR BOOK CORPORATION R&T-12
99 Hudson Street, New York City.

Gentlemen: I enclose herewith my remittance for _____ for which please send me the following books:

.....

Name

Address

City

State

(Send remittance in form of check or money order. If letter contains cash or unused U. S. postage stamps, register it.)

POPULAR BOOK CORPORATION • Publishers • 99 HUDSON STREET • NEW YORK, N. Y.

Ultra Short Waves and Television

Dr. Greenleaf Whittier Pickard

● AS this editorial is written, the European situation is still uppermost in our minds, and frequently-asked questions are: What part will radio play in the next war, aside from its normal use in military communication? Will radio methods be developed for the location of enemy submarines? How will a nation at war, or preparing for war, best keep in touch with its citizens? It may interest your readers to discuss these and allied questions from a broadcast engineer's viewpoint.

During the past quarter century many tests have been made of radio communication to and from submarines, and the results of these tests have been in full agreement with the simple theory of electro-magnetic screening by a conductor. Salt water is a rather good conductor, so good in fact that only low frequency waves can penetrate it to any appreciable depth, so it would seem that radio methods of locating submerged submarines would be of little value. In the next war, as in the World War, we must lean heavily on acoustical rather than radio methods of detecting and locating under-water craft.

The problem of radio broadcasting to a nation in war time is essentially similar to that of peace-time broadcasting, save that the audience must be protected from malicious interference from enemy stations, and, if possible, induced to ignore broadcasts of enemy propaganda. An ideal solution of this problem (as well as those of peace-time broadcasting) has already been made by Major E. H. Armstrong, and consists of an ultra-high frequency carrier of *frequency modulation*. Such a system is immune to enemy interference from any considerable distance, by reason of the propagation characteristics of ultra high frequencies, which are not turned back to earth by the ionosphere, and hence die out rapidly beyond the horizon. Such a service would also be relatively free from enemy propaganda, for as soon as a nation built up a large listening audience on such a system, few would care to stray out of the band into regions of enemy broadcasts at lower frequencies.

When, as, and if we have another major European war, it would seem that the prin-



Copyright by Harris and Ewing

Dr. Greenleaf Whittier Pickard—one of the foremost radio engineers in this country. Dr. Pickard has been very active in radio research for many years and has contributed numerous valuable inventions to the radio art. Our readers will find the views of Dr. Pickard on the present-day aspects of ultra-short waves and television of unusual interest.

cipal part played by radio would again be pure communication, with the dots and dashes of the Morse code predominant. Of course, there would be an increasing use of *teletype* and *facsimile*, and quite possibly some use of *television*. And again, particularly if this country should be involved, the *radio amateur* would play an important role, as he has in many past emergencies. It takes much longer to make a technically competent code operator than it does to transform a civilian into a soldier, so the nearly fifty thousand amateurs of the United States are an important asset in time of war. It is not by accident that three-quarters

of the world's amateurs are concentrated in this country; it is because we alone, of the world's nations, have consistently encouraged amateur radio.

Having already mentioned, as an advantage of ultra high frequency broadcasting, the fact that such waves are strictly limited in range, one is led to a further discussion of this advantage. As is well-known, the lower frequency waves used in normal broadcasting are nightly turned back to earth at considerable distances from the transmitter. This "turned back", or *sky-wave* has its disadvantages in broadcasting, as a brief analysis will show. There are at present three general classes of broadcasting stations in this country, namely, *clear channel*, *regional* and *local*. While the clear channel stations make some use of the sky-wave in serving large areas of rural population with an inferior or secondary coverage, sky waves are a positive and serious disadvantage to regional and local stations, by reason of the interference at night between such stations on the same frequency channel. If it were not for the sky wave, many more and better located regional and local stations would be installed, and the listening public would obtain a greatly improved service.

When broadcasting is done at *ultra high* frequencies there is, practically speaking, no sky wave and hence no co-channel interference between stations located some two hundred miles apart, so that on a single frequency, well over a hundred stations could be sprinkled over the United States. With a very limited number of frequency channels assigned to such service, say ten channels, between one and two thousand stations could be allocated in this country. And if, in addition to the use of ultra high frequencies, Armstrong's system of *frequency modulation* were used, a still larger number of stations could operate on these same ten channels, for the reason that interference is greatly decreased by the use of frequency modulation.

Any consideration of ultra high frequency transmission leads inevitably to the subject of *television*, for television, with its broad six-megacycle bands, is necessarily placed

(Continued on page 491)

Twenty-second of a Series of
"Guest" Editorials.

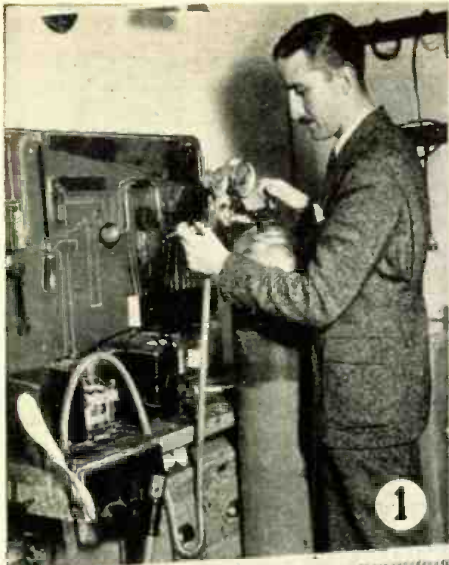

1



2

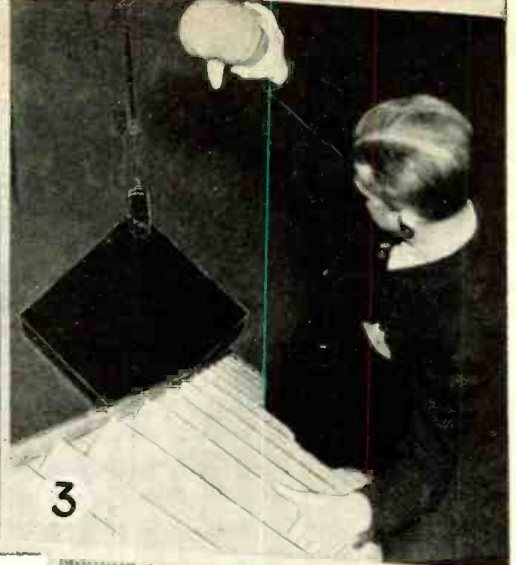

3

Can You Recognize These Sound Effects?

- 1 Airplane propeller and rush of wind past fuselage simulated by toy propeller and air tank.
- 2 The crackle and roar of a fire are imitated by the sound effects man as he crumples cellophane near the mike.
- 3 Suicide! Sound of man's body striking pavement is achieved by dropping a small pumpkin onto a hard board.
- 4 An auto wreck or a door battered in—it's all done by crushing a berry box, to make the "breaking" sound.
- 5 Cloppety-clop, the cavalry comes. Two "plumber's friends" beaten together sound like horses' hammering hoofs.
- 6 An army marches on, when these sticks pivoted in their wooden frame are caused to tap on a table top.
- 7 Skeletons rattle their bones through the haunted house when the sound effects man shakes this bunch of sticks.
- 8 Anything from a zephyr to a hurricane may come out of the square horn of this motor-driven wind machine.

—Photos Courtesy NBC.

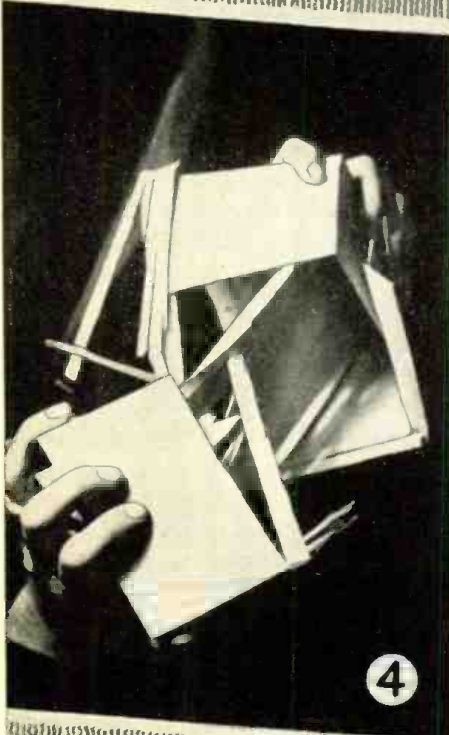

4



5



6



7

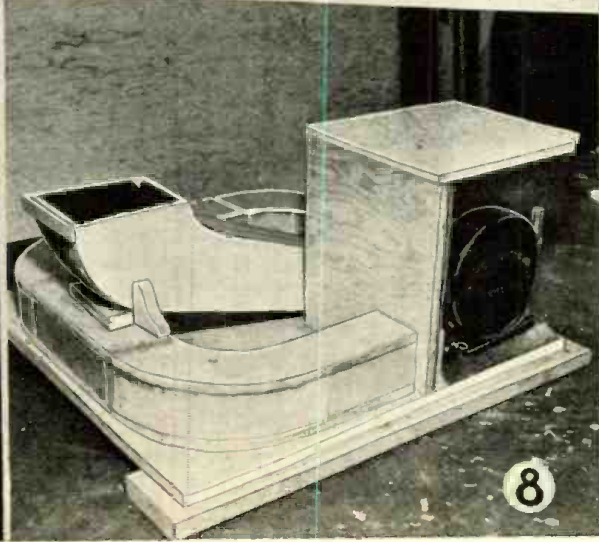

8

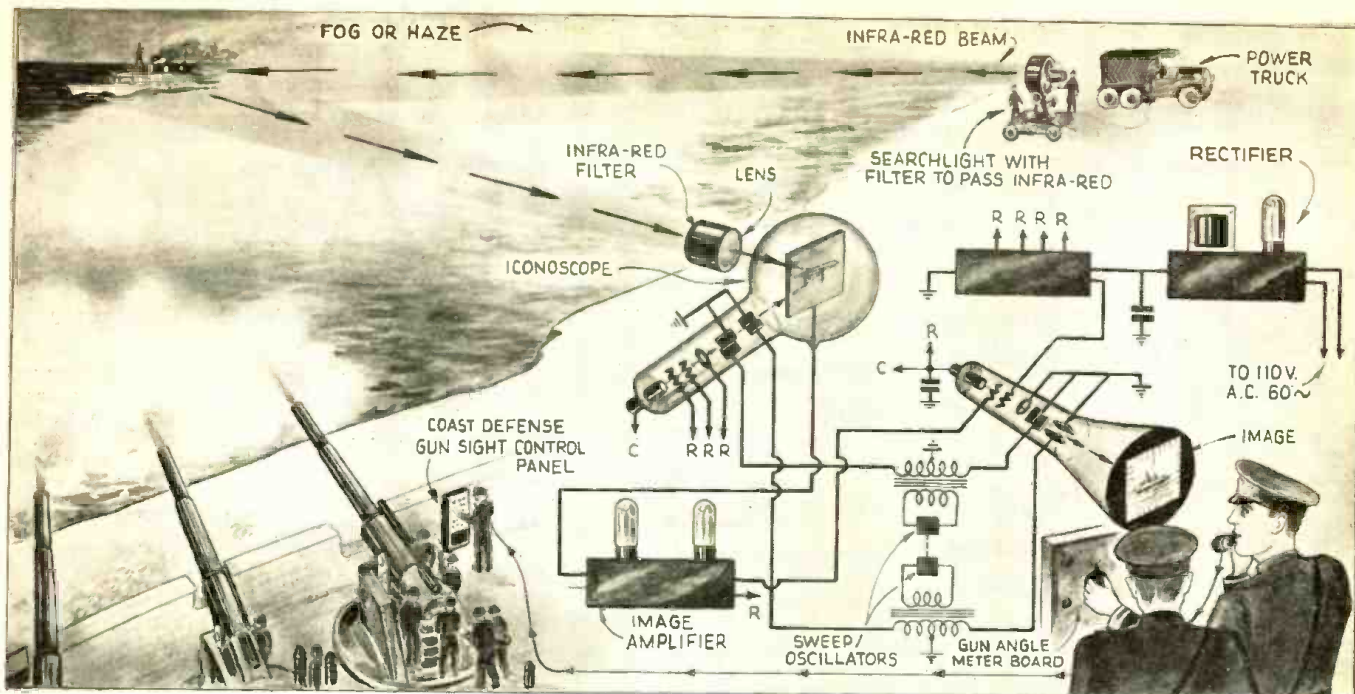

To penetrate haze or fog, television devices are used in the manner shown. The object hidden by fog or haze is illuminated by an invisible infra-red searchlight beam, and the reflected light rays are detected by an iconoscope.

TELEVISION EYE Pierces Fog

● AS the picture above shows, it is now possible to see an enemy warship or a ship in distress, even though hidden by fog or haze, thanks to Herbert E. Jones who recently was awarded a patent on this scheme. The inventor combines the use of an infra-red beam of light, which is invisible to the ordinary eye, together with a television tube such as the iconoscope, built so as to be especially sensitive to infra-red rays. If the object happens to emit infra-red rays, it is then simple of course for the

2 New Inventions

IMAGE OF ACTOR Superimposed On Any Scene

iconoscope tube, fitted with infra-red filter and lens, to locate it at once. If the object, such as an enemy warship, does not emit infra-red rays, then it would have to be located by illumination with an infra-red beam, as our artist has here shown.

Mr. Jones' patent shows a diagram for the sweep oscillators, video amplifier, etc. The same oscillators or a.c. generators which cause the cathode ray beam to scan the target plate in the iconoscope tube, also react on the cathode ray beam in the oscillo-

graph tube, so that both target and receiver screen are scanned synchronously.

Method for Super-Imposing Images

John C. Batchelor recently obtained a patent on a very ingenious scheme for super-imposing two or more television images at the transmitting stations.

An actor could be made to appear in a country scene, in an airplane, or walking along a street in a city; all without the actor having to leave the studio. Not only is this idea suitable for electrically super-imposing one scene upon another, such as the image of an actor upon a scene picked up by a second television camera from a painted stage setting, but scenes from a motion picture film may also be picked up and super-imposed against the image of the actor.

By means of a distorting amplifier, the inventor has made it possible to stagger picture impulses so that the part of a scene which will be simultaneously occupied by the image of a performer's body, for example, will be obliterated—or, in other words, the resulting effect will be that the final picture elements comprise the combination of the scenery and performer signals, and the portion of the scene which should appear immediately behind the performer (ordinarily speaking), does not appear in the final image.

The performer ordinarily appears before a black background, and in this way it is much easier for the control engineer to blend the image of the scene with that of the performer, as the background all around him is composed of one even tone.

By means of this new television system, two or more scenes may be super-imposed on one another.

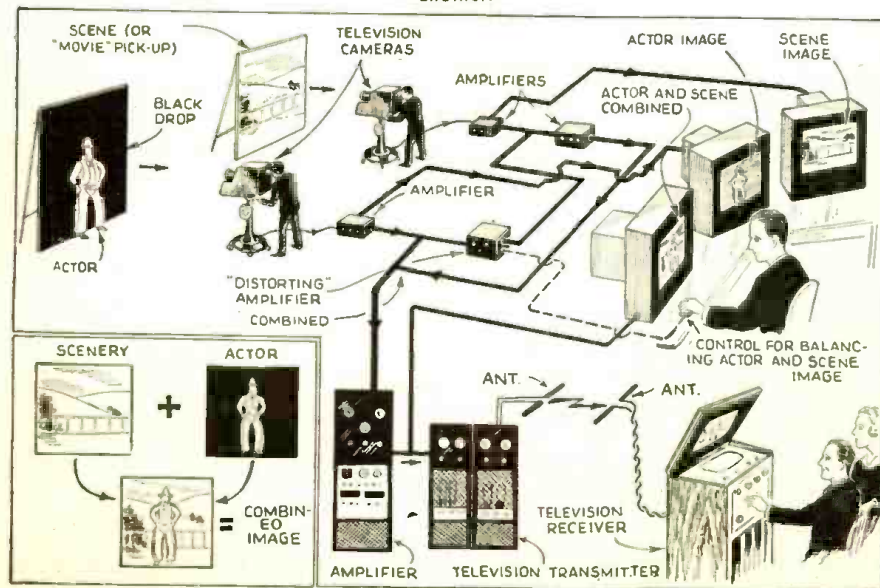

Measures Altitude Over Obstacles

● PLANE safety will be greatly increased when airlines adopt a new type of radio altimeter which is now being perfected by Western Electric engineers. The old type

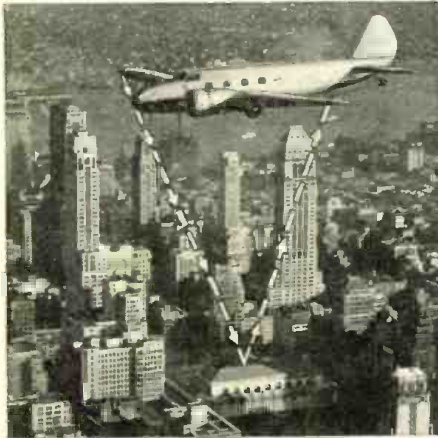

of altimeter, now in use for aviation, measures the plane's height above sea level, but cannot detect such obstacles as tall buildings, mountain ranges, and the like. The new radio device, however, makes use of an ultra-short wave transmitter located on one wing, sending a signal groundward. The reflected signal, turned back by whatever obstacle is below the plane, is picked up by a receiving antenna on the other wing, and is caused to actuate a needle on a "Terrain Clearance Indicator" meter.

France Sets Television Standards

● THE French Radio Minister has announced that television transmission standards are now set until at least July 1, 1941. Wavelengths will be 46 megacycles, with the associated sound on 42 megacycles. Fifty images per second will be sent, with a definition of 440 to 445 lines. The picture proportion will be 5 wide to 4 high, and the frame synchronizing will be about 7%. These transmissions are to take place from the Eiffel Tower.

Large Screen Home Television

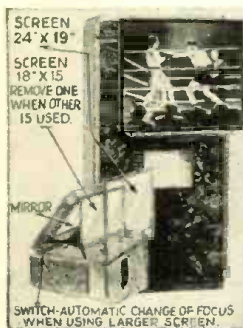

● A HOME television receiver capable of producing pictures up to 19 x 24 inches was one of the features at a recent London show. When the lid of the receiver is lifted, a 15 x 18 inch screen rises automatically in the set. If this screen is removed, another of larger

size may be placed on the front of the receiver. Pressing a button changes the focus of the television tube so that the image is sharp on either size screen.

Army Perfecting Airplane Detector

● MUCH secrecy surrounds the new light beam detector which the U. S. Army is perfecting to locate enemy planes before they get within effective bombing range of American cities. The new system is not a sound wave detector, as were the ones formerly used, and it is understood that no amount of muffling or silencing applied to the plane's motors or propellers can foil the new aerial detector.

WORLD RADIO

Ham Helps in a Hurricane

● WHEN the big wind struck Keene, N. H., wrecking communication systems, David F. Putnam, operator of WIGVF, set up his transmitter in the High School building. Haggard and weary, he pounded his key day and night for three days, handling more than 300 messages for the Telephone Company, Red Cross and National Guard. Sergeant Judd and Private



Waters, of the Guard, pitched in and helped to keep the station on the air. Other amateurs who cooperated were W1FOF, Springfield; W1AR, Boston; W1APK, Pembroke, N. H. and W1SZ, Hartford. The transmitter worked on 180 meters with an output of 60 watts, using 46 tube types, and was operated from a portable public address system during the power shut-off. A National 101-X was used for receiving.—Photo from A. E. Freeman.

Whale Wired for Sound

● MODERN ultra short-wave transmitters have solved one of the most serious problems that has affected the art of whaling since its inception hundreds of years ago. One problem that the whalers had was to track down a mammoth mammal which, when wounded by the harpoon, often van-

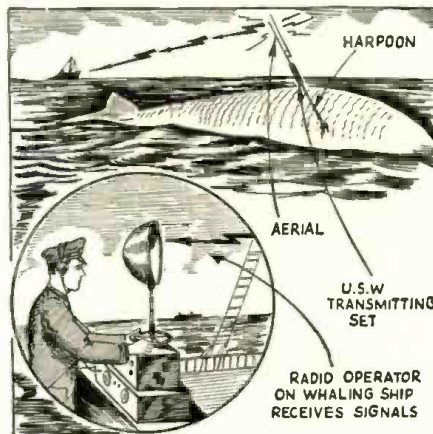

ished beyond the horizon. The new harpoon has a built-in ultra short-wave transmitter, while the whaling vessel is equipped with a receiver. The whale may vanish into the fog, but the ship can locate it instantly merely by listening to the signal sent out by the radio harpoon.

Magnetizing by Condenser Discharge

● THE usual way to make a permanent magnet is to wind a coil of wire around a steel bar and pass current through the coil. As the coil must be removed later, a small coil with high amperage is the easiest solution, but means of producing large currents, such as storage batteries or dynamos, are costly. Therefore, the engineers of the Bell Telephone Laboratories hit upon a new scheme. They connect forty 8 mf. condensers in parallel, charge the condensers from a 350-volt rectifier tube and discharge the condensers through the magnet. When the impedance of the magnet was found to produce an a.c. effect on the discharge, they simply inserted mercury vapor rectifier in series with it.



New Laws for Hams Begin Dec. 1

● EFFECTIVE December 1, 1938, a complete new set of FCC Regulations will govern amateur radio activities. For complete information, readers are advised to request a copy of the regulations (which run to 22 pages) from the Federal Communications Commission, Washington, D. C. Some of the more important changes are:—(1) 112-118 and 224-230 mc. bands now assigned to ham use. (2) Modulated oscillators and raw a.c. banned on 5 meters and up, but still permitted below 60 mc. (3) Hams must provide (but need not own) means to assure operation of transmitter within bands; monitors or frequency meters will be needed unless working the middle of the band. (4) Power must be measured accurately if station is using over 900 watts. (5) Detailed rules for procedure when FCC declares a communications emergency include compulsory listening period for first 5 minutes of each hour. 1.7 and 3.5 mc. bands reserved for relief transmissions. (6) Television work permitted from 112 mc. upward, but no longer allowed on 1.715 and 56 mc. bands. (7) No transmission of music on ham phone; single tone permitted for test. Carrier to be cut when not modulated. (8) Only stations licensed to Class A operators may use the Class A bands. (9) Portable transmitter regulations clarified. (10) New data on Class B and Class C requirements.

No Boxing on British Screens

● THE boxing promoters in Great Britain have clamped down on television, even when such a modern marvel as Jack Doyle, the Horizontal Harp, is in the ring. BBC offered Promoter Sidney Hulls a substantial sum for the television rights to a Doyle fight. Mr. Hulls turned it down on the grounds that if a person could afford to buy a television receiver, he could afford to buy a ticket to the fight.

WIDE DIGEST

Large Television a Feature of German Show

● **PROJECTED** television images, 5x6 feet in size, were one of the outstanding features of the German Television Exposition. A projector is used to throw the image on a wall at some distance from the apparatus. The brilliance of the pictures was fair but definition was reported as being inferior to that had on smaller screens.



No Hams in Greece!

● **THE** Greek Government has definitely clamped down on all importation of radio transmitting equipment and strictly forbids the use of any transmitters by private individuals. The only exceptions to these rules are three amateurs who have been given special licenses, says "The Malayan Radio Times." Indications are that they will be allowed to continue their activities; otherwise only Government departments will be permitted to own and operate radio transmitting equipment, which should effectively stifle Ham activities.

Argentina Active in Television

● **TWO-HUNDRED** line images at the rate of 25 per second have been used in Argentina, but now the trend is toward 405 to 441 lines. The familiar cathode-ray tube, which is used in American television receivers, is changed somewhat in shape (become more bulbous) in South America—this shape being somewhat like that of the "mushroom bulb" used for lighting in the United States.

Fashions for Hams

● **THE** latest style hint on what the well-dressed Ham will wear is shown herewith—his call letters embellishing the back of his workshirt. Newton Moyer, the Beau Brummel of the Short Waves, got himself a silver gray jersey and bought a set of maroon letters from a local sporting goods house. These 3-inch letters have rubberized backs and are ironed on to the shirt, after which they are sewed tight. If the YL or OW can swing a wicked needle, here's a way in which she can cooperate in dressing up the harried Ham. Or perhaps the Hams will agree with the YL who said "Fashion is Spinach!"



England Today—America Tomorrow?

● **TELEVISION** activity in England has necessitated the commercial production of ultra short wave antennas for home installation, as this view of the Belling-Lee factories proves. It has been predicted that

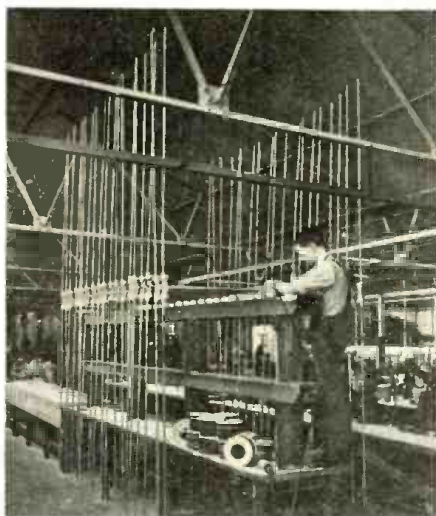

America's television boom will come early in 1939 and, if so, all the factories which now turn out metal tubing, auto radio antennas and similar products will show similar activity.

Ireland Rushes Transmitter

● **IRISH** radio listeners are now trying to get the authorities of Radio-Eireann to hasten construction of the new Eire short-wave station. According to "World-Radio," a British publication, the transmitter now in the course of construction at Moydrum, near Athlone, will be operating with 3½ kw. power before the first of the year. Testing was scheduled to begin as soon as a wavelength had been assigned.

Nations to Dodge Enemy "Jamming"

● **WHEN** national stations send programs of news or propaganda to their own citizens, enemy countries frequently "jam the waves" by sending out interference on the same wavelength. The British Broadcasting Company has perfected plans for obviating such interference.

It has long been recognized that ultra short waves do not carry efficiently beyond the horizon, therefore the British programs of news and other public information will be sent out on these waves. Signals from transmitters on the European continent would have to be on similar waves in order to block the British transmissions and these waves will not travel far enough to affect reception in Britain. Educated to listen on the ultra short waves, it is thought unlikely that the Britons will tune in enemy transmissions on other wavelengths high enough to reach the "tight little isle." Simple, isn't it!

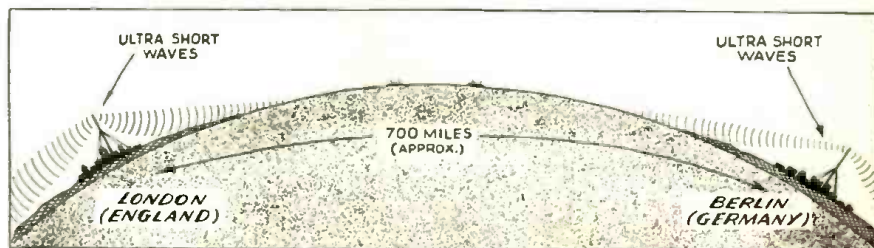

Television Principle in Airplane Beacon

● **AT** least two American agencies are working along parallel lines to increase the safety of commercial aviation. The illus-

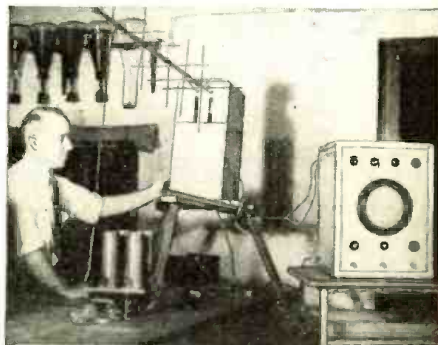

tration shows radio research engineers of Purdue University at work on such a system. The short wave transmitter at the left sends out signals which are picked up on the cathode-ray tube receiver (shown at the right) installed in the plane.

Bell Telephone engineers are working on a similar system, which shows airline dispatchers on the field the exact direction of approaching planes. The cathode-ray tube used in the Bell system will handle as many as ten planes, indicating their direction and distance from the field on the end of a cathode-ray tube marked out with compass bearings. The field may then inform each pilot of his exact position.

Television in the Spring—Sarnoff's Promise

● **"THE** results of the experimental field tests of television in the New York area conducted by RCA and NBC have convinced us that television in the home is now technically feasible," says David Sarnoff, president of RCA.

"RCA believes that the development of its television system has reached a stage where it is practicable to supply receivers to satisfy public demand in localities where television transmissions are now or may become available. Therefore, it is planning to manufacture and market a limited quantity of television receivers by the time the New York World's Fair opens. We are informed that a number of other radio manufacturers are also preparing to manufacture and sell receivers.

"We hope that advantage will be taken of these opportunities to build a new industry and establish greater public service."

E. A. Post, communications engineer of United Air Lines, inspects the DC-4's direction-finding loop antenna. Two additional receiving antennas are installed beneath the ship and a transmitting antenna above her.



↑ W. E. Reichle, Bell Labs. engineer, tests the radio telephone aboard the 42 passenger DC-4.



Aviation's Newest and Biggest Radio Rig

C. L. Stong

DC-4, new 42-passenger plane, will have 11 units of radio equipment to ensure perfect safety in the air



↑ Stanley Beers, company radio technician, carries one of the receivers aboard (see arrow). Some notion of the DC-4's relative size is conveyed by noting the stepladder under the huge wing.

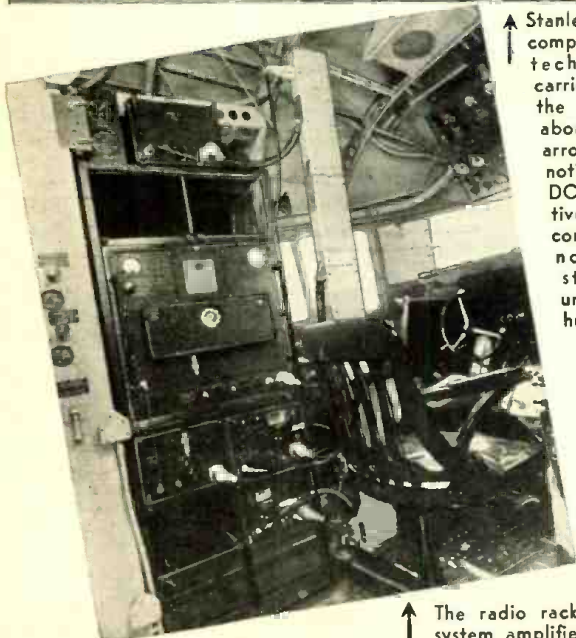

Photos courtesy Western Electric Co.

↑ The radio rack holds the inter-communicating system amplifier; the 250-watt transmitter, and the communications receiver. Auxiliary and beacon receivers are also seen.

● WHEN the giant new Douglas airliner DC-4, now undergoing tests at Santa Monica, California, roars into the sky with 42 passengers and three tons of air express, she carries the most powerful and comprehensive radio telephone yet developed for commercial air transport service.

To the air-minded public this means another long stride toward the goal of completely dependable air travel. Radio, and in particular *two-way* radio telephone between the pilot and landing field, has come to occupy such an important position as a navigating instrument, as a means for communicating weather information, and as an aid to flight scheduling and flight control generally, that airline officials now class it second only to the use of multiple engines as a safety device. To those charged with building our air transportation system, progress in aircraft radio as exemplified by the DC-4 equipment also means increased financial security because it enables larger planes, carrying more passengers, to fly longer distances at lower operating costs per passenger mile.

The 250 watt Western Electric equipment installed aboard the DC-4 is five times more powerful than conventional airplane transmitters and includes many unique features. For the first time, a flight crew is equipped to make simultaneous observations of the beacon, weather, and marker signals while holding two-way communication with the landing field. All power is supplied from the ship's 800 cycle auxiliary lighting plant. An intercommunicating system, that may be plugged into regular Bell System lines when the ship is on the ground, connects the pilot, co-pilot, flight engineer, and stewardess. During flight the pilot may talk over any one of ten different frequency bands, and a special direction finding loop enables him instantly to check the ship's position with respect to ground stations.

All major components of the system are assembled to form a panel installed on the "bridge" immediately behind the co-pilot's position. This unit, operated remotely from

a master control column which rises between the pilot and co-pilot, is entirely self-contained and is composed of the transmitter; communication, beacon, auxiliary, and marker receivers; and the intercommunicating system amplifier. Individual control panels, mounted at both flying positions, switch either headset independently to any or all receivers without affecting what is heard in the other headset. Facilities are also included in the individual panels for switching the microphones either to the ship's transmitter or to the intercommunicating system; for signalling the various stations connecting with the system; for adjusting headset volume; and for placing the transmitter on the air.

As the ship passes from one radio zone into the next, the transmitter and communications receiver to which it is geared are shifted progressively through five pairs of "day" and "night" frequencies, by means of a rotary dial on the transmitter panel. Instantaneous shift from day to night frequency is effected by a push-pull lever located on the master control column. Quartz-plate oscillators of new and superior design hold the several frequencies within required limits and a forced draft ventilation system cools the active elements of the transmitter with filtered air.

The communications receiver, too, is crystal-controlled and is of the superheterodyne type. Its maximum sensitivity is adjusted from the master control column and thereafter is regulated automatically by a special vacuum tube circuit.

The beacon receiver is basically similar to the communications receiver but differs in its purpose and in several minor features of mechanical design. Provision is made for reception on either a conventional single wire antenna, which is located beneath the fuselage, or from the shielded direction finding loop enclosed within the ship's wooden nose. The receiver is continuously tunable between the frequency limits of 195 and 415 kilocycles by means of an illuminated dial on the control column which also contains the sensitivity control knob and an indexed dial showing the loop position.

An auxiliary receiver, which may be operated from battery supply in event of power failure, covers all of the frequencies to which the pilot would normally have occasion to listen. It is tuned remotely from the control column by flexible shafting.

Marker stations are indicated by a series of colored signal lights which appear in the cockpit and which may be augmented by an audio signal heard in the headset. The crystal controlled receiver, which is of the superheterodyne type, requires no operating attention during flight.

Although the importance of this development to the immediate needs of the industry is obvious, its real significance is to be found in the future of aviation. "Over weather" or sub-stratospheric flight has been the dominant ambition of airline operators for more than a decade. Its realization necessitates flying above the clouds, and out of visual contact with the ground for long distances. Hence much of the involved problem of navigation must be shifted from the pilot's limited senses to the broader reach of radio.

Specifications for the new equipment were submitted by four leading airlines: United Air Lines Transport Corporation; Transcontinental and Western Air, Inc.; American Airlines, Inc.; Eastern Airlines, Inc.; and by the Douglas Aircraft Company, manufacturer of the DC-4. The system was designed by Bell Telephone Laboratories, Inc., and more than two years were required to perfect and complete the initial model.

RADIODDITIES

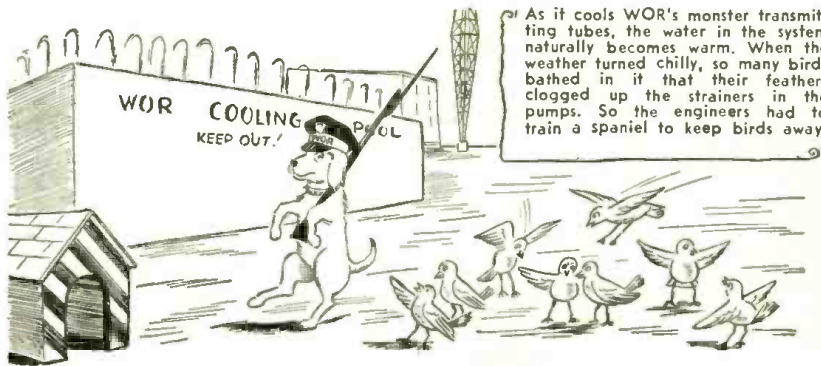

As it cools WOR's monster transmitting tubes, the water in the system naturally becomes warm. When the weather turned chilly, so many birds bathed in it that their feathers clogged up the strainers in the pumps. So the engineers had to train a spaniel to keep birds away.

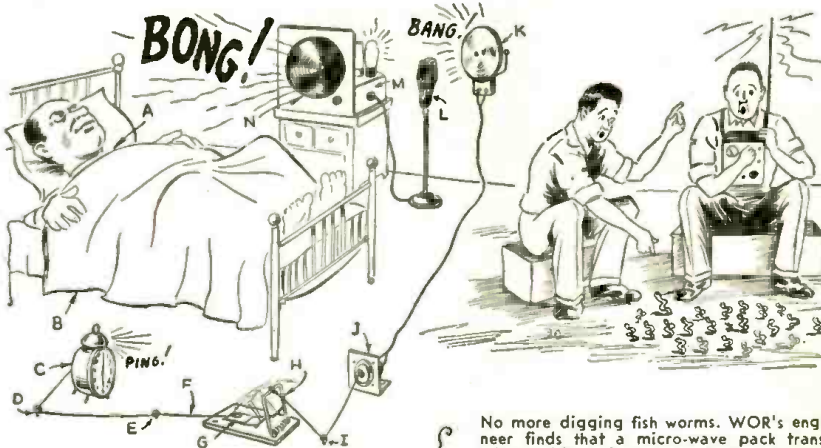

When CBS engineer John Norton worked an early shift, no alarm clock could wake him, so he invented a super-load system. A—John; B—Bed; D, E and I—pulleys; F—String; G—Mousetrap trigger; H—Mousetrap whammer; J—Switch; K—Gong; L—Mike; M—Amplifier; N—Very very loud speaker. (It worked!)

No more digging fish worms. WOR's engineer finds that a micro-wave pack transmitter drives 'em out of the ground. Moreover, tuning in on the worms' wavelength makes the critters turn out in any size desired. Ain't Science wonderful?

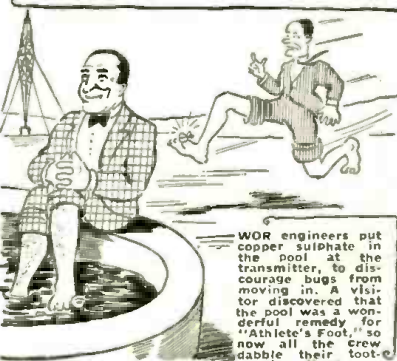

WOR engineers put copper sulphate in the pool at the transmitter, to discourage bugs from moving in. A visitor discovered that the pool was a wonderful remedy for "Athlete's Foot," so now all the crew dabble their toes there.

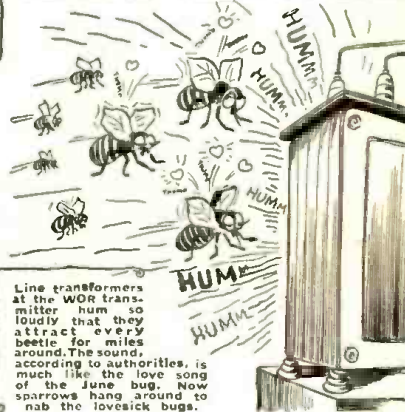

Line transformers at the WOR transmitter hum so loudly that they attract every beetle for miles around. The sound, according to authorities, is much like the love song of the June bug. Now sparrows hang around to nab the lovesick bugs.

\$5.00 for Best "Radioddity"

● THE accompanying pictures show a number of freak radio reception conditions which actually occurred in the vicinity of radio transmitters. The editors will pay a \$5.00 monthly prize for the best "Radioddity" sent in by our readers. The description should be about 150 words in length and may be accompanied by a sketch or photo. The occurrences described must be based on fact, like those here illustrated.

If you have never run across any "Radioddity" of any nature, you may be able to act as a reporter for us by interviewing radio friends and engineers, especially those connected with broadcasting stations. You will probably pick up some very amusing Radioddities.

For the best Radioddity submitted each month, the editors offer a \$5.00 prize. Others, whose contributions are used, will receive a 1 year's subscription to RADIO & TELEVISION. In the event of a tie between two or more contestants, an equal prize will be awarded to each.

Closing date for the next contest is December 10th. Prize-winning contributions will be published in the February, 1939, issue.

Address all contributions and communications to

Editor, Radioddities
RADIO & TELEVISION MAGAZINE,
99 Hudson Street,
New York, N. Y.

C. B. S.

TELEVISION HAS TECHNICALLY BEEN DEVELOPED TO A HIGH DEGREE. THIS ARTICLE PROVIDES THE LATEST INFORMATION. IT WILL BE SOME TIME BEFORE HOME TELEVISION IS REALIZED. THE ART HAS GREAT OPPORTUNITIES FOR EXPERIMENTERS AND TECHNICIANS.

Sets the Stage for TELEVISION

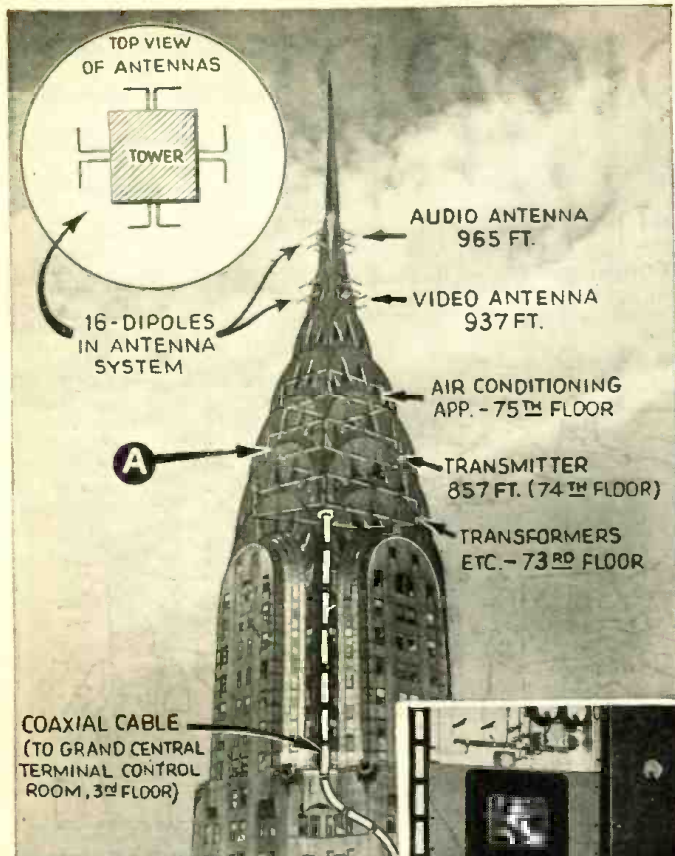

● EXPERIMENTERS equipped with television receivers will have a second source of television programs to tune in on shortly after the first of the year when the Columbia Broadcasting System's new television transmitter in New York City will be completed. This station is expected to cover a radius of about 40 miles (an area of about 4,800 square miles). Field tests have indicated that under good transmission conditions, the signals from such a station may be picked up at distances greatly in excess of 40 miles, possibly 75 to 80 miles.

The \$500,000 transmitter is being installed in the Chrysler Building at an elevation of 874 feet. The higher the antenna, the greater the range of transmission for the ultra short waves used in television.

Dr. Peter C. Goldmark, Columbia's chief television engineer, has charge of the installation. There will be 16 dipole antennas—8 for sound radiation and 8 for visual images. All antennas will be heated electrically by a thermostat control in cold weather so that ice cannot form on them.

Powerful transformers and reactors are being installed on the upper floors of the Chrysler Tower to supply this new vision transmitter with the necessary power, totaling 1,300,000 watts. Of this great power, the transmitter will use about 300,000 watts for sending out the high-definition 441-line picture signals.

The image signals will be broadcast on frequencies between 51 and 52.5 megacycles. The sound will be broadcast on 55.75 megacycles.

The principal television studio is being erected in Grand Central Railroad Terminal in New York City, a short distance from the Chrysler Building. Additional studios will be connected with the television transmitter by means of a coaxial cable, of the same size as that now in use for experimental tests between New York and Philadelphia. This cable is 3/8" in diameter and one spare coaxial channel is incorporated in the cable.

The vision transmitter is located on the 74th floor of the Chrysler Tower, while air conditioning apparatus is located on the 75th floor. On the 73rd floor are the power transformers, reactors, motor-generators and water-cooling system for the power tubes.

The call letters of CBS's new television transmitter are W2XAX. Due to the very high voltages used on the tubes of the transmitter, special safety devices are provided to protect the engineers in charge. All doors to the transmitter room proper and also high voltage equipment, will be fitted with *interlock* switches to cut off the power automatically whenever any door or panel is opened.

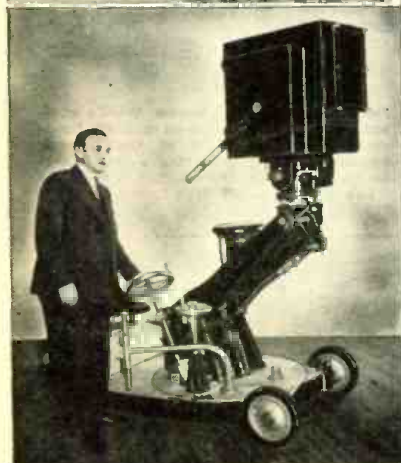
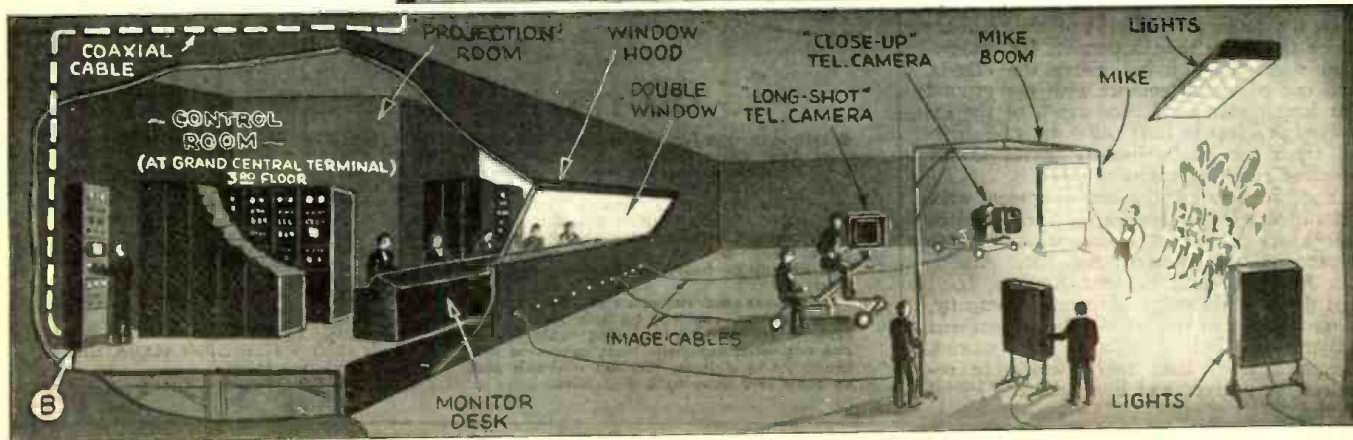
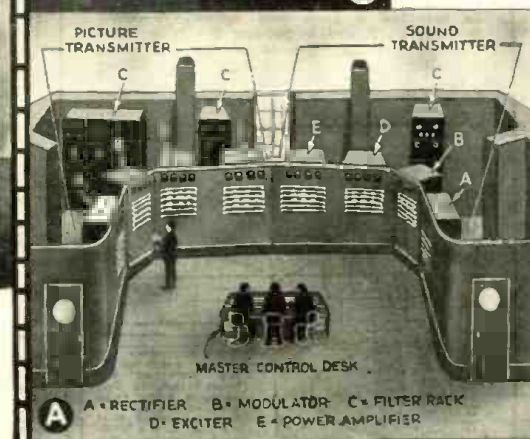

Photo above shows a CBS television camera used for picking up the image in the studio. Dr. Goldmark, CBS television engineering director, is shown at one of the monitor control panels, in photo at right, and just below it, is a glimpse of the television transmitter itself. Below—Television studio.



with the YL's



▲ DECORATIVE Elizabeth M. Zandonini (W3CDQ) got her commercial ticket in 1917, her ham license in 1922. She operates on 7, 14 and 28 mc., and works in the Natl. Bureau of Standards, in Washington. She answers letters, makes translations and helps maintain the primary standard of R.F.



▲ CHARMING Eve Sanford (W4DAI) is the wife of another ham, Dr. E. F. Sanford (W4DHM). She operates exclusively on cw, on the 40 meter band, and has had her license since June 29, 1934. Eve is a member of AI Operators, N.W. Ga. Radio, and Rag Chewers clubs; has her WAC and WAS on 40. She can send and receive upward of 55 words a minute, though 40 is her normal rate.



▲ INTENT upon her rig is Ethel Clark (W8PXE), who has the works built into a folding desk, so that it can be locked away from her two small sons. Her husband, whose hobby is radio construction, built the rig. A ham for 2 years, she hopes to add another band to her program soon.



▲ NONCHALANT Mary E. Roden (W7GPO) is an XYL like her pal, Margaret E. Willcutt (W7GQK). They're the only two of that class in their county. The two girls studied together for a year and built an 80 meter transmitter in preparation for the license exams, which they passed last January. Margaret operates on 10, 20 and 40 meters, Mary mostly on 28 mc.



◀ CAPTIVATING Mae E. Amarantes (W6DHV) has been a 100% cw ham since getting her license early in 1931. She's the first YL to get a license in her section, and built her first rig with her own fair hands. Her best DX was achieved on that outfit. Mae is an active member of the ARRL, but gets most fun from rag chews. She's an XYL.

INTERNATIONAL

Latest Radio Developments

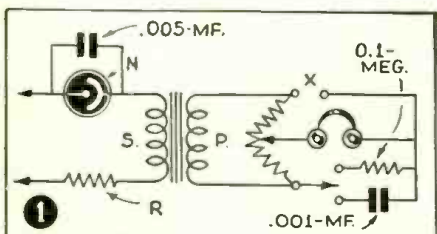

"C" and "R" Meter

1 A simple meter for testing capacity or resistance is described in "Practical and Amateur Wireless" of England. Fig. 1 shows the circuit. The oscillations are generated from a d.c. source by means of a small neon bulb paralleled with a fixed condenser. The transformer has a 1:1 ratio. The potentiometer is 10,000 ohms and is provided with a pointer having two arms to read on two separate scales—one indicating resistances; the other, capacities. The voltage source may be from 120 to 240, obtained either from a well-filtered lighting line or batteries, or a well-filtered rectifier. The component under test is connected across the X terminals, the line current switched on and the potentiometer varied until the hum heard through the phones dies away. Too high an input voltage will make this point hard to locate. While logarithmic means of calibrating the instrument may be used, it will be simpler to connect various values across the X point and draw up a scale from these known values filling in any intermediate points.

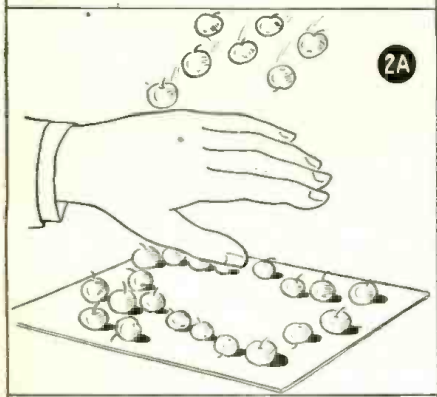

The Super Microscope

2 Television principles are employed in the latest type of microscope, as described in "Radio-Amateur," a German publication. Wave lengths of light make it impossible to get exceedingly great magnification using optical systems. Therefore, an electronic means whereby a stream of electrons is impeded by the object to be magnified and is then caused to spread over a fluorescent screen, has been devised. Fig. 2A gives an analogy, the electrons being represented by apples. Fig. 2B shows the principle of the microscope, but does not indicate the beam spread; so you see where no beam spread is used, the size of the image on the fluorescent screen would equal the size of the object. Magnifications up to tens of thousands of diameters are possible.

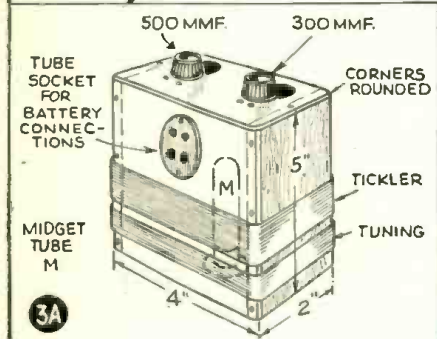
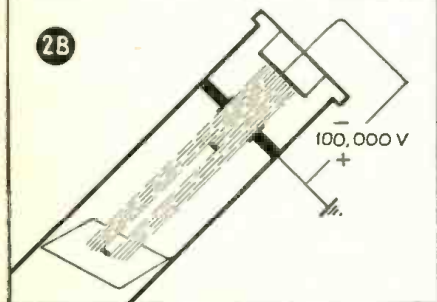

Quickly Made One-Tube Receiver

3 When the radio set breaks down just before the big fight, you do not need to miss it. A box 2" x 4" will serve not only as the cabinet but as the coil form as well. The feed-back coil may be 40 turns of No.

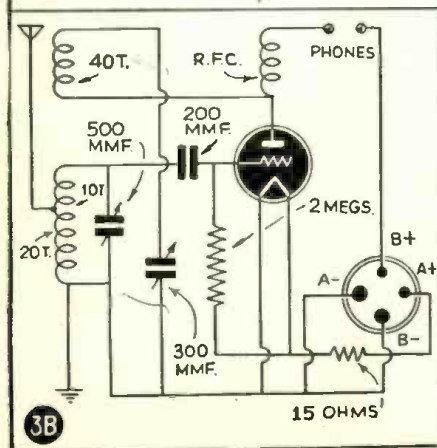

30 enameled wire, while the grid coil is 30 turns of the same size wire tapped 10 turns from the end nearest the feed-back coil. The layout is shown in Fig. 3A; the circuit in 3B. The tube socket is mounted inside the bottom of the box and the condensers on the top. While a ground is not entirely essential on this set, it is apt to oscillate unless one is used.—*Practical & Amateur Wireless (London)*.

Experimental 1 1/4 Meter Transmitter and Receiver

4 "Television and Short-Wave World" of Britain shows an interesting experimental 1 1/4 meter (240 mc.) transmitter and receiver. Fig. 4A shows the transmitter; Fig. 4B, the receiver. These may be bread-board models and the designer, Geoffrey Parr, reported good success with this type of construction. In Fig. 4A, V-1 is an Acorn tube; V-2 is a high-gain audio frequency amplifier. In Fig. 4B, V-3 is also an Acorn while V-4 is any standard A.F. amplifier tube. Condenser C-1 should be of the ceramic type; R1, a 5000 ohm, 1/2 watt resistor. Other values are shown in the accompanying table.

C1	1000 mmf.	R2	450 ohms
C2	10 mf.	R3	500 ohms
C3	10 mf.	R4	100,000 ohms
C4	50 mmf.	R5	Optional—see text
C5	100 mmf.	R6	10 megohms
C6	.01 mf.	R7	20,000 ohms
C7	10 mf.	R8	500 ohms
C8	.01 mf.	R9	75,000 ohms
R1	5,000 ohms		

In building the transmitter, use the Acorn socket as a starting point, positioning everything else as close to it as possible. The same holds true for the receiver. The aerial should be slightly under 1/8 of a wave length and should be mounted on two stand-off insulators on the side of the chassis. If the tuning condenser C-2 seems to have too much capacity, shorten the aerial; if too little, lengthen it. For the receiving aerial, a half wave length is recommended as superior to the 1/8 wave. The usual means of tuning the set are employed.

Regeneration in Superhets

5 Far more effective than ordinary receivers is a single signal receiver. One way of achieving this is to use a crystal

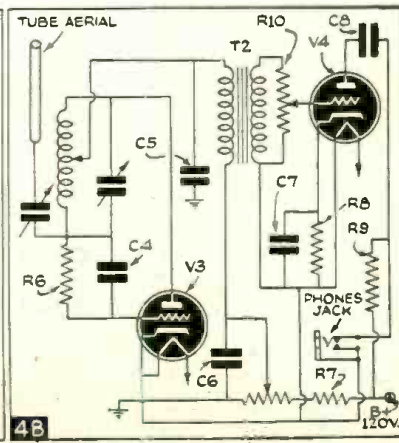
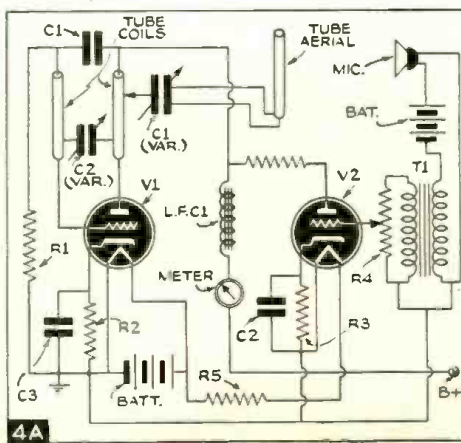

RADIO REVIEW

from World-Wide Sources

filter. Equally good and less costly is to add regeneration in the I.F. and R.F. In the I.F., regeneration works much like a regenerator first detector. The standard 465 kc. transformer takes an additional winding of 25 turns of No. 33 D.S.C. jumble-wound in the same direction as the grid coil, and at its ground end. Fig. 5A shows the connections. The feed-back coil is L3, with resistor R acting as a control. C4 prevents shorting the cathode resistor. Fig. 5B shows a system employed where no I.F. stage is included in the set. Fig. 5C shows cathode injection. In making this change in your set, remember that long leads or poor shielding will cause instability, according to "Television & Radio Bulletin." Cathode feed-back in the frequency changer stage is shown in Fig. 5D where R5 is the regeneration control. Electronic means of securing the same effect are also possible.

Pump Keeps C. R. Vacuum High

6 Gilbert Seldes, dramatic director of Columbia Broadcasting System's Television Division, is seen pointing at a pump which is connected to a metal cathode-ray tube. The end of the tube which bears the fluorescent screen has been removed and is held in Mr. Seldes' left hand. This type of tube is made to be operated while under continual exhaustion by the vacuum pump, and although it is not practical for a home television set, it has various advantages in the laboratory.

Efficient Television Aerials

7 As television approaches more closely in the United States, more thought must be given to compact antennas suitable for apartment house installations. Fig. 7A shows two means in which a simple half-wave dipole may be folded to conserve space. Fig. 7B shows how a folded reflector may be used with an aerial of this type. Such a reflector will increase gain to a marked extent. Fig. 7C shows still another means of reducing antenna lengths. In this case, metal plates are affixed to the ends of the dipole—a form of capacity loading. Twelve-gauge wire is heavy enough to support such copper plates. Fig. 7D shows another means of

loading—this time by inductance. The typical example of this type would be an aerial having an overall length of approximately 6 feet, loaded with an 18-turn inductance, air-wound to a diameter of about $1\frac{3}{8}$ inches. Cut-and-try methods on the aerial will be necessary to afford best response on $6\frac{1}{4}$ meters.—*Telev. & S. W. World (London)*.

Latest Television Camera

8 The Super Emitron, a new type of television pickup tube, which is now being used for all outside broadcasts by the British Broadcasting Co., represents a considerable improvement on the old type. A beam of electrons from a conventional electron gun G scans a mosaic M similar to that of a standard Emitron, except that in this case the mosaic elements are not photo-sensitive. In fact, the charge-storage electrode may now be a plain sheet of mica backed by a metal signal plate. The optical image is focused by a lens L onto a conducting transparent photo cathode P, which is supported on a thin sheet of transparent material (e.g., glass or mica) situated close to a polished glass window W.

The light liberates photo-electrons from the side of this photo cathode opposite to that on which it falls, these electrons having the same distribution as the light in the optical image. The electrons are accelerated by an electric field between the cathode which is held at about -500 volts, and the metal coating B on the internal walls of the cylindrical glass tube T. This coating is an extension of the second anode of the electron gun, and both are held at ground potential.

Encircling the glass neck T is an iron-clad magnetic coil C, which forms a magnetic electron lens and enables the electrons that leave the cathode to be brought to a focus on the surface of the mica mosaic. These electrons liberate several secondary electrons each when they impinge on the mica surface, and these secondary electrons now assume the same role as the photo-electrons that are ejected from the mosaic of the tube by light. From this stage onward the mechanism of signal production is essentially the same as that in the standard Emitron.—*Television & S. W. World (London)*.

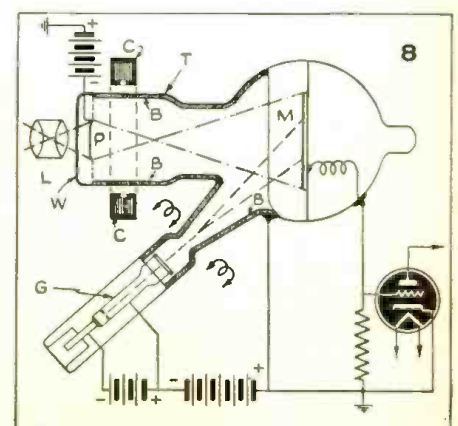
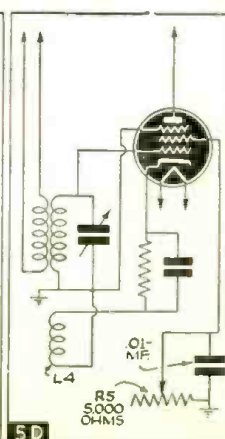
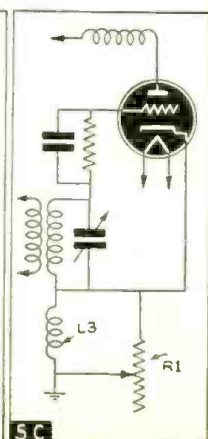
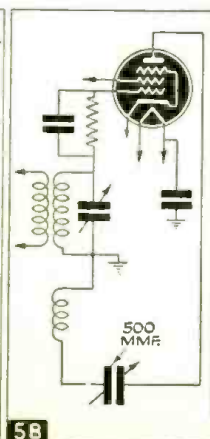
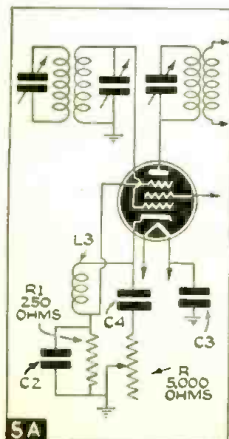
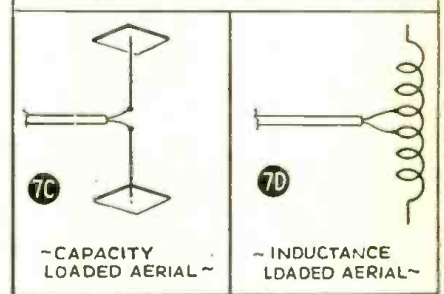
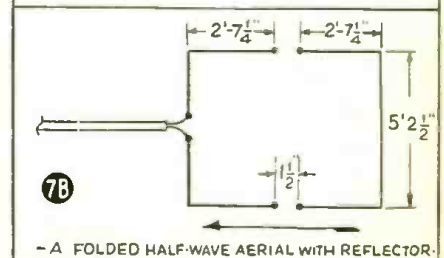
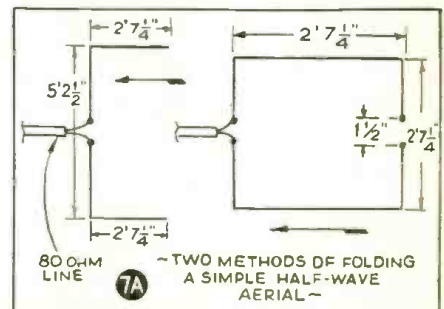



The good ship "We're Here"—one of the finest schooners in American coastal waters—scuds across the sea as the radio waves direct her.



Freddie Bartholomew became so interested in radio that he persuaded Radio Chief Matthew Murray to help him try for a 3rd Class Amateur Phone License.



Matt Murray and one of his assistants working the "We're Here" from their shack on the "Invader."

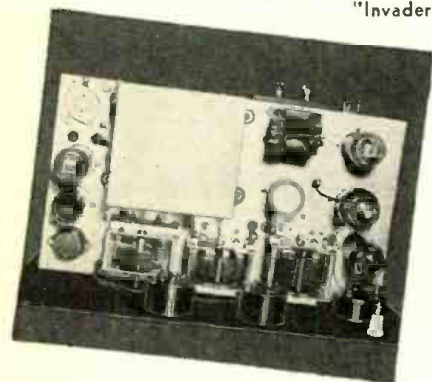

Top of xmtr. 42's as oscillator and speech amplifier, 802 final stage, 6A6 Class B modulator; built-in genemotor; 2 xtals; Collins network permits use of any length antenna. Net weight, 30 pounds. BELOW: Director ashore listens-in and directs action at sea.

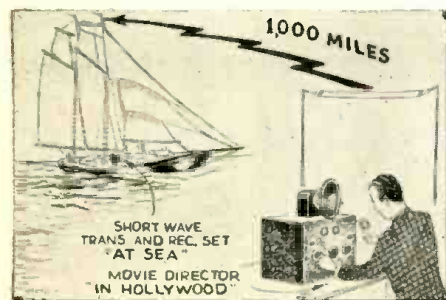

How *Radio* Helped to Film "Captains Courageous"

J. M. Goldby

The inside story of how a Radio Amateur made it possible for Hollywood to film a thrilling sea saga.

● RADIO played an important rôle and added another new field to its already numerous uses when it aided in the filming of the sea sequences of the motion picture, *Captains Courageous*. For the first time it became possible to take scenes which, without the use of radio, would have been much too dangerous to attempt. When the first previews of this film were shown to movie critics and to men versed in the technique of motion pictures, they thrilled to and marveled at the scene where the *We're Here* and the *Jennie B. Cushman* almost collided during the race toward their supposed port. This was one of the hundreds of dangerous shots that was taken, made possible only because the pilots of both vessels heard the directions fired at them by the Director instantaneously and simultaneously. Each skipper knew which way the other was going to turn. It was a difficult and dangerous maneuver which was arranged only by good radio equipment and efficient radio operators.

This was the consensus of opinion of the entire staff of photographers and technicians who worked on the picture and is explicitly summed up by Mr. Lester White, Metro-Goldwyn-Mayer's Director of Photography for the sea scenes, "I emphatically state that it would have been impossible to take most of the thrilling scenes and it would have been suicide to attempt to maneuver the ships into such dangerous positions *without radio's aid!* I've been filming sea sequences for the past few years

and can definitely state that any company who attempts to shoot sea scenes *without the aid of radio* will pay ten times the normal cost in money, time and aggravation for every one concerned."

A veritable flotilla sailed out of Los Angeles harbor for the open expanse of the Pacific Ocean, deliberately aiming for the nearest storm center. Consisting of thirteen sailing vessels, three tugs and sixty dories, this motion picture unit carried, in addition to its regular equipment of cameras, technicians, cast of actors and directors, a little-known piece of apparatus especially built for this job, plus the knowledge and ability of Matthew Murray, ace Ham operator, W6OJL, and holder of a Commercial First Class phone ticket.

When Director James Havens first conceived the idea of using radio in motion picture directing, he knew that some special equipment would have to be built to fit into his specifications because of the unusual work such apparatus would be called upon to perform.

L. W. McDowell of Long Beach, Calif., took all the requirements into consideration and finally built the transmitter shown here into its compact casing, using but 30 major parts in the entire assembly. This "rig," with an input power of only 10 watts, was able to put 80 microamps into KOU's antenna at 1300 miles and at no time was ever out of communication with this San Pedro station. It uses a 42 oscillator.

(Continued on page 511)

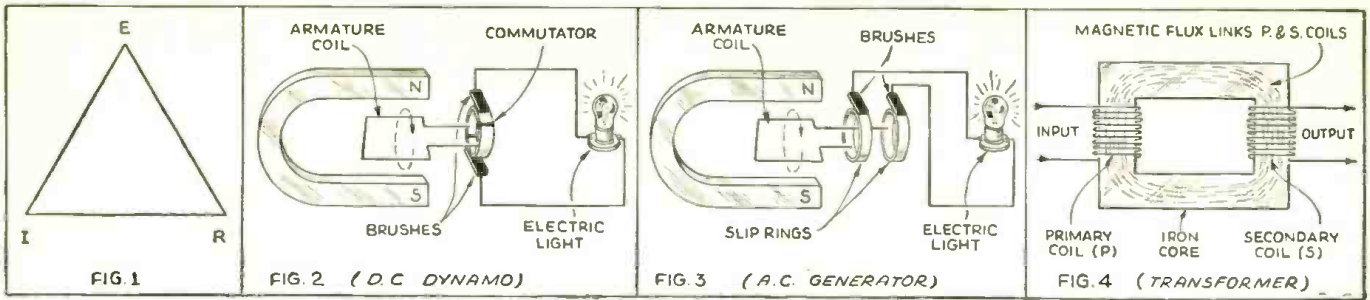

Memory trick for Ohm's Law; D.C. & A.C. dynamos; and a transformer.

The Radio Beginner—Lesson 2

How Electricity Is Generated and Measured

Martin Clifford, W2CDV

IN the first article of this series we discussed such terms as *current*, *voltage* and *resistance*. It is no haphazard chance that these terms are grouped together, and no accident or coincidence that a discussion of one usually involves the other two. Current, voltage and resistance are directly related—for if we know any two of these terms, we can always find the third through the use of a very simple, but exceedingly important formula known as *Ohm's law*. Briefly stated, Ohm's law (named after the man who first formulated it) is:

$$E = I \times R \quad I = \frac{E}{R} \quad R = \frac{E}{I}$$

Since it would be very cumbersome to write out the words—voltage—current—resistance in the formula, we simply substitute alphabetical letters for them. Thus, for example, we let the capital letter E stand for voltage; I for current (in amperes) and the letter R for resistance (expressed in ohms).

We need not make any effort to memorize this simple formula, since there is a very easy way of remembering it. Simply draw a triangle, as shown in Fig. 1. Place the letter E on top, the letter I in the lower left-hand corner and the letter R in the remaining corner. Using the triangle is not at all difficult. To find the voltage, just cover the letter E at the top of the triangle with your finger—and you have the answer—I times R. If we wished to find the resist-

ance, we would just cover the letter R with our finger and the answer would be E over I. To find the current, we would cover the letter I and the answer would be E divided by R (or E over R).

At the close of the previous lesson we discussed *alternating* and *direct* current—now let us see how these currents are produced.

How Current Is Produced

We have already seen that a permanent magnet has a magnetic field about its poles. We have also shown that if we took this permanent magnet, and plunged it in and out of a coil of wire, a galvanometer connected to the coil would show a reading. If, instead of moving the magnet in and out of the coil, we moved the coil and kept the magnet still, the result would be exactly the same. Here, then, we have the basic idea for generating current . . . simply take a permanent magnet and revolve a coil of wire around it.

In Fig. 2 we see the elementary principle of the d.c. dynamo. We are already familiar with our old friend the permanent magnet. The part labeled "armature coil" is nothing more or less than a coil of wire. This coil of wire is mounted on a shaft. The shaft is not shown in the drawing since it is purely a mechanical feature and need not concern us here. When the armature coil of wire starts to revolve between the poles of the magnet, a current of electricity is generated in the coil. However, the current in the coil would be of no use to us, unless we could in some way draw it off

and put it to use. This is done by connecting the armature coil (as shown in the sketch) to a *commutator*. The commutator in its simple form is a copper ring, the two halves of which are separated by a bit of insulating material. Since the commutator is connected to the armature coil, it rotates with it. In order to utilize the current in the rotating commutator, we place brushes of copper mesh in contact with the commutator. We can now light up a lamp by connecting it across the commutator brushes. To sum up—a d.c. dynamo may be simply a coil of wire moving in a magnetic field, plus a provision for leading the current away from the moving coil by means of sliding contacts.

The generation of *alternating* current follows the same principle, except that two *slip rings* are used to draw off the current instead of using a commutator (shown in Fig. 3). Naturally, the generators we have shown are the simplest types imaginable. Modern generators do not use permanent magnets, but use relatively soft iron over which are wound coils of wire (carrying current) to produce the magnetic effect. The amount of voltage and current that we can get out of our generator depends upon the strength of the magnetic field, the size of the wire, the number of turns that constitute the armature coil, and the speed with which we rotate the armature coil.

Transformer Action

Now that we have produced alternating
(Continued on page 500)

Schematic of transformer and three types of meter movements.

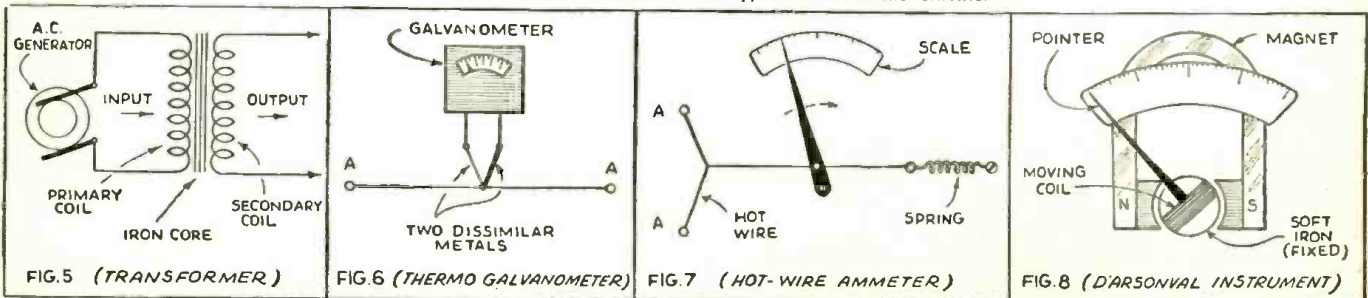

Short Waves Featured on SS. "Nieuw Amsterdam"

Below—Another view of radio cabin aboard the "Nieuw Amsterdam." The operator is adjusting the speech volume control on the radiophone transmitter.

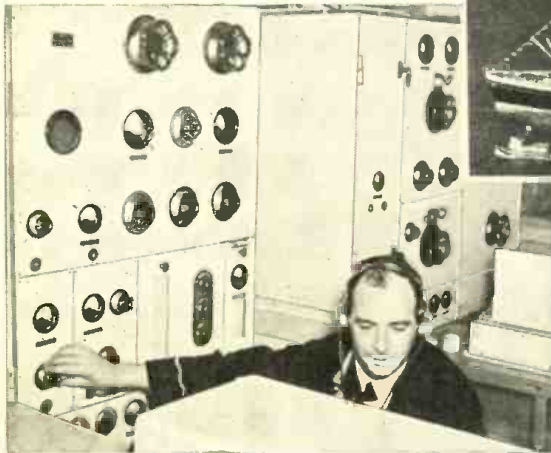

Above—The palatial new liner—SS. "Nieuw Amsterdam" entering New York Harbor. Note the comparative size of the tugboat and buildings.

Below—Radio cabin aboard the new Holland-America liner, the SS. "Nieuw Amsterdam" which is equipped with Bell system ship-to-shore service. Operator is tuning the radio phone receiver.



(Photos of radio cabin courtesy A. T. & T. Co., Long-lines Department)

● THE magnificent new Holland-America liner, the *Nieuw Amsterdam*, features short waves to a great extent. One of the accompanying photos shows one of the radio operators tuning the Phillips receiver, while another photo shows a good view of the various transmitters on the ship.

The amount of radio traffic handled on a trip across the Atlantic on such a palatial passenger steamship as the *Nieuw Amsterdam* may be readily visualized, and the several transmitters are on more or less constant duty during a great part of the trip across the ocean. Passengers can talk from the ship to shore at any time, thanks to the special radiophone transmitter with which the ship is equipped.

The main radio transmitter on the *Nieuw Amsterdam* is rated

at 800 watts and can be operated on all wavelengths between 600 and 800 meters (code).

The main receiver tunes to all wavelengths between 1800 and 24,000 meters.

A short-wave transmitter (code), rated at 200 watts, operates on all wavelengths between 17 and 55 meters.

An emergency radio transmitter (code), of 100 watts rating, can be operated on any wavelength between 600 and 800 meters.

The ship-to-shore short-wave phone transmitter, for the use of passengers, is rated at 500 watts and can operate on any wavelength between 16 and 90 meters. It is equipped with a special scrambler which renders the transmitted voice unintelligible if it should be picked up on any ordinary short-wave receiver.

Radio Talks from a Guiana Jungle



"On one occasion, a particularly vicious wasp bit me in the side . . . and my yell was heard coast-to-coast."

● RADIO may be old stuff in the United States, but the citizens in the interior of British Guiana still do not understand it, according to Orison Hungerford, operator of the Terry-Holden Expedition station VP3THE, who relayed a series of programs from the tropical jungle to the National Broadcasting Company networks.

"Our camp was some 600 miles up the

Essequibo and Rupununi rivers," said Hungerford, "and after we set up the radio shack we began to receive visitors. For a couple of weeks the most faithful of these were a group of Wai-wai Indians, who came to inspect the radio equipment and everything else we had. These Indians, who came decked out in their finest paints, must be the most curious people in the world. They didn't steal anything, but they did inspect everything around the radio shack. If there was something they didn't understand they'd simply break out in loud laughter. It took radio to make them serious.

"The ringleader of these Wai-wai Indians was a tall, handsome fellow. One night when we were working and our visitors were all gathered around I put the earphones on this fellow's head. Blank amazement. His eyes moved first to left, then to right. I took the phones off a minute and he still stood there. All this time there was never a word except those he heard through the earphones. He gave one final look around the shack and then turned on his heel and walked out. All the rest followed in silence. And that was the last we saw of our Wai-wai friends. They're probably walking yet.

"Then there was a little girl who came with her mother. She listened to the



"We were soaked, but we kept our date with the radio audience . . . and it gets cold—even in the jungle!"

strange noises coming out of our receiver while we were talking to NBC in New York. She looked first under the table, then up at the ceiling to find out where the voice was coming from. Then she went outside and looked up at the roof. All of a sudden there was a loud wail. The only way we could stop her was to let her

(Continued on page 485)

RADIO Test Quiz???

Meet Your Professor—Robert Eichberg

Pit your brains against the best brains in radio! Every month The Old Professor will back some leader in the radio field into a corner and test his general knowledge with the QUIZ. The expert will not be given a chance to see the questions in advance, or to look up the answers in reference books. There's no cribbing under The Old Professor's eye.

R. D. Washburne, Managing Editor of Radio-Craft, was this month's victim. After 32 minutes spent on the QUIZ, Mr. Washburne emerged with a score of 82½% and a slightly dazed expression.

Now see what you can do. To calculate your rating, credit yourself with 4% for every question you answer completely right; 2% for every question you get half right, etc. Average scores are: Beginners, under 50%; Experimenters and Servicemen, 50 to 75%; Experts, 75 to 95%; Wizards, over 95%. Which are you?

1. In the following list, one of the items is as out of place as a tramp at the Ritz. Can you find it and tell why?

- a. Bleeder.
- b. Trimmer.
- c. Oscillation suppressor.
- d. Potentiometer.
- e. Volume control.
- f. Rheostat.

2. In most major broadcasting stations, the sound effect of a railroad train is produced

- a. By rubbing two pieces of sandpaper together.
- b. By making sounds with the mouth.
- c. From a phonograph recording.
- d. By scuffing the feet on a sounding board.

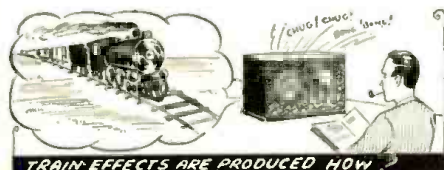

3. The tube charts list certain tubes as "general purpose tubes", but which of these jobs can't you use them for, satisfactorily?

- a. R.F. amplifier.
- b. A.F. amplifier.
- c. Power output.
- d. Detector.
- e. Rectifier.
- f. Oscillator.

4. Match up the meters listed in one column with the items to be tested, in the other.

- | | |
|----------------------|--|
| a. 0-50 ohms | A. Power rectifier output potential. |
| b. 0-50,000 ohms | B. Filament potential of battery set |
| c. 0-10 volts D.C. | C. Potential drop in bleeder. |
| d. 0-10 volts A.C. | D. Resistance of bleeder. |
| e. 0-1000 volts D.C. | E. Filament rheostat of battery set. |
| f. 0-1000 volts A.C. | F. Potential across power transformer secondary. |
| g. 0-10 ma. | G. Output to speaker voice coil. |
| h. 0-10 amps. A.C. | H. Screen grid current in R.F. |

5. If your boss told you to get him a crystal so that he could make a microphone, he might fire you if you didn't come back with a

- a. Rochelle salt crystal.
- b. Galena crystal.
- c. Quartz crystal.
- d. Carborundum crystal.
- e. Piezo-electric crystal.
- f. Silicon crystal.

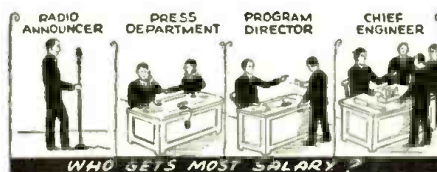

6. In broadcasting stations, which of the following jobs pays the highest average monthly wage?

- a. Announcers.
- b. Press agents.
- c. Program directors.
- d. Chief engineers.

7. Ignoring any other advantages or disadvantages, which may be inherent, which type of contact between a shaft and bearing gives the best electrical connection?

- a. Pigtail.
- b. Wiping.
- c. Sliding.
- d. Rolling.

8. A photo-electric cell can be used to advantage in all but one of the following. Which is the outcast?

- a. Burglar alarm.
- b. Light meter.
- c. Television pick-up.
- d. Motion picture sound system playback.
- e. Motion picture sound system recording.
- f. Smoke density meter.

9. In the recent European unpleasantness (just before the Four-Power Conference) it was said that Radio was especially deserving of mention as:

- a. A means for spreading propaganda.
- b. A means of spreading international good will.
- c. An aid toward the preservation of peace.
- d. Good for light entertainment, but nothing more.



10. Of course you knew all along that the purpose of a volume-expander is to

- a. Make weak stations come in with more volume.
- b. Increase the volume of all stations.
- c. Increase the apparent volume of loud passages in reproducing voice or music.
- d. Increase the apparent volume of soft passages in reproducing voice or music.

11. In putting up an outdoor antenna, many radio men use stranded enameled wire because

- a. It looks better.
- b. It does not corrode so rapidly.
- c. It offers a greater surface area.
- d. It is cheaper in the long run, as it lasts longer.

12. You ought to be ashamed if you don't know that the intermediate frequency in a superhet is obtained by

- a. Adding the frequency of the incoming wave to that of the locally generated oscillation.
- b. Subtracting the frequency of the incoming wave from that of the locally generated oscillation.
- c. Modulating the locally generated oscillation with the envelope of the incoming wave.
- d. Subtracting the frequency of the locally generated oscillation from that of the incoming wave.

13. A rabid radio fan wants to send his favorite star a birthday present. So whose birthday is which?

- | | |
|---------------------|------------------|
| a. Bing Crosby | A. Dec. 25, 1893 |
| b. H. V. Kaltenborn | B. July 28, 1901 |
| c. Bob Ripley | C. May 2, 1904 |
| d. Lowell Thomas | D. April 7, 1891 |
| e. Rudy Vallee | E. April 6, 1892 |
| f. Walter Winchell | F. July 9, 1878 |

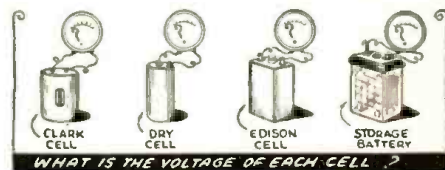

14. Just to be unreasonable, let's hear you give the correct voltage of each of these cells.

- a. Clark cell.
- b. Standard dry cell.
- c. Edison (alkaline) storage cell.
- d. Standard (lead-acid) storage cell.

15. Maybe you're too young to have heard of Jack Binns, but we oldsters remember him as

- a. A pioneer in the use of ultra-short waves.
- b. The first man to radio a call for help from a sinking ship.
- c. The first man to respond to a call for help radioed from a sinking ship.
- d. The inventor of ship-to-ship radio telephony.

16. The most efficient means of transmitting high frequencies by means of wire lines is

- a. Widely separated single wires.
- b. Twisted pair.
- c. Transposed lines.
- d. Co-axial cable.
- e. Shielded wire inside grounded shield.

17. If a voltage doubler is used to increase the voltage in a circuit approximately two-fold, a voltage multiplier

(Continued on page 490)

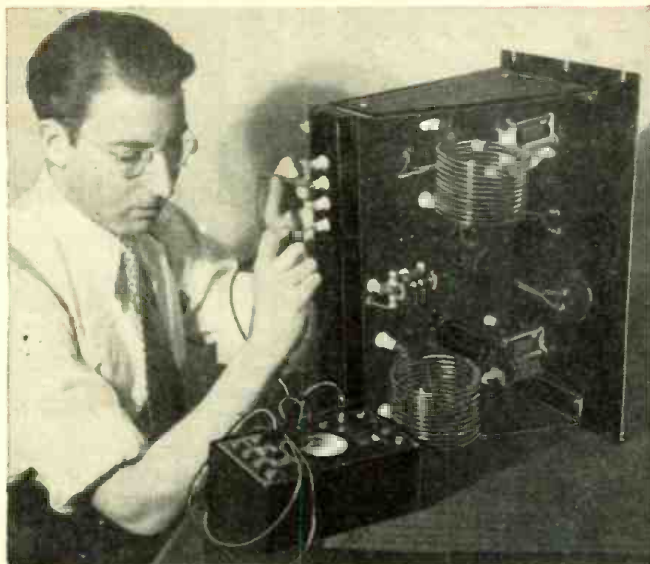

Shooting Trouble on the Ham Transmitter

Alvin Abrams, W2DTT

Several interesting problems met with in operating transmitters are here described.

● IN this article, the author will attempt to describe some puzzling conditions which have been encountered in transmitter servicing and the methods used to locate the source of trouble. These experiences have been garnered for the past six years, during which time the author has worked on nearly every type set familiar to the radio amateur. No effort has been made heretofore to describe these unusual circumstances which occur frequently and because they are so diversified and complex in nature, they stimulate the curiosity and are worthy of printed description.

As we know, all radio hand-books and periodicals describe in great detail prosaic

upon modulation it was found that the antenna current decreased and was therefore not working correctly. The causes for downward modulation were then reviewed and mentally tabulated. The first cause, overloading of the amplifier, was discounted and rejected because the plate current was normal, that is, at its calculated value. The second cause, inaccurate or off resonance tuning of the plate tank condenser, was likewise discarded because the stage was tuned precisely. The third cause, insufficient excitation was considered because it appeared that the grid current was possibly a shade too low.

The first step to a solution was made

indicating that the stage was apparently neutralized properly. As a further test, the neutralizing condenser was shifted to a random position and the amplifier condenser once again rotated until the bulb lit. The neutralizing condenser was then adjusted until the bulb went out. The setting of the condenser was identical to the previous setting.

The plate power was reapplied but still, upon modulation, the antenna current would decrease approximately 5 per cent, and again when excitation was removed the amplifier would continue to oscillate. This was extremely puzzling and annoying.

Connections to all tuned circuits were checked and found to be in good condition,

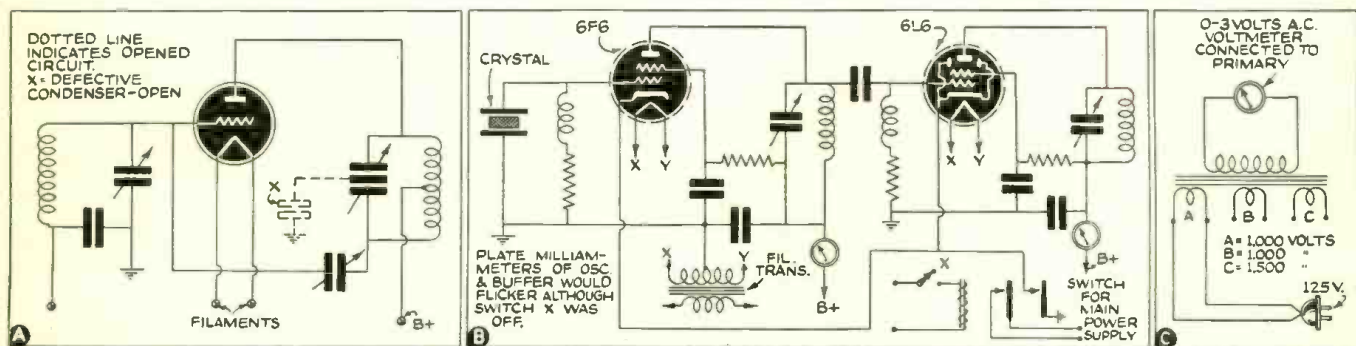

Left: Defective condenser problem—"X" marks the spot! Center: Plate meter "flicker" mystery. Right: Test for "short-circuited" secondary: the exciting current is connected to the "secondary" for this test.

transmitter troubles such as downward modulation, imperfect neutralization, distortion in audio frequency and radio frequency equipment, although it will be admitted that each case presents its own peculiar problems. It is therefore hoped that the following will prove of inestimable value when similar situations are met with. Here is a sample problem which will further clarify the type of situation referred to above.

Trouble from a Defective Condenser

The circuit involved consisted of a single-ended plate neutralized stage with a balanced tank circuit. The amplifier was neutralized and excitation and plate voltage applied. According to the meters in the circuit, it was functioning satisfactorily, but

when the B positive switch to the exciter stage was accidentally disconnected and surprisingly enough did not trip the overload relay in the circuit of the amplifier, as would normally be the case when excitation is removed from an automatically biased stage. With excitation removed, the amplifier plate current did not flicker perceptibly, and in fact, the amplifier was actually working by itself. Immediately, it was thought that the stage was out of neutralization, that is, the tube was returning part of the output power to the input, and hence was in an oscillatory condition.

A neon bulb was therefore coupled to the tank and the B positive switch was shut off but excitation applied. The amplifier tank condenser was rotated throughout the scale but the neon bulb did not light, in-

leaving only one possibility untried, that of a defective part.

It was thought that the trouble was originating from some portion of the tuning or neutralizing circuits. An ohmmeter was used to check all condensers and showed that they were in good condition, i. e. not shorted. A 250 volt source was then used to determine whether possibly one of the condensers was open. All checked good with the exception of one! This was a .002 microfarad condenser used to isolate the rotor of the amplifier plate tank condenser from ground which was put in to remove the direct current potential between rotor and stator. It was temporarily shorted out and the stage then worked to complete satisfaction.

(Continued on page 495)

New Experiments with Radio Apparatus

Photo-cell Relay

1st Prize—2 Years' Subscription

- A very sensitive photo-cell light relay is shown in the sketch. Distances up to 150 feet have been covered with it.

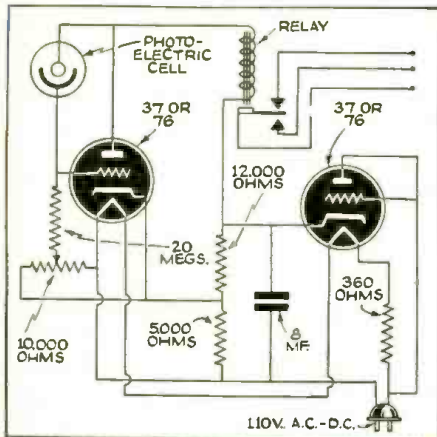

Simple Photo-cell and Relay Set-up.

The cell can be almost any photo-emissive type. The relay should be capable of operating on a variation of 1 mil. Pure D.C. is not necessary, so the 8 mf. condenser suffices for the filter system. The 20 megohm resistor is very important: any substitution (unless it is of a higher value) will result in a decrease of sensitivity. A 360 ohm resistor in the power cord provides the necessary voltage drop for the filaments.

To put the unit into operation, the potentiometer is adjusted so that, with the light source focused on the cell, the relay is just barely closed. Then when the beam is interrupted, the relay will open. For invisible beams, a piece of red cellophane can be placed over the light source. This reduces the maximum distance of operation to about ten feet.

The light source used by the author is a 21 candle-power, 6 volt auto headlight bulb, mounted in an old box camera with a small transformer and a one-inch lens.—Bill Jakes, Jr.

Line Voltage Booster

2nd Prize—1 Year's Subscription

- HERE'S a new use for an old power transformer, if the primary is still in good condition, which is usually the case. Take all the windings off down to the

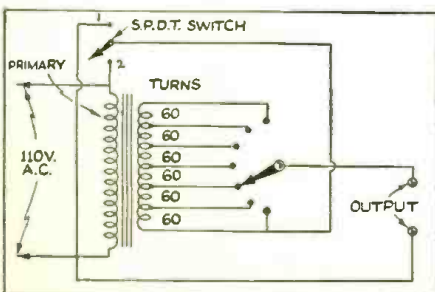

Transformer rig to boost line voltage.

Each month we will award 2 prizes, —the first, 2 years' subscription; the second, 1 year's subscription— for the best non-radio uses of ordinary radio parts and radio instrumentalities.

primary coil, which is usually on the bottom. Then wind on about 360 turns of No. 22 wire, or larger, if there is enough space in the core opening, and bring out a tap at every 60 turns. It is then connected as shown in the accompanying sketch to a switch and any suitable regulator.

With the SPDT switch in the low position, a range of from 0 to 90 volts may be had. With the switch in the high position, a range of from 110 to 200 volts may be had and both ranges are in 15 volt steps with only 7 contacts on the regulator. These voltages will vary slightly if a transformer having a primary consisting of other than a 4 to 1 turns to volt ratio is used. If the high range decreases the voltage instead of increasing it, connect the primary to the other end of secondary, thus reversing the connection.

I have found this transformer particularly useful in varying the speed of small fans, boosting the line voltage, and testing and experimenting in general around the shop. The transformer, regulator and switch may all be assembled in any suitable container for convenience.—Clarence H. Cramer.

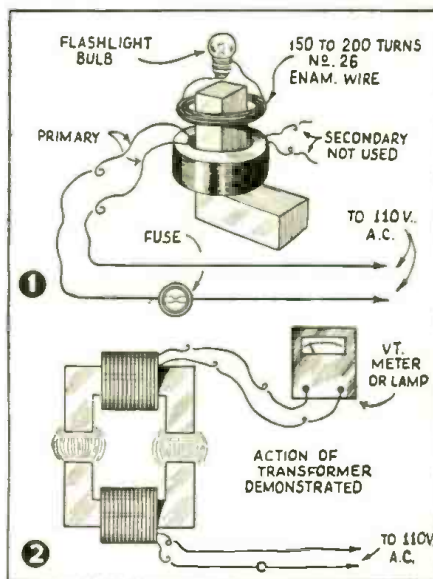

Old audio or other transformers prove useful for "induction" demonstrations at clubs, etc.

Demonstration of Transformer Action

- I SUBMIT the following device for your contest. It is part of the iron core of an old Audio Transformer with its windings. By putting 110 volts through the primary section of the coil, a current is set

up around the core. Place a coil of 150 to 200 turns of No. 26 enameled wire, with a flashlight bulb attached to each end of the coil, over it. Current will then be induced in the small coil of wire, and there will be enough to light the bulb. The small coil of wire may be slowly drawn away, and the light will grow dim.

This experiment demonstrates the action of a simple step-down transformer.—John E. Hurley.

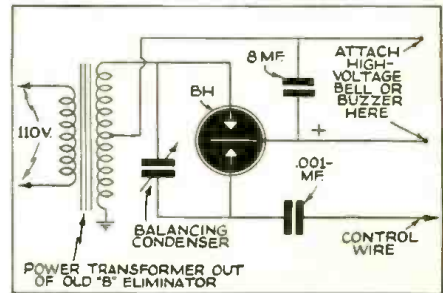

Touching the control wire actuates the alarm.

Burglar Alarm

- THE accompanying diagram shows a simple yet effective burglar or thief alarm. This hookup makes use of one of the BH rectifier tubes. The alarm is set off by touching the control wire, as shown in the diagram; this has the effect of increasing the capacity on that side of the circuit. Practically the only current consumed by the device is the slight loss in the transformer core and windings. A relay may be used with this circuit, if desired.—W. L. Reemes.

Two-timing a Chime!

- A "MELLO-CHIME"—a musical doorbell which chimes only once when you press a button, can be made to chime twice—once when the contact is made and again when it is broken. The current flows into the chime's coil at the moment the button completes the circuit; the radio condenser receives its current charge by surge action as the field about the chime coil collapses and the magnet discharges its stored energy into the condenser, when the button is opening the circuit. The condenser then discharges its energy back to the coil, where it is spent in a final effort to pull the chime pole against the musical bar or plate.—Willard Moody.

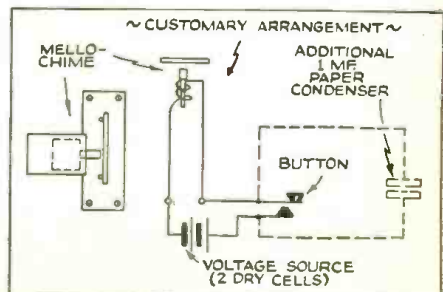

Adding a condenser gives chime 2 tones.

The Short Wave League



On the Ham Bands

(with the "Listening Post" Observers)

Edited by Elmer R. Fuller

HONORARY MEMBERS

Dr. Lee de Forest Manfred von Ardenne
D. E. Replogle E. T. Somerset
John L. Reinartz Hollis Baird

Hugo Gernsback, Executive Secretary

● AS soon as it can be compiled, a list of the stations which are known *not* to verify reports will be published. If you know of any such, please send me their calls.

Once more, I must ask you to report only good dx according to the standard

Len Carling—Observer for Illinois

Call	Freq.	R	S	Call	Freq.	R	S
VK3EH	14.060	4	7	VK4HN	14.295	3	4
VP3AA	14.085	5	8	VP7NU	14.045	5	9
VK2OG	14.100	4	6	VP7NS	14.100	5	8
CN1AF	14.275	4	7	K6FKN	14.234	5	8
PA0WN	14.265	3	5	K6ILW	14.198	5	8
K5AH	14.260	5	7	VP7NC	14.252	5	8

According to information received from Observer Hartzell, either United States or New Zealand stamps may be used for return postage from VR6AY. The QRA is Amateur Radio Station VR6AY, c/o Andrew C. Young, Picairio Island.

L. F. Gallagher—Observer for New York

Call	Freq.	R	S	Call	Freq.	R	S
VK3ED	14.300	3	5	G8UY	14.020	4	8
VK4VD	14.310	4	6	G6NI	14.100	5	7
VK2QR	14.290	2	4	G2UF	14.150	3	7
VK4JU	14.350	4	8	G5NI	14.110	5	8
VK2AIZ	14.270	3	8	VP3AA	14.350	5	7
VK2QI	14.300	3	4	VP7NS	14.030	5	9
VK3EK	14.270	5	4	VP5IS	14.310	4	8
VK3UC	14.310	4	9	VP6FO	14.300	5	7
VK2ADD	14.300	3	6	PK2AY	14.300	4	7
VK2AGT	14.320	4	6	CN1AF	14.300	5	9
G5MF	14.000	5	7	CT1QA	14.300	5	8

Tom Jordan—Observer for Pennsylvania

Call	Freq.	R	S	Call	Freq.	R	S
EA9AH	13.992	5	9	Rdo			
VO1I	14.225	5	9	Malaga	14.440	5	8
K5AH	14.200	5	6				

John Fitzpatrick—Observer for New Jersey

Call	Freq.	R	S	Call	Freq.	R	S
VR6AY	14.340	4	9	GM6RG	28.210	4	7
VK2OH	14.110	4	6	K4FKC	28.200	5	8
PK6XX	14.350	3	4	K4EZZ	28.210	5	8
VK4VB	14.135	4	6	G5BM	28.205	3	6
HR5C	14.240	5	9	EI2L	28.200	4	7
VK2OJ	14.030	4	4	W7GGG	28.225	5	9
VK4J	14.010	4	6				
CN8MV	14.050	5	7				

C. R. "Pat" Patterson—Observer for Georgia

Call	Freq.	R	S
VP7NS	14.05	5	9

Elvyn L. Barker—Observer for Maine

Call	Freq.	R	S	Call	Freq.	R	S
VP7NS	14.15	5	9	VR6AY	14.35	4	5
CX2AU	14.13	4	5	PK6XX	14.20	5	7
VP6LN	14.04	4	7	CN1AF	14.23	4	6
VP1BA	14.19	5	7	PA0MZ	14.10	5	7

Burns E. Hegler—Observer for Kansas

Call	Freq.	R	S	Call	Freq.	R	S
YN3DG	14.26	5	7	VK3HG	14.—	5	8
PK6XX	14.02	5	8	TG5	14.—	5	9
VP6LN	14.01	—	—	NY2AE	14.—	5	8

(Continued on page 488)

Here's B. Takars of Kispeszt, Hungary. His call is now HA5C.



Recognize your favorite magazine in the hand of John Versfeld of Klaasenbosch, Cape Town, P. O. Constantia, South Africa? He has logged 350 S.W. and B.C. stations, and more than 400 Hams in 53 countries.



If you ever contact Mr. Versfeld, you'll get one of these for your collection.

The QRA of VP7NC is P. O. Box 703, Nassau, Bahamas. CN1AF is at Tangier, International Zone, North Africa. The exact QRA is not known here, but an attempt will be made by yours truly to find it, and report it as early as possible.

Ernest W. Lang—Observer for Washington

Call	Freq.	R	S	Call	Freq.	R	S
KA1BH	14.110	5	6	KA1CS	14.310	5	5
KA7EF	14.140	5	8	KA1JM	14.260	5	7
KA1HS	14.280	5	6	KA1FT	14.100	5	6

Howard Kemp—Observer for Connecticut

Call	Freq.	R	S	Call	Freq.	R	S
VP6FO	14.08	5	8	VK3WA	14.277	5	6
VP5IS	14.08	5	8	VK3HG	14.035	5	5
K4FCG	14.18	5	8	VK2LC	14.05	5	4
VP3AA	14.075	5	7	K6KMB	14.21	5	7
K5AH	14.234	5	7	K6AIU	14.188	5	5
NY2AE	14.190	5	7	VR6AY	14.346	5	7
VP1BA	14.13	5	7	PK6XX	14.01	5	5
SV1KE	14.025	5	7	VK2MH	14.127	5	5
ON4AM	14.120	5	6	VK2ABK	14.087	5	6
CT1OO	14.143	5	6	VK5KF	14.115	5	6
SU1KG	14.04	5	6	VK4JT	14.035	5	6
CN8NA	14.10	5	6	K4EZR	28.—	5	8
CN8MA	14.09	5	6				

Charles H. Fuller—Observer for your editor

Call	Freq.	R	S	Call	Freq.	R	S
VK3BZ	14.150	4	6	G3FA	14.125	5	6
VP7NS	14.175	5	8	G6GF	14.200	5	7
G5ML	14.175	5	7	CX2AK	14.090	5	7
G2AI	14.175	5	6	G5QN	14.150	4	7
GM8RJ	14.175	5	6	G6JL	14.300	5	6
G6AG	14.180	4	6	VP7NU	14.100	5	6
EI8J	14.200	5	7	G2TR	14.150	4	6
G8LP	14.200	5	6				

Clarence Hartzell—Observer for Pennsylvania

Call	Freq.	R	S	Call	Freq.	R	S
VP1BA	14.112	5	8	TI3AD	28.290	5	6
YN1OP	14.307	5	8	H17G	28.310	5	8
VR6AY	14.346	5	8	G6DT	28.200	2	3
PK6XX	14.000	4	7	G8M?	28.426	3	3
NY2AE	14.210	4	6	G2KU	28.590	3	4
VP6FO	14.091	5	7	G6BH	28.230	4	4
VK2UC	14.090	5	9	G2MI	28.270	5	6
VK3PE	14.030	5	7	G8TD	28.340	3	4
VK2HF	14.270	4	8	G5BM	28.348	2	4
VK4VD	14.146	5	9	GM6RG	28.430	5	8
K7AFC	14.165	5	8	F8UE	28.390	4	4
SU1CN	14.300	3	7	EI2L	28.290	3	5

which was outlined in the October issue. Thus far, fifty-seven observers have been appointed throughout the entire world. Every continent except Australia and South America is represented. Our farthest observer from this location (Cortland, New York) is Masud Akhtar of New Delhi, India. Mr. Akhtar read this department in the September issue of RADIO & TELEVISION.

First this month we will hear from A. R. Rowley, observer for the Republic of Panama. Mr. Rowley has just received permission from the government of Panama to own and operate an amateur c.w. station on the 20- and 40-meter bands. And now, here is his report:

Call	Freq.	R	S	Call	Freq.	R	S
W6PER	14.20	5	9	J5AH	14.33	4	6
W6NIX	14.25	5	7	ZL2BE	14.05	5	6
VK2NQ	14.35	5	6	W7BJS	14.35	5	7
EA9AH	13.99	4	5	VP7NH	14.15	5	9
G2PU	14.09	5	7				

William Dean Noyes—Observer for Nebraska

Call	Freq.	R	S	Call	Freq.	R	S
VK2ABD	14.12	5	9	VK3XP	14.10	5	8
VK2ADT	14.06	5	8	VK3ZX	14.02	5	9
VK2AJU	14.11	5	8	VK3JP	14.05	5	9
VK2EH	14.10	5	9	VK4JU	14.15	4	6
VK2HX	14.11	5	8	YV1AQ	14.00	5	9
VK2JN	14.33	3	5	YV4AE	14.08	5	9
VK2UC	14.10	5	9	YV5ABQ	14.06	5	8
VK3AZ	14.12	5	9	K4EJF	14.24	4	8
VK3BZ	14.15	5	9	K4FAY	14.21	5	8
VK3ED	14.11	5	7	K6ILW	14.21	5	8
VK3ES	14.10	5	7	K6QJI	14.17	5	9
VK3PB	14.05	5	7	K6OQW	14.23	5	8
VK3OR	14.14	5	8				

Local HAM Gossip

Brunswick, Ga.

● THE Hams of Brunswick and Saint Simons Island, Georgia, have formed a club which will further the activities of all who are members and those who join later. The primary cause of the formation of the club was their interest in their community in case of an emergency.

The amateurs formed a governing board, electing a president, secretary-treasurer and vice-president. In ten weeks the club grew to a membership of over twenty-five, including hams who operate the twelve or fourteen stations located in this area.

There are two radio engineers included in the membership, Communications Engineer H. T. Adams and Radio Engineer Morgan, along with a ham of long standing, A. R. Bates, manager of the local Western Union, who is president of the organization.

The members of the club have attended regularly-spaced code schools, where the beginners have learned the fundamentals of code and another where the more-advanced code-students have had an opportunity to improve their speed.

Application has been made for a charter in the Amateur Radio Relay League, and favorable action is anticipated by the members of The Brunswick Amateur Radio Club on this matter.

They plan to build a club-house transmitter in the near future where the touring hams can visit with the members of the local club—J. E. Joines, P. O. Box 172, Brunswick, Georgia.

Amateurs Active during Boston Hurricane

● BOSTON hams had a busy time at it during and after the semi-tropical hurricane.

At 6:20 p.m. the electric power at WIAFP, of Hyde Park, went off. One of the first hams to have electric service restored. IAFP had his power line repaired by 2:00 p.m. on the 22nd.

WIAFP regularly operates on 5 meters, but none of the "local" boys seemed to have their power as yet. So, a hastily built-up 210 Hartley oscillator was put on 40 meters. Not much traffic was handled, however, since few stricken areas had electric power. Relaying was difficult because of *skip*, and also because power lines were down all over New England.

However, when the electric service was restored at W1PI, and at Hyde Park, late in the afternoon of the third day, real action began. IAFP went over to IPI's shack to help handle traffic that had been pouring in for two days. Operation was carried on 5, 80 and 160 meter phone and c.w. An emergency net was formed with WISS, WIKYJ and W3CSU. Traffic was relayed on 5 meters to W3CSU who sent it on over 80 meter c.w. at the key of WIMX, at the Mass. Institute of Technology. In addition, W1KRL handled traffic for points south and west on 160 meter phone. Other cooperating hams, included among whom were W1HLW, W1JPK, W1AGR and W1JSV, kept their local channels clear for messages intended for their areas.

Operating portable mobile were W1JDO, W1JLI and W1FTR, on visit from Hartford, Conn., who picked up plenty of local 5 meter traffic and actually delivered the messages, driving right up to the doors! Many other hams, not mentioned above, also rendered valuable assistance.

The Boston Police Department telephoned many messages to W1PI, for retransmission, since telephone lines outside the city were down. In fact, IPI had police department messages waiting for transmission before his electric power was restored. Most of the police department messages were of a personal nature, as Boston residents phoned the police, asking them to forward messages to relatives or friends in stricken areas. The police then relayed to W1PI.

A vote of thanks is due to Mrs. W1PI, who hour after hour fed the boys with hot coffee, cake, pie and sandwiches. And all that helped them to carry on from 5:00 p.m. Friday until Monday at 2:00 a.m. with only 8 hours of sleep in the whole 57 hour stretch.

It is conservatively estimated that 2000 messages were handled. After that, with every message cleared out, they called it a "night," and hit the hay at 3:00 A.M.—J. A. Schindler, W1IZI.

2½ and 5 Meter Bands Active W2JZO

● TRAMPING up to the North Pole would probably have been an easier task than to get a completed QSO from the Metropolitan area this summer. QRM and more QRM seems to be the rule.

Apart from this, however, some interesting things are taking place. W2AU, with a close-spaced home-made beam antenna and 300 watts, seems to be taking all the laurels away from the "Kilowatt boys" when it comes to putting signals into the ether. WAC (worked all continents) within twenty-four hours after the beam went up. Elmhurst must be a Ham's paradise as W2IHX worked more than one hundred Europeans within

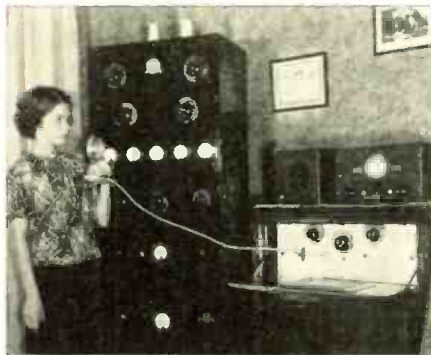

This YL is 14-year-old Betty McConnell, daughter of Roy E. McConnell, Chief Radio Engineer of Police Radio Station W9XEH, Evansville, Ind. The station is her OM's ham rig, W9H85, using a 6L6G oscillator, an 807 doubler, a 155 buffer and a pair of 155's running 350 watts in the final. Speech equipment includes a crystal mike into a 57, resistance-coupled into a 56, transformer-coupled to a pair of 56's, into a 500-ohm line to a pair of 2A3's and a pair of 830B's as modulators. It works all bands on phone or c.w. In the floods last year it was on the air for 408 hours without signing off, and was given a special frequency and the National Guard call letters LC9E.

three weeks after he moved out there! W2GRG has passed the century mark when it comes to working countries, with W2IKV a close runner-up with 77 and still going strong. W2JEH must have a warm spot in his heart for the sunny South.

W2JIL, from the wilds of Brooklyn, seems to have the technique when it comes to the making of contacts. He gets what he is after. W2JWE believes in building his own IRO receivers. Says that they pull in more DX. It must be in the way that he polishes his tubes! W2KBG made quite a record for himself on five the past summer. "DX or nothing," so Sally says, and DX it was!

The five meter band is becoming almost as crowded as the twenty meter band and not with flea-power transmitters either. Kilowatt jobs are not uncommon, with 200 to 300 watt transmitters taking the lead. This may seem funny to some of you but one of our local hams with 0.1 (1/10) watt into the antenna has been working some real DX on five meters!

Two and one-half meters seems to be almost as active as five meters, and I believe it is a better band for short distances. Less QRM and more DX. You will need a 2½ meter antenna for "rubbering in" on that band if you are expecting to give it the once-over. Don't pass it up if you have a receiver that will go down that far.

The "73 Club" here in the Metropolitan District is doing a fine piece of work. When it comes to interesting meetings, they have them—discussions and lectures by men who know their subjects. They give the Ham what will help him most; they also help him with his individual problems. Something interesting for hams at every meeting is their aim. We are wondering what has happened to the Hudson Division Radio Phone Association. Did it get lost in the local QRM? Ken Hill gave us some very fine meetings last Winter and Spring. You

know him as he is our ARRL Director, and is doing his best for us.—Albert C. Uthe, W2JZO.

Rocky Mountain Division News

● THE 12th ARRL Rocky Mountain Division convention has come to an end and through the assistance given by RADIO & TELEVISION to make this convention a success, "ham" radio has again gone a step forward.

No expense was spared to give every one attending his money's worth and yet not place the burden of such expense upon those who had no particular interest in such a gathering. Only through your whole-hearted co-operation was this possible. The attendance at the convention speaks for itself, in the amount of interest created, by the fact that the paid registrations exceeded those of any Rocky Mountain Division convention held during the past few years.—Sam Isabel Amateur Radio Ass'n, E. S. Buchanan, Activities Mgr.

Buffalo News

● DURING the fall and winter season, several local organizations will offer instruction in amateur radio; continental code and general radio theory. The first unit to announce schedules for this instruction is the radio division of the local Boy Scouts.

A six-month radio course is being offered at the Sea Scout base at the foot of Porter Avenue. This instruction is for scouts interested in radio and includes continental code as well as practical and theoretical radio.

Jack Vonn Scheidt, skipper of the local radio division, will serve as instructor. Further details are available at Boy Scout Headquarters, 110 Franklin St.

The question "How short is a short wave?" has for years challenged amateurs to investigate the possibilities of these ultra short wave transmissions. During the coming tests, another step is being taken to check the behavior of the extreme short waves. A one quarter meter transmitter is to be operated and an attempt made to send a signal from Colden to Buffalo. This is the first time that any one quarter meter transmissions have been radiated during the high frequency field tests.

Experimenters in Buffalo are asking to report upon results to Leon Ryker of 228 Jewett Ave. Canadian amateurs should report to Harry Lang of 33 Lessard Ave., Toronto, and amateurs in remote New York, Pennsylvania and Ohio areas should report to Robert T. Schlaudecker of 2424 Taggart St., Westerville, Pa.—Conrad J. Klank, 418 Perry St., Buffalo, N. Y.

"Hudson Division" News W2IKV

● THE summer months saw a great deal of rebuilding, and also many new antenna structures. Several rotating arrays are now in operation, with their users quite gratified at the results obtained. Rumor has it that one of our better known 5-meter stations is planning an elaborate rotating beam array for use with the new 300 watt transmitter he is building for the 56 mc. band. The past summer saw considerable portable mobile and mobile marine 5-meter work. In fact, one station was so scared at working a 56 mc. marine station that he, the land station, believed it was the F.C.C. finally catching on to him, for sure. (Wonder why he had a guilty conscience?) The bootleggers continue to flourish, and it is too bad that the amateur bands, already so crowded, cannot be rid of this nuisance.

To those of you who are really interested in your hobby let me repeat, now is the time to devote some serious thought to the problems confronting amateur radio. For your own good, as well as that of your fellow amateur, do something constructive, in the form of electing a suitable director, who will represent you and your club and your division. Join the League, become affiliated with your local club, and make this one of radio's most memorable seasons for yourself and fellow hams. 73 es BCNU.—Llewellyn Bates Keim, W2IKV.

South Bend, Indiana, Activities

● THE South Bend Amateur Communications Society president is Herb Cole, Chief Engineer of Tribune Stations WSBT-WEAM. He obtained our present clubrooms for us, with facilities for 200 or more. Plans are being made to form a club-network with a key station to take care of cross-communication and to maintain regular schedules. The club's Vice-President is Francis Bock, Chief Operator of the local police station, WPGN. Don Vary, W9ZTG, is our publicity man. He writes a weekly column called "CO" in the Tribune. W9KOE, Irwin Hoffer is Treasurer. W9PDS, is the Secretary.

W8QJN, a WAS-WAC man, has moved back to his place in Mishawaka, Ind., where he has (Continued on page 483)

New! Exclusive!

Roster of
New HAMS

See Page 493

What Do YOU Think?



Photos above show the high-quality transmitting and receiving equipment and the antenna mast at station ON4AP, owned and operated by Rob. Godefroid, 23 Rue Basse, Audenarde, Belgium. Mr. Godefroid is particularly interested in 5-meter work and he has special antennas

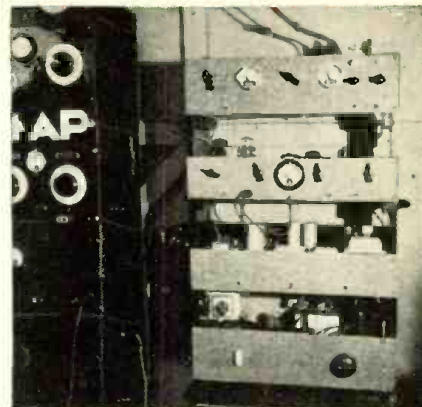
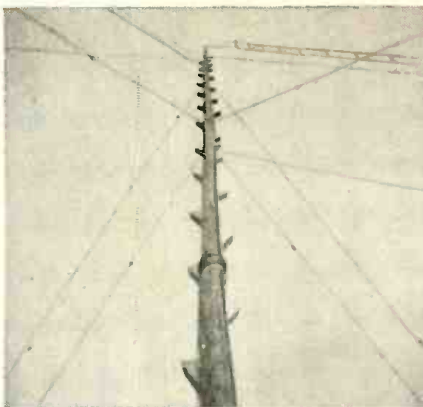

for use on this band. He uses a "one to ten" meter National receiver. One of the receivers used is a Super Sky-Rider. The transmitter panel construction will provide some new ideas for American Hams. The station transmits on 80, 40, 20, 10 and 5 meters.

Wants 3- to 6-Tube Receiver Data

Editor,

When I last heard about the old "ogre of the ham bands," he was going to gobble up a few smart young "squirts." His hallucination was truly remarkable for a man of his mental capacity. He must have had considerable experience with the bootlegging racket as he seems to know all about it. I'll bet that no one ever gave him any R-9 reports!

QSLing is a great sport. It stimulates the growth of "hamdom" and makes people more interested in S-W operations. The hams have contributed much to radio by continuous experimenting and yet Mr. Fiege condemns them.

Now for some brickbats. Whoin'll builds nine to twelve tube superhets? Not many fans who want real DX build one and two tubers. This magazine is supposed to be for the advanced fan as well as the beginner. I think that three- to six-tube receivers and medium-power transmitters are more appreciated.

Live up to your motto of having the radio experimenters' magazine. Print more constructive articles. Tell those, who don't know, how they may become amateurs and how to learn the code.

Now for some bouquets. There are several good columns but the S-W kink and the Joe Miller departments are about tops. Many times I have referred to the *kinks* printed in your magazine for aid in solving S-W problems.

Wishing you 73 and hoping that more good work is begun.

JOHN GEARY,
R.F.D. 6, Box 719,
Phoenix (the land of the SUN),
ARIZONA.

New South African Calls

Editor,

When you tune in on 20 or 40 meters DX and happen to hear an amateur with a new call sign—inter alia—South Africa, do not think you have logged someone new, no, not in the least; it is only an old one which you perhaps have already in your log book. The following letters have been allotted to the Union of South Africa, viz: ZS; ZT; ZU with Divisional numbers and individual letters.

The prefix Call letters ZT and ZU will no longer be used by South African amateurs, and a general revision of Amateur Call Letters in South Africa has taken place, and new call letters allotted; e.g.: "ZUIV—Mr. G. H. J. Sadler of 'Cul-

ham,' Tiverton Road, Plumstead, South Africa, has now been allotted new call letters viz: ZS1 (one) CO" (ZSICO).

W. T. D. MURRAY,
% S. A. Police,
DEEP RIVER, via Cape Town,
South Africa,

W8QKA Ham Station at Parma, Ohio



The photo above shows the Ham station of Joseph Horvath, W8QKA, 3710 Wellington Ave., Parma, Ohio. Receiver used is a National AC-58 and the power supply unit is home-built. The transmitter at the left of the desk is a 6L6M crystal tritret with a 10 final amplifier. The frequencies used are 3633 and 7266 kc.



An English "Ham," Harry Tee, G8UA.

An English "Ham" Greet Us

I have been a reader of S.W.&T. since 1934, and have hardly missed a month since. I think your magazine is about the best all-round one available—it has something for everybody—Ham, S.W.L. and Experimenter.

Last year I received my amateur license and am now active on the ham bands.

The transmitter here is a CO-FD-PA, using American tubes, 47 crystal oscillator, '10 doubler, and a 801 in the power amplifier, running 10 watts input. This is on 40 meters. For 20 meters I use a single '10 tube in a Hartley circuit, with about 7 watts input, and this has worked fine for DX, considering the low power. Up to the present I have worked 38 countries in 3 continents (Europe, Africa, and North America), DX includes W-1-2-3-4-8, VE1, SU, U-1-2-3-4-5-6, CT2, FA, CN, etc.

I like Joe Miller's department very much and always enjoy reading it. Keep up the good work, Joe! I would like to see a short article each month dealing with C. W. DX heard and worked on the amateur bands, so what say? (See "On the Ham Bands" in the S-W League Department.—Editor)

In closing my letter I will say how much R.&T. has helped me in the past, especially when studying for my amateur license, 73.

HARRY TEE,
(Amateur Radio Station G8UA.)
104 Rectory Road,
BURNLEY,
Lancs., ENGLAND.

Thanks for the Suggestions

Editor,

I have been interested in short wave radio for some time and at present have a 5-tube home-built set, on which I have heard stations in over thirty countries.

Joe Miller's department is very fine. The station list should not be spread through the magazine, as this is highly inconvenient; the *Question Box* should be given at least two pages. I prefer articles on small experimental sets.

I believe the collecting of QSL cards can be as interesting a hobby as radio itself. My friends and I would like to see more letters of the type that Mr. Fiege wrote. His "clowning" and the subsequent answer of his many "admirers" gave us all a big laugh. It is he who should dig a hole and crawl into it—that is, if he is able to. Hi!

H. G. DINACKER,
Reading, Pa.

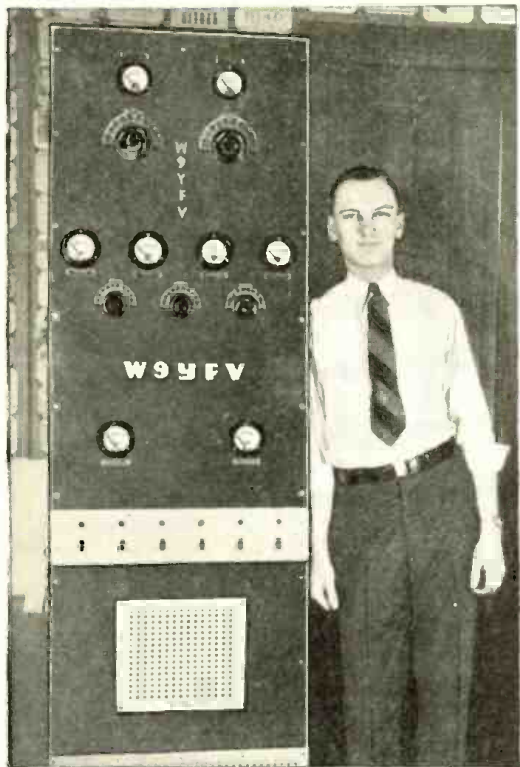

Here's the rig that reached 265 hams in 40 countries, within 60 days. The man who built and works it stands beside it.

● THE transmitter built by Edward Schmeichel at W9YFV is a home-made job but is comparable in appearance and performance to commercial apparatus. "The line-up," says Eddie, "is an RK49 tritet (using six variable gap crystals), 807 buffer doubler, a T55 buffer link coupled to a Taylor T155 in final, running 600 watts input on all bands from 10 to 160 meters." Frequently Mr. Schmeichel works on phone; the speech equipment used includes a Turner cell type crystal mike, a 6C6 pentode, 76 second speech, 76's push-pull, and 6A3 drivers coupled through a 500 ohm line to four TZ20's in push-pull parallel. The final stage normally runs at 3000 volts on c.w. and 200 volts on phone. The output is fed into a 99-foot end fed Hertz antenna which is 75 feet above ground. One interesting feature of the setup is the use of a D.P.D.T. relay to switch the antenna from the transmitter to the receiver. The transmitter readily uses break-in and push-to-talk, and is entirely controlled by relays from the operating position.

The receiver is an RME69 with a built-in noise-silencer and a DB20 pre-selector. The transmitter was completed in time for the last DX contest, and in the sixty days between March 5th and May 3rd, 1938, young Mr. Schmeichel made 265 DX contacts in 40 countries, scattered over every continent on the face of the earth. According to reports received from all over the world, W9YFV has beautiful quality on phone, and its note on c.w. is con-



Eddie Schmeichel, of the Windy City, wins the Silver Trophy this month for the best Ham Station photos. Have you entered a photo of your rig yet?

sidered by fellow Hams as "a distinct pleasure to listen to."

Mr. Schmeichel adds "I have been a consistent booster of SHORT WAVE CRAFT (the former name of RADIO & TELEVISION) and owe my start in short waves to this magazine. Vy 73 de W9YFV."

(Mr. Schmeichel's address is 2968 S. Loomis St., Chicago, Ill.)

Rules for Trophy Contestants

● WOULD you like to win one of these beautiful silver trophies? It is very easy to do so—simply send the Editors, a good, clear photograph of your Ham station. If

This beautiful silver trophy stands 11¾" high and is to be awarded monthly by RADIO & TELEVISION magazine for the best photo of a Ham station. The silver statue stands on a handsome bakelite base on which is a silver plate. The name of the winner will be engraved on this plate before the trophy is sent to him.

SIXTH Silver Trophy

Awarded to
Edward G. Schmeichel
W9YFV
Chicago, Ill.



The other half of the winning station—here's the receiver that picked up all that "round-the-world" DX for Eddie.

your station photo is selected as the best of those submitted each month, you will be awarded one of these handsome silver trophies with your name engraved on it.

The trophy stands nearly 12" high and is a fine example of the silversmith's art. We are sure that every Ham in the country will be tickled with it, if he should win it. The silver trophy represents the spirit of victory and it was designed by one of the leading silversmiths. The name of the winner each month will be engraved on a silver plate mounted on the black bakelite pedestal before the trophy is sent to the successful contestant.

The next award will be announced in the February issue, and the closing date for that contest is December 10. The judges of the contest will be the Editors of RADIO & TELEVISION. In the event of a tie, duplicate prizes shall be awarded to the contestants so tying. For further details see page 315, September issue.

World Short Wave Stations

Revised Monthly

Complete List of SW
Broadcast Stations

Reports on station changes are appreciated.

Mc.	Call	Station	Mc.	Call	Station	Mc.	Call	Station
31.600	WIXKA	BOSTON, MASS., 9.494 m., Addr. Westinghouse Co. Daily 6 am.-1 am., Sun. 8 am.-1 am. Relays WBZ.	17.810	TPB3	PARIS, FRANCE, 16.84 m. Addr. (See 15.245 mc.) 9.30-11 am.	15.260	GSI	DAVENTRY, ENG., 19.66 m., Addr. (See 17.79 mc.) 12.20-1.30 pm.
31.600	WIXKB	SPRINGFIELD, MASS., 9.494 m., Addr. Westinghouse Co. Daily 6 am.-1 am., Sun. 8 am.-1 am. Relays WBZ.	17.800	TGWA	GUATEMALA CITY, GUAT., 16.84 m., Addr. Ministre De Fomento. Irregular.	15.250	WIXAL	BOSTON, MASS., 19.67 m., Addr. University Club. Sun. 10 am.-12 n.
31.600	W3XEY	BALTIMORE, MD., 9.494 m., Relays WFBR 4 pm.-12 m.	17.790	GSG	DAVENTRY, ENG., 16.86 m., Addr. B.B.C., London. 5.45 am.-12 n., 12.20-4 pm.	15.245	TPA2	PARIS, FRANCE, 19.68 m., Addr. 98 Bis. Blvd. Haussmann. "Paris Mondial" 6-11 am.
31.600	W2XDV	NEW YORK CITY, 9.494 m., Addr. Col. Broad. System, 485 Madison Ave. Daily 6-11 pm.; Sat. and Sun. 1.30-6, 7-10 pm.	17.785	JZL	TOKYO, JAPAN, 16.87 m. Irregular.	15.230	H58PJ	BANGKOK, SIAM, 19.7 m. Irregularly Mon. 8-10 am.
31.600	W9XHW	MINNEAPOLIS, MINN., 9.494 m., Relays WCCO 9 am.-12 m.	17.780	W3XL	BOUND BROOK, N. J., 16.87 m., Addr. Natl. Broad. Co., 9 am.-8 pm.	15.230	OLR5A	PRAGUE, CZECHOSLOVAKIA, 19.7 m., Addr. (See OLR4A, 11.84) Irreg. 7.55-10.55 pm.
31.600	W3XKA	PHILADELPHIA, PA., 9.494 m., Addr. NBC. Relays KYW 9 am.-10 pm.	17.770	PHI2	HUIZEN, HOLLAND, 16.88 m., Addr. (See PHI, 11.730 mc.) Daily 7.40-8.40 am. Tues. and Thurs., 7.25-8.40 am.	15.220	PCJ2	HUIZEN, HOLLAND, 19.71 m., Addr. N. V. Philips' Radio Hilversum. Tues. 2.30-3 am., Wed. 9.30-11.30 am.
31.600	W5XAU	OKLAHOMA CITY, 9.494 m., Sun 12 n.-1 pm., 6-7 pm. Irregular other times.	17.760	DJE	BERLIN, GERMANY, 16.89 m., Addr. Broadcasting House. 12.05-10 am.; also Sun. 11.10 am.-12.25 pm. Daily 4.50-10.45 pm.	15.210	WBXK	PITTSBURGH, PA., 19.72 m., Addr. (See 21.540 mc.) 8 am.-6 pm.
31.600	W4XCA	MEMPHIS, TENN., 9.494 m. Addr. Memphis Commercial Appeal. Relays WMC.	17.760	W2XE	NEW YORK, N. Y., 16.89 m., Addr. Col. Broad. System, 485 Madison Ave. Irregular.	15.200	DJB	BERLIN, GERMANY, 19.74 m., Addr. (See 15.280 mc.) 12.05-11 am., 4.50-10.45 pm. Also Sun. 11.10 am.-12.25 pm.
31.600	W8XAI	ROCHESTER, N. Y., 9.494 m., Addr. Stromberg Carlson Co. Relays WHAM 7.30-12.05 am.	17.755	ZBW5	HONGKONG, CHINA, 16.9 m., Addr. P.O. Box 200. 4-10 am. Irregular.	15.190	—	ROME, ITALY, 19.75 m. Relays 2RO till 6 pm., irreg.
31.600	W8XWJ	DETROIT, MICH., 9.494 m., Addr. Evening News Ass'n. Relays WWJ 6-12.30 am., Sun. 8 am.-12 m.	End of Broadcast Band			15.190	—	LAHTI, FINLAND, 19.75 m. Addr. (See OFE, 9.5 mc.) Irregular.
31.600	W9XPD	ST. LOUIS, MO., 9.494 m., Addr. Pulitzer Pub. Co. Relays KSD.	17.310	W2XGB	HICKSVILLE, L. I., N. Y., 17.33 m., Addr. Press Wireless, Box 296. Tests 9.30-11.30 am., except Sat. and Sun.	15.190	ZBW4	HONGKONG, CHINA, 19.75 m., Addr. P. O. Box 200. Irregular. 11.30 pm. to 1.15 am., 3-10 am.
26.450	W9XA	KANSAS CITY, MO., 11.33 m., Addr. Commercial Radio Eqpt. Co. Testing	15.550	CO9XX	TUINICU, ORIENTE, CUBA, 19.29 m., Addr. Frank Jones, Central Tuinicu, Tuinicu, Santa Clara. Broadcasts irregularly evenings.	15.180	RW96	MOSCOW, U.S.S.R., 19.76 m., Mon., Tues., Fri., Sat. 2.30-3.30 pm. Daily 3-4 am. Mon., Wed., Thurs. 7-9.15 pm.
26.400	W9XAZ	MILWAUKEE, WIS., 11.36 m., Addr. The Journal Co. Relays WTMJ from 1 pm.	15.510	XOZ	CHENG TU, CHINA, 19.34 m. Daily 9.45-10.30 am.	15.180	GSO	DAVENTRY, ENG., 19.76 m., Addr. (See 17.79 mc.) 4.15-6, 6.20-8.30 pm., 3-5.15 am., 9 am.-12 n.
26.300	W2XJI	NEW YORK, N. Y., 11.4 m., Addr. Bamberger Broad. Service, 1440 Broadway. Relays WOR 8 am.-1 am. Irregular.	15.370	HAS3	BUDAPEST, HUNGARY, 19.52 m., Addr. Radiolabor, Gyali Ut 22. Sun. 9-10 am.	15.170	TGWA	GUATEMALA CITY, GUAT., 19.77 m., Addr. (See 17.8 mc.) Daily 10.45-11 am.; Sun. 10.45 am.-6 pm.
26.100	W9XJL	SUPERIOR, WIS., 11.49 m. Relays WEBC daily.	15.360	DZG	ZEESEN, GERMANY, 19.53 m., Addr. Reichspostzentramt. Tests irregularly.	15.160	XEWV	MEXICO CITY, MEXICO, 19.79 m., 12 n.-12 m., irregular.
26.050	W9XTC	MINNEAPOLIS, MINN., 11.51 m., Relays WCTN 9 am.-1 pm., 7 pm.-12 m.	15.360	—	BERNE, SWITZERLAND, 19.53 m. Irreg. 6.45-7.45 pm.	15.160	JZK	TOKYO, JAPAN, 19.79 m. Irregular.
25.950	W6XKG	LOS ANGELES, CAL., 11.56 m., Addr. B. S. McGlashan, Wash. Blvd. at Oak St. Relays KGFJ 24 hours daily.	19 Met. Broadcast Band			15.160	VUD3	DELHI, INDIA, 19.79 m., Addr. All India Radio. 1.30-3.30 am., 8.30-10.30 pm.
25.950	W9XUP	ST. PAUL, MINNESOTA, 11.56 m., Relays KSTP evenings.	15.340	DJR	BERLIN, GERMANY, 19.56 m., Addr. Br'dcast'g House, 8-9 am., 4.50-10.45 pm.	15.155	SM5SX	STOCKHOLM, SWEDEN, 19.79 m., Daily 11 am.-5 pm., Sun. 9 am.-5 pm.
21.550	GST	DAVENTRY, ENG., 13.92 m., Addr. (B.B.C., London) Irregular at present.	15.330	W2XAD	SCHENECTADY, N. Y., 19.56 m., Addr. General Electric Co. Relays WGY, 12.15-6 pm.	15.150	YDC	BANDOENG, JAVA, 19.8 m., Addr. N. I. R. O. M., 6-7.30 pm., 10.30 pm.-2 am., Sat. 7.30 pm.-2 am., daily 5.30-10.30 am.
21.540	W8XK	PITTSBURGH, PA., 13.93 m., Addr. Grant Bldg. Relays KDKA 6.45-9 am. Also Sunday, 6 pm.	15.320	OLR5B	PRAGUE, CZECHOSLOVAKIA, 19.58 m. Addr. (See 11.840 mc.) Sun., Wed., Sat. 5-10 pm.; Mon., Tues., Thurs., Fri. 6.55-9.55 pm.	15.140	GSF	DAVENTRY, ENG., 19.82 m., Addr. (See 17.79 mc.) 3-5.15 am., 5.45 am.-12 n.
21.530	GSI	DAVENTRY, ENG., 13.93 m., Addr. (See 21.550 mc.) 5.45-10.30 am.	15.310	GSP	DAVENTRY, ENG., 19.6 m., Addr. (See 17.79 mc.) 3-5.15 am., 1.45-4 pm.	15.130	TPB6	PARIS, FRANCE, 19.83 m., Addr. "Paris Mondial," 98 Bis Blvd. Haussmann, 2-5 am.
21.520	W2XE	NEW YORK CITY, 13.94 m., Addr. Col. Broad. Syst., 485 Madison Ave. Daily exc. Sat. and Sun. 7.30-10 am. Sat. and Sun. 8 am.-1 pm.	15.300	YDB	SOERABAJA, JAVA, N. E. I. 19.61 m., Addr. NIROM. 7.30 pm.-2 am.	15.130	WIXAL	BOSTON, MASS., 19.83 m., Addr. World Wide Broadcast'g Foundation. University Club. 10-11 am., Mon.-Fri.
21.500	W2XAD	SCHENECTADY, N. Y., 13.95 m., General Electric Co., 8 am.-12 n.	15.300	XEBM	MAZATLAN, SIN., MEX., 19.61 m., Addr. Box 78, "El Pregonero del Pacifico." Irregularly 9-10 am., 1-2, 8-10 pm.	15.120	HVJ	VATICAN CITY, 19.83 m., 10.30-10.45 am., Tues., Wed. & Thurs.
21.470	GSH	DAVENTRY, ENG., 13.97 m. (See 21.550 mc.) 5.45 am.-12 n.	15.300	—	ROME, ITALY, 19.61 m., Addr. (See 2RO, 11.81 mc.) Relays 2RO to 6 pm. irregularly.	15.110	DJL	BERLIN, GERMANY, 19.85 m., Addr. (See 15.280 mc.) 12 m.-2, 8-9 am., 10.40 am.-4.25 pm., also Sun. 6-8 am.
21.450	DJS	BERLIN, GERMANY, 13.99 m., Addr., Broadcasting House. 12.05-11 am.	15.290	LRU	BUENOS AIRES, ARG., 19.62 m., Addr. El Mundo. Relays LRI, 7-9 am.	15.080	RK1	MOSCOW, U.S.S.R., 19.87 m., Works Tashkent near 7 am. Broadcasts 2.30 pm. Daily 7-9.15 pm.
19.020	H58PJ	BANGKOK, SIAM, 15.77 m. Mondays 8-10 am.	15.280	H13X	CIUDAD TRUJILLO, D. R., 19.63 m., Relays HIX Sun. 7.40-10.40 am. Weekdays 12.10-1.10 pm.	End of Broadcast Band		
18.480	HBH	GENEVA, SWITZERLAND, 16.23 m., Addr. Radio Nations. Sun., 10.45-11.30 am.	15.280	DJQ	BERLIN, GERMANY, 19.63 m., Addr. Broadcasting House, 12.05-10 am., 4.50-10.45 pm. Also Sun. 11.10 am.-12.25 pm.	14.940	PSE	RIO DE JANEIRO, BRAZIL, 20.08 m., Broadcasts Wed. 3.45-4.15 pm.
16 Met. Broadcast Band			15.270	W2XE	NEW YORK CITY, 19.65 m., Addr. (See 21.520 mc.) Daily except Sat. and Sun. 1-6 pm., Sat. and Sun. 2.30-6 pm.	14.600	JVH	NAZAKI, JAPAN, 20.55 m. Broadcasts irregularly 5-11.30 pm. Works Europe 4-8 am.
17.820	—	ROME, ITALY, 16.84 m., Addr. (See 2RO, 11.81 mc.) Relays 2RO to 6 pm. irregularly.				14.535	HBJ	GENEVA, SWITZERLAND, 20.64 m., Addr. Radio Nations. Broadcasts Sun. 1.45-2.30 pm., Mon. 7-8.30 pm.

(Continued on page 476)

All Schedules Eastern Standard Time

Let's Listen In

With

Joe Miller

● **BEGINNING** a new period of service on this page after a brief surcease, we look forward to your co-operation, as in the past. Reports on dx heard, amateur 'phone, SWBC, and commercial 'phone are equally welcomed, and should be mailed to reach us at RADIO & TELEVISION, 99 Hudson St., New York City, not later than 5th of each month.

THE MALAYAN AMATEUR RADIO SOCIETY.

broadcast through
STATION ZGE.
(by courtesy of the P. & T. Dept., Malaya.)
on 48.90 mc. (6135 Kc/s)
from 7 p.m. - 9 p.m.
(1140 - 1340 GMT.)
every
TUESDAY, FRIDAY & SUNDAY.
(excluding Holidays)
and
welcome reports.

The Society have pleasure in acknowledging a report dated 28/4/38 from *Mr. Joe Miller* and confirm that the information given in the report agrees with the Station log for No. 23 of 1937.
Ernie H. Tanarive
Kuala Lumpur, Malaya.
23rd June 1938.



Two fine catches—ZGE and JFZC

As our mag's title was recently altered, VAC certificates had to be withdrawn till new plates, with new title, were made, so kindly be patient, OM's—the certificates are being mailed.

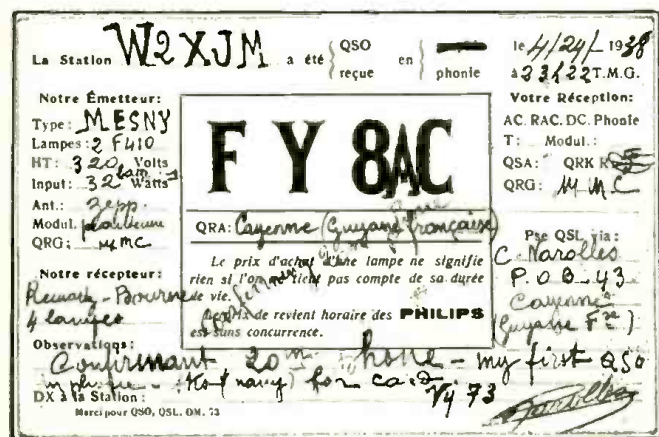

Here's to dx:

PAPUA

VHPM, 8.08 mc., Port Moresby, has been heard several times, once at 6:25 a.m., and much earlier, at 4:05 a.m. This is a new country for all dxers, and can be heard if one tries around 5:30-6:30 a.m. when it is usually on. This station has been used only for telephony, as far as we know. Reports can be sent to VHPM, Port Moresby, Papua. The signal should be well heard now in the cool weather, so try to add this FB new country to your log!

Another station at Port Moresby, VIG, on 7.31 mc., has been reported rebroadcasting a local BC station's programs, usually on 1st and 3rd Sats. of each month, from 3-5 a.m., though this is not a regular schedule, probably more of a test broadcast, occasionally.

ANGOLA

CR6AA, 13.00 mc., at Lobito, is now heard regularly on this new frequency, besides its old 7.177 mc. wave. Evidently the 9 mc. freq. is to be used only occasionally, as conditions warrant.

This new frequency should be well heard this winter, much easier to log than that 7 mc. sig., right in the thick of the 40 meter band's hash.

The schedule remains the same, Wed. and Sat.—2:45-4:30 p.m.

This station QSL's all reports with a handsome card, shown here some time ago. It is well worth having, being a "hard-to-get" country for all dxers.

Send your reports to P. O. Box 103, Lobito, Angola, Port. West Africa.

INDIA

VUD3, 15.16 mc., at Delhi, is putting a beautiful R8 signal into New York right now, and should continue doing so for a long time to come. You can't miss it, all clear by itself on 15.16 mc., just to low freq. side of England's GSO.

A carrier can be heard just before schedule, 8:30 p.m. and at 8:30 sharp, you'll hear chimes and bells striking

Jack Buntekant, Bronx, is to be congratulated on landing and getting verified, VVY2, at Poona, India. Nice going, OM, for a beginner!

INDO-CHINA

FZS, 18.388 mc., at Saigon, was logged again, at 7:03 a.m. the other day, in QSO with FTM, 19.355 mc., St. Assise, France.

FTM had called at 6:00 a.m. but no reply from Saigon; this in clear speech. FTM sends a musical signal consisting of 3 to 4 notes (tones) repeated over and over. At 7 a.m. these tones ceased, and we knew FTM would again call. We heard—"allo Saigon, ici Paree," and, turning to FZS' (Continued on page 489)

FB8AB—Madagascar. Here's the prize QSL for our 10 meter harmonics reception of O M Paul's 20 meter signals. Blue letters, red map outline.

the hour. Then an announcement in perfect English, mentioning call as VUD3.

Here's an Asiatic you can all hear, as we get it swell when using a 3 tube regenerative set! It really does pound in!

You probably feel as we do, regarding the mass of schedules and frequencies published on the new National Xmters in India, and it is a bother going through all that, when one feels he can't hear 'em anyway! But here's one we will vouch for! Schedule is from 8:30-10:30 p.m. daily, best signal at 8:30, and gradually weakening towards 10:30.

Veris have been hard to elicit from the Indian broadcasters, for some reason, but we have a QRA which should be OK, being taken from a veri. Here 'tis: Lieut. N. A. S. Lakshmanan, Station Director, All India Radio, Delhi, India. This, of course, for Delhi transmitters.

VUD2, on 9.59 mc., should be well heard when this comes out, as last year, so keep a watch out for this frequency, undoubtedly carrying same program. Best "sig." as on VUD3, is at 8:30 p.m. VUD2 is at Delhi, too.

We could give you the whole mess of station schedules, etc., but we prefer telling you what you can actually hear, and be able to "log." Do you agree with our policy?

VVN, at Madras, on 13.35 mc., using inverted speech, very strong at 4 a.m., with usual Asiatic "flutter" noticeable on signal.

Jack Buntekant, Bronx, is to be congratulated on landing and getting verified, VVY2, at Poona, India. Nice going, OM, for a beginner!

FY8AC — French Guiana. A plain white card with red lettering, but it's still a nice veri, hi!

Mc.	Call		Mc.	Call		Mc.	Call	
14.440	—	RADIO MALAGA, SPAIN, 20.78 m. Relays Salamanca 8.15-8.45 pm. Sometimes 2-4 pm.	11.801	DJZ	BERLIN, GERMANY, 25.42 m. 7.15-10.50 pm.	10.535	JIB	TAI HOKU, TAIWAN, 28.48 m. Works Japan around 6.25 am. broadcasts, relaying JFAK 9.05-10 am., 1-2.30 am. Sun. to 10.15 am.
14.420	HCJB	QUITO, ECUADOR, 20.8 m. Daily exc. Mon. 10-11 pm.	11.800	ZJZ	TOKYO, JAPAN, 25.42 m., Addr. Broadcasting Co. of Japan, Overseas Division, 7-7.30, 8-9.30 am., 2.30-4, 4.30-5.30, 8-8.30 pm., 12.30-1.30 am.	10.370	EAJ43	TENERIFFE, CANARY ISLANDS, 28.93 m. Relays Salamanca, Spain, 2-4, 5-9.45 pm.
14.166	PIIJ	DORDRECHT, HOLLAND, 21.15 m., Addr. (See 7.08B mc.) Sat. 12 n.-12.30 pm.	11.795	DJO	BERLIN, GERMANY, 25.43 m., Addr. (See 15.280 mc.)	10.350	L5X	BUENOS AIRES, ARG., 28.98 m., Addr. Transradio International. Tests irregularly.
14.004	EA9AH	TETUAN, SPANISH MOROCCO, 21.4 m. Apartado 124. News at 4.30 and 7.15 pm. Relays Salamanca from 5.40 pm.	11.790	WIXAL	BOSTON, MASS., 25.45 m., Addr. (See 15.250 mc.) Daily 4.55-6.30 pm., Tues., Thur., 4.40-6.30 pm., Sat. 1.45-6 pm., Sun. 5-6.30 pm.	10.330	ORK	RUYSSELEDE, BELGIUM, 29.04 m. Broadcasts 1.30-3 pm. Works OPM 1-3 am., 3-5 pm.
13.635	SPW	WARSAW, POLAND, 22 m. Daily 6-8 pm, Sat. & Sun. 6-9 pm.	11.780	HP5G	PANAMA CITY, PAN., 25.47 m., Addr. Box 1121. Heard till 12 m.	10.290	DZC	ZEESEN, GERMANY, 29.16 m., Addr. (See 15.360 mc.) Irregular.
12.460	HCJB	QUITO, ECUADOR, 24.08 m. Daily exc. Mon. 10-11 pm.	11.780	OFD	LAHTI, FINLAND, 25.47 m. Addr. (See OFE, 9.5 mc.) 1.05 am.-2.05 pm.	10.260	PMN	BANDOENG, JAVA, 29.24 m. Relays YDB 6-7.30 pm., 10.30 pm.-2 am., 4.30-10.30 or 11 am., Sat. to 11.30 am.
12.862	W9XDH	ELGIN, ILL., 23.32 m. Press Wireless, Tests 2-5 pm.	11.770	DJD	BERLIN, GERMANY, 25.49 m., Addr. (See 15.280 mc.) 10.40 am.-4.30 pm., 4.50-11 pm.	10.220	PSH	RIO DE JANEIRO, BRAZIL, 29.35 m., Addr. Box 709. Broadcasts 6-9 pm.
12.235	TFJ	REYKJAVIK, ICELAND, 24.52 m. Works Europe mornings. Broadcasts Sun. 1.40-2.30 pm.	11.760	TGWA	GUATEMALA CITY, GUAT., 25.51 m. (See 17.8 mc.) Irregular 10-11.30 pm. Sun. 6-11.30 pm., irregular.	10.042	DZB	ZEESEN, GERMANY, 29.87 m., Addr. Reichspostenstralamt. Irregular.
12.200	—	TRUJILLO, PERU, 24.58 m., "Rancho Grande." Address Hacienda Chiclin. Irregular.	11.760	XETA	MONTEREY, MEX. 25.51 m., Addr. Box 203. Relays XET, 1-3.30 pm. and evenings.	9.980	COBC	HAVANA, CUBA, 30.04 m., Addr. P. O. Box 132. Relays CMBC 6.55 am.-12 m.
12.060	RNE	MOSCOW, U.S.S.R., 24.88 m. Daily 6-7 am., 12 n.-2 pm., 3-6, 10.15-11 pm., also Tues., Thurs. 8.30-9 pm., also Sun. 6-10.30 am., 12 n.-5 pm., 6-6.30, 8.30-9, 10.15-11 pm.	11.760	OLR4B	PRAGUE, CZECHOSLOVAKIA, 25.51 m., Addr. (See 11.840 mc.) Irregular.	9.940	JDY	DAIREN, MANCHUKUO, 30.18 m. Relays JQAK daily 7-8 am. Works Tokyo occasionally in early am.
11.970	H12X	CIUDAD TRUJILLO, D. R., 25.07 m., Addr. La Voz de Hispaniola. Relays H1X Tue. and Fri. 8.10-10.10 pm.	11.750	GSD	DAVENTRY, ENG., 25.53 m., Addr. B.B.C., London. 3-5.15 am., 10.45 am.-6.00 pm., 6.20-8.30, 9.20-11.25 pm.	9.860	EAQ	MADRID, SPAIN, 30.43 m., Addr. Post Office Box 951. 7.30-8, 8.40-9 pm.
25 Met. Broadcast Band			11.740	COCX	HAVANA, CUBA, 25.55 m. P. O. Box 32. Daily 8 am.-1 am. Sun. 8 am.-12 m. Relays CMX, irregular.	9.833	COCM	HAVANA, CUBA, 30.51 m. Addr. Transradio Columbia, P. O. Box 33. 8-1 am. Relays CMCM.
11.920	T12XD	SAN JOSE, COSTA RICA, 25.19 m. La Voz del Pilot. Apartado 1729. 11 am.-2 pm., 5-11 pm., exc. Sun.	11.740	HVJ	VATICAN CITY, 25.55 m. Testing irregular.	9.830	IRF	ROME, ITALY, 30.52 m. Works Egypt afternoons. Relays ZRO, 6-9 pm.
11.910	CD1190	VALDIVIA, CHILE, 25.2 m., P. O. Box 642. Relays CB69 10 am.-1 pm., 11 am.-10 pm.	11.730	PHI	HUIZEN, HOLLAND, 25.57 m., Addr. N. V. Philips' Radio. Daily 6.15-6.45 pm. Sat. 7-7.45 pm.	9.760	—	SAIGON, INDO-CHINA, 30.72 m., Addr. 17, Place A. Foray. "Radio Boy-Landry." Heard 6-9.15 am.
11.900	—	HANOI, FRENCH INDO-CHINA, 25.21 m., "Radio Hanoi", Addr. Radio Club de l'Indochine. 12 m.-2 am., 6-10 am.	11.730	WIXAL	BOSTON, MASS., 25.57 m., Addr. World-Wide Broadcast Foundation, University Club. Daily exc. Sat. and Sun. 9-11 pm.	9.740	COCQ	HAVANA, CUBA, 30.85 m. Addr. 25 No. 445, Vedado, Havana, 7-1 am. Sun. 6.55 am.-12.30 pm.
11.900	XEW1	MEXICO CITY, MEXICO, 25.21 m., Addr. P. O. Box 2874. Mon., Wed., Fri. 3-4 pm., 9 pm.-12 m. Tues. and Thur. 7.30 pm.-12 m., Sat. 9 pm.-12 m.	11.720	CJRJX	WINNIPEG, CANADA, 25.6 m., Addr. James Richardson & Sons, Ltd. Daily 6 pm.-12 m., Sun. 5-10 pm.	9.710	CSW5	LISBON, PORTUGAL, 30.87 m. Addr. Nat. Broad. Sta. 5-8 pm.
11.895	HP5G	PANAMA CITY, PAN., 25.22 m., Addr. Box 1121. 9.30 am.-1 pm., 6-11 pm.	11.718	CR78H	LAURENCO MARQUES, PORTUGUESE E. AFRICA, 25.6 m. Daily 12.05-1, 4.30-6.30, 9.30-11 am., 12.05-4 pm., Sun. 5-7 am., 10 am.-2 pm.	9.700	—	FORT DE FRANCE, MARTINIQUE, 30.9 m., Addr. P. O. Box 136. 11.30 am.-12.30 pm., 6.15-7.50 pm.
11.885	TPA3	PARIS, FRANCE, 25.24 m., Addr. (See 15.245 mc.) 2-5 am., 11.15 am.-6 pm.	11.715	TPA4	PARIS, FRANCE, 25.61 m., (See 15.245 mc.) 7-9.15 pm., 9.30 pm.-12 m.	9.690	T14NRH	HEREDIA, COSTA RICA, 30.94 m., Addr. Amando C. Marin, Apartado 40. Sun. 7-8 am. Tues., Thurs., Sat. 9-10 pm.
11.885	TP87	PARIS, FRANCE, 25.24 m. (See 15.245 mc.) 7-9.15, 9.30 pm.-12 m.	11.710	S8P	MOTALA, SWEDEN, 25.63 m., 1.20-2.05, 6-9 am., 11 am.-1 pm., Sat. 1.20-2 am., 6 am.-1.30 pm., Sun. 3 am.-1.30 pm. Wed. and Sat. 8-9 pm.	9.685	TGWA	GUATEMALA CITY, GUAT., 30.96 m., Daily 10-11.30 pm.; Sun. 6-11.30 pm.
11.870	W8XK	PITTSBURGH, PA., 25.26 m., Addr. (See 21.540 mc.) 6-8.45 pm.	11.710	YSM	SAN SALVADOR, EL SALVADOR, 25.63 m., Addr. (See 7.894 mc.) Irregular 1.30-2.30 pm.	9.680	ZHP	SINGAPORE, MALAYA, 30.98 m. Sun. 5.40-9.40 am., Wed. 12.40-1.40 am., Mon.-Fri. 4.40-9.40 am., Sat. 12.25-1.40 am., 6.40-9.40 am., 10.40 pm.-1.10 am. (Sun.)
11.865	—	BERNE, SWITZERLAND, 25.28 m. Irreg. 8-9 pm.	11.710	—	SAIGON, FRENCH INDO-CHINA, 25.63 m., Addr. Boy-Landry, 17 Place A Foray. 6-9.15 am.	9.675	DZA	ZEESEN, GERMANY, 31.01 m., Addr. (See 10.042 mc.) Irregular.
11.860	GSE	DAVENTRY, ENG., 25.29 m., Addr. (See 11.75 mc.) 3-5.15, 5.45 am.-12 n.	11.700	HP5A	PANAMA CITY, PAN., 25.65 m. Addr. Radio Teatro, Apartado 954. 10 am.-10 pm.	9.670	—	ROME, ITALY, 31.03 m. Relays ZRO 6-9 pm. Irregular.
11.855	DJP	BERLIN, GERMANY, 25.31 m., Addr. (See 15.280 mc.) Irregular 11.35 am.-4 pm.	11.700	CBI170	SANTIAGO, CHILE, 25.65 m. Addr. P.O. Box 706. Relays CB89 6 pm.-12 m.	9.670	W3XAL	BOUND BROOK, N. J., 31.03 m., Addr. NBC, N. Y. C. 5 pm.-12 m.
11.840	KZRM	MANILA, P. I., 25.35 m. Addr. Erlanger & Gallinger, Box 283. 9 pm.-10 am. Irregular.	11.676	IQY	ROME, ITALY, 25.7 m. Relays ZRO 1.35-2.25, 6-9 pm.	9.660	LRX	BUENOS AIRES, ARG., 31.06 m., Addr. El Mundo. Relays LRI, 9.30 am.-11 pm.
11.840	CSW	LISBON, PORT., 25.35 m. Nat'l Broad. Station. 11.30 am.-1.30 pm. Irregular.	11.530	SPD	WARSAW, POLAND, 26 m., Addr. 5 Mazowiecka St. 6-9 pm.	9.650	CS2WA	LISBON, PORTUGAL, 31.09 m., Addr. Radio Colonial. Tues., Thurs. and Sat. 3.30-6 pm.
11.840	OLR4A	PRAGUE, CZECHOSLOVAKIA, 25.34 m., Addr. Czech Shortwave Sta., Praha XII, Fochova 16. Daily 12.55-4.30 pm. Mon., Tues., Thurs., Fri. 7.55-10.55 pm., Sun. 5.55-8.55 pm.	11.402	H80	GENEVA, SWITZERLAND, 26.31 m., Addr. Radio Nations. Sun. 7-7.45 pm., Mon. 1-1.15 am., 7-8.30 pm.	9.645	HH3W	PORT-AU-PRINCE, HAITI, 31.1 m., Addr. P. O. Box A117. 1-2, 7-8 pm.
11.830	W9XAA	CHICAGO, ILL., 25.36 m., Addr. Chicago Federation of Labor. Irregular 7 am.-6 pm.	11.040	CSW7	LISBON, PORTUGAL, 27.17 m., Addr. Nat. Broad. Sta. 1.30-5 pm.	9.640	CXA8	COLONIA, URUGUAY, 31.12 m., Addr. Belgrano 1841. Buenos Aires, Argentina. Relays LR3, Buenos Aires 6 am.-10 pm.
11.830	W2XE	NEW YORK CITY, 25.36 m., Addr. Col. Broad. System, 485 Madison Av., N.Y.C. 6.30-11 pm.	11.000	PLP	BANDOENG, JAVA, 27.27 m. Relays YDB. 6-7.30 pm., 10.30 pm.-2 am., 4.30-10.30 or 11 am. Sat. until 11.30 am.	9.635	ZRO	ROME, ITALY, 31.13 m., Addr. (See 11.810 mc.) 12.05-9 pm.
11.826	XE8R	HERMOSILLA, SON., MEX., 25.37 m., Addr. Box 68. Relays XE8H. 1-4 pm., 9 pm.-12 m.	10.960	—	TANANARIVE, MADAGASCAR, 27.36 m., Addr. (See 9.38 mc.) 12.30-45, 3.30-4.30, 10-11 am. Sun. 2.30-4 am.	9.630	HJ7ABD	BUARAMANGA, COL., 31.14 m. 10 am.-12 n., 4-11 pm.
11.820	G5N	DAVENTRY, ENG., 25.38 m., Addr. (See 11.75 mc.) Irregular.	10.670	CEC	SANTIAGO, CHILE, 28.12 m. Irregular.	9.625	JFO	TAI HOKU, TAIWAN, 31.16 m. Relays JFAK irreg. 4-10 am.
11.810	ZRO	ROME, ITALY, 25.4 m., Addr. E.I.A.R., Via Montello 5. Daily 4.40-8.45 am., 10 am.-9 pm.	10.660	JVN	NAZAKI, JAPAN, 28.14 m. Broadcasts daily 2-8 am. Works Europe irregularly at other times.	9.616	HJ1ABP	CARTAGENA, COL., 31.20 m., Addr. P. O. Box 37. 11 am.-1 pm., 5-11 pm., Sun. 10 am.-1 pm., 3-6 pm.
11.805	COGF	MATANZAS, CUBA, 25.41 m., Addr. Gen. Betancourt 51. Relays CMGF. 2-3, 4-5, 6-11 pm.	10.600	Z1K2	BELIZE, BRIT. HONDURAS, 28.25 m., Tues., Thurs., Sat. 1.30-2, 8.30-9 pm.	9.615	ZRK	KLIPHEUVAL, SOUTH AFRICA, 31.2 m., Addr. P. O. Box 4559, Johannesburg. Daily, exc. Sat. 11.45 pm.-12.50 am., Daily exc. Sun. 3.20-7.20, 9-11.45 am., Sun. 3.30-4.30 or 4-5, 5.30-7, 9-11.45 am.
11.805	OZG	SKAMLEBOAEK, DENMARK, 25.41 m. Addr. Statsradiofonien. Irreg.				9.607	HP5J	PANAMA CITY, PANAMA, 31.23 m. Addr. Apartado 867. 12 n. to 1.30 pm., 6-10.30 pm.

End of Broadcast Band

(Continued on page 501)

All Schedules Eastern Standard Time

Radio Kinks

Each month the Editor will award a 2 year subscription for the best kink submitted. All other kinks published will be awarded eight months' subscription to RADIO & TELEVISION. Look over these kinks; they will give you some idea of what is wanted. Send a typewritten or ink description with sketch, of your favorite to the Kink Editor.

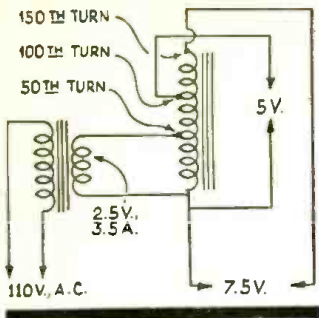

First Prize

Auto Transformer

A single winding auto transformer is a handy thing for securing a variety of filament voltages when used in conjunction with a filament transformer having but one low-voltage winding. The auto transformer may consist of 150 turns of No. 24 D.C.C. wire, wound on the core of an old audio transformer. It should be tapped at the 50th and the 100th turn. When connected as shown, it will deliver either 5 or 7½ volts from a transformer having a 2½ volt secondary. Other taps on the auto transformer will deliver any desired voltage. If the auto transformer heats up unduly, it would be advisable to use a heavier gauge wire than No. 24.—*Eugene Crow.*

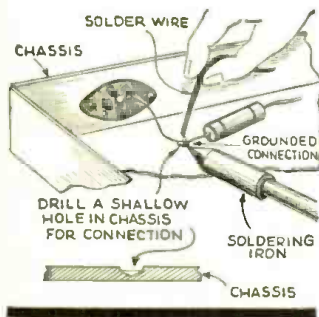

Soldering to Chassis

Perhaps the sloppiest looking piece of work the average constructor turns out is the "common ground" on the chassis, usually just a large blob of solder, irregular in shape and unpleasant in appearance. I have found a way in which to make solder joints to the chassis both easily and neatly. Simply drill a shallow hole at the point where the wire is to be connected to the chassis. This affords a well polished surface to which the solder easily adheres. Molten solder is then run into the cup-shaped depression thus formed, and the joint is made in a moment.—*John Metzler.*

Flexible Coupling

Here is a FB insulated and flexible extension condenser shaft; the shaft consists of a piece of glass tubing, which can be made any desirable length, fitting into a rubber coupler which in turn fits onto the condenser shaft. By using this arrangement, a costly extension is not needed when one uses an inclined panel, as this coupler will operate satisfactorily at angles up to 60 degrees.—*R. H. Alexander.*

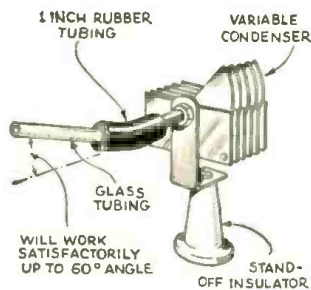

Keeps Pencil Ready

Every Ham knows that the hardest piece of equipment to keep is a common, ordinary lead pencil. The pencil is always missing just when needed most to copy some real DX signals and I therefore hit upon this scheme to keep a pencil on the desk at all times. All you do is drill a ⅛" hole up under the desk, put a string through, tie the pencil to one end and a weight to the other. When you want the pencil, reach under the edge of the desk where the pencil is hidden and pull it out—the weight keeps the pencil in place.—*N. W. Slater.*

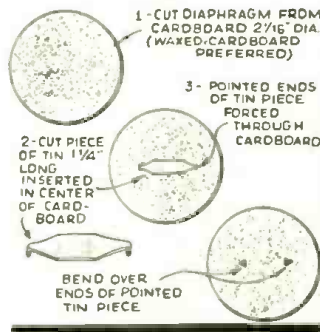
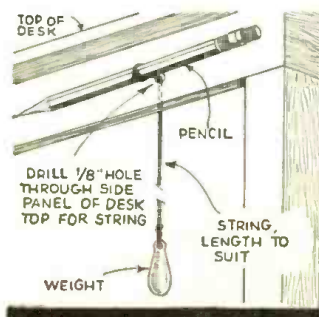

Home-Made Phone Diaphragm

Sometimes the diaphragm of a headset becomes bent or otherwise damaged, in which case it is practically impossible to repair, and a new one must be purchased. This often necessitates considerable delay, during which time the phone is unusable.

Not wishing to wait while a new diaphragm was shipped from the factory, I cut a diaphragm from the waxed pasteboard in an old empty fruit jar, and fitted it with an armature cut from an old tin can—the pointed ends of the tin being pressed through the cardboard and clamped on the back. The results were so good that I put a cardboard diaphragm in the other phone, too. I found that the tone was better, and there was apparently less noise.—*Ernest Valencia.* (ED. NOTE: It may be necessary to add a washer to keep the tin armature from striking the phone's pole-pieces.)

Umbrella Antenna

A discarded umbrella from which the silk or cotton has been removed makes a highly effective antenna for a portable receiver or transmitter. The ribs are left intact and are extended, as if in use. This type of antenna has considerable area, and while the metal is not as highly conductive as copper, it suffices very well for all practical purposes. If a porcupine antenna is preferred, the umbrella may be turned inside out. Incidentally, it does not matter if one or two of the ribs are broken—so a broken umbrella can be used.—*Mario LaCognato.*

Co-Axial Lead-In

To make this neat lead-in panel, cut a piece of bakelite, plywood, or other suitable material to fit in the window sill, so that the window, when partly open, will rest on the top edge of the panel, which may be weather-stripped to provide a tight fit.

Holes are then drilled to accommodate insulated banana or G R jacks; jack feed-thru insulators may be used also. A lightning arrester, antenna coupler, and changeover switch, to connect the aerial to either the receiver or transmitter, may also be mounted on the board.—*Charles E. Baker, Jr.*

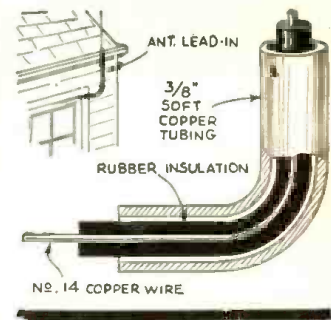

Automatic Code Sender

A novel, inexpensive, automatic code sender for the Ham using ICW, or code practice aid for prospective Hams, may be had by anyone possessing a phonograph and suitable amplifier. Merely feed the output of the amplifier through a 3 to 1 transformer into pickup, and that of an audio oscillator into input. A ¼ lb. weight is attached to the pickup to make a "home recording" needle cut. Records are of the "home recording" type, available at most music stores.—*Ed. Ramey.*

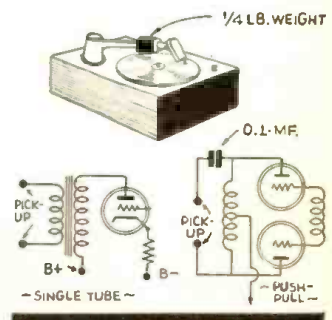

Build this 441 Line

T.R.F. Television Receiver

Part 2—Conclusion

TELEVISION HAS TECHNICALLY BEEN DEVELOPED TO A HIGH DEGREE. THIS ARTICLE PROVIDES THE LATEST INFORMATION. IT WILL BE SOME TIME BEFORE HOME TELEVISION IS REALIZED. THE ART HAS GREAT OPPORTUNITIES FOR EXPERIMENTERS AND TECHNICIANS.

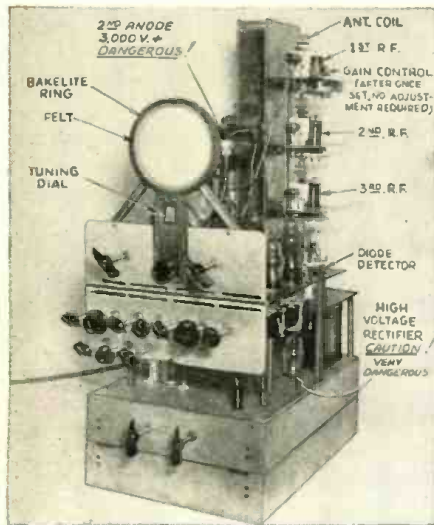

The finished chassis—ready for a cabinet and a visual broadcast.

● IN the Nov. issue of this publication, a description was given of the cathode-ray tube mounting together with the D.C. restorer circuit, the synchronizing separator, two power-supplies, and the vertical and horizontal sweep circuits for a T.R.F. (tuned radio frequency) 441-line television receiver.

There follows a description of the tuned radio frequency circuits, the detector, the video amplifiers and a suitable antenna system for this receiver.

The reasons for choosing a T.R.F. receiver for television are obvious.

1. Simplicity of construction.
2. Broad frequency response (2,500,000 cycles side-bands must be passed for maximum detail of the transmitted image, according to present day standards).
3. Minimum number of tubes and associated apparatus.
4. Freedom from complicated alignment procedures.
5. Last, but not least, lower cost to the constructor.

Three R.F. Stages

The radio frequency section of this receiver consists of three stages of amplification, using the special television amplifier tubes designated as type 1851, which have a very high mutual conductance, namely 9000 micromhos, as against 1200 to 1800 for a similar tube used in short-wave and broadcast receivers; yet the inter-electrode capacities are reasonably small.

Here is a word of caution on using the 1851 tubes. Under no circumstances must these tubes be used in a horizontal position, as the close spacing between the ele-

ments would surely cause trouble due to these elements sagging and touching one another.

Each R.F. stage is thoroughly shielded, preferably in copper or brass. Aluminum may be used, but because of the difficulty in soldering it, the shielding is not as effective.

The circuits used differ from the usual T.R.F. receiver only in that each stage is broadened out by "swamping" a fairly low resistor across the tuned circuit, in order to pass the unusually broad frequency band previously mentioned. Great care must be taken in the physical "layout" of the components so that every lead is as short as possible. By way of mention, no wire need be purchased for wiring the R.F. and V.F. circuits other than the filament, ground and B+ leads for the various tubes. The leads

aboo" in the construction of T.R.F. ultra short-wave receivers. Great care should be exercised to avoid them. In some cases, where oscillation of one or more of the R.F. stages is encountered, "by-passing" the filament leads or inserting a small R.F. choke in series with each filament lead will remedy the trouble. (See Fig. 1.)

Mica condensers are used throughout the R.F., detector and V.F. circuits for by-passing. Where paper condensers are imperative due to the large capacity required, these should be shunted with a mica condenser no smaller than .005 mf. The reason for this procedure is that at these very high frequencies, mica condensers have the least inductance. Therefore, the high frequencies will be by-passed by the mica condensers and the paper condensers will take care of the lower frequencies. The total gain of the receiver is governed by the biasing resistor of 1500 ohms in addition to the regular bias of 175 ohms in the cathode of the first R.F. stage.

Detector

The detector is a diode of the 6H6 type, similar to the detectors used in broadcast receivers, with the exception that only one section is used in order not to load up the circuit with too much "shunting" capacity, and thus lose some of the very high video frequencies. The plate resistor of this tube is in series with a small choke which, with the reflected capacity of the succeeding tube, "boosts" the response at the highest frequency to be amplified and still keeps the phase change down to negligible proportions. This procedure is followed in the two succeeding video stages. (See Fig. 2 and the schematic diagram.)

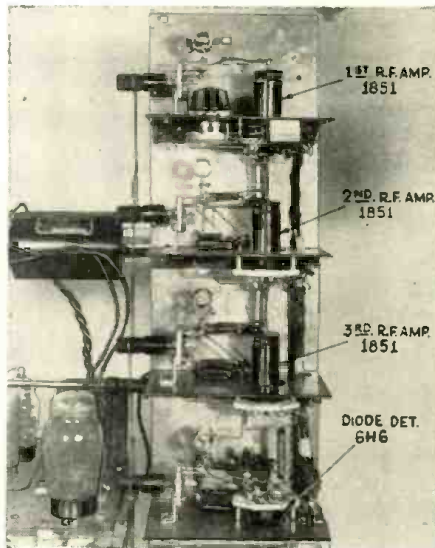

Side view of the R.F. stages. Note the careful interstage shielding.

of each resistor and condenser serve satisfactorily for connectors, and in many instances these leads should be cut much shorter. Too much emphasis cannot be stressed in using the very *shortest* leads possible.

Another very important factor to remember is to run all ground leads to one point in each shield, and then solder this point to a wire which runs down through all the shields on each side and connects only at one point on the chassis. In other words, there will be one wire from each stage (R.F., detector, and V.F.) running to one point of the chassis somewhere in the lowest compartment of the assembly, and there grounded to an actual ground.

"Ground loops" are the greatest "bug-

Side view of video stages. A flashlight cell provides hum-free biasing.

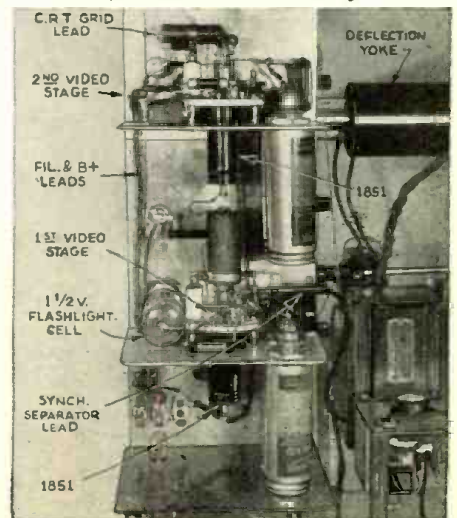

Adding the R.F. and Video stages to the Townsend Television Receiver, thus completing the apparatus.

Henry Townsend

Video Amplifier

The video amplifier also uses two of the special television steep slope pentodes designed expressly for this purpose. This amplifier must pass frequencies from 30 cycles to 2.5 megacycles and amplify these frequencies equally, with negligible phase displacements.

The data furnished with these tubes recommends that a cathode resistor of at least 150 ohms be used as bias. At radio frequencies, this resistor can be by-passed without the least bit of degeneration or phase change, but when we encounter this problem at a frequency of 30 cycles, it would require a bypass condenser of at least 1000 microfarads. Even at the low voltage used, it would be quite a large condenser physically, and therefore, instead of the usual cathode biasing, a small 1½-volt dry cell was chosen for the bias of these tubes, shunted by a .01 mf. mica condenser. This eliminated all problems of phase change and degeneration at this frequency; and in the end, it is more economical.

By studying the photographs accompanying this article, the reader will notice that the physical "layout" of the R.F., detector and the video amplifier makes for extremely short leads between stages and, at the same time, looks well and functions better than would a less compact layout.

The condensers, tuning the three R.F. stages and detector, are so arranged that extensions (preferably of bakelite) protrude from the shield and these, in turn, can be "ganged" together with a "fish line" for single dial control.

The writer does not deem this the ultimate in mechanical perfection and perhaps

A close-up of an R.F. stage, showing an easy method of ganging condensers.

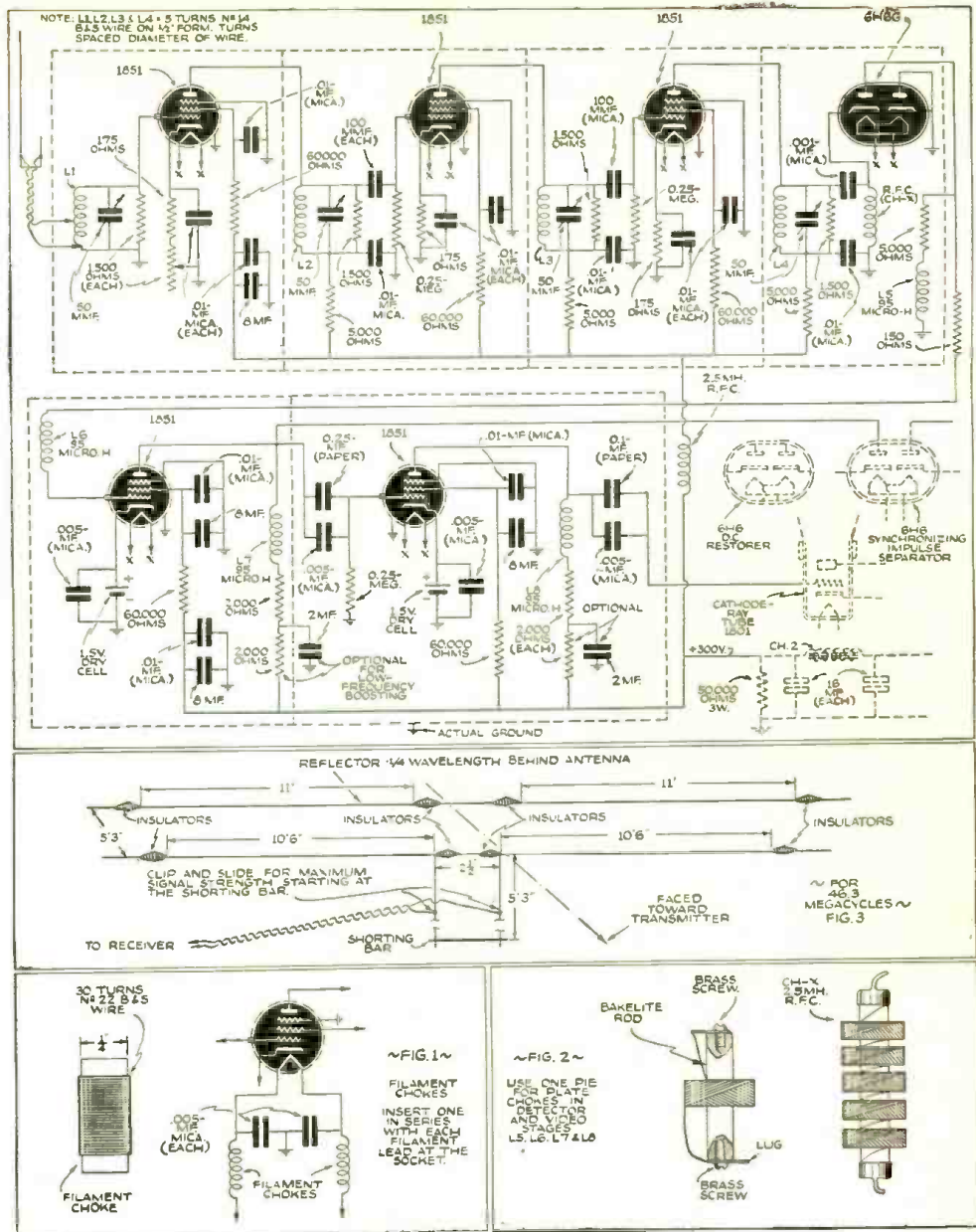
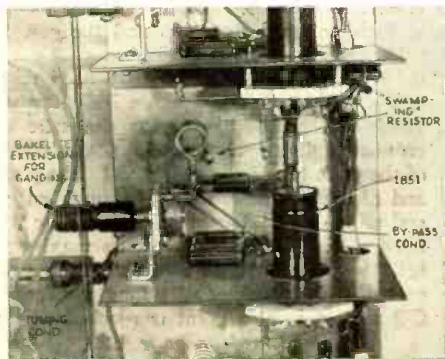

Schematic diagram at top shows R.F. and video circuits. Fig. 1 illustrates method of avoiding "ground loops"; Fig. 2, detail of special choke; Fig. 3, all antenna specifications.

the constructor will find a better way to do the same thing more efficiently and economically. However, this television receiver works, and works well.

If this article will instill a better thought or design in the mind of the constructor, either mechanically or electrically, he is at liberty to follow his reasoning to a conclusion.

It is to be remembered that the receiver incorporates only three R.F. stages and should be able to receive the transmission of television stations throughout the country for reasonable distances, but under no consideration should this be taken that a receiver located, say in Chicago, will pick up programs from New York or Los Angeles. The capability of this receiver will depend not only upon location, but the power of the transmitter and other conditions peculiar to ultra-short wave transmission and reception.

It was not so very long ago that we spoke of the horizon as the limit of transmission

on these frequencies. However, greater distances have been covered, though not consistently. Another fact to keep in mind is that a greater signal strength is required to receive an image than to receive sound.

To make a check-up easier for yourself, locate the receiver for the first trial within a two or three mile radius of the transmitter. After results are obtained, greater distance between receiver and transmitter may be attempted. The set's performance will be most surprising even to the ultra critical observer.

The antenna system for this receiver consists of a half-wave doublet with a matching stub or transformer. (See Fig. 3.) Where space is available, a reflector consisting of two half-wave sections will materially increase the signal strength if properly placed and constructed.

As most of the television transmitters in the United States emit horizontally polarized waves, the antenna will be in a
(Continued on page 511)



An inexpensive all-band receiver for the SWL.



Rear view of easy-to-build receiver.

Wiring the 3-tube receiver is dead easy when you follow this detailed picture diagram.

● HERE is a simple 3-tube receiver that offers a surprising number of good features yet is simple enough for the novice to build and effective enough in its operation on the air to command the interest of the more experienced constructor and short-wave listener.

The receiver utilizes plug-in coils and provides continuous coverage of all ranges from 16 to 550 meters, or approximately

3-Tube A.C. Receiver

Range 16 to 550 Meters J. T. Wilcox, W2CLS

20,000 to 550 kilocycles. This includes the broadcast band and all the important short wave ranges, broadcast, police, amateur, aviation, marine, etc. All operating power is obtained from the 110-120 volts A.C. light lines.

A 6K7 high-gain metal amplifier tube is employed in a regenerative detector circuit as the first tube. The regenerative feature provides great sensitivity and is smoothly controlled by a potentiometer on the front panel, by means of which the voltage applied to the screen grid is varied. The antenna is capacity coupled to the grid of this tube, the condenser being one of the variable "trimmer" type, thus permitting the antenna coupling to be varied, and adapting the set to use with any type of antenna.

The output of the 6K7 is thoroughly fil-

tered by means of a choke and condenser to prevent overloading or other trouble which might develop if R.F. were allowed to reach the audio circuits. It is then resistance-coupled to a 6F6 power-amplifier pentode, with additional filtering to prevent hum, this filter consisting of the 100,000-ohm resistor and .5 mf. condenser in the plate supply to the 6K7 tube. This audio tube is self-biased and the metal shells of both it and the 6K7 are grounded to insure a high order of operating stability.

The loud speaker is an electro-dynamic type with a built-in transformer to match it to the output impedance of the 6F6. Field-coil excitation is obtained by connecting this coil in the B plus lead, where it serves as a filter choke with the 8 mf. condensers.

(Continued on page 492)

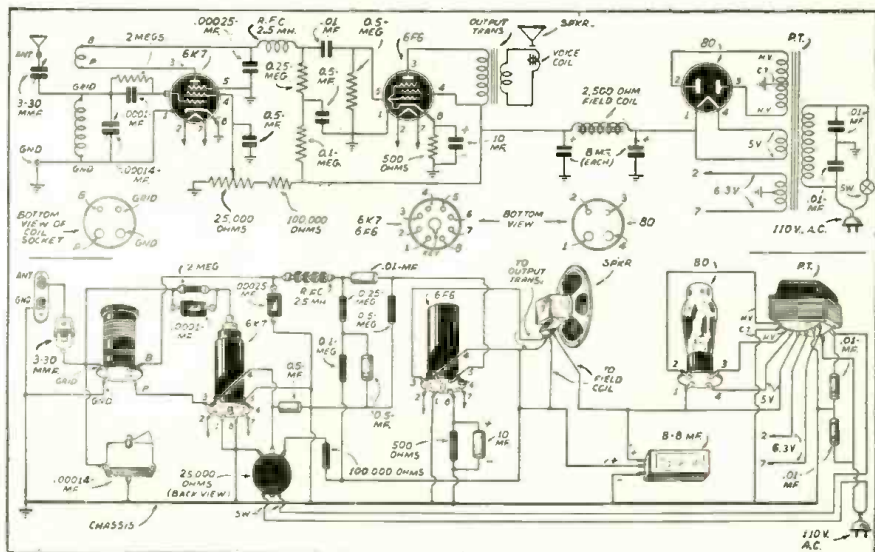

Economical 25 Watt Xmitter Kit

● THIS transmitter was designed in an effort to eliminate the headaches that confront the newcomer to amateur radio. It represents one of the simplest, efficient transmitters that a beginner can obtain in its price bracket.

Arriving at a practical layout was not an easy matter. Many types of oscillators were built and tested in order to choose the one from which the engineers could get the most for the least cost. The regenerative crystal oscillator was undoubtedly the best oscillator from all angles. It was built with a minimum of parts and keyed stably with no difficulty. Using a 6L6 tube, approximately twenty-five watts was obtained on the fundamental frequency and good output was secured on the second harmonic, with this Eagle FB25 transmitter. With a 160 and 80 meter crystal, the four most popular amateur channels are covered. The only tools necessary for construction are a pair

of pliers, a soldering iron and a screwdriver. The power supply is mounted on a similar chassis to the transmitter's and de-

New 25 watt Xmitter, available in kit form.

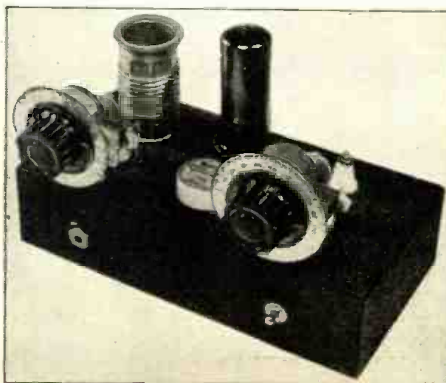

livers 425 volts of well-filtered D.C. No difficulties should be encountered in wiring the outfit, and the placement of resistors and condensers is left to the discretion of the constructor, who should attempt to keep the R.F. leads as short as possible.

Tuning the rig is simple: First, the crystal and the desired plate coil are placed in their respective sockets and the power-pack cable plugged into its receptacle on the rear of the chassis. A small neon tube, which is used as a resonance indicator instead of a milliammeter for the sake of economy, should be placed on the stator of the plate tuning condenser C-1. The plate and filament voltage should be switched on and with the key closed, C-1 should be rotated until the neon tube reaches maximum brilliancy. Now the antenna should be connected and the antenna tuning condenser C-2 rotated until a point is reached where

(Continued on page 492)

WORLD'S LOWEST-PRICED QUALITY TEST UNITS

AMAZING ANALYZERS

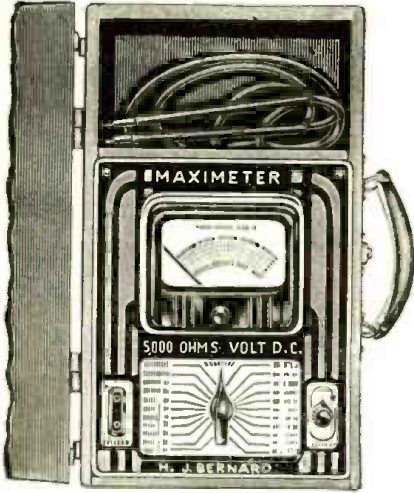

5,000 OHMS PER VOLT D.C.

MAXIMETER, above, with $4\frac{1}{2}$ " square meter, provides the first complete set of ranges ever offered. D-C ranges are at 5,000 OHMS PER VOLT, a-c at 1,200 ohms per volt, including exclusive output meter range of 150 millivolts (1.5 volts for connection across voice coil when aligning receivers. Readings obtained before the a.c. starts working. All batteries self-contained. **29 RANGES**
 0-10-50-250-500-2500 volts d.c., all at 5,000 ohms per volt
 0-1-10-100-1,000 ma (one amp.) d.c.
 0-3,000 ohms (20 ohms center); 30,000, 300,000, 3,000,000 and 30,000,000 ohms.
 0-150 millivolts a.c. output meter (condenser self-contained)
 0-15-150 volts a.c. output meter
 0-15-150-1,500 volts a.c.
 Minus 10 to plus 58 DB in 3 Ranges (0.005-05 mfd.) (0.5-50 mfd.) (14-14 henries) (14-14,000 henries)
 0-150 watts for a-c line. 0-1.3 amperes a.c.
Model 384 Master Micro-Multimeter, the BERNARD MAXIMETER; ship. weight 12 lbs. Net Price \$29.90

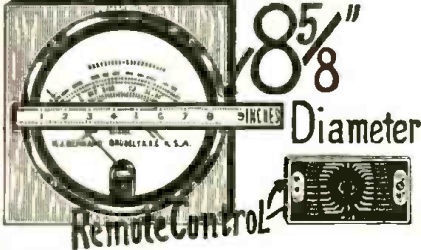

85/8"
3 1/8"
Diameter

Remote Control
Model 388 Bernard ATLAS. Shipping weight 6 lbs. Net Price \$29.90

PUSH-BUTTON TUBE TESTER

AN up-to-the-minute push-button tube tester and tube seller for direct readings on all tubes, both metal and glass, whether a-c or battery types. **TUBOMETER** tests for quality, individual element leakage (both hot and cold); shorts, opens, noise and gas, all in accordance with highest engineering standards for "emission" testers.

A fine-voltage control is included. Individual switch control of all elements takes care of "floating filaments" and other non-standard tube arrangements. Extra socket facilities and other ample provisions guard against obsolescence.

Fast, accurate, simple, the Bernard Tube Tester uses no adapters.

Large $4\frac{1}{2}$ " square illuminated meter, with provision for external use of the meter alone (0-1 ma.). Tests include all the old tubes, also all the new tubes, among them the new television tubes, e.g., 1851, the 1-1-volt 50 ma. and other battery tubes; gas tubes, such as 2A4G, 0A4G, 884; ballasts, magic eyes, etc.

The impressive appearance inspires customer confidence; the rugged construction assures dependable service and long life. Attractive cabinet of solid instrument wood, with removable cover. Tubometer is equipped with carrying handle (not shown). Bernard super-accuracy prevails throughout. Model 387. Shipping weight, 11 lbs. Net price **\$20.90**

Counter Model. No. 387C. 519.90.

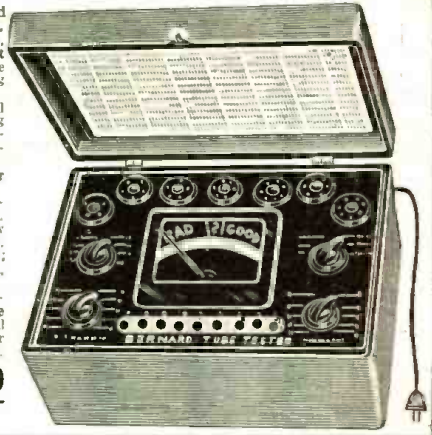

BERNARD SUPER-ACCURATE MINIATURES 5,000 OHMS PER VOLT D.C.

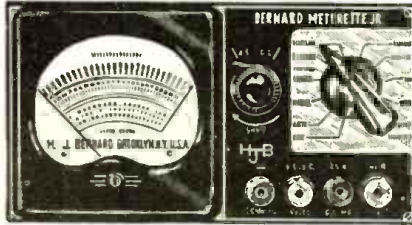

World's lowest-priced 5,000-ohms-per-volt. **METERETTE JR.**, in open box, is a pocket-sized super-accurate micro-multimeter. It is the best switch-type pocket instrument made and the fastest seller. Model 381-J, shipping weight 3 lbs. Net price **\$10.90**

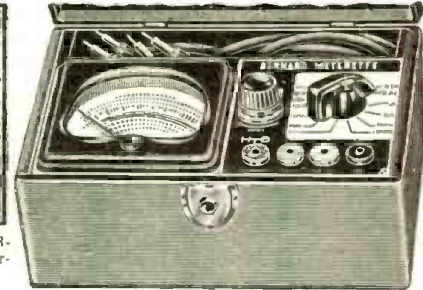

METERETTE, SR. is housed in a handsome instrument wood cabinet and has removable hinged cover and test lead compartment. Leads included in price. Model 381-S, shipping weight 3 lbs. Net price **\$13.90**

METERETTE is the outstanding 5,000-ohms-per-volt, providing super-accuracy and durability at lowest price. The junior model, 381-J, illustrated above (left), is housed in an open box of finished instrument wood, while the same chassis, when housed in a closed box, with removable hinged cover and compartment for the supplied test leads, constitutes **METERETTE SENIOR**, Model 381-S (at right). **METERETTE** is the first combination of super-accuracy, high sensitivity and low cost in a universal multimeter. A 3" square meter is used. Like all Bernard multimeters, it has only two controls, instead of the usual three, and separate selector switch positions for a.c., separate ones for d.c. The 3-volt battery (10¢ renewal cost) is self-contained.

14 RANGES
 0-10-50-250-500-2,500 volts d.c., all at 5,000 ohms per volt. 0-10-100-1,000 milliamperes d.c. Also 0-200 micro-amperes d.c. 0-2,600 and 1,000-2,000,000 ohms. 0-10-100-1,000 volts a.c., all at 1,200 ohms per volt.

1000 OHMS PER VOLT D.C.
 A 1,000-ohms-per-volt model, same appearance as **METERETTE**, is **MINIMETER**, with following fourteen ranges: 0-10-50-250-500 volts d.c.; 0-1-10-100-1,000 ma.; 0-400 ohms (100-ohm center). 0-250,000 ohms 0-10-100-1,000 volts a.c. Open box model, **MINIMETER JR.**, Model 386-J, price \$8.90.

SEE YOUR JOBBER OR WRITE FOR CATALOG "V."

TELEVISION SIGNAL GENERATOR

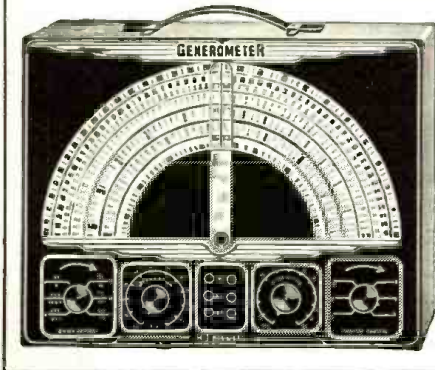

OPERATING entirely on fundamentals. **Generometer** is a signal generator covering 120 kc to 70 mc in six bands (down to 4.3 meters), by front-panel switch selection. Thus it supplies all the useful intermediate and radio frequencies for the complete alignment of all types of radio receivers. Future requirements are provided for by the inclusion of television bands.

The leakage has been eliminated, so that the attenuator works efficiently on all bands. By means of a switch, modulated or unmodulated carrier output may be selected. Combines Low Price with the Perfection of Service Found Only in the Highest Priced Signal Generators.

The dial is enormous—ELEVEN INCHES DIAMETER. Accuracy is 1% on i.f. and broadcast, 2% on short waves, 5% on ultra waves. Separate audio output.

SIX RANGES:
 A. 120 kc to 380 kc D. 4 mc to 12 mc
 B. 380 kc to 1,100 kc E. 12 mc to 50 mc
 C. 1.1 mc to 3 mc F. 25 mc to 70 mc

Generometer, Model 382, for 50-60 cycles, 90-150 volts, a.c. Shipping weight, 12 lbs. Net price \$19.90

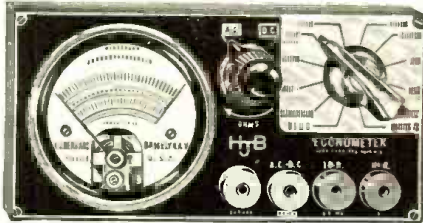

1,000 OHMS PER VOLT D.C.

ECONOMETER is a miniature extraordinary. It really fits in your pocket. Despite lowest price it has super accuracy. A 2" meter (0-1 ma.) is used, with easy-to-read scale. Housed in attractive instrument cabinet.

14 RANGES
 0-5-10-100-500 volts d.c., all at 1,000 ohms per volt.
 0-5-10-100-500 volts a.c.
 0-1-10-100-1000 ma. (up to one ampere). **MODEL 383**
 0-400 ohms (50 ohm center); **\$7.90**
 300-325,000 ohms.

SUPER ACCURACY

Bernard instruments are the first and only highly-accurate ones in the lowest-priced field. All models in attractive cabinets of solid instrument wood with DeLuxe finish.

BERNARD

H. J. BERNARD 319-Y THIRD AVENUE BROOKLYN, N. Y.

Export Representative: Pan-Mar Corporation, 1270 Broadway, N. Y. City

FULLY GUARANTEED

Each Bernard instrument carries a card containing our guarantee. So far as we know, ours are the only guaranteed instruments in the lowest-priced field.

Question Box

Single Tube Ham Transmitter

? I would like to construct a Ham transmitter using a single 6L6 tube, with crystal control. I have a power unit delivering the necessary voltages. Can you supply me with a list of parts, together with the diagram?—Adam Poretti, Bethesda, Maryland.

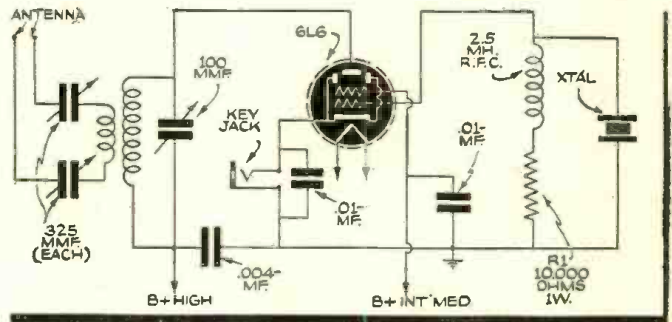

Low Cost, Low Power Ham Transmitter—1163

A. Here is a diagram of a simple crystal control "Ham" transmitter using a 6L6 tube. All parts needed are shown in the sketch.

Treasure Locator

? Can you inform an ardent reader of your magazine what issue of SHORT WAVE & TELEVISION contained an article on an Ore, Pipe and Treasure Locator?—Chas. Mecham, Fort Worth, Texas.

A. An article on such a radio device appeared in the issue of May, 1937. Write our circulation department for a copy.

Data on 5 Meter Antennas

? Do antennas for 5 meter work differ in any respect from the antennas that are used for 40, 80 and 160 meter work? How are they determined, and is there any book available in which one may secure some data with reference to the problems in designing such antennas especially for 5 meter or ultra-high frequency work?—Allen Johnson, Philadelphia, Pa.

A. The problem of designing an antenna for the ultra-high frequencies in the neighborhood of 5 meters is in no respect any different from those used on the lower frequencies. Antenna lengths are determined in the same fashion, tuned feeders remain multiples of a quarter wave, and matching systems are treated in the same manner. Ultra-high frequency antennas are, of course, much smaller than their lower frequency counterparts and it is therefore more readily possible to observe their performance with a neon bulb or galvanometer.

Photocell Relay Circuit

? In the October issue of RADIO & TELEVISION there appeared in the Question Box a diagram of a simple photocell relay circuit. I would like to obtain a more sensitive circuit, using a stage of amplification. I intend to use this for starting and stopping a motor. Can you give complete list of parts?—Alfred Barthly, Tampa, Fla.

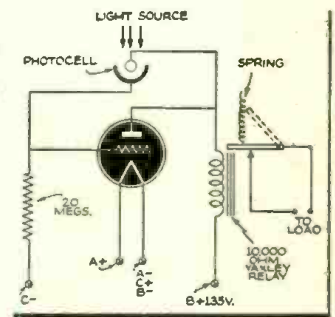

P-E Cell Circuit—1164

A. There is no reason why a stage of amplification cannot be used with a photocell. Here is a diagram for a photocell relay circuit which is slightly different from the one shown in the October issue, and which is suitable to operate a motor. The circuit shows the parts that are needed.

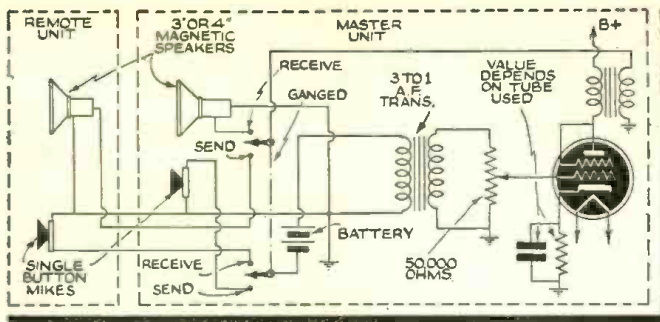

Simple Two-way Intercommunicator—1161

Inter-Communication System

? I wish to connect two single-button mikes and two small magnetic speakers in such a manner that inter-communication can be carried on between a room on a second floor in my home and the kitchen, which is on the lower floor. If possible, can you show by diagram the simplest way this may be accomplished?—H. A. Stebbins, Madison, Wisconsin.

A. Here is a simple diagram using a stage of amplification for two mikes and two speakers. Both switches are located in the master unit, which may be used in either room. It is a simple affair and makes a satisfactory two-way communication system.

Set Squeals

? Recently I have constructed a four-tube TRF, regenerative receiver. After adding an audio power stage, squealing and body capacity were experienced when the regeneration control was advanced. Can you suggest anything to remedy this?—Tony Piccolo, Ogdensburg, N. Y.

A. The trouble you are experiencing is due to R.F. getting into the audio section. We suggest that you try placing a .002 mid. condenser from the plate of the detector to ground or B minus. Refer also to diagram number 1131 in the June, 1938, issue of SHORT WAVE & TELEVISION. If this does not help, it would be best to change the complete layout of parts.

Two-Element Detector Circuit

? I wish to use a two-element detector circuit in a receiver that I am constructing to cover the 2000 to 3000 kilocycle band. Could you supply such a detector circuit, giving the coil-condenser combination? I intend using two stages of tuned radio frequency amplification for local reception. —Nathan Lefkowitz, Lafayette, Indiana.

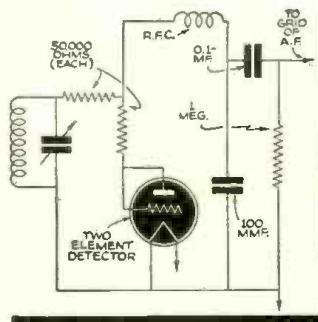

Diode Detection—1162

A. The sketch shown here illustrates a grid-leak two-element detector circuit. Either a D.C. filament tube or an A.C. heater tube may be used and as all common receiving tubes deliver about the same results, the choice will depend largely on the filament voltage supply available. The grid and plate of the tube are connected together as one terminal and the cathode or negative side of the filament serves as the other terminal. If a heater tube is used, it is well to bias the heater positively with respect to the cathode to prevent hum.

The condenser-coil combination in each tuned circuit will have about 37 microhenries inductance and may be made by winding 20 turns of No. 28 enameled wire on a 1½ inch diameter insulating tube. This is the tuned secondary. The condenser for this should be .00025 mf. The primary may be 20 turns of No. 30 enameled wire if screen grid tubes are used in the R.F. stages and 12 turns of the same size wire if three-element tubes are used. Ten turns of No. 32 enameled wire can be used for the input of the antenna coil. In each case the primary may be wound directly over one end of the secondary, with a layer of paper between both windings.

Two stages of R.F. amplification are usually recommended for local reception and three or even four stages for long distance.

TECO TEST EQUIPMENT Sold with a GUARANTEE & 10 DAYS FREE TRIAL!!!

Buy direct from the factory. Save 50%. If the Instrument you buy does not meet your needs, return it for full credit on any other TECO equipment. Buy TECO and SAVE the difference!



NEW TECO TUBE TESTER

Model T-10 A genuine achievement! For accurate and rapid work. Has d'Arsonval moving coil meter. Tests all types of tubes. For use on 110 V., 60 cycle AC.

Features • Tests all 4, 5, 6, 7s, 7L and metal base tubes. • Tests by the well established emission method for tube quality, directly read on the Good ? Bad scale of the meter. • Affords separate neon test for leakage and shorts between elements. • All services performed with 5 controls at maximum—many tests not requiring all controls. • Modern attractive etched panel housed in rugged leatherette carrying case with removable hinged cover and handle. • 60 cycle AC operation. • Supplied with instructions and reference table covering all tubes which you will commonly encounter in servicing. Size 11 1/2 x 9 1/2 x 5 1/2". Net Price.....

\$11⁷⁵

TECO POCK-O-METER AC and DC

A new pocket size volt-ohm-milliammeter that includes AC measurements and is the lowest priced, full-service instrument ever offered! Has 3" d'Arsonval movement 0-1 milliammeter. Comes with etched panel.

SPECIFICATIONS

5 DC ranges: 0/1.5/15/25/75/500 volts.
5 AC ranges: 0/15/40/75/200/1200 volts.
4 DC current ranges: 0/1/10/100/500 ma.
2 resistance ranges: 0/500/500,000 ohms (low ohms read to 1 ohm)
Pock-O-Meter supplied complete with batteries, test leads, and instructions. Size 6 1/2 x 3 1/2 x 2 1/2"; shipping weight 5 lbs. Our net price.....

\$8⁴⁵

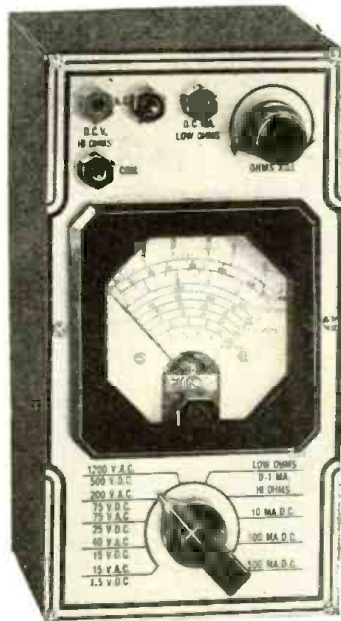

NEW TECO MULTIMETER

MODEL T-15 Here's the unit you need for rapid, accurate measurements. A 1000 ohms per volt type instrument featuring d'Arsonval type movement 0-1 milliammeter. Accuracy 2%. Attractive etched metal panel. For use on 110 V. 60 cycle AC. 2 RESISTANCE RANGES, 0-500 ohms, 500-5 megohms. HIGH AND LOW CAPACITY SCALES. 0.0005-1 mf. and 0.5-200 mf. COMPLETE AC and DC VOLTAGE and CURRENT RANGES. DC Voltage: 0-15, 0-150, 0-750 volts; AC Voltage: 0-15, 0-150, 0-750 volts; DC Current: 0-1, 0-15, 0-150, 0-750 ma.; AC Current: 0-15, 0-150, 0-750 ma. THREE DECIBEL RANGES.

TECO Multimeter comes complete in carrying case with test leads and instructions. Size 11 1/2 x 9 1/2 x 5 1/2". Shipping weight 3 lbs. Our net price.....

\$13⁶⁰



TEST EQUIPMENT COMPANY of America

139 CEDAR STREET

SW-12

NEW YORK, N. Y.

not been since he was W9LZO. He will come on on 160 meter fone, and does some experimenting with a 5 meter rig.

Amateur Activity in Baltimore

● 3-AIB is back on the air with phone, operating on 14158 kc. 3-IK is still fooling with 56 megacycles. 3-FAM occasionally on 14 meg. 3-CBV works only foreigners on 14 meg. 3-FXU rebuilt and is on 10 meter phone. 3-IIG working 10 meter phone. 3-CJH put up 2-sect. 8JK for 20 CW. 3-GNB a new one to be on 20 CW when LE finishes the rig. 3-CDZ says he will be on when he gets new receiver. 3-ASZ is back after an absence of about 5 years and is on 20 phone. 3-FWU is going to rebuild for 10 meter phone. The 28 meg. band is really opening up here. And I understand that there are going to be about 18 new stations here with 1 KW rigs soon! We expect a lot of new fellows to get licenses here in the very near future. Well, when I get the "final" hooked up and couple it to this 2-section 8JK beam I have up here, guess I won't have to worry much about it anyway. I have worked LU, VK, ON, OO, VP, VS, XZ, VE-1, 2, 3, 4, 5, XT, T1, CO, HC, SU, VR, F, G, SV, W10, HH, K6, HA, VU, J, XE, CN, PA, PK, VO, YN, GI, KA, YR, GM, ZS, SM, HB, GW, and AC since last November with this 200 watts input. All worked on 20 meter phone. Totals are 28 zones and 43 countries compiled.—Louis Charles Bremer, W3LE, 130 So. Broadway, Baltimore, Md.

New York and Vicinity W2CLS

● MET Laurence Cockaday, W2JCY, few weeks ago and he had just finished a new H.F. antenna

Local HAM Gossip

(Continued from page 471)

which uses no insulation other than air and is working P.B. He will give the info to the gang soon in a magazine article.

"Ben" Franklin, W2GRG on 20 has his new rotary beam working fine now and with his 1 A. behind it, is going places. We had an opportunity to work many of the local gang, including W2AN, whom we used to work when he was W8AQZ in Ohio about 15 or more years ago. These local rag-chews are really worth while. Among the stations contacted were W2JZO, W2JIE, W2LEJ, W2CDL, W2JDS, W2GDP and W2KDS, all putting in fine signals.

Ten meters has been picking up somewhat, although not up to what it was a few months ago. Seems like a lot of old timers are working 10 steady and doing a good job. Included among them are W2AOG, W2AWC, W2ZTP, W2BMK and W2ISY.—J. T. Wilcox, 500-9th Street, Carlstadt, N. J.

Report from L. M. Funk, Fire Marshal of Dallas, Tex.

● THAT part of Dallas, lying west of the Trinity River, and known locally as Oak Cliff, is within itself a metropolitan city of 120 square miles area. This vast area of approximately 100,000 people was suddenly cut off from all means of communication from Dallas proper about 6:30 P.M. on Sunday, October 9, 1938 when a fire of unknown origin broke out.

The five fire stations in Oak Cliff were com-

pletely isolated from the headquarters station, and the citizens of Oak Cliff were unable to phone in alarms to headquarters.

Deputy Chief L. M. Long of the Dallas Fire Department, remembering that the Fire Marshal, L. M. Funk, numbered among his friends a host of amateurs, called on him for assistance. Together they contacted Bob Huffhines, W5OL, of Oak Cliff, who dug up an old 160 meter rock crusher.

The Fire Marshal then made another run to his residence and brought an amateur receiver to the Fire Department Headquarters, where he tuned in W5OL, and then through KVP, the Police & Fire Radio Station, two-way communication was resumed to the Oak Cliff area.

Directions and instructions were sent out from headquarters over KVP, and all of the Oak Cliff equipment and stations replied by telephone to W5OL, where Bob relayed the information to headquarters over his station, W5EQJ, Odiss Peacock, assisted in keeping things in order.

This two-way communication was continued throughout the night, and just before day the workmen completed the repairs to the Fire Department lines, the emergency was declared ended and W5OL pulled the switch.

"73 Club" New York W2DIT

● THE "73 Club," one of the liveliest amateur radio clubs in the metropolitan area of New York, is laying plans for what promises to be a very successful season.

If you 20 meter phone "hams" haven't contacted Miss Ruth Feldman, who daily operates W2ASA, as yet, do so, for this "gal" just disseminates oodles plus of personality and interest.—Alvin Abrams, W2DIT.

1-Meter Waves with Ordinary Tubes

Nelson G. Haas and
Carl A. Erbacher

Ultra-high frequencies are attained by using such standard tubes as the 27, 37, 56, or 76, in conjunction with old parts, found in any workshop.

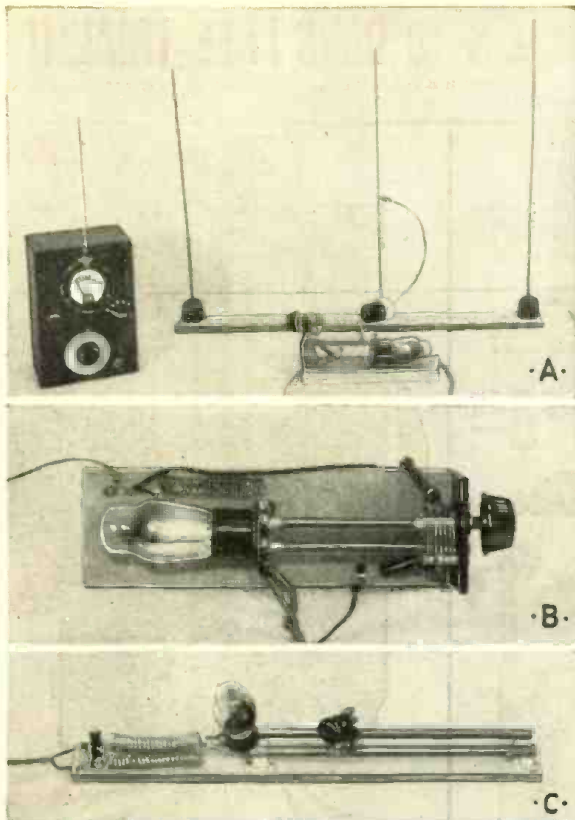

A—Antenna system for 1-meter oscillator consists of antenna, reflector and director. Output meter is placed in beam.
B—The completed 1-meter oscillator. Note simple layout.
C—Another neat layout. Using a 45, 71 or 210, this rig afforded more power, but would go only to 1.6 meters.

● VACUUM tube oscillators on a frequency of 224 million cycles per second, antennas less than a foot in length, radio signals carrying speech or music steered and bent around corners, much as beams of light would be—these are the interesting characteristics of a band of ultra-high frequency waves that can be generated with the simplest circuits and the most common varieties of tubes—the wavelengths around one meter!

Useful radio waves, the length of which can be measured by a yardstick, aimed in the exact direction one wants, to a receiver beyond the optical range; the entire apparatus, including the already assembled antenna arrays, can be packed into a fair sized soap box. In the many years the writers have been engaged in the radio game, building, testing and operating their own stations, never have they encountered a phase of radio half so fascinating, or nearly so instructive a laboratory test for the development of equipment such as oscillator circuits and antenna—receiver performances, dielectrics, etc.

For instance, it is but the work of minutes to set up an experimental antenna array and take field strength readings when the antenna can be measured with a 12-inch ruler. And the most convenient part is that all the apparatus needed is readily available, since it is the same type parts used in constructing higher wave equipment. But little room is needed for this sort of work, a desk top offers ample space for transmitter, antennas and a receiver.

The first radio waves generated by that eminent physicist, Heinrich Hertz, in 1887,

ago, nothing more was known of the very short, or Hertzian, waves than was known at the conclusion of those early experiments by the man who gave his name to them.

For a long period following a return of interest in Hertzian waves, scientists found no particular use for them, and their characteristics remained an abstract proposition—something to know about, and nothing more. The advent of the acorn and the door knob type tube a few years ago re-awakened the experimenter's interest in Hertzian waves but did little else—for he immediately bumped into the stone wall of far-too-expensive equipment.

But from the commercial laboratories, with their theory-trained workers, their resources of specially designed tubes and associated equipment, have come some interesting circuits and results. It is these circuits and accomplishments that the writers have endeavored to utilize by incorporating the most salient features with the usual ham, or amateur, practices, at the same time keeping to the reputedly less efficient older and far cheaper types of tubes and dielectrics. The results have been more than satisfactory to us so we pass them along to the reader, the man who is tiring of the commonplace in radio and who wants to delve into the last unexplored frontier of radio development.

A line to caution the too-enthusiastic experimenter seeking unusual or startling results. The powers generated by the tubes specified in this article, while ample for observation and communication, are comparatively minute. Should one have the

urge to use larger tubes and higher powers, be careful in the applications the outputs are applied to!

The human body resonates as a half wave, at about $3\frac{1}{2}$ meters, as a full wave at $1\frac{1}{4}$ meters and as two full waves at a little under one meter. Which means that with a 15 or 20 watt oscillator, even on $3\frac{1}{2}$ meters, the body will, under favorable conditions, resonate sufficiently so that a second person can light a small neon lamp on one's nose or ears, or toes, points of maximum voltage. Exposure to more power than this would very likely raise the internal temperature of the body and, if sufficiently powerful, destroy the body cells. So best

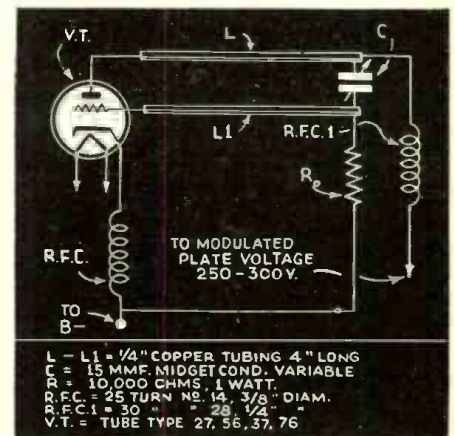

Schematic diagram and list of parts used in constructing the 1-meter oscillator, utilizing standard receiving tubes.

stick to the apparatus described until one becomes thoroughly familiar with the characteristics of the waves around one meter!

Having decided to adopt modern laboratory practices now used in ultra-high frequency work to equipment readily available to the average experimenter, the writers lost little time in finding which of the many possible circuits would prove the most suitable. All the basic oscillating circuits pre-

viously used in commercial laboratory circuits were quickly wired up and tried. Comparison showed that only one, the split-Colpitts, or ultra-audion oscillator, approached a satisfactory standard when using ordinary triode tubes. The ultra-audion circuit discards the familiar coil and condenser combination, used to obtain resonance, and—borrowing laboratory technique—uses instead resonant “long lines” made of tubing to tune both the plate and grid circuits.

The tubes at first were of the receiver UX audio output type, such as 171s, 112s and finally, in an attempt to increase power, 245s. All these tubes oscillated without any coaxing on waves as short as 1.6 meters. While using these tubes we discovered that they handled much the same as they would on 5 meters, insofar as output was concerned.

For checking wavelength, a simple version of a Lecher wire system was used. This comprised a 6-foot length of 1 x 2 inch lath to which were nailed 2 lengths of bare No. 14 copper wire, terminating at one end in a U-shaped loop and left open at the other end. A flash-light bulb and socket, to which were fastened 2 clips on very short leads, made up the “bridge” to short the wires and so get a possible reading.

To determine the wavelength the loop of the Lecher wires is placed in close proximity to the transmitter and the bridge is slid along the wires, starting at the loop end, until it indicates the maximum current point by the flashlight bulb lighting most brightly. From that point on the wires to the loop should be exactly half a wavelength, and can be measured off with a ruler, allowing, of course, 39.37 inches to the meter, so as to get the wavelength in meters.

An antenna cut to resonance and having a flashlight bulb in its center gave some indication of output that could be used for comparison, but a field-strength meter, such as the writers described in May, 1938, SHORT WAVE & TELEVISION as a crystal rectifier unit, proved invaluable for making field-strength measurements.

The super-regenerative receiver we used tuned down, when checked by Lecher wires, to $\frac{3}{4}$ meter and the detector tube in it, a 56, oscillated smoothly at that short wavelength. The cylindrical plate in a tube of the type such as the 56, 27 or 37, insures a far lower grid-plate capacity than is found in the type tubes first used in the transmitter.

The transmitter shown in the accompanying photograph was then constructed. Its details can be readily ascertained by studying both the photograph and the diagram. From the start it was successful beyond our expectations. In wavelength it would tune down to about $\frac{3}{4}$ of a meter, all the while running cool and stable. In fact, the signal from this transmitter, when tuned in on the super-regenerative receiver, stayed in one place on the dial for hours of constant checking. The 56s in both receiver and transmitter, neither of which were being operated at more than 200 volts, did not drift enough to necessitate retuning the receiver. This on one meter, without the aid of special tubes and equipment usually believed necessary for successful operation on that wavelength!

(Next article covers receiver)

Radio Talks from Jungle

(Continued from page 466)

manipulate the dials. It finally dawned on her that the voice was coming out of the radio apparatus.”

The greatest curse of tropical radio, according to Hungerford, was the insect. The nightly yield of electrocuted bugs averaged one quart.

LET THE POSTMAN BRING YOU THIS FREE CATALOG



AMERICA'S GREAT BUYING GUIDE

FREE

Model B-49
LAFAYETTE SUPER B-49 \$8.95
5 TUBE AC-DC WALNUT ONLY



F.3.5 LENS \$22.50
ZEPHYR CANDID CAMERA



188 PAGES OF GREAT VALUE



LAFAYETTE RADIO
1939 GIFT CATALOG NO. 73
WHOLESALE RADIO SERVICE CO. INC.
NEW YORK, N. Y. • CHICAGO, ILL. • ATLANTA, GA.
BOSTON, MASS. • BRONX, N. Y. • NEWARK, N. J. • JAMAICA, L. I.

Your buying guide, and a saving guide, too. That's the story behind this new FREE catalog. To bring you the latest, the best in 1939 Lafayette radios, parts, tubes. Public Address equipment, and amateur apparatus—all at thrifty prices. There are over 50,000 items in this great book, and every

single one a standout buy! Mail coupon today for your FREE copy. Wake up to sensational values!



TAKE THE GUESSWORK OUT OF YOUR CHRISTMAS SHOPPING WITH THIS NEW

FREE Gift CATALOG

1939 LAFAYETTE RADIOS
PUBLIC ADDRESS SYSTEMS
50,000 PARTS & TUBES
ELECTRICAL APPLIANCES
AMATEUR APPARATUS
TELEVISION KITS
CAMERAS

To make your Christmas shopping easier, to enable you this year to give beautiful, worthwhile gifts at money saving prices, we offer a special FREE Christmas-shopping catalog. Send for a copy today. It's crammed full of electric trains, cameras, modern appliances, electric shavers, radios—gifts for Mother, Dad, Junior, Sis, and the girl friend too. Mail the coupon today. It will pay you!

7 branches to serve you
WHOLESALE RADIO SERVICE CO. INC.
NEW YORK, N. Y. • CHICAGO, ILL. • ATLANTA, GA.
100 SIXTH AVENUE • 901 W. JACKSON BLVD. • 265 PEACHTREE STREET
BOSTON, MASS. • BRONX, N. Y. • NEWARK, N. J. • JAMAICA, L. I.



Valu-Bill says:
If you think I'm playing Santa Claus, get these FREE books and see for yourself!

WHOLESALE RADIO SERVICE CO. INC.
100 SIXTH AVENUE NEW YORK, N. Y.
Rush FREE 1939 Radio Catalog No. 73-4M8
Rush FREE 1939 Gift Catalog No. 75-4M8

Name.....
Address.....
City..... State.....

PASTE COUPON ON PENNY POSTCARD

How to Build the W8KPX

BEGINNER'S HAM Receiver

Harry D. Hooton, W8KPX

High in efficiency, low in cost, this Selective and Sensitive 4-tube Ham set affords band spread on Five Bands.

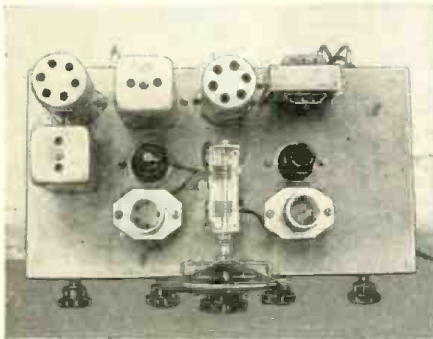
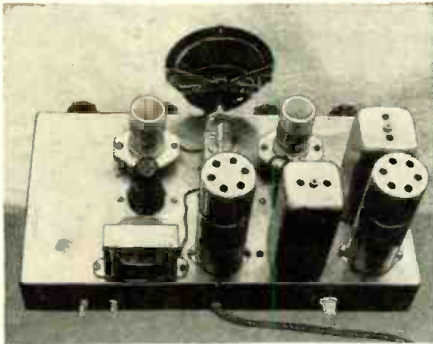

Top: A rear view of the W8KPX Special. Below: Top view, showing layout of parts.

● SINCE the publication of the "W8KPX" Beginner's Transmitter article in the July, 1938, issue of RADIO & TELEVISION, the author has received a number of requests from Ham beginners and would-be Hams for constructional data on a companion Beginner's Ham Receiver. In each case the writer specified a set capable of efficient five-band operation, with plenty of *sensitivity, selectivity and band-spread*, easy to build and operate and, finally, of the lowest cost consistent with the desired results.

4 Tubes Do the Work

The little 4-tube dual-regenerative superhet to be described here has been designed especially for use with the 75-watt transmitter, and is ideal for either the newcomer or the dyed-in-the-wool "old-timer" who wishes only a simple, low-cost receiver.

As the diagram, Fig. 1, shows, the circuit has been worked out around the new 6P7G pentode-triode and 6F8G dual-triode

tubes, with regeneration in both the r.f. and i.f. circuits. Using only two metal and two glass tubes, the results, so far as sensitivity, image frequency rejection and selectivity are concerned, are actually better than those obtained from most 6- or 8-tube receivers using the conventional superheterodyne circuits. Briefly, the line-up consists of a 6L7 regenerative mixer, a 6C5 high-frequency oscillator, a 6P7G as i.f. amplifier and regenerative detector and a 6F8G as two stages of resistance-capacity coupled A.F. amplification. The iron-core, 465 kc. i.f. transformers give an appreciable increase in gain over the ordinary air-core types.

Regeneration is introduced into the mixer circuit by means of a few turns of "tickler" winding in series with the 6L7 cathode and coupled to the "cold" end of the mixer grid coil. The regeneration control for this circuit consists of a 5,000 ohm potentiometer shunted across the cathode coil. It is

(Continued on opposite page)

Schematic and picture diagrams, below, make the wiring a matter of but a few hours' work.

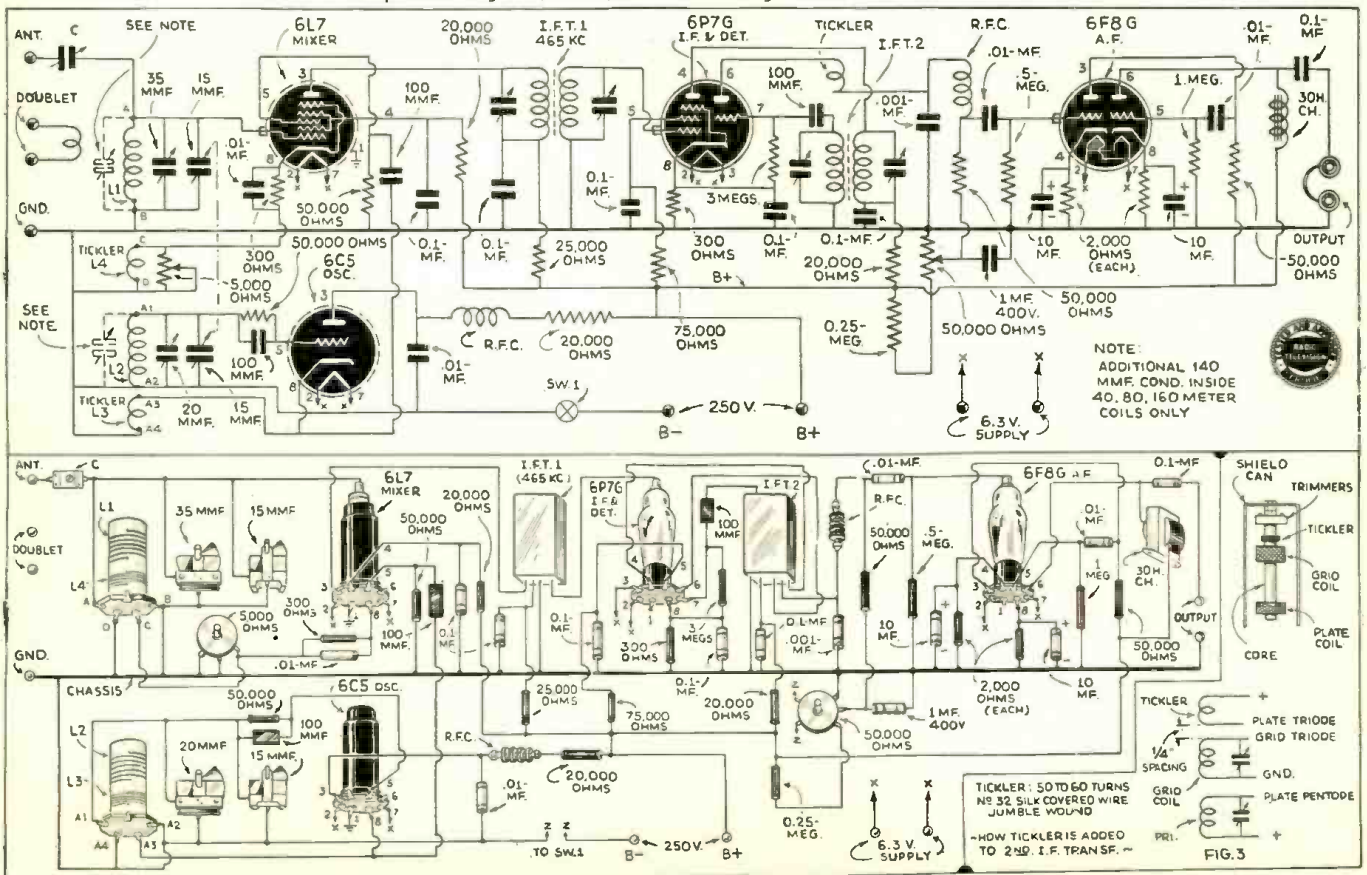

If you order any of the sets described below **NOW**, we will guarantee that your set will reach you in time for the holidays. We built up a stock to take care of rush orders. Act promptly.

THE NEW AND IMPROVED DOERLE MODEL D-38

A. C. 17½ x 8½ x 8½
7 Tubes 4½ to 3000 Meters

The last word in short wave receivers. Before you buy send for circular D-38, an eight-page booklet containing schematic and picture diagrams, instructions, and sketches.

Read this booklet and compare with the other models you have in mind. Then send your order to the concern who in your opinion is giving you the best for your money.

Complete, with all coils, and tubes, no extras **\$32.50**

Kit, factory assembled, but unwired, less tubes, with all coils **\$22.50**

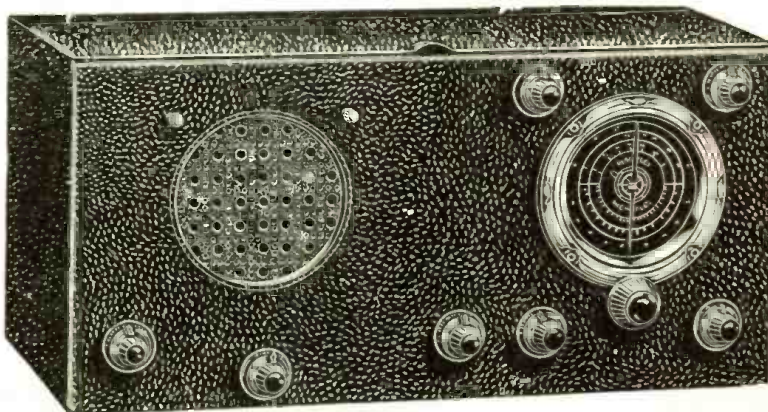

7C 5-Tube

Short Wave Receiver 8½ to 625 meters

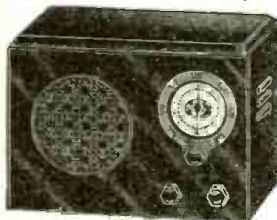

Bigger and More Powerful Than Ever

A Giant in Performance

Our Model 7C, A Midget in Size—A Giant in Performance. One of our most popular short wave receivers.

Our files contain many letters from satisfied listeners from all over the world which testify to the popularity of this set, and their lists of DX stations received on the loudspeaker is amazing. Uses a 6KT radio-frequency stage, a 6F7 twin 2 in 1 tube, as regenerative detector and first audio, one 6C5, one 12A7, twin 2 in 1 tube, and one 6X2A.

Earphone pack has been incorporated to permit the use of phone when loudspeaker operation is not desired. Operates from regular house current.

Size: 10x7½x7½. Complete with all coils, 9½ to 600 meters, and all tubes, ready to use, nothing else to buy... \$16.50

In Kit form, but factory assembled, including all coils and tubes, but unwired... \$12.95

*Available in battery model upon special order at same price.

**Also available in ham model with special tuning circuit to provide additional bandspread at \$1.00 additional.



BS-5 Six tube Bandswitch Receiver, no plug-in-coils, select the band by a simple flip of the switch. Loudspeaker Operation

12 to 600 meters, automatic headphone jack also included.

Complete, ready to use, including tubes, factory wired and laboratory tested, \$18.50.

Complete kit, factory assembled, ready to wire, including tubes and cabinet, \$16.50.

3 Tube Electric Model, complete, tested and ready to use, with 5 plug-in coils, 12 to 600 meters, at \$6.50.



Kit form, factory assembled, but unwired, with coils, less tubes, \$3.50.

Available in battery model at same prices. If specified. If tubes are desired, add \$1.50.

FLASH! SEND 10¢ FOR OUR NEW CATALOG containing CIRCUIT DIAGRAMS, and complete information on over 25 different types of short wave receivers and transmitters from \$2.50 and up. This catalog is chock full of schematic and picture diagrams, hook ups and short wave information. A book in itself. Well worth the dime, which will be refunded with your first order.

OSCAR B. KUSTERMAN 68 Barclay Street, Dept. 12
:: New York City ::

necessary to re-vamp the output I.F. transformer, adding a small tickler winding as shown in Fig. 3. Regeneration in the second detector is controlled by varying the voltage applied to the triode plate of the 6P7G tube by means of the 50,000 ohm potentiometer connected across a portion of the "B" supply.

The 10 meter amateur band to occupy approximately 50 degrees on the 270 degree dial. On the lower frequency bands, the band-spread increases as the frequency is lowered, until the full 270 degree scale is utilized on 160 meters. On the 10 and 20 meter bands the coils are wound on midget 1-inch isolantite forms, and the band-setting condensers consist of the 20 and 35 mmf. units whose knobs show just below the tuning dial in the photographs. The 40, 80 and 160 meter coils are wound on the standard, 5-prong forms and carry their own band-setting condensers inside the forms.

Adjust the mixer regeneration control to a point about one-half way on and turn up the potentiometer in the second detector plate circuit until a slight hissing sound is heard in the phones. Set

the tuning dial at half scale. Connect the antenna and ground wires and, with a small insulated screwdriver, adjust the band-setting condenser inside the oscillator coil to the approximate center of the band. Adjust the mixer band-setter for maximum signal strength, rotating the mixer regeneration control back and forth to obtain the most satisfactory setting. Pick out a good steady, weak signal, tuning it in as accurately as possible, and adjust the screws in each I.F. transformer for the greatest gain or signal strength. Go over the trimmers several times in order to obtain accurate alignment.

Either a plain single wire or a doublet antenna may be used with the receiver. A single wire, well insulated and in the clear, 20 to 50 feet long, will be satisfactory for all bands. However, on 10 and 20 meters a doublet will probably be better.

Coil Data

Grid Coil	Spacing	Mixer Coils	Wire	Band
4 turns	1"	3 turns	20 enam.	10 meters
12 turns	1½"	4 turns	20 enam.	20 meters
17 turns	1¾"	6 turns	22 enam.	40 meters
35 turns	1¾"	9 turns	26 enam.	80 meters
58 turns	1¾"	14 turns	28 enam.	160 meters

Oscillator Coils

Grid Coil	Spacing	Tickler	Wire	Band
4 turns	1"	4 turns	20 enam.	10 meters
12 turns	1½"	4 turns	20 enam.	20 meters
15 turns	1½"	6 turns	22 enam.	40 meters
32 turns	1¾"	9 turns	26 enam.	80 meters
52 turns	1¾"	16 turns	28 enam.	160 meters

The 10- and 20-meter coils are wound on 1" forms; the 40-, 80- and 160-meter coils are wound on 1½" forms. Spacing refers to length of winding on the form, not the distance between turns.

Parts List

HAMMARLUND

- 1—2-gang tuning condenser, 15 mmf. per section
- 1—Single tuning condenser, 35 mmf.
- 1—Single tuning condenser, 20 mmf.
- 6—"Air-padding" condensers, 140 mmf. each
- 6—XP-53 coil forms, 5-prong type
- 2—Midget r.f. chokes, 2.5 millihenry
- 2—Iron-core I.F. transformers, 465 kc. (one input and one output)
- 4—Midget isolantite coil forms, 5-prong type
- 2—Isolantite sockets, 5-prong type
- 4—Isolantite sockets, 8-prong type
- 1—Midget trimmer condenser, 3-30 mmf.
- 2—Aluminum tube shields

SPRAGUE (Condensers)

- 6—Paper condensers, 0.1 mf., 600 volts
- 4—Paper condensers, 0.01 mf., 600 volts
- 1—Paper condenser, 1.0 mf., 400 volts
- 1—Dual electrolytic condenser, 10-10 mf., 50 volts
- 3—Mica condensers, 0.0001 mf.
- 1—Mica condenser, 0.001 mf.

(Continued on following page)

H. G. CISIN'S FAMOUS KITS

1939 SPACE EXPLORER

All-Wave All Electric (A. C.-D. C.)
4-Tube Receiver

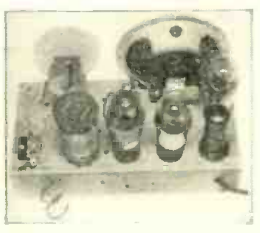

SEVEN BANDS—10 to 2000 meters. Professional Band Spread Communication Set.
Powerful, Sensitive and Selective. Full loud speaker volume. Reception from as many as 39 foreign stations in a single evening reported and verified by many owners.
Uses one 6C8, one 76, one 12-A-7

(Twin-Tube) and one Metal K105-A; as regenerative detector, powerful two-stage pentode audio amplifier, half-wave rectifier and automatic ballast stage. Self-contained power supply operates on 105-120 volts, any frequency a.c. or d.c. interchangeably. Built-in chromatic speaker phone jack, antenna control, full-vision airplane type dial, band spread variable, dual regeneration control, sturdy metal chassis. Clear explanatory diagram simplifies wiring.

Complete Kit of All Chassis Parts, Power Supply and Diagram (unwired, less tubes, coils and speaker) **\$4.95**

Wired and Tested \$1.50 extra. Four Matched Tubes, \$2.45. Four 8-W. Coils 10 to 200 Meters \$1.25. Best Coils, 200-550 m. \$1. Long Wave Coil 550 to 2000 Meters \$1. Tru-Fidelity Chromatic Speaker \$1.45.

H. G. CISIN'S All-Wave Air Scout Jr. Radios

THREE-TUBE \$3.20

ALL ELECTRIC
ALL WAVE SET
MODEL 3A-E

A powerful sensitive all-wave set. Holds wonderful records for foreign reception. Also brings in police calls, amateur, code, Transatlantic phone and broadcast entertainment. Excellent volume. Works from any A.C. or D.C. house current. Easiest set to build. Empire's newest metal ballast tube as one of the tubes. Speaker mounts on attractive panel. Range 9 1/2 to 610 meters or to 150 meters with special long wave coil. Complete Kit includes: Earphone, broadcast coil, 70 to 200 meter coil, Panel, Chassis, High Grade Variable Condenser, Potentiometer, Antenna Trimmer, Dial, Sockets, Knobs, Wire, Resistors, Condensers, and all other required parts including instructions and dia. **\$3.20** With Phone (Less tubes, unwired)

ONE-TUBE BATTERY SET—Model 1B. Satisfied owners report MARVELOUS FOREIGN RECEPTION. Also other S.W. and broadcast reception same as model 3 A-E. Earphone reception. Complete kit includes parts listed above plus 30 tube and filament receptacle. Uses inexpensive batteries **\$2.45** With Tube and give batteries **\$2.45** With Tube and Phone (unwired)

TWO-TUBE BATTERY SETS—Model 2B. Complete kit including all parts in the 1-tube model plus parts for extra audio stage including power tube **\$2.95** With Two Tubes including power tube **\$2.95** With Two Tubes and Phone (unwired)

THREE-TUBE DE LUXE BATTERY SET—Model 3B. Complete kit including all parts in the 1-tube model plus parts for two extra audio stages including two 31-type tubes and 33 **\$3.45** With Three Tubes power output tube **\$3.45** With Three Tubes and Phone (unwired)

Following Auxiliary Parts are available: 9 1/2 meter coil 25c; 15 to 25 meter coil (foreign) 25c; 40 to 80 meter coil (foreign) 25c; 22 1/2 volt "B" battery 75c; Two flashlight "A" batteries 10c each; 5" Wind-up Loud Speaker \$1; Complete Antenna Kit 50c; Wood Screw Kit 10c. Tubes for Model 3A-E each 35c. Long Wave Unit and coil for any model \$1. Double Earphones \$1.30. Bandspread Attenuator \$1.50. Air Scout Jr. model wired extra \$1.00.
NOTE: If you already have earphones, two extra foreign coils may be substituted in any model. flashlight cells.

AIR WAVE AIR SCOUT

1 TUBE 3-IN-1 KIT

THRILLING SHORT WAVE RECEPTION
KEEN BROADCAST RECEPTION
INTERESTING LONG WAVE RECEPTION

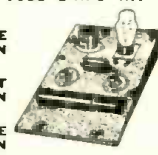

All three types of reception with this remarkable, low-priced set, merely by interchanging plug-in coils. Coil included in kit brings in Broadcasting, Police Alarms and other interesting short wave programs. Five other coils available cover 5 different wave bands. **FOREIGN RECEPTION** under suitable conditions. Three foreign coils 25c ea. extra. Upper broadcast band coil 50c. Long Wave unit and coil 75c. Designed for earphone, but operates loud speaker on strong stations. Works with any battery-type tube. Uses inexpensive batteries. Dry cell tube (50c) requires 1 or 2 flashlight cells and small "B" battery. 5-volt tube (25c) substitutes storage battery for flashlight cells.
Kit comes complete with black mounting panel, coil, all necessary parts, detailed instructions and amazing new full sized picture guide which fastens under panel showing exactly where to mount parts and fasten wire.

H. G. CISIN, CHIEF ENGINEER
Allied Engineering Institute, Dept. S-50
98 Park Place, New York, N. Y.

Build this 4-Tube HAM Receiver

(Continued from preceding page)

BRUSH
1—Pair crystal headphones

RCA (Tubes)
1—6L7 (metal) 1—6P7G (glass)
1—6C5 (metal) 1—6F8G (glass)

CENTRALAB (Resistors)
1—Volume control, 5,000 ohms
1—Volume control, 50,000 ohms with SPST switch
3—Fixed resistors, 1 watt, 50,000 ohms
3—Fixed resistors, 1 watt, 20,000 ohms
1—Fixed resistor, 1 watt, 25,000 ohms
2—Fixed resistors, 1 watt, 300 ohms
2—Fixed resistors, 2 watts, 2,000 ohms
1—Fixed resistor, 2 watts, 1/2 megohm
1—Fixed resistor, 2 watts, 75,000 ohms
1—Fixed resistor, 1/4 watt, 0.5 megohm
1—Fixed resistor, 1/4 watt, 1 megohm
1—Fixed resistor, 1/4 watt, 3 megohms

CROWE
1—Dial (Micrometer type, 270 degrees)

MISCELLANEOUS
1—Filter choke, 50 ma., 30 henry
4—Pointer knobs
1—Steel chassis, 7 x 13 x 2 inches

S. W. League

(Continued from page 470)

Lester Fuller, Jr.—Observer for Arizona

Call	Freq.	R	S	Call	Freq.	R	S
KA1ZL	14.070	4	7	PK6XX	14.020	5	8
KA1JM	14.075	4	7	PK2AY	14.250	3	5
KA1KK	14.075	3	5	CN1AF	14.080	3	5
VK5MF	14.4	4	6	ZS5AW	14.080	4	7
VK4BJ	14.4	7	8	VK2NS	14.000	5	8

Romney Miller—Observer for Rhode Island

Call	Freq.	R	S	Call	Freq.	R	S
ZL2BE	14.10	5	7	V86AG	14.08	5	6
KA7EF	14.15	5	6	J2MI	14.10	5	6
VK2NS	14.02	5	8	J2NF	14.05	5	8
VK3EH	14.05	5	7	NY2AE	14.25	5	8
VP2LB	14.13	5	7	ZS5AW	14.08	5	7
VP7YA	14.07	5	8	ZS6AJ	14.015	5	9

Ed. Davenport—Observer for Vermont

Call	Freq.	R	S	Call	Freq.	R	S
VP2LC	14.13	5	7	VP7NS	14.17	5	4

Bob Tagliauer—Observer for Kentucky

Call	Freq.	R	S	Call	Freq.	R	S
VR6AY	14.350	3	4	VK2JU	28.150	5	8
ZL2DE	14.120	4	6	PA0FB	28.180	5	7
VK2NS	14.020	5	7	G5VM	28.185	5	8
VK3VD	14.145	5	8	G5J	28.180	5	8
VP7NU	14.045	5	7	G5J	28.150	5	6
VP7NS	14.075	5	8	VP7NS	28.190	5	6
VP6FO	14.085	5	7	G5VM	28.190	5	6
VP1BA	14.115	5	9	G8SA	28.105	5	9

Bill Henderson—Observer for Arkansas

Call	Freq.	R	S	Call	Freq.	R	S
VK2NS	14.02	5	8	VK3VW	14.03	5	6
VK4JP	14.30	5	9	PK6XX	14.20	5	9

Jack Wells—Observer for Alabama

Call	Freq.	R	S	Call	Freq.	R	S
VO1I	14.11	5	7	PK1VY	14.08	5	8
KA1ZL	14.26	4	7	PK6XX	14.009	5	7
VR6AY	14.345	5	7	CN8AV	14.12	5	7
K5AH	14.26	5	8	CN1AF	14.278	5	8
NY2AE	14.20	5	8	VP7NS	14.09	5	8
ZB1L	14.14	5	5	SV1KE	14.00	4	7
PA0EO	14.135	5	7	ZL2BE	14.215	5	6
FA3HC	14.04	5	6	VK2ABD	14.515	5	6
EA9AH	13.99	5	9	TG5	14.05	5	7

From Observer Wells I have learned the QRA of CN1AF. Address reports to this station as follows: Sr. Jose M. Sierra—19, Rue des Sources, Tangier Zone, North Africa.

R. A. Rush—Observer for California

Call	Freq.	R	S	Call	Freq.	R	S
VK2GU	28.420	5	9	VR6AY	14.348	5	7
ZL3KZ	28.400	5	6	PK6XX	14.020	4	7
H17G	28.450	5	7				

Ray Halliday—Observer for South Carolina

Call	Freq.	R	S	Call	Freq.	R	S
K6LB	28.262	5	7	VV1AQ	28.276	5	6
H17G	28.270	5	8	K4EJG	28.075	5	9
G6BW	28.268	5	5				

Roger Legae, Jr.—Observer for New York

Call	Freq.	R	S	Call	Freq.	R	S
ZL2BE	28.4	5	7	KA1FH	14.27	4	5
ZL2BT	28.35	5	7	KA1CS	14.294	4	5
ZL3BV	28.3	5	7	KA1HS	14.29	4	5
VK2GU	28.3	5	7	PK1VY	14.28	5	7
ZS1AX	28.35	5	6	VK7RX	14.3	4	6
ZS6ED	28.1	5	7	SU1AX	14.03	5	7
ZS6DW	28.1	5	7	ZS5AB	14.3	4	6
FA3JY	28.3	5	6	CN1AF	14.278	5	7
CN8AV	28.3	5	8	ZB1L	14.14	5	6
SU1RO	28.1	4	5	CX2CO	14.01	4	6
TG9AA	28.3	5	7				

DATAPRINTS

Only 33 1/2c each
in orders of 3 at \$1

BUILD YOUR OWN—SAVE MONEY!

RADIO CONTROL FOR MODEL BOATS, PLANES, ETC.

Circuit data 50c

20 ELECTRIC LODGE & PARTY TRICKS. Fun Galore!
"How to Do 'Em" Data 50c

S-W DIATHERMY (Artificial Fever)
Dataprint giving Constructional data for Small, Medium and Large size App. (All 3).....50c

Induction PIPE & ORE LOCATOR
Construction Data.....50c

RECORD VOICE OR CODE on Steel Wire!
Telegraphone Data, for Voice or Code.....50c

TESLA COIL DATA:
Data print—drawings and data for building 36-inch spark Tesla... 50c
Exciter—1 K.W. 25,000 Vt. Transf. 50c
3" Spk. Tesla Coil. Works on Ford Coil. 50c
3" Spk. Oudin Coil. Works on 110 A.C. 50c
20 "Tricks" with Teslas & Oudins 50c
8" Spk. Tesla Coil. 15,000 Volt Exciter 1/4 K.W. 15,000 Volt Transf. 50c
Violeta—1" Spk. Oudin. Vibrator type Operate Oudins from V. T. Osc. 50c

More DATAPRINTS You Need!
Water Turbines "Rewinding" Armatures
Water Wheels Induction Balance
100 Mechanical Movements Teletograph
Motor Circuits (20) Elmhoven String Galva-
Telephone Hookups (20) nometer
Polarized Relay, Ultra- Magnets and Solenoids—
sensitive Get list before ordering.
Ring 4 bells on 2 wires Wheatstone Bridge
20 Simple Bell Hook-ups Induction Coils—1 to 12
Electric Chime Ringer fits incl. Spk. data
Electric Pipe Thawer
Welding Trf. 2 K.W. 110 V. Prim. 18 V. Sec.....50c
5 Prints \$1.50 or 10 for \$2.00; single prints 50c

The DATAPRINT Co.
Lock Box 322 RAMSEY, N. J.

Formulas and Recipes FOR THE PRACTICAL MAN

CONTENTS OF BOOK

- Adhesives: Glues, Cements, Gums, Mucilages, Lubricants.
- Cleansing: Stain Removers, Paint Removers, Bleaches, Cleaning Fluids.
- Metal Craft: Coloring, Oxidizing, Plating, Repairing, Welding, Polishes, Alloys, Solders, Amalgams.
- Paints: Colors, Stains, Varnishes, Enamels, Luminous Paint, Washable Paint; Paint-Removing, Waterproofing, Fireproofing.
- Glass-Working: Cutting, Drilling, Boring, Bending, Blowing, Etching, Engraving, Frosting, Silvering, etc.
- Wood-craft: Fillers, Fireproofing, Acid-proofing, Waterproofing; Furniture Polishes, Paint Removers, etc.
- Inks: Recipes, Eradicators, Ink Stain Removers; Special Inks: Colored, Indelible Sympathetic, Invisible, Hectograph.
- Photography: Developers, Emulsions, Fixers, Sensitizing, Toning, Printing, Photographic Paper, Blueprint Paper.
- Antidotes for Poisons, Remedies for Burns and Scalds, Disinfectants, First-Aid in Accidents, Emergency Remedies, Home Remedies.
- Preparation, Manipulation, Handling, Mixing, Measuring, Weighing, Filtering, Straining Solutions; List of Technical Substances; Use of Hydrometer, Use of Thermometer; Tables of Weights and Measures, Decimal System, Useful Tables.

PRICE 50c Postpaid
Send stamps, cash, check or Money Order

TECHNIFAX

DIVISION RT-1238
558 W. WASHINGTON BLVD. CHICAGO, ILL.

Let's Listen In

(Continued from page 475)

wave. we heard an R5-6 "sig." with a rapid flutter, reply to FTM "—ici Saigon, allo—"

FZR, on 16.25 mc., used to be a stand-by at 8:30 a.m., but we have not heard it lately.

It would be a good bet to try FZR, at 8:30 a.m., but begin looking for it at 7 a.m., from which time it has been heard. However, FZR usually works FTK, 15.88 mc., also at St. Assise. Watch FTK daily, a very powerful "sig." and if you hear speech, try for FZR, which puts in a very nice "sig" here, often R7-8.

For these stations, write to Centre Radioelectrique de Saigon, Postale Boite 238, Saigon, French Indo-China, and you'll earn a very courteous veri.

JAPAN

A new sw broadcast signal from Japan is being very well heard mornings, in conjunction with JVN, on 10.66 mc. This new transmitter operates on 9.73 mc., and is almost as good as JVN. It is listed as *on the air* from 1:50 a.m. on, or same schedule as JVN. Check the sig with JVN's. Both carry same program.

A new one reported lately is JZO, 10.27 mc., at Tokyo, heard almost daily from 8:30-9:30 a.m. The Jap phones are having a busy time of it, as, despite our very limited time spent in dxing a.m.'s, we've heard 'em very often.

JVF, 15.62 mc., heard at 1:15 a.m. and 5:45 p.m. JVE, 15.66 mc., heard at 3:55 a.m., also 1:15 a.m. JVH, 14.60 mc., 4:25 a.m. and 5:55 p.m. JVA, 18.91 mc., at 7:05 a.m., and JIB, 10.535 mc., at Taiwan (Formosa), heard phoning at 5:45 a.m. This last, a new country distinct from Japan, is also often heard carrying musical programs in a.m. JIB verifies from same QRA (address) as all Jap phones.

NEW CALEDONIA

"Radio Noumea," on 6.12 mc., has lately been heard signing FK8AA, the call of an amateur there.

The schedule is now Tues. and Sats., 2:30-3:30 a.m., so look for this one, a real dx catch for anyone's "log." QRA is Charles Gaveau, FK8AA, 44 Rue de L'Alma, Noumea, New Caledonia.

PHILIPPINES

KZGH, at Iloilo, has QSL'd to Ashley Walcott, with a courteous letter from Francisco Blanco, the station supervisor. Veri states transmitter is in operation daily from 6 p.m.-10 a.m., E.S.T., in connection with local 2-wire telephones. 400 watts are used, freqs. changed by a dialing system. Five different freqs. are used, those mentioned being 6.755, 5.445, and 2.73 mc.

NEW GUINEA

VHSU, at Salamaua, was logged testing with an unidentified VHU4, one morning from 5:30-8 a.m., using 3 freqs. This also from Ashley Walcott, W6. On 8.07 and 6.54 mc.

JAVA

PLP, 11 mc., and PMN, 10.26 mc., are really "rolling in" here, an R8-9 "sig" many mornings! PLE, 18.80 mc. (all three at Bandoeng), logged by G. C. Gallagher, phoning Tokyo at 2 a.m. and 9:20 a.m.

YDA, 6.04 mc., Bandoeng, is now relaying PLP's programs from 7-10 a.m. irregularly.

CHINA

China is using her transmitters very often of late, normal, considering conditions.

XTR, 9.40 mc., now at Chungking, is a frequently heard signal, from 6-7 a.m., or later, with a very powerful signal.

XTS, 11.44 mc., at Chungking, contacts XTJ, at Hankow, on 11.69 mc., almost any time of a.m.; lately at 5:15 a.m. One a.m. we heard XTS change over to XTR, probably for a better contact with Hankow. This happened at 5 a.m.

DX REVIEW

FED. MALAY STATES—ZGB, 13.63 mc., Kuala Lumpur, heard lately at 6:50 a.m., with a very fine signal.

SIAM—HSP, 17.74 mc., Bangkok, logged by G. C. Gallagher, at 2 a.m. and 10 a.m., quite regularly.

MANCHUKUO—TDD, 5.83 mc., Shtinkyo, heard phoning at 7 a.m., also TDE, 10.065 mc., at 7 a.m. TDE is to be heard at all hours of a.m., contacting and phoning with JVO, 10.37 mc., Tokyo. G. C. Gallagher, W6, contributes this item. Also JDY, 9.93 mc., usually a broadcaster phoning at 9:20 a.m.

FORMOSA—JLB, 10.535 mc., Taiwan, relays JFAK, broadcast band transmitter, daily, 9:05-9:55 a.m. Gives news in English and Japanese. Same program on JFO, 9.636 mc., which operates from 4-10:30 a.m. This from OM Gallagher.

INDO-CHINA—Radio Phico, at Saigon, reported on 6.21, 9.72, and 11.71 mc., at 7:30 a.m. by OM Gallagher.

CHINA—XGJ, 11.68 mc., Hankow, "The Voice of China," broadcasting schedule 7-7:30 a.m.

XGOW, 9.30 mc., Shanghai, broadcasting 7:30 a.m. and heard shifting to 9.19 mc. From G. C. Gallagher.

(Continued on page 509)

A NEW Edition

Thoroughly revised—greatly enlarged and offering a wealth of new up-to-minute information

THE RADIO MANUAL



Here's the only complete Handbook for students, amateurs, operators, and inspectors. It covers the entire field of radio in 1,000 pages with hundreds of illustrations and diagrams. It is actually a complete course of training in radio operation and a complete reference book for everyone in the field. It gives instantly the answer to every question about principles, methods, and apparatus of radio transmitting and receiving.

A Complete Course in a Single Volume New 1938 Edition

Covers in full detail the Electron Tube—Vacuum Tube Amplifiers and Oscillators—Modulation and Modulation Analysis—Microphones—Radio and Audio Frequency Measurements—Antenna

Resistance Measurements—Latest Broadcast Transmitters with installations, adjustments, operation, and maintenance instructions—Latest Marine Radiotelegraph Transmitters and Receivers—Duties of Ground Station Radio Operators—Theory, Operation and Use of Radio Range and Marker Beacons (localizers), Landing Beams including Lorenz System of Instrument Landing—Radio Direction Finder—the two U. S. Auto Alarms approved by the F. C. C.—Ultra-high Frequency Police Transmitters and Receivers—All Important Radio Provisions of the Communications Act of 1934 as amended effective 1937—Rules and Regulations of F. C. C.—General Radio Regulations Governing Distress Signals, etc.

New Information Never Before Available

This is just a hint of the vast amount of new information packed into this great book. In addition, the entire field of Radio is covered in complete detail, making The Radio Manual essential to every student, operator, and inspector.

Prepared by F. C. C. Expert

The author, G. E. Sterling, is Assistant Chief, Field Section, Engineering Dept., Federal Communications Commission.

FREE EXAMINATION

The Revised Edition of "The Radio Manual" has just been published. Over 1000 pages. Hundreds of illustrations. Bound in Flexible Fabrikoid. The coupon brings the volume for free examination. If you do not agree that it is the best Radio book you have seen, return it and owe nothing.

Clip and Mail This Approval Order Form

D. VAN NOSTRAND CO., 250 Fourth Ave., New York

Send me on approval THE RADIO MANUAL. Within 5 days after I receive the book, I can return it and owe nothing. If I keep it, I will send you \$2.00 as first payment and I will pay \$2.00 monthly thereafter for 2 months—\$6.00 in all. (5% discount for cash.) (R.&T.-12.)

Name

Address

City State

Reference

Address

FOR FREE CATALOG of best books of practical instruction and technical information, check here. If you do not want The Radio Manual cross out paragraph above.

SUPERIOR PRESENTS TWO INSTRUMENTS
from its new 1100 series!!!!

Never before has Superior offered so much for so little! Always the best buy in the Instrument Field, Superior in this new 1100 series gives you even more value! We have incorporated many refinements, many new features . . . all proven to be sound and practical. We urge you to read the descriptions below carefully; see how these instruments fit your needs. Buy direct from manufacturer and save 50%.

The New Model 1130-S

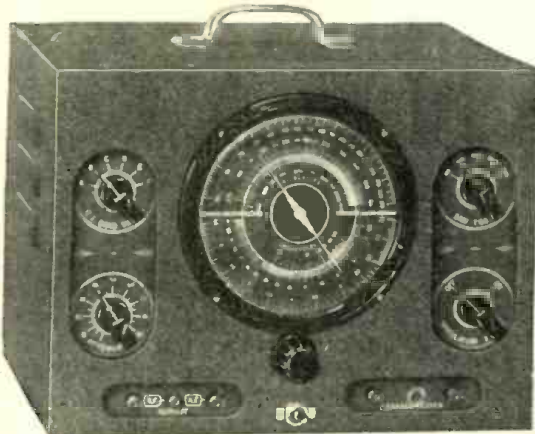

SIGNAL GENERATOR
with Audio Frequencies

SPECIFICATIONS:

1. Combination R.F. and Audio Signal Generator, R.F. 100 kc. to 100 Mc., A.F.—100-7,500 cycles. All Direct reading, all by front panel switching.
2. R.F. and A.F. output independently obtainable alone or with A.F. (any frequency) modulating R.F.
3. Accuracy is within 1% on I.F. and Broadcast bands; 2% on higher frequencies.
4. Audio frequencies in 5 bands; 100, 400, 1000, 5000, and 7500 cycles.
5. Giant airplane full vision, direct-reading dial.
6. Condenser and other leakages tested to 100 megohms.
7. All services on 90-130 volts A.C. or D.C. (any frequency).

Model 1130-S comes complete with tubes, test leads, carrying handle, instructions. **\$11.85**
 Size 12" x 9" x 6 1/2". Shipping weight 15 pounds. Our net price

The New Model 1180-S

SET-TESTER

A complete testing laboratory all in one unit. Tests all tubes, reads A.C. volts, D.C. volts, A.C. current, D.C. current, High Resistance, Low Resistance, Low Capacity, Decibel, Inductance, and Watts. Comes housed in sturdy black case with sloping panel, for rapid and simple measurements.

Model 1180-S complete with test leads, tabular charts, instructions, and tabular data for every known type receiving tube and many transmitting tubes. Shipping weight 18 pounds. Only

\$17.85

Portable Cover
 95c extra



Works on 90-120 volts 60 cycles A.C. Tests all 4, 5, 6, 7 and 7L and octal base tubes, including diodes. Tests by the well established emission method for tube quality, directly read on the GOOD ? BAD scale of the meter. Affords separate neon test for leakage and shorts between elements. Complete A.C. and D.C. Voltage and Current Ranges. D.C. Voltage: 0-15, 0-150, 0-750 volts. A.C. Voltage: 0-15, 0-150, 0-750 volts. D.C. Current: 0-1, 0-15, 0-150, 0-750 ma. A.C. Current: 0-15, 0-150, 0-750 ma. Resistance Ranges: 0-500 ohms, 500-5 megohms. High and Low Capacity Scales. .0005 to 1 mfd. and .05 to 200 mfd. 3 Decibel Ranges -10 to +19, -10 to +38, -10 to +53. Inductance: 1 to 700 Henries. Watts: Based on 5mw at 0 D.B. in 500 ohms .006000 to 600 Watts.

SUPERIOR INSTRUMENTS CO., 136 LIBERTY ST., Dept. S.W.
 NEW YORK, N. Y.

RADIO Test Quiz???

(Continued from page 467)

- a. Increases the voltage in a circuit several fold.
- b. Increases the range of a voltmeter.
- c. Increases the effective voltage in a plate circuit.
- d. Increases the apparent voltage in a grid circuit.

18. When a radio engineer tells you that your new apparatus should have P-B T, you know he means

- a. Pre-band transmission.
- b. Pretty-bum trimmers.
- c. Push-button tuning.
- d. Prime-Mu tubes.

19. A radio compass, as used on ships and planes, is very useful, but you'd be wrong if you said that it is

- a. A compass which is corrected by means of a radio beam.
- b. A means of determining the position of a plane or ship through the use of triangulation.
- c. A loop antenna operated to determine the craft's direction from a transmitter.
- d. A compass used by surveyors to determine a suitable location for a transmitter.

20. When Pa sent Willie out to buy a radio "fan" magazine, he spanked the kid for bringing back

- a. Radio Guide.
- b. Broadcasting.
- c. Radio Stars.
- d. Radio Mirror.

21. Being the 13th letter of the alphabet, M may be unlucky for you in this one, but try to tell what the m stands for in the following radio abbreviations.

- a. mc.
- b. mf.
- c. ma.
- d. mmf.
- e. m.
- f. mh.

22. In a transformer coupled audio frequency amplifier, a pulsating direct current is fed through the primary of the audio frequency amplifying transformer, with the result that the secondary produces

- a. A higher voltage pulsating direct current.
- b. A higher voltage non-pulsating direct current.
- c. A higher voltage alternating current.
- d. A higher amperage pulsating direct current.
- e. A higher amperage non-pulsating direct current.
- f. A higher amperage alternating current.

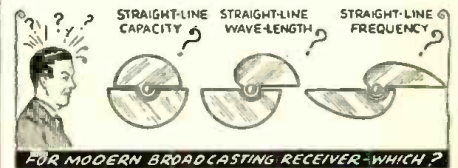

23. If you were designing a modern broadcast receiver, the type of tuning condenser you would be most likely to employ is

- a. Straight line capacity.
- b. Straight line wavelength.
- c. Straight line frequency.
- d. Modified straight line capacity.
- e. Modified straight line wavelength.
- f. Modified straight line frequency.

SOLAR
MINICAP
 Newest development
 in Electrolytic Capacitors
 Catalog upon request
SOLAR MFG. CORP. 599-601 Broadway, New York

UNIDIRECTIONAL DYNAMIC
D9T
 ← BACK No Pickup
 ← FRONT Full Coverage
VOLUME INCREASED
 by Reducing Feedback
 D9T, List \$37.50, High Imp., 25' Cable.
 D9, List \$35.00, Low Imp., 25' Cable.
 Write for Catalogue No. 29
 Manufacturers full line Dynamic, Crystal, and Carbon Microphones and Stands.
AMERICAN MICROPHONE CO., INC.
 1915 So. Western Ave., Los Angeles, Calif.

24. A strain type insulator is so-called because

- a. It can stand high electrical strain.
- b. It strains out unwanted stations.
- c. It can stand high mechanical strain.
- d. It puts an awful strain on the pocket-book.

25. Even though you may not believe it, an interference generator is most used

- a. To drown out Russian programs in Germany and vice versa.
- b. To test "noise-free" antenna installations.
- c. To test shielding of a set.
- d. No such device is commercially produced.

(Answers on page 512)

Ultra Short Waves and Television

Dr. G. W. Pickard

(Continued from page 453)

on these frequencies, for the good and sufficient reason that there is absolutely no other place for it in the whole radio spectrum. There is another good reason why it cannot go on lower frequencies, and this is the fact that the lower frequencies involve sky-waves, with consequent plural path transmission and a nasty mess of "ghost" images on the screen. The Federal Communications Commission has tentatively assigned, on an experimental basis only, 19 television channels, each 6 megacycles wide and running from 44 to 294 megacycles, and this assignment seems wise.

It is becoming increasingly evident that the problems confronting television as a public service are today economic rather than technical. Before it can become a public service comparable with sound broadcasting, channel assignments must be made commercial rather than experimental, many hundreds of miles of expensive coaxial cable must be laid for the distribution of network programs, and a large audience with comparatively expensive receivers must be built up. The programs themselves—the "daily grind" type of programs as distinct from the occasional "important event"—must be made interesting in themselves as distinct from the novelty of the medium, or television as a public service will most emphatically get off to a false start! Otherwise, as the novelty of seeing a picture on the screen wears off, and the audience becomes really critical of program material, there is the danger that the receivers will soon begin to gather dust.

And it must be constantly borne in mind that broadcasting in this country is solely supported by advertising, which pays for units composed of time and audience. Those myriads of us who listen from early morning to late at night to sound broadcasting, and who also go to the movies, know very well that the ear can take much more punishment than the eye. Also, one can hardly imagine a television program being used as a background for various home activities, bridge, for example. Taking these factors into consideration, it would seem that television programs would be a matter of two or three hours a day, rather than all day and half the night, so unless its advertisers pay rather dearly for their limited time, television stations will run in the red.

Everything in Radio

SEND FOR ALLIED'S AT LOWEST PRICES!
180 Page 1939 CATALOG

SETS! 62 NEW 1939 *Knights*
AT AMAZINGLY LOW PRICES!

DEALERS!—see the new sensational Knight Radios in ALLIED'S 1939 Catalog. 62 models for every purse and purpose—new advanced features, new beauty, finer tone, better performance—at new low prices. Sets from 4 to 16 tubes—many with Push-Button Tuning; new "Tiny Knights," 1½ Volt battery sets; new AC, AC-DC, 6 Volt, 32 Volt and auto models. Also, see the most extensive line of phono-radio combinations, phonographs, and record players in radio—all priced to bring you greater savings and bigger profits! Send coupon for your Free ALLIED Catalog!



BACKED BY ALLIED'S IRONCLAD GUARANTEE

All Knight Radios are covered by ALLIED'S Ironclad Guarantee—it gives you fullest protection!

PARTS! KITS!

SERVICEMEN!—All standard lines of test equipment—Rider's Chalyt, Rural Meter, etc.—and over 14,000 exact duplicate and replacement parts.

RADIO BUILDERS!—We can supply Free Parts Lists covering any kit described in this or any other magazine. Write!

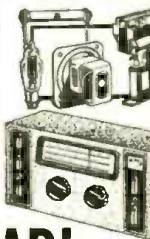

P.A.! THAT SET NEW VALUE STANDARDS
SOUND MEN! See the revolutionary new Knight Sound Systems, 8 to 65 watts—standard and deluxe jobs—for portable or permanent installations. New 30 Watt Mobile Systems, Electric Guitar Amplifier—and the most complete line of recording equipment in any catalog!



TESTERS!

New Push-Button Equipment—makes your servicing easier and quicker.

Fastest service, lowest prices, highest quality—these are the watchwords which have made ALLIED Radio's Leading Supply House!

HAM GEAR!

AMATEURS!—A complete Ham section, packed with high-grade, low-cost Short Wave Gear. See the new National NC-43 and 510, Hallcrafters "Diversity" and "3-19," Howard 450, 440 and 430, and Sargent "39 Streamliner" receivers; and the National 600 Watt, Hallcrafters "117," and "Pee-Wee" transmitters. Write to us about our painless Time Payment Plan—the most convenient in Radio!

Send for Your Free copy of the 1939 ALLIED Catalog today! You'll save and profit with our low prices and speedy service. It includes Everything in Radio—thousands of money-saving, profit-making items for every radio man. It's copiously illustrated so that you can see what you buy; skillfully indexed so that every item is at your fingertips. Send the coupon for Radio's Buying Guide!



FREE CATALOG

ALLIED RADIO

ALLIED Radio

ALLIED RADIO CORP.
Dept. 3-M-9
833 W. Jackson Blvd., Chicago, Ill.
Send me your Free 1939 Catalog.

Name
Address
City State

A NEW SERVICE FOR OUR READERS!
Be Sure to see the new FREE CATALOGS AND INFORMATION Department on Page 511.

BRUSH HIGH LEVELER SERIES MICROPHONES

Range in price from
\$22.50 to \$32.50

New Brush Headphones

Write for your Brush catalog today
THE BRUSH DEVELOPMENT COMPANY
3326 PERKINS AVENUE
CLEVELAND, OHIO

BETTER PERFORMANCE with BUD TRANSMITTING CHOKES

- (1) effective choking on all amateur frequencies
- (2) unusually low power loss
- (3) uniformly built of 5 lateral wound tapered sections

Moderately priced to give you "THE BEST FOR LESS." Send 10c for Log Book SW 128



BUD
BUD RADIO, INC.
CLEVELAND, OHIO

OUR NEW SHORT WAVE LISTENER MODEL THE DOERLE MODEL D39

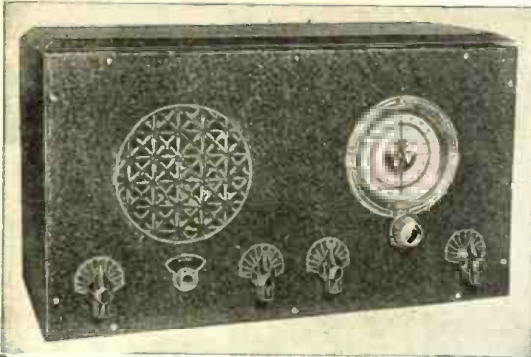

THE OUTSTANDING VALUE FOR 1939

Model D39 designed to have all the desirable features of our larger models but at a price within reach of all.

Uses a 6k7g tube as screen grid tuned R.F. amplifier, a 6j7g tube as tuned electron coupled screen grid regenerative detector, a 76g tube as a driver audio which is fed into the popular and efficient 2516g beam power audio output tube which delivers over two watts of undistorted audio power to the dynamic speaker.

A 25z6g tube is used as the rectifier and is fully capable of supplying the power requirements of the set. A type k92a tube is used as the ballast to drop the filament supply to the proper voltage.

Separate controls for volume, tone, regeneration and R.F. gain are used. A headphone jack is incorporated to permit the use of phones when desired which automatically cuts off the speaker when phones are plugged in.

A carefully designed circuit is used so as to give maximum efficiency and output. The built-in power supply is well filtered to eliminate hum. Filter networks are incorporated in the audio amplifiers and a tuneable hum filter removes all traces of this condition common in many short wave sets. Operates from regular 110 volt house current. Covers from 9 to 600 meters with no skips which includes the standard broadcast band and all short wave bands except the amateur 5 meter band. Send stamp for circular D39.

Sold complete ready to use nothing else to buy with all tubes and coils 9 to 600 meters wired and tested

All parts needed to build and wire but less tubes, with all coils, cabinet, chassis and diagram. May be obtained in battery model or 220 volt model at same prices for portable or foreign use.

\$19.95

\$14.95

FLASH! SEND 10¢ FOR OUR NEW CATALOG containing **CIRCUIT DIAGRAMS**, and complete information on over 25 different types of short wave receivers and transmitters from \$2.50 and up. This catalog is chock full of schematic and picture diagrams, hook ups and short wave information. A book in itself. Well worth the dime, which will be refunded with your first order.

OSCAR B. KUSTERMAN 68 Barclay Street, Dept. 12
New York City

SPRAGUE ATOMS

"Mightiest Midgets of All"

- ★ **DUAL COMBINATIONS**
OR SINGLES
- ★ **SMALLEST SIZES ON THE MARKET**
- ★ **ALL WORKING VOLTAGES**
- ★ **UNCONDITIONALLY GUARANTEED** AGAINST BLOWUPS
- ★ **LOW LEAKAGE** PREVENTS OVERHEATING
- ★ **QUICK BUILD-UP**—
HIGH SURGE VOLTAGE
FOOL-PROOF

IN BRIEF... recommended universally for replacements... especially where space is at a premium or where you need a really reliable condenser at a **ROCK BOTTOM PRICE**.

A typical ATOM value—8-8 mfd. 450 volt 1" diam. 2 3/4" long. list only \$1.00



SPRAGUE
450 VOLTS

SPRAGUE PRODUCTS CO.
North Adams, Mass.

Your Inquiries Invited

When you need amateur equipment it is to your advantage to write to Bob Henry, W9ARA. You get personal attention; terms financed by myself so you buy with less cost and more convenience; fair trade-in value for your equipment; ten day trial of all receivers; and my cooperation in every way to see that you are 100% satisfied. No wonder Bob Henry's customers are boosters. You will be too. For the newest equipment, the latest information and technical help:

WRITE TO:

BOB HENRY,
BUTLER, MISSOURI

Compare Bob Henry's Terms with Others

Model and Receiver	Cash Price	Down Payment	12 Mo. Payments
The NEW NC-44	\$49.50	\$9.90	\$3.49
NC80X and NC81X	99.00	19.80	6.99
Improved NC101X	129.00	25.80	9.11
The NEW NC100A	120.00	24.00	8.48
RME-70	138.60	27.72	9.79
Sky Champion	49.50	9.90	3.49
Sky Challenger II	77.00	15.40	5.44
Super Skyrider	99.00	19.80	6.99

Also Super Pro, HRO, PR15, Breting 9, Sargents, others.

Similar terms on Harvey, Hallicrafer, National, RCA, RME, Temco transmitters and National, Thordarson, U.T.C., Utah, Stancor kits.

Special Department for Export Orders

HENRY RADIO SHOP
211 North Main Street Butler, Missouri

3-Tube A.C. Receiver

(Continued from page 480)

The power-supply is conventional, using a type 80 glass rectifier tube. The transformer provides 325 volts to each plate of the rectifier, 5 volts for the rectifier filament and 6.3 volts for the filaments of the 6K7 and 6F6.

The design is one developed in the laboratory of Wholesale Radio Service Company. It is available in kit form for the benefit of constructors who prefer to "roll their own." If the chassis supplied with the kit is used, the mounting holes provided in it and the panel automatically determine the placement. Keep the lead from the 6K7 grid terminal to the grid-leak and condenser as short as practical.

Parts List

- 1—Set 4-prong short wave coils (16-217 meters)
- 1—Pair broadcast coils (190-550 meters)
- 1—.00014 mf. tuning condenser
- 1—25,000 ohm regeneration control and switch
- 2—.5 mf. condensers
- 3—.01 mf. condensers
- 1—10 mf. condenser
- 1—3-30 mmf. trimmer condenser
- 1—Power transformer 325-0-325 V., 6.3 V., 5.0 V.
- 2—Octal sockets
- 2—4-prong sockets
- 1—Panel, punched and drilled, 7" x 10"
- 1—Chassis punched and drilled
- 1—Knob
- 1—Dial, vernier type
- 1—"Ant.—Gnd." binding post strip
- 1—R.F. choke, 2.5 mh.
- 1—A.C. line cord and plug
- 2—1 w. resistors, 100,000 ohms
- 1—1/2 w. resistor, 500,000 ohms
- 1—1/2 w. resistor, 2 meg.
- 1—1/2 w. resistor, 250,000 ohms
- 1—2 w. resistor, 500 ohms
- 1—Dynamic speaker, 2500 ohm field, with output transformer.
- 3—Tubes (6K7, 6F6, 80)

Coil Data

Meters	Grid Coil	Ticker
10-20	4 3/4 T. No. 22 D.S.C. (Spaced 8 T. per inch)	4 T. No. 31 D.S.C. (Close-wound)
20-40	10 1/4 T. No. 22 D.S.C. (Spaced 12 T. per inch)	6 T. No. 31 D.S.C. (Close-wound)
40-80	22 3/4 T. No. 22 D.S.C. (Spaced 16 T. per inch)	7 T. No. 31 D.S.C. (Close-wound)
100-245	67 T. No. 28 D.S.C. (Close-wound)	22 T. No. 28 D.S.C. (Close-wound)
230-570	12 banks, 8 T. each	32 T. No. 36 D.S.C. No. 32 D.S.C. (Close-wound)

Form dia. 1 1/2". Tuning Condenser .00014 mf.
*Optional coil is 1 layer, 126 T. No. 28 S.S.C. Close-wound.

25 Watt Xmitter Kit

(Continued from page 480)

the crystal stops oscillating, which will be indicated by the failure of the neon tube to glow. By decreasing the capacity of C-2, the transmitter will function again and C-2 should be decreased until the set keys normally, as noted by listening to the signal in a receiver or a monitor. After this is done, it may be necessary to readjust C-1 slightly to compensate for the antenna.

The midget can be used as an exciter by connecting a wire from the antenna post to the grid of the following stage.

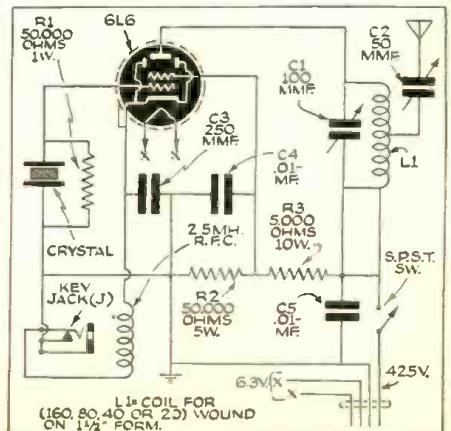

Hook-up of Eagle Xmitter

New HAM Licenses

COMPILED FROM THE LATEST RECORDS OF THE FEDERAL COMMUNICATIONS COMMISSION

THERE are now nearly 50,000 licensed radio amateurs in this country. And hundreds of new amateurs are being licensed every month.

Heretofore no publication has listed the names and addresses of the new licensees as issued. RADIO & TELEVISION Magazine now provides this unique service, and will publish a list of newcomers in every issue. Check the names carefully so that you will be able to get in touch, not only with those amateurs in your neighborhood and vicinity, but also those distant amateurs whom you wish to contact either by mail or by radio.

The first list contains 275 names of newly licensed amateurs.

- | | |
|--|---|
| K6QJS Leo A. St. Dennis, Morse Field, Naalehu, Hawaii. | W2LQA Charles Melville, 226 E. 7th St., Plainfield, N. J. |
| K6QLB Bernard P. Showalter, 250 S. Hotel, Honolulu, T. H. | W2LQB Robert F. Wilhelm, 35 Lincoln Pl., Brooklyn, N. Y. |
| K6QLG Henry D. Kalahuawe, Vineyard St., Wailuku, T. H. | W2LQC Charles F. Herman, 30-12 94th St., Jackson Heights, N. Y. |
| K7CNJ Charles B. Michael, Quinhaqak, Alaska. | W3BDR Gerald S. O'Connor, 3600 Halderman Ave., Brentwood, Md. |
| W1CGL Robert Nils Eichorn, 32 Lamper Hill Rd., Auburn, Mass. | W3BNI Elmer Brinliff, 718 Fillmore St., Riverside, N. J. |
| W1DEU Henry Dudley Minich, 465 Main St., Melrose, Mass. | W3HSW James A. Mallory, 1/4 mi. south of McLean, Va. |
| W1LOK John B. McGowan, 66 Bedford Rd., Woburn, Mass. | W3HSZ Frank J. Ritter, 2448 S. Bouvier St., Phila., Pa. |
| W1LOL Henry A. Sawinski, 15 Warren St., Taunton, Mass. | W3HTA Robert Geo. Hoffecker, R.F.D. 1, Newark, Del. |
| W1LOM George Kershenbaum, 1100 Albany Ave., Hartford, Conn. | W3HTB Melvin J. Keydash, 704 Ramsay, Baltimore, Md. |
| W1LON Charles W. Knight, 41 Ralph, Springfield, Mass. | W3HTC Franklin M. Stratton, R.F.D. 7, South Richmond, Va. |
| W1LOO Murray E. Hall, 2 Cliff St., Saugus, Mass. | W3HTF Herman Lukoff, 2853 N. 22nd St., Phila., Pa. |
| W1LOP Julius L. Galinski, 7 Clay, Hartford, Conn. | W3HTG Wm. M. Meloney, 18 S. Harrisburg, Atlantic City, N. J. |
| W1LOQ Walter E. Tannan, 18 Windsor Rd., Somerville, Mass. | W3HTJ Paul V. Simpson, 21 Osborne, Phila., Pa. |
| W1LOR Francis T. Wittmann, 124 Grove St., Melrose, Mass. | W3HTK Frank J. Blioczyk, 91 Bruanig Ave., Trenton, N. J. |
| W1LOS George C. Wright, 7 South Main St., Sharon, Mass. | W3HTK Raymond L. Bocland, 3285 16th St. N. E., Washington, D. C. |
| W1LOT Newton Stephen, 12 Howitt Rd., Boston, Mass. | W3HTL Norman E. Baitorff, 28 Cumberland, Trenton, N. J. |
| W1LOU Raleigh Martin, Jr., 37 Russ Lane, Bristol, Conn. | W3HTM Carl F. Clauss, 2511 W. Firth St., Phila., Pa. |
| W1LOV Basil L. Wright, 5 Shelby, East Boston, Mass. | W3HTN Harold R. Woodyard, 3235 Wellington St., Phila., Pa. |
| W1LOW Victor H. Ziminski, 182 Marble St., Athol, Mass. | W3HTO Charles G. Crider, Jr., 28 N. 21st St., Camp Hill, Pa. |
| W1LOX Fredrick H. Tabor, Oyster Harbors, Osterville, Mass. | W3HTR Albert C. Faust, 32 W. Main St., Shiremanstown, Pa. |
| W1LOY Francis A. Webb, Old Mill Road, Osterville, Mass. | W3HTS Charles M. Dihbell, 1810-12 Tilgham St., Allentown, Pa. |
| W1LOZ Carl P. Rounds, 17 Oakland St., Auburn, Maine. | W3HTT James T. Leshar, 630 Mauch Chunk, Easton, Pa. |
| W1LPA John Skutoun, 71 Davis Ave., Auburn, Maine. | W3HTU De Forest L. Trautman, Jr., 933 Cornell Ave., Drexel Hill, Pa. |
| W1LPC Geo. K. Boutwell, Lupinwood, Greenfield, Mass. | W3HTV James R. Dale, Jr., 314 42nd St., Newport News, Va. |
| W1LPE Nickolas A. Chakos, 215 Saratoga, East Boston, Mass. | W3KS Louis E. Kearney, 4046 Maywood St., Phila., Pa. |
| W1LPF Carroll M. Callamore, 116 Andrews St., Lowell, Mass. | W3MY Melville W. Ghen, 1410 Denniston, Pittsburgh, Pa. |
| W1LPG Bryant E. Richardson, 160th Co. C.C.C., Greenville, Maine. | W4AIK Leslie B. Stanton, 916 Spruce St., Gasden, Ala. |
| W1LPH Willard E. Barnett, 20 Woodland Pl., Hyde Park, Mass. | W4FQQ Kenneth Patterson, 47 Ave. "A," Ojus, Fla. |
| W1LPM Wm. W. Fairbanks, Hartford, Canyville, Mass. | W4FQR Winborn L. Metcalfe, 5805 Central Ave., Tampa, Fla. |
| W1LPN John E. Callry, 486 School, Putnam, Conn. | W4FQS Walter H. Sturdivant, R.F.D. 8, Atlanta, Ga. |
| W1LPT Andrews G. Moore, Airport, St. Johnsbury, Vt. | W4FQT William L. Townsley, 324 N. Willett St., Memphis, Tenn. |
| W1MXU John P. Tyskewicz, 19 Morris, Hartford, Conn. | W4FQV Nelson D. Large, 936 Sycamore St., Rocky Mount, N. C. |
| W2BLQ Selwyn J. Slack, 188 Everett Pl., Englewood, N. J. | W4FQW Lawrence Wm. Barrett, 702 Hicks St., Waycross, Ga. |
| W2CRJ Charles E. Similey, 249 Ampere Parkway, Bloomfield, N. J. | W4FQX Edward T. Blackman, 2955 Minoual Drive, Decatur, Ga. |
| W2EIA Herbert C. Cook, Lyan St. & Blossom Rd., Valley Stream, L. I., N. Y. | W4FQY John McJunkins Brackett, 257 S. Jefferson St., Mobile, Ala. |
| W2EJY Geo. E. Stephenson, 59 Roosevelt Ave., Roosevelt, N. Y. | W4FQZ Calvin S. Bryant, 809 E. Main St., Avon Park, Fla. |
| W2GYA Leland A. Druny, 24 Furman Ave., Brooklyn, N. Y. | W4FRA Robert H. Sturivant, Jr., R.F.D. B. Intersection of Balton & Simpson Rds., Atlanta, Ga. |
| W2IAE Anthony A. Chizmadia, 107 Washington St., Perth Amboy, N. J. | W4FRC Union G. Knight, 304 Isabel St., Greensboro, N. C. |
| W2KMM Max J. Weiner, 117 Harrison Ave., Hasbrouck Heights, N. J. | W4FRD Lennox K. Ingram, 314 N. Second St., Wilmington, N. C. |
| W2LPO Sidney F. Curtis, 145-25 156th St., Jamaica, L. I., N. Y. | W4FRE Claire Alvin Kennedy, Jr., 1059 15 Ave. S., St. Petersburg, Fla. |
| W2LPP Robert H. Kraft, 31 W. John St., Hicksville, N. Y. | W4FRF Hilton E. Hightower, Damascus, Ga. |
| W2LPQ Percy Laster, 1050 Hoe Ave., N. Y. C. | W4FRG John J. Glidwell, Jr., 3945 St. John, Jacksonville, Fla. |
| W2LPR Alfred F. Sprague, 18 Jamaica Blvd., Carle Place, N. Y. | W4FRH Robert W. Franklin, R.F.D. 1, Swannanoa, N. C. |
| W2LPS Merritt L. MacKnight, 961 Palisade Ave., North Bergen, N. J. | W4FRL Arthur S. Fish, 337 S. W. 14th Ave., Miami, Fla. |
| W2LPT Seymour Levine, 422 Crown St., Brooklyn, N. Y. | W4MJ Livingstone R. Wever, 806 E. 40th St., Savannah, Ga. |
| W2LPU Wm. E. Talbert, Jr., 45 W. 110th St., N. Y. C. | W4PX Wm. Marcus Jones, Route 5, Jacksonville, Fla. |
| W2LPV Frederick Sprick, 10 Michigan, Paterson, N. J. | W5ADL Wm. H. Scott, Jr., Marks, Miss. |
| W2LPW Vincent J. Reavely, 244 Atlantic Ave., Oceanside, N. Y. | (Continued on following page) |

ALWAYS
RELIABLE
..everywhere



TYPE
BT
INSULATED
Metallized
RESISTORS

Wherever radio is used throughout the world—there you will find IRC Insulated Metallized Resistors.

No other resistors offer such amazing protection against all kinds of moist, hot or humid atmospheric conditions. No other resistors offer so much real quality in every mechanical and electrical characteristic.

PLAY SAFE!

Remember: IRC Insulated Metallized Resistors are both color coded and imprinted with wattage rating and value for your convenience. Sold by leading jobbers in all needed ranges in 1/2, 1 and 2 watt sizes. Use them on every service replacement job. Play safe by giving your customers the best!

"They Stay Put"

**INTERNATIONAL
RESISTANCE COMPANY**
401 N. Broad St., Philadelphia, Pa.
In Canada, 187 Duchess St., Toronto, Ont.



NOW—TWO TERMINAL RADIO SUPPLY HOUSES IN NEW YORK CITY!

NEW STORE AT 68 WEST 45 ST. CONVENIENT to MIDTOWN N.Y.!

Both Stores Completely Stocked with Everything in Radio from Nuts and Bolts to Complete Transmitters—at Lowest Prices!

New York, N. Y., Nov. 15—On December 1st, 1938, the Terminal Radio Corp. opens another radio supply house at 68 West 45 Street, New York. Two well-equipped, easily accessible TERMINAL radio supply houses, one at the downtown Hudson Terminal and the new store just a short distance from midtown Times Square, now serve N.Y.! Both stores are open until 8:00 P.M. every evening.

Mail orders are intelligently handled, accurately filled and promptly shipped. Even our customers in far-off countries, who've never seen us and whom we've never seen, know well of our fair dealings and dependable service.

Cable Address: **TERMRADIO**

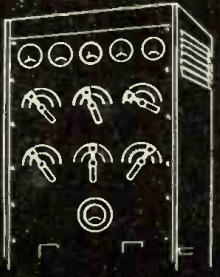

TERMINAL Radio Corporation

80 CORTLANDT STREET, NEW YORK, N. Y.



RADIOCRAFTER

2 3/4" VERNIER DIAL
 ROTARY BUFFED NICKEL SILVER DISC. POSITIVE FRICTION DRIVE

No freq. change removing hand from knob, as with plain dials. Net Price, less knob, .90c
 1 1/2" Bakelite Knob, .15c
 Catalog Free. Complete line modern, low-cost dials & knobs.

N. E. RADIOCRAFTERS
 1156 COMMONWEALTH AVE.
 BROOKLINE, MASS.

At Your Jobber or Direct. Postpaid

CHASSIS — CABINETS PANELS & CANS

STANDARD SIZES ON HAND
 SPECIAL SIZES MADE TO ORDER
 KORROL RADIO PRODUCTS CO.
 Dept. S-12

350 Greenwich St. New York City

BE SURE TO READ!
 "FREQUENCY CONTROL with QUARTZ CRYSTALS"

A new booklet covering the theory and use of quartz crystals. Only 10c. (Canada 15c). Buy it Now!

At all Bliley Dealers. **10¢**

New HAM Licenses

(Continued from preceding page)

- W5BIP Herbert Tex Wiley, 2 mi. south of Paris, Texas.
- W5BKJ Kyle Johnson, Johnson Ranch, Castolon, Texas.
- W5CZT Earl G. Coston, 822 N. Asbury, Bethany, Okla.
- W5HKO James Edwin Ogle, Broken Bow, Okla.
- W5HKP Joseph J. Zammit, 4779 St. Roch, New Orleans, La.
- W5HKQ James B. Shelton, Waterproof, La.
- W5HKR Bryan Cowan, 204 S. Market, Brenham, Texas.
- W5HKS Robert C. Culpepper, St. Joseph, La.
- W5HKT Luther N. Davis, Jr., 301 S. 15th Ave., Hattiesburg, Miss.
- W5HKU Lyndon Erroll Dawson, 212 Greer St., Haynesville, La.
- W5HKV Franklin H. Dutton, near Covington, St. Tammany, La.
- W5HKW Silas M. Richie, 3018 Wilkinson, Ft. Worth, Texas.
- W5HXJ John Wm. Midkiff, 250 Magnolia, Hot Springs, Ark.
- W5HKZ Thomas Henry Morrell, 2709 Dodson Ave., Ft. Smith, Ark.
- W5HLB Harry B. Smith, 326 S. W. 23rd St., Oklahoma City, Okla.
- W5HLC Teddy LaVerne Van Pelt, 228 N. Union, Shawnee, Okla.
- W5HLD Robert A. Wells, 504 W. Indiana, Enid, Okla.
- W5HLE Lee V. Wolfinger, 24th & Elizabeth, Muskogee, Okla.
- W5HLF Dickson E. Nuckols, 1007 Olive St., Texarkana, Texas.
- W5HLG Lee W. Wall, 2030 Wash St., Amarillo, Texas.
- W5HLH John D. Tallant, Compromise St., Kinner, La.
- W5HLI Lena E. Kay, 1286 Victoria, Beaumont, Texas.
- W5HLJ Thomas A. Jennings, Vance, Miss.
- W5HLK Clark A. Perkins, 402 E. 8th St., Del Rio, Texas.
- W5HLL Ralph R. Rush, 905 D. St., Lawton, Okla.
- W5HLM Paul V. Fohrman, 1909 N. J., Ft. Smith, Ark.
- W5HLN Wm. M. Adkisson, 602 Parkview St., Dallas, Texas.
- W5HLO Maurice G. Chernin, 400 Cincinnati St., El Paso, Texas.
- W5HLP David H. Weinstein, Oleander Hotel, Grand Isle, La.
- W5HLR Franklin B. Glenennine, 402 N. Broadway, Mt. Allen, Texas.
- W5HLS Varnell E. Fleming, 208 N. Gregg, Big Spring, Texas.
- W5HLU Glen Triitt, Ponder, Texas.
- W5HLW Howard H. Hicks, Hotel Rex, Main St., Eudora, Ark.
- W5HLX Leonard B. Haggard, Industrial Add., Pawhuska, Okla.
- W5HLY John Porter Hardy, Tunica, Miss.
- W5HLZ Jack D. Giles, 822 State, Natchez, Miss.
- W5HMA Shirley S. Allighi, U.S.U.C.R. Unit 3, 305 N. Blvd., Baton Rouge, La.
- W5HMB Mark N. Terrell, Jr., 5619 Miller St., Dallas, Texas.
- W6CIJ John Court, 1101 Sutter St., San Francisco, Calif.
- W6DLL Reginald Neelands, 10584 Ashton Ave., Los Angeles, Calif.
- W6GFI Roy R. M. Meadows, 831 1/2 N. June, Hollywood, Calif.
- W6HMW Hinman E. Bastran, 237 W. 82nd St., Los Angeles, Calif.
- W6KMZ Alfred B. Summers, 10 E. Fine St., Flagstaff, Ariz.
- W6NAY Masayoshi Harada, 1777 Euclid Ave., Berkeley, Calif.
- W6QIQ George A. Scott, 1229 28th St., San Diego, Calif.
- W6QJF Donald A. Walker, 1020 W. 103rd St., Los Angeles, Calif.
- W6QJK Stanley H. Lari, 4053 Front St., San Diego, Calif.
- W6QJL Avery T. LeNoir, 32 West 2nd Ave., Mesa, Ariz.
- W6QJN Robert B. McLaughlin, 3576 Beewick St., Los Angeles, Calif.
- W6QJO Harry V. McMorris, 205 N. Kenmore Ave., Los Angeles, Calif.
- W6QJP Floyd A. St. Louis, Route 5, Modesto, Calif.
- W6QJT Avery A. Ishmael, Jackson, Calif.
- W6QJU Robert F. Martin, 5264 Sumner Ave., Los Angeles, Calif.
- W6QJW Howard F. Shepherd, Jr., 1220 S. Saint Andrews Pl., Los Angeles, Calif.
- W6QJX Verdie V. Keene, 124 S. Parish, Burbank, Calif.
- W6QJY Charles F. Denny, Willits, Calif.
- W6QJZ Thomas C. DuVall, 732 Euclid, Upland, Calif.
- W6QKB Stephen H. Lazarian, Jr., 56 E. Harriet, Altadena, Calif.
- W6QKC Richard L. Venturino, 6580 Christensen Lane, Hayward, Calif.
- W6QKD Lawrence E. Ruff, 274 Euclid Ave., Long Beach, Calif.
- W6QKE George Edward Wann, 10591 Blythe, Los Angeles, Calif.
- W6QKF Donald Soo Hoo, 541 16th St., Oakland, Calif.

(Continued on page 497)

All about the SHORT WAVE LEAGUE

A FEW WORDS AS TO THE PURPOSE OF THE LEAGUE

The SHORT WAVE LEAGUE was founded in 1930. Honorary Directors are as follows:

Dr. Lee de Forest, John L. Reinartz, D. E. Replogle, Hollis Baird, E. T. Somerset, Baron Manfred von Ardenne, Hugo Gernsback, Executive Secretary.

The SHORT WAVE LEAGUE is a scientific membership organization for the promotion of the short wave art. There are no dues, no fees, no initiations, in connection with the LEAGUE. No one makes any money from it; no one derives any salary. The only income which the LEAGUE has is from its short wave essentials. A pamphlet setting forth the LEAGUE'S numerous aspirations and purposes will be sent to anyone on receipt of a 3c stamp to cover postage.

FREE MEMBERSHIP CERTIFICATE

As soon as you are enrolled as a member, a beautiful certificate with the LEAGUE'S seal will be sent to you, provided 10c in stamps or coin is sent for mailing charges.

Members are entitled to preferential discounts when buying radio merchandise from numerous firms who have agreed to allow lower prices to all SHORT WAVE LEAGUE members.

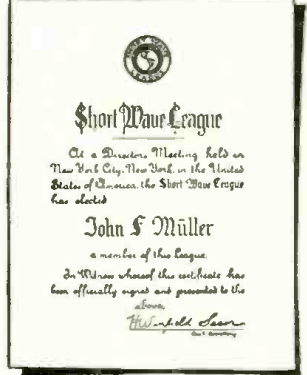

If you wish your name engraved on the Free membership certificate, as illustrated above, please send 25c to cover cost.

SHORT WAVE ESSENTIALS LISTED IN OPPOSITE COLUMN SOLD ONLY TO SHORT WAVE LEAGUE MEMBERS

They cannot be bought by anyone unless he has already enrolled as one of the members of the SHORT WAVE LEAGUE or signs the blank below (which automatically enrolls him as a member, always provided that he is a short wave experimenter, a short wave fan, radio engineer, radio student, etc.).

Inasmuch as the LEAGUE is international, it makes no difference whether you are a citizen of the United States or any other country. The LEAGUE is open to all.

Application for Membership SHORT WAVE LEAGUE

SHORT WAVE LEAGUE 99-101 Hudson Street, New York, N. Y. 12-38

I, the undersigned, herewith desire to apply for membership in the SHORT WAVE LEAGUE. In joining the LEAGUE I understand that I am not assessed for membership and that there are no dues and no fees of any kind. I pledge myself to abide by all the rules and regulations of the SHORT WAVE LEAGUE, which rules you are to send to me on receipt of this application.

I consider myself belonging to the following class (put an X in correct space): Short Wave Experimenter Short Wave Fan Radio Engineer Student

I own the following radio equipment:

Transmitting
 Call Letters
 Receiving
 Name
 Address
 City and State
 Country

I enclose 10c for postage and handling for my Membership Certificate.

Accessories for Members of the SHORT WAVE LEAGUE

Every member of the SHORT WAVE LEAGUE wants to identify himself in some way. For your convenience the League directors have prepared suitable letterheads, lapel buttons, stickers, etc. In addition there are many short-wave accessories, such as globes, etc., which the League offers only to members at special prices. Take your choice from this advertisement. THESE ESSENTIALS ARE SOLD ONLY TO LEAGUE MEMBERS.



LEAGUE LETTERHEADS
A beautiful, official letterhead has been designed for members' correspondence. The letterhead is invaluable when it becomes necessary to deal with the radio industry, mail order houses and radio manufacturers, as many houses offer members of the LEAGUE preferential discount. The letterhead is also absolutely essential when writing for verification to radio stations either here or abroad. It automatically gives you a professional standing.

A—SHORT WAVE LEAGUE letterheads. 50c per 100

WORLD GLOBE

This important essential is an ornament for every den or study. It is a globe, 6 in. in diameter, printed in fifteen colors, glazed in such a way that it can be washed. This globe helps you to intelligently list foreign stations. The base is of solid acetal and the semi-meridian of a nickel-like metal. Entire device substantially made, and has an attractive appearance to every station, emphasizing the long-distance work of the operator.



D—Globe of the World 89c
Prepaid

D—89c each

SHORT WAVE MAP OF THE WORLD

This beautiful map, measuring 18x26 in. and printed in 18 colors is indispensable when hung in sight or placed "under the glass" on the table or wall of the short wave enthusiast. It contains a wealth of information such as distances to all parts of the world, political nature of the country in which a broadcaster may be located, etc., and from that station is located, etc., and the map is blocked off gives the time in different parts of the world at a glance.



F—SHORT WAVE Map of the World. Prepaid 25c

WORLD RADIO MAP AND STATION FINDER

The finest device of its kind published. The world's map on heavy board is divided into 23 sections. The rotary dial shows you immediately the exact time in any foreign country. Invaluable in logging foreign stations. Also gives call letters, assigned to all nations. Size 11"x22".



G—Radio Map of the World and Station Finder. Prepaid 25c

LEAGUE LAPEL BUTTON



This beautiful button is made in hard enamel in four colors, red, white, blue and gold. It measures three quarters of an inch in diameter. By wearing this button, other members will recognize you and it will give you a professional air. Made in bronze, gold filled, not plated. Must be seen to be appreciated.

E—35c each



G—15c for 25

These seals or stickers are executed in three colors and measure 1 1/2 in. in diameter, and are gummed on one side. They are used by members to affix to stationery, letterheads, envelopes, postal cards and the like. The seal signifies that you are a member of the SHORT WAVE LEAGUE. Sold in 25 lots or multiples only.

E—SHORT WAVE LEAGUE lapel button. Prepaid 35c

EE—SHORT WAVE LEAGUE lapel button. Prepaid \$2.00

SHORT WAVE LEAGUE
99-101 Hudson St., New York, N. Y.

SHORT WAVE LEAGUE 12-38
99-101 Hudson Street, New York, N. Y.
Gentlemen,

I am a member of the SHORT WAVE LEAGUE
Please send me application for membership in the SHORT WAVE LEAGUE.

Please send me the following short wave essentials as listed in this advertisement:

.....
.....
for which I enclose \$..... herewith.

Name.....
Address.....
City and State.....
Country.....
(The LEAGUE accepts money order, cash or new U. S. Stamps in any denomination. Register cash and stamps.)

for December, 1938

Shooting Trouble on the Ham Transmitter

(Continued from page 468)

Plate Meter Flickered with B-Return Open

The transmitter consisted of a 6F6 oscillator, 6L6 buffer or doubler and an HF-100 amplifier. Upon turning on the filament switch, the plate currents of the oscillator and doubler would flicker and vary over a wide scale, when the filaments had warmed, although the plate switch which simultaneously controlled the plate power to the final amplifier and the B negative returns to the exciter was off.

Occasionally the plate currents would stop, but then after a few seconds would continue as described. The transmitter was shut off and this procedure tried.

An ohmmeter was placed between the cathode and ground to determine if there was a high resistance short or leak between possibly the B negative relay contacts or the associated wiring. No indication was observed but this was not considered as a conclusive test because of the possibility that part of the wiring was breaking down only when a voltage was actually set up. Next—

An external source of 100 volts was obtained with the B negative grounded to the transmitter chassis and the B positive attached to the cathode of the 6F6 and the 6L6 with a 1/2 watt neon bulb in series with one of the legs. The B negative switch that controlled the relay which was connected from cathode to ground to complete the circuit, was left in an off position. When the voltage was turned on, the same condition manifested itself, that is, the bulb flickered. The wiring in the transmitter from cathode through the switch to ground was then disconnected from the socket. This would then prove whether the wiring was at fault or not. Upon reapplication of the voltage, the condition was found to still exist. This proved that the wiring was in good condition. The 6F6 was then removed from the socket, but still the condition persisted. The 6L6 was removed and the condition had disappeared.

It was therefore concluded that the filament of the 6L6 was periodically shorting to the cathode when the filament was warm, thereby causing an indication of plate current on both tubes in conformity with the swaying of the filament as it made contact with the cathode.

On the Trail of a "Shorted" Secondary

At the time of the breakdown, proper servicing instruments were not available and hence, handicapped the author in proving that the part was at fault.

The circuit involved was the main power-supply for an HF-200 amplifier and the power supply for the modulator. One power transformer was used to supply voltages to both stages and consisted of three separate windings. A humorous situation presented itself when the transmitter was operated. Upon speaking into the microphone, the main fuse would blow. This was indicative of some trouble because the same size fuse had been used previously and was of ample rating. Apparently on modulation (a Class "B" modulation system was used), the increased current drain would set up a high line current which was just sufficient to melt the fuse.

Of course the main power transformer was immediately thought of as the cause, and so the secondary connections to the transformer were disconnected preparatory to testing it out.

The normal procedure would be to test each of the three individual secondaries with
(Continued on following page)

Please say you saw it in RADIO & TELEVISION

NEW SENSATIONALLY DIFFERENT!

SPRAYBERRY

Radio Home Study

Gives You Simplified Training

You Can UNDERSTAND

and

CASH IN ON

Get my FREE BOOK



You Learn by Doing Actual Experiments with Real Equipment

Don't Fail to Investigate This New Home Training Method.



I Back You Up All the Way with Close Personal Attention

I ACTUALLY SET YOU UP FOR A BUSINESS OF YOUR OWN

Here's the finest, most up-to-the-minute Radio Education available anywhere. Specially designed to give you intense, practical, quick training . . . for a money-making career in the fast moving Radio Industry. Even equips you for your own business.

TRAINING PREPARES YOU FOR JOBS AT \$40. TO \$60. PER WEEK

NO PREVIOUS EXPERIENCE NEEDED

My Training starts right at the beginning of Radio . . . unfolds each subject in a simplified, logical, understandable style. You easily learn all about Television, Electronics, Police Radio, Ship Radio, Commercial Radio Broadcasting . . . Radio Set Repair and Installation work, etc.

YOU GET PROFESSIONAL EQUIPMENT TO HANDLE PROFITABLE SPARE-TIME SERVICE JOBS . . . WHILE LEARNING

Positively the finest equipment offered with any Radio Course is delivered to you as a regular feature of SPRAYBERRY Training. You'll learn how to put these Testing Units and Tools to money-making use through the valuable spare-time BUSINESS BUILDERS I supply. I show you how and where to get Radio Service jobs right in your own neighborhood. You get invaluable practical experience . . . add to your bank account at the same time.

EXPERIMENTAL OUTFITS GIVEN

Sprayberry outfits make Radio Study easy and interesting because you work out practical applications of Radio Principles with your own hands.

The Sprayberry Course Is Sold Under an Iron-Clad, Money-Back Agreement

SPECIAL SERVICEMAN'S COURSE

I offer advanced Training for those already in Radio. Complete details of this advanced Course and fundamental Course, features, etc., fully described in my new 48-page FREE BOOK. Send for your copy today.

RUSH THIS COUPON FREE BOOK

SPRAYBERRY ACADEMY OF RADIO
F. L. Sprayberry, President
145-M University Place, N. W.
Washington, D. C.

Please send me FREE copy of "HOW TO MAKE MONEY IN RADIO".

Name..... Age.....
Address.....
City..... State.....
(Mail in envelope or paste coupon on postcard)

Economical 25-Watt TRANSMITTER



An efficient, economical transmitter, using the 6L6 metal tube. The kit is furnished complete with essential parts, fully mounted on black cracked Bud chassis. No drilling necessary. All you need is pliers and soldering iron.

The New EAGLE FB25

COMPLETE KIT, READY TO WIRE
We furnish a ready-wound plug-in coil for your particular band. Your choice of 160-30-40 or 20 meters.

\$695

ACCESSORIES

6L6 Power Tube—88c. High Grade Crystal and Holder—\$2.50. Ready-wound plug-in coils for extra bands—50c ea. Wiring (optional) \$2.00.
Power Supply Kit for FB25 or Eagle Minuteman...\$3.95
5Z5 or 80 Tube for power supply...25c
Power Supply Wired (optional)...75c

FEATURES
● Versatility ● Economy
● Quality parts ● 2 band operation with one Crystal
● 25 watts of power ● Easily Constructed.
● Simple to Operate. ● An ideal transmitter or Exciter.

Just the RECEIVER for Duplex Work

EAGLE Minuteman

2½-5-10 METERS

Amateur Band Receiver for consistent reception on the loudspeaker.

MINUTE MAN KIT Complete with 3 Coils **\$4.75**

2 Tubes 6C5 & 42 **\$1.25**

WIRING CHARGE OPTIONAL **\$1.25**

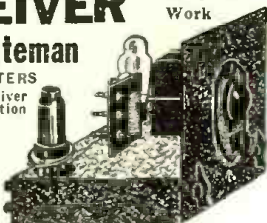

Just the receiver for duplex work. The most sensitive and selective super regenerative receiver known, uses metal and glass tubes. The last word in performance and simplicity of design. The last 2½ to 10 meter receiver ever offered to the amateur at such ridiculously low price. No license necessary to operate it.

MAIL ORDERS FILLED PROMPTLY.
\$2.00 Deposit, Check or Money Order, Balance C.O.D.

EAGLE RADIO CO.

84 CORTLANDT ST., DEPT. J, NEW YORK CITY

Shooting Trouble on the Ham Transmitter

(Continued from preceding page)

an ohmmeter, and thus determine whether there was a serious departure in resistance from similar windings.

Two secondary windings were rated to deliver 1000 volts and one winding 1500 volts. The turns ratio for the 1000 volt windings was 8.7 to 1 and for the 1500 volt winding, 13 to 1. Knowing the turns ratio, it would then be possible to calculate the voltage at the primary when a 110 volt source was connected to any one of the secondaries. If the voltage obtained at the primary deviated from the calculated value, it would then be sufficient proof that part of that secondary was shorted. A 0-150 A.C. voltmeter was available and the line voltage measured, which proved to be 125 volts. The stepped down voltage at the primary when the line voltage was connected to a 1000 volt secondary should be 1.43 volts. With this in mind, the test was run and the voltage obtained at the primary was 1.42 volts as indicated on a 0-3 volts A.C. voltmeter that was connected across the primary. As this was very close to the calculated value, it was agreed that that secondary did not have any shorted turns. The test was then repeated on the other 1000 volt winding, and this time the voltmeter indicated 1.55 volts, showing that a considerable portion of the turns was shorted (short-circuited), thus lowering the turns ratio and increasing the voltage by a relative amount.

This winding was used for the modulator power-supply and when the current through the winding increased, a heavy parasitic load was reflected back into the primary, thus blowing the fuse.

CASH IN

ON YOUR SPARE TIME!

300 WAYS TO MAKE MONEY

ONLY

25c

Per Copy



68 PAGES

MAIL ORDER PLANS TESTED MONEY MAKERS BUSINESS SECRETS SUCCESS SCHEMES

BRAND NEW BOOK 40,000 WORDS in TEXT!

In "CASH IN" you get ALL the real money-makers—dozens of profitable tested mail order plans, confidential business secrets, dozens of practical tested formulas, successful tested schemes—actual experiences of men who have started on a shoestring—with less than \$10 capital.

SOLD ON A MONEY-BACK GUARANTEE!

25c

Per Copy

Buyers of This Book Tell Us—

"Biggest value I've yet to see. Book is worth at least a dollar." S. BUDA, B'klyn, N. Y.
"Your book is as good if not better than others selling at \$1.00."
GEORGE BRUNET, Montreal, Can.

"CASH IN is the best value I have yet to see in the mail order field."

LAWRENCE FOX, Brooklyn, N. Y.

"CASH IN" contains only tested ideas covering every type of full-or spare-time enterprise—it's a "masterpiece" in business ventures. 25 CENTS per copy. Sent POSTPAID anywhere upon receipt of 25 cents U.S. stamps or coin.

NATIONAL PLANS INSTITUTE
246-T FIFTH AVENUE NEW YORK, N. Y.

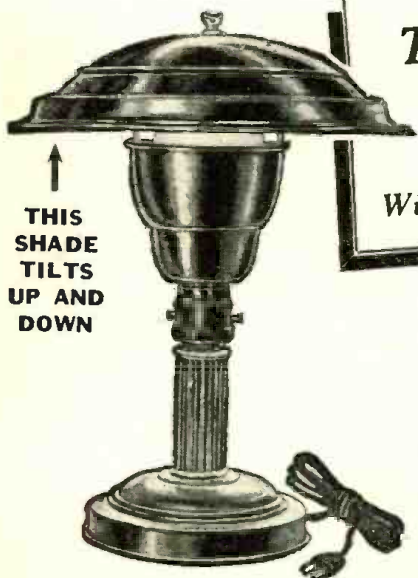

↑ THIS SHADE TILTS UP AND DOWN

This MODERN DESK LAMP Is Yours Absolutely FREE With a Year's Subscription to RADIO & TELEVISION

JUST THINK OF IT—you can get absolutely FREE, the beautiful desk lamp shown at the left. This attractive desk lamp is suitable for home, desk, den, office, laboratory, studio or workshop. It is sent to you by the publishers with their compliments for a one-year subscription to RADIO & TELEVISION. Look at the many fine features which this handsome desk lamp has. Read the list below.

LOOK AT THESE FEATURES!

- ⊗ Constructed of metal with attractive bronze finish.
- ⊗ Scientifically constructed to give glareless, diffused light.
- ⊗ Helmet-type shade can be tilted to any convenient angle.
- ⊗ Stands 13" high and has 10" metal shade.
- ⊗ 5-foot rubber insulated cord and plug.
- ⊗ Constructed to last for many years.

Clip Coupon Today — and Mail!

Send your subscription today to RADIO & TELEVISION for One Year (12 issues) and receive absolutely FREE one of these truly remarkable desk lamps. New subscribers are accepted or you may extend your present subscription another twelve months under this offer. Mail your remittance of \$2.50 (Plus 25c for shipping charges on lamp) to the publishers of RADIO & TELEVISION. (Canada and foreign \$3.25) You will promptly receive your FREE DESK LAMP by return mail. Use the coupon at the right to order your subscription.

RADIO & TELEVISION

99 Hudson Street

New York, N. Y.

RADIO & TELEVISION, 99 HUDSON ST., NEW YORK, N. Y.

Gentlemen: Enclosed you will find my remittance of \$2.50 for which enter my subscription to RADIO & TELEVISION for One Year (12 issues). Send me promptly my FREE DESK LAMP. (Canada and foreign \$3.25.) In U. S. add 25c additional to cover shipping charges of lamp.

() NEW SUBSCRIBER () EXTEND PRESENT SUBSCRIPTION

Name

Address

City State

(Send remittance by check, money order or unused U. S. Postage stamps. Register letter if you send cash or stamps.)

R&T-1238

New HAM Licenses

(Continued from page 494)

- W6QKI Delos Pendleton Trim, 4205 Kansas, San Diego, Calif.
- W6QKJ Ralph J. Myers, 2017 25th St., Sacramento, Calif.
- W6QKK Peter James Neimo, 990 Scott, San Diego, Calif.
- W6QKL Aaron S. Aaronian, Peach Ave. & U. S. Highway No. 99, Fresno, Calif.
- W6QKM Donald D. Wells, 201 S. Linden Drive, Beverly Hills, Calif.
- W6QKN Franklin W. Scott, 1024 N. Redington St., Hanford, Calif.
- W6QKO Donald C. Miller, 270 E. McFarlane St., Ventura, Calif.
- W6QKQ Ray. W. Bailey, 977 Santa Ross, San Luis Obispo, Calif.
- W6QKR Wm. Barrett, 4521 Delongpre, Los Angeles, Calif.
- W6QKS Harry L. Blocker, 223 W. 3rd St., Long Beach, Calif.
- W6QKT Ernest Beard, 11th St., Montague, Calif.
- W6QKU Angus C. Fox, Jr., 519 Sacramento St., Nevada City, Calif.
- W6QKV Stephen A. Douglas, 26 Rock, Reno, Nev.
- W6QKW Robert Carter, 1001 8th Pl., Hermosa Beach, Calif.
- W6QKZ Warren H. Palmer, 2953 Long Beach Blvd., Long Beach, Calif.
- W6QLA William R. Porter, 412 S. Parton, Santa Ana, Calif.
- W6QLC George M. Salamovich, 210 1/2 El Redondo, Calif.
- W6QLE Shiko G. Tahara, 1609 S. Tamarind, Comp-ton, Calif.
- W6QLF David Wm. Hart, 1324 Punta Gorda Ave., Santa Barbara, Calif.
- W6QLH Chauncey E. Downey, 2451 Gunn Dr., Oak-land, Calif.
- W7HCH Harold A. Norby, Route 2, Newberg, Oregon.
- W7HCJ Ralph J. Farano, N. 4906 Lacey St., Spo-kane, Wash.
- W7HCK Ellison S. Mark, 703 4th Ave., East Kali-spell, Mont.
- W7HCL William A. Sourwine, Belton, Mo.
- W7HCM Wm. Samuel Moutton, 514 E. 6th, Tilla-mook, Oregon.
- W7HCN Paul S. Thun, 915 E. 5th St., Tillamook, Oregon.
- W7HCO Adam Waszradowski, 2804 E. 16th St., Van-couver, Wash.
- W7HCP John Walker, Apt. 4, 1409 W. 4th Ave., Spo-kane, Wash.
- W7HCQ Richard M. Rogers, 2544 N. E. 48th Ave., Portland, Oregon.
- W7HCR Louis S. Scofield, 821 S. Dakota St., Butte, Mont.
- W7HCS George Emil Minich, 4411 29th St., Seattle, Wash.
- W7HCU Wm. C. Boughtan, 103 E. 54th St., Seattle, Wash.
- W7HCW Fred S. Winkleman, 1606 Ash Ave., Cot-tage Grove, Ore.
- W7HCY David B. Newman, 626 5th St., Astoria, Ore.
- W7HCZ Christian Melgard, Port Orchard, Wash.
- W7HDB Edwin M. Bodan, 112 S. Albion, Burley, Idaho.
- W7HPA Clifford R. Masters, R.R. 1, Alicel, Ore.
- W8AKO Earl T. Denton, 453 1/2 N. Chestnut St., Butler, Pa.
- W8ARY Lester S. Young, 46 Main St., Yorkville, N. Y.
- W8BZP Joseph N. Peckham, 24 Case Ave., Auburn, N. Y.
- W8CDJ John N. Weaver, 467 Cayuta Ave., Waver-ly, N. Y.
- W8FPK Allen G. Sanderson, 380 Elmhurst, Highland Park, Mich.
- W8GIY Jim F. Correll, Camp Skeel, Oscoda, Mich.
- W8GOP Ralph E. Grant, 2221 Benjamin, Saginaw, Mich.
- W8IOY Mitchell J. Boho, 2243 Spokane Ave., Carr-ick, Pittsburgh, Pa.
- W8SLP Arthur J. Odgers, Apt. 103, 610 Andrews St., N. E. Massillon, Ohio.
- W8SLQ Cecil P. Randall, 1113 W. Kalamazoo St., Lansing, Mich.
- W8SLR Hal Joe Shafer, 1112 Norwood, Toledo, Ohio.
- W8SLU Clare C. Harroun, 3106 Caroline, Auburn Heights, Mich.
- W8SLV Walker Faussett, 710 E. Clinton St., Howell, Mich.
- W8SLW Chester P. Rempinski, 6128 Comstock, Det-roit Mich.
- W8SLX Louis H. Rose, St. Joseph Hall, University of Dayton, Dayton, Ohio.
- W8SLY Milton E. Kohl, 424 Brookside Drive, Dayton, Ohio.
- W8SLZ Harold E. Knipe, 510 Brown St., Strouds-burg, Pa.
- W8SMA Lawrence R. Walsh, 407 Clinton St., Ham-ilton, Ohio.
- W8SMC John Joseph Erhart, 844 Charlotte St., Cin-cinnati, Ohio.
- W8SMG Fletcher H. Moore, 1148 Overlook Ave., Cincinnati, Ohio.
- W8SMI Lyman A. Goldsmith, 297 Maple St., Buf-falo, N. Y.
- W8SMK Floyd La Verne Draper, Route 3, Vassar, Mich.

(Continued on following page)

For TOUGH ASSIGNMENTS Investigate This Set

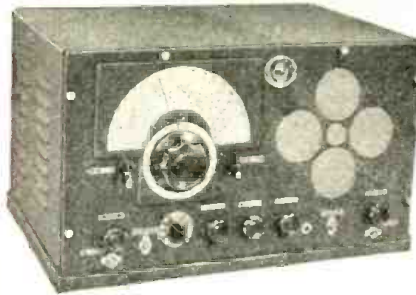

Model 51 Can "Take It"

Beautifully built, and of the finest materials. Engineered with the latest developments in the art. A rugged, sensitive, selective, compact receiver that will give a good account of itself in any location. For communication work in commercial-type installations or amateur stations Model 51 will give utmost satisfaction. Easy to operate, but with controls on the panel wherever desirable for an experienced operator. RE-GENERATIVE INPUT having sensitivity and image rejection equal to 3 or 4 R.F. stages at the higher frequencies. Quiet, stable, practically free from frequency drift. Uses a new I.F. system operating below the tube hiss level. Performance for communication work equal to that of any receiver, regardless of price.

Streamliner '39

A sensational value in a communication receiver. 5-tube superhet, covers 10 meters. Illuminated dial. 2 stages I.F., panel trimmer. Beat Oscillator. AVC. 2 tuning bands. Covers 9.5 to 350 meters. Uses hand switching—no plug-in coils. Net Price, complete with tubes, speaker, \$33.90 power, ready to go. Equals performance of receivers selling for many times the price.

Model 51 Features

- Regenerative Input, all Bands
- High 10/20 Meter Efficiency
- 10 New Type Glass Tubes
- Equivalent Performance 13 Tubes
- Isolantite Insulation
- Shadow Tuning
- Iron Core I.F.
- Band Spread
- C.W. Pitch Control
- R.F. and Det. Panel Trimmers
- Break-In Switch
- Headphone Jack
- R.F. Input Control
- Manual Volume or AVC
- Tone Control
- Push-Pull Audio
- 8" Jensen Speaker
- A.C.-D.C. Circuit
- Full Wave A.C. Rectification
- Both Power Lines Filtered
- Lifetime Filter Condensers,—no Electrolytics
- Shielded, Moisture-proof Bypasses
- Insulated, Moisture-proof Resistors

ALWAYS IN ALIGNMENT—

Perfect tracking between oscillator and detector circuits with fixed trimming is obtainable only in the laboratory. Model 51 makes possible perfect alignment on all frequencies at all times because of panel-operated individual trimmers on R.F. and detector circuits. The operator has only to touch these to assure himself at any time as to alignment. Extreme selectivity of regenerative R.F. stage, equivalent to an I.F. stage selectivity, makes panel trimming imperative on this receiver.

A GO-GETTER FOR DX

Regenerative input brings through those weak signals, lost in the "mud" on many large, multi-tube receivers. The ideal set for the DX hunter. Write for complete data.

MODEL 51 NET PRICES

Model 51-AK, 9.5 to 350 meters. 110 volts AC-DC \$157.00
 Model 51-MK, 9.5 to 3750 meters. 110 volts AC-DC \$175.00

E. M. SARGENT CO., 212 9th St., Oakland, Calif.

DECIBEL METERS

Larger dial opening gives more light on scale

by **TRIPLET**

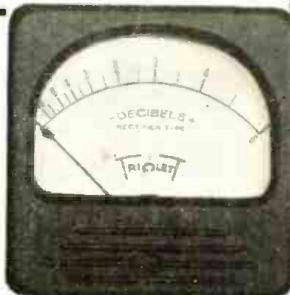

- ★ 3" and 4" Sizes Stocked
- ★ Other Sizes Available
- ★ Round or Square
- ★ Attractively Priced

Model 327-A Decibel Meter

3" Instrument in New Style Molded Case .. \$12.00

Standard range reads up 6 and down 10 decibels, zero decibel at 1.73 volts, 500 ohm line, 6 milliwatts, standard damping furnished unless highly damped is specified.

ALSO 4" MODELS

Model 321—3" Round \$12.00
 Model 421—4" Square \$13.17

Decibel Meter Kit—Model 150 Kit complete with Decibel Meter, necessary multipliers, switch and other accessories \$20.00

THE TRIPLET ELECTRICAL INSTRUMENT COMPANY
 2812 HARMON DRIVE, BLUFFTON, OHIO

COMPLETE DYNAMIC TESTING

Direct, quick, practical instruction for complete 14-point check of all receivers with cathode ray, easily mastered by anyone who can read a circuit diagram. Without it, you're behind the times! Get your copy TODAY!

FREE WITH ANY C-B INSTRUMENT
 Clough-Brengle Co., Chicago, Ill., U.S.A.



NEW CATALOG #161

JUST OFF THE PRESS

May we send you a copy?

CORNELL - DUBILIER
 ELECTRIC CORPORATION

1027 Hamilton Blvd.,
 So. Plainfield, N. J.

Cable Address: CORDU



EVERYTHING IN RADIO!

A COMPLETE SOURCE FOR YOUR RADIO NEEDS
 Our immense stock of radio sets, parts and supplies enables you to purchase your entire needs on one order. You will find all your Nationally Known Favorites in this big book which is FREE for the asking. Practically every order is shipped the same day it is received.
 WRITE FOR BIG NEW CATALOG

BURSTEIN-APPLEBEE CO.
 1012-14 McGee St. • Kansas City, Mo.

STOP, LOOK & BUY!

Rockbottom Prices On Army and Navy and Surplus Merchandise

When prices are low we buy! They're low now—**LOWER THAN THEY EVER WILL BE**—hence this sale. Most of the merchandise is new—never used; some of it reconditioned. 100% satisfaction on each transaction or your money refunded.

ORDER FROM THIS PAGE. Use the convenient coupon below. Be sure to include sufficient extra remittance for parcel post charges, else the order will be shipped express, charges collect. Any excess will be refunded. C.O.D. shipments require a 20% deposit. If full remittance accompanies order deduct 2% discount. Send money order—certified check—new U. S. stamps. No C.O.D. to foreign countries.

ORDER TODAY QUANTITIES LIMITED QUICK SHIPMENTS ASSURED

EDISON 1/50TH H.P. UNIVERSAL MOTOR

Made by Edison Electric Co. for Dictaphone machines. Can be used on 110 volt D.C. or A.C. lines (any frequency on A.C.). Double shaft, 5/16th in. diam. Any speed obtainable with suitable rheostat. Size 9" x 4" high, 3/4" wide overall. Shp. Wt. 8 3/4 lbs.

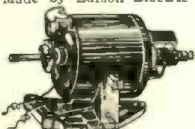

ITEM NO. 10
Your Price **\$2.25**

VARIABLE SPEED UNIVERSAL MOTOR

FOR 110 VOLTS, A.C. OR D.C.
Made for Dictaphone machines by American Gramophone Co. Used, but in excellent condition. Special lever control permits variable speeds up to 3000 r.p.m. 1/4" shaft extends from both sides of motor. Measures 7 1/2" x 3 1/2" diam. overall. Shp. Wt. 6 3/4 lbs.



ITEM NO. 11
Your Price **\$2.55**

SPERRY GYROSCOPE LIQUID COMPASS

Made for U.S. Signal Corps; sensitive and accurate. Quick readings easily made from top; accurate readings of graduations through focusing magnifying lens on side of instrument. Complete with level sights and ratchet leather carrying case. Excellent for boats, boy scouts, campers, bikers, etc. A few turns of wire around its case makes it usable as a galvanometer. Shp. Wt. 3 lbs.



ITEM NO. 12
Your Price **\$1.85**

PORTABLE TELEGRAPH AND BUZZER FIELD SETS

Made for military use by Western Electric. A wonderful buy if only for the parts it contains. Never been used. Good for code practicing; signaling; communications, etc. Contains 2-tone, high-frequency buzzer with platinum contacts, telegraph key, telephone switches, earphone, condensers, transformers, chokes, etc. A \$50 value easily. Complete in wooden case with dialing keys and instructions. Shp. Wt. 12 lbs.



ITEM NO. 16
Your Price **\$5.45**

PRISMATIC RIFLE SIGHT AND OBSERVERS' SCOPE

Made by Warner & Swasey. Consists of achromatic ocular and objective lenses (6 power), calibrated reticule with cross hairs, 2 highly polished prisms set in solid bronze frame with soft rubber eye cup. Micrometer adjustments for windage and windage. Used on Krag, Enfield, Savage, Springfield, etc. With mount and leather case. Shp. Wt. 4 lbs. Regular price \$38.00.



ITEM NO. 18
Your Price **\$8.95**

TELEGRAPHIC TAPE RECORDER

A wonderful buy! Apparatus makes a written record of code and similar messages on paper tape. An ideal machine for learning code or groups. Radio men can easily adapt it to short-wave receivers for taking permanent records of code messages. Double pen permits simultaneous recording of two messages. Pens are operated by battery and key while tape feeder is spring driven (hand wound) brass on heavy iron base. Completely reconditioned. (Less tape; easily obtained anywhere.) Original cost \$85.00. Shp. Wt. 20 lbs.

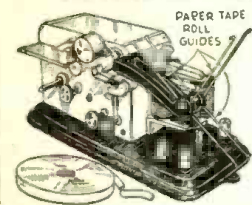

ITEM NO. 20
Your Price **\$19.95**

ARMY AIRCRAFT KEY

Type J.E. Army aircraft solid brass transmitting key with large heavy duty tungsten contacts. Well balanced action—easy on the fist. Shp. Wt. 2 lbs.



ITEM NO. 22
Your Price **\$1.90**

WESTERN ELECTRIC BREAST MIKE

A lightweight aircraft-type carbon microphone with breast plate mounting. Can be adapted for home broadcasting or private communication systems. With cord and plug. Shp. Wt. 4 lbs. (Illustrated at right.)



ITEM NO. 14
Your Price **\$2.45**

Magnavox Anti-Noise Microphone. Also good for home broadcasting etc. With cord and plug. Shp. Wt. 2 lbs.

ITEM NO. 15
Your Price **\$1.80**

NAVY PORTABLE SEARCHLIGHT

3/2 MILE RANGE
Cast aluminum and bronze housing. Mangin type parabolic glass reflector 5" diam. Trigger switch and handle for operating, tilting and focussing lamp. Made by General Electric and National X-Ray Co. for U.S. Navy. Measures 4" deep x 5 1/4" diam. overall. Focal length 13 1/2". Approximately 100 candle power. Has threaded nipple for 3/4" pipe support. Complete with wooden carrying case. Excellent for camps, trailers, barns and outdoor and indoor displays. Supplied with either 6 or 12 volt lamp. Shp. Wt. 14 lbs. (Net 4 lbs.)



ITEM NO. 17
Your Price **\$6.65**

AIRCRAFT GENERATOR PROPELLER

"Deslauriers" automatic controllable. Operating speed 1,500 r.p.m. Blade 1 1/2" x 2" sweep 23°. All aluminum and bronze housing. Complete with streamlined housing (shown dotted). 1/16" shaft. Net weight 5 1/2 lbs. Shp. Wt. 7 lbs. Original cost \$200.



ITEM NO. 19
Your Price **\$5.25**

NAVY FLOODLIGHT

Made to U.S. Navy rigid specification these sturdily constructed floodlights are now available at less than half of their original price of \$70.00. Brand new merchandise, never before used. Pittsburgh floodlight type FLC-500, 16" Durex aluminum reflector. Floodlight has double adjustments and is weatherproof. Takes 300 to 500 Watt Mazda base lamp. Measures 18" x 18" x 2 1/4" overall. Shp. Wt. 55 lbs.



ITEM NO. 21
Your Price **\$29.70**

ANTI-CAPACITY SWITCHES

Made by Western Electric. Double throw switch with 12 terminals—equivalent to two double-pole, double-throw switches. All contacts are of platinum plate. Original price \$3.50 each. Shp. Wt. 1 lb.



ITEM NO. 23
Your Price **\$1.55**

WE HAVE NO CATALOG. ORDER FROM THIS PAGE.

HUDSON SPECIALTIES - 40-T West B'way - N.Y.C.

IT'S EASY TO ORDER—CLIP COUPON—MAIL NOW

HUDSON SPECIALTIES CO., 40-T, West Broadway, N. Y. C. 1238

I have circled below the numbers of the items I'm ordering. My full remittance of \$..... (include shipping charges) is enclosed.
OR my deposit of \$..... is enclosed. (20% required), ship order C.O.D. for balance. (New U.S. stamps check or money order accepted.)

Circle Item No. wanted: 10 11 12 14 15 16 17 18 19 20 21 22 23

Name Address

City State

Send remittance by check, stamps or money order; register letter if you send cash or stamps.

New HAM Licenses

(Continued from preceding page)

- W85MM Geo. R. Black, 462 Wyoming Ave., Wyoming, Pa.
- W85MN Paul Wm. Buehler, 3610 Hoiles, Toledo, Ohio.
- W85MO Nelson N. Clark, Montello Park, Holland, Mich.
- W85MQ Alban A. Michael, 145 Amity Rd., Reading, Ohio.
- W85MR Frederick A. Mason, 2715 1/2 Albion, Toledo, Ohio.
- W85MS Harry A. Martin, 341 S. Linden, Marshall, Mich.
- W85MT Albert Wismer, 4219 Station Ave., Ash-tabula, Ohio.
- W85MU Carl F. Kriskalla, 1294 Newport, Detroit, Mich.
- W85MW Earnest A. Heu, 433 Forest Ave., Bellevue, Pa.
- W85MX Louis A. Dimasi, 641 Highland Ave., Greenburg, Pa.
- W85MY Howard G. Halbert, Jr., R.F.D. 4, Monongah, W. Va.
- W85MZ Allison F. Childs, 435 Thompson St., Ann Arbor, Mich.
- W85NJ Lynn E. Dahlstran, 1328 Poplar St., Flint, Mich.
- W9AQW Chester Buchanan, 1/2 mile east of Logansport, Ind.
- W9ASC Herbert M. Sigman, 6409 Oleatha St., St. Louis, Mo.
- W9EYE Ward D. McIntyre, 129 Lake St., Chadron, Nebr.
- W9KAG Eugene L. Cummings, 6091 E. 14th, Kansas City, Mo.
- W9KBC Peter Laneioni, Co. 1693 C.C.C., Platteville, Wis.
- W9KBG William M. Lee, 3824 Park Ave., Indianapolis, Ind.
- W9KBI Stephen V. Marzycycki, 104 N. Rural, Chipewa Falls, Wisc.
- W9KBC John L. Morris, 909 W. Washington, Cham-paign, Ill.
- W9KBN Raymond P. Murray, 404 Mission St., St. Mary's, Kans.
- W9KCB Ernest C. Wolfe, 6310 Grant St., St. Joseph, Mo.
- W9KCD Harold J. Krauskopf, 2429 Weisser Park, Ft. Wayne, Ind.
- W9KEQ Wm. T. Hines, 206 E. Empire, Bloomington, Ill.
- W9KEX Helen S. Hahn, 2209 Blake Blvd., Cedar Rapids, Iowa.
- W9KFD Harold M. Hassmann, 16 Sherman Pl., Appleton, Wisc.
- W9KFE Henry C. Frayer, 1058 Linden Ave., Wil-mette, Ill.
- W9KFJ Lane D. Cess, 1611 Pattie, Wichita, Kans.
- W9JFI Robert H. Overbeck, 111 Louisville, St. Louis, Mo.
- W9JFO Norbart J. Niewiadomski, 1749 S. 58th St., West Allis, Wisc.
- W9JGJ Charles von Bohr Lau, 5331 Lake Park, Chicago, Ill.
- W9JGT Everett Nelson Shinn, 3415 Larkwood, Louis-ville, Ky.
- W9JHB Charles G. Sanner, 765 Alpine St., Dubuque, Iowa.
- W9JHJ Jos. Dudley James, 817 Dearborn St., Chicago, Ill.
- W9JII Donald D. Duncan, 952 N. Lewis Ave., Waukegan, Ill.
- W9JIK Bernard Groll, 3415 Osage St., St. Louis, Mo.
- W9JIT Winston Hartley Starks, Main St., Har-din, Ky.
- W9JKI Richard Kerr Moore, 211 E. Jefferson, Kirk-wood, Mo.
- W9JKV George W. Onken, 718 Adams, Jefferson City, Mo.
- W9JOZ Gilbert G. Matthews, 317 S. Kinlworth, Oak Park, Ill.
- W9JPB M. Eugene Walker, Trafalgar, Ind.
- W9JPM Raymond A. Wee, 432 Pearl Ave., Fargo, N. D.
- W9JPZ Florian E. Pijanowski, 2219 Whipple, Chi-cago, Ill.
- W9JQH Ernest Jacob Vold, Main St., Tuttle, N. D.
- W9JTI Joseph S. Szewuk, 634 Second St., Hunt-ington, Ind.
- W9JTK Austin Mosher, 118 1/2 S. 4th St., Watseka, Ill.
- W9JTL Clyde L. Mock, 813 N. Morgan, Rush-ville, Ind.
- W9JUB Charles D. Earough, 1407 14th Ave., Cen-tral City, Nebr.
- W9JWA Clyde C. Arntzen, Crescent City, Ill.
- W9JWJ Joanna Locke Barnes, 724 N. Florissani Rd., Ferguson, Mo.
- W9JWK Grant F. Baurt, 1220 Putman Ave., Janes-ville, Wis.
- W9JWM Adin E. Randall, 1042 Main St., Eau Claire, Wis.
- W9JWR Bryan O. Pritt, 616 Cheyenne, Alliance, Nebr.
- W9JWS Fred C. Bulmain, Jr., 2729 Winter St., Ft. Wayne, Ind.
- W9JWT Reid H. Purran, 2541 Summerdale, Chi-cago, Ill.
- W9JWU Robert Wm. Will, 1441 7th St., So. Fargo, N. Dak.
- W9JWW Leslie F. Card, Harveyton, Ky.
- W9JWX Albert Kurz, Gackle, N. D.
- W9JXH Frank H. Inderwie, 1601 Broadway, Kansas City, Mo.

NEW RADIO APPARATUS

Test Equipment Speeds Your Radio Education

● METERS and test equipment are useful in trouble shooting because they eliminate the guesswork. They have the same value to the amateur as surgical instruments have to a doctor. No amateur can actually know what takes place in a circuit unless he has the proper equipment to enable him to diagnose actual circuit conditions. The time saved by the use of such equipment may be used for more hours of operating and enjoyment of the equipment. Often a part will change its value after an hour or so of use and it is practically impossible to detect a condition of this sort, without the proper measuring instruments. For that reason, we have expanded this department to include test equipment.

Versatile Multimeter

● A NEW multimeter for A.C. and D.C. use is being produced by Superior Instruments Co. This model 1180 meter works on 90 to 120 volts,



60 cycles. A.C.; it tests all 4, 5, 6, 7L and octal base tubes, both on the meter and with a neon tube. Its voltage ranges are 0-15, 0-150 and 0-750 D.C. and A.C. Its current ranges are 0-15, 0-150, 0-750 ma., A.C. and D.C., plus 0-1 ma. D.C. Its resistance ranges, 0-500 ohms, to 5 megohms. Its capacity scale, .0005 to 1 mf. and .05 to 200 mf. Its decibel ranges, minus 10 to plus 19, plus 38, plus 53. Its inductance range 1 to 700 henries. This test instrument is provided with a sloping panel and carrying case, and comes complete with test leads, charts and instructions.

Test Meter With Unusual Range

● A POCKET-SIZED 5,000-ohms-per-volt 14 range universal micro-multimeter, known as Meterette, is being featured by H. J. Bernard. It employs a 3" square Bakelite-cased meter, with a 200 microampere, d'Arsonval movement.

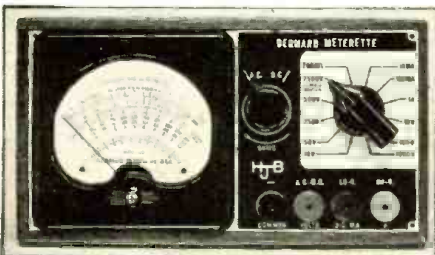

The Meterette has only two controls, due to a special method of combining the "Ohms" adjuster with the A.C.-D.C. switch. A 2,500-volt D.C. range is stressed for amateur, cathode-ray and television purposes.

The ranges are: 0-10-50-250-500-2,500 volts D.C. at 5,000 ohms per volt; 0-10-100-1,000 volts A.C. at 1,200 ohms per volt; 0-2,000-2,000,000 ohms; 0-200 microamperes, 0-10-100-1,000 milliamperes.

Insuline Catalog No. 200

Insuline Corp. of America. Pictures and descriptions of items for the Constructor, Ham and Service Man. A complete index makes this unusually well laid-out catalog easy to use.

New Dual Electrolytics



and their permanent sealing has longer life than ever before.

● THE Minicap line of Solar condensers now includes a dual unit which extends the capacitors to practically all commonly used values. It is claimed that these electrolytic capacitors occupy minimum space,

New Transmitting Condensers

● OIL-FILLED, oil-impregnated construction and rectangular shape are the features of the new Sprague CR transmitting condensers. These are labeled with complete information, including capacity, maximum D.C. working voltage and maximum surge voltage. The oil used has a flash-point of 500° F. and thus affords very high protection.

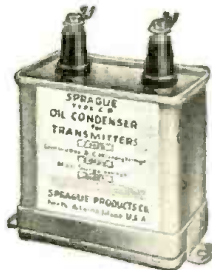

New Vernier Dial

● A HANDSOME nickel-silver disc, 2 3/4" in diameter, with etched black numerals, is the central portion of this new dial being produced by New England Radiocrafters.

It is driven at slow speed through a friction clutch by means of a neat black knob which may be mounted at any angle from the center line in order to obtain panel symmetry. The knob is not supplied as part of the outfit. It is easily mounted, being attached on the front of the panel, in which it is necessary to drill only one hole for the pointer and another for the knob bushing. A 4" dial will soon be available.

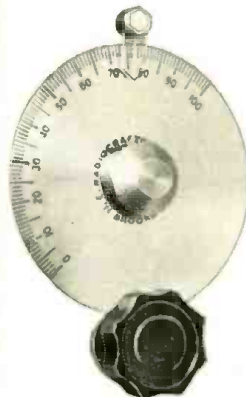

Hammarlund's New Catalog

● THE new Hammarlund '39 catalog has 16 pages, printed in two colors, and lists midret, split stator, transmitting and micro condensers; various types of plug-in coils and forms; transmitting and receiving chokes; flexible couplings; coil and tube shields; variable, air-tuned and iron core transformers; trimming, padding and neutralizing condensers; receivers and cabinets.

How To Build Radio Receivers

This 44 page book published by the Meissner Mfg. Co., contains several useful formulae and charts, as well as a technical discussion of design principles, general hints for the constructor, and complete instructions for the construction and operation of twenty of the most popular Meissner kits, each description being illustrated with large detailed schematic and picture diagrams. A full list of parts for each individual set is likewise provided. Price of book 50c.

Cornell-Dubilier New Catalog No. 161

● THIS new 40 page catalog, handsomely printed in two colors, gives photographic illustrations, physical measurements, electrical characteristics and list prices of the wide variety of capacitors which the company makes. Included are:— eleven types of dry electrolytics, two types of wet electrolytics, fifteen types of paper condensers, two types which use Dykanol, six types of mica condensers and two types of interference filters.



You can't afford to be without this finest of all radio catalogs! Whether it's Sound Equipment, Test Instruments or a new "Rig" you need, you can make substantial savings at Wards. Every article listed in this catalog must pass Wards "Bureau of Standards" tests, and 65 years of successful business on a "satisfaction or your money back" policy is your guarantee of quality. Order your equipment from Wards, pay for it as you use it with Wards Time Payment Plan and know that you are getting the best at the lowest prices! Mail the coupon today.

MONTGOMERY WARD

9 GREAT MAIL ORDER HOUSES
580 RETAIL STORES

Montgomery Ward & Company
Dept. SW-21, Chicago, U. S. A.
Please rush me New 1939 Radio Catalog FREE!

Name _____
Address _____
City _____ State _____

RADIO HAMS

make the best salesmen for short-wave diathermy units to physicians. Large commissions paid.

Leading mfr., established 1879.
McINTOSH ELECTRICAL CORPORATION
223 N. California Ave., Chicago, Ill.

HEADSETS

Amateurs! Are you getting the best results possible from your short-wave set? You're not! Try a TRIMM COMMERCIAL... that's what's missing from your rig.

Write Dept. R-912 for folder
TRIMM RADIO MANUFACTURING CO.
1770 W. Berceau Ave. Chicago, Ill.

RADIO INSTRUCTION

THIS FREE BOOK

will help you lick your code problems!



If you are having trouble learning code, — if you cannot develop the speed you need — send for the FREE "Book of Facts." There are many fine operators now on the air who were having the same trouble you are — they sent for this Candler "Book of Facts," — and that was the beginning of the end of their code difficulties.

They took the inexpensive Candler Code Course, and after a few weeks practice with the Candler System, they were amazed at their rapid progress. These operators were taught sound-consciousness and mental coordination — soon they were reading code as easily as print, without strain, nervousness, in fact without conscious effort.

Don't stumble and sweat over this job of learning code! It's easy with the Candler System — and many times quicker! Send for the FREE "Book of Facts!" It will tell you all about the Candler System, and how men like World's Champion McElroy obtained their marvelous speed the Candler Way. Beginners or Advanced Courses!

CANDLER SYSTEM CO.

Dept. S-12, ASHEVILLE, NO. CAROLINA, U.S.A.
"World's Foremost Code Authority"

THERE AIN'T NO SUCH THING



as not being able to master radio code. The

RALSTON RADIO CODE COURSE

will quickly yet thoroughly give you the confidence, accuracy and speed of an expert. Hear this new recorded course at your dealers today or write

RALSTON RECORD COMPANY

5433 WILLOWS AVE. PHILA., PA.

LEARN CODE RIGHT

Always ready—no weather interference—beats having someone send to you. Speed range 5 to 40 W.P.M. Radio or Morse.

STANDARD with 10 tapes and book of instructions . . . \$20.25

JUNIOR with 5 tapes and book of instructions (not rented) . . . \$12.00

RENTAL Standard with 10 tapes and book of instructions \$3.00 first month, \$2.25 each additional month.

Complete oscillator equipment, less battery. . . \$6.50

Write for details today



INSTRUCTOGRAPH CO.

Dept. SW-12 912 Lakeside Place Chicago, Ill.
Representatives for Canada: Toronto
Radio College of Canada 863 Bay Street

RADIO COURSES

RADIO OPERATING—BROADCASTING
For Gov't License Preparation

- RADIO SERVICING — a practical course
- RADIO AMATEUR CODE ● TELEVISION
- ELECTRONICS—1 yr. day course 2 yrs. eve.

Day and Evening Classes. Booklet Upon Request.

New York Y. M. C. A. Schools

6 W. 64th Street New York City

RADIO ENGINEERING,

broadcasting, aviation and police radio, servicing, marine radio telegraphy and telephony, Morse telegraphy and railway accounting taught thoroughly. Engineering course of nine months' duration equivalent to three years of college radio work. All expenses low. Catalog free. School established 1874.

Dodge's Institute, Turner St., Valparaiso, Ind.

Radio Beginner's Course

(Continued from page 465)

current by means of an A.C. generator, there are a number of things that we can do with this current. We can put the current through a coil and get a magnetic field; and if we place another coil near to the first one we will get our current back again. But we have already learned that iron is a much better conductor of magnetic lines of force than the surrounding air. If then we would provide the magnetic lines of force with an "iron" path instead of an "air" path, we would get a greater transfer of energy. At this point, let us no longer call the coils of wire "first" coil and "second" coil, but rather "primary" coil and "secondary" coil. (Fig. 4.)

So far the primary and secondary have had the same number of turns. But suppose that we made the secondary coil with twice the number of turns that it had before. We would then find that the voltage across the secondary would be doubled. If we tripled the number of turns in the secondary coil we would get triple the voltage. Fig. 5, using conventional radio symbols, shows a simple transformer connected across an A.C. generator. If our generator were designed to deliver 110 volts, we could get 220 volts in the secondary by simply winding that secondary coil with twice the number of turns that the primary coil has. Thus we can increase our voltage, but we do so at the expense of our current, which becomes reduced.

The voltage times the current in amperes equals watts of power. Suppose that we built a step-up transformer that would give us twice the voltage of the generator. If we measured the reduced amount of current and multiplied it by the increased voltage, we would get an answer which we would call "watts."

The thermo-galvanometer is shown in Fig. 6. If two dissimilar metals are brought together and heated, a current of electricity is generated. The current generated is in direct proportion to the amount of heat. In this case, if we passed a current through the wire marked A, the two dissimilar metals connected to the wire would increase sufficiently in temperature to develop an electric current which would be indicated on the galvanometer.

Still another method of measuring current is through the use of a hot-wire ammeter, as shown in Fig. 7. In this instance, when a current passes through the wire marked A, the wire gets warm and expands, causing the spring to move the indicating needle over a scale. The amount that a given wire will expand depends upon the amount of current.

However, the most widely employed current or voltage measuring device is the D'Arsonval instrument, shown in Fig. 8. Once again we have our powerful steel magnet. Placed between the poles of this magnet is a tiny coil of wire, delicately pivoted in place. A needle pointer is connected to the coil and so placed that it can move over a scale. The needle is held in zero position by means of a small, fine spring, quite similar to the hair springs found in watches.

Now let us pass a small current through the coil; this will create a magnetic field about the coil. This magnetic field will tend to align itself with the magnetic field already existing between the poles of the permanent magnet; hence, the coil of wire will move.

(Lesson 3 next month covers resistance, inductance and capacity and oscillatory circuits.)

RADIO INSTRUCTION

HOW TO LEARN CODE

Whether you wish to enter radio as a career or as a hobby the All Electric Master Telex Code Teaching Machine will show you how. Telex records your sending in visible dots and dashes on a specially prepared waxed paper tape and then sends back to you at any speed you desire. It does not merely show you code. It is code. No experience needed.



While not designated as standard equipment, Telex is used at many U.S. Army Posts, Naval Training Stations as well as the American Telephone & Telegraph Co. Also by practically every private school in the U.S. teaching the code; and many foreign governments. We furnish you complete course, including practice messages, the All Electric Master Telex, plus a personal service on a MONEY BACK GUARANTEE. Low cost. Easy terms. Without obligation write for booklet "S12."

TELEPLEX CO., 67-69 Park Place, New York
In Canada write:
CANADIAN ELECTRONIC INST. TORONTO, ONT.

AMATEUR RADIO LICENSES DAY AND EVENING CLASSES

You are trained by a commercial operator and licensed amateur who has years of ACTUAL TEACHING EXPERIENCE.

REASONABLE RATES GUARANTEED RESULTS

We have hundreds of licensed ex-students.

Home Study Courses

AMERICAN RADIO INSTITUTE

1123 Broadway, Dept. 12-RT, New York City

LEARN RADIO TELEVISION

500 LICENSED graduates placed in past 7 years in shipping, broadcasting, aviation, police, etc.; we also teach radio servicing and repairing; new beginners' class Sept. 12th, Nov. 7th.; 52-page catalog free; oldest, largest and best equipped.

MASS. RADIO SCHOOL

18 BOYLSTON ST., BOSTON Est. 1899

BE A RADIO SERVICE EXPERT

Modern receivers require men with modern training for service work

LEARN AT HOME

Our home instruction method and service equipment offer starts you earning money almost at once. Up to \$9 an hour easy in a short time. Write for free book.

Radio Training Ass'n of America

4525 Ravenswood Ave., Chicago

RADIO ENGINEERING

RCA Institutes offer an intensive course of high standard embracing all phases of Radio and Television. Practical training with modern equipment at New York and Chicago schools. Also specialized courses and Home Study Courses under "No obligation" plan. Catalog Dept. SW-38.

RCA INSTITUTES, Inc.

A Radio Corporation of America Service

75 Varick St., New York. 1154 Merchandise Mart, Chicago

A FREE BOOK FOR EVERYONE IN RADIO

1938 RADIO REFERENCE ANNUAL

RADIO-CRAFT brings you all phases of Radio—servicing, public address, set construction, electronics, popular departments, as latest in Radio—New Tubes—Data Sheets—Television—Operating Notes, etc. Over 175 Illustrations in every issue.

To readers of this announcement we present a SPECIAL OFFER—Seven Months' Subscription to RADIO-CRAFT and a FREE copy of the 64-page 1938 RADIO REFERENCE ANNUAL for One Dollar. New subscribers welcome—old subscribers can extend their present subscription seven months.

Remit ONE DOLLAR by check, money order or stamps for your FREE subscription to RADIO-CRAFT.

RADIO-CRAFT
997 HUDSON STREET, NEW YORK, N. Y.

World Short Wave Stations

(Continued from page 476)

31 Met. Broadcast Band

Mc.	Call	Mc.	Call
9.600	RAN	9.523	ZRH
9.595	HBL	9.520	OZF
9.590	VUD2 VUD3	9.520	YSH
9.590	PCJ	9.510	GSB
9.590	YK6ME	9.510	HJU
9.590	YK2ME	9.510	—
9.590	W2XE	9.500	VK3ME
9.590	W3XAU	9.500	XEWV
9.580	GSC	9.500	OFE
9.580	VLR	9.500	HS8PJ
9.580	OAX5C	9.488	EAR
9.570	KZRM	End of Broadcast Band	
9.570	WIXX	9.445	HCODA
9.560	DJA	9.437	COCH
9.550	TPBII	9.380	—
9.550	W2XAD	9.370	XOY
9.550	OLR3A	9.355	HCITC
9.550	XEFT	9.350	COCD
9.550	YDB	9.345	HBL
9.550	VU82	9.330	OAX4J
9.540	DJN	9.300	HIG
9.540	HJ5ABD	9.280	HC2CW
9.540	VPD2	9.200	COBX
9.535	JZI	9.125	HAT4
9.535	—	9.100	COCA
9.530	W2XAF	9.091	PJCI
9.530	VUC2	9.030	COBZ
9.526	XEDQ	8.965	COKG
9.526	ZBW3	8.841	HCJB
9.525	LKJI	8.700	HKV

(Continued on page 505)

RADIO INSTRUCTION

You Can LEARN RADIO

Here's Your Complete Radio Education:

Sound, Speech and Music—
Electrons—Current—Electric Units and Circuits—Resistance—Ohm's Law—Batteries—Magnetics—Electromagnetism—Transformers—Inductance—Alternating Current—Filters—Electrical Measuring Instruments—Radio Waves—Radio Stations—Receiving Equipment—Vacuum Tubes—Radio and Audio Frequency—Amplification—Superheterodynes—Loud Speakers—Batteries—Operated Receivers—Power Supply Units—Electric Receivers—Automobile and Aircraft Receivers—Phonograph Pickups—P.A. Systems—Short Wave Receivers—Photoelectric Cells—Television—Antennas and Grounds—Testing and Servicing Receivers—Sound Motion Pictures—Appendixes—856 Review Questions for Self Study—**AND DOZENS OF OTHER SUBJECTS!**

from this GREAT BOOK

All in one big handy volume! All the fundamentals you need to know about Radio, Electricity, Sound, Television, Cathode-Ray Tubes, etc., etc.—in order to qualify for a good-paying radio job, here at last is a practical, inexpensive way to get into the profession. Save your time and save your money with the world's most popular radio text—Ghirardi's Radio Physics Course! Thousands of successful men in radio acquired their background training through this great book.

EASY SHORT-CUTS

Constantly condensed in this one great book you'll get 36 separate "easy-to-learn" courses of self-instruction prepared by that renowned radio authority and instructor, Alfred A. Ghirardi. Each section is highly simplified, clear and easy to understand—yet each is so thorough and practical that every minute you spend on this "quick-study" system rapidly pushes ahead your radio training. You check your own progress with self-testing review questions. No previous training or knowledge of mathematics is required. Everything is explained and illustrated simply, thoroughly. No wonder Ghirardi's Radio Physics Course is used by more radio schools and students than any other radio book in the world!

Now here's all you do to get started:—fill out the coupon—mail it today. Take 10 days to look over the book. Then, if you don't feel it will help YOU, return it and your money will be immediately refunded. You risk nothing! Come, man, let's get going!

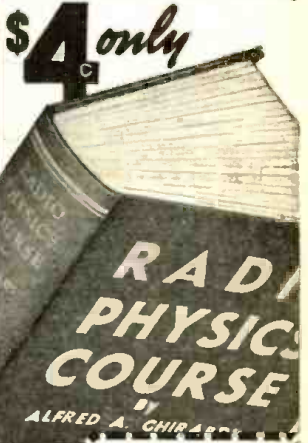

\$4 only

RADIO & TECHNICAL PUBLISHING CO., 45 Astor Place, New York, Dept. R&T-128

Here is \$4. (\$4.50 foretime) for my copy of RADIO PHYSICS COURSE. Ship postpaid at once with 10-day money-back guarantee.

NAME

ADDRESS

CITY STATE

Send free descriptive literature.

YOUR FUTURE IN RADIO TELEVISION

These growing industries need trained men for sales, service, operation. Your chance for employment and advancement depends on thorough training. National Schools offer you time-tested training. Complete, modern facilities and equipment in the largest trade school in the West.

NATIONAL SCHOOLS
4000 S. Figueroa Street, Los Angeles

NATIONAL SCHOOLS, Dept. RT12, Los Angeles
Please send free Radio and Television Booklet.

NAME AGE

ADDRESS

CITY STATE

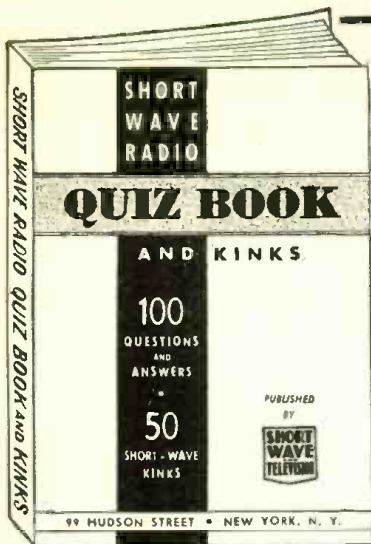

FREE BOOKS—AND HOW YOU

CAN GET THEM!

HERE is a brand *new* book—with an unusually interesting content. The text—prepared by the Editorial Staff of RADIO AND TELEVISION, contains a variety of material which only experts could select and incorporate in such an excellent volume.

“SHORT WAVE RADIO QUIZ BOOK AND KINKS” cannot be bought—it is sent to you absolutely FREE with your subscription to RADIO AND TELEVISION at the Special Rate of Seven Months for One Dollar. (Old subscribers may get this book by extending their subscription.)

The book contains 64 pages with a heavy flexible colored cover. It measures 5½ x 8½ inches, and includes hundreds of photographs and diagrams. The contents are outlined below.

Contents of the “QUIZ BOOK”

Questions and Answers Covering S-W transmitters.
 Questions and Answers Covering S-W Receivers.
 Ultra-Short-Wave Transmitters and Receivers.
 S-W “Kinks”—Short-cuts and Practical Wrinkles, Coil Winding Data.
 How to Add an Audio Amplifier to a Small S-W Receiver.

How to Connect an R.F. Stage Ahead of Your Present Receiver.

Dozens of Novel New Hook-Ups for the S-W Experimenter.

Clear diagrams showing how to connect the latest type tubes in place of your old tubes, so as to obtain greater DX.

HOW TO “HOOK UP”—

- S-W Converters
- Noise Silencers
- Power supplies
- Modulators
- Beat Oscillators
- Antennas
- Pre-selectors
- 5-meter receivers

2 Other FREE Books

ABC OF TELEVISION



Contains latest material on Television developments. It covers theory of scanning; simple television receiver, how the eye sees; the photo-electric cell; neon lamps; need for broad channel width in transmission of high-fidelity television signals; cathode ray tube and television receivers; Farnsworth system of television transmission, and other important features.

SHORT WAVE GUIDE



Covers hundreds of Short-Wave questions and answers; illustrates popular Short-Wave kinks; gives instructions for building simple Short-Wave receivers; instruction on the best type of antenna to use; diagrams and construction details for building a simple “ham” transmitter; practical hints on Short-Wave tuning.

RADIO AND TELEVISION • 99 Hudson Street • NEW YORK, N. Y.

RADIO AND TELEVISION, 99 Hudson Street, New York, N. Y. R&T-1238
 Gentlemen: Enclosed you will find my remittance of \$..... for which enter my subscription to RADIO AND TELEVISION as checked below; also send me, postpaid, the book or books which I have marked at the right.
 7 months—\$1.00—choice of any one of three (3) books. (Canadian and foreign—\$1.30)
 14 months—\$2.00—choice of any two (2) of the three (3) books. (Canadian and foreign—\$2.60)
 21 months—\$3.00—all three books. (Canadian and foreign—\$3.90)
 If you are a subscriber now, we will extend your present subscription.
 New subscriber Old subscriber

- S.W. RADIO QUIZ BOOK AND KINKS
- ABC OF TELEVISION
- SHORT WAVE GUIDE

Name..... Address.....
 City..... State.....

Send your remittance by check or money order. If you send cash or unused U.S. postage stamps, please be sure to register your letter for your own protection.

110 Volt D.C. Transmitter—Part II—Conclusion Herman Yellin, W2AJL

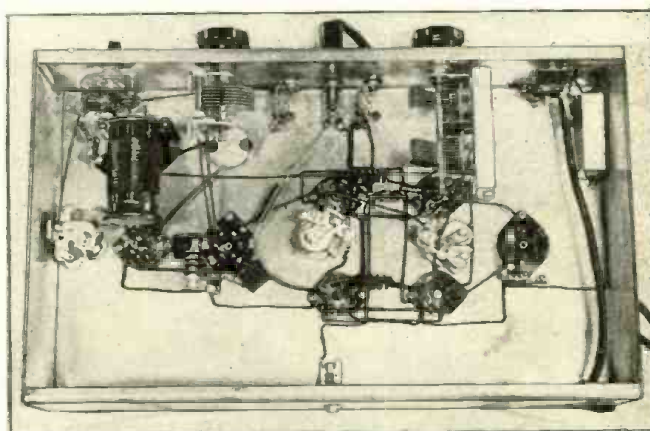
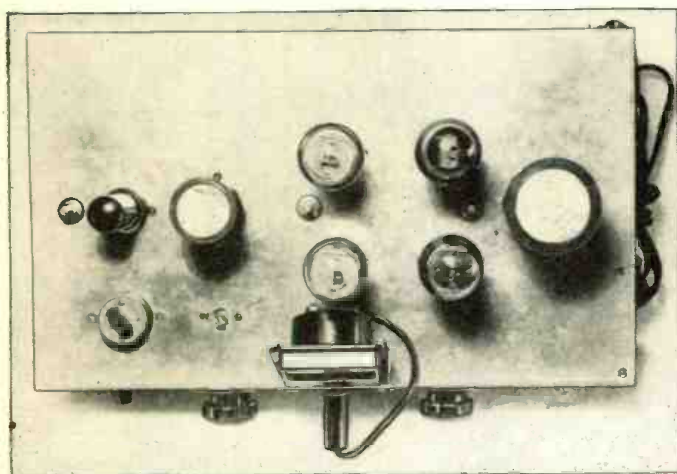

Top and bottom views of the D.C. Transmitter

Tri-tet Oscillator Used

● THE oscillator is of the justly popular, time-tried “tri-tet” type. This oscillator makes use of a cathode coil tuned to approximately one and a half times the frequency of the crystal being used. The plate circuit is then tuned to the second harmonic of the crystal frequency.

Tuning the cathode circuit is not at all critical, the same setting of the cathode condenser (C1) holding good for the entire amateur band in use. A little juggling of the turns and the positions of the taps results in a value of inductance for each band, such that the cathode condenser need not be readjusted for crystals on different bands.

Two taps are taken from the coils besides the end leads.

For 160-meter crystals, the entire coil of 35 turns is used; for 80 meter crystals only 14 turns, and for 40 meter crystals 5 turns are used. The unused turns are shorted out by the rotary tap switch (SW-1).

As the photo indicates, mount the

G.E. PHONOGRAPH MOTOR

Formerly Sold for \$15.00

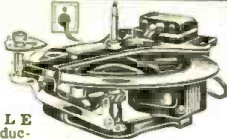

Only \$4.95

VARIABLE speed induc-

tion type self-starting, 110 volt, 25 to 60 cycle, A.C. with speed control. Plug and cord. Speed range from 5 to 200 R.P.M. Can be installed in place of old-fashioned, hand-winding speed motor. Also ideal for display turn table, and a hundred other uses. These General Electric Motors are brand new. In original factory cartons. \$4.95 G. E. Electric Phonograph motor as described

Shipping Weight—12 lbs.

Westinghouse Power Generator

Manufactured for U. S. Signal Corps 200 Watt. 110 V. AC

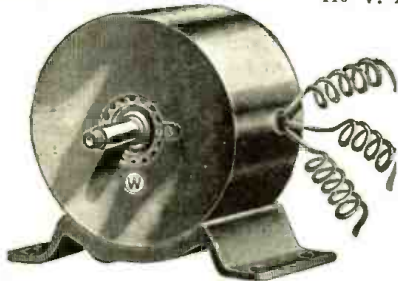

A. C. ELECTRICAL POWER

from a Windmill, from available Waterpower, from your Automobile, from your Motorcycle, from your Bicycle, Foot-pedals or Handcrank (for transportable Radio Transmitters, Strong Floodlights, Advertising Signs); do you want to operate AC Radio sets from 32 V. DC farm light systems; operate two Generators in series to get 200 V. AC; obtain two phase and three phase AC, etc., etc.

There Are Over 25 Applications Some of which are:

A.C. Dynamo Lighting from eight to ten 20 Watt 110 Volt lamps. Short Wave Transmitter supplying 110 Volts AC for operating "Ham" transmitter. Operating 110 V. AC 60 Cycle Radio Receiver in DC districts. Motor Generator. Public Address Systems. Electric Sirens on motor boats, yachts, etc. Camp Lighting. Short Wave artificial "fever" apparatus. Television. Pelton Waterwheel for lighting or other purposes. Airplane: for lighting strong searchlights or electric signs. Laboratory work, etc., etc. 1/4 to 1/2 H.P. needed to run Generator.

BLUE-PRINT 22 x 28 in. and Four-Page 8 1/2 x 12 in. INSTRUCTION SHEETS FREE with Generator.

Generator, as described, including four replacement carbon brushes. Blue-print and instructions \$7.90

Send \$2.00 deposit, balance C.O.D. Shipping weight 18 lbs. (Replacement carbon brushes bought separate \$1.50 per set of four. Set of instructions bought separate \$1.00.)

MONEY-BACK GUARANTEE

WELLWORTH TRADING COMPANY 560 West Washington Blvd., Dept. RT-1238, Chicago, Ill.



ELECTRICAL OCCUPATIONS FOR BOYS

By Lee N. Kilnefelter, B. S., M. A.

Covering the entire field of electrical occupations available. Radio, Telegraphy, Ignition and Electrical Engineers, Power Station Operators, Army & Navy Specialists, etc.—Each fully describes his own type of work and answers typical questions. Recommended by electrical magazines, engineers, instructors, and Government officials. 64 full-page illustrations. For YOUR COPY, send coupon below:

E. P. DUTTON & CO., Inc. Dept. S—300 Fourth Ave., N.Y.C. Gentlemen: \$2 enclosed, for which please send me postpaid my copy of ELECTRICAL OCCUPATIONS FOR BOYS.

Name _____ Address _____ City _____ State _____

cathode coil socket about 1/4 inch behind the coil switch, making for very short leads. The cathode condenser is mounted alongside the oscillator tube socket with its shaft slotted with a hacksaw and protruding above the chassis for ready adjustment.

Although a thermocouple milliammeter will measure the crystal current accurately, such accuracy is not needed, especially with the high expense of this type of meter. A 60 milliamper (2 volt) pilot-light bulb will serve admirably, indicating when the current is too high and providing a valuable aid in tuning the oscillator for optimum output. The allowable current varies among different types of crystals, being about 100 milliamperes maximum for the variable frequency crystal used by the author.

Oscillator Coupling

The oscillator is inductively coupled to the amplifier by means of a split grid coil wound on the same form as the oscillator plate coil, one section on each side of the plate coil. Each of the grid coils (L-2 & L-3) consists of the same number of turns and is spaced the same distance from the ends of the plate coil and is wound in the same direction. Excitation to the amplifier is determined by the number of turns in the grid coils and the distance separating them from the plate coil winding. Increasing the number of turns, or winding the grid coils closer to the plate winding, will increase the excitation. If the coil winding specifications are followed exactly, the excitation will be just right, and no adjustments to the coil should be necessary.

It will be noticed that both the oscillator and amplifier plate coils are center-tapped. In winding these coils, each half of the coil wound as a separate coil. The ends of the coils then appearing at the center of the dual coil are soldered together inside the coil form, and one of the wires brought to the proper coil form prong. Taps on the oscillator cathode coil are made in the same manner.

Amplifier

The amplifier is quite conventional, consisting of four 25L6G tubes in push-pull parallel. Between the grids of each pair of parallel tubes is placed a small r.f. choke (RFC-3) to prevent parasites. These consist of six turns of No. 18 hookup wire, air-wound to a diameter of 3/8 inch and the turns spaced about twice the wire diameter. Insertion of these chokes effectively squelches any tendency towards parasites.

Cross neutralization is employed in the amplifier, using a pair of variable neutralizing condensers having a maximum capacity of 6 mmf. Condensers with as low a minimum capacity as possible should be used, since the interelectrode capacity of the 25L6 is quite low. These condensers are mounted on the chassis with their shafts extending above the chassis to facilitate tuning up the transmitter. As is the case with all the other variable condensers, these condensers must be insulated from the chassis. Ordinary extruded fibre washers will prove adequate because of the low voltages encountered. If the condenser shafts are slotted with a hacksaw, the condensers can be adjusted with an insulated screw-driver and no knobs will be needed.

In wiring the push-pull amplifier stage, keep the leads from the grid coils (L-2 and L-3) to the grids of the 25L6Gs equal in length. Likewise keep the wires from the plates of the tubes to the ends of the plate coil (L-5) and to the split stator tank condenser (C-6) equal in length. A balanced wiring layout will be much freer from parasites and will not prove difficult to neutralize. (Continued on following page)

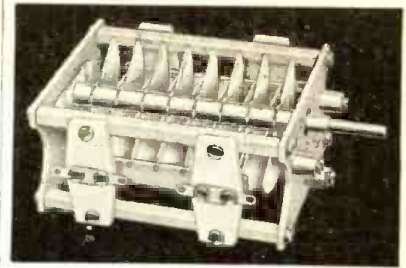

NEW "TC" TRANSMITTING CONDENSER

Hammarlund's new "TC" transmitting condensers include many outstanding and exclusive features. They are available in a wide range of capacities and voltage ratings with both single and dual stators. Wide plate spacing permits their use in transmitters up to 1 kw. input. Special full floating bearing construction eliminates binding and twisting. Heavy polished aluminum plates with rounded edges increase efficiency. Write for bulletin describing special rotor and contact construction and other details.

HAMMARLUND MFG. CO., INC. 424 W. 33rd St., N.Y.C. RT-12

() Please send "TC" bulletin

Name _____

Address _____

City _____ State _____



Canadian Office: 41 West Ave. No., Hamilton, ONT.

HAMMARLUND

DEPENDABLE CONDENSER BANKS



Build your own to exact needs, with these AEROVOX uncased paper sections.

Non-inductively wound paper and foil sections. Thoroughly impregnated with high-melting-point compound.

Any desired voltage and capacity combination. Units clamped or taped together. And you save much money.

Black varnished paper wrapper. 8" wire leads.

In 200, 400, 600 and 1000 v. .1 to 2 mfd.

Ask local AEROVOX jobber for these and other types you need. Get latest catalog—or write us direct.



70 Washington St. Brooklyn, N. Y.

IN CANADA: AEROVOX CANADA, Limited Hamilton, Ont.

FOUR NEW 10¢ RADIO BOOKS

110 Volt D.C. Transmitter

(Continued from preceding page)

Tuning Up

With all wiring completed, the transmitter is ready to be tuned-up. This is not at all difficult, since once the preliminary adjustments, such as adjusting the oscillator cathode condenser and the amplifier neutralizing condensers have been completed, there are only two tuning controls.

After the transmitter has been connected to the 110 volt d.c. line, first being certain that the *positive* side of the line will connect to the plates of the tubes and *not* to the chassis, close switch SW-3, lighting the *filaments* of all the tubes. Let the tubes warm up for about 30 seconds and then close switch SW-2 which will apply the *plate voltage*. With the meter plug inserted in the oscillator cathode jack (J-1) we are ready to tune the oscillator. Insert the crystal in the crystal socket, and (assuming that operation of the transmitter is desired on the second harmonic of the crystal) make sure that the coils in the oscillator and amplifier *plate* circuits are set for the band of double the oscillator frequency. With the cathode tuning condenser set at about 75 percent of its maximum capacity and the switch SW-1 set at the proper tap for the crystal, vary the oscillator plate tuning condenser C-4. A point will be found where the plate current decreases and then increases again. At the point of *minimum* plate current, the plate circuit is tuned to the second harmonic of the crystal frequency. Remove the meter plug from the oscillator cathode and insert it in the amplifier cathode jack (J-3) and *short* the telegraph key. Varying the amplifier plate condenser will also result in a dip in plate current at some setting. This indicates resonance with the oscillator. For the initial tuning of the amplifier, keep the neutralizing condensers at their minimum capacity setting. The antenna should be *disconnected* from the amplifier.

Neutralizing

We are now ready to neutralize the amplifier stage. The meter plug should be inserted in the amplifier grid jack (J-2) and the plate and screen voltages disconnected from the amplifier. The meter will then read rectified grid current, which is a measure of the amount of excitation to the amplifier. Rotating the amplifier condenser through resonance will, if the amplifier is not neutralized, result in a flicker of the grid current meter; in general the greater the flicker of current the further away from correct neutralization. When the stage is perfectly neutralized, there will be absolutely no flicker of the grid meter.

After the amplifier stage has been neutralized and tuned to resonance the *crystal oscillator* should be checked and adjusted for optimum output. With the meter in the amplifier grid jack and the key down, vary the cathode condenser slightly for maximum oscillator output, as indicated by a maximum reading of the grid current. It will be found that this condition will almost coincide with a small dip in the current flowing through the crystal, as indicated by the crystal pilot lamp bulb. The setting of the condenser for minimum crystal current is the desirable position.

If operation is desired on the *fundamental* frequency of the crystal, the cathode switch is set so that the entire cathode coil is shorted out. The oscillator then becomes a standard pentode oscillator; tuning the transmitter remains the same as when using the oscillator as a tri-tet, except that the oscillator cathode circuit is not used.

RADIO FANS EVERYWHERE—these little ten cent text books give you an excellent foundation for the study of radio. They are clearly written, profusely illustrated and contain over 15,000 words in each book. You'll be amazed at the wealth of information these volumes have. They are handy for review or reference books.

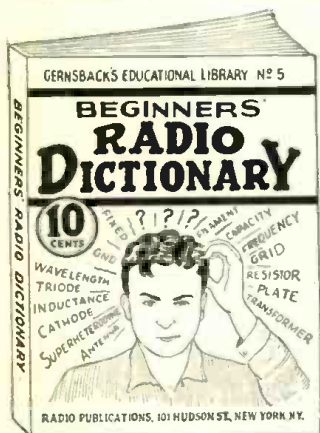

NO. 5—BEGINNERS' RADIO DICTIONARY

Are you puzzled by radio language? Can you define frequency? Kilocycle? Tetrode? Screen grid? Baffle? If you cannot define these very common radio words and dozens of other, more technical, terms used in all radio magazines and instruction books, you need this book in your library. It's as modern as tomorrow—right up to the minute. It tells you in simple language just what the words that puzzle you really mean. You cannot fully understand the articles you read unless you know what radio terms mean. This is the book that explains the meanings to you. Can you afford to be without it, even one day longer?

**FAMOUS
GERNSBACK
EDUCATIONAL
LIBRARY**

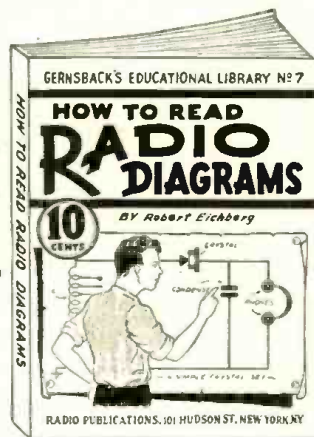

NO. 7—HOW TO READ RADIO DIAGRAMS

All of the symbols commonly used in radio diagrams are presented in this book together with pictures of the apparatus they represent and explanations giving an easy method to memorize them. This book, by Robert Eichberg, the well-known radio writer and member of the editorial staff of RADIO-CHART magazine, also contains two dozen picture wiring diagrams and two dozen schematic diagrams of simple radio sets that you can build. Every diagram is completely explained in language which is easily understood by the radio beginner. More advanced radio men will be interested in learning the derivation of diagrams, and the many other interesting facts which this book contains.

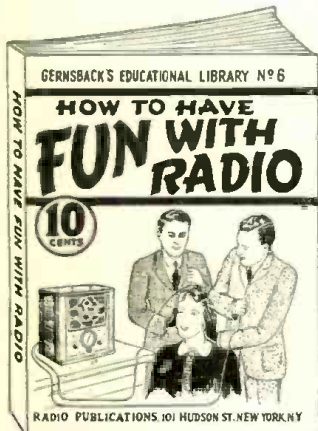

NO. 6—HOW TO HAVE FUN WITH RADIO

Stunts for parties, practical jokes, scientific experiments and other amusements which can be done with your radio set are explained in this fascinating volume. It tells how to make a newspaper talk—how to produce silent music for dances—how to make visible music—how to make a "silent radio" unit, usable by the deafened—how to make toys which dance to radio music—sixteen clever and amusing stunts in all. Any of these can be done by the novice, and most of them require no more equipment than can be found in the average home. Endless hours of added entertainment will be yours if you follow the instructions given in this lavishly illustrated book.

**ADDS
FOUR
NEW
BOOKS!**

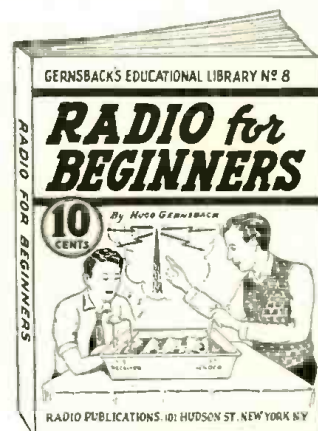

NO. 8—RADIO FOR BEGINNERS

Hugo Gernsback, the internationally famous radio pioneer, author and editor, whose magazines, RADIO & TELEVISION and RADIO-CHART are read by millions, scores another triumph with this new book. Any beginner who reads it will get a thorough ground work in radio theory, clearly explained in simple language, and through the use of many illustrations. Analogies are used to make the mysteries of radio as clear as "2+2 is 4". It also contains diagrams and instructions for building simple radio sets, suitable for the novice. If you want to know how transmitters and receivers work, how radio waves traverse space, and dozens of other interesting facts about this most modern means of communication, this is the book for you!

Other Titles in This Series!

- Four other volumes in this ten-cent radio book series—each on a popular subject—are available. The titles are:
- No. 1—HOW TO BUILD 4 DOERLE SHORT-WAVE SETS
 - No. 2—HOW TO MAKE THE MOST POPULAR ALL-WAVE 1- AND 2-TUBE RECEIVERS
 - No. 3—ALTERNATING CURRENT FOR BEGINNERS
 - No. 4—ALL ABOUT AERIALS

BOOKS ARE ALL UNIFORM

Every book in the GERNSBACK EDUCATIONAL LIBRARY has 32 pages—with illustrations varying from 20 to 66 in number. Each title volume contains over 15,000 words. Positively radio's greatest book buy! If you do not think these books worth the price asked, return them in 24 hours and your money will be instantly refunded.

RADIO PUBLICATIONS
101 HUDSON STREET NEW YORK, N. Y.

MAIL COUPON TODAY!!

RADIO PUBLICATIONS, Dept. R&T-12-38
101 HUDSON STREET, NEW YORK, N. Y.

Gentlemen: Please send immediately, **POSTPAID**, the book numbers circled below. I am enclosing...cents—each book being 10c.

1 2 3 4 5 6 7 8

Send **FREE** listing of 48 new 10c publications.

Name

Address

City State

Remit by check or money order—register letter if you send cash or unused U. S. postage stamps.

UNUSUAL CHRISTMAS GIFTS

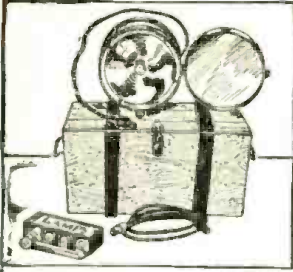

U. S. ARMY SIGNAL CORPS LAMPS

The lamp of 100 uses

Scout Signalling
Night Bowling Alleys
Trailer Lamp
Night Motor Boat Races
Auto, Truck and Trailer Camps
Tractor Light
Camp Light
Barnyard Lighting
Night Fishing
Radio Shacks
Bungalows
Picnics, etc.



Scouts Signalling

Large size—12 1/2" wide, 5 3/4" deep, 15" high including socket, fitted with 10" silver plated reflector (no glass, nothing to break). Packed in portable wooden carrying case, with hinged cover, lamp and handles. Every case contains weatherproof extension cord and plug, 2 extra bulbs, telegraph signalling key and 16 page U.S. Army Instruction Manual. Shipping weight 18 lbs. Price \$3.95
(Cost the Government about \$25.00)

\$3.95

F.O.B. N. Y. 3 for \$10.00

Small size—9" wide, 5" deep, 10 3/4" high including socket. Lamp furnished with 6 volt current. One extra bulb furnished free. Additional bulbs, 15c each. Packed in corrugated carton. Shipping weight 2 lbs. Price \$1.95
(Cost the Government about \$10.00)

\$1.95

F.O.B. N. Y. 3 for \$5.00

These lamps will make an attractive souvenir of the World War for your Club, Motor Boat, House, Den, Radio Shack or Country Home. They will also be an acceptable gift to any of your friends.

A Slide Rule Everyone Will Prize PRACTICAL, EDUCATIONAL, TIME SAVER

Features: Nickel Silver framed indicator with integral friction springs. Scales calibrated directly on well-seasoned wood. Retains accuracy regardless of temperature or humidity changes. Instructions and illustrations of primary operations clearly printed on reverse side of rule for ready reference or teaching. Each rule with a durable socket carrying case for convenience and protection.

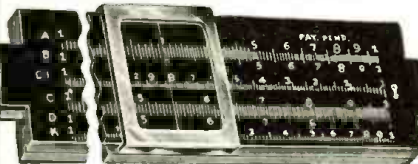

We offer an eight inch, white wood, accurate slide rule with A, B, C, D, C1 and K Scales, a 20-page Book of Instructions, How to Use a Slide Rule, a 36-page Book of 300 Examples and Answers, a two-toned Facsimile of the Declaration of Independence, suitable for framing, and an 8-page catalog illustrating and describing indoor games and many unusual items, all five prepaid anywhere in the United States and Canada for **50c**

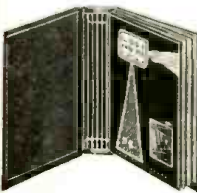

STURDY BINDERS

for any size magazines. Covered with black corrugated fabricoid. Has two stamped metal ends with 12 Spring Wire separators. Magazines can be inserted and removed in a Hifi, 12 1/2"x9 3/4" fits R.&T. Radio News, etc. 80c
10 3/4"x7 1/2" fits Popular Mechanics, etc. 70c
8 3/4"x5 3/4" fits Readers Digest, etc. 60c

BEAUTIFUL CHRISTMAS CARDS

at Wholesale Prices

21 Assorted Old English color print and engraved cards with envelopes to match, packed in attractive Holiday boxes, parcel post prepaid in U.S. and Canada.

Guaranteed to please or money back.

(Retail Value \$2.10) Your Cost **75c**

Send for catalog containing full descriptions of these and many other interesting items.

GOLD SHIELD PRODUCTS

Dept. RT-12 350 Greenwich St. New York

World S-W Stations

(Continued from page 501)

Mc.	Call	Station	Time
8.665	COJK	CAMAGUEY, CUBA, 34.64 m., Addr. Finlay No. 3 Altos. 5.30- 6.30, 8-11 pm., daily except Sat. and Sun.	
8.665	W2XG8	HICKSVILLE, N. Y., 34.64 m., Addr. Press Wireless, Mon. to Fri. News at 9 am. and 5 pm.	
8.580	YNPR	MANAGUA, NICARAGUA, 34.92 m. Radiodifusora Pilot.	
7.894	YSD	SAN SALVADOR, EL SALVADOR, 37.99 m., Addr. Dir. Genl. Tel. & Tel. 7-11 pm.	
7.870	HCIRB	QUITO, ECUADOR, 38.1 m. La Voz de Quito. 9-11 pm.	
7.854	HC2J5B	GUAYAQUIL, ECUADOR, 38.2 m. Evenings to 11 pm.	
7.797	HBP	GENEVA, SWITZERLAND, 38.48 m., Addr. Radio-Nations.	
7.510	JVP	NAZAKI, JAPAN, 39.95 m., 8-9.30 am.	
7.450	T12R3	SAN JOSE, COSTA RICA, 40.27 m. "Radioemisora Athena". 9.30-11 pm., exc. Sun.	
7.410	HCJ84	QUITO, ECUADOR, 40.46 m., 7- 9.30 pm. irregularly.	
7.410	YDA	TANDJONGPRIOK, JAVA, 40.46 m., Addr. N.I.R.O.M., Batavia, 10.30 pm.-2 am.; Sat. 7.30 pm.- 2 am.	
7.380	XECR	MEXICO CITY, MEX., 40.65 m., Addr. Foreign Office. Sun. 7-8 pm.	
7.220	HKE	BOGOTA, COL., S. A., 41.55 m. Tues. and Sat. 8-9 pm. Mon. and Thurs. 6.30-7 pm.	
7.200	YNAM	MANAGUA, NICARAGUA, 41.67 m. Irregular at 9 pm.	
7.177	CR6AA	LOBITA, ANGOLA, PORT. WEST AFRICA, 41.75 m., Wednesday and Saturday 2.45-4.30 pm.	
7.100	FO8AA	PAPEETE, TAHITI, 42.25 m., Addr. Radio Club Oceanic. Tues. and Fri. 11 pm.-12.30 am.	
7.088	PIIJ	DORDRECHT, HOLLAND, 42.3 m., Addr. Dr. M. Hellingman, Techni- cal College. Sat. 11.10-11.50 am.	
6.990	XEME	MERIDA, YUCATAN, 42.89 m., Addr. Calle 59, No. 517, "La Voz de Yucatan desde Merida." Irregular.	
6.977	XBA	TACUBAYA, D. F., MEX., 43 m. 9.30 am.-1 pm., 7-8.30 pm.	
6.805	HI7P	CIUDAD TRUJILLO, DOM. REP., 44.06 m., Addr. Emisoría Diaria de Comercio. Daily exc. Sat. and Sun. 12.40-1.40, 6.40-8.40 pm. Sat. 12.40-1.40 pm. Sun. 10.40 am.- 11.40 am.	
6.790	PZH	PARAMIRABO, SURINAM, 44.16 m., Addr. P. O. Box 18, Daily 6.06-8.36 am., Sun. 9.36-11.36 am. Daily 5.36-8.36 pm.	
6.775	HIH	SAN PEDRO DE MACORIS, DOM. REP., 44.26 m., 12.10-1.40 pm., 7:30-9 pm. Sun. 3-4 am., 4:15-6 pm., 4:40-7.40 pm.	
6.750	JVT	NAZAKI, JAPAN, 44.44 m., Addr. Kokusei-Denwa Kaisha, Ltd., Tokyo. Irregular.	
6.730	HI3C	LA ROMANA, DOM. REP., 44.58 m., Addr. "La Voz de la Feria." 12.30-2 pm., 5-6 pm.	
6.720	PMH	BANDOENG, JAVA, 44.64 m. Re- lays N.I.R.O.M. programs. 4.30-11 or 11.30 am. Also Sat. 9.30 pm.- 1.30 am.	
6.690	TIEP	SAN JOSE, COSTA RICA, 44.82 m., Addr. Apartado 257, La Voz del Tropico. Daily 7-10 pm.	
6.675	HBQ	GENEVA, SWITZERLAND, 44.94 m. Addr. Radio-Nations. Off the air at present.	
6.672	—	— 44.94 m., relays Salamanca, Spain, 7-9.45 pm.	
6.672	YVQ	MARACAY, VENEZUELA, 44.95 m. Irregular.	
6.635	HC2RL	GUAYAQUIL, ECUADOR, S. A., 45.18 m., Addr. P. O. Box 759, Sun. 5.45-7.45 pm., Tues. 9.15- 11.15 pm.	
6.630	HIT	CIUDAD TRUJILLO, D. R., 45.25 m., Addr. "La Voz de la RCA Victor," Apartado 1105, Daily exc. Sun. 12.10-1.40 pm., 5.40-8.40 pm.; also Sat. 10.40 pm.-12.40 am.	

(Continued on following page)

BROWNING "83"

Build This Wonderful New Receiver Yourself IN ONLY 6 HOURS!

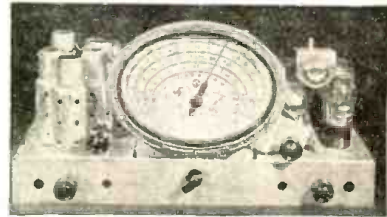

- 4 BANDS • PHASE INVERSION • P.P. AUDIO
- BAND PASS I.F. • DX RECEPTION
- .54 to 22 MEGACYCLES IN 4 BANDS

This is ONE kit that is really a knockout. Designed by Mr. Glenn Browning of the Browning-Drake fame, it is the last word in performance. The chassis is drilled to accommodate any three extra circuits that you may decide to try out. Its full vision 7 1/2" Scale makes S.W. tuning a pleasure. Write at once for FREE description.

FOR THE AMATEUR

The famous Bandswitch Triplets, 5P-5G and 5H are expressly designed to cover 10 to 160 meters for Crystal oscillators; Frequency meters; monitors; field strength indicator, etc. Send for free circuit diagram as to their wide use.

BROWNING LABORATORIES, INC.

WINCHESTER, MASS. Dept. T-11

Export Dept. 461 4th Ave., N. Y. C.



ASTATIC

Newest!

MULTI-UNIT

Dual Diaphragm CRSTAL MICROPHONE

SELF LOCKING TILTING HEAD

Top quality for public address and night club use. Cannot be acoustically overloaded. Two models: MU-2 (\$29.50) with two dual diaphragm crystal units, and MU-4 (\$39.50) with four dual diaphragm crystal units. Black and chrome. Complete with socket and 25-ft. cable. See jobber or write for literature.

Astatic Microphone Laboratory, Inc.

Dept. J-5, Youngstown, Ohio

Licensed under Brush Development Co. Patents



THE NEW EARCAPS

improve the quality of your headphones to give results of a dynamic speaker. Immediate delivery for Ambassador, Baldwin, Brandes, Cannonball, Globe, Kellogg, Murdoch, Radiocar, Solid, Trimm Featherweight and Professional, and Western Electric phones. May one pair of the New Earcaps be your Christmas Gift. Inventor and Manufacturer Dept. 5-12

PAUL JARNAK, 69 West 83rd St., New York City

WE HAVE THE RADIO YOU WANT



Our 1939 catalog is chock full of new Standard Brand Radios for Home-Farm-Auto. Over 400 models. Also hundreds of Electric Appliances for the home. Celebrating our 50th Anniversary with Big Bargains. Write for your copy today. It's FREE.

MODELL'S, Dept. 60, Cortlandt St., N. Y. C.

COMMERCIAL NOTICES 10¢ A WORD

Under this heading only advertisements of a commercial nature are accepted. Remittance of 10¢ per word should accompany all orders. Copy should reach us not later than the 10th of the month for the second following month's issue.

A.C. GENERATORS
NEW 110 VOLT A.C. FANBELT generators for portable power. 8 sizes. Write LeJay Manufacturing, 117 LeJay Building, Minneapolis, Minn.

AGENTS WANTED
300% PROFIT SELLING GOLD Leaf Letters for Store Windows. Free samples. Metallic Co., 446 North Clark, Chicago.

BLUEPRINTS AND DIAGRAMS
W8KPX—DIAGRAMS ANY TYPE transmitter or receiver. Free questions answered full detail \$0.35. "Ham" apparatus built to order. W8KPX—Harry D. Hooton, Henderson, W. Va.

CORRESPONDENCE COURSES
500,000 USED CORRESPONDENCE Courses and Educational Books Sold. Rented. Exchanged. All subjects. Satisfaction guaranteed. Cash paid for used courses. Complete details and bargain catalog free. Send name. Nelson Company, 3487 Manhattan Building, Chicago.

INSTRUCTION
RADIO ENGINEERING. BROADCASTING, aviation and police radio, servicing, marine and Morse telegraphy taught thoroughly. All expenses low. Catalog free. Dodge's Institute, Colt St., Valparaiso, Ind.

MISCELLANEOUS
RAZOR BLADE SHARPENER. 100 shaves with same blade. 25¢ postpaid. Howard H. Brown, Edgerton, Wis.

3/4" INCH TR. 0-125 VT. A.C. Voltmeter. 0-10 A.C. Ammeter. \$2.75 each. Weston D.C. 0-7 and 0-140 Voltmeter. 2 1/2" with 9 pt. D.P. Switch \$2.75. Nat'l. MB27-4 Sig. T.R.F. chassis and Thord. 45 P.P. Pack. \$1.50. 10" MUTER DYN. SPEAK. \$3.00 Victor 727 Hi-Fi Orthophonic Horn. Mag. and Acoustic Pick-ups. \$10.00. plus express. \$400.00 RCA battery Superhet—\$25.00. Harry Ackerson, Ramsey, N. J.

WE OFFER SUBJECT TO PRIOR sale 7 m.m. lacquered cable used by the Government. It is an ideal cable for high voltage, low current service, such as used in radio transmitters, amplifiers, etc. It is a special steel wire, 20 gauge, with very heavy rubber insulation. Worth 12¢ a foot. Special price 50 ft. \$2.00. 100 ft. \$3.00. P.O.B. N. Y. Gold Shield Products, 350 Greenwich St., New York City.

PATENT ATTORNEYS
INVENTORS—PROTECT YOUR rights before disclosing your invention to anyone. Form "Evidence of Conception"; "Schedules of Government and Attorneys' Fees" and Instructions sent free. Lancaster Alvin & Root, Inc. 436 Bowen Building, Washington, D. C.

QSL—CARDS—SWL
100 NEAT SWL CARDS PRINTED with your name and address sent postpaid for \$1. Bunch of samples and RST Chart for five cents in stamps. W1BEF, 16 Stockbridge Ave., Lowell, Mass.

RADIOS
IF YOU ARE LOOKING FOR wonderful values in a 5 tube radio with dynamic speaker or a 7 tube superhet 12-55, 34-120, 180-550 meters, write for our illustrated folder describing six models. Agents can make good money handling our line. H. G. Young, 127 Liberty St., New York.

SHORT WAVE COMPONENTS
THE BEST FOR LESS IN CRYSTAL mikes \$2.95 and up. Money back if not satisfied. Mangan Electronic Industries, North Warren, Penna.

SHORT WAVE RECEIVERS
USED DOERLE'S D-38, BS-5, 7C, reconditioned by factory. 40% off. See January Short Wave & Television for description. Kusterman, 68 Barclay St., New York.

SONG POEMS WANTED
WANTED ORIGINAL POEMS, songs for immediate consideration. Send poems to Columbian Music Publishers, Ltd., Dept. K49, Toronto, Can.

FOR SALE (NON COMMERCIAL) 3¢ A WORD

Under this heading we accept advertisements only when goods are offered for sale without profit. Remittance of 3¢ per word should accompany all orders. Copy should reach us not later than the 10th of the month for the second following month's issue.

I HAVE SEVERAL GOOD PM 5" dynamic speakers in the original factory cartons that make very FB mikes. I want to dispose of these units at factory cost as I no longer use this type spkr. in our equipment. Will ship COD if your offer is satisfactory. Paul C. Mangan, Box 218, No. Warren, Penna.

SELL COMPLETE HAM OUTFIT 40 watt transmitter with power supply and meters. 5 tube receiver both absolutely complete and in excellent condition. Price \$40.00. F. W. Fretzel, 840 S. Keniston Ave., Los Angeles, Calif.

FEDERAL ORTHO-SONIC POWER unit. Two rectifiers, good chokes and filter. Suitable for experimental. trans-

mitting or receiving. Price \$15.00. Butler, 15 Balmoral place, Winnipeg, Man., Canada.

COMPLETE NATIONAL RADIO Institute course—Radio, Serieling, Sound Pictures, Public Address, Text books and experimental equipment. \$20.00 cash. F. Aldridge, 1228 Shepard St., Petersburg, Va.

FOR SALE: BRAND NEW DESK type 50 watt phone 80 watt code 5-10-20 meter transmitter, fully guaranteed, at reasonable price. Illustrated description furnished. Alvin Abrams (W2DWT) 20 Laurel Hill Terrace, New York City.

CQ 5-METER ENTHUSIASTS—Brand new Lafayette model "19"

transceiver complete with tubes \$10.00. Price \$20.85 elsewhere. You save \$10.85. Interested? Write: James C. Moulton, 4912 Quebec Street, NW, Washington, D. C.

SUPER-7 \$24.00, SKY CHIEF \$24.00; PR-10 \$29.00, SR Super-Sky-rider \$39.00, Breting 12 \$59.00, latest model SX-16 Super-Skyrider with crystal \$79.00 W9ARA, Butler, Mo.

1937 HAYNES CLIPPER, PERFECT condition, \$30 prepaid. Max Welton, 31 E. 24th, Holland, Mich.

NEW MASTER TELEPLEX. ALSO Standard number one, instruction course included, half price. Gertrude Salz, 2614 Greenmount, Baltimore, Maryland.

BARTER AND EXCHANGE — FREE!

NO ADVERTISEMENT TO EXCEED 35 WORDS, INCLUDING NAME AND ADDRESS
Space in this department is not sold. It is intended solely for the benefit of our readers, who wish to buy or exchange radios, parts, phonographs, etc. AS we receive no money for these announcements, we cannot accept responsibility for any statements made by the readers. Use these columns freely. Only one advertisement can be accepted from any reader in any one issue. All dealings MUST be above board. Remember you are using the U. S. Mail in all these transactions and therefore you are bound by the U. S. Postal Laws. Describe anything you offer accurately and without exaggeration. Treat your fellow men the way you wish to be treated. We welcome suggestions that will help to make this department interesting and helpful to our readers. Copy should reach us not later than the 10th of the month for the second following month's issue.

WANTED: CODE INSTRUCTION machine or typewriter. Have auto radio or will pay cash. Jack Israel, 319 Peshine Ave., Newark, N. J.

WANTED: 16MM PROJECTOR, looks do not matter but must work 100%. 100 volts A.C. Have plenty radio parts, stamps, etc. All letters answered. Also swap SWL cards. D. Witman, Peters Place, Red Bank, N. J.

WANTED PEN-PALS IN FOREIGN countries to exchange snap shots and stamps. L. S. Finnegan, 723 S. Federal Ave., Mason City, Iowa, U.S.A.

WILL SWAP 7 INCH UTAH DYNAMIC speaker, new receiver of many types, meters, metal receiver cabinets, audio and power transformers. Wanted—A folding camera, Francis McAllan, W1FXZ, 37 Oakland St., Natick, Mass.

WANT 50 WATT OR MORE modulator—Have an E flat Alto Saxophone in exchange. Will consider other trades. F. A. Kramer, Hamburg, Iowa.

WANTED: CIRCUIT DIAGRAMS, etc. for a RCA Radiola 20. Also interested in Radiola 20 parts, etc., and 1923-1928 volume of RCA Victor service notes. Fred Lurski, 15 Grove Terrace, Irvington, New Jersey.

OFFER 2 1/2 METER, 4 TUBE transmitter, carbon mike, \$20 R.C.A. record player, for exceptional camera or National SW3 with accessories, or superhet. Dick Gearhart, 920 School, Indiana, Penna.

WANTED: SMALL SHORTWAVE broadcast and transceivers for quantity of new radio parts and new tubes. Russell Spera, 35-37-34th St., Astoria, Long Island, New York.

HAVE ONE AND TWO TUBE radios, crystal sets, parts. Want rifles, radios, etc. John Haynes, Doe Run, Missouri.

WILL SWAP \$12 N.R.I. COURSE specializing in communications complete with all extra booklets and experimental material for Sky siddy. Super Clipper, or better communications receiver, Henry Greenwalt, Box 46, Mountville, Pa.

SWAP: VOLUME NO. 1, NO. 2 Official Radio Service Manuals, never used, value \$8 for A.C. record player. 5-8 watt amplifier, Irvin 16MM camera, or 20 Hy. 300 Ma. 3000 V. filter choke. F. A. Smith, 1267 Logan Ave., Tyrone, Pa.

WANTED: GOOD TYPEWRITER in good condition. Will swap violin course practically new. Has not been used. Costs \$36. Or what have you? Charles Rosich, 662 Jackson Ave., Bronx, N. Y.

WANTED CAMERA ALSO PHOTO namic speakers, power transformers and Short Wave Crafts, Bernard Hines, 4012 W. 10th Avenue, Gary, Indiana.

HAVE RIDERS MANUAL NO. 3, 2 Official Radio Manuals and all other kinds of radio parts. Will trade for ohmmeter or tube tester. Abe Oestgen, 335 E. Lewis St., Fort Wayne, Ind.

WILL TRADE \$139 "DE FOREST'S Training" radio course, practically complete, and 60 back issues Radio News for good low power phone transmitter, 10 to 80 meters preferred. Clifford Jenkins, Clayton, New Mexico.

WANTED: SET ANALYZERS, meters, what have you. I have good 1/3 H.P. 110 V. A.C. motor. Also Majestic A and B eliminators, dynamic speakers, Majestic receiver (A.C.), Nelson A. Hitchcock, Williams-town, Pa.

I HAVE 15 COPIES READER'S Digest. 2 valuable volumes (completely illustrated with mannikins) "Medical Instructor for the People" 7 Canadian and Mexican coins. Want 16mm film or what? W9WSZ, 3815 Congress Street, Chicago, Illinois.

160M CRYSTAL AND HOLDER, National i.f. transformer, Brownscope microphone, xmitting, reg. parts. 350V transformer. I want antiques, antique jewelry or what? W9TMQ, 3860 Harrison Street, Chicago, Ill.

WANTED: 1 OR 2 EIMAC 50T's, crystal mikes, 40M crystal above 3125 K.C. other trans. equipment. Have Emerson motor-generator, 6 boxes 12 gauge shogun shells, other things to trade. H. Buehrle, 722 Penna., Gary, Ind.

WILL TRADE FOR STANDARD radio equipment a fine old violin. Perfect condition. Case included. Address letter stating cash offer or description of equipment to Post Office Box 651, Aired, N. Y.

(Continued on following page)

World S-W Stations

(Continued from preceding page)

- Mc. Call
- 6.625 PRADO RIOBAMBA, ECUADOR, 45.28 m. Thurs. 9-11.45 pm.
- 6.610 YNLG MANAGUA, NICARAGUA. 45.39 m. Emisora Ruben Dario. 1-3, 7-11 pm.
- 6.558 HI4D CIUDAD TRUJILLO, D. R., 45.74 m. Except Sun. 11.55 am.-1.40 pm.
- 6.550 XBC YERA CRUZ, MEX., 45.8 m. 8.15-9 am.
- 6.550 TIRCC SAN JOSE, COSTA RICA, 45.8 m., Addr. Radioemisora Catolica Costarricense, Sun. 11 am.-2 pm., 6-7, 8-9 pm. Daily 12 n.-2 pm., 6-7 pm., Thurs. 6-11 pm.
- 6.545 YV6RB BOLIVAR, VENEZUELA, 45.84 m., Addr. "Ecos de Orinoco." 6-10.30 pm.
- 6.520 YV4RB VALENCIA, VENEZUELA, 45.98 m. 11 am.-2 pm., 5-10 pm.
- 6.516 YNIGG MANAGUA, NICARAGUA, 46.02 m., Addr. "La Voz de las Lagos." 8-9 pm.
- 6.500 HIL CIUDAD TRUJILLO, D. R., 46.13 m. Addr. Apartado 623. 12.10-1.40 pm., 5.40-7.40 pm.
- 6.480 HIIL SANTIAGO DE LOS CABALLEROS, D. R., 46.28 m., Addr. Box 356. 9.40-11.40 am., 7.40-9.40 pm.
- 6.470 YNLAT GRANADA, NICARAGUA, 46.36 m., Addr. Leonidas Tenorio, "La Voz del Mombacho." Irregular.
- 6.465 YV3RD BARQUISIMETO, VENEZUELA, 46.37 m. Radio Barquisimeto, irregular.
- 6.450 HI4V SAN FRANCISCO DE MACORIS, D. R., 46.48 m., 11.40 am.-1.40 pm., 5.10-9.40 pm.
- 6.440 TGQA QUEZALTENANGO, GUATEMALA, 46.56 m. Daily 6.10-10.10 pm., Sun. 1-3 pm.
- 6.340 HIIX CIUDAD TRUJILLO, D. R., 47.32 m. Sun. 7.40-10.40 am., daily 12.10-1.10 pm., Tues. and Fri. 8.10-10.10 pm.
- 6.335 OAXIA ICA, PERU, 47.33 m., Addr. La Voz de Chiclayo, Casilla No. 9. 8-11 pm.
- 6.324 COCW HAVANA, CUBA, 47.4 m., Addr. La Voz del Radio Philco, P. O. Box 130. 6.55 am.-12 m. Sun. 9.55 am.-10 pm.
- 6.310 HIZ CIUDAD TRUJILLO, D. R., 47.52 m. Daily except Sat. and Sun. 11.10 am.-2.25 pm., 5.10-8.40 pm. Sat. 5.10-11.10 pm. Sun. 11.40 am.-1.40 pm.
- 6.300 YV4RD MARACAY, VENEZUELA, 47.62 m. 6.30-9.30 pm. exc. Sun.
- 6.295 OAX4G LIMA, PERU, 47.63 m., Addr. Apartado 1242. Daily 7-10.30 pm.
- 6.280 HIG TRUJILLO CITY, D. R., 47.77 m. 7.10-9.40 am., 11.40 am.-2.10 pm., 3.40-9.40 pm.
- 6.270 YV5RP CARACAS, VENEZUELA, 47.79 m., Addr. "La Voz de la Philco." Daily to 10.30 pm.
- 6.255 YV5RJ CARACAS, VENEZUELA, 47.18 m.
- 6.243 HIN CIUDAD TRUJILLO, D. R., 48 m., Addr. "La Voz del Partido Dominicano." 12 n.-2 pm., 6-10 pm.
- 6.240 ZGE KUALA LUMPUR, FED. MALAY ST., 48.1 m. Addr. Malayan Amateur Radio Society, Sun. Tues. and Fri. 6.40-8.40 am.
- 6.235 HRD LA CEIBA, HONDURAS, 48.12 m., Addr. "La Voz de Atlantida." 8-11 pm.; Sat. 8 pm.-1 am.; Sun. 4-6 pm.
- 6.225 YVIRG VALERA, VENEZUELA, 48.15 m. 6-9.30 pm.
- 6.210 SAIGON, INDO-CHINA, 48.28 m., Addr. Radio Boy-Landry, 17 Place A. Foray. 4.30 or 5.30-9.15 am.
- 6.205 YV5RI CCRO, VENEZUELA, 48.32 m., Addr. Roger Leyba, care A. Urbina y Cia. Irregular.
- 6.200 HIBQ CIUDAD TRUJILLO, D. R., 48.36 m. Irregular.
- 6.190 TG2 GUATEMALA CITY, GUAT., 48.4 m., Addr. Dir. Genl. of Electr. Commun. Relays TGI Mon.-Fri. 6-11 pm., Sat. 6 pm.-1 am. Sun. 7-11 am., 3-8 pm.
- 6.185 HIIA SANTIAGO, D. R., 48.5 m., Addr. P. O. Box 423. 7 am.-5 pm.
- 6.156 YV5RD CARACAS, VENEZUELA, 48.71 m. 1 am.-2 pm., 4-10.40 pm.
- 6.153 H15N MOCA CITY, D. R., 48.75 m. 6.40-9.10 pm.

Mc. Call

- 6.007 ZRH ROBERTS HEIGHTS, S. AFRICA, 49.94 m., Addr. (See ZRK, 9.606 mc.) Daily exc. Sun. 10 am.-3.30 pm.; Sun. 9 am.-12 n., 12.15-3.15 pm. Daily exc. Sat. 11.45 pm.-12.50 am.
- 6.007 ZRJ JOHANNESBURG, S. AFRICA, 49.94 m., Addr. S. African Broad. cast. Co., 3.30-4 pm. exc. Sun.
- 6.005 HP5K COLON, PAN., 49.96 m., Addr. Box 33, La Voz de la Victor. 7-9 am., 10.30 am.-1 pm., 5-11 pm.
- 6.005 CFCX MONTREAL, CAN., 49.96 m., Can. Marconi Co. Relays CFCF 6.45 am.-12 m.; Sun. 8 am.-10.15 pm.
- 6.005 VE9DN DRUMMONDVILLE, QUE., CAN., 49.96 m., Addr. Canadian Marconi Co.
- 6.004 RV59 MOSCOW, U.S.S.R., 49.97 m. Irregular.
- 6.002 CXA2 MONTEVIDEO, URUGUAY, 49.98 m., Addr. Rio Negro 1631. Relays LS2, Radio Prieto, Buenos Aires. 10 am.-10 pm.
- 6.000 ZEA SALISBURY, RHODESIA, S. AFRICA, 50 m. (See 6.147 mc., ZEB.) Also Sun. 3.30-5 am.
- 6.000 XEBT MEXICO CITY, MEX., 50 m., Addr. P. O. Box 79.44. 8 am.-1 am.

End of Broadcast Band

- 5.977 CS2WD LISBON, PORTUGAL, 50.15 m., Addr. Rua Capelo 5. 3.30-6 pm.
- 5.975 OAX4P HUANCAYO, PERU, 50.16 m. La Voz del Centro del Peru. 8 pm. on.
- 5.970 YV5RC CARACAS, VEN., 50.26 m., Addr. Radio Caracas. Sun. 7 am.-10 pm. Daily 7-8 am., 1-1.45 pm., 4-9.30 or 10 pm.
- 5.968 HVJ VATICAN CITY, 50.27 m. Off the air at present.
- 5.950 HH2S PORT-AU-PRINCE, HAITI, 50.37 m., Addr. P. O. Box A103. 7-9.45 pm.
- 5.935 YVIRL MARACAIBO, VEN., 50.52 m., Addr. Radio Popular, Jose A. Higuera M, P. O. Box 247. Daily 11.43 am.-1.43 pm., 5.13-10.13 pm.; Sun. 9.13 am.-3.13 pm.
- 5.913 YV4RP VALENCIA, VEN., 50.71 m. Irreg.
- 5.900 ZNB MAPEKING BRI. BECHUANALAND S. AFRICA, 50.84 m. Addr. The Govt. Engineer, P. O. Box 106. 6-7 am. 1-2.30 pm.
- 5.900 TILS SAN JOSE, COSTA RICA, 50.85 m. 6-10 pm.
- 5.898 YV3RA BARQUISIMETO, VEN., 50.86 m., Addr. La Voz de Lara, 12 n.-1 pm., 6-10 pm.
- 5.885 HI9B SANTIAGO, D. R., 50.95 m. Irregular 6-11 pm.
- 5.875 HRN TEGUCIGALPA, HONDURAS, 51.06 m. 1.15-2.16, 8.30-10 pm.; Sun. 3.30-5.30, 8.30-9.30 pm.
- 5.855 HILJ SAN PEDRO DE MACORIS, D. R., 51.25 m., Addr. Box 204. 12 n.-2 pm., 6.30-9 pm.
- 5.845 YVIRB MARACAIBO, VEN., 51.3 m., Addr. Apartado 214. 8.45-9.45 am., 11.15 am.-12.15 pm., 4.45-9.45 pm.; Sun. 11.45 am.-12.45 pm.
- 5.825 TIGPH SAN JOSE, COSTA RICA, 51.5 m., Addr. Alma Tica, Apartado 800. 11 am.-1 pm., 6-10 pm. Relays TIX 9-10 pm.
- 5.813 TIGPH2 SAN JOSE, COSTA RICA, 51.59 m., Addr. Senor Gonzalo Pinto, H.
- 5.790 TGS GUATEMALA CITY, GUAT., 51.75 m. Casa Presidencial, Senor J. M. Caballero. Irregular.
- 5.758 YNOP MANAGUA, NICARAGUA, 52.11 m. 8-9.30 pm.
- 5.740 YV2RA SAN CRISTOBAL, VENEZUELA, 52.23 m., Addr. La Voz de Tachire. 11.30 am.-12 n., 5.30-9 pm., Sun. till 10 pm.
- 5.735 HCIPM QUITO, ECUADOR, 52.28 m. Irregular 10 pm.-12 m.
- 5.145 OKIMPT PRAGUE, CZECHOSLOVAKIA, 58.31 m., Addr. (See OLR, 11.84 mc.) Fri. 4.45-5.10 pm.; Sat. 5.15-5.40 pm.
- 5.145 PMY BANDOENG, JAVA, 58.31 m. 5.30-11 am.
- 4.995 VUD2 DELHI, INDIA, 60.06 m., Addr. All India Radio, 7.30 am.-12.30 pm.
- 4.950 YUM2 MADRAS, INDIA, 60.61 m., Addr. All India Radio, 7 am.-12 n.
- 4.905 YUB2 BOMBAY, INDIA, 61.16 m., Addr. All India Radio, 7 am.-12.30 pm.

BARTER and EXCHANGE FREE ADS (continued)

TRADE TYPEWRITER FOR ARTICLES of value such as tools, card file, office supplies, pen and pencil set, kodak, etc. Frank Handshue, Seville, Ohio.

SWL EXCHANGE

SHORT WAVE LISTENERS IN all countries. Would like to exchange SWL cards with anyone anywhere. QRA—Art. Corninboeur, 113 Parrot Place, Brooklyn, N. Y., U.S.A.

SHORT WAVE LISTENERS. SWL's I would like to swap cards with U. S. and foreign countries. I QSL 100% hr. QRA—Arthur Woods, R.F.D. No. 1, Wellsburg, W. Va., U.S.A.

WOULD LIKE TO EXCHANGE SWL cards with any SWL in U.S. or foreign countries. All cards received here will be answered with our card. QRA John L. Ballin, 40 East 6th St., New York, N. Y.

I QSL 100%. SWL's in all parts of the world. I will exchange my card for yours. QRA—Jock Clements, 6800 Division Ave., Birmingham, Ala., U.S.A.

SHORT WAVE LISTENERS IN U.S.A. and foreign countries. Would like to exchange my SWL card for yours. Also swap "snack" photos. I QSL 100%. Edmund Bruinier, 34-21, 89th Street, Jackson Heights, Long Island, New York, U.S.A.

YOUR SWL CARD WILL BE APpreciated. Answer all. Lewis Neuman, Box 8363, Pittsburgh, (18) Penna.

SWL'S WILL SEND MY CARD for one of yours. I QSL 100%. U.S.A. or foreign countries. F. E. Massey, 58, St. Agnes Road, Cornmeadow, Worcester, England.

WOULD LIKE TO SWAP SWL cards with SWL's and Hams all over the world, but mainly in foreign countries. What say old Bug? F. A. Moore, 109 W. Granville Rd., Worthington, Ohio, U.S.A.

WANT TO SWAP QSL CARDS with YL amateur radio ops. Will QSL 100%. W9SEF. Harold Lantow, Renwick, Iowa.

ATTENTION! SWL'S OR PICTURE postcard collectors. Will swap my SWL card or picture postcard or both for one or both of yours. I will reply promptly. George Mills, 13, Citchley Street, Ilkeston, Derbyshire, England.

I WILL EXCHANGE SWL CARDS with any person American or foreign. What say gang K? Fred White, 34 Gould Street, Wakefield, Mass., U.S.A.

POSTCARD VIEWS. SWL CARDS wanted at this SWL post from all countries. Will correspond with SWL's Africa, Asia. All letters, cards answered 100%. QRA—VE3SWL, Meredith M. Stroh, 172 Queen St., N., Kitchener, Ontario, Canada.

SHORT WAVE LISTENERS IN U.S.A. and foreign countries. Would like to exchange my SWL card for yours. Louie Kucera, P.O. Box 102, Apache, Oklahoma.

AUSTRALIAN SWL WOULD LIKE to exchange cards with U.S.A. and foreign listeners. 100 percent QSL from here! How about it, chaps? QRA—Albert E. Kent, "Cranbury," Stoney Creek Road, Hurstville, N.S.W., Australia.

SWL'S AND HAMS ALL OVER the world. Let's swap cards. I QSL 100%. QRA—Joe Berly, Jr., 107 N. Clemons Ave., Clemons, S. Carolina.

SHORT WAVE LISTENERS IN all countries. I would like to swap SWL cards with anyone anywhere. QRA—Jack DeMay, 655-90 St., Brooklyn, N. Y., U.S.A.

SHORT WAVE LISTENERS AND HAMS IN U.S.A. and foreign countries. Like to send one of my SWL cards in exchange for yours. Fred W. Goods, 2437 Shattuck Ave., Berkeley, Calif., U.S.A.

ATTENTION SWL'S ALL OVER the world. I will swap cards 100% with everyone. Let's be the best of friends. QRA—H. B. Emmett, 1639-Sixth Street, Portsmouth, Ohio.

SWAP SWL OR POSTCARDS with everyone, everywhere. Maylan Wilbur, Weld, Maine.

Let's Listen In with Joe Miller

(Continued from page 489)

JAPAN—Mr. Gallagher reports this news from West Coast.

JZZ, 17.78 mc., with a special broadcast 8-8:30 a.m., requesting reports.

JVH, 14.60 mc., broadcasting program Sun.—12:30-1 a.m., often till 1:15 a.m.

JVL, 11.66 mc., phoning 1 a.m., also JVA, 18.91 mc.

INDIA—On West Coast. Delhi on 4.99 mc. Call VUD2, is heard stronger than on 9.59 mc., this on the morning schedule. Roy Myers and Ashley Walcott report the 4.99 mc. freq. Morning schedule is 6:30 a.m. on.

TURKEY—TAO, 15.195 mc., at Ankara, is reported heard, with a schedule of 1:20-5 p.m. This station is believed to relay 2R04 quite often, as the Italian station's programs are often heard through TAO. This new and as yet unconfirmed station is also reported on 9.465 mc., daily from 6:30-7 a.m., but we believe this to be on only irregularly.

EGYPT—SUZ, 13.82 mc., Cairo, heard at 12:45 p.m., using inverted speech. SUZ is very often heard at 11 a.m. in schedule with GBB, 13.585 mc., Rugby.

MOROCCO—CNR, 12.83 mc., at Rabat, was logged once at 2:45 a.m., with a woman heard phoning in side band secrecy. CNR usually heard in early afternoons.

DUTCH BORNEO—YCP, 9.12 mc., at Balikpapan, heard almost daily, contacting a new Javanese phone on 10.055 mc., at 4:30 a.m., by N. G. Stahevitch, W6. Both were heard R8-9. Clear speech transmission used only. Here's your chance to "log" a rare new country in Dutch Borneo! All Javanese phones are QSL'd through the Javanese phone QRA (address) in Bandoeng.

MOZAMBIQUE—CR7BH, 11.718 mc., heard weakly of late, during afternoon schedule, 3-4 p.m., by Jack Buitekant, W2. Mr. Stahevitch reports CR7BH at 10-11 a.m. on West Coast, R7.



The amateur bands have shown renewed activity with the advent of cooler weather, and from now on, there'll be plenty of px for all.

Ten meters has opened up nicely, and numerous South African phones are being logged at up to R9. This "FB" reception should continue right through to February, though, of course, 10 is more subject to variations in conditions than 20 m., the ol' reliable 3x band. Best times for 10 on East Coast is from 11 a.m.-1:30 p.m., when Europeans, and later South Africans, are well heard.

Also reported are occasional ZL's and VK's, these heard in early evenings from 6-8 p.m., but very irregular, here on East Coast.

Twenty meters is rather quiet now, but South Africans should begin to evidence themselves soon after this article appears, on East Coast, from 11 p.m.-1 a.m.

Very few Asians are now heard in East in mornings on 20, the West Coasters enjoying more or less exclusive reception of the PK's, VS's, etc. Here goes:

ASIA

VU2CQ, 14270 kilocycles, India, reported by Roy Myers.

KA1JM, 14300, the yacht "Jen," in Manila Harbor, P.O. Box 817, Manila, Philippines, is a new one heard by Ashley Walcott. Also KA3KK, 14320, Boguio, which is operated by the w.k. KA's, 1YL, and 1ZL. Roy Myers also reports KA3KK.

VS3AF, 14350, in Jahore, Non-Fed. Malay States, is a nice dx catch for Mr. Walcott. Congrats, OB.

VS6AG, Hong Kong, is a "regular" on 14080. F18AC, French Indo-China, our ol' friend Rene, is often heard on 14070.

From Burma, XZ2DY, 14100, has the best "sig." sez Ashley, who reports other dx above. Others, much weaker, are XZ2EX, 14340, and XZ2PB, 14040.

PK1GL, 14270. PK1VY, 14270, and PK2RN, 14320, are reported 7-8 a.m. by Gail Beyer, W9, FB, OM!

Ralph Gozen reports a veri of PK1VY.

We recently received a veri, somewhat late, from PK6WF, who is OM Federoff, conducting a geological expedition into the wilds of Dutch New Guinea and Papua. Believe it or not, OM Federoff sent us the QSL, together with a dozen "FB" photos of native scenes, very interesting, too, all by air mail from Dobo, New Guinea! Talk about being obliging, whew! Wish we could enlarge on this interesting letter here. Taxx a million, OM!

J6DU, 14180, J5CC, 14405, J2M1, 14080, and J2CR, 14035, all reported by Jim Doyle, W9, Vy FB, OB! Ralph Gozen also reports J5CC.

From South Africa, the following are reported on 20 meters:

ZS1AX, 14080; ZS1BL, 14360; ZS1CN, 14070 and 14290; ZS1B, 14060; ZS2AZ, 14120; ZS2AH, 14020; ZS2RB, 14050; ZS2T, 14030; ZS4H, 14270; ZS5AW, 14090; ZS5AD, 14100; ZS5BZ, 14030; ZS5RH, 14400; ZS5BS, 14140, 6 watts; ZS5T, 14050; ZS6AJ, 14130; ZS6BA, 14350; ZS6DJ, 14040; ZS6AD, 14080; ZS6DM, 14090 and 14300; ZS6DW, 14040 and 14070; ZS6V, 14030 and 14370; ZS6EF, 14370; ZS6EY, 14080; ZS6ED, 14040; ZS6FB, 14140.

ZE1JX in Southern Rhodesia on 14020.

All above reported by Roy Myers, Ashley Walcott and N. G. Stahevitch, all W6.

VQ2HC, 14310, heard by Roy Myers, from Northern Rhodesia. Mr. Stahevitch also reports this catch.

ZL2IQ, 14050, reported by Gail Beyer.

ZL2BE, New Zealand, on 14210, heard at 7:10 a.m. by Roger Legge, W2.

A nice one on 20 is CN1AF, 14280, heard nearly daily 5-7 p.m. Many report him. Located at Tangier, International Zone. QRL is Jose M. Sierra, 19 Rue Sources, Tangiers, International Zone. CN1AF QSL's promptly.

ZR1L, 14130, Malta, reported by Gail Beyer.

On 10 meters, we've heard a few So. Africans in the brief time we've tried this band on Sun. ZE1JR, ZE1JN, ZS1AX, ZS5CL, ZS6S, ZS6A, ZS6EG, ZS6DY, ZS4H are all we've heard.

Roger Legge reports ZL3BV at 7 p.m., also ZL2BT. Also SU1RO, at 9:30 a.m., all on 10, FB, Roger!

A tip: VR6AY doesn't want reply coupons, as they cannot be redeemed. Send U. S. stamps or New Zealand stamps.

Let's hear from all you OM's next month. All our vy 73s to you, OB's, es lots es lots o' dx to ye!

FREE-FIFTEEN 10¢ PUBLICATIONS

featuring construction of the most popular short-wave receivers and transmitters with a One-Year's Subscription to Radio & Television

THESE publications are large printed sheets which average in size about 11"x17", the majority of them printed on both sides. All have photographic reproductions of the complete project, as well as detail illustrations. In addition, there are complete wiring diagrams and various technical details to assist the experimenter and builder in constructing the set. Full parts lists are always given, and the printed text runs anywhere from 500 to 3,000 words, depending on the complexity of the radio receiver. ALL RECEIVERS AND TRANSMITTERS ARE STRICTLY UP-TO-DATE; THERE ARE NO ANTIQUES OR OUT-OF-DATE PUBLICATIONS IN THIS

LIST. These projects are particularly valuable to the experimenter and constructor who builds "his own". Indeed, the 50 publications shown on this page represent the cream of recent radio construction by the master radio builders of America. Designs of this kind usually are sold for 25¢ to \$1.00 apiece, and frequently you do not get half the technical information we give you. When mailing us your subscription, use the special coupon on this page. Select your 15 projects by their serial numbers. We accept money orders, cash, checks or new U.S. stamps (no foreign stamps or currency accepted). If you send cash or stamps register your letter against possible loss.

THESE 15 PROJECTS, IF BOUGHT SINGLY, WOULD HAVE COST YOU \$1.50. YOU CAN NOW GET THEM ABSOLUTELY FREE!

HOW TO BUILD THE SWITCH BAND-2 RECEIVER. A low-cost receiver for 6 volt battery or A.C. operation which enables the short-wave fan to hear stations in all parts of the world. No. 1

HOW TO MAKE A 2-TUBE RECEIVER FOR THE BEGINNER. This receiver consists of detector and two audio stages. A double purpose tube is used to secure the 2 audio stages. Tubes are for 1½ volt battery operation. No. 2

HOW TO MAKE THE PORTABLE SUPERHET 4. An ace all-wave superhet for battery operation. This receiver features band-spread and has a built-in beat oscillator. No. 3

HOW TO BUILD A 4-BAND 3-TUBE SUPERHET. A 3-tube receiver giving 4-tube results. Rack and panel type construction is employed. It has a regenerative second detector. No. 4

HOW TO MAKE A FIXED-BAND 8-TUBE SUPERHET. This short-wave "fan" receiver tunes over a wide band of frequencies without coil switching or changing. It's a real performer. It operates directly from 110 V. A.C. and has band-spread. No. 5

HOW TO BUILD A 5-TUBE SUPERHET FOR HAM AND HAM. A sure-fire receiver for all short-wave enthusiasts. It uses plug-in coils and iron core I.F. transformers which assure plenty of gain. No. 6

HOW TO MAKE A TWIN-PENTODE RECEIVER. This receiver, especially designed for the beginner, employs but one dual purpose tube which gives results equivalent to a 2-tube receiver. It is for 2-volt battery operation with headphones. No. 7

HOW TO BUILD AN EFFECTIVE SHORT WAVE PRESELECTION. A signal-booster that will greatly improve reception on any short-wave super. It employs two 6K7 tubes in parallel in a highly efficient circuit in which both input and output are tuned. No. 8

HOW TO BUILD A REGENERATIVE 2-TUBER. This unusual receiver has the tickler coil in the screen grid circuit of the detector. The receiver tunes from 9-270 meters; band-spread is included; metal or glass tubes may be employed. No. 9

HOW TO MAKE THE S.W.&T. COMMUNICATIONS RECEIVER. An unusually fine receiver for the critical Ham and Fan, incorporating many exceptional features. Regeneration is employed in the first detector stage which makes use of an acorn tube. The receiver also incorporates a noise-control circuit, variable selectivity control and a tuning meter. No. 10

HOW TO MAKE A BAND-SWITCHING 2-VOLT RECEIVER. This fine receiver for battery operation employs a band-switching arrangement, enabling the builder to tune from 15-550 meters by flipping a switch. No. 11

HOW TO BUILD THE MULTI-BAND 2 RECEIVER. A receiver for the short-wave beginner. It has a remarkable tuning range of 2½-270 meters with band-spread on all bands. Plug-in coils are used and complete data for an A.C. power supply is given. No. 12

HOW TO MAKE THE VS-5 METAL TUBE SUPERHET. This complete all-wave receiver boasts, among other things, variable selectivity, metal tubes, AVC and band-spread. The tuning range is from 17-550 meters. No. 13

HOW TO BUILD A BEGINNERS 2-TUBE SUPER. A simplified superhet using 2 volt battery tubes which is just the thing for the beginner. It employs plug-in coils which cover a tuning range from 15-200 meters. No. 14

HOW TO MAKE A T.R.F.-3 FAN RECEIVER. This is an all-around receiver employing 2 volt tubes. A T.R.F. stage ahead of the regenerative detector insures good selectivity and sensitivity. Band-spread is provided by a two-speed dial. No. 15

HOW TO BUILD THE FORTY-NINER—A RECEIVER FOR LEAN PURSES. This novel receiver features a spare-charge detector and requires only 12 volts of B battery. It uses 2-49 tubes which may be operated from any 2 volt A battery. No. 16

HOW TO MAKE A REAL 5-METER SUPERHET. This carefully designed receiver for ultra-short wave reception employs a straightforward circuit. Careful placement and high quality parts insure fine results. No. 17

HOW TO BUILD THE 2-VOLT SUPER DX-4. This superhet, though small in size is big in performance. Using battery type tubes, it features continuous band-spread, and automatic volume control, which may be cut in or out as desired. No. 18

HOW TO MAKE THE ULTRA-HIGH FREQUENCY WIZARD-6. This is a first-class 5-meter super-regenerative receiver, using acorn tubes in the R.F. and detector stages. The other tubes are of the metal type. The use of the acorn tubes insures exceptionally fine results. No. 19

HOW TO BUILD A HIGH-GAIN METAL-TUBE RECEIVER. This little receiver is a real performer, tuning from 10-200 meters. Continuous band-spread is provided. No. 20

HOW TO BUILD THE WORLD-WIDE 10-METER CONVERTER. Many enthusiastic reports have been received from the builders of this unit, which may be attached to your present receiver for picking up 10 meter signals from all parts of the world. Only 2-tubes are used. No. 21

HOW TO BUILD A DE LUXE 3-TUBER. This is the receiver for the Ham or Fan who wants a really high class receiver of simple design. It employs an unusual band-spreading dial. The circuit, employing metal tubes, has a stage of T.R.F. followed by a regenerative detector and a stage of audio. No. 22

HOW TO BUILD THE OCTODE METAL TUBE-3. This receiver is capable of excellent performance on the short waves. It requires only one plug-in coil for each band as a stage of untuned R.F. precedes the detector. It also has an A.F. stage for boosting the volume to comfortable headphone level. No. 23

HOW TO MAKE THE 3-IN-1 REFLEX SET. A 2-tuber giving 4-tube performance is this receiver which does its work with a minimum of tubes. A 6RT is used as a combined R.F. amplifier, detector and first audio stage; a 6C5 is used as second audio stage. No. 24

HOW TO BUILD THE 100 WATT QRM DODGER—A COMPACT 5-METER TRANSMITTER. This M.O.P.A. rig puts out a hefty signal and by use of a calibrated variable oscillator control will overcome the QRM problem on 5 meters. No. 25

HOW TO BUILD A DE LUXE 5-METER MOBILE STATION. A really fine M.O.P.A. mobile transmitter which will work real DX on portable location. It employs five metal tubes. No. 26

HOW TO BUILD THE H-G-M MEDIUM POWER TRANSMITTER. A crystal control unit with an output of 90 watts. Band-switching is employed for operation on the 80, 40, 20 and 10 meter Ham bands. It gave excellent results under test. No. 27

HOW TO MAKE THE 806 ALL-BAND TRANSMITTER. An unusual transmitter delivering 400 watts output from an 806 final amplifier. A crystal Pen-tet oscillator is used, followed by a driver stage. Real DX has been worked on 10, 20, 40 and 80 meters with this smooth working job. No. 28

HOW TO BUILD A 125-WATT MODULATOR USING 35T's. This is an ideal unit for the amateur and will modulate any transmitter with a power input up to about 400 watts. A total of 10 tubes are used including the power supply unit. No. 29

HOW TO BUILD THE C-O-M 150 WATT TRANSMITTER. An unusual crystal oscillator, multiplier with but one tuned circuit. It uses a pair of 8K37's in parallel with a RK39 driver. The crystal oscillator circuit uses a 6L6. No. 30

A LONG-LINES TRANSMITTER FOR I-METER TRANSMISSION, AND A COMPANION RECEIVER. A really special job for the seriously minded experimenter. This outfit permits short distance contacts in this interesting band. No. 31

HOW TO BUILD A 200 WATT XMITTER WITH PEN-TET EXCITER. This transmitter will really go to town. The use of the Pen-Tet crystal oscillator and frequency multiplier circuit eliminates many headaches from cracked crystals. No. 32

HOW TO BUILD A 10 AND 20 METER TRANSMITTER. A 200 watt transmitter which worked world-wide DX on test. Although compact, it is highly efficient in the 10 and 20 meter bands. Five tubes are used. No. 33

HOW TO MAKE THE WIZARD I-TUBE 50-WATT TRANSMITTER. An amateur, crystal-controlled c.w. transmitter using the RK20 screen grid Pentode. In tests, it compares with 250-watters. No. 34

HOW TO MAKE THE "OSCILLODYNE" I TUBE WONDER SET. One of the most sensitive short-wave sets designed, employing a really new circuit for the first time. Battery operated. No. 35

HOW TO MAKE THE "19" TWINPLEX (ONE TUBE PERFORMS AS TWO) RECEIVER. One of the most sensitive 1-tube sets ever designed and very popular. No. 36

HOW TO MAKE THE IMPROVED 3-TUBE DOERLE SET FOR BATTERY OPERATION. One of the finest of the Doerle series, by the famous short-wave inventor. No. 37

HOW TO MAKE THE "GO-GET-'EM 2" RECEIVER FOR THE BEGINNER. This unusual 2-tube circuit gives 3-tube results. Battery operated. Excellent for beginners. No. 38

HOW TO MAKE THE I-TUBE ALL-ELECTRIC OSCILLODYNE. This is the famous electrified short-wave receiver. Easy to build for little money. Operates on A.C. and D.C. No. 39

HOW TO MAKE THE 2 TO 5 METER TWO-TUBE LOUDSPEAKER SET. This receiver may be used with batteries or with an A.C. power pack. Packs a big wallop. No. 40

HOW TO MAKE THE 3-TUBE BATTERY SHORT-WAVE RECEIVER. This receiver was a prize winner in SHORT WAVE CRAFT. An unusual short-wave receiver, easy to build. No. 41

THE BRIEF-CASE SHORT-WAVE RECEIVER AND HOW TO BUILD IT. So small that the entire set, batteries, head set, aerial and everything, goes into a briefcase. Stations from Europe are often received. By Hugo Gernsback and Clifford E. Denton. No. 42

HOW TO BUILD THE POCKET SHORT-WAVE RECEIVER. One of the smallest, pocket-size, battery receivers ever designed by Hugo Gernsback and Clifford E. Denton. A marvelous set that brings in European stations. No. 43

HOW TO BUILD THE CIGAR-BOX I-TUBE "CATCH ALL" RECEIVER. An effective short-wave battery set which fits into a small cigar box, insuring high portability yet great efficiency. No. 44

HOW TO BUILD THE "DUAL-WAVE" SHORT-WAVE BATTERY RECEIVER. With this set, you can hear both ends of radiophone talk, on one set of phones, in other words, you can listen to a ship at sea and the land station communicating with it, simultaneously, by means of this double receiver. No. 45

HOW TO BUILD THE I-TUBE "53" TWINPLEX RECEIVER. The twinplex, although it has only one tube, works as if it had two. Marvellous in efficiency. Uses either batteries or A.C. power pack for "B" supply. No. 46

HOW TO BUILD THE PORTABLE MINIDYNE SHORT-WAVE BATTERY SET. Uses no aerial, no ground. The total weight is 3½ lbs. and measures 5x5x6 inches. Self-contained batteries, tube, condensers, and loop. Highly sensitive circuit. No. 47

HOW TO BUILD THE HAM-BAND "PEE-WEE" 2-TUBER. A handy receiver with high efficiency and band-spread tuning. Works a loudspeaker, yet the entire receiver is no larger than your hand. Works with either batteries or an A.C. power pack. No. 48

HOW TO BUILD THE DUO-AMPLIDYNE. The ideal 1-tube set for the beginner. One of the finest 1-tube sets; it really gives 2-tube performance. Made for battery operation. With only ten-foot antenna brings in the good European stations. No. 49

HOW TO BUILD THE "MONO-COIL 2". No more "plug in" coils. This set eliminates bothersome coils and is made to cover short-wave bands. Works with either batteries or A.C. power pack. No. 50

RADIO & TELEVISION, 99 Hudson Street, New York, N. Y.

Gentlemen: Enclosed you will find my remittance of \$2.50 for which enter my subscription to RADIO AND TELEVISION for One Year (12 issues). Send me promptly, absolutely FREE and POSTPAID, the 15 publications I have circled at the right. (CANADA AND FOREIGN \$3.15)

NEW SUBSCRIBER EXTEND PRESENT SUBSCRIPTION

Name _____

Address _____

City _____ State _____ R.&T-12

Send remittance by check or money order. Register letter if you send cash or unused U. S. Postage Stamps.

1	2	3	4	5
6	7	8	9	10
11	12	13	14	15
16	17	18	19	20
21	22	23	24	25
26	27	28	29	30
31	32	33	34	35
36	37	38	39	40
41	42	43	44	45
46	47	48	49	50

RADIO & TELEVISION
99 HUDSON STREET
NEW YORK, N. Y.

RADIO & TELEVISION

441 Line Television Receiver

(Continued from page 479)

horizontal position with the reflector placed one-quarter wave length behind the antenna proper.

The transmission line from the antenna to the receiver is connected to the matching stub (preferably by clips), so that it can be adjusted for maximum signal strength.

Parts List—R.F., Det. and Video Sections

RAYTHEON (Tubes)

5—1851 tubes
1—6H6G tube

HAMMARLUND

4—HF-50 mmf. variable condensers
3—2.5 mh. R.F. chokes
6—8-prong sockets

AEROVOX (Condensers)

13—.01 mf. 500 V. fixed, mica
1—.001 mf. 500 V. fixed, mica
4—.005 mf. 500 V. fixed, mica
2—.0001 mf. 500 V. fixed, mica
1—.1 mf. 600 V. fixed, paper
1—.25 mf. 600 V. fixed, paper
2—.2 mf. 400 V. fixed, paper
4—.8 mf. electrolytic

I.R.C. (Fixed Resistors)

1—150 ohms BT (all ½ watt)
3—175 ohms BV
4—1500 ohms BT
4—2000 ohms BT
4—5000 ohms BT
5—60,000 ohms BT
3—250,000 ohms BT

CLAROSTAT

1—1500 ohm potentiometer

MISCELLANEOUS

Shielding material (copper, brass or aluminum)
12—½" stand-off insulators
Assorted screws

Radio Helped Make Movie

(Continued from page 464)

tor and an 802 final with 42 speech and 6A6 Class B modulator using a single-button mike. The genemotor is built in for the plate supply and is equipped for relay action for break-ins. It has plug-in coils and carries two crystals which makes it possible to switch from one frequency to another without loss of time and because of the Collins network is enabled to work on all frequencies, regardless of length of antenna. It is completely controlled by the switch on the hand "mike" and its total weight is 30 lbs. in a 20 x 10 x 10 inch case. It uses an ordinary storage "A" battery for its power.

Continuous contact was kept with the headquarters in the studios of MGM in Los Angeles via KOU. This ingenious wrinkle was added to the technique of modern motion picture production when a director sitting on a Hollywood sound stage, supervised an important sea episode being photographed 1,000 or more miles away at sea, by means of *short-wave radio-telephone!* He could listen to the dialogue spoken by the actors in the scene by the use of a loudspeaker near him.

The radio equipment worked perfectly at all times, regardless of the distance from KOU, the land outlet. Perhaps everything went so smoothly because of the yacht frequencies used. 2174 and 2738 kc. (138 and 109 meters). They had first tried working on the 5-meter band but gave that up because of too much interference and the difficulty in bridging distances.

This is the first time that an entire movie company of cast, technicians and directors returned to port with smiles wreathing their faces as they contemplated a difficult assignment completed with ease and despatch. And it has definitely been established that radio will be used at all times during the filming of sea sequences.

FREE CATALOGS and INFORMATION

By carefully reading the advertising columns, you will find many offers to furnish literature containing valuable technical information that will help you in your work. Use this list freely.

Firm	Business	Offer	No.	Cost	Adv. Page
Aerovox Corp.	Parts Mfr.	Catalog		Free	503
Allied Engineering Inst.	Kit Mfr.	Circulars		Free	488
Allied Radio Corp.	Mail Order	1939 Catalog		Free	491
American Microphone Co.	Parts Mfr.	Catalog	29	Free	490
American Radio Institute	Radio School	Booklet		Free	500
Astatic Microphone Lab.	Parts Mfr.	Catalog	11	Free	505
Bernard, H. J.	Test Equipment	Catalog	V	Free	481
Bliley Electric Co.	Parts Mfr.	Engineering Bulletin	E-6	10c	494
		Circular	A-6	Free	
Browning Laboratories	Kit & Parts Mfr.	Brochure . . . Browning 83		Free	505
		Bulletin . . . BL-5 Tuners		Free	
		Circuit Diagram 5P, 5G, 5H		Free	
Brush Development Co.	Parts Mfr.	Catalog		Free	491
Bud Radio, Inc.	Parts Mfr.	Catalog	139	Free	491
		Station Log & Data Bk.		10c	
Burstein-Applebee Co.	Mail Order	Catalog		Free	497
Candler System Co.	Code Course	Book of Facts		Free	500
Clough-Brengle Co.	Test Equipment	Catalog		Free	497
Cornell-Dubilier Elec. Corp.	Parts Mfr.	Catalog	161	Free	497
Coyne Electrical School	Trade School	Electrical Catalog		Free	451
		Radio Catalog		Free	
Dodge's Institute	Radio School	Catalog		Free	500
Dutton, E. P., & Co.	Book Publisher	Literature		Free	503
Eagle Radio Co.	Kit Mfr.	S. W. Diagrams		Free	496
Gold Shield Products	Mail Order	Catalog		Free	505
Hammarlund Mfg. Co.	Set & Parts Mfr.	1939 Catalog		Free	503
		"TC" Bulletin		Free	
Henry Radio Shop	Mail Order	List		Free	492
Instructograph Company	Code Machine	Information		Free	500
International Resistance Co.	Parts Mfr.	Folder		Free	493
Jarnak, Paul	Parts Mfr.	Illus. Literature		Free	505
Korrol Radio Products Co.	Parts Mfr.	Folder		Free	494
Kusterman, Oscar B.	Set & Kit Mfr.	Catalog		10c	487
		Circular	D39	3c	492
McIntosh Electrical Corp.	S.W. Diathermy	Information		Free	499
Mass. Radio School	Radio School	52-page Catalog		Free	500
Midwest Radio Corp.	Set Mfr.	1939 Catalog		Free	B. C.
Modell's	Mail Order	1939 Catalog		Free	505
National Company, Inc.	Set & Parts Mfr.	Catalog		Free	I.B.C.
National Radio Institute	Radio School	64-page Book		Free	449
National Schools	Radio School	Radio & Television Bklt.		Free	501
N. E. Radiocrafters	Parts Mfr.	Catalog		Free	494
New York YMCA Schools	Trade School	Booklet		Free	500
Radio & Technical Publ. Co.	Radio Textbooks	Circulars on each Book		Free	501
Radio Train. Assn. of Amer.	Radio School	Book		Free	500
Ralston Record Company	Code Course	Information		Free	500
RCA Institutes, Inc.	Radio School	Catalog		Free	500
Remington Rand, Inc.	Typewriter Mfr.	Catalog		Free	512
Sargent, E. M., Co.	Set Mfr.	Data		Free	497
Solar Mfg. Corp.	Parts Mfr.	General Parts Catalog	9S	Free	490
		Transmitting Catalog	2X	Free	
		Condenser Testers Cat.	CBCC-1	Free	
Sprague Products Co.	Parts Mfr.	Catalog		Free	492
Sprayberry Acad. of Radio	Radio School	48-page Book		Free	495
Superior Instruments Co.	Test Equipment	Catalog		Free	490
Teleplex Co.	Code Machine	Booklet	S12	Free	500
Terminal Radio Corp.	Mail Order	Bulletin		Free	494
Test Equip. Co. of Amer.	Test Equipment	Catalog		Free	483
Trimm Radio Mfg. Co.	Parts Mfr.	Folder		Free	499
Triplett Electrical Inst. Co.	Parts Mfr.	Catalog		Free	497
Van Nostrand, D., Co.	Technical Books	Catalog		Free	489
Ward, Montgomery, & Co.	Mail Order	1939 Radio Catalog		Free	499
Wholesale Radio Service Co.	Mail Order	1939 Radio Catalog		Free	485
		1939 Gift Catalog		Free	

GREATEST BARGAIN

in 10 years



as little as

Remington NOISELESS Portable
NOW AS LITTLE AS 10c a day

10c A DAY

Imagine a typewriter that speaks in a whisper! You can write in a library, a sick room, a Pullman berth, without disturbing others. And superb performance that literally makes words flow from the machine. The Remington Noiseless Portable is equipped with all attachments that make for complete writing equipment—it manifolds and cuts stencils perfectly. Furnished in black with chromium fittings.

SPECIFICATIONS

Standard keyboard. Takes paper 9.5 inches wide. Standard size, 12 yard ribbon. Makes up to 7 legible carbons. Back spacer. Paper fingers. Roller type. Black key cards with white letters. Double shift key and shift lock. Right and left carriage release. Right and left cylinder knobs. Large cushion rubber feet. Single or double space adjustment. A brand new NOISELESS typewriter, right off the assembly line.

10-DAY FREE TRIAL

For the first time in history you can own a genuine Remington Noiseless Portable for as little as 10c a day or \$3.00 a month. Think of it! The finest Remington Portable ever built at the lowest terms we have ever offered. And you don't risk a penny! We will send this brand new Remington Noiseless Portable for a TEN DAYS' FREE TRIAL! If you are not satisfied, send it back. We pay all shipping charges.

FREE TYPING COURSE

With your Remington Noiseless Portable—absolutely free—a 19-page course in typing teaching you the Touch System, always used by experts. With the help of this course you will find typing the most enjoyable way you ever wrote.



SPECIAL CARRYING CASE

Carrying Case, handsomely covered in DuPont fabric is included with your purchase. The case makes it easy to take your machine anywhere. You can use it on trains, or on your knees at home. Don't delay. Mail the coupon.



MAIL NOW

Remington Rand Inc. Dept. 300-12
465 Washington St., Buffalo, N. Y.

Tell me, without obligation, how to get a Free Trial of a new Remington Noiseless Portable, including Carrying Case and Free Typing Course for as little as 10c a day. Send Catalog.

Name
Address
City State

Answers to QUIZ on page 467

1. b—All others are resistors
2. c
3. c & e
4. aE, bD, cB, dG, eC, eA, fF, gH, hG
5. a—e is also a general term
6. d
7. a
8. e
9. a
10. c
11. b & c
12. b & d
13. aC, bF, cA, dE, eB, fD
14. a. 1.434; b. 1.5; c. 1.2; d. 2.
15. b
16. d
17. b
18. c
19. a & d
20. b
21. a, mega; b, micro; c, milli; d, micromicro; e, meters; f, milli.
22. c
23. f
24. c
25. b (& sometimes c)

STATEMENT OF THE OWNERSHIP, MANAGEMENT, CIRCULATION, ETC., REQUIRED BY THE ACT OF CONGRESS OF AUGUST 24, 1912. Of Radio & Television, published monthly at Springfield, Mass., for October 1, 1938. State of New York } ss. County of New York }

Before me, a Notary Public in and for the State and county aforesaid, personally appeared Hugo Gernsback, who, having been duly sworn according to law, deposes and says that he is the editor of the Radio & Television, and that the following is, to the best of his knowledge and belief, a true statement of the ownership, management (and if a daily paper, the circulation), etc., of the aforesaid publication for the date shown in the above caption, required by the Act of August 24, 1912, embodied in section 411, Postal Laws and Regulations, printed on the reverse of this form, to wit:

1. That the names and addresses of the publisher, editor, managing editor, and business managers are: Publisher, Popular Book Corporation, 99 Hudson Street, New York City; Editor, Hugo Gernsback, 99 Hudson Street, New York City; Managing Editor, H. Winfield Secor, 99 Hudson Street, New York City; Business Managers, none.
2. That the owner is: (If owned by a corporation, its name and address must be stated and also immediately thereunder the names and addresses of stockholders owning or holding one per cent or more of total amount of stock. If not owned by a corporation, the names and addresses of the individual owners must be given. If owned by a firm, company, or other unincorporated concern, its name and address, as well as those of each individual member must be given.) Popular Book Corporation, 99 Hudson Street, New York City; D. Gernsback, 99 Hudson Street, New York City; H. Winfield Secor, 99 Hudson Street, New York City.
3. That the known bondholders, mortgagees, and other security holders owning or holding 1 per cent or more of total amount of bonds, mortgages, or other securities are: (If there are none, so state). None.
4. That the two paragraphs next above, giving the names of the owners, stockholders, and security holders, if any, contain not only the list of stockholders and security holders as they appear upon the books of the company but also, in cases where the stockholder or security holder appears upon the books of the company as trustee or in any other fiduciary relation, the name of the person or corporation for whom such trustee is acting, is given; also that the said two paragraphs contain statements embracing affiant's full knowledge and belief as to the circumstances and conditions under which stockholders and security holders who do not appear upon the books of the company as trustees, hold stock and securities in a capacity other than that of a bona fide owner; and this affiant has no reason to believe that any other person, association, or corporation has any interest direct or indirect in the said stock, bonds, or other securities than as so stated by him.
5. That the average number of copies of each issue of this publication sold or distributed, through the mails or otherwise, to paid subscribers during the six months preceding the date shown above is (This information is required from daily publications only.) (Signature of publisher) H. GEINSBACK Sworn to and subscribed before me this 29th day of Sept. 1938. MAURICE COYNE. (My commission expires March 30, 1940.) New York County Clerk No. 562.

Interesting articles to be found in the current issue of

Radio-Craft

TUBES: New Tubes for 1939. Read about the 22 new tubes and B ballasts just introduced.

SERVICING: Making a Service Man's Test Unit The Super-Geno-Scope — Part I. A compact instrument for faster servicing.

SHORT WAVES: Traffic Lights in Your Car—by Radio! A new avenue of business for the Serviceman; helps speed traffic and reduce hazards.

SOUND: Play Talkies Through Your Radio Receiver.

TEST EQUIPMENT: Experiments with Multi-brators—Charles Sicuranza.

—December issue on all newsstands November 1.

Index to Advertisers

A	
Aerovox Corporation	503
Allied Engineering Institute	488
Allied Radio Corporation	491
American Microphone Co., Inc.	490
American Radio Institute	500
Astatic Microphone Laboratory, Inc.	505
B	
Barter & Exchange Free Ads.	506—509
Bernard, H. J.	481
Billie Electric Co.	494
Browning Labs., Inc.	505
Brush Development Co., The	491
Bud Radio, Inc.	491
Burstein-Applebee Co.	497
C	
Candler System Co.	500
Clough-Brengle Company	497
Commercial Notices	506
Cornell-Dubilier Electric Corp.	497
Coyne Electrical School	451
D	
Dataprint Company	488
Dodge's Institute	500
Dutton, E. P., & Co., Inc.	503
E	
Eagle Radio Co.	496
F	
For Sale Ads.	506
G	
Gold Shield Products	505
H	
Hammarlund Manufacturing Co., Inc.	503
Henry Radio Shop	492
Hudson Specialties Company	498
I	
Instructograph Company	500
International Resistance Company	493
J	
Jarnak, Paul	505
K	
Korrol Radio Products Co.	494
Kusterman, Oscar B.	487, 492
M	
McIntosh Electrical Corp.	499
Mass. Radio School	500
Midwest Radio Corporation	Back Cover
Modell's	505
N	
National Company, Inc.	Inside Back Cover
National Plans Institute	496
National Radio Institute	449
National Schools	501
New England Radio Crafters	494
New York YMCA Schools	500
R	
Radio Amateur Course	Inside Front Cover
Radio & Technical Publ. Co.	501
Radio-Craft	500
Radio Publications	504
Radio Training Assn. of America	500
Ralston Record Company	500
RCA Institutes, Inc.	500
Remington Rand, Inc.	512
S	
Sargent, E. M., Co.	497
Short Wave League	494, 495
Solar Mfg. Corp.	490
Sprague Products Co.	492
Sprayberry Academy of Radio	495
Superior Instruments Company	490
T	
Technifax	488
Teleplex Co.	500
Terminal Radio Corporation	494
Test Equipment Company of America	483
Trimm Radio Mfg. Co.	499
Triplet Electrical Instrument Co.	497
V	
Van Nostrand, D., Co.	489
W	
Ward, Montgomery, & Co.	499
Wellworth Trading Company	503
Wholesale Radio Service Co., Inc.	485

(While every precaution is taken to insure accuracy, we cannot guarantee against the possibility of an occasional change or omission in the preparation of this index.)



NC-100 XA

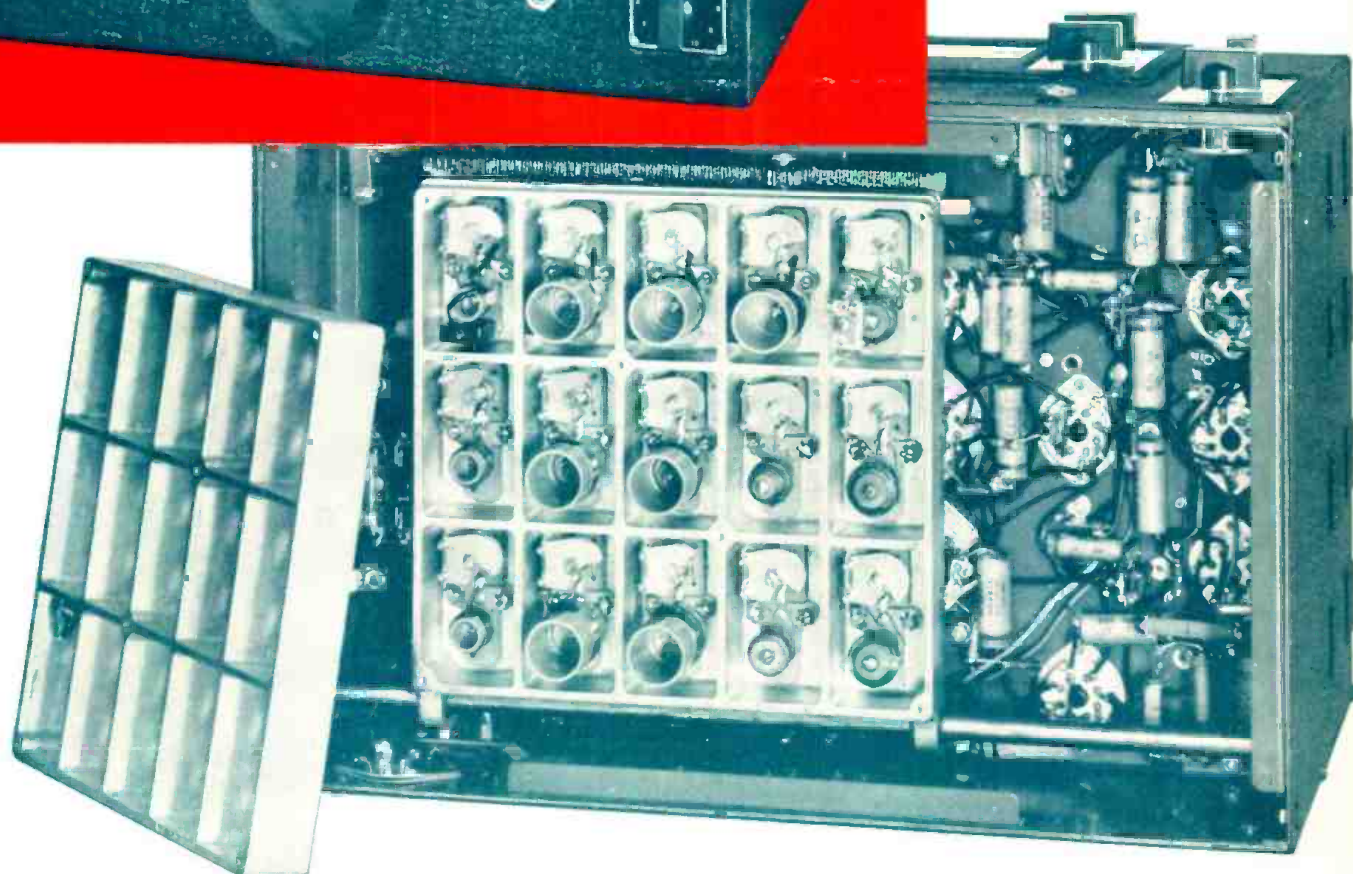

QUALITY THROUGHOUT

Look at the HF coils in the NC-100XA above. Each in its own separate compartment in the heavy cast aluminum shield. Each of low-loss construction, painstakingly wound and carefully matched. Each trimmed by an air-dielectric condenser. And each with the shortest possible leads, for the entire coil assembly moves on a track, bringing the desired coil range into position directly below the main tuning condenser. Such construction is expensive, but it is typical of the quality that extends to every detail . . . National builds to a quality standard, for men who judge receivers on performance.

**NATIONAL
COMPANY**
MALDEN • MASS.



SENSATIONAL MIDWEST FACTORY-TO-YOU SALE

MODERNIZE YOUR OLD RADIO... PUT THIS NEW CHASSIS IN YOUR PRESENT CABINET!

15-TUBE
WORLD-WIDE CHASSIS

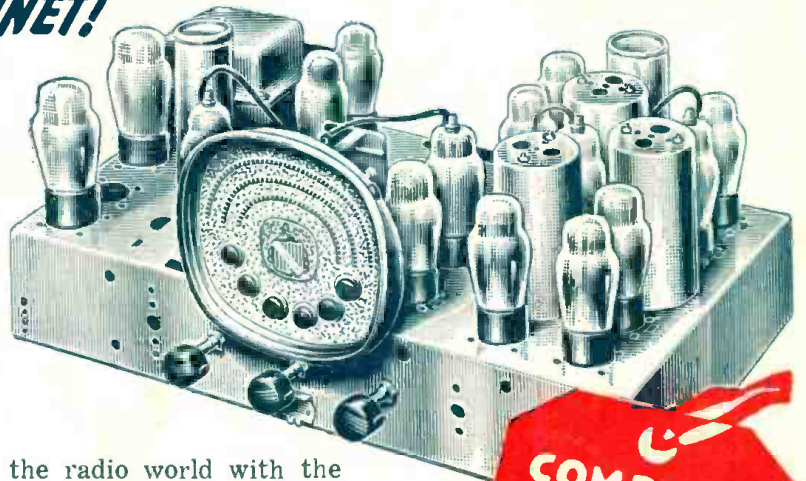

SAVE UP TO 50%

ONCE again Midwest scoops the radio world with the year's greatest radio value! Here it is! A big, powerful, 15-tube, world-wide Midwest. At its sensational factory-to-you price of \$29.95, this new 1939 radio is the biggest bargain in Midwest's nineteen years of pioneering! Why be content with an 8 or 10-tube set . . . when it is so easy to install this new, big, powerful 15-tube chassis (in your present cabinet) for the same price! For a little more than the cost of new tubes, you can modernize your old radio and get exciting world-wide reception.



6-Tube Table Models . . . To 17-Tube 5-Band Radios

Midwest makes a radio to suit every purse . . . and prices are as low as \$10.95. Send for the new 1939 Midwest catalog and feast your eyes on a complete line of magnificent rare-wood consoles even more beautiful than the new Midwest 17-tube Model "D" shown at the left. Now, you can delight in 12,000-mile range on 5 bands, glorious new tone and brilliant overseas reception. Stations on the other side of the world come in like "locals." Many thrilling exclusive features.

NOTE—Midwest radios are sold only DIRECT from the factory by mail—never through stores or dealers!

SEND FOR FREE 1939 FACTORY CATALOG

LIBERAL TRADE-IN ALLOWANCE

Up To \$40.00 For Your Old Radio

The famous Midwest 30-day Trial Plan enables you to try any Midwest radio for 30 days before you make up your mind. You can trade in your old set and receive as much as \$40.00 trade-in allowance. Tell us the make and age of your present radio—so we can determine how much to allow you on it. New Easy-Pay Plan makes it easier than ever before to own a Midwest. Absolute satisfaction guaranteed on a money-back basis. Write today for FREE catalog.

AMAZING NEW EASY-PAY PLAN

30 DAYS FREE TRIAL

PASTE COUPON ON 1¢ POSTCARD... OR

Write Today!

MIDWEST RADIO CORPORATION
Dept. 14-HH Cincinnati, Ohio

Send me your new FREE catalog, complete details of your liberal 30-day FREE Trial Offer, factory-to-you wholesale prices, and big TRADE-IN Offer.

Name..... (PLEASE PRINT CLEARLY)

Address.....

Town..... State.....

User-Agents Make Easy Extra Money. Check Here for details

MIDWEST *Factory-to-You* **RADIOS**

DEPT. 14-HH MIDWEST RADIO CORPORATION...CINCINNATI, OHIO, U.S.A.

Manufacturers of Quality Radios Since 1920