

THE RADIO EXPERIMENTER'S MAGAZINE

HUGO CERNSBACK  
Editor

# SHORT WAVE ★ AND TELEVISION

July

WORLD'S  
LARGEST  
SHORT WAVE  
CIRCULATION

Short-Wave  
Weather Balloon

See Page 118

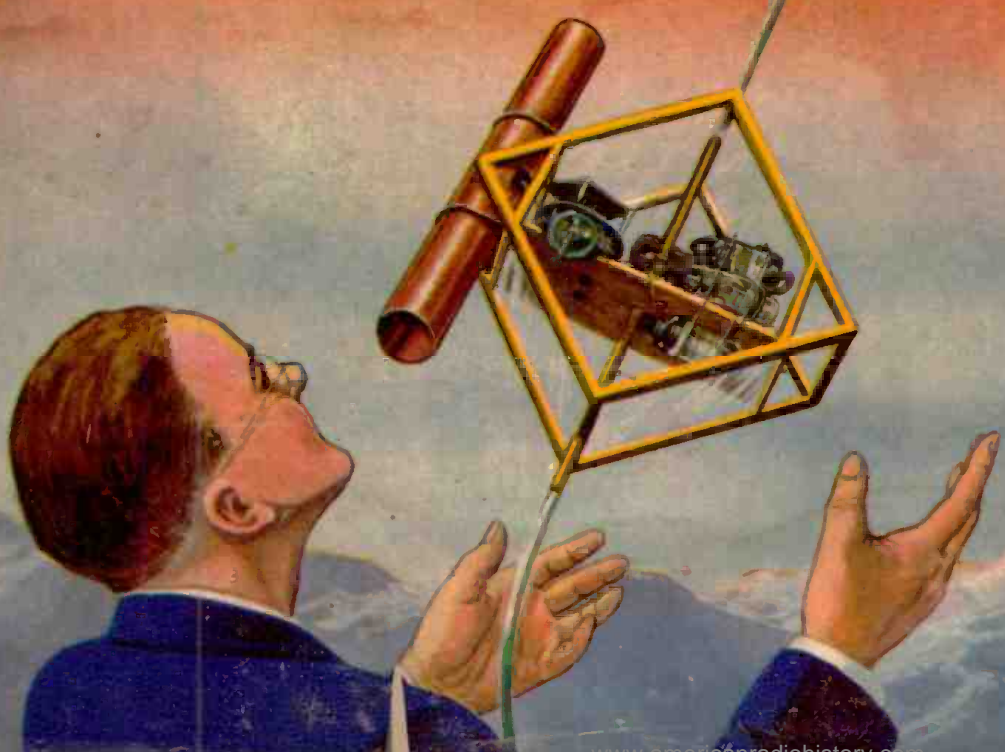

25¢

**RCA ALL  
THE WAY**

# RCA Radio News

RCA Manufacturing Company, Inc. • Camden, New Jersey  
A Service of the Radio Corporation of America

**EVERYTHING IN  
RADIO-MICROPHONE  
TO LOUDSPEAKER**

To the consumer, RCA means high quality performance at low cost...To the radio man, RCA means easier selling, higher profits

## ENJOY NEW RADIO THRILL!

*Thousands Getting New Pleasure  
from Radio that's RCA All The Way!*

The air is full of thrills! Every hour of every day finds colorful, exciting programs being broadcast for you to hear—to enjoy!

As fine as these programs are—it's up to you to get the thrill of radio that's RCA All the Way—perfect performance beginning with the RCA microphone in the studio and coming to you with equal perfection from your RCA Victor receiver. Only by owning an RCA Victor radio can you get this thrill.

### They Cost as Little as \$20

You can enjoy radio that's RCA All the Way at low cost with one of RCA Victor's new 1937 models! They are now on display at your RCA Victor dealer's store. Designed for every purse they cost as little as \$20. Among the many models priced below \$100 are several with RCA Victor's Magic Brain, Magic Eye, Metal Tubes. Every chassis is housed in a beautiful cabinet—and there is a large variety of cabinet styles—one of which is sure to catch your eye. At slightly higher prices are the fine models which feature RCA Victor's latest triumph—the Magic Voice.

But visit your dealer. See and hear these superb radios. Take particular notice of their thrilling performance. Then match them against any other radios of equal price—and RCA will win you!

RCA Victor Console Model 9K3 . . . with Magic Voice, Magic Brain, Magic Eye, Metal Tubes. 530 to 22,000 kcs. Beam Power Amplification. Selector Dial. 9 tubes, \$134.95.



### New Tube Manual!

The RC-13 Manual on RCA Radio Tubes gives service men complete information on all receiving tube types including Metal and G-Series tubes. Get your copy from your RCA tube distributor.

### RCA Radiotron Check-up Restores Radio's Pep and Power

Radios, like anything else that's constantly in use, eventually tire and lose the efficiency which gave you outstanding performance when the set was new.

You can restore your radio's original pep and power—give it new life and “new set” tone by having your radio service man administer the cure-all of an RCA Radiotron check-up.

This check-up consists of 10 testing, cleaning and adjusting steps which cost you only \$1.50.

### Get More Service Jobs— Push the Check-Up

If you're a service man you will discover, as hundreds of other men in your business have, that the RCA Radiotron Check-up Plan not only gives you additional service jobs but in addition, helps you sell parts, new sets and other appliances that you have for sale.

You will find the RCA check-up an easy service to sell. Because there's nothing unusual about check-ups in American life. People are accustomed to check-ups of all sorts. They know the value of check-ups. Therefore, a radio check-up is quite acceptable.

You get selling help, too, direct from RCA Radiotron. For full column advertisements are running in the Saturday Evening Post and Collier's every other week . . . newspaper ads are appearing in over 100 cities . . . the check-up is being featured with commercial announcements on a full hour Sunday radio program. And in every one of these advertising efforts RCA Radiotron is featuring you as the man to perform this check-up service. In addition, RCA Radiotron also offers you mailing pieces for your own use—mailing pieces that will include your own name and address and which will bring you directly to the attention of all your prospects. Secure yours today. Use them. Get behind this check-up service—and profit! You can get full details from your jobber, who will also be glad to tell you about the new RCA Radiotron Auto Radio Check-up.

### This is P. A. Time— The Time to Cash In!

Warm weather and bright sunshine are here. And that means it's P.A. time—and the time for you to cash in on installations of public address systems.

Your prospects? There are many. This season of the year is ideal for outdoor installations such as in amusement parks, athletic fields, camps, resorts, swimming pools and “garden” night clubs.

The best way for you to get your share of this P.A. business is to offer prospects RCA equipment. Public address systems bearing the RCA trademark provide real quality. And that's only natural. For behind them are the years of experience RCA has gained as the world's leading maker of sound products.

RCA offers these portable P.A. models that will cover all your needs for the type of equipment. Both give you the sales advantage of the RCA name. All are literally packed with performance features that help make them easy to sell. All sell at modest cost—yet assure you good profits.

Get after the P.A. market today. Get your share of the profits that are in it. Push the RCA public address systems shown here—and win many installation jobs! Write us for free details.



RCA Portable Sound System PG-98 . . . provides volume for audiences up to 1600 persons. 12 watts. RCA Velocity Microphone. Two Electro Dynamic Speakers. Easily accessible controls. Comes complete with six RCA Radiotrons.

RCA Portable Sound System PG-62-E . . . provides volume for audiences up to 3,000 persons. 20 watts. RCA Velocity Microphone with adjustable banquet stand. Two special Electro Dynamic Speakers. Provides for mixing voice with musical background. Comes complete with seven RCA Radiotrons.



In addition to these two systems shown above, RCA also offers another Portable Sound System, the PG-63-B—a 6-watt system providing volume for audiences up to 600 persons.

# How a "Tip" got Tom a Good Job

**Panel 1:** THERE'S D.J.C. IN BERLIN... THE TENTH FOREIGN STATION TONIGHT. RADIO'S CERTAINLY FUN.

**Panel 2:** HELLO, TOM, HOW'S EVERYTHING? NOT SO GOOD BILL, BUT I'M STILL PLAYING WITH RADIO. HAD D.J.C. LAST NIGHT. IS RADIO STILL YOUR HOBBY TOO?

**Panel 3:** NO, TOM, I'VE BEEN TOO BUSY MAKING GOOD MONEY OUT OF RADIO LATELY TO 'PLAY' WITH IT. YOU'RE SURE LUCKY, BILL. I NOTICED YOUR NEW CLOTHES AND SNAPPY CAR. I THOUGHT YOU HAD INHERITED A MILLION.

**Panel 4:** YOU HAVE THE SAME CHANCE TOM. ABOUT A YEAR AGO I SHOWED YOU A BOOK FROM NATIONAL RADIO INSTITUTE TELLING ABOUT THE OPPORTUNITIES AND FUTURE IN RADIO, AND NOW OTHERS HAD SUCCEEDED THROUGH THEIR HOME TRAINING, WELL I ENROLLED.

**Panel 5:** I'M DOING SWELL IN RADIO, MARY AND I ARE TO BE MARRIED NEXT MONTH. RADIO IS MORE THAN A PLAYTHING. IT'S A BIG BUSINESS AND GROWING FAST. TAKE MY TIP AND GET INTO RADIO NOW, TOM!

**Panel 6:** IF BILL SUCCEEDED, I CAN TOO! THEN I CAN MAKE REAL MONEY SERVICING RADIO SETS. OR GET A JOB IN A BROADCASTING STATION. OR INSTALL AND SERVICE LOUD SPEAKER SYSTEMS. OR MAKE GOOD MONEY IN ANY ONE OF THE MANY OTHER NEW AND GROWING BRANCHES OF RADIO. I'M GOING TO SEND FOR THAT FREE BOOK RIGHT NOW!

**Panel 7:** YOU CERTAINLY KNOW RADIO. MINE NEVER SOUNDED BETTER. THANKS!

**Panel 8:** N.R.I. TRAINING CERTAINLY PAYS. I JUST STARTED A FEW MONTHS AGO AND I'M ALREADY MAKING GOOD MONEY IN MY SPARE TIME.

**Panel 9:** OH, TOM, IT'S WONDERFUL HOW FAST YOU'VE GONE AHEAD IN RADIO. WE NEVER COULD HAVE GOTTEN MARRIED ON THAT YOU WERE GETTING BEFORE.

**Panel 10:** OUR WORRIES ARE OVER, I'M MAKING GOOD MONEY NOW, AND THERE'S A FUTURE AHEAD FOR US IN RADIO.

HERE'S PROOF THAT N.R.I. MEN MAKE GOOD MONEY

**\$3,500 a Year in Own Business**

"After completing the N. R. I. Course I became Radio Editor of the Buffalo Courier. Later I started a Radio service business of my own, and have averaged over \$3,500 a year."—T. J. TELAACK, 657 Broadway, Buffalo, N. Y.

**\$10 to \$25 a Week in Spare Time**

"I am making from \$10 to \$25 a week in spare time while still holding my regular job as a machinist. I owe my success to N. R. I."—W.M. F. RUPP, 130 W. 6th Street, Conshohocken, Pa.

**GET MY FREE LESSON on Radio Servicing Tips**

I'll prove that my Training is practical, money-making information, that it is easy to understand—that it is just what you need to master Radio. My lesson text, "Radio Receiver Troubles—Their Cause and Remedy" covers a long list of radio receiver troubles in A. C., D. C., battery, universal, auto. T. R. F., superheterodyne, all-wave and other types of sets. And a cross reference system gives you the probable cause and a quick way to locate and remedy these set troubles. A special section is devoted to receiver check-up, alignment, balancing, neutralizing and testing. Get the lesson free. No obligation. Just mail coupon.

**... I will train you to start a spare time or full time Radio service business Without Capital**

**Many Radio Experts Make \$30, \$50, \$75 a Week**

J. E. Smith, President National Radio Institute

Do you want to make more money? The world-wide use of Radio sets has made many opportunities for you to have a spare time or full time Radio service business of your own. Three out of every four homes in the United States have Radio sets which regularly require repairs, servicing, new tubes, etc. Many sets are old and will soon be replaced by new models. I will train you to sell, install, service all types of Radio sets—to start your own Radio service business and build it up. Mail coupon for my 64-page book. It's FREE.

**Get Ready Now for a Business of Your Own and for Jobs Like These**

Broadcasting stations employ engineers, operators, station managers and pay up to \$5,000 a year. Spare time Radio set servicing pays as much as \$200 to \$500 a year—full time Radio servicing jobs as much as \$30, \$50, \$75 a week. Many Radio Experts own and operate their own full time or part time Radio sales and service businesses. Radio manufacturers and jobbers employ testers, inspectors, foremen, engineers, servicemen, paying up to \$6,000 a year. Radio operators on ships get good pay and see the world besides. Automobile, police, aviation, commercial Radio, and loud speaker systems offer good opportunities now and for the future. Television promises many good jobs soon. Men I have trained at home are holding jobs in all these branches of Radio. Read their statements in my 64-page book. Mail the coupon.

**Many Make \$5, \$10, \$15 a Week Extra in Spare Time While Learning**

Practically every neighborhood needs a good spare time serviceman. The day you enroll I start sending you Extra Money Job Sheets. They show you how to do Radio repair jobs that you can cash in on quickly. Throughout your training, I send you plans and ideas that have made good spare time money for hundreds of fellows. I give you special Radio equipment for conducting experiments and building circuits which illustrate important Radio principles. My Training gives you practical experience while learning.

**Find Out What Radio Offers You—Mail Coupon Now**

Mail the coupon now for my Lesson on Radio Servicing Tips and my book, "Rich Rewards in Radio." Both are free to anyone over 16 years old. My book describes Radio's spare time and full time opportunities, and those coming in Television; tells about my Money Back Agreement; shows you actual letters from men I have trained, telling what they are doing and earning. Find out what Radio offers you! MAIL THE COUPON in an envelope, or paste it on a penny postcard—NOW!

J. E. SMITH, President NATIONAL RADIO INSTITUTE Dept. 7GB3, Washington, D. C.

**MAIL THIS. Get a lesson and 64 page book FREE**

Dear Mr. Smith, I want to take advantage of your offer. Without obligating me, send me your Free Lesson and your book "Rich Rewards in Radio." (Please write plainly.)

NAME..... ADDRESS..... CITY..... STATE.....

Please mention SHORT WAVE & TELEVISION when writing advertisers

**IN THIS ISSUE: PROMINENT SHORT-WAVE AND TELEVISION AUTHORS**

**Goldsmith • Peterson • Metz • Shuart • Kahlert • Miller • Perrine**

**HUGO GERNSBACK**  
Editor



**H. WINFIELD SECOR**  
Managing Editor

**GEORGE W. SHUART,**  
W2AMN  
Associate Editor

*Combined With*  
**Official SHORT WAVE LISTENER**

**Contents for July, 1937**

Editorial—"Televisual Use of Ultra-High Frequencies,"  
by Dr. Alfred N. Goldsmith.....115

What an A.T. & T. Co. Engineer Has To Say—an inter-  
view with Dr. J. O. Perrine, by H. W. Secor.....116

Around-the-World Radio Echoes, by A. C. Peterson, Jr.,  
Bell Telephone Laboratories.....117

Short-Wave Weather Balloons.....118

Eye and Ear "Signals" Guide Airplane Pilots, by H. I.  
Metz, Bureau of Air Commerce.....119

5-Meter Waves Visible With New Cathode Ray Tube.....120

Beelitz—Where Germany Picks Up Overseas S-W  
"Sigs".....120

Simple 1-Tube Booster Aids "DX" Fan, by G. W. Shuart,  
W2AMN.....121

The Super-10 Receiver "For The Man Who Builds His  
Own," by P. Kemle.....122

40 Watt Transmitter for the "Newcomer".....124

Can Real "DX" Be Worked On Low-Power? by Ernest  
Kahlert, W2BHZ.....125

A Good 200-Watt S-W "Diathermy" Oscillator, by Henry  
Johnstone.....126

Let's "Listen In" with Joe Miller.....128

World S-W Station List, by M. Harvey Gernsback.....129

"Ham" and "Fan" Shack Photos.....130

\$5.00 for Best Short-Wave KINK.....132

Short Waves and Long Raves.....134

What's New in Short Wave Apparatus.....136

Short-Wave QUESTION BOX.....138

Short Wave League—"When To Listen In," by M. Har-  
vey Gernsback.....140

Short-Wave Scout Trophy.....157

World-Wide Short-Wave Review, edited by C. W. Palmer 158

Book Reviews.....159

"Identifying" S-W Stations.....160

**Certified Circuits**



● **SHORT WAVE & TELEVISION** goes to a large expense in verifying new circuits. When you see this seal it is your guarantee that such sets have been tested in our laboratories, as well as privately, in different parts of the country. Only "Constructional-Experimental" circuits are certified by us.

When you see our certified seal on any set described, you need not hesitate to spend money for parts, because you are assured in advance that the set and circuit are bona fide and that this magazine stands behind them.

**SHORT WAVE & TELEVISION** is the only magazine that certifies circuits and sets.

**OUR COVER**

● Short waves are a great aid to our weather experts, and our cover illustration this month shows one of the weather balloons, which carries an ultra-short-wave transmitter. These balloons are released in different parts of the country and they radio back to a *ground* receiving station, important data on the conditions of the upper atmosphere. This information proves extremely valuable to our weather forecasters. Read all about it on page 118.

COPYRIGHT, 1937, BY H. GERNSBACK

Published by **POPULAR BOOK CORPORATION**

404 N. Wesley Avenue, Mount Morris, Ill.

Editorial and Executive Offices - - - - 99-101 Hudson St., New York, N. Y.  
HUGO GERNSBACK, President - - - - H. W. SECOR, Vice-President  
EMIL GROSSMAN - - - - - Director of Advertising  
European Agent: Gorrings's American News Agency, 9A Green St.,  
Leicester Square, London W. C. 2  
Australian Agents: MCGILL'S AGENCY, 179 Elizabeth St., Melbourne

**Features in the August Issue**

- The "S.W. & T." DeLuxe Communications Receiver, by George W. Shuart, W2AMN
- A High Class "Ham" Transmitter, by Arthur H. Lynch
- An Effective Short-Wave Pre-Selector, by Raymond P. Adams
- Getting The "Best Results" From Your S-W Receiver, by H. W. Secor
- The "Surface Wave" In Radio Transmission—Does It Exist?
- Television—Latest News and Pictures
- A Message From Baron Manfred Von Ardenne, Europe's famous television expert
- And all the usual features.

**SHORT WAVE & TELEVISION**—Monthly. Entered as second-class matter May 7, 1930, at the post office at Mount Morris, Illinois, under the act of March 3, 1879. Trademarks and copyrights by permission of H. Gernsback, 99-101 Hudson St., N. Y. C. Text and illustrations of this magazine are copyrighted and must not be reproduced without permission. **SHORT WAVE & TELEVISION** is published on the 1st of every month. Twelve numbers per year. Subscription price is \$2.50 a year in the United States and possessions and Canada. Foreign countries, \$3.00 a year. Single copies 25c. Address all contributions for publication to Editor **SHORT WAVE & TELEVISION**, 99-101 Hudson St., New York, N. Y. Publishers are not responsible for lost manuscripts. Contributions cannot be returned unless authors remit full postage. **SHORT WAVE & TELEVISION** is for sale at all principal newsstands in the United States and Canada. European agents: Brentano's, London and Paris. Printed in U. S. A. Make all subscription checks payable to Popular Book Corporation.



# Televisual Use of Ultra-High Frequencies

Dr. Alfred N. Goldsmith  
Consulting Industrial Engineer

● SCIENCE moves in cycles its wonders to perform! The first method of producing images was that of the optician. This is the most nearly perfect form of color television of which we know. In every camera, light waves coming from considerable distances are caused to form a colored image on a photographic film or plate. The great industries of motion-picture and still-picture photography have been built up around this type of "television." The wavelengths used are extremely short—in fact, much shorter than we shall probably be able to generate and modulate by any direct electrical means which are now foreseeable. The wavelength is about half a thousandth of a millimeter and the hyper-super-ultra-high frequency of these light waves is about half a billion megacycles!

Long distance radio—and even broadcasting—started out by using fairly long waves, hundreds or thousands of meters in length. The "center of interest" in radio has continually shifted toward the *short* waves. Starting with the 10,000- or 20,000-meter transatlantic communication waves of 10 or 15 years ago, there was a gradual shift toward waves between 100 and 1000 meters in length. These were most popular when broadcasting originated and largely determined our present technique in that field. Then the waves from 10 to 100 meters engaged the attention of all who were concentrating on *long-distance* telegraph or telephone communication, and gave a tremendous impetus to progress by commercial organizations and *amateurs* alike. More recently—in fact, within the last few years—the pioneers have explored the domain from 1 to 10 meters (that is, from 300 to 30 megacycles). These ultra-high frequencies are clearly a sort of intermediate stage between the long waves of radio "antiquity" and the light waves which enable us to see and which are the basis of optics, photography, and picture projection. It is but natural that the *televisual* use of ultra-high frequencies should be promising. The ultra-high-frequency waves are short enough to be transmitted with great steadiness under any conditions, and their frequency is sufficiently high to prevent the Kennelly-Heaviside layer from reflecting them (except, perhaps, very occasionally). Here is a *steady* and *high-quality* medium of communication. Further, their frequency is sufficiently high to permit television modulation to be carried out accurately and with-

out too many electrical circuit problems.

The first question facing the television experimenter is: Shall I use 30-megacycle (10-meter) waves or 300-megacycle (1-meter) waves for television? The lower frequency has some real advantages. These waves pass over the average city with less absorption and are more readily generated by efficient and available tubes. However, they have the disadvantage that they are more prone to jump over long distances, thus causing interference in remote localities and complicating greatly the problem of frequency allocation by governmental authorities. They are also more susceptible to natural static than are the higher frequencies in this band.

These higher frequencies (closer to the 300-megacycle region) have the advantage that they are less open to natural static or even man-made interference and that they can be more accurately radiated in given directions or regions by small reflecting antenna systems. They also have the advantage of a controllable and limited range which makes them suitable for easy regional allocation. But they have the disadvantage that it is difficult to generate much energy efficiently on these extraordinarily high frequencies and that the absorption of these waves, even in smaller towns or open country, is high. In fact, "line-of-sight" transmission is practically essential for these high frequencies.

It is probably best to use the lower end of this ultra-high-frequency band for television, at least for local service in the immediate future. It then becomes possible to cover metropolitan areas twenty or thirty miles in radius with a considerable degree of reliability. Interference from automobile ignition systems and medical diathermal equipment will be encountered, but can be reduced or eliminated by orderly campaigns with public support. The television picture which is transmissible on these frequencies is probably of sufficiently high quality to have continuing entertainment value and to satisfy the public. It may be added that sound programs (that is, telephone broadcasting) of *extremely high fidelity* is also possible on these frequencies. All in all, the recommendation of the radio industry to the Federal Communications Commission that the ultra-high-frequencies from 42 to 90 megacycles (excluding the amateur band from 56 to 60 mega- (Continued on page 141)



Dr. Alfred N. Goldsmith, Consulting Engineer; Past President, Institute of Radio Engineers, and The Society of Motion Picture Engineers.

Seventh of a Series of "Guest" Editorials

SHORT WAVE & TELEVISION IS PUBLISHED ON THE 1st OF EVERY MONTH

This is the July, 1937 Issue—Vol. VIII, No. 3. The Next Issue Comes Out July 1

SHORT WAVE & TELEVISION, Published monthly at Mount Morris, Ill.

EDITORIAL and EXECUTIVE Offices, 99 Hudson St., New York City

# RADIO • TELEVISION • COAXIALS

## WHAT an A. T. & T. Co., Engineer Has to Say

An Interview with—

**Dr. J. O. PERRINE**

Associate Editor of the Bell System Technical Journal,  
American Telephone and Telegraph Company

By H. W. Secor



Dr. J. O. Perrine

Dr. J. O. Perrine has aided in the publication of technical papers relating to the development and utility of Transoceanic Radio Telephony. In this capacity he is in a good position to give us what may be considered the latest picture of the situation in this field, and the problems connected with its daily operation; also some of the things we may expect from the new inter-city coaxial cable. He was a captain in the Signal Corps during the World War, and was senior technical officer in the Signal Corps Officers' Training School. Associated with radio and high-frequency phenomena for many years, he now takes the role of spokesman for the many research and operating men associated with radio telephony in the Bell System. Dr. Perrine is also one of the foremost lecturers on science and communication.

● Overseas telephony on a thorough-going commercial basis has just passed its *tenth* birthday and is well on its way toward further extension and development. During this infancy stage we have, with great admiration, watched it grow and seen its service extended to country after country and to the various ships at sea, until at present more

than 93 per cent of the telephones of the world are within reach of a United States subscriber. During this past decade we have seen experimental voice channels set up on a two-way basis from airplanes to ships at sea; and on April 25, 1935, an interconnection of wire lines and three radio (short-wave) channels was set up in tandem, which created a two-way circuit that went completely around the world. Over this round-the-world circuit Mr. Walter S. Gifford, President of the American Telephone and Telegraph Company, talked with Mr. Theodore G. Miller, vice-president of the same company, between two rooms atop the Long Distance building at 32 Sixth Avenue, New York City. The conversation was conducted back and forth with practically the same ease as that over a local connection. Distance has been annihilated, time has been shortened, and the world brought closer together.

Let us reflect a bit at this point. We know that there are good and bad radio days. Some days it is possible for radio amateurs to reach great distances on short waves with relatively small amounts of power, and then there are days when nothing seems to get through. Some days long distances are reached only for short intervals of time. In giving a communication service to the public, it must be on a 24-hour basis every day, seven days a week, etc. Ample power must be utilized to get the message through, regardless of conditions. The telephone company, in adherence to its policy that the message must get through if possible, has utilized every technological facility and improvement available for its circuits. In the field of broadcasting, the transmitter is interested

in reaching as many listeners as possible; accordingly, its waves are allowed to spread out in most all directions, somewhat like a table lamp in your living room. A communication channel, on the other hand, is interested in having its transmitters reach only certain desired receivers; hence its waves are usually concentrated as much as is economically possible in a given direction, somewhat like a searchlight. The antennae systems of the radio transmitters are therefore made highly directional, and thus renders the energy that moves into space more effective. At the receivers of the communication channel, the use of highly directive antennae helps to mitigate noise and interference from the unwanted directions and improves greatly the signal-to-noise ratio.

Thousands of visitors to the Long Distance building at New York and the outlying radio stations have been awed and thrilled to see the telephone plant in actual operation.

There is perhaps no one better fitted to tell us of some of the problems met with, than Dr. J. O. Perrine.

### Early Experiments—First Transoceanic Phone

"Dr. Perrine," I asked, "How long has the A. T. & T. Company been interested in long-distance radio telephony?"

"Let me see now," replied Dr. Perrine. "Our engineers have been experimenting (Continued on page 150)

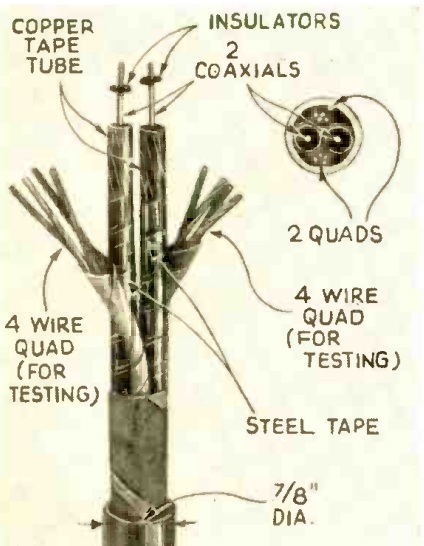

A section of the twin coaxial cable installed between New York and Philadelphia, a distance of about 94 miles.

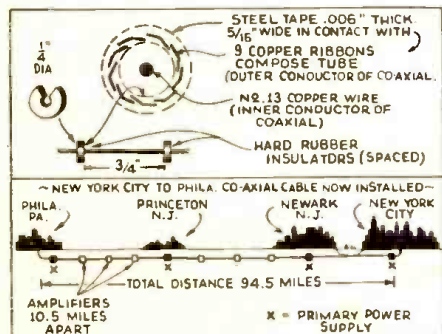

Diagrams above show how copper tube is built up, also "repeater" system between New York and Philadelphia.

The New York terminal of the coaxial cable in the "Long-Lines" Building at 32 Sixth Avenue, New York City. Photo Bell Telephone Labs. >





Fig. 3-A — Conditions at 1:30 a.m. Greenwich time on June 21.

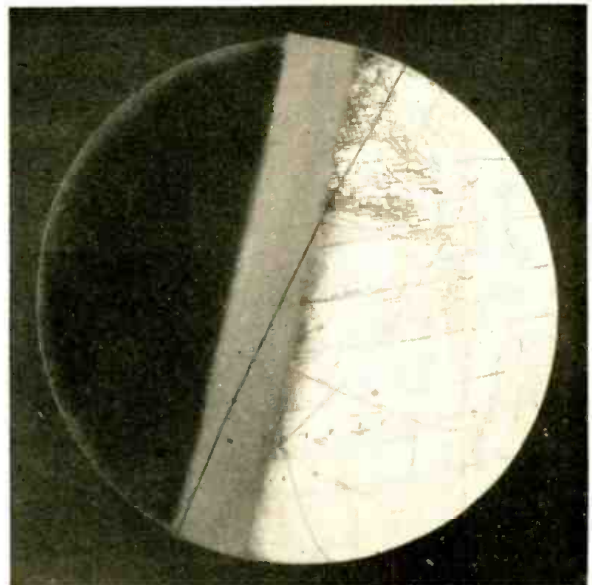

Fig. 3 — Lighting conditions for the position of the earth at 1:30 p.m. Greenwich Mean Time for December 21.

Photos courtesy Bell Telephone Labs.

# Around-the-World RADIO ECHOES

By A. C. Peterson, Jr.,

Radio Transmission Development, Bell Telephone Laboratories

● SINCE the earliest experiments with long wire telephone circuits, echoes have been a source of annoyance. They are normally caused by the reflection of energy at impedance irregularities along the transmission path. In radio transmission, where the signal energy is confined only by the earth and the ionosphere, echoes are caused by the signal arriving at the receiver after travelling over different paths. Since these paths may differ considerably in length, there is a corresponding difference in the time of arrival of the signals, and thus the effect on reception is similar to that of echoes caused by reflection on wire lines.

Radio waves passing between two points on the earth follow great circle paths, that is, paths lying wholly in a

plane determined by the two points and the center of the earth. For any two points which are not diametrically opposite each other there is only one such plane, but there are two directions that a radio signal can take in passing from one point to the other. This is illustrated at the left of Figure 1 for transmission from London to New York. One path extends westerly from London in the great circle plane, and the other follows a reverse track around the earth in an easterly direction from London. The direct signal, having much the shorter distance to travel, reaches New York first, while the reverse-path signal, travelling farther, arrives later, and appears as an echo.

Besides these two paths in opposite directions there are also echo paths due

to signals passing the receiver, completely encircling the earth one or more times, and being received again on each transit at a diminishing intensity. A signal may start easterly from London, reach New York, and then continue on around the world one or more times before it becomes inaudible. Such echo paths are illustrated in the center of Figure 1. A signal may also start westerly from London, and after reaching New York continue on around the world as indicated at the right of the illustration. From the point of view of the receiver, echoes fall into two groups: one group, called front around-the-world echoes, reaches the receiver from the same direction as the direct signal; the other group, including the reverse-path (Continued on page 146)

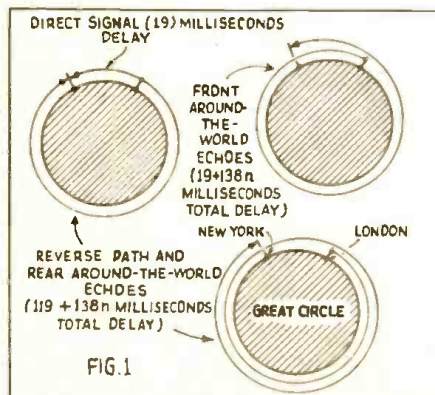

Fig. 1—A radio signal from London to New York may cause an echo by travelling around the world in either a westerly or an easterly direction, and in either direction it may encircle the earth one or more times.

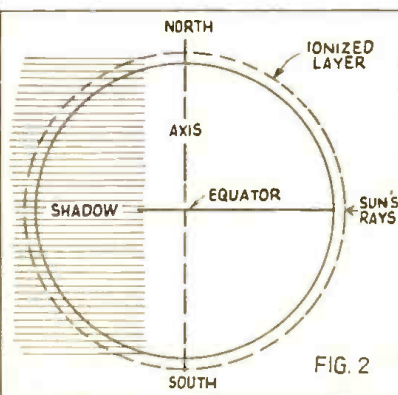

Fig. 2—One-half of the surface of the earth is always illuminated by the sun, but at an altitude of 150 kilometers (90 miles) the illumination extends about 12 degrees beyond the illuminated surface of the earth, as shown above.

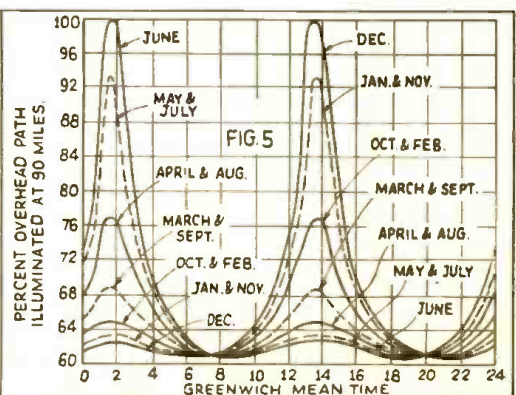
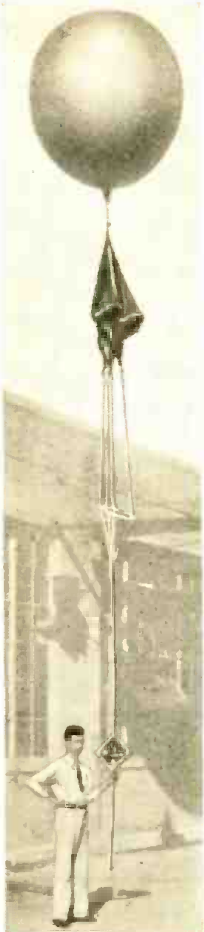

Fig. 5—Percentage illumination of the around-the-world great circle path from London to New York for various months of the year.

# Short-Wave Weather Balloons Provide Data On Upper Atmosphere

The latest method of obtaining weather reports automatically from the upper atmosphere, is by means of balloons which carry tiny 5-meter transmitters. Certain signals recorded automatically on a chart in a ground station indicate variations in air pressure, temperature and humidity.



● ONE of the latest devices to help determine the weather conditions in the upper atmosphere is the featherweight short-wave transmitter here illustrated. This newest type radiometerograph was developed under the direction of Dr. L. F. Curtiss, physicist of the National Bureau

light the filaments of the tubes.

One of the newest features is the lightest weight 45-volt "B" Battery ever designed and built. These batteries are shown in the photos and were developed by a prominent American battery manufacturer; they are even smaller than the 30-type tubes; a very fine tribute to our battery designing engineers.

The balloon transmitter is keyed by a tiny electric motor weighing but 27 grams (less than 1 ounce) and it sends out signals regularly every 15 seconds. In between these fixed radio signals occur the signals which indicate air pressure, temperature and humidity. These signals are very short so that the

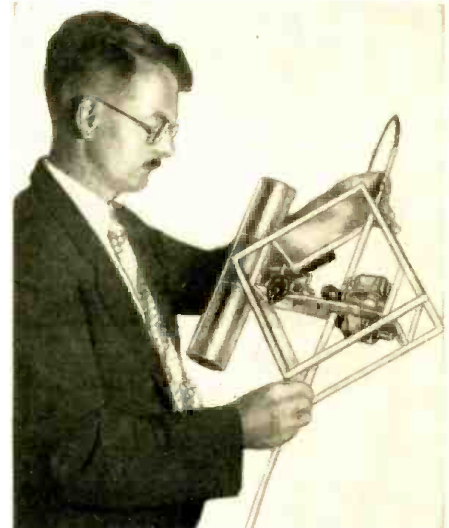

Dr. L. F. Curtiss holding featherweight "balloon" transmitter.

Left—One of the hydrogen-filled weather balloons ready to be released. Tiny 5-meter transmitter is shown secured to the tail of the balloon.

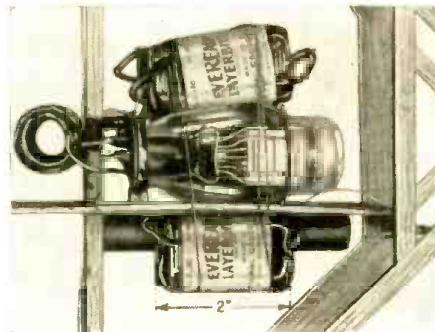

This picture shows the two 30-type tubes which are connected in a push-pull circuit, together with the newest type miniature 45-volt "B" batteries.

of Standards, at Washington, D. C., and through whose courtesy we are enabled to provide this data.

One of the accompanying diagrams shows the push-pull transmitter circuit used for the featherweight balloon sets. This circuit utilizes two 30-type tubes and they are connected in push-pull. As Dr. Curtiss points out, these tubes were selected because of their low cost (in the event that the transmitter is not recovered) and also due to their low filament drain. This is a very important item as becomes apparent, as only a small battery can be provided to

menous distance over which the signals from the tiny, extremely low-power balloon transmitter have been received—100 miles! Equally interesting is the fact that signals have been recorded from the balloons at an altitude as great as 24 miles (127,000 ft.).

The method of using the balloons is rather novel. The balloon, the size of which is seen from the photograph, is filled with hydrogen gas and the balloon is closed. At the maximum altitude to which the balloon ascends it bursts, and this factor, of course, will vary with the condition of the air, etc. When the balloon bursts the tiny radio transmitter is carried to earth by a parachute, to prevent damage to persons or objects on the earth at the point of landing. Dr. Curtiss states that it is hopeful that in the near future that these short-wave balloon transmitters can be made so cheaply that it will not be worthwhile to attempt their recovery in good condition.

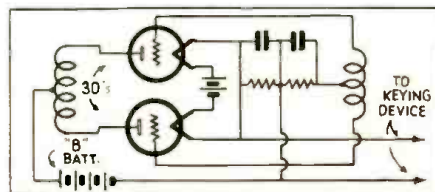
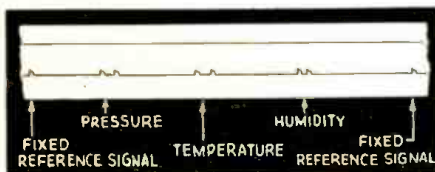

Diagram of the 5-meter transmitter is given above.



The special super-regenerative receiver used at the ground station to record the signals from the balloons; the recorder is shown at the left of the picture.



A typical chart, as recorded by the apparatus shown above, is here reproduced. By the sequence of signals the experts are able to interpret them to read varying degrees of air pressure, temperature and humidity.

transmitter is off most of the time.

The type of receiver used at one of the ground stations is quite interesting. Contrary to expectations it is not of the superheterodyne type but of the super-regenerative pattern. This receiver is arranged to work a special pen recorder and one of the typical reception charts is reproduced on this page. The notches on the continuous line across the chart show where the various balloon signals are received, and as the chart moves at a given time rate and has besides a time graph recorded on the chart, the reception of the signals is accurately clocked.

The antenna used for receiving the balloon signals is a 5-meter half-wave doublet mounted in a vertical position. The exact frequency used is 55 megacycles, or 5.4 meters. The most astonishing fact of all perhaps, is the tre-

A typical "ground" receiving station where the 5-meter signals from one of the balloon transmitters is picked up and automatically recorded. A vertical half-wave doublet is employed.





# EYE and EAR "Signals"

## Tell Pilot He Passed Beacon

By H. I. Metz

Assistant Airways Engineer, Bureau of Air Commerce

The latest ultra-short wave beacons devised by the Bureau of Air Commerce utilizes a high-pitched signal radiated vertically on a wavelength of 3.9 meters. As the pilot passes over a radio range-beacon he receives two signals: one—a flashing light, and the other a high-pitched aural signal which he hears in his headphones.

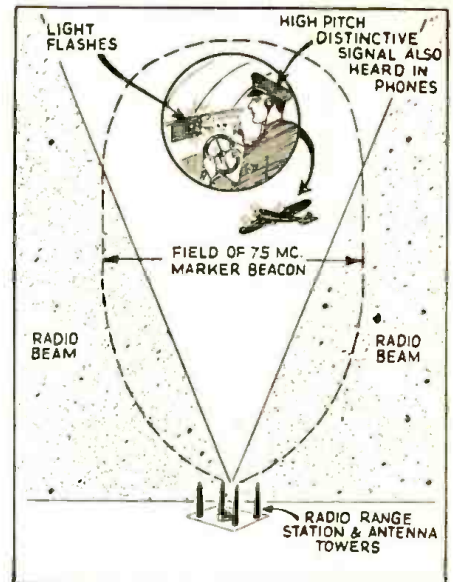

● A RELIABLE beam of radio energy directed skyward and supplementing the familiar "cone of silence" of a radio range beacon has been recently developed by the Bureau of Air Commerce. Development work on this vertical beam, known as a "Z marker," has been in progress in the field and laboratories of the Bureau by the radio development section under the direction of William E. Jackson, chief of the section for several years. Recent advances have produced exceptional results.

Trial installations of the latest equipment have been made at Chicago, Kansas City, Newark, and Washington, the Washington installation being reserved for further testing of numerous refinements. The new installations operate on a frequency of 75 megacycles (3.99 meters) with 3,000 cycle modulation. All of the original trial markers, which operated on 91 megacycles with 60-cycle modulation, have been shut down.

The special 6¼ pound airplane receiver developed by the Bureau to utilize these marker signals provides both aural and visual indication for the pilot. The aural signal is obtained by connect-

ing the audio output of the new marker receiver in parallel with the output of the regular range receiver. The pilot, in flying the regular range signal, hears the marker signal superimposed on the range signal as the ship passes over the range station. It becomes audible slightly before the ship passes into the

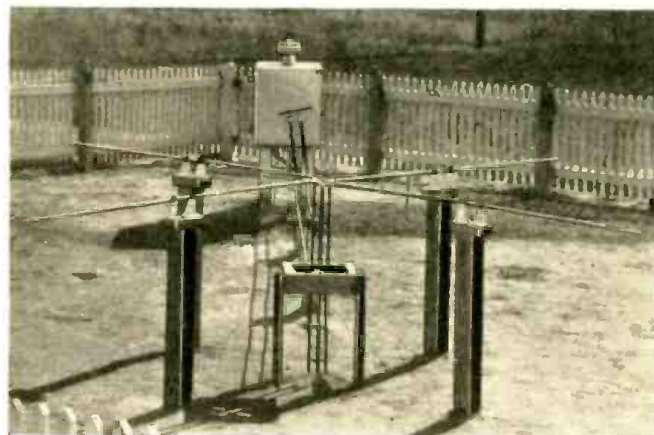

Fig. 3—Shows the transmitting antenna array used for radiating the vertical "Cone of Silence" marker signal.

This diagram shows how the 3.9 meter or 75 mc. "Cone of Silence" radio marker signal is radiated by the special transmitter here described, causing both an "aural" as well as a "visual" signal to notify the pilot that he has just passed a range beacon.

switchboard lamp mounted on the instrument panel adjacent to the flight instruments. It remains lighted over most of the period that the marker signal is audible.

The receiver, shown in figure 1, is a simple detector and audio amplifier consisting of a 954, a 6F7, and an 85 tube. The output circuit contains a 3,000-cycle band pass filter to avoid erroneous indications. Other circuit details are shown in the diagram, figure 2. These characteristics were measured with a G. R. type 604B signal generator adjusted for 30 percent modulation. The sensitivity was 460 microvolts, and can be varied from a maximum of about 300 microvolts by adjustment of the tap on the detector grid coil.

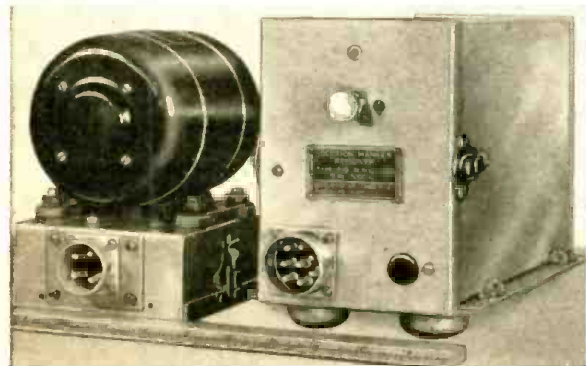

Fig. 1—Here is the extremely light-weight airplane receiver designed for picking up the "Cone of Silence" marker signal.

usual "cone of silence," and increases rapidly to a predetermined maximum loudness. The maximum signal strength remains constant for a considerable period, depending upon speed and altitude, and then fades away. Being of high pitch, the marker signal causes no interference in reception of range signals.

The visual signal is a standard 12-volt white

Several Types Tried  
Several types (Continued on page 142)

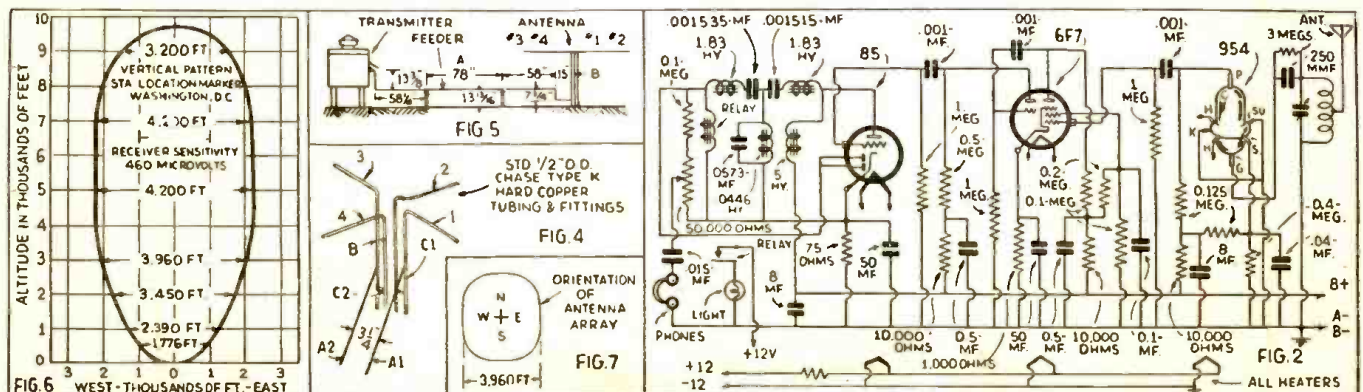

Fig. 2—Shows diagram of 75 mc. receiver with relay for flashing light signal. Fig. 3—Arrangement of transmitter, feeder and antenna. Fig. 4—Arrangement of transmitter, feeder and antenna. Fig. 5—Vertical wave patterns of 75 mc. signal. Fig. 6—Horizontal pattern of a signal at 3,000 ft. observation level.

# 5-Meter Waves Visible With New Cathode Ray Tube

● A NEW cathode ray tube with an entirely new method of beam deflection has recently been developed in Europe and is at present the most discussed subject among engineers and scientists abroad. The operation of this new device stands for something entirely new in the field of cathode ray tube application and design, and reminds one of a cross-breed between an electric-motor and a cathode ray tube.

The main principle of the new device is the combination of two deflection plates with a pair of coils; the latter are, of course, installed outside the tube. The two plates mentioned are placed direct-



Above—the special concentric cone electrode which is used to provide radial deflection.

ly in the propagation path of the cathode ray beam, which is produced as usual in the neck of the tube. When the beam enters the space between the two plates something strange happens; it is thrown out of its regular path of straight forward propagation, and is forced to rotate in a circular form.

But this is not the only obstacle placed into path of the beam. After it has passed the motor-combination (consisting of the two plates mentioned and a pair of coils) which forces the beam to rotate, it is confronted with a cone-condenser of co-axial design. The beam must pass through this condenser before it can reach its final target, namely the fluorescent screen.

While passing the co-axial condenser, the beam is "pulled up and down," of course in a radial direction, i.e., from the center axis of the tubes towards the wall and vice versa. (Continued on page 149)

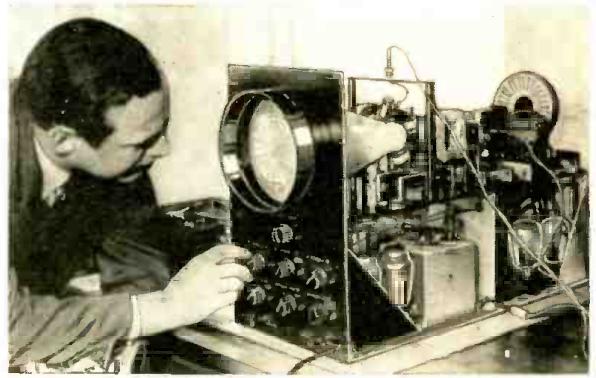

Baron Manfred Von Ardenne shown with his newest invention—a cathode ray oscilloscope which has a circular rotating beam.

Extreme left—typical oscillogram showing two impulses separated about 7 millionths of a second.

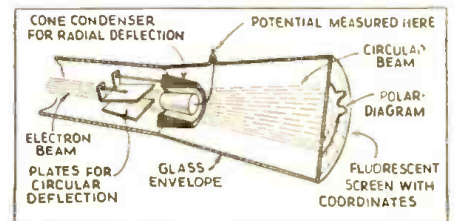
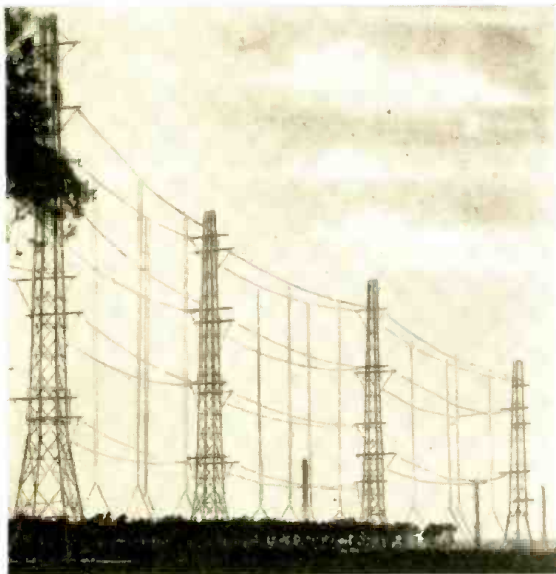
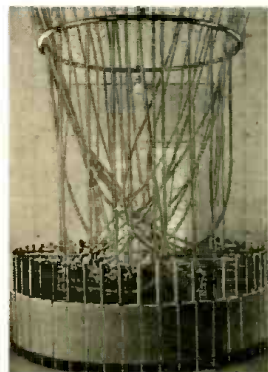

Diagram showing how cathode ray is deflected by electro-static cone condenser.



Above—View of some of the antennas at the German short-wave receiving station at Beelitz, near Berlin. A "reflector" is used behind the aerial. Left—Giant antenna switch controlling the connections of three receivers and 40 directional aeri-als.



● THE accompanying photos show some interesting views of the newest short-wave receiving equipment at Germany's trans-Atlantic receiving station located at Beelitz, near Berlin. The large photo at the left, shows part of the elaborate short-wave antenna system; 40 aeri-als similar to the one shown being installed around the receiver building. Each aerial section between two towers has 16 dipoles. Behind each antenna there is a reflector, and these two can be interchanged by an elaborate switching system shown in the lower left-hand photo. Push-button control

# BEELITZ – Where Germany Picks Up Overseas S-W "Sigs."

permits the operator to use any combination of aeri-als desired. Three receivers can be operated from each antenna set-up. The central photo shows one of the interchangeable oscillators which can be handled the same as a plug-in coil; the one shown has a range of 10 to 14 meters.

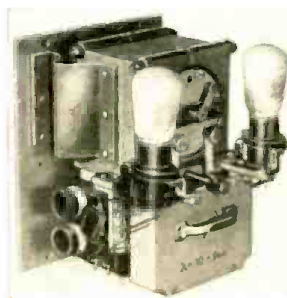

Above—Photo shows one of the interchangeable local oscillators for 10 to 14 meters range. Right—Appearance of one of the air and water-tight trans-Atlantic receivers, which uses 24 tubes. Receivers are also vibration proof.

One of the photos, shows an ultra-short-wave receiver of the type used for short-wave reception from America. It uses 24 tubes and it is air, gas, and water-tight, and also will withstand vibration caused by air attacks. The apparatus shown has been designed by the famous "Telefunken" engineers.

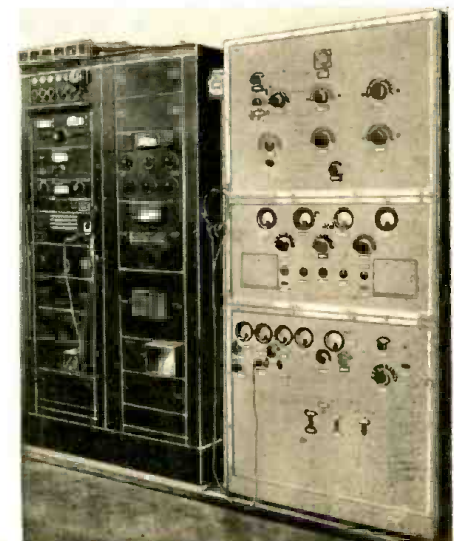

# Short-Wave Beginner

## SIMPLE 1-TUBE BOOSTER

### AIDS "DX" FAN

By George W. Shuart, W2AMN

Did you ever attempt to tune in a distant short-wave station, and finally give up in disgust, because your set could not bring in the voice loud enough? This very simple 1-tube booster will solve the problem for you, and greatly increase the range of the average short-wave receiver.

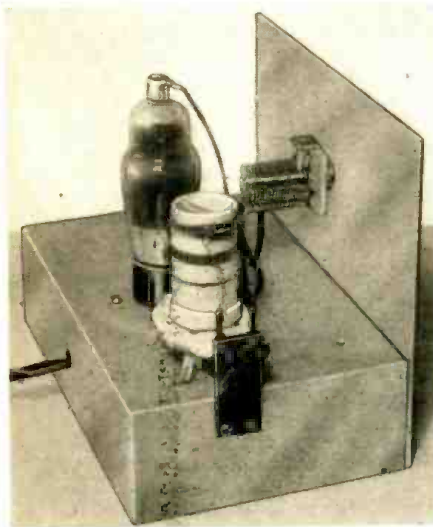

A rear view of the "weak signal" booster.

● THERE are undoubtedly many short-wave "fans," amateurs, or experimenters who now possess receivers which can well make use of additional amplification. The booster or pre-amplifier about which we are presently concerned offers a method of improving the operation of certain types of receivers in many ways. For instance, the main advantage is in the additional amplification made possible through its use. The greatest difference will be noticed in the strength of the very weak signals. Also there will be a somewhat better ratio of signal-to-noise. In certain types of superheterodynes the addition of the preselector of this type goes a long way toward reducing, or eliminating images. Then again, receivers not provided with coupling arrangements suitable for doublet antennas will benefit in that a doublet may easily be used with this instrument.

The main consideration was whether or not *regeneration* should be used in the booster. The addition of regeneration provides an extra control, however, its cost is very small and its addition provides greatly increased selectivity and sensitivity. In fact, the regeneration control may be set at a point where it need not be changed over the entire tuning range of the booster or it may be adjusted to a more critical point for maximum sensitivity. The flexibility in this regard favored its being incorpo-

rated. The method of obtaining regeneration is via the conventional cathode tap commonly referred to as *electron coupling*.

In the photograph we note that the antenna coupling coil is mounted so that it may be varied with respect to the grid coil. This adjustable coupling is really essential for maximum efficiency. In the diagram we find that there are two methods of coupling this booster to the present receiver, that is, the one with which it is to be used. Most receivers of later design employ a separate antenna coil in the input stage, while others employ the capacitive method which means that the antennas are coupled through a very small capacity connected directly to the grid side of the input circuit.

There are a number of antenna systems which may be used with this booster, four of the most prominent and effective



The 1-tube R.F. booster viewed from the front.

ones are shown in the diagram; one is a half-wave doublet with *spaced* feeders. The other employs a *twisted pair* for feeders or lead-in. The twisted lead-in arrangement is more convenient, although its electrical operation is not as flexible as the other. The spaced feed-line will provide a wider frequency response than the twisted pair, inasmuch as a condenser may be employed to tune the spaced line.

In another sketch, we have shown the Zeppelin or single wire with antenna having spaced feeders at the end. Twisted feeders should *not* be used with this type of (Continued on page 143)

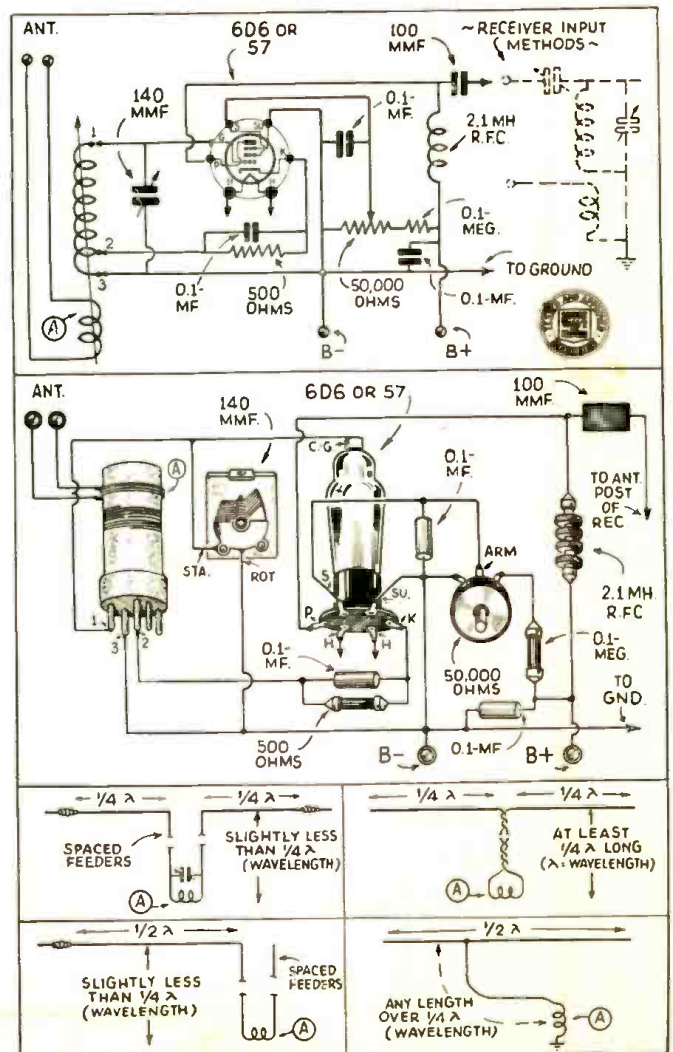
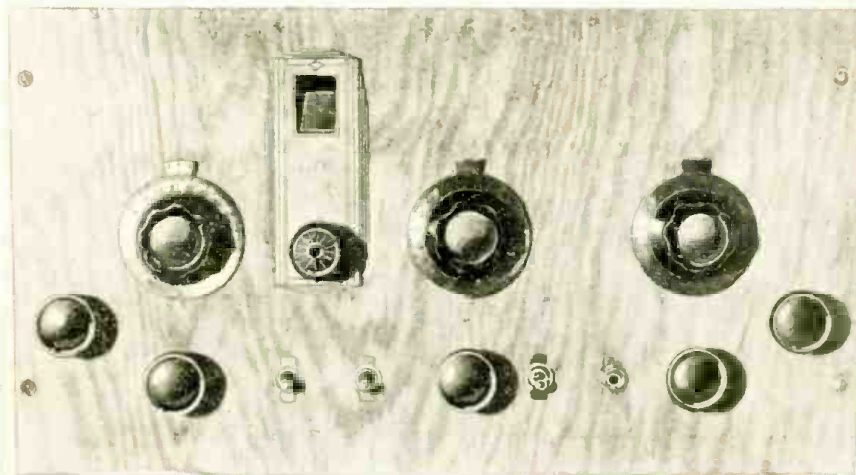

Diagram of pre-amplifier and improved antenna connections.

# The SUPER-10 • A Receiver

By P. Kemle



Front view of the Super-10 receiver.

First the three filter condensers; at the extreme left hind corner is the power transformer; to the right of the power transformer is the filter choke; to the right of the choke is the 80 rectifier tube. Right behind the drum dial is the 6K7 B.F.O. tube; behind it the B.F.O. transformer. Immediately behind the first detector is the input I.F. transformer. To the right of it the 6K7 I.F. tube, and next the output I.F. transformer. In the centre line at the left the B.F.O. transformer. To the right of it the 6C5 first A.F. tube. Next to the right the 6H6 second detector. At the extreme back to the right of the 80 rectifier tube are the pair of 6F6's (second A.F.).

As you may notice there are two tube sockets not used. They were originally intended for amplified A.V.C. but after I had the receiver working, it was so satisfactory that I left it out.

#### Plug-in Coils Used.

I have experimented at length and finally decided to stay with plug-in coils. Although the front panel may not be as modern as when a tuning unit is employed, it is more efficient and to an amateur, efficiency counts after all. I have all metal tubes, with the exception of the rectifier—which is glass—in order to keep the R.F. gain as high as possible. Metal tubes present two great advantages for the high frequency section of a super het. First, there is the increased gain made possible by the improvement in design over glass. One advantage is the better shielding afforded. Second, is the employment of the 6L7 type tube for the first detector mixer. The 6L7 is probably the best "mixer" now available. Its use assures a high conversion gain of the first detector oscillator combination.

• IN these days of such excellent commercial type Ham receivers for sale at prices just about equal to the cost of parts, it may be asked why anyone should want to build his own set. A commercial receiver may bring in foreign stations one hundred per cent, but the greatest credit goes to the man who receives a goodly number of "DX" stations on a completely "home-built" job.

The receiver about to be described was built with this feeling in mind, and while it may not outdo a manufactured receiver, its performance leaves little to be desired, considering cost and home construction.

#### Numerous Controls Provided

The panel as may be seen in the photograph is fitted with controls for literally everything in the set. The main dial (drum-type) is located a little to the left of the center. The knob to the left of the main dial is the oscillator band-setting condenser; the knob to the right of the main dial is the first-detector band-setting condenser and the knob at the extreme right is the R.F. band-setting condenser.

The knobs at the extreme left and right are used as drawer handles where the chassis pulls out as a drawer, sliding at the bottom. It is necessary that the chassis pulls out for the exchange of the plug-in coils.

In the lower line of controls the one on the left, right below the oscillator control is the tone-control and A.C. switch. Below the main dial (drum) on the left is the B.F.O. switch; to the right the "stand-by" switch. Right below the first detector knob is the special audio control; to the right of it is the A.V.C. switch, then next the phone jack. Right below the R.F. knob is the R.F. "gain" control.

The panel measures 12 x 20 inches, made of three-ply fir veneer, finished like the rest of the cabinet and lined with a thin sheet of aluminum to eliminate hand-capacity.

The speaker is mounted right below the panel on a piece of Celotex 20 x 22

inches, 1 inch thick; the lower end is in line with the cabinet, while the top is 7 inches back, to give the Celotex panel a slanting position. The result is a wonderful improvement in quality, even with high "Q" iron core I.F. transformers.

#### Layout of Parts

The chassis is 12 x 17 inches, 3/16 of an inch aluminum, 3 inches deep. The three shields dividing the three stages, oscillator, first-detector and R.F. are 1/16 of an inch aluminum. The single box at the left of the drum dial is the 6J7 oscillator. In the centre or to the right of the drum dial is the 6L7 first detector. On the extreme right is the 6K7 R.F. stage. Immediately behind the oscillator stage is the power-supply.

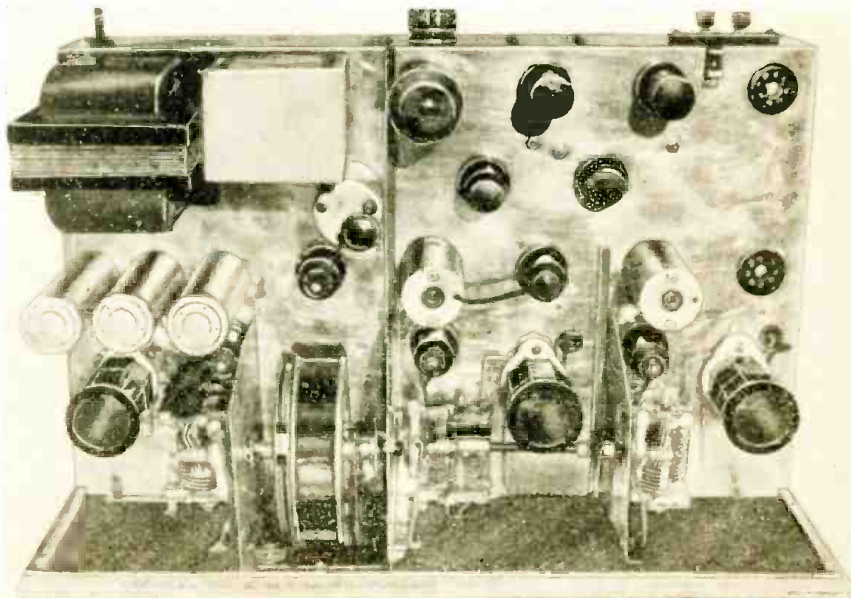

Chassis of the Super-10 receiver, showing shielding and layout of tubes, etc.

# for the MAN Who Builds His Own

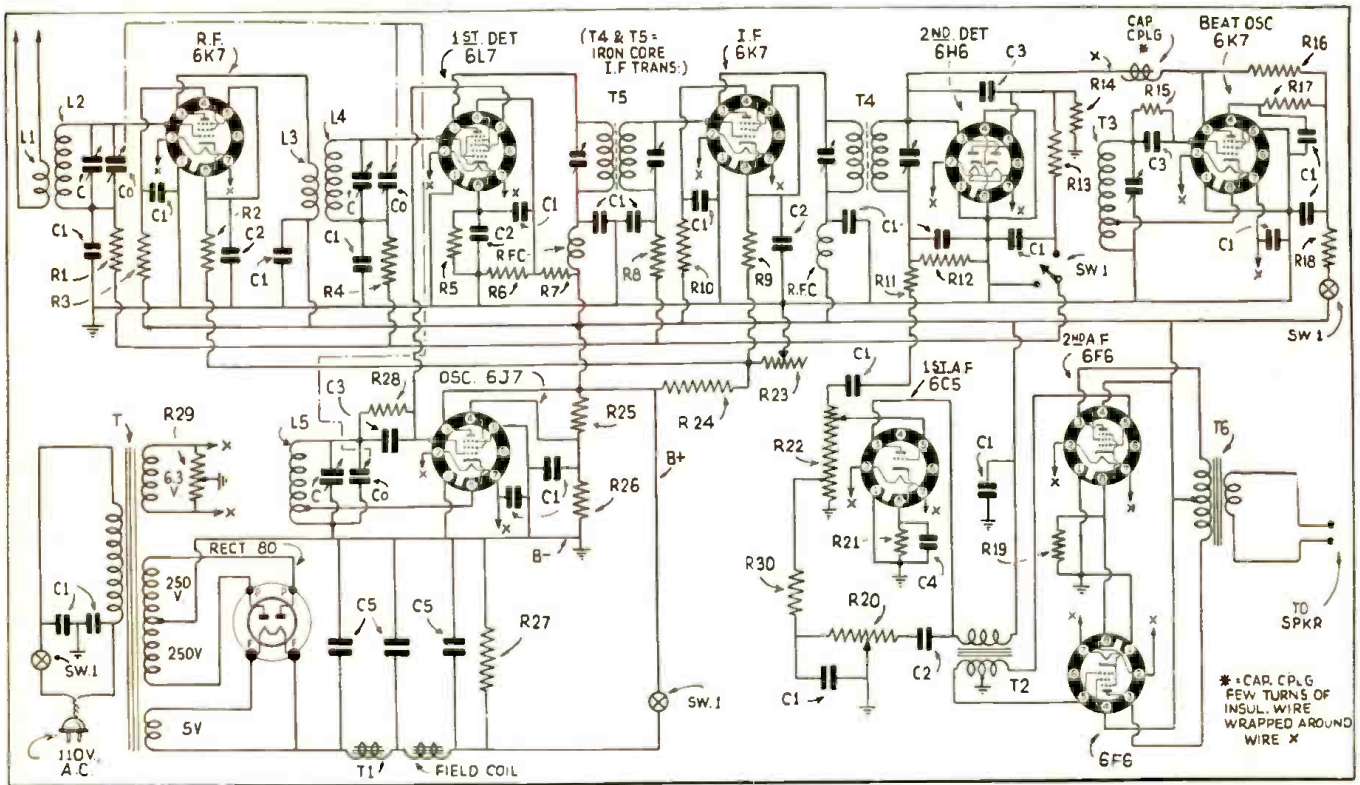

Wiring diagram of the "Super-10" receiver, which includes rectifier and filter.

The selectivity is taken care of by one stage of I.F. using modern iron-core I.F. transformers. The degree of selectivity thus obtained resembles a single-signal effect.

The second detector uses the popular 6H6 double diode tube. This tube, in addition to handling large inputs without distortion, makes possible the production of proper automatic volume control voltage for minimizing fading in the simplest manner. The *beat-frequency* oscillator when switched on produces a heterodyne whistle on all stations, which renders the location of weak phone or broadcast station easy. It is coupled from its plate with 7 turns (*insulated*) to the grid lead of the second I.F. transformer.

### Audio Circuit—Head-phones

The Audio circuit is as simple as it is good, with a special taper control. A single 6C5 triode feeds through a high quality audio transformer to a pair of push-pull 6F6 power amplifier tubes.

Head-phone output is taken from the output transformer, the speaker being automatically disconnected when the phone plug is in circuit. This permits of "DX" hunting with a pair of ear-phones, without disturbing all the rest of the family. This feature is particularly useful late at night or early in the morning. (Jack not shown.)

In wiring the filament circuit should be done first; next all R.F. leads should be put in place. After that all by-pass condensers and resistors should be wired in.

The mounting bolt for each socket should have a soldering lug placed under its nut, and this lug used as the *ground* point for all by-pass condensers connected to the circuit of that particular tube. This gives *single-point grounding* for each stage, which is necessary for complete stability of all circuits. These grounding lugs can be soldered directly to the adjacent shield connections of the sockets. No. 16 solid tinned push-back (copper) wire was used throughout the receiver. No leads had to be shielded in the original receiver.

As can be seen in the top of chassis photo, the power-supply is "built in." Its condenser input is a 30 henry 150 ma. filter choke with the speaker field used. Both A.C. lines are by-passed by .01 mf. paper condensers. It is of importance that all parts be of very good quality. It will pay. First, better service. Second, longer service—with less trouble.

### Tuning

By setting the band-setting condensers at the beginning of the band, the three band-spreading condensers coupled with the main dial (drum type) spreads the band over 50 to 70% of the dial.

This 10-tube receiver provides loudspeaker or head-phone reception on the principal bands. Other features are—continuous band-spread, built-in power supply, double-diode detector, beat-oscillator, plug-in coils for different bands, iron-core I.F. transformers, and the use of metal tubes—except the rectifier.

### Line-Up

The I.F. transformers should be lined up with an oscillator if possible. Also a good job can be made if very careful lining up is done with an incoming signal.

### The Cabinet

The cabinet is of the mantel type, very frequently seen over fire places. I found it very comfortable to have my books close at hand. Any handy man should be able to construct it. It is made of ¾ inch clear fir, 4 feet 8 inches long, 4 feet high and 12½ inches deep, and has one door on each side. In the centre at the bottom is the speaker and above the panel with controls. There are two shelves on each side about 15 inches long. Cabinet is also home-made with the exception of doors. They are factory-made to fit opening 1 inch thick.

### Legend

#### KENYON

- T—Power Transformer
- T1—30H 150 ma. Filter choke
- T2—Push-pull "input" transformer
- T6—"Output" transformer and speaker

#### HAMMARLUND

- T3—B.F.O. transformer 465 kc.
- T4-5—Iron-core I.F. transformer, 465 kc.
- C—100 mmf. Var. Cond.
- CO—35 mmf. Var. Cond.

#### CORNELL—DUBILIER

- C1—.01 mf. paper
- C2—.1 mf. paper
- C3—.0001 mf. mica
- C4—10 mf. Electrolytics low voltage type
- C5—8 mf. Electrolytics

(Continued on page 145)

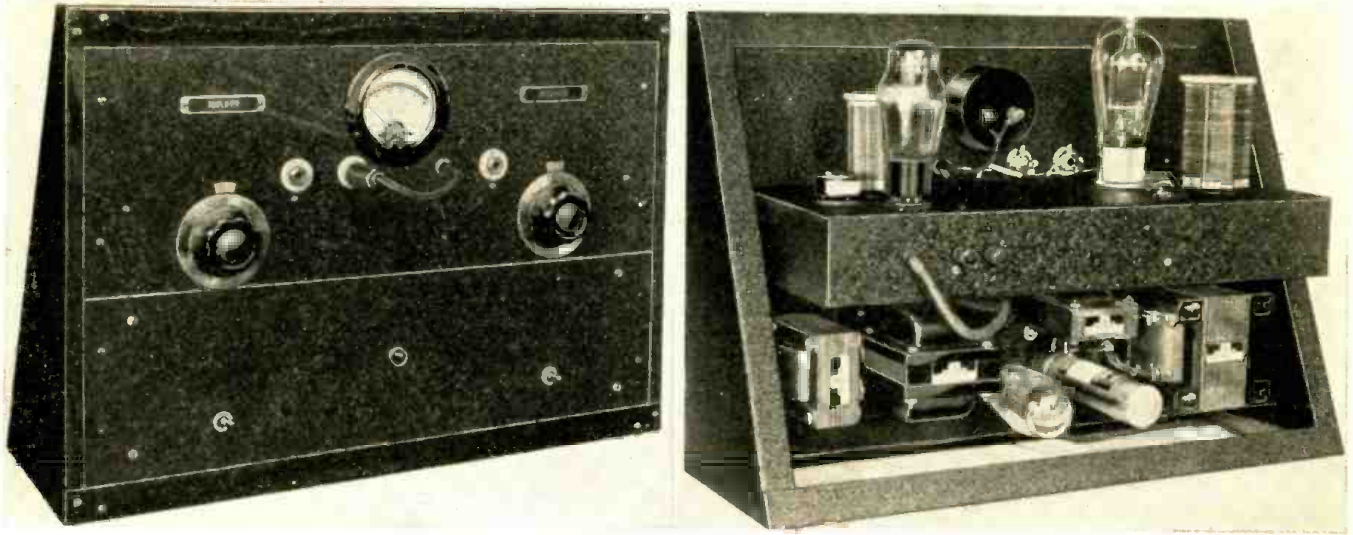

Above—front view of the transmitter; it is crystal-controlled. Rear view appears at right.

# 40 Watt Transmitter for the "NEWCOMER"

● THE greatest problem which faces the newcomer to "Hamdom" is the choice of his first transmitter, not so much due to the lack of material to choose from, but perhaps due to the multitude of various circuits and combinations, all of which undoubtedly have their good points.

Simplicity and efficiency should be the object in any case, and we believe the transmitter described in this article is an ideal one for the beginner. It consists of a tet-trode beam tube (6L6) oscillator driving a T-20 triode and the overall output is approximately 40 watts. It was primarily designed for 80 meter operation and complete data for that band will be given. However, by the choice of proper coils and a suitable crystal, this transmitter may be operated on either 160, 80 and 40 or 20 meter band.

Here is a "dandy" transmitter for the beginner—this set is available in "kit" form and full-size working drawings are supplied. It uses a T-20 or 825 and a 6L6, with crystal control. Power-supply is also described.

Simplicity was the main objective in the design of this transmitter; there are only two tuning controls, one is for the plate circuit of the crystal oscillator stage, and the other is for the output of the final amplifier. The tank circuit, L-1 and C-5 as shown in the diagram serve for tuning the oscillator and also as the input circuit to the amplifier. Plate neutralization is employed in the final amplifier in the form of a center tapped coil. However, the tuning condenser C-7 is only shunted across the plateside, and the neutral-

izing coil is tantamount to a separate coil inductively coupled to the plate coil. This method permits good electrical balance without the use of split stator condensers, thus reducing cost considerably.

The transmitter as shown in the photos consists of two units mounted in a convenient desk-type rack. The top unit is the entire R.F. portion, while the power-supply is located on the bottom panel. The layout presents a very neat and business-like appearance. There are three jacks located under the D.C. milliammeter. A plug from the meter permits it to be changed from the one circuit to another. One jack is used for reading the oscillator plate current, the other is used for measuring the amplifier grid current, and the third one is used for measuring the plate cur- (Continued on page 144)

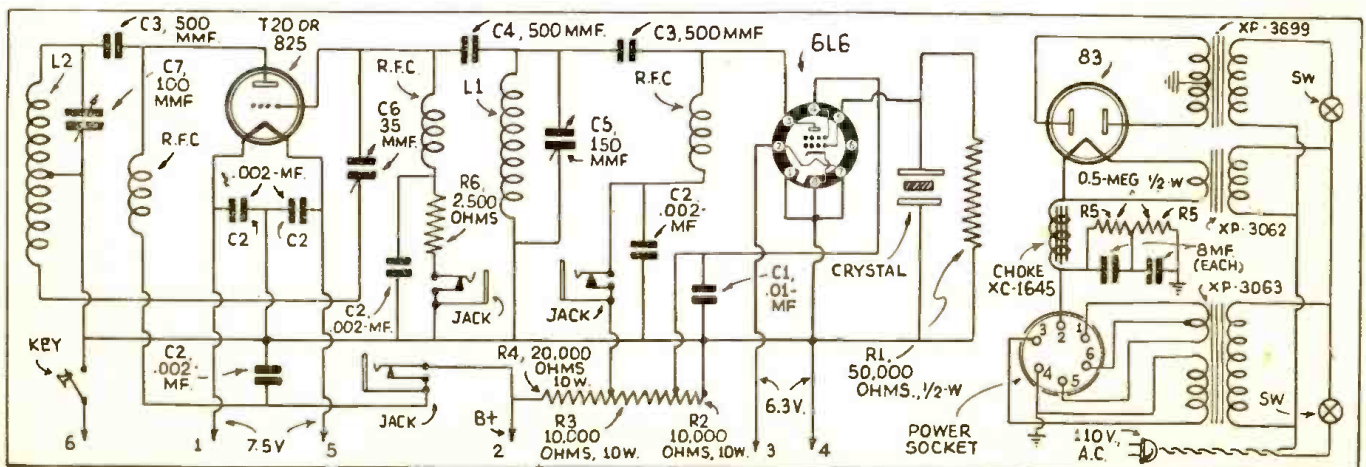

Circuit diagram of the 40-watt transmitter.

# Can Real "DX" Be Worked On Low Power? YES—

Says Ernest Kahlert, W2BHZ

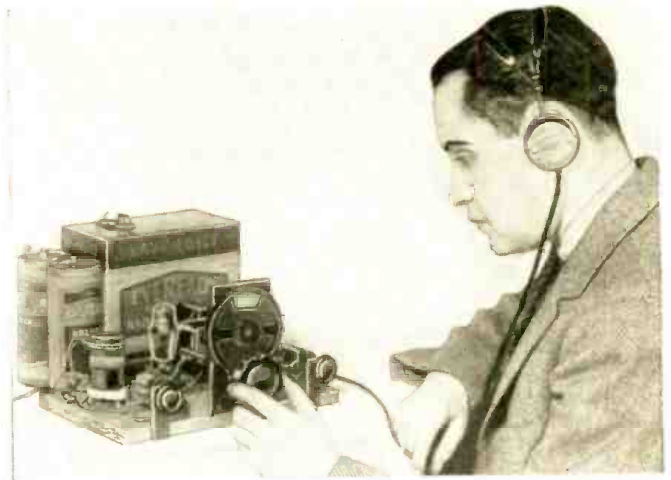

Mr. Kahlert's 2-tube receiver in operation—stations "half-way around the world" roll in easily!

**PK1BX**

TO RADIO W2BHZ  
 QTH 5 2 19  
 QTH 5 2 19  
 QTH 5 2 19

QTH 5 2 19  
 QTH 5 2 19  
 QTH 5 2 19

QTH 5 2 19  
 QTH 5 2 19  
 QTH 5 2 19

P. A. COETSEE Buttersburg  
 64. BURGER STREET.  
 THE FORK, PENNSYLVANIA

**ATLZ**

TO RADIO  
 W 2 B H Z  
 CONFIDENTIAL

**SOUTH AFRICA**

To Radio  
**W2BHZ**

**OZ2B**

Handwritten notes and signatures on a QSL card.

**J3DE**

TO RADIO  
 QTH 14, MC. GEE ST. S. B. S. 20

QTH 11, 101 D  
**PY2HM**

TO RADIO  
 QTH 11, 101 D

• THE question often arises can one really work dx satisfactorily with low-power and a small two or three tube receiver. By *low-power* we mean 25 to 100 watts input. The answer is yes if one's "rig" is properly laid out, antenna included. Many fellows are doing fine work today with no better than a detector and "one-step" and 46's or tens in the "final" amplifier of their transmitter. It is the writers' intention to show how this is actually accomplished with the rig illustrated, which—although made up of old parts—becomes very effective, with proper adjustment and suitable antennas.

In general, users of *low-power* sets

Just a few sample QSL cards received by the author, which testify to some of the "long-distance" two-way contacts established with low power.

ought to ask themselves such questions as the following: *Is my receiver free from hum and background noise? Is my receiving antenna tuned? Have I the best antenna my location can afford? Is my transmitter working at its maximum capability?*

### 2-Tube Receiver Rolls 'Em In

The receiver used by the author is a detector and one-step audio-amplifier affair, and as economy was the watchword 30's (type 30 tube) were used to keep the cost down as well as the hum. The filament supply is from dry cells, through a rheostat and a 0-150 ma. scale milliammeter to insure correct filament temperature. This meter is simply inserted in the filament circuit and lies on the shelf of the table on which the whole rig is mounted. The set is mounted on a piece 8 in. by 11 inches, cut from the end of an apple-box. The variable condensers are mounted on small pieces of hard rubber cut from an old panel. The main tuning condenser was mounted rather high up and the dial fitted with a large knob to make tuning easier. The tuning condenser is one of those old slide-plate Cardwells that has been collecting dust for about seven years, but even though it is large, it certainly is *not* noisy. A .0001 mf. variable condenser is used mounted at the right as a "band-finder" and to give a little higher C in the tank to increase stability.

The coils are wound so that only a fraction of the .0001 mf. capacity is used. Regeneration is controlled by another .0001 mf. condenser mounted at the left. Trouble was experienced with this condenser and a pigtail had to be soldered on to *kill* the noise. The detector circuit has .0001 mf. in the grid condenser and a 4 meg. gridleak. The output of the detector passes through the usual small pi choke into an old 3½ to 1 ratio audio transformer and the audio tube. A 250,000 ohm resistor is necessary in this case to remove a slight tendency to fringe howl and give perfectly smooth regeneration without *pulling*. Three bakelite sockets were originally used but were noisy on ten meters so *isolantite* had to be substituted for the detector tube and coil. The detector tube and coil sockets should be the kind that cut into the tube prongs, *not just rub*. Even with these sockets, every so often the coil and tube should be wiggled around to *brighten* the contact. This may sound a bit nonsensical but is really necessary on *ten meters*. In a battery set like this, where the plate voltage is 45 and the currents are small, particular care should be used in getting good contacts!

### Coils Home-made

The coils should be wound on *isolantite* or R-39; in this case R-39 will keep the coil Q high. The coils themselves are wound with No. 30 D.C.C. The antenna coil is two turns of No. 18 D.C.C. held on the form by notches and its own springiness, at first; when the correct adjustment is made, the turns can be held permanently in one spot with Dupont household cement obtained from the local hardware store. A twisted pair from the antenna switch is soldered to two spring clips on the base-board and the antenna coil clipped into these to allow changing bands.

We now come to the *antenna tuning* and therein lies the greater part of our story, provided one has a *noiseless, humless and smoothly operating* regenerator. Before continuing on the antenna angle we would like to make mention of an interesting incident regarding *hum*. Whenever the (Continued on page 155)

### Next Issue!

Ultra modern "Ham" transmitter, 5 to 80 meter operation, 400 watts output, phone and C.W. Employs the latest in tube and circuit design, by Arthur Lynch, W2DKJ.

# A Good 200-Watt

By Henry Johnstone



The short-wave diathermy oscillator in operation, showing how electrodes are placed for treating an ailment of the arm.

● NOT a day passes that we do not find requests in our mail for information on building diathermy apparatus. It seems that short-waves are today playing a major part in the treatment of human ailments. The purpose of this article is to present a simple, complete working instrument which may be employed by those who thoroughly understand the technique of using such a piece of apparatus.

Before we enter into further discussion of the details of the machine, we must warn that novices and those unfamiliar with this new profession should not attempt either treatment of other persons or themselves, because undoubtedly serious damage can easily be done.

The majority of letters requesting information on these machines have come from either doctors, or persons who desire to build a machine for their local physician and thus make a fair profit.

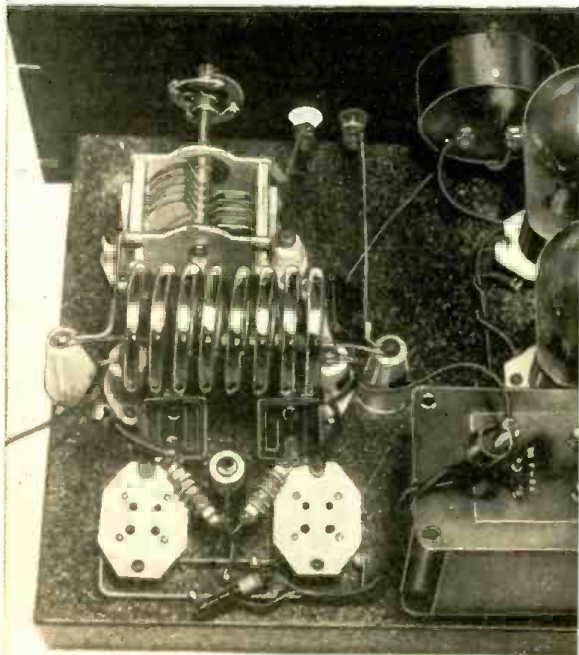

Close-up of the high-frequency oscillator circuit, showing the two large tubes used. The variable condenser is connected in the output treatment circuit.

The machine described in this article and shown in the illustration follows closely the accepted design, insofar as the fundamentals are concerned. However, a few additional "gadgets" have been added which greatly improve the machine. The first important point is the frequency at which the machine should operate. This has been a great controversial subject and we hesitate to recommend any particular frequency, and suggest that members of the medical profession be consulted as to what frequency should be used. In our

pull Hartley circuit which has proven to be the best and most simple arrangement.

The entire apparatus is self-contained in a 19 by 8½-inch metal case. On the front panel are located the controls for regulating the strength of the application, together with a plate milliammeter, which is used as a relative check to show how the tubes are operating, and it may also be used as a gauge of application dosage.

On the panel will also be seen a *time-switch*. This is a spring-operated device which may be set for any length of time up to 1½ hours. Such a device permits the machine to be set for operation over a period of from 5 to 90 minutes, and there will be no danger of over-dosage. A *circuit-breaker* is also found on the front panel. A variable resistance is shunted across the coil of the circuit-breaker, permit-

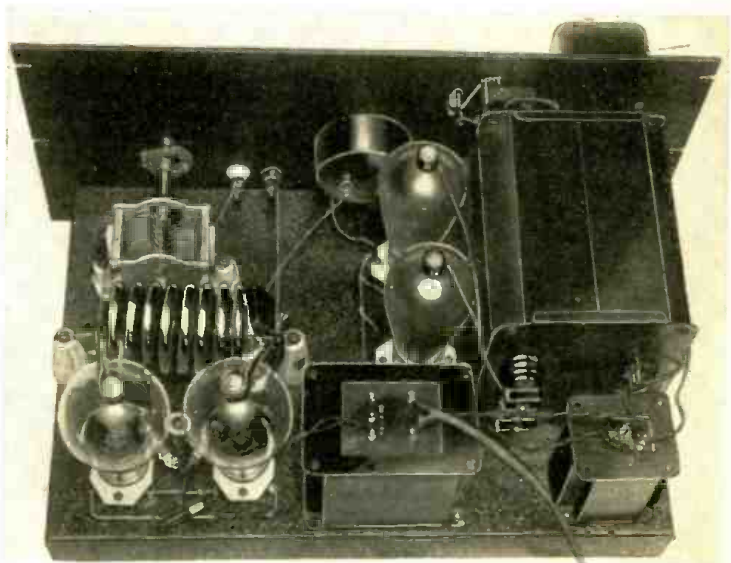

Rear view of the diathermy oscillator, showing the coils, condensers and 808 tubes.

experiments the machine was made to operate in the ultra high frequency region; however, different size inductances may be employed for operating on other frequencies.

#### Coils Changed for Different Frequencies

In the accompanying coil table we have shown one set of coils for the ultra high frequency spectrum, and another set for frequency around 20 megacycles. The tubes employed are the RCA-808 high efficiency triodes, and the two of them in this machine are capable of delivering around 200 watts of R. F. We have employed a push-

ing it to be adjusted to *break* at predetermined loads.

#### How Automatic "Circuit-Breaker" Works

For instance, if the operator of the machine finds that a reading of 200 milliamperes on the meter provides satisfactory results, the circuit-breaker is adjusted so that any current over 200 milliamperes will throw the machine out of operation by opening the switch. This adjustable circuit-breaker was employed as a precautionary measure against over-dosage or injury. This can be borne out by a simple illustration. Suppose the pads had been placed on the patient and the instrument adjusted to proper dosage; if the patient should move in some manner to disturb the pads and increase the strength of application, the circuit would immediately open. Also should someone become entangled with the instrument or



# S-W Diathermy Oscillator

cables and thus overload it, it would immediately go out of operation, thus avoiding possible injury. Also the average physician not being a radio technician might accidentally overload the tubes and thus ruin them. The circuit-breaker also prevents such damage inasmuch as excessive current will throw the machine out of operation.



The editors have been deluged with requests for construction data on a short-wave Diathermy Oscillator. Here is a set that will deliver about 200 watts of high frequency energy; it employs two RCA 808 triodes. New features are an adjustable time-switch, and an automatic circuit-breaker which will trip when pre-set for a certain pre-determined current. A "dosage meter" is also provided.

### Power Supply

The power-supply consists of three transformers. One high voltage transformer with a high and low primary tap. The low voltage tap provides 1,160 volts from the rectifier, while the high voltage tap increases this by 25%. There are two filament transformers, one used to heat the filaments of the 866 rectifier tubes, while the other supplies filament voltage for the 808 oscillators. In operating the machine, the filaments should be lighted for at least 10 minutes before the high voltage is applied. Where the machine is being used over a period of several hours, off and on at short intervals, the filaments should be left lighted continuously.

Normally, without the electrodes being applied to a patient the plate milliammeter will show about 50 milliamperes.

The adjustable condenser which is controlled from the front panel is then adjusted after the electrodes have been



Front view of the S-W Diathermy apparatus, showing the "dosage meter," adjustable time switch and the circuit-breaker at the extreme left. The control for the tuning condenser in the patient's circuit is shown at the right.

applied until the plate milliammeter shows some 150 to 300 milliamperes, depending upon how much energy is required for application. Up to 300 mills the rule is, as the current increases, the amount of dosage increases. All things being as they should be, the

current as indicated by the milliammeter should not change after the electrodes have been applied; however, if the patient moves slightly the current is liable to change. Only a slight re-adjustment of the tuning control is required to re- (Continued on page 148)

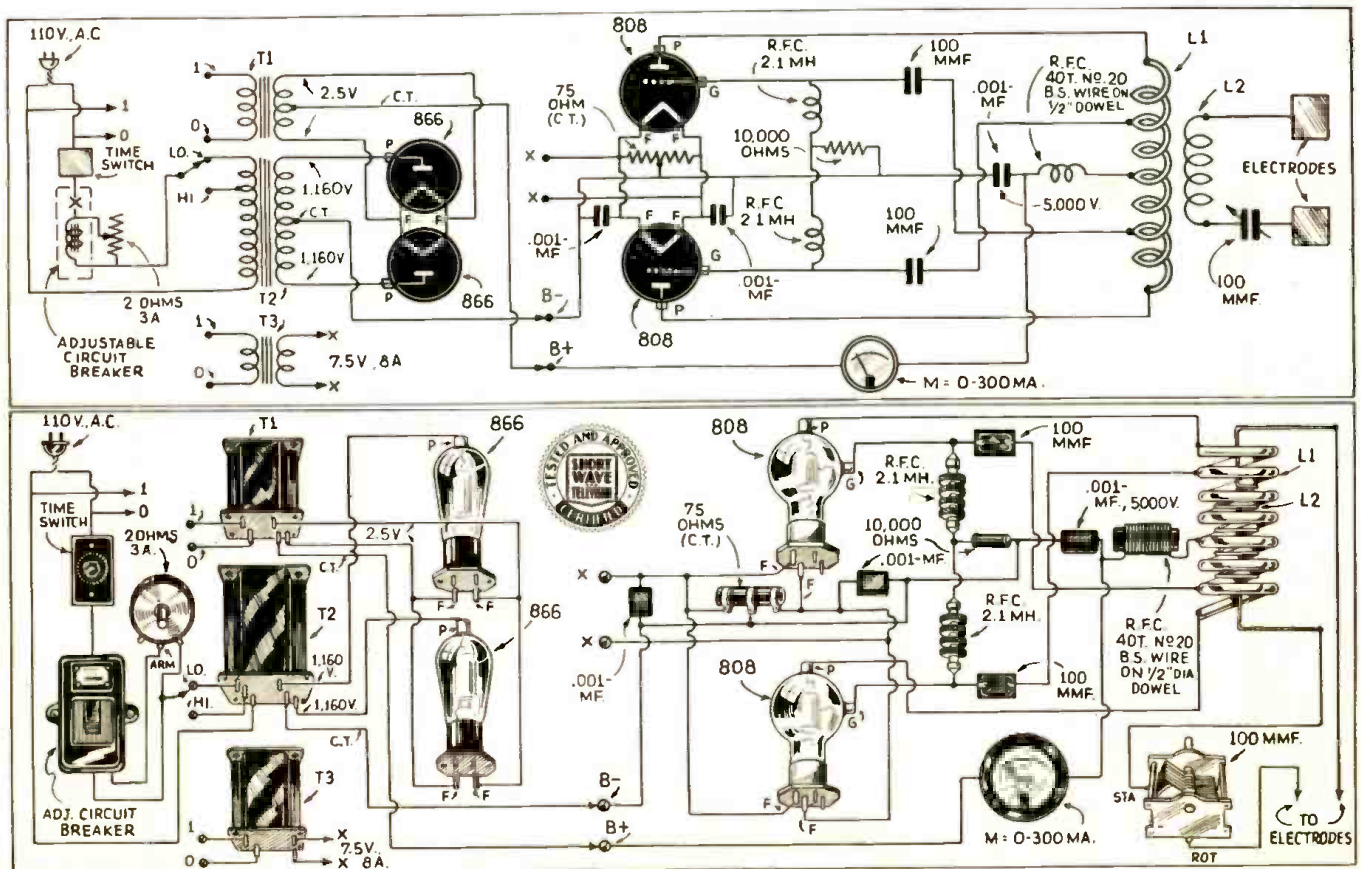

Complete Circuit of the S-W Diathermy Oscillator

# Let's "Listen In" With

*Joe Miller*



VS2AK—A valued veri from the Malay States.

● DURING the first part of April, conditions were quite good; Asiatic signals on the lower frequencies were still being well heard, as throughout the winter. However, reception during the latter part of April began to show the inroads of summer conditions, with Asiatics weakening and noise-level rising on all bands.

We can now look forward to better reception from the European stations throughout the summer on the higher frequencies, 19, 25 and 31 meters, but the 49 meter band will be more or less passé until the arrival of Fall, with the resultant reduction of noise-level on this popular band.

However, discussing prospects of DX on the twenty meter band, Asiatics are still coming through at this late date with numbers of PKs, (Java), KAs (Philippines), and XUs (China) being reported by many of our best DXers. Orientals are generally heard best during the cool weather. The Australian amateurs (VKs), on the other hand, find the warm weather best for "pushing through" to the States, and may be heard throughout the Summer in the early morning hours, chiefly from 12 to 2 a.m. and from 4:30 to 6 a.m. EST. In summer, African amateurs may be looked for between 1:30 and 5 p.m. EST.

European amateurs are heard well in Summer, coming through best from 3 to as late as midnight, with peak conditions from 4 to 8 p.m. EST. South American hams are heard in the evening hours, generally between 6 and 9 p.m. EST.

Now to reception for the last month.

## French Somaliland

FZES, 17.28 mc., located at Djihouti was logged at 7:30 a.m. with a fairly good signal calling Paris. This is rather earlier than their usual time of operation, which is around 8:30 a.m. This station does not operate on phone very often, usually being on CW (code) only. As this station is located on a frequency seldom used by other radiophone stations, if it is on the air one has little difficulty in identifying this nice catch, especially if the language heard is French.

Address reports on this station to: FZES—Le Chef de la Sta. Radiotelegraphique Djibouti, Ministère des P.T.T., Service de la Telegraphique sans Fil, Djibouti, French Somaliland. We would suggest that you DX fans copy all QRAs listed in our articles as they may prove of value in the future when any of the catches here mentioned are heard.

## India

VWY2, Poona, which operates on either 17.48 or 17.54 mc. is often heard at 8 a.m. when Poona calls London and telephones in inverted speech. This station is generally heard with a good signal, being one of the strongest Asiatic phones heard here. We have given information on this station's schedule to member of our DX friends and they have found little difficulty in logging this Asiatic phone, so it should be easily logged by any DXer who

## Our Short Wave "DX" Editor

Winner of 30th "S-W Scout" Trophy

tries for this catch persistently. Send reports on VWY2 to The Indian Radio & Cable Comm. Co., Ltd., Beam Wireless Station, Poona, 6, India.

## Tahiti

FO8AA, 7.10 mc., Papeete is still well heard, operating on a regular schedule on Tuesdays and Fridays between 11 and 12 p.m. though often they carry over to as late as 12:30 p.m. This station sends an attractive QSL card which any DXer would be proud to own.

## Malay States

ZGE, 6.21 mc., Kuala Lumpur, which has changed from their old frequency of 6.13 mc., was logged twice during April near 7 a.m. The signal of this ace catch was rather hard to "log" due to the summer noise-level already prevailing on this band. This will be a good station to try for beginning next Fall, as our reception proves that it can be heard here on the East Coast.

A report has reached us from Singapore through Mr. A. L. McIntyre, informing us that station ZHI, formerly operating on the 49 meter band, is no more—having been off the air since the first of the year. Its place has been taken by station ZHL



CQN—A view of the studio of this famous Asiatic station.

which has just begun broadcasting on a frequency of 1333 kc., which is in the broadcast band.

## Japanese Transmitters

JIB, 10.53 mc., located at Formosa, an island off Japan, and considered another country, has been logged several times near 6 a.m., when it phones either JVL or JVN. Signal is quite strong and has the typical Asiatic "flutter" which makes it easy to identify this station. JIB may be logged by tuning to the low frequency side of JVN, and operates quite regularly near time mentioned. JIB will verify through the Tokio address on a regular "J" card.

JDY, 9.925, located at Dairen, Manchukuo, is still being logged between 2:30 and 3:30 a.m.

## Java

YDB, Soerabaja, has lately moved from their regular frequency, 9.65 mc., to 9.55 mc., which is in the thick of the 31 meter band and may be heard just above VPD2. PMH, 6.72 mc. at Bandoeng, was heard well during the first part of the month, but faded out later in April. Ashley Walcott, San Francisco, reports a new telephone station at Palembang, Sumatra, call letters not known, phoning PLQ, 10.68 mc., Bandoeng, irregularly 5:30 to 6:30, and

7:30 to 8 a.m. This new Sumatran uses a frequency of 7.87 mc. Also heard phoning PLV, 9.415 mc. Bandoeng, irregularly from 9 to 9:40 a.m.

## Australia

VK6ME, 9.59 mc., the Perth, West Australian short-wave station of Amalgamated Wireless, is now broadcasting irregularly with a schedule daily except Sunday from 6 to 8 a.m. Closes with "God Save the King."

VLZ, 13.34 mc., Sydney is heard frequently at 5 a.m. phoning PLE, 18.83, Bandoeng, and reported by Ashley Walcott.

ZMBJ, 8.84 mc., the S.S. Awatea, was heard broadcasting music around 6 a.m. one morning.

## Ceylon

VPB, Colombo, is now being heard on about 6.15 mc. having moved up slightly from 6.13 and operates on schedule of 7 to 10:30 a.m. This station is not to be considered an easy catch and will not be well heard again until Fall. VPB may be identified by time signals consisting of 6 pips, similar to Daventry's, and heard at 9:30 a.m., with a woman announcer. This information supplied by Ashley Walcott and George Sholin of San Francisco.

## China

XTC, 9.285 mc., was logged phoning XTV, 9.49 mc., at Canton, at 5:20 a.m. Both were good signals. XTC is at Shanghai.

XTK, 9.08 mc., Hankow, phones XTC from as early as 4 to as late as 9:50 a.m. Sometimes XTL, 5.48 mc., Hankow is used in place of XTK, this probably during the winter months.

NGOX, 6.87. Nanking has faded out for the summer, but will again return to be logged well in the cold weather, despite its low power, 500 watts. This station sends a very simple card but one which is highly prized.

XU8ZW has confirmed a report from Carlos Irizarry, Brooklyn, of reception last winter on a frequency of 7.23 mc. This is classed as an "ace catch" and we congratulate OM Carlos for his success in logging this distant station. Carlos heard this station at 8 a.m. broadcasting recordings and reports good signal strength on this frequency.

XU8ZW is operated by Father E. Gherzi, in charge of the Zikawei Observatory at Shanghai and works on frequencies of 13.045 mc. with a power of 300 watts, and on 7.23 mc. with a power of 50 watts. This is a station to be looked for next winter and we will give a schedule of daily operation when we hear from this station.

XOJ, 15.8 mc., Shanghai has been heard from as early as 7 p.m. to as late as 12 midnight lately when it puts in an average R3 to 6 signal and also between 5:30 and 7 a.m. when it puts in an average R5 to 8 signal. XOJ usually phones JVE or JVF, both just to the low-frequency side of XOJ.

## Canary Islands

EA8AB, 7.01 mc., Tenerife, was tuned  
(Continued on page 153)

14 APR 1937 Anno XV

MINISTERO DELLA MARINA  
UFFICIO GENERALE DI  
RADIOGRAFIA  
Direttore E. R. P. C. 360 P

Requiere alla de Los Letrados de  
quadrante in Ateneas  
Reply to your letter of

ICK-IUD

Si conferma la ricezione.

IL CAPO SEZIONE  
*Rolam*

ICK-IUD—A double veri of Tripoli and Ethiopia, both in Africa.

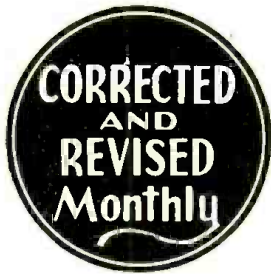

# World S-W Station List

## Complete List of Broadcast, and Telephone Stations

All the stations in this list use telephone transmission of some kind. Note: Station calls printed in bold face are broadcast stations; others are telephone stations.

Please write to us about any new stations or other important data that you learn through announcements over the air or correspondence with the stations.

↓ S.W. BROADCAST BAND ↓

Mc.	Call	Station
31.600	W3XEY	BALTIMORE, MD., 9.494 m., Relays WFBR 4 pm-12m.
31.600	W2XDV	NEW YORK CITY, 9.494 m., Addr. Col. Broad. System, 485 Madison Ave. Daily 5-10 pm.; Sat. and Sun. 12.30-5, 6-9 pm.
31.600	W4XCA	MEMPHIS, TENN., 9.494 m., Addr. Memphis Commercial Appeal. Relays WMC.
31.500	W8XAI	ROCHESTER, N. Y., 9.494 m., Addr. Stromberg Carlson Co. Relays WHAM 7.30-12.05 am.
31.600	W8XWJ	DETROIT, MICH., 9.494 m., Addr. Evening News Ass'n. Relays WWJ 6-12.30 am., Sun. 8 am-12 m.
31.600	W9XPD	ST. LOUIS, MO., 9.494 m., Addr. Pulitzer Pub. Co. Relays KSD.
26.100	GSK	DAVENTRY, ENG., 11.49 m., Addr. B. B. C., London. Operates irregularly 5.45-8.55 am., 9.55 am-12 n.
25.950	W6XKG	LOS ANGELES, CAL., 11.56 m., Addr. B. S. McGlashan, Wash. Blvd. at Oak St. Relays KGFJ 24 hours daily.
24.600	W9XAZ	MILWAUKEE, WIS., 12.19 m., Addr. The Journal Co. Relays WTMJ from 1 pm.
21.550	GST	DAVENTRY, ENG., 13.92 m., Addr. (See 26.100 mc.) Irregular at present.
21.540	W8XK	PITTSBURGH, PA., 13.93 m., Addr. Grant Bldg. Relays KDKA 7-9 am.
21.530	GSJ	DAVENTRY, ENG., 13.93 m., Addr. (See 26.100 mc.) 5.45-8.55 am., 9.15 am-12N.
21.520	W2XE	NEW YORK CITY, 13.94 m., Addr. Col. Broad. Syst., 485 Madison Ave. Relays WABC 6.30-11 am.
21.470	GSH	DAVENTRY, ENG., 13.97 m. (See 26.100 mc.), 5.45-8.55 am., 9.15 am-12 m.

↓ S.W. BROADCAST BAND ↓

21.420	WKK	LAWRENCEVILLE, N. J., 14.01 m., Addr. Amer. Tel. & Tel. Co. Calls S. Amer. 7 am-7 pm.
21.080	PSA	RIO DE JANEIRO, BRAZ., 14.23 m., Calls WKK daytime.
21.060	WKA	LAWRENCEVILLE, N. J., 14.25 m., Addr. (See 21.420 mc.) Calls England morning and afternoon.
21.020	LSN6	BUENOS AIRES, ARG., 14.27 m., Addr. Cia. Internacional de Radio. Works N. Y. C. 7 am-7 pm.
20.860	EHY-EDM	MADRID, SPAIN, 14.38 m., Addr. Cia. Tel. Nacional de Espana. Works S. Amer. mornings.
20.700	LSY	BUENOS AIRES, ARG., 14.49 m., Addr. Transradio Internatl. Tests irregularly.
20.380	GAA	RUGBY, ENG., 14.72 m. Calls Arg., Brazil mornings.
20.040	OPL	LEOPOLDVILLE, BELGIAN CONGO, 14.97 m. Works ORG mornings.
20.020	DHO	NAUEN, GERMANY, 14.99 m., Addr. Reichspostenstralamt. Works S. Am. mornings.
19.900	LSG	BUENOS AIRES, ARG., 15.08 m., Addr. (See 20.700 mc.) Tests irregularly.
19.820	WKN	LAWRENCEVILLE, N. J., 15.14 m., Addr. A. T. & T. Co. Calls England daytime.
19.680	CEC	SANTIAGO, CHILE, 15.24 m., Addr. Cia. Internacional de Radio. Calls Col. and Arg. daytime.
19.650	LSN5	BUENOS AIRES, ARG., 15.27 m., Addr. (See 21.020 mc.) Calls Europe daytime.

Mc.	Call	Station
19.620	VQG4	NAIROBI, KENYA, 15.28 m., Addr. Cable and Wireless, Ltd. Calls London 7.30-8 am.
19.600	LSF	BUENOS AIRES, ARG., 15.31 m., Addr. (See 20.700 mc.) Tests irregularly.
19.480	GAD	RUGBY, ENG., 15.4 m. Calls VQG4 7.30-8 am.
19.355	FTM	ST. ASSISE, FRANCE, 15.5 m. Calls S. America mornings.
19.345	PMA	BANDOENG, JAVA, 15.51 m. Works Holland 5.30-11 am.
19.260	PPU	RIO DE JANEIRO, BRAZ., 15.58 m., Addr. Cia. Radiotel. Brasileira. Works France mornings.
19.220	WKF	LAWRENCEVILLE, N. J., 15.6 m., Addr. A. T. & T. Co. Calls England daytime.
19.200	ORG	RUYSSELEDE, BELGIUM, 15.62 m. Calls OPL mornings.
19.160	GAP	RUGBY, ENG., 15.66 m. Calls Australia 1-8 am.
19.020	HS8PJ	BANGKOK, SIAM, 15.77 m. Mondays 8-10 am.
18.970	GAQ	RUGBY, ENG., 15.81 m. Calls S. Africa mornings.
18.890	ZSS	KLIPHEUVEL, S. AFRICA, 15.88 m., Addr. Overseas Comm. of S. Africa, Ltd. Calls GAQ 9-10 am.
18.830	PLE	BANDOENG, JAVA, 15.93 m. Calls Holland early am.
18.680	OCI	LIMA, PERU, 16.06 m. Tests with Bogota, Col.
18.620	GAU	RUGBY, ENG., 16.11 m. Calls N. Y. daytime.
18.480	HBH	GENEVA, SWITZERLAND, 16.23 m., Addr. Radio Nations. Tests irregularly.
18.345	FZS	SAIGON, INDO-CHINA, 16.35 m. Works Paris early morning.
18.340	WIA	LAWRENCEVILLE, N. J., 16.36 m., Addr. A. T. & T. Co. Calls England daytime.
18.310	GAS	RUGBY, ENG., 16.38 m. Calls N. Y. daytime.
18.290	YVR	MARACAY, VENEZ., 16.39 m. Works Germany mornings.
18.250	FTO	ST. ASSISE, FRANCE, 16.43 m. Works S. America daytime.
18.200	GAW	RUGBY, ENG., 16.48 m. Works N. Y. C. daytime.
18.135	PMC	BANDOENG, JAVA, 16.54 m. Works Holland mornings.
18.115	LSY3	BUENOS AIRES, ARG., 16.56 m., Addr. (See 20.700 mc.) Tests irregularly.
18.040	GAB	RUGBY, ENG., 16.83 m. Works Canada morning and afternoon.
17.810	PCV	KOOTWIJK, HOLLAND, 16.84 m. Works Java 6-8 am.

↓ S.W. BROADCAST BAND ↓

17.790	GSG	DAVENTRY, ENG., 16.86 m., Addr. B. B. C., London. 5.45-8.55 am., 9 am-12 n., 12.20-3.45, 4-6, 6.20-8.30 pm.
17.785	JZL	TOKIO, JAPAN, 16.87 m. Tests irregularly.
17.780	W3XAL	BOUND BROOK, N. J., 16.87 m., Addr. Natl. Broad. Co. 6.30 am-6.30 pm.
17.770	PHI	HUIZEN, HOLLAND, 16.88 m., Addr. (See PHI, 11.730 mc.) Daily except Wednesday. 8-9.30 am.; Sun. 7-10 am.
17.760	DJE	BERLIN, GERMANY, 16.89 m., Addr. Broadcasting House. 12.05-5.15 am.; 5.55-11 am. Sun. 11.10 am-12.25 pm.
17.760	W2XE	NEW YORK CITY, 16.89 m., Addr. Col. Broad. System, 485 Madison Ave. 11 am-12 n.

Mc.	Call	Station
17.755	ZBW5	HONGKONG, CHINA, 16.9 m., Addr. P. O. Box 200. 4-10 am. irregular.

↑ S.W. BROADCAST BAND ↑

17.741	HSP	BANGKOK, SIAM, 16.91 m. Works Germany 4-7 am.
17.650	XGM	SHANGHAI, CHINA, 17 m. Works London 7-9 am.
17.520	DFB	NAUEN, GERMANY, 17.12 m. Works S. America, near 9.15 am.
17.480	VWY2	KIRKEE, INDIA, 17.16 m. Works London 7.30-8.15 am.
17.120	WOO	OCEAN GATE, N. J., 17.52 m., Addr. A. T. & T. Co. Works ships irregularly.
17.080	GBC	RUGBY, ENG., 17.56 m. Works ships irregularly.
16.835	ITK	MOGAOSCIO, ITAL SOMALILAND, 18.32 m. Calls IAC around 9.30 am.
16.270	WLK	LAWRENCEVILLE, N. J., 18.44 m., Addr. A. T. & T. Co. Works S. Amer. daytime.
16.270	WOG	OCEAN GATE, N. J., 18.44 m., Addr. A. T. & T. Co. Works England Late afternoon.
16.240	KTO	MANILA, P. I., 18.47 m., Addr. RCA Comm. Works Japan and U. S. 5-9 pm. irregularly.
16.233	FZR3	SAIGON, INDO-CHINA, 18.48 m. Calls Paris early morning.
16.030	KKP	KAHUKU, HAWAII, 18.71 m., Addr. RCA Comm. Works Dixon 3-10 pm.
15.880	FTK	ST. ASSISE, FRANCE, 18.9 m. Works Saigon 8-11 am.
15.865	CEC	SANTIAGO, CHILE, 18.91 m. Calls Peru daytime irregular.
15.810	LSL	BUENOS AIRES, ARG., 18.98 m., Addr. (See 21.020 mc.) Works London mornings and Paris afternoons.
15.660	JVE	NAZAKI, JAPAN, 19.16 m. Works Java 3-5 am.
15.620	JVF	NAZAKI, JAPAN, 19.2 m. Works Cal. near 5 am. and 8 pm.
15.450	IUG	ADDIS ABABA, ETHIOPIA, 19.41 m. Works Rome 9.15-10.30 am.
15.440	XEBM	MAZATLAN, SIN., MEX., 19.43 m., Addr. Flores 103 Alto. "El Pregonero del Pacifico." Irregularly 7 am-10 pm.
15.415	KWO	DIXON, CAL., 19.46 m., Addr. A. T. & T. Co. Works Hawaii 2-7 pm.
15.370	HAS3	BUDAPEST, HUNGARY, 19.52 m., Addr. Radiolabor, Gyali Ut 22. Sun 9-10 am.
15.360	DZG	IEESEN, GERMANY, 19.53 m., Addr. Reichspostenstralamt. Tests irregularly.
15.355	KWU	DIXON, CALIF., 19.53 m., Addr. A. T. & T. Co. Phones Pacific Isles and Japan.

↓ S.W. BROADCAST BAND ↓

15.340	DJR	BERLIN, GERMANY, 19.56 m., Addr. Broad'g House. 8-9 am., 4.50-10.45 pm.
15.330	W2XAD	SCHENECTADY, N. Y., 19.56 m., Addr. General Electric Co. Relays WGY 10 am. to 6 pm.
15.310	GSP	DAVENTRY, ENG., 19.6 m., Addr. (See 26.100 mc.) 6.20-8.30 pm.
15.290	LRU	BUENOS AIRES, ARG., 19.62 m., Addr. El Mundo. Irregular.
15.280	H13X	CIUDAD TRUJILLO, D. R., 19.63 m., Relays HIX Sun. 7.40-10.40 am. Week-days 12.10-1.10 pm.
15.280	DJQ	BERLIN, GERMANY, 19.63 m., Addr. Broadcasting House. 12.05-5.15, 6-8, 8.15-11 am., 4.50-10.45 pm.
15.270	W2XE	NEW YORK CITY, 19.65 m., Addr. (See 21.520 mc.) 12 N-6 pm.

(Continued on page 131)

## Hats Off, Boys! Here's a Live "YL" Shack—From Budapest

Editor, SHORT WAVE & TELEVISION:

Herewith a photo of my "shack." Should the picture and the description prove satisfactory. I shall be glad to see them published in *Short Wave & Television*. I should imagine that they would prove interesting to the amateurs in your country. I am the first licensed Hungarian YL (young lady operator), and to the present time, the only one. I have been a short wave amateur since 1932, and contacted six continents this September. I am now going to send my cards for my CW WAC (worked all continents) "certification." I work on 7 and 14 mc. amateur bands, and have many good "W" (U. S.) radio friends. I would be very glad to make a QSO with a W-YL. The description of my "shack" follows:

In the center of the table is my short-wave receiver (Schnell O-V-2, with a range from 16 to 200 meters) with the loudspeaker on top of it. Next to the receiver is my microphone and the little doll, Zsuzsika, hi!

Under the flowers is my 2-tube broadcast receiver which has a range of 200 to 600 M. On the right, on the little table, is my C.O.P.A. xmitter and the wavemeter.

I work with 25 watts on 7,195 and 14,390 kc. with crystal control. However, when the QRM is bad and I find it necessary to QSY, I can only do so with the P.A. operated as a push-pull T.P.T.G. oscillator on other frequencies.

On the wall you can see my call letters, QSL cards, the map, and to the right the splendid QSL card of station W3VJ from Salisbury, Md.

I work as a radio operator in Budapest's official station, where I can work with commercial stations of New York (Mackay). My full QRA is at present: Kislaludy u. 22. Budapest. I will now say very 73 to all, W-YL's and OB's and hope to meet you "on the air" often.—Lenke Tischler, HAF1YL, Radio Amateur Station, Kislaludy-u. 22., Budapest, Hungary.



(Fine! Lenke! Let's hear from more of the YL's. Don't be bashful girls, step right up and show us those photos of your "rigs."—Editor.)



### From "The Land of the Rising Sun"

Editor, SHORT WAVE & TELEVISION:

This is my official short wave listening post in the "Land of the Rising Sun." It is a Patterson PR-16C communications receiver—best receiver in Japan! The antenna is 15 ft. vertical and one end is 31 ft. above the ground. The location is very good and it is on the hill looking down upon the beautiful "Shiranui-Sea."

Total of 1,589 stations were heard on dynamic speaker, hi! hi! (All phone stations, only 1 CW) I have heard Russia, Philippine Islands, Java, Sumatra, Celebes, China, Manchukuo, Siam, France, U.S.A., Spain, Australia, Buenos Aires, Cuba, Dominican Republic, Venezuela, Chile, Porto Rico, Mexico, Canada, Hawaii, Japan, Hongkong, Korea, Alaska, Italy, England, Formosa, and India. There were many other stations heard, but I could not identify them. I also heard and received a veri from the new experimental station HS8PJ in Siam, hi!

I would like to exchange SWL cards with the listeners across the beautiful sea. I have, at present, 103 "pen pals" abroad. I am a member of the I.B.C., R9LL, and S.W.L.; and an ardent reader of *Short Wave & Television*

My best DX on 20-meter amateur phone (from Japan) is W6JYH in Los Angeles. Just imagine! QSA5R4-5 on dynamic. I forgot to tell you that this picture is only one part of my room. I am in Hawaii now, so please send all SWL cards to the following address.—O. I. Noda, 817 Sheridan St., Honolulu, Hawaii.

## He Finds the "Electrodyne" Tops!

Editor, SHORT WAVE & TELEVISION:

I have just finished the *Electrodyne* short-wave receiver originally described in the May, 1934, issue of *Short Wave Craft* magazine, but more elaborately described in the subsequent June issue.

This *Electrodyne* receiver is absolutely the best short-wave set that I have ever built. Its sensitivity is astounding—its volume is amazing, and its DX ability is a revelation! That electron-coupled detector makes the *Electrodyne* receiver the acme of circuit perfection.

However, I have made some improvements on the set which have brought out the very best there is in an already wonderful circuit. These improvements are all ideas which have appeared in various issues of "S. W. C." and I simply incorporated them in the *Electrodyne*.

I use an audio choke in the detector plate circuit, instead of the original resistor, and this increases the gain considerably. Because the choke more nearly matches the plate impedance of the screen-grid tube and allows the full plate voltage to the tube, which is necessary if full amplification is to be derived from the 32 detector. Also, I built an extra stage of audio. A 30 type tube follows the detector. This makes a total of three audio stages. The detector tube must be shielded to prevent feed-back, which manifests itself in the form of a high-pitched whistle. (I shielded all of the tubes.) Not wanting to wind the filament choke, I used one of the 2.5 mh. size wound on the isolantite core. This choke makes it unnecessary to use any resistance in the filament of the detector—providing the "A" source is three volts. The resistance of the choke drops three volts to the required two. But a resistance is necessary in the filament circuit of the audio tubes, to prevent them from having the full three volts applied. I used a six-ohm rheostat. I substituted a .00005 mf. condenser for the .0001 mf. grid condenser of the original, and that really did the trick on the high frequencies!

I have received France, Germany, England, Spain, and several other foreign stations with full earphone volume—on two feet of antenna!

Many, many thanks to *Short Wave & Television* magazine for this splendid little receiver.

OLIE W. HUDSON,  
415 Chandler St.,  
Topeka, Kansas.

(Glad you like the "Electrodyne," Olie, and let's know how you make out with some of our new set designs.—Editor.)

## He Wants to Win S.W. Scout Trophy

Editor, SHORT WAVE & TELEVISION:

I am sending you a photo of my "listening post." My receiver is an 18-tube Midwest, 1936, and since that time I have been reading your magazine. I have purchased other radio magazines but I like your *Short Wave & Television* much better than the others.

Here's hoping that I'll be lucky enough to win your monthly prize.

I have started to "log" as many stations as possible in 30 days—May 15th to June 14th. I hope to win a "Trophy." I have sent out 108 letters and now have 48 veris in my possession. The stations are very slow in sending verifications.—Henry Sroka, 1507 Noble St., Chicago, Ill.



Henry Sroka, Chicago, Ill., enjoys his 18-tube "Midwest" receiver. He's after that S-W Scout Trophy—here's wishing you luck!

Mc.	Call		Mc.	Call		Mc.	Call	
15.260	GSI	DAVENTRY, ENG., 19.66 m., Addr. (See 26.100 mc.) 12.20-3.45, 9-11 pm.	15.500	LSM2	BUENOS AIRES, ARG., 20.69 m., Addr. (See 21.020 mc.) Works RIO and Europe daytime.	12.060	PDV	KOOTWIJK, HOLLAND, 24.88 m. Tests irregularly.
15.252	RIM	TACKENT, U.S.S.R., 19.67 m. Works RKI near 7 am.	14.485	TIR	CARTAGO, COSTA RICA, 20.71 m. Works Central America and U. S.A. daytime.	12.000	RNE	MOSCOW, U.S.S.R., 25 m. Daily 3-6 pm., Sat., Sun., Tues., Thurs., 10.15-10.45 pm., also Sun. 6-11 am., Mon 6-7 am. and 8.30-9 pm. Wed. 6-7 am., Thurs. 8.30-9 pm.
15.250	W1XAL	BOSTON, MASS., 19.67 m., Addr. University Club. Sundays 11 am-12.30 pm. Irregular other days.	14.485	YSL	SAN SALVADOR, SALVADOR, 20.71 m. Irregular.	11.991	FZS2	SAIGON, INDO-CHINA, 25.02 m. Phones Paris mornings.
15.245	TPA2	PARIS, FRANCE, 19.68 m., Addr. 98 bis. Blvd. Haussmann. "Radio Colonial." 5-10.05 am.	14.485	HPF	PANAMA CITY, PANAMA, 20.71 m. Works WNC daytime.	11.960	HI2X	CIUDAD TRUJILLO, D. R., 25.08 m., Addr. La Voz de Hispaniola. Relays HIX Tue. and Fri. 8.10-10.10 pm.
15.230	HS8PJ	BANGKOK, SIAM, 19.32 m. Irregularly Mon. 8-10 am.	14.485	TGF	GUATEMALA CITY, GUATEMALA, 20.71 m. Works WNC daytime.	11.955	IUC	ADDIS ABABA, ETHIOPIA, 25.09 m. Works IAC around 12 midnight.
15.230	OLR5A	PRAGUE, CZECHOSLOVAKIA. Irregular.	14.485	YNA	NICARAGUA, MANAGUA, 20.71 m. Works WNC daytime.	11.950	KKQ	BOLINAS, CALIF., 25.1 m. Tests irregularly evenings.
15.220	PCJ	HUIZEN, HOLLAND, 19.71 m., Addr. N. V. Philips' Radio, Hilversum. Tues. 4.30-6 am., Wed. 8-11 am.	14.485	HRL5	NACAOME, HONDURAS, 20.71 m. Works WNC daytime.	11.940	FTA	STE. ASSISE, FRANCE, 25.13 m. Works Morocco mornings and Argentina late afternoon.
15.210	W8XK	PITTSBURGH, PA., 19.72 m., Addr. (See 21.540 mc.) 9 am.-7 pm.	14.485	HRF	TEGUCIGALPA, HONDURAS, 20.71 m. Works WNC daytime.			
15.200	DJB	BERLIN, GERMANY, 19.74 m., Addr. (See 15.280 mc.) 12.05-5.15 am., 5.55-11 am., 4.50-11 pm. Also Sun. 11.10 am. to 12.25 pm.	14.470	WMF	LAWRENCEVILLE, N. J., 20.73 m., Addr. A. T. & T. Co. Works England daytime.			
15.190	ZBWA	HONGKONG, CHINA, 19.75 m., Addr. P. O. Box 200. 11.30 pm. to 1.15 am, 4-10 am.	14.460	DZH	ZEESSEN, GERMANY, 20.75 m., Addr. (See 15.360 mc.) Irregular.			
15.180	GSO	DAVENTRY, ENG., 19.76 m., Addr. (See 26.100 mc.) 12 M.-2.15 am., 5.45-8.55 am., 4-6, 6.20-8.30 pm.	14.443	GBW	RUGBY, ENG., 20.78 m. Works U. S. A. afternoons.	11.900	XEWI	MEXICO CITY, MEXICO, 25.21 m. Monday, Wed. and Fri. 3-4 pm., 9 pm.-12 m. Tues. to Thurs., 7.30 pm.-12 m. Sat. 9 pm. to 12 m. Sunday 12.30-2 pm.
15.180	RW96	MOSCOW, U.S.S.R., 19.76 m., Sun 2-3 pm.	14.200	EASAH	TETUAN, SPANISH MOROCCO, 21.13 m. Daily except Sun. 2.15-5, 7 and 9 pm.	11.895	HP5I	AGUADULCE, PANAMA, 25.22 m., Addr. La Voz del Interior. 7.30-9.30 pm.
15.160	JZK	TOKIO, JAPAN, 19.79 m., 2.30-3.30 pm., 4-5 pm., 12 m.-1 am.	13.990	GBA	RUGBY, ENG., 21.44 m., Works Buenos Aires late afternoon.	11.880	TPA3	PARIS, FRANCE, 25.23 m., Addr. (See 15.245 mc.) 4-5 am., 10.15 am.-5 pm.
15.150	YOC	BANDOENG, JAVA, 19.8 m., Addr. N. I. R. O. M. 6-7.30 pm., 10.30 pm.-2 am., Sat. 7.30 pm.-2 am., 5.30-10.30 am.	13.690	KKZ	BOLINAS, CALIF., 21.91 m., Addr. RCA Communications. Irregular.	11.870	W8XK	PITTSBURGH, PA., 25.26 m., Addr. (See 21.540 mc.) 7-10.30 pm.
15.140	GSF	DAVENTRY, ENG., 19.82 m., Addr. (See 26.100 mc.) 9.15 am.-12 n., 4-6.9-11 pm.	13.635	SPW	WARSAW, POLAND, 22 m., Mon., Wed. Fri., 12.30-1.30 pm.	11.860	YDB	SOERABAJA, JAVA, 25.29 m., Addr. N. I. R. O. M. Sat. 7.30 pm. to 2.30 am., daily 10.30 pm. to 2 am.
15.120	HVJ	VATICAN CITY, 19.83 m., 10.30-10.45 am., except Sun., Sat. 10-10.45 am.	13.585	GBB	RUGBY, ENG., 22.08 m. Works Egypt and Canada afternoon.	11.860	GSE	DAVENTRY, ENG., 25.29 m., Addr. (See 26.100 mc.) Irregular.
15.110	DJL	BERLIN, GERMANY, 19.85 m., Addr. (See 15.280 mc.) 12 m.-2, 8-9 am., 11.35 am. to 4.30 pm. Sun. also 6-8 am.	13.415	G CJ	RUGBY, ENG., 22.36 m. Works Japan and China early morning.	11.855	DJP	BERLIN, GERMANY, 25.31 m., Addr. (See 15.280 mc.) Irregular 11.35 am. to 4 pm.
			13.410	YSJ	SAN SALVADOR, SALVADOR, 22.37 m. Works WNC daytime.	11.840	CSW	LISBON, PORT., 25.35 m. Nat'l Broad. Stat. 11.30 am.-1.30 pm.
			13.390	WMA	LAWRENCEVILLE, N. J., 22.4 m., Addr. A. T. & T. Co. Works England morning and afternoon.	11.840	OLR4A	PRAGUE, CZECHOSLOVAKIA, 25.35 m. Daily 8.55 am. to 12 n., 2.25-4.30 pm. Sun. 2-7.30 am. Thurs. and Sat., 5-7.30 am. Mon. and Thurs., 7.55-11 pm.
			13.380	IDU	ASMARA, ERITREA, AFRICA, 22.42 m. Works Rome daytime.	11.830	W9XAA	CHICAGO, ILL., 25.36 m., Addr. Chicago Federation of Labor. Irregular.
			13.345	YVQ	MARACAY, VENEZUELA, 22.48 m. Works WNC daytime.	11.830	W2XE	NEW YORK CITY, 25.36 m., Addr. Col. Broad. System, 485 Madison Av., N.Y.C., relays WABC 6-9 pm.
			13.285	CGA3	DRUMMONDVILLE, QUE., CAN., 22.58 m. Works London and ships afternoons.	11.820	XEBR	HERMOSILLA, SON., MEX., 25.38 m., Addr. Box 68. Relays XEBH, 2-4 pm., 9 pm.-12m.
			13.330	IRJ	ROME, ITALY, 22.69 m. Works Tokio 5-9 am. irregularly.	11.820	GSN	DAVENTRY, ENG., 25.38 m., Addr. (See 26.100 mc.) Irregular.
			13.075	VPD	SUVA, FIJI ISLANDS, 22.94 m. Irregularly.	11.810	2RO	ROME, ITALY, 25.4 m., Addr. E.I.R.R., Via Montello 5. Daily 6.13-10.30 am, 11.30 am.-5.30 pm. Sun. 6.43-9 am., 11.30 am.-5.30 pm.
			12.840	WOO	OCEAN GATE, N. J., 23.36 m., Addr. A. T. & T. Co. Works with ships irregularly.	11.803	JZJ	TOKIO, JAPAN, 25.42 m., Addr. Broadcasting Co. of Japan, Overseas Division. 12 m.-1 am, 9-10 am, 2.30-3.30 pm., 4-5 pm.
			12.825	CNR	RABAT, MOROCCO, 23.39 m., Addr. Director General Tele. & Teleg. Stations. Works with Paris irregularly.	11.800	OER2	VIENNA, AUSTRIA, 25.42 m. Daily 10 am.-5 pm. Sat. until 5.30 pm.
			12.800	IAC	PISA, ITALY, 23.45 m. Works Italian ships mornings.	11.795	DJO	BERLIN, GERMANY, 25.43 m., Addr. (See 15.280 mc.) Irregular.
			12.780	GBC	RUGBY, ENG., 23.47. Works ships irregularly.	11.795	OAX5B	ICA, PERU, 25.43 m., Addr. Radio Universal. 11 am.-12 n, 4-11.15 pm.
			12.485	HIN	CIUDAD TRUJILLO, O. R., 24 m. "Broadcasting National." 12 n.-2 pm. 6-11 pm. approx.	11.790	W1XAL	BOSTON, MASS., 25.45 m., Addr. (See 15.250 mc.) Daily 3.30-5.45 pm. Irregular at other times.
			12.325	DAF	NORDDEICH, GERMANY, 24.34 m. Works German ships daytime.	11.770	DJD	BERLIN, GERMANY, 25.49 m., Addr. (See 15.280 mc.) 11.35 am.-4.30 pm., 4.50-11 pm.
			12.300	CEB	SANTIAGO, CHILE, 24.39 m., Addr. Louis Desmaras, Casilla, 761. 11 am.-1 pm., 4-8 pm., Sun. 4-10 pm.	11.760	OLR4B	PRAGUE, CZECHOSLOVAKIA, 25.51 m., Addr. (See 11.875 mc.) Irregular.
			12.290	GBU	RUGBY, ENG., 24.41 m. Works N. Y. C. evenings.	11.750	GSD	DAVENTRY, ENG., 25.53 m., Addr. B. B. C., London. 12 M.-2.15 am., 12.20-3.45 pm., 6.20-8.30 9-11 pm.
			12.250	TYB	PARIS, FRANCE, 24.49 m. Irregular.	11.730		SAIGON, INDO CHINA, 25.57 m., Addr. Radio Phico. Irregular 5.30-9.30 am.
			12.235	TFJ	REYKJAVIK, ICELAND, 24.52 m. Works Europe mornings. Broadcasts Sun. 1.40-2.30 pm.	11.730	PHI	HUIZEN, HOLLAND, 25.57 m., Addr. N. Y. Philips' Radio. Irregular.
			12.215	TYA	PARIS, FRANCE, 24.56 m. Works French ships in morning and afternoon.			
			12.150	GBS	RUGBY, ENG., 24.69 m. Works N. Y. C. evenings.			
			12.130	DZE	ZEESSEN, GERMANY, 24.73 m., Addr. (See 15.360 mc.) Tests irregular.			
			12.120		ALGIERS, ALGERIA, 24.75 m. Calls Paris 12 m.-6.30 am.			

↓ S.W. BROADCAST BAND ↓

↑ S.W. BROADCAST BAND ↑

(Continued on page 133)

\$5.00 Prize

### USEFUL ANTENNA KINK

I am sure that the following idea will

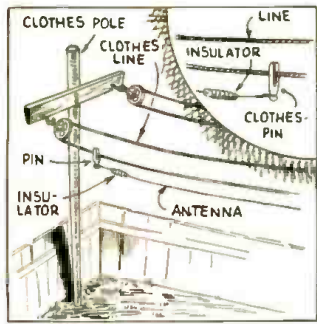

be found useful to all radio amateurs. The materials used for this kink are very simple and inexpensive. They consist of two clothes-pins, a long wire and two insulators. Fasten one end of the wire to the knob-end of a clothes-pin. Fasten the clothes-pin to the clothes-line. (A shirt of course, every home has) and pull the line out as far as possible. Then let the wire hang fairly loose and again fasten the other end to the other clothes-pin and again fasten it to the clothes-line. This temporary antenna (which may also be used as a permanent antenna) is very useful when one is needed in a "hiffy." This arrangement can be made to overcome the lightning hazard as the antenna can be hauled in in a few seconds time.

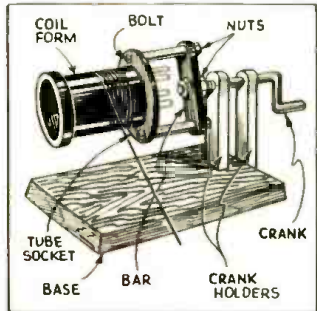

### COIL WINDER

I am submitting the following wrinkle which I believe will be helpful to radio amateurs and experimenters. It shows a way to hold plug-in coils while winding them. I first took a wafer socket and fastened it to an iron bar and put a space between bar and socket by means of bushings. I made a crank out of heavy wire, and then threaded the end of it. I made a small base with two small triangular shaped crank-holders near the end. I drilled a hole in the iron bar. Inserted the crank in the holders and fastened the tube socket to the crank as shown in the diagram.—Frank I. Douglas.

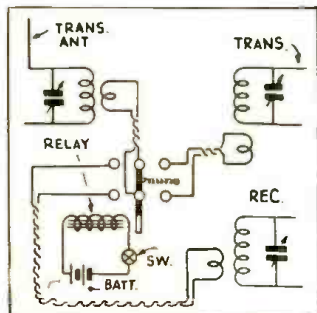

### ANTENNA CHANGE-OVER RELAY

Many short-wave "hams" will find this scheme useful where "link coupling" is employed between the antenna tuning unit and the transmitter tank circuit. A double-throw, double-throw relay is connected in the circuit so as to connect the link to the receiver during reception, and to the transmitter during transmission. The diagram shows a separate switch for operating the relay; however, many other arrangements may be employed, such as using a small transformer which is operated with an on-off switch in the transmitter. Thus the antenna is changed over and the transmitter turned on and off with one operation, thus greatly facilitating "break-in."—Paul Henderson.

## \$5.00 FOR BEST SHORT-WAVE KINK

The Editor will award a five dollar prize each month for the best short-wave kink submitted by our readers. All other kinks accepted and published will be awarded eight months' subscription to SHORT WAVE & TELEVISION. Look over these "kinks"; they will give you some idea of what the editors are looking for. Send a typewritten or ink description, with sketch, of your favorite short-wave kink to the "Kink" Editor, SHORT WAVE & TELEVISION.

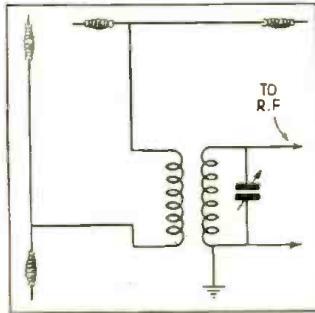

### SHORT-WAVE ANTENNA

Here is a kink that ought to be of use to some of your readers. In experimenting with two antennas, I found that the long one worked best on the 49 meter band, and the short one gave greater signal strength on the 20 meter band. Still better results were obtained by using them as a "doublet." This was due to the non-directional effect as the antennas are almost at right-angles. The use of a doublet resulted in greater input selectivity, even with close coupling. This arrangement can be used when there is not enough space for an actual doublet.—John Matern.

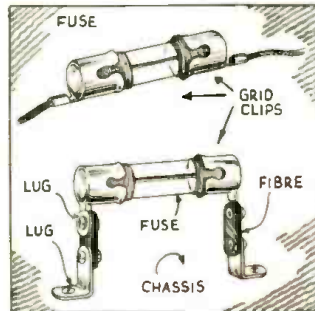

### FUSE KINK

Having a need for an efficient fuse holder, not taking up too much space, I hit upon the following idea: The new metal tube grid-clips just fit the ends of small 2 and 3 amp. line fuses and the 10, 15 and 20 amp. auto set type. When clipped on the fuse, they can be soldered as a resistor is soldered to the "one lug" type tie points and bolted to the chassis. I find this fuse holder very handy and will encourage the use of fuses as "safety valves" in short-wave set work.—N. C. Mine.

### SIMPLIFYING COIL WINDING

Although the following kink isn't original, I feel that it is known only to a few. It greatly simplifies coil winding and this I

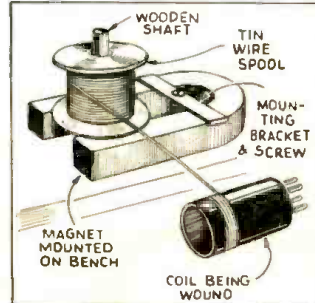

know will be appreciated by those radio experimenters who "wind their own" coils. Wind the coil wire on a tin spool and slip over a wooden shaft mounted between the poles of a magnet. This magnet provides perfect tension!—Ken Curry.

### CROSS INDEX FOR SW&T'S

Yours is absolutely the best radio magazine ever to enter this country. I have a complete list up-to-date, from January 1934, bound in yearly volumes. I have just completed "indexing" the last set. Each copy is separately indexed in a special book, then again in another section the whole lot for the year is alphabetically set out. This is surely worthy of a space in your wonderful "Kink" page.—R. L. LeMaire.

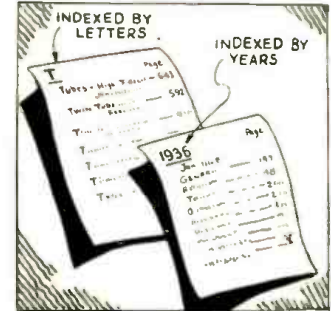

### QSL KINK FROM YL

I am entering the following kink in your contest. To make inexpensive and individual QSL's procure a post-card size duplicator, one of the type which uses a gelatine substance, and draw off a pattern using the special ink furnished with duplicator. Place the pattern, ink-side down on the gelatine, and leave for a few minutes. Take off pattern and it is then possible to take a large number of prints off the gelatine. These may be made on post-cards or any other kind of cardboard or paper.—Miss M. E. Burke.

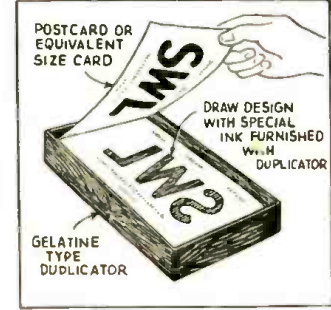

### MEASURING TAPE FOR WORLD GLOBE

This chart is made accordingly. To a 7-inch globe, each 1/16-inch=100 miles each 1-inch=1,000 miles, etc. It is a very simple matter to measure distance to any city with a chart made like this one. You see the idea of using paper is that it is flexible; it will bend according to the globe. Obtain a strip of cellophane with this glued on over the writing on the chart. This prevents the reading being rubbed off and it is flexible at the same time. For larger globes, the distance may be figured on the chart the same way, except first you must make sure to see the legend on the globe, then measure the legend distance on the globe exactly. After this make the chart. For a 7-inch globe a chart has to be about 9 1/2 to 10-inches long. In order to measure half-way around.—Martin O. Axland.

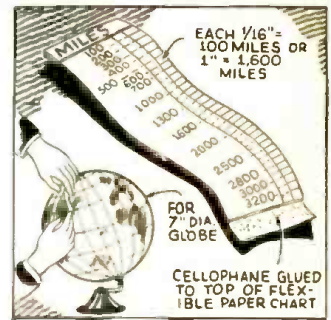

### LEAD-IN INSULATORS

Here is a description of my favorite short-wave stunt, which has found great favor in my vicinity, and I believe that other amateurs in the country would wel-

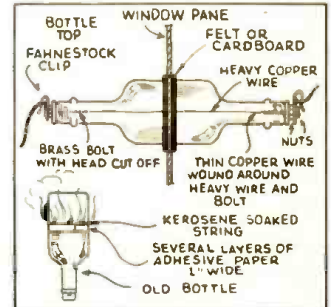

come the opportunity to learn how to make a set of cheap antenna lead-in insulators. They consist of upper portions of bottles with small holes in the necks, perfume or shampoo bottles are preferable; these may be cut by wrapping several turns of 1-inch wide adhesive paper on them, then winding a kerosene-soaked string along the paper and knifing it. When the glass is hot, dip into cold water and the glass will snap off, due to the contraction caused by the cold water. If it is desired to bore holes through window glass, use a high-speed carbon drill and lubricate the point with oil of turpentine. For details consult the drawing.—G. Villafan.

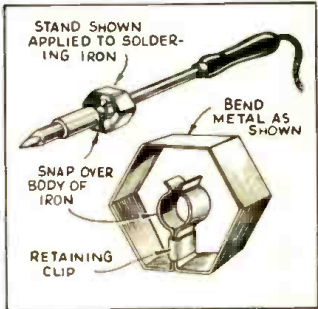

### SOLDERING IRON STAND

This idea is not original but it is practical. The stand is made from metal strip-ting such as found on packing cases. It is easily made and costs nothing. This arrangement permits the soldering iron to rest on any particular one of the sides of the hexagonal stand. The diameter of the stand should be sufficiently great to permit the iron to be snapped out of the grip and easily removed. For getting into tight places the holder is slid back toward the handle.—Carl Bonzo, Jr.

### REGENERATION AID

The diagram below shows how your regeneration can be made much smoother. Condenser B should be set so that the tube oscillates with the correct screen voltage.

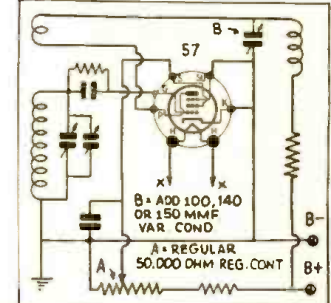

Mc.	Call	Mc.	Call	Mc.	Call	
11.720	CJRX	11.720	WINNIPEG, CANADA, 25.6 m., Addr. James Richardson & Sons, Ltd. 4-10pm.	10.290	DZC	ZEESEN, GERMANY, 29.16 m., Addr. (See 15.360 mc.) Irregular.
11.718	CR7RH	11.718	LAURENCO MARRQUES, PORTUGESE, E. AFRICA, 25.6 m. Daily 4.30-6.30, 9.30-11 am., 12.30-3.30 p.m. Sun. 6-8 am., 10 am.-12.30 pm., 1.30-3.20 pm.	10.260	PMN	BANDOENG, JAVA, 29.24 m., Relays YDB 5.30-10.30 or 11 am., Sat. to 11.30 am.
11.715	TPA4	11.715	PARIS, FRANCE, 25.61 m., (See 15.245 mc.) 5.15-7 pm., 9 pm.-12 m.	10.250	LSK3	BUENOS AIRES, ARG., 29.27 m., Addr. (See 10.310 mc.) Works Europe and U.S.A. afternoons and evenings.
11.710	SBG	11.710	MOTALA, SWEDEN, 25.63 m., 9 am.-1.30 pm.	10.230	CED	ANTOFAGASTAN, CHILE, 29.33 m. Tests 7-9.30 pm.
<b>↑ S.W. BROADCAST BAND ↓</b>		10.220	PSH	10.220	PSH	RIO DE JANIERO, BRAZIL, 29.35 m. Irregular.
11.680	KIO	11.680	KAHUKU, HAWAII, 25.68 m., Addr. RCA Communications. Irregularly.	10.170	RIO	BAKOU, U.S.S.R., 29.15 m. Works Moscow 10 pm.-5 am.
11.600	COCX	11.600	HAVANA, CUBA, 25.86 m. 8 am.-1 am. Relays CMX.	10.140	OPM	LEOPOLDVILLE, BELGIUM CONGO, 29.59 m. Works Belgium around 3 am. and from 1-4 pm.
11.595	VRR4	11.595	STONY HILL, JAMAICA, B. W. I., 25.87 m. Works WNC daytime.	10.080	RIO	TIFLIS, U.S.S.R., 29.76 m. Works Moscow early morning.
11.560	VLZ3	11.560	FISKVILLE, AUSTRALIA, 25.95 m., Addr. Amalgamated Wireless of Australasia Ltd. Tests irregularly.	10.070	EDM-EHY	MADRID, SPAIN, 29.79 m. Works S. A. evenings.
11.500	XAM	11.500	MERIDA, YUCATAN, 26.09 m. Irregular 1-7.30 pm.	10.065	JZB-TDB	SHINKYO, MANCHUKUO, 29.81 m. Works Tokio 6.30-7 am.
11.500	PMK	11.500	BANDOENG, JAVA, 26.09 m. Tests irregularly.	10.055	ZFB	HAMILTON, BERMUDA, 29.84 m. Works N. Y. C. irregular.
11.413	CJA4	11.413	DRUMMONDVILLE, QUE., CAN., 26.28 m. Tests irregularly.	10.055	SUV	ABOUZABAL, EGYPT, 29.84 m. Works Europe 1-6 pm.
11.405	HBO	11.405	GENEVA, SWITZERLAND, 26.30 m., Addr. Radio Nations. Sat. 5.30-6.15, 7-8.30 pm.	10.042	DZB	ZEESEN, GERMANY, 29.87 m., Addr. Reielspoetzenstraiamt. Irregular.
11.280	HIN	11.280	CIUDAD TRUJILLO, D. R., 26 m., Addr. La Voz del Partido Dominicano. Irregular.	9.990	KAZ	MANILA, P. I., 30.03 m., Addr. RCA Communications. Works Java early morning.
11.050	ZLT4	11.050	WELLINGTON, NEW ZEALAND, 27.15 m. Works Australia and England early morning.	9.950	GCU	RUGBY, ENGLAND, 30.15 m. Works N. Y. C. night time.
11.040	CSW	11.040	LISBON, PORTUGAL, 27.17 m., Addr. Nat. Broadcasting Sta. 1.30-6 pm.	9.930	HKB	BOGOTA, COL., 30.21 m. Works Rio evenings.
11.000	PLP	11.000	BANDOENG, JAVA, 27.27 m. Relays YDB. 5.30-10.30 or 11 am. Sat. until 11.30 am.	9.930	CSW	LISBON, PORTUGAL, 30.31 m., Addr. Nat. Broad. Station. 6-9 pm.
10.970	OCI	10.970	LIMA, PERU, 27.35 m. Works Bogota. Col. evenings.	9.890	LSN	BUENOS AIRES, ARG., 30.33 m., Addr. (See 10.300 mc.) Works N. Y. C. evenings.
10.840	KWV	10.840	DIXON, CALIF., 27.68 m., Addr. A. T. & T. Co. Works with Hawaii evenings.	9.870	WON	LAWRENCEVILLE, N. J., 30.4 m., Addr. A. T. & T. Co. Works England nights.
10.770	GBP	10.770	RUGBY, ENGLAND, 27.85 m. Works Australia early morning.	9.860	EAQ	MADRID, SPAIN, 30.43 m., Addr. Post Office Box 951. Daily 5.15-7.30 pm., Sat. also 12 n.-2 pm.
10.740	JVM	10.740	NAZAKI, JAPAN, 27.93 m. Works U.S.A. 2-7 am. Broadcasts daily 9-10 am., 2.30-3.30 pm.	9.830	IRM	ROME, ITALY, 30.52 m. Works Egypt afternoons.
10.675	WNB	10.675	LAWRENCEVILLE, N. J., 28.1 m., Addr. A. T. & T. Co. Works with Bermuda irregularly.	9.800	LSI	BUENOS AIRES, ARG., 30.61 m., Addr. (See 10.350 mc.) Tests irregularly.
10.670	CEC	10.670	SANTIAGO, CHILE, 28.12 m. Daily 7-7.15 pm.	9.790	GCW	RUGBY, ENGLAND, 30.64 m. Works N. Y. C. evenings.
10.660	JVN	10.660	NAZAKI, JAPAN, 28.14 m. Broadcasts daily 2-8 am. Works Europe irregularly at other times.	9.760	VLJ-VLZ2	SYDNEY, AUSTRALIA, 30.74 m., Addr. Amalgamated Wireless of Australasia Ltd. Works Java and New Zealand early morning.
10.550	WOK	10.550	LAWRENCEVILLE, N. J., 28.44 m., Addr. A. T. & T. Co. Works S. A. nights.	9.750	WOF	LAWRENCEVILLE, N. J., 30.77 m., Addr. A. T. & T. Co. Works London, night time.
10.535	JIB	10.535	TAIWAN, FORMOSA, 28.48 m. Works Japan around 6.25 am.	9.740	COCQ	HAVANA, CUBA, 30.78 m. 6.50 am. 1 am.
10.520	VLK	10.520	SYDNEY, AUSTRALIA, 28.51 m., Addr. Amalgamated Wireless of Australasia Ltd. Works England 1-6 am.	9.710	GCA	RUGBY, ENGLAND, 30.89 m. Works S. A. evenings.
10.430	YBG	10.430	MEDAN, SUMATRA, 28.76 m. 5.30-6.30 am., 7.30-8.30 pm.	9.675	DZA	ZEESEN, GERMANY, 31.01 m., Addr. (See 10.042 mc.) Irregular.
10.420	XGW	10.420	SHANGHAI, CHINA, 28.79 m. Works Japan 12 m.-3 am.	9.670	TIANRH	HEREDIA, COSTA RICA, 31.02 m., Addr. Amando C. Marin. Apartado 40. 8.30-10 pm., 11.30 pm.-12 m.
10.410	PDK	10.410	KOOTWIJK, HOLLAND, 28.8 m. Works Java 7.30-9.40 am.	9.660	LRX	BUENOS AIRES, ARG., 31.06 m., Addr. El Mundo. 7 am.-11.30 pm.
10.410	KES	10.410	BOLINAS, CALIF., 28.8 m., Addr. RCA Communications. Irregular.	9.650	CTIAA	LISBON, PORTUGAL, 31.09 m., Addr. Radio Colonial. Tues., Thurs. and Sat. 3-6 pm.
10.370	JVO	10.370	NAZAKI, JAPAN, 28.93 m. Broadcasts around 5 am.	9.650	YDB	SOERABAJA, JAVA, 31.09 m., Addr. N. I. R. O. M. Daily except Sat. 6-7.30 pm., 5.30 to 10.30 or 11 pm. Sat. 5.30-11.30 am.
10.370	EHZ	10.370	TENERIFFE, CANARY ISLANDS, 28.93 m. Relays EAJ43 2-4, 6-8.30 pm.	9.650	DGU	NAUEN, GERMANY, 31.09 m., Addr. (See 20.020 mc.) Works Egypt afternoons.
10.350	LSX	10.350	BUENOS AIRES, ARG., 28.98 m., Addr. Transradio International. Broadcasts 5-6 pm. Mon. and Fri. Tests irregularly at other times.	9.645	HH3W	PORT-AU-PRINCE, HAITI, 31.1 m., Addr. P. O. Box A117. 1-2, 7-8 pm.
10.330	ORK	10.330	RUYSSELEDE, BELGIUM, 29.04 m. 1.30-3 pm.	9.645	YNLF	MANAGUA, NICARAGUA, 31.1 m. 8-9 am., 12.30-2.30, 6.30-10 pm.
10.300	LSL2	10.300	BUENOS AIRES, ARG., 29.13 m., Addr. Cia. Internacional de Radio. Works Europe evenings.	9.635	2RO	ROME, ITALY, 31.13 m., Addr. (See 11.810 mc.) Daily 12.40-5.30 pm. Mon., Wed. and Fri. 6-7.30 pm. Tues., Thurs. and Sat. 6-7.45 pm.
9.630	HJ2ABD	9.630	BUCHARMANGA, COL., 31.14 m. 11.30 am.-12.30 pm., 5.30-6.30, 7.30-10.30 pm.	9.630	HJ2ABD	BUCHARMANGA, COL., 31.14 m. 11.30 am.-12.30 pm., 5.30-6.30, 7.30-10.30 pm.
9.620	HJ1ABP	9.620	CARTAGANA, COL., 31.19 m., Addr. P. O. Box 37. 11 am.-1 pm., 5-11 pm. Sun. 10 am.-1 pm., 3-6 pm.	9.615	HP5J	PANAMA CITY, PANAMA, 31.22 m. Addr. Apartado 867. 12 n. to 1.30 pm., 6-10.30 pm.
<b>↓ S.W. BROADCAST BAND ↓</b>						
9.600	RAN	9.600	MOSCOW, U.S.S.R., 31.25 m. Daily 7-9 pm.	9.600	RAN	MOSCOW, U.S.S.R., 31.25 m. Daily 7-9 pm.
9.600	CB960	9.600	SANTIAGO, CHILE, 31.25 m. Heard after 9.30 pm.	9.600	CB960	SANTIAGO, CHILE, 31.25 m. Heard after 9.30 pm.
9.595	HBL	9.595	GENEVA, SWITZERLAND, 31.27 m., Addr. Radio Nations. Irregular.	9.595	HBL	GENEVA, SWITZERLAND, 31.27 m., Addr. Radio Nations. Irregular.
9.590	PCJ	9.590	HUIZEN, HOLLAND, 31.28 m., Addr. (See 15.220 mc.) Sun. 2-3, 7-8 pm. Tues. 1.30-3 pm. Wed. 7-10 pm.	9.590	PCJ	HUIZEN, HOLLAND, 31.28 m., Addr. (See 15.220 mc.) Sun. 2-3, 7-8 pm. Tues. 1.30-3 pm. Wed. 7-10 pm.
9.590	VK6ME	9.590	PERTH, W. AUSTRALIA, 31.38 m., Addr. Amalgamated Wireless of Australasia, Ltd. 6-8 am. ext. Sun.	9.590	VK6ME	PERTH, W. AUSTRALIA, 31.38 m., Addr. Amalgamated Wireless of Australasia, Ltd. 6-8 am. ext. Sun.
9.590	VK2ME	9.590	SYDNEY, AUSTRALIA, 31.38 m., Addr. Amalgamated Wireless of Australasia, Ltd., 47 York St. Sun. 1-3, 5-9 am. 10.30 am.-12.30 pm.	9.590	VK2ME	SYDNEY, AUSTRALIA, 31.38 m., Addr. Amalgamated Wireless of Australasia, Ltd., 47 York St. Sun. 1-3, 5-9 am. 10.30 am.-12.30 pm.
9.590	W3XAU	9.590	PHILADELPHIA, PA., 31.28 m. Relays WCAU 11 am. to 7 pm.	9.590	W3XAU	PHILADELPHIA, PA., 31.28 m. Relays WCAU 11 am. to 7 pm.
9.580	GSC	9.580	DAVENTRY, ENGLAND, 31.32 m., Addr. B. B. C. London. 9-11 pm.	9.580	GSC	DAVENTRY, ENGLAND, 31.32 m., Addr. B. B. C. London. 9-11 pm.
9.580	VK3LR	9.580	MELBOURNE, AUSTRALIA, 31.32 m., Addr. 61 Little Collins St. Mon.-Fri. 3.30-8.30 am. Sat. 5-8.30 am. Sun. 3-7.30 am.	9.580	VK3LR	MELBOURNE, AUSTRALIA, 31.32 m., Addr. 61 Little Collins St. Mon.-Fri. 3.30-8.30 am. Sat. 5-8.30 am. Sun. 3-7.30 am.
9.575	HJ2ABC	9.575	CUCUTA, COL., 31.34 m. 8 pm. to 12 m.	9.575	HJ2ABC	CUCUTA, COL., 31.34 m. 8 pm. to 12 m.
9.570	W1XK	9.570	SPRINGFIELD, MASS., 31.35 m., Addr. Westinghouse Electric & Mfg. Co. Relays WBZ 6 am. to 12 m. Sun. 7 am. to 12 m.	9.570	W1XK	SPRINGFIELD, MASS., 31.35 m., Addr. Westinghouse Electric & Mfg. Co. Relays WBZ 6 am. to 12 m. Sun. 7 am. to 12 m.
9.565	VUB	9.565	BOMBAY, INDIA, 31.36 m., Addr. Indian State Broadcasting Corp. 11.30 am.-12.30 pm. Tues, Thurs., Fri. irregularly.	9.565	VUB	BOMBAY, INDIA, 31.36 m., Addr. Indian State Broadcasting Corp. 11.30 am.-12.30 pm. Tues, Thurs., Fri. irregularly.
9.560	DJA	9.560	BERLIN, GERMANY, 31.38 m., Addr. Broadcasting House. 12.05-5.15 am., 4.50-10.45 pm.	9.560	DJA	BERLIN, GERMANY, 31.38 m., Addr. Broadcasting House. 12.05-5.15 am., 4.50-10.45 pm.
9.555	HJ1ABB	9.555	BARRANQUILLA, COL., 31.39 m., Addr. P. O. Box 715. 11.30 am. to 1 pm., 4.30-6 pm.	9.555	HJ1ABB	BARRANQUILLA, COL., 31.39 m., Addr. P. O. Box 715. 11.30 am. to 1 pm., 4.30-6 pm.
9.550	OLR3A	9.550	PRAGUE, CZECHOSLOVAKIA, 31.41 m. See 11.875 mc. for schedule.	9.550	OLR3A	PRAGUE, CZECHOSLOVAKIA, 31.41 m. See 11.875 mc. for schedule.
9.540	DJN	9.540	BERLIN, GERMANY, 31.45 m., Addr. (See 9.560 mc.) 12.05-5.15 am., 4.50-10.45 pm.	9.540	DJN	BERLIN, GERMANY, 31.45 m., Addr. (See 9.560 mc.) 12.05-5.15 am., 4.50-10.45 pm.
9.540	VPD2	9.540	SUVA, FIJI ISLANDS, 31.45 m., Addr. Amalgamated Wireless of Australasia, Ltd. 5.30-7 am.	9.540	VPD2	SUVA, FIJI ISLANDS, 31.45 m., Addr. Amalgamated Wireless of Australasia, Ltd. 5.30-7 am.
9.535	JZI	9.535	TOKIO, JAPAN, 31.46 m., Addr. (See 11.800 JZI) 9-10 am.	9.535	JZI	TOKIO, JAPAN, 31.46 m., Addr. (See 11.800 JZI) 9-10 am.
9.530	W2XAF	9.530	SCHENECTADY, N. Y., 31.48 m., Addr. General Electric Co. 4 pm.-12 m.	9.530	W2XAF	SCHENECTADY, N. Y., 31.48 m., Addr. General Electric Co. 4 pm.-12 m.
9.525	ZBW3	9.525	HONGKONG, CHINA, 31.49 m., Addr. P. O. Box 200. Irregular 11.30 pm. to 1.15 am., 4-10 am.	9.525	ZBW3	HONGKONG, CHINA, 31.49 m., Addr. P. O. Box 200. Irregular 11.30 pm. to 1.15 am., 4-10 am.
9.525	LKJ1	9.525	JELOY, NORWAY, 31.29 m. 5-8 am.	9.525	LKJ1	JELOY, NORWAY, 31.29 m. 5-8 am.
9.520	HJ4ABH	9.520	AHMENIA, COLOMBIA, 31.51 m. 8-11 am., 6-10 pm.	9.520	HJ4ABH	AHMENIA, COLOMBIA, 31.51 m. 8-11 am., 6-10 pm.
9.510	VK3ME	9.510	MELBOURNE, AUSTRALIA, 31.55 m., Addr. Amalgamated Wireless of Australasia, 167 Queen St. Daily except Sun. 4-7 am.	9.510	VK3ME	MELBOURNE, AUSTRALIA, 31.55 m., Addr. Amalgamated Wireless of Australasia, 167 Queen St. Daily except Sun. 4-7 am.
9.510	GSB	9.510	DAVENTRY, ENGLAND, 31.55 m., Addr. (See 9.580 mc.—GSC) 12 M-2.15 am., 12.20-6 pm., 6.20-8.30 pm.	9.510	GSB	DAVENTRY, ENGLAND, 31.55 m., Addr. (See 9.580 mc.—GSC) 12 M-2.15 am., 12.20-6 pm., 6.20-8.30 pm.
9.505	HJ1ABE	9.505	CARTAGENA, COLOMBIA, 31.57 m., Addr. P. O. Box 31. 5-10.30 pm.	9.505	HJ1ABE	CARTAGENA, COLOMBIA, 31.57 m., Addr. P. O. Box 31. 5-10.30 pm.
9.500	HJU	9.500	BUENAVENTURA, COLOMBIA, 31.58 m., Addr. National Railways. Mon., Wed. and Fri. 8-11 pm.	9.500	HJU	BUENAVENTURA, COLOMBIA, 31.58 m., Addr. National Railways. Mon., Wed. and Fri. 8-11 pm.
9.500	PRF5	9.500	RIO DE JANIERO, BRAZ., 31.58 m. Irregularly 4.45 to 5.45 pm.	9.500	PRF5	RIO DE JANIERO, BRAZ., 31.58 m. Irregularly 4.45 to 5.45 pm.
9.500	EAR-EAQ2	9.500	MADRID, SPAIN, 31.59 m., Addr. (See 9.860 mc.) Exc. Mon. 2.30-3, 6.30-7. 7.30-9.30 pm., Mon. 7.30-9.30 pm.	9.500	EAR-EAQ2	MADRID, SPAIN, 31.59 m., Addr. (See 9.860 mc.) Exc. Mon. 2.30-3, 6.30-7. 7.30-9.30 pm., Mon. 7.30-9.30 pm.
<b>↑ S.W. BROADCAST BAND ↓</b>						

(All Schedules Eastern Standard Time)

(Continued on page 135)

# SHORT WAVES and LONG WAVES

## Our Readers Forum

### J. L. Bodycote Has 847 QSL's

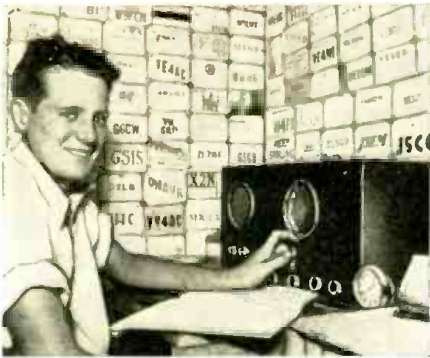

Here's Judge L. Bodycote, a "cracker-jack" S-W listener. If they're "gettable," Judge "bags" 'em!

Editor, SHORT WAVE & TELEVISION:

The receiver I employ is an RCA-ACR 136 7-tube Communications type. My antennas are a 60-foot, 40-meter doublet, 70 feet high, running E.-W. with 53-foot twisted feeders, and a 200-foot inverted "L", 74 feet high running N.-S. My DX is 47 VK's on 20 meter phone ON, SW, F8, LU, K6, K5, EA, G, ZL, etc. I have a total of 847 QSL's from "all over the world." I've been a reader of *Short Wave Craft* for two years, and couldn't get along without it.

My DX is: VK30C, VK2AZ, VK5AI, VK5LR, G6XR, G5N1, ON4VK, and many others.

Member of *Short Wave League* and *International Broadcasting Club* (London).  
 Judge L. Bodycote  
 29 Melrose Ave.  
 East Norwalk, Conn.

### Has Received 21 Countries

Editor, SHORT WAVE & TELEVISION:

I have been a constant reader of your fine magazine ever since I first became interested in Short Wave DX'ing, several years ago. Next to "Listening In" with Joe Miller, I enjoy reading your "Short Waves and Long Raves" best.

My receiver is an 18 tube Midwest, coupled to a McMurdo R9 antenna. I find that this combination works very well together and have gotten excellent results from it.

## Trophy Winner—Walter E. Butts

The picture herewith shows trophy winner Walter E. Butts of Worthington, Ohio. He



was the thirty-sixth trophy winner in our Short Wave Scout DX "Log" Contest. Mr. Butts says in his letter—"My friends all think that the trophy is the finest that they have ever seen. I certainly agree with them too. I am very proud of it and wish to thank you sincerely for the trophy. I will be glad to answer all SWL cards and prefer to receive them written in English, where foreign listeners are concerned. A 16-tube Midwest is used."

Walter E. Butts,  
 620 Hartford St.,  
 Worthington, Ohio.

My antenna is 58 feet high and situated NE-SW. With my aerial in this position I find that signals can be received as well from one direction as another.

I have been DX'ing on the *Short Waves* for about three years, but did not get very good results until I purchased my new receiver last November. Since then I have received 21 countries, and verified 12 of them. Since the first of Nov. I have heard the following DX: All VE districts, CO2-7-8, K4-6-7, XE1-2-3, LU5-7-9, OA4, VO1, VK2-3, CE1-3, YV1, G2-5-6, VP2-3-9, F3, SU1, J2, VQ1, and H15-7. I will look forward to seeing future issues of your swell magazine.

Delbert Holden,  
 523 O Street,  
 Fresno, California



A swell "SWL" card is sent out by Delbert Holden.

### Likes the "2 Vt. Super DX-4"

Editor, SHORT WAVE & TELEVISION:

Many thanks for your latest battery set, the "2-Volt Super DX-4." It is just what I have been waiting for. As I write I am listening to ZTJ (Johannesburg) S. A. The volume is overpowering on the Europeans and even now it is at "entertaining strength," and I use no ground! It can beat all the sets round about.

Your magazine beats all the English journals for the amount of educational matter, and I would not miss getting it for worlds.

My hands are itching to turn those knobs! So wishing you success with your publication, I am,

Yours faithfully,  
 R. Hodgson,  
 8 Main St.,  
 Lower Heysham,  
 Lancashire, England

### An Enthusiastic "XYL" Operator



Hilda Scott Harwood, a southern "XYL," hailing from Richmond, Va.

Editor, SHORT WAVE & TELEVISION:

The main receiver is a revamped Hallicrafter and works very well on 20, 40 and 80 meters. The 5 meter receiver on the left of the Hallicrafter is a National. Above is the old three-circuit Zenith regenerative receiver and it is fine for code practice up to 1,200 meters. The two "Mac" keys are used with a buzzer for code practice. The phones are Baldwin type "C" but are used very little, as the Hallicrafter brings them in loud enough for speaker use most of the time. The five meter "rig" is used for local reception and the phones are used with it.

I will send to any amateur or SWL (Short Wave Listener) a souvenir for their station, if they will send a three-cent stamp to cover mailing. The demand for these souvenirs has been so great that I have to ask for the stamp, so I'll have money enough to buy new equipment. Hi! I will trade photos with anyone and all mail will be answered.

I like *Short Wave & Television* very much and wish it every success.

Hilda Scott Harwood  
 3104 Edgewood Avenue  
 Richmond, Va.

### Has 12 S. W. & T. Sets Working O.K.!

Editor, SHORT WAVE & TELEVISION:

I have been taking your magazine since it first came on the newsstands, and haven't missed one. I have a dozen of your sets working O.K., now, and I have six in one cabinet, with a single switch to turn on or off any one I want to use. By this you can see that short waves keep me busy.

Well, every "Fan" has his pet set and I have mine. It is the "2-tube Doerle" for 31 meters and the Periphone Master 2-tube. I have been using a 10 meter set for the past month as a one-tube set. This will be news to you, and no kidding, all the W6 stations (Ham) come in like a ton of brick, but one day recently I couldn't get a station on 10-meters. I heard a station in Dublin, Ireland, E12J talking to W6, and a British (India) station talking to a VE3ACU.

"A Constant Reader,"

J. C. Haley,  
 807 N. 23rd Street,  
 St. Joseph, Mo.

(Hotcha! J.C.H.! Hope you like the "brand" of our sets we've been showing you lately. —Editor.)

(Continued on page 154)



Mc.	Call	Mc.	Call	Mc.	Call
9.430	XEFT	VERA CRUZ, MEXICO, 31.61 m. 11.30 am. to 4 pm., 7 pm. to 12 m.	7.901	LSL	HURLINGHAM, ARGENTINA, 37.97 m. Works Brazil at night.
9.470	XEDQ	GUADALAJARO, GAL., MEXICO, 31.68 m. Irregular 7.30 pm. to 12.30 am.	7.860	SUX	ABOU ZABAL, EGYPT, 38.17 m. Works with Europe, 4-6 pm.
9.450	ICK	TRIPOLI, N. AFRICA, 31.71 m. Works Rome, 5.30-7 am.	7.854	HC2JSB	GUAYAQUIL, ECUADOR, 38.2 m. Evenings.
9.450	TGWA	GUATEMALA CITY, GUATEMALA, 31.75 m., Addr. Ministre de Fomento. Daily 12 n. to 2 pm., 8 pm. to 12 m. Sat. 9 pm. to 5 am. (Sun.)	7.799	HBP	GENEVA, SWITZERLAND, 38.47 m., Addr. Radio-Nations. Irregular.
9.440	FZF6	FORT de FRANCE, MARTINIQUE, 31.78 m. 11.30 am., 12.30 pm., 6.15-7.15 pm., 8-9 pm.	7.715	KEE	BOLINAS, CAL., 38.89 m. Relays NBC and CBS programs in evening irregularly.
9.440	HC2RA	GUAYAQUIL, ECUADOR, 31.78 m. Irregularly till 10.40 pm.	7.626	RIM	TACHKENT, U.S.S.R., 39.34 m. Works with Moscow in early morning.
9.428	COCH	HAVANA, CUBA, 31.8 m., Addr. 2 B St., Vedado. 7 am.-1 am.	7.610	KWX	DIXON, CAL., 39.42 m. Works with Hawaii, Philippines, Java and Japan, nights.
9.415	PLV	BANDOENG, JAVA, 31.87 m. Works Holland around 9.45 am.	7.550	T18WS	PUNTA ARENAS, COSTA RICA, 39.74 m., Addr. "Ecos Del Pacifico", P. O. Box 75. 6 pm.-12 m.
9.350	HS8PJ	BANGKOK, SIAM, 32.09 m. Thursday, 8-10 am.	7.520	KKH	KAHUKU, HAWAII, 39.89 m. Works with Dixon and broadcasts irregularly nights.
9.330	CGA4	DRUMMONDVILLE, CANADA, 32.15 m. Works England irregularly.	7.510	JVP	NAZAKI, JAPAN, 39.95 m. Irregular.
9.330	OAX4J	LIMA, PERU, 32.15 m., Addr. Box 1166, "Radio Universal." 7 pm.-12 m.	7.500	RKI	MOSCOW, U.S.S.R., 40 m. Works with RIM early am.
9.300	YNGU	MANAGUA, NICARAGUA, 32.26 m. 12 n.-2 pm., 6-7 pm.	7.390	ZLT2	WELLINGTON, N. Z., 40.6 m. Works with Sydney, 3-7 am.
9.280	GCB	RUGBY, ENGLAND, 32.33 m. Works Canada and Egypt evenings and afternoons.	7.380	XECR	MEXICO CITY, MEX., 40.65 m., Addr. Foreign Office. Sunday 6-7 pm.
9.170	WNA	LAWRENCEVILLE, N. J., 32.72 m. Works England evenings.	7.220	HKE	BOGOTA, COL., S. A., 41.55 m. Tues. and Sat. 8-9 pm. Mon. and Thurs. 6.30-7 pm.
9.150	YVR	MARACAY, VENEZUELA, 32.79 m. Works with Europe afternoons.	7.200	YNAM	MANAGUA, NICARAGUA, 41.67 m. Daily at 9 pm.
9.125	HAT4	BUDAPEST, HUNGARY, 32.88 m., Addr. "Radiolabor," Gyali-ut. 22. Sun. and Wed. 7-8 pm., Sat. 6-7 pm.	7.100	FO8AA	PAPEETE, TAHITI, 42.25 m., Addr. Radio Club Papeete. Tues. and Fri. 11 pm.-12 m.
9.060	TFK	REYKJAVIK, ICELAND, 33.11 m. Works London afternoons.	6.996	PZH	PARAMIRABD, DUTCH GUIANA, 42.88 m., Addr. P. O. Box 18. Daily 6.06-8.36 am., Sun. 9.36-11.36 am., Daily 5.36-8.36 pm.
9.020	GCS	RUGBY, ENGLAND, 33.26 m. Works N. Y. C. evenings.	6.977	XBA	TACUBAYA, D. F., MEX., 43 m. 9.30 am.-1 pm., 7-8.30 pm.
9.010	KEJ	BOLINAS, CAL., 33.3 m. Relays NBC and CBS programs in evening irregularly.	6.976	HCETC	QUITO, ECUADOR, 43m., Addr. Teatro Bolivar. Thurs. till 9.30 pm.
8.957	VWY	KIRKEE, INDIA, 33.43 m. Works with England in morning.	6.905	GDS	RUGBY, ENG., 43.45 m. Works N.Y.C. evenings irregularly.
8.960	—	ALGIERS, ALGERIA, 33.48 m. Works Paris afternoons.	6.860	KEL	BOLINAS, CALIF., 43.70 m. Tests irregularly. 11 am.-12 n., 6-9 pm.
8.950	HCJB	QUITO, ECUADOR, 33.5 m. 7-10 pm. except Monday.	6.850	XGOX	NANKING, CHINA, 43.8 m. Daily 6.40-8.40 am., Sun. 4.40-6.05 am.
8.795	HKV	BOGOTA, COLOMBIA, 34.09 m. Mon. and Thurs. 7-7.30 pm.	6.830	HI7P	CIUDAD TRUJILLO, DOM. REP., 44.12 m., Addr. Emisora Diaria de Comercio. Daily exc. Sat. and Sun. 12.40-1.40, 6.40-8.40 pm. Sat. 12.40-1.40 pm. Sun. 10.40 am.-11.40 am.
8.775	PNI	MAKASSER, CELEBES, N. I., 34.19 m. Works Java around 4 am.	6.770	HIH	SAN PEDRO DE MACORIS, DOM. REP., 44.26 m. 12.10-1.40 pm., 7.30-9 pm. Sun. 3-4 am., 4.15-6 pm., 4.40-7.40 pm.
8.765	DAF	NORDEICH, GERMANY, 34.23 m. Works German ships irregularly.	6.775	WOA	LAWRENCEVILLE, N. J., 44.41 m., Addr. A. T. & T. Co. Works England evenings.
8.760	GCQ	RUGBY, ENGLAND, 34.25 m. Works Africa afternoons.	6.750	JVT	NAZAKI, JAPAN, 44.44 m., Addr. Kokusai-Deiwa Kaisha, Ltd., Tokio. Irregular.
8.750	FZ8	DJIBOUTI, FR. SOMALILAND, AFRICA, 34.29 m. Works Paris around 2.30 am.	6.730	HI3C	LA ROMANA, DOM. REP., 44.58 m., Addr. "La Voz de la Feria." 12.30-2 pm., 5-6 pm.
8.730	GCI	RUGBY, ENGLAND, 34.36 m. Works India 8 am.	6.720	PMH	BANDOENG, JAVA, 44.64 m. Relays NIROM programs. 5.30-9 am.
8.720	VPD3	SUVA, FIJI ISLES, 34 m., Addr. (See 9.540 mc. VPD2). 5.30-7 am.	6.710	TIEP	SAN JOSE, COSTA RICA, 44.71 m., Addr. Apartado 257, La Voz del Tropico. Daily 7-10 pm.
8.680	GBC	RUGBY, ENGLAND, 34.56 m. Works ships irregularly.	6.672	YVQ	MARACAY, VENEZUELA, 44.95 m. Sat. 8-9 pm.
8.665	CO9JQ	CAMAGUEY, CUBA, 34.62 m., Addr. 4 General Gomez. 5.30-6.30, 8-9 pm., daily except Sat. and Sun.	6.670	HC2RL	GUAYAQUIL, ECUADOR, S. A., 44.95 m., Addr. P. O. Box 759. Sun. 5.45-7.45 pm., Tues. 9.15-11.15 pm.
8.580	YNLG	MANAGUA, NICARAGUA, 34.92 m. 7.30-9.30 pm.	6.650	IAC	PISA, ITALY, 45.11 m. Works ships irregularly.
8.560	WOO	OCEAN GATE, N. J., 35.05 m. Works ships irregularly.	6.630	HIT	CIUDAD TRUJILLO, D. R., 45.25 m., Addr. "La Voz de la RCA Victor." Apartado 1105. Daily exc. Sun. 12.10-1.40 pm., 5.40-8.40 pm.; also Sat. 10.40 pm.-12.40 am.
8.400	HC2CW	GUAYAQUIL, ECUADOR, 35.71 m. 11.30 am.-12.30 pm., 8-11 pm.	6.625	PRADO	RIOBAMBA, ECUADOR, 45.28 m. Thurs. 9-11.45 pm.
8.380	IAC	PISA, ITALY, 35.8 m. Works Italian ships irregularly.			
8.190	XEME	MERIDA, YUCATAN, 36.63 m., Addr. Calle 59, No. 517, "La Voz de Yucatan desde Merida." 10 am.-12 n., 6 pm.-12 m.			
8.185	PSK	RIO DE JANEIRO, BRAZIL, 36.65 m. Irregularly.			
8.035	CNR	RABAT, MOROCCO, 37.33 m. Sun. 2.30-5 pm.			
7.975	HC2TC	QUITO, ECUADOR, 37.62 m. Thurs. and Sun. at 8 pm.			
6.558	HI4D	CIUDAD TRUJILLO, D. R., 45.74 m. Except Sun. 11.55 am.-1.40 pm.			
6.550	XBC	VERA CRUZ, MEX., 45.8 m. 8.15-9 am.			
6.550	TIRCC	SANJOSE, COSTARICA, 45.8 m., Addr. Radioemisora Catolica Costarricense. Sun. 11 am.-2 pm., 6-7, 8-9 pm. Daily 12 n.-2 pm., 6-7 pm., Thurs. 6-11 pm.			
6.545	YV6RB	BOLIVAR, VENEZUELA, 45.84 m., Addr. "Ecos de Orinoco." 6-10.30 pm.			
6.530	YN1GG	MANAGUA, NICARAGUA, 45.94 m., Addr. "La Voz de los Lagos." 8-9 pm.			
6.520	YV4RB	VALENCIA, VENEZUELA, 46.01 m. 11 am.-2 pm., 5-10 pm.			
6.500	HIL	CIUDAD TRUJILLO, D. R., 46.15 m., Addr. Apartado 623. 12.10-1.40 pm., 5.40-7.40 pm.			
6.500	TIOW	PUERTO LIMON, COSTA RICA, 46.15 m., Addr. Ondas del Caribe. Daily 12 n.-1.30 pm.			
6.477	HI4V	SAN FRANCISCO de MACORIS, D. R., 46.32 m. 11.40 am.-1.40 pm., 5.10-9.40 pm.			
6.470	YNLAT	GRANADA, NICARAGUA, 46.36 m., Addr. Leonidas Tenorio. "La Voz del Mombacho." Irregular.			
6.450	HI8A	CIUDAD TRUJILLO, D. R., 46.51 m. 8.40-10.40 am., 2.40-4.10 pm. Sat. 9.40-10.40 pm. Sun. 2.40-4.40 pm.			
6.420	HI1S	SANTIAGO, D. R., 46.73 m. 11.40 am.-1.40 pm., 5.40-7.40, 9.40-11.40 pm.			
6.410	TIPG	SAN JOSE, COSTA RICA, 46.8 m., Addr. Apartado 225, "La Voz de la Victor." 12 n.-2 pm., 6-11.30 pm.			
6.400	YV5RH	CARACAS, VENEZUELA, 46.88 m. 7-11 pm.			
6.380	YV5RF	CARACAS, VENEZUELA, 47.02 m., Addr. Box 983. 6-10.30 pm.			
6.360	HRP1	SAN PEDRO SULA, HONDURAS, 47.19 m. 7.30-9.30 pm.			
6.360	YV1RH	MARACAIBO, VENEZUELA, 47.19 m., Addr. "Ondas Del Lago," Apartado de Correos 261. 6-7.30 am., 11 am.-2 pm., 5-11 pm.			
6.350	HRY	TEGUCIGALPA, HONDURAS, 47.24 m. 6.30-8.30 pm.			
6.340	HI1X	CIUDAD TRUJILLO, D. R., 49.32 m. Sun. 7.40-10.40 am., daily 12.10-1.10 pm., Tues. and Fri. 8.10-10.10 pm.			
6.316	HIZ	CIUDAD TRUJILLO, D. R., 47.5 m. Daily except Sat. and Sun. 11.10 am.-2.25 pm., 5.10-8.40 pm. Sat. 5.10-11.10 pm. Sun. 11.40 am.-1.40 pm.			
6.310	TG2	GUATEMALA CITY, GUAT., 47.55 m., Addr. Secretaria de Fomento. Relays TG1 1.40 pm.-1 am.			
6.300	YV4RG	MARACAY, VENEZUELA, 47.62 m. 8-10.30 pm.			
6.282	COHB	SANCTI SPIRITUS, CUBA, 47.76 m., Addr. P. O. Box 85. 4-6, 9-11 pm.			
6.280	HIG	CIUDAD TRUJILLO, D. R., 47.77 m. 7.10-8.40 am., 12.40-2.10, 8.10-9.40 pm.			
6.270	YV5RP	CARACAS, VENEZUELA, 47.79 m., Addr. "La Voz de la Philco." Irregular.			
6.243	HIN	CIUDAD TRUJILLO, D. R., 48 m., Addr. "La Voz del Partido Dominicano." 12 m.-2 pm., 7.30-9.30 pm., irregularly.			
6.235	HRD	LA CEIBA, HONDURAS, 48.12 m., Addr. "La Voz de Atlantida." 8-11 pm.; Sat. 8 pm.-1 am.; Sun. 4-6 pm.			
6.230	YV1RG	VALERA, VENEZUELA, 49.15 m. 6-9.30 pm.			
6.230	OAX4G	LIMA, PERU, 48.15 m., Addr. Apartado 1242. Daily 7-10.30 pm.			
6.210	YV5RI	CORO, VENEZUELA, 48.31 m., Addr. Roger Leyba, care A. Urbina y Cia. Irregular.			
6.190	HI8Q	CIUDAD TRUJILLO, D. R., 48.47 m. 11.45 am.-1 pm., 4.45-6.45 pm.			
6.185	HI1A	SANTIAGO, D. R., 48.5 m., Addr. P. O. Box 423. 11.40 am.-1.40 pm.; 7.40-9.40 pm.; Wed. 6-10.30 pm.			
6.171	XEXA	MEXICO CITY, MEX., 48.61 m., Addr. Dept. of Education. 7-11 pm.			

↓ S.W. BROADCAST BAND ↓

6.160 YV5RD CARACAS, VENEZUELA, 48.7 m. 11 am.-2 pm., 4-10.40 pm.  
(Continued on page 137)

(All Schedules Eastern Standard Time)

# WHAT'S NEW In Short-Wave Apparatus

The short-wave apparatus here shown has been carefully selected for description by the editors after a rigid investigation of its merits.

## KNIGHT 11 Tuber Has Automatic Dialing

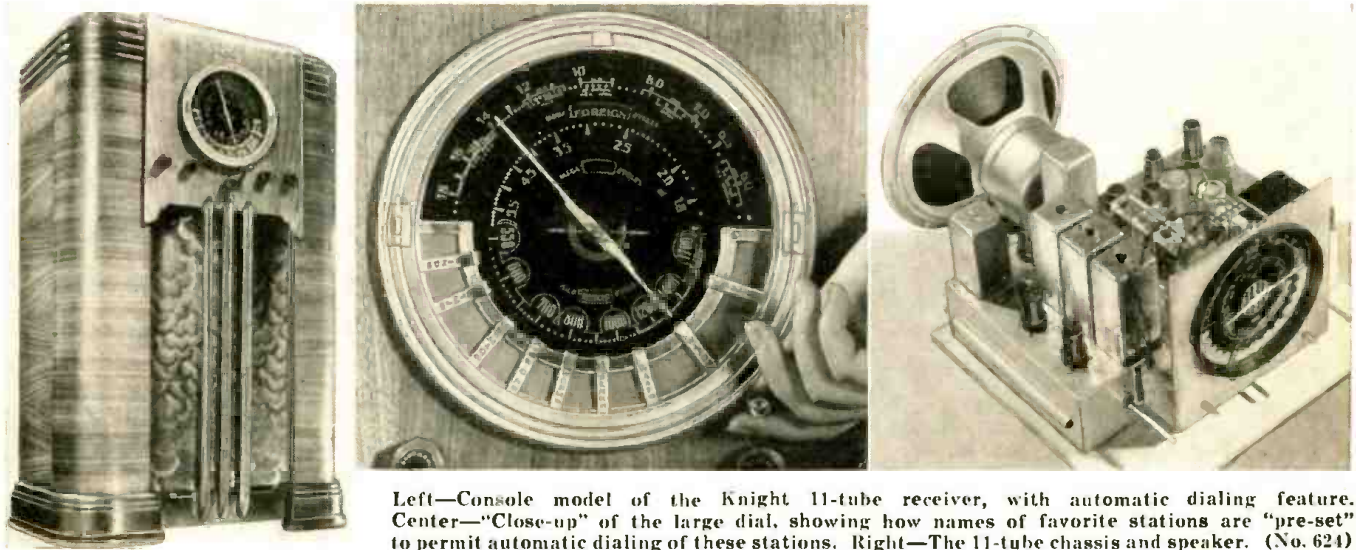

Left—Console model of the Knight 11-tube receiver, with automatic dialing feature. Center—"Close-up" of the large dial, showing how names of favorite stations are "pre-set" to permit automatic dialing of these stations. Right—The 11-tube chassis and speaker. (No. 624)

● OF interest to all short wave "Fans" and broadcast listeners who desire a real thrill as well as a great convenience in tuning, here is the new 11-tube Knight receiver. At the flip of a finger you can tune in instantly any one of 12 "favorite" stations, which are pre-set around the bottom half of the dial as the pictures show. This receiver has all of the latest features—including automatic frequency tuning, which tunes the set automatically and exactly to the station, in case you should tune in carelessly.

This 11-tube set covers three full bands—16 to 54 and 52 to 178 meters, for short-wave domestic and overseas programs, as

well as *amateur* and *police* signals; and it also covers the band from 174 to 560 meters, which includes the American and Canadian standard *broadcast* stations.

Other interesting features are the giant color-band dial; metal tubes; 9 watts power output; a 12-inch electro-dynamic speaker; automatic frequency control; automatic tone control; automatic volume control; inter-station noise silencer; three-gang tuning condenser; R.F. pre-selection; and double push-pull audio. The console cabinet measures 41" high, 26½" wide and 14½" deep. Ten new tubes and one glass type are used effectively as follows: 6K7 as Pre-tuned R.F.; 6A8 as Mod.-Osc.; 6K7 as

I.F.; 6J7 as A.F.C.; 6H6 as Det.-A.V.C.; 6C5 as 1st Audio; 2-6C5 as push-pull 2nd Audio; 2-6F6 as push-pull power stage; 80 as rectifier. You receive the most from each of these tubes, reflected in full nine watts undistorted output and high fidelity tone.

Automatic tone control boosts bass automatically, without cutting out the high notes. This receiver has five positions permitting perfect acoustical matching for any type of program. It also has final position for best possible noise-free distance and short-wave reception.

This article has been prepared from data supplied by the courtesy of the Allied Radio Corp.

## New Devices for S-W Amateurs

### New Dynamic Microphone



● THE new dynamic microphone shown in the photo is a product of the American Microphone Company. It is available in two types, the standard type D-5, and the high impedance unit type D-5-T. These units come complete with a plug at the microphone end. This with a 25-ft. shielded rubber-covered cable microphone is 2½-inches in diameter and 3½-inches in length, and weighs 1½ lbs. It is finished in black satin with chrome trim. The sensitivity level of the mike is approximately minus 55-DB. High permeability nickel-alloy transformer is enclosed in the microphone case. This combination will work with cables up to a length of 50 ft. without frequency discrimination. The impedance of one unit is 10,000 ohms, while that of the low impedance

unit is approximately 50 ohms. This is suitable for public address, amateur work, and many other similar uses (No. 625)

This article has been prepared from data supplied by courtesy of American Microphone Co.

### Mounting for Ham License

● AT last the amateur is provided with a very convenient and neat-appearing mounting unit for his license. The illustration shows the general design, whose main features are the swivel holder with the transparent celluloid windows on either side. The unit shown in the illustration is for desk mounting. Another type is available with an offset arm, permitting it to be mounted on the side-wall.

Our information bureau will gladly supply manufacturers' names and addresses of any item mentioned in SHORT WAVE & TELEVISION. Please enclose a stamped return envelope.

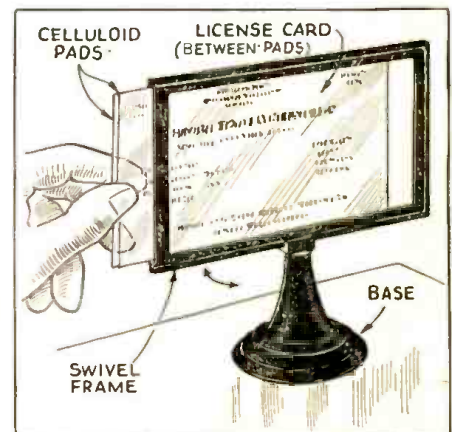

Clever 2-faced License Holder Shows Both Sides (No. 626)

Mc.	Call	Mc.	Call	Mc.	Call
6.160	VUZ	6.090	ZBW2	6.005	HP5K
	COLOMBO, CEYLON, 48.7 m. Daily exc. Thurs. and Fri., 7 1m.-12.30 pm.; Sun. 7-11.30 am.	6.085	HJ5ABD	6.005	CFCK
6.150	CSL		LISBON, PORTUGAL, 48.78 m. Irregular. 7-8.30 am., 2-7 pm.		VE9DN
6.150	CJRO	6.083	VQ7LO	6.005	VE9DN
6.147	ZEB		WINNIPEG, MAN., CANADA, 48.78 m., Addr. (See 11.720 mc.) 4-10 pm.	6.000	ZEA
6.147	COKG	6.080	ZHJ	5.990	XEBT
6.145	HJ4ABU		BULAWAYO, RHODESIA, S. AFRICA, 48.8 m. Sun. 3.30-5 am.; Tues., Fri., 1.15-3.15 pm.; Mon. and Thurs. 11 am.-12 m.		
6.140	W8XK	6.080	CP5		
6.137	CR7AA	6.080	HP5F		
6.135	HJ1ABB	6.080	W9XAA		
6.135	HI5N	6.073	DJM		
6.130	TGXA	6.070	HJ3ABF		
6.130	COCD	6.070	CFRX		
6.130	VE9HX	6.070	YV1RE		
6.130	ZGE	6.070	VE9CS		
6.130	LKL	6.065	HJ4ABL		
6.125	—	6.065	SBG		
6.125	OAX1A	6.060	W8XAL		
6.122	HP5A	6.060	W3XAU		
6.122	HJ3ABX	6.060	OXY		
6.120	W2XE	6.050	HJ3ABD		
6.120	XEUZ	6.045	HI9B		
6.115	OLR2C	6.042	HJ1ABG		
6.110	XEPW	6.040	W4XB		
6.110	VUC	6.040	W1XAL		
6.105	HJ4ABB	6.040	YOA		
6.100	W3XAL	6.030	HJ4ABP		
6.100	W9XF	6.030	HP5B		
6.100	HJ4ABE	6.030	VE9CA		
6.097	ZTJ	6.030	OLR2B		
6.095	ZJH	6.025	HJ1ABJ		
6.090	HJ4ABC	6.020	DJC		
6.090	CRCX	6.020	XEUW		
		6.018	ZHI		
		6.015	HI3U		
		6.012	HJ3ABH		
		6.010	VP3MR		
		6.010	COCO		
			HONGKONG, CHINA, 49.26 m., Addr. P. O. Box 200. Irregular.		
			CALI, COLOMBIA, 49.3 m., Addr. La Voz de Valle. 12m.-1.30 pm., 5.10-9.40 pm.		
			NAIROBI, KENYA, AFRICA, 49.31 m., Addr. Cable and Wireless. Ltd. Mon.-Fri. 5.45-6.15 am., 11.30 am.-2.30 pm., also Tues. and Thurs. 8.30-9.30 am.; Sat. 11.30 am.-3.30 pm.; Sun. 11 am.-2 pm.		
			PENANG, FED. MALAY STATES, 49.34 m. 6.40-8.40 am., except Sun., also Sat. 11 pm.-1 am.		
			LAPAZ, BOLIVA, 49.34 m. 7-10.30 pm.		
			COLON, PAN., 49.34 m., Addr. Carlton Hotel. 11.45am.-1.15 pm., 7.45-10 pm.		
			CHICAGO, ILL., 49.34 m., Addr. Chicago Fed. of Labor. Relays WCFI irregular		
			BERLIN, GERMANY, 49.34 m., Addr. Broadcasting House. Irregular.		
			BOGOTA, COL., 49.42 m. 7-11.15 pm.		
			TORONTO, CAN., 49.42 m. Relays CFRB irregularly 7 am.-12 m.		
			MARACAIBO, VEN., 49.42 m. 6-11 pm.		
			VANCOUVER, B. C., CAN., 49.42 m. Sun. 1.45-9 pm., 10.30 pm.-1am.; Tues. 6-7.30 pm., 11.30 pm.-1.30 am. Daily 6-7.30 pm.		
			MANIZALES, COL., 49.46 m. Daily 11 am.-12 m., 5.30-7.30 pm.; Sat. 5.30-10.30 pm.		
			MOTALA, SWEDEN, 49.46 m. Relays Stockholm 1.30-6 pm.		
			CINCINNATI, OHIO, 49.6 m., Addr. Crosley Radio Corp. Relays WLW 5.30 am.-7 pm., 10 pm.-1 am.		
			PHILADELPHIA, PA., 49.5 m. Relays WCAU 7-10 pm.		
			SKAMLEBOAEK, DENMARK, 49.5 m. 1-6.30 pm.		
			BOGOTA, COL., 49.59 m., Addr. Colombia Broadcasting, Box 509. 12m.-2 pm., 7-11 pm.; Sun. 5-9 pm.		
			SANTIAGO, D. R., 49.63 m. Irregular 6-11 pm.		
			BARRANQUILLA, COL., 49.65 m., Addr. Emisora Atlantico. 11 am.-11 pm.; Sun. 11 am.-8 pm.		
			MIAMI BEACH, FLA., 49.65 m. Relays WIOD 12m.-2 pm., 5.30-6 pm., 10 pm.-12 m.		
			BOSTON, MASS., 49.65 m., Addr. University Club. Generally from 6-10 pm.		
			TANDJONGPRIOK, JAVA, 49.65 m., Addr. N.I.R.O.M. Batavia. 10.30 pm.-2 am.; Sat. 7.30 pm.-2 am.		
			MEDELLIN, COL., 49.75 m. 8-11 pm.		
			PANAMA CITY, PAN., 49.75 m., Addr. P. O. Box 910. 12m.-1 pm., 7-10.30 pm.		
			CALGARY, ALTA., CAN., 49.75 m. Thur. 9 am.-2 am.; Sun 12 m.-12 m.		
			PRAGUE, CZECHOSLOVAKIA, 49.75 m. (See 11.875 mc.)		
			SANTA MARTA, COL., 49.79 m. 5.30-10.30 pm., except Wed.		
			BERLIN, GERMANY, 49.83 m., Addr. (See 6.079 mc.) 11.35 am.-4.30 pm.		
			VERA CRUZ, MEX., 49.83 m., Addr. Av. Independencia 98. 8 pm.-12.30 am.		
			SINGAPORE, MALAYA, 49.18 m., Addr. Radio Service Co., 20 Orchard Rd. Mon., Wed. and Thur. 5.40-8.0 am.; Sat. 10.40 pm.-1.10 am.		
			SANTIAGO DE LOS CABALLEROS, D. R., 49.88 m. 7.30-9 am., 12m.-2 pm., 5-7 pm., 8-9.30 pm.; Sun. 12.30-2, 5-6 pm.		
			BOGOTA, COL., 49.91 m., Addr. Apartado 565. 6-11 pm.; Sun 12m.-2 pm., 4-11 pm.		
			GEORGETOWN, BRI. GUIANA, 49.9 m. Sun. 7.45-10.15 am.; Daily 4.45-8.45 pm.		
			HAVANA, CUBA, 49.92 m., Addr. P. O. Box 98. Daily 9.30 am.-1 pm., 4-7 pm., 8-10 pm.; Sat. also 11.30 pm.-2 am.		
			COLON, PAN., 49.96 m., Addr. Box 33. 7.30-9 am., 12m.-1 pm., 6-9 pm.		
			MONTREAL, CAN., 49.96 m., Can. Marconi Co. Relays CFCF 6 am.-11.15 pm.; Sun. 9 am.-11.15 pm.		
			DRUMMONDVILLE, QUE., CAN., 49.96 m., Addr. Canadian Marconi Co. Sat. 11.30 pm.-2 am.		
			SALISBURY, RHODESIA, S. AFRICA, 50 m. (See 6.147 mc., ZEB.)		
			MOSCOW, U.S.S.R., 50 m. Irregular.		
			MEXICO CITY, MEX., 50.08 m., Addr. P. O. Box 79-44. 8 am.-1 am.		
			MEDELLIN, COL., 50.26 m., Addr. La Voz Catia. 8-11.30 pm.		
			VATICAN CITY, 50.27 m. 2-2.15 pm. daily; Sun. 5-5.30 am.		
			BOGOTA, COL., 50.42 m. 6-11 pm.		
			GUATEMALA CITY, GUAT., 50.5 m. 4-6, 9-11 pm.; Sun. 2-5 am.		
			MARACAIBO, VEN., 50.59 m., Addr. Radio Popular, Jose A. Higuera M., P. O. Box 247. Daily 11.43 am.-1.43 pm., 5.13-10.13 pm.; Sun. 9.13 am.-3.13 pm.		
			PORT-AU-PRINCE, HAYTI, 50.63 m., Addr. P. O. Box A103. 7-9.45 pm.		
			VALENCIA, VEN., 50.71 m. Irregular.		
			PUNTARENAS, COSTA RICA, 50.85 m. 6-10 pm.		
			BARQUISIMETO, VEN., 50.86 m., Addr. La Voz de Lara. 12 m.-1 pm., 6-10 pm.		
			TAIHOKU, FORMOSA, 50.93 m. Works Tokio 6-9 am.		
			QUITO, ECUADOR, 50.98 m. 8-11 pm.		
			TEGUCIGALPA, HONDURAS, 51.06 m. 1.15-2.16, 8.30-10 pm.; Sun. 3.30-5.30, 8.30-9.30 pm.		
			SAN PEDRO DE MACORIS, D. R., 51.25 m., Addr. Box 204. 12 m.-2 pm., 6.30-9 pm.		
			LAWRENCEVILLE, N. J., 51.26 m., Addr. A. T. & T. Co. Works Bermuda nights.		
			MARACAIBO, VEN., 51.28 m., Addr. Apartado 214. 8.45-9.45 am., 11.15 am.-12.15 pm., 4.45-9.45 pm.; Sun. 11.45 am.-12.45 pm.		
			SHINKYO, MANCHUKUO, 51.46 m. Works Tokio 6-9 am.		
			SAN JOSE, COSTA RICA, 51.5 m., Addr. Alma Teca, Apartado 800. 11 am.-1 pm., 6-10 pm. Relays TIX 9-10 pm.		
			CARACAS, VEN., 51.72 m., Addr. Radio Caracas. Sun. 8.30-11.30 am., 1.30-10.30 pm. Daily 10.45 am.-1.30 pm., 4-10.30 pm.		
			NAZAKI, JAPAN, 51.81 m. Irregular.		
			LIMA, PERU, 51.9 m., Addr. P. O. Box 853. Mon., Wed. and Sat. 9-11.30 pm.		
			MANAGUA, NICARAGUA, 52.11 m. 8-9.30 pm.		
			GUATEMALA CITY, GUAT., 52.26 m. Wed., Thur. and Sun. 6-9 pm.		
			QUITO, ECUADOR, 52.36 m. Irregular 10 pm.-12 m.		
			SAN CRISTOBAL, VEN., 52.45 m., Addr. La Voz de Tachira. 6-11.30 pm.		
			SAN RAMON, COSTA RICA, 54.55 m. Irregular 3.30-4, 8-11.30 pm.		
			BANDOENG, JAVA, 58.31 m. 5.30-11 am.		
			LAWRENCEVILLE, N. J., 59.08 m., Addr. A. T. & T. Co. Works England late at night irregularly.		
			HAMILTON, BERMUDA, 59.7 m. Works N. Y. C. irregularly at night.		
			REYKJAVIK, ICELAND, 60 m. Works Europe nighttime irregularly.		
			RUGBY, ENG., 60.3 m. Works ships irregularly.		
			RUGBY, ENG., 62.24 m. Works N.Y.C. nighttime irregularly.		

4 S.W. BROADCAST BAND 4

(Continued on page 149)

(All Schedules Eastern Standard Time)

# QUESTION BOX SHORT WAVE

EDITED BY  
G. W. SHUART, W2AMN

● Because the amount of work involved in the drawing of diagrams and the compilation of data, we are forced to charge 25c each for letters that are answered directly through the mail. This fee includes only hand-drawn schematic drawings. We cannot furnish "picture-layouts"

or "full-sized" working drawings. Letters not accompanied by 25c will be answered in turn on this page. The 25c remittance may be made in the form of stamps, coin or money order. Special problems involving considerable research will be quoted upon request. We cannot

offer opinions as to the relative merits of commercial instruments. Correspondents are requested to write or print their names and addresses clearly. Hundreds of letters remain unanswered because of incomplete or illegible addresses.

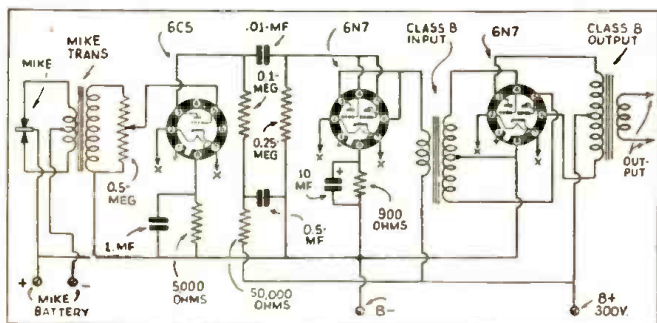

Low Power Modulation (1072)

### LOW-POWER MODULATOR

Richard Gulatsi, Jr., Mt. Vernon, N.Y.

(Q.) Kindly print in the coming issue of the Question Box a diagram of a suitable modulator for the "W2AMN 5-Meter Mopra" described in the September, 1936, issue of *Short Wave & Television*. A double-button carbon microphone will be used, so please show input connections for this mike. This modulator should have an audio output of at least 18 watts. I leave the choice of tubes to you.

(A.) We have shown a diagram of a simple modulator which may be used with the "5-Meter Mopra." This modulator will have an output of slightly over 10 watts and will be thoroughly capable of modulating the 5-meter transmitter. All metal tubes are used. The design of the amplifier is extremely simple; its cost should be quite nominal. The gain control is located in the first tube, this control should be adjusted for best quality as indicated by the sound of the transmitted signal. The output winding of the class "B" transformer should be designed to work into an impedance of approximately 6,000 ohms, although anywhere from 5,000 to 6,000 ohms will work satisfactorily.

### TRANSMITTING ANTENNA

R. Kobaryaski, Honolulu, T. H. (Q.) I recently received your copy of the *Short Wave Guide*. I became immediately interested in the simplest "Ham" transmitter using an 802 tube described in it. However, I will appreciate it very much if you will print in the coming issue on the Question Box page, the type of, and the dimensions if possible, of an antenna system to be operated

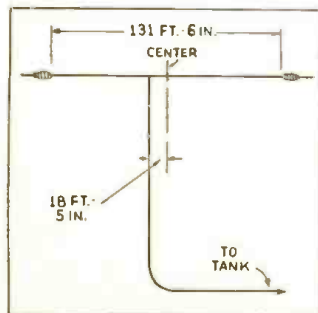

Antenna (1073)

on the 3.5 mc. band, to go with the above transmitter.

(A.) We have shown data for an antenna which will work very nicely with the 1-tube transmitter described in the *Short Wave Guide*. This is a single wire flat top with a single wire feeder. The dimensions are given in the drawing. The feeder should run at right-angles to the antenna for distance equal to at least 1/4 of the length of the antenna. The total length of the lead-in is not critical.

### A.C.-D.C. AMPLIFIER

R. Patrick, Pullman, Wash. (Q.) I am now using a 1-tube receiver and would like to build an A.C.-D.C. amplifier to be used in conjunction with it. Would you

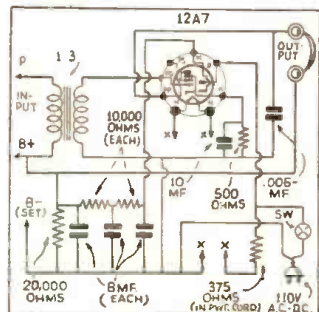

Amplifier (1074)

kindly print the diagram showing how this could be done, and also show how the power supply for the A.C.-D.C. amplifier employing a 12A7 tube may be used to operate the other tube.

(A.) We have shown the complete diagram of a 12A7 pentode amplifier and rectifier combination. The power-supply portion may be used to furnish voltage for the other tube. We have not shown the other tube in the filament circuit. However, if you are using a 6.3 volt .3 amp. heater tube this may also be connected in series with the 12A7 heater, and in this case the line cord resistor should have 20 ohms less resistance than that shown.

### BEST TYPE COUPLING

Wm. E. Chenoweth, Hawarden, Ia. (Q.) Will you please answer the following in your short-wave Question Box. Just which is the best type of coupling to use between the detector and the R.F. stage of a short-wave receiver.

(A.) The best method so far developed is the inductive method

which employs a separate winding for the plate circuit of the R.F. stage and another winding for the grid of the detector. Data on coils designed for this purpose can be found in the February, 1937, Question Box.

### RECEIVER QRM

A SWL, Wollaston, Mass. (Q.) I built a one-tube regenerative receiver using a 30-tube. I find that this set has a fierce output, audible for at least eight miles. The "Ham" annoyed by it notified the F. C. C. in Boston. When I found out how serious this was and that the set acted so, I tore it down and I will build a set that has not these qualities. Please print this in your magazine so that the innocent listeners will not get into hot water with the Radio Inspectors. Please give some causes for the terrific output-signal regenerative circuits have, and, if possible, how to eliminate them.

(A.) We are all familiar with the "bloopers" used in the "old days," and the great amount of interference they caused, and it is only natural to expect the same on the short-waves. A partial remedy is to use very loose antenna coupling and plate voltage to the detector as low as is commensurate with efficient operation. Of course, the only real remedy is the addition of an R.F. stage between the antenna and the detector.

### INSTALLING AN "R" METER

Francis Mulkern, Norwood, Mass. (Q.) Will you please tell me through your Question Box, how I am to add an "R" meter to a 2-tube regenerative receiver? (A.) An "R" meter cannot successfully be used in conjunction with such a simple receiver. You will find an "R" meter in the more elaborate superheterodynes.

### A SIMPLE 2-TUBER

Harry Campbell, Portland, Me. (Q.) Would you please print a diagram for a 2-tube receiver similar to the Globe Trotter. I would also like to have the list of parts, together with their values. This receiver is to be battery-operated and should employ two type 30 tubes.

(A.) We have shown a circuit diagram of a conventional 2-tube battery set. This would require two 1 1/2-volt dry cells for the filament supply and two 45-volt batteries for the plate supply. While the single 45-volt battery may be used, better results will be obtained with 90 volts applied to the plate of the amplifier tube.

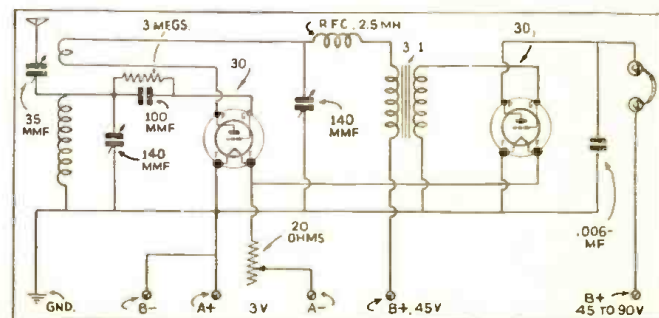

A 2-Tube Battery Set (1076)

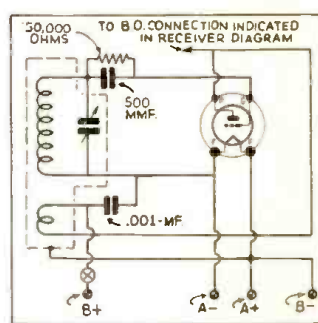

Beat Oscillator (1075)

### BEAT OSCILLATOR FOR BATTERY TYPE SUPER

A. A. Pinero, Buenos Aires, Argentina. (Q.) In your December issue for 1936, page 470, there appeared a two-volt Super DX-4, which is a splendid receiver. However, I would like to add a beat oscillator to this receiver. The lead which goes to the beat oscillator is indicated in the diagram.

(A.) The beat oscillator diagram is shown. The connection from the plate of the type 30 oscillator goes to the lead indicated in the original diagram. A conventional beat oscillator transformer is used and is indicated by the dotted lines. This should respond to the same frequency as the I.F. transformers used in the receiver. A switch is located in the "B" lead for turning on and off the oscillator.

### RADIO LAWS

K. Mori, Sanger, Calif. (Q.) The rule No. 380 states—An amateur radio station shall not be located upon premises controlled by an alien. This is the rule which appeared on the F. C. C. pamphlet regarding this rule, is it lawful to buy a premise of my own from an alien and build a station on it, or is it lawful to build a station on a premise of a citizen? (A.) You practically answered your own question when you stated that you're buying premises from an alien. Although we are not lawyers, we believe that so long as you, being a citizen, remain in control of the property, and being the rightful owner, that the alien proposition is no longer considered. We imagine the law refers to cases wherein aliens own the property or have a controlling interest in it in the form of a lease which would, of course, violate rule No. 380.

# NEW 1937 SHORT WAVE APPARATUS

(PROMPT SHIPMENTS ON ALL ITEMS)

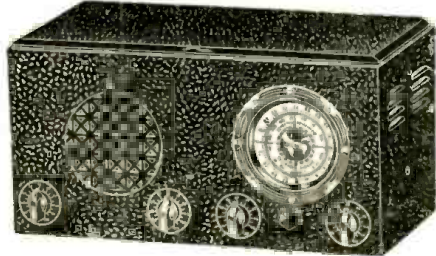

## EILEN ER-19-B 7-tube BANDSPREAD BEAM POWER RECEIVER

(8 1/2 to 3,000 meters)

Our largest, finest, and most sensitive new 1937 receiver, unequalled in appearance, performance and value. Uses a special, highly efficient and selective circuit producing results which will satisfy even the most discriminating short wave fan.

Constructed of the finest materials and to conform with the highest engineering standards, this instrument uses two 6D6, two 6J5G, one 7B, one 6L6, and one 5Y3 high gain tubes as **TUNED RF AMPLIFIER, TUNED ELECTRON COUPLED SCREEN-GRID REGENERATIVE DETECTOR**, powerful 3 stage audio frequency amplifier with new beam amplifier tube output stage delivering 3 watts peak of audio power to the built-in high fidelity dynamic loudspeaker. **VARIABLE NOISE SUPPRESSOR**, rectifier and complete built-in **HUM-FREE** power supply. **BANDSPREAD TUNING**—a special electron tube circuit enabling the operator to reduce or eliminate certain types of noises occurring in all short wave receivers—automatic headphone jack—smooth and noiseless controls—highly efficient interchangeable inductors—doublet or aerial-ground connections—**POWERFUL** hi-fidelity audio system—large, illuminated airplane type vernier dial—sensitivity, volume, and selectivity that will amaze you. Features to be found in ER-19.

**ER-19 in BEAUTY**, as well as performance, is in a class by itself—heavy steel cabinet with hinged lid finished in durable black shrivel-colored dial lights behind black and white scale—chrome plated excelsior—drilled dial plates—plated chassis and shielding—Operates entirely from your 105 to 130 volts AC house current.

**ER-19** under fair conditions will bring in dozens of foreign as well as domestic short wave stations with enormous volume. Order one and see for yourself.

**ER-19, complete, READY TO USE**, with 7 RCA or Sylvania tubes, 12 low-loss silver plated coils for 8 1/2 to 3000 meters, wired in cabinet, and instructions.....**\$21.95**

(If metal tubes are preferred over the glass type, add \$1 to above price.)

**\$21.95**

For those who wish to build their own we offer:

**KIT of all parts, coils for 8 1/2-3000 meters, un-wired (less tubes & cabinet).....\$14.95**

Cabinet, extra.....**\$2.50**

7 matched Sylvania tubes, extra.....**3.35**

Wired and tested, extra.....**2.00**

**AMATEURS:** Model ER-19-B has same specifications as ER-19 except that it is equipped with plate voltage cut-off switch and special bandspread coils for 20-40, 80-100 M bands spreading these bands 80% of dial scale. Add \$1 to price of ER-19. (10 meter band coils if desired extra .45.)



**NEW! The MF-25 Beginner's Transmitter**

An inexpensive transmitter capable of delivering a good 20 watts crystal power to the antenna on the 160, 80, 40 meter bands and 15 watts on 20 meter band. Using the new 6L6G in a Tri-Tet circuit allowing operation on two bands with one crystal. Highest grade parts mounted on metal chassis housed in a beautiful crackle finished cabinet, antenna tuning unit built in. Eilen silvered transmitting dials. Triplett meter, including set cathode and plate tank coils for any one band. Specially priced at **\$11.95**, in kit form, including all parts necessary to put in operation except accessories listed below.

Extra: 6L6G \$1.25. Quartz crystal \$1.95 for 80, 160 meter band. 40 meter \$2.50. Crystal holder \$1.00. Coils for additional bands \$1.00 per set.



## BS-5

### 6-Tube Band switch Receiver

10 to 600 Meters

A powerful, sensitive, and selective SW receiver covering the entire wave-length span of 10 to 600 meters in 5 steps. **NO PLUG-IN COILS** are used. Simply turn the waveband selector switch and enjoy reception on any wave-length within this range.

Uses two 6D6, one 7B, one 43, one K42A, and one 25Z5 tubes as RF amplifier, electron coupled screen grid regenerative detector, powerful 2 stage audio amplifier with pentode output stage, rectifier, and complete built-in power supply.

**HUM-FREE**—hi-fidelity dynamic loudspeaker—illuminated airplane type vernier dial—band spread tuning control—automatic headphone jack—extremely smooth acting controls—operates from your AC or DC house current—beautiful heavy, black shrivel finish chassis and cabinet.

**DELIVERS GREAT LOUDSPEAKER VOLUME ON THE GREAT MAJORITY OF SHORT WAVE FOREIGN STATIONS UNDER FAIR CONDITIONS.**

**PRICE, complete with 6 tubes, cabinet, wired, and instructions,.....\$16.95**



See editorial article Page 42

**BEAM POWER TUBES TO BE HAD**

**BS-5 KIT**, of necessary parts, including detailed instructions; less tubes, cabinet, unwired.....**\$10.95**

**SPECIAL:** Complete kit, cabinet, tubes and instructions, unwired.....**\$14.95**

(If metal tubes are preferred to glass type, add \$1)

**AMATEURS:** Model BS-5-AB has same specifications as BS-5 except that it has special bandspread circuit for 20-40-80-160 M bands and is equipped with plate voltage cut-off switch. Add \$1.00 to above price.

## 7C 5-Tube Short Wave Receiver

8 1/4 to 625 meters

**Bigger and More Powerful Than Ever A Giant in Performance**

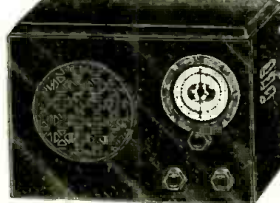

**FULL 6 TUBE PERFORMANCE plus THE NEW K92A SERIES TUBE** makes this an outstanding value. Equipped with a powerful 3 stage audio frequency amplifier.

Uses 6D6-0F7 (twin 2 in 1 tube)—7B—K92A—12A7 (twin tube) tubes as RF amplifier, electron coupled screen grid regenerative detector, powerful 3 stage audio amplifier with pentode output stage, rectifier and complete built-in power supply. Operates entirely from 105 to 130 volt AC or DC light socket.

**BAND SPREAD TUNING**—smooth regeneration control—built-in high quality loudspeaker—automatic headphone jack—large illuminated airplane type vernier dial—large low-loss inductances. Heavy, black shrivel finish metal chassis and cabinet. Must be seen to be appreciated. Satisfied owners report as high as 35 foreign countries on the loudspeaker with this model. You may do the same under fair conditions. **ORDER YOURS TODAY! YOU WILL NOT REGRET IT!**

**EILEN 7C RECEIVER**, wired, in cabinet, complete, **READY TO USE**, with Sylvania 5 RCA tubes, 4 coils for 8 1/2 to 200 meters, and simple instructions.....**\$12.95**

Broadcast Band Coils, extra.....**\$1.25**

**7C KIT**, unwired, of necessary parts, 4 coils for 8 1/2 to 200 meters, and instructions less cabinet, speaker, tubes.....**\$7.25**

Beautiful metal cabinet, extra.....**\$1.25**

3 matched RCA tubes.....**3.15**

Special loudspeaker.....**1.45**

(2) Broadcast band coils, 200-625 meters.....**1.25**

Labor for wiring & testing, extra.....**1.25**

**SPECIAL: COMPLETE KIT**, unwired, cabinet, 5 tubes, speaker, 4 coils for 8 1/2 to 200 meters, and simple instructions.....**\$11.45**

2 broadcast Coils, extra.....**\$1.25**

**AMATEURS:** Model 7C-AB, same specifications as 7C except that it has special circuit and coils for spreading out the 20-40-80-160 M bands over 80% of dial. Also equipped with plate voltage cut-off switch. Same price as 7C. Model 6B or 6B-A battery model of 7C. Operates from inexpensive dry batteries. Same price.

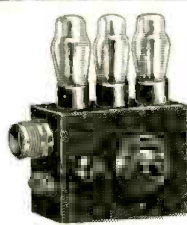

## 3-Tube Short Wave Radio Only \$3.25

(less tubes, phones, unwired)

A dependable receiver which is guaranteed to give results. Operates entirely from the AC or DC house current. Simple to build and easy to operate. Beautiful, black, shrivel finish cabinet and instructions furnished. Wave-length range 12-600 meters. An ideal set for the beginner who wishes to learn the thrill of short wave reception.

**THREE TUBE BATTERY SET**, less tubes, phones, unwired **\$2.00**

**TWO TUBE BATTERY SET**, less tubes, phones, unwired **\$2.00**

**KITS** wired, extra 75c. Tubes, each 50c. Broadcast band coils (2), extra 95c. Cannonball double headphones \$1.35.

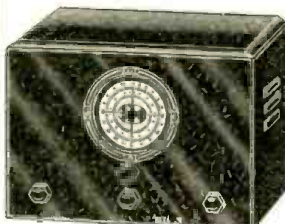

## AN-5 Four Tube BANDSPREAD RECEIVER

A powerful and highly selective short wave receiver designed for the man who prefers the use of headphones.

Uses 6D6-0F7—6D6—7B—6A4—76-84 tubes in five-tube performance circuit as **TUNED RF amplifier, electron coupled screen grid regenerative detector**, two stage audio amplifier, rectifier, built-in power supply. **HUM-FREE, POWERFUL**. Readily operates a speaker. Operates from your 105-130 volt AC house current.

**AN-5**, complete with 4 matched tubes, coils for 9 to 200 meters, cabinet, wired **READY FOR USE.....\$15.95**

Broadcast band coils (2), extra.....**\$1.45**

**AMATEURS:** Model AN-5-AB has same specifications as AN-5 except that it has plate voltage cut-off switch and special bandspread coils for 20-40-80-160 meter bands. Add \$1 to price of AN-5.

## NEW! THE LAST WORD IN SHORT WAVE RECEIVERS

### Model RX 20

An 8 Tube 616 Beam Power Audio Electrical Bandspread Receiver. 2 1/2 to 3000 Meters

Our latest development. An 8-tube receiver for the AMATEUR and Short Wave fan, using a tuned R.F. Stage and tuned Electron coupled regenerative detector. Covers all wavelengths now in use including the ultra high frequencies and experimental bands. A gain control for the entire receiver is included. 5 WATTS OF AUDIO POWER AVAILABLE FOR THE BUILT HI-FIDELITY DYNAMIC SPEAKER.

For the HAM we offer type AB. Special Band Spread coils covering all the ham bands with individual padding condensers in each coil are included in this model. Also a stand by switch for use during transmission periods. The phone jack is included which automatically cuts out speaker. Built in hum free power supply.

**READY TO USE FACTORY WIRED AND TESTED INCLUDING TUBES AND BAND SPREAD COILS FOR THE HAM BANDS AND 200 TO 3000 METERS GENERAL COVERAGE COILS.**

Uses the following tubes: 6K7G tuned R.F. amplifier, 6K7G tuned electron coupled detector, one 6J5G ultra high frequency oscillator tube. Two 6C3G audio amplifiers one 6C5G is the noise suppressor and 6L6G BEAM POWER AUDIO OUTPUT TUBE and a 5Y3G rectifier.

For the Short Wave Fan: RX-20R complete as above with coils from 2 1/2 to 3000 meters \$28.95

For the Amateur: RX-20AB complete as above with special amateur bandspread coils and 200 to 3000 meter coils \$29.95.

**RX-20AB Amateur KIT:** Includes all parts factory assembled ready to wire no holes to drill or parts to mount and schematic and picture diagram and a beautiful cabinet. **KIT OF PARTS**, \$19.95. Tubes, \$4.50 EXTRA. Special band spread coils \$1.00 per band for any one ham band.

**RX-20R S.W.L. KIT:** Same as amateur kit but with regulated coverage coils from 2 1/2 to 3000 meters. **KIT OF PARTS**, \$19.75. Tubes, \$4.50. EXTRA.

**FREE: New 1937 catalogue**

of short wave receivers, transmitters, & 5 meter apparatus. Send stamp to cover mailing costs on YOUR copy.

**JUST OFF THE PRESS!**

Prompt service, 20% deposit on C. O. D. orders

**EILEN RADIO LABORATORIES, Dept. SC 7, 136 Liberty Street, NEW YORK, N. Y.**

Please mention SHORT WAVE & TELEVISION when writing advertisers

# A "WORLD-BEATER"



## The NEW ACE DO-ALL

SEVEN TUBE HIGH PERFORMANCE COMMUNICATIONS RECEIVER

The ONLY Receiver incorporating ALL of these DESIRABLE FEATURES!

- **TWO TUNED STAGES**  
A positive necessity for extreme sensitivity and "split-hair" selectivity.
- **2 1/2 to 3000 METERS**  
Your Do-All is never obsolete. It tunes to all bands! Today and tomorrow!
- **BEAM POWER**  
New 6L6 Beam Power tube makes available 6 Watts Clear, crisp audio output.
- **LATEST TUBES**  
6K7—Tuned R.F. Amplifier.  
6K7—Tuned electron coupled regenerative detector.  
7B—U.H.F. 2 1/2 to 10 meter super regenerative detector.  
7B—6C5G-6L6C High Fidelity three stage audio power Amplifier.  
5Y4G—Full wave, high voltage rectifier.
- **DUAL REGENERATION**  
An exclusive Ace feature! Semi-Automatic for peak reception. Manual setting control.
- **HEAD PHONE JACK**  
Automatic, complete speaker cut-off—
- **HIGH FIDELITY SPEAKER**  
Full size, heavy dynamic speaker, accurately matched for maximum power and quality.
- **FULL BANDSPREAD**  
Separates those weaker foreign stations!
- **NOISE SUPPRESSOR**  
A remarkable development pioneered by Ace Laboratories. Positive switch control suppresses interfering noises, bringing out the foreign stations with tremendous volume.
- **AND—**  
Velvet smooth, calibrated controls—Doublet or single antenna input—Self contained, HUMBLESS\* Power Supply—Metal tubes for lower background level—Dual Panel Illumination. Sensitivity, power, selectivity, quality surpassed by none!

### FOR COMPLETE DETAILS

**DO-ALL DELUXE STANDARD MODEL (9 to 3000 Meters)**  
Six tube Receiver, complete with matched tubes, and cabinet. Nothing else to buy! (Not wired) **\$1975**

Laboratory wired and tested, ready for you to attach antenna plug into socket, and thrill to new and strange programmes! Price..... **\$2175**

If tubes, cabinet, and 200 to 3000 meter wavelength range are not desired at present you may deduct from the above price..... **\$500**

**DO-ALL DELUXE ULTRA MODEL (2 1/2 to 3000 Meters)**  
Seven tube Receiver, complete with matched tubes and cabinet. Ready to be wired. **\$2375**

Laboratory wired and tested, ready to operate. The entire world of Radio at your command! Complete **\$2625**

If tubes, cabinet, and 200 to 3000 meter wavelength range are not desired at present you may deduct from the above prices..... **\$500**

## BATTERY OPERATION AC-DC FOR VACATION, CAMP, MOBILE WITH THE ACE "UNIVERSAL-SIX" FOUR TUBE RECEIVER FOR HOME, HOTEL, PORTABLE

IMAGINE! A compact, self contained, sensitive receiver with real SIX TUBE performance that will operate on any AC or DC house line. Simply plug in a cable and—PRESTO!—a completely battery operated set that you can use in your car, boat, or any other place! The same full toned loud speaker volume—the same thrilling foreign reception—the same ease of operation! No changes in wiring. Really TWO receivers for less than you would expect to pay for only one!

Look at this powerful tube line-up: Screen grid pentode RF stage—high gain regenerative detector—THREE STAGE high quality audio amplification with power pentode output—heater type rectifier and humless power supply. FULL SIX TUBE POWER from two dual "Twin" 6P7 tubes and heavy duty 38 and 1-V tubes!

And these features: Full bandspread 9 1/4 to 625 meters—self contained, good quality loud speaker—New Transmitter type tuning dial with dual speed friction drive—Provision for headphones—Indirect panel illumination—Velvet smooth control of regeneration—Operates entirely from any AC or DC house socket OR ON BATTERIES. Low current drain means long, economical life of tubes and batteries.

This receiver is easy to build—easy to operate—and it certainly pulls 'em in!! Order your Universal Six now! You will be amazed at the full loud speaker volume of distant stations! Every set is fully guaranteed. Buy with safety!



**ACE UNIVERSAL-SIX** receiver with four tubes, cabinet, all coils, and built-in speaker. COMPLETE, nothing else to buy. Not wired. Laboratory wired and tested, complete. **\$1275**  
**\$14.50**

**QUALITY ACE RADIO LABORATORIES VALUE**  
227 GREENWICH ST., Dept. C-7, NEW YORK CITY

See page 154 for the 6 Best Books on Short Waves

Manufacturers of  
**VITREOUS TRANSMITTING GRID LEAKS**  
**VOLUME CONTROLS • POWER RHEOSTATS**

Write for Complete Free Catalog  
**ELECTRAD, Inc.**  
175 Varick Street, New York

**CHASSIS—CABINETS**  
**PANELS & CANS**  
STANDARD SIZES ON HAND  
SPECIAL SIZES MADE TO ORDER  
**KORROL RADIO PRODUCTS CO.**  
232 Greenwich St., Dept. S-7, New York City

Please mention SHORT WAVE & TELEVISION when writing advertisers

## SHORT WAVE LEAGUE

Hugo Gernsback  
Executive Secretary

### Here's Your Button

The illustration herewith shows the beautiful design of the "Official" Short Wave League button, which is available to everyone who becomes a member of the Short Wave League.



The requirements for joining the League are explained in a booklet, copies of which will be mailed upon request. The button measures 3/4 inch in diameter and is inlaid in enamel—3 colors—red, white, and blue.

Please note that you can order your button AT ONCE—SHORT WAVE LEAGUE supplies it at cost, the price, including the mailing, being 35 cents. A solid gold button is furnished for \$2.00 prepaid. Address all communications to SHORT WAVE LEAGUE, 99-101 Hudson St., New York.

## When To Listen In By M. Harvey Gernsback

All Schedules Eastern Standard Time

**DAVENTRY**

● THE new high-power transmitters at Daventry are now in regular service. Three transmitters, each of 50 kw. (50,000 watts) output are available for simultaneous use. In addition the old G5SW transmitter has had a power-stage added, which raises its output to 25 kw. The two old 10 kw. stations are still in commission. The operating schedule calls for simultaneous operation on 4 frequencies in each transmission. The extra transmitters (the two 10 kw. units) will not be used normally. For schedules see station list.

**GERMANY**

A station calling itself "the voice of the German Communist Party" is heard from 4-5 p.m. on 10.07 and 9.850 mc. No location is given in the announcements but it is supposed to be operating *secretly* in Germany. Signals are very strong from this "mystery" station.

**PANAMA**

A new station is now operating in Panama City. Call is HI5A. The station operates on 6.12 mc. The tentative schedule is 12n-1 p.m., 8-10 p.m. Address P.O. Box 58.

**GUATEMALA**

TG2 at Guatemala City is supposed to be "on the air" after the first of May, according to a letter from the chief engineer. The operating schedule is from 11 p.m. to 1 a.m. on 6.31 mc. Address Secretaria de Fomento.

**SWEDEN**

SM5SX at Stockholm has discontinued operations on 11.71 mc. In its place SBG at Motala relays the Stockholm broadcast station daily from 9 a.m.-1:30 p.m. on 11.71 mc., and from 1:30-6 p.m. on 6.065 mc.

**BALTIMORE**

W3XEY is operating on 31.6 mc. daily from 4 p.m.-12 m. It relays the programs of WFBR. Location is Baltimore, Md.

**MILWAUKEE**

A newcomer to the 11 meter broadcast band is W9XAZ at Milwaukee, Wis. This station broadcasts daily from 1 p.m. on and relays WTMJ. Owner is The Journal Co. W9XAZ; operates on 24.6 mc.

**CHILE**

The call letters of the Santiago station on 12.3 mc. are CEB, according to latest reports at hand.

# 8 BANDS ON THE NEW HAYNES

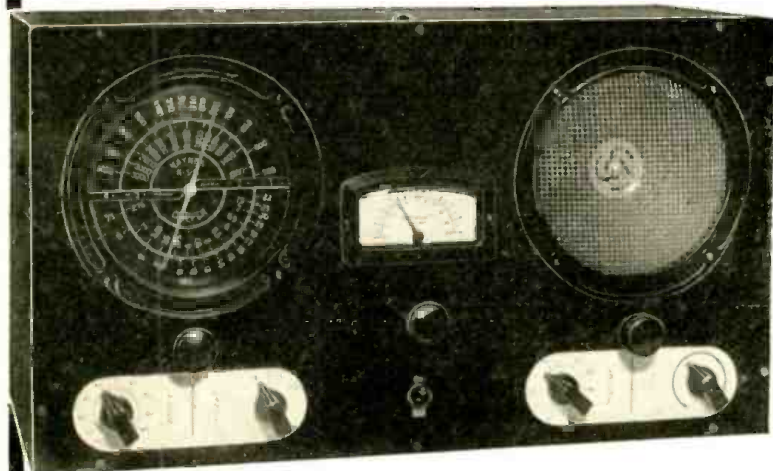

5 TUBE  
**R-S-R CLIPPER**  
 3 TO 1600 METERS  
 WITH  
**VERNIER BANDSPREAD OVER THIS WHOLE TREMENDOUS RANGE**

- \* Beam power output with 6" dynamic speaker.
- \* Separate tone, sensitivity and volume controls.
- \* Bandswitching (no plug-in coils) down to 14 meters.
- \* Removable air-wound coils for the ultra-high frequencies.
- \* Regeneration control that is absolutely smooth and free from tuning interaction.
- \* 5-inch main tuning dial, calibrated in kilocycles.
- \* Perfect super-regenerative control on the ultra-frequencies.

Complete with five Sylvania tubes, ready to operate from any 110 volt AC line .. **\$28.85**  
 Shipping weight 30 lbs.

## ASK THE MAN WHO OWNS ONE

A BEAUTIFUL communication receiver in both appearance and operation. Five tubes always in full use with R.F. amplification on all frequencies. Uses the genuine Haynes electron coupled regenerative-super-regenerative circuit which means that it really "goes to town" on the high frequency bands. Tube line-up is: 6K7 RF amplifier, 6J5G regenerative and super-regenerative detector, 6J5G first audio amplifier, 6L6G power output, 80 rectifier.

## THE NEW 2½ to 560 Meters DX-4 4-TUBE SHORT WAVE RECEIVER

If you are interested in REAL long distance reception—if you want a specialized short wave receiver which can reach out and pull in, not only the ordinary Europeans but those hard to get little fellows in the out-of-the-way corners of the world—and if you do not own such a receiver because heretofore you could not afford it, YOUR PROBLEM IS SOLVED! For the first time in radio history such a receiver is now available at a truly low price. The DX-4 has what it takes: Band switching, Beam power output tube, 6J5G regenerative and super-regenerative detector, Dynamic speaker, Full AC operation with 80 rectifier, Tremendous electrical bandspread. SELECTIVITY, SENSITIVITY and POWER.



HERE IS A REVOLUTIONARY NEW RECEIVER which actually gives the results you want on long distance foreign reception at a price that is absolutely without precedent. Complete with four Sylvania tubes ready to operate from any 110 volt line .. **\$17.85**  
 Shipping weight 18 lbs.

**RADIO CONSTRUCTORS LABORATORIES**  
 Dept. SW-7, 136 LIBERTY ST., NEW YORK, N. Y.



# Televisual Use of Ultra-High Frequencies

By Dr. A. N. Goldsmith

(Continued from page 115)

cycles) be used for television appears to be a wise suggestion.

The televisual use of these ultra-high-frequencies is certain to bring about a revolution in radio technique. Hardly anything looks the same or acts the same at these frequencies, as at the much lower frequencies which have previously been used.

The television pick-up is of course an extremely novel device which looks like a fantastic camera and contains a sensitive television pick-up tube in place of a photographic plate. The amplification of the video frequencies which are produced by the pick-up camera requires wide-band operation on a hitherto undreamed-of basis. Thus, where 10-kilocycle modulation was regarded as

quite a problem in present day broadcasting, 2,000-kilocycle or higher modulation must be commonplace for television pictures of good quality. Oscillators and modulators for these frequencies are also electrical puzzles, and it has taken the utmost resourcefulness of the development engineer to produce adequate equipment of this type. The vacuum tubes which are used at such high frequencies require a design where inter-electrode capacities are made vanishingly small, and where every material is worked to the limit, consistent with its capacities. The construction of the pick-up tubes for the television camera has presented an entirely new array of problems, as has also the construction of the

receiving cathode-ray tubes. In fact, there has sprung up an entirely new branch of science known as "electron optics," the laws and procedure of which are required to enable satisfactory pick-up and reproduction in television. There is one very encouraging aspect about the televisual use of the ultra-high-frequencies. With its myriad of problems, many of which are as yet only partially solved, it provides rich material for the ambitious and skilled experimenter and development engineer. Here we have a job which will last over decades and which will offer a remarkable successful opportunity to make some careers in a new field which is bound to prove of major interest to humanity.

Please mention SHORT WAVE & TELEVISION when writing advertisers

# WHAT HAS HARRISON?

*Everything for the Ham!!*

★ **RECEIVERS**

HALLICRAFTERS  
HAMMARLUND  
HAYNES  
NATIONAL  
PATTERSON  
RME  
SARGENT, Etc.

Write for details.  
Easy Time Payments.

★ **TRANSMITTERS**

HARVEY  
TEMCO  
UTAH, Etc.

★ **TUBES**

AMPEREX  
EIMAC  
GAMMATRON  
RCA  
RAYTHEON  
TAYLOR, Etc.

★ **PARTS**

Every part that is made—  
**HARRISON HAS IT!**  
Or we'll get it for you—  
quickly!

In addition to all regular Amateur supplies  
Harrison offers—

## THIS MONTH'S SPECIAL

### BEAM POWER TUBES 6L6 — 69<sup>c</sup>

GLASS

Brand new, fully tested, finest quality. This remarkable tube is used in most all modern transmitters and P.A. Amplifiers. High output! Octal base, glass bulb.

**Only a fortunate purchase enables us to sell these excellent, transmitter tested tubes at this amazing price!**

List Price \$2.50. Every tube is fully guaranteed for 30 days! At this low price we cannot mention the name of the manufacturer—one of the largest and most reputable!

(ORDERS FOR FOUR OR MORE TUBES SHIPPED PREPAID)

**BUY NOW AND BUY PLENTY!**  
You'll Never See Prices This Low Again!

ORDER EVERYTHING  
YOU NEED — NOW!

HAMS! Send your QSL card  
for our Ham Bulletins.

QUALITY—the Highest  
SERVICE—the Finest  
VALUE at Lowest Prices

## HARRISON RADIO CO.

"THE FRIENDLY AMATEUR SUPPLY HOUSE"  
12 WEST BROADWAY  
NEW YORK CITY

## Eye and Ear "Signals" Tell Pilot He Passed Beacon

(Continued from page 119)

of transmitting antennas were tried in an attempt to obtain a marker pattern free of dead spots or lobes and having a circular shape. It was also desired to have the pattern size several times larger than the cone of silence of the range station at 3,000 feet and fairly uniform in size above 3,000 feet altitude.

The antenna array which gave these desired features proved to be quite simple in construction and adjustment, as will be observed in figures 3, 4 and 5. The pattern of this array spreads quite rapidly up to 3,000 feet and then remains nearly constant up to its top at about 9,000 feet. At 3,000 feet altitude and a ground speed of 100 m. p. h. the signals last approx. 27 sec.

The pattern, expressed in feet, is shown in curves, figures 6 and 7. It should be mentioned that there is some apparent displacement of the pattern in actual flight over that shown in the curves. The pattern of the receiving antenna on the ship and slight mechanical delay in the receiver relay cause the marker indicator lamp to delay in lighting until the ship is nearly over the range station. The curves of figures 9 and 10 were based on time of marker signal indication only and were obtained by approaching and flying directly over the station from several directions, immediately retracing each direction and averaging the two indications.

The pattern size and height are a function of both transmitter power and receiver sensitivity. The receiver sensitivity involves also the effective height of the receiving antenna. In the tests made by the Bureau the receiving antenna consisted of a single 65-inch wire running longitudinally 7 inches below the fabric belly of the ship and connected to the receiver by means of a 43-inch unshielded lead-in. During development the receiver sensitivity was reduced until it would not respond to various ultra high and broadcast frequency signals encountered in the vicinity of Washington, D. C. The proper sensitivity was about 460 microvolts. Then a good band pass filter at 3,000 cycles was added in the output circuit.

With the foregoing receiving conditions established the power of the transmitter was adjusted until the pattern size represented here was obtained. Obviously it is possible to provide, by increase of power and some sacrifice in narrowness at lower altitudes, a marker pattern extending above 9,000 feet for special locations.

The transmitting antenna array consists of four horizontal half-wave doublets supported one-fourth wave above ground and pointing in four directions from a common center. These four antennas are excited at the common center through a special arrangement of down leads that provides balanced currents in all four antennas and a phase difference of 90 electrical degrees between the currents in adjacent antennas. To properly monitor the operation of this antenna and transmitter some of the radio frequency signal is rectified and filtered and coupled to the control line leading from the range station to the control station at the airport. At the control station the signal is used to operate a meter which clearly indicates to the operator the condition of the transmitting equipment.

In looking forward it is anticipated that ultra-high frequencies will be used very extensively throughout the country for a variety of services. It is obvious that if other services are given frequency assignments very close to the 75 megacycle marker frequency some interference might result in the use of the present receivers. Crystal-controlled superheterodyne receivers will require higher frequency stability in the marker transmitters than that now afforded. The Bureau is experimenting with crystal-controlled superheterodyne receivers and concentric line- and crystal-controlled transmitters. It is believed that this equipment will meet all future selectivity and stability requirements.

DEPENDABLE

ECONOMICAL

MODERN



**KEN-O-TAP**

*The Practical Solution to the Modulation Problem*

**KEN-O-DRIVE**

*The Modern Answer to Critical Driver Operation*

**KEN-O-DYNE**

*The Precision Method of Matching Output Tubes to Speakers*

**KEN-O-LINE**

*The Efficient Coupling Device from Universal Line*

Ask your dealer for a free copy of our revised 16 page T line catalog. Contains a large selection of modern audio circuits ranging in power output from four to 120 watts. These circuits feature Beam Power Tubes, Inverse Feed-Back and Cathode Drivers which provide the ultimate in audio design.

**Kenyon Transformer Co., Inc.**  
840 Barry St. New York, N. Y.  
Export Dept. Cable Address: 25 Warren St. Simonrice, New York, N. Y.



### ASTATIC

#### CRYSTAL MICROPHONES WITH TWO NEW FEATURES

The Special Astatic Plug and Socket Connector which permits instant interchange of microphones on the same cable or permits the use of several lengths of cable on the same microphone. PLUS the new Astatic Spring Cable Protector which prevents cable breakage at mountink.

SEE YOUR ASTATIC JOBBER  
Licensed under Brush Development  
Company Patents. Astatic pending.

**ASTATIC Microphone Laboratories, Inc.**  
DEPT. SW YOUNGSTOWN, OHIO

## BLILEY CRYSTALS

20-40-80-160 Meter Bands

\$3.95 up.

**Bliley Electric Co., Erie, Pa.**



# The ULTIMATE in U.H.F. PRODUCTS

## ULTRA DUPLEX 5 TUBE BATTERY PORTABLE 2 1/2 to 5 Meters (56 to 120 M.C.)

NEW TUBES, NEW CIRCUIT, the ideal complete station for portable use. Receiver and transmitter absolutely independent of each other. Receiver uses 1-19, 1-1F5G, as detector, 1st and 2nd stage of A.F. Transmitter uses 1-19, oscillator, 1-1E6G speech amplifier, 1-1E7G class A modulator. Past proven performance together with the addition of several up to the minute features insures superb results. Separate antennas are used for receiver and transmitter to obtain the peak of efficiency for both units regardless of frequency settings. Supplied complete with all coils including coil for 10 meter reception.

- 19-1F5G-19-1E5G-1E7G
- Built in Wright DeCoster Nokoil Speaker
- Extremely low current drain
- 100% class A plate modulation
- Negligible receiver radiation
- Receiver or transmitter may be turned off when not in use
- Great usable sensitivity
- Automatic phone jack

Complete with built in Nokoil speaker and cabinet with battery compartment, wired and tested, less tubes, batteries, microphone and antenna ..... **\$20.95**

Set of 5 Sylvania tube ..... \$4.62  
American S.B. hand mike ..... 2.95  
Adjustable 8 ft. antenna ..... 1.60

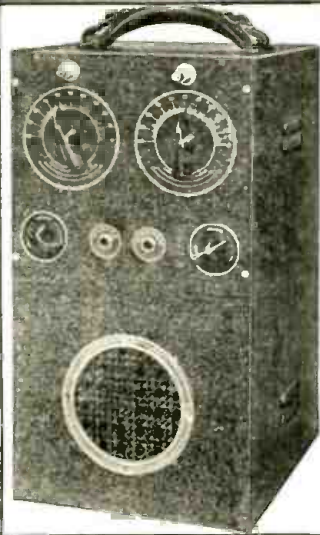

## ULTRA DUPLEX 6 TUBE MOBILE OR A.C. 2 1/2 to 5 Meters (56 to 120 M.C.)

This unit uses six of the latest 6 volt tubes in a circuit which may be operated from a 6 volt automobile battery or by substituting power supplies from 110 volts A.C. Receiver uses 1-6J5G as a super-sensitive detector, 1-6J7 1st A.F. stage, 1-6F6 output stage. Transmitter consists of 1-6E6 oscillator, 1-6J7 speech amplifier, 1-6L6 class A modulator. Power output of transmitter is 10 watts 100% plate modulated. Separate antennas are used for peak efficiency of both units regardless of frequency settings. Changeover from 6 volt to A.C. operation is extremely simple. All that is necessary is to remove the built in genemotor and insert the A.C. power supply.

- 6J5G-6J7-6F6-6E6-6J7-6L6
- Built in 350 volt 150 mil filtered genemotor
- Built in dynamic speaker
- 10 watts power output
- 100% plate modulation
- Absolutely independent receiver and transmitter
- Negligible receiver radiation
- Automatic phone jack

Ultra 6 tube Duplex complete with built in dynamic speaker and A.C. power supply, wired & tested, with cabinet, less tubes, mike and antenna ..... **\$28.90**  
Ultra Duplex complete with built in dynamic speaker, and 150 mil genemotor, wired & tested, with cabinet, less tubes, mike and antenna ..... \$38.45  
Set of 6 Sylvania tubes ..... 5.35  
American S.B. hand mike ..... 2.95  
Adjustable 8 ft. antenna ..... 1.60

## SENSATIONAL ULTRA "SKY ROVER" 2-TUBE TRANS-RECEIVERS

### A.C.-D.C. MODEL

Numerous letters of appreciation received from the many purchasers of the Ultra Sky Rover since its release a few months ago pronounces it as the sensation of the year. Never before was a unit of this type available at any price. This compact and self-contained unit will receive from 2 1/2 to 4000 meters with a high degree of excellence. Will receive foreign stations, amateurs, police calls, broadcast, press, airplane and weather reports, time signals, and all ultra high frequency stations. As a 2 1/2 to 5 meter transmitter surprising results will be obtained when calling friends from afar.



### BATTERY MODEL

In compliance with countless requests we have designed a battery model of the now famous A.C.-D.C. Skyrover. This remarkable unit uses 2 twin tubes, 19 & 1E7G which insure consistent loudspeaker volume and powerful transmission. Receives from 2 1/2 to 4000 meters, transmits on 2 1/2 and 5 meters. Cabinet is provided with handle (not shown) for portable use. May also be mounted in a car. The same features which characterize the electric model are incorporated in this unit.

**\$6.45**

- Either kit, un-wired, less tubes and accessories
- Set of 2 Sylvania tubes for electric model ..... \$1.65
  - 6J5G and 12A.....
  - Set of 2 Sylvania tubes for battery model ..... \$1.95
  - 19 and 1E7G.....
  - Set of 4 coils 2 1/2 to 15 meters..... 30c
  - Set of 4 coils 15 to 200 meters..... 95c
  - Set of 5 coils 200 to 4000 meters..... \$1.75
  - American S.B. Handmike..... \$2.95
  - Cabinet less battery compartment..... 95c
  - Cabinet with battery and speaker compartment \$4.25
  - 6-inch magnetic speaker..... \$1.25
  - Wired and tested..... \$2.00

### FEATURES

- ★ Transmits from 2 1/2 to 5 meters
- ★ Receives from 2 1/2 to 4000 meters (12 bands)
- ★ Separate electrical and mechanical bandspread
- ★ Loud speaker volume
- ★ Automatic super-regeneration from 2 1/2 to 15 meters
- ★ House to house communication
- ★ Plate modulation

## 3-Tube Portable Transceiver (2 1/2 VO 5 METERS) (Built-in Loud Speaker)



A compact powerful 2 1/2 & 5 meter portable transceiver designed for loud speaker operation, is now available in the Ultra 3 B. This remarkable unit will be found capable of maintaining positive contact when communication is once established. Class A 100% modulation is employed. This has been made possible by the new 2 Volt tubes: 1F4 Class A modulator—1B3 high gain speech amplifier. These together with a 19 tube, Oscillator-Super regenerative detector result in an ideal transceiver. When used as a receiver loud speaker volume is assured. Plate modulation.

Supplied complete with all coils including coil for 10 meter reception.

- Complete kit of parts (including all coils), less batteries, tubes, speaker, microphone and cabinet un-wired..... **\$9.95**
- Wired and tested..... \$2.50
  - Sylvania, 19-1F4-1B3 set of 3 matched tubes \$2.50
  - Cabinet with built-in speaker and battery compartment ..... 2.25
  - Cabinet less built-in speaker with battery compartment ..... 1.95
  - Cabinet less built-in speaker, less battery compartment ..... 1.10
  - American S.B. Handmike..... 2.95
  - Matched speaker..... 1.25

# Ultra High Frequency Products Co., 123 Liberty St., New York

## Simple 1-Tube Booster Aids "DX" Fan

(Continued from page 121)

antenna. While they will work to some extent, they will not provide as efficient operation as the spaced pair. The spacing on either type of antenna may be from two to six inches. The two-inch type insulator or transposition block would seem to be the best arrangement. The remaining antenna shown in the diagram is a half-wave antenna with a single-wire feed system. The distance between the center of the antenna and the point at which

the lead-in is attached should be equal to 1/4 of the total length of the antenna. With this antenna one connection of the input coil is grounded as shown in the diagram.

The operation of this amplifier is exactly the same as a regenerative detector—however the tube is never permitted to oscillate. This means that the regeneration control should always be set below the point where the tube breaks into oscillation. The mechanical details are shown in the photograph, and should offer no difficulty to the constructor.

### Parts List for Booster

#### HAMMARLUND

- 1—mid-geet 140 mmf. variable condenser (HF)
- 1—5 prong isolantite socket
- 4—small isolantite coil forms (CF-M)
- 1—6 prong isolantite socket
- 1—2.1 mh. R.F.

#### SPRAGUE

- 3—.1 mf. by-pass condensers
- 1—100 mmf. condenser

#### I. R. C.

- 1—500 ohm 1/2-watt resistor
- 1—.1 meg. 1/2-watt resistor
- 1—50,000 ohm potentiometer

### RAYTHEON

1—6D6 or 57 tube.

### COIL DATA

- No. 1—5 turns No. 24 osc. close wound, tap at 1 turn
- No. 2—10 turns No. 24 osc. close wound, tap at 1 turn
- No. 3—24 turns No. 24 osc. close wound, tap at 2 turns
- No. 4—45 turns No. 24 osc. close wound, tap at 2 turns

The antenna coil is not critical and may consist of 2-5 turns, the smaller number used with the twisted feeders and the larger with the spaced feeders.

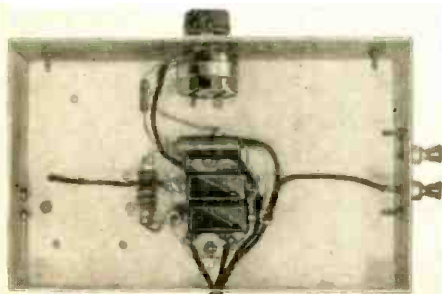

Bottom View

### \$25.00 FOR GOOD 1-TUBE SET

• WE are offering \$25.00 for a good 1-tube set, either in the form of a short-wave receiver or a converter. Please note that there is little use in sending in an ordinary hook-up for a 3-element tube as most of the circuits possible with these tubes have been published.

What the editors want is a new circuit designed around one of the latest type tubes having a multiplicity of grids.

Please mention SHORT WAVE & TELEVISION when writing advertisers

### ULTRA MODEL 1A1 Precision Signal Generator

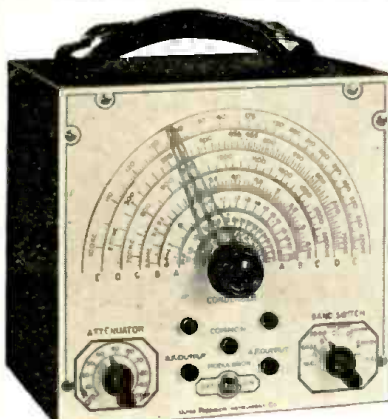

- Wide range 100 K.C. to 66 M.C. (3000 to 4.5 meters).
- Direct reading dial accurately calibrated for entire range.
- Accuracy of calibration 1/2 of 1% on I.F. and broadcast bands, 1% on short wave bands.
- High ratio vernier dial drive with hair splitting pointer.
- Separate outputs for both R.F. and audio.
- Attenuator for both R.F. and audio channels.
- Modulated or unmodulated R.F.
- Pure sine wave audio output.
- Due to pure wave form of both R.F. and audio outputs the unit may be used in conjunction with an oscillograph.
- Tests condensers for opens and shorts by pitch method.
- Outstanding appearance. Unit has beautifully etched metal panel.
- A.C. and D.C. operation. Any cycle.
- Supplied for 110 volt A.C. and D.C. operation. May be supplied for any operating voltage from 110 volts up, on request at no extra charge.

Model 1A1 Precision signal generator supplied complete with tubes, cabinet, and operating instructions as illustrated and described

**\$12<sup>50</sup>**

### ULTRA PRECISION A.C.-D.C. PORTABLE ALLTEST METER

- OHMMETER.
- A.C.-D.C. volt milliammeter (2000 ohms per volt).
- Accuracy of A.C. readings linear regardless of frequency, waveform, or temperature.
- Completely self contained for all ranges (no external batteries or plugging into power line required).
- Built-in tube rectifier.
- D'Arsonval jeweled movement (500 micro-amperes).
- Overall accuracy on A.C. or D.C. 2%.
- VOLTS—0.5—0.50—0.250—0.1000.
- MILS—0.1—0.5—0.250—0.1000.
- OHMS—0.200, 0.200,000, 0.2 meg.
- Large easy to read scales with knife edge pointer.
- May be used as field strength meter.

ULTRA PRECISION A.C.-D.C. PORTABLE ALLTESTMETER as illustrated complete with two 7 1/2 volt Burgess batteries, built-in tube rectifier, and operating instructions



**\$13<sup>95</sup>**

### ULTRA PRECISION INSTRUMENTS CO.

123 Liberty St., Dept. S-1, New York City

### Over 35,000 Set Builders Use This SHORT WAVE COIL BOOK

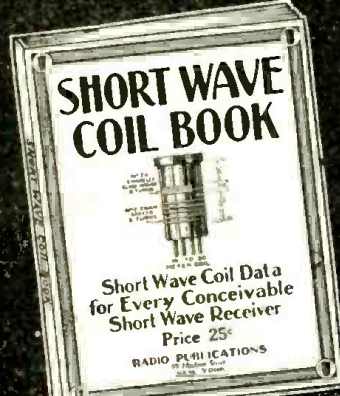

Every experimenter who has ever tried to build a short wave set knows only too well by experience, that the difference between a good and a poor receiver is usually found in the short wave coils. Very often you have to hunt through copies of magazines, books, etc., to find the information you require about coil winding. Between the two covers of this book you now find every possible bit of information on coil winding that has appeared in print during the past two years.

Illustrations galore, giving full instructions how to wind coils, dimensions, sizes of wire, curves, how to plot them, by means of which any coil for any particular short wave set can be figured in advance, as to number of turns, size of wire, spacing, etc.

There has never been such data published in such easy accessible form as this.

**PRICE 25c PREPAID**

For a copy of this handy book, send 25c U. S. coin or unused U. S. Postage Stamps to

**RADIO PUBLICATIONS**  
87 HUDSON STREET NEW YORK, N. Y.

### THORNE'S RADIO COIL WINDER



DESIGNED FOR THE AMATEUR AND RADIO REPAIR SHOP

Will wind Transformers, Straight or Honeycomb coils and Ear Phone armatures. Revolution recorder. 14 Speed changes.

Write for Illustrated Circular and Price.

**SUNSHINE NOVELTY CO.**  
226 S. W. 2nd Ave., Miami, Florida.

### TREASURE LOCATORS BLUEPRINTS and INSTRUCTIONS

For Building the Following Treasure Finders and Prospecting Outfits

- No. 1. Hughes Induction Balance Circuit
- No. 2. Sensitive Hughes Induction Balance Circuit
- No. 3. Single Super-Sensitive Hughes Induction Balance Circuit
- No. 4. Radio Frequency Oscillator Circuit
- No. 5. Audio Frequency Oscillator Circuit
- No. 6. Combination Radio Transmitter and Receiver Circuit

With any one of these systems you can construct instruments to locate buried treasures, metal war relics, mineral deposits, subterranean water veins, buried gas and water pipes, lost objects, tools and treasures sunken in water, etc.

For each set of blueprints and instructions **\$1.00**

The complete set of six folders (Sent postpaid) **\$5.00**

**TECHNIFAX**  
Division 77-W  
578 W. WASHINGTON BLVD. CHICAGO, ILL.

### 40 Watt Transmitter

(Continued from page 124)

rent of the final amplifier.

The oscillator coil L-1 consists of 30 turns of No. 20 enameled wire, space-wound on a 1 1/2-inch diameter form. The amplifier coil, L-2 consists of 50 turns of No. 20 enameled wire space-wound on a 2 1/2-inch diameter form tapped at the twenty-fifth turn. Actually, only 25 turns are employed in the plate tuned circuit.

The method of adjusting the transmitter is very simple. With a dummy plug in the amplifier plate-circuit jack (this plug may consist of a piece of 1/4-inch bakelite rod, rounded off on the end so that it will fit in the jack and remove plate voltage from the tube) and the filaments heated, we can turn on the plate voltage switch. This will apply voltage to the oscillator only. The meter plug should be inserted in the plate jack of the oscillator. Next rotate the variable condenser C-5, which is the oscillator tuning condenser until a decided dip is indicated in the meter reading. Adjust the variable condenser slightly to the high-frequency side of this dip. The oscillator is now functioning properly.

If we plug the meter jack into the grid circuit of the amplifier, we will note a sizeable grid current. With condenser C-6 set at a minimum capacity, rotate condenser C-7 until a decided change is noticed in the grid current of the amplifier tube. Then increase the capacity of C-6, the neutralizing condenser gradually; at the same time swing the final amplifier condenser C-7, back and forth past the point where the fluctuation in grid current occurred. Continue this operation until C-6 is set to a point where rotating C-7 will have no effect on the grid current. We then thoroughly neutralize the final amplifier. In the meantime, make a note of the dial reading of C-7 as to the exact point at which the change in grid current occurred, for this will be near resonance, and the amplifier condenser should be left at this point.

Next open the key and remove the dummy plug from the amplifier plate jack and insert the meter in place of the dummy plug. We then should close the key and immediately be prepared to make the final adjustment of C-7, bringing the plate current of the final amplifier to the lowest possible value.

- STANCOR**
- 1—Plate transformer, type XP-3699
  - 1—Rect. filament transformer, type XP-3062
  - 1—Filament transformer, type XP-3063
  - 1—Swinging choke, type XC-1645
- AEROVOX**
- C—1 dual 8 mf. electrolytic condenser, type No. 66L5
  - C1—1 .01 mf. mica condenser, type No. 1450
  - C2—5 .002 mf. mica condenser, type No. 1457
  - C3—2 .0005 mf. mica condenser, type No. 1450
  - C4—1 .0005 mf. mica condenser, type No. 1450
- CARDWELL**
- C5—1 150 mmf. MR-150 BS
  - C7—1 100 mmf. MT-100 GS
- HAMMARLUND**
- C6—1 35 mmf. star double-spaced condenser
- RESISTORS**
- R1—1 50,000 ohms half-watt
  - R2—1 10,000 ohms 10 watt Red-devil
  - R3—1 10,000 ohms 10 watt Red-devil
  - R4—1 20,000 ohms 10 watt Red-devil
  - R5—2 1/2 meg. 1/2 watt
  - R6—1 2500 ohms 10 watt Red-devil
- RFC**—3 2.5 mh. at 125 ma R.F. choke
- L1—1 5-prong plug-in coil form 1 1/2" dia.
  - L2—1 5-prong plug-in coil form 2 1/2" dia.
- MISCELLANEOUS**
- 3—5-prong clip-tite sockets
  - 1—4-prong clip-tite socket
  - 1—6-prong clip-tite socket
  - 1—8-prong clip-tite socket
  - 1—4-prong statite socket
  - 1—6-prong male connector
  - 3—midget closed circuit jacks, and panel insulating washers
  - 1—phone plug
  - 2—toggle switches
  - 1—jewel pilot light socket and 6.3 volt lamp
  - 2—binding posts
  - 1—Gordon deluxe oscillator name plate
  - 1—Gordon deluxe amplifier name plate
  - 1—150 ma. 3 1/2" Triplett meter
  - 2—2 1/2" instrument dials, Crowe or Gordon
  - 1—80 meter crystal
  - 1—83 rectifier tube
  - 1—6L6G oscillator tube
  - 1—825 Taylor tube
- Screws, nuts, and hardware, AC cord and plug, hook-up wire
- 1—R.F. panel Standard 7" x 19"
  - 1—power-supply panel Standard 5 1/4" x 19"
  - 1—R.F. chassis 17" x 7 1/2" x 2 1/2"
  - 1—power-supply chassis 17" x 4 1/2" x 1 1/4"
- This article has been prepared from data supplied by the courtesy of The Standard Transformer Corporation.

Please mention SHORT WAVE & TELEVISION when writing advertisers

# The Super-10•A Receiver for the Man Who Builds His Own

(Continued from page 123)

### SWITCHES

SW1—S.P.S.T. toggle switches

### I. R. C.

- R1—100000 ohms 1 watt Resistor
- R2—350 ohms 1 watt Resistor
- R3—100000 ohms 1 watt Resistor
- R4—100000 ohms 1 watt Resistor
- R5—500 ohms 1 watt Resistor
- R6—75000 ohms 1 watt Resistor
- R7—10000 ohms 1 watt Resistor
- R8—100000 ohms 1 watt Resistor
- R9—350 ohms 1 watt Resistor
- R10—100000 ohms 1 watt Resistor
- R11—100000 ohms 1 watt Resistor
- R12—150000 ohms 1 watt Resistor
- R13—1 megohm 1 watt Resistor
- R14—1 megohm 1 watt Resistor
- R15—60000 ohms 1 watt Resistor
- R16—10000 ohms 1 watt Resistor
- R17—50000 ohms 1 watt Resistor
- R18—50000 ohms 1 watt Resistor
- R19—500 ohms 10 watt Resistor
- R21—400 ohms 1 watt Resistor
- R24—100000 ohm 1 watt Resistor
- R25—50000 ohms 1 watt Resistor
- R26—50000 ohms 1 watt Resistor
- R27—25000 ohms 50 watt Resistor
- R28—50000 ohms 1 watt Resistor
- R30—2500 ohms 1 watt Resistor

### ELECTRAD

- R20—250000 Tone-Control with switch
- R22—Taper control (0.5 meg.)
- R23—10000 ohms sensitivity control
- R29—20 ohms centre-tapped

### MISCELLANEOUS

- R.F.C. 8 M.H. chokes
- 1—12" speaker, with output transformer
- 1—Headphone set. Trimm.
- 1—phone jack
- 2—4 prong tube socket
- 1—4 prong cable connector
- 9—8 prong tube sockets for metal tubes
- 5—Grid caps for metal tubes
- 3 ft. 4-wire cable for speaker connection
- 1—A.C. cord and plug
- 3—S.P.S.T. toggle switches
- 1—chassis 12x17x3
- 1—twin binding post terminal

### COIL DATA

Band	L1	L3	L2, 4 & 5	Tap
1750	9	28	58 No. 28	18
3500	6	19	29 No. 20	9
7000	5	9	10 No. 18	3
14000	5	5	7 No. 18	2

L1, 3 close wound No. 36 D.S.C.  
1750 and 3500 close wound. En.  
7000 and 14,000 spaced to cover. En.  
1 1/4 inch.

## Short Waves Report Solar Eclipse

● The total eclipse of the sun occurring on June 8, and the events leading up to it have been reported by short waves to American broadcast audiences. The accompanying picture shows the set-up of NBC who sent out a radio expedition especially to cover this important event.

The radio reports of the eclipse were heard over NBC networks from Enderbury Island, and the diagram shows how short waves carried the announcer's descriptions from this uninhabited island in the midst of the Pacific Ocean.

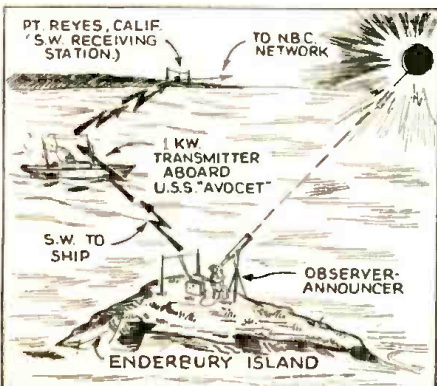

# ALLMETER

23 MEASURING INSTRUMENTS IN ONE **\$10.40**



IMAGINE precision test instruments averaging 45¢ each in cost to you. Yet that's what the ALLMETER averages, and it is a precision instrument for measuring a-c and d-c volts and currents, resistance, capacity, inductance and decibels. The fan-type meter has d'Arsonval movement (0-1 ma, 1,000 ohms per volt).

## OSCIMETER

Lowest-priced direct frequency-reading all-wave signal generator. This instrument, accurate to 1% on 1-f and broadcast bands, 2% on short waves, covers 100 kc. to 22 mc., all on fundamentals, in five hands. It is switch-controlled, has attenuator, and enables also leakage test of condensers, tubes, etc. It has sine-wave r.f., also separate modulator, cut in or out by switching. Its purpose is to align all types of receivers.

This instrument works on 90-130 volts, a.c. or d.c. If a.c. is used it may be of any commercial frequency. Tubes are oscillator, rectifier and modulator. R-F output may be at high or low impedance, from separate posts. Also separate audio output enables testing P.A. systems and other a-f amplifiers. Housed in black wrinkled finished shield cabinet, with carrying handle, the signal generator, 5 lbs. unboxed, is easily portable. Order Oscimeter Model T-40, complete with three tubes and instructions. (Shipping weight 6 lbs.) **\$10.40**

### FEATURES:

- The accurate services rendered are:
- |  |   |
|--|---|
| A-C Volts, 15-150-750, at 1,000 ohms per volt                                | 3 |
| A-C Currents, 15-150-750 ma.   | 3 |
| D-C Volts, 15-150-750, at 1,000 ohms per volt                                | 3 |
| D-C Currents, 15-150-750 Ma.   | 3 |
| Capacities, .01-50 Mfd.  | 1 |
| Low Resistance, .03-500 ohms   | 1 |
| High Resistance, 500-500,000 ohms  | 1 |
| Inductance, 5-1,000 henries (measurable even with load current through coil) | 1 |
| Decibels, minus 12, zero, plus 10  | 1 |
| Decibels, previous scale plus 20   | 1 |
| Vacuum-tube voltmeter, 15-150-750 volts                                      | 3 |
| Output meter   | 1 |
| Short Tester   | 1 |

Thirteen services, equal to 23 instruments, all from same two binding posts. Model AMR (sh'p'g wt. 6 lbs.), for 60 cycle, 90-130 volts a.c. Complete instructions. Net price **\$10.40**

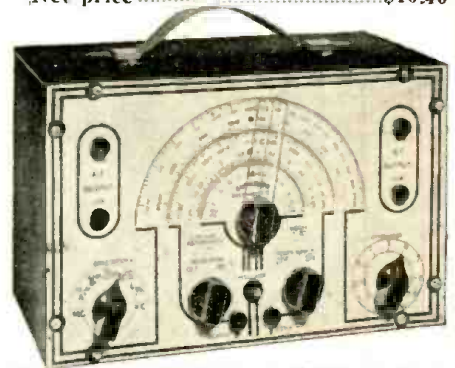

An especially attractive front panel distinguishes the appearance of the Oscimeter. A transparent mask and inscription protector produces a brilliant effect, due to both transmitted and reflected light, easy on the eyes.

## TUBE TESTER

We absolutely believe this instrument to be the best buy for either novice or expert serviceman. It is not only as thorough and accurate, but actually a faster tube tester than similar but more elaborate and expensive instruments. Tests tubes on the "emission" principle, and permits testing for shorts or leakage between elements so that positive accuracy in checking is obtained. Checks all types of tubes, whether UX or octal base, and allows for separate checking of diode sections of composite tubes. Real rugged construction, and priced so low that no serviceman or constructor can afford to be without it. The following salient features are incorporated in this instrument:

- Tests all 4, 5, 6, 7s-7L and octal base tubes.
- Tests all diode, triode, pentode and tetrode receiving tubes, as well as many transmitting tubes.
- Tests diode, triode and pentode sections of composite tubes separately.
- English reading meter, with "Bad—?—Good" scale.
- Incorporates Neon Test for determining leakage or shorts between elements.
- Attractively designed front-panel. Metal case—dimensions—10x6 1/2 x 5 1/4 ins.
- Compact and lightweight. Ideal for Service Laboratory or field servicing.



Price with Complete Directions **\$10.40**

Model V-45 Tube Tester. The panel is designed for symmetry and high accessibility, with utter convenience of operation. Carrying handle (not shown) included.

Order direct from Us. Send full amount and package will go express collect. Or send 20% balance C.O.D. **SUPERIOR INSTRUMENTS CO., 136 LIBERTY STREET NEW YORK, N. Y., DEPT. SW-7** Catalogue PV, in colors, describes our complete line. Send for it today. It's Free.

## ENJOY Short Wave Programs when others are asleep—Use



### CANNONBALL HEADSETS

FAVORITE SET OF "HAMS"  
Heavy bar magnets built into Cannonball Phones greatly increase efficiency—will satisfy you.

and get the clearest reception. Write for illustrated folder S-7.

**C. F. CANNON COMPANY**  
SPRINGWATER, N.Y.

## TR-6A6 TRANSMITTER—RECEIVER

### FOR 5-METER BAND DUPLEX OPERATION

A complete 5-Meter Station, including a Receiver and Transmitter for D.U.P.L.E.X. break-in operation. Both units housed in a sturdy black crystalline cabinet, with separate tuning dials and speaker.

AMATEUR PRICE \$39.75 NET LESS TUBES Also A Crystal Controlled Model

Write for new 1937 catalog

## CAMERADIO

963 LIBERTY AVE. PITTSBURGH, PA. 30 TWELFTH ST. WHEELING, W.VA. Established 1919

*We'll train YOU QUICKLY*  
for **Good FULL-TIME**  
and **SPARE-TIME Jobs in**  
**ELECTRICITY**

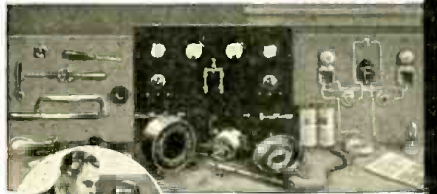

**Train for a Better Job and a Future**  
*Train in your Spare Time*  
by **PRACTICAL Shop Methods**

**WITHOUT LEAVING HOME**

Now, Electric Institute brings—**TO YOUR VERY DOOR**—practical training necessary for the rich rewards in Electricity. Keep your present job—no need to leave home—now you learn **ELECTRICITY** easily, practically—**RIGHT AT HOME**—in your spare time.

**PREPARE TODAY FOR OPPORTUNITIES AHEAD**

Get into a real money making field where there are many opportunities in Electricity. There is no better way to succeed than to **TRAIN** for work in an industry that is expanding. New Electrical projects constantly mean more jobs for men with practical training. Almost every industry uses **TRAINED ELECTRICAL MEN**. Or you can own and operate an electrical business of your own.

**Opportunities to Earn Up to \$5, \$10 a Week or More While Training**

With this amazingly easy, fascinating method of **HOME SHOP TRAINING** it is possible to start **EARNING MONEY** almost at once. Do not confuse E. I. Training with dry, theoretical text book courses. Electric Institute tells you exactly **WHAT to do**—**THEN YOU DO the ACTUAL JOBS** with **ELECTRICAL EQUIPMENT** and **APPARATUS** which comes with your training at no extra cost.

Become a **TRAINED** man without leaving home or your present job—then be ready to step into a **REAL ELECTRICAL JOB**.

**Money Back If Not Satisfied**

You must be satisfied. We give you an agreement to return every cent you pay on tuition if, after completing our training, you are not satisfied in every way with our instruction, equipment or other services given you.

With our training, our graduates receive life time consultation service, employment service and many other features to help them succeed in Electricity.

Electric Institute is ready to show you the way in the great, growing field of **ELECTRICITY**—where trained men are **ALWAYS NEEDED**. Mail coupon **TODAY**—for big, free book of facts about this revolutionary Practical Home Shop Training and the tremendous opportunities in **ELECTRICITY**.

**DIESEL ELECTRIC POWER, RADIO and REFRIGERATION**

Take advantage of the opportunities awaiting trained men in these and many other branches of Electricity, with **ELECTRIC INSTITUTE** practical training. Mail coupon for complete facts about **ELECTRIC INSTITUTE**—it may be the turning point in your life.



**RUSH THE COUPON—TODAY—BIG BOOK—FREE**

H. W. Petersen, President  
Electric Institute, Inc.,  
Dept. 16711, Hinsdale, Illinois

Send Free Book with all facts about E. I. Home Shop Training.

Name.....Age.....  
Address.....  
City.....State.....

**Around the World Radio Echoes**

(Continued from page 117)

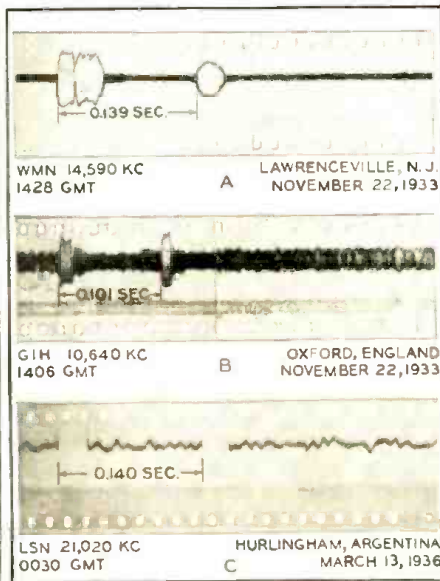

Fig. 6—Around-the-world echoes as they were recorded at Netcong, New Jersey.

transmission at these higher frequencies becomes poor. When the layer is illuminated, however, these frequencies are reflected, and long-distance transmission becomes possible. As a result of these facts it is common practice in radio transmission to use the higher frequencies for daylight conditions over the transmission path, and the lower frequencies for nighttime conditions. For the transition period between dark and daylight, frequencies in the neighborhood of ten thousand kilocycles are employed.

Since the altitude of the refracting layer is from 100 to 250 kilometers (60 to 150 miles), an around-the-world signal path is never entirely in darkness, so that frequencies much below 10,000 kilocycles seldom experience around-the-world echoes. On the other hand, there are times of the year when certain paths may be completely in daylight. Under these comparatively uniform and favorable conditions of illumination, there is every likelihood that around-the-world echoes will be prevalent at higher frequencies.

Illumination of the ionosphere beyond the shadow line at the earth's surface is illustrated by Figure 2, which represents conditions when the earth's axis is at right-angles to the sun's rays. This occurs around March 21 and September 21. During winter in the northern hemisphere, the north pole is tilted about 23 degrees away from, and in summer the same amount

toward, the sun. The tilt is such that only great circle paths passing within some 4000 kilometers of the poles are ever totally illuminated at ionized layer heights of 150 kilometers (90 miles). It is not to be expected, therefore, that echoes will occur frequently on around-the-world paths that are more than this distance from the poles. The time of day and season of the year when they are most apt to appear on favorable paths may be readily determined by computation.

At an altitude of 150 kilometers the great circle path between New York and Lon-

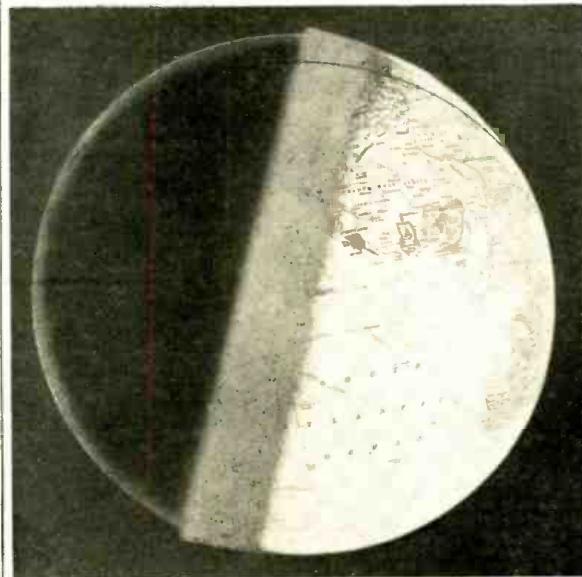

Fig. 4—Lighting conditions for the position of the earth at 7:30 a.m. Greenwich Mean Time on December 21.

and rear around-the-world echoes, is received from a direction 180 degrees from the direct signal.

Short-wave transmission over long distances depends largely on the reflection of the waves back and forth between the earth and the ionized layer high overhead. The reflecting behavior of the ionized layer is a function of both the frequency of the waves and the exposure of the layer to light from the sun. When the ionized layer is in darkness, frequencies above about 10,000 kilocycles are not reflected for the most part, and thus long-distance

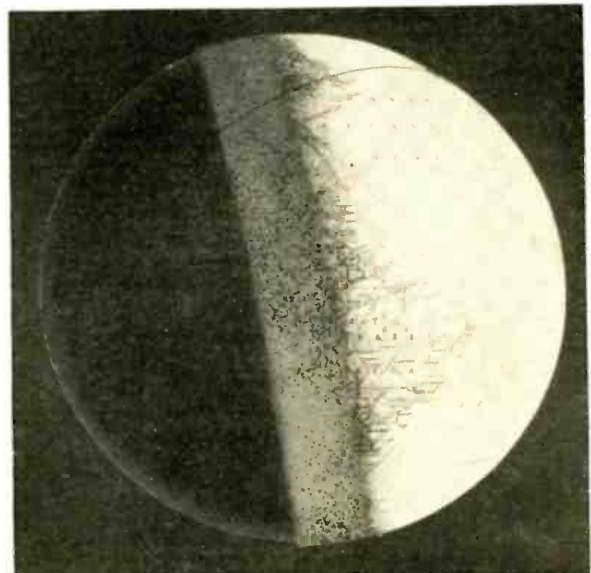

Fig. 7—Early morning in April or September.

Please mention SHORT WAVE & TELEVISION when writing advertisers

don is entirely illuminated around June 21 and December 21 at certain times of the day. The accompanying photographs of a globe illuminated by sunlight illustrates the seasonal shift of sunlight effects. The light areas in each case correspond to illumination at a height of 150 kilometers. The picture Fig. 3-A represents conditions at 1:30 a.m. Greenwich time on June 21, and Fig. 3 shows conditions at 1:30 p.m. December 21. At both these times the great circle path between New York and London, which is marked on the globe, is entirely illuminated; around 7:30 a.m. and at 7:30 p.m. on any day of the year only about sixty per cent of the path is illuminated, as shown in Figures 4 and 5. Curves showing the percentage illumination of the New York-London path for the various months are illustrated by Figure 5. Observations indicate that the average intensity of the echoes varies in about the same way as the percentage illumination. Although total illumination occurs on paths through New York and Buenos Aires, around-the-world echoes are only rarely encountered here because these paths have to pass over the polar regions where the attenuation is great. The most likely time of occurrence is around the equinoxes, and echoes are then occasionally observed.

Due to the long around-the-world path,

the echoes described above are considerably attenuated even on occasions when conditions are favorable for their transmission. The echo signal is rarely found to have a serious effect on the intelligibility of fixed-carrier radiotelephone circuits.

Oscillograph records made at Netcong, New Jersey, of around-the-world echoes received on various short-wave radio circuits are shown in Figure 6. When the receiver and transmitter are located close together, the direct signal will have a negligible time of transmission, while the around-the-world echo will be delayed by about 138 milliseconds. This is shown by A of the illustration. For a reverse-path echo, the difference in time of reception is the difference in the lengths of time required for the signal to go around the reverse path and along the direct path. For the London to New York circuit this amounts to the difference between 119 and 19 milliseconds or 100 milliseconds, and is illustrated at B. For a front around-the-world echo, illustrated at C, the difference in time of reception will be the time required for the signal to encircle the earth. Assuming that the signals travel at the velocity of light, the actual measured echo delays would require a path length about three and three-tenths per cent greater than the circumference of the earth.—*Courtesy Bell Laboratories Record.*

## Set-Making Easy with New Switch-Coil

By Clifford E. Denton

● Set builders everywhere have been interested in building All-Wave receivers but have hesitated to tackle the many problems involved. The best solution and the easy way, at that, is to use one of the new Multi-Wave Coil Assemblies or complete tuning units now available.

These new assemblies consisting of the proper coils, switch and padding condensers all mounted in place and wired, assures success to every set-builder. In the complete tuning units the necessary tube sockets, tuning condenser, by-pass condensers and resistors are all wired into place and all circuits are tuned at the factory in a standard receiver before shipment.

The unit assembly of both of the types available ("fan" and "ham") is simple in construction using highly developed coils for each band. As the coils mount on the switch (except the long-wave band) there are a minimum of leads which could cause changes in calibration if displaced. These are no common grounds, each circuit ground returns directly to its respective tuning-condenser gang-wiping contact. This results in greater gain with stability.

Air-dielectric trimming condensers are used on all bands except the high-frequency bands, which require no trimmers. The padding condensers are mica insulated on the long-wave band, broadcast and police bands. The other bands either do not use padders or have high "Q" mica condensers.

With an intermediate frequency of 456 kc. and the R.F. stage ahead on all bands, except the very highest, a very satisfactory signal-to-noise ratio is maintained with a minimum of image and repeat interference.

Both types can be used with and the complete assembly is supplied with the large 8" type tuning dial that is so desirable today.

As these assemblies form the heart of a real All-Wave receiver it is apparent that the set-builder can incorporate any circuit modification that he desires.

The completely wired tuning unit is illustrated in Fig. 1 and shows the relation of the various parts, such as the tuning condenser, tube sockets, etc. The unit is intended to be mounted in a standard 3" chassis pan by cutting an opening large enough to permit the entire assembly to be inserted from the top, with the mounting flange resting on the side edges of the chassis opening. The unit may be bolted directly to the chassis or a cushion mounting can be used by placing rubber washers between the tuning unit assembly flange and the chassis. If the latter method is used, be sure to solder a flexible braided cable to some point on the main chassis and solder the other end to the assembly chassis of the tuning unit. This provides the "B" minus return for the tubes mounted on the tuning unit sub-chassis.

There is ample space allowance to permit a control (volume control) to be mounted to the right of the tuning unit in such a position as to balance the band-switch control, with respect to the tuning knob.

The complete schematic diagram of the wired tuning unit was shown on page 39, May issue and indicates all of the parts furnished with the unit. The antenna and ground terminals are mounted directly on the unit and are internally wired to the assembly. Only six connections are brought out from the assembly to be connected to the remainder of the receiver; these leads are all color-coded so anyone can follow them.

On the unit designed for Amateur or "Communication" type receivers which has a 260 mmf. tuning condenser and covers the 5 meter band at the high frequency end, there are two changes which should be noted on the diagram. First, the grid-coupling condenser is changed from .00005 mf. to (Continued on page 152)

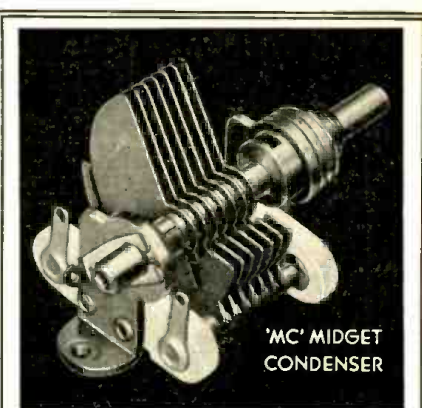
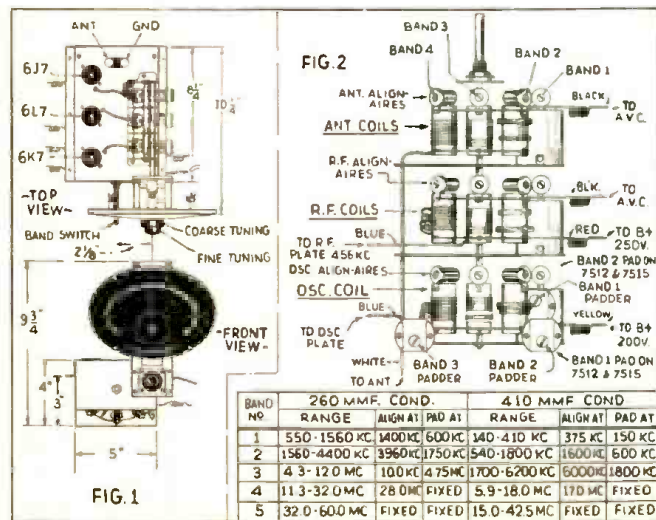

## BETTER CONDENSERS for BEST RESULTS

SINCE introduction, Hammarlund precision variable condensers have been the constant favorite of critical engineers, amateurs, operators, and set builders, for their exacting and diversified needs in quality receivers and transmitters!

Every Hammarlund condenser, designed for peak electrical and mechanical performance, has wide capacity ratios, vibration-proof construction, noise-free operation, quality insulation, and selected metals—all with an eye to dependable, trouble-free, long lasting service. For instance, the MC midget condenser, illustrated above, uses Isolantite insulation; a new noiseless silver-plated beryllium wiping contact; wide split type rear bearing; wide special front bearing; cadmium plated soldered brass plates, etc.

A wide variety of condensers are made for every need—such as single and split-stator midget and micro variable condensers (42 sizes—20 to 320 mmf.); single and split-stator transmitting condensers (38 sizes—20 to 1000 mmf., 1000 to 12000 volts); the star midget condensers (7 sizes—15 to 140 mmf.); famous midline condensers (3 sizes, 250 to 500 mmf.); trimming and padding condensers (23 types, 3 to 1000 mmf., single and dual, Isolantite and bakelite bases), etc.

This extensive group of condensers with their special design and construction makes them ideally suited for compensating, vernier, regeneration, neutralizing, and general broadcast tuning applications as well as air craft, police car and marine work and laboratory and test equipment in general.

If you want the best results, use Hammarlund condensers—they'll never fail you!

The complete line of Hammarlund condensers is thoroughly described and profusely illustrated in the new 1937 catalog. The coupon below will bring you your copy free of charge.

**Mail Coupon Now!**

HAMMARLUND MFG. CO., INC.  
424-438 W. 33rd St., N. Y. City

Please send me the new "37" HAMMARLUND catalog.

Name \_\_\_\_\_

Address \_\_\_\_\_

City \_\_\_\_\_ State \_\_\_\_\_ SWT-7

**HAMMARLUND**

Please mention SHORT WAVE & TELEVISION when writing advertisers

**CALLING ALL HAMS  
NEAR BALTIMORE**

SEE THE  
**WHOLESALE RADIO PARTS CO.**  
314 W. REDWOOD ST.

FOR  
YOUR



ADD-A-UNIT

**TRANSMITTER KIT  
and "HAM" TRANSFORMERS**



**ONLY \$49.75**  
LESS TUBES,  
METERS, CAPITAL

It's easy for you to own a transmitter with a "kick" in it. This **UTAH** transmitter kit enables you to start out with a modern dependable unit—at a fraction of the cost of a factory assembled job. Later on you can plug in additional units and have a complete professional style 400 Watt phone transmitter. Each kit is a complete unit, easily assembled and wired. Each part is tested by **UTAH** so you know it's right.

Start now and start right with this **UTAH** kit. See your closest **UTAH** jobber, or write direct to us—**TODAY!** Address Department SW-7.

**UTAH RADIO PRODUCTS CO.**  
CHICAGO, U.S.A.

TORONTO ONTARIO, CANADA BUENOS AIRES (UCOA RADIO PRODUCTS CO.)

**"15 YEARS OF LEADERSHIP"**

FREE BOOKS WITH SUBSCRIPTIONS TO  
SHORT WAVE AND TELEVISION.  
SEE PAGE 156

**GOOD RESULTS Demand  
GOOD INSTRUMENTS**



**MODEL 241**  
High Frequency  
Thermo Ammeter

Triplett Electrical  
Instrument Co.  
287 Harmon Ave.  
Bluffton, Ohio

**TRIPLETT** manufactures a complete line of measuring instruments for radio, electrical and general industrial purposes both standard and custom built. For better short wave work, write for catalogue.



**A Good 200-Watt S-W  
Diathermy Oscillator**

(Continued from page 127)

store normal operation. Regarding the electrodes, we suggest that anyone building this machine or using it purchase standard electrodes designed for an instrument having a power of around 200 watts. If these electrodes are home constructed, there is always a danger of injury. Remember the insulation should be capable of withstanding from 5,000 to 10,000 volts and there should be absolutely no live surfaces exposed so that anyone may come in contact with them, because very severe burning will be the result of any contact with exposed metal surfaces.

**Parts List for Diathermy Machine**

- AEROVOX**  
2—100 mmf. mica condensers 1,000 V.  
1—.001 mf. mica condenser 5,000 V.  
2—.001 mf. mica condensers 1,000 V.
- HAMMARLUND**  
1—100 mmf. transmitting condenser MTC.  
2—2.1 mh R.F. chokes.  
4—4 prong isolantite sockets.

- KENYON**  
T-1—2.5 V. 10-A filament transformer.  
T-2—1,160 V. 250 ma. plate transformer.

- RCA**  
2—808 triodes.  
2—866 rectifiers.

- TRIPLETT**  
1—0-300 ma. meter.

- PAR METAL**  
1—8 1/2 by 19-inch panel.  
1—17 by 11 by 2-inch chassis.  
1—single section 8 3/4-inch cabinet.

- AEROVOX**  
1—75 ohm center tap resistor.  
1—10,000 ohm 20 watt resistor.

- MISCELLANEOUS**  
1—circuit-breaker  
1—time switch.  
1—2 ohm 3A rheostat.

- COIL DATA**
- SHORT WAVES**  
16 T. No. 10 wire, 2 1/2 inches in diameter, length of coil 4-inches \*output coil 7 turns  
10 wire 1 1/2-inch diameter (inside of large coil).

- ULTRA SHORT WAVES**  
6 T. 1/4-inch copper tubing 2 1/2-inch diameter length 4-inches \*output coil 4 T. No. 10 wire, 1 1/2-inch diameter (inside of large coil).

\*Some experimenting should be done with the size of this coil because of differences in applicator lead lengths, in order to allow the output circuit to tune to resonance with the tube circuit.

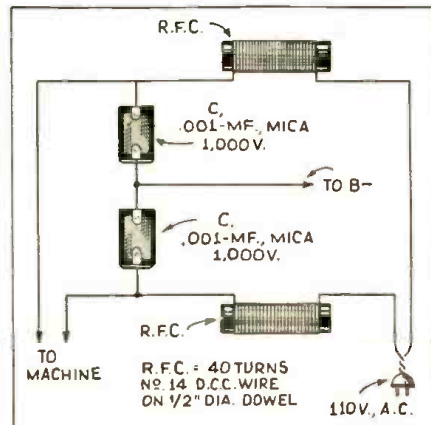

110 volt line filter to prevent R.F. surging back into the supply circuit.

**In the Next Issue!**

You can't afford to miss the "S.W. & T." Communications Receiver by W2-AMN. It's a Wow!

*Accessories for Members of the*  
**SHORT WAVE LEAGUE**

Every member of the **SHORT WAVE LEAGUE** wants to identify himself in some way. For your convenience the League directors have prepared suitable letterheads, label buttons, stickers, etc. In addition there are many short-wave accessories, such as maps, globes, etc., which the League offers only to members at special prices. Take your choice from this advertisement. **THESE ESSENTIALS ARE SOLD ONLY TO LEAGUE MEMBERS.**



**LEAGUE LETTERHEADS**

A beautiful, official letterhead has been designed for members' correspondence. This letterhead is invaluable when it becomes necessary to deal with the radio industry, mail order houses and radio manufacturers, as many houses offer members of the League preferential discount. The letterhead is also absolutely essential when writing for verification to radio stations either here or abroad. It automatically gives you a professional standing.

A—SHORT WAVE LEAGUE letterheads. 50c per 100

A—50c per 100

**WORLD GLOBE**

This important essential is an ornament for every den or study. It is a globe, 6 in. in diameter, printed in fifteen colors, glazed in such a way that it can be washed. This globe helps you to intelligently pick foreign stations. The base is of solid walnut, and the semi-meridian of a nickel-like metal. Entire device substantially made, and will give an attractive appearance to every station, emphasizing the long-distance work of the operator.



D—Globe of the World 89c

D—89c each

**SHORT WAVE MAP OF THE WORLD**

This beautiful map, measuring 18x26 in. and printed in 18 colors is indispensable when hung in sight or placed under the glass on the table or wall of the short wave enthusiast. It contains a wealth of information such as distances to all parts of the world, political nature of the country in which a broadcast station is located, etc. and from the manner in which the map is blocked off gives the time in different parts of the world at a glance.



F—SHORT WAVE Map of the World. Prepaid 25c

**WORLD RADIO MAP AND STATION FINDER**

The finest device of its kind published. The world's map on heavy board is divided into 23 sections, while the rotary disc shows you immediately the exact time in any foreign country. Invaluable in logging foreign stations. Also gives call letters assigned to all nations. Size 11"x22"

G—Radio Map of the World and Station Finder. 25c

**LEAGUE LABEL BUTTON**



E—35c each

**LEAGUE SEALS**



G—15c for 25

These seals or stickers are executed in three colors and measure 1 1/4 in. in diameter, and are gummed on one side. They are used by members to affix to stationery, letterheads, envelopes, postal cards and the like. The seal signifies that you are a member of the **SHORT WAVE LEAGUE**. Sold in 25 lots or multiples only.

H—SHORT WAVE LEAGUE seals, per 25, Prepaid 15c

E—SHORT WAVE LEAGUE label button 35c

EE—SHORT WAVE LEAGUE label button, like the one described above but in solid gold. Prepaid \$2.00

**SHORT WAVE LEAGUE**  
99-101 Hudson St.,  
New York, N.Y.

**SHORT WAVE LEAGUE.**  
99-101 Hudson Street, New York, N. Y. 7-37

Gentlemen,  
I am a member in the **SHORT WAVE LEAGUE**.  
Please send me application for membership in the **SHORT WAVE LEAGUE**.

Please send me the following short wave essentials as listed in this advertisement:

for which I enclose \$..... herewith.  
Name \_\_\_\_\_  
Address \_\_\_\_\_  
City and State \_\_\_\_\_  
Country \_\_\_\_\_  
(The League accepts money order, cash or new U. S. Stamps in any denomination. Register cash and stamps.)

Please mention **SHORT WAVE & TELEVISION** when writing advertisers

### 5-Meter Waves Visible

(Continued from page 120)

Let us assume that the beam rotates with the maximum speed of 200,000 revolutions per second, quite an enormous speed. And let us assume that the voltage feed into the co-axial-cone-condenser is of an extremely high frequency, but we do not know the frequency. By looking at the screen we observe that each of the many small curves "painted" upon the screen covers a length of exactly the width of one of the 100 segments of the polar-coordinate system. What is the frequency? Quite simple: We divide the number of beam revolutions by the number of polar segments; i.e., 200,000 revolutions by 100 (number of segments) which gives us the "length of time" for each of the small curves painted upon the screen to 1/20,000-000 second.

Curves with a frequency as high as this could not be observed with an ordinary cathode ray oscillograph, but are now possible, because the tremendously high speed of 200,000 revolutions per second pulls the single curves far enough apart so as to make them distinct and measurable.

If only a third of a segment of the polar diagram is covered by a single curve, the time indicated is exactly 1/60,000,000 second; a value which corresponds with a frequency of 60 mc., and equals a wavelength of 5 meters.

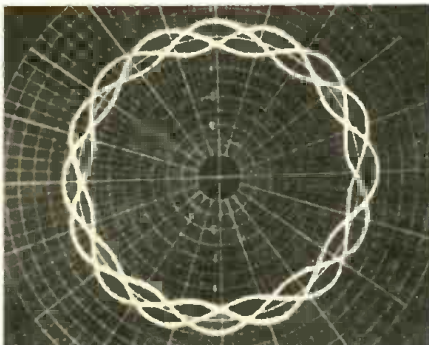

This photo shows front view of the new Von Ardenne Oscillograph while reproducing a frequency pattern of complex nature.

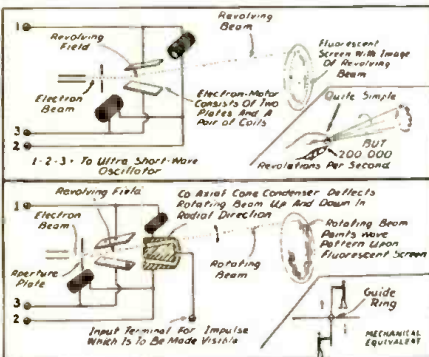

Top—Everyone knows how to whirl a piece of rope. This simple principle is applied to whirl an electron beam, but with the unusual speed of 200,000 revolutions, per second.

Lower diagram—We see the same "electron-motor" but with a funnel (with inside cone), called by the inventor a "co-axial-condenser" installed in front.

#### 160 Meter Coil Data for "MT" Xtal Transmitter

● The author has received many requests for 160 meter coil data for the "MT" transmitter, published in the September 1936 issue.

The coils should be made as follows:  
Osc. Tap Wire Amp. Wire Space Ant.  
41 turns 1/2 No. 22 44t. No. 18 1 dia. 15 turns  
way up D.C.C. D.C.C. on cold end.

All coil forms 2 1/4 inches in diameter.  
—H. D. Hooton, W8KPX.

## At Last! A Super With Regenerative Input—

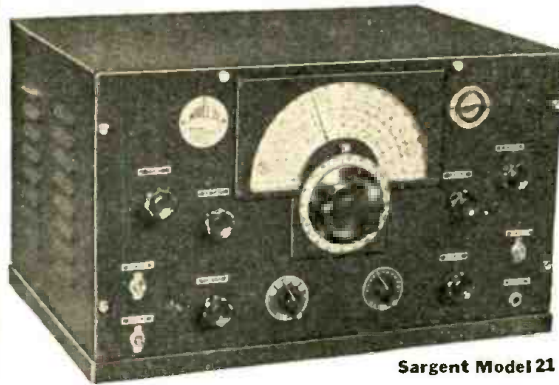

Sargent Model 21

Input regeneration does it! Model 21, when correctly operated has no tube hiss on phone signals, even the weakest ones, and has only a very light hiss on C.W. There are 2 ways of receiving weak signals in ordinary practice. One, the most prevalent, is to use a receiver with an ordinary non-regenerative input and a high gain I.F. Lack of sensitivity at the input frequency necessitates so much I.F. amplification that tube hiss sometimes accompanies it. Consequently, weak signals, if heard at all, are unpleasant to listen to. The other method, used in Model 21, is to make the input extremely sensitive. Thus, less I.F. amplification is necessary, and tube and circuit noises are not amplified to an audible level. The receiver has separate adjustments for controlling the amount of amplification in R.F., I.F., and audio. The Sargent system of noise level control is based upon obtaining proper balance between these three. When correctly adjusted, results are amazing.

#### BUILT FOR EXTREME DX

Model 21 has been primarily designed for extreme DX reception. Although built to communication standards throughout, it has still been possible to include a sensitivity level far greater than that usually found in super-hets.

#### AVAILABLE IN 2 TUNING RANGES

Model 21 is available in Amateur Tuning Range, 9.5 to 550 meters, or in Commercial Tuning Range, 9.5 to 3750 meters. Both ranges are continuous, no skips, no dead spots. Receivers for the 2 are absolutely identical, the only difference being in the number of coils furnished.

- "Red Hot" on 10 Meters
- 12 Tubes (metal)
- Shadow Tuning
- Large, Calibrated Tuning Dial
- Regenerative Input, all bands
- Iron Core I.F.'s
- Band Spread
- C. W. Oscillator, panel beat control
- Separate R.F. Gain Control
- Manual Volume or Amplified AVC
- Heavy, welded steel cabinet
- Speaker separate, in attractive cabinet
- Made in 2 Tuning Ranges:  
Amateur Model 9.5—550 Meters  
Commercial Model 9.5—3750 Meters

#### 6 VOLT BATTERY MODEL

Furnished for either tuning range at \$3.00 higher than the A.C. price. Excellent for portable or direction finding work.

#### New Net Prices, 110 v. 60 cy. Operation (Effective May 15th)

Model 21-AA, 9.5-550 meters.....\$139.00  
Model 21-MA, 9.5-3750 meters.....\$155.00  
These prices include R.C.A. tubes, power supply, Jensen Speaker and speaker cabinet.

- These Model 11 prices became effective May 15th:
- Model 11 Net Prices for 110 V. 60 cycles operation
- Model 11-UA, UNIVERSAL tuning range, 9.5 to 20,000 meters.....\$77.00
- Model 11-MA, MARINE tuning range, 9.5 to 3,750 meters.....\$57.00
- Model 11-AA, AMATEUR tuning range, 9.5 to 550 meters.....\$32.00
- Prices include power supply, speaker and R.C.A. tubes.

### E. M. SARGENT CO.

Cable Address "EMSCO"  
212 Ninth Street Oakland, Calif.

### American DYNAMIC (High or Low Impedance)



- D-5-T 10,000 Ohms List \$32.50
- D-5 50 Ohms List \$27.50

Both equipped with 25' Cable and Plug  
● Excellent Frequency Response  
● Rugged ● Low Priced

#### A TRUE DYNAMIC

Write for catalogue on Dynamic, Crystal, Carbon, and Condenser Microphones, Stands, and Accessories.

AMERICAN Microphone Co., Inc., Ltd.  
1915 S. Western, Los Angeles.

## WORLD S-W Station List

(Continued from page 137)

4.790	YESBK	VANCOUVER, B. C., CAN., 62.63 m., Addr. Radio Sales Service, Ltd., 780 Beatty St. Except Sun. 11.30-11.45 am., 3-3.15, 8-8.15 pm.
4.752	WOO	OCEAN GATE, N. J., 63.1 m., Addr. A. T. & T. Co. Works ships irregularly.
4.690	HCZET	GUAYAQUIL, ECUADOR, 65.22 m., Addr. Apartado 249. Wed. and Sat. 9.15-11 pm.
4.272	WOO	OCEAN GATE, N. J., 70.22 m., Addr. A. T. & T. Co. Works ships irregularly.
4.250	RV15	KHABAROVSK SIBERIA, U. S. S. R., 70.42 m. 1-10 am.
4.107	HCJB	QUITO, ECUADOR, 73 m. Daily 7.30-8.45 am. Daily except Mon. 11.30 am.-2.30 pm., 5-7 pm., 7-10 pm.
4.098	WND	HIALEAH, FLORIDA, 73.21 m., Addr. A. T. & T. Co. Works Bahamas irregular.

COMPLETE

# STANCOR KIT

4 OSCILLATORS

- Straight Pentode
- Tritet
- Jones
- Bi-Push
- Triode
- Dual Triode

4 AMPLIFIERS

- Single Triode (T20 or Type 10)
- Push-Pull Triode (T20 or Type 10)
- Single Pentode (RK-39 etc.)
- Push-Pull Pentode (Bi-Push) Forty-Eight Combinations

48 CIRCUIT COMBINATIONS

FOR \$49<sup>95</sup>

Here's a natural for the medium-power amateur. 4 Oscillators... 2 Buffer-Doublers... and 4 Amplifiers... 55 to 120 watts input... ALL FROM A SINGLE KIT. The kit includes circuits on the most recently released tubes... and circuits on older types of tubes that you probably have in your shack. The new Stencor "48-C" Kit contains all the parts you need FOR EVERY CIRCUIT — less crystal, tubes and meter. COMPLETE SCHEMATIC BLUE PRINTS FREE WITH EVERY KIT

## STANDARD TRANSFORMER CORPORATION

850 BLACKHAWK STREET • CHICAGO

**Here's RADIO'S  
MONTHS-AHEAD  
CATALOG!**

**ALLIED'S 156-PAGE SPRING  
CATALOG SCOOPS RADIO FIELD!**

Here's a new book—a complete book—a book that makes all other catalogs obsolete! Packed with Everything in Radio that's months-ahead, it includes the latest Amateur transmitters, receivers and transceivers; dozens of Build-Your-Own kits; more than 10,000 exact duplicate and replacement parts; 53 new Super-Value Knight Radios; test instruments; Sound Systems; radio books, tools, etc. See what's new—see what's important in Radio!—Send coupon for this great book today!

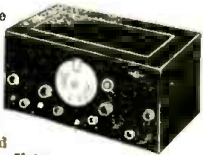

**FASTER SERVICE—LOWER PRICES!**

You save more—get more—profit more—when you order from ALLIED! Our complete stocks, central location, efficient buying and selling methods, and speedy shipping department mean faster service, lower prices and greater values for you. Make ALLIED—Radio's Leading Supply House—your single dependable source for high-grade radio supplies!

FREE Catalog



**ALLIED RADIO Corp.**

833 West Jackson Blvd., Dept. 3-G,  
Chicago, Illinois.  
Send me your new Spring 1937 Catalog.

Name \_\_\_\_\_  
Address \_\_\_\_\_  
City \_\_\_\_\_

**NEW JUST OUT!**

**GADGETS**  
MAGAZINE  
JULY 1937

NOV. 1937  
NOV. 1937

IN THIS ISSUE  
**5 FORTUNES IN GADGETS**

OVER 150 ILLUSTRATIONS  
DEPARTMENTS IN THIS MAGAZINE  
THE MONTH'S LATEST GADGETS  
NEWEST GADGET PATENTS  
GADGET PATENT ADVICE  
HOW TO MAKE YOUR OWN GADGETS

Editorial & General Offices  
99 HUDSON STREET NEW YORK, N. Y.

25 Cents \$3 A YEAR

The world's only magazine on this subject. Contains 150 illustrations of the latest and best gadgets, novelties, and specialties. A veritable gold mine of information which you can not get in any other way.

Every month, GADGETS transacts not only America but the entire world for the newest, most useful articles of this type, including the latest gadget and novelty patents.

Don't fail to read the article FORTUNES IN GADGETS! Learn how inventors become rich in inventing or devising simple gadgets!

If your newsdealer cannot supply GADGETS MAGAZINE send 25c to

**GADGETS Magazine**  
99-S Hudson Street, New York City

**What an A. T. & T. Co. Engineer  
Has to Say**

(Continued from page 116)

with long waves as far back as 1914, and with short waves since 1927.”

“Were the results very encouraging back in 1914?” I asked.

“Oh yes,” said Dr. Perrine. “In 1915 our engineers succeeded in being heard out of Arlington, Virginia, as far away as Paris, France, and not long afterward in Honolulu.”

“Has the experimental work been conducted continuously since that time?” I asked.

“In reality, yes,” replied Dr. Perrine. The radio telephone equipment which we developed for the Army and Navy laid the foundation for later advances. One of the most serious limitations for long-distance radio telephony in the early days was the lack of vacuum tubes of suitable power carrying capacity. As you probably know,” continued Dr. Perrine, “The experimental work out of Arlington entailed something like five-hundred 20-watt vacuum tubes.”

“How did you overcome this limitation, Dr. Perrine?” I asked.

“Well,” he replied, “when our Laboratories perfected the method of hermetically sealing copper and glass together, we were able to build water-cooled vacuum tubes of fairly large power-carrying capacity. These made very good amplifiers for stepping up the energy level. From that time on the venture gave promise of commercial possibility.”

“Dr. Perrine,” I asked. “tell us about the opening of commercial service. It was in 1927, I believe?”

“Yes,” he replied, “that was on January 7, 1927, on a wave-length of 5,000 meters. You probably know that this channel uses what is known as the single side-band, suppressed carrier system.

**How Optimum “Long” Wave was Selected**

“Yes, I recalled that,” I answered. “I have described to our readers the circuit layout and the voice-operated device that made possible the two-direction operation on the same wave-length. But tell me, Dr. Perrine,” I continued, “how did you come to select the wave-length of 5,000 meters?”

“That is a very interesting question,” said Dr. Perrine; and he continued, “A large number of experiments were conducted on wave-lengths above and below 5,000 meters, and the results of signal-to-noise surveys indicated that the 5,000-meter region was the most satisfactory of the long-wave spectrum.”

“This single side-band suppressed carrier system—was that something new at the time?” I asked.

“No,” replied Dr. Perrine, “this was a developed application of the multi-channel carrier system, utilized over open-wire lines, whereon four telephone messages are transmitted simultaneously over the same two wires, without the slightest interaction. This system uses electric wave filters, which were developed by Dr. G. A. Campbell and his associates, and amplifiers, modulators and demodulators developed by other engineers at our laboratories. Under William Wilson, Lloyd Espenschied, Ralph Bown, R. A. Heising, A. A. Oswald, and a host of others here and in England, a very fine transmitter and receiving system was built up. This is an example of the high degree of coordination required among different development groups.”

**Effect of Sun Spots on Transmission**

“That is very interesting,” I said. “But going more into the radio transmission side, I should like to ask you what effects does the solar activity have on your long and short-wave circuits?”

“Well,” answered Dr. Perrine, “during the sunspot maximum when solar activity is also the greatest, the performance of the short wave channels, especially over long distances, is decidedly poorer compared to the sunspot minimum condition. This is especially the case over transmis-

sion paths which traverse areas where the aurora are very frequently seen, such as our circuits to Europe, the great circle path of which extends fairly far north. Generally speaking, short-wave transmission is degraded during the sunspot maximum period. You probably recall that the effect of solar activity is usually manifested in other terrestrial phenomena, such as erratic motions of the compass needle, which are called magnetic storms; beautiful auroral displays, and the oscillations of large electric currents in the earth's crust, simply referred to as earth currents. During severe magnetic storms, as these effects are generally called, some short-wave channels are at times degraded beyond commercial usage. In moderate and mild magnetic storms the longer of the short waves are used very successfully. There is little change in the long-wave performance during the minimum-maximum periods of solar activity. In general, the long waves are slightly improved during the sunspot maximum period, as compared with the minimum period—the opposite of the effect on the short waves.”

“What happens when your circuits go out during disturbed periods, Dr. Perrine?” I asked.

“When the European short-wave circuits, because of severe disturbances, are degraded beyond usage,” he replied, “the traffic is moved over the long waves. The long waves are vulnerable to static, to which the short waves are much less susceptible. Hence the two types of facilities supplement each other in their characteristics. Incidentally the circuits to South America, Bermuda, Central America, and the Orient are very seldom degraded beyond commercial usage during magnetic storms.”

**How “Best” Wavelength is Determined**

“Tell me, Dr. Perrine,” I asked, “how do you determine what wave-length to use for the short-wave operation?”

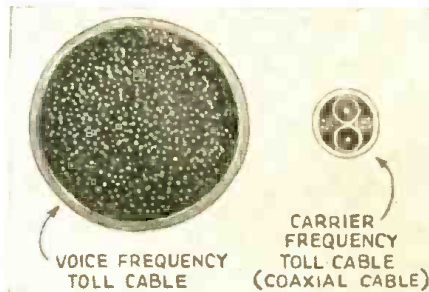

Comparison between an ordinary “voice-frequency” toll cable at the left, and one of the new “coaxial” toll cables.

“Oh, that is more or less determined by the results of past performance,” he replied, “and this may be modified by practical tests on any particular wave-length or frequency. As you know, the frequencies used for transmission across the oceans, or for ship-shore, change with the seasons. Many years of observation and measurement have indicated roughly what the optimum frequency is for the different times of day, and for the different seasons. Our operating people know more or less what to expect and prepare themselves accordingly.”

“What determines whether a circuit is commercially usable, Dr. Perrine?” I asked.

“Well,” he replied, “that is the condition in which the subscriber would get complete transmission satisfaction and would be able to get his message through without difficulty. If noise or fading introduces distortion to such an extent that little transmission satisfaction obtains, and repetitions are becoming frequent, it is considered

Please mention SHORT WAVE & TELEVISION when writing advertisers



unusable for commercial operation. Whenever a short-wave circuit is on the verge of becoming uncommercial the next optimum frequency is explored and a wave-length change is generally made to insure satisfactory transmission."

"In connection with your *ship-shore* circuit, Dr. Perrine," I asked, "how do you determine what wave-length to use for the various distances of ship position?"

"Based on the results of years of observations on *short-wave* facilities," explained Dr. Perrine, "our engineers have prepared special charts showing the best wave-length to use for contacting any ship for any distance, for any particular time of day. By consulting these charts the optimum wave-length is very quickly determined for any distance or time."

#### "Foreign" S-W Broadcast Pick-ups

"That is very interesting," I said, "but how about these *foreign* broadcasts that come over your facilities. Will you tell us something about them, Dr. Perrine?"

"I shall be glad to," he replied. "Program transmissions over our (short-wave) channels have been an important part of the service for the past several years. These in turn are fed to the American broadcasting networks for retransmission. The average run of these *foreign* programs that are routed over our overseas circuits is handled on what is known as a "regular" basis; in this only one distant radio transmitter is used, and this is set on the optimum frequency. For a *special* transmission two or more distant transmitters may be used, and unless radio conditions at the time are doubtful these different transmitters are set on the optimum wave-length. If, however, the *short-wave* transmission conditions are doubtful one of the distant transmitters is set on the optimum frequency and the others are set above or below the optimum frequency, as radio observations may best indicate. For example, if 24 meters is the optimum wave-length for the given time of day and conditions are somewhat doubtful, the observation station in exploring 16 and 33 meter wave-lengths finds 33 meters quiet and the fields getting stronger, while observations on 16 meters show weaker fields than normal, then the use of the 33-meter wave-length is advised as the next alternative, and accordingly one transmitter would be set on 24 meters and the other on 33 meters."

"That is a new angle," I said. "Your receiving arrangement is also very interestingly set up."

"Yes," replied Dr. Perrine, and he continued, "Usually for these programs two or more *short-wave* receivers will be used for either regular or special programs. One may be a single receiver, and the other may be associated with a *diversity* arrangement of antennae. A regular and emergency set-up is always used. The technical operators at the terminal are continually monitoring on the different receivers and switch the network to the receiver giving the best reception."

"This *diversity* arrangement," I asked, "is it similar to that used by the RCA?"

"Yes, it is," he answered. "We use this system in connection with rhombic antennae, developed by Edmond Bruce of our laboratories, and it makes a very effective set-up. The diversity system helps to mitigate the effects of fading, which at times can be quite bad. The rhombic antennae have very good *directional* properties, which help keep the *noise-level* down. And by the way, before leaving this point, may I say that the radio companies as well as ourselves furnish facilities for the transmission of programs; hence there are many rebroadcasts that do not involve our overseas circuits."

#### Some Light on "Coaxial" Cables

"I should like to ask you a few questions about the new *coaxial* cable, Dr. Perrine."

"Surely, go right ahead," he answered. "Reports I have seen," I continued, "indicate that a large number of simultaneous messages or conversations can be carried over a single coaxial conductor arrange-

ment. Will it be possible to carry a *television* program, using the frequency range occupied by these numerous channels?"

"Yes," replied Dr. Perrine, "that seems like a possibility, and it illustrates very nicely the versatility of the electromagnetic spectrum. For each telephone conversation a band of 4000 cycles is used, ranging from 60,000 cycles as a minimum carrier frequency; and since there are 240 channels of approximately 4000 cycles each, the upper end is 60,000 plus 240 times 4000, or 1,020,000 cycles. Of course, this million-cycle band may be utilized "en bloc" for a single television channel."

"One million, twenty thousand cycles!" I exclaimed, and went on, "Why that's about a 293-meter wave-length, using the speed of light as the velocity. That seems low in frequency compared to the short-wave radio channels."

"Yes, it is," said Dr. Perrine, "but we have been using coaxial cable transmission lines at our radio receiving stations now for years. That is, they bring the energy collected by the various antennae systems to the radio receiver. Some of these coaxial transmission lines are over two thousand feet long, and they are used on frequencies as high as 21 megacycles."

"What would you say would be the present frequency limit, Dr. Perrine?" I asked.

#### 1500 mc Over a "Coaxial"!

"Well," he answered, "from the laboratory reports and especially the results in the *extremely high-frequency* region, conducted by Dr. G. C. Southworth, it would be a rather rash conjecture to venture any guess about the upper limit. It is not uncommon to transmit frequencies as high as 1500 megacycles! It may interest you to know that, from Dr. Southworth's investigations, it is possible to remove the central conductor entirely from the cable, and the *wave transmission* at these very high frequencies still continues! Moreover, even the copper tube which comprises the outer conductor of the coaxial system could be removed, and the flow of energy would still continue so long as there is some sort of *wave guide* retained to direct the wave. In fact, a rod of insulating material would probably serve."

"My, how fascinating!" I exclaimed and proceeded. "But getting back to the New York-to-Philadelphia coaxial cable. There was a demonstration on November 30th and December 1st of last year, as I recall. What was the arrangement at that time?" "At that time," replied Dr. Perrine, "thirty-six out of the possible 240 channels were provided with terminal equipment. These channels were looped back and forth about twenty times, giving a transmission path 3,800 miles long in the coaxial system. In order to get a circuit of this length, it was necessary to modulate from one carrier frequency to another some seventy times. Moreover, on each of the twenty round-trips, the voice went through the repeaters, or amplifier units, a total of 400 times. This circuit, as you probably remember, was demonstrated to members of the Federal Communication Commission on November 30th and to members of the press on the following day."

"That was quite a remarkable set-up!" I exclaimed. "What were the energy losses of this cable, Dr. Perrine?"

"If we may call the loss for the mid frequency of the broad band the *average* loss, this is about 4.5 DB (decibels) per mile," he replied, and went on, "The total average loss is in the order of 17,000 DB. As you know, every 3 DB reduces the *power one-half*. That is, 6 DB reduces it one-quarter, 10 DB one-tenth, 20 DB one-hundredth, 60 DB one-millionth, etc. If it were not for the repeaters, or amplifier units, the ratio of the energy at the beginning of the circuit to that at the end of this 3,800-mile path would be 10 with 1,700 ciphers after it, that is, a million multiplied by itself more than 283 times."

"Good heavens!" I exclaimed. "That is one of the biggest numbers I ever heard of!"

"It is a very large number," he replied. "In fact, it is larger than the ratio of the size of the universe to that of the electron."

Top  
Quality  
-ALWAYS!



You take no chances with Raytheon tubes. When you make a replacement with Raytheons — you can forget them! Every Raytheon tube is top quality! Every one is precision engineered... built to give clear, true-toned reception, and extra long life. They won't bounce back! And every customer will be a permanent satisfied customer.

Because of their top quality, you'll find Raytheons practically everywhere! In U. S. Army, Navy and Aviation Communications. In major broadcasting chains. In thousands of amateur radio transmitters and receivers. In millions of home radio sets as original equipment. In leading auto radios, because of their sturdiness, uniformity and ability to withstand continuous shocks and rough usage. On thousands of dealers' and servicemen's shelves... and so on down the line.

So — when you handle or use Raytheons, you're not only in good company — but you know you're taking no chances.

ASK YOUR JOBBER

**RAYTHEON**  
RADIO TUBES

RAYTHEON PRODUCTION CORPORATION

420 Lexington Ave.	55 Chapel Street
New York, N. Y.	Newton, Mass.
445 Lake Shore Drive	555 Howard Street
Chicago, Illinois	San Francisco, Cal.
415 Peachtree St., N. E.	
Atlanta, Ga.	

RAYTHEON IS THE MOST COMPLETE LINE—ALL TYPES OF GLASS, OCTAL BASE, METAL, RESISTANCE AND AMATEUR TRANSMITTER TUBES.

Please mention SHORT WAVE & TELEVISION when writing advertisers

# AMAZINGLY NEW, MIDLANDS GREAT "COLOR-CODED"

## RADIO TELEVISION EXTENSION TRAINING

Originated and developed by experienced engineers and educators. Backed by the resources and modern facilities of nationally known, 5000-watt Columbia basic network broadcasting station, KMBC. "Color-Coded" training fits you for better jobs in radio—prepares for future television opportunities. Graduates qualified to take Government operator's license exams. Lifetime employment service. Get the facts without delay.

**WE SEND ALL NECESSARY EQUIPMENT FOR YOUR "HOME LABORATORY" EXPERIMENTS**

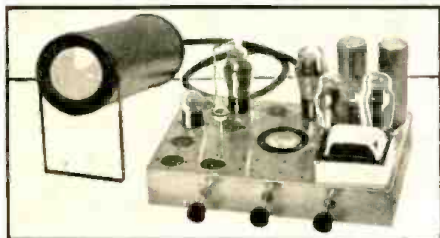

You will build this modern oriltoscope. And it will be yours to keep.

You get 90 modern "color-coded," illustrated lessons, 10 attractive "Home Laboratory" manuals; 10 big shipments of experimental equipment including 3-inch Cathode Ray tube—necessary tools. Then, after completing your "home training," you get a bus ticket to Kansas City and 4 weeks' intensive training in our fine school laboratories. WE ARE NOT CONNECTED WITH ANY OTHER RADIO OR TELEVISION SCHOOL.

### MIDLAND TELEVISION, Inc.

29th Floor, Kansas City Power & Light Bldg.  
112 W. 14th St., Kansas City, Mo.

**IT'S Free**

Get the Facts Before you Act! Send for your copy today.

**FORTUNES IN FORESIGHT**

### MAIL COUPON TODAY

MIDLAND TELEVISION, Inc. (Mail in 29th Floor, Kansas City envelope or paste Power & Light Bldg. on postcard)  
112 W. 14th St., Kansas City, Mo.

Without obligating me, send your new FREE book about the Radio-Television profession, "FORTUNES IN FORESIGHT."

Name..... Age.....  
Address.....  
City..... State.....

## RADIO INSTRUCTION

### NEW "OFFSET" CRYSTAL "PICK-UP"

● The engineers of the Astatic Microphone Laboratory, have just released their new *Trutan Model B-16 Pickup*. The offset head maintains the projected vibration axis of the pickup, tangent to the record groove throughout the entire playing surface, to a degree not otherwise attainable. The result is a marked reduction in tracking error over conventional designs, giving more lifelike reproduction and longer record service.

Further developments of the well-known Astatic crystal pickup cartridge have produced for the B-16 a frequency-response curve exactly suited to present-day recording practice. Arm resonance has been completely eliminated.



Latest "Off-set" Crystal Pick-up.

Designed to play all sizes of lateral transcriptions, the B-16 has a reversible action to allow easy "needle-loading" from above, and employs double-row ball-bearing swivel. Cartridge is equipped with plug-in connector, the crystal is laboratory sealed against moisture, and the entire instrument is laboratory tested, Beautifully finished in modernistic black and chrome; arm-length, needle-point to center of base is 12 inches.

This article has been prepared from data supplied by courtesy of Astatic Microphone Lab., Inc.

## Set-Making Easy With New Switch-Coil

(Continued from page 147)

.000025 mf. and a .0005 mf. by-pass condenser to ground is connected to one of the heater terminals on the 6J7 oscillator tube. In all other respects the circuit diagram applies to both types of tuning units.

The coils and band-switch are so connected that the low-frequency bands are at the left-hand or counter-clockwise position of the band-switch. The tuning ranges and alignment points for each band are indicated in the table of Fig. 2. The location of the various trimmers and padders for each band is shown in Fig. 2. Although the trimmers and padders may be in a slightly different position than indicated in the drawing depending on the type of tuning condenser required, and the ranges covered, it is possible to identify these units at a glance.

The tuning units are aligned and properly padded at the factory in a receiver. Thus, good reception should be obtained immediately when the set is placed into operation. If the adjustments have been changed for some reason then the set can be re-aligned by following the directions covered in the following paragraphs.

Two capacities of tuning condensers are used, 410 mmf. for the standard ("fan") assembly and 260 mmf. for the "Communications" ("ham") job. The tuning ranges for both capacities are given in the following table.

#### 260 mmf. Condenser

Band	Range	KC
1	550-1560	KC
2	1560-4400	KC
3	4.3-12.0	MC
4	11.38-32.0	MC
5	32.0-60.0	MC

#### 410 mmf. Condenser

Band	Range	KC
1	140-400	KC
2	530-1800	KC
3	1750-6200	KC
4	5.9-18.0	MC
5	14.0-43	MC

This article has been prepared from data supplied by courtesy of Meissner Mfg. Co.

## HOW TO LEARN CODE

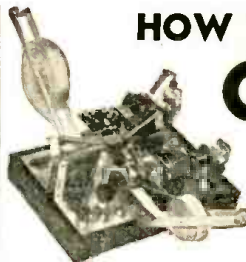

Whether you wish to enter radio as a career or merely add another valuable and fascinating accomplishment to your achievements, the All Electric Master Telex Code Teaching Machine will show you how. Telex records your sending in visible dots and dashes on a specially prepared waxed paper tape and then SENDS BACK to you at any speed you desire. It does not merely show you code. It is code. No experience needed. Beginners, amateurs, experienced ops. get ahead faster this better way. We furnish you complete course, including practice messages, the All Electric Master Telex, plus a personal service on a MONEY BACK GUARANTEE. Low cost. Easy terms. Without obligation write for booklet "87."

### TELEPLEX CO.

72-76 Cortlandt St. New York City  
TELEPLEX—The Magic Key of the Air Ways

**RADIO ENGINEERING**

**TRI-STATE COLLEGE**

**DEGREE IN 2 YEARS.**

Complete Radio Engineering Course in 96 weeks. Bachelor of Science Degree. Radio (television, talking pictures and the vast electronic field) offers unusual opportunities for trained radio engineers. Courses also in Civil, Electrical, Mechanical, Chemical, Aeronautical Engineering; Business Administration and Accounting. Low tuition, low living costs. World famous for technical two-year courses. Those who lack high school may make up work. Students from all parts of the world. Enter September, January, March, June. Write for catalog, 2577 College Ave., Angola, Ind.

## RADIO ENGINEERING,

broadcasting, aviation and police radio, servicing, marine radio telegraphy and telephony, Morse telegraphy and railway accounting taught thoroughly. Engineering course of nine months' duration equivalent to three years of college radio work. All expenses low. Catalog free. School established 1874. Dodge's Institute, Turner St., Valparaiso, Ind.

### RADIO COURSES

**RADIO OPERATING:** Prepare for Gov't License Exam. ● **RADIO SERVICING:** Including Short Wave ● **AMATEUR CODE** ● **ELECTRONICS** ● **TELEVISION:** Day and Evening Classes. Booklet Upon Request.  
**New York YMCA Schools**  
6 W. 64th Street, New York City

## BE A RADIO SERVICE EXPERT

Modern receivers require men with modern training for service work

**LEARN AT HOME**

Our home instruction method and service equipment offer starts you earning money almost at once. Up to \$3 an hour easy in a short time. Write for free book.

**Radio Training Ass'n of America**  
Dept. SWT-77  
4525 Ravenswood Ave., Chicago

## RADIO ENGINEERING

RCA Institutes offer an intensive course of high standard embracing all phases of Radio. Practical training with modern equipment at New York and Chicago schools. Also specialized courses and Home Study Courses under "No obligation" plan. Catalog Dept. SW-37.

### RCA INSTITUTES, Inc.

75 Varck St., New York, 1154 Merchandise Mart, Chicago  
Recognized Standard in Radio Instruction Since 1909

Get into **RADIO** REAL JOBS REAL PAY

Earn While Learning at Home! TELEVISION, PHOTO ELECTRIC CELLS PUBLIC ADDRESS

Many R-T-I Trained Men make up to \$75 a week and more in full-time radio jobs—\$5-\$15 in spare time along. More trained men needed. Learn at home by quick, easy, R-T-I WAY. Endorsed by 50 big concerns. Write for Big Opportunity Book, FREE.

**RADIO AND TELEVISION INSTITUTE, Inc.**  
2130 Lawrence Ave., Dept. 21-B, CHICAGO, ILL.

PHILCO  
GROSCLO  
GRUNOW  
ZENITH  
and 46 other mfrs. endorse R-T-I

Please mention SHORT WAVE & TELEVISION when writing advertisers

# RADIO INSTRUCTION

## Let's "Listen In" with Joe Miller

(Continued from page 128)

in one Saturday at 3:30 p.m. with a fair signal, though marked by bad CW QRM. This station can be logged without much difficulty if one has a well-calibrated dial. Nevertheless, this station—operated by the Radio Club Tenerife—is considered a difficult station to log, chiefly due to the almost impossible CW QRM situation prevailing on that frequency, requiring a very selective receiver to enable good reception to be had.

EA8AB maintains a schedule of 3:15 to 4:15 p.m., operating on Monday, Wednesday, Friday and Saturday, and sends a very attractive QSL card, as shown in our first article. This station will again be heard fine when Fall rolls around.

EAJ43, 10.37 mc., also Tenerife, is becoming a standby signal, and can be depended upon any evening it is tuned for. The best signal is between 6 and 9 p.m. although they seem to operate later upon occasion, so that a definite schedule can not be depended upon. EAJ43 sends an attractive card with some photo of native scenes from the Canary Islands. Both EAJ43 and EA8AB are classed as Africans and both may be reached by addressing reports to the Radio Club Tenerife, P. O. Box 225, Tenerife, Canary Islands.

### French Indo-China

Radio Saigon, which was heard early in the month on approximately 11.70 mc., maintains a schedule of from about 5 to 9:30 a.m. daily and Ashley Walcott now reports it on exactly 11.705 mc. The station announces as "Ici Station Roy-Landry, Rue Catinat, Saigon." This is undoubtedly last summer's "Phileo Radio." This is another Asiatic to be looked for next Fall and Winter, having now faded out.

FZS, 18.388 mc., Saigon, is reported phoning irregularly from 5:20 to 6 a.m. by Ashley Walcott. This station has a peculiar carrier which may help to identify it, the signal having a very rapid "flutter."

FZR, 16.25 mc., also Saigon, has been reported at the very early hour of 5:30 a.m. phoning FTK, 15.88 mc., both poor signals. FZR usually maintains schedule with FTK near 8:30 a.m. but is often heard earlier. This is a good bet as FZR generally has a very strong signal for such a distant station.

### Miscellaneous

Some late specials here are ZTJ, 6.0975 mc., Johannesburg, still being heard between 12 and 12:45 a.m. but with a poor signal, high noise level making it impossible to get a good log.

KZGG, 6.98 mc., Cebu, Philippine Islands has been logged at 4:10 a.m. thanks to Ashley Walcott's tip. Ashley has received a veri stating KZGG has 400 watts and uses frequencies of 7.83, 6.98, 5.21, and 4.345 mc., but that 6.98 mc. is the usual frequency for service with Manila, to which their antenna is directed. Working schedules are 6:30 to 11:15 p.m. and 1 to 4:15 a.m. KZGG occasionally works on 7.83 mc. and is heard daily except Sunday at about 4:10 a.m. by Mr. Walcott. QRA: Mr. A. D. Sison, Radiophone Station Supervisor, Philippine Long Distance Telephone Company, Cebu, Philippine Islands. Tnx for this FB tip, OM.

CR6AA, 9.666 mc., at Lobito, Angola, Portuguese West Africa, has verified our report of February 13 when they were heard with signal ranging up to an R6 to 7. This is the third veri we have received from this ace catch and we now have both frequencies verified, including 7.177 mc.



## CANDLER Training Will Do the Same for YOU!

As you read these words you don't concentrate on each individual letter. At a glance you grasp several words—faster than anyone can write them. The same is true when you talk. Without thinking of separate letters, you talk whole words. The CANDLER system will teach you to read and send code with the same ease and speed. It's very interesting. Just a matter of practicing the right way. Ask any skilled operator about the CANDLER system. Thousands of them, including Champion McElroy, owe their speed to CANDLER training. A few days of practice under CANDLER instruction is worth months of undirected effort. Get started right. The only difference between you and a skilled operator is the coupon below. Mail it today! Walter Candler will do the rest!

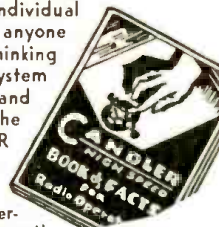

**CANDLER SYSTEM COMPANY**  
Department S-7  
ASHEVILLE, N. C.

CANDLER SYSTEM CO.  
Dept. S-7 Asheville, North Carolina.  
Please send me FREE Book of Facts.

Name .....

Address .....

City .....

State .....

### HAM STARDUST Africans

FT4AG logged at 4:45 p.m. on 14330 with a very good R8 to 9 signal. This one at Tunis. SU1SG, Egypt, also logged with a FB signal. SU5NK, 14310, logged at 5:40 p.m., announcing "SU5 Norway Kilowatt."

CN8MB, 14122, logged at 4:25 p.m. announcing as "CN8 Mexico Boston." ZS6-AJ, 14020, logged at 11:40 p.m.

Africans still coming through very well on the West Coast with the following being logged by Ashley Walcott: ZS2N, 14080; ZS2X, 14050 and 14365; ZS6AJ, 14020; and ZU6P, 14075. Also ZE1JF, 14070; ZE1JR, 14044; and 14255. That is all on the Africans here, the Asiatic hams taking the spotlight this month.

EA8AF, 14127, Canary Islands, logged at 11:10 p.m.

### Asiatics

PK1MX, 14090, Java, announcing as "Mexico, Xray" was logged at 7:35 a.m. giving a good clear signal. Many other Asiatics are reported, mainly by listeners out westward. Ashley Walcott out on the West Coast hears 'em as we hear the Europeans here, and reports a mess of them, as follows: KA1AN, 14070; KA1AP, 14218; KA1DL, 14040; KA1ER, 14050 and 14320; KA1KY, 14240; KA1MD, 14180; KA1RB, 14140; KA1YL, 14170; XU8HW, 14060; XU8MT, 14010. XU8HW has been reported by quite a number of DXers, including Irv Goodeve, Carlos Irizarry, Pedro Rodriguez and John DeMyer. XU8HW also reported on 14310.

Also reported are VS2AK, 14080; VS2-AO, 14180; PK1BX, PK1VY, PK1GL, all on 14260 and PK2VD on 14265. Also PK1-VH, 14330; PK1VM, 14090; PK1ZZ, 14280; PK3GD, 14030; PK3LC, 14010; PK3ST, 14310; PK3WI, 14040; PK4DG, 14380; PK6-AJ, 14100; PK6CI, 14080; XU3GG, 14200.

In Ceylon, John DeMyer reports VS7RA. Irv Goodeve reports VSTAK, on approximately 14000 at 1:20 a.m. Also reported by Carlos Irizarry are PK3TW, PK4JD, PK6CJ, VS6AS, KA1MG; frequencies not stated on these.

Others reported lately are OH3NP, YM4AA, and ZL2LC heard near 14090 at 7:20 a.m., and ZL2LO at 7:32 a.m., frequencies of last not given.

### T. R. McElROY

WORLD'S CHAMPION RADIO TELEGRAPHER  
175 Congress Street, Boston, Mass.

MAC KEY @ \$7.95 a real speed key.  
MAC KEY DELUXE @ \$15.00 Spfn.  
MAC CORD @ \$1.00 Spfn speed key cord.  
MAC CASE @ \$3.95 Sofn speed key case.  
MAC OSC @ \$3.95 ac/dc oscillator. Tone control  
If u hv Mac Key wrt me for xmy ipt & drsb ifn.  
All my stuff emcy gad best pduts obl. 73 Mac.

## LEARN CODE RIGHT

Tapes for Every Need—  
Even Airways—Send  
you Typical Messages by  
**INSTRUCTOGRAPH**

It's easy and practical to learn or improve your Radio or Morse Code, any speed, senior model with 10 tapes and Book of Instructions—\$20.25. (rented at low cost.) Junior model with 5 tapes and Book of Instructions—\$12.00. (Not rented.) Complete oscillator equipment, less battery, \$3.20. Send for details today to—



INSTRUCTOGRAPH CO., Dept. SW-7  
912 Lakeside Place  
Chicago.

Canadian Representative: Radio College of Canada, 663 Bay St., Toronto

WE ALSO HANDLE: HALLICRAFTER and R.M.E. SHORT-WAVE RECEIVERS—MICROPHONES—VIBROPLEXES—TAYLOR TUBES. CASH OR TERMS.

## FREE BOOK of Opportunity

Instructive facts about  
**TELEVISION RADIO**  
SOUND RECORDING

Complete, practical instruction. Earn room and board while learning. Coach railroad fare allowed to Los Angeles.  
**NATIONAL SCHOOLS**

National Schools, Dept. 7-SWC,  
4000 So. Figueroa St., Los Angeles, Calif.

NAME .....

AGE .....

ADDRESS .....

CITY .....

STATE .....

Please mention SHORT WAVE & TELEVISION when writing advertisers

# THEN



## NOW

### C-D DYKANOL CAPACITORS

With the development of Dykanol in the laboratories of Cornell - Dubilier, previous manufacturing concepts of oil capacitors were completely changed. Not only was it possible through the use of this impregnating medium to reduce the weight and size of these capacitors by fully 60%, but also, to considerably increase the already high quality standard of C-D oil capacitors. For complete dependability standardize on C-D Dykanol capacitors. Utilized by leading manufacturers of radio equipment; U. S. Army, Navy, Signal Corps, and other government divisions; and wherever uninterrupted operation is essential. Today! Ask your local C-D authorized distributor to show you the salient features of these capacitors. Catalog No. 137A free on request.



## CORNELL-DUBILIER

### CORNELL-DUBILIER CORP.

1002 HAMILTON BOULEVARD - SO. PLAINFIELD, NEW JERSEY

### \$1.00 Tube Sale

A very fortunate purchase permits us to offer you these high grade radio tubes at extremely low prices. The figure following the number indicates the quantity of tubes that will be given for \$1.00. No order for less than \$1.00 will be accepted.

200A	4	1223	3	40	3	71A	12	85	4
801A	3	214	3	31	4	75	8	89	4
2A3	3	24A	4	42	6	70	8	X90	4
2A5	3	225S	3	43	3	77	11	112A	10
2A6	76	24	15	45	8	810G	8	610G	8
2A7	4	30	4	46	6	70	4	610G	8
2B7	3	31	4	47	3	80	4	6A8	4
323	81	32	4	48	3	82	4	6A8	4
6A7	3	33	3	49	3	83	4	6F5	3
6B7	3	34	3	50	3	84	3	6F6	3
6C6	3	35	4	51	3	85	3	6H6	3
6D6	3	36	4	55	6	182	3	6J7	3
6E5	2	37	3	56	5	183	3	6K7	3
6F7	4	38	3	58	4	484	4	6Z4	3
210	3	38	3	58	4	485	4	6L6	3
12A7	3	3044	4	59	4	484	4	5Y3G	3

### New 1937 Hum Free Power Supply Pack

This pack will supply 2 1/2 or 6.3 filament V. (please specify) up to 8 tubes. Supplies tube certified by C.D. volt. 350 volts at 80 mA. 6 A.M.S. filament. B.C. supply tapped at 45, 90, 180, and 250. Well filtered; extra heavy chassis. Complete kit with wiring diagram and drilled chassis. Less tubes, wired—50 extra. Tube—rectifier tube—40 extra.—Shipping weight 27 lbs.—\$3.49. Note: This power supply has drilled chassis and can be easily converted into a 15 Watt amplifier with our kit of essential parts. Diagram 25c extra. Kit of parts—\$9.40 extra. Kit of tubes for Amplifier—\$4.77 extra—AD-201A.

### 5 BAND ALL WAVE COIL SUPER-NET KIT

5 Band All Wave Tuning Assembly 42,000 K.C. to 550 K.C. (7 to 600 meters). Completely assembled and wired. Complete switch, an all wave Super-Het. YAKLEY sinkle knob hand switch. Genuine MEISSNER coils. Unit completely wired with all connections soldered; CD mica condensers, etc. Can be installed in your present receiver by connecting grid and plates of 5 tubes. Size of unit 8"x8"x2 1/2". AM0606—tuning unit assembled and wired. Reg. \$12.95. OUR Price—\$4.95. Complete instructions and diagrams. Extra—25c. This unit can be made into an 8 or 10 tube set. Kit of all essential parts for 8 tube set—\$9.95. Kit of tubes \$6.23. Kit of parts—10 tube set \$11.96. Kit of tubes \$8.35. Less speaker, chassis and dial. Mica eye tuning unit \$1.00 extra. Mica eye tube 90c extra. I.F. Double air tuned Ferro iron core. 456-485 K.C. I.F. transformers. Reg. \$4.00. AD-111—Special 90c. SAVE DOLLARS Send for Our Spring Catalog Check Full of Red Hot Money Saving Items at Less Than Mfgs. Cost.

### United Radio Co.,

58 Market St., Dept. S-7 Newark, N. J.

### CORWICO NOISE MASTER ALL-WAVE ANTENNA

On broadcast as well as shortwave frequencies, in any location, you can eliminate "man-made" static with CORWICO NOISE MASTER ALL-WAVE ANTENNA. Send for complete literature. CORWICO WIRE CO., 30 CHURCH STREET, NEW YORK CITY

In the Azores CT2AB, 14346 was heard at 4:35 p.m. SM7YA, logged on 14050 at 10:45 p.m. announcing as SM7 Yokohama, America. Also VP1AA heard twice on 14125 at 11:50 p.m. and 12:40 a.m.; also by Dick Hofsaes at 1 a.m. VP1AA is listed in the call-book as in British Honduras, but the signal heard was undoubtedly from a great distance and we believe it to be located in Zanzibar, as, after hearing VP1AA, we heard a Canadian amateur call excitedly, "Hello, VP1AA, Zanzibar," repeatedly. We have a report that a well known eastern DXer has received a QSL from VP1AA. from Zanzibar, SM5-SV, 14000, also logged at 6:15 p.m. with a "FB" signal.

In Australia, outstanding catches are VK7YL, 14065 at 4 a.m., VK7JB, 14090, and VK6FL, 14330 at 4:50 a.m.

Late specials from Roy Myers are J2MI, 14290, Japan, heard daily 3 to 4 a.m. Roy says this amateur announces in a high-pitched voice, poor modulation, as J-Japan, No. 2. M-Mexico, I-India. Also J2KJ, from 2 to 4 a.m., same frequency as VK2AB, with good modulation.

All these Asiatics mentioned, with one or two exceptions, have been logged between 5:30 and 8 a.m. here and on the West Coast from 6 to 10:30 a.m. On the West Coast, Africa is usually heard 9 to 11 a.m. and around midnight. Africans are generally heard between 4 and 6 p.m.; Australians between 5:30 and 7 a.m.

Murray Buitkant, 3020 Coney Island Ave., Brooklyn, N.Y., would like to exchange QSL cards with any DXers.

### VAC Listing

Beginning this month and hereafter, we will endeavor to list all DXers records of total verifications from each continent (VAC) and total countries verified, all of this, of course, on phone. Here is a partial listing of DXers who have 5 VAC or better. Any DXer with 5 verifications or more from each continent may have his DX record published here every month so we urge all eligibles to send us their rating on a post-card by the 20th of each month direct to our address. The ratings follow:

John DeMyer	36 VAC	96 countries
Eddie Schmeichel	33 VAC	85 countries
Charlie Miller	23 VAC	63 countries
Pierre Portman	21 VC	76 countries
Roy Myers	17 VAC	86 countries
Russ Ballard	12 VAC	61 countries
Irving Goodeve	10 VAC	61 countries
Ralph Gozen	6 VAC	62 countries
Ashley Walcott	5 VAC	62 countries
Ed Goss	5 VAC	59 countries
Pedro Rodriguez	5 VAC	58 countries

### FLASH!

Station SUI5G, Alexandria, Egypt, on 14,000 kc. will send a special broadcast on June 25th, at 7 p.m. E.S.T. The broadcast will be for a half-hour and will open with the chimes of a clock recording 2 a.m. Egyptian time. All reports will be verified with a handsome QSL card. It should be accompanied by a reply coupon.

This has been arranged by Joe Miller, our DX Editor, and is for the benefit of SHORT WAVE & TELEVISION MAGAZINE and the I. D. A. We urge all listeners to try for this station. It comes in with very good signal strength! The address is: Frank H. Penrit, Catholic Club Mustapha Baracks, Alexandria, Egypt.

## Short Waves and Long Waves

(Continued from page 134)

### "Ham & Fan Band-Spread 2" Hot Stuff!

Editor, SHORT WAVE & TELEVISION: I built your receiver called the "Ham and Fan Band-Spread-2" described in the Dec. issue of Short Wave Craft and wish to report some of the results I have had with it.

On the 75-meter phone band I have received every district in the United States and a few in Canada and South America. On the 49-meter broadcast I have received these stations: COCO Havana, Cuba; W8XK Pittsburgh, Pa.; W8XAL Cincinnati, O.; W9XF Chicago, Ill.; CRCX Toronto, Can.; W8XAU Newtown Square, Pa.; W3XAL Bound Brook, N.J.; COCD Havana, Cuba. Bob Westphal, 6422 LaMiroda, Ave. Los Angeles, Calif.

# SHORT-WAVE BOOKS with a WORLD-WIDE REPUTATION!

#### HOW TO BUILD AND OPERATE SHORT-WAVE RECEIVERS

This is the most up-to-date book on the subject—edited and prepared by the editors of SHORT WAVE AND TELEVISION. It contains a complete list of not only of typical short-wave receivers, but short-wave converters as well. 150 Illustrations. 72 Pages. 50c

#### HOW TO GET BEST SHORT-WAVE RECEPTION

This book tells you everything you have ever wanted to know about short-wave reception. The author, a professional radio listener and radio fan for many years, gives you his long experience in radio reception and all that goes with it. 40 Illustrations. 72 Pages. 50c

#### HOW TO BECOME AN AMATEUR RADIO OPERATOR

By Lieut. Myron F. Eddy, whose experience in the amateur field has made him pre-eminent in this line. Licensed phone operator. If you wish to take up radio work eventually—this is the book you must get. 150 Illustrations. 72 Pages. 50c

#### TEN MOST POPULAR SHORT-WAVE RECEIVERS

—HOW TO MAKE AND WORK THEM—THE EDITORS OF SHORT WAVE AND TELEVISION describe ten outstanding short-wave receivers. Each receiver is fully illustrated with a complete layout, pictorial representation, photograph, and complete hook-up and strength-while-50c. 75 Illustrations. 40 Pages. 25c

#### THE SHORT-WAVE BEGINNER'S BOOK

Here is a book that solves your short wave problems from the simplest fundamentals to the present stage of the art as it is known today. It is the only low-priced reference book on short waves for the beginner. 75 Illustrations. 40 Pages. 25c

#### 101 SHORT-WAVE HOOK-UPS

Here is a worthwhile book that every short-wave listener, every short-wave fan, and every amateur needs. It gives you the 101 best short-wave hook-ups which have appeared heretofore. 100 Illustrations. 72 Pages. 50c

#### SHORT WAVE & TELEVISION

99-101 HUDSON ST., NEW YORK, N. Y.

For the amount of \$... for which you are to send me, postpaid, the books checked below.

- How to Get Best Short-Wave Reception.....50c each
- 101 Short-Wave Hook-Ups.....50c each
- How to Build and Operate Short-Wave Receivers.....50c each
- How to Become an Amateur Radio Operator.....50c each
- Ten Most Popular Short-Wave Receivers, How to Make and Work Them.....25c each
- The Short Wave Beginner's Book.....25c each

Name.....

Address.....

City (State in form of check or money order. If letter contains cash or unused U. S. postage stamps, register it).....

Please mention SHORT WAVE & TELEVISION when writing advertisers

# Real "DX" on Low Power?

(Continued from page 125)

110 volt lead to the transmitter was brought near the receiver there was quite a bad modulation of signals. To cure this the transmitter on and off switch for the filaments was placed on the rear of the shelf in the back, necessitating a separate 110 volt lead for the 2.5 volt filament transformer.

## Antenna Should Be Tuned!

The antenna tuning unit is connected to the receiver by a twisted-pair link of low loss hookup wire and to the transmitter by a link of two No. 16 wires spaced about 1/4 inch apart, spaced with small drilled hard-rubber blocks. The wire used for the receiver "link" should be of small diameter to keep down capacity loss.

Series tuning is always used here in tuning the antenna, and the antenna tuning condensers are mounted with hard-rubber to a wooden piece screwed to the back of the table. The antenna coil is held by two glass towel-bars. The link coil to the switch is slipped into the antenna coil, and when the correct setting has been found, cemented to the coil. Cementing the links to the coils is necessary to save time in changing bands, which operation would otherwise be quite arduous; as it is only five units have to be changed. To get the correct setting of the links, the antenna should be tuned to the receiver and the coupling adjusted at either the receiver or the antenna coil link—or both—to give the best volume with good selectivity.

The antennas used in this case are three in number. They are of No. 16 enameled copper wire. For 20 meters, two 99 feet laid out according to a great-circle chart are used; for ten meters a vertical, consisting of two half waves stacked to give better low-angle radiation. A half-wave stub is used and the antenna fed at the lower end. A single 16 foot vertical could be used for ten, and two 33 foot antennas for twenty. This latter arrangement is not nearly so good as the first. The series tuning condensers of the antenna tuning unit are equipped with jacks and the twenty meter feeder section and the ten-meter feeder plugged in, depending on the band being used. The ten-meter feed is the conventional Zepp arrangement, but for twenty a combination Zepp and end-feed aerial is used. Instead of bringing the two antennas down to a tank coupled to the transmitter plate coil, they each terminate at a single-pole single-throw switch mounted on a 3/4 by 1 1/4 piece, supported by the moulding of the room. From the two S.P.S.T. switches mounted 6 inches apart on the supporting piece, 16 feet of Zepp feeder are brought down to the series tuning condensers. If the feeders dangle, pin them up! This allows either antenna to be switched in in twenty seconds from the operator's chair, and as both are of the same electrical length no retuning is necessary. Note: One 33 foot antenna can be used, if there is not enough space in a given direction for 99 feet.

## Transmitter Tricks

The transmitter is a 59 tritet—59 cathode bias regeneration doubler and push-pull tens "final," with about 90 watts input. Extremely low C is used, the kind envisaged when the case calls for push-pull Eimacs at 4000 volts in the doubler and final. In the xtal oscillator one need not be so particular, except with ten-meter operation. One thing of note—it was found that a switch had to be inserted in the plate leads of the oscillator and doubler in conjunction with the xtal oscillator switch in the B— of the 59's. If both B— and B+ leads were not cut, it produced an increase in the background noise of the receiver. This is due to oxide from the filaments getting on the other electrodes in the tube and making little cathodes of them. Plate voltage applied seemed to cause a queer kind of tiny oscillations. Talking of hum again—with the 110 volt plug out of the socket, the operation of the receiver should be noted. If you still hear additional noises with the 59 filaments lighted things should get a good going over. In this case it was found necessary to suspend the 59 filament transformer on rubber bands, to keep its vibration to itself. The rest of the transformers in the set are on only when sending, and the transmitter could jump up and down on the table if it wanted to.

On this simple "rig" WAC has been accomplished five times in two months on 20 meters; also 4 continents have been worked on ten meters in about a month and a half. In conclusion we would like to say that attention to details really does pay!

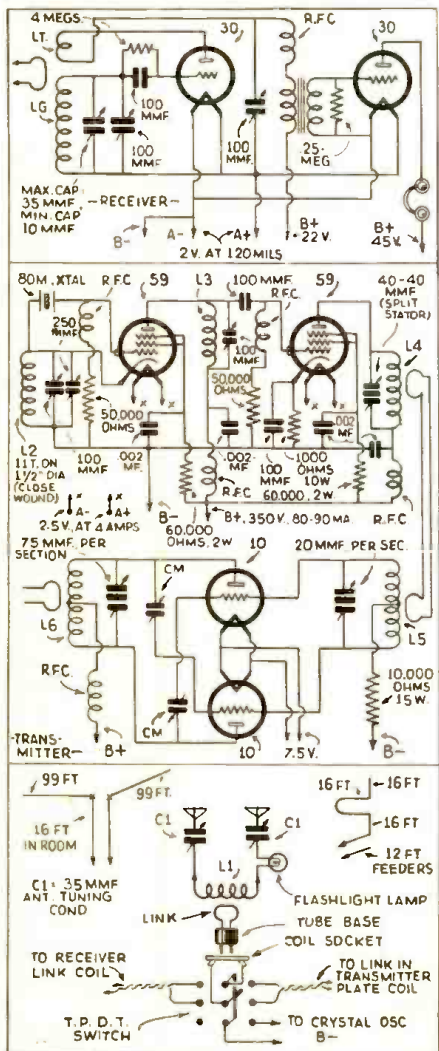

Hook-up of 2-Tube Receiver, also Transmitter diagram.



# Amazingly Easy Way to Get into ELECTRICITY

Send Today for Details of "Pay-After-Graduation" Plan

Don't spend your life never sure of a job. Let us prepare you for your start in a good paying field. Let us teach you how to prepare for positions that lead to good salaries in Electricity—NOT by correspondence, but by an amazing way we teach right here in the great Coyne Shops. You get a practical training in 90 days. Mail the coupon below. If you are short of money I'll send you all details of my "pay-after-graduation plan" where many get my training first and start paying for it 5 months after they start school and then have 18 months to complete their payments.

## LEARN BY DOING—IN 90 DAYS BY ACTUAL WORK IN THE GREAT COYNE SHOPS

I don't care if you don't know an armature from an air brake—I don't expect you to! Coyne training is practical "learn-by-doing" training. Don't let lack of money hold you back from getting all details of my amazing plan.

## MANY EARN WHILE LEARNING

If you need part time work to help pay your expenses, we may be able to help you as we have hundreds of others. When you graduate we'll give you lifetime employment service. And, in 12 brief weeks, in the great shops of Coyne, we train you as you never dreamed you could be trained... on one of the greatest outlays of electrical apparatus ever assembled... real dynamos, engines, power plants, autos, switchboards, housewiring, armature winding and many other branches of Electricity.

## Electric Refrigeration Air Conditioning

Right now we are including additional instruction in Electric Refrigeration and Air Conditioning without extra cost so that your training will be complete and you can get into this marvelous, rapidly expanding field.

**GET THE FACTS** Coyne is your great chance to get into Electricity. This school is 38 years old—Coyne training is tested. You can find out everything absolutely free. Simply mail the coupon and let us send you the big, free Coyne book with photographs... facts... opportunities. Tells you how many earn expenses while training and how we assist our graduates in the field. No obligation to you. So act at once. Just mail coupon.

**BIG FREE BOOK**  
Send for my big book containing photographs and telling the complete story—absolutely FREE.  
H. C. Lewis

## COYNE ELECTRICAL SCHOOL

500 S. PAULINA ST., Dept. B7-83, CHICAGO, ILL.

H. C. Lewis, Pres., COYNE ELECTRICAL SCHOOL  
500 S. Paulina Street, Dept. B7-83, Chicago, Ill.

Dear Mr. Lewis: Without obligation send me your big, free catalog with facts about Coyne Training and details of your "Pay-Tuition-After-Graduation" Plan.

Name.....Age.....  
Address.....  
City.....State.....

COIL DATA				
Receiver				
10	20			
Grid—2 1/2 T.	5 3/3 T.			} No. 30 dec.
Tieker—2 1/2 T.	3 T.			
For other coil data refer to the Feb., 1937, Question Box.				
Transmitter				
10 Meters				
Coil	No.	Diameter	Length	Size wire
L3	9	1 1/4"	1 1/4"	No. 14 en.
L4	6	1 1/4"	2 1/4"	No. 14 en.
L5	8	1 1/4"	2 1/4"	No. 14 en.
L6	6	2"	2 3/4"	No. 8 en.
L1	8	2"	2 3/4"	1/8" copper tube
20 Meters				
L3	10	1 1/4"	1 1/4"	No. 18 dec.
L4	11	1 1/2"	1 1/2"	No. 18 dec.
L5	14	1 1/2"	1 1/2"	No. 18 dec.
L6	12	2"	2 3/4"	No. 8 en.
L1	20	2 3/4"	7 1/2"	3/8" copper tube

Please mention SHORT WAVE & TELEVISION when writing advertisers

**SUCCESSFUL** in  
**PERFORMANCE.. DESIGN..**  
**CONSTRUCTION.. SALES..**  
*say leading P.R. men*

**AMPERITE VELOCITY**  
**ACHIEVES**  
**UNIQUE RECORD**  
**IN ACTUAL USE**



*Featuring..*

1. Output increased 6 DB.
2. Triple shielded—against all RF or magnetic fields, entirely eliminating hum pickup.
3. Eliminates feedback troubles.
4. Excellent for close talking and distant pickup.
5. Acoustically designed to eliminate any possibility of cavity resonance.
6. Fitted with switch and cable clamp.

NEW MODELS RBHn (High Impedance): RBMn (200 ohms), with Cable Connector and Switch

**\$42.00 LIST**  
 NEW MODELS RBSn, RSHn, streamline, slightly lower output and frequency range than above, with switch only

**\$32.00 LIST**  
 Models RAL (200 ohms): RAH (2000 ohms). Built to Ampere standards: No peaks. Flat response. Triple shielded. Shock absorber. Swivel bracket.

**\$22.00 LIST**  
 Finishes: All microphones have the new standard Gunmetal Finish. Available in Chrome, extra, \$1.00 List.

**FREE WINDOW DECAL**, advertising your SOUND SERVICE. Four-color design. 5/4 x 9/4. Write for it now.

Cable Address: Altem, New York  
**AMPERITE Co.** 561 BROADWAY NEW YORK

**AMPERITE** Velocity **MICROPHONE**

**STOPPANI COMPASS**

A Precision Instrument made in Belgium. Purchased by the U. S. Government at more than \$30.00 each. Ideal for Radio Experimenters Laboratory, also may be used as a Galvanometer for detecting electric currents in radio circuits. Ruby, jeweled, solid bronze, 4 inches square, fitted in a hardwood case. Also used by hunters and surveyors.



Our price prepaid \$4.50 each

**GOLD SHIELD PRODUCTS**  
 99 Hudson St., 11th Floor  
 New York City

H. G. CISIN'S All-Wave Air Scout Jr. Radios  
**THREE-TUBE ALL ELECTRIC ALL WAVE SET** MODEL 3A-E **\$3.20**  
 WITH PHONE Less Unwired

A powerful sensitive all-wave set. Holds wonderful records for foreign reception. Also brings in police calls, amateur, code, transatlantic phone and broadcast entertainment. Excellent volume. Works from any A.C. or D.C. house current. Easiest set to build. Employs newest metal ballast tube. Speaker mounts on attractive panel. Range 9 1/2 to 610 meters or to 1500 meters with special long wave coil. Complete Kit includes: Earphone, broadcast coil, 70 to 240 meter coil, Panel (two styles available, pointed or rectangular top), Chassis, High Grade Variable Condenser, Potentiometer, Antenna Trimmer, Dial, Sockets, Knobs, Wire, Resistors, Condensers, and all other parts. Parts including instructions and diagram.

**\$3.20** With Phone (Less Unwired)  
**ONE-TUBE BATTERY SET—Model 1B.** Satisfied owners report **MARVELOUS FOREIGN RECEPTION.** Also other S.W. and broadcast reception same as model 3A-E. Earphone reception. Complete kit includes parts listed above plus 30 tube and filament rheostat. Uses inexpensive batteries.

**\$2.45** With Tube and Batteries  
**TWO-TUBE BATTERY SET—Model 2B.** Complete kit including all parts in the 1-tube model plus parts for extra audio stage including power tube.

**\$2.95** Phone (unwired)  
**THREE-TUBE DE LUXE BATTERY SET—Model 3B.** Complete kit including all parts in the 1-tube model plus parts for two extra audio stages including two 30-type tubes and 33 power output tube.  
 Following Auxiliary Parts are available: 9 1/2 to 20 meter coil 25c; 15 to 45 meter coil (foreign) 25c; 40 to 80 meter coil (foreign) 25c; 2 1/2 volt "B" battery 75c; Two flashlight "A" batteries 10c each; 5" Flnd-All Loud Speaker \$1; Complete Antenna Kit 50c; Wood Screw Kit 10c; Tubes for Model 3A-E, each 45c; Long Wave Unit and coil for any model \$1; Double Earphones \$1.30. Any model wired extra 75c.  
**NOTE:** If you already have earphones, two extra foreign coils may be substituted in any model.

H. G. CISIN, Chief Eng., ALLIED ENG. INSTITUTE  
 98 Park Place Dept. S-37 New York, N.Y.

**New "Television" Sign**

● The Times Square evening crowds in New York City have recently been entertained by a sign which represents a close approach to television. It was built by Douglas Leigh of New York City, and 2,000 incandescent lamps (50,000 watts), used in connection with a new method of rapid switching, permit the moving images or drawings to be flashed to the public.

This newest type animated sign, which so nearly approaches television, has created a very favorable impression. One of the reasons why this sign is an improvement over previous attempts at similar signs, is due to the fact that the switching method for lighting the desired lamps to reproduce a given drawing or sketch works so smoothly and quickly. This new idea was developed in Stockholm, Sweden. Some of the animated cartoons occupy, for example, an eight minute cycle and include such subjects as a horse that runs, kicks, jumps, dances, skates, etc. Also running signs that operate like a movie trailer.

This sign entertains and advertises simultaneously, and one of the new features is that it is no trouble to change "copy," and the sign may carry different "copy" continuously, extending from one minute to an hour or more of constant changes.

Our information bureau will gladly supply manufacturer's names and addresses of any items mentioned in SHORT WAVE & TELEVISION.

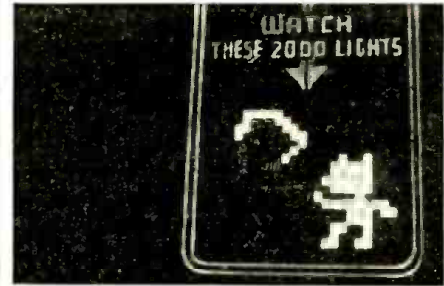

New sign in New York City resembles television.

**New Desk Stand Contest**

● THE new Amperite desk stand shown in the accompanying picture has been designed for both utility and beautiful appearance. It represents quite a radical departure from the usual type microphone stand.

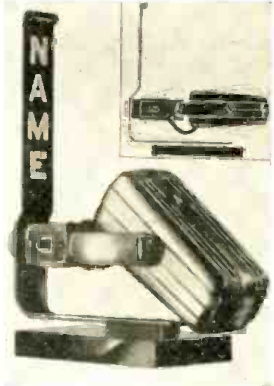

(No. 628)

By placing the microphone horizontally, the center of gravity is lower, thus making the stand unusually stable. The leaf spring suspension also acts as an excellent shock absorber; the microphone can be rotated into practically any position. Its horizontal position makes it excellent for pulpit, desk and foot-light installations. This handsome microphone stand is finished with a black base and a chrome-plated spring. An attractive feature is a name plate which can be provided, as shown, with any number of letters up to ten.

The Amperite Company offers a microphone and stand as first prize for the best name for the stand. Duplicate awards will be made in the case of a tie. Those who submit the ten next best names, in the opinion of the judges, will be awarded a microphone stand also.

The contest closes July 1st. The judges will be John Rider, of Rider's Manual and Joseph Kaufman, Director of Education, National Radio Institute.

**Get These FREE!**  
**Books**

Now you have the opportunity to add one or two new, absolutely FREE books to your library. A subscription to SHORT WAVE & TELEVISION for seven months at the sensationally small cost of One Dollar brings to you your choice of two books as illustrated and described below. For Two Dollars you will receive SHORT WAVE & TELEVISION for fourteen months and BOTH books sent to you absolutely FREE. UNDER NO CONDITIONS CAN EITHER OF THESE BOOKS BE PURCHASED. ANOTHER SAVING FOR YOU—THE PUBLISHERS' PAY POSTAGE ON THE BOOK OR BOOKS YOU CHOOSE.



**ABC OF TELEVISION**  
 This book contains only the latest material available on Television. It is written by a well-known radio authority.

**Partial Contents of ABC of Television:**  
 The simplest television receiving: how the eye sees—Theory of scanning: the Nipkow disc and its relation to television: the photo-electric cell: neon lamps: brief description of several modern mechanical systems—Need for a large number of picture elements: need for broad channel width in transmission of high-fidelity television signals—The use of the cathode ray tube in television receivers: necessary associated equipment used in cathode-ray systems—How a television station looks and operates—The Iconoscope as used for television transmission in the ICA system—The Farnsworth system of television transmission—The future of television.

**64 PAGES—100 ILLUSTRATIONS. Stiff, Flexible Covers, 5 1/4 x 8 1/4 INCHES**

**SHORT WAVE GUIDE**  
 It is an excellent book—recommended by short-wave enthusiasts everywhere.

**Partial Contents of Short Wave Guide:**  
 SHORT-WAVE QUESTIONS AND ANSWERS—SHORT-WAVE LINKS, ILLUSTRATED—HOW TO BUILD SIMPLE SHORT-WAVE RECEIVERS WHICH IN THE BEST TYPE OF AERIAL TO USE—A SIMPLE "HAM" TRANSMITTER—All the details, including list of parts, wiring diagrams and constructional details in building a simple "ham" transmitter will be found in this book.—PRACTICAL HINTS ON SHORT-WAVE TUNING.

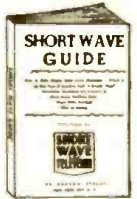

**64 PAGES—196 ILLUSTRATIONS. Stiff, Flexible Covers, 5 1/4 x 8 1/4 INCHES**

**ADD THESE BOOKS TO YOUR LIBRARY**

When you subscribe to SHORT WAVE & TELEVISION, you get these books FREE. If you already are a subscriber, and you send for these books, your present subscription will be extended for another seven or fourteen months.

**SHORT WAVE & TELEVISION**

99 G Hudson Street, New York, N. Y.

**SHORT WAVE & TELEVISION**, 7-37  
 99 G HUDSON STREET, NEW YORK, N. Y.  
 Gentlemen: Enclosed find my remittance of One Dollar (Canada and Foreign \$1.50) for which enter my subscription to SHORT WAVE & TELEVISION for seven months. You are also to send me ABSOLUTELY FREE and POSTPAID the book indicated by (X) below.  
 ABC OF TELEVISION  New Subscriber  
 SHORT WAVE GUIDE  Old Subscriber  
 (Two Dollars is enclosed. Send SHORT WAVE & TELEVISION for seven months and send me BOTH BOOKS ABSOLUTELY FREE. (Canadian and Foreign \$2.60)

Name .....

Address .....

City .....

State .....

Send remittance in form of check, money order or unused U.S. Postage Stamps. (Foreign: International Postal Money Order.) Register letter if you send cash.

**WESTINGHOUSE POWER GENERATOR**

Manufactured for U. S. Signal Corps  
**A.C. Electrical 200 Watt 110 V. AC Power**

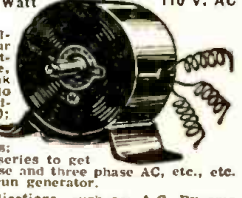

from a Windmill, from available Waterpower, from your Automobile, from your Motorcycle, from your Bicycle, Foot-pedals or Handcrank (for transportable Radio Transmitters, Strong Floodlights, Advertising Signs); do you want to operate AC Radio sets from 32 V. DC farm light systems; operate two generators in series to get 200 V. AC; obtain two phase and three phase AC, etc., etc. 1/4 to 1 1/2 H.P. needed to run generator.

There are Over 25 Applications, such as: A.C. Dynamo Light from eight to ten 20 Watt 110 Volt lamps, Short Wave Transmitter supplying 110 Volts A.C. for operating "Ham" Transmitter, Operating 110 V. AC 60 Cycle Radio Receiver in DC districts, Motor Generator, Public Address Systems, Electric Sirens on motor boats, yachts, etc. Camp Light, etc., etc.

Blueprint 22x28 in. and Four-Page 8 1/2 x 12 in. Instruction Sheets, Generator, as described including four replacement carbon brushes. Shipping weight 18 lbs. **\$7.90**

We will forward Shipments by Express Collect if sufficient postage is not included.

**WELLWORTH TRADING CO.**

560 W. Washington Blvd., Dept. SWT-737, Chicago, Ill.

The only magazine of its kind in the world! See page 150.

Please mention SHORT WAVE & TELEVISION when writing advertisers

# SHORT WAVE SCOUTS

## New "Continent" Scout Trophy Contest



● MANY of our readers have suggested that we offer a new type of contest for the Short-Wave Scout Silver Trophy. We have therefore decided to begin a new series of contests and you can start "listening in," and writing for veris at once.

This new series of contests will be confined to reception from stations on one continent at a time. The first of these contests will be for the greatest number of verified stations heard in Asia. You may "listen in" from now until Aug. 25th, but you will have to allow time for veris to reach you.

The same general rules as given previously apply. That is, a notarized affidavit must be sent with the veri cards and, of course, all of the veris will have to be for the continent assigned for each particular contest. The Asia "listening in" contest will close Aug. 25th, and the trophy award will be announced in the November number which goes on the newsstands October 1st.

A—By midnight August 25th, all entries for the Asia contest must therefore be in the hands of the Editors, together with veris and the notarized oath that the contestant personally listened to all of the stations listed.

B—For the next three issues, the August, September and October numbers, trophies will be awarded on the basis of the old rules, which require that 50% of the stations heard and verified must be foreign, and also that the listening time may be any 30-day period. In either contest, and in the event of a tie between two or more contestants, each listing the same number of stations, the judges will award a similar trophy to each contestant so tying.

C—Bear in mind that the veri cards should be absolute verifications, and not simply an acknowledgment that you notified a station that you heard them. Several stations do not verify, but simply send an acknowledgment card. Note that in either contest that only experimental phone or broadcast stations should be entered in your list. No amateur transmitters or commercial code stations can be entered. For the Aug. Sept. and Oct. contests, which follow our regular rules, the entries must be in the Editors' hands by midnight of the 25th day of the month for the next succeeding issue. The contest for the Aug. issue will close in New York City, June 24th, etc.

D—Please note once more, that only letters or cards which specifically verify reception of a given station on a given wavelength and on a given date will be accepted! Don't forget to send International Postal Reply Coupon, costing 9 cents at your P.O. with requests for foreign veris.

E—Any type of short or all-wave receiver may be used by the listener. Please specify type and make of set, how many tubes, type of aerial and its dimensions in a brief statement accompanying the veri cards. All veri cards will be returned prepaid after judging each contest. The judges in each contest will be the Editors of *Short Wave & Television* and the opinions of the judges will be final.

F—When sending in entries, type your list, or write in ink, and give the total number of stations both Foreign and Domestic. Send veri cards with your letter and oath certificate all in one package. Use a single line for each station and list them in a regular order, such as: frequency, schedule. (All time should be reduced to E.S.T., which is five hours behind Greenwich Meridian Time.) Name of station, city, country; musical identification signal if any.

● ON this page is illustrated the handsome trophy which was designed by one of New York's leading silversmiths. It is made of metal throughout, except the base, which is made of handsome black Bakelite. The metal itself is quadruple silver-plated, in the usual manner of all trophies today.

It is a most imposing piece of work, and stands from tip to base 22½". The diameter of the base is 7¾". The diameter of the globe is 5¼". The work throughout is first-class, and no money has been spared in its execution. It will enhance any home, and will be admired by everyone who sees it.

The trophy will be awarded every month, and the winner will be announced in the following issue of *SHORT WAVE & TELEVISION*. The winner's name will be hand engraved on the trophy.

The purpose of this contest is to advance the art of radio by "logging" as many short-wave phone stations, amateurs excluded, in a period not exceeding 30 days, as possible by any one contestant. The trophy will be awarded to that *SHORT WAVE SCOUT* who has logged the greatest number of short-wave stations during any 30-day period.

### No Entries This Month!

Come on fellows, what's wrong? This is the first time in many months that we have failed to receive an entry for the Short-Wave Scout Trophy! Read the simple rules which explain how easy it is to win one of these handsome "silver trophies" which stand nearly 2 feet high!—Editor.

### Notice To Trophy Contestants

● The closing date for the Asia contest announced in the May issue, has been advanced from June 25th to August 25th, in order to provide sufficient time for the veris to reach the contestants from Asiatic stations. Note: We are also including in the Asia group, short-wave stations in the Philippines and the East Indies.

The group for which entries must be in the Editor's hands by September 25th are Australia, Africa and Oceania.

## TWO SIZZLING HAM SPECIALS



2A3H Heater-type Triode Power Amplifier made by a nationally known manufacturer. Each individually boxed and guaranteed. No. XX13. YOUR COST, Each..... **39¢**

### BRUSH CRYSTAL PHONES

Can be used as a crystal mike. Uses a two-plate bimorph element with silver electrodes and specially built 1½" cone drive unit. Frequency range 60-10,000 cycles; high output; high impedance. In inlaid brown bakelite case. No. 13922—with metal handband and 5 foot cord.



YOUR COST..... **\$2.94**  
No. 13923 — with chrome plate and black enamel handle. Extends from 12 to 17". 5 foot cord.

YOUR COST..... **\$3.82**

## NEW HAM CATALOG FREE MAIL COUPON

**WHOLESALE RADIO SERVICE CO. INC.**  
NEW YORK, N.Y. CHICAGO, ILL. ATLANTA, GA.  
100 SIXTH AVENUE 301 W. JACKSON BLVD. 430 W. PEACHTREE ST., N.W.  
BRONX, N.Y. NEWARK, N.J. JAMAICA, L.I.  
342 E. FORDHAM RD. 216 CENTRAL AVE. 1008 S. 164TH STREET  
(LUBAUCH 7000)

WHOLESALE RADIO SERVICE CO., Inc.  
100 Sixth Avenue, New York, N. Y.

Rush FREE Ham Catalog 66-4G7.

Name \_\_\_\_\_  
Address \_\_\_\_\_  
City \_\_\_\_\_ State \_\_\_\_\_

CLIP THIS COUPON!

## WORLD WIDE RADIO ALL WAVE SPECIAL!!



### For a Limited Time Longer!

The sensational "Ace Dace" Two Tube receiver for only \$2.25! Thousands sold at regular \$3.00 price. THIS MONTH ONLY—for \$2.25 we send you, postpaid, the complete kit containing an attractive metal chassis, panel, and every part needed to build this powerful all electric short and long wave receiver, un-wired, less tubes and phones. No batteries needed! Just plug into any house current socket. AMAZING VALUE! Can actually bring in foreign stations from all parts of the world, police calls, airplanes, amateurs, etc., as well as your local stations! Ace radios give GUARANTEED RESULTS! Our clear diagrams make it simple to hook-up. Free Circular.

**ONE TUBE** Battery operated receiver. Complete kit of parts, un-wired, less tube, batteries, and phones. **\$1.25**

**TWO TUBE** Battery receiver. For most excellent beginner's receiver! Complete kit—power and volume buy this less tubes, batteries, and phones. **\$2.00**

Any kit laboratory wired and tested 75¢ extra. First grade tubes—75¢ each. Double headphones—\$1.15 REMEMBER! We pay the postage. Saves you up to 50¢.

ENJOY NEW THRILLS!! SEND FOR YOUR ACE RADIO TODAY!  
**ACE RADIO LABORATORIES**  
70 Barclay St. Dept. C-7 New York City

## RADIOS.. SAVE UP TO 50%

**DEAL DIRECT...FACTORY PRICES!** Many models to select from: AC-DC; All-Wave; Farm sets that operate like city radios! Your name and address on postcard brings you NEW Bargain Catalog in colors FREE. Get details of 30-DAY TRIAL plan and non-refundable proposition. GOLDENTONE RADIO CO. Dept. C-7, OARBORN, MICHIGAN

**30 DAY TRIAL \$6.98 UP**

**Free Catalog**

## COMPLETE ELECTRIC PLANTS

**ONAN ALTERNATING CURRENT PLANTS** furnish same as city current anywhere. Operate on gasoline. Run Radio, Water System, Refrigerator, all Appliances. Complete, ready to run. **SIZES 350 WATTS UP** Easy to install. Available from stock. For Farms, Camps, Commercial use. Sizes for any purpose. Write for details. D. W. ONAN & SONS 557 Royalston Ave. Minneapolis, Minn

# There is regular fifty cent value in this series of radio 10c books!

RADIO FANS! Help yourselves to a radio education for the price of forty cents (10c per book). These books give you a good foundation towards the study of radio. You'll be amazed at the wealth of information contained in them. They are especially written for beginners but are useful review and reference books for all.

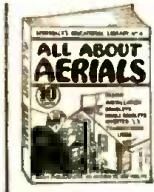

### ALL ABOUT AERIALS

In simple, understandable language this book explains the theory underlying the various types of aerials; the inverted "L," the Doublet, the Double Doublet, etc. It explains how noise-free reception can be obtained, how low-impedance transmission lines work; why transposed lead-ins are used. It gives in detail the construction of aerials suitable for long-wave broadcast receivers, for short-wave receivers, and for all-wave receivers. The book is written in simple style. Various types of aerials for the amateur transmitting station are explained, so you can understand them.

### ALTERNATING CURRENT FOR BEGINNERS

This book gives the beginner a foothold in electricity and radio. Electric circuits are explained. . . this includes Ohm's Law, alternating current, sine waves, volts, amperes, condensers, transformers, motors and generators, A.C. instruments, housewiring systems, electrical appliances and electric lamps. Here are some of the practical experiments which you can perform. Simple tests for differentiating between A.C. and D.C.; how to light a lamp by induction; making a simple electric horn; demagnetizing a watch; testing motor armatures; charging storage batteries from A.C. outlet; testing condensers with A.C.; making A.C. electro magnets; frying eggs on a cake of ice; making simple A.C. motors and many others.



### HOW TO MAKE THE MOST POPULAR ALL-WAVE 1- AND 2-TUBE RECEIVERS

This book contains a number of excellent 1- and 2-tube sets, some of which have appeared in past issues of RADIO-CRAFT. These sets are not toys, but have been carefully engineered. They are not experiments. To mention only a few of the sets the following will give you an idea. The Megadyne 1-Tube Pentode Loudspeaker Set, by Huko Gernsback—Electrifying The Megadyne—How to Make a 1-Tube Loudspeaker set, by W. P. Chesney—How to Make a Simple 1-Tube All-Wave Electric Set, by F. W. Harris—How To Build A Four-in-Two All-Wave Electric Set, by J. T. Bernsley, and others.



### HOW TO BUILD FOUR DOERLE SHORT-WAVE SETS

Due to a special arrangement with the publishers of SHORT WAVE CRAFT, we present in this book complete details for building the Doerle sets, also an excellent power pack if you plan to electrify any of the sets.

Contains EVERYTHING that has ever been printed on these famous receivers. These are the famous sets that appeared in SHORT WAVE CRAFT: "A 2-Tube Receiver that Reaches the 12,500 Mile Mark," by Walter C. Doerle, "A 3-Tube 'Signal Gripper,'" by Walter C. Doerle, "The Doerle '2-Tube' Adapted to A. C. Operation," "The Doerle 3-Tube 'Signal Gripper' Electrified," and "The Doerle Goes 'Band-Spread.'"



The group in which entries must be in our hands by October 25th, includes the veris from European short-wave stations, including Iceland.

For entries to be in the Editor's hands by November 25th, North America (including Central America, West Indies, Canada and Mexico) veris are to be in by that time.

For entries to be in our hands by December 24th, South American stations are the objective.

## World-Wide S-W Review

Edited by C. W. PALMER

### Super-Regeneration in a Television Receiver

• *Wireless World* (London) presents an interesting circuit which should have

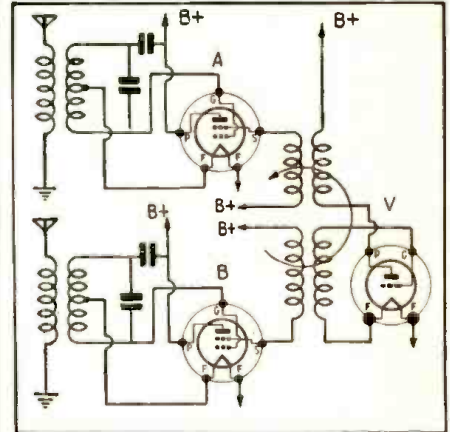

How super-regeneration may be used in a television receiver.

bearing on the development of television receivers.

Two tubes A and B receiving modulated carrier waves of different frequencies, such as the sound and picture signals of a television program, are back-coupled to work as super-regenerators and both are "quenched" from a single local oscillator tube, V.

The tube A is beat from the plate circuit and tube B from the grid circuit of the tube V. The supply circuits are decoupled.

**RADIO PUBLICATIONS**  
101 Hudson Street, New York, N. Y. SWT-737

Please send immediately books checked:

How to Build 4 Doerle Short-Wave Sets, No. 1.....10c

How to Make the Most Popular All-Wave 1- and 2-Tube Receivers, No. 2.....10c

Alternating Current for Beginners, No. 3.....10c

All About Aerials, No. 4.....10c

I am enclosing.....c; the price of each book is 10c. (U. S. Coin or U. S. Stamps acceptable.) Books are sent post-paid.

Send me FREE circular listing 48 new 10c publications.

Name.....

Address.....

City..... State.....

Each book contains 32 pages, profusely illustrated with clear, self-explanatory diagrams. They contain over 15,000 words of clear legible type. They are an education in themselves and lay the ground-work for a complete study of radio and electricity.

If you do not think that these books are worth the money asked for them, return them within 24 hours and your money will be instantly refunded.

**Radio Publications**  
101 Hudson St., New York, N.Y.

Send for our FREE circular listing 48 new 10c Publications

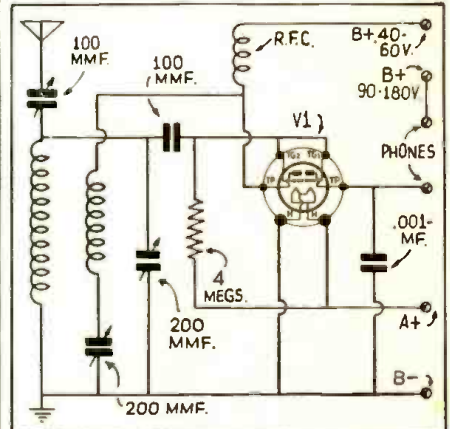

### Separate Regeneration Control

The two tube actions can be very nicely obtained by the use of a "twin triode" or class B tube, as described in a recent issue of *English Mechanics* (London).

It will be noticed that the grids of both sections of the tube are connected together. The plate circuit of one section includes the R.F. choke and connections to the regeneration coil via the controlling condenser to ground. The other plate circuit contains the phones or the output leads to an A.F. amplifier if one is used.

## ELGIN QUALITY INSTRUMENTS

### MODEL 801 Volt-Ohmmeter

A sensitive, compact and accurate volt-ohmmeter that will be the busiest instrument in your "lab," or out on jobs. DC voltage readings -.0-5-50-500 and 1000, resistance readings from 1/2 to 500 and 200 to 500,000 ohms. Will read from 0 to 1 Ma. Low resistance range direct reading. Meter has 1000 ohm per volt sensitivity. Battery is self contained. Panel is clearly lettered.



DEALERS NET PRICE WITH BATTERY.....\$5.75

Model 801-A—Similar to above, with following readings available—0/5/50/500/1000 volts D.C., 0/5/50/500/1000 volts A.C., 0/500/500,000 ohms. Net Price.....\$11.95

**TRY-MO RADIO CO., Inc.**  
85 CORLANDT ST. N. Y. C.

## DATAPRINTS!

← 20 ELECTRIC LODGE & PARTY TRICKS. Fun Galore!  
"How to Do 'Em" Data 50c

RADIO CONTROL → for MODEL BOATS, etc.  
Circuit data.....50c

More DATAPRINTS You Need!  
50c each Prepaid.....Any 3 prints for \$1.00

- 100 Mechanical Movements
- Water Turbines
- Water Wheels
- Motor Circuits (20)
- Telephone Hook-ups (20)
- Polarized Relay, Ultra-sensitive
- Shocking coil
- 20 Simple Bell Hook-ups
- Electric Chime Ringer fits any clock
- Induction Balance
- Telautograph
- Einthoven String Galvanometer
- Electric Fan Motor
- Induction PIPE & ORE LOCATOR
- Construction Data.....50c

**The DATAPRINT Co.**  
Lock Box 322 RAMSEY, N. J.

say  
say  
Please mention SHORT WAVE & TELEVISION when writing advertisers



### BOOK REVIEW

**TELEVISION, THEORY AND PRACTICE**, by J. H. Reyner, Consulting Engineer. Size, 6x8 3/4 in., 196 pages, 88 illustrations, cloth-bound. Published by the Sherwood Press, Cleveland, Ohio.

What is Television? is the opening chapter title; this chapter includes such important elements as Scanning, Building Up the Picture, Frequency Limitations, etc. Succeeding chapters deal with The Television Art as Found in Practice, Light Cells, Synchronism, Framing, The Eye in Television, Various Optical systems—including the Mirror Drum—Polarized Light—The Kerr cell.

Photo Cells of Various Types, their Sensitivity, High Frequency Response and Circuits are discussed and illustrated. The Cathode Ray Tube and its Operation is described, as well as the Time-Base Circuits—Synchronization—The Iconoscope—The Farnsworth and Zworykin systems, etc.

Film Television, The Television Receiver, Velocity Modulation and Color Television are covered in succeeding chapters. A section is devoted to Continental Television Practice and Short-Wave Television; a final chapter entitled, "Television Tomorrow—Its Entertainment Value" completes the treatise, plus an index.

**"200 METERS AND DOWN"**—The Story of Amateur Radio. By Clinton B. DeSoto. Size, 6 3/4 by 9 3/4 inches. 181 pages, flexible heavy paper covers. Published by the American Radio Relay League, West Hartford, Conn.

For the first time the extremely interesting story of Amateur Radio—from 1908 to the present day—is told by one who has been very close to the subject—Clinton DeSoto, Assistant Secretary of the American Radio Relay League.

Mr. DeSoto has traveled a great deal and been in very close contact with the operators of Ham stations; further he has taken the trouble to delve deeply into the early history of amateur radio communication in the United States. He devotes an interesting section to the early activities of Hugo Gernsback and the work he did for Amateur Radio, beginning way back in 1908, together with the establishment of the first experimental radio magazine, Mr. Gernsback's brain-child *Modern Electrics*, and the establishment of *The Wireless Association of America*, also his later publication, *The Electrical Experimenter*, and the formation of the *Radio League of America*. Many other names familiar to the "old-timer" in Amateur Radio received their due mead of credit, including such men as A. P. Morgan, George Eltz, Ellery W. Stone, etc.

### New P.M. Speaker Line

● A NEW line of Permanent Magnet Dynamic speakers developed by Utah Radio Products Company has been expanded to meet practically all radio and sound system requirements, according to a recent announcement by Ira J. Owen. Thirty-four models are available, with cone diameters ranging from five inches to fourteen inches, employing magnets weighing from five to forty-six ounces, and with output capacities as high as thirty watts! A new type of molecular structure in the magnet greatly lengthens magnetic life; over a period of years there is no audible decrease in speaker efficiency.

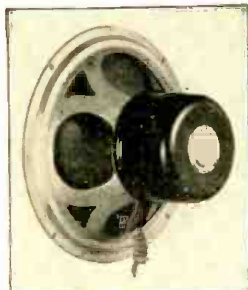

(No. 627)

This article has been prepared from data supplied by courtesy of Utah Products Company.

# CLASSIFIED

Advertisements are inserted at 5c per word to strictly amateurs, or 10c a word to manufacturers or dealers. Each word in a name and address is counted. Cash should accompany all orders. Copy for the August issue should reach us not later than June 5.

AGENTS WANTED	MISCELLANEOUS	QSL—CARDS—SWL
<p><b>GOLD LETTERS FOR STORE</b> Windows. 500% Profit. Free Samples. Metallic Co., 433-R N. Clark, Chicago.</p> <p><b>"HAM" OFFERS AND WANTS</b></p> <p><b>SKYDIVERS HALLCRAFTERS</b> bargains, many makes new and used, will trade. Also trade Leica and Zeiss and Lenses. Wells-Smith, 71 E. Adams St., Chicago. Formerly at 26 N. Wells St.</p> <p><b>MASTERPIECE IV—RARE</b> Baird gain \$110. Write Baltzy, 1711 Riverside Ave., Muncie, Ind.</p> <p><b>SELL: HALLCRAFTER SKY</b> Buddy \$24.50. W3FYW, Ardmore, Pa.</p> <p><b>FIVE INCH CATHODE RAY</b> Television—with complete tubes \$59.87. W8NYX, Lansing, Michigan.</p>	<p><b>WE ORIGINALLY HAD FIVE</b> thousand Stoppant Compasses for which the U.S. Government paid over \$30.00 each. We sold all but a very few. We cannot obtain more to sell at three times our present price. Send in your order before they are all sold at \$4.50 each, postage paid. Gold Shield Products, Room 14, Eleventh floor, 99 Hudson St., New York City.</p> <p><b>COIL INDUCTANCE CHARTS—</b> complete set for any size coil; accurate; \$2.15 prepaid. Slide Rules—4 inch circular type \$2.00; 8" dia., 29" scale, \$5.00 prepaid. Dataprint Co., Box 322, Ramsey, N. J.</p> <p><b>IDENTIFICATION MEDALS FOR</b> key rings. Name, Call Letters, and Address. Only 20c prepaid. Dave Gordon, 113 Kentucky Ave., Lexington, Ky.</p> <p><b>PATENT ATTORNEYS</b></p> <p><b>INVENTORS. ALL PATENT AND</b> trademark cases submitted given personal attention by members of the firm. Form "Evidence of Conception" and Instructions free. Lancaster, Alvine &amp; Rommel, 436 Bowen Building, Washington, D. C.</p>	<p><b>100 NEAT SWL CARDS PRINTED</b> with your name and address sent post-paid for \$1. Hunch of samples and RST chart for five cent stamp. W1BEP, 16 Stockbridge, Lowell, Mass.</p> <p><b>DIRECTORY OF SHORT WAVE</b> Listeners 25c. Listing of Name &amp; Address along with 8 1/2"x11" Certificate one year, 25c. Write SWL Directory, Sta. B, Box 116, Toledo, Ohio.</p> <p><b>SWLs, QSLs CARDS, ATTRACTIVE</b> Reply getters, Samples (Stamps), W-8-E-S-N, 1827 Cune, Toledo, Ohio.</p> <p><b>QSL SWL CARDS, NEAT, ATTRACTIVE,</b> reasonably priced, samples free. Miller, Printer, Ambler, Pa.</p> <p><b>RADIO EQUIPMENT</b></p> <p><b>ALUMINUM NAME PLATES, 7</b> for 25c prepaid. Made to your specifications. Dave Gordon, 113 Kentucky Ave., Lexington, Kentucky.</p> <p><b>SHORT WAVE RECEIVERS</b></p> <p><b>BLUEPRINT, DISTANCE RECORD</b> crystal set, 17 others, with "Radio-builder" year—25c. Laboratories, 151-A Liberty, San Francisco.</p> <p><b>TELEVISION</b></p> <p><b>TELEVISION KITS AND PARTS,</b> Arthur Pohl, 2123 Hubbard, Detroit, Mich.</p>

## More and More Radio Men Are Reading RADIO-CRAFT!

RADIO-CRAFT is devoted to all phases of radio, to servicing, and to the advanced set builder. Brings you shortcuts that show you the way out of difficult problems. Latest Radio Equipment is illustrated and described. Then there's the International Radio Review. Service Data Sheets, New Tubes, Radio Month in Review, Set Construction, Television, operating Notes, and other interesting departments. Edited by Hugo Gernsback. Over 175 Illustrations in each issue.

**8 Months \$1**  
for

**RADIO-CRAFT, 99 C Hudson Street, New York, N. Y.**

## AMERICA'S MOST POPULAR RADIO BOOKS

We herewith present a selected collection of recent important radio books. We have selected these volumes because they represent the foremost radio books of their kind in print today. We publish no catalog. Order direct from this page. Prompt shipments will be made to you. Remit by money order or certified check. Register all letters containing cash.

- SHORT WAVES.** 284 pages, 258 illus. **\$ .69**
- PRACTICAL TELEVISION.** 223 pages, 127 illus. **\$3.69**
- ELEMENTS OF RADIO COMMUNICATION** 286 pages, 241 illus. **\$2.98**
- RADIO PHYSICS COURSE.** 992 pages, 510 illus. **\$4.00**
- THE RADIO AMATEUR'S HANDBOOK.** 448 pages, 126 illus. **\$1.97**
- RADIO THEORY AND OPERATING.** 1,000 pages; over 800 illus. **\$4.38**
- MODERN RADIO ESSENTIALS.** over 200 pages, and over 100 illus. **\$1.95**
- FOUNDATIONS OF RADIO.** 246 pages, 145 illus. **\$2.47**
- PHOTOCELLS AND THEIR APPLICATION.** 332 pages, 180 illus. **\$2.88**
- ELECTRONICS.** 134 pages, 45 illus. **\$1.95**
- SHORT WAVE RADIO HANDBOOK.** 128 pages, 150 illus. **\$1.00**
- PRINCIPLES OF RADIO.** 478 pages, 306 illus. **\$3.46**
- EXPERIMENTAL RADIO.** 256 pages, 168 illus. Prepaid. **\$2.69**
- MODERN RADIO SERVICING** (300 pages, over 700 illus. **\$4.00**
- DRAKE'S CYCLOPEDIA OF RADIO AND ELECTRONICS.** 1050 pages, 1178 illus. **\$4.88**

- FUNDAMENTALS OF RADIO** 426 pages, illustrated. Prepaid. **\$3.46**
- ELECTRICITY AT HIGH PRESSURES AND FREQUENCIES.** 248 pages, 141 illus. Prepaid. **\$1.89**
- RADIO CONSTRUCTION AND REPAIRING.** 444 pages, illustrated **\$2.50**
- THEORY OF VACUUM TUBE CIRCUITS.** 226 pages, 226 illus. **\$3.00**
- PRINCIPLES OF RADIO COMMUNICATION.** 988 pages, profusely illus. **\$7.35**
- RADIO ENGINEERING.** 688 pages, 418 illus. **\$5.00**
- EXPERIMENTAL RADIO ENGINEERING.** 346 pages, 250 illus. **\$3.46**
- RADIO OPERATING QUESTIONS AND ANSWERS.** 427 pages, 106 illus. **\$2.50**
- OFFICIAL RADIO SERVICE HANDBOOK.** over 1,000 pages, over 1,000 illus. Prepaid. **\$3.95**
- OFFICIAL SHORT-WAVE RADIO MANUAL.** 240 pages, many illustrations. Vol. 1 (1934) Prepaid. **\$2.00**
- Vol. 2 (1935) Prepaid. **\$2.50**
- OFFICIAL RADIO SERVICE MANUAL.** Volume 4, 2,000 illus., over 400 pages. Prepaid. **\$3.00**
- OFFICIAL RADIO SERVICE MANUAL.** Volume 5, over 3,000 illus., over 1,000 pages. Prepaid. **\$5.86**
- OFFICIAL RADIO SERVICE MANUAL.** Volume 6, over 1,200 pages, over 2,500 illus. Prepaid. **\$7.00**

### 15 HANDY — POCKET-SIZE RADIO BOOKS

Here are 15 up-to-date books on radio and air conditioning. Modern in every sense. ALL BOOKS UNIFORM (from 64 to 72 pages; 50 to 120 illustrations. All books written by well-known authors. Order by Number.

- 1 RADIO SET ANALYZERS
- 2 MODERN RADIO VACUUM TUBES
- 3 THE SUPERHETERODYNE BOOK
- 4 MODERN RADIO HDKUPS. By R. D. Washburne
- 5 HOW TO BECOME A RADIO SERVICE MAN
- 6 BRINGING ELECTRIC (RADIO) SETS UP TO DATE. by C. E. Denton
- 7 RADIO KINKS & WRINKLES (for Experimenters)
- 8 RADIO QUESTIONS & ANSWERS. by R. D. Washburne
- 9 AUTOMOBILE RADIO & SERVICING
- 10 HOME RECORDING AND ALL ABOUT IT. by Geo. J. Sullha
- 11 POINT-TO-POINT RESISTANCE MEASUREMENTS by C. E. Denton
- 12 PUBLIC ADDRESS INSTALLATION AND SERVICE
- 13 ABC OF AIR CONDITIONING. by Paul D. Harrison.
- 14 POCKET RADIO GUIDE, by N. H. Lessen.
- 15 ABC OF REFRIGERATION PRIOR PREPAID **45c**  
EACH BOOK

#### HOW TO ORDER

No. C.O.D. orders. Our prices are net, as shown. Some of the books sent prepaid (in U.S. only). Those that are not thus listed are shipped collect if sufficient postage is not sent. Add 7% of price for postage.

**RADIO PUBLICATIONS, 97 HUDSON ST., NEW YORK, N. Y.**

Please mention SHORT WAVE & TELEVISION when writing advertisers



Handier than Ever 

**ELECTROLYTICS**

- ★ Now as handy mechanically as they have long been electrically. Adjustmount flanges permit any mounting.
- ★ Instantly adjusted for any hole spacing, flat or upright mounting, singly or stacked.
- ★ Ultra-compact PBS cardboard-case electrolytics come in 200 and 450 v. ratings; popular capacities; single, double and triple sections.

**DATA:** Ask your local AEROVOX supply house for AEROVOX catalog. Or write us direct.

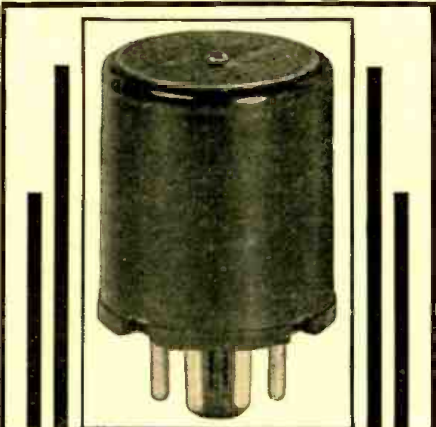

**THE BRUSH TRANSFILTER FILLS THE GAP**

© The transfilter fills the selectivity gap between the electrically tuned circuit and the quartz filter. A transfilter can be employed in any superheterodyne whose intermediate frequency amplifier can be tuned to 465 kilocycles.

Technical data on request

**The BRUSH DEVELOPMENT COMPANY**  
3326 PERKINS AVENUE  
CLEVELAND OHIO

**Identifying S-W Stations**

By Joe Miller

B—Broadcast: C—Commercial Stations  
Part One

Freq. Mc.	Station Call	Identification
21.45	OLR6A	B—A melody from "New World Symphony," by Anton Dvorak heard at beginning and end of broadcasts.
20.04	OPL	C—Leopoldville, Belgian Congo. Calls "Allo Bruxelles" repeatedly, speaks in French. Phones ORC.
19.98	KAX	C—Manila, Philippines. Calls sometimes given before transmission: "This is station KAX, Manila on 19980 kc., Now—" Inverted always used during transmission.
19.62	VQG	C—Nairobi, Kenya Colony. Calls London, mentioning "Nairobi calling." Inverted used.
19.345	PMA	C—Bandoeng, Java. Calls "Allo, Amsterdam." Inverted used.
19.355	FTM	C—St. Assise, France. Sends 4 note musical signal before transmissions and while standing by.
19.206	ORG	C—Brussels, Belgium. Phones OPL in French and S. A. in Spanish.
19.02	HSSPJ	B—Bangkok, Siam. Not used at present. See HSSPJ, 9.35 mc.
19.016	HSE2	C—Bangkok, Siam. Works Manila, Tokyo and Germany. Uses inverted. Now used in place of HSP for telephony.
18.97	GAQ	C—Rugby, England. Works ZSS using inverted.
18.91	JVA	C—Nazuki, Japan. Code sometimes before transmissions. Uses inverted. Calls in English at start and end of transmission.
18.89	ZSS	C—Klipheuvcl, South Africa. Phones GAU or GAQ, Rugby, using inverted. Fading signal, moving back and forth about once per second.
18.83	PLE	C—Bandoeng, Java. All announcements in phone work, English, inverted always used. See PLV, 9.415 mc.
18.62	GAU	C—Rugby, England. Phones ZSS, VWY, and U. S. A. Inverted always used.
18.40	PKK	C—Kootwijk, Holland. Calls "Allo, Bandoeng," phoning Java, uses inverted.
18.388	FZS	C—Saigon, Indo-China. Calls "Allo, Parve, ici Saigon," uses inverted. Has very rapid flutter on signal.
18.27	IUD	C—Addis Abeba, Ethiopia. Calls "Pronto Roma, da Addis Abeba." Uses clear speech, in Italian. Uses "Pronto" often during conversation. Man or woman may be heard. Often works IAC.
18.135	PMC	C—Bandoeng, Java. Calls Holland, speaking Dutch, uses inverted.
17.775	PHI	B—Huizen, Holland. Calls in 7 languages, including English. Interval signal, metronome, with 80 beats per minute. Closes with Netherlands National Anthem.
17.73	HSP	C—Bangkok, Siam. Now uses modulated CW only. Phone transmissions rerouted to HSE2, 19016 mc.
17.70	IAC	C—Coltano, Italy. Phones IUG, others, calls at beginning, and irreg. throughout: "Pronto—da Radio Coltano." Always clear speech, in Italian.
17.70	JFZC	C—Nippon Yusen Kaisha Liner "Chichi bu Maru," identifies at start and finish of phone transmissions. Uses inverted. Also JFZC, 6.65 mc.
17.545	VWY2	C—Poona, India. Varies frequency, occasionally, inside these limits.
17.480	FZES	C—Djibouti, Fr. Somaliland. Calls "Allo, Paris, ici Djibouti." Speaks French.
16.385	ITK	C—Mogadiscio, Italian Somaliland. Calls in Italian, "Pronto—da Mogadiscio." Calls Addis Ababa, Roma and Eritrea. Uses clear speech, in Italian.
16.25	FZR	C—Saigon, Fr. Indo-China. Calls "Allo, Parve, ici Saigon." Uses inverted, usually phoning FTK, 15.88 mc.
16.24	KTO	C—Manila, Philippines. Call given at beginning and end of transmissions: "This is station KTO, Manila, on 16240 kc., now—" Inverted always used.
16.155	KBT	C—Manila, Philippines. Call give in code before transmissions. Inverted always used. Address: See KZGF, 6.46 mc.
16.117	IRY	C—Rome, Italy. Phones ITK and IUD. Calls "Pronto—da Roma." Clear speech in Italian.
16.03	KKP	C—KKS: C—K6NO; C—Kahuka, Hawaii. Call at beginning and end of all transmissions. Inverted used, except when experimenting, when call K6NO is used. (To be continued)

**Index to Advertisers**

**A**

Ace Radio Laboratories.....140, 157  
Aerovox Corporation.....160  
Allied Engineering Institute.....156  
Allied Radio Corp.....150  
American Microphone Co., Inc., Ltd.....149  
Amperite Company.....156  
Astatic Microphone Laboratory, Inc.....142

**B**

Bliley Electric Co.....142  
Brush Development Co., The.....160

**C**

Cameradio Co.....145  
Candler System Co.....153  
Cannon, C. F., Company.....145  
Classified Advertisements.....159  
Cornell-Dubilier Corp.....154  
Cornish Wire Co.....154  
Coyne Electrical School.....155

**D**

Dataprint Company.....158  
Dodge's Institute.....152

**E**

Eilen Radio Laboratories.....139  
Electrad, Inc.....140  
Electric Institute, Inc.....146

**G**

Gadgets Magazine.....150  
Gold Shield Products Co.....156  
Goldentone Radio Co.....157

**H**

Hallierafters, Inc.....Back Cover  
Hammarlund Manufacturing Co., Inc.....147  
Harrison Radio Company.....142

**I**

Instructograph Company.....153

**K**

Kenyon Transformer Co., Inc.....142  
Korrol Radio Products Co.....140

**M**

McElroy, T. R.....153  
Midland Television, Inc.....152

**N**

National Company, Inc.....Inside Back Cover  
National Radio Institute.....113  
National Schools.....153  
New York Y.M.C.A. Schools.....152

**O**

Onan, D. W., & Sons.....157

**R**

Radio & Television Institute.....152  
Radio Constructors Laboratories.....141  
Radio Publications.....158, 159  
Radio Training Assn. of America.....152  
Raytheon Production Corporation.....151  
RCA Institutes Inc.....152  
RCA Manufacturing Co., Inc. Inside Front Cover

**S**

Sargent, E. M., Co.....149  
Short Wave Coil Book.....144  
Short Wave League.....148  
Standard Transformer Corporation.....149  
Sunshine Novelty Co.....144  
Superior Instruments Company.....145

**T**

Technifax.....144  
Teleplex Co.....152  
Triplett Electrical Instrument Co.....148  
Tri-State College.....152  
Try-Mo Radio Co., Inc.....158

**U**

Ultra High Frequency Products Co.....143  
Ultra Precision Instruments Co.....144  
United Radio Company.....154  
Utah Radio Products Co.....148

**W**

Wellworth Trading Company.....156  
Wholesale Radio Service Co., Inc.....157

(While every precaution is taken to insure accuracy, we cannot guarantee against the possibility of an occasional change or omission in the preparation of this index.)

Please mention SHORT WAVE & TELEVISION when writing advertisers

KABLE BROS. CO., PRINTERS

## PERFORMANCE PLUS:



Built for *extra* performance, the twelve tube NC-100 Receiver includes every refinement for difficult short wave work. Among its many unusual features is the unique Movable Coil Tuning Unit which combines the high electrical efficiency of plug-in coils with the convenience of the coil switch. Tuning from 540 KC to 30 MC is covered in five ranges, so that stations are well spread out. Each of the fifteen high frequency coils is shielded in its own compartment of cast aluminum. The turn of a knob on the front panel brings the desired range into position and plugs it in. Idle coils are isolated, leads are short, and calibration is exact. There are no dead spots in the NC-100 Receiver.

Fully worthy of the advanced performance of the Tuning Unit are other details of the superheterodyne circuit. Thorough use of low loss insulation and of air-dielectric condensers, together with carefully designed high-Q coils, results in exceptionally high signal-to-noise ratio and high usable sensitivity. The advanced design of the (optional) Crystal Filter provides unusual effectiveness when QRM is severe.

Panel controls are complete, and include separate switches for B-supply, Filaments, CW Oscillator, and AVC; as well as dials for Audio Gain, RF Gain, Tone Control, and CW Oscillator Tuning. Crystal Filter controls include Phasing and Selectivity. The precision Micrometer Dial, direct reading to one part in five hundred, provides exceptional ease of tuning together with great accuracy in logging.

These are but a few of the features that combine to make the NC-100's performance so outstanding, and its low price so remarkable. An illustrated folder will be mailed on request if you mention Dept. S-7.

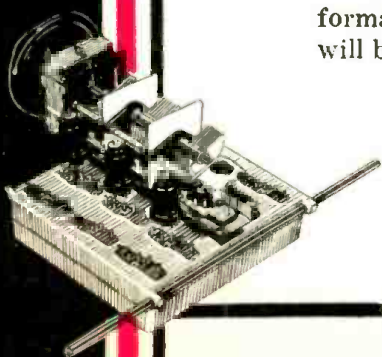

NATIONAL COMPANY, INC., MALDEN, MASS.

# Announcing



## The New 1938

# SUPER SKY RIDER

Leading Radio Columnist  
**HANDS AN ORCHID**  
to the Super Sky Rider†

### Visited by Diplomats

On Wednesday evening I was honored to entertain B. P. Stoyanovitch, Consul General of Yugoslavia, and his staff while we listened to a special broadcast up among the megacycles from Belgrade.

With a battery of five communications receivers which had been warming up for hours, I sat down full of confidence and started spinning dials. Well, maybe not confidence, exactly, but hope, anyway. But imagine my embarrassment when minutes passed and we logged practically everything in the world except Belgrade.

However, at the end of about fifteen minutes we dragged in a speech in an unfamiliar language, and immediately Mr. Stoyanovitch burst forth in happy smiles. It was the voice of the Prime Minister of Yugoslavia and the receiver that did the trick was the old reliable SX11 superskyrider. After trying for a few minutes to log the program on the other receivers, just by way of something to fall back on in case of emergency, but having no luck, we turned off the others and sat back to listen. And if you don't think a terrible weight was lifted from my brow when the skyrider did its stuff, then you never had eleven officials of a foreign nation standing skeptically by while you try to produce results in short wave radio reception.

†Reproduced from Ted Rogers' Radio Column, New York World-Telegram, April 17, 1937

### THE HALLICRAFTERS' GREATEST ACHIEVEMENT

Imagine a receiver that gives you complete coverage from 5 to 550 meters, taking in everything from the 5 meter band to the top of the broadcast band—with wide range variable selectivity (single signal razor-sharpness to true high fidelity!)—with an ingenious, new, electrical band-spreading device\*\* that provides 1000° of band spread—an "S" meter that works on weak signals—with improved image and signal-to-noise ratio, and a dozen other outstanding features. Now you can listen to two-way police communications on 7½ meters—to the interesting and active new 5 meter band—in fact to everything on short waves and the broadcast band as well.

Imagine all this on one receiver—there's not another feature the amateur or short wave listener could possibly desire. It's absolutely revolutionary in performance and scope. It's the New 1938 Super Sky Rider, now on display at your dealer's, at an amazingly low price for so much value. Available on Hallicrafters' liberal Time Payment Plan. See it today!

\*R. M. A. has defined High Fidelity as 7000 cycles at 20 D. B. down.  
\*\*Patent applied for.

### FEATURES

- 5 to 550 Meters Coverage.
- 6 Bands.
- 11 Tubes.
- Wide Range Variable Selectivity.
- Better than One Microvolt Average Sensitivity on all bands.
- 1000° Electrical Band Spread.
- "S" Meter.
- 13 Watt Undistorted Output.
- Air-Trimmed R. F. Circuit.
- Improved Expanding I. F. Transformers.
- Improved Crystal Filter Control.

See the New 1938 Super Sky Rider at your dealer's or write for complete information:

**the hallicrafters inc.**  
2601 Indiana Avenue, Chicago, Ill. • Cable Address "Hallicraft" Chicago  
America's Leading Manufacturer of Communications Receivers