

HUGO GERNSBACK  
Editor

# SHORT WAVE ★ AND TELEVISION

May 37

WORLD'S  
LARGEST  
SHORT WAVE  
CIRCULATION

See Page 10



25¢

IN U. S. AND  
CANADA

AT LAST  
THE NEW

# DX-4

SHORT WAVE  
RECEIVER

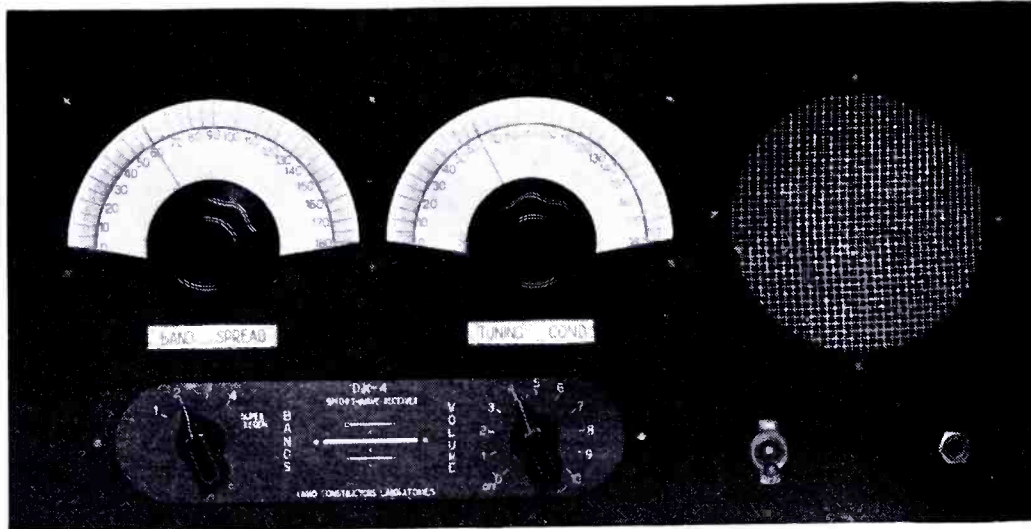

**2½ to 560 METERS**

A receiver which actually gives you the results you want on long distance foreign reception at a price that is absolutely without precedent.

Complete with **\$17<sup>85</sup>** tubes, ready to operate.

## A Revolutionary Development!

If you are after results—if you want a specialized short wave receiver which can reach out and pull in, not only the ordinary Europeans but those hard to get little fellows in the out-of-the-way corners of the world—if you want a receiver which will become your friend; which you will learn to swear *by*—not *at*—and if you do not own such a receiver because heretofore you could not afford it, **YOUR PROBLEM IS SOLVED!** For the first time in radio history such a receiver is at last available at a truly low price. Quantity buying and unique production methods plus skillful engineering, which takes full advantage of recent tube developments, have made the DX-4 possible. There is no longer any question as to the outstanding receiver in the low price field and every radio expert who has seen and operated the DX-4 will back up this statement.

**WE ARE SHOWING** on this page the three greatest values in short wave radio that have ever been offered. These are *not* merely low priced receivers thrown together with the customary junk parts. They are as carefully engineered, manufactured and tested as the most expensive sets.

RACO receivers are built to produce results—which accounts for our rapid growth during the past two years. We take this opportunity (our second anniversary) to thank our old customers for the many new ones they have recommended to us and to wish them all the **BEST OF DX.**

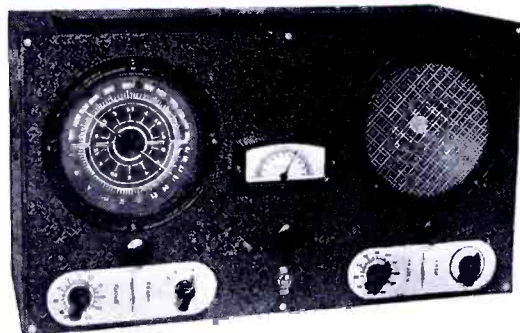

## THE HAYNES R-S-R CLIPPER (5 TUBES)

THE FINEST RECEIVER WE BUILD. WE HAVE TOLD YOU ALL WE CAN ABOUT THIS SET.

## ASK THE MAN WHO OWNS ONE!

A beautiful communication receiver in both appearance and operation. Five tubes always in full operation with R.F. amplification on all waves from 3 to 555 meters. 6L6 output to 6" dynamic speaker. Such perfect bandspread that the twenty meter amateur band may be spread over the entire bandspread dial if desired. The main tuning dial itself is five inches in diameter! Uses the genuine Haynes electron coupled regenerative-super-regenerative circuit which means that it really "goes to town" on the high frequency bands.

**HAYNES R-S-R CLIPPER** complete with five Sylvania tubes ready to plug in to 110 volt outlet and operate, shipping weight 25 lbs. **\$2885**

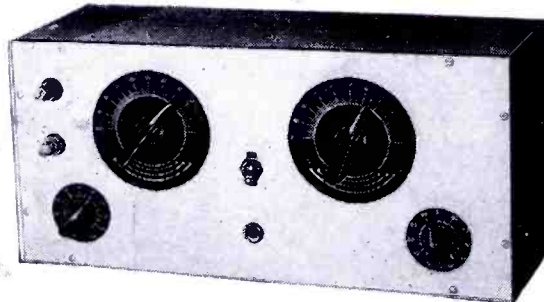

**DON'T LET THE PRICE FOOL YOU!**  
This is a real DX job!

### R-S-R JR.

#### 3 TUBE COMMUNICATION RECEIVER, 5 to 555 METERS

An adaptation of the original Haynes R-S-R circuit using only one stage of audio amplification which is sufficient for good ear-phone reception on even the weak foreign stations. Full AC operation using high voltage transformer and 80 rectifier. Two of the new 6J5G High frequency Super-Triodes are used as electron coupled detector and amplifier. Six plug-in coils included giving maximum DX at minimum cost with no skips in the tuning range.

**COMPLETE KIT** including all coils, drilled panel, chassis, power supply, etc., less tubes, cabinet and wiring.....\$7.60  
Crystallized metal cabinet..... 1.00  
Kit of three Sylvania tubes..... 1.25  
Assembled, wired and tested..... 2.35

## SPECIFICATIONS

- ★ Tuning Range, 2½ to 560 meters. (The DX-4 is designed for maximum results on the short waves and is only suitable for local reception on the standard broadcast band. Its selectivity is such, however, that it positively will separate the local broadcast stations in spite of its unretarded sensitivity.)
- ★ Full Electrical Bandspread, using separate dials and variable condensers.
- ★ Beam Power Output, with dynamic speaker.
- ★ Seven Tuning Bands with separate coils.
- ★ Band Switching from 560 to 13½ meters.
- ★ Incorporates the same smooth, supersensitive electron coupled regenerative and super-regenerative detector circuit as used in the famous Haynes R-S-R CLIPPER.
- ★ Plain or super-regeneration can be used at will below 20 meters.
- ★ Removable air-wound coils for 10, 7 and 5 meter ranges.
- ★ Operates from 110 volt AC only; has built-in high voltage power supply specially filtered for short wave reception on either speaker or phones including line filter.
- ★ TUBES: 6J5G detector, 6J5G first audio, new 6V6 beam power second audio output, 80 rectifier.

**RADIO CONSTRUCTORS LABORATORIES**

Dept. SW-5, 136 LIBERTY ST., NEW YORK, N. Y.

RACO

RACO

**COYNE TRAINING PAYS**

"I have never spent an equal amount of time, energy or money which paid me such great and ever increasing returns as that which I spent at Coyne."  
—Norman B. Neely, California



**GOT A JOB and A RAISE**

"It didn't take me long to get a job after finishing your course. Also the training I received there has helped me to a raise already."  
—Kenneth F. Larson, Alabama



**CREDIT TO COYNE**

"I would like to report that I have been working with an electrical contractor as a repair man of all electrical devices . . . I want to give all the credit to Coyne Training that I have been able to hold a job of this kind."  
—Donald Shears, Pa.



**THOUSANDS are MAKING**  
**\$30-\$40-\$50 a WEEK**  
*in* **ELECTRICITY**  
**LEARN BY DOING —**  
**12 WEEKS TRAINING IN BIG COYNE SHOPS**  
**GIVES YOU YOUR START IN THIS GIGANTIC FIELD**



It's Easy to Train at Coyne for your start in Electricity. Break out of the Low-pay, untrained class. If you are interested in bettering your position in life, send in the coupon for information on COYNE Practical Training in Electricity.

Thousands of Trained Electrical Men are making good money in the many branches of Electricity. Industry everywhere is being modernized with new electrical equipment . . . will use more electricity. Many Power Plant Operators now make up to \$50 per week. Electrical Maintenance Men are paid \$150 a month and up. Refrigeration and Air Conditioning Service Men earn \$30-\$40-\$50 a week. Armature Winders make \$40 a week and more. Aviation and Auto Ignition Men also make good money at steady jobs. Many others operate their own business. These are only a few of the opportunities in Electricity.

**Train on FULL SIZE Equipment—**  
**NOT by Correspondence—NOT by Text Books**

COYNE Shop Training is NOT by correspondence or Home Study. You come right to the big COYNE Shops in Chicago to get this practical Training. You work on real equipment—such as generators, real dynamos, you wind armatures, work on diesel engines, airplane motors, and do many other practical Electrical jobs. Here is one of the greatest working outlays of its kind in America. No embarrassing reciting. No dry text books. You don't need high school education or previous experience. It is this real job Training that enables COYNE to train you for a better pay job.

**AIR CONDITIONING, DIESEL and**  
**ELECTRIC REFRIGERATION included**

Spreading over the nation is a vast network, these fast developing branches of ELECTRICITY are employing more men and paying more in salaries every year. Homes, offices, factories, trains, autos, airplanes are being air-conditioned. Autos may soon be diesel-powered. This valuable instruction included without extra cost. Clip and send Coupon—NOW!

**YOU TRAIN HERE**  
Many thousands of dollars worth of real practical equipment and machinery is installed in our fireproof modern school.

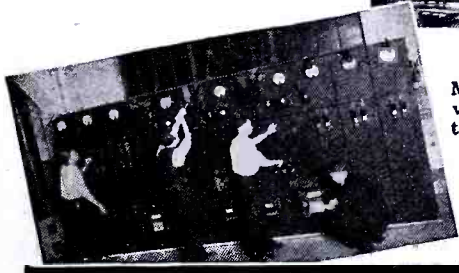

Many shop views like this shown in my catalog



**Send for EASY PAYMENT PLAN**  
**—New Low Cost Board and Room Plan**

My friend, don't waste the golden years of your life saying, "I can't afford Specialized Training!" Of course you can! Get my catalog—see for yourself how we help graduates year after year. I have a special new low cost Board and Room Plan whereby students take care of their living expenses while at COYNE. Don't let lack of money hold you back. Be sure to send the Coupon for information on how to get training first, then pay tuition in 18 easy Monthly Payments, starting 5 months after you begin school.

**PART TIME EMPLOYMENT**

If you need part time work to help pay living expenses while here, we'll help you. We help hundreds of students through this special department and may be able to help you.

**JOB AFTER GRADUATION SERVICE**

We keep in touch with many large firms in many branches of ELECTRICITY, ready at all times to supply their needs for trained men. After you graduate you get Lifetime job assistance through our Free Employment Department. As a COYNE graduate you get free business service and technical consultation to help you as you advance in your job; also, the privilege of review at any time without additional tuition charge.

**Employers PRAISE These COYNE Graduates**

"Mr. Lingerfelt's services very satisfactory. His practical shop training at COYNE has certainly helped increase his efficiency."  
"John Lindquist was given an increase in salary due to the high quality of his work."  
(Names of companies on request). We have scores of such letters. Get complete story. You owe it to yourself. Clip and send Coupon—NOW!

**GET FULL FACTS**  
You'll see everything in the Big FREE COYNE Book . . . facts . . . opportunities . . . jobs . . . salaries . . . actual photos of hundreds of ambitious fellows preparing for better jobs. You'll see proof that COYNE training pays. This big Book is yours without obligation. So act at once. Just mail Coupon.



**MAIL THIS NOW**  
*for* **MONEY MAKING DETAILS**

H. C. LEWIS, President,  
COYNE ELECTRICAL SCHOOL,  
500 S. Paulina St., Dept. 57-83, Chicago, Ill.  
Without obligating me, send full details and your Big FREE Illustrated Catalog.

Name.....Age.....  
Street.....  
Town.....State.....  
Mail in Envelope or paste on Postcard

H. C. LEWIS, President  
**COYNE ELECTRICAL SCHOOL**  
500 S. Paulina Street Dept. 57-83 Chicago, Illinois

Please mention SHORT WAVE & TELEVISION when writing advertisers

**IN THIS ISSUE: PROMINENT SHORT-WAVE AND TELEVISION AUTHORS**

**Hogan • Eckhardt • Denton • Shuart • Hooton • Kennedy • Fisher • Miller • Fouch**

**HUGO GERNSBACK**  
Editor



**H. WINFIELD SECOR**  
Managing Editor

**GEORGE W. SHUART,**  
**W2AMN**  
Associate Editor

*Combined With*  
**Official SHORT WAVE LISTENER**

**Contents for May, 1937**

Editorial—Short Wave Broadcasting, by John V. L. Hogan .....	3
Television Abroad.....	4
Short-Wave Heroes of the Flood.....	5
American Television Steps Ahead!.....	6
New 441-Line High-Fidelity Television Demonstrated.....	7
Television Course, Lesson 4, by George H. Eckhardt.....	8
Radio "Ore, Pipe and Treasure" Locator, by Gerhard Fisher .....	9
Short-Wave Phone A Great Help in Modern "Fire-Fighting," by H. W. Secor.....	10
World-Wide Short-Wave Review, Edited by C. W. Palmer .....	11
For the Short-Wave Beginner—The "Multi-band 2," by George W. Shuart, W2AMN.....	12
The "VS-5" Metal Tube S-W Superhet, by Harry D. Hooton, W8KPX.....	14
The "C-O-M" 150 Watt Transmitter, by George W. Shuart, W2AMN.....	16
A Vibrator Power Supply, by Maurice E. Kennedy, W6KQ, W6BGC.....	18
How To Build a "Field Strength" Meter.....	18
What's New In Short-Wave Apparatus—Sargent Model 21 .....	19
NC 101-X Receiver.....	20
RCA Transmitter.....	20
The Meissner All-Wave 12, by Clifford E. Denton.....	21
Let's "Listen In" with Joe Miller.....	22
World S-W Station List, by M. Harvey Gernsback.....	23
Record What YOU Hear!, by James L. Fouch.....	24
NBC'S New Aerials Favor South America and Europe.....	24
Squeeze This Tube To Vary The Frequency.....	26
European S-W Receiver Has Range 13 to 200 Meters.....	26
Short Waves and Long Raves.....	28
Short Wave League—"When To Listen In," by M. Harvey Gernsback.....	30
\$5.00 For Short-Wave KINK.....	32
Short Wave Scouts-Thirty-eighth Trophy.....	33
Short-Wave QUESTION BOX.....	34
Super-Pro Covers 20 to 40 mc. Band.....	45
T. L. McElroy's "Code-Speed" Challenged!.....	61

**Certified Circuits**



● **SHORT WAVE & TELEVISION** goes to a large expense in verifying new circuits. When you see this seal it is your guarantee that such sets have been tested in our laboratories, as well as privately, in different parts of the country. Only "Constructional-Experimental" circuits are certified by us.

When you see our certified seal on any set described, you need not hesitate to spend money for parts, because you are assured in advance that the set and circuit are bona fide and that this magazine stands behind them.

**SHORT WAVE & TELEVISION** is the only magazine that certifies circuits and sets.

**OUR COVER**

● Short-wave portable phone sets are just beginning to interest our fire-fighting experts. The front cover illustration this month shows one application of the short-wave phone—for guiding a fireman out of a smoke-filled building. These S-W phone sets will also prove extremely useful for coordinating the activities of several fire companies, when fighting large conflagrations. See page 10.

COPYRIGHT, 1937, BY H. GERNSBACK

Published by **POPULAR BOOK CORPORATION**

404 N. Wesley Avenue, Mount Morris, Ill.

Editorial and Executive Offices - - - - 99-101 Hudson St., New York, N. Y.  
**HUGO GERNSBACK**, President - - - - **H. W. SECOR**, Vice-President  
**EMIL GROSSMAN** - - - - - Director of Advertising  
 European Agent: Gorrings's American News Agency, 9A Green St.,  
 Leicester Square, London W. C. 2

Australian Agents: **McGILL'S AGENCY**, 179 Elizabeth St., Melbourne

**Features in the June Issue**

- An 125-Watt Modulator using 35-T's, by George W. Shuart, W2AMN
- S-W Beginner—Complete information on regenerative "pre-selectors," together with data on various types of antennas for the Short-Wave Listener.
- A short-wave vacation set.
- The Economy Super-het, by H. G. McEntee, W2FHP
- Piping R.F. with Co-Axial Lines, by P. H. Smith
- Photographing Television Images—Also Latest Television News.

**SHORT WAVE & TELEVISION**—Monthly. Entered as second-class matter May 7, 1930, at the post office at Mount Morris, Illinois, under the act of March 3, 1879. Trademarks and copyrights by permission of H. Gernsback, 99-101 Hudson St., N. Y. C. Text and illustrations of this magazine are copyrighted and must not be reproduced without permission. **SHORT WAVE & TELEVISION** is published on the 1st of every month. Twelve numbers per year. Subscription price is \$2.50 a year in the United States and possessions and Canada. Foreign countries, \$3.00 a year. Single copies 25c. Address all contributions for publication to Editor. **SHORT WAVE & TELEVISION**, 99-101 Hudson St., New York, N. Y. Publishers are not responsible for lost manuscripts. Contributions cannot be returned unless authors remit full postage. **SHORT WAVE & TELEVISION** is for sale at all principal newsstands in the United States and Canada. European agents: Brentano's, London and Paris. Printed in U. S. A. Make all subscription checks payable to Popular Book Corporation.

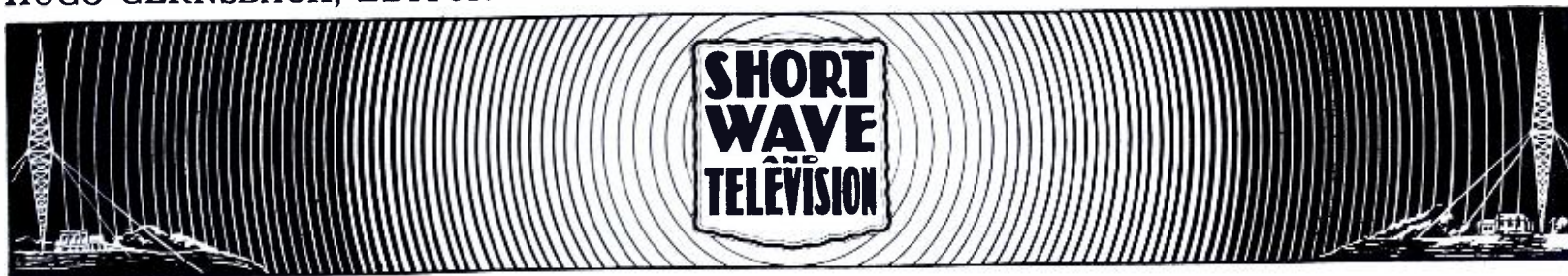

# Short Wave Broadcasting

By John V. L. Hogan

Consulting Engineer; Past President, Institute of Radio Engineers; President, Interstate Broadcasting Company (WQXR)

● NOT so many years ago, one of radio's leading engineers advised a group of technical graduates to avoid radio as a life work, for the reason that it seemed to him to offer few opportunities for the newcomer in the scientific field. I would be the last to criticize that advice, given as of that time, for then there was no broadcasting, no facsimile, no television and, indeed, no short-wave commercial communication. Radio was circumscribed by the apparatus and legislative limitations that assigned the main factors in its application to the 300-600 meter range for marine communication, the 600-1,600 meter range for exclusive use of the Governmental services, and the bands from 1,600 to perhaps 16,000 meters for long distance telegraphy. But since then the applied science of radio has been stimulated by the development of broadcasting in the range from 187 meters to 546 meters, and the business of broadcasting has given occupation to many times the number of individuals who were engaged in radio before 1921. In this *broadcasting* field alone, there are more radio engineers employed than would have been thought possible by those whose outlook was bounded by the requirements of the communication services of the first decade of the century.

Yet broadcasting is only a part of what has come since 1920, and perhaps only a small part of what is to come in radio. After Marconi, Conrad, and the other investigators of the third decade had shown what really could be done with the waves of lengths from about 15 to about 100 meters, a whole new application of *short waves* to long distance telephone and telegraph communication rapidly developed. Of course, Lodge, Marconi, and others, had used these *short waves* for years. However, there was important new apparatus development, and notably the production of transmitters capable of generating short continuous waves of substantial power, and receivers capable of intercepting and effectively reproducing short wave signals. The use of these instrumentalities demonstrated in many quarters of the world, that short waves were extremely useful for signaling over great distances, because of their natural properties, including their effective reflection or refraction from the Heaviside layer. The proof of these now accepted facts gave rise to another important service in radio, the *communication service* which gives employment to hundreds of engineers and thousands of others.

Today we are on the eve of a further development in radio service. The *ultra-short* waves, of lengths shorter than 7 meters or so, are just the same as when they were

used by Hertz and his confreres. But we have also found new apparatus to generate them powerfully and to receive them efficiently, and to modulate them with telephonic and picture signals. We have also found that they are, as Hertz seems to have suspected, principally useful within what is loosely called the *optical* range, and that they are entirely different from the longer short waves (from 14 or 15 meters up) in that they generally break right through the Heaviside layer, and, being without that excellent characteristic of coming back to earth, are of little value for long-distance signaling. But that very property, which limits their useful effects to a zone that is roughly marked by the horizon, is valuable in that it similarly limits their interference effects. Thus, by using waves short enough to avoid anything analogous to Heaviside layer bending, it becomes possible to assign the same frequencies, or closely neighboring frequencies, to services radiating from stations in cities not more than a few hundred miles apart, and to operate these services simultaneously without mutual interference but with excellent coverage in their own service areas.

What does all this mean for *broadcasting*? Perhaps the most striking thing is that it at once solves the most severe problems facing the Federal Communications Commission, in their struggle to preserve some degree of useful broadcasting service for the rural listeners (who constitute about one-half of the nation's radio population) while at the same time meeting the pressing demands for more and more broadcasting stations in cities and towns. It is not hard to visualize a new situation in which the present broadcast waves, from 187 meters (1,600 kilocycles) to 546 meters (550 kilocycles) are used exclusively for the combined urban and distant services that characterize our high-power broadcasters today, and in which all *local* and *regional* broadcast services are carried on upon the very *short* waves (say from 4 to 7 meters) which give excellent coverage, by night and by day, for distances of 30

or 40 miles and which have no "fading wall" and no "night interference range."

Such a plan for broadcasting would take care of the existing demand for as many more broadcasting stations, for individual trading areas, as can be economically justified, all on the very short waves. It would also provide an excellent and increased *high-fidelity* broadcasting service for all the radio set owners of the United States, whether urban or rural, on the present *medium* frequency broadcasting channels. It could also take care of the needs of our neighbors in Canada and Mexico (Continued on page 36)



John V. L. Hogan, well-known American radio engineer. Responsible for station WQXR, first American "high-fidelity" broadcast station. Also interested in television and facsimile research.

Fifth of a Series of "Guest" Editorials

**SHORT WAVE & TELEVISION IS PUBLISHED ON THE 1st OF EVERY MONTH**

This is the May, 1937 Issue—Vol. VIII, No. 1. The Next Issue Comes Out May 1

SHORT WAVE & TELEVISION, Published monthly at Mount Morris, Ill.

EDITORIAL and EXECUTIVE Offices, 99 Hudson St., New York City

# TELEVISION ABROAD

Latest European Television Developments, including those in Germany and England.

Below—Berlin's newest portable television station. The truck carries a complete short-wave-television transmitter, also film development apparatus, the film being developed and washed in 30 seconds! The film is exposed in the camera seen at the top of the car.

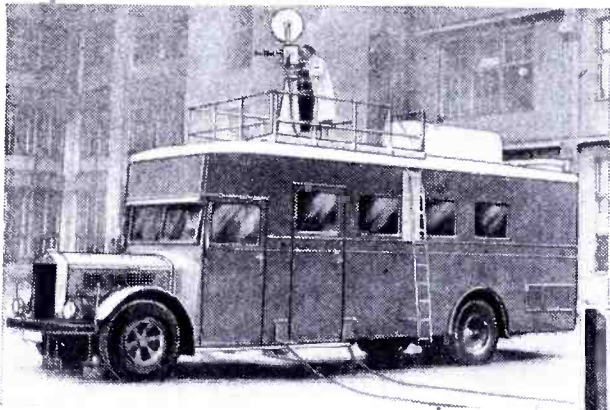

Right—William Tayton, whose face was the first to be televised (1926 by Mr. Baird of London). He is shown holding an ordinary 5-inch cathode ray tube; on the stand to his right, we see three cathode ray tubes; 12, 15 and 22 inches in diameter, respectively. The 22-inch tube is the largest yet built.

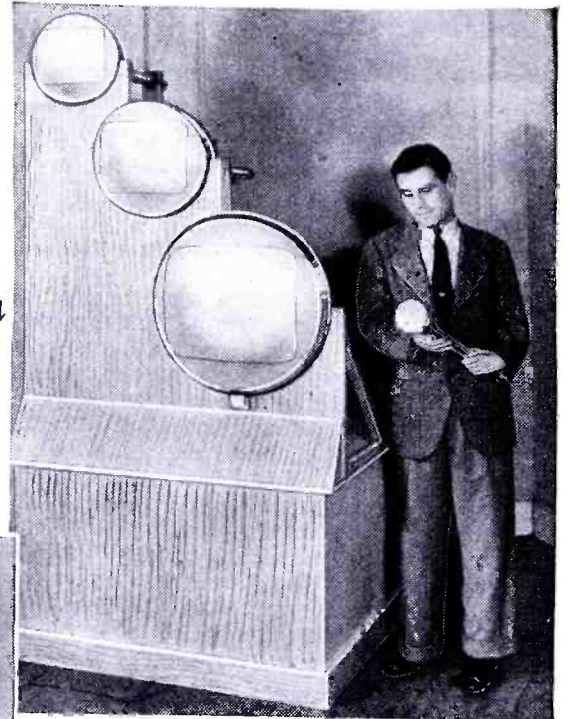

Below—A "close-up" of the complete television film developing and transmitting apparatus installed in mobile station, shown at left. 1—is the control unit for the power-supply; 2—is the film developing, fixing and washing tanks; 3—is the film dryer and scanner; 4—short-wave transmitter.

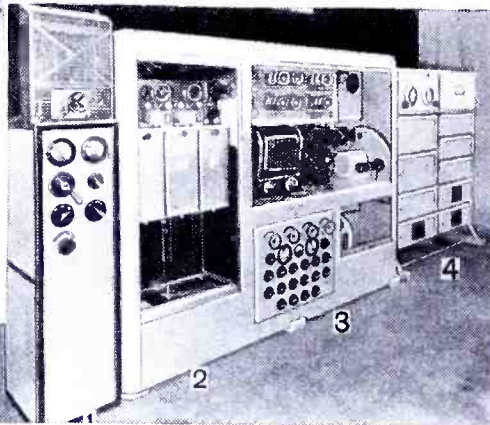

Photos above, and at right, show what we may expect in this country tomorrow when television becomes an everyday occurrence. These mobile television stations will be very useful for picking up street scenes such as fires, accidents, races, etc.

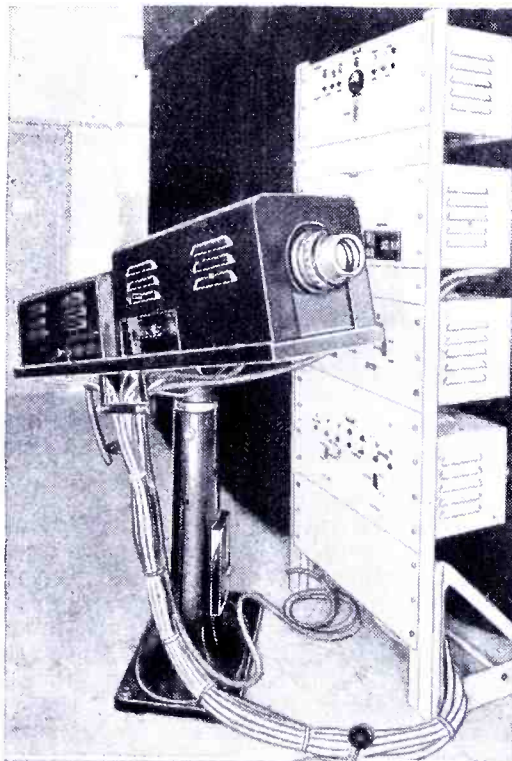

Right—German television receiver of unusual design. The large cathode ray tube is installed behind a plate glass window. The tuning controls are at the bottom of the panel and the loud-speaker grill is shown in the center. The size of the image is 7x9 inches. There are four controls, each of the two knobs or dials being of the "double" type. This is one of the latest and best television receivers built abroad.

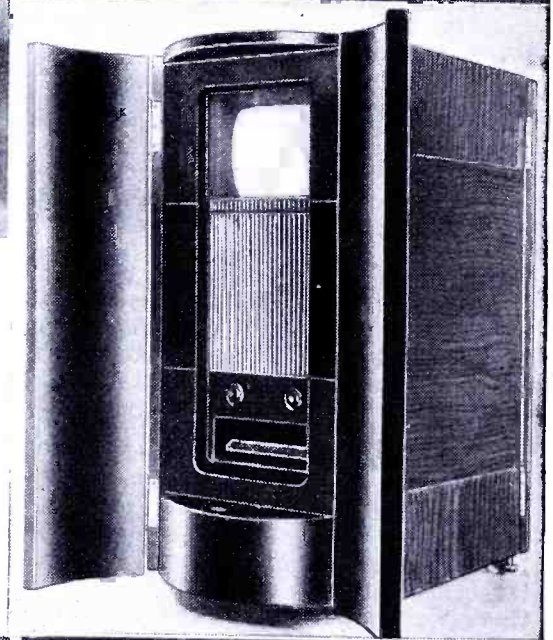

Left—3x4 foot television images projected on screen! The image is reconstructed on the end of a cathode ray tube and a powerful lens in front of the tube, picks up the image and projects it on to the screen. The television amplifier and tuning apparatus is shown in the panel rack. The cathode ray tube operates on 18,000 volts and creates an image 3x4 inches. The extremely brilliant image is magnified by the lens to give a large screen picture.

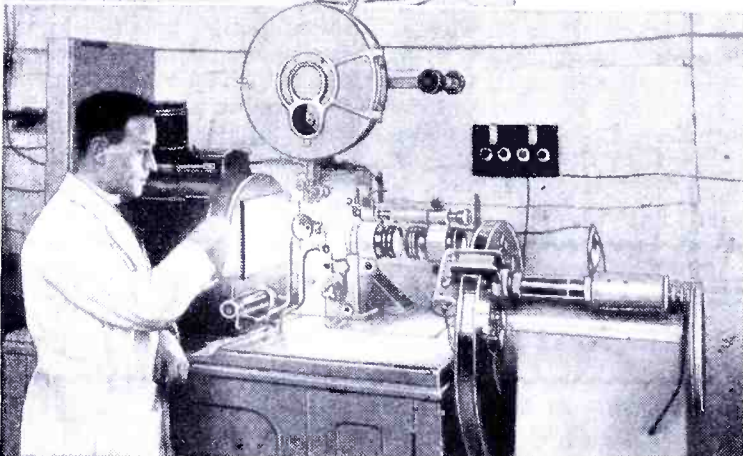

Left—Television in London—At the left, projector unit with light source and film mechanism; in the center, the optical system and, at the right, the air-tight enclosed scanning disc with synchronizer.

Right—English "film" television apparatus. This machine takes pictures on ordinary film; then develops, washes and dries the film in 30 seconds! The apparatus also sends the film through a scanning device, and approximately 30 seconds after exposure, the "televiwer" sees the image on his receiver.

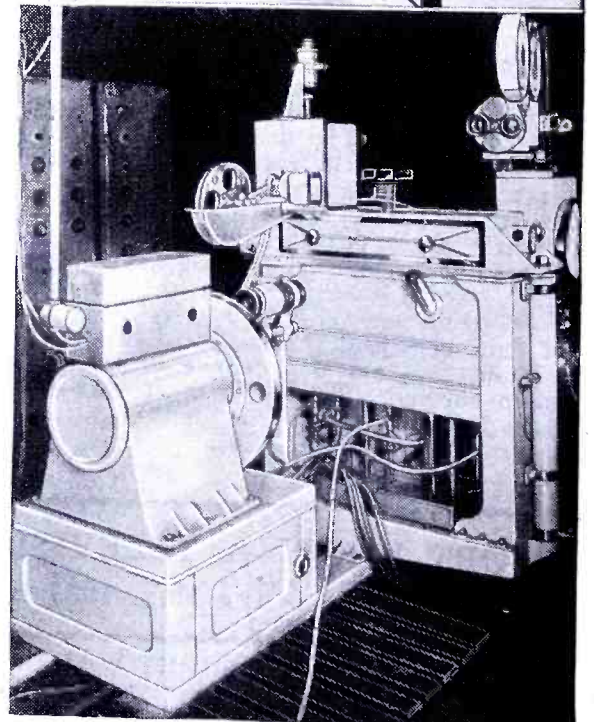

# Short-Wave Heroes of the FLOOD

"Ham" radio operators vied with radio experts of the large broadcasting companies, in carrying on communication in Flood Areas.



This exciting scene was snapped during the recent flood in the Ohio valley and shows two of the C.B.S. experts on the job. A 5-meter "packet," carried the first-hand description of the flood.

Left: Another 5-meter short-wave transmitter on the job in Evansville, Ind. Left to right: Engineers R. Linberg and E. McCormack, Announcer—Norman Barry.

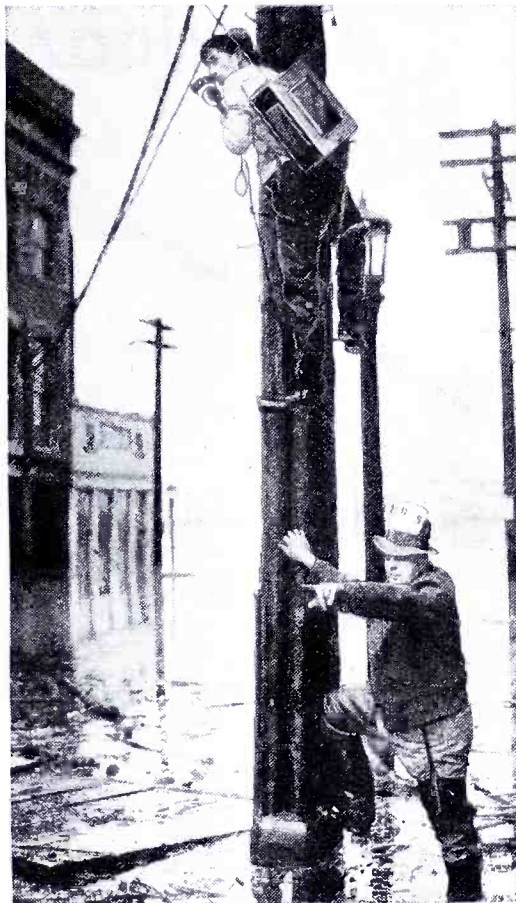

● HERE is the story of how W8ESN, (Lee Kemberling, Toledo, Ohio) better known as the "Fireman of the Air," got started on the Flood Relief Work. W8ESN, who is a City Fireman on duty at No. 17 Fire Station in Toledo; (a driver of No. 17's Hook and Ladder Truck) whose hobby is "ham" radio and QSL and SWL printing, was called on the telephone by City Manager Edy at 12 o'clock, midnight,

after Mr. Edy had received the radio message from WHAS (Louisville) on Jan. 25, requesting 500 uniformed policemen.

Mr. Edy then ordered W8ESN home to "contact" by *amateur radio*, and make arrangements for the sending of 16 uniformed policemen to Louisville. W8ESN went on the air at 12:45 a.m. and immediately contacted W9ETI of Chicago, who in turn relayed traffic and helped make arrangements for airplanes, etc., for the transportation of these policemen. W8ESN then reported back to the Fire Station and remained on fire duty until 7 a.m. Between 12:45 a.m. and 4 a.m., W8ESN contacted and completed 2-way contacts for Mr. Edy and Chief of Police Ray Allen.

The Red Cross executive secretary, Miss Beatrice Ilett, heard of the "2-way" contacts and at once called Mr. Edy and succeeded in having W8ESN—Lee R. Kemberling—detailed from the Fire Department, to the services of the Red Cross until the flood emergency was under control. The Red Cross and W8ESN "long-distanced" to the Federal Communications Commission office in Detroit, Mich., in order to receive an O.K. to appoint W8ESN as an Official Red Cross emergency radio station. (Continued on page 48)



The hero of our story, Lee R. Kemberling, "ham" call W8ESN, who stayed "on the job" for hours and hours relaying all sorts of short-wave flood messages.



Here we see Bill Fligel, WBBM engineer, in charge of CBS technical operations at Evansville, Ind. He worked Chicago on his "ham" station, W9CIA.

OFFICIAL RED CROSS RADIO EMERGENCY STATION				
<b>W8ESN</b>				
VIA AMATEUR RADIO				
CITY OF ORIGIN	STATION OF ORIGIN	NUMBER	DATE	CHECK
TO: _____				

One of the message blanks used by Lee R. Kemberling in dispatching radio traffic during the flood. Note the "Short Wave League" insignia.

# American Television Steps Ahead!

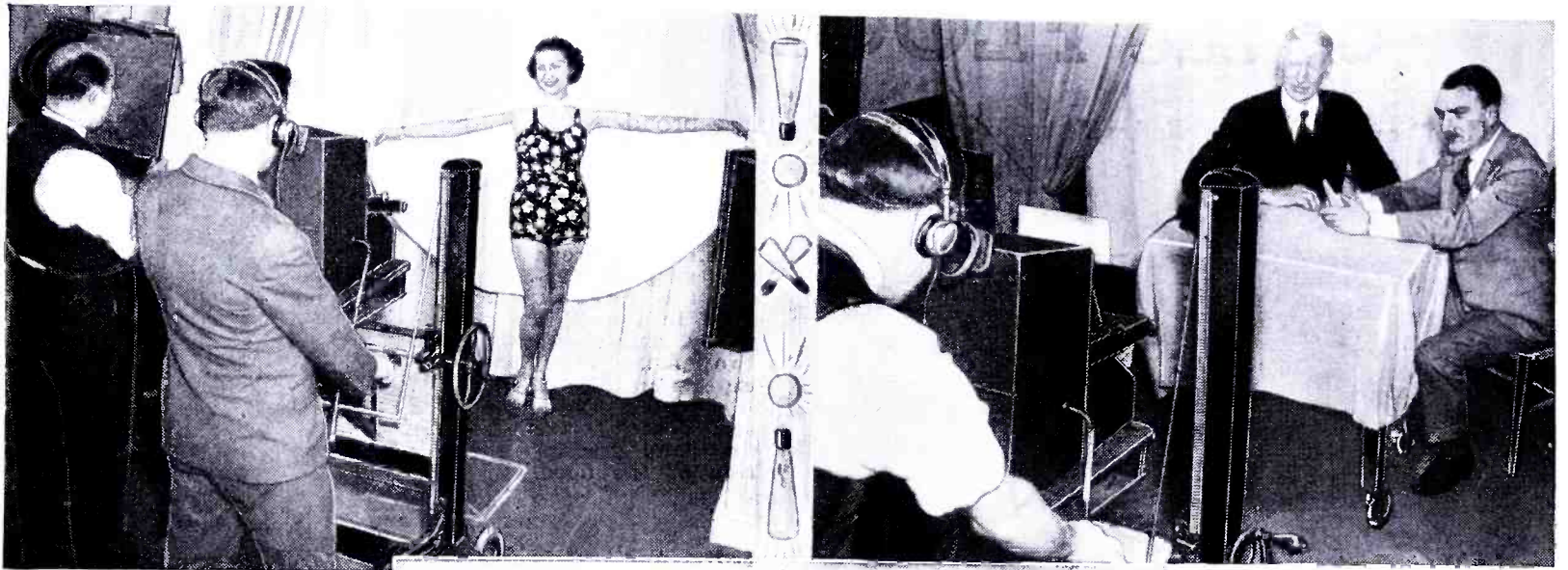

Television style show, given as part of the Philco program in Philadelphia recently; Miss Jeri La Porte showed the 100 editors present—via television—one of the newest styles in bathing suits. This television "style show" gives a very good idea of what our women folks will be treated to tomorrow, when television becomes a part of our daily "home life." The images were the best seen so far and used 441 lines.

Here's Connie Mack being interviewed by one of America's best known news commentators—Boake Carter. By the time he "buzzed off" the audience present at the Philco television show got another good slant on what "television" is going to mean to the American radio public tomorrow. Possibly one year hence, we shall have half a dozen television stations broadcasting interesting program features, like the interview between Connie Mack and Boake Carter. The baseball fans present had a rare treat while listening to Mr. Mack's replies to Mr. Carter's questions.

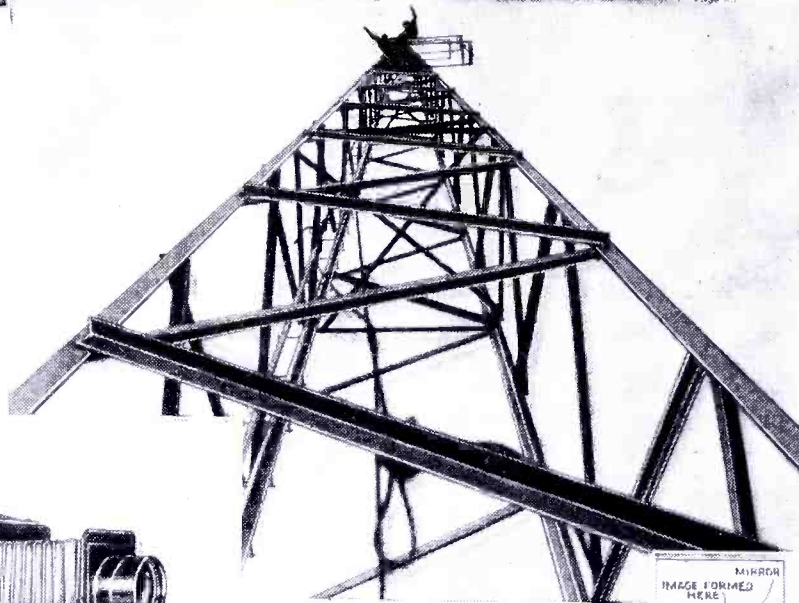

Above—Steel mast which supports the "voice" and "image" antennas for Philco's television transmitter W3XE. This mast was recently erected to support the two ultra-high frequency antennas 210 feet above the street. Co-axial cables connected the antennas with the transmitting apparatus below. The transmitter is located at the Philco plant and was about three miles distant from the receiver set-up.

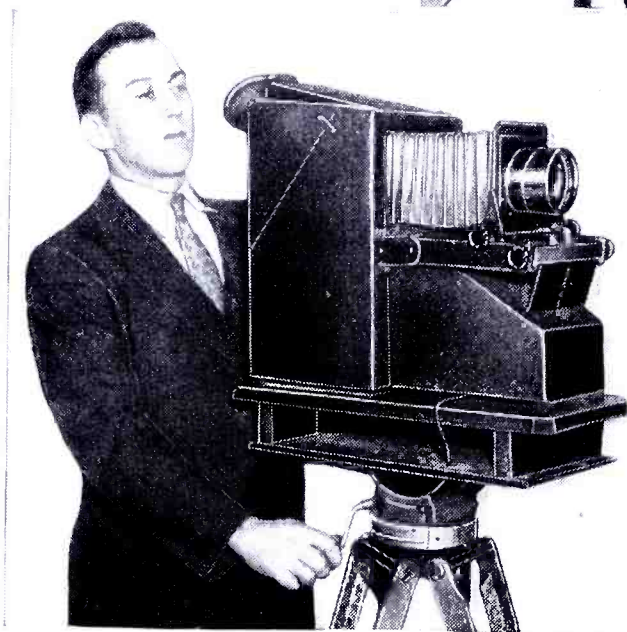

Charles Stec is shown operating the ingenious television camera, which picks up the image. The camera can be quickly focused and moved about. It is as compact and portable as a movie camera, and those who saw the images reproduced three miles away, via short waves, were impressed with the great improvement in the "studio pickup."

Right—P. J. Konkle, Philco television engineer, is observed holding the "electric eye" or camera tube which is located inside of the television camera, shown in photo above. A lot of research was carried out on this "electric eye" and a recent demonstration shows that there has been a marked improvement.



Above—the Philco television "receiver." Using 26 tubes and several tuning and focusing control knobs, the television image and its accompanying sound are "tuned in" on this single instrument. It is about the size of the average radio console, and the image is observed in the mirror fitted at the top of the lid, which swings upward, as shown. The 12-inch cathode ray tube is mounted vertically in the cabinet.



# New 441-Line High-Fidelity Television demonstrated . . .

A new advance in American television was demonstrated at Philadelphia recently, when the first demonstration of the new Philco, high-fidelity 441-line images were displayed before 100 editors. Considerably greater detail in the images was noticeable. The number of tubes and controls in the receiver were markedly reduced.

● MORE than one hundred editors and publishers of daily newspapers and magazines recently attended the first large-scale demonstration of Philco high-fidelity television. The program, lasting nearly one hour, was broadcast from the studios of the Philco Company at its plant at Tioga and "C" Streets, in Philadelphia, and was received at the Germantown Cricket Club, about 3 miles distant, at Manheim and Morris Streets, in an outlying section of Philadelphia.

Television receivers installed in the ballroom of the club reproduced the new 441-line pictures as they came through the ether. This was the first demonstration of high-fidelity 441-line pictures.

The program presented many novelties designed to illustrate the latest advance in television. The engineers arranged in a unique way to show the increase in clearness in the pictures when the number of lines was increased from 345 to 441.

The program included a fifteen-minute television fashion show, and an interview with Boake Carter, prominent news commentator, quizzing Connie Mack, famous base-ball manager, on 1937 base-ball prospects.

Musical features from the movies and "news-reels" were also shown. Vocal numbers from the studio completed a well-rounded program.

### How Soon Shall We Have Television?

Sayre M. Ramsdell, Vice-President of the Philco Radio & Television Corporation, said, among other things:

"The program which will be presented this afternoon is originating in the studio at the Philco plant at Tioga and "C" Streets. It has been prepared to clearly show the advances made in recent months by our Television Department.

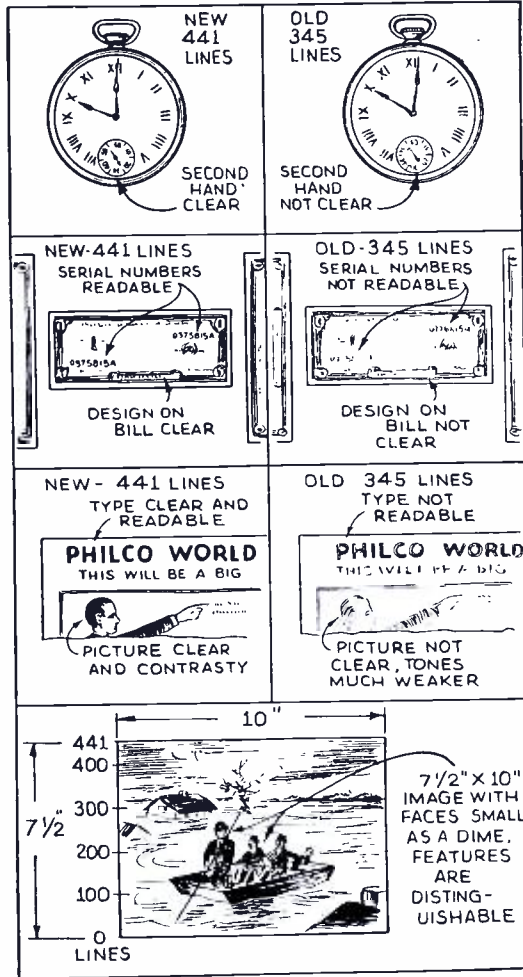

In the demonstration, with new 441-line pictures, the second hand of a watch was visible at the receiver; the serial number on a one dollar bill could be read; newspaper type was much clearer; and on group pictures or images, faces, even though small, were distinguishable.

ment. Increasing the number of scanning lines from 345 to 441 has considerably improved the picture quality as you will see.

"Two questions naturally will arise in your minds, and I may as well anticipate them and give you my views upon them at the outset.

"The first is:—will television supersede sound broadcasting? My answer to that is most positively not. Each has its own field and function, and sound broadcasting will continue to occupy its important place in the home.

"The second is:—when will we have television? On this point I will venture no prediction as to time. Certain things must be accomplished before it can become generally used. These things are:

"1. Technical standards for television transmission will have to be approved by the Federal Communications Commission so that any receiver will receive from any transmitter within range.

"2. The present limited range of television, averaging about 25 miles, will have to be increased. Key cities, such as New York, Philadelphia, San Francisco, Boston, Washington will have television first.

"3. Before we have commercial television, the Government will have to issue commercial licenses suitable for television, that is in the 42-90 megacycle band.

"4. A source of programs will have to be developed. In putting on a short sketch by television more is required in the way of costumes, rehearsal and stage properties than for any known entertainment field. Actors no longer can read their scripts. Both appearance and voice are necessary for the television star. The problem of giving the American people television programs 365 days of the year assumes staggering (Continued on page 44)

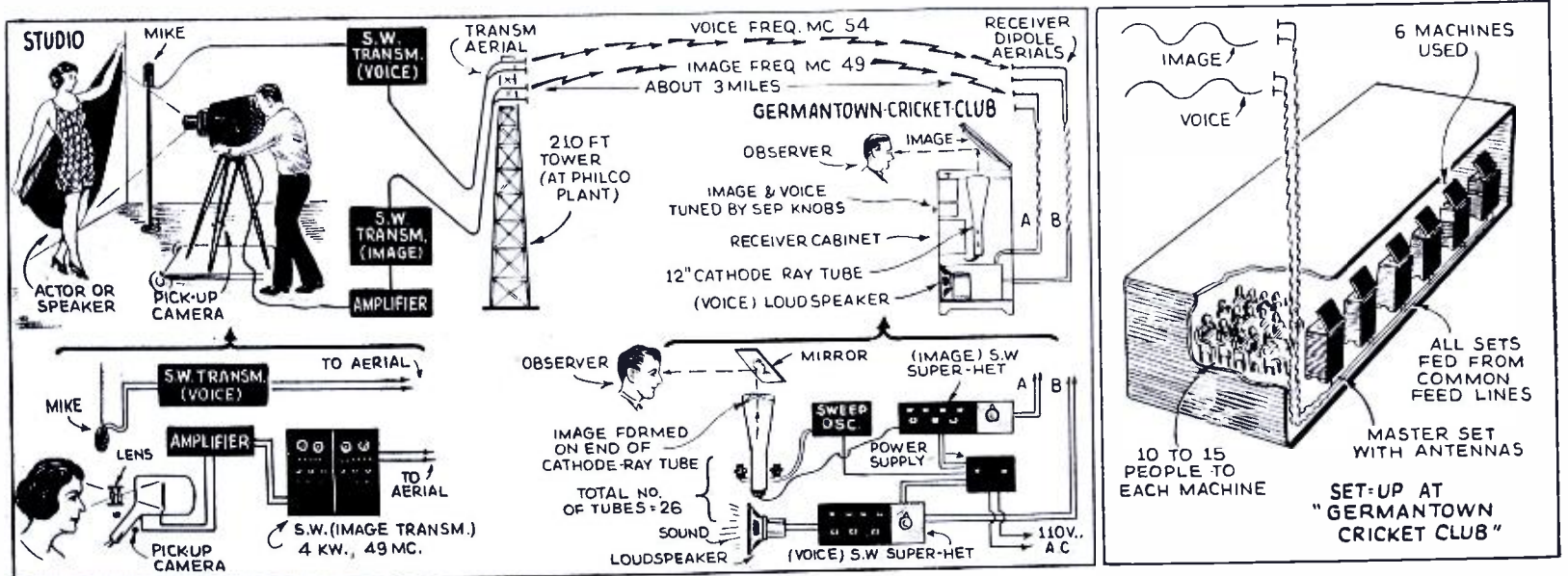

The picture-diagram above shows the general set-up of the Philco high-fidelity, 441-line television apparatus as demonstrated in Philadelphia recently. The number of tubes in the receiver has been reduced from 33 to 26, and the number of controls from 14 to 10.

# TELEVISION COURSE

## How the Cathode Ray Tube Scans

### Lesson 4

By George H. Eckhardt,  
 Author, "Electronic Television"

● NATURALLY the greatest amount of interest in electronic television will be in the receivers, and the question in the minds of the great army of *radio amateurs* is—"Will we be able to make our own receiver sets?" The answer to this question is—"Yes." But before the amateur can make his own receiving set two things must be available to him, (1) he must have definite data with values, and (2) he must be able to procure a good cathode ray tube made especially for television reception.

The information which the amateur will need must be definite; and this information, in the last analysis, can come only from the laboratories in which television research has been pursued. The writer has been assured that very shortly he will be free to release this information. But even with this information available, the amateur must first be "grounded" in the fundamentals of *electronic television*, and know exactly what he is trying to do. In television there can be nothing like the radio set which gives "fair" results. A television receiver must give "good" results or it is *worthless!* In fact one of the strongest arguments, advanced by one of the three large companies controlling television, against having the amateur take part in television progress is the fact that many amateurs, having insufficient data, and cathode rays tubes not especially adapted to television reception, will obtain results which will reflect no credit upon television. Only with the proper information and cathode ray tubes especially made for television reception can the amateur hope to obtain results that will reward him for his trouble.

It may be definite-

ly stated, however, that everything needed, except this definite information and a special tube, is now available. A tube will be in production within the next month or so, and the information will then also be available. While the cathode ray tube needed for television reception does not differ greatly from the tubes now made for use in oscillograph equipment, yet there are differences, and these differences are important, as will be pointed out.

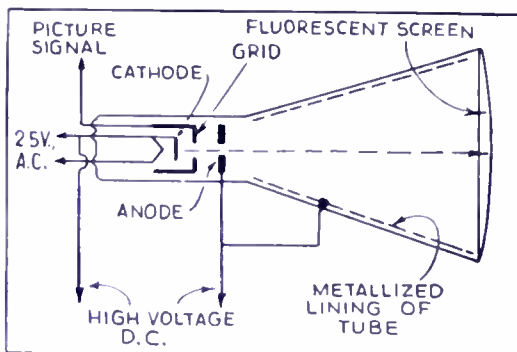

Sectional view of simple Cathode Ray Tube. Fig. 4.

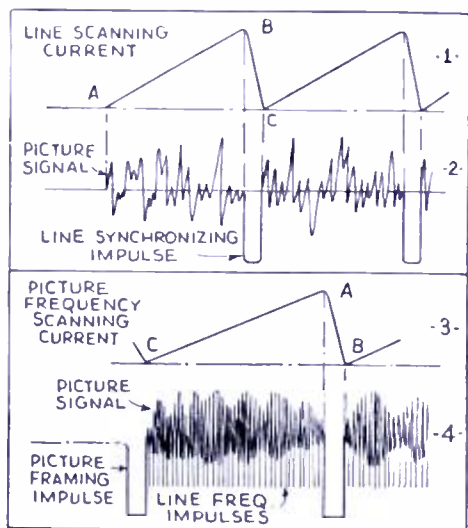

This diagram shows typical wave-form of scanning and picture signals. Fig. 3.

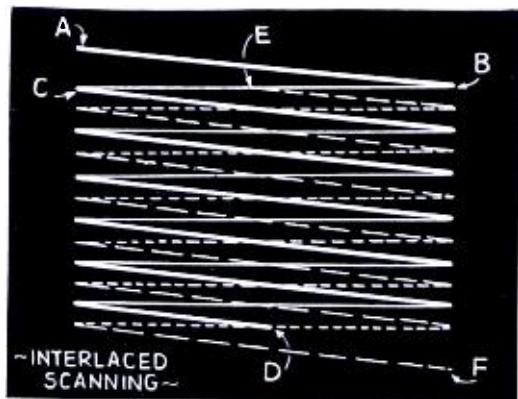

Interlaced Scanning: the first scan follows the full line; the second scan the dotted line. Fig. 2.

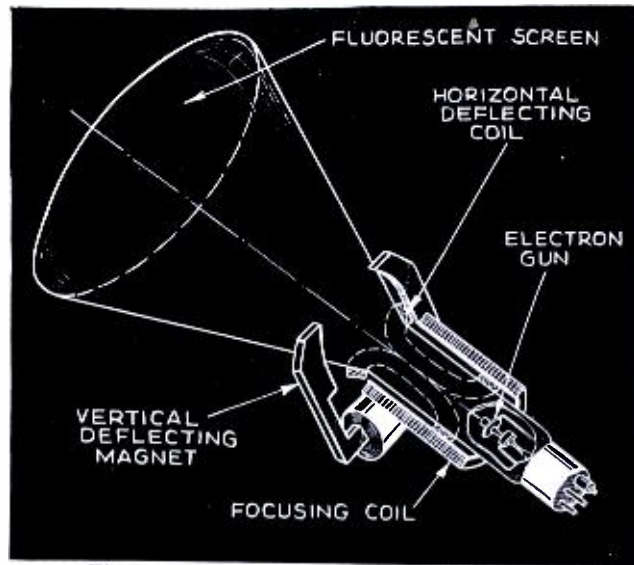

Fig. 1. Farnsworth "Oscillight" tube.

the cathode and the anode. This is analogous to the grid in an ordinary tube and is the controlling element. (See Fig. 4.)

Thus it will be seen that the modulated stream from the electron gun will vary with the varying signals coming from the television transmitter, and that this varying beam, when striking the fluorescent surface at the end of the tube, will be translated into varying degrees of light.

However, since high definition of 441 lines is being used, it is necessary that the spot formed when the beam strikes the fluorescent screen be as sharp and "definite" as possible. Therefore it is necessary to focus this beam. This focusing can be done either *electrostatically* or *electromagnetically*. It seems that the best results are obtained by focusing the beam *electromagnetically*.

With the beam sharply focused and varying in intensity with the incoming signals, we have a spot of respective varying intensity of light on the fluorescent screen.

Now, with this spot, we must "paint" the picture. This spot must move across the screen in exactly the same way, and in *perfect synchronism*, as the picture is being scanned at the pick-up camera.

The standards prescribe 441 lines, with a frame frequency of 30 per second, and a field frequency of 60 per second, *INTERLACED*. It is highly important that *INTERLACED* scanning be understood. (See Figure 2.)

Now each picture *frame* at the pick-up camera is scanned twice in every one-thirtieth of a second. Thus we have 30 complete "frames" per second. The spot on the receiver tube, of course, must move in exact synchronism with this scanning operation at the pick-up.

Let us follow the spot. (Figure 2.) Starting at a point "A" the spot moves uniformly from "A" to "B," varying in intensity with the varying signal coming in from the transmitter. Instead of moving exactly horizontally the spot moves slightly downward. The journey from "A" to "B" has been at a uniform rate, but at "B" the spot flies back to a point "C," and the journey from "B" to "C" takes only about one-tenth of the time that the journey from "A" to "B" took. Then the spot moves to the right from "C," and the operation is continued until the (Continued on page 51)

- The cathode ray tube consists of:
- (1) the *cathode* itself, which is treated with the usual barium and strontium oxides. This cathode can be heated with either D.C. or A.C. current, and when so heated it emits a "mist" of electrons.
  - (2) the *anode*. It is necessary to produce a "stream" from this "mist," and give that stream velocity. For this purpose an anode is placed before the cathode. A second *anode* is formed by the metallic coating in the tube itself.
  - (3) the *grid*; a grid is placed between

# Radio Ore, Pipe and Treasure Locator

By Gerhard Fisher

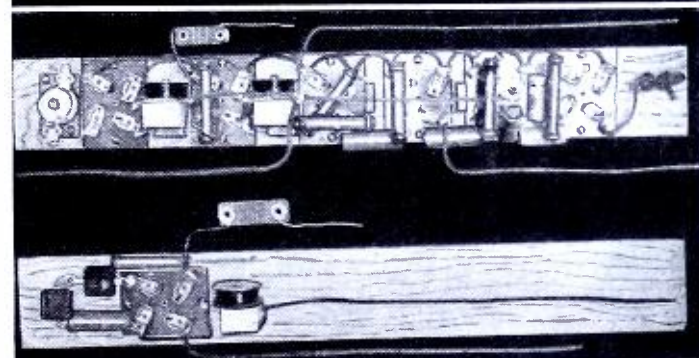
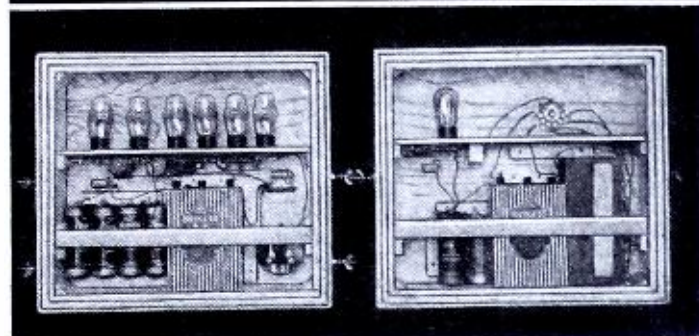
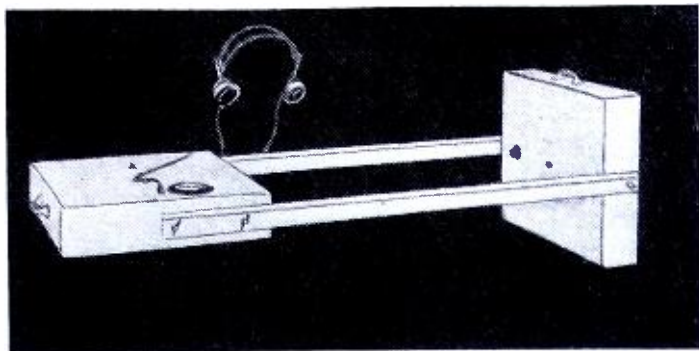

No other radio invention is of such popular interest as the "Treasure Locator." Its use for spotting "lost" underground pipe lines, ore bodies, etc., makes this a particularly interesting article. The author has had considerable experience in this little-known field, and the "live" experimenter will find it well worth his while to "read up" on this subject. "Radio Locators" are going to point the way to new oil and ore deposits tomorrow.

● METAL locators have been described in various radio magazines, and circuits have been published in, more or less, great detail but in almost all instances such instruments were of strictly experimental nature. One would have to be fairly well acquainted with radio circuits and their workings to make an instrument perform to any degree of satisfaction. Probably only a very few people ever constructed a metal locator which was sensitive and stable in operation and so easy to build that it could be duplicated and give the same satisfactory results.

The instrument, in this article, is called the *Metallscope*, or *M-Scope*. It was developed as early as 1929 and is protected by the U. S. Patent No. 2066561. The principle used is that of a *radio balance*.

In general, the *radio balance* con-  
(Continued on page 53)

Left—Top photo shows side view of assembled "ore locator." Center photo—Loop aerials, wound around cabinets containing transmitter and receiver. Lower photo—chassis of transmitter and receiver.

Right—diagram showing how field from transmitter loop is affected by presence of metallic body, causing an indication in the receiver.

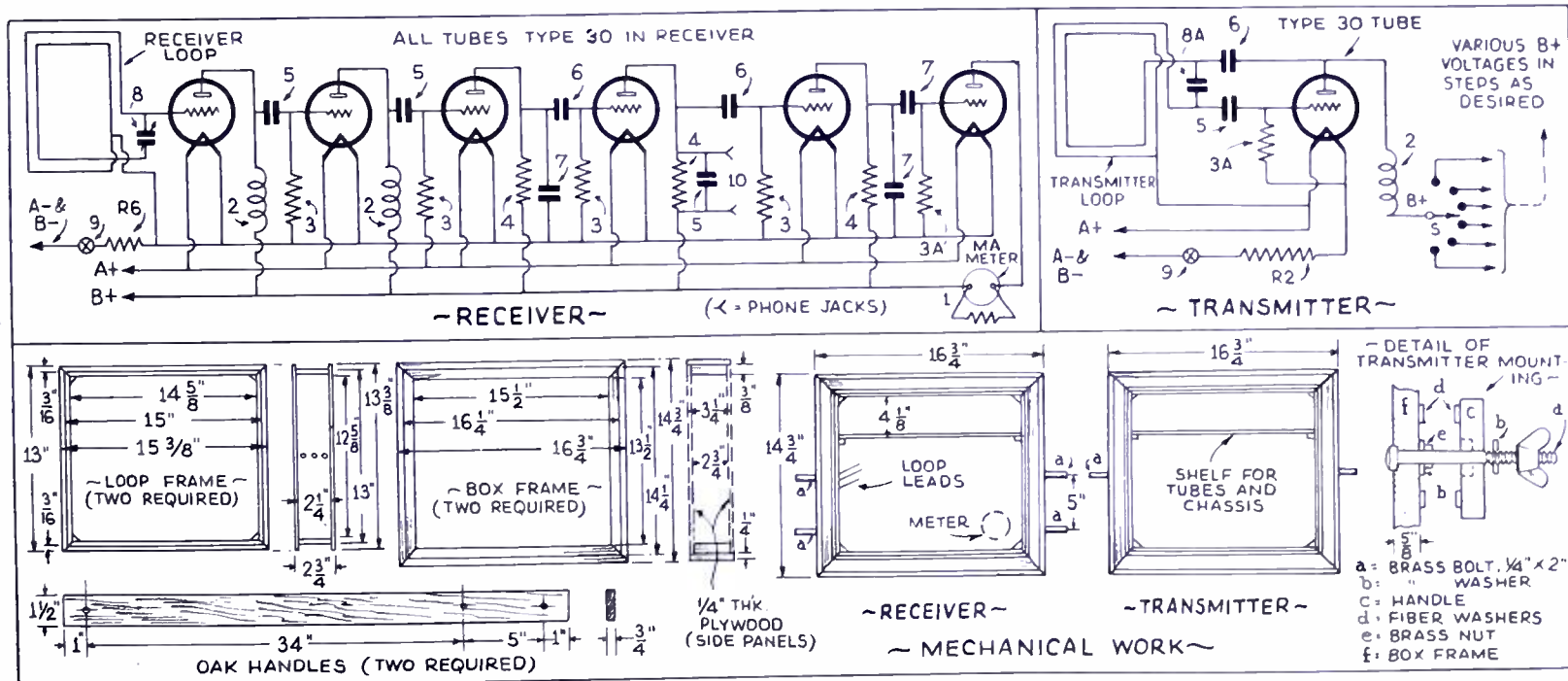
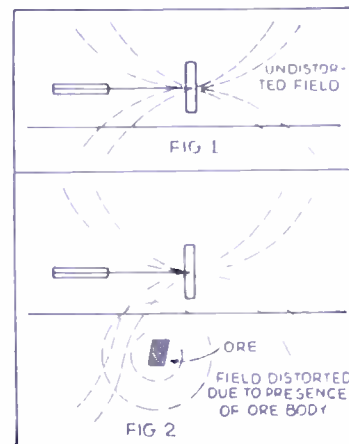

Diagrams of "ore locator" transmitter and receiver; also dimensions of loop aerials and instrument cases.

# Short-Wave Phone A Great Help in Modern *Fire-Fighting*

By H. W. Secor  
Cover Feature

Short-wave phone sets—weighing but a few pounds—complete with batteries, will help greatly in saving lives at conflagrations. Firemen can call for as well as give information of value in fighting fires. A unified command is also made possible for fighting large fires where many groups of men and equipment have to be coordinated.

● THE front cover illustration shows how a five-meter short-wave set, such as a transceiver, may prove very useful to the modern fire-fighter. Short-wave phone sets, such as that shown in use in our cover picture, may be used to ask questions of one of the officers and may also carry valuable information from the chief, for instance, to a trapped fireman. The fire-fighter shown in our cover illustration and who has just rescued a woman, may wish to know

used in many ways, as the accompanying pictures show.

Fig. 1 shows the situation illustrated on the front cover, where a fireman may ask for direction, or again, he might call for a ladder to be raised to a certain place. Fig. 2 shows how firemen's lives might be protected where they are fighting a conflagration from the roof of the same or an adjoining building. The New York Fire Department some months ago had a parallel

case to that shown in Fig. 2, but instead of using short-wave apparatus for establishing communication between the ground and the roof, a telephone line was used. Telephone wires are always more or less of a hazard at such times as these and are liable to get tangled up and disrupted just when they are needed most.

Fig. 3 shows how short-wave phone sets will prove more useful in linking together observers at 1, with officers at

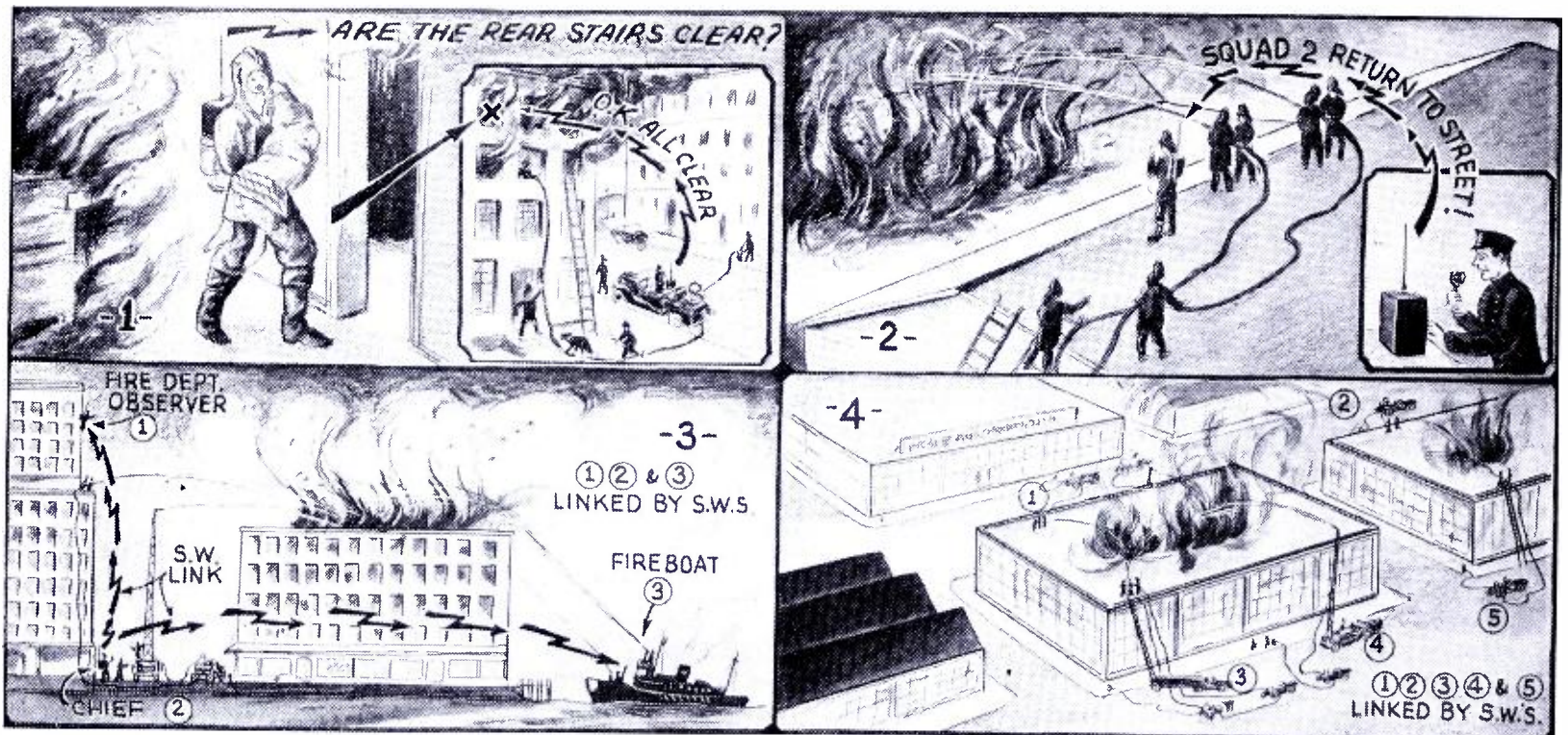

Fig. 1, above, shows how fireman can ask which stairway or ladder to use, via short-wave phone. Fig. 2—short-wave phone sets used to establish communication between the officers and the fire-fighters on a roof. Fig. 3 shows how three important points can be linked by short-wave phone while fighting a large conflagration. Fig. 4—short-wave phone sets are imperative for coordinating various groups of men and fire-fighting equipment.

whether a certain stairway or ladder is still safe for him to use, and he can ask this question by means of his short-wave set and receive an answer instantly.

The short-wave transmitting and receiving set, built with self-contained batteries, need weigh but a few pounds. Some of these portable radio transmitters and receivers designed to be carried on the person have been developed by an expert of the New York Police Department, for example, until it is now possible to have an eight-tube superheterodyne receiver enclosed in a case about the size of a small Kodak. The short-wave set to be used by one of the officers might be a semi-stationary affair, if mounted in one of the fire trucks, or it might be of the portable type. There is no doubt that tomorrow we shall see the fire departments of all of our larger cities equipped with these short-wave "pack" sets, which can be

### IN THE NEXT ISSUE!

"Hams" and "Fans" will find a wealth of interesting and important articles in the June number.

A 125-watt modulator, using 35-T's in a new improved circuit, will be described and illustrated by George W. Shuart, W2AMN.

The Short-Wave Beginner will find a valuable article in his department, describing how to build a DX booster, together with a lot of valuable data on its proper connection.

Arthur H. Lynch, well-known to the Short-Wave Fraternity, is preparing a series on a new "high-quality" transmitter, and this series will begin in an early number.

2, and, finally, with the officer in charge of a fire-boat. Directions and suggestions can be given back and forth as to the best point of attack for the men directing the streams of water, etc.

One of the greatest uses for short-wave phone sets would be in fighting a large fire, such as shown in Fig. 4. Every so often we have a really gigantic conflagration where fire-fighting equipment and companies from all parts of a large city are concentrated, as shown in the picture. Here, one will quickly realize that some means of rapid communication between the officers of the different fire-fighting companies is absolutely essential.

Short waves have been put to practical use in a very novel way by a French fire department. Whenever an alarm is received the person in charge turns a switch, which causes a prearranged sequence of signals to ring bells in the firemen's homes.

# WORLD-WIDE SHORT-WAVE REVIEW

-Edited By C. W. PALMER

## Micro-Micro Short-Wave Tuner

● ONCE in a blue moon, some radio man somewhere (especially in Oshkosh) gets a really brilliant idea (known as a "brain-storm"—if he has a brain).

Here is one of these scintillating ideas—which appeared recently in the form of a letter in *World-Radio* (London). The letter reads—"Sir: I have the pleasure of submitting a simple method for tuning in those elusive short-wave stations, which

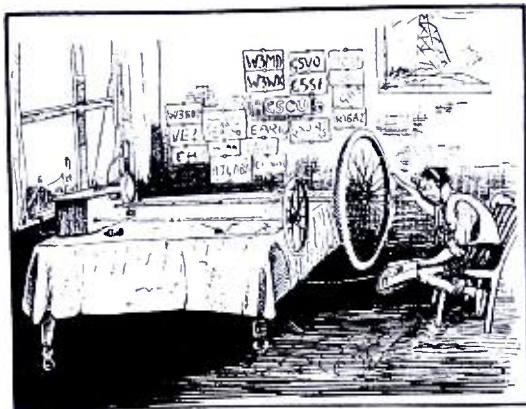

How to tune in those micro-micro-waves!

you may consider good enough to pass on to your readers. I think the drawing is self-explanatory, but should further technical details of the additional components be required, I shall be pleased to supply them. It is amazing what results can be obtained by using such simple apparatus intelligently. (Signed) N. Thusiast."

We might add that a simple improvement which any radio "fan" can add to this outstanding development in the short-wave field, is the addition of a celestial telescope for viewing the dial position—so that the stations (if any) can be found again after they have once been logged.—Hi!

## A Code Practice Oscillator

● BEGINNERS in the mysteries of amateur radio often run up against a stone wall when it comes to learning the code—and any little help which can be offered is received like a drowning man reaching for a straw.

In a recent issue of *Wireless World* (London) a 2-way code practice oscillator which can be made to imitate exactly the high-pitched whistle of a C.W. or I.C.W. transmitter, was published.

Feeling that some of our readers may

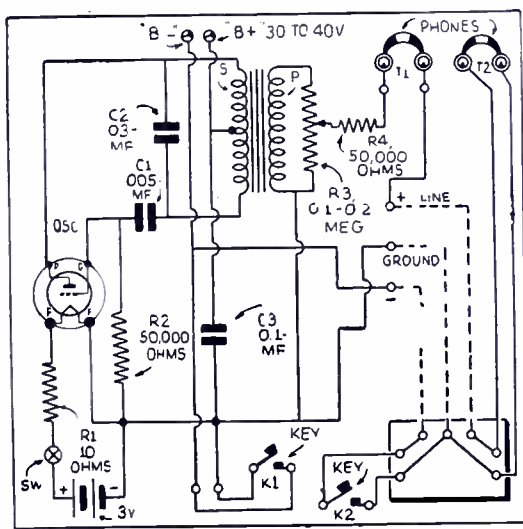

2-way "code-practice" oscillator.

## \$25.00 FOR GOOD 1-TUBE SET

● THE editors know that our short-wave set-builders and experimenters must have developed some extra fine 1-tube circuits—possibly for receiving sets, short-wave converters, etc.

We are therefore offering \$25.00 for a good 1-tube set, either in the form of a short-wave receiver or a converter. Please note that there is little use in sending in an ordinary hook-up for a 3-element tube as most of the circuits possible with these tubes have been published.

What the editors want is a *new* circuit, designed around one of the latest type tubes having a multiplicity of grids. Refer to the March issue, page 675, where a very ingenious 1-tube S-W converter circuit is given. This will give you some idea of what we are after.

As a preliminary, you may send in a diagram and a description of the set and a good *clear* photo or two of it. A list of parts should accompany the description and the editors, who will act as the judges, and whose opinion will be final, reserve the privilege of requiring the set to be sent to them for inspection and test if they so desire. With the dual purpose tubes now available many ideas will suggest themselves. For example—Receivers with R. F. and Detector Stages; Detector and A.F. stage; Detector and Plate-Supply Rectifier; 1-tube Super-het; Reflex set, etc.

find this unit is exceptional utility in learning the code—either with another beginner in amateur radio or even better, with an experienced operator, we are reprinting the circuit with the necessary constants of parts used.

The unit consists of an audio oscillator using a battery type tube, such as a type 30 or any other available triode, and an audio transformer having a low ratio of primary to secondary turns and a center-tapped secondary (such as those used for push-pull amplifiers).

This oscillator is rigged up so that two pairs of phones and two keys are used, with a simple break-in system, one at the oscillator unit and the other at a distance—and connected by a cable to the oscillator unit.

The construction is simple and should be no problem to anyone who has built a few radio receivers.

## A Pocket Aerial

● A RECENT issue of *Practical and Amateur Wireless* (London) contained a short description of a novel aerial which should interest American radio fans.

The aerial, which fits into the pocket (like a fountain pen) when folded, consists of a spiral of thin wire about 16 feet long. The fibre housing with its clip provides a ready means of securing the aerial to some convenient object when the set is in use.

The wire is made of spring metal and can be extended to its full length and springs back into the fibre tube when released. It can be extended to any length (up to its maximum length) and thus provides a ready means of tuning it for short-wave and ultra-short wave work.

The handy radio man can make a similar aerial to this one using spring steel wire and a piece of fibre tubing.

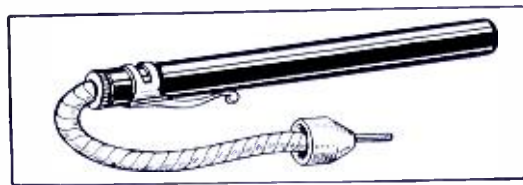

An English idea of a "pocket" aerial.

## Short Wave Condenser

● ENGLISH radio designers often call for a "split-phase" or split stator condenser for controlling regeneration and for other services where it is desired to increase coupling to one circuit and decrease it at the same time in another circuit.

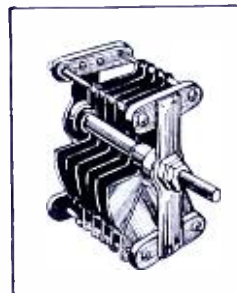

A new type of split-stator condenser which has recently made its appearance on the English market was shown in the latest issue of *Wireless World* (London). This condenser has a capacity of 21 mmf. between the rotor and each stator at full mesh position, and a capacity of 3 mmf. at minimum position.

## Automatic Regeneration Control

● ONE of the main drawbacks to the straight regenerative set for short-wave reception is the difficulty in keeping the set just under the point of oscillation. This requires continual re-adjustment by the operator, as the set is tuned from one part of the dial to another.

An effective way to eliminate this trouble at least to a great extent, was printed recently in *Radio Welt* (Vienna). This consists of providing an alternative path for the feedback currents to travel, in addition to the path through the feedback coil. As shown in the circuit, the resistance R represents a constant impedance shunting the tickler coil, L2. As the frequency is increased, the reactance of coil L2 increases so that the feedback currents tend to pass more and more through the resistance R. This counteracts the tendency of a regenerative circuit to increase in the feedback current as the frequency is increased.

The value of resistor R must be found experimentally for each set of coils to give the correct amount of compensation. This resistance can be made variable—and in-

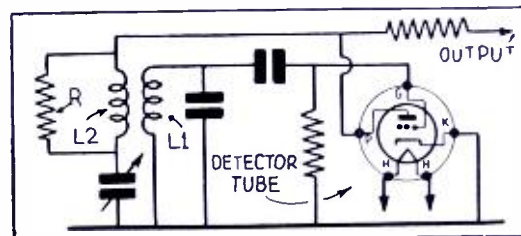

Experimental circuit for automatic regeneration control.

identally provides a very satisfactory control of regeneration for the set.

The effect of compensation can be further increased, if desired, by connecting a

(Continued on page 51)



# FOR the SHORT-WAVE

## Build the

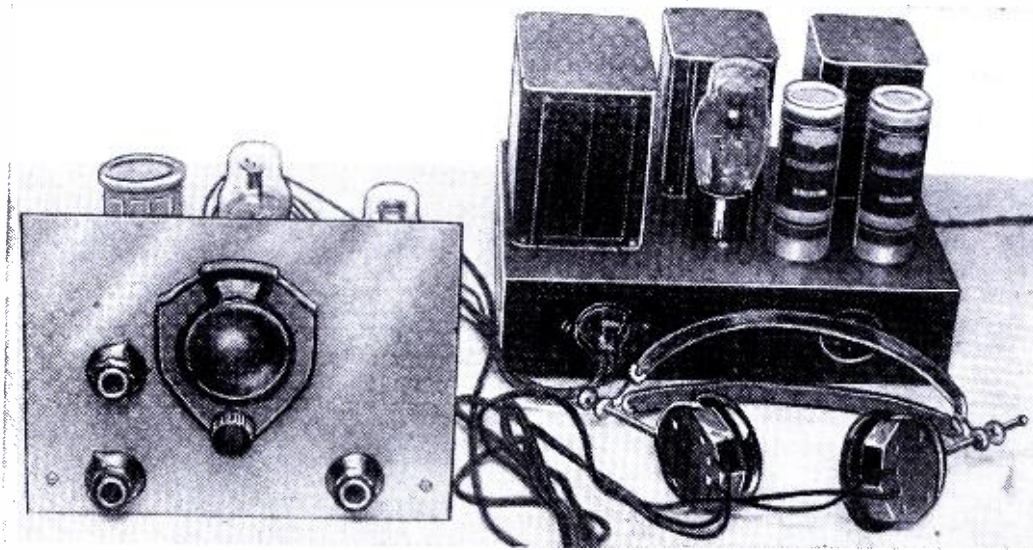

tions that otherwise you could not hear. The interest in these *real short-wave* bands lies in the fact that they are not consistent, and therefore it requires diligence and "stick-to-it-iveness," so that when conditions are right you will hear the stations. Then again, some of these stations only have a power of from 25 to 30 watts and it is really DX when you hear them from Africa or Asia with such low power; recently "foreign" stations have been heard on the *five-meter* Amateur band! There again lies an opportunity for the old DX thrill! And how!

All set to "listen in" on the world! The 2-Tube Beginners' receiver, with power-supply unit. Brush crystal phones are shown, but any sensitive high-impedance phones can be used.

### We Go Down to 2.5 Meters

● IN a previous article in this department we discussed a battery-operated receiver for the Short-Wave Beginner. Undoubtedly there are a good many beginners who desire to start out with a simple *battery-operated* receiver because of its simplicity and low cost. On the other hand, we are sure that a great many can afford the *electrified* type of receiver, which operates directly from the power mains.

The *electrified* receiver offers a good many advantages that cannot be found in the battery-type receiver. The electric set is much more flexible and it is possible to obtain a greater amount of sensitivity, because of the higher voltage at which the more sturdy A.C. tubes operate. In the past, most electrified

beginner's receivers have been limited to covering the short-wave bands from 15 to 200-meters. Today, with the increased activity in the shorter wave bands, for instance, in the *10-meter Amateur* Band, the *nine-meter Police* band, and the *six-meter Television* band, together with the *five-meter Amateur* band, there is considerable diversion from DXing in the ordinary short-wave channels.

One might frown upon this statement, but consider that after you've been listening on the ordinary short-waves for a certain length of time and have heard most of the "hard-to-get" stations, and the urge for adventure strikes you, you can go down to the 10-meter *Amateur* band and hear sta-

For the above reasons we have designed this receiver to operate all the way down to approximately 2½-meters by the simple expedient of *plug-in* coils. The detector used is a 6J5G. This is a triode of the glass type with an octal base recently designed for high and ultra-high frequency service. The output tube can be any one of a number of pentodes; the 41 or 42 being used in this receiver. The complication in the design of the receiver lies in the change from the *high* to the *ultra-high* frequencies. But, by employing a separate socket for the ultra-high frequency coils, and juggling the connections in the regular plug-in coil, the problem was worked out very satisfactorily. For instance, on the regular short-wave bands we needed a 140 mmf. tuning condenser and a 15 mmf. condenser for

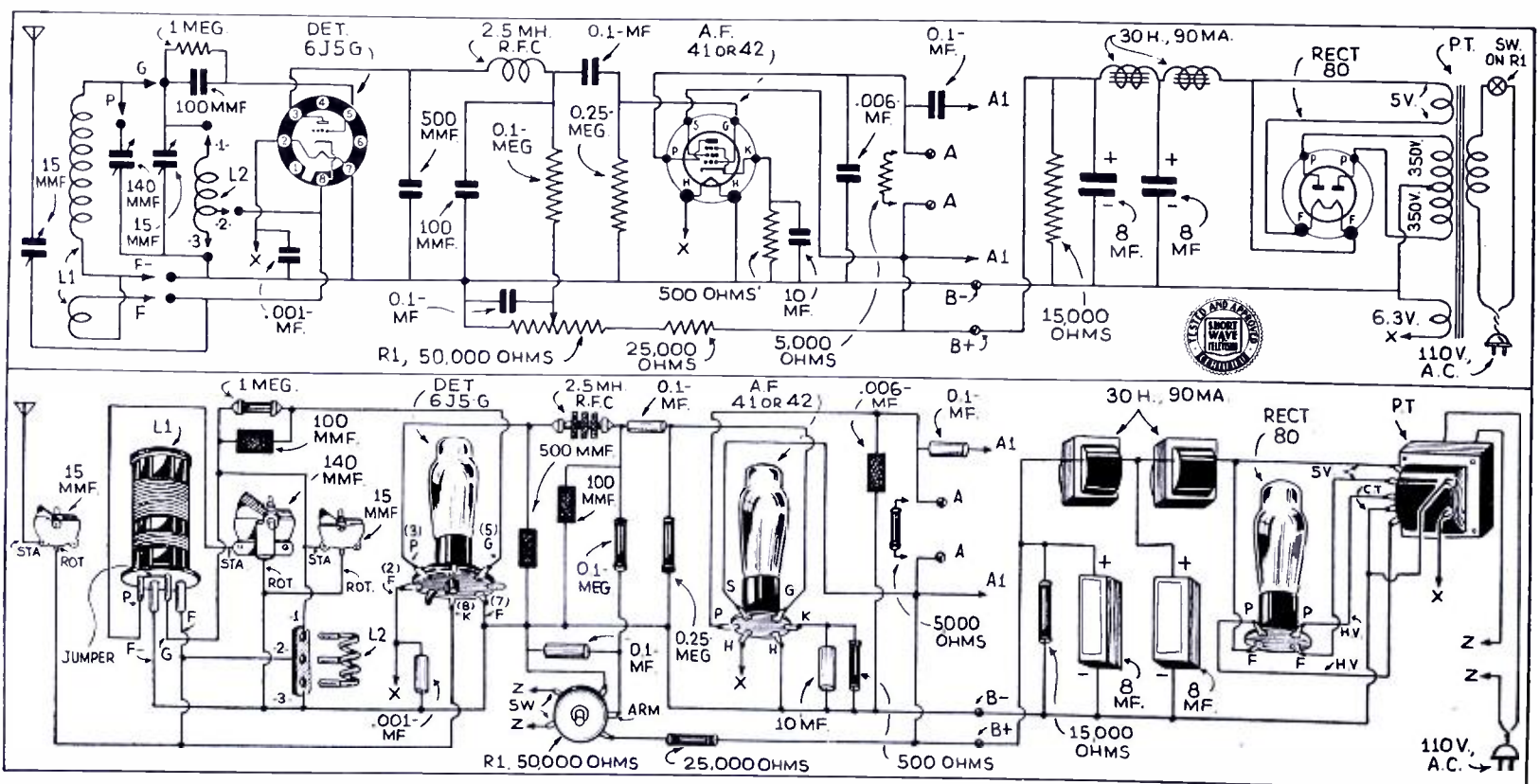

Wiring diagram of the "multi-band 2" receiver. The tubes selected for this set ensure the maximum results.

# BEGINNER

By George W. Shuart  
W2AMN

## "Multi-band 2" and Hear 'em All!

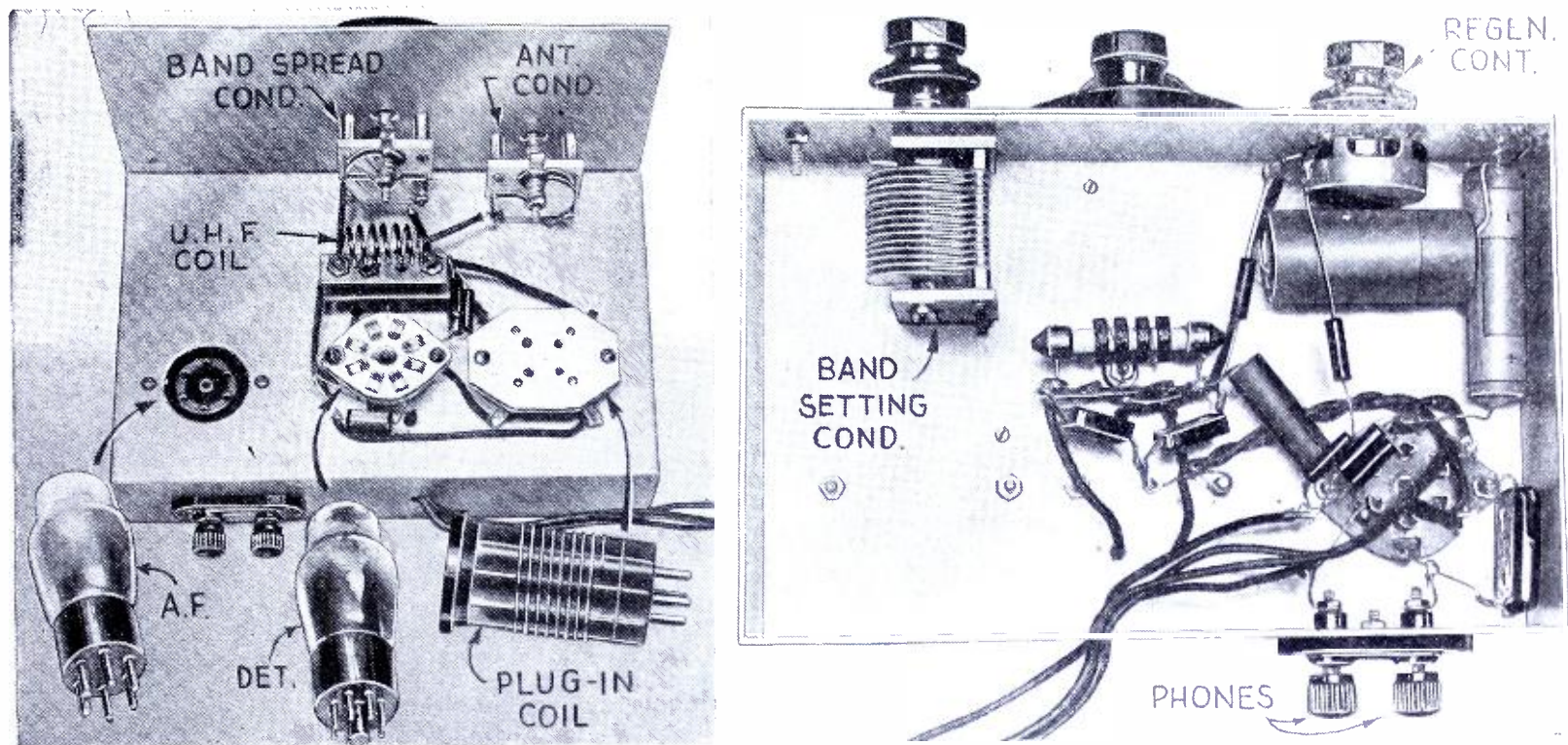

Left—Rear view of the "Multi-band 2"—an ideal A.C. operated set for the beginner. Right—Bottom view of the receiver.

band-spread tuning. By referring to the diagram it will be seen that one prong in the four prong coils is used for two connections—they are the *common grounds*.

### Standard Plug-in Coils Used

The blank prong thus made available is connected to the grid side of the winding, so that when this coil is removed only the small condenser is connected in the tuning circuit. When the large coil is inserted and the ultra-high frequency coil is removed, both condensers are *paralleled* in the grid circuit. Data is given in the coil table for both sets of coils. Standard Hammarlund coils may be used for the ordinary high-frequency bands, by some alteration in the number of tickler turns which are now employed in the *cathode circuit*, in order to obtain satisfactory results. On the average it will be found that three or four turns in this coil will be satisfactory on all bands. Some "cut-and-try" will be necessary, on the larger coils; remove one or two turns at a time until satisfactory results are obtained. The receiver may be operated as a super-regenerator or straight regenerator on the bands from 10-meters down. On all other bands the set operates as a straight regenerative receiver. For satisfactory results in the ultra short-wave bands one plate was removed from the 15 mmf. Trim-Air condenser, leaving four plates, two rotors, and two stators.

### Antenna Coupling

The antenna is coupled directly to the cathode, the cathode coil being employed as an *antenna coupling coil*. The operation of the receiver is exactly the same as explained in the previous article, regarding the beginner's battery operated receiver. Tuning instructions there explained will hold true for this receiver, *except on the ultra-high frequency bands*. On these bands the regeneration control is adjusted to a point when the detector will *hiss* strongly. When the station is tuned in there will be a noticeable decrease in the hiss. One word of warning must be given at this point, and that is, a *super-regenerator of this type will radiate strong and interfering signals at the frequency of operation, if the following points are not carefully observed:*

Never adjust the regeneration control

beyond a point where the detector *just begins to hiss!* In other words, operate the receiver with the regeneration control set as near as possible to the point where the hiss will stop! This will practically eliminate interference with other receivers.

### "Ground" Connections Important

In laying out the receiver, a central point should be established in the chassis for the *ground* and all leads associated with the detector that are connected to the "B" negative circuit should be run to this point. Anything concerned with the audio amplifier need not be treated in this manner.

In constructing this receiver we selected one of the screws which fastened the detector socket to the chassis for the purpose. Under the top and bottom of this screw, that is, above and below the chassis, we placed a soldering lug for these *ground* connections. It will be noticed that the mounting bushings available with the Trim-Air condensers are used for mounting them. In the case of the antenna trimmer and the small tuning condenser, both are thus insulated from the panel. In the photo the large tuning condenser, that is the 140 mmf. unit, is not shown insulated through the use of these mounting studs, but this should be treated in the same manner as the others and all the ground connections from the condenser should go to the soldering lug on the socket which has been established as the *common "ground" point*.

The output (Continued on page 41)

### FEATURES

All-wave Reception—2.5 to 270 meters!

A.C. Operation—110 Vt. 60 Cycle A.C.

Headphones or Speaker.

Bandspread on All Waves.

Power-supply Unit Data Given; also Coil Data, List of Parts, Tuning Hints, etc.

# The "VS-5" METAL TUBE

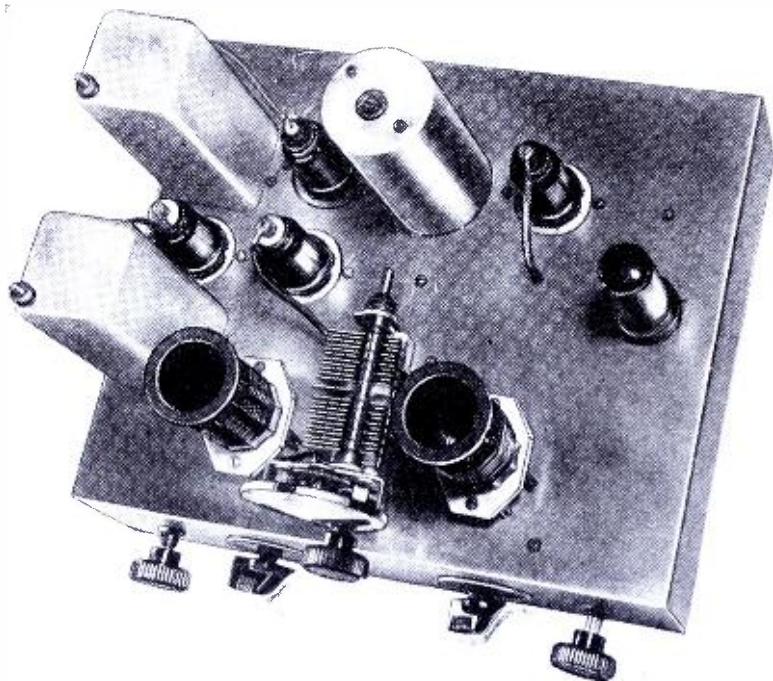

This picture of the "VS-5" Short Wave Superhet, using metal tubes, gives you a good idea of the compact, yet highly efficient construction of this set.

● AS a result of the rapid development and widespread use of the popular amateur and *short-wave broadcast* bands, adjacent channel interference has become the greatest radio problem of today. Under modern conditions, with powerful stations operating on frequencies separated from each other by only a few kilocycles, the ordinary short-wave receiver is almost useless so far as serious DX work is concerned. It is clear then that some method of controlling the band-width passed by the I.F. amplifier from the sharp "peaking" necessary to obtain freedom from interference and noise, too the broad "flat-top" required for high-fidelity reception, is as much a part of the up-to-date short-wave receiver design as AVC or metal tubes.

## Selectivity Control a Feature

The five-tube short-wave superhet shown in the accompanying photographs, has been designed and built around the Hammarlund type VT-465 I.F. transformers in which the mutual inductance between the primary and secondary is *adjustable*. Where a wide range of selectivity is desired, as it is here, these transformers may be attached to a mechanism, as shown in the drawing, and the coupling varied to any point between the two extremities of *selectivity* and *fidelity*. This mechanical method of selectivity control is desirable for the home-made superheterodyne, because no complicated or tricky electric circuits are necessary.

As the schematic diagram, Fig. 1, shows, the electrical circuit is more or less conventional, consisting of a 6A8 mixer-oscillator, two 6K7s as I.F. amplifiers, a 6Q7 detector, AVC and first A.F. amplifier and a 6F6 as output. All of the tubes used are of the metal type, although the corresponding glass types may be used if desired. The AVC action has been used on the mixer section of the 6A8 and on the first 6K7 only; this arrangement was found most satisfactory as it gives more amplification on weak signals. The variable coupling is used on the first and second I.F. transformers; the third transformer is of the fixed-coupling type. All three, however, are "air-tuned," which gives better stability.

## Mechanical Construction

The mechanical construction of this set is not difficult but it is necessary that the dimensions as given in the drawings be followed exactly. The chassis used in this particular model is of electralloy construction, 10x12x3 inches in size. The chassis and panel, if one is to be used, may be obtained ready-punched if the constructor has no means of doing this work himself.

Here is a dandy 5-tube Short-Wave Superhet receiver, which the experimenter will find easy to build. It features a new "selectivity" control and use is made of the latest type metal tubes. The mechanical construction of the set is simple and, with the instructions given, any one can build this very efficient receiver. This set is fine for the short-wave "fan" and complete coverage is provided, all the way from 17 up to 550 meters. AVC and "band-spread" are included.

The variable-coupling mechanism and the two VT I.F. transformers are mounted first. Place the rear bearing and stop plate in its position, temporarily, and cut off the cam shaft to a length which will allow it to protrude about one-half inch as shown in the drawing. It will be necessary to place the cams and the rear bearing on the cam shaft before this is permanently mounted and to see that the front and rear bearings are properly aligned with respect to the shaft. Otherwise, this control may stick or be extremely difficult to operate.

After the transformers are mounted, place the links in their proper positions as shown and make sure that the push rods work up and down freely when the bakelite strips are inserted in their slots. The cams are now placed in the positions indicated. Before these are fastened in place, however, the nuts at the top of the VT transformers should be loosened, allowing the minimum coupling. Now adjust the cams until the coupling of both transformers is varied simultaneously and to the same degree. It is a good idea to file a flat on the cam shaft, once the proper adjustment is found, in order to prevent the cams from becoming loose or slipping during operation.

## How Short Leads Are Made Possible

The sockets of the 6A8 and first 6K7 tubes are mounted with the keys facing each other; the second 6K7 and 6Q7 sockets have their keys toward the variable-coupling mechanism. This arrangement gives the shortest plate leads from the I.F. transformers to the tubes. The various fixed resistors, mica and electrolytic condensers are mounted directly on the parts themselves, their leads being of sufficient stiffness to hold them in place. The use of *dual* paper condensers throughout the receiver simplifies the construction and gives a better appearance to the under-chassis portion of the set.

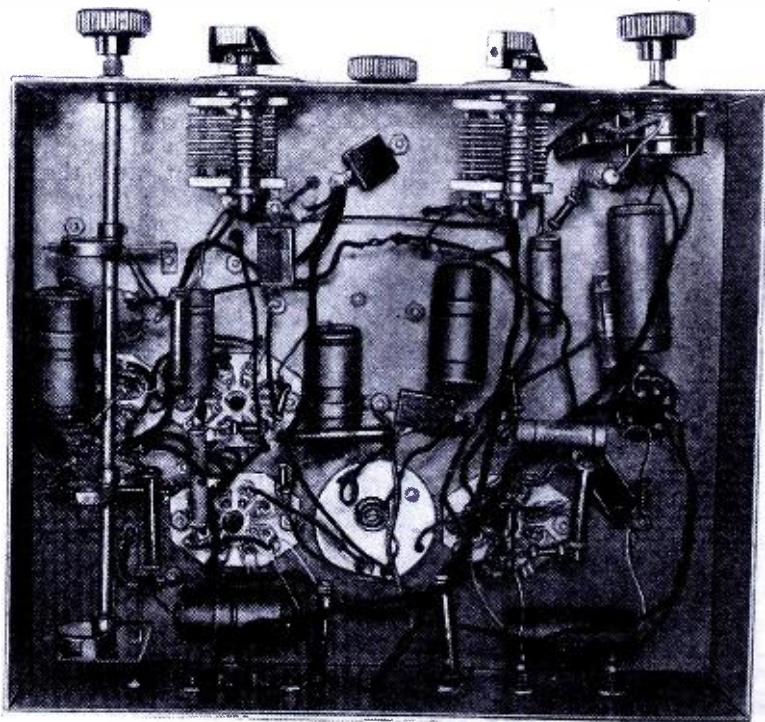

Bottom view of the "VS-5" Superhet. The cam control shaft for the variable coupling I.F. transformers may be seen at the left.



# S-W Superhet

By  
Harry D. Hooton,  
W8KPX

## Wiring Set and Adjusting I.F. Transformers

Starting with the heater circuit, connect the various parts together, as shown in Fig. 1 and the picture diagram, using either the stranded or solid tinned hook-up wire. Keep the leads as short and direct as possible and solder each joint carefully with *rosin-core* solder. The soldering iron must be *clean, well-tinned and hot enough to "sweat" the solder into the connections.* The "B-plus" by-pass condensers must be mounted close to these leads so that the I.F. currents will find a short path to ground. In mounting all of the paper condensers, try to make as many of the negative connections as possible to *one spot on the chassis*; this helps to eliminate the noise and losses caused by eddy currents circulating in the metal chassis. The author found it necessary to shield the lead to the grid of the 6Q7 triode section in order to *prevent R.F. and I.F. currents from reaching the audio circuit.*

If no test oscillator is available, it is best to align the I.F. circuits from some station operating on the broadcast (200-550 meter) band as these signals are usually more reliable than those on the short wavelengths. Remove the AVC volt- (Continued on page 37)

## List of Parts, A.C. Superheterodyne

### HAMMARLUND MFG. CO.

- One 2-gang tuning condenser, 35 mmf. per section.
- Two midget tuning condensers, 140 mmf. each.
- Five padding condensers, 140-220 mmf.
- One "air-tuned" I.F. transformer, 465 kc. (output).
- Two variable coupling I.F. transformers, 465 kc. (interstage).
- One variable coupling mechanism for above.
- Two sets (8) SWK-6 plug-in coils (17-270 meters).
- One set (2) BCC-6 plug-in coils (270-550 meters).
- Four isolantite sockets, metal-tube 8-prong type.
- Two isolantite sockets, 6-prong type.
- Two 2.1 mh. R.F. chokes, midget type.

### CORNELL-DUBILIER

- Five paper condensers, dual .1-1 mf., 600 volts.
- One paper condenser, 0.01 mf., 600 volts.
- One paper condenser, 0.03 mf., 600 volts.
- One paper condenser, 0.05 mf., 600 volts.
- Two electrolytic condensers (or one dual) 25 mf., 50 volts.
- Four mica condensers, 0.00025mf.
- One mica condenser, 0.00037 mf.
- One mica condenser, 0.0005 mf.
- One mica condenser, 0.0001 mf.

### ELECTRAD

- One volume control with tone tap, 500-1000 ohms.
- One wire-wound resistor, 500 ohms, 5 watts.

### ALLIED RADIO CORP.

- One cut and drilled 10x12x3 inch electrical chassis (see Fig. 3).
- One 8x14 inch electrical panel.

### CARBON RESISTORS—I.R.C.

- Five 1/2 watt, 100,000 ohms.
- Two 1/2 watt, 50,000 ohms.
- One 1 watt, 25,000 ohms.
- One 1/2 watt, 250,000 ohms.
- Two 1/2 watt, 1 megohm.
- One 1 watt, 250,000 ohms.
- Three 1 watt, 300 ohms.
- One 1 watt, 5,000 ohms.
- One 1/2 watt, 500,000 ohms.
- One 1 watt, 20,000 ohms.

### METAL TUBES—RAYTHEON

- One type 6A8.
- Two type 6K7.
- One type 6Q7.
- One type 6F6.

### MISCELLANEOUS

- One airplane dial.
- One SPDT switch (AVC "off-on").
- Knobs, dial plates, etc.

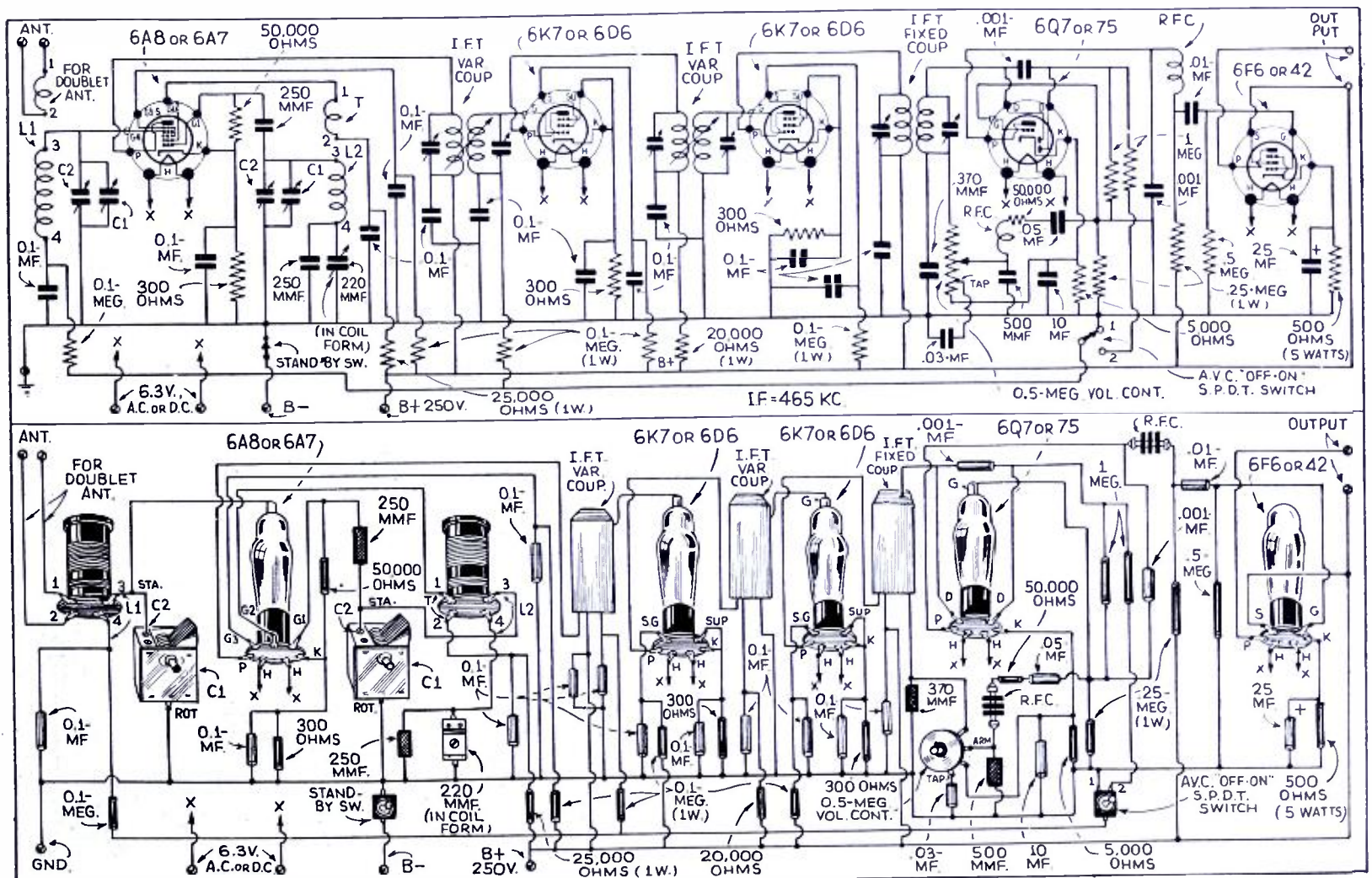

Wiring diagram is given above, in both schematic and pictorial form, for the "VS-5" Superhet.



## Discovered and Described

by

George W. Shuart,  
W2AMN

# Transmitter

it offers the *most perfect oscillator and multiplier arrangement* so far developed. We would recommend of course, that the shell of the 6L6 be grounded and link coupling used between the 6L6 plate and the tube which the oscillator is to drive. Even with 600-volts on the plate of the oscillator, absolutely no indication of a glow was present in the pilot light, either with the plate circuit loaded or unloaded, and it makes relatively no difference whether the 400 ohm resistor is wire-wound, metallized or even of the carbon type. With this circuit, of course, a *good active crystal* must be used. Many of the cheaper and not accurately ground crystals will, of course, fail to start off in this circuit. But this is no drawback, because even *good crystals* are relatively inexpensive at the present time. So much for the *oscillator circuit*.

### The 39 stage

Progressing to the 39 stage of the transmitter we find that it is a conventionally *tuned-plate* affair and it is capacity-coupled to the oscillator. This stage is thoroughly capable of driving the two RK 37's even when the 39 acts as a doubler, for it is possible to drive the grid current to 65 milliamperes in the final amplifier, which is considerably greater than the manufacturers recommend for efficient operation. It is very important that the RK 39 be shielded. The shield should extend up to the top of the tube and should not fit too closely around it. Also it is advisable to have a number of holes around the bottom and top of the shield in order to provide adequate ventilation. The final amplifier is also very simple and conventional. It is capacity coupled to the driver stage in order to simplify matters.

The two tubes were used in parallel in an effort to further simplify the transmitter, for in push-pull an additional tuned circuit would have been required, and the plate circuit of the driver would have also been more complicated. Down to 10 meters there is apparently no difference in the output of the 2-tubes, whether they are connected in push-pull or parallel. The plug-in coils for the oscillator and buffer-doubler are wound with heavy tinned copper wire on National R-39 forms. The plate coil of the final amplifier is wound on the new National XR forms and presents a very convenient arrangement, inasmuch as this coil and its mounting can (Continued on page 52)

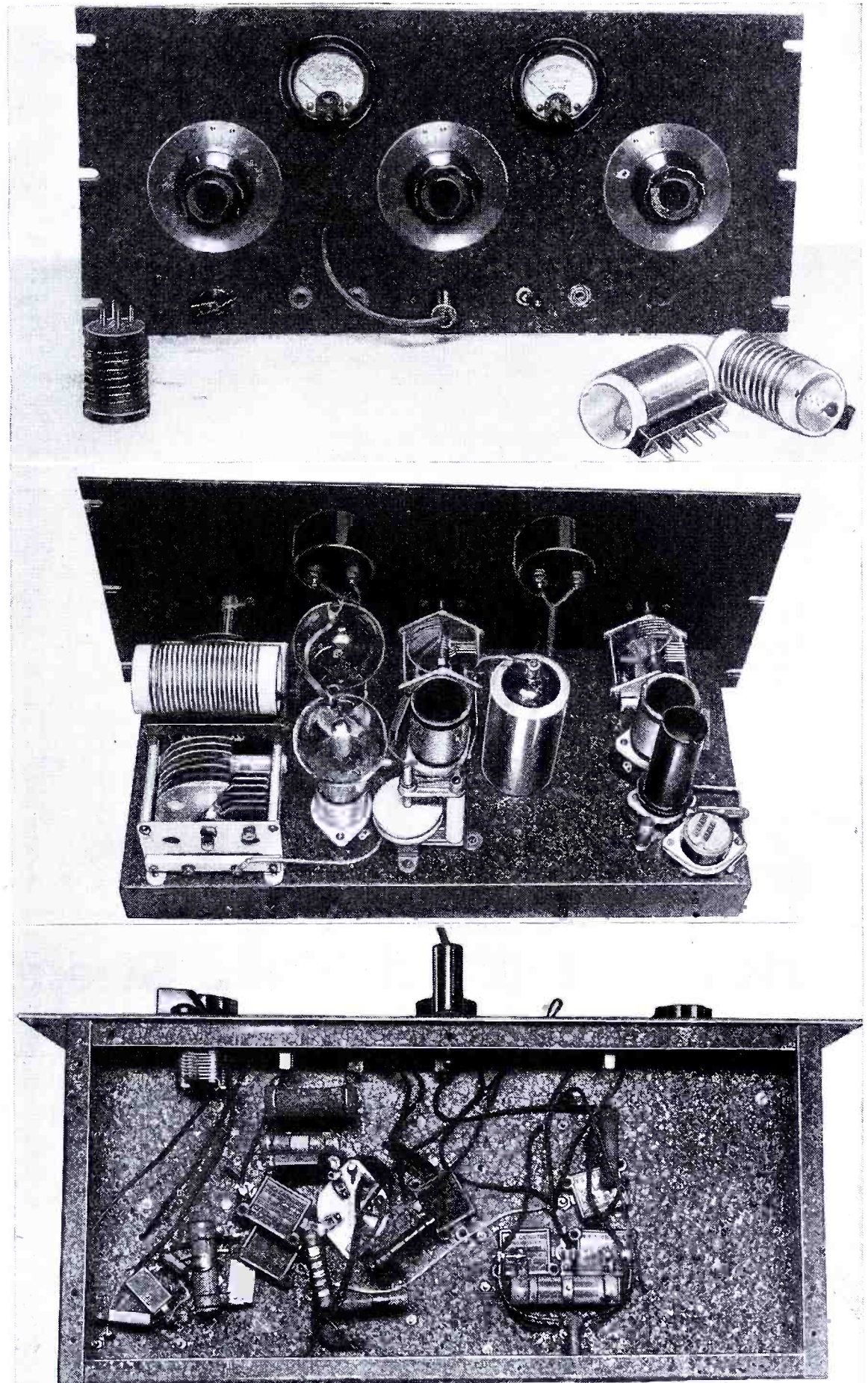

Top: Front view of the complete 150-watt Transmitter. Plug-in coils for different bands are shown.

Center: A peek at the rear of the 150-watt Transmitter. Note that the final-amplifier plug-in coil is mounted between the two sections of the split-stator condenser. The crystal is mounted at the extreme right. The two-plate neutralizing condenser is seen at the front center. Lower photo shows bottom view of Transmitter.

# A Vibrator Power Supply

By Maurice E. Kennedy  
W6KQ-W6BGC\*

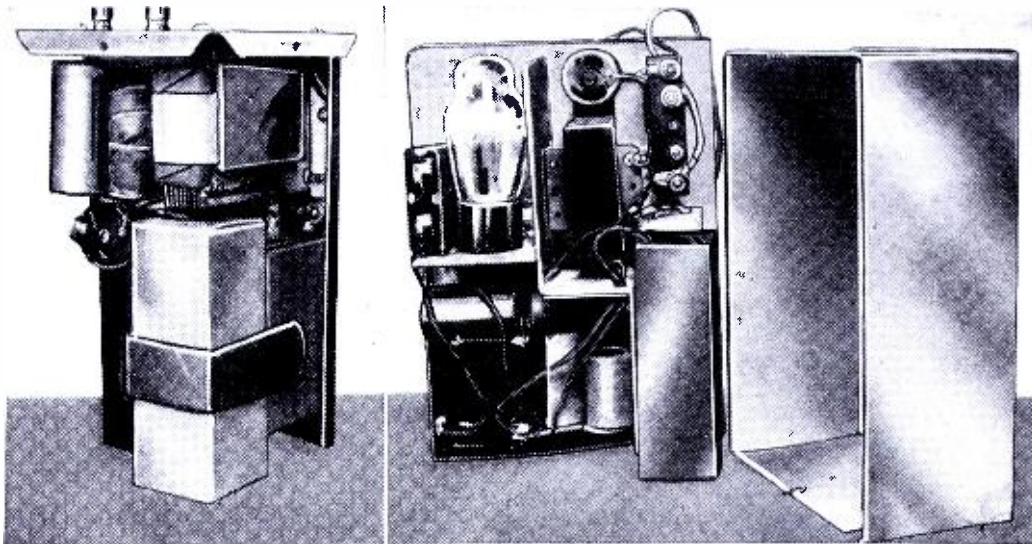

Appearance of Vibrator Power Supply units built by the author.

5-meter work and the chokes may be wound by the constructor. The self-supporting *choke* in the hot 6-volt lead is wound with 25 turns of number 12 enameled or D.C.C. copper wire, on a 1/2 inch diameter rod. When finished, slip the rod out and the choke is ready to solder in place. The R.F. choke in the positive output lead may be wound with 100 turns of number 30 D.C.C. wire on a 1/4 inch bakelite rod or use any available R.F. choke in the vicinity of 10 m.h. of the type used in receiver construction. This choke in the high voltage lead is not critical and may be unnecessary if the power unit is used to supply a "broadcast band" receiver or audio amplifier.

The two .01 m.f. condensers shown connected across the transformer's high voltage secondary terminals are used to keep the high flash voltage down, while the rectifier tube is warming up. These condensers should be mica or a good grade of paper as the a.c. voltage is high enough to puncture poor condensers.

Connections are made to the power unit by means of three binding posts or terminals. One terminal connects to the ungrounded or *hot* side of the car storage battery, the second is grounded to all parts of the power unit and metal can, and connects to the grounded

(Continued on page 38)

● INEXPENSIVE plate power for the 5-meter mobile station, the small public address truck, and the "farm" radio has always presented quite a problem to the amateur and constructor. In this article, I will describe the simple construction of *vibrator* power units to operate from a 6-volt storage battery and furnish 225-volts at 50 m.a. to the load.

Most radio supply houses carry the necessary parts and the total cost should not be over five dollars. The power transformer is of the type used by auto-radio manufacturers, the vibrator may be any of the simple single-reed replacement vibrators having a contact on each side of the reed, the filter condenser is an 8-8 mf. electrolytic, the filter choke is a small 20 henry choke of the type used in receiver construction, the tube socket is a five prong wafer type, and the rectifier is an 84-6Z4.

If a suitable metal box to house the power unit doesn't happen to be on

hand, a local tin-shop will make one up from scraps of body steel or heavy gauge sheet metal for a few cents. The box should be large enough to allow ease in mounting all parts and the exact size will depend on the dimensions of the transformer and available parts. The photographs show two power units built in different sized metal boxes.

The use of R.F. chokes in both the input and output leads is necessary for

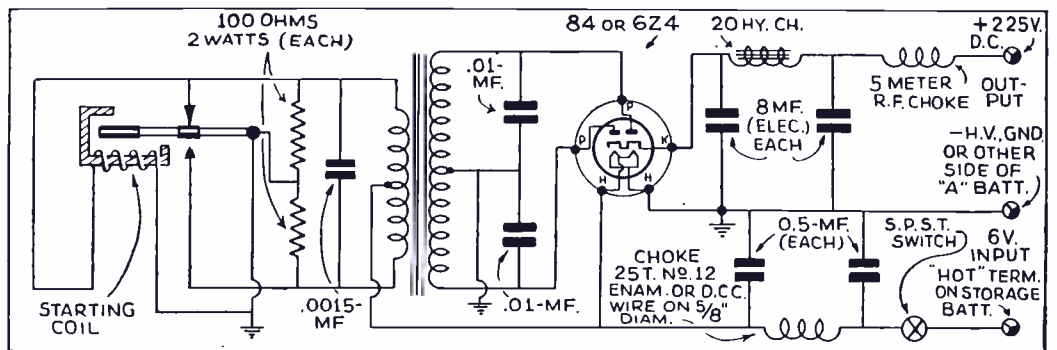

Wiring diagram of Vibrator Power Supply.

\*Radio Engineer, Los Angeles County Flood Control District.

# How to Build a "Field Strength" Meter

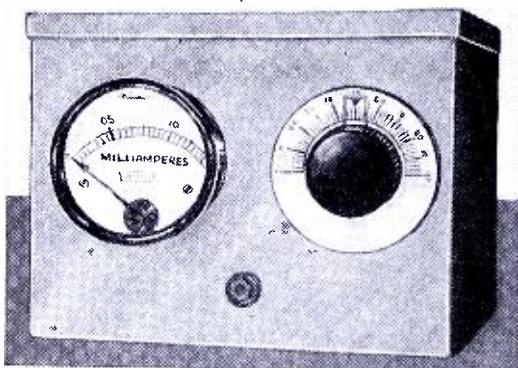

Front view of the completed field strength indicator.

● ALTHOUGH in the last year or so it has received more attention, the radiating system still remains the weakest link in the amateur transmitting layout. In many cases lack of space and facilities forces the amateur to make shift with a comparatively imperfect antenna. In these cases it is essential that the existing antenna be operated

at optimum efficiency and adjustment.

The purpose of this article is to describe a simple, inexpensive, yet useful field strength indicator. As its name implies, a field strength indicator is used to measure the strength of the radiated signal at a given point. In order to read this value quantitatively we should require an extremely complex and expensive laboratory instrument. We are not, however, interested in a quantitative reading, for all we need is a *comparative* reading which will show whether one of a number of adjustments is giving the best results.

The field strength indicator is a simple diode detector which rectifies the signal received and measures it on a low-reading D.C. milliammeter. Most of the components should be available in the amateur shack, and the first cost works out a great deal less than a thermo-coupler galvanometer. Fig. 1 shows the wiring diagram. The physical layout is unimportant and may be arranged to meet individual taste or the

limitations imposed by the apparatus  
(Continued on page 43)

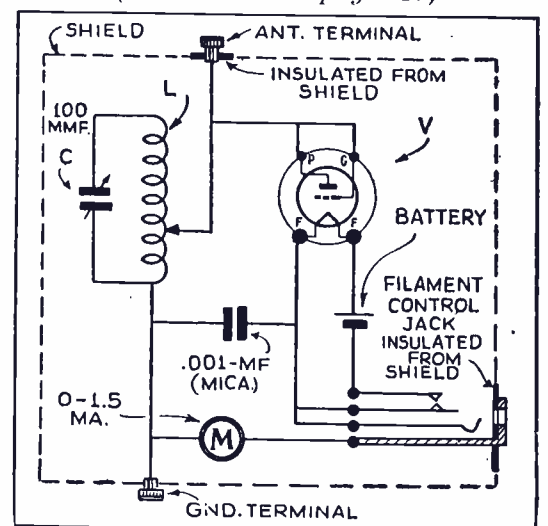

Circuit diagram of "field-strength" indicator. C—100 mmf. L—Wound with suitable number of turns to tune band required. V—2-volt Triode. M—0-1.5 ma. milliammeter.

# WHAT'S NEW

# In Short-Wave Apparatus

The short-wave apparatus here shown has been carefully selected for description by the editors after a rigid investigation of its merits.

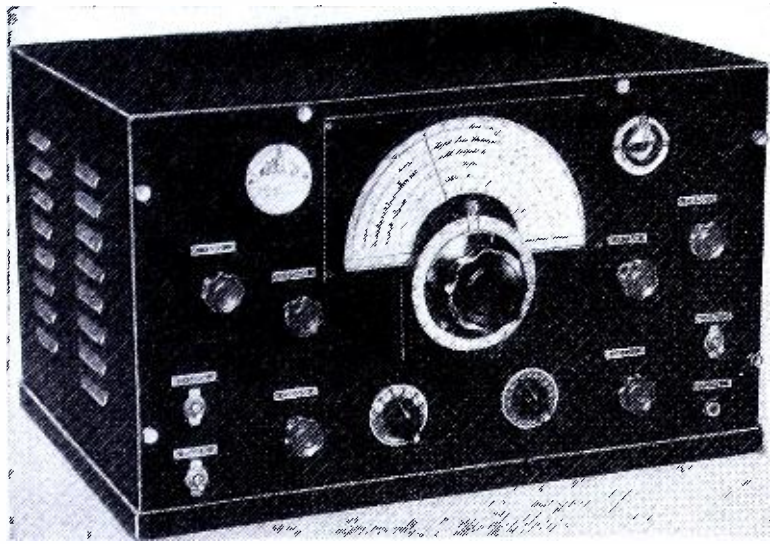

## Sargent Model 21 Super-het Has 12 Tubes

This "all-wave" receiver has its own built-in power supply, beat oscillator, regeneration and band-spread dial. It tunes in the 10-meter stations very effectively; this set is suitable for "Fan" or "Ham."

← Front panel view of the new Sargent Model-21 Super-het.

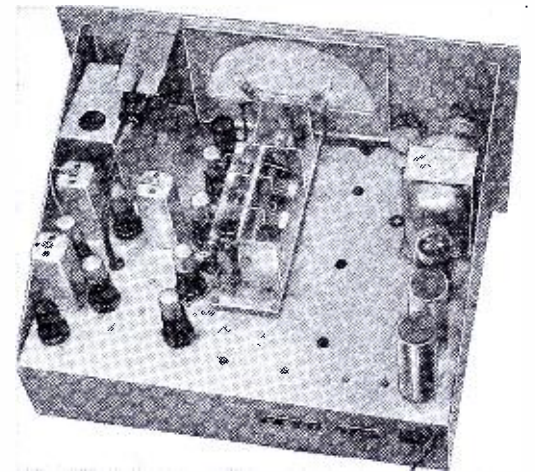

Rear view of new 12-tube super-het, suitable for requirements of the short-wave "Fan" as well as the "Ham."

● BOTH mechanically and electrically, this receiver has been constructed to the very highest standards. Prime consideration throughout has been given to the electrical efficiency and the layout has been arranged accordingly. Efficient reception at high frequencies requires short, direct leads, with individual parts so arranged as to make this possible. Coils, condensers, etc., associated with input circuits must be removed, and shielded from the output part of the receiver, otherwise feedbacks occur. With proper arrangement of parts and wiring, high efficiency and stability are obtained, and these two factors have been the objectives in designing and laying out the Sargent Model 21-12 tube receiver

**The Circuit:** This receiver is a super-heterodyne, and uses 12 tubes, including the rectifier. The circuit consists of a single stage of sharply-tuned, radio-frequency amplification, in combination with a regenerative circuit. This gives an extremely sensitive, non-critical regenerative input over the entire tuning range. The amplification and selectivity of this regenerative input stage are greater than that obtainable with 2 stages of non-regenerative amplification.

A 6L7 tube is used as a mixer, or 1st detector, with separate high-frequency oscillator. The intermediate amplifier consists of 2 stages of Litz-wound, iron-core type transformers. The second detector is a triode with separate A.V.C. and beat-oscillator tubes. The output stage is a 6F6 pentode. A 6E5 shadow-tube is used as a tuning indicator.

**Tube Line-up:** Tube line-up is as follows: 6K7 R.F. stage, 6J7 regenerator, 6L7 mixer, 6J7 H.F. Oscillator, two 6K7 I.F. stages, 6C5 2nd Detector, 6J7 Beat-Frequency Oscillator, 6J7 Amplified A.V.C., 6F6 Audio, 6E5 Tuning Indicator, 5Z3 Rectifier.

**Amateur and Commercial Models:** This set is supplied for both Amateur and Commercial (Marine) tuning ranges. Amateur model tunes from: 9.5 to 550 meters, Commercial model from 9.5 to 3,750 meters! With the exception of tuning ranges, these 2 receivers are identical in every respect. The Commercial tuning range is continuous, there being no skips or dead-spots! The dial is marked with shaded areas for both the short-wave "ship" bands and "amateur" bands. Calibration is in M.C. from 9.5 to 200 meters, and in K.C. from 200 to 3750 meters.

### Tuning Band

The "Amateur" model has 5 tuning bands, as follows:

32-18 M.C.	9.5-16.7 Meters
18- 9 M.C.	16.7-33.3 Meters
9- 4 M.C.	33.3- 75 Meters
4-1.5 M.C.	75-200 Meters

(Continued on page 47)

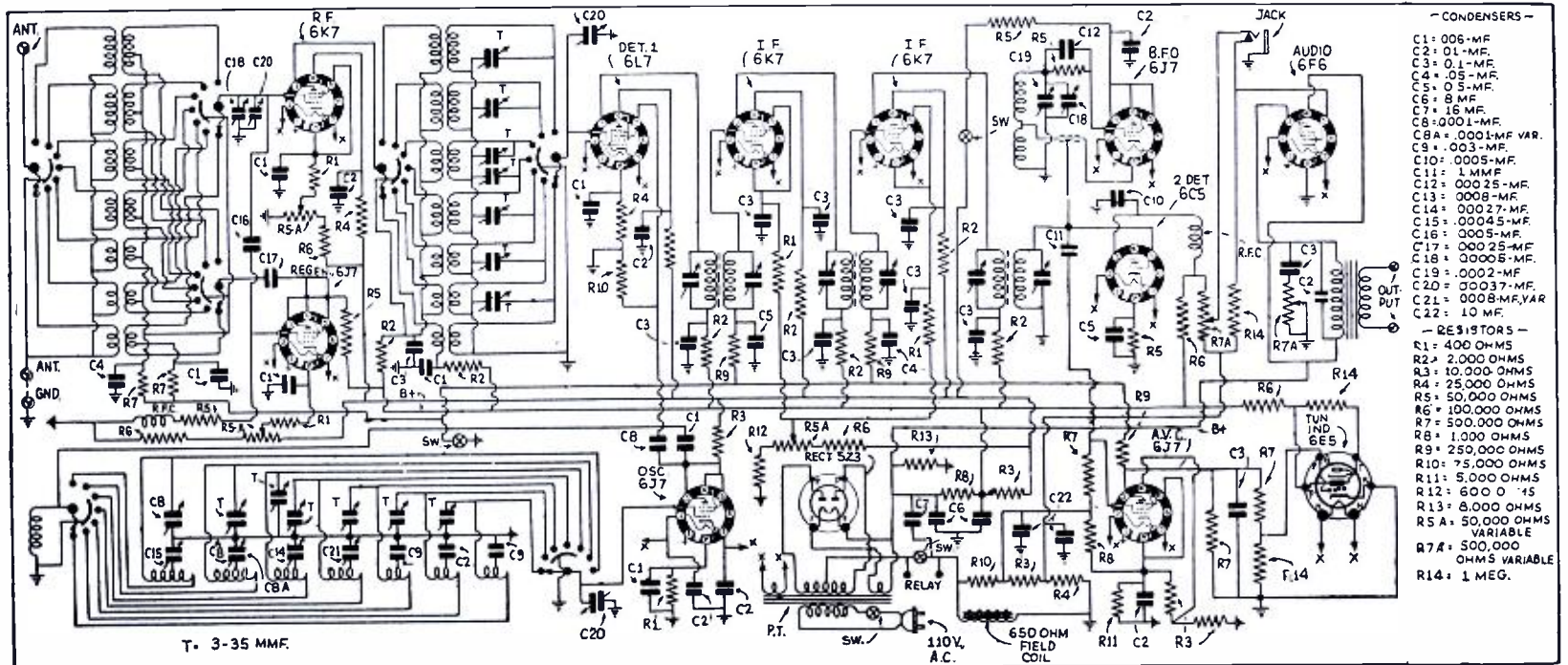

Wiring diagram of the Sargent Model-21 "all-around" receiver. It is available in two models—the "Amateur" model covers wavelengths from 9.5 to 545, and the "Commercial" model has, in addition to this coverage, complete response from 545 to 3,750 meters.

Names and addresses of manufacturers of apparatus furnished upon receipt of postcard request; mention No. of article.

# NC-101 X Receiver—An Ideal "Ham" Set

Features "Crystal Filter"—Unusual Band-Spread—C. W. Oscillator—10 watt Power Output—Band-Change Switch

Quick band change is effected by the same unique coil-shifting mechanism as used in the NC-100. Each of the five Amateur bands are spread over 400 divisions on the dial of the ever-popular PW Condenser. Special S.F.L. condenser plates, double-spaced, insure exceptionally low temperature drift. The receiver (self contained except for the speaker) may be readily converted for relay rack mounting with the brackets available. Those interested in the hook-up of this receiver may refer to page 302 of the September issue.

*This article has been prepared from data supplied by courtesy of the National Company*

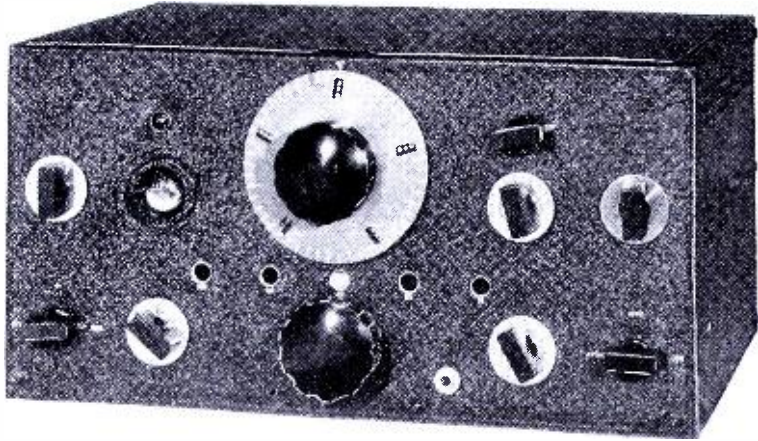

Front view of the NC-101 X "amateur" type receiver. Has 12 tubes, unusual bandspread and "built-in" power supply.

● THIS National receiver has been specially designed to cover the *amateur* bands and, moreover, it has a crystal-filter—ensuring the highest selectivity. The five bands covered, with unusual band-spread, are 1.7-2.0 megacycles; 3.5-4.0 megacycles; 7.0-7.3 megacycles; 14.0-14.4 megacycles; 28.0-30.0 megacycles. Among other important features demanded by every "ham," we find: single-control tuning, permanent calibration, a tuning indicator, amplified-delayed AVC, crystal-filter, C.W. oscillator and 10 watt power output. This receiver also has its own "built-in" power supply, 10 inch dynamic speaker and 12 tubes of the latest type.

Since only these relatively narrow bands are covered, more efficient coupling between high frequency stages is possible which results in greatly improved image ratio and performance at high frequencies over the conventional all-wave receiver. One R.F. and two I.F. stages are employed in the 12 tube circuit which includes the 6E5 tuning indicator tube. The Lamb Single Signal crystal is standard equipment. Separate controls are provided for Selectivity, Phasing, R.F. Gain, Audio Gain, Tone, C.W. Oscillator and AVC.

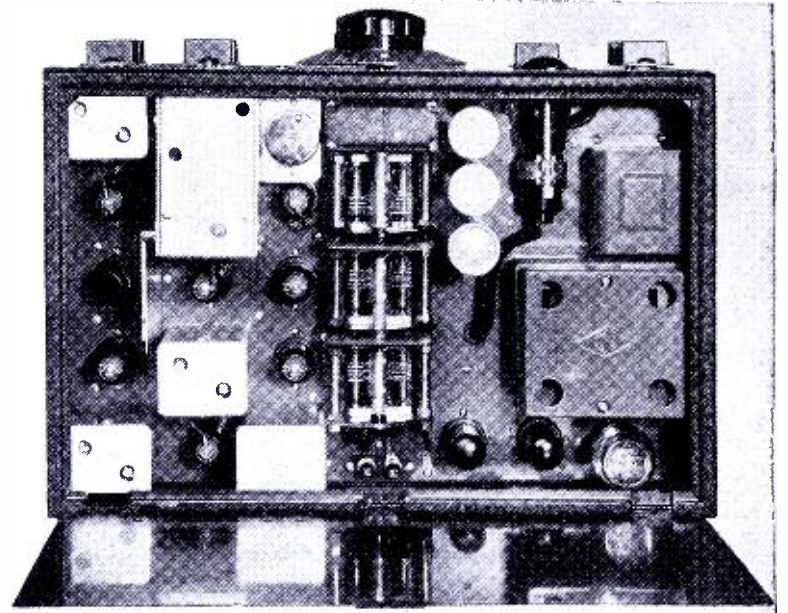

Top view of the NC-101 X—the last word in "amateur" receivers (No. 614).

## The New ACT-20 "HAM" Transmitter

● THE ACT-20 Amateur Transmitter has been designed for the amateur who wants the reliability and operating ease of factory-built equipment, at low cost. The transmitter features *single-control* panel tuning, full amateur band coverage up to 30 megacycles, and complete telephone and C-W telegraph operation. The entire equipment is mounted on a single chassis and housed in a cabinet no larger than the average communications receiver.

This transmitter is particularly desirable for operation in the 28-to-30-m.c. band. Capable of full power output at these frequencies, while offering both dependability and efficiency, it brings world-wide 10-meter communication within the range of its owner.

The r-f system has been designed to make possible rapid changes of both frequency bands and frequencies within any band, with a minimum of adjustment. This is accomplished by arranging the oscillator and buffer-doubler stage circuits, so that coils and crystals of adjacent frequencies can be interchanged without the necessity of retuning the plate circuits each time. The final amplifier stage is tuned in a conventional manner.

The completely crystal-controlled oscillator employs an RCA-807 *beam-power tube* in a conventional circuit. Special consideration has been given to

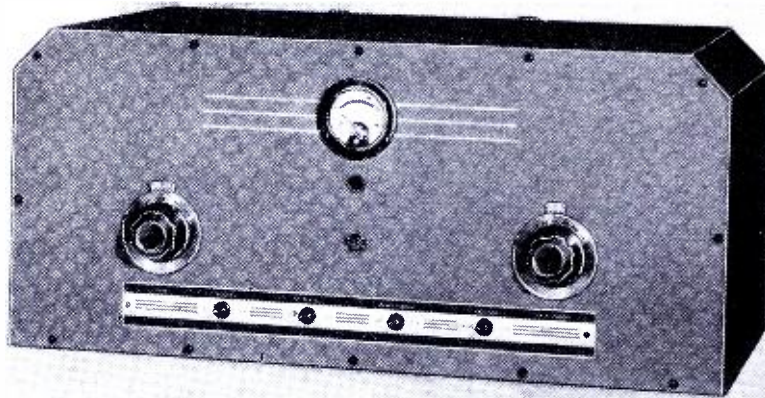

Front view of the newest sensation in "Hamdom"—the RCA 40 watt C.W. and phone transmitter.

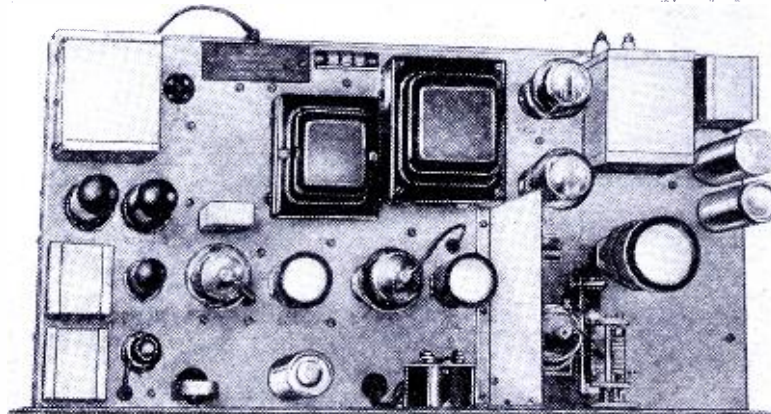

Top view of the new ACT-20 Transmitter—It should make many friends (No. 615).

the design of the tuned-plate circuit. Tuning is accomplished by a small capacitor mounted on the chassis. This capacitor may be adjusted for a crystal frequency in each of the 1.715, 3.5 and 7.0 megacycle bands, and for several frequencies in a band, so that when its capacitance is less than that required for any other crystal, the oscillator will perform satisfactorily with all crystals without retuning. This means that any frequency may be used in any of these three bands by plugging in the proper crystal and coil, without further oscillator tuning. When a 14 m.c. crystal is used, individual tuning adjustments are necessary.

The buffer-doubler stage consists of an RCA-802 R-F pentode, in a conventional circuit employing special plate tuning, similar to that described for the *oscillator*, except that in the 1.715 and 3.5 bands, an additional tuning capacitor is mounted in each coil form. These capacitors make it possible to operate on a frequency in these bands and one other band *without retuning* the buffer stage. This means that by adjusting both chassis and coil capacitors to an oscillator frequency or harmonic, *no retuning will be necessary when shifting bands*.

The final amplifier employs an RCA-807 *beam-power tube* as a Class C amplifier. The tuning capacitor for this stage is  
(Continued on page 56)

Names and addresses of manufacturers of apparatus furnished upon receipt of postcard request; mention No. of article.

# The MEISSNER ALL-WAVE 12

By Clifford E. Denton

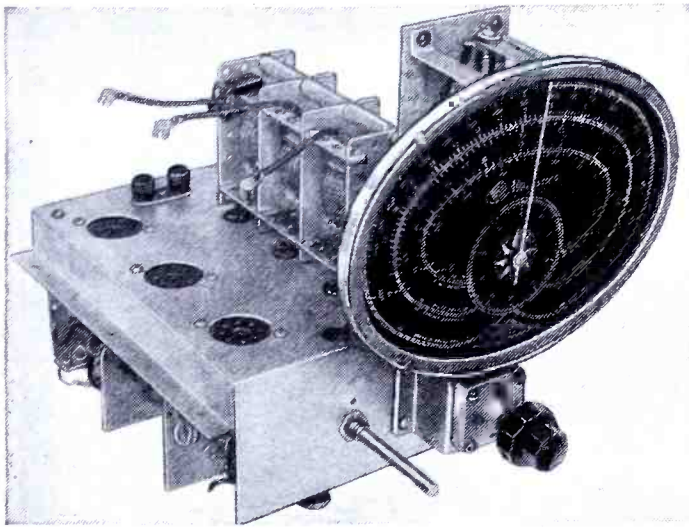

A "close-up" of the Band-switch and Coil-unit, together with the large Pre-calibrated Dial. This unit comes all wired.

Attention! Short-Wave "DX" Hounds. Here's a set that warrants your attention. It is a 12-tube all-wave superhet which can be built from a "kit"; the band-switch and coil-unit are all factory-wired and calibrated. The set has all the latest features, including Noise Silencer—AVC—Beat Oscillator—High Fidelity and Band-spread. The output stage employs two 6L6's in push-pull, which provides a tremendous audio signal.

● EVERY TIME we get into a conversation concerning radio it goes something like this. "I want to build a real All-Wave receiver. It has to have A.V.C., High Fidelity B.C. Band, that new Noise-Silencer Circuit and a Beat Note Oscillator. Say, what about the new beam power tubes?" This goes on for a while and the final question is always the same. "Where can I buy the parts?" Well, the answer to that is simple. You can buy the parts anywhere, as long as you know what you want. First you have to have the circuit and the list of parts necessary to construct the receiver that you have in mind. Secondly, you should have suitable test equipment to align the receiver after it is built. In most cases this requirement for test equipment is the real "stumbling block" for the would-be constructor. Knowing that the problem of suitable test equipment imposes a real obstacle on the set-builder, has caused the writer to hesitate in making recommendations as to a kit especially of the multiband type.

However, the All-Wave 12 incorporates so many features desired by set-builders and is so designed that the complicated tuning units and switching controls are *pre-wired* and *calibrated*, which eliminates the necessity of any but the simplest types of test equipment for satisfactory operation and construction, that the writer does not hesitate to recommend this kit for the experienced set-builder and the "dab-ber" alike.

With all of the tuned circuits *pre-tuned* and this includes the I.F. and Noise-Suppressor transformers as well, satisfactory results can be obtained with a very reasonable amount of re-adjustment to compensate for variations in circuit wiring and tubes. If the construction directions are

followed carefully, these final re-alignment adjustments can be completed in short order. *(Continued on page 39)*

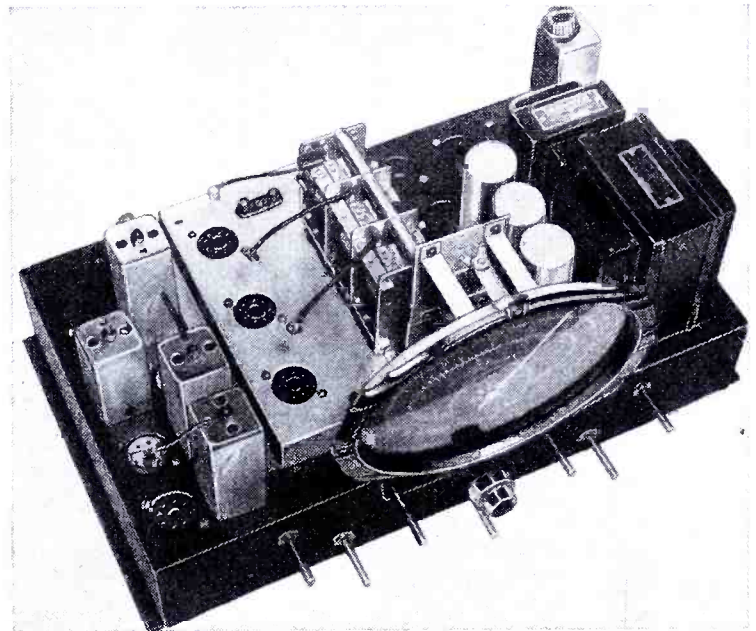

Here's the complete 12-tube Superhet—a peach of a job. Anyone can build it easily from the "kit," thanks to the elaborate instructions accompanying it.

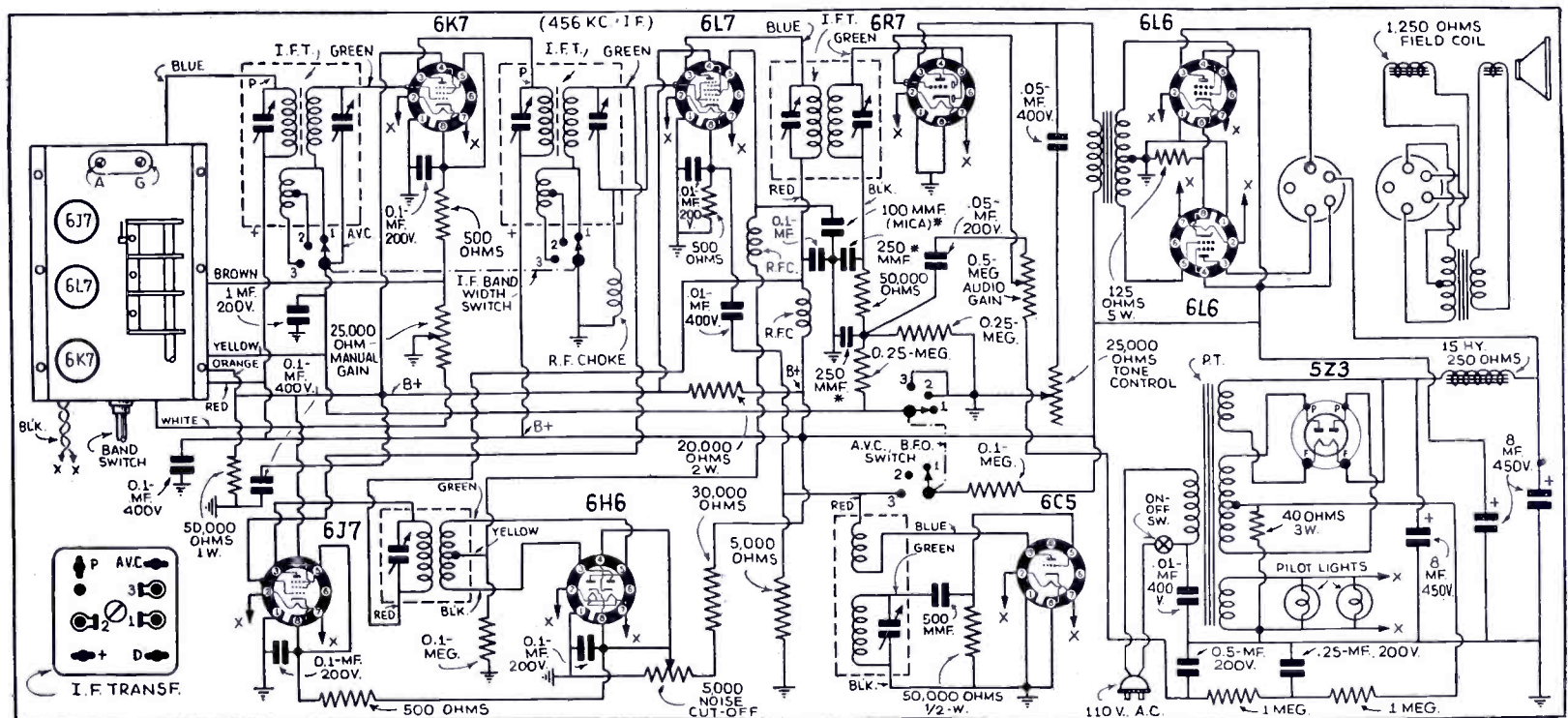

The wiring diagram for the "All-Wave 12." The most complicated wiring, that of the band-switch coil unit, is all finished at the factory.

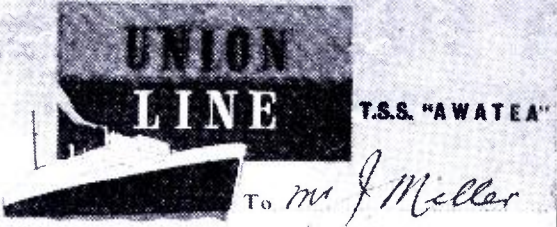

ZMBJ: "The Ears & Voice of the Tasman"  
 XMITTER: 300-400 Watts Output XTAL Controlled  
 AERIAL: 90 Ft Vertical  
 RECEIVER: 16 V Superhet on Doublet Aerial  
 between funnels

Thank You for Report 73  
 of 13/12/36 on 22 meters (13,600 1/2)  
 Verified A  
 Operator

ZMBJ—The S.S. "Awatea's Q.S.L. comes into port.

VEREENIGING VAN RADIO - AMATEURS  
 VOOR BANDOENG EN OMSTREKEN.  
 P. M. Y. Bandoeng, Nillmy-Building.  
 JAVA, NETHERLANDS INDIES.

We received your useful report on our transmission and thank you very much for it. It checks correctly with the stationlog.  
 The transmitting-station you heard is located at Bandoeng, Java, in a building, situated in the centre of that city, one of the capitals of the Netherlands Indies.  
 Our wavelength is 58 meters, power 0,6 kW. Call-signal: PMY.

The Hon. Secretary.

PMY—Java—a neat veri card from a nice catch!

# LET'S "Listen In"

With

*Joe Miller*

● REVIEWING reception conditions the last month (Feb.) one must remark upon the unpredictable reception from day to day, and from week to week.

Looking back over the same month a year ago, one could not help but notice the marked instability of reception, and of the lack of similarity in DX conditions of this year, compared with Feb. 1936.

The 20 meter band is one of our best DX barometers, and whereas we would not look for Australians to come through till past the threshold of March, this year they began to be heard quite regularly early in February. Africans on 20 meters were heard quite well for several weeks in February, from 11 p.m. to 12, our first such experience with Africans in February.

Regarding reception in general, it was usually unreliable, one day DX booming in at a certain time, and the next day poor conditions, making enjoyable reception difficult at a similar time.

## Mozambique

CR7BH, on 11.71 mc., located at Lourenco Marques, has been logged by our faithful Pacific Coast correspondent, Ashley Walcott. This Ace African "catch" was heard to announce in English and Portuguese, and is CR7AA's new Xmtr. Reported to have only 200 watts, CR7BH was heard with such a fine signal that Ashley adds: "I'd say 20 KW would be a more likely figure," hi! CR7AA on 6.137 mc., was also heard, but very weak; time of reception was 10-11 a.m. with announcer signing off at 11 a.m. saying both stations would return at 12:30 p.m. CR7BH was "logged" at this later hour, but only fair this time.

Here's a real nice catch to shoot at, all you hunters of the rare 'uns, and we thank Mr. Walcott for this Vy FB DX data.

It's important to know when "DX" short-wave stations are on the air—and how to "recognize" them. Joe Miller tells you "how and when"—from his own personal "log."

## Portuguese China

CQN, at Macao, formerly on 9.64 mc., has now shifted to 10.02 mc., and was heard but weakly on this new wave. The schedule remains same, Mondays and Fridays, 7-8:30 a.m. Thanks, Ashley, for the tip! A warning to DXers! Tuning for CQN, a strong harmonic is noticed very near CQN, and may be mistaken for this weak signal. This condition probably only local, here in N.Y.

## Sumatra

YBG, 10.43 mc., at Medan, was heard early in February broadcasting music, originating in the NIROM network, from 6:25-6:33 a.m. one morning, and from 5-6:30 a.m. once by Ashley Walcott, also with music, and unsuccessfully calling Bandoeng. Despite the ban on verifications by the Bandoeng radio government, we believe that if one sends a report on YBG direct to Sumatra, that one may be lucky enough to still obtain a "veri." Direct QRA is: A. G. van der Waag, Chief Engineer

**AFRICAN BROADCASTING COY., LTD.**  
 P.O. Box 4559, JOHANNESBURG.  
 14.8.35

Dear Sir/Madam, 193

Re reception of ZTJ - Johannesburg  
 We are in receipt of your favour of the 30th April, and have pleasure in confirming your reception of our Johannesburg short wave station on that date. We would congratulate you on your achievement.

Yours faithfully,  
*A. G. van der Waag*  
 For AFRICAN BROADCASTING COY., LTD.

ZTJ—A highly-prized Q.S.L. from a "rare" African.

## Our Short-Wave "DX" Editor

Winner of 30th "S.-W. Scout" Trophy

of the Gov't. 6th Telegraph & Telephone District, Medan, Sumatra, Netherland East Indies.

## Spanish Morocco

"Radio Tetuan," the only call assigned to this station on 6.54 mc., is still being excellently received in the afternoons from 4-5 p.m. and undoubtedly to a Spanish-speaking listener, the talks given should be most interesting, coming from one of the "hot-beds" of this world-threatening conflict.

A letter of verification to Ed Nicolessy, Brooklyn, states that the station operates daily from 9-10:45 a.m.; 2:30-3:30 p.m. and from 4-5 p.m. As the signal is very strong, though rough, anyone can easily hear this station, so go to it, OM's, another African! Write reports to: Sg't. Lorenzo Gomez Benitez, Chief of Radio Telegraph Service of the Guardia Civil, Tetuan, Spanish Morocco.

## Manchukuo

JDY, 9.925 mc., at Dairen, has been phoning JVN almost daily from 2:30-3:45 a.m., and has been heard here with a good signal at 2:50 a.m. This signal is heard well and should be found easily. By tuning JVN, and noting if JVN is phoning, then tuning just to the HF side of EAQ, one should locate JDY with little trouble.

TDE, 10.065 mc., at Shinkyo, is heard quite often, anywhere from 1-7 a.m. last heard 1:26 a.m.-2:02 a.m. This is a nice catch for any DXer to have verified, so try for it any morning, while combing the dials for DX. Write reports to: KANJOSHI Xmitting Station, Manshū Denshin Denwa Kaisha, Shinkyo, Manchukuo.

## SIAM

HS8PJ, 19.02 mc., at Bangkok, was at last logged with a good signal! We had to wait for a Monday off, and Washington's Birthday provided the opportunity. Generally we (Continued on page 49)





# World S-W Station List

## Complete List of Broadcast, and Telephone Stations

All the stations in this list use telephone transmission of some kind. Note: Stations marked with a star ★ are the most active and easily heard stations and transmit at fairly regular times. Please write to us about any new sta-

tions or other important data that you learn through announcements over the air or correspondence with the stations. Stations are classified as follows: C—Commercial phone. B—Broadcast service. X—Experimental transmissions.

### Around-the-Clock Listening Guide

It is a good idea to follow a general schedule as far as wavelength in relation to the time of the day is concerned. The observance of these simple rules will save time. From daybreak till 6 p.m. and particularly

during bright daylight, listen between 13 and 19 meters (21540 to 15800 kc.)

To the east of the listener, from about 11 a.m.-5 a.m., the 19-35 meter will be found very productive. To the west of the listener this same

band is generally found best from about 12 m. until 7 a.m. (After dark, results above 35 meters are usually much better than during daylight.) These general rules hold for any location in the Northern Hemisphere.

### Short-Wave Broadcasting, Experimental and Commercial Radiophone Stations

NOTE: To convert kc. to megacycles (mc.) shift decimal point 3 places to left: Thus, read 21540 kc. as 21.540 mc.

<p>↓ S.W. BROADCAST BAND ↓</p> <p><b>31600 kc. W2XDU</b> -BX- 9.494 meters ATLANTIC BROADCASTING CO., 485 MADISON AVE., N.Y.C. Relays WABC daily 5-10 p.m., Sat., Sun. 12:30-5, 6-9 p.m.</p> <p><b>31600 kc. W4XCA</b> -BX- 9.494 meters MEMPHIS, TENN. Relays WMC daily</p> <p><b>31600 kc. W8XAI</b> -BX- 9.494 meters STROMBERG CARLSON CO. ROCHESTER, N.Y. Relays WHAM daily 7:30 a.m.- 12.05 a.m.</p> <p><b>31600 kc. W8XWJ</b> -BX- 9.494 meters PENOBSCOT TOWER DETROIT, MICH. Daily 6 a.m.-12:30 a.m. Sun. 8 a.m.-12 M.</p> <p><b>31600 kc. W9XPD</b> -BX- 9.494 meters ST. LOUIS, MO. Relays KSD daily</p> <p><b>26100 kc. GSK</b> -B- 11.49 meters DAVENTRY B.B.C., BROADCASTING HOUSE, LONDON, ENGLAND Probably 6-8:45 a.m.</p> <p><b>25950 kc. ★W6XKG</b> -BX- 11.56 meters LOS ANGELES, CAL. Relays KGJ 24 hours daily.</p> <p><b>21540 kc. ★W8XK</b> -B- 13.93 meters WESTINGHOUSE ELECTRIC PITTSBURGH, PA. 7-9 a.m.; relays KDKA</p> <p><b>21530 kc. GSJ</b> -B- 13.93 meters DAVENTRY B.B.C., BROADCASTING HOUSE, LONDON, ENGLAND</p> <p><b>21520 kc. ★W2XE</b> -B- 13.94 meters ATLANTIC BROADCASTING CORP. 485 Madison Ave., N.Y.C. Relays WABC 7:30 a.m.-12 n.</p> <p><b>21470 kc. ★GSH</b> -B- 13.97 meters DAVENTRY B.B.C., BROADCASTING HOUSE, LONDON, ENGLAND 6-8:45 a.m., 9 a.m.-12 n.</p> <p>↑ S.W. BROADCAST BAND ↑</p> <p><b>21420 kc. WKK</b> -C- 14.01 meters AMER. TEL. &amp; TEL. CO., LAWRENCEVILLE, N. J. Calls S. America 8 a.m.-4 p.m.</p> <p><b>21080 kc. PSA</b> -C- 14.23 meters RIO DE JANEIRO, BRAZIL Works WKK Daytime</p> <p><b>21060 kc. WKA</b> -C- 14.25 meters LAWRENCEVILLE, N. J. Calls England noon</p> <p><b>21020 kc. LSN6</b> -C- 14.27 meters HURLINGHAM, ARG. Calle N. Y. C. 8 a. m.-5 p. m.</p>	<p><b>20860 kc. EHY-EDM</b> -C- 14.38 meters MADRID, SPAIN Works S. America, mornings.</p> <p><b>20700 kc. LSY</b> -C- 14.49 meters MONTE GRANDE ARGENTINA Tests Irregularly</p> <p><b>20380 kc. GAA</b> -C- 14.72 meters RUGBY, ENGLAND Calls Argentina, Brazil, mornings</p> <p><b>20040 kc. OPL</b> -C- 14.97 meters LEOPOLDVILLE, BELGIAN CONGO Works with ORG in morning</p> <p><b>20020 kc. DHO</b> -C- 14.99 meters NAUEN, GERMANY Works S. America, mornings</p> <p><b>19900 kc. LSG</b> -C- 15.08 meters MONTE GRANDE, ARGENTINA Tests Irregularly, daytime</p> <p><b>19820 kc. WKN</b> -C- 15.14 meters LAWRENCEVILLE, N. J. Calls England, daytime</p> <p><b>19680 kc. CEC</b> -C- 15.24 meters SANTIAGO, CHILE Works Buenos Aires and Colom- bia daytime</p> <p><b>19650 kc. LSN5</b> -C- 15.27 meters HURLINGHAM, ARGENTINA Calls Europe, daytime</p> <p><b>19620 kc. VQG4</b> -C- 15.28 meters NAIROBI, KENYA, AFRICA Calls London 7:30-8 a.m.</p> <p><b>19600 kc. LSF</b> -C- 15.31 meters MONTE GRANDE, ARGENTINA Tests Irregularly, daytime</p> <p><b>19480 kc. GAD</b> -C- 15.4 meters RUGBY, ENGLAND Works with Kenya, Africa, early morning</p> <p><b>19355 kc. FTM</b> -C- 15.50 meters ST. ASSISE, FRANCE Calls Argentine, mornings</p> <p><b>19345 kc. PMA</b> -B.C- 15.51 meters BANDOENG, JAVA Calls Holland early a.m. Broadcasts Tues., Thur., Sat., 10:00-10:30 a.m. Irregular</p> <p><b>19260 kc. PPU</b> -C- 15.58 meters RIO DE JANEIRO, BRAZIL Works with France mornings</p> <p><b>19220 kc. WKF</b> -C- 15.60 meters LAWRENCEVILLE, N. J. Calls England, daytime</p> <p><b>19200 kc. ORG</b> -C- 15.62 meters RUYSELEDE, BELGIUM Works with OPL mornings</p>	<p><b>19160 kc. GAP</b> -C- 15.66 meters RUGBY, ENGLAND Calls Australia, early a.m.</p> <p><b>19020 kc. HS8PJ</b> -B- 15.77 meters BANGKOK, SIAM Mon. 8-10 a.m.</p> <p><b>18970 kc. GAQ</b> -C- 15.81 meters RUGBY, ENGLAND Calls S. Africa, mornings</p> <p><b>18890 kc. ZSS</b> -C- 15.88 meters KLIPHEUVEL, S. AFRICA Works Rugby 9-10 a.m.</p> <p><b>18830 kc. PLE</b> -C- 15.93 meters BANDOENG, JAVA Calls Holland, early a. m.</p> <p><b>18680 kc. OCI</b> -C- 16.06 meters LIMA, PERU Works various S.A. stations daytime</p> <p><b>18620 kc. GAU</b> -C- 16.11 meters RUGBY, ENGLAND Calls N. Y., daytime</p> <p><b>18480 kc. HBH</b> -X- 16.23 meters RADIO NATIONS GENEVA, SWITZERLAND Broadcasts special events irregularly</p> <p><b>18345 kc. FZS</b> -C- 16.35 meters SAIGON, INDO-CHINA Phones Paris, early morning</p> <p><b>18340 kc. WLA</b> -C- 16.36 meters LAWRENCEVILLE, N. J. Calls England, daytime</p> <p><b>18310 kc. GAS</b> -C- 16.38 meters RUGBY, ENGLAND Calls N. Y., daytime</p> <p><b>18299 kc. YVR</b> -C- 16.39 meters MARACAY, VENEZUELA Works Germany, mornings</p> <p><b>18250 kc. FTO</b> -C- 16.43 meters ST. ASSISE, FRANCE Calls S. America, daytime</p> <p><b>18200 kc. GAW</b> -C- 16.48 meters RUGBY, ENGLAND Calls N. Y., daytime</p> <p><b>18135 kc. PMC</b> -C- 16.54 meters BANDOENG, JAVA Phones Holland, early a. m.</p> <p><b>18115 kc. LSY3</b> -C- 16.56 meters MONTE GRANDE, ARGENTINA Tests Irregularly</p> <p><b>18040 kc. GAB</b> -C- 16.63 meters RUGBY, ENGLAND Calls Canada, morn. and early aftn.</p> <p><b>17810 kc. PCV</b> -C- 16.84 meters KOOTWIJK, HOLLAND Calls Java, 6-9 a. m.</p>	<p>↓ S.W. BROADCAST BAND ↓</p> <p><b>17790 kc. ★GSG</b> -B- 16.86 meters DAVENTRY, B.B.C., BROADCASTING HOUSE, LONDON, ENGLAND 1-3, 6-8:45 a.m. 9 a.m.-12 n.; 4-5:45 p.m.</p> <p><b>17785 kc. JZL</b> -B- 16.87 meters TOKIO, JAPAN Tests Irregularly</p> <p><b>17780 kc. ★W3XAL</b> -B- 16.87 meters NATIONAL BROAD. CO. BOUND BROOK, N. J. Relays WJZ, Daily exc. Sun. 9 a.m.-5 p.m.</p> <p><b>17775 kc. ★PHI</b> -B- 16.88 meters HUIZEN, HOLLAND Daily except Wed. 8-9:30 a.m. Sun. 7-10 a.m., Sat. 8-10 a.m.</p> <p><b>17760 kc. W2XE</b> -B- 16.89 meters 485 Madison Ave., N.Y.C. 12 n.-1 p.m.</p> <p><b>17760 kc. ★DJE</b> -B- 16.89 meters BROADCASTING HOUSE BERLIN, GERMANY 12:05-5:15, 5:55-11 a.m.</p> <p>↑ S.W. BROADCAST BAND ↑</p> <p><b>17760 kc. IAC</b> -C- 16.89 meters PISA, ITALY Calls ships, 6:30-7:30 a. m.</p> <p><b>17755 kc. ZBW5</b> -B- 16.9 meters P.O. Box 200 HONGKONG, CHINA Irregular 11:30 p.m.-1:15 a.m., 4-10 a.m.</p> <p><b>17741 kc. HSP</b> -C- 16.91 meters BANGKOK, SIAM Works Germany 4-7 a.m.</p> <p><b>17650 kc. XGM</b> -C- 17 meters SHANGHAI, CHINA Works London 7-9 a.m.</p> <p><b>17520 kc. DFB</b> -C- 17.12 meters NAUEN, GERMANY Works S. America near 9:15 a.m.</p> <p><b>17480 kc. VWY2</b> -C- 17.16 meters KIRKEE, INDIA Works Rugby 7:30-8:15 a.m.</p> <p><b>17310 kc. W3XL</b> -X- 17.33 meters NATIONAL BROAD. CO. BOUND BROOK, N. J. Tests Irregularly</p> <p><b>17120 kc. WOO</b> -C- 17.52 meters A. T. &amp; T. CO., OCEAN GATE, N. J. Calls ships</p> <p><b>17080 kc. GBC</b> -C- 17.56 meters RUGBY, ENGLAND Calls Ships</p> <p><b>16385 kc. ITK</b> -C- 18.31 meters MOGADISCIO, ITAL. SOM- ALILAND Calls IAC around 9:30 a.m.</p>	<p><b>16270 kc. WLK</b> -C- 18.44 meters LAWRENCEVILLE, N. J. Phones Arg., Braz., Peru, daytime</p> <p><b>16270 kc. WOG</b> -C- 18.44 meters OCEAN GATE, N. J. Calls England, morning and early afternoon</p> <p><b>16240 kc. KTO</b> -C- 18.47 meters MANILA, P. I. Calls Cal., Tokio and ships 8-11:30 a.m.</p> <p><b>16233 kc. FZR3</b> -C- 18.48 meters SAIGON, INDO-CHINA Calls Paris and Pacific Isles</p> <p><b>16030 kc. KKP</b> -C- 18.71 meters KAHUKU, HAWAII Phones KWU 3-10 p.m.</p> <p><b>15880 kc. FTK</b> -C- 18.90 meters ST. ASSISE, FRANCE Phones Saigon, morning</p> <p><b>15865 kc. CEC</b> -C- 18.91 meters SANTIAGO, CHILE Works other S.A. stations afternoons</p> <p><b>15810 kc. LSL</b> -C- 18.98 meters HURLINGHAM, ARGENTINA Calls Brazil and Europe, daytime</p> <p><b>15760 kc. JYT</b> -X- 19.04 meters KEMIKWA-CHO, CHIBA- KEN, JAPAN Irregular in late afternoon and early morning</p> <p><b>15660 kc. JVE</b> -C- 19.16 meters NAZAKI, JAPAN Phones Java 3-5 a.m.</p> <p><b>15620 kc. JVF</b> -C- 19.2 meters NAZAKI, JAPAN Phones U.S., 5 a.m. &amp; 4 p.m.</p> <p><b>15460 kc. KKR</b> -C- 19.4 meters RCA COMMUNICATIONS, BOLINAS, CAL. Tests Irregularly</p> <p><b>15450 kc. IUG</b> -C- 19.41 meters ADDIS ABABA, ETHIOPIA Calls IAC 9:15-10:30 a.m.</p> <p><b>15440 kc. XEBM</b> -B- 19.43 meters "EL PREGONERO DEL PACI- FICO" MAZATLAN, SIN., MEX. Address: Flores 103 Alto, Heard Irregularly 7 a.m.-10 p.m.</p> <p><b>15415 kc. KWO</b> -C- 19.46 meters DIXON, CAL. Phones Hawaii 2-7 p.m.</p> <p><b>15370 kc. ★HAS3</b> -B- 19.52 meters BUDAPEST, HUNGARY Broadcasts Sundays, 9-10 a.m.</p> <p><b>15360 kc. DZG</b> -X.C- 19.53 meters REICHSPOSTZENSTRALAMT, ZEESEN, GERMANY Tests Irregularly</p>
--	--	---	--	---

# Record What YOU HEAR!

By James L. Fouch

Short-Wave Listeners as well as "Hams" are rapidly learning to record interesting features.



Fig. 1—Recording a Transmission on Aluminum Alloy Records at Amateur Station W6LRP

● "HOW'S my modulation?" or "Calcutta calling!" How many times have you wished that you could have recorded the words or program that followed? If you are an amateur or short-wave listener you can now record such transmissions on the apparatus offered upon the market today. Amateurs can now give a check on the other fellow's modulation, just by playing back a recording made during his transmission. Let him pick his own "bouquets."

The short-wave listener can easily repay himself for staying up till those wee-small hours by being able to hear the very same programs, recorded by himself, at some later date. It's also a sure way to get a dandy verification from that D.X. station and the small, six inch discs are quite easy to mail.

### Recorders Used in Ham Stations

In figure 1, is seen the typical amateur station using the Universal model 12, recording machine. Only a power of three and a half watts is required from the receiver; of which many on the market have a great deal more. The



Fig. 2—Acetate High-Fidelity Recordings of "Foreign" Broadcasts being made by a Short-Wave Listener

## NBC's New Aerials Favor South America and Europe

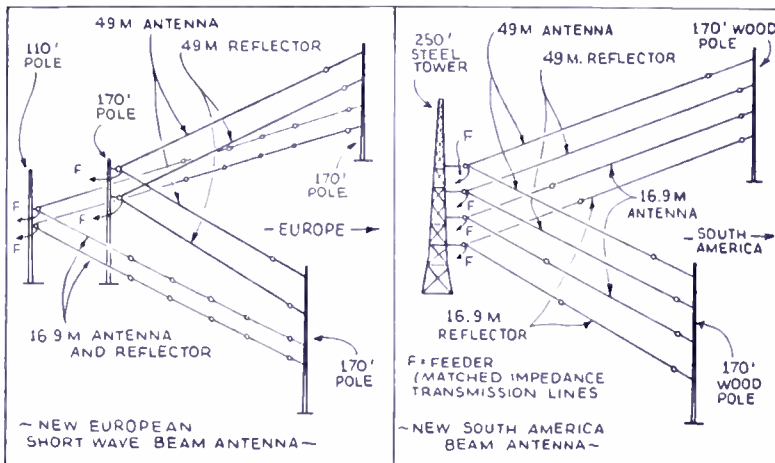

file with the FCC an application for permission to install a 500,000 watt transmitter for WJZ. There is an additional experimental channel in the 2,000 kc. spectrum which is used from time to time with a power of approximately 10,000 watts.

The addition of the directional beam antennas will insure much finer service and reception in those countries upon which the force of the wave (Continued on page 63)

Perspective views of the South American and European "directive" antennas recently built by NBC.

Drawing at right shows plan views of new NBC "directive" antennas.

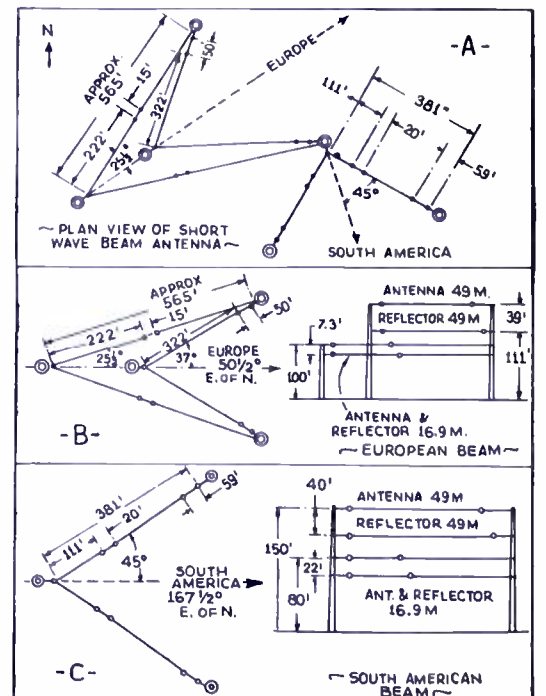

● FOUR new and elaborate directional beam antennas have been under construction since October at NBC's short-wave transmitting station, W3XAL, Bound Brook, New Jersey.

Two of these antennas will concentrate the W3XAL transmissions to South America on 6100 kcs., and 17780 kcs., and the other beams, of the same frequencies, will direct the transmissions toward Europe.

The 17780 kc. South American beam was completed and officially placed in operation January 20th, to carry the broadcast of the Presidential Inauguration. Completion of other beams will follow shortly.

In addition to the directional beam antennas, NBC is building new and more

elaborate non-directional antennas for general broadcast service to all countries. These short-wave antennas, of which there are seven, occupy 25 of the 54 acres belonging to station WJZ. The other 29 acres are occupied by the new WJZ 640 foot anti-fading antenna. The completion of the short-wave project will make the WJZ-W3XAL station one of the world's outstanding plants.

For several years W3XAL has transmitted short-wave programs on 17780 kcs., with a power of 10,000 watts, and on 6100 kcs., with a power of 25,000 watts. W3XAL has been used for several years on 6425 kcs., with a power of 25,000 watts. There is in addition a 20,000 watt auxiliary transmitter for the WJZ channel. There is now on

Latest idea in engineering design for directive antennas. To be used by NBC in broadcasting to South America and Europe.

**15355 kc. KWU**  
-C- 19.53 meters  
DIXON, CAL.  
Phones Pacific Isles and Japan  
↓ S.W. BROADCAST BAND ↓

**15340 kc. ★DJR**  
-B- 19.56 meters  
BROADCASTING HOUSE,  
BERLIN, GERMANY  
8-9 a.m.

**15330kc.★W2XAD**  
-B- 19.56 meters  
GENERAL ELECTRIC CO.  
SCHENECTADY, N. Y.  
Relays  
WGY 10 a.m.-6 p.m.

**15310 kc. ★GSP**  
-B- 19.6 meters  
DAVENTRY  
B.B.C., BROADCASTING  
HOUSE,  
LONDON, ENGLAND  
6-8 p.m.

**15290 kc. LRU**  
-B- 19.62 meters  
"EL MUNDO"  
BUENOS AIRES, ARGEN-  
TINA, S. A.  
Daily 7 a.m.-6:30 p.m.

**15280 kc. ★DJQ**  
-B- 19.63 meters  
BROADCASTING HOUSE  
BERLIN, GERMANY  
6-8, 8:15-11 a.m., 4:50-10:45 p.  
m., also  
Sundays 11:10 a.m.-12:20 p.m.

**15270 kc. ★W2XE**  
-B- 19.65 meters  
ATLANTIC BROADCASTING  
CORP.  
485 Madison Av., N.Y.C.  
Relays  
WABC daily 1-7 p.m.

**15260 kc. GSI**  
-B- 19.66 meters  
DAVENTRY,  
B.B.C., BROADCASTING  
HOUSE, LONDON, ENGLAND  
12:15-3:45 p.m.

**15252 kc. RIM**  
-C- 19.67 meters  
TASHKENT, U.S.S.R.  
Phones RKL near 7 a.m.

**15250 kc. W1XAL**  
-B- 19.67 meters  
BOSTON, MASS.  
Irregular, in morning

**15245 kc. ★TPA2**  
-B- 19.68 meters  
"RADIO COLONIAL"  
PARIS, FRANCE  
Service de la Radiodiffusion  
98, bis, Blvd. Haussmann  
6-11:05 a.m.

**15230 kc. HS8PJ**  
-B- 19.32 meters  
BANGKOK, SIAM  
Irregular, Mon. 8-10 a.m.

**15230 kc. OLR5A**  
-B- 19.70 meters  
PRAGUE  
CZECHOSLOVAKIA  
see 11875 kc.  
Irregular

**15220 kc. ★PCJ**  
-B- 19.71 meters  
N.V. PHILIPS' RADIO  
HUIZEN, HOLLAND  
(Studio at Hilversum, Holland)  
Tues. 4:30-6 a.m.  
Wed. 8-11 a.m.

**15210 kc. ★W8XK**  
-B- 19.72 meters  
WESTINGHOUSE ELECTRIC  
& MFG. CO.  
PITTSBURGH, PA.  
Relays KDKA

**15200 kc. ★DJB**  
-B- 19.74 meters  
9 a.m.-7 p.m.  
BROADCASTING HOUSE  
BERLIN, GERMANY  
12:05-5:15 a.m., 5:55-11 a.m.  
4:50-10:45 p.m.  
Sun. also 11:10 a.m.-12:25 p.m.

**15190 kc. ZBW4**  
-B- 19.75 meters  
HONGKONG, CHINA  
P. O. Box 200  
11:30 p.m.-1:15 a.m., 4-10 p.m.

**15180 kc. ★GSO**  
-B- 19.78 meters  
DAVENTRY  
B.B.C., BROADCASTING  
HOUSE,  
LONDON, ENGLAND  
1-3 a.m.

**15180 kc. RW96**  
-B- 19.76 meters  
MOSCOW, U.S.S.R.  
Sun. 2-3 p.m.

**15160 kc. JZK**  
-B- 19.79 meters  
TOKIO, JAPAN  
2:30-3:30 p.m. Tues. and Fri.  
Daily 12 m.-1 a.m., 4-5 p.m.

**15150 kc. ★YDC**  
-B- 19.80 meters  
NIROM  
BANDOENG, JAVA  
6-7:30 p.m. 10:30 p.m.-2 a.m.  
Sat. 7:30 p.m.-2 a.m. (Sun.)  
5:30-10:30 a.m.

**15140 kc. ★GSF**  
-B- 19.82 meters  
DAVENTRY,  
B.B.C., BROADCASTING  
HOUSE, LONDON, ENGLAND  
9 a.m.-12 n. 4:5:45, 6-8, 9-11  
p.m.

**15120 kc. HVJ**  
-B- 19.83 meters  
VATICAN CITY  
10:30 to 10:45 a.m., except  
Sunday  
Sat. 10-10:45 a.m.

**15110 kc. ★DJL**  
-B- 19.85 meters  
BROADCASTING HOUSE,  
BERLIN, GERMANY  
12-2, 8-9 a.m., 11:35 a.m.-  
4:30 p.m. Also 6-8 a.m., Sun.

↓ S.W. BROADCAST BAND ↓  
**15090 kc. RKI**  
-B, C- 19.88 meters  
MOSCOW, U.S.S.R.  
Phones Tashkent near 7 a.m.

**15055 kc. WNC**  
-C- 19.92 meters  
HIALEAH, FLORIDA  
Calls Central America, daytime

**14980 kc. KAY**  
-O- 20.03 meters  
MANILA, P. I.  
Phones Pacific Isles

**14970 kc. LZA**  
-B, C- 20.04 meters  
RADIO GARATA,  
SOFIA, BULGARIA  
Broadcasts Sun. 12:30-8 a.m.,  
10 a.m.- 4:30 p.m., Daily 5-6:30  
a.m., 12 n-2:45 p.m.

**14960 kc. PSF**  
-C- 20.43 meters  
RIO de JANEIRO, BRAZIL  
Works with Buenos Aires  
daytime

**14950 kc. HJB**  
-C- 20.07 meters  
BOGOTA, COL.  
Calls WNC, daytime

**14940 kc. HII**  
-C- 20.08 meters  
CIUDAD TRUJILLO, D.R.  
Phones WNC daytime

**14940 kc. HJA3**  
-C- 20.08 meters  
BARRANQUILLA, COL.  
Works WNC daytime

**14845 kc. OCJ2**  
-C- 20.21 meters  
LIMA, PERU  
Works other S.A. stations  
daytime

**14790 kc. ROU**  
-C- 20.28 meters  
OMSK, SIBERIA, U.S.S.R.  
Works Moscow Irregularly  
7-9 a.m.

**14730 kc. IQA**  
-C- 20.37 meters  
ROME, ITALY  
Tests Irregularly

**14653 kc. GBL**  
-C- 20.47 meters  
RUGBY, ENGLAND  
Works JVH 1-7 a.m.

**14640 kc. TYF**  
-C- 20.49 meters  
PARIS, FRANCE  
Works Saigon and Cairo 3-7  
a.m., 12 n.-2:30 p.m.

**14600 kc. JVH**  
-B, C- 20.55 meters.  
NAZAKI, JAPAN  
Irregular 5-11:30 p.m.  
Phones Europe 4-8 a.m.

**14590 kc. WMN**  
-O- 20.56 meters  
LAWRENCEVILLE, N. J.  
Phones England  
morning and afternoon

**14535 kc. HBJ**  
-B- 20.64 meters  
RADIO NATIONS,  
GENEVA, SWITZERLAND  
Sat. 5:30-8:15, 7:15-8:30 p.m.

**14530 kc. LSN**  
-C- 20.65 meters  
HURLINGHAM, ARGENTINA  
Calls N.Y.C. afternoons

**14500 kc.**  
-C- 20.69 meters  
ASMARA, ERITRIA, AFRICA  
Works Rome and Addis Ababa  
6:30-7:30 a.m.

**14500 kc. LSM2**  
-C- 20.69 meters  
HURLINGHAM, ARGENTINA  
Calls Rio and Europe daytime

**14485 kc. TIR**  
-C- 20.71 meters  
CARTAGO, COSTA RICA  
Phones Cen. Amer. & U.S.A.  
Daytime

**14485 kc. YSL**  
-C- 20.71 meters  
SAN SALVADOR, SALVADOR

**14485 kc. HPF**  
-C- 20.71 meters  
PANAMA CITY, PAN.  
Phones WNC daytime

**14485 kc. TGF**  
-C- 20.71 meters  
GUATEMALA CITY, GUAT.  
Phones WNC daytime

**14485 kc. YNA**  
-C- 20.71 meters  
MANAGUA, NICARAGUA  
Phones WNC daytime

**14485 kc. HRL5**  
-C- 20.71 meters  
NACAOME, HONDURAS  
Works WNC daytime

**14485 kc. HRF**  
-C- 20.71 meters  
TEGUCIGALPA, HONDURAS  
Works WNC daytime

**14470 kc. WMF**  
-C- 20.73 meters  
LAWRENCEVILLE, N. J.  
Phones England in daytime

**14460 kc. DZH**  
-C, X- 20.75 meters  
REICHSPOSTZENSTRALAMT,  
ZEESEN, GERMANY  
Irregular

**14440 kc. GBW**  
-C- 20.78 meters  
RUGBY, ENGLAND  
Calls U.S.A., afternoons

**14200 kc. EA9AH**  
-B- 21.13 meters  
TETUAN, SPAN, MOROCCO  
Broadcasts daily except Sun.  
2:15-5, 7 and 9 p.m.

**13990 kc. GBA**  
-C- 21.44 meters  
RUGBY, ENGLAND  
Calls Buenos Aires, late afternoon

**13980 kc. PZ1AA**  
-B- 21.46 meters  
PARAMIRABO,  
DUTCH GUIANA, S.A.  
Irregular evenings.

**13820 kc. SUZ**  
-C- 21.71 meters  
ABOU ZABAL, EGYPT  
Works with Europe 11 a.m.-2 p.m.

**13690 kc. KKZ**  
-C- 21.91 meters  
RCA COMMUNICATIONS,  
BOLINAS, CAL.  
Tests irregularly

**13635 kc. SPW**  
-B- 22 meters  
WARSAW, POLAND  
Mon., Wed., Fri. 12:30-1:30 p.m.  
Irregular at other times

**13610 kc. JYK**  
-C- 22.04 meters  
KEMIKAWA-CHO, CHIBA-  
KEN, JAPAN  
Phones California till 11 p. m.

**13585 kc. GBB**  
-C- 22.08 meters  
RUGBY, ENGLAND  
Calls Egypt & Canada, afternoons

**13415 kc. GCJ**  
-C- 22.36 meters  
RUGBY, ENGLAND  
Calls Japan & China early  
morning

**13410 kc. YSJ**  
-C- 22.37 meters  
SAN SALVADOR, SALVADOR  
Phones WNC daytime

**13390 kc. WMA**  
-C- 22.40 meters  
LAWRENCEVILLE, N. J.  
Phones England  
morning and afternoon

**13380 kc. IDU**  
-C- 22.42 meters  
ASMARA, ERITREA, AFRICA  
Works with Rome daytime

**13345 kc. YVQ**  
-C- 22.48 meters  
MARACAY, VENEZUELA  
Calls Hialeah daytime

**13285 kc. CGA3**  
-C- 22.58 meters  
DRUMMONDVILLE, QUE.,  
CAN.  
Works London and Ships  
afternoons

**13220 kc. IRJ**  
-C- 22.69 meters  
ROME, ITALY  
Phones Tokyo 5-9 a.m.  
Irregularly

**13075 kc. VPD**  
-X- 22.94 meters  
SUVA, FIJI ISLANDS  
Daily exc. Sun. 12:30-1:30 a.m.

**12840 kc. WOO**  
-C- 23.36 meters  
OCEAN GATE, N. J.  
Calls ships

**12825 kc. CNR**  
-B, C- 23.39 meters  
DIRECTOR GENERAL  
Telegraph and Telephone  
Stations, Rabat, Morocco  
Broadcasts, Sunday, 7:30-9 a. m.

**12800 kc. IAC**  
-C- 23.45 meters  
PISA, ITALY  
Calls Italian ships, mornings

**12780 kc. GBC**  
-C- 23.47 meters  
RUGBY, ENGLAND  
Calls ships

**12396 kc. CT1GO**  
-B- 24.2 meters  
PAREDE, PORTUGAL  
Sun. 10-11:30 a.m., Tues.,  
Thurs., Fri. 1:00-2:15 p.m.

**12325 kc. DAF**  
-C- 24.34 meters  
NORDEICH, GERMANY  
Works German ships daytime

**12300 kc.**  
-B- 24.39 meters  
SANTIAGO, CHILE, S.A.  
Luis Desmaras, Casilla 761,  
11 a.m.-1 p.m., 4-8 p.m.,  
Sun., till 10 p.m.

**12290 kc. GBU**  
-C- 24.41 meters  
RUGBY, ENGLAND  
Calls N.Y.C., afternoon

**12250 kc. TYB**  
-C- 24.49 meters  
PARIS, FRANCE  
Irregular

**12235 kc. ★TFJ**  
-B, C- 24.52 meters  
REYKJAVIK, ICELAND  
Phones England mornings,  
Broadcasts Sun. 1:40-2:30 p.m.

**12215 kc. TYA**  
-C- 24.56 meters  
PARIS, FRANCE  
Works French Ships in morning  
and afternoon

**12150 kc. GBS**  
-C- 24.69 meters  
RUGBY, ENGLAND  
Calls N.Y.C., afternoon

**12130 kc. DZE**  
-C, X- 24.73 meters  
REICHSPOSTZENSTRALAMT,  
ZEESEN, GERMANY  
Tests Irregularly

**12120 kc.**  
-C- 24.75 meters  
ALGIERS, ALGERIA  
Calls Paris 12 m.-6:30 a.m.

**12060 kc. PDV**  
-C- 24.88 meters  
KOOTWIJK, HOLLAND  
Tests Irregular

**12000 kc. RNE**  
-B- 25 meters  
MOSCOW, U. S. S. R.  
Daily 12:30-6 p.m.  
Sun. 6-9, 10-11 a.m.  
Wed. 6-7 a.m.

**11991 kc. FZS2**  
-C- 25.02 meters  
SAIGON, INDO-CHINA  
Phones Paris, morning

**11955 kc. IUC**  
-C- 25.09 meters  
ADDIS ABABA, ETHIOPIA  
Calls IAC around 12 m.

**11950 kc. KKKQ**  
-X- 25.10 meters  
BOLINAS, CALIF.  
Tests, irregularly, evenings

**11940 kc. FTA**  
-C- 25.13 meters  
STE. ASSISE, FRANCE  
Phones CNR morning,  
Hurlingham, Arde., nights

↓ S.W. BROADCAST BAND ↓  
**11900 kc. XEWI**  
-B- 25.21 meters  
MEXICO CITY, MEX.  
Mon., Wed., Fri. 3-4 p.m.,  
9 p.m.-12 m.  
Tues., Thurs. 7:30 p.m.-12 m.  
Sat. 9 p.m.-12 m.;  
Sun. 12:30-2 p.m.

**11880 kc. ★TPA3**  
-B- 25.23 meters  
"RADIO COLONIAL"  
PARIS, FRANCE  
4-5 a.m., 11:16 a.m.-6 p.m.

**11875 kc. OLR4C**  
-B- 25.24 meters  
PRAGUE, CZECHOSLOVAKIA  
Daily 8:55 a.m.-12 n., 2:25-4:30  
p.m.  
Sun. 2-7:30 a.m., Thurs. and  
Sat. 5-7:30 a.m., Mon. and  
Thurs., 7-10 p.m.

**11870 kc. ★W8XK**  
-B- 25.26 meters  
WESTINGHOUSE ELECTRIC  
& MFG. CO.  
PITTSBURGH, PA.  
7-10:30 p.m.  
Relays KDKA

**11860 kc. YDB**  
-B- 25.29 meters  
N.I.R.O.M.,  
SOERABAJA, JAVA  
Sat. 7:30 p.m.-2 a.m. (Sun.)  
Daily 10:30 p.m.-2 a.m.

**11860 kc. GSE**  
-B- 25.29 meters  
DAVENTRY,  
B.B.C., BROADCASTING  
HOUSE, LONDON, ENGLAND

**11855 kc. DJP**  
-B, X- 25.31 meters  
BROADCASTING HOUSE,  
BERLIN, GERMANY  
Irregular, 11:35 a.m.-4:30 p.m.

**11830 kc. W9XAA**  
-B- 25.36 meters  
CHICAGO FEDERATION OF  
LABOR  
CHICAGO, ILL.  
Relays WCFL Irregular

**11830 kc. ★W2XE**  
-B- 25.36 meters  
ATLANTIC BROADCASTING  
CORP.  
485 MADISON AVE., N. Y. C.  
Relays WABC 7-10 p.m.

**11820 kc. GSN**  
-B- 25.38 meters  
DAVENTRY  
B.B.C., BROADCASTING  
HOUSE,  
LONDON, ENGLAND  
Irregular

**11810 kc. ★2RO**  
-B- 25.4 meters  
E.I.A.R.  
Via Montello 5  
ROME, ITALY  
Daily 6:43-10:30, 11:30 a.m.-  
5:30 p.m., Sun.  
6:43-9, 11:30 a.m.-5:30 p.m.

**11800 kc. ★JZJ**  
-B- 25.42 meters  
TOKIO, JAPAN  
Daily, 4-5 p.m.  
Tues. and Fri. 2:30-3:30 p.m.  
Daily 12 m.-1 a.m.; 9-10 a.m.

**11800 kc. OER2**  
-B- 25.42 meters  
VIENNA, AUSTRIA  
Daily 10 a.m.-5 p.m.  
Sat. till 5:30 p.m.

**11795 kc. HP5I**  
-B- 25.43 meters  
AGUADULCE, PANAMA  
Broadcasts evenings irregularly

**11795 kc. DJO**  
-B, X- 25.43 meters  
BROADCASTING HOUSE,  
BERLIN, GERMANY  
Irregular

**11795 kc. OAX5B**  
-B- 25.43 meters  
"RADIO UNIVERSAL"  
ICA, PERU  
11 a.m.-12 n., 4-11:15 p.m.

**11790 kc. W1XAL**  
-B- 25.45 meters  
BOSTON, MASS.  
Daily 5:15-6:15 p.m.  
Sun. 5-7 p.m.

**11770 kc. ★DJD**  
-B- 25.49 meters  
BROADCASTING HOUSE,  
BERLIN, GERMANY  
11:35 a.m.-4:30 p.m.; 4:50-  
10:55 p.m.

# Squeeze This Tube To Vary The Frequency

A new European invention—A "flexible" glass vacuum tube for accurately adjusting the frequency of micro-waves.

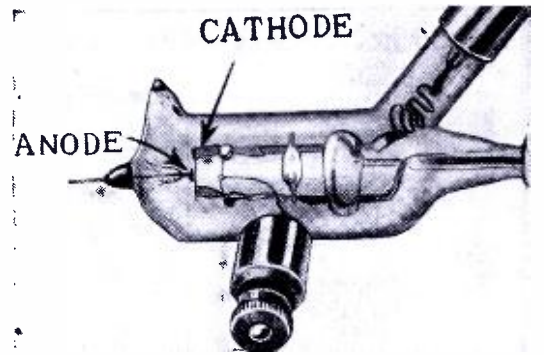

Close-up of the remarkable new "flexible" glass vacuum tube.

● THE steadily increasing interest in the application of the very short *decimeter* and *centimeter* (one-tenth and one-hundredth meter) waves for communication has caused many well-known laboratories in this country and abroad to do a lot of research work in these very high frequencies. However, engineers and research workers found themselves confronted with a number of unforeseen and unexplainable effects which made quantitative measurements in this wave range not only difficult, but also inaccurate. Let's see what happened! The ultra-high radio frequencies drove the electrons into movements no

one expected. The electrons lost speed, bounced back and forth, or even moved in a circular direction instead of going straight ahead. It took some time until scientists found the reasons for the discrepancies occurring when measurements in the range of these extremely high frequencies had to be made. Today of course, much more is known about the transit habits of electrons, under the influence of extremely high frequencies, (Continued on page 38)

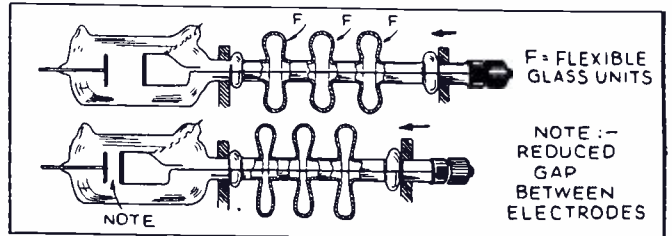

Just how the distance between the electrodes in the new compressible glass vacuum tube occurs, is made clear in the above drawing. The tube is actually "compressed" to vary the distance between the anode and cathode.

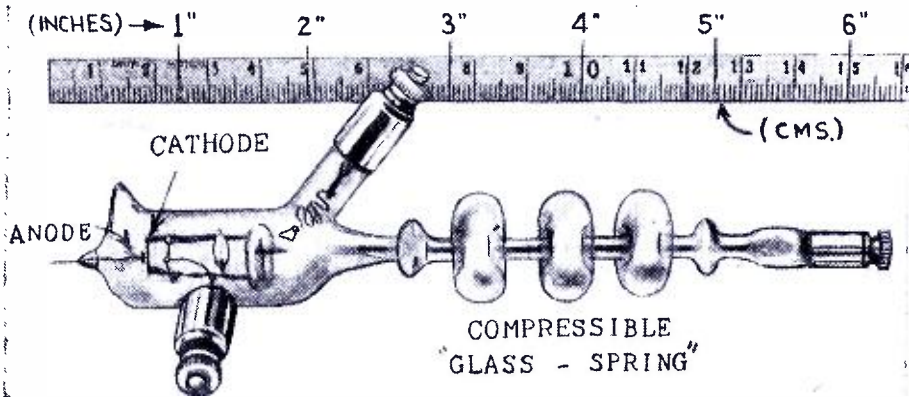

Picture above shows relative size of the new compressible glass tube for micro-waves.

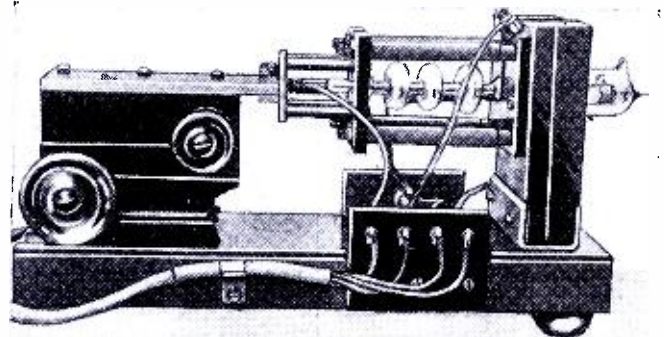

Here is the actual worm-gear compressor and the tube about to be "squeezed."

# European S-W Receiver Has Range 13 to 200 Meters

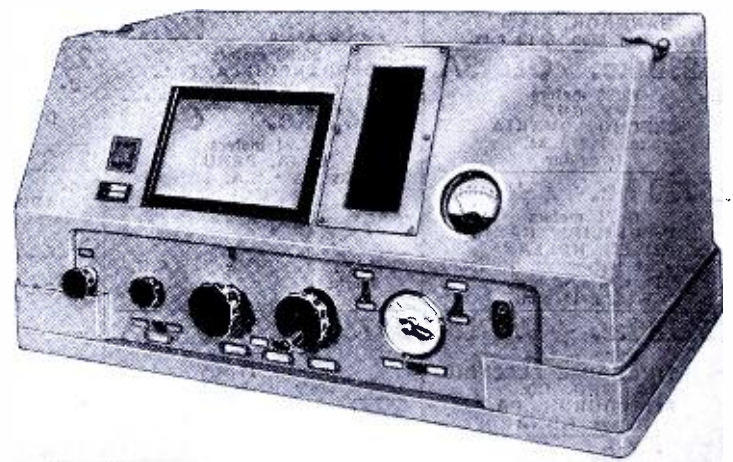
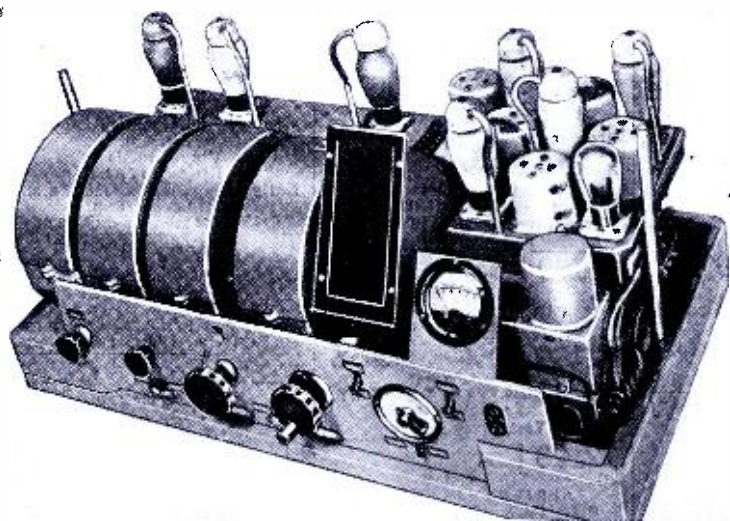

Above—Chassis view, also front panel appearance of new German S-W receiver. This set has a range of 13 to 200 meters, and one of its features is its extremely high sensitivity.

● THE main characteristic of this new European receiver is its extremely high selectivity, despite the fact that crystal filters are not employed. Another point of interest is its high sensitivity. The manufacturer of this receiver, the Telefunken Co., claim an overall sensitivity starting with 0.4 and ending with 1.5 microvolts.

The inclined front panel shows at the left a special calibration chart for each of the 8 ranges into which the complete range from 13 to 200 meters is divided. This is done despite the fact that the tuning dial with translucent illumination is accurately calibrated.

The large knob in the center operates the tuning circuits of the 2 R.F. stages and the first oscillator. The second knob a little more to the left controls the 8 tuning ranges. A small window above the knob indicates the range switched in. The next knob is used for volume (Continued on page 45)

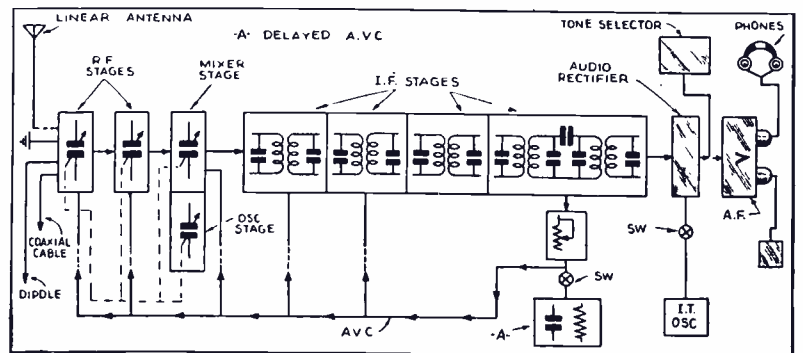

Diagram of the new short-wave receiver illustrated above.

**11760 kc. OLR4B**  
-B- 25.51 meters  
PRAGUE, CZECHOSLOVAKIA

**11750 kc. ★GSD**  
-B- 25.53 meters  
DAVENTRY, B.B.C., BROADCASTING HOUSE, LONDON, ENGLAND  
12:15-5:45 p.m., 6-8, 9-11 p.m.

**11730 kc.**  
-B- 25.57 meters  
"RADIO PHILCO" SAIGON, INDO-CHINA  
Irregular 5:30-9:30 a.m.

**11730 kc. PHI**  
-B- 25.57 meters  
HUIZEN, HOLLAND

**11720 kc. ★CJRX**  
-B- 25.6 meters  
WINNIPEG, CANADA  
Daily, 8 p. m.-12 m.

**11715 kc. ★TPA4**  
-B- 25.61 meters  
"RADIO COLONIAL" PARIS, FRANCE  
6:15-8 p.m., 10 p.m.-1 a.m.

**11710 kc. SM5SX**  
-B- 25.63 meters  
STOCKHOLM, SWEDEN  
Sun., 5-7 a.m., Wed., 4-5 p.m.

**↑ S.W. BROADCAST BAND ↓**

**11680 kc. KIO**  
-C, X- 25.68 meters  
KAHUKU, HAWAII  
Broadcasts Tues. 12:30-1 a.m., Thurs. 9:30-10 p.m. Sat. 10-10:30 p.m., irregular

**11600 kc. ★COCX**  
-B- 25.86 meters  
HAVANA, CUBA  
Relays CMX 8 a.m.-1 a.m.

**11595 kc. VRR4**  
-C- 25.87 meters  
STONY HILL, JAMAICA, B.W.I. Works WNC daytime.

**11560 kc. VIZ3**  
-X- 25.95 meters  
AMALGAMATED WIRELESS OF AUSTRALASIA, FISKVILLE, AUSTRALIA  
Calls Canada evening and early a.m.

**11500 kc. XAM**  
-X- 26.09 meters  
MERIDA, YUCATAN  
Irregular 1-7:30 p.m.

**11500 kc. PMK**  
-B-C- 26.09 meters  
BANDOENG, JAVA

**11413 kc. CJA4**  
-C- 26.28 meters  
DRUMMONDVILLE, QUE., CAN.  
Tests with Australia irregularly in evening

**11405 kc. HBO**  
-X- 26.30 meters  
RADIO NATIONS, GENEVA, SWITZERLAND  
Sat. 5:30-6:15, 7:15-8:30 p.m.

**11280 kc. HIN**  
-B- 26 meters  
LA VOZ DEL PARTIDO DOMINICANO, CIUDAD TRUJILLO, D.R.  
4:40-5:40 p.m.

**11200 kc. XBJQ**  
-X- 26.79 meters  
BOX 2825, MEXICO CITY, MEX.  
Irregular

**11050 kc. ZLT4**  
-C- 27.15 meters  
WELLINGTON, N. ZEALAND  
Phones Australia and England early a.m.

**11040 kc. ★CSW**  
-B- 27.17 meters  
NAT. BROADCASTING STATION, LISBON, PORTUGAL  
1:30-6 p.m.

**11000 kc. PLP**  
-B-C- 27.27 meters  
BANDOENG, JAVA  
Relays YDB 5:30-10:30 or 11 a.m., Sat. till 11:30 a.m.

**10970 kc. OCI**  
-C- 27.35 meters  
LIMA, PERU  
Works with Bogota, Col., evenings

**10840 kc. KWV**  
-C- 27.68 meters  
DIXON, CAL.  
Works with Hawaii evenings.

**10770 kc. GBP**  
-C- 27.85 meters  
RUGBY, ENGLAND  
Calls Sydney, Austral. early a. m.

**10740 kc. JVM**  
-B-C- 27.93 meters  
NAZAKI, JAPAN  
Phones U.S., 2-7 a.m.  
Broadcasting daily 9-10 a.m.

**10675 kc. WNB**  
-C- 28.1 meters  
LAWRENCEVILLE, N. J.  
Calls Bermuda, daytime

**10670 kc. ★CEC**  
-C- 28.12 meters  
SANTIAGO, CHILE  
Broadcasts Daily 7-7:15 p.m.

**10660 kc. ★JVN**  
-B-C- 28.14 meters  
NAZAKI, JAPAN  
Broadcasts daily 2-8 a.m.

**10550 kc. WOK**  
-C- 28.44 meters  
LAWRENCEVILLE, N. J.  
Phones Arge., Braz., Peru, nights

**10535 kc. JIB**  
-C- 28.48 meters  
TAIWAN, FORMOSA  
Phones around 6:25 a.m.

**10520 kc. VLK**  
-C- 28.51 meters  
SYDNEY, AUSTRALIA  
Calls Rugby, early a.m.

**10430 kc. YBG**  
-C- 28.76 meters  
MEDAN, SUMATRA  
5:30-6:30 a. m., 7:30-8:30 p. m.

**10420 kc. XGW**  
-C- 28.79 meters  
SHANGHAI, CHINA  
Calls Japan 12 m.-3 a.m. and California late evening

**10410 kc. PDK**  
-C- 28.80 meters  
KOOTWIJK, HOLLAND  
Calls Java 7:30-9:40 a. m.

**10410 kc. KES**  
-X- 28.80 meters  
BOLINAS, CALIF.  
Tests evenings

**10370 kc. EHZ**  
-C, B- 28.93 meters  
TENERIFFE, CANARY ISL.  
Relays EAJ43, 2-4, 6-7 or 9 p.m.

**10350 kc. LSX**  
-C- 28.98 meters  
MONTE GRANDE, ARGENTINA  
Tests irregularly 8 p.m.-12 mid-night. Broadcasts Mon. and Fri. 5-6 p.m.

**10330 kc. ★ORK**  
-B, C- 29.04 meters  
RUYSELEDE, BELGIUM  
Broadcasts 2:30-4 p.m.

**10300 kc. LSL2**  
-C- 29.13 meters  
HURLINGHAM, ARGENTINA  
Calls Europe, evenings

**10290 kc. DZC**  
-X- 29.16 meters  
REICHSPOSTZENTRALAMPT, ZEESEN, GERMANY  
Broadcasts irregularly

**10260 kc. PMN**  
-B, C- 29.24 meters  
BANDOENG, JAVA  
Relays YDB 5:30-10:30 or 11 a.m.

**10250 kc. LSK3**  
-C- 29.27 meters  
HURLINGHAM, ARGENTINA  
Calls Europe and U. S., afternoon and evening

**10230 kc. CED**  
-X- 29.33 meters  
ANTOFAGASTAN, CHILE  
Tests 7-9:30 p.m.

**10220 kc. PSH**  
-C- 29.35 meters  
RIO DE JANEIRO, BRAZIL

**10170 kc. RIO**  
-C- 29.5 meters  
BAKOU, U.S.S.R.  
Works with Moscow 10 p.m.-5 a.m.

**10140 kc. OPM**  
-C- 29.59 meters  
LEOPOLDVILLE, BELGIAN CONGO  
Phones around 3 a.m. and 1-4 p.m.

**10080 kc. RIR**  
-C- 29.76 meters  
TIFLIS, U.S.S.R.  
Works with Moscow early morning.

**10070 kc. EDM-EHY**  
-C- 29.79 meters  
MADRID, SPAIN  
Works with S. America evenings

**10065 kc. JZB-TDB**  
-B- 29.81 meters  
SHINKYO, MANCHUKUO  
Phones Tokyo 6:30-7 a.m.

**10055 kc. ZFB**  
-C- 29.84 meters  
HAMILTON, BERMUDA  
Phones N. Y. C. daytime

**10055 kc. SUV**  
-C- 29.84 meters  
ABOU ZABAL, EGYPT  
Works with Europe 1-6 p.m.

**10042 kc. DZB**  
-X- 29.87 meters  
ZEESEN, GERMANY  
Irregular

**9990 kc. KAZ**  
-C- 30.03 meters  
MANILLA, P.I.  
Works with Java, Cal. and ships early morning

**9950 kc. GCU**  
-C- 30.15 meters  
RUGBY, ENGLAND  
Calls N.Y.C. evening

**9930 kc. HKB**  
-C- 30.21 meters  
BOGOTA, COL.  
Phones Rio de Janeiro evenings

**9930 kc. ★CSW**  
-B- 30.21 meters  
NATL. BROAD. STATION LISBON, PORTUGAL  
6-9 p.m.

**9890 kc. LSN**  
-C- 30.33 meters  
HURLINGHAM, ARGENTINA  
Calls New York, evenings

**9870 kc. WON**  
-C- 30.4 meters  
LAWRENCEVILLE, N. J.  
Phones England, evening

**9860 kc. ★EAQ**  
-B- 30.43 meters  
P. O. Box 951, MADRID, SPAIN  
Daily 5:15-9:30 p.m.; Saturday also 12 n.-2 p.m.

**9840 kc. JYS**  
-X- 30.49 meters  
KEMIKAWA-CHO, CHIBAKEN, JAPAN  
Irregular, 11:30 p.m.-3 a.m.

**9830 kc. IRM**  
-C- 30.52 meters  
ROME, ITALY  
Phones Egypt in the afternoon

**9800 kc. LSI**  
-C- 30.61 meters  
MONTE GRANDE, ARGENTINA  
Tests irregularly

**9790 kc. GCW**  
-C- 30.64 meters  
RUGBY, ENGLAND  
Calls N.Y.C., evening

**9760 kc. VLJ-VLZ2**  
-C- 30.74 meters  
AMALGAMATED WIRELESS OF AUSTRALIA, SYDNEY, AUSTRALIA  
Phones Java and N. Zealand early a.m.

**9750 kc. WOF**  
-C- 30.77 meters  
LAWRENCEVILLE, N. J.  
Phones England, evening

**9740 kc. ★COCQ**  
-B- 30.78 meters  
HAVANA, CUBA  
6:50 a.m.-1 a.m.

**9710 kc. GCA**  
-C- 30.89 meters  
RUGBY, ENGLAND  
Calls Arge. & Brazil, evenings

**↓ S.W. BROADCAST BAND ↓**

**9680 kc. ★CT1AA**  
-B- 31 meters  
"RADIO COLONIAL" LISBON, PORTUGAL  
Tues., Thurs., Sat. 4-7 p.m.

**9675 kc. DZA**  
-B- 31.01 meters  
ZEESEN, GERMANY  
Irregular

**9670 kc. TI4NRH**  
-B- 31.02 meters  
AMANDO CESPEDES MARIN, APARTADO 40, HEREDIA, COSTA RICA  
Daily 8:30-10, 11:30 p.m.-12 m.

**9660 kc. ★LRX**  
-B- 31.06 meters  
"EL MUNDO" BUENOS AIRES, ARGENTINA  
7-11:30 p.m. or 12 m.

**9650 kc. YDB**  
-B- 31.09 meters  
N.I.R.O.M. SOERABAJA, JAVA  
Daily exc. Sat. 6-7:30 p.m., 5:30-10:30 or 11 a.m., Sat. 5:30-11:30 a.m.

**9650 kc. DGU**  
-B- 31.09 meters  
NAUEN, GERMANY  
Works with Egypt in afternoon

**9645 kc. HH3W**  
-B- 31.1 meters  
P.O. BOX A117, PORT-AU-PRINCE, HAITI  
1-2, 7-8 p.m.

**9645 kc. YNLF**  
-B- 31.1 meters  
MANAGUA, NICARAGUA  
8-9 a.m., 12:30-2:30, 6:30-10 p.m.

**9635 kc. ★2RO**  
-B- 31.13 meters  
E.I.A.R., ROME, ITALY  
Daily 12:40-5:30 p.m.  
Mon., Wed., Fri. 6-7:30 p.m.  
Tues., Thurs., Sat. 6-7:45 p.m.

**9630 kc. HJ2ABD**  
-B- 31.14 meters  
BUCARAMANGA, COL.  
11:30 a.m.-12:30 p.m., 5:30-6:30, 7:30-10:30 p.m.

**9620 kc. HJ1ABP**  
-B- 31.19 meters  
P.O. BOX 37, CARTAGENA, COL.  
11 a.m.-1 p.m. 5-11 p.m.  
Sun. 10 a.m.-1 p.m., 3-6 p.m.

**9615 kc. HP5J**  
-B- 31.22 meters  
APARTADO 867, PANAMA CITY, PANAMA  
12n-1:30 p.m., 6-10:30 p.m.

**9600 kc. RAN**  
-B- 31.25 meters  
MOSCOW, U.S.S.R.  
Daily 7-9 p.m.

**9600 kc. CB960**  
-B- 31.25 meters  
SANTIAGO, CHILE  
9:30 p.m. on

**9595 kc. ★HBL**  
-B- 31.27 meters  
LEAGUE OF NATIONS, GENEVA, SWITZERLAND  
Saturdays, 5:30-6:15 p. m.  
Mon. at 1:45 a.m.

**9590 kc. ★PCJ**  
-B- 31.28 meters  
N. V. PHILIPS RADIO, HUIZEN, HOLLAND  
(Studio at Hilversum, Holland)  
Sun. 2-3, 7-8 p.m. Tues. 1:30-3 p.m. Wed. 7-10 p.m.

**9590 kc. ★VK2ME**  
-B- 31.28 meters  
AMALGAMATED WIRELESS LTD., 47 YORK ST., SYDNEY, AUSTRALIA  
Sun. 1-3, 5-9, 9:30-11:30 a.m.

**9590 kc. ★W3XAU**  
-B- 31.28 meters  
PHILADELPHIA, PA.  
Relays WCAU  
Daily 12 n-8 p.m., Sun. and Thurs. 12 n.-7 p.m.

**9580 kc. ★GSC**  
-B- 31.32 meters  
DAVENTRY, B.B.C., BROADCASTING HOUSE, LONDON, ENGLAND  
6-8, 9-11 p.m.

**9580 kc. ★VK3LR**  
-B- 31.32 meters  
Research Section, Postmaster Gen'l's Dept., 61 Little Collins St., MELBOURNE, AUSTRALIA  
3:15-8:30 a.m., except Sun., also Fri. 10 p.m.-2 a.m.

**9575 kc. HJ2ABC**  
-B- 31.34 meters  
CUCUTA, COL.  
8 p.m.-12 n.

**9570 kc. ★W1XK**  
-B- 31.35 meters  
WESTINGHOUSE ELECTRIC & MFG. CO., SPRINGFIELD, MASS.  
Relays WBZ, 7 a.m.-1 a.m.  
Sun. 8 a.m.-1 a.m.

**9565 kc. VUB**  
-B- 31.36 meters  
BOMBAY, INDIA  
11:30 a.m.-12:30 p.m., Tues., Thurs., Fri.

**9560 kc. ★DJA**  
-B- 31.38 meters  
BROADCASTING HOUSE, BERLIN  
12:05-5:15 a.m., 4:50-10:45 p.m.

**9555 kc. HJ1ABB**  
-B- 31.38 meters  
BARRANQUILLA, COL., S.A.  
P. O. BOX 715  
11:30 a.m.-1 p.m., 4:30-6 p.m.

**9540 kc. ★DJN**  
-B- 31.45 meters  
BROADCASTING HOUSE, BERLIN, GERMANY  
12:05-5:15 a.m., 4:50-10:45 p.m.

**9540 kc. VPD2**  
-B- 31.45 meters  
SUVA, FIJI ISLANDS  
AMALGAMATED WIRELESS OF AUSTRALASIA  
Daily except Sun. 5:30-7 a.m.

**9535 kc. JZI**  
-B- 31.46 meters  
TOKIO, JAPAN  
Tests 2:30-3:30 p.m., 9-10 a.m.

**9530 kc. ★W2XAF**  
-B- 31.48 meters  
GENERAL ELECTRIC CO., SCHENECTADY, N. Y.  
Relays WGY 4 p.m.-12 m.

**9525 kc. ZBW3**  
-B- 31.49 meters  
HONGKONG, CHINA  
P.O. Box 200  
11:30 p.m.-1:15 a.m., 4-10 a.m.

**9525 kc. LKJ1**  
-B- 31.49 meters  
JELOY, NORWAY  
5-8 a.m.

**9520 kc. HJ4ABH**  
-B- 31.51 meters  
ARMENIA, COLOMBIA  
8-11 a.m., 6-10 p.m.

**9510 kc. ★VK3ME**  
-B- 31.55 meters  
AMALGAMATED WIRELESS, Ltd.  
167 Queen St., MELBOURNE, AUSTRALIA  
Daily exc. Sun. 4-7 a.m.

**9510 kc. ★GSB**  
-B- 31.55 meters  
DAVENTRY, B.B.C., BROADCASTING HOUSE, LONDON, ENGLAND  
2-4 a.m., 12:15-5:45 p.m.

**9505 kc. HJ1ABE**  
-B- 31.57 meters  
P.O. BOX 31, CARTAGENA, COLOMBIA  
Daily 5-10:30 p.m.

**9500 kc. HJU**  
-B- 31.58 meters  
NATIONAL RAILWAYS, BUENAVENTURA, COLOMBIA  
Mon., Wed., Fri. 8-11 p.m.

**9500 kc. PRF5**  
-B- 31.58 meters  
RIO DE JANEIRO, BRAZIL  
Irregularly 4:45-5:45 p.m.

**9490 kc. XEFT**  
-B- 31.61 meters  
VERA CRUZ, MEXICO  
11:30 a.m.-4 p.m., 7 p.m.-12 m.

**9480 kc. EAH**  
-B- 31.65 meters  
MADRID, SPAIN  
4-5 p.m.

**9470 kc. XEDQ**  
-B- 31.68 meters  
GUADALAJARO, GALISEO, MEXICO  
Between 7 p.m. and 12:30 p.m.

**9460 kc. ICK**  
-C- 31.71 meters  
TRIPOLI, N. AFRICA  
Calls Rome 5-30-7 a.m.

**9450 kc. TGWA**  
-B- 31.75 meters  
MINISTRE de FOMENTO, GUATEMALA CITY, GUATEMALA  
Daily 12 m.-2 p.m., 8 p.m.-12 m.  
Sat. 9 p.m.-5 a.m. (Sun).

**9440 kc. FZF6**  
-B- 31.78 meters  
FORT DE FRANCE, MARTINIQUE  
11:30 a.m.-12:30 p.m., 6:15-7:15 p.m., 8-9 p.m.

**9440 kc. HC2RA**  
-B- 31.78 meters  
GUAYAQUIL, ECUADOR  
Heard evenings till 10:40 p.m.

# SHORT WAVES and LONG WAVES

## Our Readers Forum

### More Medals for Joe Miller



Editor, SHORT WAVE & TELEVISION:

I have been reading your magazine for quite some time and your diagrams and hook-ups always proved very worthwhile. Your publication is most interesting; ever since I've been reading Joe Miller's S.W. "Listen In" Column, your mag-

azine is now 100%, and very excellent in all activities.

Joe's column is first-class, up-to-the-minute music, and I am sure will have great appeal to all S-W listeners.

I am an editor myself, and I believe Joe Miller's column is the best I have ever seen in my ten years of DXing.

I will continue to read your fine magazine, and will also urge others to read S.W. & T. likewise, as it is an excellent "all-around" magazine for the S-W. Fan, Radio Experimenter and Ham.

Sincerely yours,

Robert F. Gaiser,  
Short Wave Editor,  
Universal D.X. Club,  
Butler, N.J.

(Thanks, Robert, and we know that Joe Miller will be pleased to know what you think of his column too.—Editor.)

### A Boost from New Zealand!

Editor, SHORT WAVE & TELEVISION:

I am writing to express my appreciation of the 2-valve (tube) battery 5-meter receiver circuit described by Mr. George Shuart on page 282 of the September S.W. & T. I am located 'way up in the "back blocks," far from the power lines, and have to depend on dry batteries, so can't go in for elaborate jobs. Behind my home is a hill about 2,000 feet above sea level, and from the top one can see practically all of the Canterbury Plains. Using Mr. Shuart's 5-meter circuit as a "portable" up there, I have received good "sigs" over more than 130 miles airline, which I think is mighty fine for a set of this size; don't you?

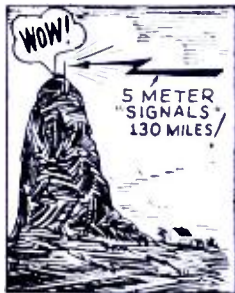

I am a keen constructor and have built up several of your sets and had excellent results!

By the way, while writing, I wonder if I might ask a small favor? Besides being a radio experimenter, I am also a keen stamp collector and would like to "swap" stamps with other readers interested in the same in the United States, Canada, and elsewhere. Would it be possible for you to insert a small notice to this effect somewhere in S.W. & T.? I'd be tremendously obliged if you could. Anyone sending me pictorial or other stamps will receive New Zealand's in exchange.

I have lately introduced S.W. & T. to some of the "lads" around here, and are they radio enthusiasts now? No Sir! They're better than that; they're all enthusiastic S.W. & T. crafters from now on.

Well 73 to the gang. Best of luck to S.W. & T.

D. R. Shires,  
Hazelburn, Pleasant Point,  
South Canterbury, New Zealand.

(Swell results, D.R.S. Here's the stamp "swap" notice and all. Glad to hear of your

success with our circuits in far away New Zealand and hope you hear from plenty of stamp "swappers."—Editor.)

### He's Built "Our" Sets and Swears by 'em!

Editor, SHORT WAVE & TELEVISION:

Having been a reader of S.W.C. for several years, I think you are entitled to some appreciation of your fine magazine. I have built in this time a dozen or more sets from your descriptions and ideas of my own, which have worked fine. I commenced with the Oscillodyne, Twinplex, and other one-tubers, then the Economy 2, which was good. I then improved on this by using a 19-tube as one-stage impedance coupling and one-stage resistance audio in place of a 15. This was a great "distance getter" and quiet. It has been my stand-by for two years, having built others up to three tubes and discarded them.

Two months ago I took the hint from your "World Wide Review" page, (Dec.) and used a pentode (1F4) as detector, in place of a 15—making the necessary changes—and it sure is a great set.

Your magazines are the best yet, and I take four regularly, but I notice lately the "World Wide Review" has one page. Why? It used to be two pages, in the old days, and it contained lots of good ideas. The "Kinks" page is also good, and have used many of them. Taking S.W. & T. as a whole it can't be beat.

Battery sets are my meat, being located 35 miles from a power line. My location is Lat. 53°51' N., Long. 109°70' W. I have heard Ham stations in Argentina, Brazil, Venezuela, Cuba, Panama, Hawaiian Islands, and all districts in U.S.A. and Canada. Some of their voices are like broadcast announcements to me. I hear all the usual S-W broadcasters, GSD etc., DJD etc., I2RO, Paris, Japan, Australia, and the usual Americans. I figure I am "going places" on a vertical half-wave twenty-meter antenna.

Yours sincerely,

Frank Jacob,  
Frenchman's Butte, Sask., Canada.

(Glad you like us so well, Frank. If we can find the space, we'll sure put two pages of "Review" in.—Editor.)

### Every "Copy" of S. W. & T. Seems Better!

Editor, SHORT WAVE & TELEVISION:

I have read your magazine for almost a year and I wish to congratulate you for the fine work. Every copy seems a little better than the last one! I am interested in 1- and 2-tube receivers.

I wish to tell you of the excellent results that I received with the 2-tube Doerle, which I built from plans in your magazine. During the months of November and December, 1936, I logged a total of 250 "hams" on the 20-meter band. They included all American districts, with a total of 40 states, second, third, fourth, and fifth districts in Canada, Hawaii, Cuba, Mexico, Panama Canal Zone, Dominican Republic and South America. Hoping to see more circuits as good as this one, I wish you the very 73 (best regards).

William Wardlow,  
Promise City, Iowa.

(Great work, William! It seems that the "Doerle" can still go places!—Editor.)

### He's Logged 600 Stations—Thanks to Our Station List!

Editor, SHORT WAVE & TELEVISION:

I have a small transmitter using only one tube, a class B. This small set, when using phone, has an output of about 3 watts with very good modulation. The microphone is a special one that is highly sensitive, and of course goes a long way to making the transmitter a success.



As I only have an "Artificial" aerial license at present, I am not able to judge the distance this low power will carry me, but during an official test, it was said to have worked the U.S.A. on CW, which is pretty good, I think you will agree.

My receiver is a B.T.S. band-spread 3-valve (tube) set with a range of 12 to 80 meters and I must say I have "logged" some very good DX with it, using the loudspeaker for most stations, and the phones for the most distant stations, like VPD2 in Suva, Fiji Isles.

With this set I have "logged" about 600 stations all over the globe and have heard all continents.

At this point I should like to express my appreciation and thanks to Short Wave & Television, for the help I have derived from the very valuable information contained in your pages. I should like to tell you that without your magazine, I should probably not have received half so many stations, as the times and wavelengths change so frequently, that unless the data is up-to-the-minute, it is practically valueless and your magazine is up-to-the-minute!

I will finish by extending cordial greetings to all readers of Short Wave & Television and wishing you all the best of luck and DX for 1937.

Yours very truly,

D. C. Chamberlain,  
Radio Station, 2CHD,  
67 Wiltshire Road,  
Thornton Heath,  
Surrey, England.

(Hotcha! D. C. C. and mighty glad to hear about your fine "DX" results. Such results and the knowledge that we helped, give us the courage to carry on.—Editor.)

### "Ham" News from Spain!

Editor, SHORT WAVE & TELEVISION:

First of all, let me thank you for sending me your interesting issues; otherwise, it would be impossible for me to get them because foreign publications are no longer sold here, since they do not reach us.

In your November issue, I saw my previous letter reproduced and noted that you wanted to hear more "HAM" news from Spain.

The situation here stands the same. No amateur transmitters are allowed to operate. Most of the finest amateur transmitters are being used by Government forces, both in the military posts of the various fronts and in the rear-guard. The rest are not allowed to work, for no one is authorized to be on the "air," with the exception of official centers and political parties attached to the Government. These political parties are



(Continued on page 56)

<p><b>9428 kc. ★COCH</b> -B- 31.8 meters 2 B ST., VEDADO, HAVANA, CUBA Daily 7 a.m.-1 a.m.</p> <p><b>4 S.W. BROADCAST BAND</b></p> <p><b>9415 kc. PLV</b> -C- 31.87 meters BANDONG, JAVA Phones Holland around 9:45 a.m.</p> <p><b>9350 kc. HS8PJ</b> -B- 32.09 meters BANGKOK, SIAM Thurs. 8-10 a.m.</p> <p><b>9330 kc. CGA4</b> -C- 32.15 meters DRUMMONDVILLE, CANADA Phones England Irregularly</p> <p><b>9330 kc. OAX4J</b> -B- 32.15 meters BOX 1166, LIMA, PERU "RADIO UNIVERSAL" 7 p.m.-12 m.</p> <p><b>9300 kc. YNGU</b> -B- 32.26 meters MANAGUA, NICARAGUA 12 n.-2 p.m., 6-7 p.m.</p> <p><b>9280 kc. GCB</b> -C- 32.33 meters RUGBY, ENGLAND Calls Can. &amp; Egypt, evenings</p> <p><b>9170 kc. WNA</b> -C- 32.72 meters LAWRENCEVILLE, N. J. Phones England, evening</p> <p><b>9150 kc. YVR</b> -C- 32.79 meters MARACAY, VENEZUELA Works with Europe afternoons.</p> <p><b>9125 kc. ★HAT4</b> -B- 32.88 meters "GYALILABOR," GYALI-UT 22 BUDAPEST, HUNGARY Sunday 6-7 p.m.</p> <p><b>9060 kc. TFK</b> -C- 33.11 meters REYKJAVIK, ICELAND Phones London afternoons. Broadcasts irregularly.</p> <p><b>9020 kc. GCS</b> -C- 33.26 meters RUGBY, ENGLAND Calls N.Y.C., evenings</p> <p><b>9010 kc. KEJ</b> -C- 33.3 meters BOLINAS, CAL. Relays NBC &amp; CBS Programs in evening irregularly</p> <p><b>8975 kc. VWY</b> -C- 33.43 meters KIRKEE, INDIA Works with England in morning</p> <p><b>8960 kc.</b> -C- 33.48 meters ALGIERS, ALGERIA Calls Paris</p> <p><b>8950 kc. HCJB</b> -B- 33.5 meters QUITO, ECUADOR 7:30-9:30 p.m., except Monday Sun. 11 a.m.-12 n.; 4-10 p.m.</p> <p><b>8795 kc. HKV</b> -B- 34.09 meters BOGOTA, COLOMBIA Mon. and Thurs. 7-7:30 p.m.</p> <p><b>8775 kc. PNI</b> -C- 34.19 meters MAKASSER, CELEBES, N.I. Phones Java around 4 a. m.</p> <p><b>8765 kc. DAF</b> -C- 34.23 meters NORDEICH, GERMANY Works German Ships irregularly</p> <p><b>8760 kc. GCQ</b> -C- 34.25 meters RUGBY, ENGLAND Calls S. Africa, afternoon</p> <p><b>8750 kc. FZE8</b> -C- 34.29 meters DJIBOUTI, FR. SOMALILAND AFRICA Calls Paris around 2:30 a.m.</p> <p><b>8730 kc. GCI</b> -C- 34.36 meters RUGBY, ENGLAND Calls India, 8 a. m.</p> <p><b>8680 kc. GBC</b> -C- 34.56 meters RUGBY, ENGLAND Calls ships</p> <p><b>8665 kc. CO9JQ</b> -X- 34.62 meters 4 GENERAL GOMEZ CAMAGUEY, CUBA 5:30-5:30, 8-9 p.m. daily except Sat. and Sun.</p>	<p><b>8580 kc. YNLG</b> -B- 34.92 meters MANAGUA, NICARAGUA 7:30-9:30 p. m.</p> <p><b>8560 kc. WOO</b> -C- 35.05 meters OCEAN GATE, N. J. Calls ships Irregular</p> <p><b>8400 kc. HC2CW</b> -B- 35.71 meters GUAYAQUIL, ECUADOR 11:30 a.m.-12:30 p.m., 8-11 p.m.</p> <p><b>8380 kc. IAC</b> -C- 35.8 meters Pisa, Italy</p> <p><b>8190 kc. XEME</b> -B- 36.63 meters CALLE 59, No. 517 MERIDA, YUCATAN "LA VOZ de YUCATAN desde MERIDA 10 a.m.-12 n., 6 p.m.-12 m.</p> <p><b>8185 kc. PSK</b> -C- 36.65 meters RIO DE JANEIRO, BRAZIL Irregularly</p> <p><b>8036 kc. CNR</b> -B- 37.33 meters RABAT, MOROCCO Sunday, 2:30-5 p. m.</p> <p><b>7975 kc. HC2TC</b> -B- 37.62 meters QUITO, ECUADOR Thurs., Sun. at 8 p.m.</p> <p><b>7901 kc. LSL</b> -C- 37.87 meters HURLINGHAM, ARGENTINA Calls Brazil, night</p> <p><b>7880 kc. JYR</b> -B- 38.07 meters KEMIKAWA-CHO, CHIBA- KEN, JAPAN 4-7:40 a. m.</p> <p><b>7860 kc. SUX</b> -C- 38.17 meters ABOU ZABAL, EGYPT Works with Europe 4-6 p.m.</p> <p><b>7854 kc. HC2JSB</b> -B- 38.2 meters GUAYAQUIL, ECUADOR Evenings</p> <p><b>7799 kc. ★HBP</b> -B- 38.47 meters LEAGUE OF NATIONS, GENEVA, SWITZERLAND 5:30-6:15 p. m., Saturday</p> <p><b>7715 kc. KEE</b> -C- 38.89 meters BOLINAS, CAL. Relays NBC &amp; CBS Programs in evening irregularly</p> <p><b>7626 kc. RIM</b> -C- 39.34 meters TACHKENT, U.S.S.R. Works with Moscow early morning</p> <p><b>7610 kc. KWX</b> -C- 39.42 meters DIXON, CAL. Works with Hawaii, Philip- pines, Java and Japan nights.</p> <p><b>7550 kc. TI8WS</b> -B- 39.74 meters "ECOS DEL PACIFICO" P. O. BOX 75 PUNTA ARENAS, COSTA RICA 6 p.m.-12 m.</p> <p><b>7520 kc. KKH</b> -C- 39.89 meters KAHUKU, HAWAII Works with Dixon and broad- casts irregularly nights</p> <p><b>7510 kc. JVP</b> -B-C- 39.95 meters NAZAKI, JAPAN</p> <p><b>7500 kc. RKI</b> -C- 40 meters MOSCOW, U.S.S.R. Works RIM early a.m.</p> <p><b>7390 kc. ZLT2</b> -C- 40.6 meters WELLINGTON, N.Z. Works with Sydney 3-7 a.m.</p> <p><b>7380 kc. XECR</b> -B- 40.65 meters FOREIGN OFFICE, MEXICO CITY, MEX. Sun. 6-7 p.m.</p> <p><b>7220 kc. HKE</b> -B- 41.55 meters BOGOTA, COL., S. A. Tue. and Sat. 8-9 p. m.; Mon. &amp; Thurs. 6:30-7 p. m.</p> <p><b>7200 kc. YNAM</b> -B- 41.67 meters MANAGUA, NICARAGUA Daily at 9 p.m.</p> <p><b>7100 kc. FO8AA</b> -B- 42.25 meters PAPEETE, TAHITI Tues. and Fri. 11 p.m.-12 m.</p>	<p><b>6996 kc. PZH</b> -B- 42.88 meters P. O. BOX 18, PARAMIRABO, DUTCH GUIANA Daily 6:06-8:36 a.m. Sun. 9:36-11:36 a.m. Daily 5:36-8:36 p.m.</p> <p><b>6977 kc. XBA</b> -B- 43 meters TACUBAYA, D.F., MEX. 9:30 a.m.-1 p.m., 7-8:30 p.m.</p> <p><b>6976 kc. HCETC</b> -B- 43 meters TEATRO BOLIVAR QUITO, ECUADOR Thurs. till 9:30 p.m.</p> <p><b>6905 kc. GDS</b> -C- 43.45 meters RUGBY, ENGLAND Calls N.Y.C. evening</p> <p><b>6860 kc. KEL</b> -X- 43.70 meters BOLINAS, CALIF. Tests Irregularly 11 a. m.-12 n.; 6-9 p. m.</p> <p><b>6850 kc. XGOX</b> -B- 43.8 meters NANKING, CHINA Daily 6:40-8:40 a.m. Sun. 4:40-6:05 a.m.</p> <p><b>6800 kc. HI7P</b> -B- 44.12 meters EMISORIA DIARIA de COM- ERCIO, CIUDAD TRUJILLO, DOM. REP. Daily exc. Sat. and Sun. 12:40- 1:40, 6:40-8:40 p.m.; Sat. 12:40- 1:40 p.m.; Sun. 10:40 a.m.- 11:40 a.m.</p> <p><b>6770 kc. HIH</b> -B- 44.26 meters SAN PEDRO de MACORIS DOMINICAN REP. 12:10-1:40 p.m., 7:30-9 p.m., Sun. 3-4 a.m., 4:15-6 p.m. p.m.; 4:40-7:40 p.m.</p> <p><b>6755 kc. WOA</b> -C- 44.41 meters LAWRENCEVILLE, N. J. Phones England, evening</p> <p><b>6750 kc. JVT</b> -B-C- 44.44 meters NAZAKI, JAPAN KOKUSAI-DENWA KAISHA, LTD., TOKIO</p> <p><b>6730 kc. HI3C</b> -B- 44.58 meters "LA VOZ DE LA FERIA" LA ROMANA, DOM. REP. 12:30-2 p.m. 5-6 p.m.</p> <p><b>6720 kc. PMH</b> -B-C- 44.64 meters BANDONG, JAVA Relays NIROM programs 5:30-10:30 or 11 a.m.</p> <p><b>6710 kc. ★TIEP</b> -B- 44.71 meters LAVOZ DEL TROPICO SAN JOSE, COSTA RICA APARTADO 257. Daily 7-10 p.m.</p> <p><b>6672 kc. YVQ</b> -C- 44.95 meters MARACAY, VENEZUELA Broadcasts Sat. 8-9 p.m.</p> <p><b>6670 kc. ★HC2RL</b> -B- 44.95 meters P. O. BOX 759, GUAYAQUIL, ECUADOR, S. A. Sunday, 5:45-7:45 p. m. Tues., 9:15-11:15 p. m.</p> <p><b>6650 kc. IAC</b> -C- 45.11 meters PISA, ITALY Calls ships, evenings</p> <p><b>6630 kc. HIT</b> -B- 45.25 meters "LA VOZ de la RCA VICTOR," APARTADO 1105, CIUDAD TRUJILLO, D.R. Daily exc. Sun. 12:10-1:40 p.m., 5:40-8:40 p.m., also Sat. 10:40 p.m.-12:40 a.m. (Sun.)</p> <p><b>6625 kc. ★PRADO</b> -B- 45.28 meters RIOBAMBA, ECUADOR Thurs. 9-11:45 p.m.</p> <p><b>6558 kc. HI4D</b> -B- 45.74 meters CIUDAD TRUJILLO, DOM- INICAN REPUBLIC Except Sun. 11:55 a.m.-1:40</p> <p><b>6550 kc. XBC</b> -B- 45.8 meters VERA CRUZ, MEX. 8:15-9 a.m.</p>	<p><b>6550 kc. TIRCC</b> -B- 45.8 meters RADIOEMISORA CATOLICA COSTARRICENSE SAN JOSE, COSTA RICA Sun. 11 a.m.-2 p.m., 6-7, 8-9 p.m., Daily 12 n.-2 p.m., 6-7 p.m., Thurs. 6-11 p.m.</p> <p><b>6545 kc. YV6RB</b> -B- 45.84 meters "ECOS de ORINOCO", BOLIVAR, VENEZUELA 6-10:30 p.m.</p> <p><b>6530 kc. YN1GG</b> -B- 45.94 meters "LA VOZ de LOS LAGOS" MANAGUA, NICARAGUA 8-9 p.m.</p> <p><b>6520 kc. ★YV4RB</b> -B- 46.01 meters VALENCIA, VENEZUELA 11 a.m.-2 p.m., 5-10 p.m.</p> <p><b>6500 kc. HIL</b> -B- 46.15 meters APARTADO 623 CIUDAD TRUJILLO, D.R. 12:10-1:40 p.m., 5:40- 7:40 p.m.</p> <p><b>6500 kc. TIOW</b> -B- 46:15 meters ONDAS del CARIBE PUERTO LIMON, COSTA RICA Daily 12 n.-1:30 p.m.</p> <p><b>6477 kc. HI4V</b> -B- 46.32 meters SAN FRANCISCO DE MACORIS, D.R. 11:40 a.m.-1:40 p.m., 5:10-9:40 p.m.</p> <p><b>6470 kc. YNLAT</b> -B- 46.36 meters "LA VOZ DEL MOMBACHO" GRANADA, NICARAGUA Leonidas Tenorio Irregular</p> <p><b>6450 kc. HI8A</b> -B- 46.51 meters CIUDAD TRUJILLO, DOM. REP. 8:40-10:40 a.m., 2:40-4:10 p.m., Sat. 9:40-10:40 p.m., Sun 2:40- 4:40 p.m.</p> <p><b>6425 kc. W9XB5</b> -X- 46.7 meters NATL. BROAD. CO. CHICAGO, ILL. Relays WMAQ. Irregular</p> <p><b>6420 kc. HI1S</b> -B- 46.73 meters PUERTO PLATA, DOM. REP. 11:40 a.m.-1:40 p.m., 5:40- 7:40, 9:40-11:40 p.m.</p> <p><b>6410 kc. TIPG</b> -B- 46.8 meters APARTADO 225, SAN JOSE, COSTA RICA "LA VOZ DE LA VICTOR" 12 n.-2 p.m., 6-11:30 p.m.</p> <p><b>6400 kc. YV5RH</b> -B- 46.88 meters CARACAS, VENEZUELA 7-11 p.m.</p> <p><b>6380 kc. YV5RF</b> -B- 47.02 meters BOX 983, CARACAS, VENE- ZUELA 6-10:30 p.m.</p> <p><b>6360 kc. HRP1</b> -B- 47.19 meters SAN PEDRO SULA, HONDURAS 7:30-9:30 p.m.</p> <p><b>6360 kc. YV1RH</b> -B- 47.19 meters "ONDAS DEL LAGO," MARACAIBO, VENEZUELA 7:30-11 p.m.</p> <p><b>6350 kc. HRY</b> -B- 47.24 meters TEGUCIGALPA, HONDURAS 6:30-8:30 p.m.</p> <p><b>6340 kc. HIX</b> -B- 49.32 meters CIUDAD TRUJILLO, DOMINICAN REP. Sun. 7:40-10:40; Daily 12:10 1:10 p.m.; Tues. and Fri. 8:10-10:10 p.m.</p> <p><b>6316 kc. HIZ</b> -B- 47.5 meters CIUDAD TRUJILLO DOMINICAN REPUBLIC Daily except Sat. and Sun. 11:10 a.m.-2:25 p.m., 5:10-8:40 p.m.; Sat. 5:10-11:10 p.m.; Sun., 11:40 a.m.-1:40 p.m.</p> <p><b>6300 kc. YV4RG</b> -B- 47.62 meters MARACAY, VENEZUELA 8-10:30 p.m.</p>	<p><b>6290 kc. YV5RP</b> -B- 47.69 meters CARACAS, VEN. LA VOZ DE LA PHILCO Irregular</p> <p><b>6282 kc. COHB</b> -B- 47.76 meters P.O. BOX 85, SANCTI SPIRITUS, CUBA 4-6, 9-11 p.m.</p> <p><b>6280 kc. HIG</b> -B- 47.77 meters CIUDAD TRUJILLO, D.R. 7:10-8:40 a.m., 12:40-2:10, 8:10-9:40 p.m.</p> <p><b>6243 kc. HIN</b> -B- 48 meters CIUDAD TRUJILLO, D.R. LA VOZ DEL PARTIDO DOMINICANO 12 n.-2 p.m., 7:30-9:30 p.m.</p> <p><b>6235 kc. HRD</b> -B- 48.12 meters LA VOZ DE ATLANTIDA LA CEIBA, HONDURAS 8-11 p.m., Sat. 8 p.m.-1 a.m. (Sun.); Sun. 4-6 p.m.</p> <p><b>6230 kc. YV1RG</b> -B- 48.15 meters VALERA, VENEZUELA 6-9:30 p.m.</p> <p><b>6230 kc. OAX4G</b> -B- 48.15 meters Apartado 1242 LIMA, PERU Daily 7-10:30 p.m.</p> <p><b>6210 kc. YV5RI</b> -B- 48.31 meters CORO, VENEZUELA Roger Leyba, % A. Urbina y Cia. Irregular</p> <p><b>6190 kc. HI8Q</b> -B- 48.47 meters TRUJILLO, DOM. REP. 11:45 a.m.-1 p.m., 4:45-6:45 p.m.</p> <p><b>6185 kc. HI1A</b> -B- 48.5 meters P. O. BOX 423, SANTIAGO, DOMINICAN REP. 11:40 a. m.-1:40 p. m. 7:40-9:40 p. m. Wed. 6-10:30 p.m.</p> <p><b>6171 kc. XEXA</b> -B- 48.61 meters DEPT. OF EDUCATION MEXICO CITY, MEX. 7-11 p.m.</p> <p><b>4 S.W. BROADCAST BAND</b></p> <p><b>6160 kc. ★YV5RD</b> -B- 48.7 meters CARACAS, VENEZUELA 11 a.m.-2 p.m., 4-10:30 p.m.</p> <p><b>6160 kc. VUZ</b> -B- 48.7 meters COLOMBO, CEYLON Daily exc. Thurs. and Fri. 7 a. m.-12:30 p.m. Sun. 7-11:30 a.m.</p> <p><b>6150 kc. CSL</b> -B- 48.78 meters LISBON, PORTUGAL Irregular 7-8:30 a.m., 2-7 p.m.</p> <p><b>6150 kc. ★CJRO</b> -B- 48.78 meters WINNIPEG, MAN., CANADA 8 p. m.-12 m. Sun. 3-10:30 p. m.</p> <p><b>6147 kc. ZEB</b> -B- 48.8 meters BULAWAYO, RHODESIA, S. AFRICA Sun. 3:30-5 a.m., Tues., Fri. 1:15-3:15 p.m., Mon. and Thurs., 11 a.m.-12 m.</p> <p><b>6147 kc. COKG</b> -B- 48.8 meters BOX 137, SANTIAGO, CUBA 9-10 a.m., 11:30 a.m.-1:30 p.m., 3-4:30 p.m., 10-11 p.m., 12 m.- 2 a.m.</p> <p><b>6145 kc. HJ4ABU</b> -B- 48.8 meters PEREIRA, COL. 9:30 a.m.-12 m., 6:30-10 p.m.</p> <p><b>6140 kc. ★W8XK</b> -B- 48.86 meters WESTINGHOUSE ELECTRIC &amp; MFG. CO. PITTSBURGH, PA. Relays KDKA 9 p.m.-1 a.m.</p> <p><b>6137 kc. CR7AA</b> -B- 48.87 meters LAURENCO MARQUES, PORT. E. AFRICA 4-9, 10:30-11 a.m., 12 n.-3:30 p.m., 11:15 p.m.-1 a.m.</p>
---	---	--	--	--

# SHORT WAVE LEAGUE



## HONORARY MEMBERS

Dr. Lee de Forest  
John L. Reinartz  
D. E. Replogle  
Hollis Baird  
E. T. Somerset  
Baron Manfred von Ardenne  
Hugo Gernsback  
*Executive Secretary*

## WHEN TO LISTEN IN

By M. Harvey Gernsback

### 25 Mc. BAND IN USE

● AT long last the neglected 25 mc. (11 meter) "broadcast band" has a station operating. Although the band has been authorized for many years for *broadcast* use it has been unused. However with the 11 year solar cycle of activity heading towards a "maximum" in 1939 or 1940, the shorter waves have become increasingly effective for *long distance* use. Broadcasters of course know this and are now beginning to realize the value of this band for long distance service.

The first station to appear on this band is W6XKG, at Los Angeles, Cal. W6XKG operates on 25.95 mc. or 11.56 meters. It relays the broadcast band station KGFJ. An interesting thing about the station is that it is on the air continuously. Its schedule is 24 hours daily, 7 days a week. Power is low, probably less than 100 watts,

but it is being clearly heard daily in the New York area. Address is, Ben S. McGlashan, Wash. Blvd. at Oak St.

Daventry will shortly join this station in the 25 mc. band. Some time this spring, probably on April or March 1st, GSK on 26.1 mc. will be placed in service in either the 6-8:45 a.m. or 9 a.m.-12 n. transmission period.

More stations will undoubtedly follow.

### BUENOS AIRES

According to a letter received from their chief engineer, the power of LRX on 9660 kc. is 10 kw. and that of LRX on 15290 kc. is 6 kw. Both stations are now using semi-directive aerials directed towards the United States.

### CANADA

A new Canadian is reported: CFRX at Toronto, Ont., is heard on 6070 kc. This station is experimental and relays the Canadian Radio Corporation's station CFRB in Toronto. At present the schedule is irregular but plans are being made to enlarge the station and eventually put it on a 16 hour-a-day schedule.

### PERU

Several new Peruvian stations are reported. OAX5B, "Radio Universal" at Ica, is operating on 11795 kc. and OAX4J at Lima, is on about 9330 kc. At Chiclayo is "Loa Voz de Chiclayo," OAX1A on 6125 kc. Further information on these will be found in the station list.

### NICARAGUA

A great many Nicaraguan stations have been added this month. At Managua there are—YNGU, 9300 kc.; YNAM, 7200 kc.; YN1GG, 6530 kc.; and YNOP, 5758 kc.

### VENEZUELA

More of the revised calls for Venezuelan stations are now at hand, so we will pass this information on to you. YV1ORSC is now YV3RC; YV8RB is now YV3RA; YV7RMO is now YV1RE; YV11RB is now YV6RB; YV4RC is now YV5RF; YV3RC is now YV5RD.

### HONGKONG

ZBW will shortly change over to its summer-time frequencies. Either 11755 kc. or 15190 kc. are used in the summer months.

### PORTUGAL

CSW at Lisbon now operates on 3 different frequencies. The new frequencies are 11040 kc. and 11875 kc. The first is on from 11 a.m.-1:30 p.m. The second from 1:30-5:30 p.m. when the station changes over to 9930 kc.

### AFRICA

CR7AA at Laurence Marques, Portuguese E. Africa is testing a new outfit on 15240 kc. and 11718 kc. weekdays from 12:45-3 p.m. and Sun. 8-10:30 a.m. Call letters are CR7RH.

### HARMONICS

During the past month a good many harmonics of 6 mc. band stations in South America have been heard near the 11 mc. band. At first it was thought that they were new stations but there were so many and when English-speaking U.S. 6 mc. stations were heard in the same region, all doubts were dispelled. Similarly 9.5 mc. band stations are being heard around 19 mc. or 15.5 meters. Daventry GSB, CSW Lisbon and several South Americans have been heard around 6 p.m. near 19 mc.

### REPORTS

We welcome reports. In fact we beg you to send them. BUT—please send reports on: 1—new stations not listed or mentioned here or in the station list. 2—Changes of

## Here's Your Button

The illustration here-with shows the beautiful design of the "Official" Short Wave League button, which is available to everyone who becomes a member of the Short Wave League.

The requirements for joining the League are explained in a booklet, copies of which will be mailed upon request. The button measures  $\frac{3}{4}$  inch in diameter and is inlaid in enamel—3 colors—red, white, and blue.

Please note that you can order your button AT ONCE—SHORT WAVE LEAGUE supplies it at cost, the price, including the mailing, being 35 cents. A solid gold button is furnished for \$2.00 prepaid. Address all communications to SHORT WAVE LEAGUE, 99-101 Hudson St., New York.



schedule, frequency, location or call letters of any station already listed. 3—Stations appearing in our list, which are actually "off the air." In this way the information can be kept more accurate. Please do not send reports on stations which we list correctly.

### DAVENTRY

Effective April 18, the schedule of operations of the English station will be revised. The new schedule will be as follows: 1:00-3:15 a.m.; 5:45-8:55 a.m.; 9:15 a.m.-12:00 Noon; 12:20-6:00 p.m.; 6:20-8:30 p.m.; 9:00-11:00 p.m.

### THANKS

Thanks this month to Satterthwaite (O.), Reese, Nutkis (N.Y.), Johnston (Alta.), Terry (Okla.), Rogers (Minn.), Burke (Me.).

### MR. WADIA, OF BOMBAY, TO VISIT U. S.

My friend D. R. D. Wadia of Bombay, India, has asked me to give your valued publication the following information:

"D. R. D. Wadia, radio merchant and widely known SWL "DXer," is coming to the United States to attend the PHILCO convention, to be held May 12th to May 19th, in New York.

After the con- (Continued on page 55)



## Short Wave League

At a Directors Meeting held in New York City, New York, in the United States of America, the Short Wave League has elected

**John F. Müller**

a member of this League.

In Witness whereof, this certificate has been officially signed and presented to the above.

*H. W. Infield Secor*  
Club Secretary

This is the handsome certificate that is presented FREE to all members of the SHORT WAVE LEAGUE. The full size is 7 $\frac{1}{4}$ "x9 $\frac{1}{2}$ ".

(See page 60)



**6135 kc. HJ1ABB**

-B- 48.9 meters  
BARRANQUILLA, COL., S. A.  
P. O. BOX 715,  
11:30 a.m.-1 p.m.; 4:30-10 p.m.

**6135 kc. HI5N**

-B- 48.9 meters  
SANTIAGO, D.R.  
6:40-9:10 p.m.

**6130 kc. TGXA**

-B- 48.94 meters  
GIORNAL LIBERAL PRO-  
GRESSISTA, GAUTEMALA  
CITY, GUAT.  
Heard in the evening.

**6130 kc. COCD**

-B- 48.94 meters  
"LA VOZ DEL AIRE"  
CALLE G y 25, VEDADO,  
HAVANA, CUBA  
Relays CMCD 11 a.m.-12 n., 7-  
10 p.m., Sun. 12 n.-4 p.m.

**6130 kc. ZGE**

-B- 48.94 meters  
KUALA LUMPUR,  
FED. MALAY STATES  
Sun., Tue., and Fri.,  
6:40-8:40 a. m.

**6130 kc. VE9HX**

-B- 48.94 meters  
P.O. BOX 898  
HALIFAX, N.S., CANADA  
Mon.-Fri., 9 a.m.-1 p.m.,  
5-11 p.m.  
Fri. 1-3 p.m.; Sat., Sun. 9 a.m.-  
1 p.m., 2-11 p.m.  
Relays CHNS

**6130 kc. LKL**

-B- 48.94 meters  
JELOY, NORWAY  
Relays Oslo 11 a.m.-6 p.m.

**6125 kc.**

-B- 48.98 meters  
"RADIO ELECTICO DE  
MONTEVIDEO"  
MONTEVIDEO, URUGUAY  
Mercedes 823  
3:30-9 p.m.

**6125 kc. OAX1A**

-B- 48.98 meters  
"LA VOZ DE CHICLAYO"  
CASILLA NO. 9  
CHICLAYO, PERU  
8-11 p.m.

**6122 kc. HJ3ABX**

-B- 49 meters  
LA VOZ DE COLOMBIA  
Apartado 2663  
BOGOTA, COLOMBIA  
Daily 10:30 a.m.-2 p.m., 5:30-  
11 a.m., Sun. 6-11 p.m.

**6120 kc. W2XE**

-B- 49.02 meters  
ATLANTIC BROADCASTING  
CORP.  
485 MADISON AVE., N. Y. C.  
Relays WABC, 11 p.m.-12 m.

**6115 kc. OLR2C**

-B- 49.05 meters  
PRAGUE  
CZECHOSLOVAKIA  
Irregular

**6110 kc. VUC**

-B- 49.1 meters  
CALCUTTA, INDIA  
Daily 3-5:30 a.m., 9:30 a.m.-  
noon, Sun. 7:30 a.m.-12n.

**6105 kc. HJ4ABB**

-B- 49.14 meters  
MANIZALES COL., S. A.  
P. O. Box 175  
Mon. to Fri. 12:15-1 p. m.;  
Tues. & Fri. 7:30-10 p. m.;  
Sun. 2:30-5 p. m.

**6100 kc. W3XAL**

-B- 49.18 meters  
NATIONAL BROADCASTING  
CO.  
BOUND BROOK, N. J.  
Relays WJZ  
Monday, Wednesday, Saturday,  
5-6 p.m., Sun. 12 m.-1 a.m.

**6100 kc. W9XF**

-B- 49.18 meters  
NATL. BROAD. CO.  
CHICAGO, ILL.  
Tues., Thurs., Fri. 12 m.-  
1 a.m., 8 p.m.-11:59 p.m.  
M., W., Sat., 12 m.-1 a.m.  
Relays WENR

**6100 kc. HJ4ABE**

-B- 49.18 meters  
MEDELLIN, COLO.  
Daily 11 a.m.-12 n., 6-10:30  
p.m.

**6097 kc. ZTJ**

-B- 49.2 meters  
AFRICAN BROADCASTING  
CO.  
JOHANNESBURG, SOUTH  
AFRICA.  
Sun.-Fri. 11:45 p.m.-  
12:30 a.m. (next day)  
Mon.-Sat. 9:30-7 a.m.  
9 a.m.-4 p.m.  
Sun. 8-10:15 a.m.; 12:30-3 p.m.

**6095 kc. JZH**

-B- 49.22 meters  
TOKIO, JAPAN  
Irregular

**6090 kc. HJ4ABC**

-B- 49.26 meters  
IBAUQUE, COL.  
7 p.m.-12 m.

**6090 kc. CRCX**

-B- 49.26 meters  
TORONTO, CANADA  
Daily 5:30-11:30 p.m.  
Sun. 5-11:30 p.m.

**6090 kc. VE9BJ**

-B- 49.26 meters  
SAINT JOHN, N. B., CAN.  
7-8:30 p. m.

**6090 kc. ZBW2**

-B- 49.26 meters  
P. O. BOX 200  
HONGKONG, CHINA  
Irregular 11:30 p.m.-1:15 a.m.,  
4-10 a.m.

**6085 kc. HJ5ABD**

-B- 49.3 meters  
"LA VOZ DE VALLE"  
CALI, COLOMBIA  
12 n.-1:30 p.m., 5:10-9:40 p.m.

**6083 kc. VQ7LO**

-B- 49.31 meters  
NAIROBI, KENYA, AFRICA  
Mon.-Fri. 5:45-6:15 a.m., 11:30  
a.m.-2:30 p.m. Also 8:30-9:30  
a.m. on Tues. and Thurs.; Sat.  
11:30 a.m.-3:30 p.m.; Sun. 11  
a.m.-2 p.m.

**6080 kc. ZHJ**

-B- 49.34 meters  
PENANG, MALAYA  
Daily exc. Sun. 6:40-8:40 a.m.  
also Sat. 11 p.m.-1 A.M. (Sun.)

**6080 kc. CP5**

-B- 49.34 meters  
LAPAZ, BOLIVIA  
7-10:30 p. m.

**6080 kc. HP5F**

-B- 49.34 meters  
CARLTON HOTEL  
COLON, PANAMA  
11:45 a.m.-1:15 pm., 7:45-10  
p.m.

**6080 kc. W9XAA**

-B- 49.34 meters  
CHICAGO FEDERATION OF  
LABOR  
CHICAGO, ILL.  
Relays WCFL  
Sunday 11:30 a. m.-9 p. m. and  
Tues., Thurs., Sat., 4 p. m.-12 m.

**6079 kc. DJM**

-B-X- 49.34 meters  
BROADCASTING HOUSE,  
BERLIN, GERMANY

**6070 kc. HJ3ABF**

-B- 49.42 meters  
BOGOTA, COLOMBIA  
7-11:15 p. m.

**6070 kc. CFRX**

-B-X- 49.42 meters  
TORONTO, CAN.  
Relays CFRB irregularly  
7 a.m.-1 a.m.

**6070 kc. YV1RE**

-B- 49.42 meters  
MARACAIBO, VENEZUELA  
6-11 p.m.

**6070 kc. VE9CS**

-B- 49.42 meters  
VANCOUVER, B. C., CANADA  
Sun. 1:45-9 p. m., 10:30 p. m.-  
1 a. m.; Tues. 6-7:30 p. m.,  
11:30 p. m.-1:30 a. m. Daily  
6-7:30 p. m.

**6065 kc. HJ4ABL**

-B- 49.46 meters  
MANIZALES, COL.  
Daily 11 a.m.-12 n., 5:30-7:30  
p.m. Sat. 5:30-10:30 p.m.

**6060 kc. W8XAL**

-B- 49.50 meters  
CROSLLEY RADIO CORP.  
CINCINNATI, OHIO  
5:30 a.m.-8 p.m.; 11 p.m.-1 a.m.  
Relays WLW

**6060 kc. W3XAU**

-B- 49.50 meters  
PHILADELPHIA, PA.  
Relays WCAU  
8 p.m.-11 p.m.

**6060 kc. OXY**

-B- 49.50 meters  
SKAMLEBOAEK, DENMARK  
1-6:30 p.m.

**6050 kc. HJ3ABD**

-B- 49.59 meters  
COLOMBIA BROADCASTING,  
BOX 509, BOGOTA, COL.  
12 n.-2 p.m., 7-11 p.m., Sun.  
5-9 p.m.

**6045 kc. HI9B**

-B- 49.63 meters  
SANTIAGO  
DOM. REP.  
Irregular 6 p.m.-11 p.m.

**6042 kc. HJ1ABG**

-B- 49.65 meters  
EMISORA ATLANTICO  
BARRANQUILLA, COLO.  
11 a.m.-11 p.m.  
Sun. 11 a.m.-8 p.m.

**6040 kc. W4XB**

-B- 49.67 meters  
MIAMI BEACH, FLA.  
Relays WIOD 12 n.-2 p.m.,  
5:30 p.m.-12 m.

**6040 kc. W1XAL**

-B- 49.67 meters  
BOSTON, MASS.  
Tues., Thurs. 7:15-9:15 p.m.  
Sun 5-7 p.m.

**6040 kc. YDA**

-B- 49.67 meters  
N.I.R.O.M.  
TANDJONGPRTOK, JAVA  
10:30 p.m.-2 a.m. Sat. 7:30 p.m.,  
2 a.m. (Sun.)

**6030 kc. HJ4ABP**

-B- 49.75 meters  
MEDELLIN, COL.  
Relays HJ4ABQ 8-11 p.m.

**6030 kc. HP5B**

-B- 49.75 meters  
P. O. BOX 910  
PANAMA CITY, PAN.  
12 n.-1 p.m., 7-10:30 p.m.

**6030 kc. VE9CA**

-B- 49.75 meters  
CALGARY, ALBERTA, CAN.  
Thurs. 9 a.m.-2 a.m. (Fri.);  
Sun. 12 n.-12 m.  
Irregularly on other days from  
9 a.m.-12 m.

**6030 kc. OLR2B**

-B- 49.75 meters  
PRAGUE, CZECHOSLOVAKIA  
Daily 2:45-4:30 p.m.

**6025 kc. HJ1ABJ**

-B- 49.79 meters  
SANTA MARTA, COLO.  
5:30-10:30 p.m. except Wed.

**6020 kc. DJC**

-B- 49.83 meters  
BROADCASTING HOUSE,  
BERLIN  
11:35 a.m.-4:30 p.m.

**6020 kc. XEUW**

-B- 49.82 meters  
AV. INDEPENDENCIA, 98,  
VERA CRUZ, MEX.  
8 p.m.-12:30 a.m.

**6018 kc. ZHI**

-B- 49.85 meters  
RADIO SERVICE CO.,  
20 ORCHARD RD.,  
SINGAPORE, MALAYA  
Mon., Wed. and Thurs 5:40-8:10  
a.m. Sat. 10:40 p.m.-1:10 a.m.  
(Sun.) Every other Sunday 5:10-  
6:40 a.m.

**6015 kc. HI3U**

-B- 49.88 meters  
SANTIAGO de los CABAL-  
LEROS, DOM. REP.  
7:30-9 a.m., 12 n.-2 p.m., 5-7  
p.m., 8-9:30 p.m., Sun 12:30-  
2, 5-6 p.m.

**6012 kc. HJ3ABH**

-B- 49.91 meters  
BOGOTA, COLO.  
APARTADO 565  
6-11 p.m.  
Sun. 12 n.-2 p.m., 4-11 p.m.

**6010 kc. VP3MR**

-B- 49.9 meters  
GEORGETOWN, BRI. GUI-  
ANA, S.A.  
Sun. 7:45-10:15 a.m.  
Daily 4:45-8:45 p.m.

**6010 kc. COCO**

-B- 49.92 meters  
P.O. BOX 98  
HAVANA, CUBA  
Daily 9:30 a.m.-1 p.m., 4-7 p.m.,  
8-10 p.m.  
Sat. also 11:30 p.m.-2 a.m.

**6005 kc. HP5K**

-B- 49.96 meters  
BOX 33, COLON, PANAMA  
7:30-9 a.m., 12 n.-1 p.m.,  
6-9 p.m.

**6005 kc. CFCX**

-B- 49.96 meters  
CANADIAN MARCONI CO.,  
MONTREAL, QUE.,  
CAN.  
Relays CFCF 6 a.m.-11:15 p.m.  
Sun. 9 a.m.-11:15 p.m.

**6005 kc. VE9DN**

-B- 49.96 meters  
DRUMMONDVILLE, QUE.,  
CAN.  
Sat. 11:30 p.m.-2 a.m. (Sun)

**6000 kc. ZEA**

-B- 50 meters  
SALISBURY, RHODESIA, S.  
AFRICA  
See ZEB. 6147 kc.

**6000 kc. RV59**

-B- 50 meters  
MOSCOW, U.S.S.R.

**5990 kc. XEBT**

-B- 50.08 meters  
MEXICO CITY, MEX.  
P. O. Box 79-44  
8 a.m.-1 a.m.

**5970 kc. HJ4ABD**

-B- 50.26 meters  
LA VOZ CATIA,  
MEDELLIN, COLOMBIA  
8-11:30 p.m.

**5968 kc. HVJ**

-B- 50.27 meters  
VATICAN CITY  
2-2:15 p. m., daily, Sun., 5-5:30  
a. m.

**5950 kc. HJN**

-B- 50.42 meters  
BOGOTA, COL.  
6-11 p.m.

**5940 kc. TG2X**

-B- 50.5 meters  
GUATEMALA CITY, GUAT.  
4-6, 9-11 p.m., Sun. 2-5 a.m.

**5925 kc. HH2S**

-B- 50.63 meters  
PORT AU PRINCE, HAITI  
BOX A103,  
7-9:45 p.m.

**5917 kc. YV4RP**

-B- 50.71 meters  
VALENCIA, VENEZUELA  
Irregular

**5900 kc. TIMS**

-B- 50.85 meters  
PUNTARENAS, COSTA RICA  
6-10 p.m.

**5898 kc. YV3RA**

-B- 50.86 meters  
"LA VOZ de LARA"  
BARQUISIMETO,  
VENEZUELA  
12 n.-1 p.m., 6-10 p.m.

**5890 kc. JIC**

-C- 50.93 meters  
TAIHOKU, FORMOSA  
Phones Tokyo 6-9 a.m.

**5885 kc. HCK**

-B- 50.98 meters  
QUITO, ECUADOR, S. A.  
8-11 p.m.

**5875 kc. HRN**

-B- 51.06 meters  
TEGUCIGALPA, HONDURAS  
1:15-2:15, 8:30-10 p.m., Sun.  
3:30-5:30, 8:30-9:30 p.m.

**5855 kc. HI1J**

-B- 51.25 meters  
BOX 204,  
SAN PEDRO de MACORIS,  
DOM. REP.  
12 n.-2, 6:30-9 p.m.

**5853 kc. WOB**

-C- 51.26 meters  
LAWRENCEVILLE, N. J.  
Calls Bermuda, nights

**5850 kc. YV1RB**

-B- 51.28 meters  
CALLE REGISTRO, LAS DE-  
LICIAS APARTADO de COR-  
RES 214  
MARACAIBO, VENEZUELA  
8:45-9:45 a.m., 11:15 a.m.-12:15  
p.m., 4:45-9:45 p.m., Sun. 11:45  
a.m.-12:45 p.m.

**5830 kc. TDD**

-C- 51.46 meters  
SHINKYO, MANCHUKUO  
Phones Tokyo 6-9 a.m.

**5830 kc. TIGPH**

-B- 51.5 meters  
ALMA TICA,  
APARTADO 800,  
SAN JOSE, COSTA RICA  
11 a.m.-1 p.m., 6-10 p.m.,  
Relays TIX 9-10 p.m.

**5800 kc. YV5RC**

-B- 51.72 meters  
RADIO CARACAS  
CARACAS, VENEZUELA  
Sun. 8:30-11:30 a.m., 1:30-10:30  
p.m.  
Daily 10:45 a.m.-1:30 p.m., 4-  
10:30 p. m.

**5790 kc. JUV**

-C- 51.81 meters  
NAZAKI, JAPAN

**5780 kc. OAX4D**

-B- 51.9 meters  
P.O. Box 853  
LIMA, PERU  
Mon., Wed. & Sat. 9-11:30 p.m.

**5758 kc. YNOP**

-B- 52.11 meters  
MANAGUA, NICARAGUA  
8-9:30 p.m.

**5740 kc. TGS**

-B- 52.26 meters  
GUATEMALA CITY, GUAT.  
Wed., Thurs. and Sun. 6-9 p.m.

**5730 kc. HC1PM**

-B- 52.36 meters  
QUITO, ECUADOR  
10 p.m.-12 m. irregular

**5720 kc. YV2RB**

-B- 52.45 meters  
"LA VOZ de TACHIRA,"  
SAN CRISTOBAL,  
VENEZUELA  
6-11:30 p.m.

**5500 kc. TI5HH**

-B- 54.55 meters  
SAN RAMON, COSTA RICA  
Irregularly 3:30-4, 8-11:30 p.m.

**5145 kc. PMY**

-B- 58.31 meters  
BANDONG, JAVA  
5:30-11 a.m.

**5077 kc. WCN**

-C- 59.08 meters  
LAWRENCEVILLE, N. J.  
Phones England irregularly

**5025 kc. ZFA**

-C- 59.7 meters  
HAMILTON, BERMUDA

**\$5.00 PRIZE**

**A VERY USEFUL IDEA**

I have found this kink very useful for soldering in "tight places" where the soldering iron tip will not enter, such as broken voice coil leads on speaker cones. This will save the time of taking off the speaker cone. The above is a copper wire twisted around the tip and then extended out about 1 inch or whatever length needed. Flow solder on end of tip so it will flow around extra wire, then tin tip of wire preparatory to soldering the connection—Anton Wolken.

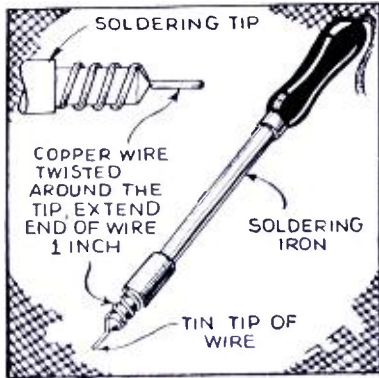

**A GREAT HELP**

Many experimenters, hams, and shop-workers who use pliers consistently, will find that this kink speeds up work as well as making it far easier. It keeps the pliers' jaws apart—R. Johnson.

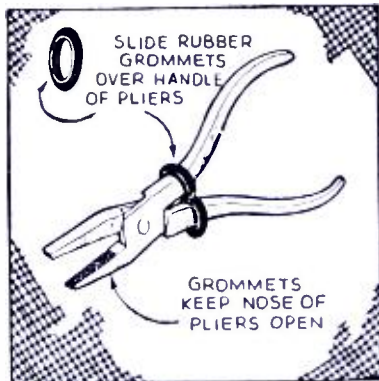

**CUT HOLES WITH SCISSORS**

An old pair of scissors will come in handy when a regular circle cutter is not available. Simply remove machine screw, place large fiber washer between the two blades, then replace the screw and set points of scissors to the desired radius and tighten firmly. Drill small hole to act as center through

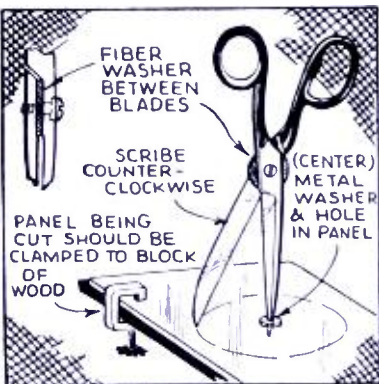

the material to be cut, then place suitable metal washer over point of narrow blade. Insert in center hole and "scribe," bearing down on cutting blade. This works best with soft metals such as aluminum.—Walter Grossheim.

**VARIABLE SELECTIVITY**

On the high frequencies I usually find that standard I.F. transformers, for 10 k.c. separation, are rather broad. So I cut a section out of the wooden dowel between the coils, which leaves one coil without support. This coil is then supported by a short piece of fiber or bakelite to which it is fastened by wax. The other end of the fiber is drilled and tapped to admit the end of a 6-32 machine screw. This machine screw passes through a hole in the side of the can, with a spring washer and nut on the inside. This assembly is clearly shown in the accompanying sketch. By turning the screw on the outside of the can, the coupling between the two coils can be varied.—Clarence H. Cramer.

**\$5.00 FOR BEST SHORT-WAVE KINK**

The Editor will award a five dollar prize each month for the best short-wave kink submitted by our readers. All other kinks accepted and published will be awarded eight months' subscription to SHORT WAVE & TELEVISION. Look over these "kinks"; they will give you some idea of what the editors are looking for. Send a typewritten or ink description, with sketch, of your favorite short-wave kink to the "Kink" Editor, SHORT WAVE & TELEVISION.

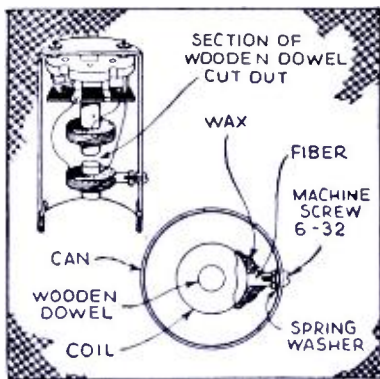

**MOUNTING THE "LINK"**

Here is a kink that will save time and patience for Hams building Xmitters using link-coupling where the R.F. stages are on the same sub-panel or base. The coupling is accomplished by means of 2 turns of 1/8" copper tubing held up by small stand-off insulators about 1" to 1 1/2" apart. The coil of tubing should be large enough to allow about 1/2" between itself and the plug-in coil all around. The sketch explains it much better.—Howard Jones.

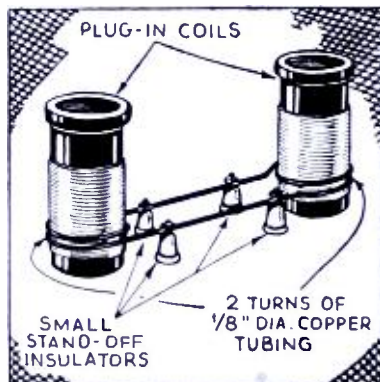

**A SIMPLE RESISTOR BOARD**

This resistor board is a very handy unit for the bench, as 35 different values between 57 and 1200 ohms can be obtained. For example, for 233 ohms, one connection is fixed to terminal 2 and the other to terminals 3 and 4.—L. Knight.

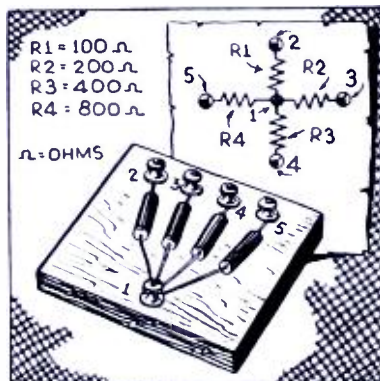

**BATTERY "WRINKLE"**

Those who use dry cells can readily appreciate the value of this idea. It consists of a narrow band cut from an old automobile inner-tube and placed around the batteries. With this arrangement the batteries may be tipped over accidentally and still the connections will not tear apart. In fact, it is

rather difficult to tip the batteries over when they are securely bound with this heavy rubber band. This is a simple kink, but it should find favor among the battery set owners.—John Nelson, N8FU, USNR.

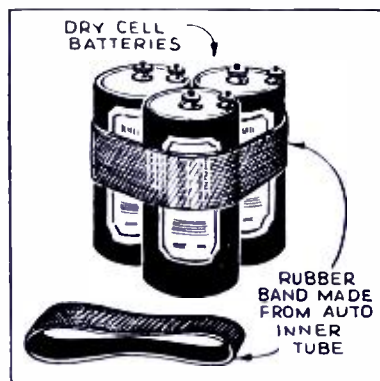

**HOME-MADE TEST PRODS**

I am an experimenter and consequently have much use for test prods. I am submitting to you my favorite and most useful kink; a combination test prod. The test prod is a combination of a straight pin and an alligator test prod. To make this you merely drill a small hole in the lower jaw of an alligator clip, and cut off the end of a pin, leaving it about three-quarters of an inch long. Now let the pin-point protrude through the hole about 1/4-inch, place a drop of solder on the rest of the pin to hold it in place, and you now have a novel test prod. The diagram illustrated will help to explain although it is simple. I believe the pin point and alligator test prods are used the most in testing. I believe this is original and I know it is very useful.—M. G. Kunkel.

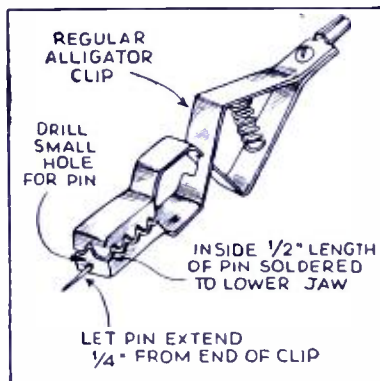

**METER SWITCH**

This kink employs one D.P. D. T. switch, and a milliammeter. It is to be used in a push-pull circuit to measure the plate current on each tube, by the use of the single meter and the D.P.D.T. switch. It will be

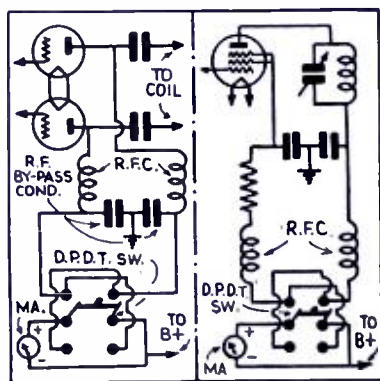

noticed that the polarity of the voltage must be the same when the switch is in either of the two positions. This is to be used in an R.F. amplifier circuit of course. This may also be used to measure the plate and the screen currents, where the screen gets its voltage from the same source as the plate.—W. L. Brown, KWTO Studios.

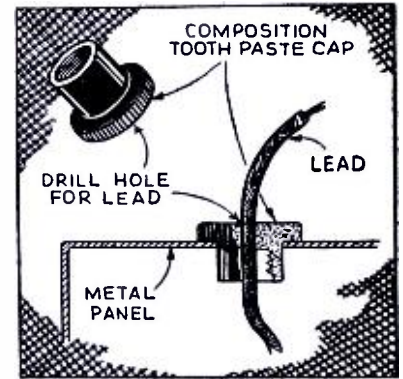

**HOME-MADE BUSHING**

The following is a method of running high-tension leads through a metal chassis. The insulators are the composition caps from tubes of tooth-paste and the like. My diagrams aren't wonderful, but I hope that they're understandable.—Warren Preeshl.

**"PHONES-TO-SPEAKER" SWITCH**

Here is a kink which I am sure will come in handy to anyone wishing to install phones on any commercial type receiver having a dynamic speaker. Although the phones may be of much higher ohmage than the voice coil, the output transformer furnishes plenty of volume. A "so-called" automatic phone jack should be used, as this completely silences the speaker when the phones are plugged in. This also avoids tearing into the chassis of the radio.—Claudie Hull.

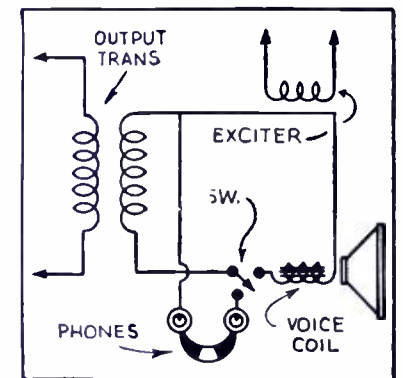

**COLOR CODE CHART**

Although this isn't original, I feel that few know about it. It is a chart for identifying color-coded resistors. Three pieces of cardboard, when made and painted in the colors indicated in the sketch, make the handy chart. The three pieces of cardboard are fastened with an eyelet or by some convenient means so that they can be lined up in accordance with the colors on the resistor.—Wyman Soule.

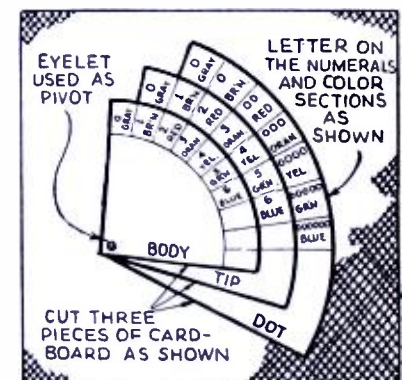

**HANDY SOLDERING KINK**

This is a very convenient method for soldering wire connections and other small work. A piece of copper wire is bent around the neck of the bottle, with a pair of pliers, and then bent up so it will pass through the upper part of the flame. The end is tinned and used as a soldering bit. This device gives you a hot point of constant temperature.—Leonard Tomsyck.

# SHORT WAVE . THIRTY-EIGHTH TROPHY . SCOUTS

Presented to

SHORT WAVE SCOUT  
**LEMUEL CAVILEER**  
 1223 Keswick Ave.  
 Haddon Heights, New Jersey

For his contribution toward the advancement of the art of Radio

by



## Honorable Mention

**Ernest Knowlton,**  
 Main Street,  
 Marlboro,  
 New Hampshire

● ON this page is illustrated the handsome trophy which was designed by one of New York's leading silversmiths. It is made of metal throughout, except the base, which is made of handsome black Bakelite. The metal itself is quadruple silver-plated, in the usual manner of all trophies today.

It is a most imposing piece of work, and stands from tip to base 22½". The diameter of the base is 7¾". The diameter of the globe is 5¾". The work throughout is first-class, and no money has been spared in its execution. It will enhance any home, and will be admired by everyone who sees it.

The trophy will be awarded every month, and the winner will be announced in the following issue of SHORT WAVE & TELEVISION. The winner's name will be hand engraved on the trophy.

The purpose of this contest is to advance the art of radio by "logging" as many short-wave phone stations, amateurs excluded, in a period not exceeding 30 days, as possible by any one contestant. The trophy will be awarded to that SHORT WAVE SCOUT who has logged the greatest number of short-wave stations during any 30-day period.

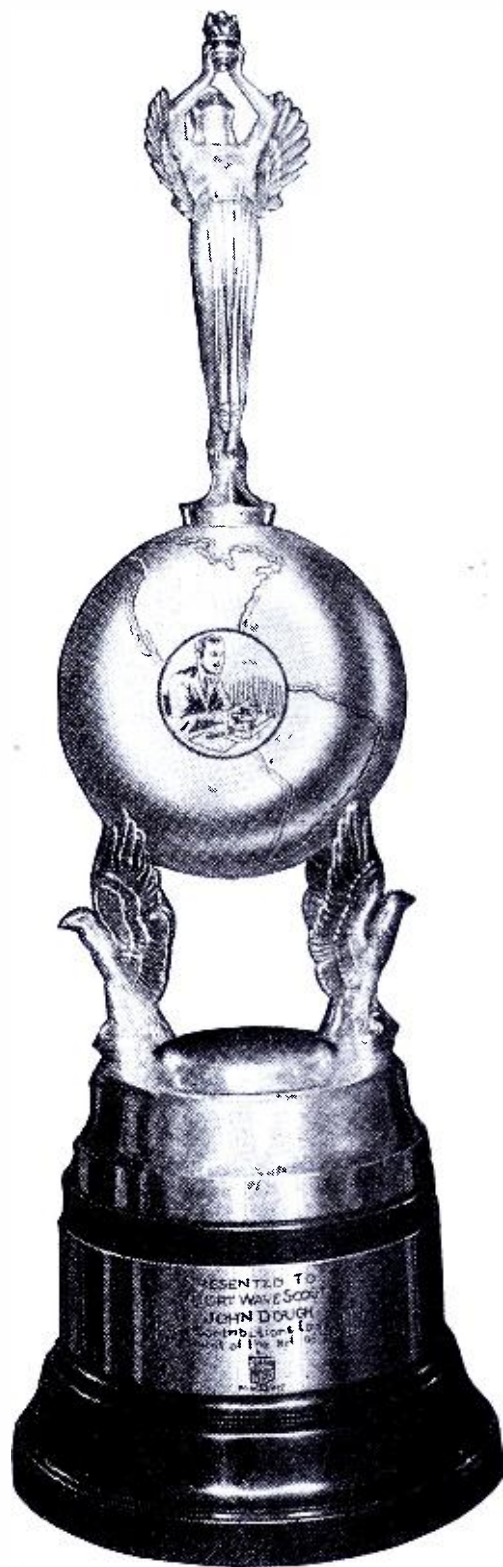

### 119 Stations—101 Foreign

● THE 38th Trophy is awarded to Lemuel Cavileer, of 1223 Keswick Avenue, Haddon Heights, New Jersey, who had an excellent total of 119 stations, 101 of which were foreign, and all of the verification cards came within the rules of the contest.

We congratulate Mr. Cavileer on his excellent total. He writes us to say that it took as many as three letters to some of the stations before he obtained the verification cards to conform with the contest rules. He says it was a long and tedious job, but it's well worth it. Even in hopes of getting the trophy, he was willing to do the job. Now that he has won it, we believe that he will be more than glad he carried on this DX campaign. The set used was a 12-tube Western Truetone.

### Mr. Cavileer's List of Stations

#### United States

Call	Freq.	Name of Station	Location
W1XAL	6,040 kc.	World-Wide Broadcasting Corp., Boston, Mass.	Boston, Mass.
W1XAL	11,790 kc.	World-Wide Broadcasting Corp., Boston, Mass.	Boston, Mass.
W1XAL	15,250 kc.	World-Wide Broadcasting Corp., Boston, Mass.	Boston, Mass.
W2XAF	9,530 kc.	General Elec. Co., Schenectady, N.Y.	Schenectady, N.Y.
W2XAD	15,330 kc.	General Elec. Co., Schenectady, N.Y.	Schenectady, N.Y.
W2XE	6,120 kc.	Atlantic Broadcasting, New York City.	New York City.

W2XE	15,270 kc.	Atlantic Broadcasting, New York City.
W3XL	17,310 kc.	National Broadcasting, New York City.
W3XAL	6,100 kc.	National Broadcasting, New York City.
W3XAL	17,780 kc.	National Broadcasting, New York City.
W3XAU	6,060 kc.	W. C. A. U., Inc., Philadelphia, Pa.
W3XAU	9,590 kc.	W. C. A. U., Inc., Philadelphia, Pa.
W8XK	6,140 kc.	Westinghouse Elec. & Mfg., Pittsburgh, Pa.
W8XK	15,210 kc.	Westinghouse Elec. & Mfg., Pittsburgh, Pa.
W8XAL	6,060 kc.	Crosley Radio Corp., Cincinnati, Ohio.
W9XF	6,100 kc.	National Broadcasting Corp., Chicago, Ill.

(Continued on page 42)

## New "Continent" Scout Trophy Contest

● MANY of our readers have suggested that we offer a new type of contest for the Short-Wave Scout Silver Trophy. We have therefore decided to begin a new series of contests and you can start "listening in," and writing for veris at once.

This new series of contest will be confined to reception from stations at one continent at a time. The first of these contests will be for the greatest number of verified stations heard in Asia. You may "listen in" from now until June 25th, but you will have to allow time for veris to reach you.

The same general rules as given previously apply. That is, a notarized affidavit must be sent with the veri cards and, of course, all of the veris will have to be for the continent assigned for each particular contest. The Asia "listening in" contest will close June 25th, and the trophy award will be announced in the September number which goes on the newsstands August 1st.

A—By midnight June 25th, all entries for the Asia contest must therefore be in the hands of the Editors, together with veris and the notarized oath that the contestant personally listened to all of the stations listed.

B—For the next four issues, the May, June, July and August numbers, trophies will be awarded on the basis of the old rules, which require that 50% of the stations heard and verified be foreign, and also that the listening time may be any 30-day period. In either contest, and in the event of a tie between two or more contestants, each listing the same number of stations, the judges will award a similar trophy to each contestant so tying.

C—Bear in mind that the veri cards should be absolute verifications, and not simply an acknowledgment that you notified a station that you heard them. The B.B.C. and several other stations do not verify, but simply send an acknowledgment card. Note that in either contest that only experimental phone or broadcast stations should be entered in your list. No amateur transmitters or commercial code stations can be entered. For the May, June, July and August contests, which follow our regular rules, the entries must be in the Editors' hands by midnight of the 25th day of the month for the next succeeding issue. The contest for the June issue will close in New York City April 24th, etc.

D—Please note once more, that only letters

or cards which specifically verify reception of a given station on a given wavelength and on a given date will be accepted! Don't forget to send International Postal Reply Coupon, costing 9 cents at your P.O. with requests for foreign veris.

E—Any type of short or all-wave receiver may be used by the listener. Please specify type and make of set, how many tubes, type of aerial and its dimensions in a brief statement accompanying the veri cards. All veri cards will be returned prepaid after judging each contest. The judges in each contest will be the Editors of Short Wave & Television and the opinions of the judges will be final.

F—When sending in entries, type your list, or write in ink, and give the total number of stations both Foreign and Domestic. Send veri cards with your letter and oath certificate all in one package. Use a single line for each station and list them in a regular order, such as: frequency, schedule. (All time should be reduced to E.S.T., which is five hours behind Greenwich Meridian Time.) Name of station, city, country; musical identification signal if any.

**SHORT WAVE**  
 EDITED BY  
**G.W. SHUART, W2AMN**

# QUESTION BOX

● Because the amount of work involved in the drawing of diagrams and the compilation of data, we are forced to charge 25c each for letters that are answered directly through the mail. This fee includes only hand-drawn schematic drawings. We cannot furnish "picture-layouts"

or "full-sized" working drawings. Letters not accompanied by 25c will be answered in turn on this page. The 25c remittance may be made in the form of stamps, coin or money order.  
 Special problems involving considerable research will be quoted upon request. We cannot

offer opinions as to the relative merits of commercial instruments.  
 Correspondents are requested to write or print their names and addresses clearly. Hundreds of letters remain unanswered because of incomplete or illegible addresses.

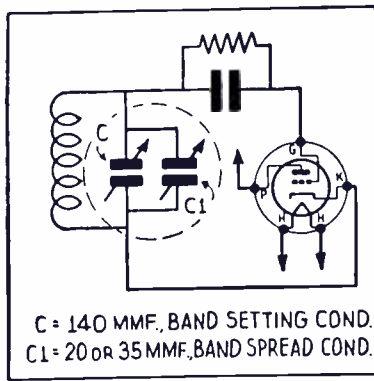

How to Obtain Band-Spread

**ELECTRICAL BAND-SPREAD**

R. James Roby, Portland, Ore.  
 (Q) I would like to know how to install band-spread tuning in the "Louis Martin" short-wave receiver described in your manual "10 Most Popular Short-Wave Receivers" and also in the Sept. 1932 issue of *Short Wave Craft*. I am going to build the set and want to have band-spread electrical instead of mechanical. Please answer in your *Question Box* as soon as possible.  
 (A) It is a very simple matter to incorporate band-spread in any of the smaller receivers, either of the tuned R.F. or superheterodyne variety. The diagram clearly shows how a smaller condenser is connected in parallel with the present tuning condenser. The larger condenser will be used for band-setting and the smaller one for band-spreading.

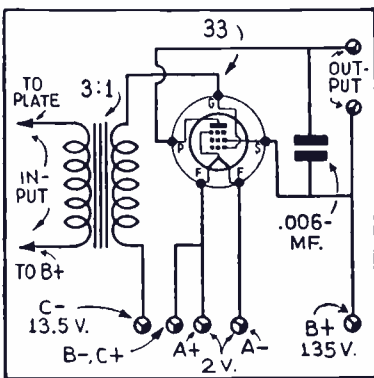

Amplifier for Battery Set

**COMPLETE I.F. AMPLIFIER**

Morton Nelson, Cedar Falls, Iowa.  
 (Q) I should appreciate it very

much if you would publish a diagram of two I.F. stages using 6K7s. This should be suitable for the Victor 2-tube superhet, described in one of your preceding issues.

(A) We have shown a complete diagram of the two stages of intermediate frequency amplification, together with the diode second detector. The input to the I.F. amplifier, of course, is connected to the plate of the first detector, while the output from the diode goes to the audio amplifier, as indicated in the diagram. Any variable-mu pentodes can be used in the I.F. portion, and the second detector may consist of a combination diode and triode.

**T.R.F. 3-TUBER**

John Pellock, Singac, N.J.  
 (Q) I would like to build a T.R.F. receiver using a 35 in the r.f. stage, a 24 detector and a 27

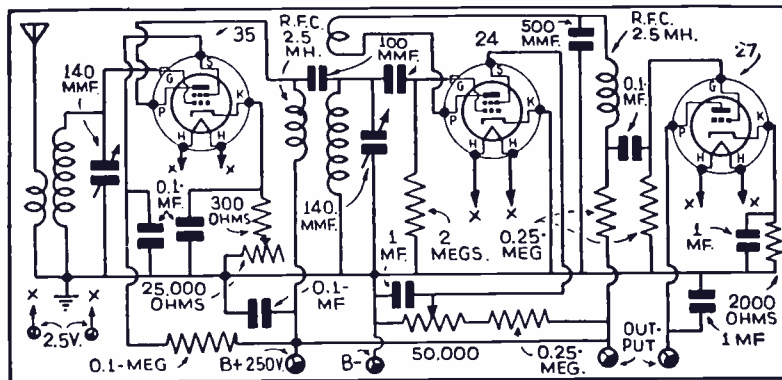

3-Tube T.R.F. Receiver for the Beginner

audio amplifier. Please show the diagram in the *Question Box* employing 4-prong 2-winding coils.

(A) The diagram you request is shown on this page. Capacitive coupling between the T.R.F. and detector stages is employed in order that 4-prong coils may be used. Although we believe that more satisfactory results can be obtained with inductive coupling and 3-winding coils. This receiver should give satisfactory earphone volume.

**ONE STAGE AMPLIFIER FOR BATTERY SET**

J. W. Huson, Cristobal, C. A.  
 (Q) I have constructed your two tube battery receiver using 30 tubes as described in the August *Question Box* and would like to add a type 33 as audio amplifier. This should require an absolute minimum of "B" battery.  
 (A) The addition of the 33 pentode should be well worth while and should provide "speaker" operation

with the receiver previously using only type 30's. Either a magnetic or a permanent dynamic speaker may be used.

**LINK COUPLING TO ANTENNA**

Stanley Sherman, Battle Creek, Michigan.

(Q) I have seen mentioned in a number of your articles the fact that link-coupling is used between the antenna tuning unit and the transmitter. Will you be kind enough to illustrate in the *Question Box* just how this should be done. I would like to construct a separate antenna tuning unit.

(A) We have shown a tuning unit used in testing many of the transmitters described in this magazine. It consists of a 26 turn coil with 2 adjustable clips and a two-turn link directly in the center of

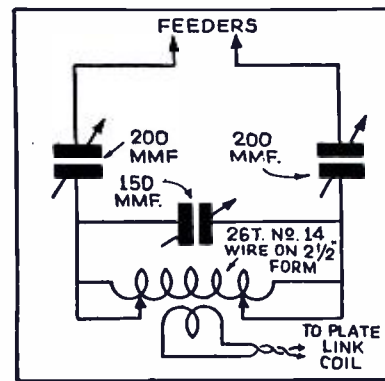

Link-Coupling Arrangement for Transmitting Antennas

**CONNECTING EAR-PHONES AND SPEAKER**

J.P.A., Terre Haute, Ind.  
 (Q) Please print in your *Question Box* as soon as possible, a phone adapter which permits use of headphones on a speaker set. It is to be used on a 1929 Crosley "Show-box-8."

(A) Connecting phones to a commercial receiver intended for speaker operation is not at all difficult. In the diagram you will find that the phones connected in series with a .1 mf. condenser are connected between the plate of the tube and the "B" minus. If there is a first audio stage in the receiver, it is advisable to connect the phones in the plate circuit of that tube, rather than the output tube. In either case, the same procedure,

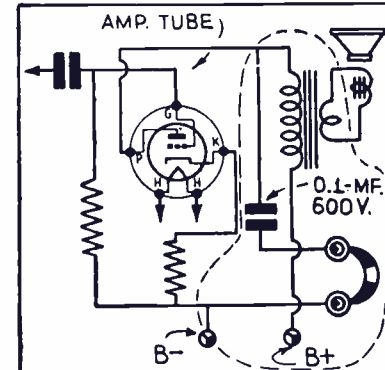

How to Connect Earphones to Speaker Set.

as indicated in the diagram, should be followed. In the case of the first A.F. amplifier where the transformer is not used, the phones will be connected across the plate resistor.

**AUDIO AMPLIFIER**

Glen Attrill, Puente, Calif.  
 (Q) Please print in your *Question Box* a hookup of an amplifier using four or five glass tubes. The output should be five to seven watts. There should be separate controls for mike and phonograph pick-up so they can be blended. The distortion should be as low as possible. The quality should be the best possible.

(A) We have shown in diagram a very useful amplifier. This will have an output of seven or eight watts and can be built in very compact form. Choose the proper "output" transformer for the particular condition under which the amplifier is to be operated.

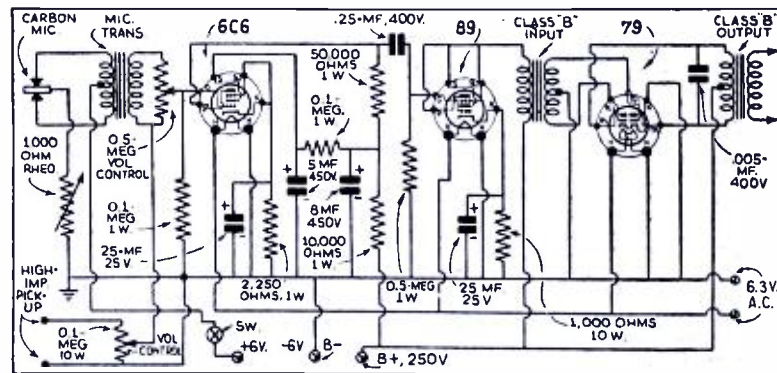

Complete Audio Amplifier, Using Class B 79.

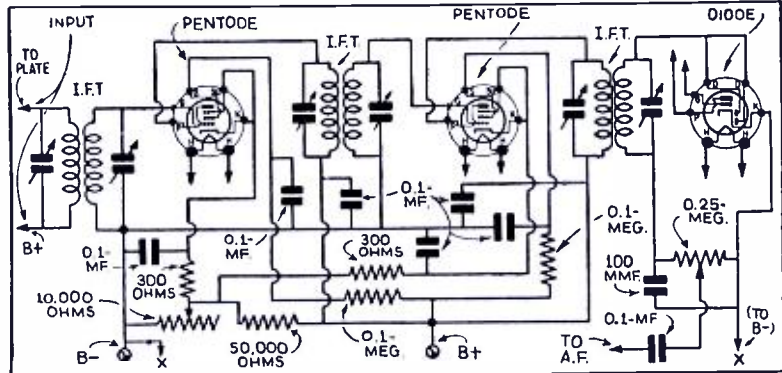

Two Stages of I.F. Amplification and Diode Second-Detector

# NEW 1937 SHORT WAVE APPARATUS

(PROMPT SHIPMENTS ON ALL ITEMS)



## Eilen RX-17 7-tube BANDSPREAD RECEIVER

(8½ to 3,000 meters)



See article p. 544 Jan. Issue Short Wave and Television. Our largest, finest, and most sensitive new 1937 receiver, unequalled in appearance, performance and value. Uses a special, highly efficient and selective circuit producing results which WILL satisfy even the most discriminating short wave fan.

RX-17 is equipped with the famous EILEN NOISE SUPPRESSOR, the latest development of our laboratories and which is skyrocketing itself into immense popularity. This remarkable development, exclusive with EILEN, enables you to enjoy reception from those far-off stations with excellent clarity and volume. Constructed of the finest materials and to conform with the highest engineering standards, this instrument uses two 6D6, two 6J5G, one 76, one 42, and one 5Y3 high gain tubes as TUNED RF AMPLIFIER, TUNED ELECTRON COUPLED SCREEN-GRID REGENERATIVE DETECTOR, powerful 3 stage audio frequency amplifier with power pentode output stage delivering 3 watts of audio power to the built-in high fidelity dynamic loudspeaker. VARIABLE NOISE SUPPRESSOR, rectifier and complete built-in HUM-FREE power supply. BANDSPREAD TUNING—special electron tube circuit enabling the operator to reduce or eliminate certain types of noises occurring in all short wave receivers—automatic headphone jack—smooth and noiseless controls—highly efficient interchangeable inductors—doublet or aerial-ground connections—POWERFUL hi-fidelity audio system—large, illuminated airplane type vernier dial—sensitivity, volume, and selectivity that will amaze you—are features to be found in RX-17.

RX-17 in BEAUTY, as well as performance, is in a class by itself—heavy steel cabinet with hinged lid finished in durable black shrivel—colored dial lights behind black and white scale—chrome plated acetone—calibrated dial plates—plated chassis and shielding—Operates entirely from your 105 to 130 volts AC house current.

RX-17 under fair conditions will bring in dozens of foreign as well as domestic short wave stations with enormous volume. Try one and see for yourself!

RX-17, complete, READY TO USE, with 7 RCA or Sylvania tubes, 12 low-loss silver plated coils for 8½ to 3000 meters, wired in cabinet, and instructions.....

**\$21.95**

(If metal tubes are preferred over the glass type, add \$1 to above price.)

For those who wish to build their own we offer:

KIT of all parts, coils for 8½-3000 meters, unwired (less tubes & cabinet)..... **\$14.95**  
Cabinet, extra..... **\$2.50**  
7 matched Sylvania tubes, extra..... **3.35**  
Wired and tested, extra..... **2.00**

**AMATEURS:** Model RX-17. All has same specifications as RX-17 except that it is equipped with plate voltage cut-off switch and special bandspread coils for 20-40-80-160 M bands spreading these bands 80% of dial scale. Add \$1 to price of RX-17. (10 meter band coils if desired extra \$1.45).

## RX-18 8-TUBE BAND SPREAD RECEIVER

(2½ to 3,000 meters)

RX-18 and RX-18-AB have the same specifications as the above RX-17 and RX-17-AB, but is equipped with an EIGHTH TUBE (6J5G) enabling the wavelength range to be extended down to 2½ meters. This additional tube is designed especially for ultra-high frequency wavelengths. This receiver is exceedingly simple to operate with excellent results.

ADD \$4.50 to price of corresponding RX-17 or RX-17-AB model. Prompt delivery can be made.



## BS-5

### 6-Tube Band switch Receiver

10 to 600 Meters

A powerful, sensitive, and selective SW receiver covering the entire wave-length span of 10 to 600 meters in 5 steps. NO PLUG-IN COILS are used. Simply turn the waveband selector switch and enjoy reception on any wavelength within this range.

Uses two 6D6, one 76, one 43, one K42A, and one 25Z5 tubes as RF amplifier, electron coupled screen grid regenerative detector, powerful 2 stage audio amplifier with pentode output stage, rectifier, and complete built-in power supply.

HUM-FREE—Hi-fidelity dynamic loudspeaker—illuminated, airplane type vernier dial—band spread tuning control—automatic headphone jack—extremely smooth acting controls—operates from your AC or DC house current—beautiful heavy, black shrivel finish chassis and cabinet.

DELIVERS GREAT LOUDSPEAKER VOLUME ON THE GREAT MAJORITY OF SHORT WAVE FOREIGN STATIONS UNDER FAIR CONDITIONS.

PRICE, complete with 6 tubes, cabinet, wired, and instructions, ready to use.....



See editorial article Page 482, Dec. issue S.W.C.

operates from your AC or DC house current.

**\$16.95**

BS-5 KIT, of necessary parts, including detailed instructions; less tubes, cabinet, unwired..... **\$10.95**

SPECIAL: Complete kit, cabinet, tubes and instructions, unwired..... **\$14.95**

(If metal tubes are preferred to glass type, add \$1)

**AMATEURS:**

Model BS-5-AB has same specifications as BS-5 except that it has special band spread circuit for 20-40-80-160 M bands and is equipped with plate voltage cut-off switch. Add \$1.00 to above price.



## 7C 5-Tube Short Wave Receiver

8½ to 625 meters

Bigger and More Powerful Than Ever A Giant in Performance

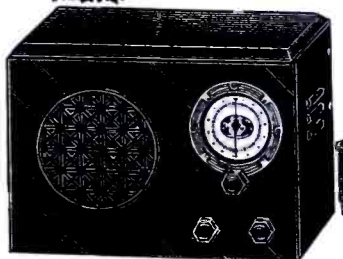

FULL 5 TUBE PERFORMANCE plus THE NEW K92A SERIES TUBE makes this an outstanding value. Equipped with a powerful 3 stage audio frequency amplifier.

Uses 6D6-6F7 (twin 2 in 1 tube)—76—K92A-12A7 (twin tube) tubes as RF amplifier, electron coupled screen grid regenerative detector, powerful 3 stage audio amplifier with pentode output stage, rectifier and complete built-in power supply. Operates entirely from 105 to 130 volt AC or DC light socket.

BAND SPREAD TUNING—smooth regeneration control—built-in high quality loudspeaker—automatic headphone jack—large, illuminated airplane type vernier dial—large low-loss inductances. Heavy, black shrivel finish metal chassis and cabinet. Must be seen to be appreciated. Satisfied owners report as high as 35 foreign countries on the loudspeaker with this model. You may do the same under fair conditions. ORDER YOURS TODAY! YOU WILL NOT REGRET IT!

EILEN 7C RECEIVER, wired, in cabinet, complete, READY TO USE, with speaker 5 RCA tubes, 4 coils for 8½ to 200 meters, and simple instructions..... **\$12.95**

(2) Broadcast Band Coils, extra..... **\$1.25**

7C KIT, unwired, of necessary parts, coils for 8½ to 200 meters, and instructions less cabinet, speaker, tubes..... **\$7.25**

Beautiful metal cabinet, extra..... **\$1.25**

5 matched RCA tubes..... **3.15**

Special loudspeaker..... **1.45**

(2) Broadcast band coils, 200-625 meters..... **1.25**

Labor for wiring & testing, extra..... **1.50**

SPECIAL: COMPLETE KIT, unwired, cabinet, 5 tubes, speaker, 4 coils for 8½ to 200 meters, and simple instructions..... **\$11.45**

2 broadcast Coils, extra..... **\$1.25**

AMATEURS: Model 7C-AB, same specifications as 7C except that has special tuning circuit and coils for spreading out the 20-40-80-160 M bands over 80% of dial. Also equipped with plate voltage cut-off switch. Same price as 7C. Model 6B or 6B-AB battery model of 7C. Operates from inexpensive dry batteries. Same price.



## 3-Tube Short Wave Radio Only \$3.25

(less tubes, phones, unwired)

A REAL, powerful 3 tube short wave set that readily brings in amateurs, police calls, broadcast stations, experimental, and foreign stations with good volume under fair conditions. THE WORLD AT YOUR DOOR!

THREE TUBE BATTERY SET, less tubes, phones, unwired \$2.95  
TWO TUBE BATTERY SET, less tubes, phones, unwired \$2.00

KITS wired, extra 75c. Tubes, each 50c. Broadcast band coils (2), extra 95c. Conventional double headphones \$1.35.



## AN-5 Four Tube BANDSPREAD RECEIVER

A powerful and highly selective short wave receiver designed for the fan who prefers the use of headphones. Uses 6F7-6D6-76-84 tubes in five-tube performance circuit as TUNED RF amplifier.

TUNED electron coupled screen grid regenerative detector, two stage audio amplifier, rectifier & built-in power supply. HUM-FREE. POWERFUL. Readily operates a speaker. Operates from your 105-130 volt AC house current.

AN-5, complete with 4 matched tubes, coils for 9 to 200 meters, cabinet, wired, READY FOR USE..... **\$15.95**

Broadcast band coils (2), extra..... **\$1.45**

AMATEURS: Model AN-5-AB has same specifications as AN-5 except that has plate voltage cut-off switch and special bandspread coils for 20-40-80-160 meter bands. Add \$1 to price of AN-5.



## HF-35 3-Tube SW Transmitter

A powerful and well engineered amateur band transmitter of great beauty and efficiency—AT A PRICE WITHIN THE AMATEUR'S REACH. Uses 50-40-40 tubes as TRITET CRYSTAL CONTROLLED OSCILLATOR—CLASS C RF POWER AMPLIFIER—built-in antenna tuning system—beautiful, black shrivel metal case and shriveling—Triplet meters—Eilen transmitting dials—highest quality construction—35 watts of power output on 20-40-80-160 M bands. A transmitter that you can be proud to own. An excellent exciter unit for high power stages to be added later. 3 coils for any 1 band and instructions included.



HF-35, assembled, and ready to wire (less tubes, power supply, crystal, holder and additional coils)..... **\$21.95**  
Matched Arcturus Tubes (3)..... **\$2.15**  
Eilen quartz crystal (80 or 160)..... **\$1.95**  
Eilen crystal holder..... **1.00**  
Coils for additional bands, per set..... **1.45**

HV-475 1-Tube power supply for use with HF-35, less tube..... **\$12.45**  
(ready to wire).....  
Labor for wiring extra \$1.50  
83 tube for HV-475, extra 55 cents

M-15 3-Tube Modulator for use with HF-35 and capable of modulating its entire output at 100%..... **\$14.95**  
(less tubes).....  
Three Arcturus tubes, 58-53-53, extra..... **\$1.95**

## FREE: New 1937 catalogue

of short wave receivers, transmitters, & 5 meter apparatus. Send stamp to cover mailing costs on YOUR copy.

JUST OFF THE PRESS!

Prompt service, 20% deposit on C. O. D. orders

**EILEN RADIO LABORATORIES, Dept. SC 5, 136 Liberty Street, NEW YORK, N. Y.**

**YOU CAN NOW OWN THE ACE DO-ALL DE LUXE**

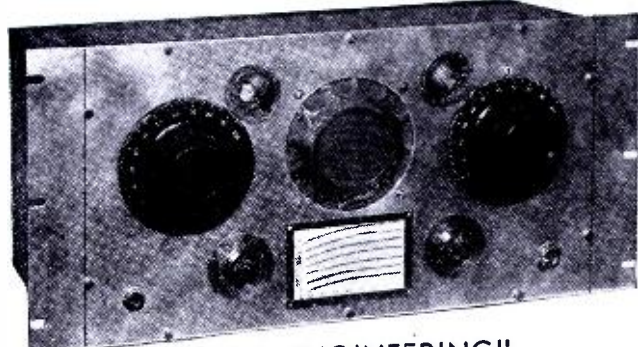

"A TRIUMPH OF ENGINEERING"

Available in 2 Models—  
7 Tubes—2½ to 3000 Meters  
6 Tubes—9 to 3000 Meters

The Do-All De Luxe contains features not found in any other receiver: **Two Tuned Stages**—a positive essential for sensitivity and sharp tuning; **Semi-automatic, duplex regeneration control**—manual control also provided; **Two new, velvet smooth, transmitter type, dual speed dials** provide full continuous band spread; **Continuous tuning range** of 100 Kc. to 120 Mc.; **Large, self-contained, powerful dynamic speaker**; **Doublet or singlet antenna input connections**; **Headphone jack with auto-tions**;

**High voltage AC power supply**; **Calibration curves** mounted on front panel; **Provision for standard 19" rack mounting** (supplied without rack ends); **All metal tubes in R.F. stages** give complete shielding, and **glass tubes in audio and rectifier stages** give greater heat dissipation; **All controls calibrated for permanency and accuracy**; **Beautiful satin-aluminum finish** on front panel and **durable baked crackle finish** on cabinet; **AND**—the Ace built-in noise suppressor (standard equipment on all models)—a development pioneered by the Ace Radio Laboratories—no adjustments necessary—just throw the noise suppressor switch on front panel and enjoy uninterrupted clear distant foreign reception.

**TUBE LINE-UP:** 6K7 (all metal) tuned high gain pre-selector stage—6K7 electron coupled regenerative detector—76 U.H.F. 2½ to 10 meter Super-regenerative detector—76-76-42 High Fidelity **THREE STAGE** audio frequency amplifier with three watts actual output—5Y4G Full-wave, high voltage full power rectifier. **TOTAL=SEVEN FULL DUTY TUBES!!**

\$14.75 brings you the complete construction kit of parts to build the standard Do-All De Luxe, including: the chassis and panel (already drilled), transformers and chokes, coils tuning from 9 to 200 meters (already wound), large dynamic speaker, vernier dials and knobs, sockets, resistors, condensers, etc., etc., in fact every part down to the smallest piece of hardware, **AND**—detailed, easy to follow, 8 page instruction booklet and interesting and essential short wave information. (Less cabinet and tubes, unwired.)

For an additional \$2.00 this model may be obtained assembled, wired and laboratory tested!

**\$14.75**

\$18.75 brings you the complete parts to build the Do-All De Luxe **ULTRA MODEL**. Everything is included as in above Standard model together with coils tuning from 2½ to 200 meters. The entire world of radio at your fingertips!

This model is supplied completely assembled, wired and laboratory tested for an additional.....

**\$2.50**

Either of above models may be supplied (whether ordered in construction kit form or already wired) together with: Complete set of matched tubes, heavy cabinet with hinged cover and 200 to 3000 meters wavelengths range coils . . . \$5.00 additional.

**ORDER YOUR DO-ALL DE LUXE TODAY AND THRILL TO THE LAST WORD IN RADIO!**

**ANOTHER Exclusive Ace Development—THE UNIVERSAL SIX**

**8¼ to 625 Meters—Four New Tubes**

**A Truly Universal Receiver Operates on AC-DC—Battery**

**IMAGINE!!** A compact, self-contained sensitive receiver with real **SIX TUBE** performance that will operate on any AC or DC house line or on batteries, without making any changes. The Ace Universal-SIX will operate anywhere! Simply plug in a cable and —**PRESTO!** A completely battery operated set with the same full toned loud speaker volume—the same thrilling foreign reception—the same miraculous ease of operation! Really **TWO** good receivers for less than you would expect to pay for either one!



**POWERFUL tube line-up:** 6F7 Screen grid pentode R.F. stage and first audio stage—6F7 Electron coupled regenerative detector and second audio stage—38 third audio power pentode output stage—I-V heater type rectifier for humless power supply! Every tube serves a useful audio purpose—no "ballast" tubes to make the set appear larger!

**MORE FEATURES:** Full Bandsread 8¼ to 625 meters—self-contained speaker—transmitter type dual speed full vision dial—provision for headphones—velvet smooth control of regeneration—operates entirely on AC, DC, or Batteries—Low current drain with high output means real economical operation.

\$7.15 brings you every part needed to build this remarkable all purpose receiver, including: drilled panel and chassis, 4 coils tuning from 8¼ to 200 meters, condensers, dials, chokes, resistors, etc., etc., in fact every part down to the last screw and nut and large, easy to follow instruction sheet. (Less tubes, speaker and cabinet, unwired)

**\$7.15**

**CLIP THIS COUPON**

Please send me your free catalog fully describing Ace Products.

Name .....

Address .....

C-5 Catalog No. 25

Laboratory Wired and Tested . . . \$1.50 additional **SPECIAL:** All necessary accessories—set of four matched tubes, sensitive speaker, cabinet and coils to tune from 200 to 625 meters—add \$5.50 to above prices.

**ORDER YOUR UNIVERSAL SIX NOW!** Every one fully guaranteed! Buy with safety!

**ACE RADIO LABORATORIES**  
227 Greenwich St., Dept. C-5, NEW YORK CITY  
THE HOUSE OF VALUE AND SERVICE

Have you a Binder in which to keep your copies of **SHORT WAVE** and **TELEVISION**? Order one today—\$1.25. Holds 12 copies. **SHORT WAVE** and **TELEVISION**, 99 Hudson St., N.Y.C.

On broadcast as well as shortwave frequencies, in any location, you can eliminate "man-made" static with

**CORWICO**

**NOISE-MASTER**

ALL-WAVE ANTENNA

Send for complete literature.

CORNISH WIRE CO., 30 CHURCH STREET, NEW YORK CITY

Manufacturers of

**VITREOUS TRANSMITTING GRID LEAKS**

**VOLUME CONTROLS · POWER RHEOSTATS**

Write for Complete Free Catalog

**ELECTRAD, Inc.**

175 Varick Street, New York

**Short Wave Broadcasting**

By John V. L. Hogan

(Continued from page 3)

for the United States channels between 550 and 1600 kilocycles could be assigned at 20 kilocycle intervals (instead of the present 10 kilocycle separation) and the Canadian and Mexican channels sandwiched in between, with a ten kilocycle separation between the nearest stations of adjacent nations. Thus at one stroke, three of the most vexing problems of today's broadcasting can be logically solved on a sound technical basis.

What is necessary before such an ideal can be realized? So far as I can see, all that is needed is the widespread availability of receiving sets capable of giving good reproduction of the *short-wave* signals. There is of course the question of noise from automobiles and other man-made radio disturbers, but these are much less troublesome in *ultra-frequency* sound reception than, for example, in television. Fortunately, static disturbances are almost absent in *ultra-frequency* work, and there is little or none of the fading that spoils musical quality. On the whole, it seems entirely clear to me that there is no real obstacle to such an improved radio broadcasting service, except the present lack of *ultra-short-wave* receivers or converters in the hands of our millions of broadcast listeners.

Of course, there is an interesting corollary to the development of short-wave sound broadcasting, and that is the *broadcasting of pictures by television and facsimile*. Whatever is done to acquaint the listening public with the value and importance of *ultra-frequency* waves will aid in the eventual coming of television. Facsimile is not so limited, but such familiarity with transmission problems will also be of assistance in its development. It is perhaps dangerous to attempt prophecy, but to my mind we shall have, first, the development of long-distance, *high-fidelity* broadcasting on the *short* broadcasting waves from 187 to 200 meters, then *facsimile* services in the high-medium band from 100 to 200 meters; then *high-fidelity* broadcasting on the *ultra-frequency* waves, then *ultra-frequency facsimile*, and finally *ultra-frequency television*.

The first of these is already under development at WQXR, on 1550 kilocycles, which has proved that these once-condemned waves are valuable for both day and night services, and the second is being tried out at W2XBH on about 2000 kilocycles. The third step, *ultra-frequency* broadcasting of sound, is also under experimental development and seems imminent as a service, but there is as yet no indication of just when we may expect the fourth and fifth steps. In any event, there is today no reason why the young electrical engineer should shun radio as a profession, for in all probability the next decade or two will see radio developments that will put the past to shame.

**VALUABLE DATA IN BACK NUMBERS!**

● **MANY** short-wave set-builders frequently need constructional data on certain transmitters or receivers as well as converters and other allied apparatus.

Recently many inquiries have been received asking for data on "1-meter" sets, for example. The January, 1936, issue contains a very good article describing how to build and operate a transmitter and a receiver of modern type, tuning over a range of from ½ to 1 meter.

This shows how important it is to retain all back numbers of this magazine, as they may prove extremely valuable at any moment. Back numbers are available from the Subscription Dept.

Substantial binders are available for preserving these back numbers.

# THE NEW DOERLE

**6 - Tube BANDSPREAD RECEIVER**  
**MARVELOUS Sensitivity and Selectivity**  
**Only Found in the Higher Priced Models**

- \*Unusually smooth acting regeneration control.
- \*Headphone jack with plate voltage cut-off switch.
- \*Highly efficient, low loss ribbed plug-in coils, are a large factor in the amazing sensitivity and selectivity of this receiver. Coils are of the large 3 winding variety and are color coded for easy identification.

\*Continuous bandspread tuning from 9 1/2 to 625 meters.  
 \*Beautiful, large illuminated dual pointer, multi-colored, airplane type dial of great beauty.  
 \*Operates from either single wire type aerial or noise-free doublet.  
 \*Volume control—stage aligning trimmer—and tone controls.  
 \*Uses (6K7G, 6K7G, 6C5G, 6C5G, 6F6G and 5Y3) tubes in a highly efficient circuit, using two tuned stages—electron coupled regenerative detector—POWERFUL 3 stage resistance capacity coupled audio amplifier with power pentode output stage—high voltage rectifier and self contained hum-free power supply. Built-in High Fidelity dynamic speaker capable of handling the entire 3 watts power output of the receiver.  
 Continuous bandspread over 9 1/2 to 625 meters is obtainable due to the use of a special type, multi-colored, airplane dial having 125 to 1 ratio and two pointers. Two knobs are provided and make possible either fast or slow motion tuning. ALL of the AMATEUR and FOREIGN SW BANDS are spread over a generous portion of the tuning dial, thereby simplifying tuning so that even a beginner can operate it to the utmost satisfaction. Entirely free from all traces of backlash.  
 The entire unit is contained in a large, black crackle finished metal chassis and cabinet of extreme beauty. Simply plug into your electric light socket and enjoy an evening of short wave thrills and entertainment such as you have never before experienced.  
 Mechanical specifications: Dimensions are 17 1/2"x8"x8 3/4". Net weight 23 lbs. Shipping weight 33 lbs. Designed to operate entirely from 100-130 volts, 50 to 60 cycles AC house current. Shipment made same day as order is received. Complete satisfaction guaranteed.

**DOERLE 6 tube AC BANDSPREAD RECEIVER**, completely wired and tested, with set of 6 matched Arcturus tubes, 8 coils for 9 1/2 to 200 meters, cabinet, instructions, and READY TO OPERATE.  
 (Specify whether metal or glass tubes desired.)



**YOUR NET COST**  
**\$27.96**

less 2 Broadcast band coils, extending the range up to 25 meters, extra \$1.45.

6 Arcturus matched tubes.....\$3.12  
 Broadcast band coils (2).....1.45

**DOERLE 6-tube AC SW KIT**, containing all necessary parts, including 8 low loss ribbed coils for 9 1/2 to 200 meters, full size hi-fidelity dynamic speaker, beautiful cabinet, and 4 page instruction booklet (less tubes, Broadcast coils, and unwired).....**\$17.96**

## DOERLE 2-TUBE BATTERY RECEIVER



One of the most popular members of the Doerle Set Family. Employs but two tubes, yet will outperform many three and four tube receivers. Uses two type 30 tubes as regenerative detector and one stage of transformer coupled audio frequency amplification. Delivers enormous headphone volume on all signals. Easily operates a loudspeaker on many stations.

The world-famous reputation of the entire Doerle line is behind this remarkable set. Requires two dry cells and one or more 45 volt "B" batteries for operation. Extremely simple to build and operate. Complete and detailed diagrams and instructions included.

**DOERLE 2-TUBE BATTERY RECEIVER KIT**, (unwired), less tubes, cabinet, B.C. coils and batteries, including coils for 10 to 200 meters, and instruction booklet.....**\$4.95**  
 Set of two MATCHED RCA tubes, extra.....\$0.80  
 Metal cabinet, black, shrivel finished.....1.25  
 2 broadcast band coils, 200-550 meters.....1.25  
 WIRED & TESTED, extra.....1.50

## THREE TUBE DOERLE AC SHORT WAVE SET

9 to 200 METERS

These three tube receivers are low in price—yet, inexpensive as they are, they pull in short wave stations from all over the world with excellent volume and regularity. Designed so as to conform to the highest engineering standards and constructed of the finest material, these receivers WILL please you.  
 Tubes used are one 6F7 (twin dual purpose tube), one 41 and one 84 functioning as screen grid regenerative detector, powerful two stage audio frequency amplifier with power pentode output stage, rectifier and built in power pack. Hum free in operation. Four tube performance. Produces enormous headphone volume and will readily operate a loudspeaker at full capacity on practically all stations.



Contains all of the latest features that can possibly contribute towards making this an outstanding value.  
 1. Illuminated airplane type vernier dial of extreme beauty.  
 2. Electron coupled screen grid regeneration circuit.  
 3. Unusually smooth regeneration control.  
 4. Band spread vernier control condenser.  
 5. Large low-loss silver plated inductances (band spread coils if desired).  
 6. Low loss equipment and construction throughout.  
 7. Cadmium plated chassis of high electrical conductivity.  
 8. Beautiful, black crackle finished steel panel and cabinet with hinged lid.  
 9. Operates from your AC house current.

**PRICE**, complete, ready to use, wired, with 3 tubes, cabinet, coils for 9 to 200 meters, less B.C. coils and phones, with 4 page instruction booklet.....**\$11.95**  
 (2 Broadcast band coils, extra \$1.45)

**THREE TUBE DOERLE AC KIT**, including drilled chassis and panel, all parts, coils for 9 to 200 meters, instructions and booklet, unwired, less cabinet tubes, B.C. coils and phones.....**\$6.95**  
 Crackle finished steel cabinet, extra.....\$1.25  
 Set of 3 MATCHED RCA tubes, extra.....1.75  
 Wired and tested, extra.....1.45  
 Broadcast band coils (2) extra.....1.45  
 Cannonball headphones, 2000 ohm, extra.....1.35

**GUY STOKELY RADIO CORPORATION,**

**126 Liberty St., Dept. S-5, New York City**

Sole manufacturers and distributors of Doerle products  
 20% deposit on C.O.D. orders. Prompt shipment

**FREE: Catalogue of Doerle Receivers sent upon request**

# The "VS-5" Metal Tube S-W Superhet

(Continued from page 15)

age by placing the AVC switch in the "off" position or by temporarily short circuiting the 1 megohm resistor. Apply the proper voltages to the heaters and plate as shown in Fig. 1, and rotate the oscillator band-setting condenser until a signal is heard. Adjust the mixer condenser for maximum volume. The selectivity control is now turned to the left as far as it will go (loose coupling) and the volume control is placed full-on. With an insulated screw-driver,

adjust the trimmers on each I.F. transformer until maximum volume is obtained. It is necessary to turn the chassis upon its end when adjusting the plate trimmer of the fixed-coupling transformer as these have their tuning condensers in the ends of the can.

### Use of "Padding" Condensers

It is not absolutely necessary to use padding condensers in the oscillator circuit. However, unless these are incorporated in the design, it will be impossible to receive stations operating on frequencies close to the ends of the band-setting dials, due to the fact that the 465 kc. difference frequency cannot be established. When the padders are used, they are placed inside the coil forms so that these are automatically changed each time a new oscillator coil is placed in the socket.

The method of adjusting the padders is simple. Place a pair of coils in their sockets and adjust the band-setting condensers for maximum volume as outlined above. It will be noticed that the mixer condenser runs about 15 or 20 degrees higher than the oscillator band-setter. Now with a non-metallic screw-driver, adjust the padding condenser until both band-setting dials read the same when the two condensers are in the maximum volume position. If the band-setters do not "track" with a reasonable degree of accuracy over the full scale of their dials, it may be necessary to remove turns from the oscillator coils until the desired results are obtained. It should be understood, however, that the padders have but little effect on the "tracking" of the main tuning circuit; if the 465 kc. I.F. beat can be obtained with the band-setters, the 2-gang 35 mmf. condensers will "track" perfectly throughout their range.

A shield plate must be used between the

stators of the 2-gang tuning condenser in order to minimize the effect of the antenna upon the oscillator. This may be obtained from an old 2-gang 140 mmf. condenser of the same type or made from a brass or aluminum sheet as shown in Fig. 2.

The author will be glad to answer any questions readers may care to ask regarding this receiver. However, it is necessary to enclose a stamped and self-addressed envelope for reply. Letters may be sent in care of Short Wave and Television.

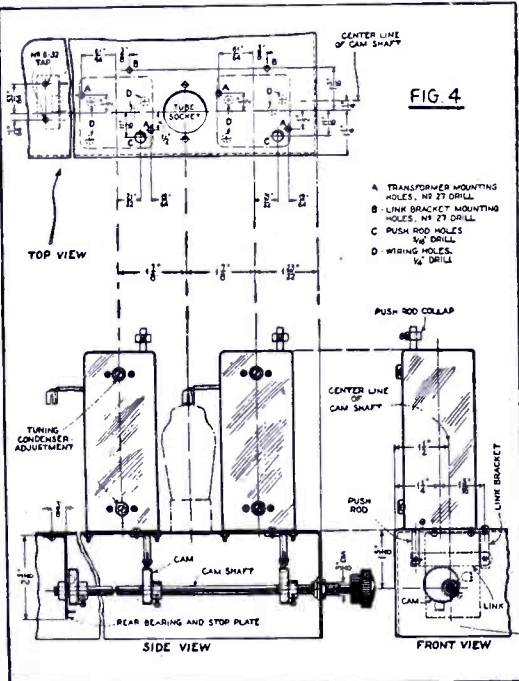

Dimensions of I.F. Transformer

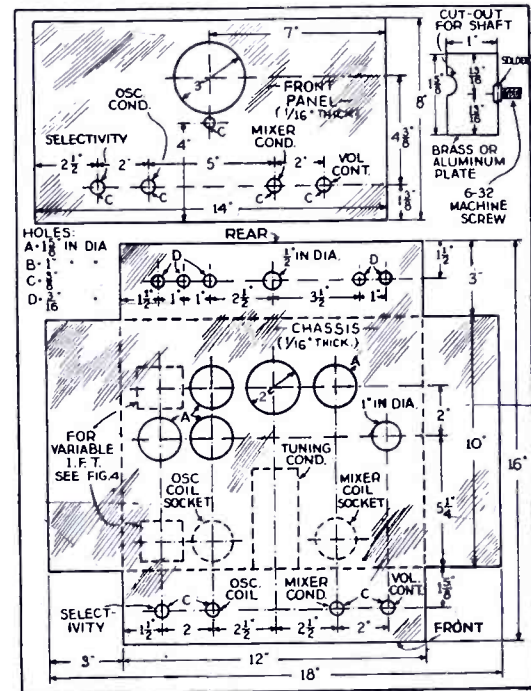

Details of Chassis.

Please mention SHORT WAVE & TELEVISION when writing advertisers

# EVERYTHING

## THE HAM NEEDS!

Transformers—Inductors—Xtals—X-Lax—Racks—Receivers—Chokes—Chassis—Chewing Gum—Condensers—Panels—Relays—Mikes—YL's—Wire—Meters—Hardware—Transmitters—Tubes—Switches—Insulators—Sockets—Resistors—etc. . . .

NO MATTER WHAT YOU NEED—

## HARRISON HAS IT!

SERVICE—that will astound you with its Super-Speed!  
QUALITY—That is Colossal!!

PRICES—that will make you swoon with joy!!  
*No end!*

All joking aside, if you are looking for good, clean Radio Equipment—prompt, friendly service—helpful information—and lowest prices on all standard lines—drop in and see me. If you are not

near-by just send in your order—or write me for Discount Schedule. We ship to any part of the world. You will be well pleased.  
TNX CUL es 73  
Bill Harrison, W2AVA

HARRISON RADIO CO. C-5  
12 West Broadway, New York City

Dear OM:

Let's see some snappy service on the enclosed order. Remittance is herewith.

Send me your new discount schedule and information on ordering.  
Tx

Name .....Call.....

Address .....

# HARRISON

RADIO COMPANY

"The Friendly Amateur Supply House"

12 WEST BROADWAY  
NEW YORK

CABLE PHONE  
"HARRISORAD" WOrth 2-6276

ALADDIN ASTATIC BIRNBACH BUD \*CARDWELL CORNELL-DUBILIER COTO-COIL EBY ESICO  
GENERAL ELECTRIC HAMMARLUND ICA JEFFERSON JOHNSON MEISSNER MAGNAVOX NATIONAL  
OHMITE PAR-METAL PATERSON PEAK READRITE RME-69 ROLA SANGAMO SHURE  
SIGNAL THORDARSON TRIMM UTAH UNIVERSAL U. T. C. WARD-LEONARD WRIGHT DECOSTER  
AMERICAN BURGESS WESTON AMPEREX BILLEY BREITING EIMAC HALLICRAFTERS  
JANETTE MACKEY PIREX RAYTHEON RCA-DEFORREST SARGENT TAYLOR TRIPLETT

## A Vibrator Power Supply

(Continued from page 18)

side of the car battery and negative of the load; the third terminal is the high voltage positive "out-put" connection and is connected to the high voltage lead from the load. (Radio equipment or amplifier.) A 90-volt tap may be provided in the usual manner by inserting a *voltage dropping resistor* (in series) and by-pass condenser. A voltage divider across the output terminals is not advisable due to the 50. m.a. load limit of the power supply.

When the power unit is completed and ready to test, connect a 6-volt battery across the input terminals and turn on the switch. The vibrator should start the instant power is supplied and vibrate freely between contacts. If the vibrator is sluggish in starting and jerky in its operation when loaded, slip it out and adjust it with the small set-screw next to the reed. When operating properly the vibrator will start easily and vibrate smoothly with not too much swing and very little noise.

If heavier loads are required such as sound truck amplifiers, semi-portable emergency transmitters or multi-tube receivers, it will be necessary to use two or more power units with the loads divided between them. Each power unit will require about 3-amperes from the storage battery, so heavy-duty batteries or 6-volt batteries in parallel should be used where two or more units are used to supply long service.

The vibrator type power unit offers inexpensive, dependable plate power for the emergency transmitter operating from storage batteries in a stricken area and will give long service to farm radios, with windmill battery chargers, P.A. trucks, and 5-meter mobile transmitters and receivers.

### Credit Correction

In the April number, page 748, the new type of tuning dial known as the "Movie Dial," should have been credited to Montgomery Ward.

## BUILD A MEISSNER -AND BE SATISFIED!

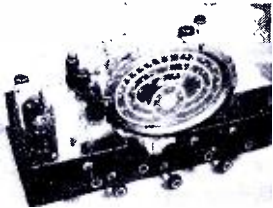

This 12 tube set incorporates the latest improvements in custom built receivers. Uses 2 6L6's in Push Pull. 5 Bands—7.5 to 2140 Meters. Noise Silencer. Beat Frequency Oscillator. Band Expansion.

ALL-WAVE "12" Tube—5 Band RECEIVER KIT  
7.5 to 2140 Meters  
Utilizing the MEISSNER Completely Assembled Tuning Unit.

The completely wired and accurately balanced and aligned tuning assembly, includes the Meissner multi-wave coil assembly, band-change switch, variable gang condenser, tube sockets for tuning unit and a calibrated "A" Aeroplane dial with "Micro-Meter" master mechanical band spread. Price \$20.58 less Tuning Unit Only. Completely Wired tubes

We will be glad to quote on all necessary parts to complete this receiver.

— FREE TO ALL —

Complete circuit diagram of the 12-Tube All-Wave and 13 other new Eagle-Meissner circuits sent free on request.

EAGLE RADIO

84 CORTLANDT ST., NEW YORK, N. Y.

## SHORT WAVE CONVERTERS FOR CAR RADIOS

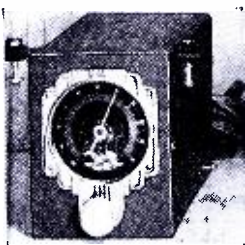

Can be attached to any car radio. Has on and off switch and does not affect the reception on the standard broadcast band.

MODEL 600 covers 49-31-25-20-19 and 16 meter bands. Designed for American and Foreign short wave broadcast. Distance range 5000 to 10000 miles List Price .....\$24.95

MODEL 300 Covers 6000 to 20000 kilocycles. Has variable condenser. List Price .....\$19.95

FOR USE OF POLICE AND OTHER OFFICERS OF THE LAW.

MODEL 100 with fixed condensers, covers 1600 to 1500 kilocycles. List Price .....\$11.95

MODEL 200 with variable condenser, covers 1550 to 6000 kilocycles. List Price .....\$17.95

MODEL 400 with fixed condenser, covers 5 to 10 meters. List Price .....\$13.95

MODEL 500 with variable condenser and illuminated dial. Very sensitive, has two metal tubes. Exceptional distance range. List Price .....\$21.95

ABC RADIO LABORATORIES 3334 N. New Jersey St., Indianapolis, Indiana, U.S.A.

## Squeeze This Tube To Vary Freq.

(Continued from page 26)

and a new name has even been coined for these unexpected irregularities. They call it "electron transit time," i.e., the time an electron requires to move between two certain points of a tube, when very high frequencies are applied. And we know further that the higher the frequency applied, the smaller must the gap be made between cathode and anode of tube in order to reduce the self-willed movements of the electrons.

This new "flexible" radio tube permits one to vary at will the gap between cathode and anode in order to direct the electrons away from these self-willed "side-leaps," and to cause them to follow the desired path. The new tube is however, not only of interest to scientists who want to make measurements in the range of the decimeter (.1 meter or 3.9 inches) waves, but probably is also of great importance to the future design of tubes for communication in this range.

Well, let's begin with the description of the new tube and its application. It was known that the gap between anode and cathode of a tube must be varied in a certain relation to the frequency applied. But how is one to move the electrodes inside of a tube, since they are sealed airtight into a glass envelope so as to retain the required vacuum?

Baron Manfred von Ardenne tackled the problem in a very interesting way. He applied an old glass-blower's trick, and fastened the anode at one side of a medium long glass-tube, but the cathode (or more exactly—the extension of the cathode) at the other end. As the illustration indicates the glass envelope has the form of a normal glass tube, but is equipped at its right side with three small extensions in *bulb* form. These bulbs (called "glass-springs") are the main trick of the whole device. We

all know that glass is quite a sturdy material without much flexibility. But bulbs of the type shown if incorporated into glass tube, permit small movements when compressed!

That is exactly what Baron von Ardenne has done—he compressed the glass bulb a little bit, and so caused an actual change in the distance between the anode and the cathode. This sounds quite unbelievable at first but is actually possible. We must consider that the anode as well as cathode are fastened to the opposite ends of the tube, and if the length of the tube is shortened the distance between both electrodes will of course become smaller.

Naturally, the tube is not compressed with unlimited power, but very gently under application of an extremely smooth operating micrometer drive. Until recently it was not possible to reduce the distance between anode and cathode to less than 0.3 millimeter (about 0.01181 inch). With the newly designed tube, the distance may be reduced to 5/1,000 millimeter (about 2/10,000 inch). This of course does not mean much compared with the dimensions of those objects to which we are accustomed in our daily life. But if we consider the tiny dimensions of electrons (each of them has a weight of about 1/46 billion, billion, billion, billionths part of an ounce) reductions of a distance, even if they are as small as 2/10,000 inch mean quite a lot.

These reductions, in the terms of decimeter (tenth meter) technique, signify that it is now possible to make quantitative measurements in the range of these ultra high frequencies. Now—if it is possible to measure certain effects of these very short waves—new tricks and circuits may be designed to handle electrons in such a way as to make them do things—they refused to do up until now.





# "CUSTOM" ALL WAVE "12"

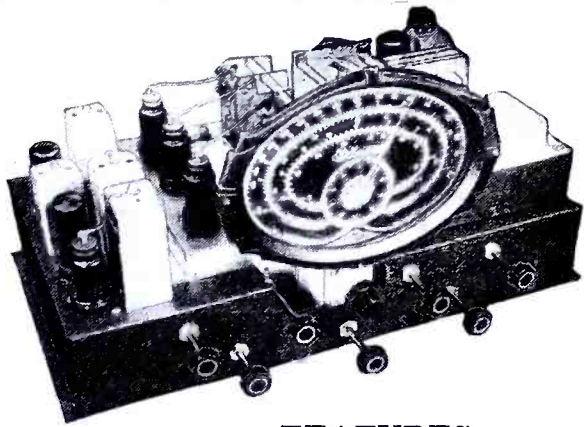

For the Custom Set Builder  
and Experimenter

## 5 Bands

7.5 to 2140 Meters

### FEATURES

- Completely Wired and Accurately Balanced and Aligned Tuning Unit.
- Air Tuned, Multi-Wave, Mono-Coil Assembly.
- Low Minimum Capacity Variable Gang Condenser.
- Accurately Calibrated 8 inch Two Speed Oval Dial.
- Band Spread with Special Band Spread Scale and Pointer.
- High Fidelity Variable Band Expansion.
- Beat Frequency Oscillator Circuit with cut out switch and switch control.
- Noise Silencer Circuit.
- FERROCART (Iron-Core) intermediate frequency Transformer.
- FERROCART (Iron-Core) output Transformer.
- Automatic Volume Control with cut out switch.
- Variable Sensitivity Control.
- Twelve new type Metal Tubes consisting of 2-6K7, 2-6J7, 2-6L7, 1-6R7, 1-6C5, 1-6A7, 2-6L6 and 1-5Z3.
- Audio Volume Control
- Push Pull Output using the new "Beam" 6L6 Metal Tubes.
- Five Bands 7.5 to 2140 meters or 140 kc to 42.5 mc.

### COMPLETE TUNING KIT

- 1—Completely wired tuning unit consisting of Multi-Wave coil assembly, wave change switch, variable condenser, tube sockets for tuning circuit, and calibrated 8" two speed oval dial with BAND SPREAD.
  - 1—Noise Silencer I.F. Transformer
  - 1—Beat Frequency Oscillator Transformer
  - 1—Band Expansion I.F. Transformer, FERROCART (iron-core)
  - 1—FERROCART (iron-core) interstage I.F. Transformer
  - 1—FERROCART (iron-core) Output I.F. Transformer
  - 5—Shielded Radio Frequency Chokes
  - 1—Complete set of blue prints with detailed wiring instructions.
- Kit Number 7501 List Price \$43.50 Net Price **\$26.10**  
Drilled and Punched Steel Chassis—  
No. 18281 List Price \$4.50 Net Price \$2.70

**MEISSNER MFG. CO.**

**Mt. Carmel, Ill.**

## The Meissner All-Wave 12

(Continued from page 21)

### Multi-Wave Assembly Feature

The receiver can be divided into two sections, the most important section being the complete *Multi-Wave Assembly*. Here on a sub-assembly chassis is correctly mounted and wired all necessary coils, band-switch, tuning condenser, calibrated 8-inch dial and all necessary resistors, condensers and sockets. Six *color-coded* leads are brought out of the tuning assembly for connection to the rest of the receiver. These leads are indicated in Fig. 1. The reader can get some idea of the construction of the unit from the photograph of Fig. A.

Five types of Multi-Wave Assemblies are available with different tuning ranges and using two values of maximum capacity in the tuning condensers.

#### 260 mmf. Tuning Condenser

Band	Range	Type No.
1	550-1560 kc.	7515
2	1560-4400 kc.	7515 and 7514
3	4.3-12 mc.	7515 and 7514
4	11.38-32. mc.	7515 and 7514
5	32.0-60 mc.	7515 and 7514

#### 410 mmf. Tuning Condenser

Band	Range	Type No.
1	140-400 kc.	7505
2	530-1800 kc.	7505, 7504, 7603
3	1750-6200 kc.	7505, 7504, 7503
4	5.9-18 mc.	7505, 7504, 7503
5	14-43 mc.	7505, 7504

The coils and the band switch are so connected that the low frequency bands are at the left-hand or counter-clockwise position of the switch. The tuning ranges and alignment points are indicated in Fig. 1. Both types of tuning units are *aligned* and *padded* in a superheterodyne receiver before shipment. If no changes are made

in the settings when placing the receiver in operation, good reception should be obtained on all bands, providing the rest of the receiver is functioning properly. If it is found that it is necessary to re-align the unit, simple and complete instructions will be found in the technical notes furnished with each assembly.

### The Second Part of the Receiver (Main Chassis)

With the R.F., Converter tube and Oscillator tube mounted on the sub-as-

sembly, it becomes an easy matter to construct the receiver. Note Fig. 2. Two I.F. stages using Hi-Q iron core transformers with electrical *band-spreading* windings and simplified switching so that Hi-Fidelity B.C. reception can be obtained and still be able to utilize the characteristic *steep-slope* resonance curve for S.W. reception. Fig. 3 is representative of the selectivity characteristic obtained with the *band-width* switch. A 6K7 tube is used in the first I.F. stage and the second I.F. stage uses a 6L7 tube and forms part of

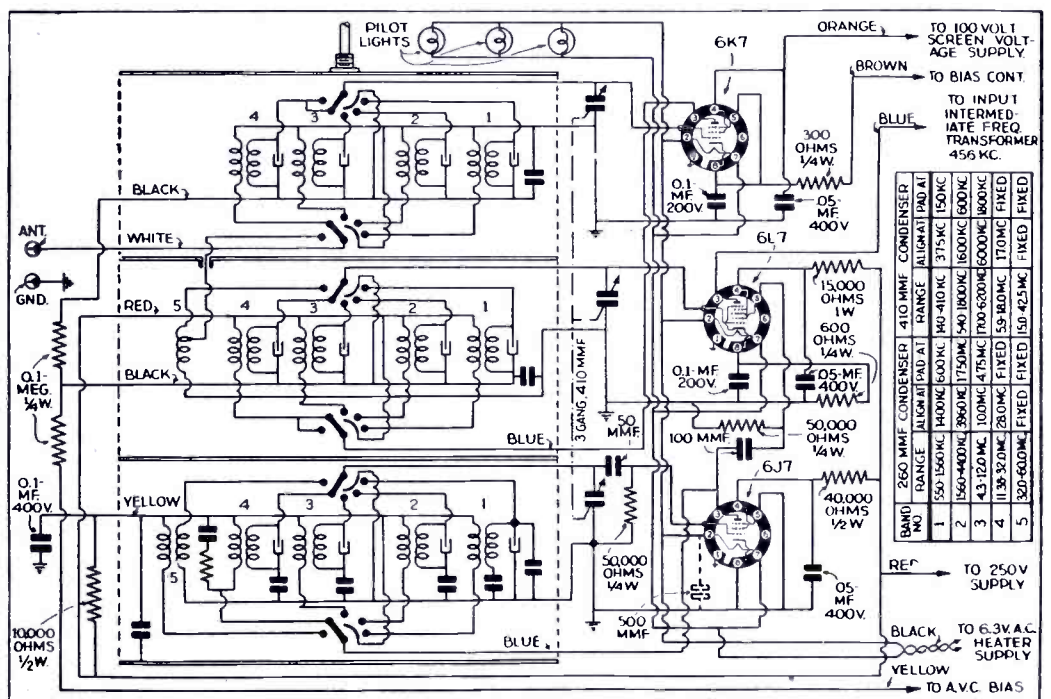

Diagram of Band-Switch Coil Unit

Please mention SHORT WAVE & TELEVISION when writing advertisers

## THE IDEAL POWER SUPPLY FOR YOUR LOW POWER RIG



ONLY \$8.50

Featuring: husky transformer, 200 ma. choke, 8 mfd. high voltage condensers, tapped bleeder resistor, standby switch, and fuse. Chassis size—8" x 6 1/2" x 6 1/2". Delivers 400 volts at 125 ma., 2 1/2 volts at 15 amperes and 5 volts at 3 1/2 amperes for the 83 rectifier. H. V. power supply, wired and tested, less tube — X21069 — \$8.50. RCA tube, Type 83—60c.

model X21069

## NEW Spring CATALOG FREE!



You'll marvel at the new LAFAYETTE line of receivers, 4 to 24 tubes from \$7.95. Farm and auto sets, including the new special trailer set, at remarkably low prices. See and hear a LAFAYETTE in your own home on our 30 DAY FREE TRIAL.

LAFAYETTE again goes to the fore with their new CO-ORDINATED SOUND SYSTEMS. There's money in this field. find out about it. Get the Spring catalog FREE.

Experimenters, hams, builders, servicemen—You can save real money by shopping from this book.

**Send for FREE information on NEW TELEVISION KIT**

**RADIOS**

**SOUND**

**PARTS**

**SPECIAL**

**WHOLESALE RADIO SERVICE CO. INC.**  
 NEW YORK, N. Y., CHICAGO, ILL., ATLANTA, GA.  
 100 SIXTH AVENUE 901 W. JACKSON BLVD. 420 W. PEACHTREE ST., N. W.  
 BRONX, N. Y. NEWARK, N. J. JAMAICA, L. I.  
 542 E. FORDHAM RD. 219 CENTRAL AVE. 40-08 166TH STREET  
 (MIDWAY PLAZA)

### WHOLESALE RADIO SERVICE CO., Inc.

**100 SIXTH AVENUE, NEW YORK, N. Y.**

Rush new 116 page FREE catalog No. 68-4E7

Enclosed please find money order  check

for power supply No. X21069

FREE information on NEW TELEVISION KIT

Name \_\_\_\_\_

Address \_\_\_\_\_

## THORNE'S RADIO COIL WINDER

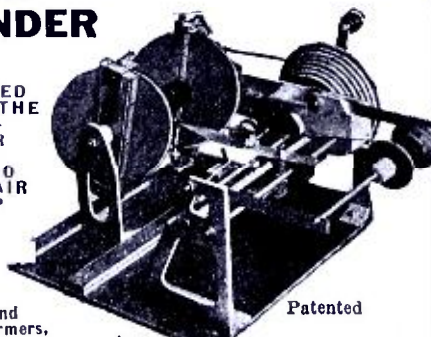

DESIGNED FOR THE AMATEUR AND RADIO REPAIR SHOP

Will wind Transformers, Straight or Honeycomb coils and Ear Phone armatures. Revolution recorder. 14 Speed changes.

Write for Illustrated Circular and Price.

**SUNSHINE NOVELTY CO.**  
 226 S. W. 2nd Ave., Miami, Florida.

the Noise Silencer Circuit which includes the 6J7 amplifier and the 6H6 diode rectifier and the center-tapped transformer No. 6762. The action of the silencer is controlled by the 5,000 ohm cut-off potentiometer.

A double pole-three position switch is used to cut out the voltage from the 6R7 diode—low mu-triode used for A.V.C. action and cuts in or out the Beat Note Signal generated by the 6C5 tube. Position "1" of the switch provides A.V.C. without beat note. Position "2" cuts out the A.V.C. and also the beat note. Position "3" has the beat note and no A.V.C.

The output of the 6R7 is transformer coupled to two of the Beam Type 6L6 Tubes. High power sensitivity of the 6L6's provides plenty of volume on all bands, even on weak signals. Proper selection of the push-pull transformer used in conjunction with the band-expanding I.F. transformers results in real quality reproduction on the B.C. band.

The tone control consists of the .05 mf condenser and the 25,000 ohm resistor connected in the plate circuit of the 6R7 tube.

The power-supply is conventional and includes a heavy duty choke in the input filter section, which reduces the hum voltage developed in the speaker field winding to a low level.

### Construction and Operation

The construction of the receiver is simple and requires a minimum of tools if the chassis is obtained with all holes punched or drilled for the proper placement of the various parts. The chassis is made of steel finished in a black wrinkle effect that contrasts with the highly polished coil cans and the cadmium-plated tuning assembly. Full constructional details are available with the kit of parts so that any one who can do a good soldering job can build a receiver that is equal in looks and performance to any factory-built job.

To complete the alignment of the receiver it is only necessary to check the I.F. stages at 456 kc. by tuning in a known frequency signal and adjusting the I.F.'s for the loudest signal or use a signal-generator if one is available. Set band-width switch at position 1 for this adjustment. To adjust the Noise-Silencer transformer, set the noise-level control to the left until there is a noticeable reduction in the noise level (background noise). Set the control just beyond this point and tune in a medium strength signal on the receiver. Trim the condenser on the Noise Silencer Transformer until the signal is reduced as much as possible (minimum output).

The Beat-Note transformer should be adjusted by rotating the small black knob mounted on top of the Beat-Note Oscillator transformer. Generally, this adjustment can be made once and left alone. However, it is a simple matter to make adjustments at any time as this transformer is conveniently located on the rear right-hand side of the chassis.

It is surprising that so many of the most desirable features will be found in a receiver that is really easy to construct and place into operation. The secret lies in the careful planning of the complete assembly and the precision of coil and condenser matching at the factory. Such a receiver as described would have been impossible to build a short time ago and yet, with modern design and production facilities, such a receiver is an assured fact which will be best appreciated by those that have tried to build receivers from poorly matched parts.

### Parts List

- One Meissner Coil and Tuning Kit No. 7501 containing:
- 1—No. 7511 5-Band Tuning Unit, coils condenser, 8" dial, wave change switch, completely assembled and pre-aligned.
  - 2—No. 7412 Ferrocart 456 kc. Band Expanding I.F. Transformers
  - 1—No. 5714 Meissner 456 kc. Output I.F. Transformer

- 1—No. 6762 Meissner 456 kc. Single-Tuned I.F. Transformer. Center-tapped secondary
  - 1—No. 6753 Meissner 456 kc. Beat-Frequency Oscillator Coil
  - 1—No. 7908 Meissner R.F. Choke
  - 2—No. 5590 Meissner Shielded R.F. Chokes.
- Eight—Octal Metal tube sockets
- One—Four prong Tube Socket
  - One—25,000 Ohm Manual Gain Control
  - One—5,000 Ohm Noise Silencer Control
  - One—500,000 Ohm Volume Control
  - One—25,000 Ohm Tone Control with A.C. Switch
  - Two Meissner, 2-pole, 3-position rotary switches No. 18254
  - One—40 Ohm, 3 Watt Resistor
  - One—125 Ohm, 5 Watt Resistor
  - Two—500 Ohm, 1/2 Watt Resistors
  - One—5,000 Ohm, 1/2 Watt Resistor
  - One—30,000 Ohm, 1/2 Watt Resistor
  - One 20,000 Ohm, 2 Watt Resistor
  - One—50,000 Ohm, 1 Watt Resistor
  - Two—50,000 Ohm, 1/2 Watt Resistors
  - Two—100,000 Ohm, 1/2 Watt Resistors
  - Two—1 Meg., 1/2 Watt Resistors
  - Two—250,000 Ohm, 1/2 Watt Resistors
  - One—.01 Mf. 200 Volt Paper Condenser
  - One—.05 Mf. 200 Volt Paper Condenser
  - Four—.1 Mf. 200 Volt Paper Condensers
  - One—.25 Mf. 200 Volt Paper Condenser
  - Two—.01 Mf. 400 Volt Paper Condensers
  - One—.5 Mf. 200 Volt Paper Condenser
  - One—.05 Mf. 400 Volt Paper Condenser
  - Three—.1 Mf. 400 Volt Paper Condensers
  - Two—.00025 Mf. Mica Condensers
  - One—.0001 Mf. Mica Condenser
  - One—.0005 Mf. Mica Condenser
  - One—10"x17"x3" Metal Chassis
  - One—Power Transformer, Primary 110 Volts, Secondary, C.T. 700 Volts at 200 MA. Sec.

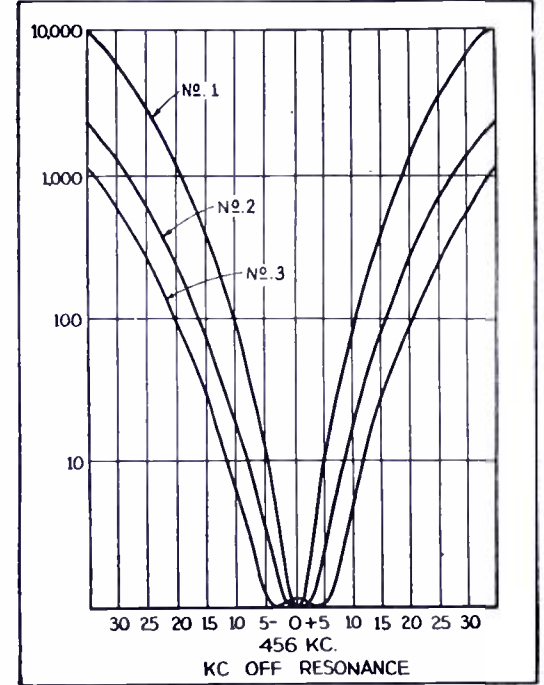

Resonance curve for the receiver

- Secondary No. 2, 6.3 Volts at 4.5 Amperes and Secondary No. 3—5 Volts at 3 Amperes.
  - Three—8 Mfd. 450 W.V. Electrolytic Condensers
  - One—Dynamic Speaker with output transformer to match 6L6 tubes in P.P. Field Resistance 1250 Ohms.
  - One—5-Prong Speaker Plug
  - One—5-Prong Speaker Socket
  - One—Push-pull Input Audio Transformer
  - One—15 Henry, 250 Ohm, 200 MA. Filter Choke
  - One—A.C. Line Cord and Plug
  - One—1/2" Rubber Grommet for Line cord
  - Four—Metal tube grid clips
  - Three—6.3 Volt Pilot Lights
  - Machine screws, washers, lockwashers, soldering lugs and other small miscellaneous hardware.
  - Tubes Used (12)
  - Two—6K7 Metal Tubes
  - Two—6J7 Metal Tubes
  - Two—6L7 Metal Tubes
  - One—6R7 Metal Tube
  - One—6H6 Metal Tube
  - One—6C5 Metal Tube
  - Two—6L6 Metal Tubes
  - One—5Z3 Glass Rectifier Tube.
- This article has been prepared from data supplied by courtesy of the Meissner Mfg. Co.*

Please mention SHORT WAVE & TELEVISION when writing advertisers

## Build the "Multi-band 2" and Hear 'em All!

(Continued from page 13)

of the receiver can be used in two ways. For earphone operation, connect a 4,000 or 5,000 ohm 20-watt resistor across the phone terminals and operate the earphones through the .1 mf. condenser by connecting them to terminals marked "A-1" in the diagram. For loud-speaker operation use terminals marked "A" and disconnect the resistor. The power-supply diagram is also given and is extremely easy to follow; it is conventional in all respects and one should have no trouble with it. We recommend the use of best quality parts, for while this particular receiver may be changed or discarded at a future date, the power-supply will always serve as a permanent piece of apparatus in the experimenter's shack.

### Antenna to Use

The antenna employed with this receiver was a single 8 ft. vertical wire with about 40 ft. of lead-in. This lead-in was connected to the top of the vertical section. This serves excellently for both short and ultra short wave operation. For ordinary short-wave work, the 8 ft. section would not be needed, but its use improves the operation of the receiver on the ultra-high frequencies to a very marked degree.

### Parts List—Beginner's Set

#### CARDWELL

- 1—140 mmf. Trim-Air condenser
- 2—15 mmf. Trim-Air condensers

#### HAMMARLUND

- 1—SWK-4 coil kit
- 1—4 prong isolantite socket
- 1—8 prong (octal) isolantite socket
- 1—2.1 mh. R.F. choke

#### CORNELL-DUBILIER

- 1—.001 mf. mica condenser
- 2—.0001 mf. mica condenser
- 1—.0005 mf. mica condenser
- 1—.006 mf. mica condenser

#### SPRAGUE

- 8—.1 mf. tubular condensers
- 1—10 mf. electrolytic condenser (Low Voltage)
- 2—8 mf. electrolytic condensers (500 Volts)

#### ELECTRAD

- 1—50,000 ohm potentiometer

#### IRC

- 1—1 meg. ½ watt resistor
- 1—¼ meg. ½ watt resistor
- 1—.1 meg. ½ watt resistor
- 1—25,000 ohm ½ watt resistor
- 1—500 ohm 1 watt resistor
- 1—5,000 ohm 20 watt resistor
- 1—15,000 ohm 50 watt resistor

#### KENYON

- 1—power trans. (see diagram T 205)
- 2—filter chokes (T 153)

#### RAYTHEON

- 1—6J5G tube
- 1—41 or 42 tube

#### BRUSH DEVEL. CO.

- 1—pair crystal head-phones

#### MISCELLANEOUS

- 1—Panel 6x8 inches
- 1—Chassis 2x5x8 inches
- 1—4 prong wafer socket
- 1—6 prong wafer socket
- 1—dial
- 3—knobs

### Coil Data for "Multi-Band 2" Receiver

BAND GRID		TICKLER	
(meters) COIL	WIRE	L.W.	(close wound)
135-270	28 T. No. 28 enam.	1 7/8"	16 T. No. 30 DSC.
66-150	38 T. No. 26 tinned	1 3/4"	11 T. No. 30 DSC.
35-75	18 T. No. 24 tinned	1 1/2"	6 T. No. 30 DSC.
17-41	9 T. No. 16 tinned	1 1/4"	5 T. No. 30 DSC.

L. W.—Length of winding; All coils wound on 1 1/2" 4-prong ribbed form. Space between grid and tickler 1/4".

Remove enough tickler turns from the above standard data, to obtain smooth regeneration.

The five meter coil consists of 7 turns, 1/2 inch in diameter, tapped at 2nd turns. Space turns to place band in center of dial.

# KENYONIZE TO MODERNIZE AND ECONOMIZE



Kenyon Transformer Co., Inc., is pleased to announce 38 additions to the "T" line which are designed to take care of newer tubes and circuit developments.

## KEN-O-TAP

### THE UNIVERSAL MODULATION TRANSFORMER KEN-O-TAP IS THE PRACTICAL SOLUTION TO THE MODULATION PROBLEM

This new low cost universal modulation transformer may be used with any type of tube or tube combinations in transmitters. The multi-taps provide impedances to match any combination of modulator and class "C" conditions encountered in amateur transmitter applications. Will never become obsolete. Secondary designed to carry the full class "C" load.

- Type T-493 Audio Level, 40 watts; will modulate 80 watts. Net Price \$ 4.20
- Type T-494 Audio Level, 75 watts; will modulate 150 watts. Net Price \$ 6.00
- Type T-495 Audio Level, 125 watts; will modulate 250 watts. Net Price \$12.00
- Type T-496 Audio Level, 300 watts; will modulate 600 watts. Net Price \$18.00

## KEN-O-DRIVE

### THE UNIVERSAL DRIVER TRANSFORMER KEN-O-DRIVE IS THE MODERN ANSWER TO CRITICAL DRIVER OPERATION

Will match a 500 ohm line or any driver plate or plates to class "AB" or "B" grids.

- Type T-264 Level, 7 watts Net Price \$4.20.
- Type T-263 Level, 18 watts Net Price \$5.40

### RK39 MODULATION OUTPUT TRANSFORMER

Our type T-462 is especially designed for RK39 beam power tubes in class "AB". The secondary winding of this transformer will carry the class "C" load and is tapped to match many of the popular 250 watt tubes.

Secondary impedances are 4,000, 6,000 and 8,000 ohms. Secondary maximum D.C., 300, 250 and 200 MA. Net Price \$9.90.

### RK39 LINE AND SPEAKER OUTPUT TRANSFORMER

T-307 is similar to the above unit except the output is 500-200 or 15-8-4 ohms. May also be used for push-pull parallel 6L6 tubes in class AB<sub>2</sub>. Primary 6400 ohms or 1900 ohms. Net Price \$9.60.

For full information on these units ask your dealer for the new catalog describing our complete line of amateur and P. A. audio and power components.

Chief Engineer, Radio Section

Export Dept. 25 Warren St., New York, N.Y. **KENYON TRANSFORMER CO. Inc.** 840 Barry St., New York, N.Y. Cable Address SIMONTRICE NEW YORK

Are You a Subscriber? See Page 58 for Remarkable Subscription Offers.

### THE METAL TUBE SELF POWERED FIVE BAND PRESELECTION BOOSTER



- Continuous band spread.
- Built-in Power Supply 110-V AC-DC.
- Pre-Adjusted Low Loss Coils
- Calibrated Tuning Dials.
- Volume Control and A.C. Switch.
- Black Crackle Metal Housing.
- Operates with Doublet or Single Ant.
- Tuning Range 9 to 560 Meters.

Boost weak and fading signals, for use with T.R.F. Regenerative or super receivers, by Amateurs or Short Wave Fans. Builds up tremendous increase in signal strength also sensitivity and selectivity. Decreases noise to signal ratio and assures low image frequency response.

Kit of all parts, chassis, housing, diagram, less coils and tubes, unwired \$4.95

Kit of 6 coils 9 to 560 M. 2.05  
Kit of 3 Tubes 6J7-6C5-K105A. 2.05

Wired and tested, all coils, 3 tubes, ready to operate \$12.00

STANDARD RADIO, SW-116 West St., New York City

## THE NEW RCA ACT-20 AMATEUR TRANSMITTER

20 WATTS C-W, 16 WATTS PHONE  
100% MODULATION

The flexibility of 5-band operation, a minimum of adjustments, and reliable performance make the ACT-20 an ideal low-powered transmitter.

Amateur Net Price \$129.50 Less Tubes Accessories

Write for new 1937 catalog

# CAMERADIO

963 LIBERTY AVE. 30 TWELFTH ST. PITTSBURGH, PA. WHEELING, W.VA.

Established 1919

# Get on the Air!



with  
the

## ADD-A-UNIT TRANSMITTER KIT

### Only \$49<sup>75</sup>

This powerful CW Transmitter can be yours at this amazingly low price. Every part you need—except tubes, meters and crystal—to have a completely self-contained amateur transmitter, is in this kit. You get the benefit of UTAH'S 15 years in the design and manufacture of outstanding radio parts.

We show you how to build this transmitter yourself—at a fraction of the cost of a factory assembled job. Later on you can plug in additional units, built from UTAH kits, and have a complete professional style 400 Watt Phone Transmitter.

Start *now* and start **RIGHT**, with this UTAH kit. See your UTAH jobber, or write for complete details—**TODAY!**

**UTAH RADIO PRODUCTS CO.**

Dept. SW5, Chicago, U. S. A.

TORONTO  
Canada

BUENOS AIRES  
(UCOA Radio Products Co.)

**"15 YEARS OF LEADERSHIP"**

## CABINETS

CHASSIS, PANELS AND CANS  
MADE TO YOUR SPECIFICATIONS

Send drawing or blue print for our estimate.

**KORROL MFG. CO., Dept. S-5,**  
232 Greenwich St., New York City

## SEE THE SKY-CHALLENGER

Hallicrafters' New  
COMMUNICATIONS RECEIVER!

Amateur Radio's Greatest Value! 9 Tubes—Complete coverage of all active amateur bands—Electrical Band Spread—Sensitivity and selectivity superior to many higher priced receivers. See it at your dealers or write for complete information!

**the hallicrafters, inc.**

2601 Indiana Avenue, Chicago, U.S.A.  
Cable Address "HALLICRAFT"

See Page 64 for the 6 Best Books  
on Short Waves

## Short Wave Scouts

(Continued from page 33)

Call Freq. Name of Station Location	HJ1ABJ—6,025 kc.—Julio A. Sanchez, Santa Marta.	
W9XAA—6,080 kc.—Chicago Fed. of Labor, Chicago, Ill.	HJ2ABD—5,980 kc.—Sr. Hector McCormick, Bucaramanga.	
W9XAA—11,830 kc.—Chicago Fed. of Labor, Chicago, Ill.	HJ4ABL—6,065 kc.—"Ecos de Occidente," Manizales.	
<b>Canada</b>		
CJRO—6,150 kc.—James Richardson & Son, Winnipeg.	HJ3ABH—6,012 kc.—"La Voz de la Victor," Bogota.	
CJRX—11,720 kc.—James Richardson & Son, Winnipeg.	HJ3ABD—6,050 kc.—Colombia Broadcasting, Bogota.	
VE9DN—6,005 kc.—Canadian Radio Commission, Montreal.	HJ4ABE—5,930 kc.—"La Voz de Antioquia," Medellin.	
VE9HX—6,130 kc.—Halifax Herald and Mail, Halifax.	HJ4ABC—6,070 kc.—Cesar y Mario Arango, Pereira.	
<b>Mexico</b>		
XEBT—6,000 kc.—"El Buen Tono," Mexico City.	HJ5ABC—6,150 kc.—R. Angulo, Cali.	
XEXA—6,185 kc.—"Secretary of Public Education," Mexico City.	HJU—9,510 kc.—National Railroad, Buenaventura.	
XEWI—5,975 kc.—"I.M.V.I. Association," Mexico City.	<b>Peru</b>	
XECR—7,385 kc.—"Sect. of Relations," Mexico City.	OAX4G—6,230 kc.—Auto Tallere's Reunidos, Lima.	
XEUW—6,020 kc.—"Fernando Pazos Sosa," Vera Cruz.	OAX4D—5,780 kc.—All-America Cables, Inc., Lima.	
XEFT—6,120 kc.—"Fuerte de Sn. Juan," Vera Cruz.	<b>Venezuela</b>	
<b>Panama</b>		
HP5B—6,030 kc.—"Miro Mar," Panama City.	YV2RC—5,800 kc.—YV1RC, Inc., Caracas.	
HP5J—9,590 kc.—"Servicio Publico," Panama City.	YV4RC—6,375 kc.—Ecos del Avila, Caracas.	
HP5F—6,080 kc.—"Servicio Publico, Colon.	YV3RC—6,150 kc.—Radiodifusora Venezuela, Caracas.	
<b>Cuba</b>		
COCB—6,130 kc.—"The Voice of the Air," Havana.	YV8RB—5,880 kc.—"La Voz de Lara," Barquisimeto.	
COCH—9,428 kc.—General Broadcast Co., Havana.	YV12RM—6,300 kc.—Louis Victor Croquer, Maracay.	
COCO—6,010 kc.—Havana Broadcasting, Havana.	YV5RMO—5,850 kc.—L. Garcia Nebot, Maracaibo.	
COKG—6,150 kc.—"Loma de Quintero," Santiago.	<b>Brazil</b>	
<b>Costa Rica</b>		
TIEP—6,710 kc.—"La Voz del Tropico," San Jose.	PRA8—6,040 kc.—Radio Club of Pernambuco, Pernambuco.	
TIGPH—5,830 kc.—"Alma Tico," San Jose.	PRF5—9,501 kc.—Comp. Radio Internacional, Rio de Janeiro.	
TIRCC—6,550 kc.—"Radio Catolica Costarricense, San Jose.	<b>France</b>	
T18WS—7,550 kc.—"Abel Salazar. F.," Puntarenas.	TPA2—15,245 kc.—Radio Coloniale, Paris.	
<b>Guatemala</b>		
TGS—5,713 kc.—"Office Radio of the President," Guatemala City.	TPA3—11,880 kc.—Radio Coloniale, Paris.	
TG2X—5,940 kc.—"National Police," Guatemala City.	TPA4—11,715 kc.—Radio Coloniale, Paris.	
TGW—9,450 kc.—"Cafe de Guatemala," Guatemala City.	<b>Switzerland</b>	
<b>Honduras</b>		
HRPI—7,100 kc.—"Manul Escoto," San Pedro Sula.	HBL—9,595 kc.—League of Nations, Geneva.	
HRD—6,235 kc.—Dr. Tuleo Castaneda, La Ceiba.	HBJ—14,535 kc.—League of Nations, Geneva.	
<b>Nicaragua</b>		
YNVA—8,590 kc.—Victorino Arguello, Nicaragua.	HBP—7,799 kc.—League of Nations, Geneva.	
YNLG—8,500 kc.—Benjamin J. Guerra, Nicaragua.	<b>Holland</b>	
<b>Haiti</b>		
HH2S—5,915 kc.—"Societe de Haitienne," Port au Prince.	PHI—17,770 kc.—Philips Radio Labs., Eindhoven.	
HH2F—6,065 kc.—"Societe de Haitienne," Port au Prince.	PCJ—15,220 kc.—Philips Radio Labs., Eindhoven.	
<b>Republica Dominicana</b>		
HI3U—6,383 kc.—"Commercial Radio" HI3U, Santiago.	<b>Germany</b>	
HI1S—6,420 kc.—"The Voice Spanish," Santiago.	DJD—11,770 kc.—Broadcasting House, Berlin.	
HI3C—6,730 kc.—"La Romana," Ciudad Trujillo.	DJC—6,020 kc.—Broadcasting House, Berlin.	
HI4D—6,500 kc.—Sindicato HI4D, Ciudad Trujillo.	DJS—17,810 kc.—Broadcasting House, Berlin.	
HIX—5,980 kc.—Secretaria de Comunicatus," Ciudad Trujillo.	DJN—9,540 kc.—Broadcasting House, Berlin.	
HIZ—6,316 kc.—Frank Hatton HIZ, Ciudad Trujillo.	DJB—15,200 kc.—Broadcasting House, Berlin.	
HIT—6,630 kc.—Radiodifusora HIT, Ciudad Trujillo.	DJO—11,800 kc.—Broadcasting House, Berlin.	
HIH—6,780 kc.—Radiodifusora HIH, San P. de Macoris.	DJA—9,560 kc.—Broadcasting House, Berlin.	
HI1A—6,190 kc.—Radiodifusora HI1A, Santiago.	DJM—6,080 kc.—Broadcasting House, Berlin.	
HI5N—6,150 kc.—Rep. Dominicana Antillas, Santiago.	DZB—10,040 kc.—Broadcasting House, Berlin.	
HIL—6,500 kc.—Radiodifusora HIL, Ciudad Trujillo.	DZA—9,680 kc.—Broadcasting House, Berlin.	
<b>Ecuador</b>		
HC2RL—6,650 kc.—Dr. Roberto Levi, Guayaquil.	<b>Miscellaneous</b>	
HC2JSB—9,510 kc.—Ecuador Radio, Guayaquil.	2RO-3—9,635 kc.—Ente Italiano Andizioni, Rome, Italy.	
HCJB. 8,948 kc.—Quito Site of HCJB, Quito.	HAS-3—15,370 kc.—Royal Hungarian Post, Budapest, Hungary.	
PRADO—6,618 kc.—"Fabrica de Tejidas," Riobamba.	EAQ—9,860 kc.—Radiodifusion Ibero Americana, Madrid, Spain.	
HC2CW—8,404 kc.—"Ondas de Pacifico," Guayaquil.	SPW—13,653 kc.—Polskie Radjo, Warsaw, Poland.	
<b>British Guiana</b>		
VP3MR—6,010 kc.—British Guiana Broadcast Co., Georgetown.	LZA—14,970 kc.—Radio Station Sofia, Sofia, Bulgaria.	
<b>Colombia</b>		
HJIABE—9,500 kc.—"Jarabe Anti Tisico," Cartagena.	CT1AA—9,650 kc.—Radio Colonial, Lisbon, Portugal.	
HJ1ABE—6,115 kc.—"Jarabe Anti Tisico," Cartagena.	HVJ—15,121 kc.—Citta del Vaticano, Vatican City, Rome, Italy.	
HJ1ABG—6,042 kc.—"Emisora Atlantico," Barranquilla.	ORK—10,330 kc.—Belradio, West Flanders, Belgium.	
	OPM—10,140 kc.—Congo Belge, Leopoldville, Belgium Congo.	
	KAY—14,980 kc.—R. C. A. Central, Manila, Philippine Islands.	
	RIM—7,626 kc.—Radio Centre, Moscow, U.S.S.R.	
	TFJ—12,235 kc.—Iceland State Broadcasting, Reykjavik, Iceland.	
	3LR—9,580 kc.—National Broadcasting Service, Lyndhurst, Australia.	
	VK3ME—9,518 kc.—Amalgamated Wireless Ltd., Melbourne, Australia.	

**Don't Miss Big  
"Ham" and "Fan"  
Features  
in Next Issue**

Please mention SHORT WAVE & TELEVISION when writing advertisers

# How to Build a "Field Strength" Meter

(Continued from page 18)

available. It is important that the device be adequately screened.

The field strength indicator may be used for the following purposes:—

- Field strength indication,
- Linear monitor for modulation.
- Neutralizing indicator.
- Wavemeter.

### Field Strength Indication

The procedure for field strength indication is as follows:—

Place the indicator at some point within the immediate field of the antenna. It is often possible and most convenient to locate it in the shack, but in this case care must be exercised to see that the indicator and its associated antenna are not in the direct field of the transmitter. To begin with, let us assume that the antenna is swung above a back garden and that it is not convenient to place the indicator in the shack.

A box or old table should be set in the garden directly under the antenna if possible. The field strength indicator is placed upon it and earthed—one of those commercial earthing rods driven into the ground will do. A pick-up wire should now be con-

made that the field strength indicator might be upset by radiated waves from surrounding objects. That fact is true, but, provided it is not moved, it will still give a true comparison of various adjustments. If the field of the antenna is more powerful for a given setting, then it follows that the reflected wave will be more pronounced in the same degree.

Although the author has not tested the suggestion, it seems reasonable to suppose that, by using a simple tuned RF stage ahead of the diode detector in the indicator, readings could be taken at a distance of several wavelengths from the antenna, and hence a radiation directional curve could be plotted.

When the indicator can be located in the shack, an indirectly heated triode can be used, and in this way the operator obtains a check on the operation and adjustment of his transmitter at all times.

### Linear Monitor for Modulation

The detection characteristic of a diode is linear. This field strength indicator can be used as a radio telephone monitor by fitting it with a pick-up wire a few inches long. Headphones are plugged into the jack, and the field strength indicator placed in the field of the antenna or of the modulated RF amplifier. A simple listening test may thus be carried out which will give an exact picture of the modulation. In the case of CW stations, super-imposed ripple on the D.C. plate current and key clicks are readily apparent.

### Neutralizing Indicator

In the same general way the field strength indicator makes a highly sensitive neutralization indicator. A short pick-up wire is used, and the indicator serves the purpose in the same fashion as the time-honoured flash lamp and loop. The degree of sensitivity is so much higher that a more precise degree of neutralization can be reached. The smaller the deflection on the meter, the more perfect the neutralization.

### Wavemeter

The device may also be used as a wavemeter for rough check only. A short rigid pick-up wire, only a few inches long, should be used, and this should be so arranged that when connected it is always in the same position relative to the screening can of the indicator. Calibration can be carried out against a known standard.

Where power in excess of 100 watts has been used, the indicator has achieved useful work in finding metal which was absorbing radiation from the antenna. By "exploring" the field of the antenna, it will often be found that sudden peak deflections appear on the milliammeter. These can usually be traced to the presence of a standard lamp, curtain rod, or some other metal object close to the pick-up wire (which should be a short rigid piece of brass rod in this case), which is radiating, and hence using up power and distorting the field of the antenna. This can often be corrected by bonding to earth, or removing the offending article. The latter method is the easier!

For operation on five meters, a modified field strength indicator might be used with a large single turn inductance acting as a loop antenna. Such an arrangement would be especially useful for checking the directive properties of a beam radiating system. —*T. & R. Bulletin, London.*

### Optical Range

An approximate rule for finding the range of vision for small heights is to increase the square root of the number of feet that the eye is above the level surface by a third of itself, the result being the distance of the horizon in miles. Refraction is taken into account in this approximate rule.

An example will illustrate the application of the rule.

The eyes of an observer are 36 feet above a level surface; therefore, the horizon is  $\sqrt{36} + \frac{1}{3} \sqrt{36}$  miles distant. Square root of 36 is 6, one-third of 6 is 2,  $6 + 2 = 8$  miles.—*T. & R. Bulletin, London.*

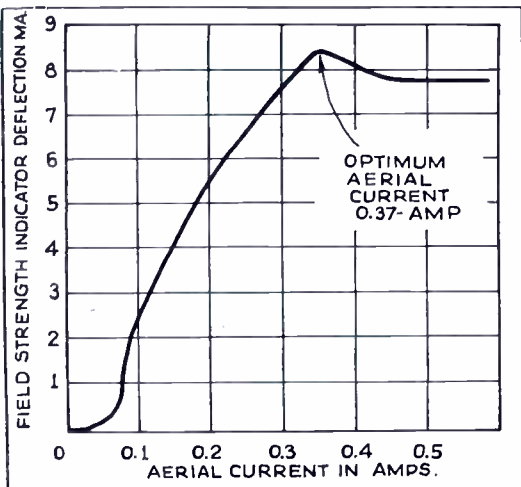

A graph showing a series of readings taken at a medium power station, during the adjustment of a Collins aerial coupling network.

nected to the antenna terminal on the indicator box. A walking-stick driven into the ground makes a suitable "mast" and the pick-up wire should be run parallel to the antenna. The length of the wire depends on the power being radiated by the antenna, but only a few feet will be necessary even for low power.

The indicator should then be switched on and the filaments allowed to warm up. With the transmitter radiating, the field strength indicator should be tuned to resonance, as shown by a deflection on the meter. This should show about half scale. If the deflection is more than half scale the pick-up wire needs to be reduced until the right length to give half scale deflection is reached. If the operator is making his adjustments single handed, it is best to arrange for the meter to be read from the shack window through a pair of field glasses. If assistance is available, the one reading the field strength indicator should keep well away from it in order that the presence of the mass of his body will not cause errors. Much calling back and forth can be overcome by the simple expedient of arranging beforehand a tabulated list of the tests to be made in order. The readings can then be noted against this list and conclusions reached by comparing the field strength indicator readings with readings taken in the station of dial settings, anode current and radiation.

As most amateurs have discovered, the radiation meter can lie! The curve, Fig. 2, shows a series of readings taken at a medium-powered London station during the adjustment of a Collins coupler. It should be borne in mind that the indicator does not read radiation, but gives a true picture of the actual "flux density" appearing about the antenna. A suggestion has been

*Now—*

TEN METERS WITH NEW "SUPER-PRO"!



**H**AMMARLUND now announces a special "Super-Pro" receiver to cover from 7½ to 240 meters, that affords new outstanding results!

The new 7½ to 15 meter range in this latest model is the result of painstaking research and engineering, and is not just a casual makeshift! Two steps of R.F. amplification are used in this range as well as in the remaining four ranges from 15 to 240 meters. This provides an image rejection ratio of 150 to 1, and a sensitivity of 0.8 micro-volt (30% modulated) with a signal to noise ratio of 6 to 1 at 10 meters!

The 2000 kilocycle span on the 10 meter amateur band is covered by 90 degrees of the band spread dial. Similar wide band spread is available on the other popular high frequency bands.

All of the other popular features that contribute to the success of the standard 15 to 560 meter "Super-Pro" have been retained in this model, viz.—direct tuning, accurately calibrated 3 to 16 kc. band-width panel control, graduated audio and sensitivity controls, calibrated beat oscillator control, 8 metal and 8 glass tubes, stand-by switch, AVC-manual switch, rugged self-contained tuning unit with trouble-free cam operated knife switch, variable crystal filter, etc.

Further details on this model and the standard model appear in a special booklet. Mail coupon below for your copy!

HAMMARLUND MFG. CO., INC.  
424-438 W. 33d St., N. Y. SWT-5

- Please send me new "Super-Pro" booklet.
- Please send me new "37" catalog.

Name.....

Address.....

City..... State.....

**HAMMARLUND'S 25<sup>TH</sup> YEAR**

Please mention SHORT WAVE & TELEVISION when writing advertisers

**FINEST FOR Every RADIO NEED**

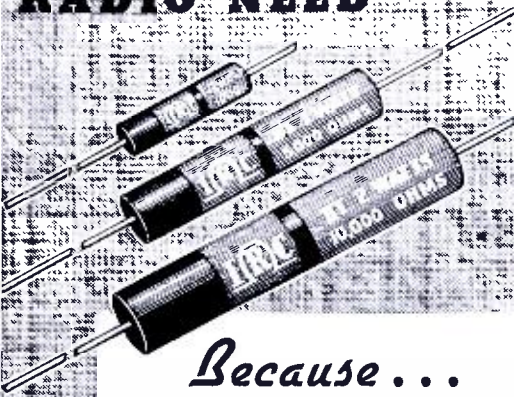

*Because...*

- Famous Metallized Type Resistance Element.
- Fully insulated—no shorting.
- Sealed throughout—impervious to atmospheric effects.
- Enclosed positive contact—will not break or become "open".
- Small, sturdy, light in weight.
- Both RMA color coded and imprinted with resistance value and wattage rating.

1/2 WATT. List 17c. NET 10c  
 1 WATT. List 20c. NET 12c  
 2 WATTS. List 30c. NET 18c



**INSULATED METALLIZED RESISTORS**



**40 WATTS OUTPUT FOR \$40**

A low-cost transmitter that has EVERYTHING! Uses Crystal control... 6L6 tube for oscillator... Type 10-B25 or T-20 amplifier tubes... Room for buffer stage or R.F. for phone operation. It's stable... efficient... compact... economical. Build this professional-appearing transmitter... you'll get perfect performance.

Complete layout template AT-1 with complete operating instructions will be mailed for... **25¢**

**STANDARD TRANSFORMER CORPORATION**  
 850 BLACKHAWK ST., CHICAGO

**New 441-Line High-Fidelity Television Demonstrated**

(Continued from page 7)

proportions, so far as personal energy and finances are concerned.

"5. Reduction in the cost of television receivers. At present in England there is no great rush to buy television receivers now selling from \$500 to \$600."

**Television's Outstanding Forward Step**

During the past year a single set of standards was proposed for the U.S.A. by the Television Committee of the Radio Manufacturers Association. These standards have been endorsed by the active workers in the field of cathode ray television, who have altered, or are altering their equipment to conform. Among other things these standards specify an increase in the number of picture scanning lines to 441. The highest previously used was 345 lines.

**Field Tests at Philco**

Exactly six months ago the Philco company, at the close of a series of field tests in Philadelphia, invited the press to witness a television demonstration at Rydal, Pa. Radio pictures scanned by 345 lines were shown. Their steadiness and clearness brought forth much favorable comment. On this occasion it was announced that the transmitting and receiving equipment would be dismantled and rebuilt to operate as a 441 line system. This was to give pictures of even better detail, more nearly equal to "home movies."

**First Broadcast of 441 Lines**

Philco's improved 441 line system has been on the air for broadcast experiments since last December. During the first few weeks of these experiments, while initial adjustments were being carried out, picture quality steadily increased. It has now reached that stage of excellence where the effects of higher picture resolution are plainly evident to the observer. This is the system demonstrated a few weeks ago.

Philco television engineers demonstrated by convincing technical tests that the high fidelity television system has the distinction of affording the highest picture definition obtainable at present. The secret of this achievement rests not only in 441 line scanning, but in utilizing a communication channel wide enough to permit the transmission of the fine detail necessary to give unusually clean-cut, realistic pictures.

**Observers Note Improvement Due to 441 Lines**

The increase from 345 lines to 441 lines represents about a 30% increase, which possibly would not be noticed by the casual observer unless he was given an opportunity to compare the two pictures side by side. A test of this nature was arranged by the engineers as a part of the demonstration. By means of an electrical network, which could be switched in and out of the circuit at the transmitter, the resolution could be reduced (in one direction) so as to simulate that ordinarily secured with a 345 line system. Then, by a throw of the switch, the system could be quickly converted to 441 lines with maximum detail. The effect of thus increasing the definition was surprising. It was especially so when looking at objects on which there was small lettering—for instance, the serial number on a one dollar bill, or the second hand of a watch.

To sum up an experienced observer's reaction when viewing a 441 line television picture, it can be said that the higher detail produces a smoother, more pleasing picture, in which the line formation is no longer visible from the ordinary viewing distance, which is about five feet.

**Importance of High-Definition Television**

Albert F. Murray, engineer in charge of television said: "The Philco television engineers in their developments and field tests have uppermost the thought 'The quality of the picture depends upon the fidelity of the system.' And after all its the quality of the picture in the observer's home that really counts at this stage of television development. This means that not only 441 line systems are needed, but high-fidelity 441 line systems are required to really interest the customer when commercial television finally arrives. We have pioneered the wide channel—6 megacycles—move which goes hand-in-hand with high-fidelity television."

**Data on Philco's High-Fidelity Television System**

**TRANSMITTER**

1. Location On top floor of main Philco plant at Tioga and "C" streets, Philadelphia, Pa.
2. Sound transmitter Frequency 54 Mc. (megacycles) Power .25 kw. (kilowatts)
3. Television Transmitter Frequency 49 Mc.; power 4 kw (peak)
4. Modulation System Unique high-fidelity system developed at Philco.
5. Over-all Transmitter Fidelity To enable high-definition pictures to be transmitted Philco engineers have designed equipment responding to an unusually wide band of modulating frequencies, the maximum being about 4.5 Mc.
6. Call Letters Both sound and television stations operate under a single set of call letters—W3XE Philco, Philadelphia.
7. Antenna Height above street level—210 feet. Television transmitter antenna consists of array composed of two dipoles, each fitted with a reflector. The sound antenna consists of a vertical half-wave. Both antennas are fed by coaxial transmission lines.
8. Transmitter Range About 10 miles.
9. Source of Picture Television pictures transmitted from studio, motion picture film, and outdoors, using the Philco camera tube.

**THE PHILCO SYSTEM**

1. Number of Lines 441.
2. Frame Frequency 30 per second.
3. Field Frequency 60 per second, interlaced.
4. Aspect Ratio 4:3
5. Polarity of Transmission Negative.

(Note: These and other characteristics of the system are in accordance with the recommended standards of the RMA Television Committee)

6. Synchronizing Amplitude selection is used in connection with the "narrow vertical" synchronizing pulse.

**RECEIVERS**

1. Philco field test receivers Receivers use independent television and sound receivers for flexibility. These tune over the range 42-86 Mc.
2. Total number of tubes employed 26
3. Picture tube 12 inches in diameter, giving "white and black" pictures approximately 7½x10 inches.

High-fidelity picture reproduction on these receivers results from a design which gives an extremely wide receiver acceptance band, wider than 4.5 Mc.

The 26 tube receiver consumes about 370 watts.

**DISTANCE BETWEEN PHILCO AND GERMANTOWN CRICKET CLUB—3 miles (approximately).**

# Hammarlund Develops New "Super-Pro" With 20 to 40 MC. Band

By Donald Lewis

● AFTER an intensive period of experimentation, the engineers of Hammarlund have just produced an additional model of the 16-tube "Super-Pro" with a 20 to 40 megacycle band, that is unusually efficient. I operated the receiver for quite a while and found it to be a most outstanding unit.

Before going into a description of the receiver, I should like to emphasize a few points that I believe are most important. This model like the other "Super-Pro" types has been carefully engineered, with the additional frequency range incorporated only after considerable laboratory work and modeling, rather than by the usual casual makeshift application. For instance, specially built measuring equipment permitted an accuracy of construction heretofore impossible. Then theoretical and practical tests were checked against each other with painstaking care to insure perfection. Where standard materials were found to be objectionable due to losses and so forth, selected low-loss substances were substituted. In other words, the same care of design and production followed for the standard "Super-Pro" was duplicated in this new model. The natural result is that its efficiency is remarkably high.

In this new model, two stages of radio-frequency amplification have been included for all the five ranges. This affords a gain never before available and an image-rejection ratio exceedingly high. To be more specific, on a test on 28 megacycles the image-rejection ratio was found to be 150 to 1, while the sensitivity on the same frequency with a six-to-one signal-to-noise ratio was .8 microvolt. Such a high-image rejection ratio definitely eliminates all fear of the "two-spot tuning." There just isn't any such thing with this model, it is one-

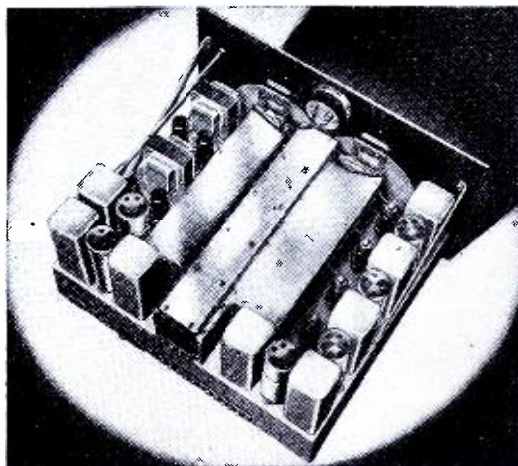

New "Super-Pro" chassis.

spot all the time. The high gain affords signal coverage that will crowd the old "log" book.

Another interesting characteristic of this new receiver is the tremendous band-spread possible on the 28 to 30 mc. band. This 2000 kilocycle region is covered by 90 degrees of the band-spread dial. Thus it becomes quite a simple matter to really pick apart even the most crowded sections. Due to the design of this receiver, all of the "amateur" bands fall in the center of the tuning range of each band. Thus it is possible to set the tuning dial at any particular amateur band and turn the band-switch. You will promptly fall into the next amateur channel without further adjustment. Then by turning the band-spread dial you will bring in the stations desired.

As in the standard "Super-Pro," there are five tuning ranges. Here, of course, the tuning begins at 40 mc. as follows: 20 to 40 mc., 10 to 20 mc., 5 to 10 mc., 2.5 to 5 mc., and 1250 to 2500 kc. This tuning coverage arrangement provides complete control of ultra-high frequency and high-frequency channels most popular today.

Of course all of the many unusual features that contribute to the success of the standard "Super-Pro" have been retained. That is, the accurately calibrated three to sixteen kilocycle continuously-variable band-width panel-control is still used, to not only afford selectivity control, but to also provide fidelity and tone control. The graduated audio and sensitivity controls permit, as before, accurate adjustment and simplified "logging." With the zero to 2500 cycle beat-note panel-control, it is possible to select a frequency within this range on either side of zero beat.

For those who require additional hair-breadth selectivity for C.W. code, a crystal model is also made.

*This article has been prepared from data supplied by courtesy of Hammarlund Mfg. Co.*

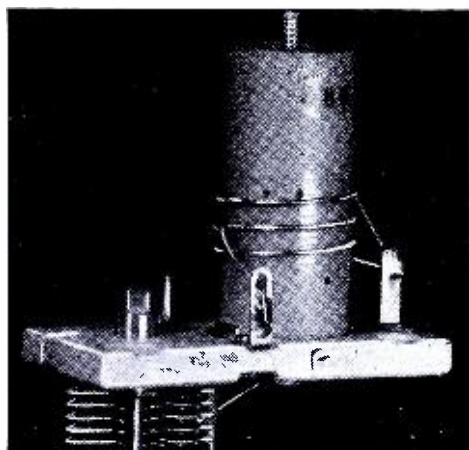

10 meter coil. Note air-tuning condenser and copper disc. Air-tuning condenser is used for aligning at high frequencies and copper disc for aligning at low frequencies.

## European S-W Receiver Has Range 13 to 200 Meters

(Continued from page 26)

control and at the extreme left we see the control to vary the A.V.C.

At the left we see the four separate shield cans for the four R.F. tuning circuits. The cans are made of cast aluminum and are sealed completely water and airtight. Each can contains a coil rotator and the tuning condenser. It is of interest to note that the switch is stationary but the coils revolve. Another interesting detail is the design of the switch springs; they are made of a new material called beryllium bronze and are equipped with platinum contact points. The four tuning circuits are of course ganged.

In the center, the large tuning scale is calibrated in megacycles and translucent

illuminated. The meter at the right is used to control the plate and heater voltages. It is of interest to note that the receiver may be operated either from batteries or from the power line, a design detail not only of great importance in case of emergency, but also in case the receiver is to be used far from civilization.

The complete outfit has been designed with the thought in mind to make this receiver absolutely water and air-tight and fool-proof. Chassis as well as the cover box are made of cast aluminum.

The tubes are arranged in such a manner as to avoid circuit variation because of heat dissipation. Also the I.F. circuits and especially the local oscillator are shielded to prevent any outside influence.



156 PAGES OF INTEREST FOR EVERY AMATEUR AND RADIO BUILDER

Send for the new Spring 1937 ALLIED Radio Catalog—it's packed with values from cover to cover—loaded with the industry's latest developments—complete with Everything in Radio! 10,000 exact duplicate and replacement parts; complete lines of Amateur transmitting and receiving gear; 53 new Knight Radios; test equipment; Public Address systems; Build-Your-Own kits; books, tools, etc. Write for your FREE copy today!



### EVERYTHING NEW IN AMATEUR TRANSMITTING AND RECEIVING GEAR

See the greater Amateur section in the new Spring ALLIED Catalog for the finest in transmitters, receivers and transceivers, both in factory-built and kit form; the new RCA-ACR 155; "Sky-Challenger"; U t a h-Add-A-Unit X-mitter; I.P.S. "Rubber Crystal"; Meissner No. 7502 kit, and many others. There's a reason why thousands of Hams say: "ALLIED is tops in Amateur Radio!"



### "Build your own" WITH ALLIED APPROVED PARTS

ALLIED's new Spring Catalog lists more than 10,000 exact duplicate and replacement parts for building or repairing any circuit. We can supply matched kits for constructing any circuit described in this or any other radio publication. Write for Free Parts Lists covering: Knight Super Gainer; Meissner All-Wave 14; 5 Meter Transceiver; 2 Tube DX'er and many others. ALSO: see pages 123-4-5 of ALLIED's new Catalog for other new, low-priced kits.

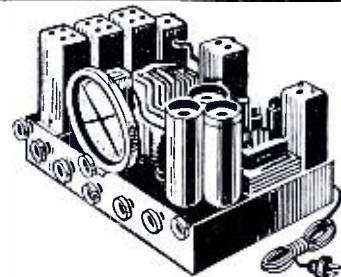

### COMPLETE STOCKS—FASTEST SERVICE LOWEST PRICES

You can buy with confidence at ALLIED—Radio's Leading Supply House! Our tremendous stocks, our central location, our efficient merchandising methods mean greater values, faster service and lowest prices for you! Why shop skimpy, incomplete "Amateur booklets"?—Fill all your requirements from the new ALLIED Catalog—Radio's COMPLETE Supply Guide!

FREE CATALOG

## ALLIED RADIO CORP.

833 W. Jackson Blvd., Dept. 3E  
Chicago, Ill.

Send me your FREE Spring 1937 Catalog.

Send me parts list for.....

Name.....

Address.....

Please mention SHORT WAVE & TELEVISION when writing advertisers

**WHY EXPERIMENT?**

**HERE IS AN INTERFERENCE FILTER THAT REALLY WORKS**



**QUIETONE**

The problem of power line and antennae disturbances in radio reception has grown tremendously with the development of new electrical appliances. It is, as has been proven in the past, a most difficult one to properly solve.

Laboratory and field tests have proven that the C-D QUIETONE will effectively and economically offer a positive solution to the majority of these irritating disturbances.

Behind the C-D QUIETONE is the reputation of an organization whose advances in the field of wireless, radio and telephonic communication extend over more than 27 years, therefore . . . why experiment with an unproven product?

Available at all leading C-D distributors. Complete technical bulletin available free on request.

**MICA DYKANOL PAPER  
WET & DRY ELECTROLYTIC  
CORNELL-DUBLIER CORP.**  
1027 Hamilton Blvd. So. Plainfield, N. J.

**CORNELL DUBLIER**

**NEW FEATURES**

of

**ASTATIC**

**D-104  
CRYSTAL  
MICROPHONE**



See Your Jobber

The time-proven D-104 is NOW available in a new, beautifully finished bright chromium case—with a thickness of 13/16" instead of 1" as formerly. It is NOW also equipped with high grade plug and socket, including the Astatic special spring cable protector, which insures freedom from cable breakage at the mounting. At no increase in its famous low price, built rugged for long service, giving quality "speech range" performance under all conditions, the D-104 is more than ever the favorite of amateurs the world over. List Price \$22.50.

Licensed under Brush Development Company Patents. Astatic Patents Pending

**ASTATIC MICROPHONE LABORATORY Inc.**  
Dept. SW, YOUNGSTOWN, OHIO, U. S. A.

**TREASURE-FINDERS  
ORE-LOCATORS**

manufactured by  
**FISHER RESEARCH LAB.**  
745 Emerson St., PALO ALTO, CALIF.

## Record What You Hear!

(Continued from page 24)

Since the higher audio frequencies are very essential in recording. This is usually governed by the setting of the selectivity control. Only aluminum alloy discs are recorded on this machine, producing good quality and clarity of tone. Twelve-inch records can be recorded with the same ease as six-inch ones. Both the machine and the records are the most economical to purchase and for this reason are finding their way into *Ham stations* throughout the country.

Mounting of the apparatus upon a solid and level bench is one of the first requisites. A spirit-level mounted on the deck of the machine is supplied for checking the horizontal position in both directions. Freedom from vibration is of utmost importance. Do not pick a table that is "weak in the knees." Recording upon this machine is quite simple. The lead-screw that guides the recording head across the disc is driven from the spindle of the turntable. The recording head guide shoe is merely placed on the lead-screw and you adjust the volume. The lead-screw clutch also clamps the disc, to be recorded, firmly to the turntable; preventing any slipping. The turntable may be run at regular phonograph speed of 78 R.P.M. or at transcription speed of 33-1/3 R.P.M. A *stroboscope* disc is furnished for the checking of the exact speed. The stroboscope may be operated under electric lights using any standard frequency of alternating current.

### How to Record Voice, Code or Music

In figure 1, the operator is seen adjusting the volume control to the proper recording level as indicated on the scale of the volume-level meter supplied on the machine. Variations in the recording head damping, of course, require different recording levels. Stylus pressure adjustment is made by a thumbscrew on the recording head arm. The right amount of pressure will nearly eliminate all of the groove hiss. A quick check can be made by adjusting the pressure screw while listening to the groove on a pair of head-phones via a play-back pick-up while recording. Recordings made upon aluminum alloy discs are every bit as good as a standard phonograph record, if the small details are once maintained, such as, adjusting the recording head angle to 62 to 65 degrees from horizontal when recording at 78 R.P.M. and to 65 to 70 degrees when recording at 33-1/3 R.P.M. The stylus pressure should be from 10 to 18 ounces. The exact amount depends upon the hardness and condition of the record surface. These recordings are very different from the old home recordings and require a special stylus for the actual grooving of the metal. The best recording styli for aluminum alloy is the sapphire, to which care must be given as they are easily chipped if carelessly handled. Cactus, bamboo, and fibre needles are preferred for play-back needles, since they reduce the groove noise to a minimum and provide a longer life to the record. Over-modulation of the grooves causes cross-overs, echo, and other forms of distortion in reproduction. So, do not attempt to force too much volume into a record.

### How Listener Can Record S-W Programs

Figure 2, illustrates a typical *short-wave listener's* set-up, using a moderately priced acetate recording machine. On this machine can be produced high-fidelity recordings on acetate-coated discs only.

A word here about the *coated discs*; substantially all of the instantaneous transcriptions being made today are on acetate coated discs. The reason for this is the quality of reproduction and the *extremely low groove noise*, together with a *greater volume range*. In these features they far surpass any of the regular phonograph records.

In order to produce high-quality results, precision workmanship is necessary throughout. Here, a special floating, cut-

ting head, operating on three and a half watts of audio power, is standard equipment. It maintains a constant angle with the record surface and actually cuts the material from the disc. In figure 2, the operator is seen checking the belt tension before lowering the cutting head to the record. A synchronous motor powers the turntable through a belt drive. Full speed is obtained within one revolution. Constant speed is highly desired, hence the powerful synchronous motor. Any change in speed while recording will produce a "wow or waver" on a sustained tone. Properly designed mechanically, this machine is entirely free from that trouble. Different power line frequencies are compensated for in an instant by slipping the belt to another groove calibrated for that frequency.

The play-back pick-up "A" in figure 2, is furnished with the machine and can be used in "monitoring" the record as it is being recorded. A pair of head-phones matched directly into the pick-up does the trick, or maybe you can use the audio section of that old radio in the corner for a monitor. An output meter or other indicating device is good to have but the head-phones will do nicely; since, the tone quality can be checked along with the volume. This is very important on D.X. where there is a tendency to fade.

On the sixteen inch acetate recording machine records may be removed and replaced without the necessity of detaching any parts. There is an absolute freedom in recording with the lead-screw driven from below the deck and separate from the turntable proper. The lead-screw is also constructed so that a recording may be started or stopped anywhere on the disc, merely by shifting a small lever on the recording head arm.

"B" in figure 2, is an *indicator*, located in back of and parallel to the lead-screw, showing the *number of minutes of recording space* left upon any record up to 17 inches in diameter. This particular machine will record up to 130 grooves per inch, thus extending the recording time several minutes on the larger discs. In the small drawer "C", the accessories are stored; such as an adjustable power microscope; micrometer caliper for measurement of a thread of the material cut from the record, indicating the depth of the cut. Other small tools and belts find a place here, also.

The Universal 16 inch portable recorder is ruggedly built, but weighs only 60 lbs, complete, and can easily be carried from your home to the short-wave club for a demonstration of what you have been receiving, or to your friend's for a check of his reception. Historical and epic making events are being transmitted daily, but have you any record of them? The recording machine now offered, present a means for the short-wave "ham" or *listener* to obtain a greater enjoyment and education from his equipment than he has ever had in the past. Why not be one of the first in your district to be really up to date?

This article has been prepared from data supplied by courtesy of Universal Microphone Co. Mr. Fouch is Test Technician for this company.

## The Editors Want

articles describing in detail television receivers on which short-wave experimenters may pick up the television images being broadcast by the RCA Station, atop the Empire State Bldg., in New York City, on about 5 meters, and also those being broadcast from the Don Lee Station on a similar wavelength in California. All articles accepted and published will be paid for at regular space rates. Send outline of article and what photos or diagrams available to: The Editor, Short Wave and Television, 99 Hudson St., New York, N.Y.



## Sargent Model 21 Superhet Has 12 Tubes

(Continued from page 19)

1500-550 K.C.      200-545 Meters  
The "Commercial" model has the 5 tuning bands above, plus two more, as follows:  
550-200 K.C.      545-1500 Meters  
200- 80 K.C.      1500-3750 Meters

### The Regenerative Input

The most important circuits in any radio receiver are those associated with the *input*. These circuits must deal with extremely weak signal currents—before amplification—state the Sargent engineers. The *input circuits* have the responsibility of conducting the weak signal currents, with a minimum of loss, from the antenna to the grid of the first tube, at which point amplification commences. The stronger the signal that is applied at this point, the less the amount of amplification needed in the rest of the receiver to produce a given *output*, and consequently the less the tube hiss and other receiver noises. Thus the signal-to-noise ratio of the entire receiver depends entirely upon input sensitivity. Distance range also is dependent upon this. Signals, weak to start with, and suffering too much power loss in the input circuits, reach the first tube with too low a voltage to rise above the hiss level. Under such conditions, no amount of amplification later on in the receiver will bring them back—they are permanently lost.

By the use of a new type of regenerative circuit with a separate tube to provide the regenerative function, many difficulties have been completely eliminated. Here the input consists of 2 tubes, with grids connected in parallel. One is the R.F. stage tube, 6K7, which is operated at all times at full voltage, and hence at peak efficiency. The other, the regenerative tube, has its bias controllable from the panel, and this, in turn, *controls the regeneration*. Even with regeneration all the way off, the R.F. tube is still acting as an efficient amplifier, and on strong signals where sensitivity is unimportant, the receiver is usually operated that way. However, when it is desired to tune in *weak* signals, the regeneration is brought up to a peak, greatly increasing the sensitivity and selectivity of the input. The I.F. amplification is correspondingly reduced, keeping the noise at a minimum, and the signal is brought through the receiver with the best possible signal-to-noise ratio.

**Noise Control:** The action outlined above gives the operator a considerable amount of control over the noise level. By holding down the I.F. amplification the peaks of voltages due to static, automobile interference, etc., can be restricted to a fairly low level.

**Separate R.F. Gain Control:** A panel control is provided to control the bias on the R.F. amplifier tube separately from other adjustments. This makes it possible to apply an increased bias to this tube when receiving on a frequency adjacent to a very strong signal. While some sensitivity is lost by doing this, the extra bias prevents the grid from going positive and ruining the selectivity of this stage. Consequently this bias control makes it possible to work very close to the frequency of a strong station without "blanketing." This is one of the most important controls on the receiver.

**R.F. Stage Trimmer:** Receivers employing one or more of the usual broad-tuning type of R.F. stages can use fixed R.F. trimmers inside the coil unit, and with careful coil design, the *tracking* will be close enough for all practical purposes. Not so with a regenerative stage. Regeneration sharpens the input to a point where it has more selectivity than an I.F. stage, and a panel adjustment is necessary. This adjustment is not critical, and for a small band,—i.e. an *amateur* or *short-wave ship band*,—need not be made more than once. Many experienced operators prefer a panel trimmer on

## Sargent Model 21 Communication Super

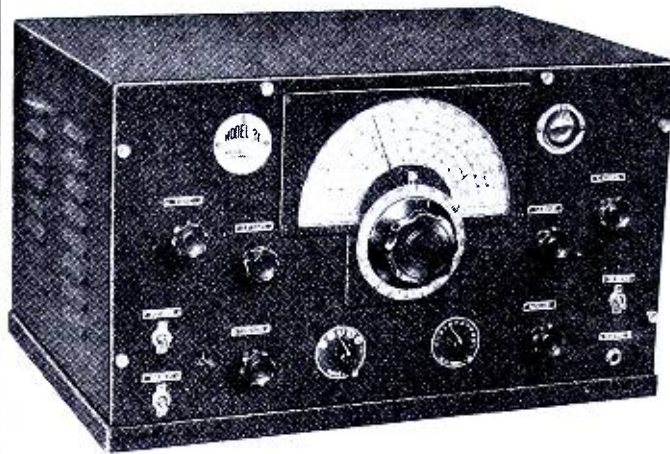

- 12 Tubes (metal)
- Shadow Tuning
- Large, Calibrated Tuning Dial
- Regenerative Input, all bands
- Iron Core I.F.'s
- Band Spread
- C. W. Oscillator, panel beat control
- Separate R.F. Gain Control
- Manual Volume or Amplified AVC
- Heavy, welded steel cabinet
- Speaker separate, in attractive cabinet
- Made in 2 Tuning Ranges:  
Amateur Model 9.5—550 Meters  
Commercial Model 9.5—3750 Meters

### About That Regenerative Input

An extra control that gives added sensitivity over that obtainable in any other receiver! How many times have you wished for just one more knob to turn that would bring those weak signals on 10 and 20 up to readability? The input regeneration is the answer. Model 21, with regeneration off, has amplification and input sensitivity equal to any other receiver, and WITHOUT regeneration brings through the signals on an even basis with other sets. The regeneration furnishes the additional sensitivity that puts this receiver way out in front of the others for weak signal pick-up—hence for DX.

### Steps Out on "10" and "20"

Special circuits are used throughout for 10 meters. Model 21 is really a receiver within a receiver—a 10 meter set and an all-wave set built together in the same unit. The special 10 meter circuits plus regeneration, which really does its stuff, makes Model 21 supreme on these important bands.

### Battery Model for Direction Finders

Model 21 is available for 6 volt battery operation (with B batteries or separate power supply) in either the amateur or commercial tuning range. The battery model is exceptionally good for radio direction finding work. Its complete shielding eliminates direct pick-up, giving sharply directional signals with a good loop. Battery models priced \$3.00 net higher than corresponding A.C. models.

### Net Prices, 110 Volt 60 Cycle Operation

Model 21-AA, 9.5-550 meters ..... net \$125.00  
Model 21-MA, 9.5-3750 meters.....net \$135.00

These prices include R.C.A. tubes, power supply, Jensen Speaker and speaker cabinet.

### IMMEDIATE DELIVERY

## E. M. SARGENT CO.

Cable Address "EMSCO"  
212 Ninth Street Oakland, Calif.

any receiver. Adjustment of this trimmer has no effect whatsoever on frequency.

**Positive Re-Set Dial:** Illustration shows the main tuning dial, with clear cut, easily read calibration. The chrome plated dial, on the large tuning knob, is geared to the main dial indicator and furnishes a micrometer scale, by which the main indicator may be re-set exactly to the frequency of any desired station, once its setting has been determined.

**The Band Spreader:** The chrome plated dial serves also as a *band-spreader* on the wide *amateur* bands. This dial makes 4 complete revolutions while the main indicator is traveling from 0 to 180 degrees. From this information, the amount of *spread* can be calculated for any given band. For the narrow bands, the indicator on the skirt of the tuning knob is used, and its travel measured along the markings on the chrome dial. The knob makes 5 complete revolutions for each one of the chrome dial, and gives about half a dial spread on the narrow amateur bands.

### 10 Meter Operation

Although the efficiency is high over the entire tuning range, especially good results have been obtained on the 10 meter band. Model 21 has been laid out as a 10 meter receiver, coils for this band being given preferred positions, separate by-passes, etc., being used. It is really a receiver within a receiver, and could be said to consist of a 10 meter tuning system and another system covering the other waves. With this arrangement, plus the regeneration, peak efficiency is reached on 10 meters and a world-wide range on this band is available to the operator.

**A.V.C.—Manual Volume System:** Two types of volume control, with *cut-over* switch are provided. A separate 6K7 A.V.C. tube is provided, for amplified A.V.C. This permits the use of a triode 2nd detector, necessary for C.W. and desirable for reception of all kinds. A.V.C. action in the regu-

## Good Results Demand Good Instruments

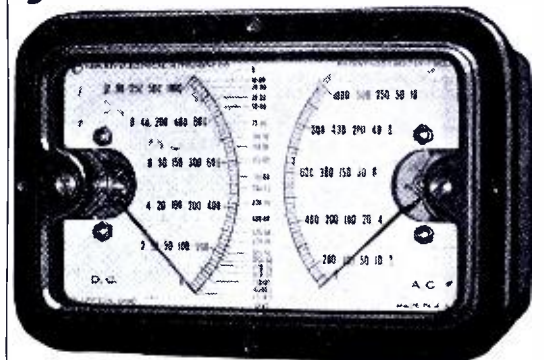

### THE TWIN

- Any Combination of Two Separate 3" Instruments In Rectangular Molded Case
- Two Distinct Readings At a Glance
- Measure Antenna and Modulation Current
- Determine Filament and Plate Voltages



Precision Instruments  
Economically Priced

WRITE FOR CATALOGUE

The Triplet Electrical Instrument Co.  
285 Harmon Ave., Bluffton, Ohio  
Please send me more complete information on  
.....Triplet Instrument.

I am interested in.....  
Name .....  
Address .....  
City ..... State.....

Please mention SHORT WAVE & TELEVISION when writing advertisers

## H. G. CISIN'S FAMOUS KITS

**ALL-WAVE AIR SCOUT JR.**  
1-TUBE MODEL  
**\$2.45 WITH TUBE and PHONE**

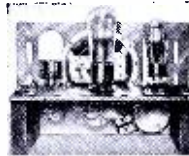

*Rear View of 2-Tube Model*

Complete Kit with Tube, Earphone, Panel, Chassis, Broadcast Coil and 70 to 200 meter Coil (unwired, less batteries). Many satisfied owners report **MARVELOUS FOREIGN RECEPTION!** Also brings in police calls, airplanes, amateurs, code, Trans-Atlantic Phone and other thrilling short wave reception.

Following parts included in the one-tube \$2.45 Kit: 30-tube, Earphone, broadcast coil, 70 to 200 meter coil.

Panel (two styles available, rectangular or pointed top), wood chassis, coil socket, knobs, tube socket, high grade rotating plate variable condenser, roll of hook-up wire, black and gold calibrated dial, grid leak, grid condenser, regen. control potentiometer, miles by-pass condenser, filament rheostat, six connection clips, variable antenna trimmer condenser, picture wiring diagram and detailed instructions.

**TWO-TUBE model.** Complete kit including all parts in the 1-tube model plus parts for extra **\$2.95 With Two Tubes & Phone**

**THREE-TUBE DE LUXE Model.** Complete kit including all parts in the 1-tube model plus parts for two extra audio stages including two 30-type tubes and 33 power output tube. **\$3.45 Tubes & Phone**

Following Auxiliary Parts are available: 10 to 20 meter coil 25c; 15 to 45 meter coil (foreign) 25c; 40 to 80 meter coil (foreign) 25c; 22 1/2 volt "B" battery 75c; Two flashlight "A" batteries 10c each; 5" Find-All Loud Speaker \$1; Complete Antenna Kit 50c; Wood Screw Kit 10c.

**NOTE:** If you already have earphones, two extra foreign coils may be substituted in any model.

**H. G. CISIN, CHIEF ENG., ALLIED ENG. INSTITUTE, 98 PARK PLACE, DEPT. S-35, NEW YORK, N. Y.**

losses that ordinarily accompany other types of filters, this receiver is not furnished with a crystal.

**Headphones, Audio and Speaker:** The audio system consists of a single 6F6, with tone control. The output of this tube is connected to a 10" Jensen dynamic speaker. On battery models, a permanent magnet dynamic type speaker is used. An attractive speaker cabinet, with finish to match the receiver, is furnished as part of the regular equipment. This cabinet is of metal, but is completely lined with wood baffling. The resulting tone is very pleasing.

A headphone jack is connected in the detector plate circuit. This connection keeps noise level sufficiently low so as not to tire an operator on a long watch, and enables the receiver to be operated at full sensitivity.

**Shadow Tuning:** A 6E5 shadow tube is used as a tuning indicator. This is adjusted to be sensitive to extremely weak carriers, and the indicator will respond to practically any audible signal.

**B Break:** A "B" break switch is provided on the panel of the receiver. Two insulated terminals for connection to a "B" break relay are brought out the rear of the chassis. These are in parallel with the switch connections.

**Power Supply:** This set has a built-in power-supply. This is thoroughly filtered, and operation is entirely humless.

**Cabinet:** The cabinet is ruggedly built along commercial lines. It is made entirely of 18 gauge steel. All joints are spot-welded. The cabinet is well ventilated, and extremely strong, serving as a protector of the receiver during shipment and a complete shield when the set is in operation.

**Rack Size Panel:** Panel and chassis draw out the front of the receiver by removing the thumb nuts. This allows easy inspection of chassis and tubes without disturbing the power connections. It also eliminates any need for hinging the top of the cabinet. The panel fits standard mounting racks, the chassis being sufficiently narrow to slip between the uprights. Cabinet and panel are finished in a handsome black crackle effect.

## ELECTRICITY

is the **FOUNDATION** of Radio!

**6c** a day will start you on a **PROFITABLE CAREER**



\$1.50 a volume, on easy monthly payments.

### AUDEL'S NEW ELECTRIC LIBRARY

Questions, answers, diagrams, calculations, underwriter's code; design, construction, operation and maintenance of modern electrical machines and appliances **FULLY COVERED**.

You can start your subscription with any volume. Write today for electric folder and **FREE TRIAL** offer.

**THEO. AUDEL & CO., 49 W. 23rd St., New York City**  
Mail Vol. 1, Electric Library on 7 days' free trial. If O.K. I will remit \$1.50, otherwise I will return it. I also request you to mail one book each month on same terms. No obligation unless I am satisfied.

Name \_\_\_\_\_  
Address \_\_\_\_\_  
Occupation \_\_\_\_\_ SW

lation of short-wave fading is almost perfect. Manual control is effected by varying the bias on the R.F. and I.F. tubes. This, in addition to the separate *R.F. gain control* gives a very fine degree of possible variation in signal strength.

**Beat Frequency Oscillator:** Panel adjustment of the beat note pitch is provided. The B.F.O. itself consists of an entirely self-contained shielded unit, containing tube, coils, resistors and by-passes. This unit, air spaced from the chassis, completely isolates this oscillator except at point of coupling. Coupling consists of an extremely small capacity from B.F.O. cathode to 2nd detector grid.

**The Coil Unit:** This unit consists of separate coils for each band, with a special switching connection for *short-circuiting* those to the low frequency side of the coils in use. This completely eliminates "dead-end" loss. Each stage is shielded completely from the others, and the entire coil unit is air spaced from the chassis, so as to confine coil currents to the unit itself and prevent them from going through the whole chassis.

**Selectivity:** Due to the use of 2 sharply-tuned iron-core I.F. stages, plus the regeneration when needed, this set is very selective. Selectivity can be made considerably better than 10 k.c. on all bands, and approaches that obtainable in many crystal-filter type receivers. Inasmuch as this degree of selectivity is obtainable without the

**Battery Model**

This model is exactly the same as the A.C. set, except that there is no power-supply and rectifier. It is designed for 6 volt operation with 135-180 volt B supply, available in both tuning ranges. Complete shielding of this model makes it excellent for use with *loop for direction finding*.

**Dimensions:** Length, overall, 19 1/2". Height, including rubber feet, 11 3/4". Panel size, 10 1/2" x 19". Front-to-back, 13 3/4",— add 1 1/2" for knobs.

*This article has been prepared from data supplied by courtesy of E. M. Sargent Co.*

## FOR SALE

Patents and manufacturing rights on

### UNO ALL WAVE COIL

Proprietor too busy with his own business to give it attention. Everything perfected, ready to market.

Communicate with

**FRED C. TIEDEMANN**  
c/o Short Wave & Television,  
99 Hudson St., New York City

### ANTENNA TUNING UNIT

Just out—Unit will match double feeders so that signal to noise ratio is greatly improved; it also tunes antenna to resonate at frequency of incoming signals. Can be used on double or single wire antenna in conjunction with any short wave set. We invite your inquiry.

**OXFORD LABORATORIES**  
BOX 244 OXFORD, MD.

## Short-Wave Heroes of the Flood

(Continued from page 5)

The O.K. was received promptly.

In one hour's time, Miss Ilett of the Red Cross had installed a private telephone line directly from the Red Cross Headquarters to W8ESN. In the mean time W8ESN had contacted and arranged regular schedules on a 24 hour basis, with the following amateur stations: W8YX of Cincinnati; W8LEK of Columbus; W8PGL of Wheelersburgh; and W9ETI of Chicago. These stations gave us the greatest possible amount of co-operation.

With the co-operation of the following Toledo amateurs—W8GJS, Bill Golding, ex-W4DPK, Ned Miller (formerly of Miami, Fla.) and W8KPH. Paul Luckman, W8ESN, was able to operate on a continuous 24 hour operation. The Monitoring Department was ably handled by Ray Lewis (with a Scott 24); Fred Satterthwaite (with an RME 69), and Jo-Jo Solark (with a Breting 12). Mrs. Kemberling cheerfully kept busy feeding the "gang" down in the basement, while Mr. Alexander ran errands and brought parts for the station.

W8GJS and ex-W4DPK relieved W8ESN at the "mike" on regular 8 hour stretches, while W8KPH took complete charge of "message filing." This schedule of operation was maintained efficiently until the ban was lifted on Feb. 5 at 5 a.m.

After 96 hours, of little or no rest, at the controls; Mr. Kemberling was ordered by his doctor to take a rest; after which he immediately got back into harness.

The transmitter operated O.K. at all times, with the only exception of four 866's "going West," and the electric light meter trying to establish a new non-stop speed-record. Through the co-operation of W8-JEX, Chris. Thomson, another Toledo "ham," loaned to W8ESN the use of four 866's when W8ESN sent a Police Scout Car to him at 4 o'clock in the morning of Jan. 29.

Traffic was handled for the following organizations: City Manager Edy; Chief of Police Ray Allen; Chief of the Fire Department; American Red Cross under Miss Beatrice Ilett; American Legion under Henry B. Hermen; Volunteers of America; "Radio Don" of Station WSPD; Lucas County Relief Administration, and the Salvation Army.

Please mention SHORT WAVE & TELEVISION when writing advertisers

# Let's Listen In With Joe Miller

(Continued from page 22)

cannot tune after 7:30 a.m. then leaving for work.

## China

XTV, on 9.49 mc., Hankow, was logged at 6.26 a.m. once phoning XPC, 9.285 mc., Shanghai, both good "sigs" here.

Ashley Walcott, San Francisco, reports a new one, which may be XTR, Swatow, heard on 9.36 mc., phoning either XTV or XPC, between 2-7 a.m.

XGOX, has moved to 6.87 mc., from 6.72 mc., and heard more clearly.

XOJ, 15.80 mc., Shanghai, continues being heard often from as early as 9 p.m. to midnight, usually with JVF, 15.6 mc., Tokyo.

XGV, on 7.36 mc., at Shanghai, has changed from 7.41 mc., according to announcement heard by Ashley Walcott. XGV heard in 'Frisco mornings with an R9 signal at 9:30 a.m. calling KWX, 7.61 mc., at Dixon, Cal. From 10:30-11:30 KWX phones XGW, 10.42 mc. All this from Ashley Walcott.

## Netherland Indies

As is now known the N. E. Indies Gov't. no longer verifies reports on their phone stations, but still *verify reports on their musical programs*, which may still be heard from PLP, 11.00 mc., and PMN, 10.26 mc., both at Bandoeng. PLP is always the better of the two, and easily logged. Best "sigs" from 6-7 a.m.

PLE, 18.83 mc., Bandoeng, heard sending music at 7:30 p.m. by Charlie Miller, Ky.

Ashley Walcott forwards some "FB" dope on N.E.I. phones. YCP, 9.12 mc., at Balikpapan, Borneo; phones PNI, 8.775 mc., irreg. from 6:15-6:30 a.m. YBZ, Menado, Sumatra, 7.68 mc., is heard with PNI irreg. from 5:45-6:15 a.m.

## Australia

VK9MI, on 6.02 mc., the good ship "S.S. *Kanimbla*," has been heard by John De Myer, Lansing, Mich., at 6:45 a.m.-7:30 a.m. John says that 9MI is often R8, and at 7 a.m. the ship's chimes and whistle are heard. Woman announcer.

John also reports the new VK6ME, at Perth, W. Australia, on 9.597 mc., signing off at 7:30 a.m. Try for this new one!

We will mention ZMBJ here. Lately we have received 3 veri cards from this nice catch, an easy one for DXers. 2 veris were for 8.84 mc., and one for 13.60 mc. reception. We wish to here acknowledge receipt of a copy of *New Zealand Radio Times*, through courtesy of Lionel A. Jones, Chief Operator, ZMBJ. Thank you, Lionel, OM!

This magazine contains a very complete description of the remarkably elaborate equipment aboard this fine vessel, the "S.S. *Awatea*." It is regretted even a partial description of the equipment could not be mentioned here, but it did astonish "Ye Ed," to read how well equipped this ship was, with its several Xmtrs and receivers.

ZMBJ is heard with a fine "sig" here, nearly daily from 1 a.m. up to as late as 6:30 a.m. It usually phones VLK or VLZ, at Sydney, on 10.52 and 9.76 mc., respectively, in early mornings. Music usually heard near 6:30 a.m.

QRA is: Lionel H. Jones, Chief Operator, "S.S. *Awatea*," Union S.S. Co., Auckland, New Zealand.

For you DXers who need a New Zealand verification (and there are quite a few) here's your chance! As illustrated in this article, ZMBJ does send a nice QSL, too!

## Africans

ITK, 16.385 mc., Mogadiscio, Italian Somaliland, heard daily by Ashley Walcott phoning IBS, 14.485 mc., San Paolo, Italy, 9:45-10:45 a.m.

ITR, 14.63 mc., believed at Mogadiscio, heard at 2 a.m. phoning ORK, by Bob Gaiser, Pres. Universal DX Club, Butler, New Jersey. Heard here at 2:16 a.m.

OPM, 10.14 mc., Leopoldville, Belgian

Congo, reported at 1:15-1:45 a.m. phoning other Congo stations by Russell Ballard and Ashley Walcott, both in California.

Ashley also hears DGH, Nauen, 10.44 mc., phoning SUZ, Cairo, Egypt, at 2 a.m. quite often, also near 10 a.m. SUZ usually phones GBB, 13.58 mc., Rugby, at 11 a.m. sharp. Try for SUZ, this is considered an "easy" African!

QRA of SUZ: Marconi, Radiotelegraph Co., P.O. Box 795, Cairo, Egypt. Usually answers inside of two months.

FZE9, 7.56 mc., Djibouti, French Somaliland, reported at 8:30 a.m. by Bob Gaiser. Used clear and inv. speech.

## Asia

VWZ, Kirkee, India, on about 8.70 mc., has been reported by Bob Gaiser at 2 a.m.

VWY, 33.41 meters, reported by Charlie Miller and Eddie Schmeichel near 2:30 a.m. phoning Rugby.

All DXers who wish their ratings published, kindly send your total VAC, and countries verified, to Y.T., on a postal. Just estimate how many veris you have from each of the six continents, and how many countries you have QSLs from. Only phone veris considered, of course. Next month, a separate listing will be made, naming each DXer in their order of standing.

## HAM STARDUST

February has been a good month for the amateur phone DX. Asiatics "pushing through" often, in early a.m. and VKs now being heard well, near 2 a.m., and between 6-8 a.m. Also, the Africans broke through somewhat similarly to last Nov., from 11-12 p.m.

Africans heard here on 20 meters from 11-12: ZS6AU, 14280; ZT2G, 14255; ZS2N, 14020; ZS2X, 14340; ZT6N, 14020; ZT6AL, 14135; ZS6AJ, 14140; ZU6P, 14080, all these in So. Africa.

Other Africans heard between 11-12 were: ZE1JR, So. Rhodesia, 14044 and 14275, SU1AK, Egypt, near 14280, SUIKG, 14040; EA8AE, Canaries, 14080; ON4CGW, Belgian Congo, 14065.

Heard at other hours: ZU5X, 14090, 3:40 p.m.—ZS6AM, 14090, 5:20 p.m., both in So. Africa. Also CN8AA, 14080 and CN8AG, 14110, at 3:25 and 5:20 p.m. respectively, both in French Morocco.

VP1AA, 14035, Zanzibar, logged by Bob Gaiser at 5 p.m., Vy FB, Bob!

Charlie Miller also reports ON4CGW, at 6:15 p.m.

EL1A, 14300, Liberia, logged from 1-1:45 a.m. by Murray Buitekaut and Ed. Schmeichel. Nice DX, boys!

YE ED wrote ZU6P, Bill Meyer, at Johannesburg, to inform him that many SWLs were complaining about his failure to QSL, when IRCs were enclosed, and reports correct.

It is to Bill's credit, that he took the matter seriously enough to send a radio message thru W9ARA, informing Y.T. that he would answer shortly with full explanation.

Bill also promised to QSL Y.T.s 10-20m. reports. Some wait, since December 1935!

This should be "good news" to many disappointed DXers, so bear up, OMs, it won't be long now!

SU1GP, 14070, Egypt, heard by Ralph Gozen, 9:45 p.m. FT4AG, Tunis, heard by Pierre Portmann at 5:30 p.m. FB!

## Asia

VU2CQ, on 14358, at Bombay, heard FB at 7:06 a.m. calling a W4. Though only 10 watts, this "FB" DX catch is really consistent, and sends a very FB QSL, which Carlos Irizarry has already received. Congrats, Carlos!

Eddie Schmeichel has "logged" some great Asiatic DX. VU2CQ, PK4AU, 14384, Sumatra, PK3ST, 14300 and PK1MX, 14090, Java, all at 7:30 a.m. VU7FY is another

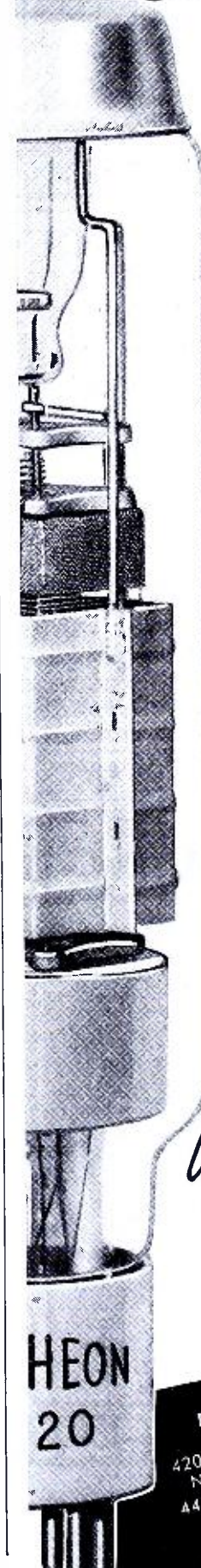

Raytheon — makers of the world's finest tubes was the first manufacturer to come to the rescue of the radio amateur! The first to build a transmitter tube especially designed for amateurs! Always—Raytheon has led the way. The first efficient triode . . . the first transmitting pentode . . . and the first zero bias Class B modulator . . . all were first introduced by Raytheon! That's why the amateurs who use Raytheon tubes are among the record breakers and leaders in amateur transmitting.

Only the finest materials in the world go into Raytheon Amateur Tubes — Tantalum plates, Nonex hard glass bulbs, Isolantite bases, etc. Every Raytheon tube is built to give the most output per dollar over the longest period of time! Whether you need tubes for a radio receiver or for an amateur transmitter—Raytheons are your best bet!

Used and RECOMMENDED  
BY Leading AMATEURS  
Sold BY ALL  
PARTS JOBBERS

RAYTHEON PRODUCTION CORPORATION  
420 Lexington Ave. New York, N. Y.  
445 Lake Shore Dr. Chicago, Ill.  
415 Peachtree Street, N. E. Atlanta, Ga.  
55 Chapel Street Newton, Mass.  
555 Howard St. San Francisco, Cal.

**NEWLY IMPROVED!**

## Model T-37 SIGNAL GENERATOR

- Accuracy 1/2 of 1% on I.F. Bands. 1% on Broadcast Band. 2% on S.W. Bands.
- We are now using a new hair-line pointer which enables reading to within 1/10 of 1%.
- Thousands of satisfied owners, since its introduction less than a year ago.

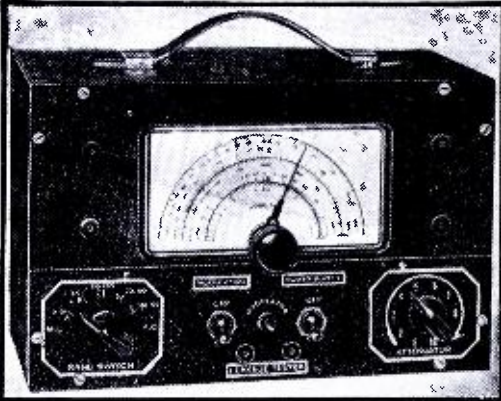

**Complete . . . only \$12<sup>40</sup>**

- 110 Volts A.C. or D.C.
- 100 kc.—22 megacycles all on fundamentals.
- Dial is direct reading in frequencies.
- I.F. output may be taken from a high impedance or a low impedance post, in with attenuation present for either.
- Separate audio output at 2 amplitude levels, so that tone may be used for checking public address systems, audio amplifiers in receivers, and speech amplifiers in transmitters.
- Two extra posts on front panel enable leakage tests. Condensers may be checked for leakage, so may tubes, and other normally high resistance currents, otherwise difficult to test.

Model T-37 All-Wave Signal Generator, wired, in shielded cabinet with carrying handle and calibrated, tested; complete with 2 Tubes & Neon Tube, \$12<sup>40</sup> instructions (shipping weight 7 lbs.)

**136 LIBERTY STREET  
NEW YORK, N. Y., Dept., SW-5**

**SUPERIOR INSTRUMENTS COMPANY,**

## SENSATIONAL ULTRA "SKY ROVER" 2-TUBE TRANS-RECEIVERS

**A.C.-D.C. MODEL**

Numerous letters of appreciation received from the many purchasers of the Ultra Sky Rover since its release a few months ago pronounce it as the sensation of the year. Never before was a unit of this type available at any price. This compact and self-contained unit will receive from 2 1/2 to 4000 meters with a high degree of excellence. Will receive foreign stations, amateurs, police calls, broadcast, press, airplane and weather reports, time signals, and all ultra high frequency stations. As a 2 1/2 to 5 meter transmitter surprising results will be obtained when calling friends from afar.

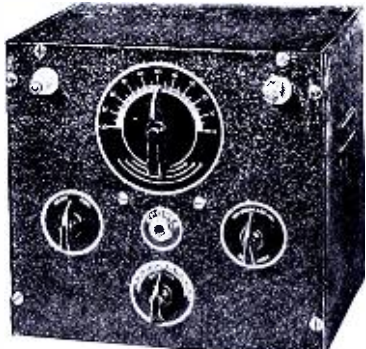

**BATTERY MODEL**

In compliance with countless requests we have designed a battery model of the now famous A.C.-D.C. Skyrover. This remarkable unit uses 2 twin tubes, 19 & 1E7G which insure consistent loudspeaker volume and powerful transmission. Receives from 2 1/2 to 4000 meters, transmits on 2 1/2 and 5 meters. Cabinet is provided with handle (not shown) for portable use. May also be mounted in a car. The same features which characterize the electric model are incorporated in this unit.

**FEATURES**

- ★ Transmits from 2 1/2 to 5 meters
- ★ Receives from 2 1/2 to 4000 meters (12 bands)
- ★ Separate electrical and mechanical bandspread
- ★ Loud speaker volume
- ★ Automatic super-regeneration from 2 1/2 to 15 meters
- ★ House to house communication

Either kit, unwired, less tubes and accessories \$6.45  
 Set of 2 Sylvania tubes for electric model  
 6J5G and 12A7.....\$1.65  
 Set of 2 Sylvania tubes for battery model  
 19 and 1E7G.....\$1.95  
 Set of 4 coils 2 1/2 to 15 meters.....30c  
 Set of 4 coils 15 to 200 meters.....95c  
 Set of 5 coils 200 to 4000 meters.....\$1.75  
 American S.B. Handmike.....\$2.95  
 Cabinet less battery compartment.....95c  
 Cabinet with battery and speaker compartment.....\$2.25  
 5-inch magnetic speaker.....\$1.25  
 Wired and tested.....\$2.00

**123 LIBERTY ST.  
NEW YORK, N. Y.**

**ULTRA HIGH FREQUENCY PRODUCTS CO.**

## POWERTONE

**MODEL 801  
Volt-Ohmmeter**

A sensitive, compact and accurate volt-ohmmeter that will be the busiest instrument in your "lab," or out on jobs. DC voltage readings -0.5-50-500 and 1000. resistance readings from 1/2 to 500 and 200 to 500,000 ohms. Will read from 0 to 1 Ma. Low resistance range direct reading. Meter has 1000 ohm per volt sensitivity. Battery is self contained. Panel is clearly lettered. Compensator provided for zero adjustment. Complete with test prods. Measures only 5"x3 1/4"x2 1/2".

**DEALERS NET PRICE \$5.75  
WITH BATTERY.**  
 Send 10c for instructive S.W. and P.A. Manual

**TRY-MO RADIO CO., Inc.  
85 CORTLANDT ST. N. Y. C.**

**RADIOS..SAVE UP TO 50%**

**DEAL DIRECT...FACTORY PRICES!** Many models to select from: AC-DC; All-Wave; Farm sets that operate like city radios! Your name and address on postcard brings you NEW Bargain Catalog in colors FREE. Get details of 30-DAY TRIAL plan and agent-user proposition!

**6<sup>98</sup> UP**

**30 DAY TRIAL**

**Free Catalog**

**GOLDENTONE RADIO CO.  
Dept. c5, DEARBORN, MICHIGAN**

good one in India on 14385, 7-8 a.m. Only 10 watts, but an FB signal.

We wish to thank all those who kindly wrote us. Though delay could not be avoided due to the small amount of time we have available for correspondence, we wish to assure all who wrote us that an answer will soon be sent to all.

We are forced by the large volume of mail, to make the rule that, unless return postage is included, we will be unable to answer letters. All letters will be cheerfully answered at first opportunity, if postage is enclosed, and answer requested.

**CQ**

Judging from the drinking parties we hear on the phone bands, I don't think that all of the copper tubing bought by the Amateurs is used for tank coils.—Martin E. Clark, W2IYM.

**CQ**

W3JC recently received a letter from an irate BCL who claimed Harold was putting several strong HARMONICAS in his receiver. JC is worried for fear the FCC will clamp down on him for transmitting music over the ham band.—William Vissers, Jr., W3RN.

**CQ**

Believe it or not, my young brother has the idea that the English "G" stations are owned and operated by the Federal Bureau of Investigation!—Bob Benson.

Please mention SHORT WAVE & TELEVISION when writing advertisers

**Review of Super Skyrider Set on Test**

This fine receiver has been given a month's test at our "Listening Center," and has been found to be one of the best DX receivers we have ever tried.

Using the crystal model, reception was very good, stations covered by QRM of all sorts being easily pulled thru in good shape, and the receiver's sensitivity was remarkably good. To compare any super's sensitivity with that of a TRF regenerative, usually puts the super in the background, but the "Super Skyrider" came out just about even, which, in our humble opinion, makes it a really good DX receiver!

The dial helps make DXing more of a pleasure, with direct-reading dial calibrated in kc. and mc. With the help of the band-spread dial, slight errors in calibration on dial are easily rectified.

All in all, this is a very good "DX" receiver, and several of our friends who own one also attest to its excellence.

As all of our 20 meter DX in this month's article was "logged" on the Super-Skyrider, need one require a better testimonial?

The set was obtained for test through the courtesy of the Roye Sales Agency.

**Last Minute News**

Through John Kraus, W8JK, a FB "old timer," we learn that hereafter all Belgian Congo Amateurs will begin their call letters with the prefix OQ5, instead of the old ON4, with three letters following, effective March 1.

Thus, says John, ON4CGW, heard lately on 20 phone, will change his call to OQ5AA. John should know, having worked ON4CGW on two-way phone, and received the data direct!

QRA of OQ5AA is Dr. George Westcott, Tondo, Via Irebu, Belgian Congo. Dr. Westcott is a medical missionary, formerly residing in Ypsilanti, Michigan.

John also adds that another missionary ON4CSL, will change his call to OQ5AE. Thanks for all the valuable data, John!

In regard to EL2A, the Liberian Amateur phone, he is no longer on the air. He contracted malaria, and in the three months in Liberia he lost thirty-eight pounds. EL2A left Monrovia on January 27, 1937, and another operator has been assigned to replace him. This new operator we believe to be the oft-reported EL1A, heard on 20 and 40 meter phone near 1-2 a.m. E.S.T.

Mr. Sangiem Powtongsook, one of HS8PJ's best engineers at Bangkok, Siam, writes to give some late data on Siamese Radiophone transmitters.

HSP, on 17.74 mc, now uses only modulated CW xmissions. The burden of commercial traffic is now carried by HSE2, 19.016 mc, which is very near to HS8PJ's 19.02 mc., used on the Monday 8-10 a.m. xmission. Watch for HSE2 in early A.M.S.!

Mr. Powtongsook adds that he is a regular reader of SW & T, and that he is also the operator of Amateur stations HSIPJ and HSIRJ. Many thanks for the information, OM, and please keep us informed regularly on any new changes in the Siamese Radiophone System!

"YE D-X ED" JOE MILLER.

**CQ**

"Knock! knock!"  
 "Who's there?"  
 "CFRN."  
 "CFRN who?"  
 "CFRN laid an egg!"—Eric Gibling.

**CQ**

W8BLL was "monkeying" with a 5-watt rig; later, to his surprise he found out he had been heard in Africa. (He received a letter!)—Fred Colt.

**CQ**

When I received my first "furiner" on a two-tube blooper set, my gold teeth arced over.—Hays Pool, W5EVX.

**CQ**

The first time I heard W9HSX calling C.Q. I thought he was calling Ezekiel. Hi! —Vernon Black.

# RADIO INSTRUCTION

## Television Course

(Continued from page 8)

point "D" is reached. Note that "D" represents a half line. In one-sixtieth of a second the "field" has been covered by 220½ lines.

Now at "D" the spot goes back to a point "E," "midway between the first two scanning lines." The process is then repeated with 220½ lines again in one-sixtieth of a second. Each of this second set of lines falling exactly between the respective first set. Thus each picture frame is covered twice, each time with 220½ lines in one-sixtieth of a second, which is equal to 441 lines per frame. Actually the whole 220½ lines are not consumed entirely in scanning the picture, since two lines are always necessary to get back to the point of starting again.

### How the "Spot" Is Moved Across Screen

We have described the manner in which the spot moves across the fluorescent screen, "painting" the picture. The question then is, *how* is the spot moved. The electron beam can be deflected either *electro-statically* or *electro-magnetically*. It is now conceded that the best and most practical manner in which to deflect the beam is electro-magnetically. In electro-static deflection, plates must be built into the tube. It is obviously desirable to build the tube itself as simply and cheaply as possible, and this is one reason why electro-magnetic deflection is desirable, although there are also good engineering reasons for its use beyond that of economy.

Thus the tube is supplied with *horizontal* and *vertical* deflecting coils. It will be seen that while the vertical frequency is 60, the horizontal frequency will be 13,230 (thirty times 441).

But here another problem presents itself. It will be seen, from Figure 2 that the journey from "A" to "B," while the line is being scanned, consumes ten times as much time as the quick return from "B" to "C." To achieve this the *saw-tooth wave current* is used. The generation of this current, one of the most important factors in making electronic television possible, will be gone into later.

The pattern of the *saw-tooth wave current* supplied to the line scanning coil is as shown in the upper part of Figure 3. From "A" to "B" the spot moves uniformly across the screen. The picture signal comes in as shown in two Figure 3.

During the quick return from "B" to "C" a synchronizing impulse is supplied, as shown in two Figure 3. This synchronizing impulse serves to keep the receiver and transmitter "in step." It also has the added advantage of extinguishing the spot during its quick return.

While the line scanning is in progress, and the spot moving from right to left, and quickly back again; the picture frequency current is operating also upon the beam through the medium of the vertical coils. A saw-tooth wave current is also used here, as shown in three Figure 3; and four in the same figure shows the final results.

Thus while one set of coils is moving the spot back and forth across the screen, another set of coils is moving it down and up, at the same time. The resultant of these two coils moves the spot as shown in Figure 2.

Four, Figure 3, shows what comes to the receiver from the transmitter, and the next article will show how the receiver is actually constructed so that this may be translated into the picture.

The Radio Manufacturers Association has recommended certain standards for television in United States, and for all practi-

cal purposes these may be regarded as the official standards, recognized by the laboratories that are doing the television research. In fact they were largely suggested by these laboratories' themselves. Therefore, in all discussion of television receivers these standards must be kept in mind and understood.

### Recommended Standards RMA Committee on Television

Item No.	Frequency allocation:	RMA Recommended Standard
1.	Lower limit.....	42 Mc.
	Upper limit.....	90 Mc.
	An experimental band starting.....	120 Mc.
2.	Channel width.....	6 Mc.
3.	Spacing between television and sound carriers.....	3.25 Mc. (approx.)
4.	Relation of sound carrier to television carrier.....	Sound carrier higher in frequency
5.	Polarity of transmission .....	Negative
6.	Number of lines.....	441
7.	Frame frequency.....	30 per second
	Field frequency.....	60 per second, interlaced
8.	Aspect ratio.....	4:3
9.	Percentage of television signal devoted to synchronizing signals.....	Not less than 20%
10.	Synchronizing signal:	
	(a) Duration of horizontal blanking signal .....	Approximately 1/10th of the time to scan one line, 1/10th of the time to scan one field, respectively.
	(b) Position of synchronizing impulse in regard to blanking signal .....	At leading edge (ap-prox.)

## Automatic Regen. Control

(Continued from page 11)

condenser of very small capacity (about .0002 to .00002 mf. according to the wave range) in series with resistor R. This will allow the control to be increased to such an extent that the regeneration actually falls off toward the high-frequency end of the band—a characteristic which is sometimes desired when using screen-grid tubes.

To permit the full effects of this system to be realized, several hints were given in *Radio Welt*. In the first place, the coupling between the aerial and the grid coil should be decreased to prevent the capacity of the aerial from affecting the action. The same holds true if a preceding stage of amplification is used. Also, de-coupling chokes should be replaced with pure resistance to eliminate any possible inductive coupling between the choke and any tuned circuits in the set.

The dyed-in-the-wool experimenter and "ham" will find this circuit one which has many possibilities.

### New Bulletin on Radio Equipment

● One of the newest bulletins of Ham, Fan, and Public Address apparatus is that bearing the number 68, and just released by the Wholesale Radio Service Company. This beautifully illustrated bulletin describes a very complete line of All-Wave, Short-Wave receivers, Ham transmitters, and Transmitter parts, Radio Experimental parts, Service Replacement parts, Service Test equipment, and an elaborate line of Public Address equipment. For free copy of this interesting bulletin ask for No. 68, and write to the Service Department, Short Wave & Television, 99 Hudson Street, New York City.

## ...for AMBITIOUS MEN ONLY!

**SPRAYBERRY ACADEMY OF RADIO**  
 F. L. Sprayberry, President  
 2544 University Pl., N. W., Washington, D. C.  
 Sure! Let me have the Facts! Without obligation on my part, please send me your Free book "MORE MONEY IN RADIO" and other details of famous Sprayberry Training.

Name \_\_\_\_\_  
 Address \_\_\_\_\_ SW 5/37

PASTE COUPON ON PENNY POSTCARD AND MAIL TODAY.

THE MOST IMPORTANT COUPON YOU'LL EVER CLIP

I Will Show You How My

**2-WAY MONEY-MAKING RADIO**

**TRAINING PLAN**

... Can Prepare You at Home for a Good-Paying RADIO Job ... at a Cost of Less than 17c a Day!



Whether you've got a job or are looking for one—whether you're looking for a profitable lifetime profession or a part-time money maker and whether or not you've ever had previous Radio experience, you owe it to yourself to investigate my success Radio Training method at once. I'll show you how to make spare time profits while you learn. I'll fit you out with Professional Radio Equipment, teach you to use it on all kinds of work and teach you modern business methods.

**I ACTUALLY SET YOU UP READY FOR BUSINESS**

It can be done! I am already doing it for ambitious fellows like you. I know I can do it for you. You'll learn at home in spare time—and you'll be pleasantly surprised how quickly you are ready for a real future in a growing industry with unlimited possibilities for well-trained men.

**RADIO—ELECTRONICS—TELEVISION—SOUND, ETC.**

Sprayberry Training covers EVERY branch of Radio in a way that is interesting and easy to understand. Get MY new booklet! Learn what it has meant to ambitious students—read the glowing records of praise from leaders of the Radio Industry. GET THE FACTS!

**DON'T WISH FOR A GOOD JOB START TRAINING FOR ONE...**

**NOW!**



Mail the above Coupon Today ... Prepare for a Job that Pays Real Money!

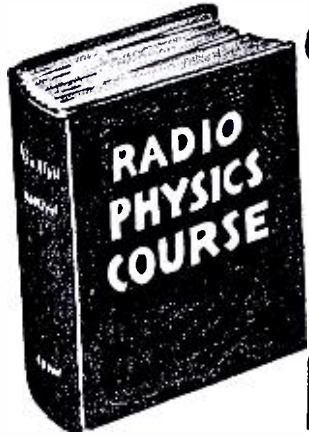

**Only \$4**  
**972**  
PAGES  
**508**  
ILLUS.

**Ghirardi's**  
**Complete**

# RADIO PHYSICS COURSE

The world's most popular complete instruction course on the fundamentals of radio, electricity and sound. Now available in one big volume for only \$4. Up-to-date. Authoritative. Easy to understand. Hundreds of good diagrams. Learn radio "the easy Ghirardi way"—save time and money. Tear out coupon and mail today.

**PARTIAL LIST OF SUBJECTS**  
Radio Broadcasting System. Sound, Speech and Music. Electron Theory; Electric Current. Electrical Units; Ohm's Law. Electrical Circuits; Batteries. Magnetism. Electromagnetism. Electromagnetic Induction. Inductance and Inductors. Capacitance and Condensers. Alternating Current Circuits. Electric Filters. Electrical Measuring Instruments. Electromagnetic Radiations. The Broadcast Station. The Receiving Station. Elementary Vacuum Tube Study. Vacuum Tube Characteristics. Vacuum Tube Construction. Vacuum Tube Action. Radio Frequency Amplification. Superheterodyne Receivers. R.F. Amplifier and Coil Design. Audio Amplification. Loud Speakers. Battery Operated Receivers. The Power Supply Unit. Electric Receivers. Auto and Aircraft Receivers. Phonograph Pickups; Sound Amplifier Systems. Short-Wave Reception. Photoelectric Cells. Television. The Antenna and Ground. Testing and Servicing. Sound Motion Pictures. Appendixes. Review Questions for Self-Study.

**MAIL TODAY!**

Radio & Technical Publ. Co., Dept. SW-57,  
45 Astor Place, New York.

- Enclosed find \$4. for RADIO PHYSICS COURSE, postpaid. (Foreign \$4.50)
- Please send free circular.

Name .....

Address .....

## TRI-STATE COLLEGE



**Degree in 2 Years**

Complete Radio Engineering course in 96 weeks. Bachelor of Science Degree. Radio (television, talking pictures and the vast

electronic field) offers unusual opportunities for trained radio engineers. Courses also in Civil, Electrical, Mechanical, Chemical, Aeronautical, Engineering; Business Administration and Accounting. Low tuition, low living costs. World famous for technical two-year courses. Those who lack high school may make up work. Short diploma courses in Surveying (36 weeks), Drafting (36 weeks). Students from all parts of the world. Enter March, June, September, January. Write for catalog.

2557 COLLEGE AVE. ANGOLA, IND.

### FREE BOOK of Opportunity



Instructive facts about  
**TELEVISION**  
**RADIO**  
**SOUND RECORDING**

Complete, practical instruction. Earn room and board while learning. Coach railroad fare allowed to Los Angeles.

### NATIONAL SCHOOLS

National Schools, Dept. 5-SWC,  
4000 So. Figueroa St., Los Angeles, Calif.

NAME ..... AGE .....

ADDRESS .....

CITY ..... STATE .....

# RADIO ENGINEERING,

broadcasting, aviation and police radio, servicing, marine radio telegraphy and telephony. Morse telegraphy and railway accounting taught thoroughly. Engineering course of nine months' duration equivalent to three years of college radio work. All expenses low. Catalog free. School established 1874.

Dodge's Institute, Turner St., Valparaiso, Ind.

# RADIO INSTRUCTION

## The "C-O-M" 150 Watt Transmitter

(Continued from page 17)

be conveniently mounted directly on the frame of the split-stator plate condenser. There is considerable space between the two condenser sections, providing more than adequate space for mounting this coil. In fact, the mounting arrangement used is recommended by the National Company who manufacture the forms and condensers as well as a good portion of other material used in this transmitter. No antenna tuning device is shown on the transmitter. We preferred to use link coupling between the final amplifier and the antenna tuning device. This is a very convenient and efficient method of coupling to the antenna and it is recommended in all cases where it is difficult to run the usually widely-spaced feeders directly to the transmitter.

### Plate Current Values

A rough indication of what might be expected in the way of plate currents in the various stages will undoubtedly help the reader in knowing whether or not his transmitter is functioning properly. The oscillator under load should have a plate current from 30 mills when operated at the crystal frequency and 40 to 45 mills when the plate circuit is tuned to the second harmonic of the crystal. The RK 39 plate current will be around 10 mills with the key of the final amplifier open, and when the 39 is used as a straight amplifier, and about 20 milliamperes when it is used as a doubler. With the final amplifier delivering power to the antenna the plate current of the 39 when operated either as a doubler or straight amplifiers will be in the neighborhood of 80 to 90 milliamperes.

Let's see photos and descriptions of "our" transmitters that YOU build!

The final amplifier with the plate circuit unloaded should show a plate current of around 15 to 20 milliamperes and with 1,000 volts on the plate, under full load, the plate current should not exceed 200 milliamperes. With 1,250 volts on the plate of the tubes, 190 ma. will be approximately correct.

There is no fixed bias on the final amplifier, and therefore the key should not be closed unless excitation is being applied to the grids of the two amplifier tubes. However, if anyone building this transmitter happens to be using the vacuum-tube "keying" arrangement, there will be sufficient automatic bias due to the voltage drop across the keying tubes, to furnish enough grid bias to eliminate all danger, should the excitation fail at any time with the key closed. This is another good feature of the tube keying arrangements.

The final amplifier can be used as a doubler-stage at considerably reduced power output, but it would be best to always use it as a straight amplifier. If used as a frequency doubler, the grid resistor should be increased from the present 2,000, to 3,000 or 4,000 ohms. Also, the plate current should be kept down to approximately 135 or 140 ma., otherwise the tubes will be dissipating too much power, and "short life" will be the result.

Various views of the transmitters are shown in the photos, and they thoroughly illustrate the general placement of parts and arrangement of controls on the panel. We believe that anyone building this transmitter will be more than pleased with its performance. It is so compact that it can be placed on the operating table along with the receiver, for it is no larger than the average commercial receiver.

## FASTEST WAY TO LEARN CODE

Easy, Fascinating, LEARN by EAR To Be a GOOD OP.



The New All Electric Master Teleplex Code Teaching Machine is exactly what thousands are looking for. No experience needed. Ideal for beginners—steps up WPM for ALL Ops. There is no guess work with Master Teleplex, because it records your sending in visible dots and dashes. You SEE and HEAR exactly how you are making your signals. You learn code the way you'll be using it—by SOUND. Complete course included at no extra charge. Used by many schools and several governments for teaching code. Low cost easy terms. MONEY BACK GUARANTEE. Send now for booklet S5, no obligation. Post card will do.

**TELEPLEX CO.**  
72-76 Cortlandt St. New York, N.Y.

## LEARN RADIO

New Classes Now Forming! Send for 40-page catalog, explains fully. 300 licensed graduates placed in past 4 1/2 years in broadcasting, shipping, police radio, aviation, etc. We teach all branches. Oldest, largest and best equipped school in New England. Equipped with Western Electric sound and broadcasting equipment and RCA marine transmitter. Course prepares for United States Government telegraph or telephone license. Write Dept S-5 for catalog. **MASS. RADIO SCHOOL, 18 Boylston St., Boston**



**Earn While Learning at Home!**  
**TELEVISION, PHOTO ELECTRIC CELLS, PUBLIC ADDRESS**  
Many R-T-I Trained Men make up to \$75 a week and more in full-time radio jobs—\$5-\$16 in spare time alone. More trained men needed. Learn at home by quick, easy, R-T-I, W.A.V. Endorsed by 40 big concerns. Write for big Opportunity Book FREE. **RADIO AND TELEVISION INSTITUTE, Inc.** Endorse 2130 Lawrence Ave., Dept. 215, CHICAGO, ILL. R-T-I

## RADIO ENGINEERING

RCA Institutes offer an intensive course of high standard embracing all phases of Radio. Practical training with modern equipment at New York and Chicago schools. Also specialized courses and Home Study Courses under "No obligation" plan. Catalog Dept. SW-37.

**RCA INSTITUTES, Inc.**  
75 Varick St., New York. 1154 Merchandise Mart, Chicago  
Recognized Standard in Radio Instruction Since 1909

## BE A RADIO SERVICE EXPERT

Modern receivers require men with modern training for service work  
**LEARN AT HOME**  
Our home instruction method and service equipment offer starts your earning money almost at once. Up to \$3 an hour easy in a short time. Write for free book.  
**Radio Training Ass'n of America**  
Dept. SWT-75  
4525 Ravenswood Ave., Chicago

### Parts List—150 Watt Transmitter

- Cornell-Dubilier**  
7—.001 mf. mica cond. (1000 V.)  
2—.01 mf. mica cond. (1000 V.)  
2—100 mmf. mica cond. (1000 V.)  
1—.001 mf. mica cond. (5000 V.)
- National**  
1—150 mmf. var. cond. TMS-150  
1—100 mmf. var. cond. TMS-100  
1—100-100 mmf. var. cond. TMC-100D  
1—neutralizing cond. NC800  
1—140 mmf. var. cond. (ST-140)  
5—5 prong R39 coil forms  
3—XR13 coil forms  
3—PB5—plug base  
3—XB5—plug socket  
4—5 prong isolantite sockets  
1—8 prong isolantite socket  
2—4 prong isolantite sockets  
2—2.5 mf. RF chokes (R100)  
1—1 mh., RF choke (R154U)
- Electrad**  
1—2000 ohm 10 watt resistor  
1—400 ohm 10 watt resistor

Please mention SHORT WAVE & TELEVISION when writing advertisers

# RADIO INSTRUCTION

- 1—50,000 ohm 20 watt resistor
- 1—4,000 ohm 20 watt resistor
- 1—10,000 ohm 20 watt resistor
- 1—400 ohm 20 watt resistor
- 1—20,000 ohm 20 watt resistor
- 1—2000 ohm 20 watt resistor
- 1—100 ohm center-tapped resistor

**TRIPLETT**

- 1—0-100 ma. meter (small)
- 1—0-200 ma. meter (small)

**RAYTHEON**

- 1—6L6
- 1—RK39
- 2—RK37

**PAR-METAL**

- 1—8 3/4 x 19 inch black crackle panel
- 1—8 x 17 x 2 inch black crackle base

**Bliley**

- 1—crystal and holder

**MISCELLANEOUS**

- 1—60 ma. 2 V. pilot light
- 1—socket for pilot light
- 4—single closed-circuit jacks
- 2—phone plugs (for meter and key)

**Coil Data for Xmitter**

**\*Osc. and buffer coils**

Band	Turns	Wire
80 m.	30	No. 18 tinned
40 m.	16	No. 18 tinned
20 m.	7 1/2	No. 16 tinned

**\*Wound full length on R39 form**

**\* final amp.**

Band	Turns	Wire
80 m.	40	No. 18 tinned
40 m.	24	No. 16 tinned
20 m.	16	No. 16 tinned

**\*Wound full length on XR13 form**

**WE ARE LOOKING!**

For GOOD "Set-Construction" articles. Address all suggestions, diagrams and photos to the Editor. All articles accepted and published will be paid for.

## Radio Ore, Pipe and Treasure Locator

(Continued from page 9)

sists of a radio transmitter, which may be tuned to any frequency between 50 and 5,000 kc., 5,996 and 59.9 meters wavelength, and which in addition is modulated by a frequency of 1,000 cycles. The output is coupled to a balanced loop antenna. The receiver consists of an impedance coupled radio amplifier, detector, audio-amplifier and a sensitive tube volt-meter. The receiver also is connected to a balanced loop antenna. Transmitter and receiver chassis, batteries, tubes and meters are installed inside the loops to avoid so-called vertical antenna effects, the presence of which would make it impossible to balance the equipment.

The metallascope described, makes use of a vertical transmitter and a horizontal receiver, but it is possible to reverse this arrangement. Transmitter and receiver are connected by handles, between which the operator walks. The transmitter is turned to such a position that the receiver is located in the neutral point of the transmitter field. If the M-scope is properly built, the transmitter and receiver will balance at approximately right-angles to each other. The two fields, as shown in the illustration Fig. 1 balance each other and no signal will be picked up by the receiver with the result that the 1,000 cycle modulation note cannot be heard in the phones. The presence of metal in one of these transmitting fields will disturb the balance as shown in Fig. 2. The receiver now is not any longer located in the neutral point and a loud indication can be heard in the headphones and the tube volt-meter will register the strength of the disturbance.

It will be noticed that a non-radiating receiver and a modulated transmitter are used, as an oscillating receiver would radiate and cause another field and serious disturbance which would make it impossible to balance the instrument. No metal of any consequences is used in the Metallascope to avoid inherent distortion of the electrical field.

Most experimenters are puzzled why it

is not possible to increase the power of the transmitter and the amplifications of the receiver indefinitely and so increase the sensitivity of the instrument but there are certain limitations. The closer the transmitter and receiver are located to each other, the less power can be used in the transmitter; otherwise no balance can be obtained. Close distance of transmitter and receiver will make it possible to detect small metal object to a shallow depth. Increasing the distance between transmitter and receiver and raising power and amplification will permit locating objects at great depths, but in turn the objects also have to be large. A compromise is reached in the instrument shown, but for maximum results naturally the length of handles, etc., can be varied.

The Metallascope, for commercial use, uses a frequency of 175 kc. Good results also can be obtained on higher frequencies, if one is interested in locating buried metal objects like buried treasure, but the higher the frequency the more careful the set will have to be built, otherwise body capacity or too much metal used in construction will raise havoc with the radio balance.

When making tests, the same should be carried out, at least in the beginning, on pipe lines, which have been buried for some time. Pipe lines lying on the ground will hardly give an indication. The reason for this seemingly rather queer behavior is easily explained. The ground itself is a conductor and in a pipe line buried in the ground eddy currents are set up by the transmitter which will radiate and create a large disturbance in the matrix surrounding the pipe. The result is a good indication in the phones and on the tube volt-meter. A pipe line lying on top of the ground creates very little disturbance.

The diagram shown represents a simple and effective Metallascope and the values shown may serve as guidance to the experimenter. By changing the inductance and capacity values and the impedance of the choke coils, the frequency may be varied at will. The values shown are approximately for 170 kc. Furthermore,

## I can show YOU how to "pound brass" like a Champion—and take it, too!

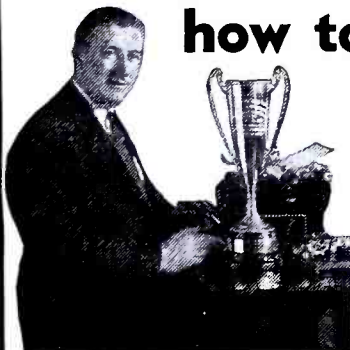

### It's Easy the CANDLER Way!

You will succeed with the CANDLER system, because your natural sound consciousness will be so developed that you can send and receive code as easily as you talk and listen. It's so easy to learn when Walter Candler helps you. You may be a beginner, or you may want to increase your speed and improve your technique. . . . it makes no difference. Candler's personalized and scientific training assures your quick success. Your part is easy. Just mail the coupon below.

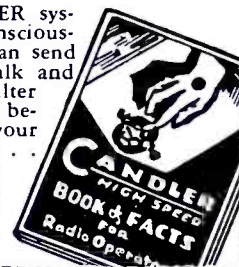

**CANDLER TRAINED** Theodore R. McElroy, World's Champion Radio Operator, who teaches Candler System at Harvard College. Skill in telegraphing is not a special gift of nature to be enjoyed by a few. It is a natural result of well-trained and perfectly coordinated faculties, and can be acquired by anyone in a few weeks. You'll see progress every day the CANDLER way. Send the coupon for proof of what CANDLER training will do for you.

**CANDLER SYSTEM CO.**  
Department SW-5  
ASHEVILLE, North Carolina

Candler System Co.  
Dept. SW-5, Asheville, North Carolina  
Please send me Free Book of Facts.

Name \_\_\_\_\_  
Address \_\_\_\_\_  
City \_\_\_\_\_ State \_\_\_\_\_

**T. R. McELROY**  
WORLD'S CHAMPION RADIO TELEGRAPHER  
175 Congress Street, Boston, Mass.  
MAC KEY @ \$7.95 a real speed key.  
MAC KEY DELUXE @ \$15.00 Spfn.  
MAC CORD @ \$1.00 Spfn speed key cord.  
MAC CASE @ \$3.95 Spfn speed key case.  
MAC OSC @ \$3.95 ac/dc oscillator. Tone control.  
If u hv Mac Key wri me fo xmy ipt & dsrb inf.  
All my stuff emcy gad best pduts obl. 73 Mac.

**YOUR CODE—TAPES FOR EVERY NEED**

For Example: Airways Tapes on Weather, Maps, APOBS, Winds Aloft?

You can easily learn or improve your code—typical messages are sent you by the INSTRUCTOGRAPH.

Practice any time at any speed desired. You may buy or rent at low cost. Send for full information today to—

**INSTRUCTOGRAPH CO., Dept. SW-5**  
912 Lakeside Place  
Chicago.  
Canadian Representative: Radio College of Canada, 863 Bay St., Toronto

**WE ALSO HANDLE: HALLICRAFTER SHORT WAVE RECEIVERS—MICROPHONES - VIBROPLEXES — TAYLOR TUBES. CASH OR TERMS.**

**Be a RADIO and TELEVISION EXPERT**

Qualify for U. S. Government License in 6 Months

Recognized as one of America's finest in Radio-Television Training. First National's course is so thoroughly organized you can qualify for U. S. Gov't. Operator's license in 6 months. That's your ticket to the big jobs.

**Learn In Our Broadcast and Television Stations**—Six short months intensive training with actual experience "on the job" at the controls of Radio Station KXBY and Television Station W9XAL fits you for the big jobs in Radio. Don't miss this chance at SUCCESS. Write today for complete information.

**FIRST NATIONAL TELEVISION, INC. TRAINING DIVISION**  
Dept. BB-6 Power & Light Bldg., Kansas City, Mo.

**BIG FREE BOOK TELLS ALL!**

Please mention SHORT WAVE & TELEVISION when writing advertisers

**GREAT 10c BOOKS**

Each book contains 32 pages and numerous illustrations. Over 15,000 words in each book.

**HOW TO MAKE FOUR DOERLE SHORT WAVE SETS**

LITERALLY thousands of radio fans have built the famous DOERLE Short Wave Radio Receivers. So insistent has been the demand for these receivers, as well as construction details, that this book has been specially published.

- Contains EVERYTHING that has ever been printed on these famous receivers. These are the famous sets that appeared in the following issues of SHORT WAVE CRAFT: "A 2-Tube Receiver that Reaches the 12,500 Mile Mark," by Walter C. Doerle (Dec., 1931-Jan., 1932). "A 3-Tube 'Signal Gripper,'" by Walter C. Doerle (November 1932). "Doerle 2-Tube Adapted to A. C. Operation" (July 1933). "The Doerle 3-Tube 'Signal-Gripper' Electrified," (August 1933) and "The Doerle Goes 'Band-Spread'" (May, 1934).

Due to a special arrangement with SHORT WAVE & TELEVISION, we present a complete 32-page book with stiff covers, printed on an extra heavy grade of paper with numerous illustrations. Nothing has been left out. Not only are all the DOERLE sets in this book, but an excellent power pack if you wish to electrify any of the DOERLE sets, is also described.

**HOW TO MAKE THE MOST POPULAR ALL-WAVE 1- and 2-TUBE RECEIVERS**

THERE has been a continuous demand right along for a low-priced book for the radio experimenter, radio fan, radio Service Man, etc., who wishes to build 1- and 2-tube all-wave sets powerful enough to operate a loudspeaker.

This book contains a number of excellent sets, some of which have appeared in past issues of RADIO-CRAFT. These sets are not toys but have been carefully engineered. They are not experiments. To mention only a few of the sets the following will give you an idea.

- The Megadyne 1-Tube Pentode Loudspeaker Set, by Hugo Gernsback.
- Electrifying The Megadyne.
- How To Make a 1-Tube Loud-speaker Set, by W. P. Chesney.
- How To Make a Simple 1-Tube All-Wave Electric Set, by F. W. Harris
- How To Build A Four-In-Two All-Wave Electric Set, by J. T. Bernsley, and others.

Not only are all of these sets described in this book, but it contains all of the illustrations, hookups, etc.—each book is thoroughly modern and up-to-date.

Remember, these books sell at the extraordinary low price of ten cents; you can not possibly go wrong in buying them. Despite its low cost, our usual guarantee goes with this book as well!

IF YOU DO NOT THINK THAT THESE BOOKS ARE WORTH THE MONEY ASKED FOR THEM RETURN THEM WITHIN TWENTY-FOUR HOURS AND YOUR MONEY WILL BE INSTANTLY REFUNDED.



There has never been such a wealth of data published in low-priced radio books of this type in the history of the radio publishing business. Take advantage of the special offer we are making and use the coupon below.

**RADIO PUBLICATIONS**  
101 Hudson Street  
New York, N. Y.

Send for our FREE circular listing 48 new 10c Publications

RADIO PUBLICATIONS 101 Hudson Street New York, N. Y. SWT-5-37

Please send immediately books checked:

How to Build Four Doerle Short-Wave Sets, No. 1.....10c

How to Make the Most Popular All-Wave 1- and 2-Tube Receivers, No. 2.....10c

I am enclosing.....c; the price of each book is 10c. (U.S. Coin or U.S. Stamps acceptable.) Books are sent postpaid.

Send me also your FREE circular listing 48 new 10c publications.....

Name.....

Address.....

City..... State.....

shielded grid or pentode tubes could be substituted, but due to the fact that the instrument should be kept light, it is best to use the conventional type 30 and 31 tubes, as screen grid and pentode tubes require higher plate voltages and also are more noisy in operation.

Before going into the value of condenser and resistors, the writer would like to warn the experimenter of a certain racket imposed upon the public. One manufacturer of treasure locating instruments claims that a meter is used in his radio-balance, built to his secret specifications by a large manufacturer of meters, but these statements are misleading. A standard zero to one (0-1) milliammeter is all that is required to build a satisfactory instrument.

The same outfit makes a statement that it has such a sensitive instrument that it will detect a sheet of gold leaf, weighing only a fraction of an ounce, several feet underground. The experimenter may believe that he can build an instrument that will locate a fraction of an ounce of gold several feet under ground, but this cannot be accomplished.

The instrument is sensitive only to the actual surface of an object. It may locate a sheet of gold leaf, but it will not detect a gold coin that has several times the weight, but which has a much smaller surface than a sheet of gold leaf.

**Key No.**

- "1" One milliammeter (d.c.) with sufficient shunt resistance to allow approximately  $\frac{3}{4}$  full scale deflection with receiver switch "On" and transmitter switch "Off." Meter case should be bakelite.
- "2" R.F. Chokes. 1500 turns each, of No. 34 copper wire, enamel covered, Random wound or "duo-lateral."
- "3" One megohm resistors.
- "3A" Three megohm resistor.
- "4" One-tenth megohm resistor
- "5" Fixed condensers; capacity, .0005 mf.
- "6" Fixed condensers; capacity, .006 mf.
- "7" Fixed condensers; capacity, .001 mf.
- "8" Adjuster, trimmer type condenser, capacity, 0 to .0005 mf.
- "SA" Fixed condenser; capacity, .00025 mf.
- "9" Switches, push-pull type preferred.
- "10" Tip-jacks for phone connection. Phone jack can be used.
- "S" Four point, single gang, selector switch.
- "R1" 10 ohm filament resistor.
- "R2" 5 ohms.
- "R4" 2.5 ohms.
- "R6" 2 ohms. (Use R1 for one type 30 tube, R2 for one type 31 tube. R4 for four type 30 tubes. R5 for five type 30 tubes. These resistors can be made up of 30 Nichrome wire, wound on a fibre strip. This wire has approximately one ohm resistance for each 1.6 inch of length. The length to use, therefore, for the various resistors is: R1, 16 inches. R2, 8 inches. R4, four inches. R5  $3\frac{1}{2}$  inches.)

The loop frames are wound with 80 turns No. 33 D.C.C. copper wire center-tapped. This article has been prepared from data supplied by courtesy of Gerhard R. Fisher Research Labs.

**Hints on Short-Wave Ore and Pipe Locators**

THE radio experimenter has a wonderful field open to him in the realm of ore and pipe locators. The surface has only been scratched so far, and the editors would strongly recommend that radio experimenters get busy in this field. A few hints which may lead to a better solution of the problem are given herewith.

Some months ago, or in the February issue of this magazine to be exact, the ultra-short wave *Obstacle Locator* which is in daily use on the famous French steamship *Normandie*, was described. Those interested in this matter of locating pipes, etc., would do well, as a preliminary, to read the article on the *Normandie's Obstacle Locator* very carefully and give it some further study.

The editors have a hunch that one fine day a new radio type "ore and pipe locator" will be devised, the cost of which will be reasonable, and its efficiency far higher than that attained so far. Take, for instance, the ultra-short wave *Obstacle Locator* in use on the *Normandie*. We might

Please mention SHORT WAVE & TELEVISION when writing advertisers

**GREAT 10c BOOKS**

Each book is uniform in size, contains 32 pages and 15,000 words of clear legible type. Lays the ground-work for a complete study of Radio and Electricity.

**ALL ABOUT AERIALS**

In simple, understandable language this book explains the theory underlying the various types of aerials; the inverted "L," the Doublet, the Double Doublet, etc. It explains how noise-free reception can be obtained, how low-impedance transmission lines work; why transposed lead-ins are used. It gives in detail the construction of aerials suitable for long-wave broadcast receivers, for short-wave receivers, and for all-wave receivers. The book is written in simple style. Various types of aerials for the amateur transmitting station are explained, so you can understand them. It eliminates, once and for all the confusion about the type of aerial to choose for best broadcast and short-wave reception. For the thousands of radio fans, both short-wave and broadcast, who wish to know just what type of antenna they should use and why, this book has been especially published.

**ALTERNATING CURRENT FOR BEGINNERS**

This book contains everything to give the beginner a foothold in electricity and Radio. Electric circuits are explained. Ohm's Law, one of the fundamental laws of radio, is explained; the generation of alternating current; sine waves; the units—volts, amperes, and watts are explained. Condensers, transformers, A.C. instruments, motors and generators—all these are thoroughly discussed. Housewiring systems, electrical appliances and electric lamps

Here are some of the practical experiments which you can perform at home. Simple tests for differentiating between alternating and direct current; how to light a lamp by induction; making a simple electric horn; demagnetizing a watch; testing motor armatures; charging storage batteries from A.C. outlet; testing condensers with A.C.; making A.C. electro magnets; frying eggs on a cake of ice; making simple A.C. motors and many others.

Remember, these books sell at the extraordinary low price of ten cents; you can not possibly go wrong in buying them. Despite its low cost, our usual guarantee goes with this book as well!

IF YOU DO NOT THINK THAT THESE BOOKS ARE WORTH THE MONEY ASKED FOR THEM RETURN THEM WITHIN TWENTY-FOUR HOURS AND YOUR MONEY WILL BE INSTANTLY REFUNDED.

Each book is uniform in size and contains 32 pages of well-illustrated text.

There has never been such a wealth of data published in low-priced radio books of this type in the history of the radio publishing business.

Take advantage of the special offer we are making and use the coupon below.

**RADIO PUBLICATIONS**  
101 Hudson Street  
New York, N. Y.

Send for our FREE circular listing 48 new 10c Publications

RADIO PUBLICATIONS 101 Hudson Street New York, N. Y. SWT-5-37

Please send immediately books checked:

All About Aerials, No. 4.....10c

Alternating Current for Beginners, No. 3.....10c

I am enclosing.....c; the price of each book is 10c. (U.S. Coin or U.S. Stamps acceptable.) Books are sent postpaid.

Send me also your FREE circular listing 48 new 10c publications.....

Name.....

Address.....

City..... State.....





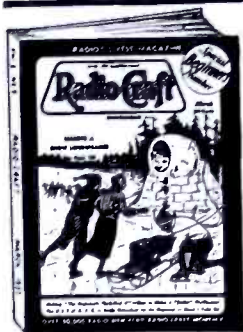

## More AND MORE RADIO MEN Are Now Reading RADIO-CRAFT!

RADIO-CRAFT is devoted to all the numerous phases of radio, to servicing, and to the advanced set builder and technician. It brings you short-cuts that show you the way out of difficult problems. Latest Radio Equipment is illustrated and described. Then there's the International Radio Review, Service Data Sheets, New Tubes, Radio Month in Review, Set Construction, Television, Operating Notes, and other interesting departments.

Edited by HUGO GERNSBACK  
Over 175 Illustrations in Each Issue  
8 Months for \$1.00

RADIO-CRAFT 99 C HUDSON STREET NEW YORK, N. Y.

# NO SET BUILDER SHOULD BE WITHOUT THIS GREAT COIL DATA BOOK

## SHORT WAVE COIL BOOK

**Short Wave Coil Data for Every Conceivable Short Wave Receiver**

Price 25¢

RADIO PUBLICATIONS  
99 Hudson Street  
NEW YORK

IT is now possible for the experimenter and short wave enthusiast to obtain the most exhaustive data on short wave coil winding information that has ever appeared in print.

As every experimenter who has ever tried to build a short wave set knows only too well by experience, the difference between a good and a poor receiver is usually found in the short wave coils. Very often you have to hunt through copies of magazines, books, etc., to find the information you require.

Between the two covers of this book you now find every possible bit of information on coil winding that has appeared in print during the past two years. Only the most modern "dope" has been published here.

No duplication. Illustrations galore, giving not only full instructions how to wind coils, but dimensions, sizes of wire, curves, how to plot them, by means of which any coil for any particular short wave set can be figured in advance, as to number of turns, size of wire, spacing, etc.

There has never been such data published in such easy accessible form as this.

### FRIENDS PESTER HIM

Dear Sirs:  
I received your Short Wave Coil Book and am very well pleased. I showed it to my radio friends and now they are always pestering me for coil data, hi hi!

BERNARD A. DECKELMANN,  
11348 So. State St., Chicago, Ill.

### RADIO PUBLICATIONS

97 Hudson Street, New York, N. Y.

Radio Publication, 97 Hudson Street, New York, N. Y. SWT-5-37

Please send immediately, your Short Wave Coil Book, for which I enclose 25¢ herewith (coin, U. S. stamps or money order acceptable). Book is to be sent prepaid to me.

Name .....

Address .....

City and State .....

try adapting this principle to our ore and pipe locator problem. All we need is the ultra-short wave transmitter (operating on say a fraction of a meter wave length) and a sensitive receiver, each mounted in a parabolic reflector, and the two reflectors mounted together on an arm of any definite length. The two reflectors are then mounted so as to turn toward each other, in the same way as the arrangement on the *Nor-mandie*, and by tying the controls for the two reflectors together, through a common control lever and "angle indicator," the operation of the device will be greatly simplified.

The principle upon which this system works is similar to that of the well-known "range-finder" in use by army and navy gunners. The length of the base line being known, the distance of the object (in this case a metal pipe or ore body) is readily determined mathematically, when the angles of the two reflectors are known. It is a simple matter to calibrate the apparatus so that the range or distance can be read off directly in feet (or meters).

Instead of using parabolic reflectors, which might be too expensive for the average experimenter, he may use instead parabolic-shaped reflectors made of copper or brass bars (or wire). Data for constructing various types of beam concentrating antennas will be found in a number of the recent radio hand-books.

A somewhat different scheme than the one just described, and one which involves the use of short waves for locating underground ore veins, etc., was described and illustrated in the Aug. 1936 issue of this magazine.

A vacuum tube of the new high frequency type should be used, such as the RCA "Acorn" type, or the Western Electric 240H type. See Jan. 1936 issue for construction of one-half to one meter transmitter and receiver.

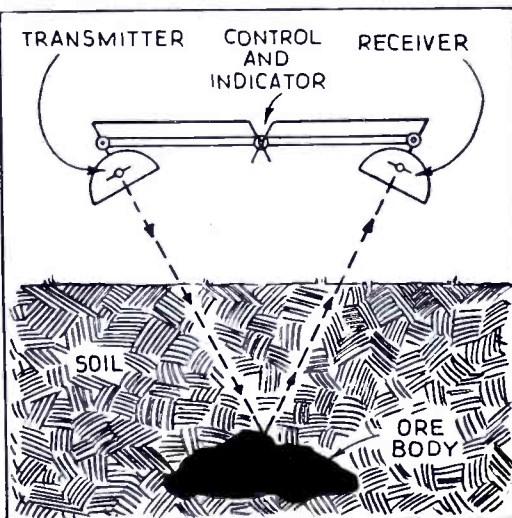

Ore locating by reflected radio wave.

## When to Listen In

(Continued from page 30)

vention, Mr. Wadia plans visiting the West Coast, and the Grand Canyon, Yellowstone Park, and Hollywood are starred on his itinerary. En route, he will stop off for visits with American friends whose acquaintances have been made through radio.

While he is in this country, Mr. Wadia plans keeping in contact with his family by means of schedules between VU2CQ of Bombay, and W9DXX of Chicago."

Alice R. Bourke,  
W9DXX.

## INTERNATIONAL S-W TALKS ON AGRICULTURE

A series of international short-wave programs on agricultural topics, sponsored by the New York State College of Agriculture and the General Electric Company, will be broadcast every Tuesday until May 18 over W2XAD and W2XAF. Two broadcasts will be made each Tuesday; one at 2:30 p.m. EST in English over W2XAD and a Spanish translation of the afternoon talk at 7:15 p.m. EST over W2XAF, especially directed to Central and South America.

## BIG FREE ELECTRICAL BOOK TELLS YOU HOW

MANY TRAINED MEN

EARN \$30-\$40-\$50 A WEEK AND MORE IN Electricity

YOU TOO can train for a BETTER JOB and MORE MONEY in ELECTRICITY

Do you want a BETTER JOB—MORE MONEY and a future free from Job Worry? Then send for my big free Electrical Book Today and learn the FACTS about the amazing opportunities in Electricity—AND—how this new modern, up-to-date Practical Home Shop Training can help you qualify for these opportunities.

### PRACTICAL SHOP TRAINING ON REAL ELECTRICAL EQUIPMENT AND APPARATUS—RIGHT IN YOUR OWN HOME

"Learn-by-Doing" becomes a fact with this fascinating, new, modern, up-to-date Practical Home Shop Training in Electricity. With your instruction material, you get Electrical Equipment, Apparatus, Tools and Supplies with which you learn to do REAL PRACTICAL WORK—just like you would do out on the job. Don't you agree that this is without question the most PRACTICAL Home Training in America?

### OPPORTUNITIES TO EARN UP TO \$5.00, \$10.00 A WEEK AND MORE WITH SPARE TIME WORK WHILE TRAINING

We tell you how to DO these jobs, furnish real electrical equipment and supplies for many of them, and give you valuable Sales and Advertising helps to show you how to Sell Your Services. In fact, it should take only one or two small jobs a month to more than make the training PAY FOR ITSELF.

### TRAINING IN RADIO, REFRIGERATION, AIR-CONDITIONING, DIESEL ELECTRIC POWER and MANY OTHERS INCLUDED

My book also tells how E. I. Training helps YOU to INCREASE YOUR EARNING power still more by including training in these big, important branches of Electricity. Each one practically an industry in itself—each one a complete field—yet, you get all of these and more in E. I. Practical Home Shop Training.

### GET INTO A GROWING FIELD FOR A BIG PAY FUTURE

GET INTO ELECTRICITY—get into a field that is growing and expanding—get into a field where opportunities for REAL JOBS and REAL MONEY await the TRAINED MAN.

Naturally to qualify for these jobs you MUST BE TRAINED. In fact you want the BEST, the most Thorough and Complete, the most PRACTICAL Training, money can buy. We believe E. I. Practical Home Shop Training To Be That Kind Of Training. But, we don't want you to take our word for it. We want you to judge for yourself the value of this new modern up-to-date Training method—where you learn on Real Electrical Equipment and Apparatus—right in your own home. So send for my Big Electrical Book TODAY for full information on this new, easy, interesting and Profitable Practical Home Shop Training. Remember this book cost you nothing—puts you under no obligation and NO SALESMAN WILL CALL ON YOU.

### Practical Shop Training on REAL Equipment

E. I. Training is DIFFERENT training. You get Real Electrical Equipment, Apparatus, Tools and Supplies to work on. This material comes to you as a regular part of your training at NO extra cost.



### "Learn By Doing" In Your Own Home

With this big outfit of equipment, you perform many interesting experiments, conduct important tests and do many real electrical jobs to make your training easy, interesting and PRACTICAL.



### Use Equipment for Many Money Making Jobs!

A great deal of this equipment can be USED in doing many profitable spare time jobs, profitable because you will have no expense for the material you use. My big free book tells you more of this valuable feature of E. I. Training.



### Your Own Electrical Shop

This equipment comes to you throughout your entire training, starting the very DAY you enroll, so that as you progress with your training, you are building your own Home Electrical Shop with the Equipment, Apparatus, Tools and Supplies I give you.



### Get this Interesting Valuable Book TODAY!

Doesn't what I've told you sound interesting? Isn't it worth investigating? Ask yourself could any method of Training be more easy, interesting or profitable to the ambitious man or young man anxious to get into the BIG PAY field of ELECTRICITY.

SEND FOR THIS BIG ELECTRICAL BOOK FREE

H. W. Petersen, President  
Dept. 167E, ELECTRIC INSTITUTE, Inc.  
Hinsdale, Illinois

Send Free Book and full details of E. I. Home Shop Training.

Name.....Age.....

Address.....

City.....State.....

INVESTIGATE - GET THE FACTS

# America's Most Popular Radio Books

**IMPORTANT—All prices have been drastically reduced—many new books included!**

We herewith present a selected collection of recent important radio books. We have, after an exhaustive study, selected these volumes because they represent the foremost radio books of their kind in print today. There is such a great variety that we are sure it will satisfy any taste as well as any requirement that the student of radio might have. We publish no catalog and ask you to be kind enough to order direct from this page. Prompt shipments will be made to you direct from the publishers. We merely act as a clearing house for a number of radio publishers and **OUR PRICES ARE AS LOW OR LOWER THAN WILL BE FOUND ANYWHERE.** Remit by money order or certified check. Register all letters containing cash.

**SHORT WAVES**, by C. R. Leutz and R. B. Gable. Stiff Covers. Size 6x9". 384 pages, 258 illustrations. Price was formerly \$2.98. **NEW PRICE \$ .69 NOW.**

**PRACTICAL TELEVISION**, by E. T. Lerner. Cloth covers, size 5½x8¾". 223 pages. 127 illustrations. Price... **\$3.69**

**ELEMENTS OF RADIO COMMUNICATION** (Second Edition), by John H. Morecroft. Cloth covers, size 6 x 9½". 286 pages, 241 illustrations. Price... **\$2.98**

**RADIO PHYSICS COURSE** (2nd enlarged edition), by Alfred A. Ghirardi. Cloth covers, size 7¼x9¼". 992 pages, 510 illustrations, numerous tables. Price... **\$4.00**

**THE RADIO AMATEUR'S HANDBOOK** (New Revised Edition), by A. Frederick Collins. Cloth covers, size 5¼x7¾". 448 pages, 126 illustrations. Price... **\$1.97**

**RADIO THEORY AND OPERATING**, by M. T. Loomis, 5th revised Edition. Cloth-bound; size 5½x8x1½" thick; 1,000 pages; over 800 illus.; 450 review questions and answers. Price... **\$4.38**

**MODERN RADIO ESSENTIALS**, by Kenneth A. Hathaway. Cloth covers, size 8½x5¾", over 200 pages, and over 100 illustrations. Price... **\$1.95**

**FOUNDATIONS OF RADIO**, by Rudolph L. Duncan. Cloth covers, size 5½x8", 246 pages, 145 illustrations. Numerous tables. Price... **\$2.47**

**PHOTOCELLS AND THEIR APPLICATION** (Second Edition), by V. K. Zworykin and E. D. Wilson. Cloth covers, size 5½x8", 332 pages, 180 illustrations. Price... **\$2.88**

**ELECTRONICS**, by R. C. Hudson. Cloth covers, size 6x9". 134 pages, 45 illustrations. Price... **\$1.95**

**SHORT WAVE RADIO HANDBOOK**, by Clifford E. Denton. Paper covers, size 6½x8¾". 128 pages, 150 illustrations. Price... **\$1.00**

**PRINCIPLES OF RADIO**, by Keith Henney, M. A. Cloth covers, size 8x5½". 478 pages, 306 illustrations. Price... **\$3.46**

**EXPERIMENTAL RADIO**, by R. K. Ramsey, Prof. of Physics, Indiana University. Cloth covers, size 5½x6¾". 256 pages, 168 illustrations. Price... **\$2.69** Postpaid.

**MODERN RADIO SERVICING** (2nd Revised and Greatly Enlarged Edition of Radio Servicing Course) by Alfred A. Ghirardi. Cloth covers, size 8x6", 1300 pages, over 700 illustrations. Price... **\$4.00**

**DRAKE'S CYCLOPEDIA OF RADIO AND ELECTRONICS**, by H. P. Manly. Cloth covers, size 6x9". 1050 pages, 1178 illustrations. 1932 Edition. Price... **\$4.88**

**FUNDAMENTALS OF RADIO**, by R. R. Ramsey, Professor of Physics, Indiana University. Cloth covers, size 9x6", 426 pages, illustrated. Price prepaid... **\$3.46**

**ELECTRICITY AT HIGH PRESSURES AND FREQUENCIES**, by Henry L. Transtrom. Paper covers, size 7¼x5¼". 248 pages, 141 illustrations. Price Prepaid... **\$1.89**

**RADIO CONSTRUCTION AND REPAIRING**, by James A. Moyer and John F. Westrel. Cloth covers, size 8x5", well illustrated, new revised fourth edition, containing 444 pages, still remaining **\$2.50** at the same price

**THEORY OF VACUUM TUBE CIRCUITS**, by Leo James Peters. Cloth covers, size 6x9". 226 illustrations, 226 pages. Price... **\$3.00**

**PRINCIPLES OF RADIO COMMUNICATION**, by J. H. Morecroft, Prof. of Electrical Engineering, Columbia University. Cloth covers, size 9½x6", 988 pages, profusely illustrated. Price... **\$7.35**

**RADIO ENGINEERING**, by Frederick Emmons Terman. Cloth covers, size 6x9", 688 pages, 418 illustrations. Price... **\$5.00**

**EXPERIMENTAL RADIO ENGINEERING**, by John H. Morecroft. Cloth covers, size 6x9". 346 pages, 250 illustrations. Price... **\$3.46**

**RADIO OPERATING QUESTIONS AND ANSWERS**, (Revised Sixth Edition), by Nilson and Homung. Cloth covers, size 5½x8", 427 pages, 106 illustrations. Price... **\$2.50**

**OFFICIAL RADIO SERVICE HANDBOOK**, by J. T. Bernsley. Over 1,000 pages, over 1,000 illustrations. Special section contains over 250 pages of operating notes for service men. Beautiful linen, gold-stamped cover, 6x9". Price prepaid... **\$3.95**

**OFFICIAL SHORT-WAVE RADIO MANUAL**, by Hugo Gernsback and H. W. Secor, with over 240 pages, illustrations. Flexible, looseleaf leatherette Binder. Size 9x12". Price Prepaid. Vol. 1 (1934) ..... **\$2.00**  
Vol. 2 (1935) ..... **\$2.50**

**OFFICIAL RADIO SERVICE MANUAL**, Volume 4, by Hugo Gernsback and C. Walter Palmer. Flexible, looseleaf leatherette cover, size 9x12", over 2,000 illustrations, over 400 pages. Price Prepaid... **\$3.00**

**OFFICIAL RADIO SERVICE MANUAL**, Volume 5, by Hugo Gernsback and C. Walter Palmer. Flexible, looseleaf leatherette cover, size 9x12", over 3,000 illustrations, over 1,000 pages. Printed on thin Bible-paper. Price prepaid... **\$5.86**

**OFFICIAL RADIO SERVICE MANUAL**, Volume 6, by Hugo Gernsback and N. H. Lessem. Looseleaf Binder, Hard Covers, size 9x12", over 1,200 pages, over 2,500 illustrations. Printed on heavy durable paper with special, new type lock-grip binder. Price prepaid... **\$7.00**

## HOW TO ORDER

We cannot ship C.O.D. Our prices are net, as shown. Some of the books sent prepaid (in U. S. only). Those that are not thus listed will be shipped by express collect if sufficient postage is not included by you.

## NEW LOW PRICED RADIO BOOKS

Here are 14 up-to-date books on radio and air conditioning. Modern in every sense. ALL BOOKS UNIFORM from 64 to 72 pages; 50 to 120 illustrations. All books written by well-known authors. Order by Number.

- No. 1 RADIO SET ANALYZERS
  - No. 2 MODERN RADIO VACUUM TUBES
  - No. 3 THE SUPERHETERODYNE BOOK
  - No. 4 MODERN RADIO HOOK-UPS, by R. D. Washburne
  - No. 5 HOW TO BECOME A RADIO SERVICE MAN
  - No. 6 BRINGING ELECTRIC (RADIO) SETS UP TO DATE, by C. E. Denton
  - No. 7 RADIO KINKS & WRINKLES (for Experimenters)
  - No. 8 RADIO QUESTIONS & ANSWERS, by R. D. Washburne
  - No. 9 AUTOMOBILE RADIO & SERVICING
  - No. 10 HOME RECORDING AND ALL ABOUT IT, by Geo. J. Saliba
  - No. 11 POINT-TO-POINT RESISTANCE MEASUREMENTS by C. E. Denton
  - No. 12 PUBLIC ADDRESS INSTALLATION AND SERVICE
  - No. 13 ABC OF AIR CONDITIONING, by Paul D. Harrigan
  - No. 14 POCKET RADIO GUIDE, by N. H. Lessem.
- PRICE PREPAID EACH BOOK..... **.45**

**RADIO PUBLICATIONS, 97 HUDSON ST., NEW YORK, N.Y.**

mounted on the front-panel providing the single-control tuning feature of the ACT-20. The final amplifier is neutralized for maximum stability. This is accomplished by means of a specially designed, adjustable capacitor mounted on the chassis. A meter and selector switch are provided on the front panel so that buffer-doubler or final-amplifier plate current can be observed. The final amplifier is capable of delivering an average power output of 20 watts to the antenna. Coils are available for the entire 5-band range of the transmitter (1715 to 30,000 kc.).

The transmitter may be keyed in the buffer-doubler and final amplifier stages, with the oscillator running continuously—or the oscillator may be "keyed" simultaneously with the other two stages. Keying of the oscillator alone is not recommended.

The modulator section of the ACT-20 single chassis transmitter consists of an RCA-6F5 high-gain speech-amplifier stage, an RCA-6F6 audio-drive stage and a push-pull RCA-6L6 Beam-Power Modulator Stage. The audio-amplifier gain control is readily accessible on the front panel.

A "phone-CW" switch connects the mod-

## The New ACT-20 "Ham" Transmitter

(Continued from page 20)

ulation transformer in the power-amplifier plate circuit for phone operation and automatically provides the correct voltages for the RCA-807 as a plate-modulated amplifier. In the C-W position the switch disconnects plate voltage from the speech amplifier, and substitutes a bleeder resistor, which prevents the high voltage from rising to a value in excess of safe filter capacitor ratings for the "key-up" position.

The RCA-6F5, high-gain speech amplifier, has a transformer input circuit for coupling to a double-button carbon microphone, by means of a four-prong tube socket. Voltage for the microphone is supplied automatically when the plug is inserted in the socket. Other types of microphones or inputs may be used provided they terminate in 500 to 600 ohms and have a level of approximately -35 db.

The power-supply consists of two RCA-83 full-wave mercury-vapor rectifiers oper-

ated in parallel, a fused and tapped 110-120 volt plate-transformer, filter choke, filter capacitors and a filament heating transformer for all tubes.

All transformers, chokes, capacitors and resistors have ample ratings.

The rectifiers supply plate voltage for the entire transmitter and fixed bias for the modulator.

A main power-switch turns on all heater voltages while a separate switch controls the high-voltage power supply. The switches are so connected that the plate voltage cannot be turned on before the filament voltage is applied. A red-jewel pilot light, mounted on the front panel, indicates when the main power switch has been turned on.

The antenna-coupling system consists of an integral coupling coil on each final-amplifier coil unit, and is so arranged that either a grounded system or transmission-line feed may be used.

This article has been prepared from data supplied by courtesy of RCA Manufacturing Co.

## Short Waves and Long Waves

(Continued from page 28)

now broadcasting regularly in the 40-meter band.

Most of the receivers in use here were not fitted to catch short waves. For this reason and in view of the fact that both opponents are transmitting news and speeches and SOS messages on short waves, there has been a great demand for modern sets covering every wavelength, from 20 to 600 meters. Therefore, the radio-supply stores have sold out all that they had in stock, mainly American makes. During the first days of this war, a Madrid store sold 436 sets during a week. It seems that it is now difficult to replace these stocks, due to lack of foreign currency.

You will realize that all who had here a fancy for radio and enjoyed the thrill of radio-experimenting, are at present longing to meet again "through the air" their old acquaintances and newcomers, too, so we all are looking forward to the occasion when we may burst into the air and roar "Llamada general..." or "This is the Spanish EA3... calling CQ...!"

F. Oliveras Sarri, Pasaje Marimon, 18 Barcelona, Spain.

Glad to hear from you. We're sure our readers enjoy your letters too.—Editor.

## We Helped Him Hear 90 S-W Stations

Editor, SHORT WAVE & TELEVISION:

I have bought your wonderful magazine for over two years and can find absolutely no fault with it. It has helped me to identify more than half of the some ninety-odd short-wave stations I have heard. These stations include the Daventry and Berlin stations; also, "El Prado," T1PG, RNE, JVT, JVM, PCJ, Radio Colonial, HRN, COCO, COCH, COCD, all the Venezuelan stations, also some Columbians and all the American stations. Bill Daugherty, 80 5th St., N.E., Barberton, Ohio.

Please mention SHORT WAVE & TELEVISION when writing advertisers



**"Ever Tear Open a 'BARGAIN' CONDENSER to See What Makes It So Cheap?"**

**SPRAGUE**  
*The Standard of Condenser Quality*

"Don't buy condensers blindfolded!"

"Take an average or 'bargain' cardboard dry electrolytic for instance. Tear it apart. See if the terminals are embedded—see whether or not the unit is doubly-sealed in a moisture-proof container. See if ordinary wax instead of high quality heat-proof wax is used. Tear open defective condensers to learn exactly why they failed. . .

"Nothing will prove more convincing in getting you to standardize on Spragues, as thousands of discriminating servicemen and amateurs have already done. Their solid, honest construction tells its own story of outstanding condenser quality!"

**SPRAGUE PRODUCTS CO., North Adams, Mass.**

**New Tube Tester**

● THE new Ranger-Examiner Tube-Tester incorporates the latest engineering improvements for checking any type radio tube for value, "shorts" and inter-element leakage, under actual load conditions.

The instrument has an approved emission type circuit for speedy and accurate testing. Only four simple operations are required. Results are shown on the direct reading GOOD-BAD scale of a Triplett Model 221 precision meter.

A unique shadow-graph A.C. meter for line voltage adjustment is a popular feature. In addition to showing the actual line-voltage setting, this meter serves as a pilot light in indicating when tester is connected to the power supply.

This tester has a sturdy metal case with black electro-enamel finish. The size is 5 7/8" x 7 7/8" x 4 1/8" and the panel is modernistic silver and black with carrying handle, which folds against case when not in use.

This article has been prepared from data supplied by courtesy of Readrite Meter Works.



New Tube Tester. (No. 620)

**New RCA-806 Medium Power Triode**

● THE new RCA-806 medium power triode has many outstanding features and fills a very important gap in the "family" of Amateur tubes. A single tube operated in the R.F. class "C" classification will deliver 450-watts, and the maximum plate input of the tube is 600-watts with a rating of 150-watts plate dissipation. The recommended voltages for these tubes are from 2,000 to 3,000. The driving power required for an output of 450-watts is only 20 watts.

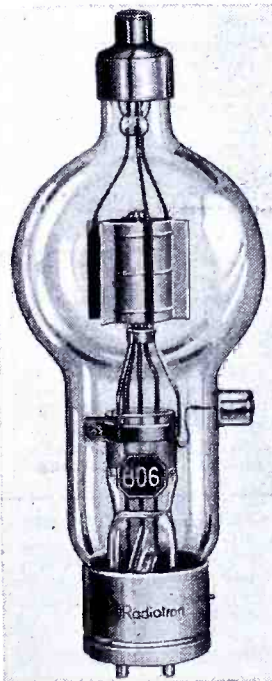

(Continued on page 59)

**"Sure!.. I've even TORN OPEN SPRAGUES to see what makes 'em SO GOOD!"**



**CONDENSERS**  
*USE SPRAGUES.. and Note the Difference*

"Look inside a Sprague dry electrolytic such as the PTM-8 'Pinhead' Tiny-Mike. Note that both terminals are deeply IMBEDDED IN HIGH MELTING POINT pitch. No chance for corrosion here! Note that an inside container is used as a DOUBLE SEAL against moisture which so commonly increases leakage and lowers voltages with a consequent rise in heat in ordinary condensers.

"In short, note that Sprague not only makes the finest, most reliable condensers, but also takes every precaution to keep them as fresh as the day they left the factory.

"Yours for long, trouble-free condenser service."

Sincerely, *Harry Kalkus*  
Sales Manager,

**SPRAGUE PRODUCTS CO., North Adams, Mass.**

**WESTINGHOUSE POWER GENERATOR**

Manufactured for U. S. Signal Corps  
A.C. Electrical 200 Watt Power 110 V. AC

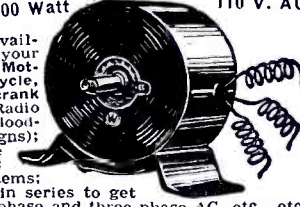

from a Windmill, from available Waterpower, from your Automobile, from your Motorcycle, from your Bicycle, Foot-pedals or Handcrank (for transportable Radio Transmitters, Strong Floodlights, Advertising Signs); do you want to operate AC Radio sets from 32 V. DC farm light systems; operate two generators in series to get 200 V. AC, obtain two phase and three phase AC, etc., etc. to 1/2 H.P. needed to run generator.

There Are Over 25 Applications, such as: A.C. Dynamo light from eight to ten 20 Watt 110 Volt lamps. Short Wave Transmitter supplying 110 Volts A.C. for operating "Ham" Transmitter Operating 110 V. AC 60 Cycle Radio Receiver in DC districts. Motor Generator. Public Address Systems. Electric Sirens on motor boats, yachts, etc. Camp Lighting, etc., etc.

Blueprint 22x28 in. and Four-Page 8 1/2 x 12 in. Instruction Sheets. Generator, as described including four replacement carbon brushes. Shipping weight 18 lbs. . . . . **\$7.90**

**WESTINGHOUSE UNIVERSAL MOTOR**

**\$2.95** 110 Volts AC and DC

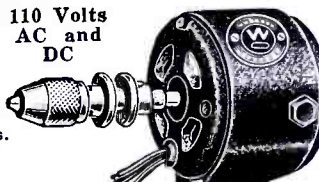

Shipping Weight 3 lbs.

These Motors are manufactured by the Westinghouse Electric Co. They are absolutely new. Specifications: 1/30 H.P. operates on either A.C. or D.C., 110 volts, 5000 R.P.M. Rheostat can be used to vary speed. Height 3 1/4". Length 3 3/4". Width 1 1/2". Shaft 1/4" one inch long. Can be used to drive Sewing Machines, Models, Buffing, Polishing Head, Drills, Grindstones, etc., etc. **\$2.95**

MOTOR only . . . . . **\$2.95**

MOTOR with Arbor and 1/4" Chuck . . . . . **\$3.95**

Add 25c for special packing and mailing anywhere in U.S.A.

All merchandise in original packages—never used. Money-back guarantee.

We will forward Shipments by Express Collect if sufficient postage is not included.

**WELLWORTH TRADING CO.**  
560 W. Washington Blvd., Dept. SWC-537, Chicago, Ill.

**WORLD WIDE ALL WAVE RADIO**

**SPECIAL!! For a Limited Time Longer!**

The sensational "Ace Dace" Two Tube receiver for only \$2.25! Thousands sold at regular \$3.00 price. **THIS MONTH ONLY**—for \$2.25 we send you, postpaid, the complete kit containing an attractive metal chassis, panel, and every part needed to build this powerful all electric short and long wave receiver, unwired, less tubes and phones. No batteries needed! Just plug into any house current socket. **AMAZING VALUE!** Can actually bring in foreign stations from all parts of the world, police calls, airplanes, amateurs, etc., as well as your local stations! Ace radios give **GUARANTEED RESULTS!** Our clear diagrams make it simple to hook-up. Free Circular.

**ONE TUBE** Battery operated receiver. Complete kit of parts, unwired, less tube, batteries, and phones. **\$1.25**

**TWO TUBE** Battery receiver. For most excellent power and volume buy this beginner's receiver! Complete Kit—Unwired, less tubes, batteries, phones. **\$2.00**

Any kit laboratory wired and tested 75c extra. First grade tubes—75c each. Double headphones—\$1.15 REMEMBER! We pay the postage. Saves you up to 50c. ENJOY NEW THRILLS!! **SEND FOR YOUR ACE RADIO TODAY!**

**ACE RADIO LABORATORIES**  
70 Barclay St. Dept. C-5 New York City

**PARTS PRICES SLASHED!**

Complete stock of fine-quality replacements for Short Wave—P. A.—Ham and Service work at big savings. Why carry expensive stocks? Use our RUSH shipment plan.

**BOND RADIO COMPANY**  
13135 Hamilton Ave., Detroit, Michigan

**COMPLETE ELECTRIC PLANTS**

ONAN ALTERNATING CURRENT PLANTS furnish same as city current anywhere. Operate on gasoline. Run Radio, Water System, Refrigerator, all Appliances. Complete, ready to run. **SIZES 350 WATTS UP**

Easy to install. Available from stock. For Farms, Camps, Commercial use. Sizes for any purpose. Write for details. **D. W. ONAN & SONS**  
555 Royalston Ave. Minneapolis, Minn.

Please mention SHORT WAVE & TELEVISION when writing advertisers

# Free!



## WHAT THEY SAY ABOUT THE WORLD-GLOBE LAMP!

### THIS USEFUL AND ORNAMENTAL WORLD-GLOBE LAMP

NEVER in the six years that SHORT WAVE CRAFT has been published, have we found anything that is as useful and ornamental as the WORLD-GLOBE LAMP we now offer free to our readers.

This useful, beautiful WORLD-GLOBE LAMP measures 17½" high. It has an attractive colored shade, with nautical and map designs, is 8" in height and 16" in diameter. It is made of fine quality parchment, highly glazed, to assure long life. A slightly damp cloth quickly removes dust from the shade. The 6¼" globe, printed in many colors, has a full meridian, and rotates. Hundreds of names—countries, cities, rivers, oceans and others are clearly printed on the globe.

Ideal for SHORT-WAVE FANS!

YES, THE GLOBE REVOLVES!

**All Admired It**  
Gentlemen:  
I am perfectly satisfied with your GLOBE-LAMP. It is just what you have said about it in every way. All my family and friends have admired it. It arrived in perfect condition. Many thanks and the best of good luck to you and your SHORT WAVE CRAFT.  
(Signed)  
William Owens,  
30 North Fifth Street,  
Bangor, Penna.

**Wouldn't Take \$15.00 For It**  
Gentlemen:  
I received the Globe-Lamp and I am very much pleased with it. I think it is handsome and think a good deal of it. I wouldn't take \$15.00 for it. The lamp sets on top of the radio and is handy to glance at when I hear the foreign stations.  
Warren G. Ryder,  
Barnstable Radio Shop,  
Barnstable, Mass.  
P.S.: Many thanks for the lamp! WGR

**Unique, Beautiful and Useful**  
Gentlemen:  
The Globe-Lamp arrived today, also the magazine. Congratulations on a premium so unique, beautiful and, above all, useful, especially to DXers on the short-wave bands. I already have a large globe, but I expect to use this small one much more frequently and with equal satisfaction. It goes fine with the new Hammerlund "Super Pro."  
T. H. Warnock,  
99 Elm Street,  
Meriden, Connecticut.

**Very Well Pleased**  
Gentlemen:  
I am very well pleased with my Globe-Lamp. It presents a handsome and novel appearance and is most appropriate when located near an all-wave radio set. When lighted at night, it sheds a warm, soft glow, and the parchment shade shows up most attractively. Unquestionably, the combination of the lamp and SHORT WAVE CRAFT for \$2.50 is a real bargain.  
William E. Sloan, Jr.,  
67 Exchange Street,  
Rochester, New York.

### MAIL COUPON TODAY!

SHORT WAVE & TELEVISION 99 Hudson Street, New York, N. Y. SWT-5-37  
Gentlemen: Enclosed you will find my remittance of \$2.50 (plus \_\_\_\_\_cents shipping charges) for which enter my subscription for SHORT WAVE & TELEVISION for one year (12 issues). This amount entitles me to a WORLD-GLOBE LAMP free. See chart next to coupon for shipping charges on WORLD-GLOBE LAMP.  
( ) Enclosed find my remittance of \$2.50. Please send me the WORLD-GLOBE LAMP by express, collect.  
Name \_\_\_\_\_  
Address \_\_\_\_\_  
City \_\_\_\_\_ State \_\_\_\_\_  
Send remittance in form of check or money order—register letter if it contains cash, stamps, or currency.

Another feature on this WORLD-GLOBE LAMP is the movable hour scale found at the north pole. This permits determining the correct time in any part of the world.

The metal parts are finished in antique bronze. A piece of heavy green felt is glued under the base, therefore it may be placed anywhere, without fear of marring table, desk, etc.

The weight of the WORLD-GLOBE LAMP is nearly three pounds. When packed for shipping, six pounds.

Here is the way to get this beautiful prize. Fill in the coupon in the left hand corner—cut it out and mail it to us together with your remittance of \$2.50. You will receive a full year's subscription (12 months) to SHORT WAVE & TELEVISION—the greatest short-wave magazine in the world today. In addition, we will send you absolutely FREE one of these handsome WORLD GLOBE LAMPS. Old subscribers may renew their subscription now for another year following expiration of their present one and still receive this WORLD-GLOBE LAMP.

Only a limited number of WORLD-GLOBE LAMPS are available. Take advantage of this offer without delay in order to insure receiving your free gift. RUSH THE COUPON TODAY.

### How to Order Your WORLD-GLOBE LAMP

Simply fill in the coupon at the left and mail together with check or money order. Register letter if cash or coin is sent. To cover shipping charges on WORLD-GLOBE LAMP, add to your remittance the amount indicated. If you are located: East of the Mississippi add 35 cents; Between the Mississippi and the West Coast add 70c; Foreign Countries add \$1.30. Any excess remittance will be refunded.

SHORT WAVE & TELEVISION, 99 Hudson Street, New York, N.Y.

## YOU CAN'T BUY THESE BOOKS— BUT YOU CAN HAVE EITHER OR BOTH

# FREE

The publishers of *Short Wave & Television* give you the opportunity to add one or two new books to your library. They make the offer even more attractive by giving the books to you absolutely FREE. A subscription to *Short Wave & Television* for seven months at the sensationally small cost of One Dollar brings to you your choice of the books illustrated and described below. For Two dollars you will receive *Short Wave & Television* for fourteen months and BOTH books sent to you absolutely FREE. ANOTHER SAVING FOR YOU—THE PUBLISHERS PAY POSTAGE ON THE BOOK OR BOOKS YOU CHOOSE.

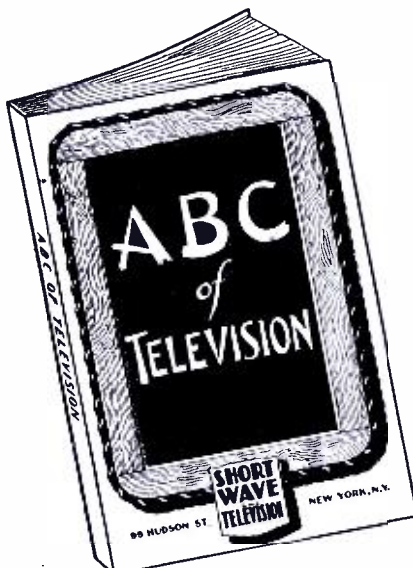

**ABC OF TELEVISION**  
This book contains only the latest material available on Television. It is written by a well-known radio authority, and the book is available only with a subscription to SHORT WAVE & TELEVISION. The book cannot be purchased alone.  
**Partial Contents of ABC of Television**  
**CHAPTER 1**—The simplest television receiver; how the eye sees; its likeness to television equipment.  
**CHAPTER 2**—Theory of scanning; the Nipkow disc and its relation to television; the photo-electric cell; neon lamps; brief description of several modern mechanical systems.  
**CHAPTER 3**—Need for a large number of picture elements; need for broad channel width in transmission of high-fidelity television signals.  
**CHAPTER 4**—The use of the cathode ray tube in television receivers; necessary associated equipment used in cathode-ray systems.  
**CHAPTER 5**—How a television station looks and how the various parts are operated.  
**CHAPTER 6**—The Iconoscope as used for television transmission in the RCA system.  
**CHAPTER 7**—The Farnsworth system of television transmission.  
**CHAPTER 8**—The future of television; probable cost of receivers; some expressions of opinion by prominent men; list of present television transmitters.  
64 PAGES—100 ILLUSTRATIONS  
Stiff, Flexible Covers, 5¼x8¼ INCHES

**SHORT WAVE GUIDE**  
A few thousand copies of SHORT WAVE GUIDE still remain from our subscription campaign earlier in the season. It is an excellent book—recommended by short-wave enthusiasts everywhere. Send for your copy if you have not already received it.  
**Partial Contents of SHORT WAVE GUIDE**  
SHORT-WAVE QUESTIONS AND ANSWERS  
So many questions and answers were sent to SHORT WAVE & TELEVISION space did not permit them to be included. In this book we have printed hundreds of questions and answers, with complete illustrations.  
**SHORT-WAVE KINKS, Illustrated**  
In SHORT-WAVE GUIDE you'll find dozens of short-wave kinks and wrinkles described and illustrated.  
**HOW TO BUILD SIMPLE SHORT-WAVE RECEIVERS**  
Complete constructional plans, including schematic diagrams, lists of parts, are included for building a number of one-, two-, and three-tube receivers.  
**WHICH IS THE BEST TYPE OF AERIAL TO USE?**  
The many antenna systems suitable for short-wave receivers are carefully described and illustrated in SHORT WAVE GUIDE.  
**A SIMPLE "HAM" TRANSMITTER**  
All the details, including list of parts, wiring diagrams and constructional details in building a simple "ham" transmitter will be found in this book.

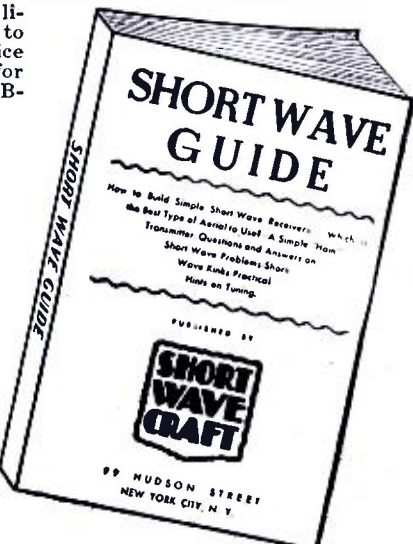

**PRACTICAL HINTS ON SHORT-WAVE TUNING**  
Hundreds of short-wave stations are heard daily by "fans," but do you know how to tune them in, you could hear more stations and get greater enjoyment and thrills from your receiver. Expert advice on proper short-wave tuning is included in SHORT WAVE GUIDE.  
64 PAGES—100 ILLUSTRATIONS  
Stiff, Flexible Covers, 5¼x8¼ INCHES

SHORT WAVE & TELEVISION, 99 HUDSON STREET, NEW YORK, N. Y. 5-37  
Gentlemen: Enclosed you will find my remittance of One Dollar (Canada and Foreign \$1.30) for which enter my subscription to SHORT WAVE & TELEVISION for Seven Months. You are also to send me ABSOLUTELY FREE and POSTPAID the book indicated by (x) at the right.  
( ) Two Dollars is enclosed. Send SHORT WAVE & TELEVISION for fourteen months and send me BOTH BOOKS ABSOLUTELY FREE. (Canadian and Foreign \$2.60)  
Name \_\_\_\_\_ Address \_\_\_\_\_  
City \_\_\_\_\_ State \_\_\_\_\_  
Send remittance in form of check, money order or unused U.S. Postage Stamps. (Foreign: International Postal Money Order.)  
Register letter if you send cash.

**ADD THESE BOOKS TO YOUR LIBRARY!**  
When you subscribe to SHORT WAVE & TELEVISION, you get these books FREE. If you already are a subscriber, and you send for these books, your present subscription will be extended for another seven or fourteen months. It's easy to add these books to your technical library.  
**SHORT WAVE & TELEVISION**  
99 HUDSON STREET, NEW YORK, N.Y.

Please mention SHORT WAVE & TELEVISION when writing advertisers

# Have YOU Tried DATAPRINT SERVICE?



These NEW Prints show you How to Build Electrical Apparatus!  
New low price—Any 3 Prints...\$1.00

Can YOU Fry Eggs on a Cake of Ice? Data .....50c

## TESLA COIL DATA:

- Dataprint—drawings and data for building 36 inch spark Tesla.....50c
- Exciter—1 K.W. 20,000 Vt. Transf. 50c
- 3" Sp'k. Tesla Coil. Works on Ford Coil.....50c
- 3" Sp'k. Oudin Coil. Works on 110 V. A.C. 50c
- 20 "Tricks" with Teslas & Oudins.....50c
- 8" Sp'k. Tesla Coil.....50c
- Exciter—1/4 K.W. 15,000 W. Transf. 50c
- Violetta—1/2 Sp'k. Oudin, Vibrator type.....50c
- How to Operate Oudins from V. T. Osc. 50c
- WELDING
- Electric Welding Trf. 2 K.W. 110 V. Prim. 18 V. Sec. 50c

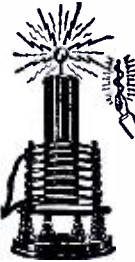

## S-W DIATHERMY (Artificial Fever)

Dataprint, Constructional data for Small, Medium and Large size App... 50c

## Magnets & Solenoids!

- Data only—50c per print.
- A—Powerful Battery Magnet, Lifts 40 lbs.
- B—110 V. D.C. magnet to lift 25 lbs.
- C—110 V. D.C. magnet to lift 300 lbs.
- D—110 V. D.C. Solenoid, lifts 2 lb. thru 1 in.
- E—110 V. D.C. Solenoid, lifts 6 lb. thru 1 in.
- F—12 V. D.C. Solenoid, lifts 2 lb. thru 1 in.
- G—110 V. A.C. Solenoid; Powerful (60 cycle.)
- A.C. MOTOR—1/16 H.P. "Easiest to Build"—110 V. 60 cy. A.C. Data .....50c

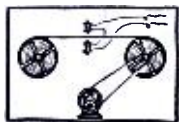

## RECORD PROGRAMS on Steel Wire!

Telegraphone Data, for Voice or Code.....50c

## Induction PIPE & ORE LOCATOR

Construction Data.....50c



## 20 ELECTRIC LODGE & PARTY TRICKS. Fun Galore!

"How to Do 'Em" Data 50c

## RADIO CONTROL for MODEL BOATS, etc.

Circuit data.....50c



## More DATAPRINTS You Need!

- 50c each Prepaid.....3 prints for \$1.00
- Water Turbines
- Water Wheels
- Motor Circuits (20)
- Telephone Hook-ups (20)
- 100 Mechanical Movements
- Polarized Relay, Ultra-sensitive
- Shocking coil
- Ring 4 bells on 1 circuit
- 20 Simple Bell Hook-ups
- Public Address System
- Electric Chime Ringer fits any clock
- 60 or 1200 cycle Synch. Motor
- "Rewinding" Small Motor Armatures.....\$0.50
- Induction Balance
- Telautograph
- Eindhoven String Galvanometer
- Electric Fan Motor
- Watch Demagnetizer
- Electric Furnace Draft Regulator
- Building a Simple Telephone
- Ignition Coil Data
- Electric Pipe Thawer
- Wheatstone Bridge
- Induction Coils—1 to 12 inch Sp'k. data



## SLIDE RULE—4" Metal

Price \$2.00 Net.

With Case and Instructions. Multiplies, Divides, Adds, Subtracts, Gives Roots, Powers, Sines, Cosines, etc. Also Logs of Numbers. Approved by colleges. 8" Dia. 25" Scale "Special Rule." \$5.00 Net.

The **DATAPRINT** Co. Lock Box 322 RAMSEY, N. J.

## New RCA-806

(Continued from page 57)

Complete characteristics of the tube follow, and its general construction can be seen from the accompanying photo.

### RCA 806 R-F Power Amplifier, Oscillator, Class B Modulator

Tentative Characteristics

Filament Voltage (A. C. or D. C.)	5.0 Volts
Filament Current	10 Amperes
Amplification factor	12.6
Direct Interelectrode Capacitances (Approx.):	
Grid-Plate	3.4 mmf.
Grid-Filament	6.1 mmf.
Plate-Filament	1.1 mmf.
Bulb	GT-30
Top Cap.	Medium Metal Skirted
Side Cap.	Medium Metal
Base	Jumbo 4-Large pin
Type of Cooling	Air

### Maximum Ratings and Typical Operating Conditions

As A-F Power Amplifier and Modulator—Class B	
D-C Plate Voltage	3000 max. Volts
Max.—Signal D-C Plate Current	200 max. Milli-amperes
Max.—Signal Plate Input	500 max. Watts
Plate Dissipation	150 max. Watts
Typical Operation:	

Unless otherwise specified, values are for 2 tubes

D-C Plate Voltage	2000	3000	Volts
D-C Grid Voltage	-150	-240	Volts
Peak A-F Grid-to-Grid Voltage	340	405	Volts
Zero—Sig. D-C Plate Current	20	20	Milliamperes
Max.—Sig. D-C Plate Current	390	330	Milliamperes
Load Resistance (Per tube)	2875	5375	Ohms
Effective Load Res. (Plate-to-plate)	11500	21500	Ohms
Max.—Sig. Driving Power (Approx.)	14	10	Watts
Max.—Sig. Power Output (Approx.)	500	660	Watts

### As R-F Power Amplifier—Class B Telephony

Carrier conditions per tube for use with a max. modulation factor of 1.0

D-C Plate Voltage	3000 max. Volts		
D-C Plate Current	150 max. Milli-amperes		
Plate Input	225 max. Watts		
Plate Dissipation	150 max. Watts		
Typical Operation:			
D-C Plate Voltage	2000	3000	Volts
D-C Grid Voltage	150	240	Volts
Peak R-F Grid Voltage	180	200	Volts
D-C Plate Current	110	70	Milliamperes
D-C Grid Current (Approx.)	1	0	Milliamperes
Driving Power (Approx.)	8	5	Watts
Power Output (Approx.)	70	70	Watts

### As Plate Modulated R-F Power Amplifier—Class C Telephony

Carrier conditions per tube for use with a max. modulation factor of 1.0

D-C Plate Voltage	2500 max. Volts		
D-C Grid Voltage	1000 max. Volts		
D-C Plate Current	200 max. Milli-amperes		
D-C Grid Current	50 max. Milli-amperes		
Plate Input	500 max. Watts		
Plate Dissipation	110 max. Watts		
Typical Operation:			
D-C Plate Voltage	2000	2500	Volts
D-C Grid Voltage	500	600	Volts
Peak R-F Grid Voltage	790	890	Volts
D-C Plate Current	195	195	Milliamperes
D-C Grid Current (Approx.)	40	40	Milliamperes
Driving Power (Approx.)	28	32	Watts
Power Output (Approx.)	300	390	Watts

### As R-F Power Amplifier and Oscillator—Class C Telegraphy

Key down conditions per tube without modulation

D-C Plate Voltage	3000 max. Volts			
D-C Grid Voltage	1000 max. Volts			
D-C Plate Current	200 max. Milli-amperes			
D-C Grid Current	50 max. Milli-amperes			
Plate Input	600 max. Watts			
Plate Dissipation	150 max. Watts			
Typical Operation:				
D-C Plate Voltage	2000	2500	3000	Volts
D-C Grid Voltage	400	500	600	Volts
Peak R-F Grid Voltage	640	755	870	Volts
D-C Plate Current	195	195	195	Milliamperes
D-C Grid Current (Approx.)	25	25	25	Milliamperes
Driving Power (Approx.)	15	17	20	Watts
Power Output (Approx.)	280	370	450	Watts

**ARCO Tubes** are best and they cost much less! The prices are extremely low when you consider the long service that these tubes will give you.

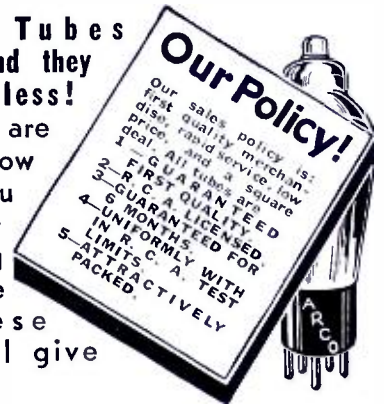

### Complete Stock Ready for Immediate Shipment

Order from this page—Remit 20% with order, balance C. O. D. All prices are F. O. B. FACTORY, Newark. Shipments go forward express or parcel post. No order for less than \$2.00 accepted.

Type	Your Cost	Type	Your Cost	Type	Your Cost	Type	Your Cost
00A	\$.72	6A7	\$.49	27	\$.29	55	\$.45
01A	.25	6B7	.54	30	.29	56	.29
01AA	.25	6C6	.43	31	.32	57	.39
1A4	.63	6D6	.43	32	.54	58	.39
1A6	.54	6E5	.54	33	.45	59	.54
1B4	.72	6E6	.72	34	.54	71A	.29
1B5/25S	.45	6F7	.63	35/51	.36	75	.39
1C6	.63	6G5	.54	36	.39	76	.29
1F4	.54	6H5	.63	37	.32	77	.43
1F6	.72	10	.81	38	.39	78	.43
1V	.39	WD11	.72	39/44	.39	79	.54
2A3	.81	WD12	.72	40	.36	80	.25
2A5	.43	12A5	.81	41	.39	81	.72
2A6	.43	12A7	.72	42	.43	82	.39
2A7	.54	12Z3	.39	43	.43	83	.39
2B7	.54	15	.72	45	.29	83V	.72
2E5	.54	19	.43	46	.49	84 6Z4	.54
5Z3	.36	20	.72	47	.45	85	.43
6A3	.72	22	.54	48	1.08	89	.54
6A4/LA	.54	24A	.36	49	.43	V99	.54
6A6	.54	25Z5	.43	50	.81	X99	.54
6B5	.81	26	.25	53	.54	112A	.32

ALL METAL TUBES							
Type	Your Cost	Type	Your Cost	Type	Your Cost	Type	Your Cost
5W4	\$.40	6C5	\$.50	6K7	\$.54	6R7	\$.60
5Z4	.80	6F5	.50	6L6	.90	6X5	.60
6A8	.60	6F6	.54	6L7	.70	25A6	.60
6B8	.70	6H6	.30	6N7	.70	25L6	.90
		6J7	.60	6Q7	.54	25Z6	.60

G SERIES TYPE TUBES							
Type	Your Cost	Type	Your Cost	Type	Your Cost	Type	Your Cost
1C7G	\$.80	5U4G	\$.60	6J7G	\$.60	6K7G	\$.54
1D6G	.80	5V4G	.80	6K5G	.54	6L6G	.90
1D7G	.70	5X4G	.60	6B6G	.54	6L7G	.70
1E5G	.80	5Y3G	.40	6D8G	.90	6N7G	.70
1E7G	1.10	5Y4G	.40	6L5G	.90	6Q7G	.54
1F5G	.80	6A8G	.60	6N6G	.90	6R7G	.54
1F7G	.80	6C5G	.50	6S7G	.90	6X5G	.60
1H4G	.40	6F5G	.50	6U7G	.54	25A6G	.60
1H6G	.70	6F6G	.54	6V6G	.70	25A7G	.90
1J6G	.54	6H6G	.50	6V7G	.54	25B6G	.70
		6J5G	.48	6K6G	.54	25Z6G	.60

**DISCOUNTS 100 TUBES AND OVER 10% 500 TUBES AND OVER 10% & 10%**

**ARCO TUBE CO. 227 Central Ave. NEWARK, N. J.**

## STOPPANI COMPASS

A Precision Instrument made in Belgium, purchased by the U. S. Government at more than \$30.00 each. Ideal for Radio Experimenters Laboratory, also may be used as a Galvanometer for detecting electric currents in radio circuits. Ruby, jeweled, solid bronze, 4 inches square, fitted in a hardwood case. Also used by hunters and surveyors. Our price prepaid \$4.50 each



**GOLD SHIELD PRODUCTS CO. 17 West 60th St. New York City**

## EXPERIMENTERS

- SPECTROSCOPE** for chemical analysis, showing countless lines of sun and stars, with chart to identify elements and book of 120 experiments..... \$2.50
- TELESCOPE** clearly showing moon craters..... \$1.00
- STROBOSCOPE** with 110-volt motor, neon lamp, and book of 100 experiments and optical effects..... \$1.00
- MAGIC ROD** glows in the dark in six colors..... \$1.00
- ELECTRIC FUN** Book of 200 stunts, 110 volts; describes interesting area, window displays, magic tracks, etc..... \$1.00
- SPINTHARISCOPE**, See atoms explode..... \$2.00

Cutting & Sens 47 T St. Campbell, Calif.

# Handy Accessories for Members of the SHORT WAVE LEAGUE

## LEAGUE LETTERHEADS

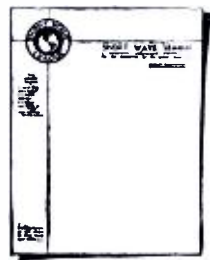

A beautiful letterhead has been designed for members' correspondence. It is the official letterhead for all members. The letterhead is invaluable when it becomes necessary to deal with the radio industry, mailorder houses, radio manufacturers, and the like; as many houses have offered to give members who write on the LEAGUE'S letterhead a preferential discount. The letterhead is also absolutely essential when writing for verification to radio stations either here or abroad. It automatically gives you a professional standing.

A—50c per 100

A—SHORT WAVE LEAGUE letterheads, per 100.....

50c

## WORLD RADIO MAP AND STATION FINDER

The finest device of its kind published. The world's map on heavy board is divided into 23 sections, while the rotary disc shows you immediately the exact time in any foreign country. Invaluable in logging foreign stations. Also gives call letters assigned to all nations. Size 11"x22".

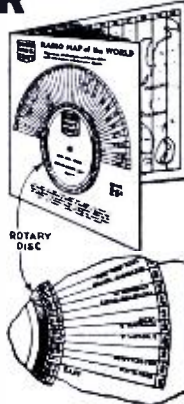

C—Radio Map of the World and Station Finder. Prepaid

25c

C—25c each

## SHORT WAVE MAP OF THE WORLD

This beautiful map, measuring 18x26 in. and printed in 18 colors is indispensable when hung in sight or placed "under the glass" on the table or wall of the short wave enthusiast. It contains a wealth of information such as distances to all parts of the world, political nature of the country in which a broadcast station is located, etc., and from the manner in which the map is blocked off gives the time in different parts of the world at a glance.

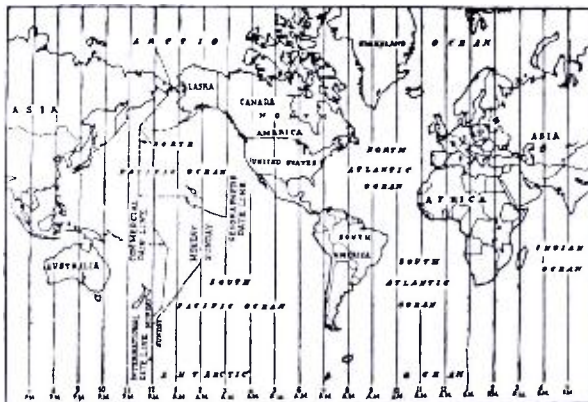

F—SHORT WAVE Map of the World.....Prepaid

25c

F—25c each

## WORLD GLOBE



This highly important essential is an ornament for every den or study. It is a globe, 6 in. in diameter, printed in fifteen colors, glazed in such a way that it can be washed. This globe helps you to intelligently log your foreign stations. The base is of solid walnut, and the semi-meridian of a nickel-like metal. Entire device substantially made, and will give an attractive appearance to every station, emphasizing the long-distance work of the operator.

D—Globe of the World.....

Prepaid

89c

PLEASE NOTE, THAT ABOVE ESSENTIALS ARE SOLD ONLY TO MEMBERS OF THE LEAGUE—NOT TO NON-MEMBERS.

Send all orders for short wave essentials to SHORT WAVE LEAGUE, 99-101 Hudson Street, New York City. If you do not wish to mutilate the magazine, you may copy either or both coupons on a sheet of paper.

## LEAGUE LAPEL BUTTON

This beautiful button is made in hard enamel in four colors, red, white, blue and gold. It measures three quarters of an inch in diameter. By wearing this button, other members will recognize you and it will give you a professional air. Made in bronze, gold filled, not plated. Must be seen to be appreciated.



E—SHORT WAVE LEAGUE lapel button..... Prepaid

35c

E—35c each

EE—SHORT WAVE LEAGUE lapel button, like the one described above but in solid gold. ....Prepaid

\$2.00

## LEAGUE SEALS



These seals or stickers are executed in three colors and measure 1 1/4 in. in diameter, and are gummed on one side. They are used by members to affix to stationery, letterheads, envelopes, postal cards and the like. The seal signifies that you are a member of the SHORT WAVE LEAGUE. Sold in 25 lots or multiples only.

G—SHORT WAVE LEAGUE seals, per 25..... Prepaid

15c

G—15c for 25

## A FEW WORDS AS TO THE PURPOSE OF THE LEAGUE

The SHORT WAVE LEAGUE was founded in 1930. Honorary Directors are as follows: Dr. Lee de Forest, John L. Reinartz, D. E. Replegle, Hollis Baird, E. T. Somerset, Baron Manfred von Ardenne, Hugo Gernsback, Executive Secretary.

The SHORT WAVE LEAGUE is a scientific membership organization for the promotion of the short wave art. There are no dues, no fees, no initiations, in connection with the LEAGUE. No one makes any money from it; no one derives any salary. The only income which the LEAGUE has is from its short wave essentials. A pamphlet setting forth the LEAGUE'S numerous aspirations and purposes will be sent to anyone on receipt of a 3c stamp to cover postage.

## FREE MEMBERSHIP CERTIFICATE

As soon as you are enrolled as a member, a beautiful certificate with the LEAGUE'S seal will be sent to you, providing 10c in stamps or coin is sent for mailing charges.

Members are entitled to preferential discounts when buying radio merchandise from numerous firms who have agreed to allow lower prices to all SHORT WAVE LEAGUE members.

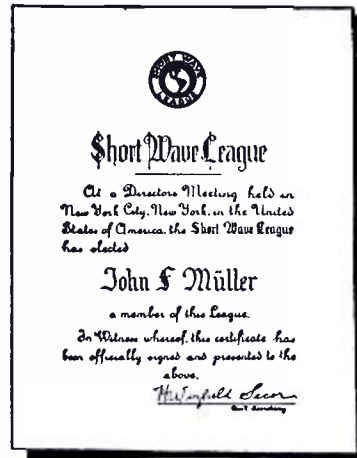

If you wish your name engraved on the Free membership certificate, as illustrated above, please send 25c to cover cost.

## SHORT WAVE ESSENTIALS LISTED HERE SOLD ONLY TO SHORT WAVE LEAGUE MEMBERS

They cannot be bought by anyone unless he has already enrolled as one of the members of the SHORT WAVE LEAGUE or signs the blank on this page (which automatically enrolls him as a member, always provided that he is a short wave experimenter, a short wave fan, radio engineer, radio student, etc.).

Inasmuch as the LEAGUE is international, it makes no difference whether you are a citizen of the United States or any other country. The LEAGUE is open to all.

## Application for Membership SHORT WAVE LEAGUE

SHORT WAVE LEAGUE 99-101 Hudson Street, New York, N. Y. 5-37

I, the undersigned, herewith desire to apply for membership in the SHORT WAVE LEAGUE. In joining the LEAGUE I understand that I am not assessed for membership and that there are no dues and no fees of any kind. I pledge myself to abide by all the rules and regulations of the SHORT WAVE LEAGUE, which rules you are to send to me on receipt of this application.

I consider myself belonging to the following class (put an X in correct space): Short Wave Experimenter  Short Wave Fan  Radio Engineer  Student  I own the following radio equipment:

Transmitting .....

Call Letters.....

Receiving .....

Name .....

Address .....

City and State.....

Country .....

I enclose 10c for postage and handling for my Membership Certificate.

## SHORT WAVE LEAGUE, 99-101 Hudson St., New York, N.Y.

SHORT WAVE LEAGUE, 99-101 Hudson Street, New York, N. Y.

Gentlemen:

I am a member in the SHORT WAVE LEAGUE  I am a new member and attach my application to this coupon

Please send me the following short wave essentials as listed in this advertisement:

.....  
.....  
.....  
.....  
.....

for which I enclose \$..... herewith.

(The LEAGUE accepts money order, cash or new U. S. Stamps in any denomination. Register cash and stamps.)

Name .....

Address .....

City and State.....

Country .....

5-37

**T. L. McElroy's Code Speed Challenged**

*Editor, SHORT WAVE & TELEVISION:*  
I recently created quite a sensation at the Northern Counties Wireless School (classed as the school in the North of England) where I am a student.

The reason for the sensation was the article in your January issue by T. L. McElroy, who claims to have done 77 words per minute as a telegraphist.

Before I showed anybody the article, I went to the principal and asked him what he thought was the maximum possible speed at which anybody could humanly receive and he replied, "Forty-five words per minute."

What did he say when I showed him the article? Well, I dare not repeat it. Presuming the words to be of five letters with an average of 2½ symbols per letter, and the grand total number of symbols per minute is 962½, excluding a space of one dot between each symbol, three dots between each letter and five dots between each word. That is the right spacing for correct sending, and the dashes should be equal to three dots each.

With the 962½ symbols per minute, there is an average of 16.04 symbols per second (with-out the spacing, remember!) of dots and dashes.

When you listen to the teleprinters (perhaps you don't) and remember that they are only doing a mere 40 to 50 w.p.m., just imagine what the stuff sounded like that Mr. McElroy was copying! He ought to apply for a job as a Teleprinter somewhere!

Surely you will agree when I say that his speed is beyond human practicability, which expresses not only my own opinion, but that of everybody else to whom I have shown the article. One of the remarks passed was, "You haven't got hold of Pitman's Shorthand Manual, have you by mistake?" That serves as an example of the incredulity with which it was received every time I showed or mentioned the article.

I would be very grateful to you if you could supply me with further details of this feat, such as the method of sending and the method used for "copying," the length of words (these should be five lettered) and whether it was plain language or code groups.

Lastly, may I congratulate you on your publication which is just about the finest I can lay my hands on. It costs just about half as much again as our British "mags," but it's worth every penny of it!

Looking forward to your reply and the next issue.—

J. TOLE,  
Lancashire, England.

*(Editor's note:—We feel sure that our readers will enjoy perusing Mr. McElroy's reply to Mr. Tole, which we reproduce below.)*

**Mr. McElroy's Reply**

January 28, 1937.

J. Tole, Esq.,  
The Grounds,  
Whittingham, near Preston,  
Lancashire, England.

Dear friend Tole:

For, how shall I say "Dear Mister" so and so when your letter to which I am now attempting a reply, is so obviously warm and friendly. I hope therefore, that you'll allow me the privilege of the "friend" salutary greeting.

Because your letter is one of many similar ones wherein the writer seeks further and more detailed information anent the various reports as to what speed the human mind can copy in radio signals, I am going to try and write at some length and give you the whole story. Who knows but that I may be able to put forth an effort worthy of publication in the magazine we both know so well and enjoy so much—*Short Wave and Television*. I am taking the liberty of sending them a carbon copy. Evidently their circulation is quite heavy in the British Isles, as I've had quite a few letters similar to yours, or at least voicing the same interest in code copying speed.

First off will you allow me to say that my good British friends are not alone in their skepticism on this speed business. There are many doubters here in the States, although I've had the pleasure of meeting so many thousands of our American "hams" and demonstrating at "hamfests" that we've all thoroughly enjoyed seeing disbelief melt into real friendship. As witness the last large affair here in the States, when I had the privilege of demonstrating before the largest group of radio amateurs ever gathered under one roof at one time, some months back in Chicago at the Central Division Convention of the A. R. R. L.

Because I have been honored with an alliance with a British amateur, radio apparatus distributor, G2NO, I feel especially close to radio-men in the British Isles, and I hopefully anticipate spending some time in England during the late spring or summer of this year, during which visit I expect keenly to enjoy giving talks and demonstrations before most of the radio associations there. The trip will most certainly be worth while if I may have the pleasure of meeting you and the many others over there who've written on this same subject.

# CLASSIFIED

Advertisements are inserted at 5c per word to strictly amateurs, or 10c a word to manufacturers or dealers. Each word in a name and address is counted. Cash should accompany all orders. Copy for the June issue should reach us not later than April 5.

<p><b>AGENTS WANTED</b></p> <p><b>GOLD LETTERS FOR STORE</b> Windows. 500% Profit. Free Samples. Metallic Co., 433-R N. Clark, Chicago.</p> <p><b>BOATS</b></p> <p><b>BUILD ELECTRIC OUTBOARD</b> motor from auto generator. Complete plans and catalog 10c. 50 other generator changes. Lelay Manufacturing, 1517 Lake, Minneapolis, Minn.</p> <p><b>BOOKS</b></p> <p><b>READ! OUTLOOK FOR TELEVISION</b> by Orrin Dunlap, Radio Editor, New York Times. Application, contributions, opportunities, technique. Originally \$4.00. Now \$2.99. Special! Ghirardi's Radio Field Service Data (1st Edition). Frequencies, codes, symptoms, remedies. Was \$1.50. Reduced to 89c. Both books for only \$3.50. Kempner Radio Book Sales, 1123 Broadway, New York.</p> <p><b>CURIOS</b></p> <p><b>INDIAN RELICS, BEADWORK, Coins, Stamps, Minerals.</b> Catalog 5c. Indian Museum, Northbranch, Kansas.</p> <p><b>GENERATORS</b></p> <p><b>TURN SCRAP INTO MONEY.</b> Autopower shows you how easily and economically auto generators can be converted into A.C. or D.C. generators, and D.C. motors, 2 to 1000 volts; for sound, radio, power, light, or welding. No previous experience necessary—complete information all in new book, with simple instructions and illustrations. Endorsed by thousands. Only \$1.00 postpaid. Autopower, 414-M So. Hoyne Ave., Chicago.</p> <p><b>"HAM" OFFERS AND WANTS</b></p> <p><b>SKYRIDERS HALLCRAFTERS</b> bargains, many makes new and used, will trade. Also trade Leica and Zeiss and Lenses. Wells-Smith, 71 E. Adams St., Chicago. Formerly at 26 N. Wells St.</p>	<p><b>ALL STAR SENIOR \$35 10 TO 550</b> meters. Beat oscillator, phone jack, and standby switches. Speaker, tubes and complete coils. Leland Olson, Litchfield, Minnesota.</p> <p><b>EXCHANGE: TYPEWRITER, UNDERWOOD No. 5</b> for short wave receiver. George Brand, Temperance, Mich.</p> <p><b>NATIONAL F.B.X.A. RECEIVER,</b> complete. Write for particulars. Charles Brown, 333 Hazel St., Lancaster, Pa.</p> <p><b>WANTED GOOD USED TRANS-</b>mitter, complete, give details. Thornton, Somerville, Ohio.</p> <p><b>INSTRUCTION</b></p> <p><b>AMATEUR RADIO, COMMERCIAL</b> Radiotelephone and Radiotelegraph licenses, complete training, Resident and correspondence courses. Every graduate a licensed operator. N. Y. Wireless School, 1123 Broadway, New York.</p> <p><b>MISCELLANEOUS</b></p> <p><b>OHM'S LAW CALCULATOR—</b>Lightning Slide Rule; solves all problems of Voltage, Current and Resistance, Power, Wire Sizes, etc. Range: 1 micro-amp. to 1000 amps.; 1 micro-volt to 10,000 volts; 1 micro-ohm to 10 meg-ohms; 1 micro-watt to 10 megawatts; wire sizes 0 to 36 B. &amp; S. gauge. Introductory price \$1.00 prepaid. The Dataprint Co., Box 322, Ramsey, N.J.</p> <p><b>QSL—CARDS—SWL</b></p> <p><b>QSL, SWL CARDS, NEAT, ATTRAC-</b>tive, reasonably priced, samples free. Miller, Printer, Ambler, Pa.</p> <p><b>ALUMINUM CALL LETTER</b> Plates. ¼"x2"x6½". \$.75 two \$1.25. W-8-E-S-N.</p> <p><b>DIRECTORY OF SHORT WAVE</b> Listeners. Names, Addresses. \$.15. W-8-E-S-N.</p>	<p><b>SWLs, QSLs CARDS, ATTRAC-</b>tive. Reasonable. Samples (Stamps). W-8-E-S-N, 1827 Cone, Toledo, Ohio.</p> <p><b>RADIO EQUIPMENT</b></p> <p><b>ANY CHASSIS LISTED IN THIS</b> or other magazines will be built by us exactly according to your drawing or their specifications for 75c. Send sketch. Send no money. We ship COD, 48 hour service, try us. Radio Equipment Company, Box 204, Charlotte, Michigan.</p> <p><b>SET BUILDERS, EXPERIMENT-</b>ers. House your apparatus in neat satin crackle finish metal cabinets, made to your specifications. Send your sketches for estimates. Price list of ready made cabinets sent on request. Wilson Mfg. Co., 4318 N. Western Ave., Chicago.</p> <p><b>NOISE REDUCING TRANSFORM-</b>er for your radio. Easily attached, made from old parts. Plans 20c, or complete equipment \$1.00. T. S. Barker, Hawthorne, New Jersey.</p> <p><b>HUNDREDS OF NEW AND RARE</b> electrical items, replacement parts and supplies. Send 10c for new 60-page wholesale catalog. Autopower, 414 S. Hoyne, Chicago.</p> <p><b>BEGINNERS! SUPER-SENSITIVE</b> crystal with short wave circuit. Dime and stamp. Arco, 30-45 41 St., Astoria, L.I.</p> <p><b>SHORT WAVE RECEIVERS</b></p> <p><b>SW CRYSTAL SET—4250 MILE</b> record. Blueprint 18 Distance Models; Catalog: "Radiobuilder" year—25c. Laboratories, 151-A Liberty, San Francisco.</p> <p><b>W8KPX DESIGNS OR BUILDS</b> any receiver or transmitter to your specifications. Precision work. Reasonable prices. Harry D. Hooton, W8KPX, Henderson, W. Va.</p> <p><b>BEST 1-5 TUBERS, ADDRESS</b> inquiry to John Newman, Emerson, Ga.</p>
--	--	--

# 69¢ WHILE THEY LAST!

**The One and Only**  
**ENCYCLOPEDIA ON SHORT WAVES**

By C. R. LEUTZ and R. B. GABLE

"SHORT WAVES" is written by Leutz and Gable, two foremost radio authorities. Charles R. Leutz is one of the pioneers in radio—designer and manufacturer of LEUTZ TRANSOCEANIC RECEIVERS. Robert Gable owned and operated one of the finest low-power broadcasting stations. He is a well-known experimenter and research worker.

Considering the value of this book alone, its cost should really be more than originally asked. You will marvel at the illustrations and ask how this book could now be sold at the sensationally low price of *sixty-nine cents*. Its original price was \$2.98 a copy.

Only a few hundred remain—once they are gone no more can be obtained by us, as the book will not be reprinted.

The book is printed on expensive super-calendered stock and contains 384 pages with over 345 photographic illustrations and diagrams. The supply of these books is diminishing rapidly—ORDER NOW. Tell your friends about this remarkable value. Send the coupon for your copy.

**Partial Contents of "Short Waves"**

HISTORICAL REVIEW \* SHORT WAVE PROPAGATION \* COMMERCIAL RADIO TELEPHONY AND TELEGRAPHY \* SHIP TO SHORE RADIO TELEPHONY \* DIRECTIONAL ANTENNAE \* TELEVISION \* AIRCRAFT RADIO EQUIPMENT \* SHORT WAVE BROADCAST RECEIVERS \* ULTRA SHORT WAVES \* AMATEUR SHORT WAVE EQUIPMENT.

**384 PAGES—OVER 345 ILLUSTRATIONS**  
*Bound in Attractive, Stiff, Red Linen Cover*  
**SIZE—6x9 INCHES**

**"SHORT WAVES" is the most important and comprehensive volume on short-waves ever published. This book has everything on short-waves—it literally contains a complete education on short-waves.**

**RADIO PUBLICATIONS**  
103 Hudson St., New York, N. Y.

RADIO PUBLICATIONS, Dept. SWT-537  
103 Hudson St., New York, N. Y.

Gentlemen: Enclosed you will find my remittance of Sixty-nine Cents (69c), cash, money order or new U. S. Postage Stamps accepted, for which send me one copy of "SHORT WAVES" by Leutz and Gable.

Name .....

Address .....

City ..... State .....

(Include 15c extra to cover mailing charges in U. S.; 25c for foreign countries)

Please mention SHORT WAVE & TELEVISION when writing advertisers

\$1.00 TUBE SALE

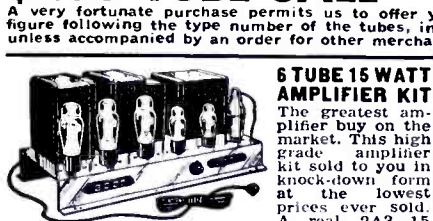

6 TUBE 15 WATT AMPLIFIER KIT

The greatest amplifier buy on the market. This high grade amplifier kit sold to you in knock-down form at the lowest prices ever sold. A real 2A3-15 Watt amplifier with complete kit of parts less tubes using the finest R.C.A. transformers and filter condensers. Parts that will last a lifetime. Chassis complete, drilled and easily put together. Very easy to assemble by means of our large working blue print. Complete parts—\$6.95. Kit of tubes \$4.65 extra. Ship. wt. 35 lbs. To give you an idea how sturdy these parts are constructed, the entire amplifier wired weighs 30 lbs.



BRUNSWICK-BREMER-TULLY 6 tube battery console radios

1 dial, completely shielded radio circuit using 3 stages R.F. Utilizes 201A and 171A tubes. 4 tuning stages, single control. Size of chassis 15 1/4 x 10 x 7. Shipping weight 78 lbs. Complete in console cabinet. Size of Console—21 x 40 x 14 1/2. Brand new factory sealed cases. We suggest freight shipments. \$4.95 LESS TUBES SHIPPING WT 70 Lbs. AD1171 AD6669 \$4.95

BUILD YOUR OWN RADIO SETS

2 Band 5-Tube Super Het Kit. Comprising of 1 oscillator, 2-456 KC. Double Tuned I-F Transformers—1 Antenna coil, 1-2 gang oscillator tracking condenser, complete with wiring diagram, unwired. \$1.95 Drilled Chassis to Match. 29c Kit of other essential parts to complete set including condensers, resistors, choke filter, volume control, nuts, bolts, etc. AD-900-B—Super Het kit. Complete less tubes. \$2.39 Set of Five Matched Tubes. \$2.95

6-TUBE ALL WAVE KIT

A complete set of coils (12 coils) covering from 12 to 555 meters (20,000 to 540 K.C.). Kit consists of 1-3 gang condenser; 1 band changing switch; 4 sets of coils, short-wave, oscillator and antenna; 2 I-F transformers; wiring diagram. Complete set of parts less tubes, chassis, speaker, dial and essentials, unwired. \$3.95 AD-5000 1 chassis for above. \$1.75 Complete set of essential parts, necessary to complete this entire set, less tubes. \$4.95 Speaker and dial. \$1.25 1 kit of 6 tubes—Glass \$3.27—Metal \$3.51 8 tube All-Wave Kit, less chassis, speaker, dial, tubes, essentials, unwired. \$4.95 1 chassis. \$1.25 Complete set of essential parts, necessary to complete this entire set, less tubes, speaker and dial, unwired. AD-5001 \$5.95 1 kit of 8 tubes—Glass \$4.25—Metal \$4.69 10 tube All-Wave Kit, less chassis, speaker, dial, essentials, tubes, speaker, dial, unwired. \$5.95 1 chassis. \$1.75 Add \$1.00 to price of each kit for Magic Eye Tuning unit, Magic eye tube 6E5. \$1.88 100 Asst. RMA Resistors. \$1.29

\$1.00 TUBE SALE

Table listing various vacuum tube types and their prices, such as 12Z3, 40, 71A, 6Z4, 6Q7G, 2A3, 24A, 41, 75, 85, 6R7G, 2A5, 25Z5, 43, 77, 89, 6X5G, 2A7, 26, 45, 78, 83, 5Y3G, 2A6, 27, 46, 79, 112A, 6A8, 2B7, 30, 47, 80, 6A8G, 6C5, 5Z3, 32, 49, 82, 1C7G, 6F5, 6A7, 3, 50, 83, 6C5G, 6F6, 6B7, 33, 53, 83V, 6D8G, 6C6, 34, 55, 182, 6F5G, 6K7, 6D6, 35, 56, 183, 6H6G, 6E5, 36, 57, 484, 6J5G, 6Q7, 6F7, 37, 58, 485, 6K7G, 6X5, 210, 38, 59, 484, 6L6G, 5Z4, 12A7, 39-44, 59, 484, 6L6G, 5Z4. These tubes are RCA Licensed and are Triple Tested.

BUILD YOUR OWN ALL WAVE RADIO

5 Band All Wave Tuning Assembly 42,000 K.C. to 550 K.C. (7 to 600 meters). Completely assembled and wired. Complete switch, an all wave Super-Het. YAXLEY Single knob band switches. GENUINE MEISSNER coils. Completely wired with all connections soldered, CD mica condensers, etc. Can be installed in your present receiver by connecting grid and plates of 3 tubes. Size of unit 8"x8"x2". AD 6666. Tuning unit assembled and wired reg. price \$12.95...our Price \$4.95 Complete instructions and diagrams, Extra. 25c This unit can be made into an 8 or 10 tube set. Kit of all essential parts for 8 tube set—\$9.95. Kit of tubes \$6.23. Kit of parts—10 tube set \$11.96. Kit of tubes \$8.35. Less speaker, chassis and dial. Magic eye tuning unit \$1.00 extra. Magic eye tube 90c extra.

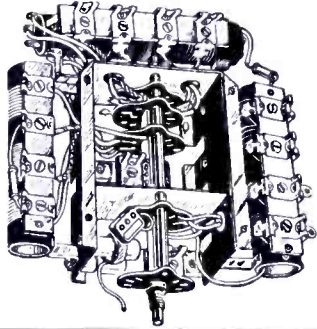

Yaxley Band-Changing Switch. Designed especially for all-wave sets. Silver plated contacts. Three positions. Excellent for short-wave as well as for analysers. No. AD-111. AD 112A. Three double sections for use on 4 band all wave radios. 5 stops—(can be adjusted to 12 stops). .49 CRL Potentiometer—Volume control 1M, 2M, 3M, 4M, 5M, 10M, 15M, 20M, 25M, 50M, 100M, 150M, 250M, 500M Special. .29 Nationally Known 6 1/2 inch Dynamic Speakers 1500 ohms. Output transformer to match 38, 12A7, 71A, 43, 45, 2A5, 47, 59, 53 tubes. 89c SAME SPEAKER—10 1/2 inch, available in the following sizes: 1000, 1500, 2000 ohm field coils; brand new, less output transformers. 10" SPEAKER less transformer. \$1.95 OUTPUT TRANSFORMERS, extra 25c PP-45-2A3 extra. 39c UNITED EAR PHONES. 89c OUTPUT TRANSFORMERS, single 39c 2,200 ohms—3,500 ohms. \$1.19

RADIO EXPERIMENTERS SURPRISE PACKAGE. A large box chocked full of assorted radio parts, worth over \$10.00—parts that any radio experimenter and set builder can use. All brand new—no junk. Weight 20 lbs.—AD-1260—\$1.29. Giant surprise kit, weight 40 lbs.—\$2.58. GE POWER TRANSFORMERS 6-7 tube 6.3 fil. AD101-99c. AD102-7.8 tube—\$1.59; AD103-8-10—\$1.96. Unshielded power transformers 6.3 fil. 6 tubes—65c; 8 tubes—85c; 10 tubes \$1.15. Flush mount 4 tubes 2 1/2 V. fil. power transformer—63c; 6 tubes—99c; 8 tubes—\$1.19; 10 tube—\$1.49. AC-DC FILTER CHOKES—Small, compact units designed for use in AC-DC midget sets—25c. 2 1/2 Mil Short Wave RF Choke. Low loss chokes pie wound on insulative forms—15c. PRESTO PHONOGRAPH PICK UP. High impedance. Brand new 12" self-balancing arm.—AD 1309X—\$3.75. MIDGET VARIABLE CONDENSERS. For use as antenna-trimmers and vernier tuning condensers. Capacity approx. 20 mmf. with knob and pointer. 9 plate No. AD-117—25c. CCA WET ELECTROLYTIC FILTER CONDENSERS. 500 Volts; 8 MFD—29c; 10 MFD—35c; 12 MFD—38c; 14 MFD—40c; 16 MFD—45c; 175 KC. I.F. TRANSFORMERS SHIELDED—39c. AD900B 456 KC. Double tuned I.F. Transformer—49c. AD900A, Spaghetti Tubing—30" lengths—12 for 25c. Pilot 30 Henry 90 mil. Filter chokes 49c. Algonquin 18" magnetic Speaker—\$2.95.

\$1.00 TUBE SALE

Universal 3 gang compact variable condensers. Capacity .000365 Mmf. Can be used with any type TRF. or Super-heterodyne All Wave receiver. Universal clock-wise or counter-clock-wise 3/8" or 1/4" shaft with compensating condensers. AD-113 49c

KOLSTER AMPLIFIER A-B-C POWER SUPPLY

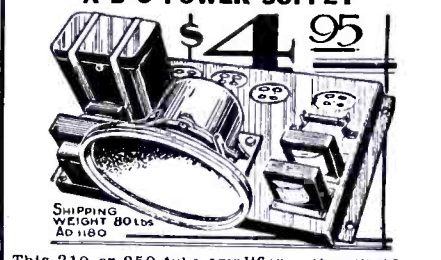

This 210 or 250 tube amplifier unit with 12 1/2" 25 Watt speaker, brand new in factory sealed cases, costing over \$100.00, ready to use as amplifier and tapped power supply. Conversion diagram for making 15 Watt High Gain amplifier furnished free. Makes a fine P. A. system.

THE NEW 1937 HUM FREE POWER SUPPLY PACK

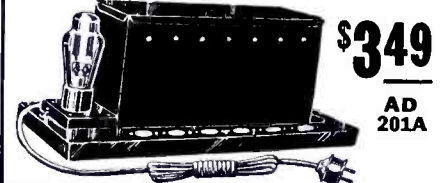

This pack will supply 2 1/2 or 6.3 (please specify) filament voltage up to 8 tubes. Pure rectified DC 350 Volts at 80 mils. "B" supply tapped at 45, 90, 180, 250 volts, 6 amps. filament. Well filtered, extra heavy. Complete kit \$3.49 with wiring diagram and drilled chassis, less tubes. Wiring 50c extra. Rectifier tube 40c. Shipping weight 27 lb.

4-TUBE TRF KIT. 4-tube TRF Circuit, operates on AC-DC current. Complete parts with drilled chassis, ready to wire with wiring diagram, includes 5" dynamic speaker, hardware, etc., less tubes and cabinet, unwired. \$4.95 Kit wired, extra. 1.00 Kit of 4 tubes. 2.25 AD 204 Walnut cabinet to match. 1.75

We do not accept any order less than \$1.00. All remittances must include a sufficient amount to cover postage and insurance. No C.O.D.s unless accompanied by a deposit. Free! Send stamp for our free catalog and bargain bulletin which contains hundreds of other items not listed above.



UNITED RADIO COMPANY Successors to Radio Trading Company 58 MARKET STREET Dept. S-5 NEWARK, N. J.



In this connection I might mention in passing that I met two radio officers from a British merchant vessel some months back at the conclusion of a demonstration I gave at a local radio club meeting. These men having been brought over by the local U. S. Government radio inspector, I don't at the moment recall the name but G2NO could give it to you as the men communicated with him upon their return. As I recall it, the club officers had these two visitors select plain English written material from a Boston newspaper of the current day; another man took it and perforated it on a Kleinschmidt perforator and then it was run through the Creed transmitting head, at a speed somewhere in the vicinity of 70 words per minute; and I gave a copy of the material as I copied it at that speed to the visitors, who said they were taking it back to England as souvenirs.

Now for a bit of technical explanation. When material is to be transmitted in radio signals at high speeds, the material is prepared on a perforated tape on a machine known as a Kleinschmidt, as referred to previously herein. This Klein is an instrument similar in appearance to a typewriter. But when a key is depressed, say the letter "V," there appears on the paper tape which is automatically fed into the perforating mechanism, a series of tiny holes. Then on the transmitting device, tiny pins shoot through these holes making contact. And the arrangement of the holes make either dots or dashes. For example, this letter "V." There appears on the tape three holes at top of imaginary center line and three holes directly under those. Then one more hole on top of tape and another one just one hole removed on under side of tape. A pin shoots through the top hole to make contact and an instant later another pin shoots through the bottom hole to

break the contact. In case of a dash the bottom hole being one hole removed, it is twice as long before the "break contact" pin shoots through. So, on the letter "V" it is three dots and a dash.

Now in ordinary application there is the space of one dot between letters and the space of three dots between words. I give herewith a sample of the tape with the word "PARIS" which is considered in commercial practice as a perfect five letter word and it is upon this word that all word counts are based.

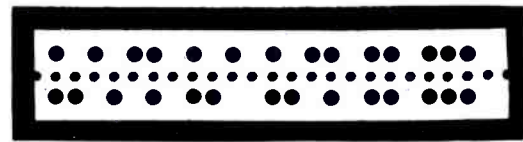

P A R I S

Note that this perfect 5-letter word takes exactly 24 center or feed holes. Now then, in high speed contests the judges take a piece of perforated tape with the "PARIS" on it and run this tape through the transmitter to determine the exact speed. Example: we run PARIS through the transmitter thirty times in one minute, the speed is 30 wpm; we run it through 70 times in one minute and the speed is 70 words per minute and then with the transmitter continuously running at that speed, brand-new, unknown plain English press material is run through and the contestants try to copy.

Just for purposes of the record, and not to do any boasting, I might say at this point that the highest speed I have ever known of actually being copied in an official tournament was the

69 words per minute I copied for three minutes steadily, with but one error, when I last regained my title in 1935.

In demonstrations at various places and times, where there was no strain such as I might be under at an official tournament, I have copied with perfect copy up to 75 and 80 words per minute. But the only records that actually count are those where there are certified officials and the figures are very carefully checked and the material carefully guarded, so that no contestant has any ideas as to what might be in the material.

Your instructor is certainly quite right when he says that the average extreme limit for copying is 45 words per minute. I have been an operator for about 25 years and have travelled extensively during that time and I know that 45 words per minute is just about the tops for the average, exceptionally good radio, telegraph or cable operator. In my own case I can simply plead that I must have very little else in my head to encumber whatever portion of the brain responds to radio-telegraph signals!

I would hardly be fair if I did not mention that exceptional skill as a typist has much to do with the higher speeds. I find no difficulty whatever in typing much better than 100 words per minute, here again figuring five strokes of the typewriter keys to the word. The average typist, skilled stenographer, types about 60 to 70 words per minute.

Although it is true that I have been very fortunate in winning a number of tournaments in transmission of signals, I can lay no claim to any extreme speeds on sending. Using a semi-automatic transmitting key of my own design, which I now market under my own name and for which I have found much use in the British Isles as well as here in the States, I have at-

(Continued on page 63)

Please mention SHORT WAVE & TELEVISION when writing advertisers



tained speeds slightly in excess of 50 words per minute, but it is a terrific strain and I would say that when I sit down and transmit 45 words per minute, 5 letters to the word, and have it recorded on an ink recorder with perfect signals, that I am doing my average limit.

As a Britisher, I feel sure you will get a chuckle out of one stunt that we here in America have enjoyed. I take a newspaper and transmit in American Morse characters which are slightly different from the Continental Morse used in cable and radio work, and by the use of a system of abbreviations common to American newspaper telegraphers, known as Phillips' code, I have given demonstrations in transmitting where the highest speed I recall at the moment was 108 words in one minute. Fun!

And now my friend, I fear I may have wearied you with this lengthy letter. But sit-

ting here writing of a subject that means so much to me, I find myself writing seemingly without end. So let us close it off with the once more expressed hope that I shall have the pleasure of seeing you and many other friendly radiomen in England during the coming summer, and that together we shall enjoy many of these demonstrations which are really fun.

Sincere good wishes and a hope that I may hear from you again,

Yours, etc.,  
T. R. McELROY.

### Credit Correction Notice

In the article entitled, "Low-Cost Oscilloscope," by H. G. McEntee, page 731 of the April issue, six "Domino" Solar condensers were used in building it; also the electrolytic condensers should have been specified as Solar "Little Giant."

## NBC's New Aerials Favor South America and Europe

(Continued from page 24)

beam is directed. The South American beam antennas are built in the form of a huge "V", with the apexes supported by a 250 foot steel tower, and with the ends supported by guyed wooden poles 170 feet high. The use of these antennas gives the effect of 60,000 watts on 17,780 kcs., and 150,000 watts on 6100 kcs.

The European beams are also built in the form of huge "V's" supported by 165, 170, and 110 foot poles. The European beam produces the effect of 200,000 watts on 17780 kcs., and 275,000 watts on 6100 kcs. The spans in the European beams are

400 feet and the South American beams, 570 feet. All of these beams are fed by means of long transmission lines with impedance-matching networks. The wooden masts consist of butt-spliced poles, each of which is 85 feet in length. A special steel splicing cage was required in each case. Each mast is supported by three sets of guy wires. The poles were specially selected and shipped from the mid-west. A crew of 25 men well equipped with hoisting machinery, cables, etc., were required to erect each pole.

### Index to Advertisers

<b>A</b>	
ABC Radio Laboratories.....	38
Ace Radio Laboratories.....	36, 57
Allied Engineering Institute.....	48
Allied Radio Corp.....	45
Arco Tube Co.....	59
Astatic Microphone Laboratory, Inc.....	46
Audel, Theo., & Co.....	48

<b>B</b>	
Bond Radio Company.....	57

<b>C</b>	
Cameradio Co.....	41
Candler System Co.....	53
Classified Advertisements.....	61
Cornell-Dubilier Corp.....	46
Cornish Wire Co.....	36
Coyne Electrical & Radio School.....	1
Cutting & Sons.....	59

<b>D</b>	
Dataprint Company.....	59
Dodge's Institute.....	52

<b>E</b>	
Eagle Radio Co.....	38
Eilen Radio Laboratories.....	35
Electrad, Inc.....	36
Electric Institute, Inc.....	55

<b>F</b>	
First National Television, Inc.....	53
Fisher Research Laboratories.....	46

<b>G</b>	
Gold Shield Products Co.....	59
Goldentone Radio Co.....	50
Guy Stokely Radio Corp.....	37

<b>H</b>	
Hallcrafters, Inc.....	42
Hammarlund Manufacturing Co., Inc.....	43
Harrison Radio Company.....	38

<b>I</b>	
Instructograph Company.....	53
International Resistance Co.....	44

<b>K</b>	
Kenyon Transformer Co., Inc.....	41
Korrol Mfg. Co., Inc.....	42

<b>M</b>	
McElroy, T. R.....	53
Massachusetts Radio School.....	52
Meissner Manufacturing Co.....	39
Milady.....	63

<b>N</b>	
National Company, Inc.....	Inside Back Cover
National Radio Institute.....	Back Cover
National Schools.....	52

<b>O</b>	
Onan, D. W., & Sons.....	57
Oxford Laboratories.....	48

<b>R</b>	
Radio & Technical Publ. Co.....	52
Radio & Television Institute.....	52
Radio Constructors Laboratories.....	.....

<b>S</b>	
Sargent, E. M., Co.....	47
Short Wave Coil Book.....	55
Short Wave League.....	60
Short Waves.....	61
Sprague Products Co.....	57
Sprayberry Academy of Radio.....	51
Standard Radio.....	41
Standard Transformer Corporation.....	44
Sunshine Novelty Co.....	40
Superior Instruments Company.....	50

<b>T</b>	
Technifax.....	63
Teleplex Co.....	52
Tiedemann, Fred C.....	48
Triplett Electrical Instrument Co.....	47
Tri-State College.....	52
Try-Mo Radio Co., Inc.....	50, 63

<b>U</b>	
Ultra High Frequency Products Co.....	50
United Radio Company.....	62
Utah Radio Products Co.....	42

<b>V</b>	
Vanderbilt Radio Co.....	50

<b>W</b>	
Wellworth Trading Company.....	57
Wholesale Radio Service Co., Inc.....	40

(While every precaution is taken to insure accuracy, we cannot guarantee against the possibility of an occasional change or omission in the preparation of this index.)

## POWERTONE

### 5-Band 4-Tube A. C. - D. C. Communications Receiver

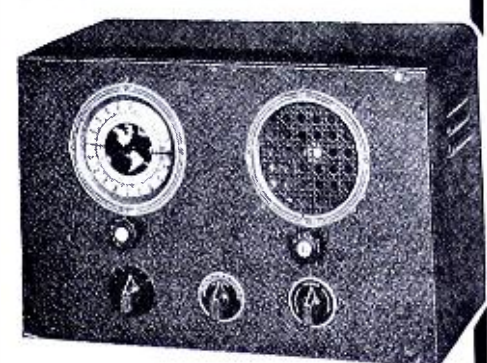

Recognized by amateurs and short-wave experimenters as one of the year's outstanding receivers. Contains the following features—Band spread tuning—New metal tubes—4" Airplane dial—Built-in dynamic speaker—5-Band switch coil assembly—15-550 meter tuning, no gaps—A.C. or D.C. operation—and many others too numerous to mention. Efficient circuit employs 2-6K7's, 1-43, and 1-25Z5. Special phone jack automatically cuts out dynamic speaker for headphone reception.  
Complete Kit of parts, unwired, less tubes and Cabinet, Your Cost.....\$10.50  
Wiring And Testing Extra.....2.50  
4 Matched Sylvania Tubes.....2.25  
All Metal Crystal Cabinet.....2.25

### BUDDY 2-TUBE A.C.-D.C. RECEIVER



Use of 1-6J7 metal tube and 1-12A7 as a combined rectifier and pentode output tube. Coils furnished tune from 15 to 200 meters. Additional coils to extend the tuning range down to 9 1/2 and up to 2000 meters are also available. Airplane dial aids materially in tuning in stations.  
Complete Kit of parts, unwired, less tubes, additional coils and cabinet.....\$4.50  
Wiring and testing.....1.25  
2 Matched Sylvania Tubes.....1.50  
9 1/2-15 and 200-2000 meter coils.....1.75  
Metal Crystallized cabinet......95

TRY-MO RADIO CO. Inc.  
85-Cortlandt St. N.Y.C.

## TREASURE LOCATORS BLUEPRINTS AND INSTRUCTIONS

For Building the Following Treasure Finders and Prospecting Outfits  
Folder No. 1. Hughes Induction Balance Circuit  
Folder No. 2. Sensitive Hughes Induction Balance Circuit  
Folder No. 3. Single Super-Sensitive Hughes Induction Balance Circuit  
Folder No. 4. Radio Frequency Oscillator Circuit  
Folder No. 5. Audio Frequency Oscillator Circuit  
Folder No. 6. Combination Radio Transmitter and Receiver Circuit

With any one of these systems you can construct instruments to locate buried treasures, metal war relics, mineral deposits, subterranean water veins, buried gas and water pipes, lost objects, tools and treasures sunken in water, etc.

**\$1.00** for each set of blueprints and instructions. The complete set of six folders.....**\$5.00** (Sent postpaid)

**TECHNIFAX**  
558 W. Washington Blvd., Division 57-W, CHICAGO, ILL.

## MILADY

The Woman Magazine Sensation  
MILADY (combined with WOMAN'S DIGEST) is the magazine of by and about women—it brings you inside facts on many popular subjects. There's tips on fashions, beauty secrets, child problems, recipes and the home. Monthly cash prizes too. There are sparkling short stories and best reviews from the world's press. MILADY has a beautiful three-color cover and contains many full-page illustrations. For your mother, your sister, sweetheart or wife. On all good newsstands at 25c a copy; or **\$1.00 to publishers for the next five monthly issues.**  
MILADY, 99-SW Hudson St., New York, N.Y.

# Here are the Six BEST SHORT-WAVE RADIO BOOKS!

Without doubt you will have to go a long way to buy better books on short waves than you find on this page. Each book is written by a well-known authority on short waves . . . each book has been carefully illustrated with photographs and diagrams to

make the study of this field of radio much simpler. The volumes on this page are the finest books on short-waves which are published anywhere today. Order one or more copies today . . . find out for yourself how fine they are. Prices are postpaid.

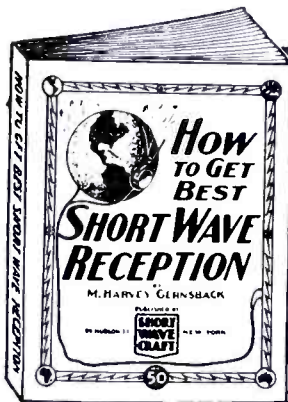

## How to Get Best Short-Wave Reception

By M. HARVEY GERNSHACK

This book tells you everything you ever wanted to know about short-wave reception. The author, a professional radio listener and radio fan for many years, gives you his long experience in radio reception and all that goes with it. Why is one radio listener enabled to pull in stations from all over the globe, even small 100 watters, 10,000 miles away, and why is it that the next fellow, with a much better and more expensive equipment, can only pull in the powerful stations that any child can get without much ado? The reason is intimate knowledge of short waves and how they behave. Here are the chapters of this new book:

1. What are Short Waves and what can the listener hear on a short-wave receiver or converter?
2. How to tune and when to listen in on the short waves.
3. How to identify short-wave stations.
4. Seasonal changes in short-wave reception.
5. Types of receivers for short-wave reception.
6. Aerial systems for short-wave receivers.
7. Verifications from short-wave stations.

The book makes excellent reading matter. There are many tricks in short-wave reception that even some of the "old-timers" do not know. Be sure to get it.

40 Illustrations, 72 Pages. **50c**  
Stiff, flexible covers

## HOW TO BUILD AND OPERATE SHORT-WAVE RECEIVERS

THIS is the best and most up-to-date book on the subject. It is edited and prepared by the editors of SHORT WAVE & TELEVISION, and contains a wealth of material on the building and operation, not only of typical short-wave receivers, but short-wave converters as well. Dozens of short-wave sets are found in this book, which contains hundreds of illustrations; actual photographs of sets built, hookups and diagrams galore.

This book is sold only at a ridiculously low price because it is our aim to put this valuable work into the hands of every short-wave enthusiast.

We know that if you are at all interested in short waves you will not wish to do without this book. It is a most important and timely radio publication.

150 Illustrations, 72 Pages. **50c**  
Stiff, flexible covers

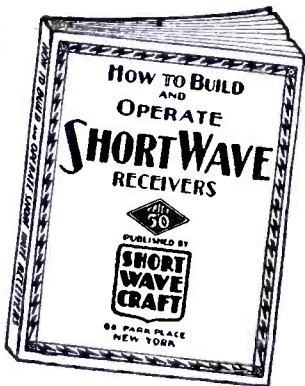

## THE SHORT-WAVE BEGINNER'S BOOK

HERE is a book that solves your short wave problems—leading you in easy stages from the simplest fundamentals to the present state of the art as it is known today. It is the only low-priced reference book on short waves for the beginner. The book is profusely illustrated—it is not "technical." It has no mathematics and no technical jargon. It also gives you a tremendous amount of important information, such as time conversion tables, all about aerials, noise elimination, all about radio tubes, data on coil windings and other subjects.

### Partial List of Contents

Getting Started in Short Waves—the fundamentals of electricity. Symbols, the Short Hand of Radio—how to read schematic diagrams. Short Wave Coils—various types and kinds in making them. Short Wave Aerials—the points that determine a good aerial from an inefficient one. The Transposed Lead-in for reducing Static. The Beginner's Short-Wave Receiver—a simple one tube set that anyone can build. How to Tune the Short-Wave Set—telling the important points to get good results. Audio Amplifiers for S-W Receivers. Learning the Code—for greater enjoyment with the S-W set. Wave length to Kilocycle Chart. Wire Chart—to assist in the construction of coils.

75 Illustrations, 40 Pages. **25c**  
Stiff, flexible covers

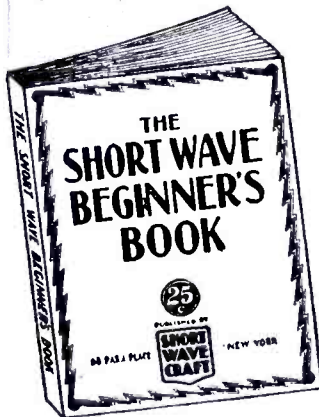

## 101 SHORT-WAVE HOOKUPS

Compiled by the Editors of SHORT WAVE & TELEVISION

EACH and every hook-up and diagram illustrated is also accompanied by a thorough explanation of what this particular hook-up accomplishes, what parts are required, coil-winding information, values of resistors, etc., in fact, everything you want to know in order to build the set or to look up the data required. To be sure, all of the important sets which have appeared in print during the past five years are in this valuable book. Sets such as the Doerle, Dinsmore, the "19" Triplex, Oscillodyne, Denton "Stand-by," Megadyne Triplex 2, "Globe-Trotter," 2-Tube Superhet, "Minidyne," "Loop" Receiver, "Doerle" 2-tube Battery, "Doerle" 3-tube Battery, "Doerle" 2-tube A.C., "Doerle" 3-tube A.C. Doerle "Signal Gripper," Duo R.F. 4-tube Receiver, The Sargent 9-33 Tapped Coil Receiver, Globe-Girdler 7, The 2-Tube "Champ," 2 Tubes Equal 3 Ham-Band "2-Tube" "Pee-Wee" Wyeth All-Wave 6, Denton Economy 3, 2-Tube "Regenerative-Oscillodyne" will be found here, with full descriptions. In many cases, we have also included a picture hook-up for those who do not wish to follow the regular symbolic hook-up, but wish to have a regular wiring diagram. This is a very handy volume, especially for those "fans" who wish to study the best sets in the short-wave art. From one tube up to ten tubes.

100 Illustrations, 72 Pages, **50c**  
Stiff, flexible covers

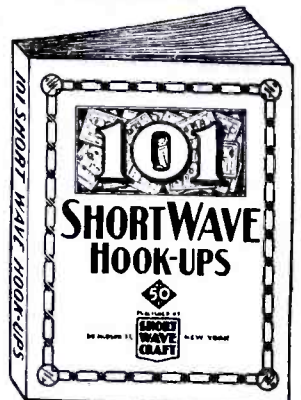

## HOW TO BECOME AN AMATEUR RADIO OPERATOR

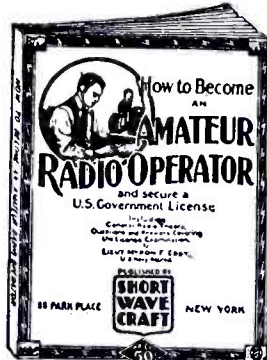

WE chose Lieut. Myron F. Eddy to write this book because his experience in the amateur field has made him prominent in this line. For many years he was instructor of radio telegraphy at the R.C.A. Institute. He is a member of the I.R.E. Institute of Radio Engineers, also the Veteran Wireless Operators' Association.

If you intend to become a licensed code operator, if you wish to take up phone work eventually—this is the book you must get.

### Partial List of Contents

Ways of learning the code. A system of sending and receiving with necessary drill words is supplied so that you may work with approved methods. Concise authoritative definitions of radio terms, units and laws, brief descriptions of commonly used pieces of radio equipment. This chapter gives the working terminology of the radio operator. Graphic symbols are used to indicate the various parts of radio circuits. General radio theory particularly as it applies to the beginner. The electron theory is briefly given, then waves—their creation, propagation and reception. Fundamental laws of electric circuits, particularly those used in radio are explained next and typical basic circuits are analyzed. Descriptions of modern receivers that are being used with success by amateurs. You are told how to build and operate these sets. Amateur transmitters. Diagrams with specifications are furnished so construction is made easy. Power equipment that may be used with transmitters and receivers, rectifiers, filters, batteries, etc. Regulations that apply to amateur operators. Appendix which contains the International "Q" signals, conversion tables for reference purposes, etc.

50c 150 Illustrations, 72 Pages, Stiff, flexible covers

## TEN MOST POPULAR SHORT-WAVE RECEIVERS

—HOW TO MAKE AND WORK THEM

THE editors of SHORT WAVE & TELEVISION have selected ten outstanding short-wave receivers and these are described in the new volume. Each receiver is fully illustrated with a complete layout, pictorial representation, photographs of the set complete, hookup and all worth-while specifications. Everything from the simplest one-tube set to a 5-tube T. R. F. receiver is presented. Complete lists of parts are given to make each set complete. You are shown how to operate the receiver to its maximum efficiency.

### CONTENTS

The Doerle 2-Tube Receiver That Reaches the 12,500 Mile Mark, by Walter C. Doerle.  
2-R.F. Pentode S-W Receiver having two stages of Tuned Radio Frequency, by Clifford E. Denton and H. W. Secor.  
My de Luxe S-W Receiver, by Edward G. Ingram.  
The Binneweg 2-Tube 12,000 Mile DX Receiver, by A. Binneweg, Jr.  
Build a Short-Wave Receiver in your "Brief-Case," by Hugo Gernsback and Clifford E. Denton.  
The Denton 2-Tube All-Wave Receiver, by Clifford E. Denton.  
The Denton "Stand-By," by Clifford E. Denton.  
The "Stand-By" Electrified.  
A COAT-POCKET Short-Wave Receiver, by Hugo Gernsback and Clifford E. Denton.  
The S-W PENTODE-4, by H. G. Cisin, M. E.  
Louis Martin's Idea of A GOOD S-W RECEIVER, by Louis Martin.

75 Illustrations, 40 Pages, **25c**  
Stiff, flexible covers

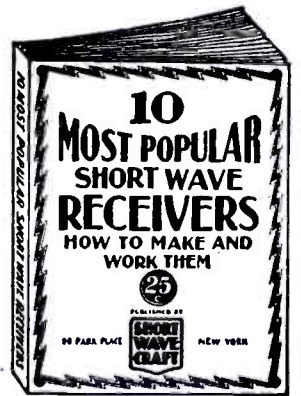

All the books shown on this page are published exclusively by

## SHORT WAVE & TELEVISION

99-101 Hudson Street  
New York, N. Y.

CLIP-MAIL

SHORT WAVE & TELEVISION, 99-101 Hudson Street, New York, N. Y. SWT-5-37

Gentlemen: I enclose herewith my remittance for the amount of \$..... for which you are to send me, postpaid, the books checked below.

- |  |  |
|--|--|
| ( ) How to Get Best Short-Wave Reception..... 50c each         | ( ) How to Become an Amateur Radio Operator..... 50c each                          |
| ( ) 101 Short-Wave Hook-ups..... 50c each                      | ( ) Ten Most Popular Short-Wave Receivers. How to Make and Work Them..... 25c each |
| ( ) How to Build and Operate Short-Wave Receiver..... 50c each | ( ) The Short Wave Beginner's Book..... 25c each                                   |

Name.....

Address.....

City..... State.....

(Send remittance in form of check or money order. If letter contains cash or unused U. S. Postage Stamps, register it.)

Please mention SHORT WAVE & TELEVISION when writing advertisers

## OVERSEAS READERS!

These books can be obtained from the following houses:

GREAT BRITAIN  
Gorrings  
9a, Green Street, Leicester Square  
London, England

FRANCE  
Editions Radio  
42 Rue Jacob  
Paris

AUSTRALIA  
McGill's  
183-195, 218 Elizabeth St.  
Melbourne, C. I.

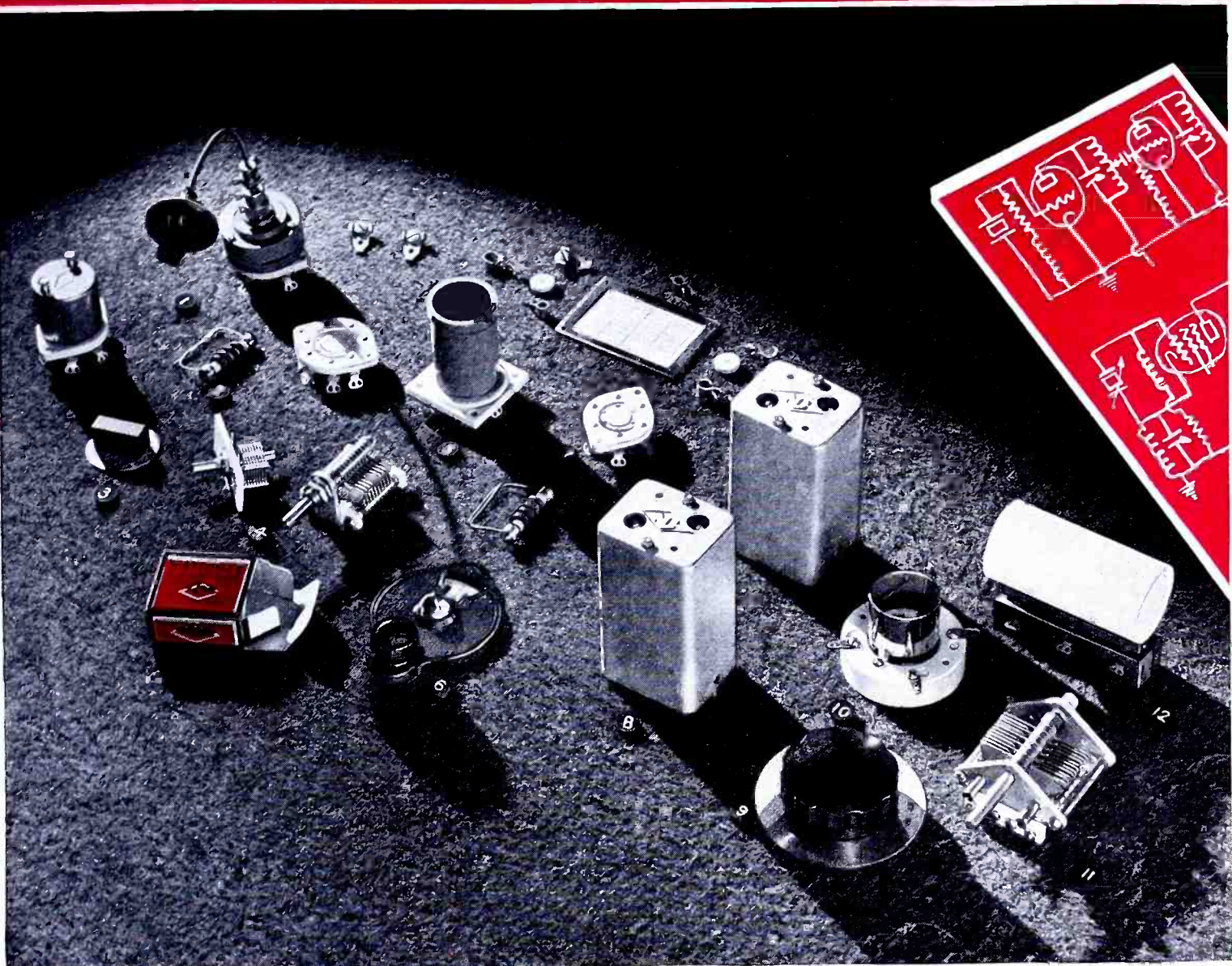

## EXCITERS, for example

National makes the parts it takes to build transmitters, and builds them well. Take excitors, for example. From adjustable-frequency crystal holder to fixed-tuned tank, National parts show specialized fitness for this work. The group of parts shown above have become standard equipment for fine excitors. All are described in the National Catalogue and Catalogue supplement, both free for the asking at your dealers.

The group of parts illustrated above are as follows:

- |                                |                                      |                                     |
|--------------------------------|--------------------------------------|-------------------------------------|
| 1. CHT and CHV Crystal Holders | 5. XR-6 Coil Form with Square Socket | 9. O Dial, Type 0-100               |
| 2. R-100 R. F. Choke           | 6. BM Dial                           | 10. XM-10 Transmitting Socket       |
| 3. HRO Dial, Type 10-0         | 7. 6-prong Socket                    | 11. TMSA-50 Condenser               |
| 4. UM and ST Condensers        | 8. FXT Fixed-tuned Exciter Tank      | 12. UR-13 Buffer Coil Form Assembly |

**NATIONAL**  
641 SHERMAN STREET



**COMPANY**  
MALDEN, MASS.



# I WILL TRAIN YOU

*to start a spare time or full time*

# RADIO SERVICE BUSINESS

# WITHOUT CAPITAL

**J. E. SMITH**  
President  
National Radio  
Institute

The man who has directed the home study training of more men for the Radio Industry than any other man in America.

*and for* **TELEVISION'S coming OPPORTUNITIES**

**HERE ARE A FEW EXAMPLES OF THE KIND OF MONEY I TRAIN MY MEN TO MAKE**



**EARNED \$50 FIRST MONTH IN SPARE TIME**

"I knew nothing about Radio. After four lessons I began servicing Radios, earning \$50 the first month. Last winter I made as high as \$100 a month in spare time."—**G. F. WALTON**, 308 West Olney Road, Norfolk, Va.

**OWN BUSINESS PAYS \$300 A MONTH**

"I now have my own Radio Business which shows three hundred dollars a month profit—thanks again to National Radio."—**FRANK T. REESE**, 39 N. Felton St., Philadelphia, Penna.



**CHIEF OPERATOR BROADCASTING STATION**

"When I completed 20 lessons, I obtained my Radio Broadcast Operator's license and immediately joined Station WMPC, where I am now Chief Operator."—**HOLLIS F. HAYES**, 85 Madison St., Lapeer, Mich.



**Get My LESSON on Radio Servicing Tips FREE**

I'll prove that my Training gives practical, money-making information, that it is easy to understand—that it is just what you need to master Radio. My sample lesson text, "Radio Receiver Troubles—Their Cause and Remedy," covers a long list of Radio receiver troubles in A.C., D.C., battery, universal, auto, T. R. F., super-heterodyne, all-wave, and other types of sets. And a cross reference system gives you the probable cause and a quick way to locate and remedy these set troubles. A special section is devoted to receiver check-up, alignment, balancing, neutralizing and testing. Get this lesson *Free*. No obligation.



**MAIL COUPON NOW**

**The Tested WAY to BETTER PAY**

Do you want to make more money? The world-wide use of Radio has made many opportunities for you to have a spare time or full time Radio service business of your own and Television development is advancing and it will offer many more opportunities in the future. Today three out of four homes in the United States have Radio sets which regularly require repairs, servicing, new tubes, etc. Many sets are old and will soon be replaced by new models. I will train you at home in your spare time to sell, install, service, all types of Radio sets—to start your own Radio business and build it up on money you make in your spare time while learning and I'll give you Television Training which will help you cash in on the profitable opportunities coming with Television. Mail coupon for my 64-page book. It's Free—it shows what I have done for others.

**Many Make \$5, \$10, \$15 A Week Extra In Spare Time While Learning**

Practically every neighborhood needs a good spare time serviceman. The day you enroll I start sending you Extra Money Job Sheets. They show you how to do Radio repair jobs that you can cash in on quickly. Throughout your training I send you plans and ideas that have made good spare time money—from \$200 to \$500 a year—for hundreds of fellows. I also send you Special Radio Equipment which gives you practical experience, and I show you how to conduct experiments and build circuits with this equipment illustrating important Radio and Television principles.

**There's a Real Future in Radio for Well Trained Men**

Radio already gives good jobs to more than 300,000 people. And in 1936, Radio enjoyed one of its most prosperous years. More than \$500,000,000 worth of sets, tubes and parts were sold—an increase of more than 60% over 1935. Over a million Auto Radios were sold, a big increase over 1935. 24,000,000 homes now have one or more Radio sets and more than 4,000,000 autos are Radio equipped. Every year millions of these sets go out of date and are replaced with newer models. More millions need servicing, repairs, new tubes, etc. A few hundred \$30, \$50, \$75 a week jobs have grown to thousands in 20 years. And Radio is still a new industry—growing fast.

**Get Ready Now for Your Own Radio Business and for Jobs Like These**

Radio broadcasting stations employ engineers, operators, station managers and pay up to \$5,000 a year. Spare time Radio set servicing pays as much as \$200 to \$500 a year—full time servicing jobs pay as much as \$30, \$50, \$75 a week. Many Radio Experts own and operate their own full time or part time Radio sales and service businesses. Radio manufacturers and jobbers employ testers, inspectors, foremen, engineers, servicemen,

paying up to \$6,000 a year. Radio operators on ships get good pay and see the world besides. Automobile, police, aviation, commercial Radio, and loud speaker systems are newer fields offering good opportunities now and for the future. Men I have trained are holding good jobs in these branches of Radio.

**Television Will Offer Many Good Jobs To Well Trained Men**

In the past fifteen years, Radio has grown from an experimenter's plaything to one of the country's great industries. And Television today is as advanced as Radio was 15 years ago. Already millions of dollars have been spent developing Television equipment. Television receivers have been built which produce images equal to home moving pictures. About twenty experimental Television stations have already been licensed. N.R.I. not only gives you the training you need to make good money in Radio now, but in addition, gives you Television training which will help you cash in on the profitable opportunities coming with Television.

**Save Money—Learn at Home Money Back Agreement Protects You**

I am so sure that I can train you at home successfully that I agree in writing to refund every penny you pay me if you are not satisfied with my Lessons and Instruction Service when you finish my Course. I'll send you a copy of this agreement with my Book.

**Find Out What Radio and Television Offer You—Get My Book Free**

Act Today. Mail the coupon now for my Free Lesson and my book, "Rich Rewards in Radio." Both are free to anyone over 16 years old. My book describes Radio's spare time and full time opportunities and those coming in Television; tells about my Training in Radio and Television; shows you actual letters from men I have trained, telling what they are doing and earning. Find out what Radio and Television offer YOU! MAIL THE COUPON in an envelope, or paste it on a penny postcard—NOW!

**J. E. SMITH, President National Radio Institute, Dept. 7EB3, Washington, D. C.**

**THIS FREE BOOK HAS HELPED HUNDREDS OF MEN MAKE MORE MONEY**

**Rich Rewards in Radio**

**GOOD FOR BOTH 64 PAGE BOOK SAMPLE LESSON FREE**

**J. E. SMITH, President, National Radio Institute, Dept. 7EB3, Washington, D. C.**

Without obligating me, send your sample lesson and free book. I am particularly interested in the branch of Radio checked.

- Radio Service Business of My Own
- Spare Time Radio Service Work
- Retail Sales of Radio Sets and Equipment
- Service Expert for Retail Stores
- Broadcasting Station Operator
- Ship Radio Operator
- Aviation Radio Operator
- Loud Speaker Systems, Installation and Service
- Auto Radio Installation and Service
- Designing and Constructing Testing Equipment
- Service Expert with Radio Factory
- Commercial Radio Station Operator
- All-around Servicing Expert
- Experimental Television Transmission
- Experimental Television Reception

(If you have not decided which branch you prefer—mail coupon now, for information to help you decide.)

Name ..... Age .....

Address .....

If you do not want to cut this cover—simply write us on a post card