

HUGO GERNSBACK  
Editor

# SHORT WAVE CRAFT

June

WORLD'S  
LARGEST  
SHORT WAVE  
CIRCULATION

Combined  
With

OFFICIAL  
*Short Wave  
Listener*  
MAGAZINE

Short Waves  
Direct You Home  
See Page 72



25

IN U.S. AND  
CANADA

# THE *New* DOERLE

## 6-TUBE BANDSPREAD RECEIVER

### Made an Instantaneous Hit!

### Marvelous SENSITIVITY and SELECTIVITY

### Only Found in the Higher Priced Models



Licensed under RCA and Hazeltine patents

The famous Doerle line of receivers are now equipped with the new Octal sockets in which glass and metal tubes are interchangeable. For the first time this quality receiver is available in KIT form for the short wave experimenter who prefers to "build his own."

Uses 6 of the latest hi-gain tubes (6K7G, 6K7G, 6C5G, 6C5G, 6F6G and 5Y3) in a highly efficient and selective circuit, using two tuned stages—electron coupled regenerative detector—POWERFUL 3 stage resistance capacity coupled audio frequency amplifier with power pentode output stage—full wave high voltage rectifier and self contained hum-free power supply. Built-in High Fidelity dynamic speaker capable of handling the entire 3 watts of audio frequency power output of the receiver.

Continuous bandspread over the entire range of 9½ to 625 meters is obtainable due to the use of a special type, multi-colored, airplane dial having 125 to 1 ratio and two pointers. Two knobs are provided and make possible either fast or slow motion tuning. ALL of the AMATEUR and FOREIGN SW BANDS are spread over a generous portion of the tuning dial, thereby simplifying tuning so that even a beginner can operate it to the utmost satisfaction. Entirely free from all traces of backlash.

The entire unit is contained in a large, black crackle finished metal chassis and cabinet of extreme beauty. All controls are mounted on the front panel and all parts are readily accessible. No adjustments whatever are necessary. Nothing to get out of order. Simply plug into your electric light socket and enjoy an evening of short wave thrills and entertainment such as you have never before experienced.

Mechanical specifications: Dimensions are 17¼"x8"x8¾". Net weight 23 lbs. Shipping weight 33 lbs. Designed to operate entirely from 100-130 volts, 50 to 60 cycles AC house current. Shipment made same day as order is received. Complete satisfaction guaranteed.

DOERLE 6-tube AC BANDSPREAD RECEIVER, completely wired and tested, with set of 6 matched Arcturus tubes, 8 coils for 9½ to 200 meters, cabinet, instructions, and READY TO OPERATE. Licensed under RCA and Hazeltine patents . . . . .  
(Specify whether metal or glass tubes desired.)

LIST PRICE \$34.95.  
Discount to Hams,  
Fans & Experimenters  
20%  
**YOUR NET COST**  
**\$27.96**

less 2 Broadcast band  
coils, extending the  
range up to 625  
meters, extra \$1.45.

DOERLE 6-tube AC SW KIT, containing all necessary parts, including 8 low loss ribbed coils for 9½ to 200 meters, full size hi-fidelity dynamic speaker, beautiful cabinet, and 4 page instruction booklet, (less tubes, Broadcast coils, and unwired) . . . . .  
6 Arcturus matched tubes . . . . . \$3.12  
Broadcast band coils (2) . . . . . 1.45

**\$17.96**

DOERLE 6-TUBE BATTERY OPERATED RECEIVER, has same specifications as above except that economical 2 volt type tubes are used and operate entirely from dry batteries. Subtract \$2 from price of electric model. (less batteries).

- ★ Continuous bandspread tuning from 9½ to 625 meters.
- ★ An ideal DX receiver for the long distance SW fan or communications receiver for the transmitting amateur.
- ★ Beautiful, large, illuminated, dual pointer, multi-colored, airplane type dial of great beauty.
- ★ Operates from either single wire type aerial or noise-free doublet.
- ★ Volume control—stage aligning trimmer—and tone controls.
- ★ Unusually smooth acting regeneration control.
- ★ Headphone jack with speaker cut-off switch.
- ★ Highly efficient, low loss ribbed plug-in coils, are a large factor in the amazing sensitivity and selectivity of this receiver. Coils are of the large 3 winding variety and are color coded for easy identification.

### New 3-Tube Doerle Receiver 9 to 625 Meters



The 3-tube AC DOERLE circuit employs a 6F7 duplex triode pentode (2 sets of tube elements in 1 bulb)—as ultra sensitive screen grid regenerative detector and first audio, followed by a 42 power pentode tube, and one 80 as full-wave rectifier and HUM-FREE power supply.

- ♦ Equipped with output filter allowing the use of EITHER headphones or full sized dynamic loudspeaker.
- ♦ Delivers tremendous volume on phones or speaker.
- ♦ BANDSPREAD TUNING control.
- ♦ POSITIVELY NO AC HUM.
- ♦ Beautiful Crown illuminated aeroplane type tuning control.
- ♦ Beautiful, plated chassis, metal cabinet with hinged cover and finished in black crackle.
- ★ Operates directly from your AC house current.

**\$13.95**

PRICE, complete, wired and tested, with 3 silvered coils for 9 to 200 meters, set of RCA tubes, cabinet, and 1 page instruction booklet . . . . .  
less 2 broadcast band coils extending range up to 625 meters, extra \$1.45  
(Amateur bandspread coils for 20-10-80-160 M bands, extra \$2.95)

DOERLE 3-tube AC Kit, including SW coils for 9 to 200 M and in-structions booklet, less cabinet, tubes, B.C. coils, unwired . . . . .  
Black crackle finished metal cabinet, extra . . . . . \$1.25  
Set of 3 MATCHED RCA tubes . . . . . 1.75  
Broadcast band coils (2) . . . . . 1.45

**\$7.95**

**3-TUBE DC DOERLE**  
Same as above except that it uses a 2E tube as regenerative detector, followed by a 20 first audio stage and a 53 power pentode output stage. Operates entirely from dry batteries. Subtract \$2 from price of AC model (less batteries).

### NEW DOERLE 5 TUBE BANDSWITCH RECEIVER 7 to 2000 meters



The DOERLE bandswitch receiver is undoubtedly one of the finest available. Covers all waves from 7 to 2000 meters without the use of plug-in coils. Simply get the waveband switch to the desired position and tune as usual.

Uses one 6J6 as RF amplifier, followed by one 6J6 as high gain, ultra sensitive regenerative detector, one 37 as first audio amplifier stage, one 42 as power pentode output tube, and one 5Y3 as full wave rectifier and built in HUM FREE power supply.

- ★ Built in high fidelity dynamic loudspeaker.
- ★ Connections for the use of headphones when desired.
- ★ Delivers tremendous volume on those hard to get DX Stations.
- ★ Illuminated, aeroplane type vernier dial.
- ★ Band-spread adjustment simplifying the separation of stations.
- ★ Smoothly operating regeneration and volume controls.
- ★ Low-loss construction throughout.
- ★ Either doublet or single wire aerial may be used.
- ★ Plated chassis and beautiful black crack finished metal cabinet.
- ★ Operates from your AC house current.

**\$24.95**

PRICE, complete, wired, ready to use, with set of 5 matched RCA tubes, cabinet \$24.95 and 4 page instruction booklet . . . . .

DOERLE BANDSWITCH RECEIVER KIT, including all necessary parts, dynamic speaker, and instruction booklet, less cabinet, tubes, unwired . . . . .  
Beautiful black crackle finished cabinet, extra . . . . . \$2.50  
Set of MATCHED RCA tubes (5), extra . . . . . 2.60

**\$14.95**

### FREE CATALOG

If you wish to preserve the front cover, COPY the coupon below and mail at once

**GUY STOKELY RADIO CORPORATION** Dept. S-6  
126 Liberty St., New York City

Gentlemen: Please mail without expense or obligation your catalog of the famous Doerle Receiving Sets, illustrating and fully describing All Electric and Battery models, also reproduction of letters from users in all parts of the country.

I enclose \$..... for which please send me .....  
(On C.O.D. orders, send 20% deposit.)

Name.....

Street Address.....

City..... State.....

**GUY STOKELY RADIO CORPORATION, 126 Liberty St., Dept. S-6, New York City**

# STOP WISHING

FOR A GOOD-PAY JOB...

# TRAIN FOR ELECTRICITY AND GET ONE!

**MANY MAKE \$30, \$40, \$50, AND UP EVERY WEEK IN ELECTRICITY**

It makes no difference whether your age is 16 or 40. . . . If you want to feel secure and not have to worry about being laid off or to have to work for any wages they want to pay you—prepare today for real opportunities in the liveliest money making field in the world. Electricity offers you the opportunity to make REAL MONEY! If you want to enjoy the good things in life that real money will make possible . . . the surest and quickest way is to get into a field that offers REAL MONEY-MAKING OPPORTUNITIES. The great and growing field of Electricity—with its vast developments reaching into almost every industry—needs men with PRACTICAL TRAINING. It pays well, and offers a future that is practically unlimited.

**LEARN BY DOING IN 12 WEEKS**

My great training shops in Chicago are known the world over for the amazingly easy, practical method by which we train ambitious fellows for good pay Electrical jobs in only 12 weeks. Start any time. You learn quickly by doing actual shop work on real Electrical machinery—without book study or useless theory. Previous Electrical experience or a lot of book learning not necessary. Expert instructors personally guide you every step of the way.

**I'LL FINANCE YOUR TRAINING!**

Don't let lack of ready cash hold you back. My plan has enabled thousands of deserving fellows to get Coyne Training first—then pay back tuition in small monthly payments extended over 18 months after graduation starting 5 months after you start school or 2 months after your required training period. Many have told me that their training has more than paid for itself out of increased earnings! Prove to me that you really want to succeed—by mailing the coupon below—and I'll tell you about this amazingly liberal plan.

*H. C. Lewis*



**Free Lifetime Employment Service**

A Free Employment Service is maintained to give Coyne graduates every possible aid in locating jobs for which they are trained. Many of our students do part-time work to help pay their living expenses while in school.

**Diesel Engines Refrigeration and Air Conditioning**

Trained men are needed in these rapidly expanding branches of the great Electrical field. Right now I'm including instruction in Diesel Engines, Electric Refrigeration and Air Conditioning AT NO EXTRA COST.

**Get the Facts Send for Free Book**

The whole fascinating story of Coyne Training is yours for the asking. Just mail the coupon and I'll send you my Big Free Book, with photographs, jobs, and money-making facts. There's no obligation and no salesman will call.



TRAIN AT COYNE



GET A GOOD JOB



EARN REAL MONEY

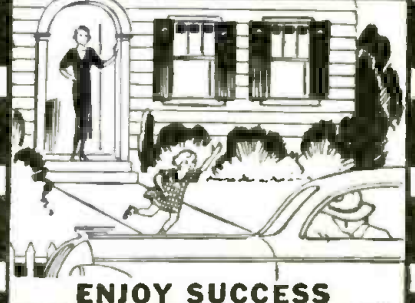

ENJOY SUCCESS

**HERE'S PROOF... that Coyne Training gets Quick Results!**

"Two weeks after leaving school I took a wiring job, and the profits from this job alone more than paid for the entire course."  
—E. O. BERNDT, ILLNOIS

"Coyne Training has certainly paid for itself many times in increased salary."  
—PAUL W. HOLDTON, OHIO

"I owe my Electrical success to your 12-week shop course."  
—R. B. UMBARGER, TENN.

"Coyne Training got me this job which has a wonderful future."  
—SHERMAN PENNY, FLORIDA

These and thousands of similar letters in our files give positive proof of the REAL MONEY VALUE of Coyne Training. These men once faced the same problem that now confronts you. Coyne Training started them on the road to success...it can do the same for you.

**COYNE ELECTRICAL SCHOOL**  
H. C. LEWIS, President  
500 S. Paulina Street, Dept. A6-82, Chicago, Ill. Founded 1899



**MAIL the COUPON for FREE BOOK!**

**H. C. LEWIS, Pres., COYNE ELECTRICAL SCHOOL**  
500 S. Paulina St., Dept. A6-82, Chicago, Ill.

Without obligating me, send Free Book and details of your "Pay-Tuition-After-Graduation" Plan.

Name .....

Address .....

City..... State.....

Mail in envelope or paste on a postcard.

Please mention SHORT WAVE CRAFT when writing advertisers

## IN THIS ISSUE: PROMINENT SHORT-WAVE AUTHORS

Wolff • Linder • Shuart • Green • McEntee • Millen • Bacon • Lynch

**HUGO GERNSBACK**  
Editor



**H. WINFIELD SECOR**  
Managing Editor

**GEORGE W. SHUART, W2AMN**  
Associate Editor

Combined With  
**Official SHORT WAVE LISTENER**

### Contents for June, 1936

Editorial—Short Waves Under “Gag” Rule, by Hugo Gernsback.....	67
How “HAMS” Sent Flood Warnings.....	68
Short Waves in the Camera’s Eye.....	69
3½” Waves Transmitted 16 Miles! By Dr. Irving Wolff, and Dr. E. G. Linder.....	70
1-Meter Transmitter and Receiver Used by NBC.....	71
Candle Flame in England Lights Lamp Here by Short Waves.....	71
Short Waves Direct You Home! (Cover Feature).....	72
“HAM” Net to Report Sailboat Races, by Curtis Arnall.....	73
Where S-W Stations Come in On Your Dial.....	73
Short Wave Craft Presents Trophy to Johnstown Flood Radio Hero.....	74
A De-Luxe A.F. Amplifier with Triple-Tone Control, by M. Harvey Gernsback.....	75
A 2-Tube, Band-Switching Receiver—For the S-W “FAN,” by G. W. Shuart, W2AMN.....	76
How to Construct the New NOISE SILENCER, by W. Green.....	78
830-B Push-Pull Amplifier, by George W. Shuart, W2AMN.....	79
A Modulator for the Modern 5-Meter Xmitter, by Howard G. McEntee, W2FHP.....	80
Short-Wave Scout “Silver Trophy” Award.....	81
Short Waves and Long Raves—Our Readers’ Forum.....	82
Short-Wave Inventions from Foreign Countries, by C. W. Palmer.....	83
Short Wave “Kinks”—\$5.00 Monthly Prize.....	84
Map of Short-Wave Stations of the World.....	85
New 4-Tube Receiver Tunes from 1 to 11 Meters, by James Millen and Dana Bacon.....	86
New Apparatus for the “HAM”.....	87
The Radio Amateur Course—Conducted by George W. Shuart, W2AMN.....	88
Short-Wave League and Scout News.....	90
Short-Wave Stations of the World List, by M. Harvey Gernsback.....	91
Short-Wave Question Box.....	96
Little-Known Facts About Short and All-Wave Aerials, by Arthur H. Lynch.....	98
Diagrams of S-W Commercial Receivers.....	99
When to Listen In, Edited by M. Harvey Gernsback.....	101

### Features in the July “HAM” Issue

- A Power Oscillator using new 804 Pentode, by George W. Shuart, W2AMN.
- 400 MC. French “HAM” Sets, by C. W. Palmer.
- All-Wave “Aircraft 3” Receiver—Battery Operated, by H. G. Cisin.
- 5 and 10-Meter, Crystal-Controlled Transmitter, by W2AMN.
- 2-Volt S-W Super-Het. for “FAN” or “HAM,” by Harry D. Hooton.
- More “Dope” on “HAM” Antennas.
- 5-Meter Transmitter-Receiver Using Metal Tubes.



### Certified Circuits

● SHORT WAVE CRAFT goes to a large expense in verifying new circuits. When you see this seal it is your guarantee that such sets have been tested in our laboratories, as well as privately, in different parts of the country. Only “Constructional-Experimental” circuits are certified by us.

When you see our certified seal on any set described, you need not hesitate to spend money for parts, because you are assured in advance that the set and circuit are bona fide and that this magazine stands behind them.

SHORT WAVE CRAFT is the only magazine that certifies circuits and sets.

### OUR COVER

● The cover illustration this month shows a short-wave transmitting and receiving set in operation in a canoe. Short-wave sets of this type will undoubtedly become much more widely used by lovers of the great outdoors. For details concerning this set, which may aid in locating one’s position if lost, see page 72.

COPYRIGHT, 1936. BY H. GERNSBACK

Published by **POPULAR BOOK CORPORATION**

**HUGO GERNSBACK**, President - - - - **H. W. SECOR**, Vice-President  
**EMIL GROSSMAN** - - - - - Director of Advertising  
 Chicago Adv. Office - - - - - **L. F. McCLURE**, 919 No. Michigan Ave.  
 Los Angeles Adv. Office - - - - **J. A. Kendall**, Box 176, Arcade Annex  
 Publication Office - - - - - 404 N. Wesley Avenue, Mount Morris, Ill.  
 Editorial and General Offices - - - 99-101 Hudson St., New York, N. Y.  
 European Agent: Gorringer’s American News Agency, 9A Green St., Leicester Square, London W. C. 2  
 Australian Agents: **McGILL’S AGENCY**, 179 Elizabeth St., Melbourne

SHORT WAVE CRAFT—Monthly. Entered as second class matter May 7, 1930, at the post office at Mount Morris, Illinois, under the act of March 3, 1879. Trademarks and copyrights by permission of H. Gernsback, 99-101 Hudson St., N. Y. C. Text and illustrations of this magazine are copyrighted and must not be reproduced without permission. SHORT WAVE CRAFT is published on the 1st of every month. Twelve numbers per year. Subscription price is \$2.50 a year in the United States and possessions and Canada. Foreign countries, \$3.00 a year. Single copies 25c. Address all contributions for publication to Editor, SHORT WAVE CRAFT, 99-101 Hudson St., New York, N. Y. Publishers are not responsible for lost manuscripts. Contributions cannot be returned unless authors remit full postage. SHORT WAVE CRAFT is for sale at all principal newsstands in the United States and Canada. European agents: Brentano’s, London and Paris. Printed in U. S. A. Make all subscription checks payable to Popular Book Corporation.



# Short Waves Under 'Gag' Rule

An Editorial by Hugo Gernsback

● THE FOLLOWING unbelievable occurrence took place not in the dark ages, not during the inquisition, not in darkest Russia, but in our own enlightened U.S.A., to wit, Peoria, Illinois, in February of this year. A young man and his father, both readers of *Short Wave Craft*, constructed the transceiver described in the February, 1934, issue of *Short Wave Craft*. The set was constructed mostly of junk parts while the son was shut in and quarantined for scarlet fever. The young man was operating the set only as a receiver, *not as a transmitter*, and in trying to tune the set to five meters, of course, heard the Peoria Police Department Station, W9XBA, on 6 meters. As the set was in an oscillating condition, no doubt, the young man radiated energy sufficient to cause some interference for the Peoria Police Department. Then things began to happen rapidly. The police broke into the home of the short-wave experimenter and arrested the young man, aged 22, and his father, aged 46. A grim note of humor enters into the proceedings here, because Lieutenant Harry McCley, head of the Police Radio Division, admitted that he would have made the arrest sooner but the scarlet fever sign on the house kept him from entering for several days. Father and son were forthwith taken to jail and kept there for about twelve hours after the arrest.

A bond of one hundred dollars each was posted. A short time later the father was fined two hundred dollars and costs by Police Magistrate, William Winn, on a city charge of building and operating a radio set interfering with the police short-wave radio system. The fine, however, was withheld, after the builder of the radio set promised not to build or operate a similar set.

It seems that the good city of Peoria on Dec. 2, 1935, enacted a new city law that forbids any receiver or transmitter interfering with police radio broadcasting. It calls for a fine of not less than twenty-five dollars nor more than two hundred dollars.

We, therefore, have here to do with a case which goes back to the invention of the vacuum tube, where receivers are apt to radiate, causing interference with other radio emissions. As Lieutenant McCley puts it, "Any short-wave set of the radiating type automatically becomes a transmitter, and it makes a mess of the police broadcasts. When we get the location of a set that is interfering, we don't know whether this is just an amateur radio man or someone who wants to check police movements. There are other sets interfering around

Peoria and East Peoria," asserted Lieutenant McCley. "We'll get them all."

It is admitted that a radiating receiver of the regenerative or super-regenerative type will cause interference. And it is also true that the Radio Act provides that no one shall transmit signals (even when sent from an oscillating receiver) whereby its effects can be received in another state, there to cause interference. (It is well to keep in mind that by adding a stage of radio frequency amplification ahead of the detector in regenerative or super-regenerative receivers, that radiation from such sets will be practically prevented.)

There is, however, nothing contained in the Radio Act that calls for any arrests of the type mentioned above, nor could there be any criminal proceedings unless it was clearly shown that there was actual intent of interfering with other radio stations.

We believe that a local police ordinance of the type adopted at Peoria is not only the height of foolishness, but legal advisers whom we have consulted are of the opinion that such an ordinance is wholly unconstitutional, for the following simple reasons:

In the first place, any radio station in this country, whether private, city, or otherwise must be licensed by The Federal Communications Commission. Thus the city of Peoria could not possibly operate its police station without a proper license from The Federal Communications Commission. Therefore, if there is any interference, willful or otherwise, it is up to The Federal Communications Commission to prosecute the offender, but by no stretch of the imagination can this be legally done by the city of Peoria through its police department.

It is one thing for a meddling and officious police department to give a fair warning to a supposed offender, and quite another thing to make wholesale arrests and throw unoffending people into jail.

Outside of all this, only an exceedingly stupid police department will make an arrest of this type. It deprives the police department of the very clues which they might get in order to track down criminals. Frightening criminals into not using radio sets, when they could otherwise be easily apprehended by the police, appears to be childish in the extreme.

A number of cities have adopted local laws similar to the one under discussion, and it would be exceedingly interesting if when an arrest is made again under similar conditions, that the constitutionality of such laws be tested.

---

**SHORT WAVE CRAFT IS PUBLISHED ON THE 1st OF EVERY MONTH**

This is the June, 1936 Issue—Vol. VII, No. 2. The Next Issue Comes Out June 1

---

# How HAMS Sent Flood Warnings And Assisted Heroically in Rescue Work in Many States

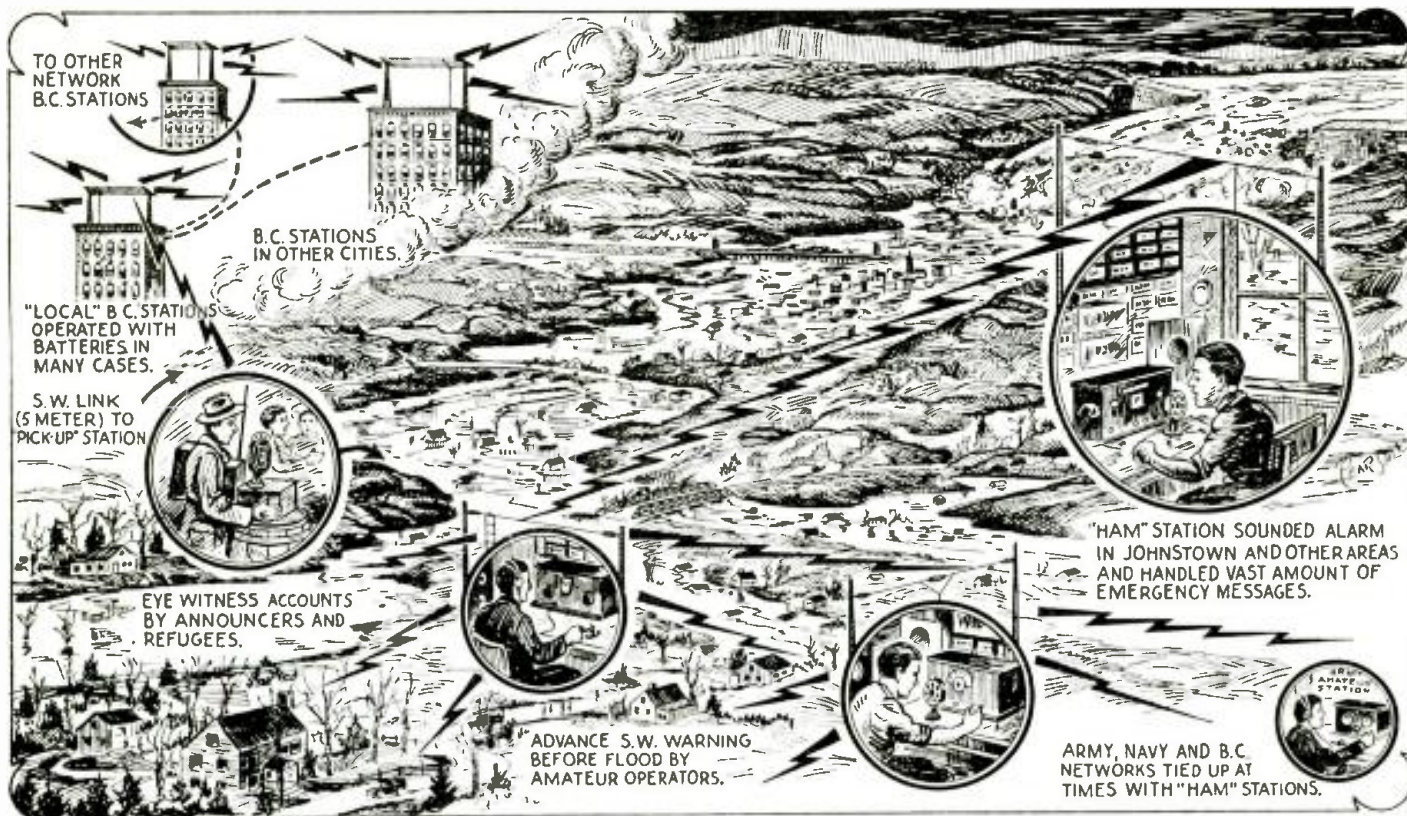

The illustration above shows some of the activities of the "Ham" short-wave stations in the "flood districts" and indicates how warnings, as well as other dispatches, were relayed from one amateur station to another. The use of short waves in picking up "on the spot" observations by broadcast network announcers is also portrayed.

● THE "Ham" or licensed amateur radio operators, with stations located in the flood areas, particularly through New England and in Pennsylvania, certainly deserve high credit for the commendable piece of work they accomplished. In many cases warnings of impending floods in new areas were radioed ahead by "Ham" stations located in districts along river valleys or basins, while many important traffic dispatches were handled between various "Ham" stations, when the regular commercial telephone and telegraph lines were either down or completely out of commission.

We haven't the space to mention the long list of names of outstanding "Hams" who operated their stations in many cases under dangerous conditions, due to the rising waters caused by the flood in Pennsylvania and other districts, but a few typical cases will be cited to show the sort of work accomplished by the "Ham" stations.

Gerald D. Coleman, operating amateur station W8FRC, provided at one time practically the only means of communication between Johnstown, Pa., and the outside world.

An operator in Scranton, Pa.,\* sent a short-wave S.O.S. to the effect that—"Water's in Johnny's kitchen and he can't get out unless he gets a boat."

Frequently the radio voice or code signals ceased abruptly—the rising waters probably reached the operating room and put the transmitter out of commission.

Carol B. Lingle, of Johnstonburg,

carried on with snappy reports; one of which follows: "Clearfield is wiped out . . . all people ordered out of Johnstown . . . fire and explosion add to the horror . . . Lock Haven is under 16 feet."

The "Ham" or amateur radio operators in all the flood districts, which included New England, Pennsylvania, Maryland, and other states, performed heroically with their short-wave transmitting and receiving stations and, in many cases, provided the only means of communication over extensive areas. Many of the short-wave "Ham" stations were tied in on an official government network, one of these being that operated by the Navy. The stations cooperating in the sending of dispatches were reserve amateur stations, one chain of stations extending from Philadelphia to Johnstown.

One of the editors heard a very interesting and spirited conversation on short-wave phone during the flood condition between an A.R.R.L. member station in Harrisburg and a "Ham" station handling traffic in Johnstown, Pa. One of the surprising

\*See New York World-Telegram, March 19th, for reports of interesting weather "Ham" flashes. Editor.

and very interesting points under discussion was a contemplated edict by the Mayor of Johnstown, in which he proposed to issue an order to shut down all amateur radio or "Ham" stations in the Johnstown area. The spokesman at the Harrisburg station told the "Ham" operator at Johnstown that he had been consulting with numerous Army officials and others and that in any event such a move would seem to show very poor discretion, in view of the excellent service which had been done by the amateur operators in the flood districts.

America's well-known news commentator, Walter Winchell, mentioned this situation in one of his Sunday evening "news flashes," and his opinion of such an order intended to suppress all amateur station operators in the Johnstown area. In view of the heroic work performed by the radio amateurs during the flood conditions, it seemed outrageous to Mr. Winchell, who also stated (in his nation-wide broadcast) that whether he knew it or not, the Mayor did not have any right to shut down amateur stations, and that only one body had such a right—the Federal Communications Commission.

Apparently, the reason for the proposed order of the Mayor of Johnstown, Pa., was because of the fact that he or his advisers thought that the amateur stations were interfering with the dispatch of regular radio traffic by commercial stations, especially the short-wave emergency stations set up

(Continued on page 112)

# SHORT WAVES in the Camera's Eye

SHORT WAVES MARCH ON! We find them in use by "Scotland Yard," reporting "Flood" news, and landing airplanes "Blind"!



Above—Dorothy Hall of New York City, who operated her amateur radio station, W2IXY, through the long hours of the flood crisis. She kept in constant communication by short waves with other amateurs in the Johnstown, Pa., flood district.—Photo at right shows short-wave transmitter and receiver installed in famous Scotland Yard "Q-Car."

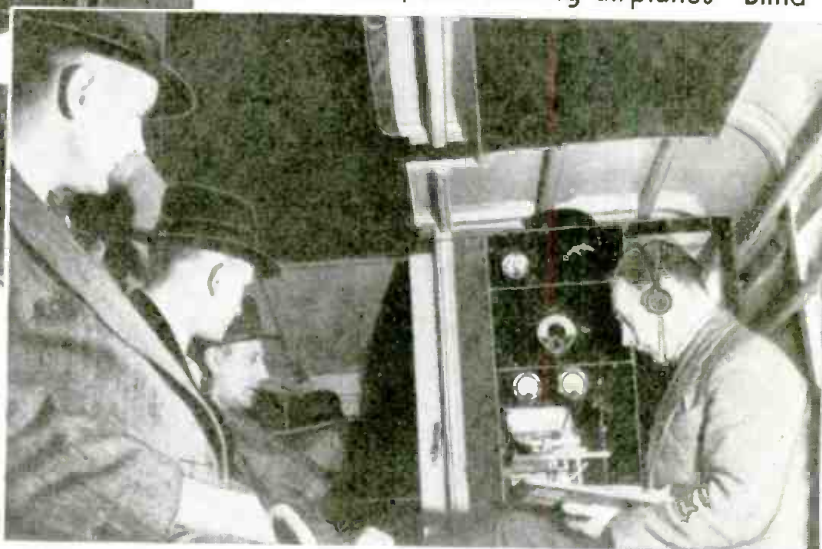

Below—Picture transmitted by short wave beam radio. The photo shows Lincoln Ellsworth, whose dramatic rescue thrilled the world after he and his radio operator, Mr. Hollick-Kenyon, had been missing for 2 months on their Antarctic flight.

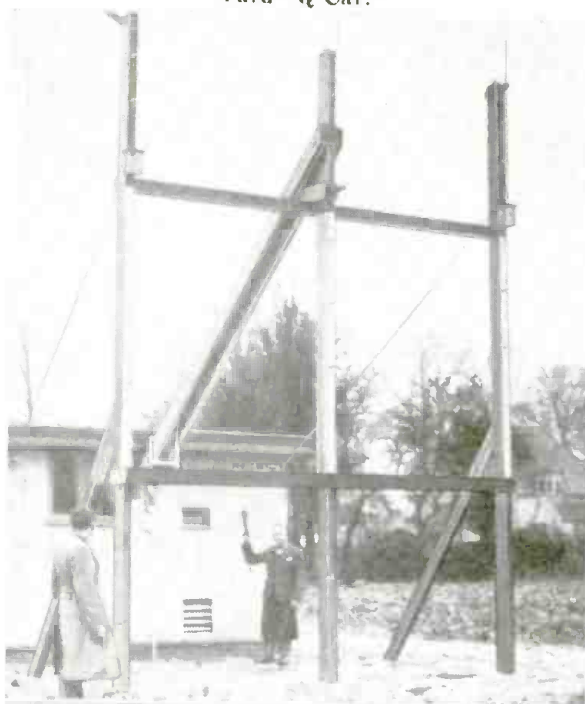

Left—The first "blind" landing apparatus installed at a British airport. It operates on the Lorenz system. The system employs two radio beacons at either end of the 'drome; each sends out a constant radio signal which guides the pilot to a safe landing. Control panel shown below.



The photo below shows Chiyono Sugita, pretty 26-year old Japanese girl, who has contacted several hundred amateur radio stations. Reports sayeth that she has received forty proposals by radio! Hi! Hi!

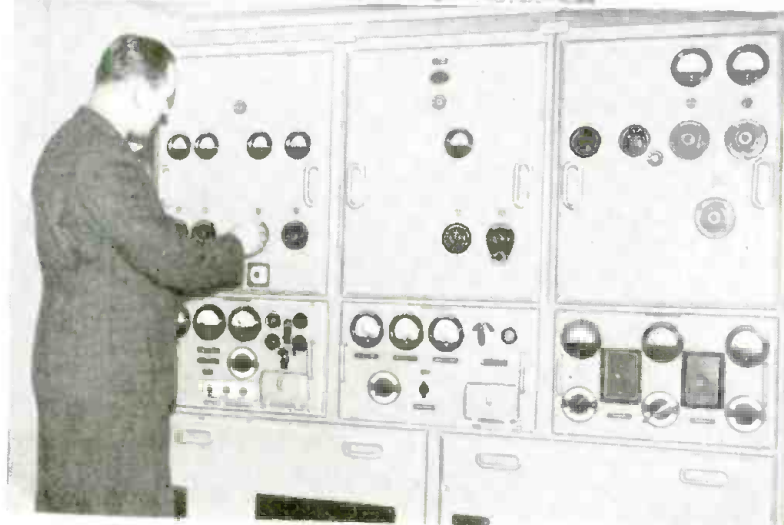

# 3½ Inch Waves Transmitted 16 Miles!

By Dr. Irving Wolff and Dr. E. G. Linder

## A Study of Their Attenuation in the Atmosphere and the Effects of Weather Conditions on Their Transmission.

● A NUMBER of tests have been carried out in different laboratories on the generation and reception of waves 10 cm. in length and shorter. However, for their practical application it is not only necessary to know that they can be generated and received, but we must also have data regarding the extent to which they are attenuated in the atmosphere, and the effect of weather conditions such as rain, snow and fog on their transmission. A series of tests to determine the attenuation of normal atmosphere were undertaken during the summer of 1934 at Atlantic Highlands, New Jersey, in co-operation with the U. S. Signal Corps, at Fort Monmouth and during the Spring of 1935, a system was placed in continuous operation between the laboratory at Camden and one of the tall buildings in Philadelphia, for the purpose of determining the effect of rain on the transmission.

The apparatus which was used in both of these tests was similar to that described in an article published in the Proceedings of the Institute of Radio Engineers in the January 1935 issue. A photograph of the transmitting apparatus is shown in Figure 1.

### Transmitter

The transmitter consisted of a specially constructed magnetron connected to a half-wave

antenna in the focus of a 4 ft. parabolic reflector, with appropriate voltage regulation of the supply circuits so that the output of the transmitter would remain reasonably constant without adjustment. Only a brief description of the tube and accompanying circuits will be given here. For more details, reference can be made to the article which appeared in the Proceedings of the Institute and an additional article which will appear shortly. A diagram of the tube is shown in Figure 2. This tube has for its basis the split anode magnetron which is shown diagrammatical-



Fig. 1—Photo above shows transmitter with reflector for 3½ inch (9 cm.) waves.

ly in Figure 3. The split anode magnetron consists of two separated halves of a cylinder, whose axis is concentric with the filament, which are individually attached to the two halves of a two-wire balanced transmission line. The other end of the transmission line is terminated by a one-half wave antenna. This differs from the magnetron which is used at lower frequencies in having the anode in two parts, whereas, in the usual magnetron the anode is a continuous cylinder about the cathode and the oscillations are taken off between the cathode and the anode. The high frequency split anode magnetron differs also in its mode of operation from the ordinary magnetron in the adjustment of the magnetic field.

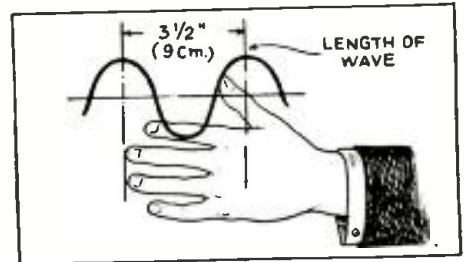

This illustration shows how short 9 cm. (3½ inch) waves really are.

### Action of Magnetron

When a magnetron is used at the lower frequencies the magnetic field should be just strong enough to prevent the electrons from reaching the anode to put the tube in an oscillating condition. As the potential applied to the anodes is increased a stronger magnetic field is required to do this. However, oscillations at a particular frequency can be obtained with a wide variety of electric and corresponding magnetic fields, the frequency being determined by the external circuit. As

we attempt to continuously raise the frequency, we find that oscillations no longer take place for all adjustments of the plate potential and magnetic field in which the electrons just fail to reach the plate, even though an external circuit is provided which could oscillate at the correct frequency. A further study shows the reason for this. The time taken for the electrons to go from the filament to the plate becomes an appreciable part of the cycle so that the phase relations, between current and voltage, which are required to deliver energy to the oscillating circuit no longer hold. Under such conditions it is necessary to time the arrival of the electron at or close to the anode in such a way that the correct phase between current and voltage will continue to be provided. This requires that the speed of travel of the electron across the tube be taken into account, a factor which is almost negligible in a consideration of oscillation, even in the so-called ultra short wave band between 3 and 10 meters. It has been found that the tube will oscillate at high frequency if the time it takes the electrons (Continued on page 109)

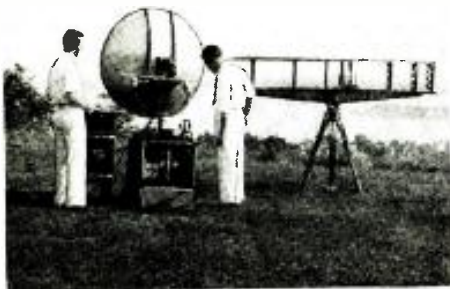

Fig. 5—The 3½ inch (9 cm.) wave transmitter set up for the tests here described.



Fig. 6—Shows receiving reflector mounted on the stern of a small ship.



# One-Meter Transmitter and Receiver Used By NBC

A "Coat-Pocket" radio transmitter weighing less than one pound, has been developed by NBC engineers for use by "foot-loose" announcers.



Above—The one-meter Receiver using a special super-regenerative circuit with an Acorn tube. It has a separate quenching oscillator and one stage of audio frequency amplification. The signals picked up by this receiver are fed into the main transmitter of the broadcast station.

● DEVELOPMENT of the world's smallest micro-wave transmitter for use in broadcast circuits was announced by O. B. Hanson, chief engineer of the National Broadcasting Company. Distances up to four miles were attained by the midget "radio station,"

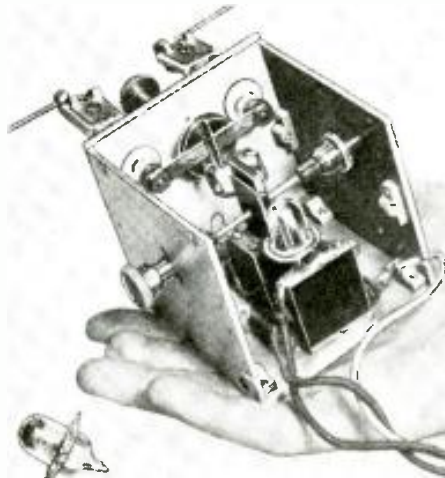

Close-up view of the 1-meter transmitter which oscillates at 309,000,000 cycles per second! It uses a 90 volt "plate" battery of a special small size. The transmitter weighs less than one pound, and the battery less than four.



The 1-meter transmitter in use by a "foot-loose" announcer, who can move around freely—a very desirable feature at outdoor athletic games, et cetera.

which can be held in the palm of the hand, in exhaustive tests recently of the first working model completed by NBC's research laboratory.

The new device is not intended for broadcasts (Continued on page 108)



Dr. Frank B. Jewett, President, New York Museum of Science and Industry (right), explaining to Dr. Marston T. Bogert (left) and Nelson A. Rockefeller, Museum trustees, the manner in which an original 1893 Westinghouse Stopper lamp was turned on by the "sound" of a candle flame on the desk of Michael Faraday in London, England, to set off the dedication ceremonies of the Museum in Rockefeller Center recently. The light of the Stopper lamp was picked up by the "electric eye" on the table, turning on two banks of high intensity mercury vapor lamps, the latest developments in electrical illuminants, said to mark the beginning of a new era in artificial illumination.

## Candle Flame in England Lights Lamp In America By Short Waves

● MICHAEL FARADAY, whose experiments of a century ago in electro-magnetism established the fundamental laws upon which all subsequent engineering development in the generation and application of electricity were based, post humously participated in the dedication ceremonies of the Museum of Science and Industry in Radio City, Rockefeller Center recently. Modern electrical magic was employed to exemplify the present perfection of an industry to which this eminent genius contributed so greatly in the embryonic era of electricity.

Sitting at Faraday's desk in

Faraday's own chair in the laboratory of the Royal Institute of London, Sir William Bragg struck a match to light a candle. The sound of the candle flame was "heard" by a modern sound-recording (Continued on page 108)

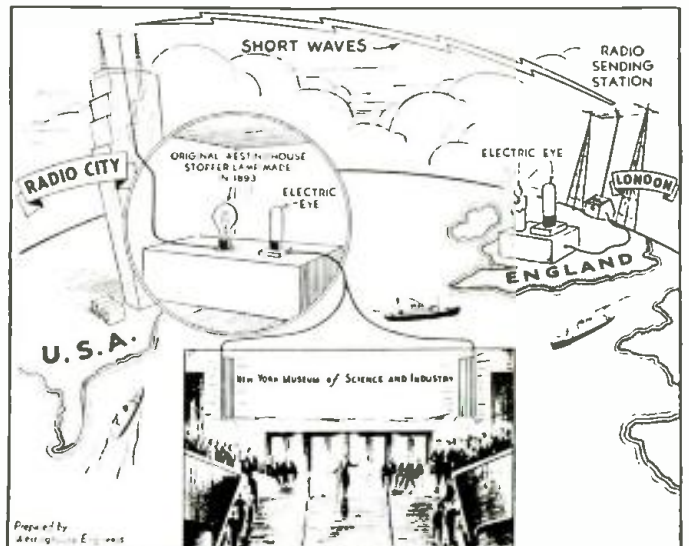

Animated diagram showing candle and short-wave broadcasting station in England, Atlantic Ocean, Radio City and receiving equipment with insert of auditorium at New York Museum of Science and Industry.

## Short Waves Direct You Home!



Perry Green, Maine guide, making a test of the ultra short wave transmitter and receiver which can be seen on his canoe. Guides of the State of Maine have approved the equipment for use in case of emergency where persons are lost in the woods or where accidents happen in the remote places where woodsmen travel. With this new ultra short wave equipment which can be carried on a packboard the guide can be in constant communication with the main camp or with other searching parties.

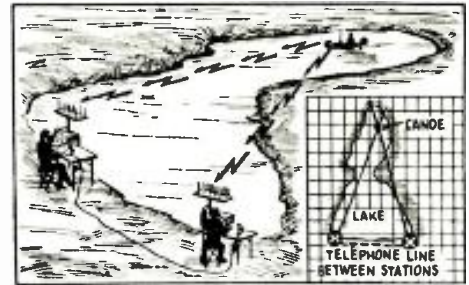

The drawing above shows how two or more shore stations can plot the position of a transmitter on a canoe, for example, and then radio this information back to the canoe operator.

and he can then, by means of his compass, shape his course accordingly so as to reach his destination. Position reports can be requested and given as often as desired, and in this way, especially in foggy weather or at night, successive location reports can be checked and the canoeist eventually directed safely home. The two "listening post" stations are connected by telephone or radio link, so that all "focal" readings on the canoe transmitter are taken simultaneously.

The accompanying photo shows a very efficient 5-meter short-wave transmitter and receiver in use on the canoe of Perry Green, a Maine guide, but the set here shown is, so far as known, only used to talk to or receive from a base station on shore. However there is no reason why one of the methods here suggested cannot be put into operation in connection with the canoe transmitter and receiver. According to one report, the state of Maine experts have approved ultra short wave equipment for use by guides in lakes or forests, so they can get in touch with their base stations in case of any emergency which may arise.

If no directional location system is to be used, and the person, for example, were lost on a large lake or on a mountain, and got in touch with a base station and told them he was lost, he would presumably be able to radio a rough description of his immediate location and rescue parties dispatched.

● **SUPPOSE** you were lost on a large lake! What would you do? Not much you could do, perhaps—but if you had a short-wave transmitter and receiver like that shown on our front-cover illustration, you could radio your predicament to the base station on shore. And if you could obtain your location from the shore station, you could set your course by a compass and "paddle your own canoe" back to camp.

Loop antennas do not work very well on short waves, at least with the ordinary circuit, but the use of a loop antenna on a receiving set would provide one of the easiest ways to arrange a direction indicating receiver. Under the usual operating conditions now prevalent on short waves, such as 5

meters, probably the simplest way in which the guide shown on the cover determines his location, if lost, would be to have two or more listening posts on shore tune in on his transmitter. Either code or voice signals could be picked up by two or more shore stations, and providing these listening posts on shore use directive antennas, such as the new rotating beam aeriels, then two or more listening post operators obtain a "focal line" on the canoe transmitter. Suppose the two focal lines are then plotted on a map; the point where these two lines or angles cross each other (intersect) marks the spot where the canoe transmitter is located. One of the shore operators can then tell the lost canoeist his exact location, according to the map,

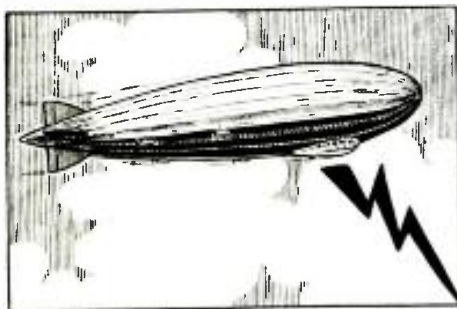

The new German airship LZ-129 "worked" the Radiomarine station at Chatham, Mass., on 24 meters, while she was flying over Europe.

● **BY THE** time this article is read, the new giant German Zeppelin, LZ-129, will have made a trip over the South Atlantic to Rio de Janeiro. A few weeks ago, during one of her trial flights over Lake Constance in Switzerland, the LZ-129 tested her various radio sets, transmitters and receivers being carried for operation on many different frequencies, both long and short waves. We have  
(Continued on page 111)

## New German Zeppelin LZ-129 Contacts U. S. on Short Waves



Photo above shows RCA Marine Coastal station at Chatham, Mass., where the 24-meter signals were picked up from the new German Zeppelin while flying over Lake Constance. The call letters of the LZ-129 are DEKKA.

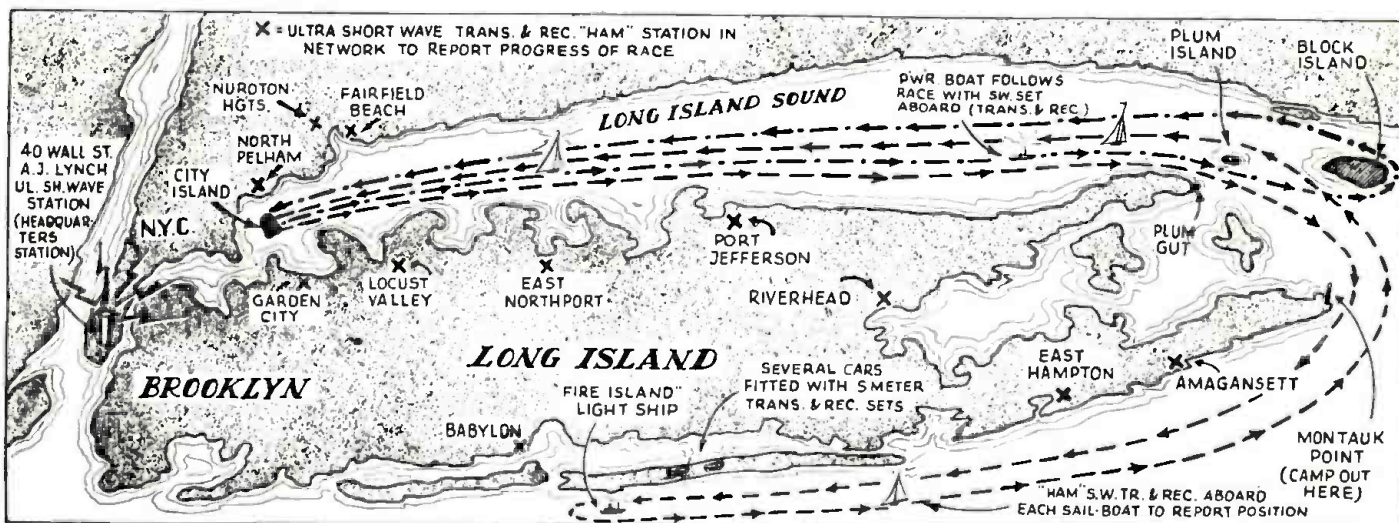

Map showing how Radio Amateur "network" will serve to report position of sailboats in races this summer on Long Island Sound. Motor cruisers on the Sound and special radio equipped cars on land, will supplement the 5-meter "flashes" from the "Ham" sets on the sailboats. A very ambitious and worthwhile effort by the 5-meter enthusiasts of the Garden City Radio Club and the yachtsmen of the Long Island Sailing Fleet. "Ham" stations on shore will pick up the reports from the yachts and relay them to headquarters.

# HAM "Net" to Report SAILBOAT RACES

● THROUGH the whole-hearted cooperation of Edwin Ruth, S. P. McMinn and Arthur Lynch of the Garden City Radio Club and Mr. W. E. Handy of the A. R. R. L., it has been possible to bring the Amateur Radio Operator and the Long Island Sailing Fleet together. I believe the result of this meeting is going to prove extremely interesting to both fields.

By Curtis Arnall

How possibly a hundred "Ham" operators and their sets will report position of sailboats in races on Long Island Sound this summer.

Every year, during the summer months, there are several important over-night sailing races held on Long Island Sound. These races take anywhere from twenty to fifty hours. By placing a radio transmitting set aboard each boat, it will be possible, at regular intervals, to broadcast back to the different Yacht Clubs, the positions of the

(Continued on page 121)

## Where S-W Stations Come In On Your Dial

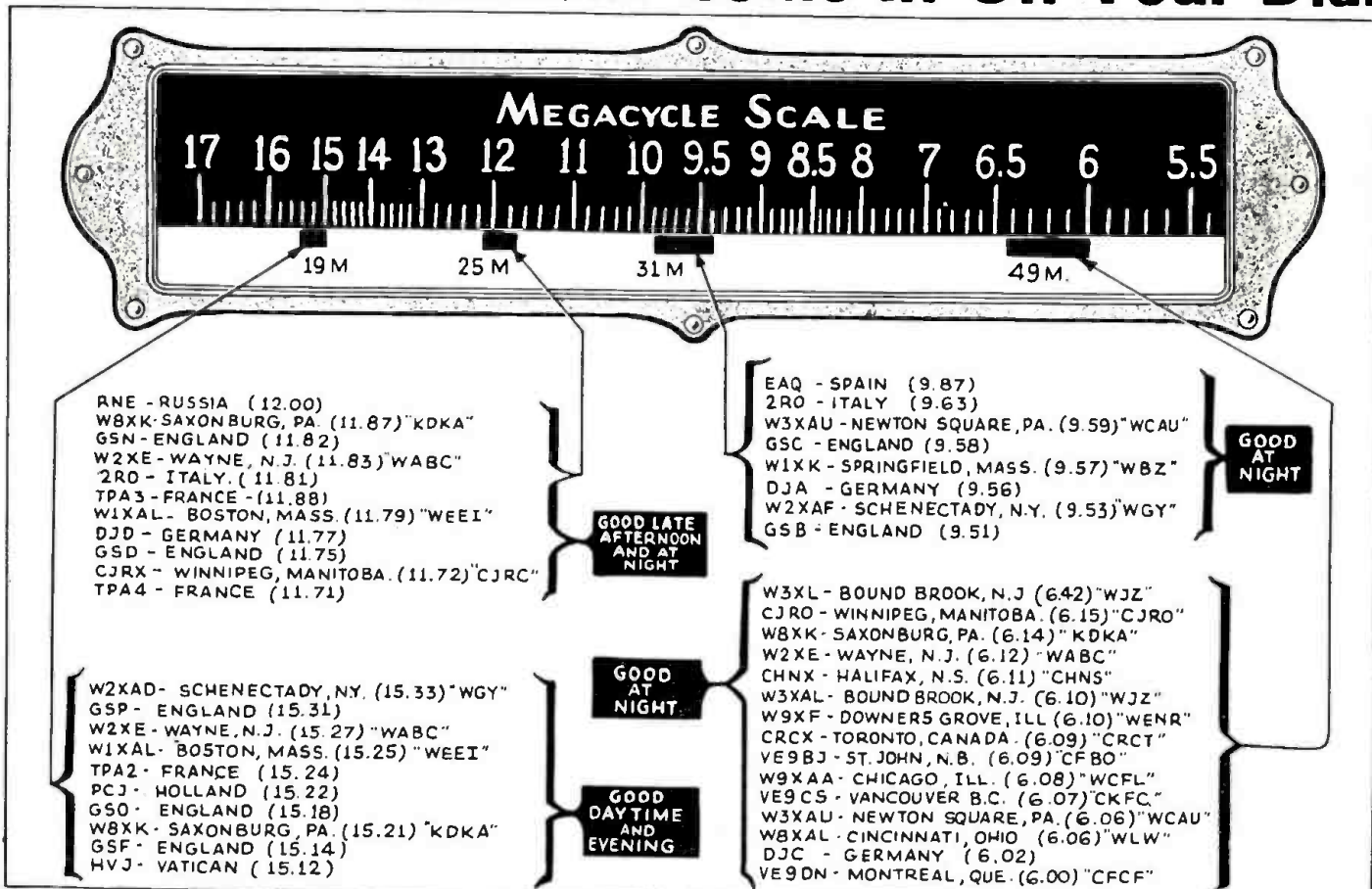

RECEPTION CONDITIONS DESIGNATED ARE BASED ON LOCATION OF LISTENER IN E.S.T. ZONE. MAKE ALLOWANCE FOR OTHER TIME ZONES

# SHORT WAVE CRAFT presents Silver Trophy to Gerald D. Coleman, W8FRC

## for His Outstanding Radio Work During the Johnstown Flood

Mr. Coleman's own story of the part his station, W8FRC, played in the Flood—Written for *Short Wave Craft*—is presented herewith.

● MANY articles have been written on the terrible destruction wrought by the greatest flood in modern history,



Gerald D. Coleman, W8FRC, and his station which performed heroic rescue work during the exciting days and nights of the Johnstown Flood.



The handsome Silver Trophy presented to Gerald D. Coleman, W8FRC, by SHORT WAVE CRAFT in commemoration of his outstanding Amateur radio work during the Johnstown flood, when he aided the Red Cross, National Guard, Telephone Companies, and the citizens of Johnstown, by keeping at his post day and night for over 60 hours.

but it will be the Amateur radio operators task to record, for all time, the complete story surrounding each "Ham" shack. This story is about W8FRC—the station ordered off the air by Mayor Shields of Johnstown, Pa.

It was noon Tuesday, March 17th, when flood conditions began to look serious. It had been raining for almost thirty-six hours and, as we found out later, it rained for thirty-six hours more. It was around 2 p.m. when the streets of downtown Johnstown, began filling with water and all people in that section were marooned for over twenty-hour hours. The water kept rising until it had reached a depth of fourteen feet in the city.

### "Amateur Radio" Only Link Left!

It was about 4 p.m. when telephone, Western Union and Postal telegraph companies and the local Broadcasting station were put out of commission. In other words the city of Johnstown was without any type of outside communication EXCEPT AMATEUR RADIO! Such a situation, as this, has always

been looked at as possible, but highly improbable. The second great catastrophe within forty-eight years was upon us and, as amateur operators, it was our duty to get in touch with the outside world and stay in touch with the outside until commercial communications were back to normal.

The first two "Ham" stations in Johnstown, to realize that a very important task was before them were W8DYY and W8FRC. Both of us are Naval Reserve men and normally operate CW on 3610 kcs. It was very important that 3610 kcs. be guarded and it was also important that the 75 meter phone band be used in order that a graphic "word-picture" of our plight be flashed to the Red Cross and Press Associations. Robert Dixon, W8DYY, and myself, W8FRC, are holders of class "A" amateur tickets, but living only a block apart we could not operate on the same frequency. As I had class "B" phone equipment I operated on 75 meter phone, and, thereby, avoided interference with each other.

(Continued on page 123)

Gerald D. Coleman, W8FRC has been selected by the editors of *Short Wave Craft* as the radio amateur most deserving of recognition for his services rendered during the emergency produced by the Johnstown flood. In commemoration of his contribution to this worthy cause, we are presenting him with this Silver Trophy for his commendable service to his fellow men through the medium of short waves. Mr. Coleman unselfishly stuck to his post without a relief operator from 4:00 p.m., Tuesday to 10:00 a.m. Friday, and his station provided the only means of communication when the telephone and telegraph circuits were rendered inoperative by the rising waters. W8FRC handled hundreds of messages for the Red Cross, the National Guard, the Telephone Company and private citizens of Johnstown. Gerald Coleman's station belongs to the Naval Reserve Amateur Radio Network, and his excellent phone and CW amateur station operates under the licensed call letters—W8FRC. The Johnstown flood acquainted not only the United States, but the entire world with the true significance and versatility of short waves—and the short-wave amateur in particular.

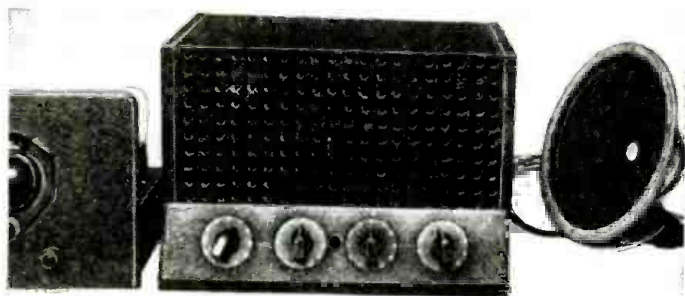

Here's the de Luxe A.F. amplifier hooked up to a small "head-phone" receiver so as to boost the signals sufficiently to operate a loud-speaker.



# A De Luxe A.F. Amplifier With Triple Tone Control

By M. Harvey Gernsback

We have been looking for a good audio amplifier for our short wave "Fan" and "Ham" friends—one that would be worth while adding to that good "head-phone" set—and here it is. It employs the new "metal" tubes and has its own "power-supply."

● "VARIETY is the spice of life," according to an old maxim. Taking this homely bit of advice to heart the author decided that perhaps a little variety in a piece of radio apparatus might add a little "spice" to it.

With this idea in mind this audio amplifier was designed. Its main claim to fame (?) lies in the fact that by adjustment of its controls it is possible to secure a variety of frequency response characteristics from it.

### 3-Tone Controls Provided

There are 3 separate tone controls. One of these raises or lowers the amplification of frequencies in the neighborhood of 80 cycles, that is, the bass notes. The second control raises or lowers the degree of amplification of the frequencies between approximately 250 and 3000 cycles. The third control controls the (Continued on page 115)

Right—close-up view of the de Luxe A.F. amplifier—a considerable amount of research work was carried on by Mr. Gernsback in developing this amplifier, and tests have shown that it will prove a very fine addition to any S-W "Fan's" equipment. P1-volume control; P2, low frequency compensator; P-3, medium freq. comp. and switch; P4, Hi-Freq. Comp.

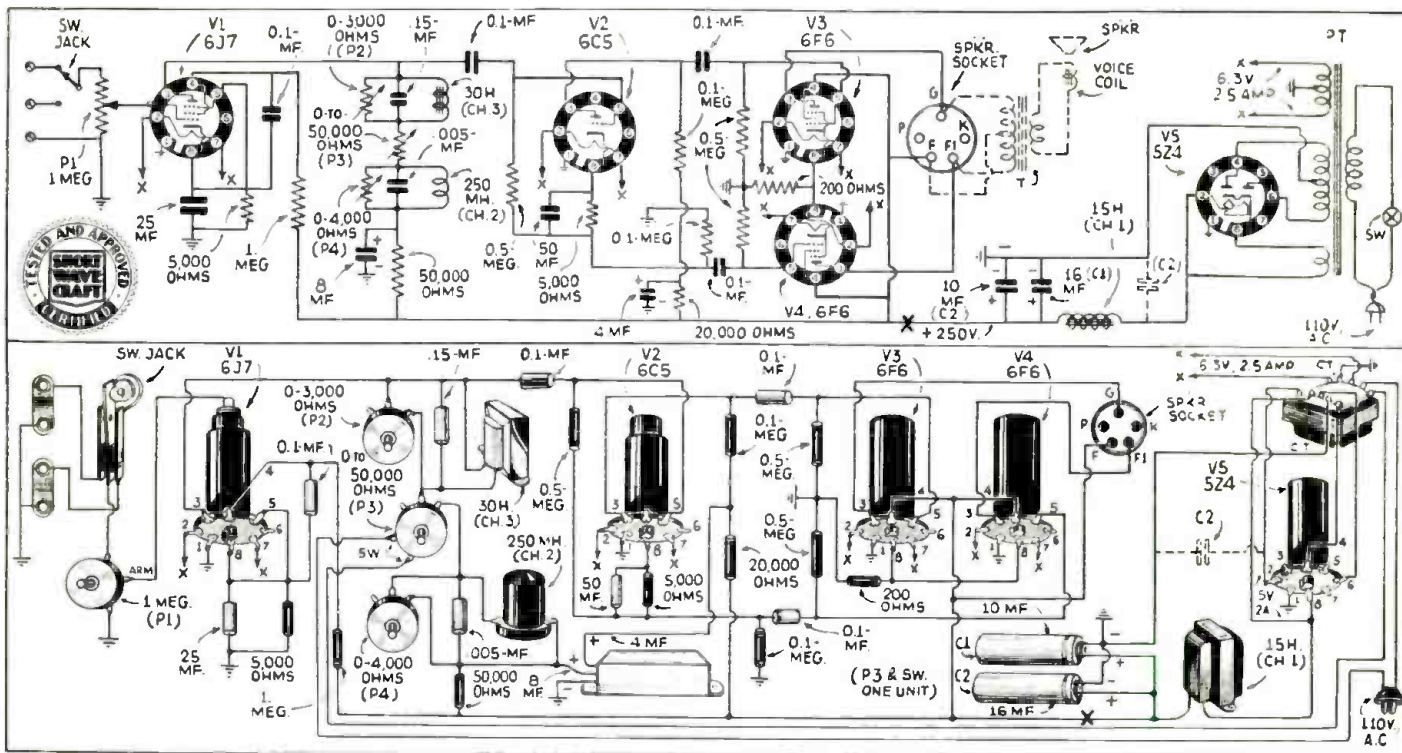
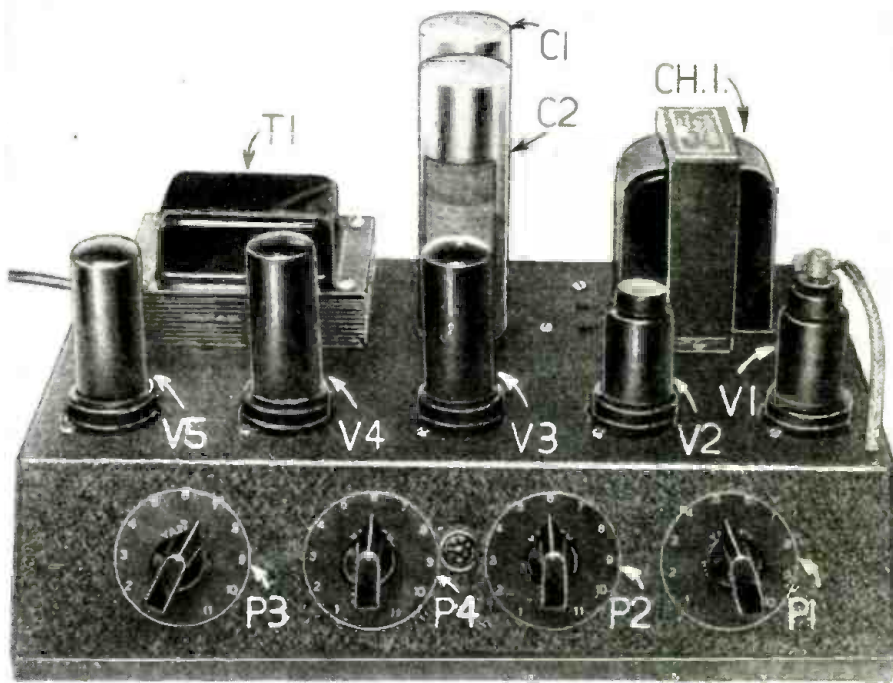

Wiring diagrams, both schematic and physical, for the de Luxe A.F. amplifier are given above. Any one who is at all familiar with wiring electrical or radio apparatus can, with the aid of but few tools and a soldering iron, easily build this amplifier.

# A 2-Tube, Band-Switching

By George W. Shuart, W2AMN

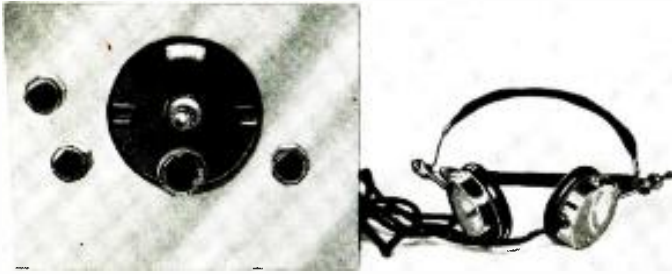

Front view of the 2-tube "switch-coil" receiver.

● NEARLY every commercial receiver today uses some form of coil-switching arrangement, while the short-wave experimenter has been constantly using plug-in coils. With the improvements in switch design, it is now possible for even the most inexperienced "Fan" to construct a receiver employing *band-switching*, and still obtain just as good results as if he had used plug-in coils.

In this article we intend to point out a few very simple rules for band-switching, and illustrate a working model as an example. In this receiver a range of from 15 to over 50 meters is divided into two stages. The first runs up to around 30 meters, while the second stage includes the ranges up to around 60 meters. Only two coils are necessary and a single "shorting" type switch.

For convenience of illustration we have selected a single regenerative detector, using a screen-grid pentode tube, resistance-coupled to a triode amplifier. Of course if the reader desires to construct a more elaborate receiver, the simple rules given, and the switch connections shown will only have to be enlarged upon.

For instance, if a stage of tuned R.F. were added to the receiver, another set of two coils and one additional (ganged) switch would be required. The parts layout plan for the receiver employing an R.F. stage ahead of the detector would be identical to other T.R.F. receivers described in past issues of *Short Wave Craft*.

Shielding is most important in this case. The coils used in this receiver are manufactured by the Miller Coil Company and are designed to be used in conjunction with an "all-band"

Here's a compact, dual-range, short-wave receiver, covering from around 15 to 60 meters and using a very efficient switch-coil arrangement. Complete constructional details are given regarding the switching arrangement, so that the reader might construct a receiver having a tuned R.F. stage if desired. There are no *dead-spots* in the operation of this set, and the switch-coil arrangement has proven every bit as efficient and flexible as the usual plug-in coils. Stations from all over the world were heard with excellent earphone volume.

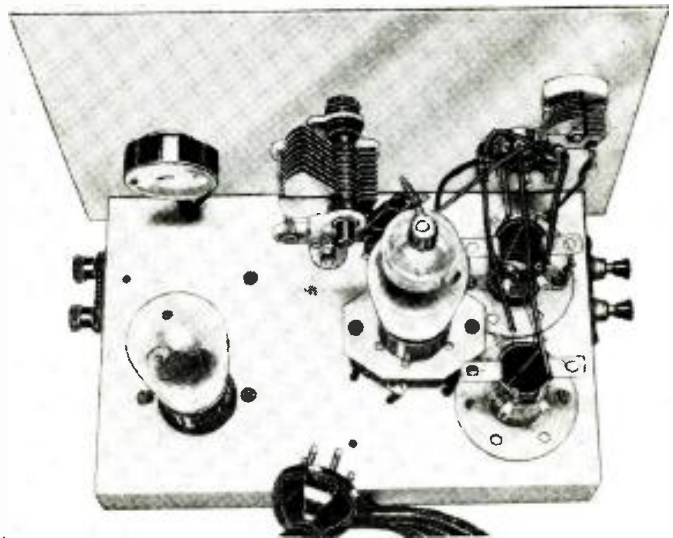

General rear view, showing how the various parts are placed on the chassis, permitting short leads.

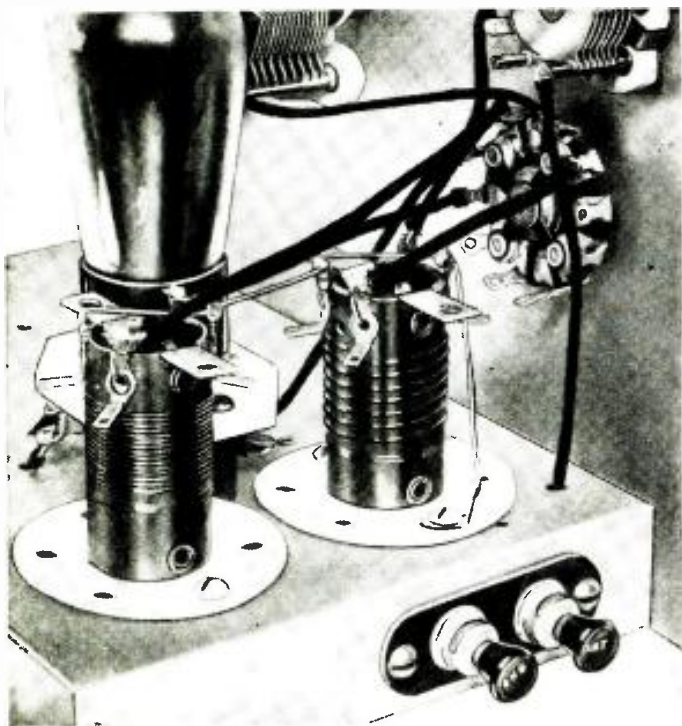

Close-up of the switching arrangement, showing the two coils and the rotary switch.

superhet. However, just two coils were selected for this receiver. Those having the proper ranges happen to be those having code numbers C-727-C-OSC and D-727-A. The smallest of these tunes from around 14 to 35 meters with the condenser shown. The larger coil as we stated before, tunes up to about 60 meters, taking in all the possible short-wave "broadcast" bands, as well as two amateur band.

It is very important to use a good switch, one having the contacts well spaced and providing a minimum of distributed capacity in the switch itself. A switch having large blades might allow sufficient capacity coupling between the two coils, to bring about a "dead-spot" in the tuning range of the smallest coil, at the point which is a fundamental resonant frequency of the larger coil. A clear drawing is given of the type switch used, and if this type is selected no difficulty will be experienced due to "dead-spots." In a regenerative receiver of the type illustrated in the photo and diagrams, the *antenna coupling* is quite an important consideration. Here band-switching is incorporated in a receiver; one would naturally assume that the antenna had to be switched also. However, a separate contact is not needed for this, if the method shown in the diagram is employed.

In this case the cathode of the detector is connected with the feed-back coil in a so-called *electron-coupled* circuit. By connecting the antenna directly to the cathode through a small fixed condenser, you can readily see that when the cathode coils are switched, the effective antenna coupling is also switched. Naturally, the coil for the highest frequency has the fewest number of tickler turns, and the coil for the lowest frequency the greater number of tickler turns. By connecting the antenna to the cathode, this tickler coil is also employed as the antenna pick-up coil, so that we

# Receiver—for the S-W Fan

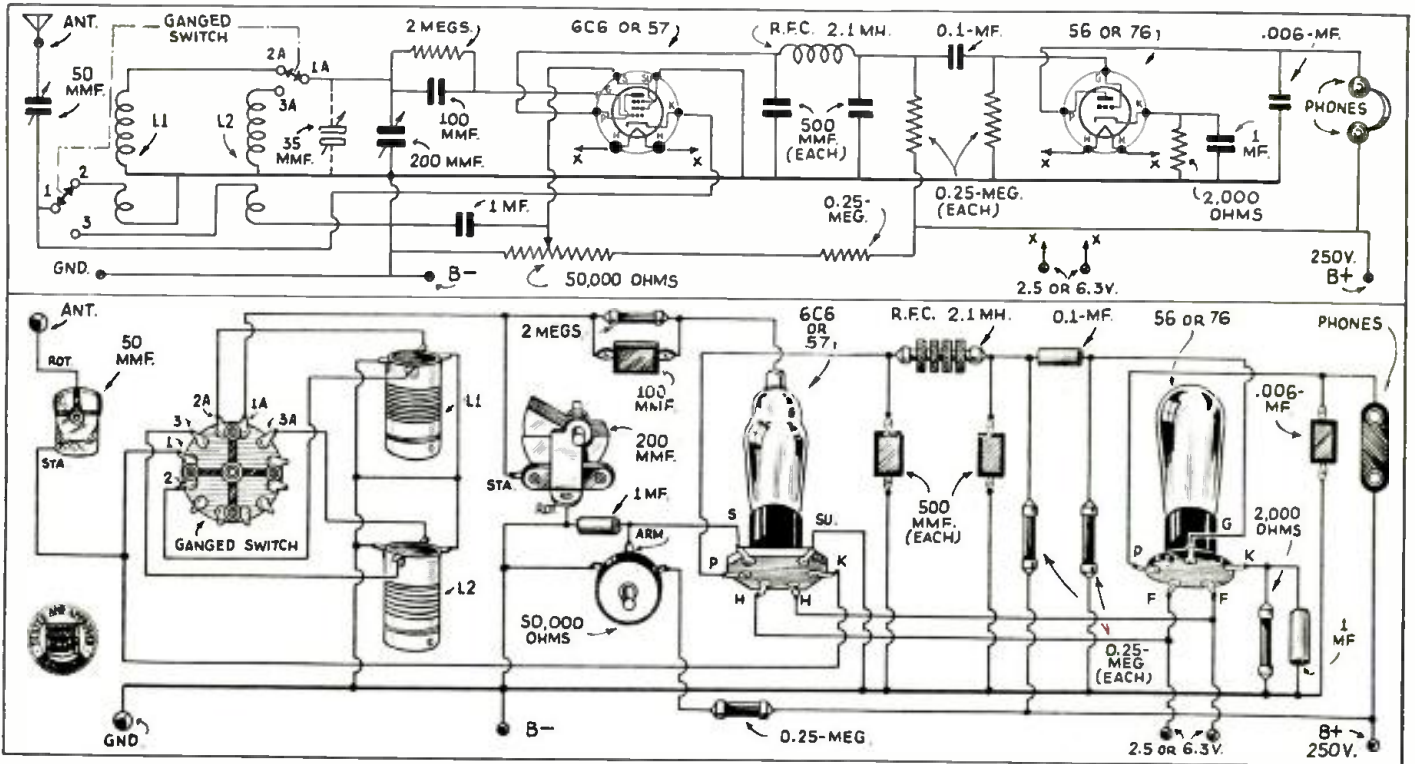

Schematic and picture wiring diagrams which even the most inexperienced may follow. This receiver is simple to build by following these diagrams. Complete satisfaction to the reader is assured.

actually change the antenna coupling when we switch from one coil to the other, thereby eliminating the necessity for changing the antenna coupling condenser. The rest of the circuit is perfectly straightforward, and needs but little explanation.

The plate circuit is well filtered, with a 2.1 mh. R.F. choke and two small fixed condensers. A single audio stage provides sufficient volume for earphone operation, and, should speaker operation be desired, an additional stage employing a pentode power tube may be added.

Of course, with 200 mmf. tuning condenser, we do not *band-spread*. However, this can be an added feature to your receiver, through the addition of a 35 mmf. condenser connected in paral-

lel with the main tuning condenser, or one of the new Crowe band-spread dials may be employed. The condenser method of *band-spread* is clearly indicated by dotted lines in the schematic drawing. Stations from all over the world were heard with this receiver and excellent volume was obtained.

Regeneration in the detector stage is controlled with a 50,000 ohm potentiometer. Between the potentiometer and the B plus there is connected a 1/4 meg. resistor. This system has been found to give exceptionally smooth control. If a power supply having a 20 to 30-volt tap is used with this receiver, the 1/4-meg. resistor may be eliminated, and the *plus* side of the potentiometer connected to the low-voltage terminal of the power supply.

The receiver shown in the photograph is built on a 7x8 inch aluminum base, 1" high, under which there is sufficient space for the various by-pass condensers, R.F. choke and resistors. The panel measures 7" high and 9" wide, and looking at the front view, we find that the antenna trimmer, which is a Hammarlund APC50, is located in the upper left-hand corner. Below this we have the Yaxley four-pole double-throw switch. Of this switch only two poles are used of course. In the center we have the main tuning dial and on the right-hand side the regeneration control potentiometer. The back view clearly shows the general layout of parts. The two coils are mounted directly behind the wave  
(Continued on page 120)

## A Stabilized Grid-Bias Circuit

● THE use of class "A" prime amplifier circuits in conjunction with short-wave receivers and transmitters has found wide acceptance due to the unusually high output that can be obtained with low voltage and limited current supply units.

One difficulty with these units up to now has been the need for a constant grid voltage. If the ordinary bias resistor is used, the "C" voltage depends on the plate current which varies with changing signal strength.

A novel way to obtain the constant bias voltage, without the need of a separate power transformer, rectifier and filter system was described in a recent issue of *Wireless World* (London). This consists of shunting a high resistance across half the high-voltage winding and tapping part of this voltage off through a metal rectifier and using this as the bias. A resistor-and-condenser filter smooths the voltage sufficiently for the bias.

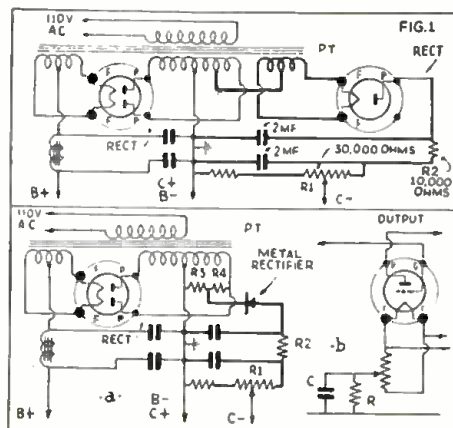

By properly polarizing the rectifier, the current for "C" bias is only drawn during the half of the A.C. cycle at which that side of the high-voltage winding of the power transformer is idle. In other words, in a full-wave rectifier circuit, only one side of the rectifier is passing current for each half cycle. And it is the idle half that is utilized in this clever scheme.

The metal rectifier can be replaced by a tube, if the power transformer has an extra filament winding which is not used. Otherwise, a filament transformer must be used to light the filament. Both the metal and tube circuits are given.

In the two diagrams to the left a novel method of obtaining bias voltage from the regular plate power-supply is indicated. This provides an extremely simple and efficient method for overcoming the grid bias problem. The polarity is such that grid bias is being supplied by one side of the high voltage secondary during the period in which it is not furnishing plate power. Thus, the plate transformer is not overtaxed in the least.

# How to Construct the New NOISE SILENCER

By W. Green

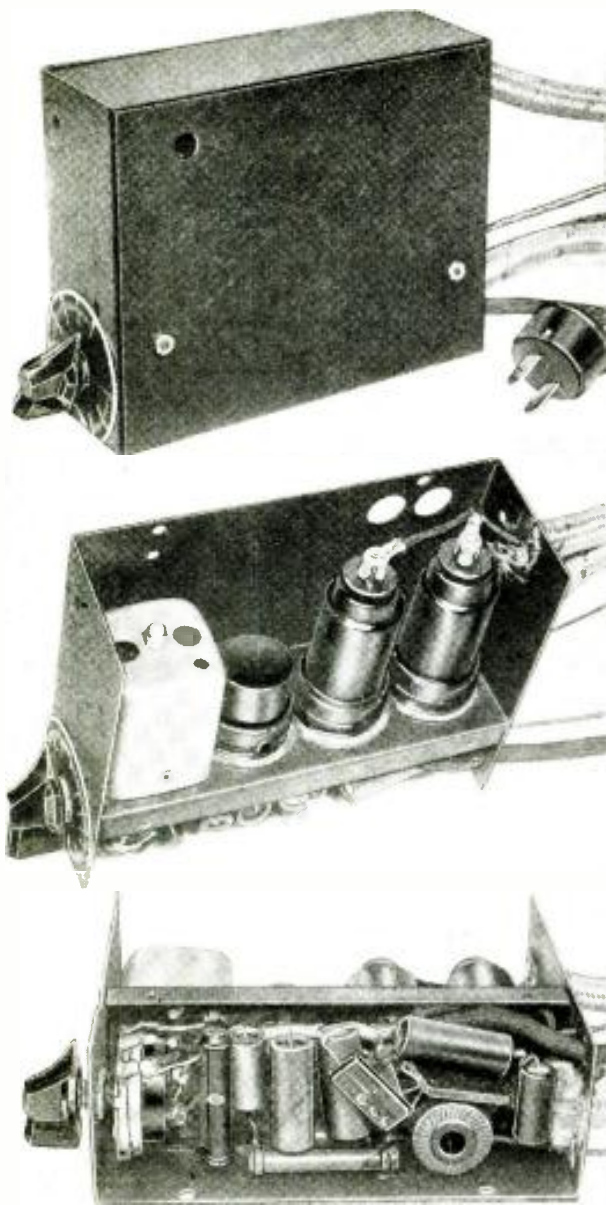

A new, clever, yet very simple device that really cuts out man-made static, ignition noises, dial telephone clicks, and interference from motors such as oil burners, vacuum cleaners and fans.

eliminators." By the use of a ground in place of the outdoor antenna, the collector of noise (the antenna) was eliminated. This, unfortunately, also eliminates the collection of signals! After this came a veritable army of filters—antenna filters and power-line filters. Each, while it assisted slightly in reducing the "noise level," nevertheless did not get at the real root of the trouble.

There are so many different types of disturbances that can be picked up, that no one filter or combination could eliminate them. The only solution with filters of this sort would be to connect

effectively eliminate or reduce this noise is essential.

### The Lamb Noise Silencer Principle

Better than this, thanks to J. J. Lamb, Technical Editor of QST, the device to be described actually does the job. While it does not entirely cut out the interference, it does, nevertheless, cut it down to such an extent as to make hitherto unintelligible reception clear, clean and enjoyable. It does not have to completely cut out the interference in order to be effective, and here's why.

Ordinary electrical disturbances in modern radio reception are found to be one of two types. There is the steady "hash" type and the second, or more common variety, "machine gun" interference. The latter, generally caused by sparking, is most frequently originated by switches, ignition systems, dial telephones and similar devices.

The action of the *noise-silencer* is to cut off the receiver momentarily during the peaks, so that they never reach the detector tube. Thus, there are periods of silence lasting about one-thousandth of a second and recurring with the frequency of the noise. These silent periods are actually not heard by the ears.

The simple analogy of motion pictures will clarify this. Although "movies" consist of 16 different pictures flashed separately on the screen every second, we see one continuous moving picture. This is the persistence or lag of vision. Similarly, in the noise silencer, we do not notice these periods of silence but hear a continuous unbroken signal.

(Continued on page 103)

● NOISE interference is the big problem that has kept the experts of radio research busy ever since the earliest days of communication. The passing years have witnessed "gadgets" for this purpose attacking the problem from every conceivable angle.

The earliest types were the "antenna

erator, fan, telephone, ignition system, etc. We can easily see the difficulty of this gigantic task. The author feels that some day in the future, every manufacturer of these interfering electrical devices will make appropriate radio filters an integral part of his equipment. Until such time, the need for a device to

Three views of the "easy-to-build" Noise Silencer as here described by Mr. Green.

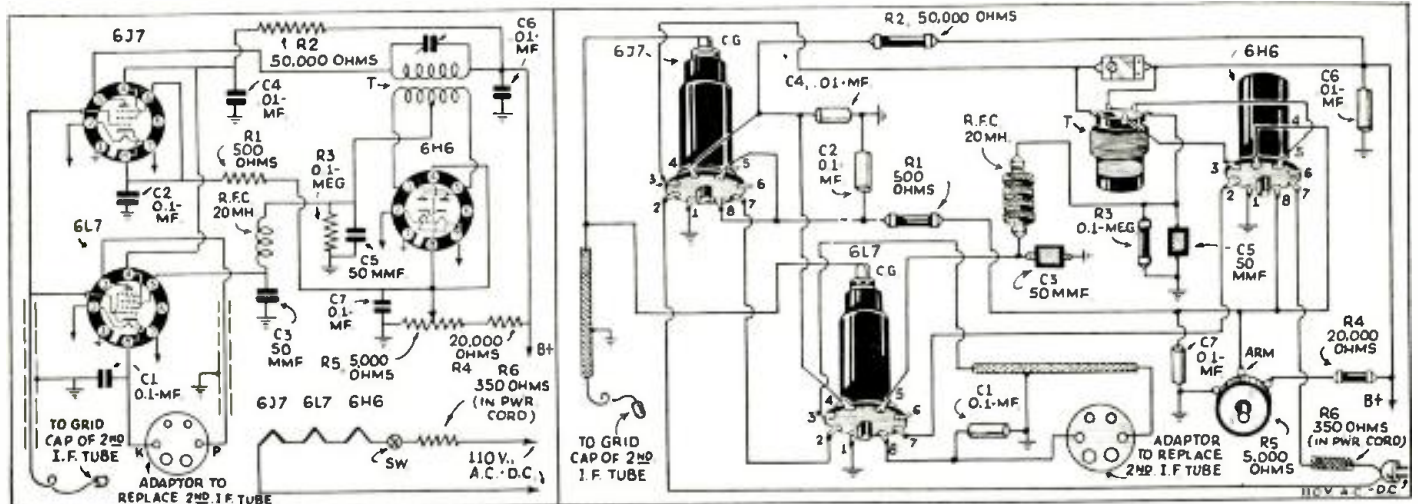

Picture and schematic diagrams of the new "Noise Silencer"; it can be added to most superhet receivers and will effectually eliminate "man-made" static—noises from electric motors, and other devices which radiate similar disturbances.



● For the benefit of those amateurs who would like to increase the output of their low-power transmitters, we take pleasure in presenting this article.

Here we have an amplifier capable of giving around 200 watts output, which is economical to build and operate. It can be added to your present transmitter, providing it has an output of around 20 watts. Two of the new type 830-B's are used in push-pull. Complete details are given.

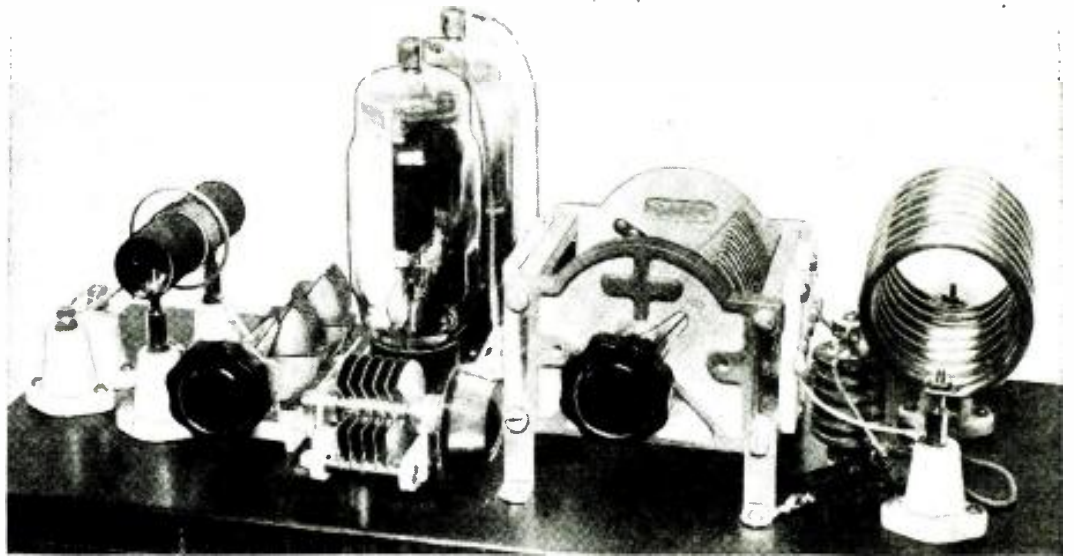

Front view of the 830-B push-pull amplifier.

# 830-B PUSH-PULL AMPLIFIER



By George W. Shuart  
W2AMN.

worked out in the form of the amplifier shown in the photos.

● THERE are many "Hams" who are operating transmitters with outputs ranging from 15 to 30 watts who would like to add an amplifier to their "rigs." The great problem has always been the type tubes to use. Mainly because of the larger investment required when increasing power, the ham has used low-power tubes and overloaded them in order to obtain greater output. This is not necessary today because, as we look through the transmitting tube data, we find a tube for every power output and one that fits the purse of nearly every amateur.

The average output required to compete with present-day conditions—an output which will permit one to work through under even the most adverse conditions, is 100 to 200 watts. This power is obtainable from the average low-power transmitter with the addition of some sort of amplifier. This problem was carefully considered and the most economical method was finally

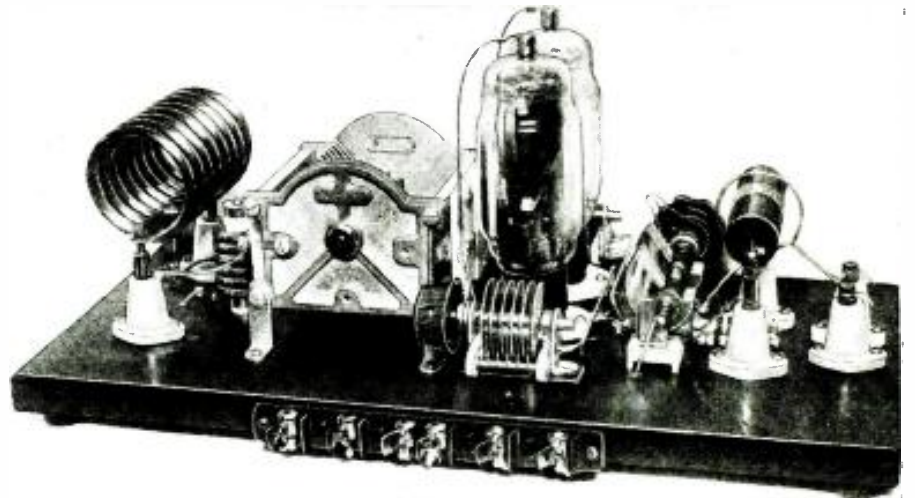

Rear view of the amplifier, showing the general construction and layout.

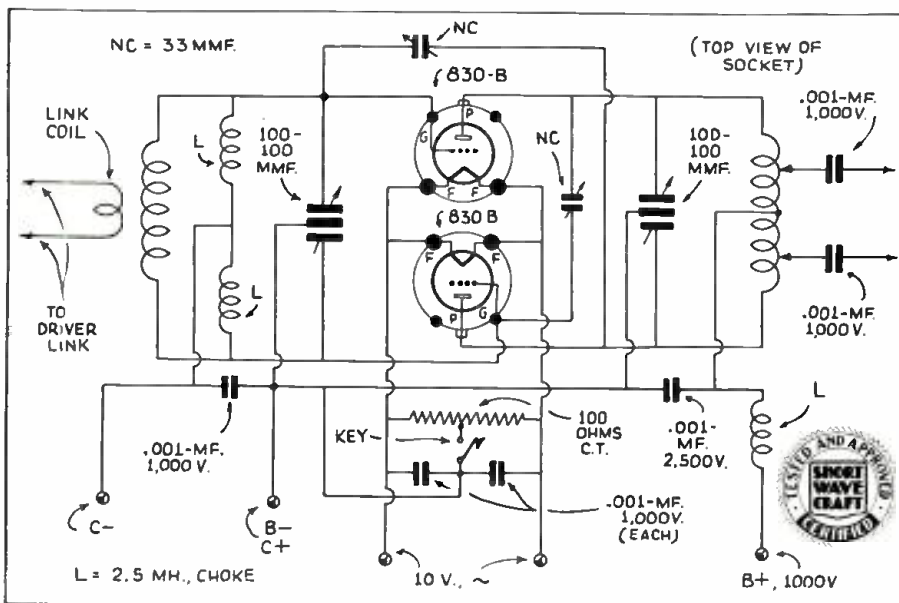

### 2-830-Bs in Push-pull

The unit shown uses two of the new RCA 830-Bs in push-pull. These tubes were chosen because of their ability to provide high-power output and their relatively low cost. Of course a single 203A would do the job just as well, but that would necessitate the use of a single ended circuit, which is not as efficient as a push-pull circuit at the higher frequencies and, besides, where we have our investment in two tubes, we are a lot safer than if we were to put the en-

*(Continued on page 104)*

Wiring diagram showing the proper connections and values of various parts.

# A Modulator for the Modern 5-m. Xmitter

(Described in May number)

By Howard G. McEntee, W2FHP

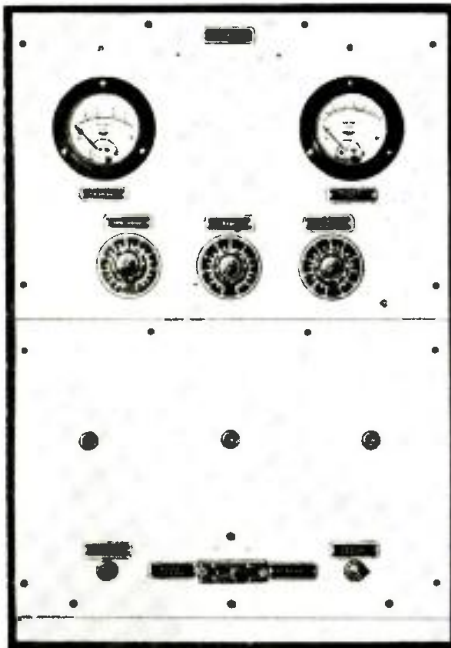

Here we have a front view of the complete modulator.

In the May issue of SHORT WAVE CRAFT, Mr. McEntee described a very efficient 5-meter MOPA transmitter. In the accompanying article the author gives a complete description of the modulating equipment used with the R. F. unit described last month.

field current to a dynamic speaker. It had a single secondary winding giving about 125 V. To this was added a winding of bell-wire providing 5 V. for the bias rectifier filament. An ordinary (Continued on page 118)

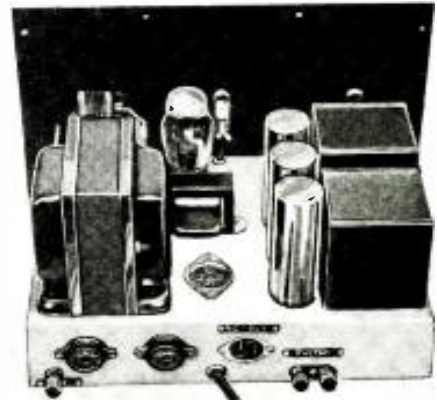

Rear view showing the general constructional details.

● THIS amplifier or modulator, is designed to be used with the 5-meter MOPA transmitter described last month. It may be used, however, with any transmitter where an audio power of 30 to 35 watts is required, and it may also, by use of the proper output transformer, be used as a high quality P. A. Amplifier. The use of triode tubes throughout aids in obtaining high-quality and "trouble-proof" operation, and their use also is an economic measure, since the output tubes, which are type 45, are among the lowest priced tubes.

The input is arranged for use with a double-button mike, and a meter and rheostat are provided to control the button current. A 4½ V. "C" battery will last quite a few months, since the average current drain is only about 20 ma. The input tube, a 2A6 with the diodes grounded, is impedance and resistance-coupled to a 56. The volume control is in the grid circuit of the 2A6, to prevent overload. A 3 to 1 transformer is used between the 56 and 45 "driver." The bias for the 45 is tapped off from

the C bias bleeder, so the filament of this tube, as well as of the output 45's is connected directly to ground, through a center-tapped resistor.

The Class AB input and output transformers must be of high quality, particularly the input transformer, or the rated power output will be much under that expected.

The output transformer has a secondary winding which is rated at 5,000 ohms and will carry the plate current of the R.F. Power Amplifier.

The power supply is on the lower chassis, and is connected by a seven-wire shielded cable with the amplifier circuit. The high voltage power transformer is designed to supply around 300 ma. on load, at about 300 volts. It has a husky 2.5 volt winding for the filaments.

The filter chokes are also rated to withstand the power requirements. The output stage is connected between the two chokes, so that a slightly higher voltage may be obtained with less drop on heavy modulation peaks.

The C bias power transformer was made from a unit designed to supply

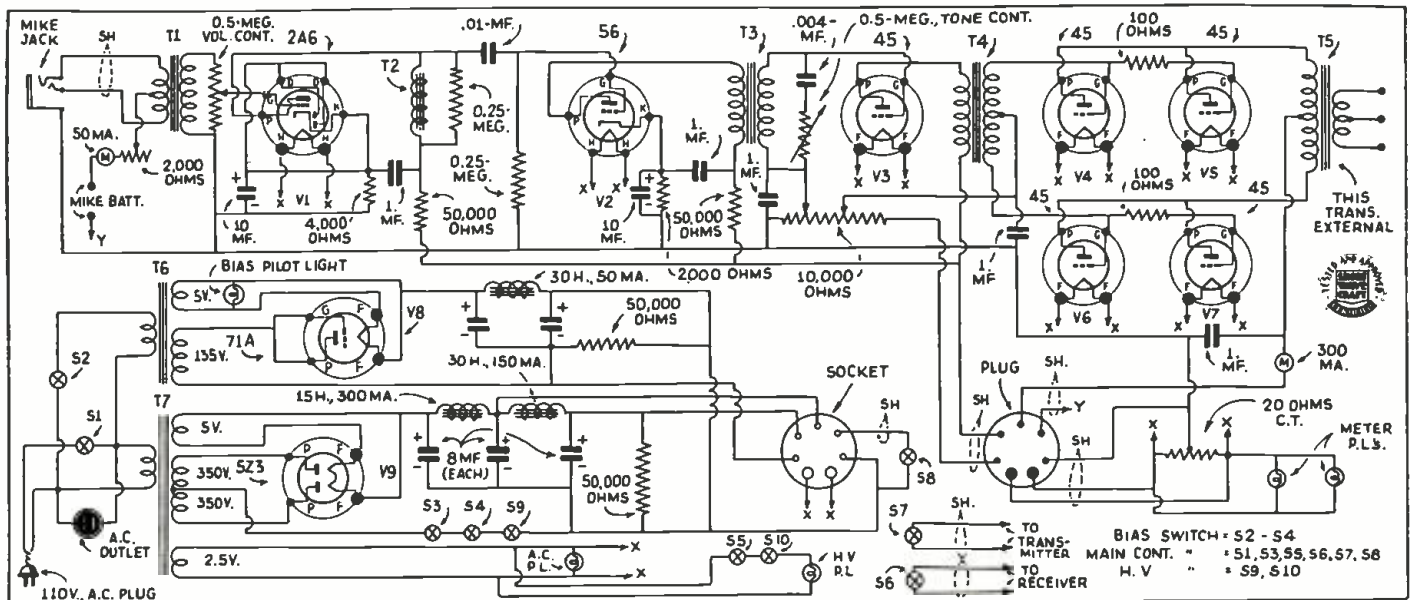

Wiring diagrams of the modulator and power-supply for the 5-meter MOPA transmitter.

# SHORT WAVE . SCOUTS

## TWENTY-SEVENTH "TROPHY CUP"

Presented to  
SHORT WAVE SCOUT  
RALPH B. BALDWIN  
Ann Arbor, Mich.

For his contribution toward the  
advancement of the art of Radio

by



Magazine

### 27th TROPHY WINNER

65 Stations—47 Foreign

● OUR heartiest congratulations to Ralph B. Baldwin of Ann Arbor, Mich., this month's winner of the handsome silver trophy, for his very fine "log" of short-wave stations heard and verified. Mr. Baldwin had a total of 65 veris, 47 of which were foreign.

How about sending us a photo of yourself, and also one of your Listening Post or station. Send the photos with the "log" of stations. If the pictures are clear, we will endeavor to find space for them when publishing the story and "log" of the prize-winner. The photos do not necessarily have to be taken by a professional photographer; the main point is that they must be clear!

In making out the list of stations to enter in this contest, be sure to put the total number of stations and also the number of foreign stations, either at the end of the list or in the letter accompanying the "log" of stations.

#### United States Stations

W1XAL—11790 kc.—Boston, Mass.  
W1XAL—6040 kc.—Boston, Mass.  
W1XK—9570 kc.—Boston, Mass.  
W2XAD—15330 kc.—Schenectady, N.Y.  
W2XAF—9530 kc.—Schenectady, N.Y.  
W2XE—15270 kc.—New York, N.Y.

### Honorable Mention Awards

T. E. Port, East Barnet, Herts, Eng.  
G. W. Dixon, Rydal, Pa.  
Elmer Phipps, Annapolis, Md.

W2XE—6120 kc.—New York, N.Y.  
W3XAL—17780 kc.—Bound Brook, N.J.  
W3XAL—6100 kc.—Bound Brook, N.J.  
W3XAU—9590 kc.—Newtown Square, Pa.  
W3XAU—6060 kc.—Newtown Square, Pa.  
W4XB—6040 kc.—Miami, Fla.  
W8XAL—6060 kc.—Cincinnati, Ohio.  
W8XK—21540 kc.—Pittsburgh, Pa.  
W8XK—15210 kc.—Pittsburgh, Pa.  
W8XK—11870 kc.—Pittsburgh, Pa.  
W8XK—6140 kc.—Pittsburgh, Pa.  
W9XAA—6080 kc.—Chicago, Ill.

#### Foreign Stations

CJRO—6150 kc.—Winnipeg, Manitoba.  
CJRX—11720 kc.—Winnipeg, Manitoba.  
CFCX—6090 kc.—Bowmanville, Ont.  
DIP—14410 kc.—Zeesen, Germany.  
DJA—9560 kc.—Zeesen, Germany.  
*(Continued on page 117)*

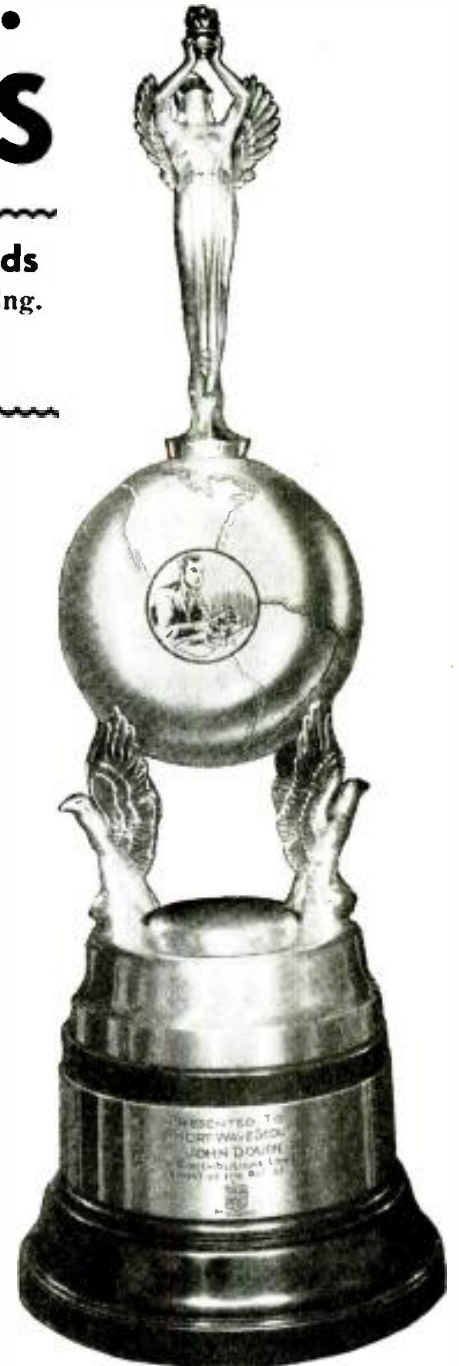

● ON this page is illustrated the handsome trophy which was designed by one of New York's leading silversmiths. It is made of metal throughout, except the base, which is made of handsome black Bakelite. The metal itself is quadruple silver-plated, in the usual manner of all trophies today.

It is a most imposing piece of work, and stands from tip to base 22½". The diameter of the base is 7¾". The diameter of the globe is 5¾". The work throughout is first-class, and no money has been spared in its execution. It will enhance any home, and will be admired by everyone who sees it.

The trophy will be awarded every month, and the winner will be announced in the following issue of SHORT WAVE CRAFT. The winner's name will be hand engraved on the trophy.

The purpose of this contest is to advance the art of radio by "logging" as many short-wave phone stations, amateurs excluded, in a period not exceeding 30 days, as possible by any one contestant. The trophy will be awarded to that SHORT WAVE SCOUT who has logged the greatest number of short-wave stations during any 30-day period.

### Trophy Contest Entry Rules

● THE rules for entries in the SHORT WAVE SCOUT Trophy Contest have been amended and 50 per cent of your list of stations submitted must be "foreign." The trophy will be awarded to the SHORT WAVE SCOUT who has logged the greatest number of short-wave stations during any 30 day period; (he must have at least 50 per cent "foreign" stations). This period need not be for the immediate month preceding the closing date. The complete list of rules appeared in the September issue of this magazine.

In the event of a tie between two or more contestants, each logging the same number of stations (each accompanied by the required minimum of 50 per cent "foreigns") the judges will award a similar trophy to each contestant so tying. Each list of stations heard and submitted in the contest must be sworn to before a Notary Public and testify to the fact that the list of stations heard were "logged" over a given 30 day period, that reception was verified and that the contestant personally listened to the station announcements as given in the list.

Only commercial "phone" stations should be entered in your list, no "amateur transmitters" or "commercial code" stations. This contest will close every month on the 25th day of the

month, by which time all entries must be in the editors' hands in New York City. Entries received after this date will be held over for the next month's contest. The next contest will close in New York City May 25th; any entries received after that date will be held over till the next month.

The winner each month will be the person sending in the greatest number of verifications. Unverified stations should not be sent in, as they will not count in the selection of the winner. At least 50 percent of the verifications sent in by each listener must be for stations located outside of the country in which he resides! In other words, if the contestant lives in the United States at least 50 percent of his "veries" must be from stations outside of the United States. Letters or cards which do not specifically verify reception, such as those sent by the Daventry stations and, also by commercial telephone stations, will not be accepted as verifications. Only letters or cards which "specifically" verify reception of a "given station," on a given wave length and on a given day, will be accepted! In other words it is useless to send in cards from commercial telephone stations or the Daventry stations, which state that specific verifications will not be given. Therefore do not put such

stations on your list for entry in the trophy contest!

SHORT WAVE SCOUTS are allowed the use of any receiving set, from a one-tuber up to one of sixteen tubes or upwards, if they so desire. When sending in entries, note the following few simple instructions: Type your list, or write in ink, pencilled matter is not allowed. Send verification cards, letters and the list all in one package, either by mail or by express prepaid; do not split up the package. Verification cards and letters will be returned, at the end of the contest, to their owners; the expense to be borne by SHORT WAVE CRAFT magazine.

In order to have uniformity of the entries, when writing or typing your list, observe the following routine: USE A SINGLE LINE FOR EACH STATION; type or write the entries IN THE FOLLOWING ORDER: Station call letters; frequency station transmits at; schedule of transmission, if known (all time should be reduced to Eastern Standard which is five hours behind Greenwich Meridian Time); name of station, city, country; identification signal if any. Sign your name at the bottom of the list and furthermore state the type of set used by you to receive these stations. State total No. stations.

# SHORT WAVES and Our Readers Forum. LONG WAVES

Arthur Harris, Jr., WJGX, Active Ham—Prize Winner



Photo above shows station of Arthur S. Harris, Jr., WJGX, of 4 Hillside Ave., Winchester, Mass. The silver trophy is that won by Mr. Harris in the "Best Listening Post" photo contest conducted by the "Official Short Wave Listener" magazine.

## OUR SETS DO MORE THAN WE CLAIM!

Editor, SHORT WAVE CRAFT:

I have been reading SHORT WAVE CRAFT for a long time and will continue to do so until the "dough" runs out. I find your station lists and time charts very helpful in tuning in DX. I have built many of your receivers and have found that if wired right, they do just what you say, and more too! The receiver I have now was described in SHORT WAVE CRAFT some time ago, and although I use different tubes the circuit is the same. It uses a 44 T.R.F., 44 detector, 201A first audio, 112 output; with this set I have received a good many stations, among them being: W8XK, W3XL, W3XAL, DJA, DJB, GSB, EAQ, FYA, and many South Americans and Amateurs. I have also received many "foreigners" but no verifications were received from them.

FRED EASTON,  
Box 200, Route 4,  
Sacramento, Calif.

(We are pleased to know that you have found our short-wave station list and time schedules helpful in tuning in distant short-wave stations. We are also tickled to learn that you have had such fine success in building numerous receivers described in SHORT WAVE CRAFT. Incidentally we might mention at this time that possibly 50 percent of the troubles experienced with receivers described in this or other magazines, is due to the fact that the constructor either carelessly or unknowingly wires the set in a sloppy fashion, plus poorly soldered or nonsoldered joints. Moreover the individual apparatus may be incorrectly placed or too crowded. If a set does not act just right, it will always pay to move R.F. chokes around and see if the set works better with the chokes in the new position. Sometimes a lot of trouble with sets such as feed-back and poor tuning characteristics are due to the nonshielding of the tubes, and it will always pay to shield them anyway.—Editor)

## DANDY "LOG" ON 2-TUBE SET!

Editor, SHORT WAVE CRAFT:

I have been an interested reader of SHORT WAVE CRAFT for quite a period of time and think it is the best magazine published dealing with the Short-Wave field. I have been extremely interested in what other fellows are logging with their sets. In this way I compare my results with theirs.

you read this. Naturally U.S. stations are omitted.

Canadian stations: CJRO, CJRX, VE9GW, VE9HX.

Davenport stations: GSA, GSB, GSC, GSD, GSE, GSF. I receive many British phone stations that pound in here with terrific volume.

French stations: "Radio Colonial" on several different frequencies.

Holland—PHI.

Spain—EAQ.

Portugal—CT1AA.

German stations: DJA, DJB, DJC, DJD.

Switzerland: HBP, HBI.

U.S.S.R.: RNE (RKI A Russian phone).

Mexican stations: XEBT.

Costa Rica: TIEP.

South Americans (all taken together): EI Prado, YV3RC, YV5RMO, HJIABB, LSX, PRF5, PSK, HJ5ABD, and others unidentified.

Cuba: COC.

Australia: VK2ME, VK3ME.

Recently I had an amateur in Southern California (W6CAH) coming in R8. I hear so many phone stations that I do not know half of their calls.

What do you think of this list?

I am a member of the ISWC and the SWL (SHORT WAVE LEAGUE) of this magazine.

In conclusion let me, as an ardent short-wave "Bug," thank you for a swell magazine. Let's have more logs of the fellows with 2-tubers. People seem to get the idea that a 16-tube set is the only kind of DX set to use!

GEORGE ZEHNER,  
Philadelphia, Pa.

(Fine business, George, and you have certainly "spanned the globe" with your 2-tube set. We are glad to know that you have had such very fine results with a set made from one of our specifications, and we believe that you will be pleased indeed with some of the new 1-, 2-, and 3-tube jobs that we are now developing for the forthcoming numbers.—Editor)

## A SUPER-SENSITIVE SET

Editor, SHORT WAVE CRAFT:

I have watched with much enthusiasm the growth of SHORT WAVE CRAFT and I possess a great many copies of your excellent magazine. After reading your magazine for a period of four years I feel that you have every reason to be proud of your efforts. Most of the circuits de-

scribed are practical and quite easy to read. I, myself, have spent a period of over two years searching for the best short-wave receiver, and I believe that I now possess one of the best receivers it is possible to construct. The layout of my receiver is as follows: I have a single stage of preselection which feeds into the first R.F. stage of a National NC5 converter. I have changed the circuit of the converter and it now incorporates a crystal filter and automatic volume control. This converter feeds directly into a Scott All-Wave receiver which consists of twelve tubes, using the superheterodyne circuit. Most of my friends have been amazed at the sensitivity of the set. Until recently I had been using

(Continued on page 102)

## One Year's Subscription to SHORT WAVE CRAFT FREE

for the "Best" Station Photo

Closing date for each contest—75 days preceding date of issue: April 15 for July issue, etc. The editors will act as judges and their opinions will be final. In the event of a tie a subscription will be given to each contestant so tying.

## "HAM" NEWS FROM BRIGHTON, IOWA

Editor, SHORT WAVE CRAFT:

The transmitter in the rack will be used on 160 meters. Next to the rack and on the table is my "television" scanner, all home-made. Next is the frequency meter or monitor. Just in back of the vibroplex key is a 5-meter transceiver, using 1-19 in PP. The microphone is on the right; on the lower shelf is my amplifier. The set I am holding on my lap is a 5-meter transmitter. All the apparatus in this photo is home-made, most of it was taken from your "FB" magazine. I am a member of the Short Wave League, and have been in radio since the days of spark xmitters and



Myrl O. Lemley, of Brighton, Iowa, and his "Ham" outfit. He toted it out in the yard for photographing.

crystal receivers. I am a steady reader of Short Wave Craft. Mostly interested in 5 meter stuff, also Television, Arc-welding and Wind-Electric plants, one of which I hope to use.

MYRL O. LEMLEY,  
Brighton, Iowa.  
RFD. 1.

(Glad to hear from you Myrl, and when you have some design data ready on that 5-meter apparatus, shoot it along to the editors. Hi!—Editor.)

# WORLD-WIDE SHORT-WAVE REVIEW

-Edited By C. W. PALMER

### 5-Meter Directional Array

A SIMPLE and effective directional antenna described in F8PA—a French radio magazine—consists of 8



Antenna composed of 8 copper rods arranged in a parabolic curve.

copper rods, each 1/2 of the radiating wavelength in meters and arranged in a parabolic curve about another rod of the same length. The latter rod acts as the radiating aerial and the position of the 8 reflecting rods determines the beam width and other characteristics of the radiating system.

The rods are secured to insulated skeleton frames at top and bottom (probably made of bakelite) which forms a rigid assembly.

The entire aerial is supported on four legs so that it can be mounted directly over the transmitter, as shown in the picture here. The power is then fed to the antenna directly from the inductances of the 5-meter oscillator by means of a short transmission line.

The simplicity of this "beam" antenna array is striking—it should make an effective radiator for the "ham" who is working in the ultra-short wave spectrum.

### An Italian Transceiver

THE combined transmitting and receiving units for portable use, in which the same tubes are used for sending and receiving, are becoming popular throughout the entire radio world.

In a recent issue of *La Radio per Tutti* (Milan) an Italian version of the well-

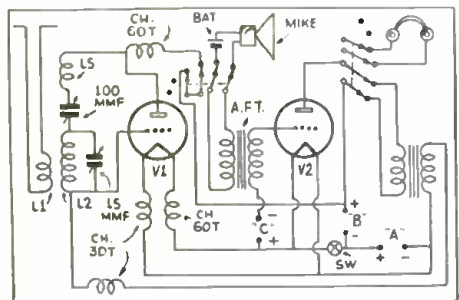

Interesting Italian Transceiver circuit, using same tubes for transmitting and receiving purposes.

● The Editors have endeavored to review the more important foreign magazines covering short-wave developments, for the benefit of the thousands of readers of this magazine who do not have the opportunity of seeing these magazines first-hand. The circuits shown are for the most part self-explanatory to the radio student, and wherever possible the constants or values of various condensers, coils, etc., are given. Please do not write to us asking for further data, picture-diagrams or lists of parts for these foreign circuits, as we do not have any further specific information other than that given. If the reader will remember that wherever a tuned circuit is shown, for instance, he may use any short-wave coil and the appropriate corresponding tuning condenser, data for which are given dozens of times in each issue of this magazine, he will have no difficulty in reconstructing these foreign circuits to try them out.

known *transceiver* principle was described. The circuit is self-explanatory. Tube V1 is the oscillator for transmitting and also the detector for receiving. Tube V2 is the modulator for voice transmission, while this tube doubles up and acts as an A.F. amplifier for receiving.

A simple 4-pole double-throw switch makes the change-over from transmitting to receiving instantaneous. One of the multi-leaf jack switches will be fine for this purpose.

It will be noticed that R.F. chokes are used to isolate both the grid lead from the oscillator to the modulator and the filament leads of the oscillator. This is necessary to prevent a loss of R.F. power through the modulator unit. The filament chokes must be wound with heavy wire to prevent dropping the oscillator filament voltage excessively.

The coils L1, L2 and L3 depend in size upon the frequency at which the unit is to be operated. The values of other parts are shown on the circuit.

### Graduating the Control

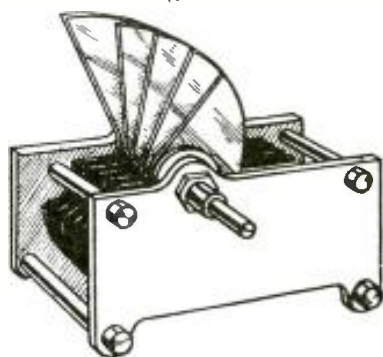

How plates of a feed-back condenser were cut to a "fan" shape, to provide more gradual increase in capacity.

● EVERYONE who has used a good regenerative receiver for short-wave reception will agree that with a limited number of tubes, really fine DX reception can be obtained.

The secret lies in the use of correct values of components which supply a smooth control of regeneration, up to the point of oscillation—and in having some means of spreading the control space by vernier dial or other means. By this method, tremendous amplification is possible in the detector tube.

(Continued on page 120)

### Super-Regenerative Circuit

● ACCORDING to a description of a new patent—No. 437160—issued to Baird Television, Ltd., in England which appeared in *Wireless World* (London) the pentagrid type of tube has been applied to the super-regenerative circuit.

The *octode*, as this type of tube is called in Europe, is applied as shown in the accompanying circuit. The ordinary control-grid is fed with the signal and the plate is

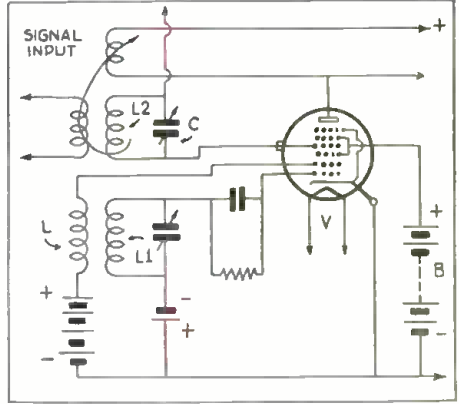

The very latest in Super-regenerative circuits, using a pentagrid tube.

used for feed-back, as in any pentode detector system.

The first and second grids (ordinarily used for the oscillator in superhet sets) are used for the "quenching" or interruption oscillator. Thus, the cathode stream of the regenerative detector is modulated by the interruption oscillator.

This combines in one tube the actions of detector and oscillator, without the disadvantages of other single tube super-regenerative circuits.

### Short-Wave Tube Sockets

● SPECIAL parts to cover the requirements of ultra-short work are finding more and more need as the applications for these waves increase. A recent issue of *Practical Television and Short-Wave Review* (London) contained descriptions of several new parts designed particularly for high-frequency use. One of these was a low-loss tube socket of the wafer type and having a ceramic insulation.

A glance at the socket reproduced shows the make-up of the socket. The usual spiral grip contacts which provide a very positive contact (compared to some of the American sockets) are of special interest. Some American socket manufacturers could do worse than copy this type of contact, rather than the flimsy springs they use at present!

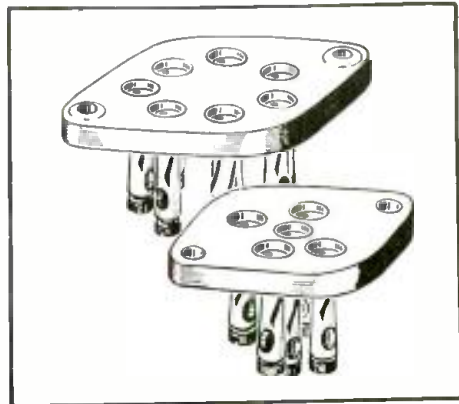

Sure-grip sockets for high-frequency tube.

\$5.00 Prize

DUPLEX POWER SUPPLY

Here is a scheme whereby a single power transformer may be used to furnish two separate power supplies. In the drawing we find that two rectifier tubes are used together with two sets of filters. In this manner, we may obtain two distinct, separate, filtered, 500-volt outputs. If the transformer has a good regulation, this arrangement may be used for supplying class B modulators as well as to the modulated rf. amplifier, derived from the same transformer without overtaxing the filter arrangement. This permits better regulation than would be obtained if a single filter were used to supply both parts of the transmitter.—Stephen Casey.

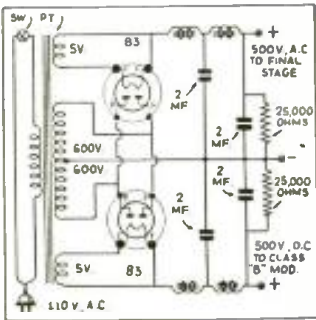

AUTOMATIC KEY

I have constructed a very novel method of obtaining "bug" operation with the ordinary side-swiper. In the drawing we find that we merely have a vacuum tube connected in a relay circuit. The side-swiper may be home-made with a single arm and contacts on both sides. The resistor R controls the speed of the dots, and it is only necessary to hold the side-swiper against dot contact and dots will be made indefinitely. The dashes of course are made by hand, the same as in an ordinary "bug." The relay in the plate circuit of the tube is necessary in order to control the circuit to be keyed.—Francis C. Fekel.

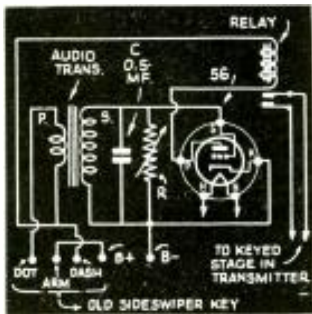

HOME-MADE 50-WATT SOCKET

Recently when experimenting with a 50-watt power amplifier, I found that I was short the necessary socket. By forming jacks from short lengths of copper tubing as shown in the drawing, and mounting them on stand-off insulators, a very efficient socket was evolved. In constructing it, attach the sockets to the insulators and then insert the tube into the four sockets before the insulators are screw-

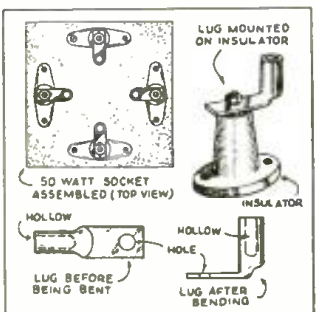

## \$5.00 FOR BEST SHORT-WAVE KINK

The Editor will award a five dollar prize each month for the best short-wave kink submitted by our readers. All other kinks accepted and published will be awarded eight months' subscription to SHORT WAVE CRAFT. Look over these "kinks" and they will give you some idea of what the editors are looking for. Send a typewritten or ink description, with sketch, of your favorite short-wave kink to the "Kink" Editor, SHORT WAVE CRAFT.

ed to the base. This permits perfect alignment which is not easily obtained if the insulators were to be mounted merely by measuring.—Stanley Cutler.

HANDY COIL ADAPTER

In my accumulation of radio parts I happen to have coils which were not all wired the same. During experiments this normally required a change in the wiring of the coil socket. To overcome this, I devised the adapter which is shown in the accompanying sketch. It consists of a tube base and a watt with four jacks and plugs. This arrangement allows the leads to be changed at will without altering the coils

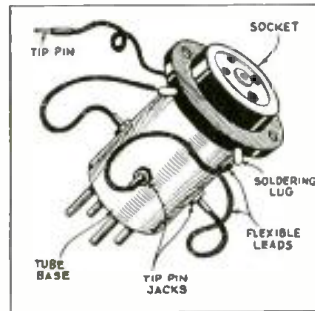

or the coil sockets.—Alexander E. Waken-tin.

IMPROVING CODE OSCILLATOR

I have constructed a number of code practice oscillators and have found that considerable difficulty could be overcome by using a grid-leak and grid condenser. This seems to aid considerably in obtaining strong oscillators. The size of the grid-leak and the condenser also have a definite control over the tone heard in the

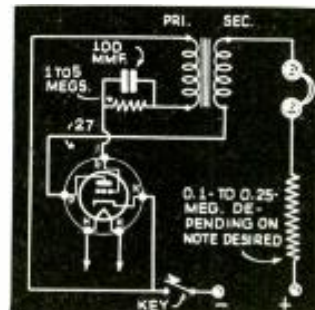

earphones. The diagram is shown herewith.—Harry Yust.

SOLDERING IRON KINK

Here is a suggestion which I think will benefit many experimenters. I had trouble in keeping my soldering iron properly tinned, so I took it to a jeweler and had him tin the point with silver solder. This has a higher melting point than lead solder and the point will stay tinned permanently. It is best to let a jeweler do the job, unless one is accustomed to using hard solder. The cost of this tinning is usually only about fifty cents. It is surprising how well this method works. The iron work should be perfectly clean and smooth before applying the new coating.—Henry W. Birno.

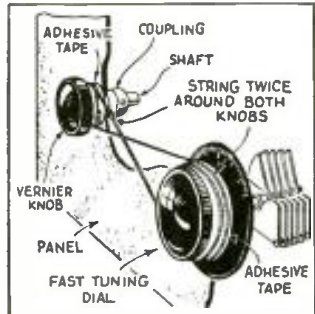

VERNIER DIAL ATTACHMENT

Lacking the funds to purchase one of the new vernier dials, I constructed the system shown in the drawing. First, adhesive tape was wrapped around the large dial knob and also the small dial knob to prevent the string from slipping. This makes an excellent vernier adjustment, as any one will quickly find when trying this "Kink".—A. V. Tuohy.

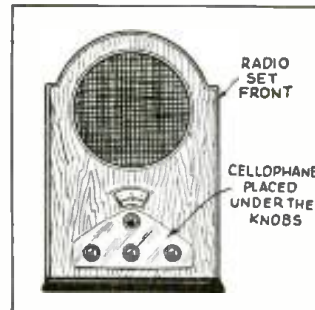

PROTECTING PANELS

I have made use of the transparent quality of cellophane as a protection to the fine finish on my all-wave receiver. The sheet of cellophane is shaped according to the layout of the controls of your receiver. A small amount of cement placed in each corner of the cellophane will hold it firmly in place. An arrangement of this type prevents fingernail scratches around the knobs and does not detract from the appearance of the set.—Wilbur Slater.

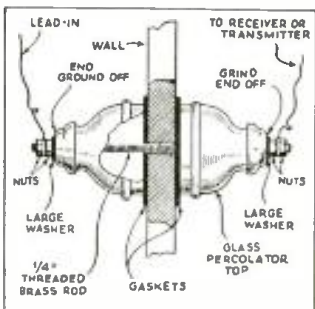

PERCOLATOR TUBES AS INSULATORS

I obtain two glass percolator tops from the local "5 and 10" which provide a very

neat and efficient lead-in arrangement. First the tops of the glass percolator caps are ground off on an emery wheel, or rather ground down sufficiently to allow a small rod to be put through them. This rod is a 1/4 inch brass threaded affair having a length extending upon the thickness of the wall through which the lead-in is to be brought. One important point to remember is that the hole through the wall must be large enough to allow plenty of clearance around the brass rod. All other details are clearly given in the drawing.—Alfred Haberman.

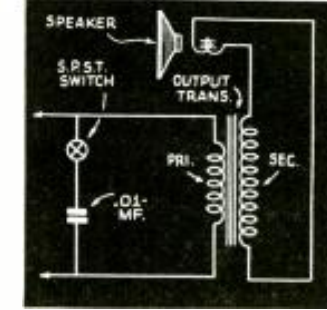

IMPROVING RECEIVER TONE

Many short-wave "Fans" and experimenters are experiencing the so-called "tin-can" effect from their loud-speakers. I overcome this trouble by connecting a .01 mf. condenser across the primary of the output transformer. In series with this condenser I also have a switch as shown in the diagram. This allows the condenser to be switched in and out of the circuit at will.—Robert Richard Roach.



HOME-MADE DIAL

The material used is any leaf foil material such as a toothpaste or shaving cream tube. The wrinkles are easily rolled out with the round, back portion of a spoon. By applying even pressure and a rotary motion the material may be rolled to a brilliant finish.—W. Lewis Teter

# Short-Wave Station Map of the World

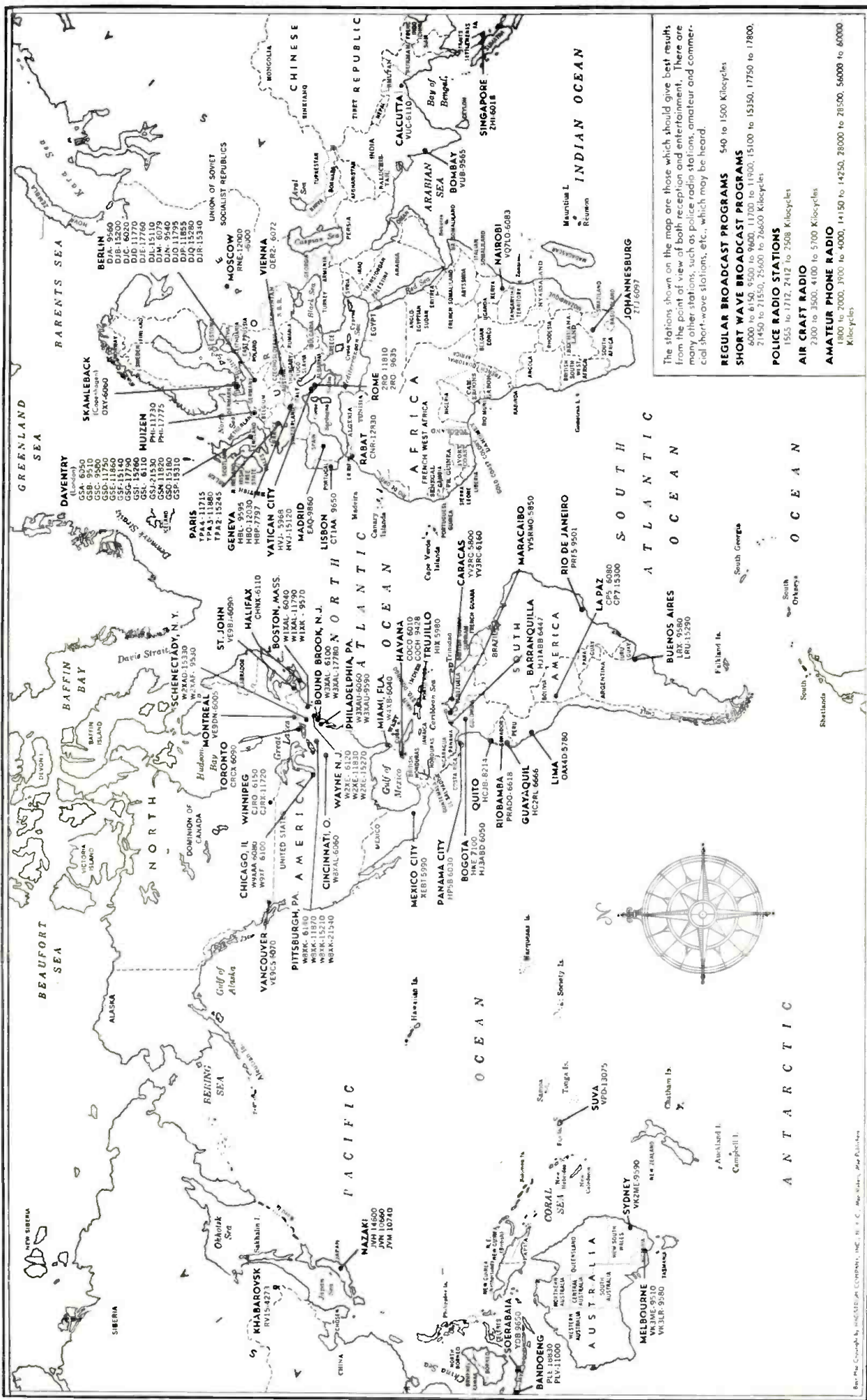

The stations shown on the map are those which should give best results from the point of view of both reception and entertainment. There are many other stations, such as police radio stations, amateur and commercial short-wave stations, etc., which may be heard.

**REGULAR BROADCAST PROGRAMS** 540 to 1500 Kilocycles

**SHORT WAVE BROADCAST PROGRAMS**  
 1500 to 6150, 6300 to 7600, 7700 to 11700, 15100 to 15350, 17750 to 17800,  
 21450 to 21550, 25400 to 26600 Kilocycles.

**POLICE RADIO STATIONS**  
 1555 to 1712, 2412 to 2508 Kilocycles

**AIR CRAFT RADIO**  
 2300 to 3500, 4100 to 5700 Kilocycles

**AMATEUR PHONE RADIO**  
 1800 to 2000, 3000 to 4000, 14150 to 14250, 28000 to 28150, 56000 to 60000  
 Kilocycles.

The map reproduced above, has been brought up-to-date and shows the location, call letters and frequencies of the leading short-wave transmitting stations of the world. Listeners residing in the United States, are particularly interested usually in the time difference existing between American cities and stations located in New York. The time is five hours later in London than it is in New York, and six hours later in Berlin than in New York. By adding the time difference between New York and western cities in the United States, the time difference between these western cities and European points can quickly be calculated.

# WHAT'S NEW

## In Short-Wave Apparatus

The short-wave apparatus here shown has been carefully selected for description by the editors after a rigid investigation of its merits

### New 4-Tube Receiver Tunes From 1 to 11 Meters

By James Millen and Dana Bacon

A Precision Super-regenerative receiver of high sensitivity—it has a super-bandsread dial

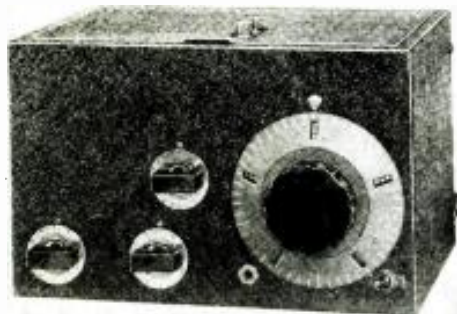

Front panel view of the new National "1-10" improved Super-regenerative receiver, fitted with super-bandsread dial. (No. 540).

● THE Type "1-10" receiver employs a 4-tube circuit, consisting of one stage of tuned R.F., a self-quenching superregenerative detector, transformer coupled to a first stage of audio which, in turn, is resistance coupled to a power output stage.

The tubes employed are as follows:

- 954—R.F.
- 955—Detector
- 6C5—First Audio
- 6F6—Second Audio

The receiver is designed for operation from the National Type No. 5886 AB power unit, all voltage dividers, etc., being built in so that but one B-voltage lead is necessary. This power supply furnishes six volts at 1.6 amperes to the heater circuit and 180 volts at 35 milliamperes to the plate and screen circuits. If desired, the heaters may be supplied from a 6-volt battery and the B-circuits from B-batteries. Voltages in excess of 180 are not recommended and receiver performance will be unsatisfactory on the "A" range at voltages below 167. If lower voltages must be used, as in por-

table operation, the 20,000 ohm resistor connected between the B+ lead and the regeneration control and the 35,000 ohm screen dropping resistor of the R.F. stage, may both be shorted out. This will allow the receiver to function normally with a maximum voltage of 90, but with reduced audio output. A 3-volt C-battery is used to supply bias

Right: Top View—Note the double-shielding between the R.F. and detector circuits, and the unique arrangement of parts.

Below: The Coils with Covers Removed—From left to right, the coils are designated as A, B, C, etc. Detector coils are in front.

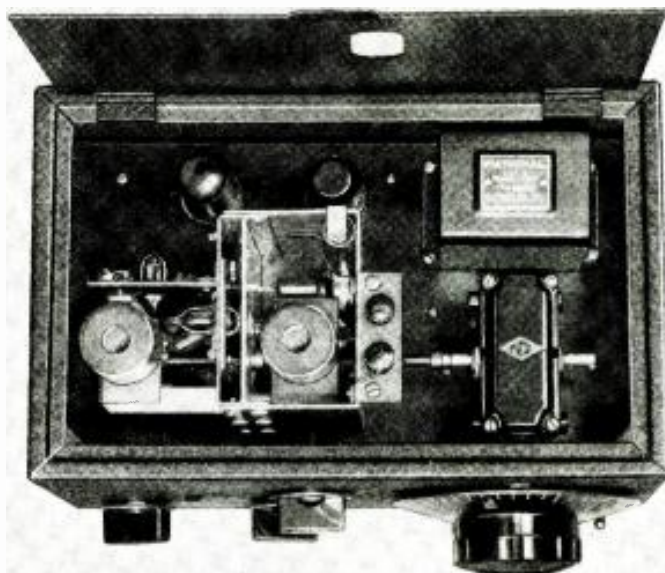

compartment, being held in place by a spring clip. Two Eveready Type 915 cells, or equivalent, are needed. They are mounted in a bakelite tube and the positive (center) terminal of the upper cell is grounded at the top by a retaining bracket.

#### Antenna

The importance of an efficient antenna cannot be over emphasized. The antenna lead, or leads, should be brought directly to the antenna binding posts at the top of the receiver. They may be threaded through

(Continued on page 106)

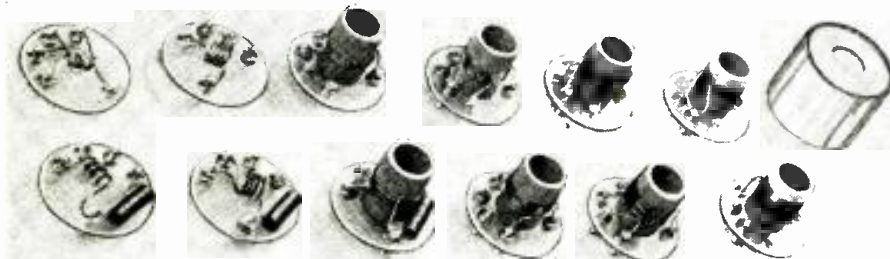

## Headphone and Jack for Use on Any Receiver

● AT some time or other every short-wave listener, particularly if he is the owner of one of the modern all-wave receivers, will want to use a pair of headphones. The average person is not sufficiently skilled to attempt the connection of a headphone jack to the modern complicated receiver.

The headphone and jack kit shown in the accompanying photo has been devised by one of the large radio manufacturers especially for use on their line of receivers, but it may also be used on the majority of all-wave receivers now on the market.

For those sets having a single tube output stage, an adapter is used in the output stage socket. In those sets having a driver tube ahead of the output stage, the adapter is plugged into the output tube socket. To connect the adapter is a very simple procedure—the output tube is re-



Headphone and jack which can be quickly put in operation on any all-wave receiver. When the phunes are in use the loudspeaker is cut out. (No. 538).

moved from its socket (or the driver tube in the second type of set); next, the adapter plug is inserted into the socket in place of the tube. The tube previously removed is now inserted into the holes in the top of the adapter plug. Finally, the headphone plug is inserted into the jack at the end of the adapter box. This headphone adapter can be left connected permanently and it does not affect the tone of the loudspeaker. The loudspeaker is automatically switched out of circuit, while the headphones are in use. Many persons who are hard of hearing may now enjoy headphone reception, even though they are quite unable to hear the radio programs when the loudspeaker is operated in the usual way.

Our Information Bureau will gladly supply manufacturers' names and addresses of any items mentioned in *Short Wave Craft*. Please enclose a stamped return envelope.

Names and addresses of manufacturers of apparatus described on this and following pages furnished upon receipt of 3-cent stamp; mention No. of article.



# NEW APPARATUS FOR THE "HAM"



New Electric "Eye", H-44.

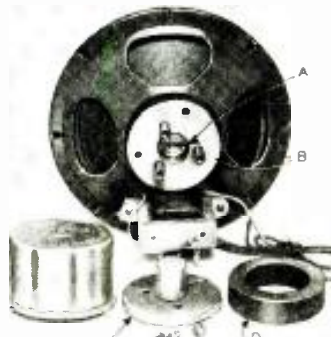

Nokoil speaker, H-45.

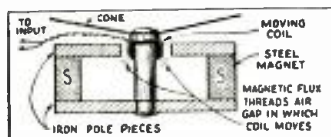

The diagram above shows the flux path of this new speaker which operates without external field excitation.

## NEW ELECTRIC EYE. H-44

● THE uses for photo-electric cells have multiplied tremendously among amateurs and experimenters during the last few years. The unit shown in the photograph is really versatile in performance, inasmuch as it can be operated in the input circuit of a vacuum tube, or it may be connected directly to a sensitive meter for measuring relative intensities of light. In other words, it is sensitive in both the *generative* and *emissive* classes. It consists essentially of two metal electrodes, sealed in a bakelite case, between which the light-sensitive material is exposed to incident light rays behind a special glass or quartz window.

One of the advantages of this type of instrument is that continuous exposure to light does not effect its sensitivity in the least.

This article has been prepared from data supplied by the courtesy of Hugh H. Eby, Incorporated.

## NOKOIL DYNAMIC SPEAKER, H-45

● THERE has been a long-felt need for a dynamic speaker which will operate with any receiver; one that provides efficient performance and requires no external excitation. This new Nokoil reproducer employs a new material, known as Alnico, as a permanent magnet.

This new material provides sufficient flux density to enable the speaker to perform as well as the finest electro-dynamic

speaker of the same size. In the photograph we have an exploded rear view of the speaker, showing its general construction. The particular model shown is equipped with a universal transformer, enabling the user to employ practically every type of output tube, be it pentode or triode.

Owners of battery-operated sets or receivers not equipped to supply field excitation for the speaker will welcome this new product.

This article has been prepared from data supplied by the courtesy of Wright DeCoster, Inc.

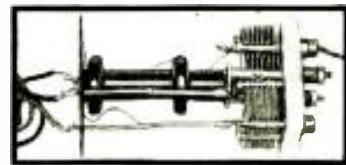

Aladdin I.F. transformer, H-46.

## IRON-CORE I.F., H-46

● A NEW *iron-core* I.F. transformer has been recently introduced in which the variable padding condensers are of the air dielectric type. It is contained in an aluminum can 1½ by 1¾ by 4 inches tall. They are supplied in numerous models intended for use either with the new metal or regular glass tubes, to be used as an intermediate coupling transformer, output of pentagrid converter or input to diode rectifiers. The *gain* of the Aladdin transformer is said to be sufficient to allow a sensitivity with one stage of R.F., comparable with that obtained with two stages of air-core transformers. The adjusting screws are conveniently located at the top of the container, in order that the chassis does not have to be turned down side up for adjusting purposes.

The "Ham" who is building a



Desk-type rack, H-47.



Enclosed relay rack, H-48.

## Universal A. C. Bridge

● HERE is an extremely useful instrument for the serviceman as well as the "Fan" for general testing purposes in the radio field—a universal A.C. bridge.

The Universal Bridge consists of a variable-ratio-arm Wheatstone Bridge, having three standards each for inductance, capacitance and resistance. A vacuum tube 1,000-cycle oscillator and two-stage amplifier, together with their power supply, are built-in components. The only additional equipment required is a *null indicator*, for



New Universal A.C. bridge which will measure capacity, resistance and inductance. (No. 541.)

which purpose a single headphone of the high impedance type will serve. The usual 110-120-volt A.C. power supply furnishes all power required for the bridge, a cord and plug being supplied for inserting in a convenient outlet.

Assuming the proper selection of standards, the variable ratio arm makes possible the use of a single dial, with linear markings from 1 to 10, for all ranges of each

## New Battery Type B. C. and S. W. Receiver

type of measurement. Simplified operation and readings are the result.

A nine-position, four-gang *selector switch* permits choice of the proper scale for the particular unknown being measured. Two additional resistor phasing controls are provided so that the resistance in capacitors and inductors may be balanced out in order to secure a definite null point. Also, a variable capacitor for obtaining a null point on resistors above 100,000 ohms is provided.

With this bridge you may make measurements of resistors, capacity and inductance. The bridge has the following ranges: Resistance, 1 ohm to 1 megohm. Inductance, 100 microhenries to 10 henries. Capacitance, 10 mmf. to 10 mf.

The bridge consumes but 40 watts when in operation and can be used on 110 to 120-volt circuits, having a frequency of 25 or 60 cycles A.C. For the serviceman, this bridge will prove sufficiently accurate for all of his requirements, the accuracy being

(Continued on page 120)

## B.C. and S.W. Receiver

● IT was almost a foregone conclusion that someone would eventually devise a simple and practical radio receiver to operate at a low cost from ordinary batteries such as can be bought at any store. Now word comes from Ann Arbor, Michigan, that such a radio has been developed after many months of research.

There are many interesting and surprising things about this revolutionary radio that will interest those who must operate their sets from batteries. To begin with, the original battery cost has been reduced one-half because no expensive "A" batteries are required. A further saving of at least twenty per cent is claimed, because of a device called the *International battery saver*. Added to this is the eighty per cent reduction of speaker battery drain, through use

of the new Perm-o-flux dynamic speaker, which utilizes a newly developed substance that will lift 140 times its own weight, as against nine times in the ordinary magnet.

The smooth-flowing response of the new Kadette receiver with this new type

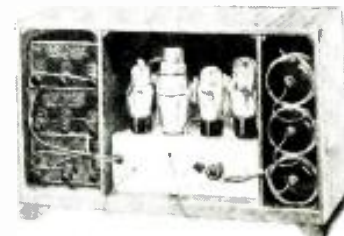

A "high-efficiency" battery superheterodyne, using newest permanent magnet dynamic speaker; it will operate 300 hours on 3 dry cells as "A" battery. (No. 542.)

speaker, brings the living reality of the studio into the home. The full, floating

(Continued on page 114)

# THE RADIO AMATEUR

*Conducted by Geo. W. Stuart*

## Radio Amateur Course

● THE most important part of a transmitter, or any piece of radio apparatus, is the source of power or the *power supply unit*. In nearly all cases the power for operating radio transmitters and receivers is taken directly from the alternating current power mains. In Fig. 1, we have the various types of rectifier units for operation directly from alternating current. Principles of alternating current and the action taking place in rectifier circuits have been clearly defined in previous lessons of this course. In Fig. 1A, we find a representative drawing of alternating current with each half of the cycle numbered starting with 1.

### The Half-Wave Rectifier

In Fig. 1B, we have the well-known half-wave rectifier with its pulsating D.C. output also illustrated. We find that the first impulse is transmitted to the output of the rectifier system. The second impulse though, as shown by the

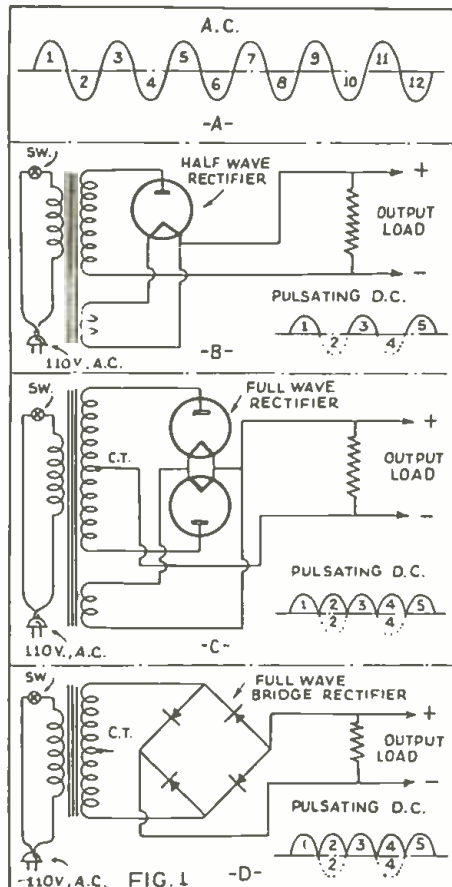

In Fig. 1. A, B, C, and D, we have various types of rectifying circuits, including the half-wave, full-wave with center-tapped transformer, and the full-wave "bridge" circuit.

### TENTH LESSON

A clear explanation of power supplies for all amateur needs, as well as hints on the selection of the various components.

dotted line is not transmitted, and then No. 3 which is in the same direction as No. 1 is also transmitted, and so on to No. 5. Here we find a considerable space in between each impulse which is received at the output terminals of the rectifier system. This is characteristic of all half-wave systems, and it will be seen that this is much harder to filter or *smooth out*, due to the great time space occurring between the direct impulses.

### Full-Wave Rectifier

However, we can utilize the other half of this A.C. input cycle, by what is known as the *full-wave* rectifier system, diagrammed in Fig. C. In this case we have no particular time space between the impulses as shown in the drawing accompanying Fig. C. This current, of course, is much easier to filter because of the relative *smoothness* compared with the output of the rectifier in Fig. B. In Fig. C, we utilize a center-tapped transformer, where the output voltage of the rectifier is approximately equal to  $\frac{1}{2}$  of the entire secondary voltage, or approximately equal to the voltage existing on either side of the center tap.

### Voltage Either Side of Center Tap

This transformer, for instance, may deliver 500 volts at the output terminals of the rectifying system. This would require that each side of the center tap deliver 500 volts, making a total secondary voltage of 1,000. This same transformer can be made to deliver 1,000 volts at the output terminals of the rectifying system if the entire secondary is used in a *half-wave* system, as shown in Fig. B. On the other hand, this would be difficult to filter. With a suitable rectifying system, we can obtain full-wave rectification and have the entire secondary voltage appear at the output terminals of the rectifier.

### The Bridge Rectifier

In Fig. D we have the bridge rectifier system which requires four  $\frac{1}{2}$ -wave rectifiers. Here the output is just as smooth as that shown in Fig. C, and the voltage is *twice as great!*

When selecting the power transformer, there are many things to consider besides the voltage rating. Of course, the primary of the transformer must be designed to operate at the voltage of the power mains. 110-volt mains require a transformer with a 110-volt

primary, and if the power mains deliver 220 volts, then of course a like primary would be needed. We also have to consider the frequency of the A.C. service. The average of course is 60 cycles. However, in different parts of the United States, and in various foreign countries, the frequency may be anywhere from 25 to 60 cycles. The average 60-cycle power transformer will operate satisfactory on either 50 or 60 cycles. However, where 25 or 30 cycle power is available, a transformer designed especially to operate at that frequency will be required.

### Power Rating of Transformer

The *power rating* of the secondary of the average transformer is given in volts and milliamperes. The voltage rating is determined entirely by the rating of the vacuum tube for which the transformer is intended to furnish power. For instance, the average 50-watt tube operates at around 1,000

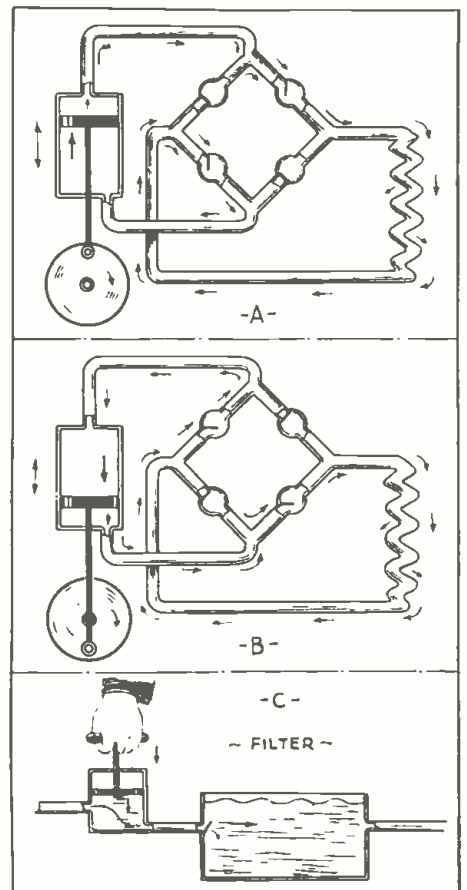

Here we have analogies of the "bridge" rectifier circuit in hydraulic form, and also an hydraulic analogy of the "filter network."

volts, therefore, a transformer delivering from 1,000 to 1,250 volts will be required. Usually, the voltage rating of the transformer is slightly greater than the tube rating, in order to allow for a voltage drop in the filtering system. If the total load on the power supply, for instance, is to be 250 ma. (milliamperes), the current rating of the transformer will have to be 250 ma., plus the current drawn by the bleeder resistor. The bleeder will be covered later on in this lesson.

**Choice of Rectifier Tube**

The choice of the rectifier tubes is quite an important one. There are two types of rectifiers generally used among amateurs and experimenters. These are of the *high vacuum* type and the *mercury vapor* type. The high vacuum rectifier in former years was so designed that there was a considerable drop in voltage through the tube. Then to overcome this mercury was added to the tube, and the ionization thus coming about during operation, lowered the resistance to a negligible amount, and, therefore, the voltage drop was practically eliminated. The rated voltage drop of the average *mercury vapor tube* is 15 volts.

For power supplies up to 300 volts the type 80 tube is recommended. For power supplies delivering in the neighborhood of 500 volts, the type 5Z3 is suitable. For good regulation in the 500-volt category, either the mercury vapor tube may be used or the new high vacuum "83V". The "83V" provides excellent regulation and has an extremely low voltage drop, due to the very close spacing of the elements. For the average power supply delivering in the neighborhood of 1,000 volts, with

The next lesson of our *Radio Amateur Course* will deal entirely with the amateur type receivers of the more simple variety, such as regenerative sets with and without R.F. amplifiers. Pointers on the design and construction of sets of this type will be given. The various types of regeneration controls will also be discussed.

These amateur lessons are prepared for persons not having technical training and who desire to learn the fundamentals. We suggest that those who have not already done so, keep a file of these lessons.

a center-tapped transformer, the type "866" which is a one-half wave mercury vapor rectifier or the high vacuum type 836 are recommended. In fact, both of these tubes work well in power supplies delivering as high as 2,000 volts. The "866" may be used on voltages well above this figure.

**The Filter Circuit**

After the alternating current has been rectified, we have to use some sort of *smoothing* or *filtering* circuit in order to deliver pure D.C. to the transmitting vacuum tubes. In Fig. 2, we show various filter systems. In 2A, we have the so-called "brute force" filter, wherein a single choke and two condensers are used. The current carrying capacity of the choke should be identical to the transformer rating. The inductance of the choke for low-voltage filters should be around 30 henries, and is not at all critical. In Fig. 2B, we have the double-section filter using two chokes and three condensers. This provides greater smoothing than the one shown in Fig. A. Both of these are known as

the *condenser input* types. Either of these filter systems work very well with the average 500-volt transformer, when the capacities of the condensers are at least 2 mf. each and the inductance of the choke CH is 30 henries each. For voltages below 500, the electrolytic condenser may be used to an advantage because of its low cost. The usual capacity of the electrolytic condenser is 8 mf. There are two types of these condensers: one is the wet, where the electrolyte is in the form of a liquid, and the other is the so-called *dry*, where the electrolyte is in the form of a paste. The advantage of the wet condenser is in that it may be overloaded and not damaged because of the *self-healing* effect which normally comes about in this type of condenser. The dry type, when punctured, usually has to be replaced.

For voltages over 500, of course the paper type condenser is really the best, and this should be of the *oil-impregnated* type. The voltage ratings of the condensers are given in peak voltage and D.C. working voltage. The D.C. *working voltage* (W.V.) should be slightly higher than the average voltage output of the power supply. For instance, a 1,000-volt power supply would require condensers having a W.V. rating of from 1,200 to 1,500 volts. In Fig. 2, we have the conventional filter arrangement used in the power supplies that develop 1,000 volts or over. In this case, we have *choke input*; meaning that there is no condenser across the input to the filter.

**Filter Chokes**

The regulation of a power supply of this type, regulation pertaining to the (Continued on page 116)

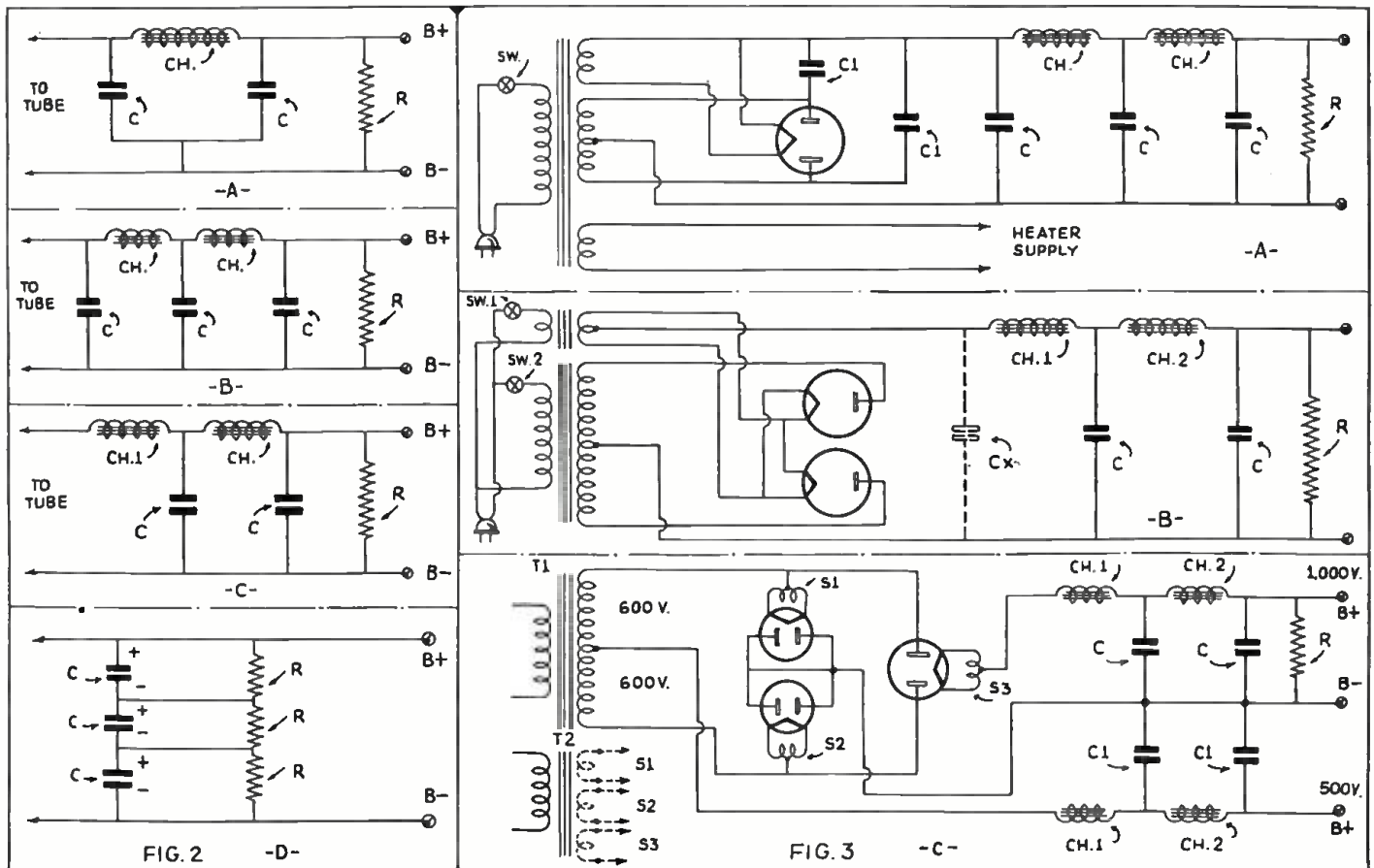

In Figs. 2, A, B, C, and D, we have various types of filter networks, together with a method of connecting condensers in series. In Figs. 3, A, B and C, we have the three fundamental power supply systems. The receiving type, the low-powered transmitting type, and finally the dual power-supply, using the "bridge" rectifier system.

# SHORT WAVE LEAGUE

## HONORARY MEMBERS

Dr. Lee de Forest  
 John L. Reinartz  
 D. E. Replogle  
 Hollis Baird  
 E. T. Somerset  
 Baron Manfred von Ardenne  
 Hugh Gernsback  
*Executive Secretary*



## Here's Your Button

The illustration herewith shows the beautiful design of the "Official" Short Wave League button, which is available to everyone who becomes a member of the Short Wave League.



The requirements for joining the League are explained in a booklet, copies of which will be mailed upon request. The button measures 3/4 inch in diameter and is inlaid in enamel—3 colors—red, white, and blue.

Please note that you can order your button AT ONCE—SHORT WAVE LEAGUE supplies it at cost, the price, including the mailing, being 35 cents. A solid gold button is furnished for \$2.00 prepaid. Address all communications to SHORT WAVE LEAGUE, 99-101 Hudson St., New York.

# SHORT WAVE SCOUT NEWS

## "Hams" Deserve Great Credit, Reports A. Centanino, of Freeport, Pa.

● BY the time this report is read the flooded areas will be back to normal, people will have forgotten some of the hazards. But one thing that shows bright is the part radio played in this calamity. Special thanks should go to the amateurs who helped. Some of the boys went for days without food. The amateurs had to handle the telephone calls, made calls for supplies and other things too numerous to mention.

Special thanks should go to amateur station W8FRC at Johnstown, Pa., for his splendid work. This station warned the outside world of the oncoming flood and then kept on the air to handle the work of getting supplies to Johnstown.

Special thanks should also go to station KDKA—W8XK of Pittsburgh. This station had to make its own power "to keep on the air," but they kept on during the whole flood, sending out news of the flood to the whole world. They also handled messages to towns around Pittsburgh.

New stations heard are: LRU on 15.29 meg. 5:30 to 12:30 a.m. LSL on 10.25 meg. 7:00 to 8:00 p.m. with music; this is a phone. HRY on 6.35 meg. 6:45 to 9:30 p.m. HIC on 6.28 meg. 9:10 p.m.

Notes of Interest: Until recently the British Broadcasting Corp. were broadcasting on 11 waves, namely: GSA, B, C, D, E, F, and G, H, I, J and L. Now they have added GSN 11.82 meg., GSO 15.18 meg., and GSP 16.74 meg. At present they are planning to step up transmitter power and are installing new aerials which will, when completed number 25 aerials in all. The striking of "Big Ben" and the Westminster Chimes are two of the important "radio-marks" identifying London. Big Ben was built in 1858 and is considered the most powerful striking clock in the world. These stations do not verify but answer all reports. The reason for not verifying being that their programs are printed in all parts of the world. "God Save the King" is played at the end of each transmission.

Let me know what you are hearing in your part of the country, and in that way we can more readily check up the S-W stations.

I answer all mail. ANGELO CENTANINO, Box 516, Freeport, Pa.

## Cleveland, Ohio, Report

● SOME time ago I reported on the Ethiopian stations, their addresses and correct frequencies, I am now happy to say

code interference; also received card. Address is British Guiana Broadcasting Co., Georgetown, B.G., S.A.

OER2-6.07 megs. on the air daily 9 a.m. to 5 p.m., card received 1.5 kw. power, crystal-controlled.

TG2X, 5.94 megs. heard 7 p.m. to midnight daily, with the Guatemala National Police Band supplying the evening's entertainment. Address is: Direccion General de la Policia Nacional, Guatemala, C.A. Card Received.

I have heard a station on about 6.01 megs. located in Tanarive, Madagascar; call as I made it out is FIU at 10 to 10:45 a.m. Announcements are in French.

Another new station heard is LZA in Sofia, Bulgaria, on about 14.96 or 14.97 megs. at 9 a.m. to about 10 a.m. on Sundays. Lady announcer.

I have sent in three reports to HRN and have not received a "veri" yet. I have heard all three of them read over the air on the "American appreciation hour" on Sundays, and also have about 20 other S-W friends of mine that sent in reports and have received no "veris" as yet. Have any of you boys received any, or are they (HRN) just stringing the S-W fans along.

Veris received this month—OER2 VK3LR, ORK, VK3ME, VIZ3, HH2S, VP3MR, TG2X.

WILLIAM C. PALMER,  
 R2 Ward Rd.  
 Brooklyn St.  
 Cleveland, Ohio.

## South Amboy, N.J., Report

● ALL of the foreign "locals" were heard the past month, as well as the U. S. stations. The following new stations were heard the past month.

HIT-6630 kc. The Voice of RCA Victor, P.O. Box 1105, Ciudad Trujillo, D.R., is heard daily except Sundays from 6 to 8 p.m.

EST. HIT announces in Spanish and English. I first heard HIT last month.

HJ4ABC, 6450 kc. Ibaque, Colombia, was heard several times with fair to good strength.

KKL, around 15 mc., Bolinas, California, was heard relaying NBC programs to Hawaii. Good strength.

HRV, about 6200 kc., La Ceibe, Honduras  
 (Continued on page 127)

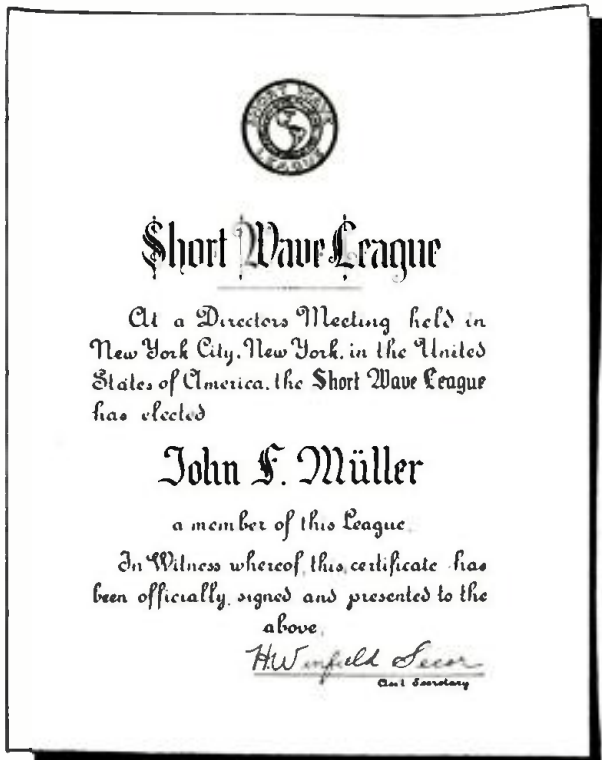

This is the handsome certificate that is presented FREE to all members of the SHORT WAVE LEAGUE. The full size is 7 1/4" x 9 1/2".

See page 122 how to obtain certificate.

that I hold three Ethiopian stations "verified" which are: ETA, ETB and ETD on phone, two cards and a letter!

HH2S 5.91 megs. heard here very evening with very good signal strength. Veri card received. Address is Societe de Haitienne de Radiodifusion Immeuble Magebeco, Port au Prince, Haiti, W.I.

VP3MR, 7.08 megs. R9 plus signal heard almost every evening, with considerable



# World S-W Station List

## Complete List of Broadcast, and Telephone Stations

All the stations in this list use telephone transmission of some kind. Note: Stations marked with a star ★ are the most active and easily heard stations and transmit at fairly regular times. Please write to us about any new sta-

tions or other important data that you learn through announcements over the air or correspondence with the stations. Stations are classified as follows: C—Commercial phone. B—Broadcast service. X—Experimental transmissions.

### Around-the-Clock Listening Guide

It is a good idea to follow a general schedule as far as wavelength in relation to the time of the day is concerned. The observance of these simple rules will save time.

From daybreak till 7 p.m. and particularly

during bright daylight, listen between 13 and 19 meters (21540 to 15800 kc.)

To the east of the listener, from about 4 p.m.-5 a.m., the 19-35 meter will be found very productive. To the west of the listener this same

band is generally found best from about 12 m. until 7 a.m. (After dark, results above 35 meters are usually much better than during daylight.) These general rules hold for any location in the Northern Hemisphere.

### Short-Wave Broadcasting, Experimental and Commercial Radiophone Stations

NOTE: To convert kc. to megacycles (mc.) shift decimal point 3 places to left: Thus, read 21540 kc. as 21.540 mc.

<b>31600 kc. W2XDU</b> -BX- 9.494 meters ATLANTIC BROADCASTING CO. 485 MADISON AVE., N.Y.C. Relays WABC daily 5-10 p.m., Sat., Sun. 12:30-5, 6-9 p.m.	<b>19820 kc. WKN</b> -C- 15.14 meters LAWRENCEVILLE, N. J. Calls England, daytime	<b>18340 kc. WLA</b> -C- 16.36 meters LAWRENCEVILLE, N. J. Calls England, daytime	<b>17741 kc. HSP</b> -C- 16.91 meters BANGKOK, SIAM Works Germany 4-7 a.m.	<b>15460 kc. KKR</b> -C- 19.4 meters RCA COMMUNICATIONS. BOLINAS, CAL. Tests irregularly
<b>31600 kc. W8XAI</b> -BX- 9.494 meters STROMBERG CARLSON CO. ROCHESTER, N.Y. Relays WHAM daily 6:30 a.m.-11:05 p.m.	<b>19680 kc. CEC</b> -C- 15.24 meters SANTIAGO, CHILE Works Buenos Aires and Colombia daytime	<b>18310 kc. GAS</b> -C- 16.38 meters RUGBY, ENGLAND Calls N. Y., daytime	<b>17650 kc. XGM</b> -C- 17 meters SHANGHAI, CHINA Works London 7-9 a.m.	<b>15415 kc. KWO</b> -C- 19.48 meters DIXON, CAL. Phones Hawaii 2-7 p.m.
<b>21540 kc. W8XK</b> -B- 13.93 meters WESTINGHOUSE ELECTRIC PITTSBURGH, PA. 6-9 a.m.; relays KDKA	<b>19650 kc. LSN5</b> -C- 15.27 meters HURLINGHAM, ARGENTINA Calls Europe, daytime	<b>18299 kc. YVR</b> -C- 16.39 meters MARACAY, VENEZUELA Works Germany, mornings	<b>17520 kc. DFB</b> -C- 17.12 meters NAUEN, GERMANY Works S. America near 9:15 a.m.	<b>15370 kc. ★HAS3</b> -B- 19.52 meters BUDAPEST, HUNGARY Broadcasts Sundays, 9-10 a.m.
<b>21530 kc. GSJ</b> -B- 13.93 meters DAVENTRY B.B.C., BROADCASTING HOUSE, LONDON, ENGLAND 9-10:15 a.m.	<b>19600 kc. LSF</b> -C- 15.31 meters MONTE GRANDE, ARGENTINA Tests irregularly, daytime	<b>18270 kc. ETA</b> -C- 16.42 meters CHIEF ENGINEER P. O. Box 283, ADDIS ABABA, ETHIOPIA Irregularly	<b>17510 kc. VWY2</b> -C- 17.13 meters KIRKEE, INDIA Works Rugby 2-7 a.m.	<b>15360 kc. DJT</b> -X-C- 19.53 meters REICHSPOSTZENSTRALMT. ZEESEN, GERMANY Works with Africa and broadcasts 11 p.m.-1 a.m.
<b>21520 kc. W2XE</b> -B- 13.94 meters ATLANTIC BROADCASTING CORP. 485 Madison Ave., N.Y.C. Relays WABC 6:30-10 a.m.	<b>19480 kc. GAD</b> -C- 15.4 meters RUGBY, ENGLAND Works with Kenya, Africa, early morning	<b>18250 kc. FTO</b> -C- 16.43 meters ST. ASSISE, FRANCE Calls S. America, daytime	<b>17310 kc. W3XL</b> -X- 17.33 meters NATIONAL BROAD. CO. BOUND BROOK, N. J. Tests irregularly	<b>15355 kc. KWU</b> -C- 19.53 meters DIXON, CAL. Phones Pacific Isles and Japan
<b>21470 kc. ★GSH</b> 13.97 meters DAVENTRY B.B.C., BROADCASTING HOUSE, LONDON, ENGLAND 6-8:45 a.m.	<b>19355 kc. FTM</b> -C- 15.50 meters ST. ASSISE, FRANCE Calls Argentine, mornings	<b>18200 kc. GAW</b> -C- 16.48 meters RUGBY, ENGLAND Calls N. Y., daytime	<b>17120 kc. WOO</b> -C- 17.52 meters A. T. & T. CO., OCEAN GATE, N. J. Calls ships	<b>15340 kc. DJR</b> -B-X- 19.56 meters BROADCASTING HOUSE, BERLIN, GERMANY 1:30-3:30 a.m.
<b>21470 kc. ★GSH</b> 13.97 meters DAVENTRY B.B.C., BROADCASTING HOUSE, LONDON, ENGLAND 6-8:45 a.m.	<b>19345 kc. PMA</b> -B-C- 15.51 meters BANDOENG, JAVA Calls Holland early a.m. Broadcasts Tues., Thur., Sat., 10:00-10:30 a.m. Irregular	<b>18135 kc. PMC</b> -C- 16.54 meters BANDOENG, JAVA Phones Holland, early a. m.	<b>17080 kc. GBC</b> -C- 17.58 meters RUGBY, ENGLAND Calls Ships	<b>15330kc. ★W2XAD</b> -B- 19.56 meters GENERAL ELECTRIC CO. SCHENECTADY, N. Y. Relays WGY 10 a.m.-2 p.m.
<b>21470 kc. ★GSH</b> 13.97 meters DAVENTRY B.B.C., BROADCASTING HOUSE, LONDON, ENGLAND 6-8:45 a.m.	<b>19260 kc. PPU</b> -C- 15.58 meters RIO DE JANEIRO, BRAZIL Works with France mornings	<b>18115 kc. LSY3</b> -C- 16.58 meters MONTE GRANDE, ARGENTINA Tests irregularly	<b>16270 kc. WLK</b> -C- 18.44 meters LAWRENCEVILLE, N. J. Phones Arg., Braz., Peru, daytime	<b>15310 kc. ★GSP</b> -B- 19.8 meters DAVENTRY B.B.C., BROADCASTING HOUSE, LONDON, ENGLAND 6-8, 9-11 p.m.
<b>21080 kc. PSA</b> -C- 14.23 meters RIO DE JANEIRO, BRAZIL Works WKK Daytime	<b>19220 kc. WKF</b> -C- 15.60 meters LAWRENCEVILLE, N. J. Calls England, daytime	<b>18040 kc. GAB</b> -C- 16.63 meters RUGBY, ENGLAND Calls Canada, morn. and early aftn.	<b>16270 kc. WOG</b> -C- 16.44 meters OCEAN GATE, N. J. Calls England, morning and early afternoon	<b>15290 kc. LRU</b> -B- 19.62 meters "EL MUNDO" BUENOS AIRES, ARGENTINA, S. A. Testing 6-7:45 and 11-11:45 p.m. Soon on regular daily schedule.
<b>21060 kc. WKA</b> -C- 14.25 meters LAWRENCEVILLE, N. J. Calls England noon	<b>19200 kc. ORG</b> -C- 15.62 meters RUYSELEDES, BELGIUM Works with OPL mornings	<b>17810 kc. PCV</b> -C- 16.84 meters KOOTWIJK, HOLLAND Calls Java, 6-9 a. m.	<b>16240 kc. KTO</b> -C- 16.47 meters MANILA, P. I. Calls Cal., Tokio and ships 8-11:30 a.m.	<b>15280 kc. DJQ</b> -B- 19.63 meters BROADCASTING HOUSE, BERLIN, GERMANY 12:30-3 a.m.
<b>21020 kc. LSN6</b> -C- 14.27 meters HURLINGHAM, ARG. Calls N. Y. C. 8 a. m.-5 p. m.	<b>19160 kc. GAP</b> -C- 15.68 meters RUGBY, ENGLAND Calls Australia, early a.m.	<b>17790 kc. ★GSG</b> -B- 16.86 meters DAVENTRY B.B.C., BROADCASTING HOUSE, LONDON, ENGLAND 6-8:45 a.m., 9 a.m.-12 n.	<b>15880 kc. FTK</b> -C- 16.90 meters ST. ASSISE, FRANCE Phones Saigon, morning	<b>15270 kc. ★W2XE</b> -B- 19.65 meters ATLANTIC BROADCASTING CORP. 485 Madison Av., N.Y.C. Relays WABC daily, 12 n.-5 p.m.
<b>20860 kc. EHY-EDM</b> -C- 14.38 meters MADRID, SPAIN Works S. America, mornings.	<b>18970 kc. GAQ</b> -C- 15.81 meters RUGBY, ENGLAND Calls S. Africa, mornings	<b>17780 kc. ★W3XAL</b> -B- 16.87 meters NATIONAL BROAD. CO. BOUND BROOK, N. J. Relays WJZ, Daily exc. Sun. 9 a.m.-1 p.m.	<b>15865 kc. CEC</b> -C- 16.91 meters SANTIAGO, CHILE Works other S.A. stations afternoons	<b>15260 kc. GSI</b> -B- 19.68 meters DAVENTRY B.B.C., BROADCASTING HOUSE, LONDON, ENGLAND 12:15-3:25 p.m.
<b>20700 kc. LSY</b> -O- 14.49 meters MONTE GRANDE ARGENTINA Tests irregularly	<b>18890 kc. ZSS</b> -C- 15.88 meters KLIPHEUVEL, S. AFRICA Works Rugby 6:30 a.m.-12 n	<b>17775 kc. ★PHI</b> -B- 16.88 meters HUIZEN, HOLLAND 8-10 a.m. daily except Tue. and Wed.; 8-11 a.m. Sat. and Sun., 1-2 p.m. Sun.	<b>15810 kc. LSL</b> -C- 16.98 meters HURLINGHAM, ARGENTINA Calls Brazil and Europe, daytime	<b>15252 kc. RIM</b> -C- 19.67 meters TACHKENT, U.S.S.R. Phones RKI near 7 a.m.
<b>20380 kc. GAA</b> -C- 14.72 meters RUGBY, ENGLAND Calls Argentina, Brazil, mornings	<b>18830 kc. PLE</b> -C- 15.93 meters BANDOENG, JAVA Calls Holland, early a. m.	<b>17760 kc. ★W2XE</b> -B- 16.89 meters ATLANTIC BROADCASTING CORP. 485 Madison Ave., N.Y.C. Relays KABC 10 a.m.-12 n.	<b>15760 kc. JYT</b> -X- 19.04 meters KEMIKWA-CHO, CHIBAKEN, JAPAN Irregular in late afternoon and early morning	<b>15250 kc. W1XAL</b> -B- 19.67 meters BOSTON, MASS. Irregular. In morning
<b>20040 kc. OPL</b> -C- 14.97 meters LEOPOLDVILLE, BELGIAN CONGO Works with ORG in morning	<b>18680 kc. OCI</b> -C- 16.06 meters LIMA, PERU Works various S.A. stations daytime	<b>17760 kc. DJE</b> -B- 16.89 meters BROADCASTING HOUSE, BERLIN, GERMANY 8:05-11 a.m.	<b>15660 kc. JVE</b> -C- 19.16 meters NAZAKI, JAPAN Phones Java 3-5 a.m.	<b>15245 kc. ★TPA2</b> -B- 19.68 meters "RADIO COLONIAL" PARIS, FRANCE Service de la Radiodiffusion 98, bis, Blvd. Haussmann 6.55-11 a.m.
<b>20020 kc. DHO</b> -C- 14.99 meters NAUEN, GERMANY Works S. America, mornings	<b>18620 kc. GAU</b> -C- 16.11 meters RUGBY, ENGLAND Calls N. Y., daytime	<b>17760 kc. IAC</b> -C- 16.89 meters PISA, ITALY Calls ships, 8:30-7:30 a. m.	<b>15620 kc. JVF</b> -C- 19.2 meters NAZAKI, JAPAN Phones U.S., 5 a.m. & 4 p.m.	
<b>19900 kc. LSG</b> -C- 15.06 meters MONTE GRANDE, ARGENTINA Tests irregularly, daytime	<b>18345 kc. FZS</b> -C- 16.35 meters SAIGON, INDO-CHINA Phones Paris, early morning			

(All Schedules Eastern Standard Time)

**15220 kc. ★PCJ**  
-B- 19.71 meters  
N.V. PHILIPS RADIO  
EINDHOVEN, HOLLAND  
Tues. 3-6 a.m.  
Wed. 7-11 a.m.  
Sun. 7-8 a.m.

**15210 kc. ★W8XK**  
-B- 19.72 meters  
WESTINGHOUSE ELECTRIC  
& MFG. CO.  
PITTSBURGH, PA.  
9 a.m.-7 p.m.  
Relays KDKA

**15200 kc. DJB**  
-B- 19.74 meters  
BROADCASTING HOUSE  
BERLIN, GERMANY  
3:50-11 a.m.

**15180 kc. ★GSO**  
-B- 19.76 meters  
DAVENTRY  
B.B.C., BROADCASTING  
HOUSE,  
LONDON, ENGLAND  
3:40-5:45 p.m.

**15140 kc. ★GSF**  
-B- 19.82 meters  
DAVENTRY  
B.B.C., BROADCASTING  
HOUSE, LONDON, ENGLAND  
9 a.m.-12 n.

**15120 kc. ★HVJ**  
-B- 19.83 meters  
VATICAN CITY  
ROME, ITALY  
10:30 to 10:45 a.m., except  
Sunday  
Sat. 10-10:45 a.m.

**15110 kc. DJL**  
-B-X- 19.85 meters  
BROADCASTING HOUSE,  
BERLIN, GERMANY  
6:30-8 a.m.

**15090 kc. RKI**  
-C- 19.88 meters  
MOSCOW, U.S.S.R.  
Phones Tashkent near 7 a.m.  
and relays RNE on Sundays  
10-11 a.m.

**15070 kc. PSD**  
-C- 19.91 meters  
RIO DE JANEIRO, BRAZIL  
Calls N.Y., Buenos Aires and  
Europe, daytime

**15055 kc. WNC**  
-C- 19.92 meters  
HIALEAH, FLORIDA  
Calls Central America, daytime

**14980 kc. KAY**  
-C- 20.03 meters  
MANILA, P. I.  
Phones Pacific Isles

**14970 kc. LZA**  
-B-C- 20.04 meters  
SOFIA, BULGARIA  
Tests irregularly till 11:30 a.m.  
on Sundays

**14960 kc. PSF**  
-C- 20.43 meters  
RIO DE JANEIRO, BRAZIL  
Works with Buenos Aires  
daytime

**14950 kc. HJB**  
-C- 20.07 meters  
BOGOTA, COL.  
Calls WNC, daytime

**14940 kc. HII**  
-C- 20.08 meters  
CIUDAD TRUJILLO, D.R.  
Phones WNC daytime

**14940 kc. HJA3**  
-C- 20.08 meters  
BARRANQUILLA, COL.  
Works WNC daytime

**14845 kc. OCJ2**  
-C- 20.21 meters  
LIMA, PERU  
Works other S.A. stations  
daytime

**14653 kc. GBL**  
-C- 20.47 meters  
RUGBY, ENGLAND  
Works JVH 1-7 a.m.

**14640 kc. TYF**  
-C- 20.49 meters  
PARIS, FRANCE  
Works Saigon and Cairo 3-7  
a.m., 12 n.-2:30 p.m.

**14600 kc. JVH**  
-B-C- 20.55 meters  
NAZAKI, JAPAN  
Phones Europe 4-8 a.m.  
Irregularly 12 m.-1 p.m.  
Mon. and Thurs. 4-5 p.m.

**14590 kc. WMN**  
-C- 20.56 meters  
LAWRENCEVILLE, N. J.  
Phones England  
morning and afternoon

**14535 kc. HBJ**  
-B- 20.64 meters  
RADIO NATIONS,  
GENEVA, SWITZERLAND  
Broadcasts irregularly

**14530 kc. LSN**  
-C- 20.65 meters  
HURLINGHAM, ARGENTINA  
Calls N.Y.C. afternoons

**14500 kc. LSM2**  
-C- 20.69 meters  
HURLINGHAM, ARGENTINA  
Calls Rio and Europe daytime

**14485 kc. TIR**  
-C- 20.71 meters  
CARTAGO, COSTA RICA  
Phones Cen. Amer. & U.S.A.  
Daytime

**14485 kc. HPF**  
-C- 20.71 meters  
PANAMA CITY, PAN.  
Phones WNC daytime

**14485 kc. TGF**  
-C- 20.71 meters  
GUATEMALA CITY, GUAT.  
Phones WNC daytime

**14485 kc. YNA**  
-C- 20.71 meters  
MANAGUA, NICARAGUA  
Phones WNC daytime

**14485 kc. HRL5**  
-C- 20.71 meters  
NACAOME, HONDURAS  
Works WNC daytime

**14485 kc. HRF**  
-C- 20.71 meters  
TEGUCIGALPA, HONDURAS  
Works WNC daytime

**14470 kc. WMF**  
-C- 20.73 meters  
LAWRENCEVILLE, N. J.  
Phones England  
morning and afternoon

**14460 kc. DZH**  
-C-X- 20.75 meters  
REICHSPOSTZENSTRALAMT,  
ZEESEN, GERMANY  
Works on telephone and broad-  
casts 12 n.-2 p.m.

**14440 kc. GBW**  
-C- 20.78 meters  
RUGBY, ENGLAND  
Calls U.S.A., afternoon

**13990 kc. GBA**  
-C- 21.44 meters  
RUGBY, ENGLAND  
Calls  
Buenos Aires, late afternoon

**13820 kc. SUZ**  
-C- 21.71 meters  
ABOU ZABAL, EGYPT  
Works with Europe 11 a.m.-  
2 p.m.

**13690 kc. KKZ**  
-C- 21.91 meters  
RCA COMMUNICATIONS  
BOLINAS, CAL.  
Tests irregularly

**13635 kc. SPW**  
-B- 22 meters  
WARSAW, POLAND  
Mon., Wed., Fri. 11:30 a.m.-  
12:30 p.m.  
Irregular at other times

**13610 kc. JYK**  
-C- 22.04 meters  
KEMIKAWA-CHO, CHIBA-  
KEN, JAPAN  
Phones California till 11 p. m.

**13585 kc. GBB**  
-C- 22.08 meters  
RUGBY, ENGLAND  
Calls  
Egypt & Canada, afternoons

**13415 kc. GCJ**  
-C- 22.36 meters  
RUGBY, ENGLAND  
Calls Japan & China early  
morning

**13390 kc. WMA**  
-C- 22.40 meters  
LAWRENCEVILLE, N. J.  
Phones England  
morning and afternoon

**13380 kc. IDU**  
-C- 22.42 meters  
ASMARA, ERITREA, AFRICA  
Works with Rome daytime

**13345 kc. YVC**  
-C- 22.48 meters  
MARACAY, VENEZUELA  
Calls Hialeah daytime

**13285 kc. CGA3**  
-C- 22.58 meters  
DRUMMONDVILLE, QUE.,  
CAN.  
Works London and Ships  
afternoons

**13075 kc. VPD**  
-X- 22.94 meters  
SUVA, FIJI ISLANDS  
Daily exc. Sun. 12:30-1:30 a.m.

**12840 kc. WOO**  
-C- 23.36 meters  
OCEAN GATE, N. J.  
Calls ships

**12825 kc. CNR**  
-B-C- 23.39 meters  
DIRECTOR GENERAL  
Telegraph and Telephone  
Stations, Rabat, Morocco  
Broadcasts, Sunday, 7:30-9 a. m.

**12800 kc. IAC**  
-C- 23.45 meters  
PISA, ITALY  
Calls Italian ships, mornings

**12780 kc. GBC**  
-C- 23.47 meters  
RUGBY, ENGLAND  
Calls ships

**12396 kc. CT1G0**  
-B- 24.2 meters  
PAREDE, PORTUGAL  
Sun. 10-11:30 a.m., Tue.,  
Thur., Fri. 1:00-2:15 p.m.

**12325 kc. DAF**  
-C- 24.34 meters  
NORDDEICH, GERMANY  
Works German ships daytime

**12290 kc. GBU**  
-C- 24.41 meters  
RUGBY, ENGLAND  
Calls N.Y.C., afternoon

**12250 kc. TYB**  
-C- 24.49 meters  
PARIS, FRANCE  
Irregular

**12235 kc. TFJ**  
-B-C- 24.52 meters  
REYKJAVIK, ICELAND  
Phones England mornings,  
Broadcasts Sun. 1:40-2 p.m.

**12215 kc. TYA**  
-C- 24.56 meters  
PARIS, FRANCE  
Works French Ships in morning  
and afternoon

**12150 kc. GBS**  
-C- 24.69 meters  
RUGBY, ENGLAND  
Calls N.Y.C., afternoon

**12130 kc. DZE**  
-C-X- 24.73 meters  
REICHSPOSTZENSTRALAMT,  
ZEESEN, GERMANY  
Works phone and broadcasts  
7-9 p.m.

**12060 kc. PDV**  
-C- 24.88 meters  
KOOTWIJK, HOLLAND  
Tests irregular

**12000 kc. RNE**  
-B- 25 meters  
MOSCOW, U. S. S. R.  
Sun. 6-9, 10-11 a.m., 12:30-  
6 p.m., 9-10 p.m.  
Wed., 6-7 a.m.  
Daily 12:30-6 p.m.

**11991 kc. FZS2**  
-C- 25.02 meters  
SAIGON, INDO-CHINA  
Phones Paris, morning

**11955 kc. ETB**  
-C- 25.09 meters  
ADDIS ABABA, ETHIOPIA  
See 18270 kc.

**11950 kc. KKQ**  
-X- 25.10 meters  
BOLINAS, CALIF.  
Tests, irregularly, evenings

**11940 kc. FTA**  
-C- 25.13 meters  
STE. ASSISE, FRANCE  
Phones CNR morning,  
Hurlingham, Arce., nights

**11880 kc. ★TPA3**  
-B- 25.23 meters  
"RADIO COLONIAL"  
PARIS, FRANCE  
2-3, 4-5 a.m., 11:15 a.m.-6:05  
p.m.

**11870 kc. ★W8XK**  
-B- 25.26 meters  
WESTINGHOUSE ELECTRIC  
& MFG. CO.  
PITTSBURGH, PA.  
5-10:30 p.m.  
Fri. till 12 m.  
Relays KDKA

**11860 kc. GSE**  
-B- 25.29 meters  
DAVENTRY,  
B.B.C., BROADCASTING  
HOUSE, LONDON, ENGLAND

**11855 kc. DJP**  
-B-X- 25.31 meters  
BROADCASTING HOUSE,  
BERLIN, GERMANY  
12 n.-2 p.m.

**11830 kc. W9XAA**  
-B- 25.36 meters  
CHICAGO FEDERATION OF  
LABOR  
CHICAGO, ILL.  
Relays WCF during daylight  
hours

**11830 kc. W2XE**  
-B- 25.36 meters  
ATLANTIC BROADCASTING  
CORP.  
485 MADISON AVE., N. Y. C.  
Relays WABC 5-9 p.m.

**11820 kc. ★GSN**  
-B- 25.38 meters  
DAVENTRY  
B.B.C., BROADCASTING  
HOUSE,  
LONDON, ENGLAND  
11:30 p.m.-1:30 a.m.

**11810 kc. ★HJ4BA**  
-B- 25.4 meters  
P. O. BOX 50,  
MEDELLIN, COLOMBIA  
11:30 a.m.-1 p.m., 6:30-10:30  
p.m.

**11810 kc. ★2RO**  
-B- 25.4 meters  
E. I. A. R.  
Via Montello 5  
RDME, ITALY  
8:15-9 a.m., 9:15-11 a.m., 11:30  
a.m.-12:15 p.m., 1:30-3 p.m.

**11800 kc. CO9WR**  
-X- 25.42 meters  
P. O. Box 85  
SANCTI SPIRITUS,  
CUBA  
4-6, 9-11 p.m.  
9 a.m.-12 n.

**11795 kc. DJO**  
-B-X- 25.43 meters  
BROADCASTING HOUSE,  
BERLIN, GERMANY  
3-4:55 p.m.

**11790 kc. W1XAL**  
-B- 25.45 meters  
BOSTON, MASS.  
Sun. 5-7 p.m.

**11770 kc. ★DJD**  
-B- 25.49 meters  
BROADCASTING HOUSE,  
BERLIN, GERMANY  
11:35 a.m.-4:35 p.m.; 4:55-  
10:45 p.m.

**11750 kc. ★GSD**  
-B- 25.53 meters  
DAVENTRY,  
B.B.C., BROADCASTING  
HOUSE, LONDON, ENGLAND  
(2:15-5:45 p.m., 6-8, 9-11 p.m.)

**11730 kc. PHI**  
-B- 25.57 meters  
HUIZEN, HOLLAND  
Irregular

**11720 kc. ★CJRJ**  
-B- 25.6 meters  
WINNIPEG, CANADA  
Daily, 8 p. m.-12 m.

**11715 kc. ★TPA4**  
-B- 25.61 meters  
"RADIO COLONIAL"  
PARIS, FRANCE  
6:15-9 p.m.  
11 p.m.-1 a. m.

**11680 kc. KIO**  
-X- 25.68 meters  
KAHUKU, HAWAII  
Tests in the evening

**11595 kc. VRR4**  
-C- 25.87 meters  
STONY HILL, JAMAICA,  
B.W.I.  
Works WNC daytime.

**11560 kc. VIZ3**  
-X- 25.95 meters  
AMALGAMATED WIRELESS  
OF AUSTRALASIA  
FISKVILLE, AUSTRALIA  
Calls Canada evening and early  
a.m.

**11413 kc. CJA4**  
-C- 26.28 meters  
DRUMMONDVILLE,  
QUE., CAN.  
Tests with Australia irregularly  
in evenings

**11200 kc. XBJQ**  
-X- 26.79 meters  
BOX 2825,  
MEXICO CITY, MEX.  
Irregular

**11050 kc. ZLT4**  
-C- 27.15 meters  
WELLINGTON, N. ZEALAND  
Phones Australia and England  
early a.m. Also broadcasts ir-  
regularly on Sunday, 9-10 a.m.

**11000 kc. PLP**  
-B-C- 27.27 meters  
BANDONG, JAVA  
Broadcasts Sat. 7 p.m.-1:30  
a.m., Sun. 5:30-10 a.m.

**10970 kc. OCI**  
-C- 27.35 meters  
LIMA, PERU  
Works with Bogota, Col.,  
evenings

**10955 kc. HSHPJ**  
-B-X- 27.38 meters  
BANGKOK, SIAM  
Broadcasts 8-10:15 a.m.

**10840 kc. KWV**  
-C- 27.68 meters  
DIXON, CAL.  
Works with Hawaii evenings.

**10770 kc. GBP**  
-C- 27.85 meters  
RUGBY, ENGLAND  
Calls  
Sydney, Austral., early a. m.

**10740 kc. ★JVM**  
-B-C- 27.93 meters  
NAZAKI, JAPAN  
Tues. and Fri. 2-3 p.m.

**10675 kc. WNB**  
-C- 28.1 meters  
LAWRENCEVILLE, N. J.  
Calls Bermuda, daytime

**10670 kc. ★CEC**  
-C- 28.12 meters  
SANTIAGO, CHILE  
Broadcasts Thurs., Sun.  
8:30-9 p.m., Daily 7:7:15 p.m.

**10660 kc. ★JVN**  
-B-C- 28.14 meters  
NAZAKI, JAPAN  
Phones Europe 3-8 a.m.  
Mon. and Thurs. 4-5 p.m.  
Daily 4-8 a.m.

**10550 kc. WOK**  
-C- 28.44 meters  
LAWRENCEVILLE, N. J.  
Phones  
Argo., Braz., Peru, nights

**10520 kc. VLK**  
-C- 28.51 meters  
SYDNEY, AUSTRALIA  
Calls Rugby, early a.m.

**10430 kc. YBG**  
-C- 28.76 meters  
MEDAN, SUMATRA  
5:30-6:30 a. m., 7:30-8:30 p. m.

**10420 kc. XGW**  
-C- 28.79 meters  
SHANGHAI, CHINA  
Calls Manila and England, 6-9  
a. m. and California late evening

**10410 kc. PDK**  
-C- 28.80 meters  
KOOTWIJK, HOLLAND  
Calls Java 7:30-9:40 a. m.

**10410 kc. KES**  
-X- 28.80 meters  
BOLINAS, CALIF.  
Tests evenings

**10350 kc. LSX**  
-C- 28.98 meters  
MONTE GRANDE,  
ARGENTINA  
Tests irregularly 8 p.m.-12 mid-  
night.

**10330 kc. ORK**  
-B-C- 29.04 meters  
RUYSELEDE, BELGIUM  
Broadcasts 1:30-3 p.m.

**10300 kc. LSL2**  
-C- 29.13 meters  
HURLINGHAM, ARGENTINA  
Calls Europe, evenings

**10290 kc. DZC**  
-X- 29.16 meters  
KONIGSWUSTERHAUSEN,  
GERMANY  
Broadcasts irregularly

**10260 kc. PMN**  
-B-C- 29.24 meters  
BANDONG, JAVA  
Calls Australia 5 a.m.  
Broadcasts Sat. 7 p.m.-1:30  
a.m., Sun. 5:30-10 a.m.

<p><b>10250 kc. LSK3</b> -C- 29.27 meters HURLINGHAM, ARGENTINA Calls Europe and U. S. after- noon and evening</p> <p><b>10220 kc. PSH</b> -C- 29.35 meters RIO DE JANEIRO, BRAZIL</p> <p><b>10170 kc. RIO</b> -C- 29.5 meters BAKOU, U.S.S.R. Works with Moscow 10 p.m.-5 a.m.</p> <p><b>10169 kc. HSJ</b> -CX- 29.5 meters BANGKOK, SIAM Testing early morning</p> <p><b>10140 kc. OPM</b> -C- 29.58 meters LEOPOLDVILLE, BELGIAN CONGO Phones around 3 a.m. and 1- 4 p.m.</p> <p><b>10080 kc. RIR</b> -C- 29.78 meters TIFLIS, U.S.S.R. Works with Moscow early morning.</p> <p><b>10070 kc. EDM-EHY</b> -C- 29.79 meters MADRID, SPAIN Works with S. America evenings</p> <p><b>10055 kc. ZFB</b> -C- 29.84 meters HAMILTON, BERMUDA Phones N. Y. C. daytime</p> <p><b>10055 kc. SUV</b> -C- 29.84 meters ABOU ZABAL, EGYPT Works with Europe 1-6 p.m.</p> <p><b>10042 kc. DZB</b> -X- 29.87 meters ZEESEN, GERMANY Works with Central America and tests 7:30-9:30 p.m.</p> <p><b>9990 kc. KAZ</b> -C- 30.03 meters MANILLA, P.I. Works with Java, Cal. and ships early morning</p> <p><b>9950 kc. GCU</b> -C- 30.15 meters RUGBY, ENGLAND Calls N.Y.C. evening</p> <p><b>9930 kc. HKB</b> -C- 30.21 meters BOGOTA, COL. Phones Rio de Janeiro evenings</p> <p><b>9890 kc. LSN</b> -C- 30.33 meters HURLINGHAM, ARGENTINA Calls New York, evenings</p> <p><b>9870 kc. WON</b> -C- 30.4 meters LAWRENCEVILLE, N. J. Phones England, evening</p> <p><b>9860 kc. EAQ</b> -B- 30.43 meters P. O. Box 951 MADRID, SPAIN Daily 5:15-9:30 p.m.; Saturday also 12 n.-2 p.m.</p> <p><b>9840 kc. JYS</b> -X- 30.49 meters KEMIKAWA-CHO, CHIBA- KEN, JAPAN Irregular, 4-7 a.m.</p> <p><b>9800 kc. LSI</b> -O- 30.61 meters MONTE GRANDE, ARGENTINA Tests irregularly</p> <p><b>9790 kc. GCW</b> -O- 30.64 meters RUGBY, ENGLAND Calls N.Y.C., evening</p> <p><b>9760 kc. VLJ-VLZ2</b> -C- 30.74 meters AMALGAMATED WIRELESS OF AUSTRALIA SYDNEY, AUSTRALIA Phones Java and N. Zealand early a.m.</p> <p><b>9750 kc. WOF</b> -O- 30.77 meters LAWRENCEVILLE, N. J. Phones England, evening</p> <p><b>9710 kc. GCA</b> -C- 30.89 meters RUGBY, ENGLAND Calls Argo. &amp; Brazil, evenings</p> <p><b>9675 kc. DZA</b> -C- 31.01 meters ZEESEN, GERMANY Works with Africa and broad- casts 5-7 p.m.</p>	<p><b>9650 kc. CT1AA</b> -B- 31.09 meters LIBBON, PORTUGAL Tues., Thurs., Sat. 3-6 p.m.</p> <p><b>9650 kc. DGU</b> -C- 31.09 meters NAUEN, GERMANY Works with Egypt in afternoon</p> <p><b>9635 kc. 2RO</b> -B- 31.13 meters E.I.A.R., ROME, ITALY M., W., F., 6-7:30 p.m. Tues., Thurs., Sat. 6-7:45 p.m.</p> <p><b>9620 kc. YDB</b> -B- 31.19 meters N.I.R.O.M. SOERABAJA, JAVA 5:30-10 a.m., 6-6:30 p.m., 10:30 p.m.-1:30 a.m.</p> <p><b>9600 kc. CB960</b> -B- 31.25 meters SANTIAGO, CHILE 9:30 p.m. on</p> <p><b>9600 kc. HJ1ABP</b> -B- 31.25 meters P.O. BOX 37, CARTAGENA, COL. 11:30 a.m.-1 p.m., 7:30-11:30 p.m.</p> <p><b>9595 kc. HBL</b> -B- 31.27 meters LEAGUE OF NATIONS GENEVA, SWITZERLAND Saturdays, 5:30-6:15 p. m. Mon. at 1:45 a.m.</p> <p><b>9595 kc. HH3W</b> -B- 31.27 meters P.O. BOX 117, PORT-AU-PRINCE, HAITI 1-2, 7-8 p.m.</p> <p><b>9590 kc. HP5J</b> -B- 31.28 meters APARTADO 867, PANAMA CITY, PANAMA 11:45 a.m.-1 p.m., 7:30-10 p.m.</p> <p><b>9590 kc. PCJ</b> -B- 31.28 meters N. V. PHILIPS RADIO EINDHOVEN, HOLLAND Sun. 7-8 p.m.</p> <p><b>9590 kc. VK2ME</b> -B- 31.28 meters AMALGAMATED WIRELESS, LTD., 47 YORK ST. SYDNEY, AUSTRALIA Sun. 1-3, 5-9, 10:30 a.m.-12:30 p.m.</p> <p><b>9590 kc. W3XAU</b> -B- 31.28 meters NEWTOWN SQUARE, PA. Relays WCAU Daily 11 a.m.-6:50 p.m.</p> <p><b>9580 kc. LRX</b> -B- 31.32 meters "EL MUNDO" BUENOS AIRES, ARGENTINA Testing</p> <p><b>9580 kc. GSC</b> -B- 31.32 meters DAVENTRY, B.B.C., BROADCASTING HOUSE, LONDON, ENGLAND 6-8, 9-11 p.m.</p> <p><b>9580 kc. VK3LR</b> -B- 31.32 meters Research Section, Postmaster Gen'l. Dept., 61 Lime Collins St., MELBOURNE, AUSTRALIA 3:15-7:30 a.m., except Sun. also Fr. 10 p.m.-2 a.m.</p> <p><b>9570 kc. W1XK</b> -B- 31.35 meters WESTINGHOUSE ELECTRIC &amp; MFG. CO. SPRINGFIELD, MASS. Relays WBZ, 6 a.m.-12 m. Sun 7 a.m.-12 m.</p> <p><b>9565 kc. VUB</b> -B- 31.36 meters BOMBAY, INDIA 11 a.m.-12:30 p.m., Wed., Thurs., Sat.</p> <p><b>9560 kc. DJA</b> -B- 31.38 meters BROADCASTING HOUSE, BERLIN 8.05-11 a.m., 4:55-10:45 p.m.</p> <p><b>9540 kc. DJN</b> -B- 31.45 meters BROADCASTING HOUSE BERLIN, GERMANY 12:30-3, 3:50-11 a.m., 4:55- 10:45 p.m.</p> <p><b>9530 kc. W2XAF</b> -B- 31.48 meters GENERAL ELECTRIC CO. SCHENECTADY, N. Y. Relays WGY 4 p.m.-12 m. Sat. 12 n.-12 m.</p>	<p><b>9525 kc. LKJ1</b> -B- 31.49 meters JELOY, NORWAY 5-8 a.m., 11 a.m.-6 p.m.</p> <p><b>9525 kc. CQN</b> -B- 31.49 meters MACAO, PORTUGUESE CHINA Mon. and Fri. 7-8:30 a.m.</p> <p><b>9510 kc. VK3ME</b> -B- 31.55 meters AMALGAMATED WIRELESS, 167 Queen St., MELBOURNE, AUSTRALIA Daily exc. Sun. 4-7 a.m.</p> <p><b>9510 kc. GSB</b> -B- 31.55 meters DAVENTRY, B.B.C., BROADCASTING HOUSE, LONDON, ENGLAND 11:30 p.m.-1:30 a.m., 12:15- 5:45 p.m.</p> <p><b>9501 kc. PRF5</b> -B- 31.58 meters RIO DE JANEIRO, BRAZIL Irregularly 4:45-5:45 p.m.</p> <p><b>9500 kc. HJU</b> -B- 31.59 meters NATL. RAILWAYS, BUENAVENTURA, COLOMBIA Mon., Wed., Fri. 8-11 p.m.</p> <p><b>9450 kc. TG1X</b> -B- 31.75 meters MINISTRE DE FOMENTO GUATEMALA CITY, GUATEMALA Irregularly 6-11 p.m.</p> <p><b>9428 kc. COCH</b> -B- 31.8 meters 2 B ST VEDADO, HAVANA, CUBA Daily 8 a.m.-7 p.m. Sun. 11 a.m.-12 n., 8:30-9:30 p.m.</p> <p><b>9415 kc. PLV</b> -C- 31.87 meters BANDONG, JAVA Phones Holland around 9:45 a.m.</p> <p><b>9330 kc. CGA4</b> -C- 32.15 meters DRUMMONDVILLE, CANADA Phones England irregularly</p> <p><b>9280 kc. GCB</b> -C- 32.33 meters RUGBY, ENGLAND Calls Can. &amp; Egypt, evenings</p> <p><b>9170 kc. WNA</b> -C- 32.72 meters LAWRENCEVILLE, N. J. Phones England, evening</p> <p><b>9150 kc. YVR</b> -C- 32.79 meters MARACAY, VENEZUELA Works with Europe afternoons.</p> <p><b>9125 kc. HAT4</b> -B- 32.88 meters "RADIOLABOR," GYALI-UT, 22 BUDAPEST, HUNGARY Sunday 6-7 p.m.</p> <p><b>9060 kc. TFK</b> -C- 33.11 meters REYKJAVIK, ICELAND Phones London afternoons. Broadcasts irregularly.</p> <p><b>9020 kc. GCS</b> -C- 33.26 meters RUGBY, ENGLAND Calls N.Y.C., evenings</p> <p><b>9010 kc. KEJ</b> -C- 33.3 meters BOLINAS, CAL. Relays NBC &amp; CBS Programs in evening irregularly</p> <p><b>8975 kc. VWY</b> -C- 33.43 meters KIRKEE, INDIA Works with England in morning</p> <p><b>8795 kc. HKV</b> -B- 34.09 meters BOGOTA, COLOMBIA Irregular; 8:30 p.m.-12 m.</p> <p><b>8775 kc. PNI</b> -C- 34.19 meters MAKASSER CELEBES, N.I. Phones Java around 4 a. m.</p> <p><b>8765 kc. DAF</b> -C- 34.23 meters NORDEICH, GERMANY Works German Ships irregularly</p> <p><b>8760 kc. GCQ</b> -C- 34.25 meters RUGBY, ENGLAND Calls S. Africa, afternoon</p>	<p><b>8750 kc. ZCK</b> -B- 34.29 meters HONGKONG, CHINA Relays ZBW Daily 11:30 p.m.-1:15 a.m. Mon. and Thurs. 3-7 a.m. Tues., Wed., Fri. 6-10 a.m. Sat. 6-11 a.m.</p> <p><b>8730 kc. GCI</b> -C- 34.36 meters RUGBY, ENGLAND Calls India, 8 a. m.</p> <p><b>8680 kc. GBC</b> -C- 34.56 meters RUGBY, ENGLAND Calls ships</p> <p><b>8665 kc. CO9JQ</b> -X- 34.62 meters CAMAGUEY, CUBA 5:30-6:30, 8-9 p.m. daily except Sat. and Sun.</p> <p><b>8590 kc. YNVA</b> -B- 34.92 meters MANAGUA, NICARAGUA 7:30-9:30 p. m.</p> <p><b>8560 kc. WOO</b> -C- 35.05 meters OCEAN GATE, N. J. Calls ships irregular</p> <p><b>8400 kc. HC2AT</b> -B- 35.71 meters CASSILLA 877 GUAYAQUIL, ECUADOR 8-11 p.m.</p> <p><b>8380 kc. IAC</b> -C- 35.8 meters Pisa, Italy</p> <p><b>8220 kc. ZP10</b> -B- 36.4 meters ASUNCION, PARAGUAY 7-9 p.m.</p> <p><b>8214 kc. HCJB</b> -B- 36.5 meters QUITO, ECUADOR 7-11 p.m., except Monday Sun. 11 a.m.-12 n.; 4-10 p.m.</p> <p><b>8190 kc. XEME</b> -B- 36.63 meters CALLE 59, No. 517 MERIDA, YUCATAN "LA VOZ DE YUCATAN desde MERIDA 10 a.m.-12 n., 6 p.m.-12 m. 8-11 p.m.</p> <p><b>8185 kc. PSK</b> -C- 36.65 meters RIO DE JANEIRO, BRAZIL Irregularly</p> <p><b>8036 kc. CNR</b> -B- 37.33 meters RABAT, MOROCCO Sunday, 2:30-5 p. m.</p> <p><b>7975 kc. HC2TC</b> -B- 37.62 meters QUITO, ECUADOR Thurs., Sun. at 8 p.m.</p> <p><b>7901 kc. LSL</b> -C- 37.87 meters HURLINGHAM, ARGENTINA Calls Brazil, night</p> <p><b>7880 kc. JYR</b> -B- 38.07 meters KEMIKAWA-CHO, CHIBA- KEN, JAPAN 4-7:40 a. m.</p> <p><b>7860 kc. SUX</b> -C- 38.17 meters ABOU ZABAL, EGYPT Works with Europe 4-6 p.m.</p> <p><b>7854 kc. HC2JSB</b> -B- 38.2 meters GUAYAQUIL, ECUADOR 8:15-11:15 p.m.</p> <p><b>7830 kc. YV9RC</b> -B- 38.31 meters CARACAS, VENEZUELA 7-11 p.m.</p> <p><b>7799 kc. HBP</b> -B- 38.47 meters LEAGUE OF NATIONS, GENEVA, SWITZERLAND 5:30-6:15 p. m., Saturday</p> <p><b>7715 kc. KEE</b> -C- 38.89 meters BOLINAS, CAL. Relays NBC &amp; CBS Programs in evening irregularly</p> <p><b>7630 kc. ZHJ</b> -B- 39.32 meters PENANG, MALAYA Daily 7-9 a.m. also Sat. 11 p.m.-1 A.M. (Sun.)</p> <p><b>7626 kc. RIM</b> -C- 39.34 meters TACKENT, U.S.S.R. Works with Moscow early morning</p> <p><b>7620 kc. ETD</b> -C- 39.37 meters ADDIS ABABA, ETHIOPIA See 18270 kc.</p>	<p><b>7550 kc. T18WS</b> -B- 39.74 meters "ECOS DEL PACIFICO" P. O. BOX 75 PUNTA ARENAS, COSTA RICA 6 p.m.-12 m.</p> <p><b>7510 kc. JVP</b> -B-C- 39.95 meters NAZAKI, JAPAN</p> <p><b>7380 kc. XECR</b> -B- 40.65 meters FOREIGN OFFICE, MEXICO CITY, MEX. Sun. 6-7 p.m.</p> <p><b>7281 kc. HJ1ABD</b> -B- 41.04 meters CARTAGENA, COLO. Irregularly, evenings</p> <p><b>7100 kc. HKE</b> -B- 42.25 meters BOGOTA, COL., S. A. Tue. and Sat. 8-9 p. m.; Mon. &amp; Thurs. 6:30-7 p. m.</p> <p><b>7080 kc. VP3MR</b> -B- 42.68 meters GEORGETOWN, BRI. GUI- ANA, S.A. Sun. 7:45-10:15 a.m. Mon. 3:45-4:45 p.m. Tue. 4:45-6:45 p.m. Wed. 4:45-7:45 p.m. Thur. 5-6:45 p.m. Sat. 4:45-7:45 p.m.</p> <p><b>7074 kc. HJ1ABK</b> -B- 42.69 meters CALLE, BOLIVIA, PROGRESO, IGUALDAD BARRANQUILLA, COLOMBIA Sun. 3-6 p.m.</p> <p><b>7030 kc. HRP1</b> -B- 42.67 meters SAN PEDRO SULA, HONDURAS Reported on this and other waves irregularly in evening</p> <p><b>6996 kc. PZH</b> -B- 42.88 meters P. O. BOX 18, PARAMIRABO, OUTCH GUIANA Sun. 9:30-11:36 a.m. Mon. and Fri. 5:36-9:36 p.m. Tues. and Thur. 8:36-10:36 a.m., 2:36-4:36 p.m. Wed. 3:36-4:36, 5:36-9:36 p.m. Sat. 2:36-4:36 p.m.</p> <p><b>6976 kc. HCETC</b> -B- 43 meters TEATRO BOLIVAR QUITO, ECUADOR Thurs. till 9:30 p.m.</p> <p><b>6905 kc. GDS</b> -C- 43.45 meters RUGBY, ENGLAND Calls N.Y.C. evening</p> <p><b>6900 kc. HI3C</b> -B- 43.48 meters LA RAMONA, DOM. REP. LA VOZ de RIO DULCE, 7:30-9:30 p.m.</p> <p><b>6860 kc. KEL</b> -X- 43.70 meters BOLINAB, CALIF. Tests irregularly 11 a. m.-12 n.; 6-9 p. m.</p> <p><b>6814 kc. HIH</b> -B- 44.03 meters SAN PEDRO de MACORIS DOMINICAN REP. 12:10-1:40 p.m., 7:30-9 p.m., Sun. 3-4 a.m. 4:15-6 p.m.</p> <p><b>6755 kc. WOA</b> -C- 44.41 meters LAWRENCEVILLE, N. J. Phones England, evening</p> <p><b>6750 kc. JVT</b> -B-C- 44.44 meters NAZAKI, JAPAN KOKUBAI-DENWA KAISHA, LTD., TOKIO</p> <p><b>6710 kc. TIEP</b> -B- 44.71 meters LA VOZ DEL TROPICO SAN JOSE, COSTA RICA APARTADO 257, Daily 7-10 p.m.</p> <p><b>6672 kc. YVQ</b> -C- 44.95 meters MARACAY, VENEZUELA Broadcasts Sat. 8-9 p.m.</p> <p><b>6660 kc. HC2RL</b> -B- 45.05 meters P. O. BOX 759, GUAYAQUIL, ECUADOR, S. A. Sunday, 5:45-7:45 p. m. Tues., 9:15-11:15 p. m.</p> <p><b>6650 kc. IAC</b> -C- 45.11 meters PISA, ITALY Calls ships, evenings</p>
--	--	--	---	---

(All Schedules Eastern Standard Time)

**6630 kc. HIT**  
-B- 45.25 meters  
"LA VOZ de la RCA VICTOR,"  
APARTADO 1105, CIUDAD  
TRUJILLO, D.R.  
Daily exc. Sun. 12:10-1:40 p.m.,  
5:40-8:40 p.m.; also Sat. 10:40  
p.m.-12:40 a.m. (Sun.)

**6618 kc. PRADO**  
-B- 45.33 meters  
RIOBAMBA, ECUADOR  
Thurs. 9:11:45 p.m.

**6611 kc. RV72**  
-B- 45.38 meters  
MOSCOW, U. S. S. R.  
1-8 p. m.

**6600 kc. HI4D**  
-B- 45.45 meters  
CIUDAD TRUJILLO, DOM-  
INICAN REPUBLIC  
Except Sun. 11:55 a.m.-1:40  
p.m.; 4:40-7:40 p.m.

**6560 kc. HI4V**  
-B- 45.73 meters  
CIUDAD TRUJILLO, D.R.  
LA VOZ de LA MARINA  
5:10-6:40 p.m.

**6550 kc. TIRCC**  
-B- 45.77 meters  
RADIOEMISORA CATOLICA  
COSTARRICENSE  
SAN JOSE, COSTA RICA  
Sun. 12:45-2:30, 6-7, 8-9 p.m.

**6528 kc. HIL**  
-B- 45.95 meters  
CIUDAD TRUJILLO, D.R.  
Sat. 8-10 p.m.

**6520 kc. YV6RV**  
-B- 46.01 meters  
VALENCIA, VENEZUELA  
12 n.-1 p.m., 6-10 p.m.

**6500 kc. HJ5ABD**  
-B- 46.15 meters  
MANIZALES, COL.  
12-1:30 p. m., 7-10 p. m.

**6450 kc. HJ4ABC**  
-B- 46.51 meters  
"LA VOZ de GAMBEBE,"  
APARTADO 39  
IBAQUE, COLOMBIA  
7:30-11 p.m.

**6447 kc. HJ1ABB**  
-B- 46.53 meters  
BARRANQUILLA, COL., S. A.  
P. O. BOX 715.  
11:30 a.m.-1 p.m.; 4:30-10 p.m.

**6425 kc. W9XBS**  
-X- 46.7 meters  
NATL. BROAD. CO.  
CHICAGO, ILL.  
Relays WMAQ, Irregular

**6420 kc. HI1S**  
-B- 46.73 meters  
PUERTO PLATA, DOM. REP.  
11:40 a.m.-1:40 p.m., 5:40-  
7:40, 9:40-11:40 p.m.

**6410 kc. TIPG**  
-B- 46.8 meters  
APARTADO 225,  
SAN JOSE, COSTA RICA  
"LA VOZ de LA VICTOR"  
12 n.-2 p.m., 6-11:30 p.m.

**6380 kc. HI3U**  
-B- 47.02 meters  
SANTIAGO de los CABAL-  
LEROS, DOM. REP.  
Irregular in evening

**6375 kc. YV4RC**  
-B- 47.06 meters  
CARACAS, VENEZUELA  
6:45-9:30 p.m.

**6316 kc. HIZ**  
-B- 47.5 meters  
CIUDAD TRUJILLO  
DOMINICAN REPUBLIC  
Daily except Sat. and Sun.  
4:40-5:40 p. m.; Sat. 9:40-  
11:40 p. m.; Sun. 11:40 a.  
m.-1:40 p. m.

**6300 kc. YV12RM**  
-B- 47.62 meters  
MARACAY, VENEZUELA  
8-10:30 p.m.

**6280 kc. HIG**  
-B- 47.77 meters  
CIUDAD TRUJILLO, D.R.  
Irregular 5-9:30 p.m.

**6230 kc. OAX4G**  
-B- 48 meters  
Apartado 1242  
LIMA, PERU  
Daily 7-10:30 p.m.  
Wed. 6-10:30 p.m.

**6200 kc. HRV**  
-B- 48.39 meters  
LA CEIBE, HONDURAS  
Testing near 11 p.m.

**6185 kc. HI1A**  
-B- 48.5 meters  
P. O. BOX 423, SANTIAGO,  
DOMINICAN REP.  
11:40 a.m.-1:40 p. m.  
7:40-9:40 p. m.

**6180 kc. XEXA**  
-B- 48.54 meters  
DEPT. OF EDUCATION  
MEXICO CITY, MEX.  
8-11:30 a.m.

**6175 kc. HJ2ABA**  
-B- 48.58 meters  
TUNJA, COLOMBIA  
1-2; 7:30-9:30 p.m.

**6170 kc. HJ3ABF**  
-B- 48.62 meters  
BOGOTA, COLOMBIA  
7-11:15 p. m.

**6160 kc. YV3RC**  
-B- 48.7 meters  
CARACAS, VENEZUELA  
11 a.m.-2 p.m., 4-10:30 p.m.

**6155 kc. COKG**  
-B- 48.74 meters  
BOX 137, SANTIAGO, CUBA  
9-10 a.m., 11:30 a.m.-1:30 p.m.,  
3-4:30 p.m., 10-11 p.m., 12 m.-  
2 a.m.

**6150 kc. CSL**  
-B- 48.78 meters  
LISBON, PORTUGAL  
7-8:30 a.m., 2-7 p.m.

**6150 kc. CJRO**  
-B- 48.78 meters  
WINNIPEG, MAN., CANADA  
8 p. m.-12 m.  
Sun. 3-10:30 p. m.

**6150 kc. HJ5ABC**  
-B- 48.78 meters  
CALI, COLOMBIA  
Daily 11 a.m.-12 n., Sun. 12 n.-  
2 p.m., Daily except Sat. and  
Sun. 7-10 p.m.

**6140 kc. W8XK**  
-B- 48.86 meters  
WESTINGHOUSE ELECTRIC  
& MFG. CO.  
PITTSBURGH, PA.  
Relays KDKA  
9 p.m.-12 m.

**6135 kc. HI5N**  
-B- 48.9 meters  
SANTIAGO, D.R.  
6:40-9:10 p.m.

**6130 kc. HJ4ABP**  
-B- 48.94 meters  
MEDELLIN, COL.  
Irregular.

**6130 kc. TGXA**  
-B- 48.94 meters  
GIORNAL LIBERAL PRO-  
GRESSISTA, GAUTEMALA  
CITY, GUAT.  
Heard in the evening.

**6130 kc. COCD**  
-B- 48.92 meters  
"La Voz del Aire"  
CALLE 6 y 25, VEDADO,  
HAVANA, CUBA  
Relays CMCD 11 a.m.-12 n., 7-  
10 p.m., Sun. 12 n.-4 p.m.

**6130 kc. ZGE**  
-B- 48.92 meters  
KUALA LUMPUR,  
FED. MALAY STATES  
Sun., Tue., and Fri.,  
6:40-8:40 a. m.

**6120 kc. W2XE**  
-B- 49.02 meters  
ATLANTIC BROADCASTING  
CORP.  
485 MADISON AVE., N. Y. C.  
Relays WABC, 9-10 p.m.

**6120 kc. XEFT**  
-B- 49.02 meters  
AV. INDEPENDENCIA 28,  
VERA CRUZ, MEX.  
11 a.m.-4 p.m., 7:30 p.m.-12 m.  
Sat. also 6:30-7:30 p.m.  
Sun. 11 a.m.-4 p.m., 9 p.m.-12  
m.  
Relays XEFT

**6115 kc. HJ1ABE**  
-B- 49.05 meters  
CARTAGENA, COL.  
P. O. Box 31  
Mon. 10 p.m.-12 m.  
Daily 7:30-9 p.m.

**6110 kc. CHNX**  
-B- 49.1 meters  
P.O. BOX 998  
HALIFAX, N.S., CANADA  
Daily 9 a.m.-12:30 p.m.,  
4-10 p.m.  
Relays CHNS

**6110 kc. VUC**  
-B- 49.1 meters  
CALCUTTA, INDIA  
Daily except Sat., 3-5:30 a. m.,  
9:30 a. m.-noon;  
Sat., 11:45 a. m.-3 p. m.

**6105 kc. HJ4ABB**  
-B- 49.14 meters  
MANIZALES, COL., S. A.  
P. O. Box 175  
Mon. to Fri. 12:15-1 p. m.;  
Tues. & Fri. 7:30-10 p. m.;  
Sun. 2:30-3 p. m.

**6100 kc. W3XAL**  
-B- 49.18 meters  
NATIONAL BROADCASTING  
CO.  
BOUND BROOK, N. J.  
Relays WJZ  
Monday, Wednesday, Saturday,  
4-5 p.m., Sat. 11 p.m.-12 m.

**6100 kc. W9XF**  
-B- 49.18 meters  
NATL. BROAD. CO.  
Relays WEEB, Chicago  
Sun., Tues., Thur. Fri. 9 p.m.-  
2 a.m.; M., W., Sat., 1-2 a.m.

**6097 kc. ZTJ**  
-B- 49.2 meters  
AFRICAN BROADCASTING  
CO.  
JOHANNESBURG, SOUTH  
AFRICA.  
Sun.-Fri. 11:45 p.m.  
12:30 a.m. (next day)  
Mon.-Sat. 3:30-7 a.m.  
9 a.m.-4 p.m.  
Sun. 8-10:15 a.m.; 12:30-3 p.m.

**6090 kc. CRCX**  
-B- 49.26 meters  
TORONTO, CANADA  
Daily 5:30-11:30 p.m.  
Sun. 11:45 a.m.-11:45 p.m.

**6090 kc. VE9BJ**  
-B- 49.28 meters  
SAINT JOHN, N. B., CAN.  
7-8:30 p. m.

**6085 kc. 2RO**  
-B- 49.3 meters  
E.I.A.R.  
ROME, ITALY

**6083 kc. VQ7LO**  
-B- 49.31 meters  
NAIROBI, KENYA, AFRICA  
Mon.-Fri. 5:45-6:15 a.m., 11:30  
a.m.-2:30 p.m. Also 8:30-9:30  
a.m. on Tues. and Thurs.; Sat.  
11:30 a.m.-3:30 p.m.; Sun. 11  
a.m.-2 p.m.

**6080 kc. CP5**  
-B- 49.34 meters  
LAPAZ, BOLIVIA  
7-10:30 p. m.

**6080 kc. HP5F**  
-B- 49.34 meters  
Carlton Hotel  
COLON, PANAMA  
11:45 a.m.-1:15 pm., 7:45-10  
p.m.

**6080 kc. W9XAA**  
-B- 49.34 meters  
CHICAGO FEDERATION OF  
LABOR  
CHICAGO, ILL.  
Relays WCFL  
Sunday 11:30 a. m.-9 p. m. and  
Tues., Thurs., Sat., 4 p. m.-12 m.

**6079 kc. DJM**  
-B-X- 49.34 meters  
BROADCASTING HOUSE,  
BERLIN, GERMANY  
3-5 p.m.

**6072 kc. OER2**  
-B- 49.41 meters  
VIENNA, AUSTRIA  
9 a.m.-5 p.m.

**6070 kc. HJ4ABC**  
-B- 49.42 meters  
PERIERA, COL.  
9:30-11:30 a.m., 7-8 or 9 p.m.

**6070 kc. VE9CS**  
-B- 49.42 meters  
VANCOUVER, B. C., CANADA  
Sun. 1:45-9 p. m., 10:30 p. m.-  
1 a. m.; Tues. 6-7:30 p. m.,  
11:30 p. m.-1:30 a. m. Daily  
6:7:30 p. m.

**6065 kc. HJ4ABL**  
-B- 49.46 meters  
MANIZALES, COL.  
Daily 11 a.m.-12 n., 5:30-7:30  
p.m. Sat. 5:30-10:30 p.m.

**6060 kc. W8XAL**  
-B- 49.50 meters  
CROSLLEY RADIO CORP.  
CINCINNATI, OHIO  
5:30 a.m.-7 p.m.; 10 p.m.-1 a.m.  
Relays WLW

**6060 kc. W3XAU**  
-B- 49.50 meters  
NEWTOWN SQUARE, PA.  
Relays WCAU, Philadelphia  
7 p.m.-10 p.m.

**6060 kc. OXY**  
-B- 49.50 meters  
SKAMLEBOAEK, DENMARK  
1-6:30 p.m.

**6050 kc. HJ3ABD**  
-B- 49.59 meters  
BOX 509, BOGOTA, Col.  
COLOMBIA BROADCASTING  
12 n.-2 p.m. 7-11 p.m., Sun.  
5-9 p.m.

**6050 kc. HI9B**  
-B- 49.59 meters  
SANTIAGO  
DOM. REP.  
Irregular 6 p.m.-11 p.m.

**6042 kc. HJ1ABG**  
-B- 49.65 meters  
EMISORA ATLANTICO  
BARRANQUILLA, COLO.  
12 n.-1 p.m., 6-10:30 p.m.  
Sun. 1-6 p.m.

**6040 kc. W4XB**  
-B- 49.67 meters  
MIAMI BEACH, FLA.  
Relays WIOD 12 n.-2 p.m.,  
5:30 p.m.-12 m.

**6040 kc. PRA8**  
-B- 49.67 meters  
RADIO CLUB OF  
PERNAMBUCO  
PERNAMBUCO, BRAZIL  
(-3 p.m., 4-7:30 p.m. daily

**6040 kc. W1XAL**  
-B- 49.67 meters  
BOSTON, MASS.  
Tues., Thurs. 7:15-9:15 p.m.  
Sun 5-7 p.m.

**6040 kc. YDA**  
-B- 49.67 meters  
N.I.R.O.M.  
TANDJONGPRIOK, JAVA  
5:45-6:45 p.m., 10:30 p.m.-1:30  
a.m.

**6030 kc. HP5B**  
-B- 49.75 meters  
P. O. BOX 910  
PANAMA CITY, PAN.  
12 n.-1 p.m., 7-10:30 p.m.

**6030 kc. VE9CA**  
-B- 49.75 meters  
CALGARY, ALBERTA, CAN.  
Thurs. 9 a.m.-2 a.m. (Fri.);  
Sun. 12 n.-12 m.  
Irregularly on other days from  
9 a.m.-12 m.

**6020 kc. CQN**  
-B- 49.83 meters  
MACAO, CHINA  
Mon. and Fri. 3-5 a.m.

**6020 kc. DJC**  
-B- 49.83 meters  
BROADCASTING HOUSE,  
BERLIN  
11:35 a.m.-4:25 p.m., 4:55-  
10:45 p.m.

**6020 kc. XEUW**  
-B- 49.82 meters  
AV. INDEPENDENCIA, 98,  
VERA CRUZ, MEX.  
8 p.m.-12:30 a.m.

**6018 kc. ZHI**  
-B- 49.9 meters  
RADIO SERVICE CO.,  
20 ORCHARD RD.,  
SINGAPORE, MALAYA  
Mon., Wed. and Thurs 5:40-8:10  
a.m. Sat. 10:40 p.m.-1:10 a.m.  
(Sun.) Every other Sunday 5:10-  
6:40 a.m.

**6012 kc. HJ3ABH**  
-B- 49.91 meters  
BOGOTA, COLO.  
APARTADO 565  
6-11 p.m.  
Sun. 12 n.-2 p.m., 4-11 p.m.

**6010 kc. COCO**  
-B- 49.92 meters  
P.O. BOX 98  
HAVANA, CUBA  
Daily 9:30 a.m.-1 p.m., 4-7 p.m.,  
Sun. 8-10 p.m.  
Sat. also 11 p.m.-12 m.

**6005 kc. HJ1ABJ**  
-B- 49.96 meters  
SANTA MARTA, COLO.  
6-11 p.m. except Wed.

**6005 kc. VE9DN**  
-B- 49.96 meters  
CANADIAN MARCONI CO.,  
MONTREAL, QUE., CANADA  
Saturdays at 11:30 p.m.

**6000 kc. HJ1ABC**  
-B- 50 meters  
QUIBDO, COLOMBIA  
5-6 p.m., Sun. 9-11 p.m.

**6000 kc. TGWA**  
-B- 50 meters  
GUATEMALA CITY, GUAT.  
12 n.-1 p.m., 6:30-7:30 p.m.,  
10-11 p.m. Sat. also from 12 m.-  
6 a.m. (Sun.)

**6000 kc. RV59**  
-B- 50 meters  
MOSCOW, U. S. S. R.  
Daily 12:30-6 p.m.

**5990 kc. XEBT**  
-B- 50.08 meters  
MEXICO CITY, MEX.  
P. O. Box 79-44  
8 a.m.-1 a.m.

**5985 kc. HJ2ABC**  
-B- 50.13 meters  
CUCUTA, COLOMBIA  
6-9:30 p.m.

**5980 kc. HJ2ABD**  
-B- 50.17 meters  
BUCARAMANGA, COL.  
6-10 p.m.

**5980 kc. XEVI**  
-B- 50.17 meters  
MEXICO CITY, MEX.  
Mon., Wed., Fri. 3-4 p.m.  
Tues., Fri. 7:30-8:45, 10 p.m.-  
12 m.; Sat. 9-10 p.m.; Sun. 1-  
2:15 p.m.

**5980 kc. HIX**  
-B- 50.17 meters  
CIUDAD TRUJILLO,  
DOMINICAN REP.  
Sun. 7:40-10:10; Daily 11:40 a.  
m.-12:40 p.m., 4:40-5:40 p.m.;  
Tues. and Fri. 8:10-10:10 p.m.

**5970 kc. HJN**  
-B- 50.26 meters  
BOGOTA, COL.  
6-11 p.m.

**5968 kc. HVJ**  
-B- 50.27 meters  
VATICAN CITY (ROME)  
2-2:15 p. m., daily. Sun., 5-5:30  
a. m.

**5950 kc. HJ4ABE**  
-B- 50.42 meters  
MEDELLIN, COLO.  
Daily 11 a.m.-12 n., 6-10:30  
p.m.

**5940 kc. TG2X**  
-B- 50.5 meters  
GUATEMALA CITY, GUAT.  
4-6, 9-11 p.m.

**5900 kc. HH2S**  
-B- 50.85 meters  
PORT-au-PRINCE, HAITI  
7:30-10:30 p.m.

**5885 kc. HCK**  
-B- 50.98 meters  
QUITO, ECUADOR, S. A.  
8-11 p.m.

**5880 kc. YV8RB**  
-B- 51.02 meters  
"LA VOZ de LARA"  
BARQUISIMETO,  
VENEZUELA  
6-10 p.m.

**5875 kc. HRN**  
-B- 51.06 meters  
TEGUCIGALPA, HONDURAS  
1:15-2:15, 8:30-10 p.m., Sun.  
3:30-5:30, 8:30-9:30 p.m.

**5860 kc. HI1J**  
-B- 51.19 meters  
SAN PEDRO de MACORIS,  
DOM. REP.  
6:30-9 p.m.

**5853 kc. WOB**  
-C- 51.26 meters  
LAWRENCEVILLE, N. J.  
Calls Bermuda, nights

**5850 kc. YV5RMO**  
-B- 51.28 meters  
CALLE REGISTRO, LAS DE-  
LICIAS APARTADO de COR-  
DES 214  
MARACAIBO, VENEZUELA  
11 a.m.-12:30 p.m., 5-9:30 p.m.

**5825 kc. TIGPH**  
-B- 51.5 meters  
SAN JOSE, COSTA RICA  
7-10 p.m.

**5800 kc. YV2RC**  
-B- 51.72 meters  
RADIO CARACAS  
CARACAS, VENEZUELA  
Sun. 8:30 a.m.-10:30 p.m.  
Daily 11 a.m.-1:30 p.m., 4-9:30  
p.m.

**5790 kc. JUV**  
-C- 51.81 meters  
NAZAKI, JAPAN

**5780 kc. OAX4D**  
-B- 51.9 meters  
P.O. Box 883  
LIMA, PERU  
Mon., Wed. & Sat. 9-11:30 p.m.

**5720 kc. YV10RSC**  
-B- 52.45 meters  
"LA VOZ de TACHIRA,"  
SAN CRISTOBAL,  
VENEZUELA  
6-11:30 p.m.

**5713 kc. TGS**  
-B- 52.51 meters  
GUATEMALA CITY, GUAT.  
Wed., Thurs. and Sun. 6-9 p.m.



<b>5500 kc. T15HH</b> -B- 54.55 meters SAN RAMON, COSTA RICA Irregularly 3:30-4, 8-11:30 p.m.	<b>5025 kc. ZFA</b> -C- 59.7 meters HAMILTON, BERMUDA Calls U.S.A., nights	<b>4820 kc. GDW</b> -C- 82.24 meters RUGBY, ENGLAND Calls N.Y.C., late at night	<b>4320 kc. GDB</b> -C- 89.44 meters RUGBY, ENGLAND Tests, 8-11 p. m.	<b>4098 kc. WND</b> -C- 73.21 meters HIALEAH, FLORIDA Calls Bahama Isles
<b>5145 kc. PMY</b> -B- 58.31 meters BANDOENG, JAVA 5:30-11 a.m.	<b>5000 kc. TFL</b> -C- 60 meters REYKJAVIK, ICELAND Calls London at night, Also broadcasts irregularly	<b>4752 kc. WOO</b> -C- 63.1 meters OCEAN GATE, N. J. Calls ships irregularly	<b>4273 kc. RV15</b> -B- 70.20 meters KHABAROVSK, SIBERIA, U. S. S. R. Daily, 3-9 a.m.	<b>4002 kc. CT2AJ</b> -B- 74.95 meters PONTA DELGADA, SAO MIGUEL, AZORES Wed. and Sat. 5-7 p. m.
<b>5077 kc. WCN</b> -C- 59.08 meters LAWRENCEVILLE, N. J. Phones England irregularly	<b>4975 kc. GBC</b> -C- 60.30 meters RUGBY, ENGLAND Calls Ships, late at night	<b>4600 kc. HC2ET</b> -B- 65.22 meters Apartado 249 GUAYAQUIL, ECUADOR Wed., Sat., 9:15-11 p.m.	<b>4272 kc. WOO</b> -C- 70.22 meters OCEAN GATE, N. J. Calls ships irregularly	<b>3040 kc. YDA</b> -B- 98.06 meters N.I.R.O.M. TANDJONGPRIOK, JAVA 5:30-11 a.m.

# Alphabetical List of S-W Stations

## By Call-Letter and Frequency

(Frequency in Megacycles)

CALL	FREQ.	CALL	FREQ.	CALL	FREQ.	CALL	FREQ.	CALL	FREQ.	CALL	FREQ.	CALL	FREQ.
CALL	FREQ.	CALL	FREQ.	CALL	FREQ.	CALL	FREQ.	CALL	FREQ.	CALL	FREQ.	CALL	FREQ.
CB960	9.06 mc.	FZR3	16.23 mc.	HM2S	5.91 mc.	HSP	17.74 mc.	OER2	6.07 mc.	TPA2	15.25	W2XE	15.27 mc.
CEC	19.68	FZS	18.35	HH3W	9.60	HVJ	15.12	OPL	20.04	TPA3	11.88	W2XE	11.83
CEC	15.87	FZS2	11.99	HIG	6.28	HVJ	5.97	OPM	10.14	TPA4	11.72	W2XE	6.12
CEC	10.67	GAA	20.38	HIH	6.81	IAC	17.76	ORG	19.20	TYA	12.22 mc.	W3XAL	17.78
CGA3	13.29	GAB	18.04	HII	14.94	IAC	12.80	ORK	10.33	TYB	12.25	W3XAL	6.10
CGA4	9.33	GAD	19.48	HIL	6.53	IAC	8.38	OXY	6.06	TYF	14.64	W3XAU	9.59
CHNX	6.11	GAP	19.16	HIT	6.63	IAC	6.65	PCJ	15.22	VE9BJ	6.09	W3XAU	6.06
CJA3	11.41	GAQ	18.97	HIX	5.98	IDU	13.39	PCJ	9.59	VE3CA	6.03	W3XL	17.31
CJRO	6.15	GAS	18.31	HIZ	6.32	(1)ZRO	11.81	PCV	17.81	VE3CS	6.07	W4XB	6.04
CJRX	11.72	GAU	18.62	HI1A	6.19	ZRO	9.64	PDK	10.11	VE9DN	6.01	W8XAL	6.06
CNR	12.83	GAW	18.20	HI1J	5.86	JVE	15.66	PDV	12.06	VIZ3	11.56	W8XK	21.54
CNR	8.04	GBA	13.99	HI1S	6.42	JVF	15.62	PHI	17.78	VK2ME	9.59	W8XK	15.21
COCD	6.13	GBB	13.59	HI3C	6.90	JVH	14.60	PHI	11.73	VK3LR	9.58	W8XK	11.87
COCH	9.43	GBC	17.08	HI3U	6.38	JVM	10.74	PLE	18.83	VK3ME	9.51	W8XK	6.14
COCO	6.01	GBC	12.78	HI4D	6.60	JVN	10.66	PLP	9.42	VLJ	9.76	W9XAA	11.83
COKG	6.16	GBC	8.68	HI4V	6.56	JVP	7.51	PLV	11.00	VLK	10.52	W9XAA	6.08
COS9Q	8.67	GBC	4.98	HI5N	6.14	JVT	6.75	PMA	19.35	VLZ2	9.76	W9XBS	6.43
CP5	6.08	GBL	14.65	HI9B	6.05	JVU	5.79	PMC	18.14	VPD	13.08	W9XF	6.10
CQN	9.53	GBP	10.77	HJA3	14.94	JYK	13.61	PMN	10.26	VP3MR	7.08	XBJQ	11.20
CRCX	6.09	GBS	12.15	HJB	14.95	JYR	7.88	PMY	5.15	VQ7LO	6.08	XEBT	5.99
CSL	6.15	GBU	12.29	HJN	5.97	JYS	9.84	PNI	8.78	VRR4	11.60	XECR	7.38
CT1AA	9.65	GBW	14.44	HJU	9.50	JYT	15.76	PPU	19.26	VUB	9.57	XEFT	6.12
CT1GO	12.40	GCA	9.74	HJ1ABB	6.45	KAY	14.98	PRADO	6.62	VUC	6.11	XEME	8.19
CT2AJ	4.00	GCB	9.28	HJ1ABC	6.0	KAZ	9.99	PR8	6.04	VWY2	8.98	XEUW	6.02
DAF	12.33	GCI	8.73	HJ1ABD	7.28	KEE	7.72	PRF5	9.50	WCN	17.51	XEVI	5.98
DAF	8.77	GCJ	13.42	HJ1ABE	6.12	KEJ	9.01	PSA	21.08	WKA	5.08	XEXA	6.18
DFB	17.52	GCQ	8.76	HJ1ABG	6.04	KEL	6.86	PSD	15.07	WKF	21.06	XGM	17.65
DGU	9.650	GCS	9.02	HJ1ABJ	6.01	KES	10.41	PSF	14.96	WKK	19.22	XGW	10.42
DJA	9.560	GCU	9.95	HJ1ABK	7.07	KIO	11.68	PSH	10.22	WKN	21.42	YBG	10.43
DJB	15.20	GCW	9.79	HJ2ABA	6.18	KKR	15.46	PSK	8.19	WLA	18.34	YDA	6.04
DJC	6.02	GDB	4.32	HJ2ABC	5.99	KKZ	13.69	RIM	15.25	WLK	16.27	YDA	3.04
DJD	11.77	GDS	6.91	HJ2ABD	5.98	KTO	16.24	RIM	7.63	WMA	13.39	YDB	9.62
DJE	17.76	GDW	4.82	HJ3ABD	6.05	KWU	15.12	RIO	10.17	WMF	14.47	YNA	14.49
DJL	15.11	GSE	9.51	HJ3ABF	6.17	KWU	15.36	RIR	10.08	WMN	14.59	YVC	13.35
DJM	6.08	GSD	9.58	HJ3ABH	6.01	KWV	10.84	RKI	15.09	WNA	9.17	YVQ	6.67
DJN	9.54	GSE	11.75	HJ4ABA	11.81	LKJ1	9.53	RNE	12.0	WNB	10.68	YVR	18.30
DJO	11.8	GSE	11.86	HJ4ABB	6.11	LRU	15.29	RNE	6.0	WNC	15.06	YVR	9.15
DJP	11.86	GSE	15.14	HJ4ABC	6.45	LRX	9.58	RV15	4.27	WND	4.10	YV2RC	5.80
DJQ	15.28	GSG	17.79	HJ4ABC	6.07	LSF	19.60	SPW	13.64	WOA	6.76	YV3RC	6.16
DJR	15.34	GSH	21.47	HJ4ABE	5.95	LSG	19.90	SUV	10.06	WOB	5.85	YV4RC	6.38
DJT	15.36	GSJ	15.26	HJ4ABL	6.06	LSI	9.80	SUX	7.86	WOF	14.47	YV5RM	5.85
DZA	9.68	GSJ	21.53	HJ4ABP	6.00	LSK3	10.25	SUZ	13.82	WOG	16.27	YV6RV	6.52
DZB	10.04	GSN	11.82	HJ5ABC	6.15	LSL	15.81	TFJ	12.24	WOK	10.55	YV8RB	5.88
DZC	10.29	GSO	15.18	HJ5ABD	6.50	LSL2	10.30	TFK	9.06	WON	9.87	YV9RC	7.83
DZE	12.13	GSP	15.31	HKB	9.93	LSM2	14.50	TFL	5.0	WOO	17.62	YV1ORSC	5.72
DZH	14.46	HAS3	15.37	HKE	7.10	LSN	9.89	TGF	14.49	WOO	12.84	YV12RM	6.30
EAQ	9.86	HAT4	9.13	HKV	8.80	LSN	14.53	TGS	5.71	WOO	8.56	ZBW	8.75
EDM	20.86	HBJ	14.54	HPF	14.49	LSN5	19.65	TGWA	6.0	WOO	4.75	ZFA	5.03
EDM	10.07	HBL	9.60	HP5B	6.03	LSN6	21.02	TGXA	6.13	WOO	4.27	ZFB	10.06
EHY	20.86	HBP	7.80	HP5F	6.08	LSX	10.35	TG1X	9.45	WOO	15.25	ZGE	6.13
EHY	10.07	HCETC	6.98	HP5J	9.59	LSY	20.70	TG2X	5.94	W1XAL	11.79	ZHI	6.02
ETA	18.27	HCJB	8.21	HRF	14.49	LSY3	18.12	TIEP	6.71	W1XAL	6.04	ZHT	7.63
ETB	11.96	HCK	5.89	HRL5	14.49	LZA	14.97	TIPGH	5.83	W1XK	9.57	ZLT4	11.05
ETD	7.62	HC2AT	8.40	HRN	5.88	OAX4D	5.78	TIPG	6.41	W2XAD	15.33	ZSS	18.89
FTA	11.94	HC2ET	4.60	HRP1	7.03	OAX4G	6.23	TIR	14.49	W2XAF	9.53	ZTJ	6.10
FTK	15.88	HC2JSB	7.85	HRV	6.20	OCI	18.68	TIRCC	6.55	W2XE	21.52	ZP10	8.22
FTM	19.36	HC2RL	6.66	HSHPJ	10.96	OCI	10.97	TISHH	5.50	W2XE	17.76		
FTO	18.25	HC2TC	7.98	HSJ	10.17	OCJ2	14.85	TISWS	7.55				

# Police Radio Alarm Stations

CGZ	Vancouver, B.C.	2342 kc.	KGHM	Reno, Nev.	2474 kc.	KGOZ	Cedar Rapids, Iowa	2466 kc.
CJW	St. Johns, N.B.	2390 kc.	KGHN	Hutchinson, Kans.	2450 kc.	KGPA	Seattle, Wash.	2414 kc.
CJZ	Verdelee, Que.	2390 kc.	KGHO	Des Moines, Iowa	1682 kc.	KGPB	Minneapolis, Minn.	2430 kc.
CZG	Prince Rupert, B. C.	1712 kc.	KGHP	Lawton, Okla.	2466 kc.	KGPC	St. Louis, Mo.	1706 kc.
CMPN	Havana, Cuba	1712 kc.	KGHQ	Chinook Pass, W.	2490 kc.	KGPD	San Francisco, Cal.	2466 kc.
KACC	Fairfield, Iowa	1682 kc.	KGHR	(Mobile) in Wash.	2490 kc.	KGPE	Kansas City, Mo.	2422 kc.
KACD	Atlantic, Iowa	1682 kc.	KGHS	Spokane, Wash.	2414 kc.	KGPF	Santa Fe, N.Mex.	2414 kc.
KACE	Olympia, Wash.	2366 kc.	KGHT	Brownsville, Tex.	2382 kc.	KGPG	Vallejo, Cal.	2422 kc.
KACF	Chickasha, Wash.	2450 kc.	KGHU	Austin, Tex.	2442 kc.	KGPH	Oklahoma City, Okla.	2450 kc.
KGHA	Portable-Mobile		KGHV	Corpus Christi, Tex.	2382 kc.	KGPI	Omaha, Neb.	2466 kc.
KGHB	In State of Wash.	2490 kc.	KGHW	Centralia, Wash.	2414 kc.	KGPI	Beaumont, Tex.	1712 kc.
KGHC			KGHX	Santa Ana, Cal.	2490 kc.	KGPK	Sioux City, Iowa	2466 kc.
KGHD	Seattle, Wash.	2490 kc.	KGHY	Whittier, Cal.	1712 kc.	KGPL	Los Angeles, Cal.	1712 kc.
KGHE	Snowqualmie Pass, Wash.	2490 kc.	KGHZ	Little Rock, Ark.	2406 kc.	KGPM	San Jose, Cal.	2466 kc.
KGHF	Las Vegas, Nev.	2474 kc.	KGJX	Pasadena, Cal.	1712 kc.	KGPN	Davenport, Iowa	2466 kc.
KGHG	Palo Alto, Cal.	1674 kc.		Albuquerque, N.M.	2414 kc.	KGPO	Tulsa, Okla.	2450 kc.

"WHEN TO LISTEN IN"  
Appears on page 101

(Continued on Page 100)

# Short Wave

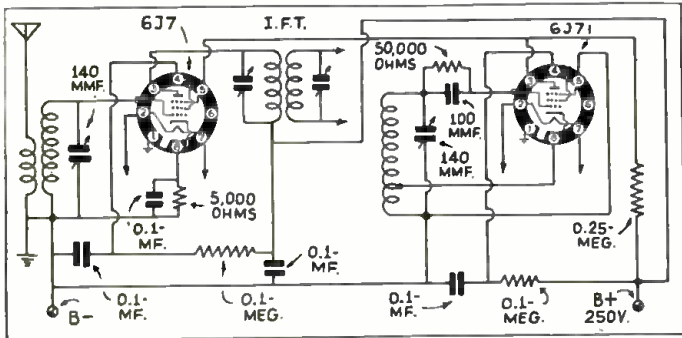

2-Tube converter using metal tubes.

## METAL TUBE CONVERTER

John Darjany, Utica, New York  
 (Q) I intend building a short-wave converter to use with my present receiver employing two 6J7's; one as a detector and the other as the local oscillator. Will you please print the diagram.

(A) We have shown the connections for a converter section of the superheterodyne using two 6J7 metal tubes. For any one who does not desire to use metal tubes, the type 57 or type 6C6's may be employed in their stead.

tor stage is controlled by a 140 mmf. variable condenser. 45 volts is used for the "B" supply, and 2 volts for the "A" supply. If the "A" supply consists of two dry cells, delivering 3 volts, then a 20-ohm rheostat should be connected in series with the batteries to limit the voltage applied to the tube filaments to 2 volts.

## ALL-ELECTRIC BOOSTER

J. Smith, New York, N.Y.  
 (Q) I would like to add a 1-stage pre-selector or booster to my present receiver. This should be a self-

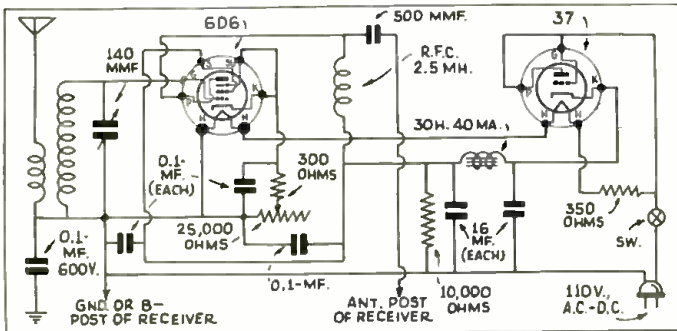

Self-powered 1-tube "booster" or preselector.

2-TUBE SET USING "30'S"  
 Jessie Conder, Shelbyville, Tenn.

(Q) I intend building a short-wave battery-operated receiver and would like to have you print a diagram of one using two type 30 tubes, to be operated from a 45-volt "B" battery. I wish to use standard 4-prong, 2-winding coils and a 3:1 radio transformer.

(A) In the diagram shown we have a conventional regenerative detector and one stage of audio amplification. Regeneration in the de-

powered affair, using a 6C6 and a 37 and operate on either A.C. or D.C.

(A) In the diagram we have shown a 6D6 used as the amplifier and a 37 as the rectifier. Better results would be obtained with the 6D6. A ground should not be connected directly to the B negative side of the circuit because the house fuses are liable to be blown. The ground connection through a condenser as shown should be employed.

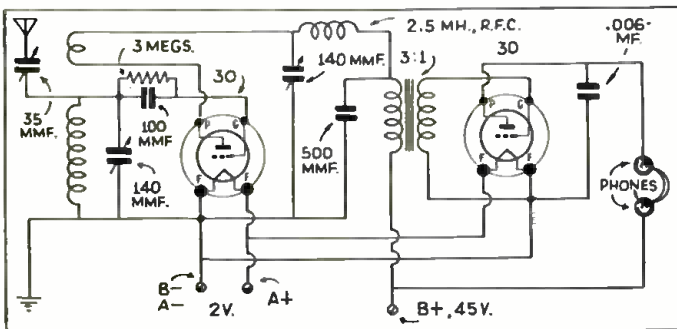

The old standby—two 2-30's.

## 2A5 P.P. AMPLIFIER

A. Cohen, Schenectady, N. Y.  
 (Q) Would you please print a diagram in your Question Box of an audio amplifier using two 2A5's in push-pull. This is to be used in conjunction with a dynamic speaker and a receiver having a triode output tube.

(A) We have shown the diagram using two 2A5's as a class "A" push-pull amplifier. The connection to the triode amplifier or output of your present receiver is also shown.

## EDITED BY GEORGE

Because the amount of work involved in the drawing of diagrams and the compilation of data, we are forced to charge 25c each for letters that are answered directly through the mail. This fee includes only hand-drawn schematic drawings. We cannot furnish "picture-layouts" or "full-sized" working drawings. Letters not accompanied by 25c will be answered in turn on this page. The 25c remit-

## POWER SUPPLY DIAGRAM

K. Mori, Sanger, Calif.  
 (Q) I would like to build a power supply delivering 135, 90, 67½, and 22½ volts. Would you be kind enough to print the diagram in the Question Box?

(A) You will find a diagram of a power supply using a 280 and a standard power transformer. In order to obtain the lower voltages you will need a voltage divider with 4 sliders. These should be adjusted to deliver the proper voltages. Each one of these should be by-passed with a 1 mf. condenser to improve regulation.

This should prove an excellent accessory to any radio shack.

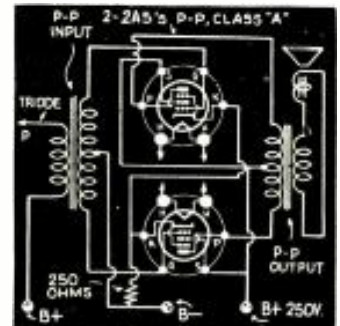

Two 2A5's in push-pull as class "A" amplifier.

a one tube receiver, and have heard much about the one-tube Scout re-

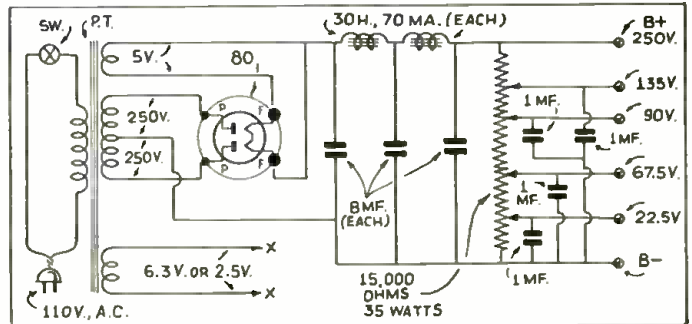

A power supply delivering many different voltages.

## 5-METER LEAD-IN

James Nicholls, Paterson, N.J.

(Q) I recently constructed a 5-meter receiver using two 56's and a 2A5. I have a 9 foot aluminum pole which I contemplate mounting in the top of a poplar tree. Would you kindly advise me as to what type of lead-in would work satisfactory?

(A) In the first place, we recommend that you cut that 9 foot rod down to approximately 8 feet; that is if you intend listening on wave lengths closely associated with 5 meters. We suggest that your lead-in be an ordinary single wire connected at the top of the vertical load, not at the bottom. This top connection seems to provide greater pickup than with the antenna connected to the bottom or lower end of the antenna proper. The length of lead-in also seems to have relatively no effect on reception.

Surprising as it may seem, this antenna arrangement under tests has not exhibited pronounced directional effects. Usually the best angle to take the lead-in off has been found to be about 45 degrees.

## ONE TUBE SCOUT

Ray Becker, Beaumont, Texas  
 (Q) I am interested in building

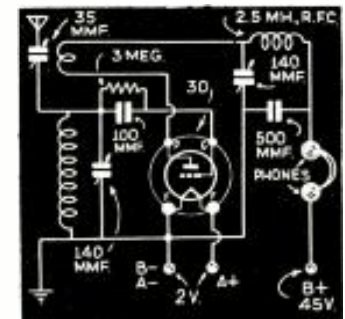

A 1-tube battery operated receiver.

# Diagrams of S-W Commercial Receivers Hammarlund "Comet-Pro" Crystal Model Super-Het Receiver—Communications Type

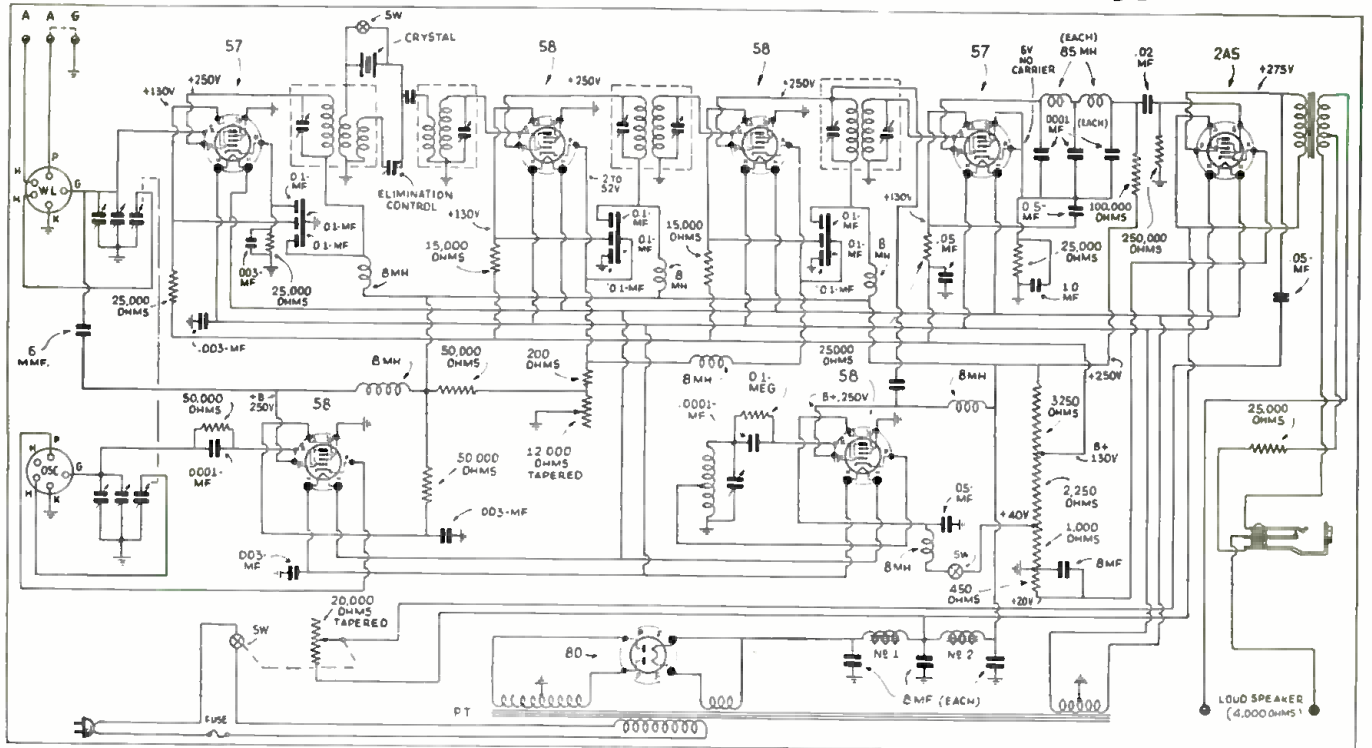

The Hammarlund "Comet-Pro" super-het receiver, using 8 tubes and a crystal filter, as shown above is particularly well suited to "Ham" or "communications" work. This receiver provides single signal selectivity; it also has special headphone jack circuit provided.

# Philco Model 15 Tube, All-Wave Super-Het Receiver, With "Antenna Tuning" Feature

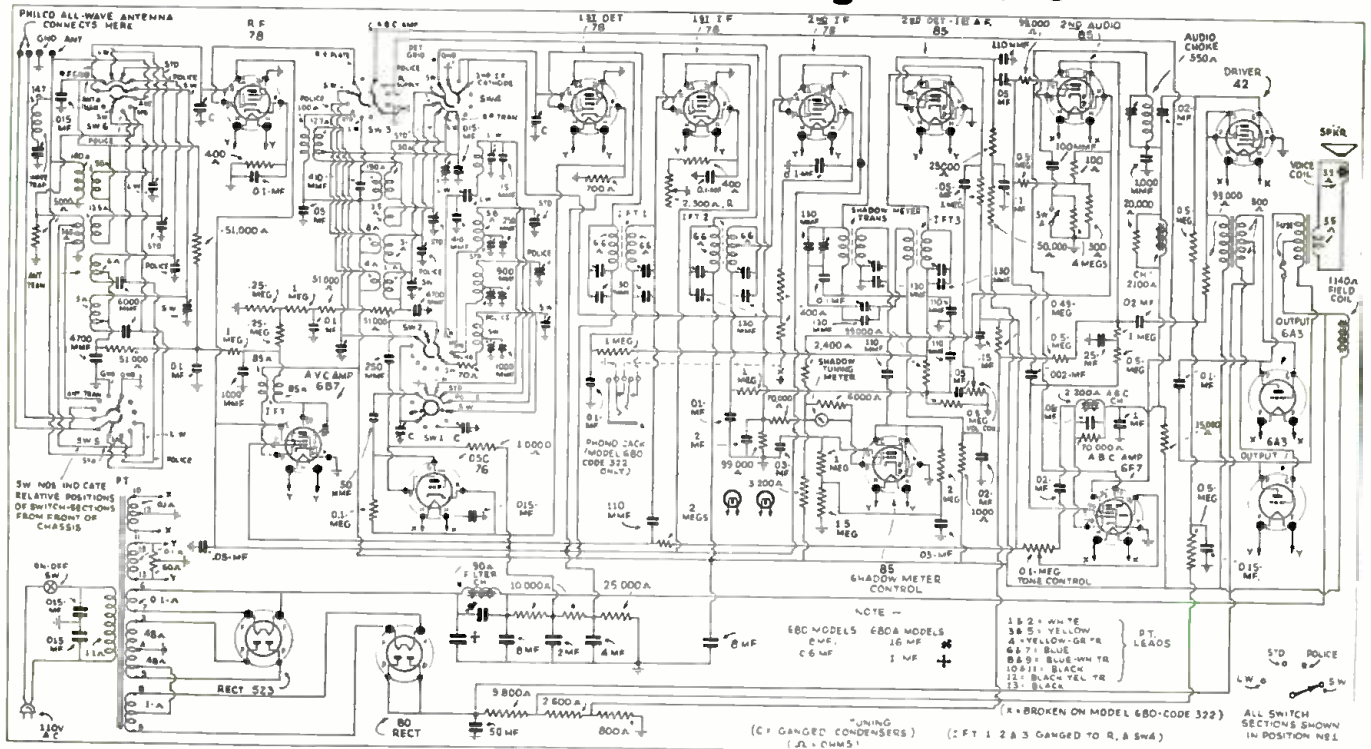

The diagram above will prove of interest to all short wave "Fans," as it shows the highly selective "antenna-tuning" circuit used on the Philco all-wave receiver. The short-wave broadcast bands, especially the 49-meter band, are so congested that such an "antenna tuning" circuit will prove doubly welcome. The bands covered are: 7.2 to 22 mc.; 2.3 to 7 mc.; 550 to 1700 kc.; 150 to 400 kc. Tuning meter is used; undistorted power output 20 watts. I.F. freq. 460 kc.

# Police Radio Alarm Stations

(Continued from page 95)

KGPP	Portland, Ore.	2442 ke.
KGFPQ	Honolulu, T.H.	1712 ke.
KGPR	Minneapolis, Minn.	2430 ke.
KGPS	Bakersfield, Cal.	2414 ke.
KGFW	Salt Lake City, Utah	2406 ke.
KGPY	Denver, Colo.	2442 ke.
KGZ	Shreveport, La.	1574 ke.
KGZA	Wichita, Kans.	2450 ke.
KGZC	Fresno, Cal.	2414 ke.
KGZE	Topeka, Kans.	2422 ke.
KGZF	San Diego, Cal.	2490 ke.
KGZH	San Antonio, Tex.	2482 ke.
KGZI	Chanute, Kans.	2450 ke.
KGZJ	Des Moines, Iowa	2466 ke.
KGZK	Klamath Falls, Ore.	2442 ke.
KGZL	Wichita Falls, Tex.	2458 ke.
KGZM	Phoenix, Ariz.	2430 ke.
KGZN	El Paso, Tex.	2414 ke.
KGZO	Tacoma, Wash.	2414 ke.
KGZP	Santa Barbara, Cal.	2414 ke.
KGZQ	Coffeyville, Kans.	2450 ke.
KGZR	Waco, Tex.	1712 ke.
KGZS	Salem, Ore.	2442 ke.
KGZT	Santa Cruz, Cal.	1674 ke.
KGZU	Lincoln, Neb.	2490 ke.
KGZV	Aberdeen, Wash.	2414 ke.
KGZW	Lulbock, Tex.	2458 ke.
KGZX	Albuquerque, N.Mex.	2414 ke.
KGZY	San Bernardino, Cal.	1712 ke.
KHTP	Houston, Tex.	1674 ke.
KIUK	Jefferson City, Mo.	2414 ke.
KNFA	Clovis, N.Mex.	2414 ke.
KNFB	Idaho Falls, Idaho	2458 ke.
KNFC	SS Gov. Stevens, (Wash.)	2490 ke.
KNFD	SS Gov. J. Rogers, (Wash.)	2490 ke.
KNFE	Duluth, Minn.	2382 ke.
KNFF	Leavenworth, Kans.	2422 ke.
KNFG	Olympia, Wash.	2490 ke.
KNFH	Garden City, Kans.	2474 ke.
KNFI	Mt. Vernon, Wash.	2414 ke.
KNFJ	Pomona, Cal.	1712 ke.
KNFK	Bellingham, Wash.	2490 ke.
KNFL	Shuksun, Wash.	2490 ke.
KNFM	Compton, Cal.	2490 ke.
KNFN	Waterloo, Iowa	1682 ke.
KNFO	Storm Lake, Iowa	1682 ke.
KNFP	Everett, Wash.	2414 ke.
KNFQ	Skykomish, Wash.	2490 ke.
KNFR		
KNFS		
KNFT	Mobile in State of Wash.	2490 ko.
KNFU		
KNFV		
KNFW		
KNFX	Alpowa Camp, Wash.	2490 ke.
KNFY	Ilwaco, Wash.	2490 ke.
KNFZ	Hells Crossing Camp, Wash.	2490 ke.
KNGA	Satus Pass Camp, Wash.	2490 ke.
KNGB	Yakima, Wash.	2490 ke.
KNGC	Vancouver, Wash.	2490 ke.
KNGD	Walla Walla, Wash.	2490 ke.
KNGE	Cleburne, Tex.	1712 ke.
KNGF	Sacramento, Cal.	2422 ke.
KNGG	Phoenix, Ariz.	1698 ke.
KNGH	Dodge City, Kans.	2474 ke.
KNGI	El Centro, Cal.	2490 ke.
KNGJ	Duncan, Okla.	2450 ke.
KN GK	Galveston, Texas	1712 ke.
KNGL	Rapid City, S. Dak.	2450 ke.
KNGM	Norfolk, Nebr.	2490 ke.
KNGN	Portable, Okla.	2450 ke.
KNGO	Shreveport, La.	2430 ke.
KNGP	Wenatchee, Wash.	2490 ke.
KNGQ	Spokane, Wash.	2490 ke.
KNGR	Muskogee, Okla.	2450 ke.
KNGT	Yakima, Wash.	2414 ke.
KNGU	Salina, Kans.	2422 ke.
KNGV	Brownwood, Tex.	2458 ke.
KNGW	Portable, Los Angeles	1712 ke.
KNGX	Lodi, Calif.	2414 ke.
KNGY	Ephrata, Wash.	2490 ke.
KNGZ	Mobile, Wash.	2490 ke.
KNHA	Green Bay, Wis.	2382 ke.
KNHB	Ada, Okla.	2450 ke.
KNHC	Redwood Falls, Minn.	1658 ke.
KNHD	Fort Smith, Ark.	2406 ke.
KNHE	Denton, Tex.	1712 ke.
KNHF	Prescott, Ark.	2430 ke.
KNHG	Fargo, N. Dak.	2442 ke.
KNHM	Berkeley, Cal.	1658 ke.
KSW	Dallas, Tex.	1712 ke.
KVP	Halifax, N.S.	1690 ke.
VDM	Montreal, Can.	1706 ke.
VYR	Winnipeg, Man.	2396 ke.
VYW	Huntington, Ind.	2490 ke.
WAKA	New London, Conn.	2466 ke.
WAKB	Freehold, N. J.	2366 ke.
WAKC	Belle Island, Mich.	2414 ke.
WCK	Boston, Mass.	1630 ke.
WEY	Detroit, Mich.	1630 ke.
WKDT	Cincinnati, Ohio	1706 ke.
WKDU	Indianapolis, Ind.	2442 ke.
WMDZ	Buffalo, N.Y.	2422 ke.
WMJ	Highland Park, Mich.	2414 ke.
WMO	Framingham, Mass.	1666 ke.
WMP	Ninngan Falls, N.Y.	2422 ke.
WNP	Tulare, Cal.	2414 ke.
WPD	Chicago, Ill.	1712 ke.
WPDB	Chicago, Ill.	1712 ke.
WPDC	Chicago, Ill.	1712 ke.
WPDD	Chicago, Ill.	1712 ke.
WPDE	Louisville, Ky.	2442 ke.
WPDF	Flint, Mich.	2466 ke.

WPDG	Youngstown, Ohio	2458 ke.
WPDH	Richmond, Ind.	2442 ke.
WDDI	Columbus, Ohio	2430 ke.
WDDJ	Passaic, N. J.	2414 ke.
WDDK	Milwaukee, Wis.	2450 ke.
WDDL	Lausung, Mich.	2442 ke.
WDDM	Dayton, Ohio	2430 ke.
WDDN	Auburn, N.Y.	2382 ke.
WDDP	Akron, Ohio	2458 ke.
WDDQ	Philadelphia, Pa.	2474 ke.
WDDS	St. Paul, Minn.	2430 ke.
WDDT	Kokomo, Ind.	2490 ke.
WDDU	Pittsburgh, Pa.	1712 ke.
WDDV	Charlotte, N.C.	2458 ke.
WDDW	Washington, D.C.	2422 ke.
WDDX	Detroit, Mich.	2414 ke.
WDDY	Atlanta, Ga.	2414 ke.
WDDZ	Fort Wayne, Ind.	2490 ke.
WDEA	Syracuse, N.Y.	2382 ke.
WDEB	Grand Rapids, Mich.	2442 ke.
WDEC	Memphis, Tenn.	2466 ke.
WDED	Arlington, Mass.	1712 ke.
WDEE	New York, N.Y.	2450 ke.
WDEF	New York, N.Y.	2450 ke.
WDEG	New York, N.Y.	2450 ke.
WDEH	Sonerville, Mass.	1712 ke.
WDEI	E. Providence, R.I.	1712 ke.
WDEJ	Brookline, Mass.	1712 ke.
WDEK	New Orleans, La.	2430 ke.
WDEL	W. Bridgewater, Mass.	1666 ke.
WDEM	Woonsoket, R.I.	2466 ke.
WDEN	Kenosha, Wis.	2450 ke.
WDEO	Baton Rouge, La.	1570 ke.

WPGM	La Grange, Ga.	2414 ke.
WPGN	South Bend, Ind.	2490 ko.
WPGO	Huntington, N.Y.	2490 ke.
WPGP	Muncie, Ind.	2442 ke.
WPGQ	Columbus, Ohio	1596 ke.
WPGS	Mincola, N.Y.	2490 ke.
WPGT	New Castle, Pa.	2482 ke.
WPGU	Cohasset, Mass.	1712 ke.
WPGV	Boston, Mass.	1712 ke.
WPGW	Mobile, Ala.	2382 ke.
WPGX	Worcester, Mass.	2466 ke.
WPGZ	Johnson City, Tenn.	2474 ke.
WPHA	Fitchburg, Mass.	2466 ke.
WPHB	Nashua, N.H.	2422 ke.
WPHC	Massillon, Ohio	1596 ke.
WPHD	Steubenville, Ohio	2458 ke.
WPHF	Culver, Ind.	1634 ke.
WPHG	Richmond, Va.	2450 ke.
WPHI	Medford, Mass.	1712 ke.
WPHJ	Charleston, W.Va.	2490 ke.
WPHK	Fairmont, W.Va.	2490 ke.
WPHL	Wilmington, Ohio	1596 ke.
WPHM	Portable in Ohio	1682 ke.
WPHN	Orlando, Fla.	2442 ke.
WPHO	Tampa, Fla.	2466 ke.
WPHP	Zanesville, Ohio	2430 ke.
WPHQ	Jackson, Mich.	2466 ke.
WPHR	Parkersburg, W.Va.	2490 ke.
WPHS	Culver, Ind.	1634 ke.
WPHU	Cambridge, Ohio	1596 ke.
WPHV	Jaeger, Ind.	1634 ke.
WPHW	Bristol, Va.	2450 ke.
WPHX	Elizabethton, Tenn.	2474 ke.
WPHY	Oil City, Pa.	2482 ke.
WPHZ	Harrisburg, Pa.	1674 ke.
WQFA	New Haven, Conn.	2466 ko.
WQFB	Macon, Ga.	2414 ke.
WQFC	Gainesville, Fla.	2466 ke.
WQFD	Columbia City, Ind.	1534 ke.
WQFE	Seymour, Ind.	1634 ke.
WQFF	Monessen, Pa.	2482 ke.
WQFG	Roanoke, Va.	2450 ke.
WQFH	Lynchburg, Va.	2450 ke.
WQFI	Petersburg, Va.	2450 ke.
WQFJ	Oneonta, N. Y.	2414 ke.
WQFK	Clearwater, Fla.	2466 ke.
WQFL	Oak Park, Ill.	1712 ke.
WQFM	Wilkes-Barre, Pa.	2442 ke.
WQFN	Winter Haven, Fla.	2442 ke.
WQFO	Lancaster, Ohio	2430 ke.
WQFP	Springfield, Ill.	1610 ke.
WQFQ	Lafayette, Ind.	2442 ke.
WQFR	Portable, N. Y.	1658 ke.
WQFS	Hibbing, Minn.	2382 ke.
WQFT	Portable, Ohio	1596 ke.
WQFU	Sharon, Pa.	2482 ke.
WQFV	Augusta, Ga.	2414 ke.
WQFW	Columbia City, Ind.	1634 ke.
WQFX	Waukegan, Ill.	1712 ke.
WQFY	Mansfield, Ohio	2474 ke.
WQFZ	Ottawa, Ill.	2458 ke.
WRBH	Cleveland, Ohio	2458 ke.
WRDQ	Toledo, Ohio	2474 ke.
WRDR	Grosse Pt. Village, Mich.	2414 ke.
WRDS	E. Lansing, Mich.	1642 ke.
W1XA0	Boston, Mass.	1712 ke.

**IN THE NEXT ISSUE!**

The Short-wave "Ham" will find the July number of particular value, and a wide variety of articles will appear in that issue:

☐ A Power Oscillator utilizing the new 804 Pentode Tube will be described by G. W. Shuart, W2AMN.

☐ The French "Hams" have been busy again—this time with 400 megacycles or 3/4 meter Transmission and Reception. Don't miss the article by C. W. Palmer in the next issue.

☐ An excellent 2-Volt Short-Wave Superhet receiver suitable for "HAMS" as well as "FANS", described in complete detail by its designer and constructor, Harry D. Hooton.

☐ The S-W "FAN" will find the 3-tube Battery Operated Receiver described by H. G. Cisin, M.E., of distinct value.

WPES	Saginaw, Mich.	2442 ke.
WPET	Lexington, Ky.	1706 ke.
WPEV	Portable (in Mass.)	1666 ke.
WPEW	Northampton, Mass.	1666 ke.
WPEX	Newton, Mass.	1712 ke.
WPEY	Muskegon, Mich.	2442 ke.
WPEZ	Highland Park, Ill.	2430 ke.
WPF0	Reading, Pa.	2442 ke.
WPF1	Jacksonville, Fla.	2442 ke.
WPF2	Baltimore, Md.	2414 ke.
WPF3	Columbus, Ga.	2414 ke.
WPF4	Hammond, Ind.	1712 ke.
WPF5	Hackensack, N.J.	2430 ke.
WPF6	Gary, Ind.	2470 ke.
WPF7	Birmingham, Ala.	2382 ke.
WPF8	New Bedford Mass.	1712 ke.
WPF9	Knoxville, Tenn.	2474 ke.
WPF0	Clarkesburg, W.Va.	2490 ke.
WPF1	Swarthmore, Pa.	2474 ke.
WPF2	Johnson City, Tenn.	2470 ke.
WPF3	Asheville, N.C.	2474 ke.
WPF4	Lakeland, Fla.	2442 ke.
WPF5	Portland, Me.	2422 ke.
WPF6	Pawtucket, R.I.	2466 ke.
WPF7	Bridgeport, Conn.	2466 ke.
WPF8	Palm Beach, Fla.	2442 ke.
WPF9	Yonkers, N.Y.	2442 ke.
WPF0	Miami, Fla.	2442 ke.
WPF1	Bay City, Mich.	2466 ke.
WPF2	Port Huron, Mich.	2466 ke.
WPF3	S. Schenectady, N.Y.	1658 ke.
WPF4	Rockford, Ill.	2458 ke.
WPF5	Providence, R.I.	1712 ke.
WPF6	Findlay, Ohio	1596 ke.
WPF7	Albany, N.Y.	2414 ke.
WPF8	Portsmouth, Ohio	2430 ke.
WPF9	Utica, N.Y.	2414 ke.
WPF0	Cranston, R.I.	2466 ke.
WPF1	Binghamton, N.Y.	2442 ke.

**Television Stations**

VE9AU	2000-2100 ke.
VE9DS	London, Ont., Can.
W2XDR	Montreal, Que.
W8XAN	Long Island City, N.Y.
W9XXK	Jackson, Mich.
W9XAK	Iowa City, Iowa
W9XAO	Manhattan, Kans.
W6XAH	Chicago, Ill.
	Bakersfield, Calif.
	2750-2850 ko.
W3XAK	Portable
W9XAP	Chicago, Ill.
W2XBS	Bellmore, N.Y.
W9XAL	Kansas City, Mo.
W9XG	W. Lafayette, Ind.
W2XAB	New York, N.Y.
VE9AR	Saskatoon, Sask., Can.
VE9ED	Mt. Joli, Que., Can.
	42000-56000, 60000-86000 ke.
W2XAX	New York, N.Y.
W6XAO	Los Angeles, Calif.
W9XD	Milwaukee, Wis.
W2XBT	Portable
W2XF	New York, N.Y.
W3XE	Philadelphia, Pa.
W3XAD	Camden, N.J.
W10XX	Portable & Mobile (Vicinity of Camden)
W2XDR	Long Island City, N.Y.
W8XAN	Jackson, Mich.
W9XAT	Portable
W2XD	New York, N.Y.
W2XAG	Portable
W1XG	Boston, Mass.
W9XK	Iowa City, Iowa
VE9BZ	Vancouver, B.C., Can.
VE9DS	Montreal, Que., Can.
VE9AU	London, Ont., Can.
VE9RC	Quebec, Que., Can.
VE9AG	Walkerville, Ont., Can.



**Eilen**  
**RX-14**  
**6-tube Band-Spread Receiver**

OUR LARGEST, FINEST, AND MOST SENSITIVE SW RECEIVER — released after months of painstaking development in order to produce an efficient, selective, and really good short wave model which WILL satisfy even the most discriminating SW fan.

Uses 6D6-6D6-76-76-42-5Y3 hi-gain tubes as TUNED RF amplifier, TUNED screen-grid regenerative detector, POWERFUL 3 stage resistance-capacity coupled audio frequency amplifier, high voltage full wave rectifier and HUM-FREE power supply. Operates entirely from 105 to 130 volt AC current.

POWERFUL hi-quality audio system delivering 3 watts of power to the built-in dynamic loudspeaker—automatic headphone jack—smooth regeneration control and volume control—positively hum free—connections for either doublet or single wire type of antenna—black shrivel finished heavy metal chassis, shielding, and cabinet of extreme beauty—must be seen to be appreciated—selectivity, sensitivity and tonal qualities that will amaze you.

**EILEN RX-14 KIT, \$15.95**  
assembled and ready to wire. of all necessary parts. 8 large low-loss coils for 9 1/2-200 meters, and shunt detailed instructions (less cabinet, tubes, and BC coils)  
Beautiful, heavy steel cabinet \$2.50  
**6 MATCHED tubes**..... 3.30  
**SPECIAL:** Complete kit, cabinet, and 6 tubes unwired, less \$19.95  
Labor for wiring and testing, extra.....\$2.00  
Broadcast band coils (2), extra..... 1.25

**IF METAL TUBES** 16K 7-6K7-6C 7-6C5-6F6-6Z1) are preferred, add \$1 in price.

**AMATEURS:**  
Model RX-14-AB 6 Tube COMMUNICATIONS RECEIVER has same specifications as RX-14 except that it is equipped with special coils for 20-40-80-160 M bands which spread these bands over the tuning dial. Also equipped with plate voltage cut-off switch for use during transmitting periods. An ideal receiver for amateur work. Add \$1 to price of RX-14.

**RX-14B:** Battery model. Subtract \$1 from above price. (Less batteries.)

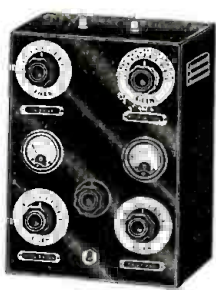

**Eilen**  
**HF-35 3-Tube SW Transmitter**

A powerful and well engineered amateur band transmitter of great beauty and efficiency—AT A PRICE WITHIN THE AMATEUR'S REACH. Uses 3B-10-46 tubes as TRI-TET CRYSTAL CONTROLLED OSCILLATOR—CLASS C RF POWER AMPLIFIER—built-in antenna tuning system—beautiful, black shrivel metal case and shielding—Triplet meters—Eilen transmitting dials—highest quality construction—35 watts of power output on 20-40-80-160 M bands. A transmitter that you can be proud to own. An excellent exciter unit for high power stages to be added later. 3 coils for any 1 band and instructions included.

**HF-35, assembled, and ready to wire** (less tubes, power supply, crystal, holder and additional coils).....\$21.95  
Matched Arcturus tubes (3).....\$2.15  
Eilen quartz crystal (80 or 160)..... 1.95  
Eilen crystal holder..... 1.00  
Coils for additional bands, per set..... 1.45

**HV-475** 1-Tube power supply for use with HF-35 (less tube)..... \$12.95  
Labor for wiring extra \$1.00  
83 tube for HV-475, extra 65 cents

**FREE**  
Large 18 page illustrated catalogue of SW receiving and transmitting apparatus, kits, parts, and accessories. Send for YOUR copy.

**Eilen**  
**HF-4-Tube 2 1/2 to 15 Meter combination RECEIVER - TRANSMITTER**

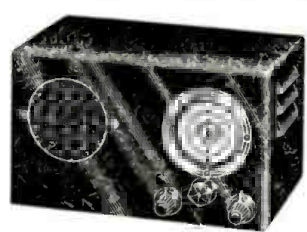

An ultra-high frequency receiver designed to give full loudspeaker volume on stations operating on wavelengths between 2 1/2 to 15 meters. Uses two 76, one 38, and one 80 tubes as ultra sensitive super regenerative detector, powerful 2 stage audio amplifier, rectifier, and built in power supply. Great volume on amateurs, police stations, hi-frequency broadcast, television and experimental stations.  
Illuminated, airplane dial—low loss silver plated inductances—headphone jack—chromium plated chassis and black shrivel finish metal cabinet. Extremely small and light in weight. Only 10"x7"x6 1/2". Operates from AC house current.  
Send—Receive switch, enabling the unit to be used as a low powered transmitter, having a range to 10 or 15 miles.  
**HF-4, complete with 4 tubes, cabinet, speaker, wired ready to use, \$14.45**  
**KIT, of all parts including speaker, cabinet, 4 tubes and instructions, unwired \$12.95**

**Eilen**  
**XN-12 4-Tube BANDSPREAD RECEIVER**



An extremely powerful TUNED RADIO FREQUENCY regenerative receiver designed for the SW fan who wishes a high grade instrument of the highest calibre. Uses 6D6-6D6-12-80 tubes as TRF amplifier. Tuned regenerative detector, pentode audio frequency amplifier, rectifier and built-in power supply. HUM-FREE. Operates from 105 to 130 volt AC house current. Illuminated, airplane dial—smooth regeneration control—BANDSPREAD TUNING—SELECTIVE—SENSITIVE—ENORMOUS HEADPHONE VOLUME—will operate speaker on majority of stations—an unusually efficient DX receiver—heavy, black shrivel finished metal chassis and cabinet. Covers 9 1/2 to 600 meters.

**XN-12 KIT** of necessary parts, 8 coils, and simple instructions (unwired, less cabinet, tubes and BC coils)..... \$9.95  
Beautiful metal cabinet, extra.....\$2.00  
Set of matched tubes..... \$1.90  
**SPECIAL:** Complete kit, cabinet and 4 tubes less BC coils (unwired)..... \$12.95  
Labor for wiring and testing, extra..... 1.50  
Broadcast band coils (2), extra..... 1.25

**AMATEURS**  
Model XN-12-AB is same as above except that it is equipped with plate voltage cut-off switch and has special handspread coils for the 20-40-80-160 M bands. Add \$1 to price.

**Eilen**  
**6C SHORT WAVE 4-TUBE RECEIVER**

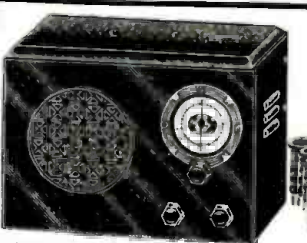

A Giant in Performance  
**FULL 6 TUBE PERFORMANCE—POWERFUL 3 STAGE AUDIO AMPLIFIER** which takes the guesswork out of so-called "loudspeaker reception."  
Uses 6D6-6E7 (twin 2 in 1) 76-12A7 (twin 2 in 1) hi-gain tubes as TRF amplifier screen grid regenerative detector, POWERFUL 3 stage audio amplifier with pentode output stage, rectifier and built-in hum-free power supply. Completely self-contained. Nothing else required. Operates entirely from 105 to 130 volt AC or DC light socket.  
**BAND SPREAD TUNING—smooth regeneration control—built-in high quality loud-speaker**—automatic headphone jack—large, illuminated airplane type vernier dial—large 3 wind black shrivel finish metal chassis and cabinet. Must be seen to be appreciated. Satisfied owners report dozens of foreign stations on loudspeaker—You may do the same under the proper conditions. ORDER YOURS TODAY! YOU'LL NEVER REGRET IT!

**AMATEURS:**  
Model 6C-AB has same specifications as 6C except that it has special tuning circuit and coils for spreading out the 20-40-80-160 M bands over 80% of dial width—plate voltage cut-off switch. Add \$1 to price of 6C.

**6C KIT** (unwired) of all necessary parts, 4 coils for 9 1/2 to 200 meters and instructions (less cabinet, tubes, speaker, and B.C. coils)..... \$7.45  
Beautiful cabinet..... \$1.95  
4 matched Arcturus tubes..... 3.15  
Special loudspeaker..... 1.45  
Broadcast band coils (2)..... 1.25  
**SPECIAL:** Complete kit, cabinet, 4 tubes, loudspeaker, and one B.C. coil..... \$12.45  
Labor for wiring and testing, extra..... \$1.50

**EILEN RADIO LABORATORIES, Dept. SC 6, 136 LIBERTY STREET, NEW YORK, N. Y.**

● DURING the month of April many European countries went on daylight saving time or "summer time" as it is known abroad. The result of this is that many European stations have altered their schedules by one hour, starting one hour earlier and closing one hour earlier than heretofore. Among the stations affected are CT1AA, ORK, TPA (Paris), and PHL. Daventry and Berlin are unaffected. In this country daylight saving went into effect in many cities the last Sunday in April. As a result the schedules of many stations are affected. All stations in New York City, Massachusetts and New Jersey are affected. Listeners living in areas with daylight saving time will note no change in these stations but listeners who remain on standard time will hear them one hour earlier. Further, listeners on daylight time will find all other stations starting and closing one hour later than formerly. All schedules in this magazine will remain in Standard time. All readers using daylight saving time must add one hour to these schedules to convert them to their time.

**When to Listen In**  
**By M. Harvey Gernsback**

(All Schedules Eastern Standard Time)

**DAVENTRY**  
● FOR May the schedule is; Trans. 1, 11:30 p.m.-1:30 a.m. on GSN and GSR Trans. 2, 6-8:45 a.m. on GSH and GSG. Trans. 3, 9 a.m.-12 noon on GSG and GSF. GSJ may replace GSF for the first hour and a half late in May. Trans. 4, 12:15-5:45 p.m. on GSD and GSB, 12:15-3:25 p.m. on GSI and 3:40-5:45 p.m. on GSO. Trans. 5, 6-8 p.m. on GSC, GSD and GSP. Trans. 6 now runs for 2 hours daily from 9-11 p.m. GSD and GSC are used and it is probable that GSP will be added also.

**ACTIVITY ON SHORTER WAVES**  
● THE 31 meter band is becoming quite congested in the evening due to the

influx of many South and Central Americans. There are now COCH, HJU, HP5J, HJ1ABP, and HH3W. In addition LRX is heard irregularly. All these are in addition to the Europeans GSC, PCJ, DJA and DJN to mention a few. Added to this are 3 U.S. stations. The result is plenty of entertainment. The 19 meter band is now active at night also. Daventry is using GSO and GSP in the late afternoon and evening and they come in very well indeed. Germany can be heard with DJQ from 12:30 a.m. on at good strength and it is probable that DJB will be used in the evening program for N. America from the first of June.

**BULGARIA**  
● LZA at Sofia, Bulgaria, a commercial code station, is now being used to broadcast music and entertainment for listeners abroad. It is not on a regular schedule as yet, but can frequently be heard on Sunday mornings from 3:30-11:30 a.m. on 14970 kc.

Please mention SHORT WAVE CRAFT when writing advertisers

# NEW VERNIER INSTRUMENT CONTROLS



No. 525

No. 525 "Front-O-Panel" illuminated air-plane type at left has slow speed ratio about 165 to 1 and fast ratio 30 to 1 in 360. Real silver-plated scale with sun-ray finish. Surface mounting for easy installation.

No. 296 "Plan-O-Vernier" transmitter style at right with built-in Crowe planetary and micrometer indicator. Ratio about 5 1/2 to 1 in 360. No backlash. Genuine spun-chrome finish.

For complete description and other items ask for Bulletin No. 75

Carried in stock by leading jobbers and dealers.



No. 296

**CROWE NAME PLATE & MANUFACTURING CO.**  
1743 Grace St., Chicago, U. S. A. Cable Address: CRONAME—CHICAGO

## SOLAR ACTIVITY

● MANY listeners have probably noticed that during the past winter the 49 meter band has not given as good reception of European stations as in other years and also that the 25 and 31 meter bands have been much better than in past winters (for night time reception). This is due to the solar cycle. Every 11 years solar activity reaches a peak. This peak is followed by a decrease in activity for 5 1/2 years to a minimum and then an increase for 5 1/2 years again to another peak. At peak time short wave radio reception is much better for long distance work on very short waves while at a minimum time the longer waves are more effective. The last minimum period occurred in 1932-33 when 70-80 meter waves were most effective for winter night transatlantic reception. The next peak occurs in about 1938 and already reception conditions have undergone marked change as evidenced by the increasing effectiveness of the very short waves. 10 meters is being used regularly for daytime transmission to Europe and Australia even now. Listeners should pay more attention to the shorter waves for the next several years as they are to be the most effective for DX.

## TO STUDY SOLAR ECLIPSE RADIO EFFECTS

● A group of Harvard scientists now en route to Siberia on the S.S. Washington to observe the solar eclipse on June 19th includes four radio specialists who will study the effect of the eclipse on radio signals, Ralph R. Beal, Research Supervisor of the Radio Corporation announced recently: "Augmenting their own study of the behavior of radio waves in space," Mr. Beal said "the RCA laboratories will assist the Siberian Expedition of Cruft Laboratory of Harvard University in making measurements on the reflection of radio waves from the ionosphere at Ak-Bulak, in northwestern Russian Turkestan. The RCA laboratories are intensely interested in solar phenomena of all kinds because the more accurately they can be measured and understood, the more efficiently wavelengths employed in long distance communication can be selected for various times of day and different seasons."

## A Super-Sensitive Set

(Continued from page 82)

a very poor type of aerial, but recently I installed a Lynch Transposition Antenna system and noticed a marked improvement in reception.

The transmitter I use is a homemade job, using any one of four crystals which are kept at constant temperature in a crystal oven. The lineup of the transmitter is 47 xtal osc. into 210 doubler or amplifier; then into 210 doubler or amplifier; amp. into 210 amplifier; into a pair of 04A's final amplifiers. Occasionally phone is used and then a single 861 is used to modulate the 04A's. The speech end consists of a Universal model KK double-button mike into a 27 into a pair of 2A5's, into a pair of 211's, then into the 861. The antenna system consists of a 40-meter Zepp-fed Hertz antenna. It is constructed out of No. 10 hard-drawn copper wire and is supported by two 60-foot metal poles. The feeders are 45 feet long and spaced 8 inches apart.

I would like to hear from anybody interested in short-wave reception who lives anywhere near Washington, D.C. Will be glad to swap photos or QSL cards. Wishing you every success with your fine magazine.

JOHN STETSON,  
219 Rosemary St.,  
Chevy Chase, Md.

(Well, John, you should certainly be able to hear a few choice DX stations with the formidable line-up you have. We believe that our readers would be interested in learning a few more details as to just how the tuning of this combination of preselector stage, short-wave converter, and a 12-tube superheterodyne works out; especially how much band-spread you obtain, etc. - Editor)

## FINALLY READY FOR IMMEDIATE DELIVERY

The dream of millions

## REALIZED!

This unit alone will take the place of all the necessary coils required to cover all amateur bands.

No switches, no soldering and no alteration to your present receiver is required to make use of this unit.

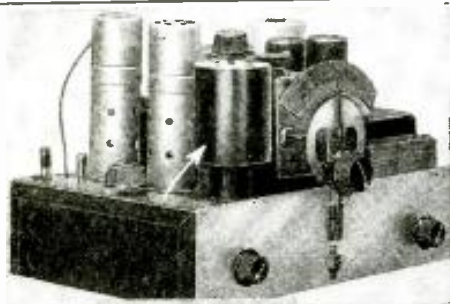

ARROW POINTS TO UNO ALL-WAVE COIL.

## ECONOMICAL — EFFICIENT — ATTRACTIVE

We guarantee satisfactory performance or your money will be refunded by your dealer. Write for our circular, "How to use it and how it works." Distributors: Harrison Radio Co., 12 West Broadway, New York City; American Sales Co., 41 West 18 St., New York City; Radio Inspection Service Co., 227 Asylum St., Hartford, Conn.; Radio Parts Co., Inc., 538 West State St., Milwaukee, Wis. Watch this list grow.

## UNO ALL-WAVE COIL CO.

11 Mollineux Place

Dept. S-6

Roosevelt, N. Y., U. S. A.

Discounts to Amateurs and Experimenters

# EBY

Specializes in Quality

- Binding Posts
- Tip Jacks
- Male Plugs
- Female Plugs
- Low-Loss Sockets
- A-C Switches
- Tap Switches
- Terminal Strips
- Short Wave Switches
- Molded Sockets
- Electric Eyes

Write for Latest Bulletin

**HUGH H. EBY Inc.**  
2066 Hunting Park Ave.  
PHILADELPHIA, PENNA.

Mail us your order for the world's most reliable and accurate Balancing or Grid Condenser

### X L VARIO DENSER in 4 ranges

- Mod. N, Cap. 1.2 to 20 MMF
- Mod. G1, Cap. 20 to 100 MMF
- Mod. G5, Cap. 100 to 500 MMF
- Mod. G10, Cap. 500 to 1000 MMF



Mod. N \$1.00 ea.  
Mod. G \$1.50 ea.



Non-corroding—Navy Type—Has Top 20 ea. Fine BE Aluminum Base (insulated) Top 15a. Type M (All Aluminum Body) at 10c each. For quick connections and positive contact at all times.  
**X. L. RADIO LABORATORIES**  
Dept. S.W. 6, 1224 Belmont Ave., Chicago, U.S.A.

## "COSMAN 4" 5-Band 4-Tube Receiver



The year's outstanding inexpensive short-wave receiver. Provides band spread tuning of any aerial. Uses two of the new Metal tubes. Built-in 1 1/2" wide speaker. 15-500 meter tuning range. 5 Band switch and variable—no plug-in coils. 4" Audiotone Dial. Hand-rubbed Tuning condenser. Built-in lower supply and numerous other features found only in higher priced receivers. Uses four tubes, 210V7's, 1-43 and 1-252's. A.C. 110 Operation.

- Complete kit of parts and instructions. \$10.50
- Not wired, less tubes and cabinet. .... \$2.50
- Wired and tested, Extra. .... \$2.50
- 4 Matched Sylvania tubes. .... 2.25
- All Metal Crystallized Cabinet for "Cosman 4". 2.25

Send For Our New 1936 Catalogue

**TRY-MO RADIO CO., INC.**  
85 CORTLANDT ST. NEW YORK CITY  
Distributor: Powertone Electric Corp., 179 Greenwich St., N.Y.C.

## GOOD RESULTS Demand GOOD INSTRUMENTS



Twin Instrument Accuracy 2%

TRIPLET manufactures a complete line of electrical instruments for radio, electrical and general industrial purposes both standard and custom built—For better short wave work, write for catalogue.

Triplet Electrical Instrument Co.  
286 Harmon Drive  
Bluffton, Ohio



Please mention SHORT WAVE CRAFT when writing advertisers

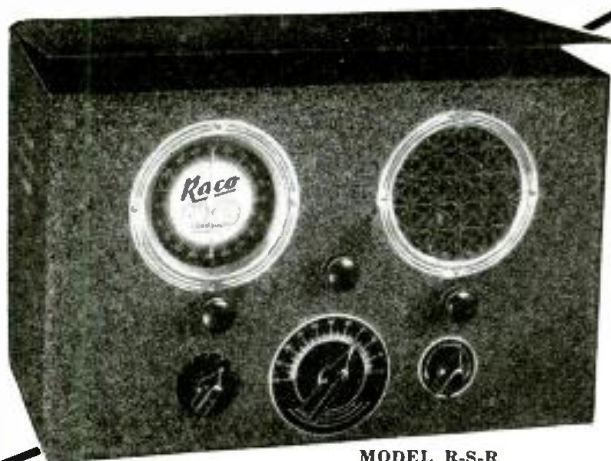

MODEL R-S-R

# HAYNES R·S·R

5-TUBE RECEIVER

## 2 1/2 TO 555 METERS

REGENERATION PLUS SUPER-REGENERATION

Combined for the first time in a single receiver having the greatest tuning range ever incorporated in one set.

- ★ Self contained power supply.
- ★ Multi-band switching (no plug-in coils) down to 15 meters.
- ★ High efficiency plug-in coil, below 15 meters with super-regeneration.
- ★ Electrical plus mechanical band-spread.
- ★ Dual regeneration control.
- ★ Hiss control on super-regeneration.
- ★ Perfect logging and absolute stability on super-regeneration.
- ★ Dynamic speaker and earphone reception.
- ★ Tubes used—2 MG6K7's, 1 MG25Z5, 1 MG43, and 1 76.

A. J. Haynes, who designed the first regenerative kit set (1922) and the first superheterodyne kit set (1924) chose RACO to build the final model of his new R-S-R receiver—another first AND DOES IT PERFORM!

The R-S-R is not only a remarkably fine DX receiver for all of the short wave and broadcast bands but it is the smoothest super-regenerator we have ever seen, giving exceptionally efficient reception on the 5 and 10 meter bands.

Come in and see us; operate the R-S-R yourself and look over our special U.H.F. equipment—transceivers, 5 meter M.O.P.A.'s, etc., all at direct laboratory built prices.

ORDER DIRECT FROM THIS AD

Complete R-S-R set: wired, tested, with 5 tubes, speaker, and cabinet. Ready to plug in and operate... **\$24.65**

Complete kit: unwired, including dynamic speaker, power supply and wired switch-coil assembly (less cabinet and tubes)... **\$14.95**

### One Tube (Type 19 Tube) Transceiver



An inexpensive 1-tube 5 and 10 meter transceiver. This extremely efficient transceiver is recommended for the short-wave enthusiast who is interested in exploring the fascinating 5 and 10 meter bands. This circuit utilizes the type 19 two volt twin tube, and is exceedingly sensitive since the super-regenerative principle is employed, when the receiving position is switched on. Batteries required are two 1 1/2 volt dry cells and 90 to 135 B supply. Complete kit with (2) 5-meter coils and dial, less batteries, Cabinet, 10 meter

coil, Tube, unwired... **\$4.75**  
 ● Cabinet, 75c. ● 10 meter coil, 50c. ● Wiring, assembly, \$1.50. ● Tube, 65c.

### NEW! POWERFUL A. C. 3-TUBE TRANSCEIVER



Here is a 5 and 10 meter transceiver that is in a class by itself! Take it with you this Summer and plug it in anywhere that 110 V. A.C. is available. The way it punches through the Q.R.M. will surprise you. Uses 2 42's and an 80. 20 Watts input to plates on 5 meters. Operates direct from 110 volt A.C. power line. Separate regeneration and volume controls on reception; gives maximum sensitivity and minimizes receiver radiation. Smooth, stable super-regenerative reception operates either speaker or earphones. Self contained power supply using large 30 H. smoothing choke and two 8mf. filter condensers. Works on both 5 and 10 meters with interchangeable plug-in coils. Complete kit, less tubes and

Cabinet, unwired **\$11.50**  
 Wired and tested \$3.50 extra. Cabinet \$1.50. Kit of 3 tubes \$1.60

### 3-Tube Portable Transceiver

Completely self contained unity coupled 5 meter transceiver using two 19 tubes and one 30. An unusually powerful, long range battery transceiver possessing excellent stability and good modulation. Push-pull 19 oscillator with two stage push-pull 11 class B audio in both sending and receiving positions giving true 5 tube performance. Batteries used: 3-45 V.B. and 2 No. 6 dry cells. Complete kit, less cabinet, tubes unwired... **\$10.95**  
 Assembled, wired... **\$3.00**  
 Cabinet... **1.50**  
 3 matched tubes... **1.65**



## RADIO CONSTRUCTORS LABS.



136 LIBERTY STREET  
 DEPT. SW.6 NEW YORK CITY  
 EXPORT DEPT.—105 HUDSON ST.

### Silencer Unit Uses 3 Tubes

The noise-silencer adaptor unit consists of three tubes, a 6L7 silencer 2nd I.F., 6J7 noise amplifier, and 6H6 noise rectifier. The silencer also has a tube-base adaptor. The 2nd I.F. tube in the receiver is removed and the adaptor put in its place. The 6L7 now functions as the new I.F. stage. The 6J7 amplifies the noise that is above the signal level and the 6H6 rectifies it. The rectified voltage is now used to automatically cut off the input into the following tube (the second detector).

An examination of the diagram will clarify the explanation. The signal enters the control grid of the 6L7 as usual, but in addition is also fed to the control grid of the 6J7. The screens of both these tubes are connected together to the B plus, through resistor R2. The output of the 6J7 is coupled to the two diode plates of the 6H6 rectifier through the transformer T. The transformer is peaked at the same frequency as the I.F. stages. This is usually 465 kc. Potentiometer R5 controls the cathode voltage of both the 6J7 and the 6H6. It provides variation of the negative bias on the control grid of the 6J7, as well as the diode plates of the 6H6. The full "B" voltage is not used

### How to Construct the New Noise Silencer

(Continued from page 78)

here but is dropped through resistor R4, so as to provide good control.

Variation of this control determines the level at which the 6H6 starts to rectify. It is set so that rectifying starts at a point just above the signal-level. When this occurs, a voltage is developed across R3, the diode load resistor, dependent on the level of the noise. The developed voltage in turn applies a negative bias to the No. 3 grid of the 6L7.

The 6L7 tube was selected because it is so nicely suited for this purpose. The tube can be made to completely cut off by biasing the No. 3 grid sufficiently negative. In other words, here is what has happened. The desired signal and the noise signal have both been applied to the grid of the 6L7. The signal is amplified and passed on to the succeeding stages. At the same time, however, it has also been applied to the 6J7. It is amplified here and passed on to the 6H6 plates. If the noise is of sufficient intensity, it is

rectified and a corresponding negative bias applied back to the 6L7, cutting off this tube during the noise peaks. The amplifying and silencing action occurs simultaneously and instantaneously, so that the set cuts off on every undesirable noise properly.

The whole silencer unit is mounted on a chassis 5 1/2" by 2" by 1 1/2" high. In order to conserve space, clip-tite sockets (spring mounting) are used. The three tubes and the transformer (T) are mounted on top. The control (R5) is mounted at the end, together with a calibrated plate reading 0-10. This is used to facilitate re-settings. The only remaining parts, 4 resistors, 7 fixed condensers, and the R.F. Choke are soldered in place on the underside of the chassis following the diagram in Fig. 5. R5 is a combination 5000 ohm potentiometer and switch. The 350 ohm line cord, switch, and the three tube heaters are connected in series.

### Connecting Silencer to Receiver

Five connections are brought from the silencer to the receiver. One is to the free grid cap which has been removed from the 2nd I.F. tube; another to the cathode connection in the same empty

Please mention SHORT WAVE CRAFT when writing advertisers

## "NOISE SILENCER"

### ● ELIMINATES "MAN-MADE" STATIC!

The noise "Check Valve," a development of James J. Lamb, editor of QST, has been acclaimed as one of the greatest discoveries in radio! Attached to any superheterodyne receiver, it eliminates noises caused by any sparking motors (oil burners, vacuum cleaners, fans, etc.) automobile ignition, high tension lines, dial telephones, etc. Reduction of noise as high as 1000 to 1 in power on sharp interference!

Just attach the noise silencer unit to rear or side of your receiver and make three simple city connections. A few minor adjustments as outlined in the instructions and you enjoy real noise free reception. Works on all wave-lengths. The louder the interference the easier it is to completely cut it out!

HARRISON presents a very compact version by William Green, of this amazing invention as described in QST and other magazines. A neat metal case measuring only 2"x5½"x1½" houses all necessary parts and the three tubes. Draws only negligible current from receiver. Has self-contained filament supply.

For SUPERHETERODYNE Receivers only. (Both RCL, SWI., and Amateur.) Mention make and model of set when ordering so we may supply the correct pronged attachment plug.



**COMPLETE KIT \$3.85**  
 of all necessary first grade parts, crystal finished cabinet with all holes drilled, and complete instructions, less tubes, unwired.  
 Three 85 Frank metal tubes..... \$2.50  
 Completely wired, ready to attach and operate, with tubes..... \$6.35

**HARRISON RADIO COMPANY** 12 WEST BROADWAY NEW YORK Dept. C-6 N. Y.

## WRIGHT-DECOSTER NOKOIL Dynamic Reproducer



No Field Coil or Current

The tremendous demand for the Nokoil Dynamic Reproducer more than repaid us for the many hours of strenuous study and work in developing this high quality unit.

First in the field and still superior

● For Car Radios ● For Battery Radios ● For Sound Installations  
 Buy through Wright-DeCoster distributors. They are always anxious to cooperate.

### WRIGHT-DECOSTER, Inc.

2257 University Ave., St. Paul, Minn.  
 Export Dept. M. Simons & Son Co., New York  
 Cable Address, "Simonrice"  
 Canadian Office, Wright-DeCoster, Inc., Guelph, Ontario

## "LITTLE GIANT" 3-Tube S. W. Kit

Complete Kit of parts, with instructions, less tubes, unwired



**\$9.45**

Compact — Smooth Regeneration — Easily Assembled — Ample Volume — Built-in Power Pack — Highest Quality Parts — Range 15-200 Meters — Uses Three Tubes: 1-77, 1-43, 1-25Z5.

Wiring and Testing.....\$3.50

Set of 3 Matched RCA Tubes.....\$1.74

**M & H Sporting Goods Co.**  
 512 Market St. PHILADELPHIA

## VEST POCKET SOLDERING IRON



Smallest good iron now on the market. Will do the work of irons twice its size. Only 11 inches long. ¾ inch in diameter. By using the highest grade elements it heats up in half the time of ordinary irons. Guaranteed to give satisfaction or money back. Sent Prepaid for.....\$1.20

GOLD SHIELD PRODUCTS CO.,  
 17 West 60th St., N. Y. City

socket, and a third to the plate. The last two connections are made by means of an adaptor. The 2nd I.F. tube is removed and a tube base is inserted in its place. The fourth wire connects the chassis of the silencer and the receiver together, and the fifth connection is a wire brought to the "B" plus in the receiver. The "B" plus voltage may be tapped off at any convenient point. It may be clipped to the speaker terminal or the plus side of the output transformer, or directly to the output of the power supply.

As will be noted in the diagrams, two of the external connections are made with shielded wire. The ordinary shielded wire cannot be used here, as the high capacity to ground would introduce excessive losses and detuning. A shielded cable with a one-half inch outside diameter is used. This cable has an insulated wire running through the center, evenly spaced. In this way good shielding and low loss is accomplished at once.

The silencer for best operation should be bolted against the rear or side of the receiver and several holes drilled to accommodate the connecting wires. The 2nd I.F. tube is removed and the adaptor plug inserted in its place. The grid lead is clipped to the SG cap of the I.F. stage. Connect the "B" plus lead as previously explained. Plug the line cord into a 110 volt AC or DC outlet. Turn on both the receiver and silencer. Since a parallel capacity has been added by the silencer

leads and the noise amplifier circuit, it will now be necessary to re-adjust two trimmers in the receiver to the intermediate frequency.

### Adjustment of Silencer is Simple

These two are the trimmers across the secondary of the I.F. input transformer and across the primary of its output transformer. A simple adjustment of these two on a steady signal will indicate the point of maximum resonance. The next step is the adjustment of the trimmer on transformer T. This is adjusted with R5 set at minimum, to the point where the output is completely blocked on a signal of moderate strength. By turning up R5, the signal will again come through. Now turn this control on full and proceed to tune in a signal in the usual manner. After the signal has been received, by turning back the control more and more, we find the noise is cut down, until the point of maximum silencing is passed, where the signal itself is suddenly cut off. Now bring back the control again so that the signal is let through. This is the point of maximum noise silencing.

From now on, control of this device is very simple. After a signal is tuned in, we merely adjust the noise-silencer for minimum noise. There is nothing more to its operation and maintenance.

### List of Parts for the Noise Silencer

- 1 Harrison Chassis
- 1 Harrison Cover
- 3 Octal sockets
- 1 Diode I.F. Transf. peaked to I.F. freq. of receiver.
- 1 RF Choke, 20 Mh.
- 1 350 ohm Line cord
- 3 .1 mf by-pass condensers
- 2 .01 mf by-pass condensers
- 2 .00005 mf mica condensers
- 1 500 ohm ½ watt resistor
- 1 50,000 ohm 1 watt resistor
- 1 100,000 ohm ¼ watt resistor
- 1 200,000 ohm 1 watt resistor
- 1 5000 ohm potentiometer with switch
- 1 I.F. adaptor
- 2 ft. shielded wire
- 2 S.G. caps
- 1 bar knob
- 1 2" plate, 0-10
- 1 6L7 tube
- 1 6J7 tube
- 1 6H6 tube

## 830-B Push-Pull Amplifier

(Continued from page 79)

tire amount in a single tube. With two tubes if one should "go west" we have only lost "half the battle"!

If driven to full rated input, these two tubes will deliver approximately 200 watts to the antenna! The driving power for the amplifier is around 15 watts minimum, although the unit used to drive the push-pull 830B's should be capable of providing from 20 to 25 watts for greatest stability and efficiency. In choosing this amplifier we considered that the average transmitter in use, in the low power class, ends up with either a single type 10 or a pair of 46's. Either would make an excellent driver for this amplifier, provided of course, that the 46's or the 10 was operated as a straight R.F. amplifier and was amply excited from another tube, preferably crystal-controlled. In other words we figured that the transmitter to which the amplifier was going to be connected started out with say a 47 crystal oscillator, followed by a 46 or similar tube as a multiplier or buffer and ended with the two 46's or a 10.

Such a "lineup" would allow multi-band operation and supply more than enough excitation to drive the 830B's to full output. The reason why we recommend that outputs from 20 to 25 watts are necessary in the driver or transmitter used to drive the amplifier, is to allow efficient operation on the higher frequency bands, such as the 20 and 10-meter bands. It is always advisable with any transmitter to have more than sufficient excitation avail-

able, in order to permit good regulation in the "driver" stage.

The amplifier shown in the photograph is built on a pine board 17" long and given a coat of black enamel to improve its appearance. However, it can be built up on a chassis and panel arrangement to fit in a rack, or along any other lines which the builder might desire. And then again, if this amplifier is to be placed above the driving unit, it may be necessary to reverse the layout. For instance, it may be advisable to place the plate coil on the opposite end of the circuit, and the grid coil on the other end, in order to permit short leads. The arrangement should be such that if the amplifier is placed above or below the driving assembly, the grid coil should come either over or beneath the output or plate tank circuit of the final amplifier in the driving unit, in order to keep the leads short.

Starting at the input end of the amplifier, we find the plug-in grid coil and the one turn "link coupling" coil. This grid coil has two jacks to simplify changing from one band to another. Three jacks might have been used thus eliminating one of the two R.F. chokes used to obtain the center feeding point or the C minus. However, if there were three jacks on the plug-in coil, one would come exactly in the center, thus complicating considerably the "link coupling" arrangement. Constructing the coil as we have in this transmitter, allows the "pickup" or link coil to be placed exactly in the center of the grid coil, without interference with any center

Please mention SHORT WAVE CRAFT when writing advertisers



tap connection. This grid circuit is tuned with a split-stator type condenser with a capacity of 100 mmf. per section. This is an ordinary receiving type Hammarlund condenser; high voltage insulation is not necessary in this circuit. The plate coil plugs into two heavy-duty jacks, the same as the grid coil, and for obtaining the center-tap connection we use a small battery clip. The heavy duty radio frequency choke used in the plate circuit is mounted directly between the plate coil and the tuning condenser. The plate tuning condenser also has a capacity of 100 mmf. per section, and is of the split-stator variety recommended for push-pull circuits. Widely spaced plates are required in this circuit because of the high plate-voltage and great amount of R.F. in the circuit.

Neutralizing is accomplished with two double-spaced condensers, having a capacity of 33 mmf. each. However, a smaller condenser having from 15 to 20 mmf. would be entirely satisfactory, inasmuch as for perfect neutralization, the condenser plates are only meshed about 25 percent. We have located these neutralizing condensers midway between the plate and grid coils. They are placed directly alongside of each of the type 830B tubes. Care should be taken in the placement of these condensers, because the leads must be symmetrical or of identical length, otherwise neutralization will be very difficult.

During experiments with this amplifier, an 802 pentode was used as a "driver." This supplied slightly over 15 watts under normal operating conditions and maximum plate efficiency in the 830-B amplifier came about with an input of 200 watts. This provided from 125 to 150 watts output which is, to say the least, quite a respectable amount. However with greater driving power the plate input to the 830-B's may be run as high as 280 watts for the two tubes, with an output of approximately 200 watts. However, the plate efficiency under these conditions is slightly less than the 200 watt input condition. With the 802 driver the grid current of the 830-B's was around 45 mills (ma.) with a grid biasing voltage of minus 90. With higher inputs and greater driving power, the grid current should be around 60 ma. for the two tubes, with a grid bias of about 110 to 120 volts.

Just before going to press, some experiments were conducted using the new R.C.A. 804 power pentode as a crystal-controlled triode driver. With around 700 volts on the plate of the 804, the input of the 830-B amplifier was driven to normal rating and over 200 watts output was obtained. This combination proved to be an ideal one for some one building an entirely new transmitter. A complete description of the 804 oscillator, which may be used to drive the 830-B's will be given in the next issue.

**PLATE COIL**

Band	31 turns No. 12 wire on 3" form
40	18 turns No. 12 wire on 3" form
20	8 turns ¼" copper tubing 2¾" diameter

**GRID COIL**

80	70 turns No. 24 DSC wire on 1" form
40	30 turns No. 24 DSC wire on 1" form
20	12 turns No. 20 DSC wire on 1" form

**Parts List**

- 1—100 mmf. per section split stator condenser, Hammarlund—MCD-100M
- 1—100 mmf. per section split stator transmitting condenser, Hammarlund—TCD-100X
- 5—.001 mf. mica condensers (1,000 volts), Cornell-Dubilier
- 1—.001 mf. mica condenser (2,500 volts), Cornell-Dubilier
- 2—33 mmf. neutralizing condensers, Hammarlund—MC-35-SX
- 2—2.1 mh. R.F. chokes, Hammarlund—CHX
- 1—2.5 mh. transmitting type R.F. choke, Hammarlund, CH-500
- 1—100 ohm center-tapped resistor, Electrad
- 2—4 prong isolantite sockets, Hammarlund
- 4—stand-off insulators (jack type), Bud.
- 2—small stand-off insulators, Bud
- 1—¾" by 17" 1" pine board, painted black
- 2—type 830-B R.C.A. Radiotrons
- 2—pointer type knobs, Crowe

**Ultra 3B—3-Tube Portable Transceiver**



A compact powerful 2 1/2, 5 and 10 meter portable transceiver is now available in the Ultra 3 B. This remarkable unit will be found capable of maintaining positive contact when communication is once established. Class A 100% modulation is employed. This has been made possible by the new 2 Volt tubes; 1F4 Class A modulator—1R1 high gain speech amplifier. These together with a 19 tube, Oscillator-Super regenerative detector result in an ideal transceiver. When used as a receiver loud speaker volume is assured. A built-in speaker model is available. In ideal localities a workable range up to 200 miles may be expected.

Complete kit of parts including all coils, low batteries, tubes, speaker, microphone and cabinet, unwired.	\$9.95
Wired and tested.	\$2.50
Sylvania 1B-1F4, 1E4 set of 3 matched tubes.	2.50
Cabinet with built-in speaker and battery compartment.	2.25
Cabinet less built-in speaker with battery compartment.	1.95
Cabinet less built-in speaker, less battery compartment.	1.10
Hand microphone.	1.95

Pictorial diagram furnished with kit

**Ultra 4A-4-Tube A.C. Operated Transceiver**

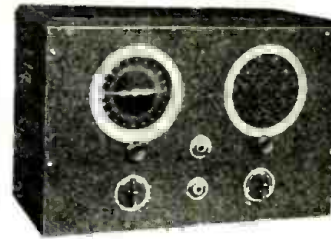

In the design of the Ultra 4A, A.C. operated transceiver, every tradition of radio value has been incorporated. Built-in dynamic speaker, self-contained power supply. Class A 100% modulation are only a few of the outstanding features of this "Ultra High Frequency" product. The new all metal tubes are used as follows: 6F6, Class A modulator—Power amplifier, 6J7, high gain speech amplifier—1st A.F. amplifier, 5Z1, rectifier, 6A6, oscillator-detector. The Ultra 4A is completely filtered at both R.F. and A.F. Levels. Automatic phone jack silences speaker. Tuning range 2 1/2 to 10 meters with 5 watts output.

Complete kit of parts including all coils, low cabinet, tubes, microphone, unwired. \$15.95

Wired and tested. \$3.00

Black wrinkle finished cabinet. 2.50

Sylvania 6A6, 6J7, 6F6, 5Z1 matched set of 4 tubes. 3.40

Hand microphone. 1.95

Pictorial diagram furnished with kit

**2 1/2 To 550 meters All-Wave Amateur 5-Tube Communications Receiver**

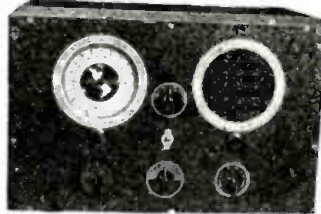

A new radio amateur communications receiver featuring bandspread plus regeneration and super regeneration is now available for the use of the discriminating amateur. 2 1/2 to 550 meters linear in efficiency is accomplished by the use of super regeneration up to 15 meters and straight regeneration between 15 to 550 meters. The new all metal tubes are used as follows: 6K7—R.F. stage, 6K7—Regenerative detector, 76—super regenerative detector, 25A6—power output stage, 25Z6—rectifier. Built-in dynamic speaker, self-contained A.C. D.C. power supply, large airplane bandspread dial, automatic phone jack.

Complete kit of parts less tubes and cabinet, unwired.	\$13.95
Wired and tested, extra.	\$3.00
Sylvania kit of 5 tubes.	4.50
Black wrinkle finished cabinet.	2.50
Set complete with 5 tubes and cabinet, wired, ready to operate.	23.10

Pictorial diagram furnished with kit

**Ultra 1 and 2 Tube Battery Transceivers**



For the beginner in the field of ultra high frequencies we unhesitatingly recommend these extremely efficient 1 and 2 tube transceivers. Can be used as 2 1/2, 5 and 10 meter receiver as well as transmitter when calling friends from afar. The one (1) tube unit uses a 10 type tube. The 2 tube unit uses one 19, plus the new 1F4, Class A modulator. Larger battery life in hand with this combination. Greatest possible range of any small transceiver can now be had. Range of 1 tube unit may be as high as 30 miles, and up to 100 miles with the 2 tube depending on locality. Batteries required are 2-1 1/2 V. dry cells and 90 to 135 B battery.

**(2 TUBE MODEL)**

Complete kit of parts including all coils, low tubes, cabinet, microphone and batteries, unwired.	\$6.95
Wired and tested.	\$2.00
Sylvania 19 and 1F4 matched tubes (2)	1.45
Cabinet less battery compartment.	1.10
Cabinet with battery compartment.	1.95
Hand microphone.	1.95

**(1 TUBE MODEL)**

Complete kit of parts (including all coils), low tubes, cabinet, microphone and batteries, unwired.	\$4.95
Wired and tested.	\$1.50
Sylvania 10 tube.	.50
Cabinet less battery compartment.	1.10
Cabinet with battery compartment.	1.95
Hand microphone.	1.95

**WRITE IN FOR FREE DESCRIPTIVE ULTRA HIGH FREQUENCY LITERATURE**  
**ULTRA HIGH FREQUENCY PRODUCTS COMPANY** 140 LIBERTY STREET NEW YORK, N. Y.

**Write to "Headquarters" and Get a Better Deal**

**"CHI-RAD"**

Headquarters for "Hams" for 15 years.  
The latest in receivers and transmitters — available on easy terms.

**Liberal Trades Arranged**

Complete stock of parts and accessories at standard prices.

**CHICAGO RADIO APPARATUS W9RA—COMPANY, Inc.—W9PST**  
415 S. Dearborn St. Chicago, Ill.

**A M E R I C A N CRYSTAL MICROPHONE**

Licensed under patents of The Brush Development Co.  
Attractive Design  
Standard accessories. Engineered for flexibility.  
Request catalogue from your jobber or direct from factory.

**AMERICAN MICROPHONE CO.**  
A California Corporation  
1915 South Western Avenue, Los Angeles, Calif.



**HIGH IN EFFICIENCY—LOW IN PRICE**

**BUD Isotex Sockets**

are ideal for your XMITTER and S. W. RECEIVER. Fine for coils, sockets too, and excellent crystal holder mountings. Top and sides glazed to resist moisture. Heavy reinforced springs to last a lifetime.

No. 954—4 Prong	List \$ .40
No. 955—5 Prong	List .40
No. 956—6 Prong	List .45
No. 957—7 Prong, Small	List .50
No. 958—7 Prong, Large	List .50

Ask your Jobber to show you No. 226 BUD SOCKET for 50 watters at only \$1.00 list or No. 227 for those 803's at only \$2.00 list. They are going big!

40% Discount to Dealers and Amateurs  
**BUDRADIO, INC.** 1937 E. 55th St. Cleveland, O.

**ECONOMY CODE MACHINE—\$12**

Learn code easily, at your convenience—and economically. Famous Instructograph principle. Complete with choice of 5 tapes, and Book of Instructions. Delivered postpaid anywhere in U.S.A. Send postpaid for full details.

**INSTRUCTOGRAPH COMPANY, Dept. W-6**  
Chicago, Ill.

912 Lakeside Place



# HARRISON RADIO COMPANY

"Short Wave Specialists Since 1925"

- Featuring Quality Equipment with
- INTELLIGENT SERVICE
  - MOST PROMPT SHIPMENT
  - LOWEST PRICES
  - EASY PAYMENT PLAN
  - LIBERAL TRADE-IN ALLOWANCE

## HALLICRAFTER

- SUPER-SKYRIDER
- SUPER-SEVEN
- SKY-BUDDY
- ULTRA-SKYRIDER

## HAMMARLUND

- COMET "PRO"
- "SUPER-PRO"

## RADIO MFG. ENGINEERS RME-69

- RCA**  
ACR-175  
ACR-136

## ROYAL PR-SIX

## NATIONAL RECEIVERS

## FULTONE

- "V"
- "DUETTE"

## PATTERSON PR-16

## HARRISON "MULTI-KIT"

## HAYNES "R-S-R"



**FREE!**

**SEND COUPON (or card) NOW!**

HARRISON RADIO CO. C-6  
12 West Broadway, N.Y.C.

Gentlemen:  
Kindly send me, without any cost or obligation, your new Short Wave Receiver Catalog. I am particularly interested in the \_\_\_\_\_ receiver.

NAME \_\_\_\_\_ (Please Print)  
ADDRESS \_\_\_\_\_  
CITY \_\_\_\_\_ STATE \_\_\_\_\_

## HARRISON CARRIES A MOST COMPLETE STOCK OF TRANSMITTING AND RECEIVING PARTS AND ACCESSORIES

Upon request we shall be pleased to send you complete literature of any Manufacturers in whose products you may be interested, together with our wholesale discount schedule.

# HARRISON RADIO COMPANY

12 West Broadway-C6-New York City

# New 4-Tube Receiver Tunes From 1 to 11 Meters

(Continued from page 86)

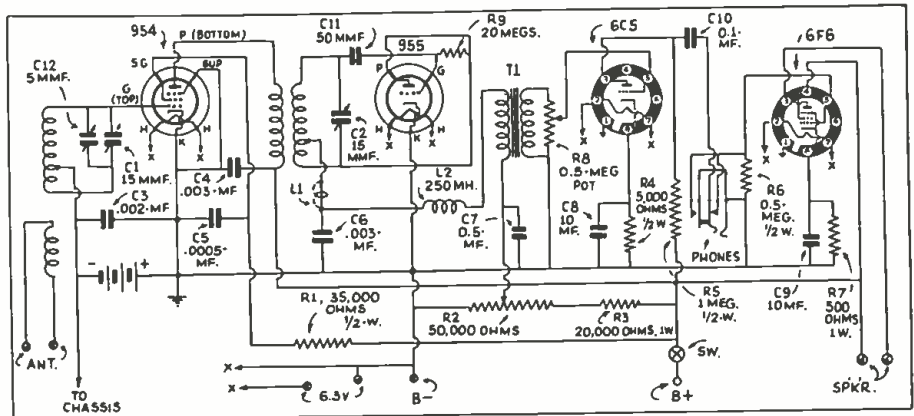

Wiring diagram of the 4-tube receiver which tunes from 1 to 11 meters.

the hole in the cover and arranged so that the cover may be opened for changing coils.

A small flexible lead will be found connected to the front antenna post. This supplies a ground connection where a single-wire antenna is used. It should be disconnected from the binding post when doublet feeders or two-wire lines are employed. An external ground connection is usually undesirable, but this point must be determined by experiment.

While the antenna primaries are of symmetrical construction, mechanical considerations prevent exact balance to ground, and there is some capacity coupling between the windings, especially at the higher frequencies.

Exact recommendations for antenna systems cannot be given, since the dimensions will depend upon the frequency at which best efficiency is desired, directional characteristics, etc. In general, however, the antenna proper should be tuned to the received signal. In many installations this condition may be satisfactorily realized by tuning the feeders with series or parallel condensers. The size of the tuning condensers will depend upon the frequency of the received signal and upon antenna dimensions. The transmission line must be efficient. As a rule, "twisted pair," or similar lines, are not satisfactory at frequencies much above 40 or 50 mc., especially where the length exceeds a full wavelength. The open wire or transposed line is much better.

Another general rule regarding antennae, is that any system which is found to be efficient in transmission will have good efficiency with the same directional characteristics, etc., in reception.

### Output Circuit and Speaker

The plate circuit of the output tube is brought to the output jack, located at the rear lefthand side. There is no output transformer in the receiver. The speaker requirements are not at all critical, any good magnetic or dynamic speaker being satisfactory provided the input impedance is approximately 7000 ohms, and provided the speaker windings are capable of carrying the plate current of the output tube (about 25 ma.). Some magnetic speakers will require a filter system, such as a 1 to 1 transformer or a 30 henry choke and 1. mfd. condenser combination. There is no provision for the field excitation of a dynamic speaker from the Type No. 5886 AB power unit. For this reason, the permanent magnet type of dynamic speaker is recommended, no field excitation being required.

The headphone jack is located on the front panel, just below and to the left of the main dial. This jack is wired into the output of the first audio stage in such a way that when the phones are plugged in,

the signal input to the last tube is completely disconnected. It is important, however, that the plate circuit of the output tube be complete at all times. If the speaker is to be disconnected, a jumper must be inserted in the tip-jacks to connect them together. The receiver should not be operated from the above mentioned power supply with the output tube removed, as the voltage might rise above 180 volts. When operated from batteries, the removal of the 6F6 is permissible and will give better battery economy.

### Controls

The main dial is the tuning control; calibration curves for the various coils are shown below. The curves are accurate to about three percent. It will be noted that frequency increases with dial reading.

The switch at the lower righthand corner breaks the positive B-supply lead and is useful for temporarily rendering the receiver inoperative during periods of transmission or when changing coils. When using B-battery supply, the switch should be thrown to the "Off" position at all times when the receiver is not in use, in order to avoid parasitic drain. No switch is provided for opening the heater circuit.

There are three small dials in addition to the main tuning dial. These control detector regeneration, audio gain, and the

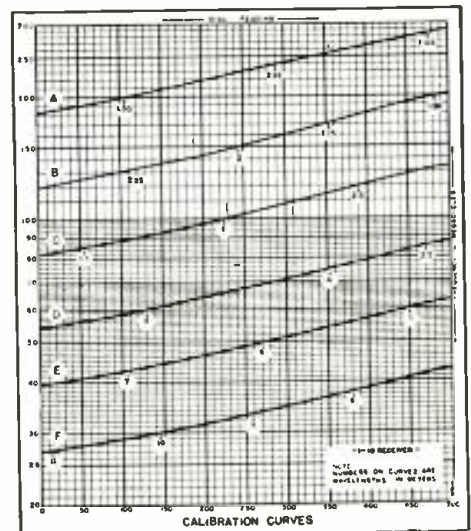

The various frequency bands covered by the new National receiver are clearly shown in the above graphic chart.

Please mention SHORT WAVE CRAFT when writing advertisers

alignment of the R.F. circuit, and are marked accordingly.

**Operating Characteristics**

The "1-10" receiver is designed primarily for the experimenter and to this end has been made to have maximum sensitivity and a wide frequency range. The use of a self-quenching super-regenerative detector with a stage of tuned R.F. provides excellent sensitivity and AVC action. Unfortunately, this type of detector introduces some distortion, since it does not have a linear characteristic. The distortion is small when signals are not modulated heavily, and increases with the percentage of modulation.

The various coils are stamped "A-1", "A-2", "B-1", "B-2", etc. They are used in pairs. The coil sockets of the R.F. and detector stages are marked "1", and "2", respectively, to correspond with the coil designations. The high frequency coils, (particularly the "A-1") must be pushed down in the socket as far as they will go. If they are not, the inductance of the primary and secondary circuits will be increased and the calibration of the circuit will be altered.

With any pair of coils in the receiver, the audio gain control should be advanced to 3 or 4 on the dial. Advancing the regeneration control will throw the detector circuits into superregeneration. This condition is indicated by a loud rushing or hissing noise. The hiss will drop down to a very low level or disappear entirely when a signal is tuned in, the reduction depending somewhat upon signal strength. The setting of the regeneration control at which the detector goes into superregeneration will vary with different sets of coils and with the condition of the 955 detector tube. On the "A" range it may be necessary to advance the control to the full on position as the detector tube begins to wear out. Sensitivity will depend upon the adjustment of the regeneration control, the maximum occurring just beyond the point where the hiss starts. The audio gain control must be used to control volume.

With the antenna disconnected and the detector just beyond the point at which superregeneration starts, rotation of the R.F. trimmer control will produce a definite decrease in the detector hiss at a certain setting, usually between 2 and 4. The R.F. circuit is aligned with the detector at the middle of this "dead spot." Advancing the regeneration control will start the hiss again. It is well for the operator to familiarize himself with the effect of these two controls as one is dependent upon the other.

The regeneration control has some tuning effect, increased plate voltage causing an increase in frequency. This necessitates re-tuning toward the lower dial numbers. The effect will vary with the coils employed and the dial setting. Similarly, the effect of the trimmer condenser will vary over the range of the receiver and also over the range of any one pair of coils. With any type of antenna connected, even a few inches of wire, the effect of the R.F. trimmer upon the detector circuit will be greatly reduced if not eliminated. It may still be found by operating the detector at the very edge of superregeneration. The trimmer setting is still critical with regard to the receiver sensitivity, however. The alignment of the trimmer will change with the dimensions of the antenna and also with the tuning of the receiver when using an antenna of fixed size. The setting which aligns the R.F. stage may move in either direction on the trimmer dial, depending upon antenna characteristics.

In determining the correct trimmer setting, when a signal is already tuned in, the operator should judge by the degree of his suppression, the maximum suppression indicating correct alignment.

It is important that the regeneration control be advanced sufficiently so that the detector is oscillating strongly. If it is not, any received signal will appear to have a series of carriers a few k.c. apart over several divisions of the tuning dial.

The operator who is not familiar with the PW type dial and tuning mechanism

# BOOST Those 10 and 20 Mtr. Sigs—

TEN TIMES THE SENSITIVITY on 10 meters.—more than that on 20! Signals you didn't know were in there—up to loud speaker volume! Tremendous increase in receiving range on these wavelengths. Highest possible L/C ratio. Layout, coils, everything designed especially for these two bands. No super reaches maximum efficiency on 10 or 20 meters without regenerative input. Sargent 10-20 Booster uses new regenerative circuit AND AMPLIFICATION—2 tubes. Results are amazing! You do not have to take our word for it.—there is a cut-over switch to cut the antenna directly to the receiver. One turn of this switch and you are convinced—AND HOW!



## FLASH

### Sargent Model 20 9 Tube Receiver

now available for 10 meters

We waited until we could offer you a design that would really DRAG THEM IN on 10 meters. It is ready now! Sargent Model 20-XSA, Code Word TWEXS, tuning range 9.5 to 550 meters, \$5.00 higher than our standard Model 20.—price complete \$64.50 net. Price includes full set of R.C.A. tubes. No other changes from regular Model 20. Ready for delivery NOW. A popular receiver of proven worth.—the greatest value in the field. Note: The Sargent 10-20 Booster helps ALL supers.—including our own.

Takes power from your receiver. Light drain. Calibrated, illuminated dial, total shielding.

### SARGENT 2-Tube 10-20 Booster

Cat. No. ZS-2—2.5 volt tubes—Code Word ZSTWD  
Cat. No. ZS-6—6.3 volt tubes—Code Word ZSSIX

**\$12.90 NET**

Prices include R.C.A. tubes Shipping Weight 10 lbs.

If your distributor cannot supply you. SEND YOUR ORDER HERE.

**IMMEDIATE DELIVERY**

**E. M. SARGENT CO., 212 9th St., Oakland, Calif.**



## The Breakers ATLANTIC CITY, NEW JERSEY

On the Boardwalk



SITUATED DIRECTLY ON THE OCEANFRONT AND CONVENIENT TO ALL PIERS AND AMUSEMENTS

**\$5 WITH MEALS Daily WITHOUT MEALS \$2.50**  
PRIVATE BATH Per Person PRIVATE BATH

Hot and Cold Sea Water in all Baths

EXCELLENT FOOD

GARAGE ATTACHED

## WORLD WIDE ALL WAVE RADIO



### ONE TUBE KIT ONLY \$1.25

Haven't you always wanted a Real Powerful Radio Receiver?

all your own! A short and long wave set that will actually bring in many foreign stations from all parts of the world, police calls, airplanes, amateurs, etc., as well as your local stations. ACE Radios give GUARANTEED RESULTS! Thousands now in use. Amazing performance!

NOW, the world famous ACE Construction Kits are priced so low that anyone can afford one! For only \$1.25, we send you, postpaid, every part needed to build a powerful one tube receiver with heavy, attractive metal chassis-panel. Not a feeble crystal set! Works on two inexpensive dry batteries. Later, you can change your set into the Two Tube Battery or All-Electric set at special low cost! You get a valuable radio education by wiring it yourself from our clear diagrams. It's easy for even a child! Just a few simple connections. Wavelength range 15 to 600 meters.

FOR MORE POWER AND VOLUME \$2.00 BUY THE TWO TUBE KIT . . . \$2.00

ALL ELECTRIC TWO TUBE RECEIVER \$3.00

Tubes—75c each. Double headphones—\$1.15  
Any kit laboratory wired and tested—\$2.00 extra  
REMEMBER—WE pay the postage!  
Save you 15c to 50c or more.

ORDER NOW! NOT A TOY OR AN ATTACHMENT!!  
**ACE RADIO LABORATORIES**  
1619 Broadway Dept. C-6 New York City



### New NEON Oscilloscope Kit

No need for expensive equipment! Make this one. Checks on your signal modulation, quality—and the other fellows'. Useful in service work too.

**KIT**

Includes improved tube with finest fidelity response that gives clear defined pictures; clips; scanning mirror and motor shaft adapter. Net price to amateurs **\$2.00 ONLY.**

### Vari-Speed Motor

Absolutely constant speed—new vari-speed control, calibrated in R.P.M. for any constant speed from 50 to 1000. (This type of motor is necessary for expert results.) Makes your oscilloscope a precision instrument. NOW, NET **\$9.50** (With 10 to 1 reduction shaft, as shown, for displays, etc. \$1.50 extra.)

**Build This Complete Kit**  
All essentials included—vari-speed motor, neon tube, etc. all for **\$11.50** net price of . . . . .  
Act now. Send your order

**SUNDT ENG. CO.**  
4262 Lincoln Ave. Chicago, Ill.



The Finished Job!

Please mention SHORT WAVE CRAFT when writing advertisers

# All train YOU QUICKLY for Good FULL-TIME and SPARE-TIME Jobs in ELECTRICITY



Get Into a Big Pay Field  
for a Big Pay Future  
Train in your Spare Time  
by PRACTICAL Shop Methods

## WITHOUT LEAVING HOME

Now, Electric Institute brings—TO YOUR VERY DOOR—practical training necessary for the rich rewards in Electricity. Keep your present job—no need to leave home—now you learn ELECTRICITY easily, practically—RIGHT AT HOME—in your spare time.

## Prepare for Jobs Leading to Salaries of \$30, \$40, \$50 a Week

Get into a real money making field for a big pay future. There is no better way to succeed than to TRAIN for work in an industry that is expanding. New Electrical projects constantly mean more jobs for men with practical training. Almost every industry uses TRAINED ELECTRICAL MEN. Or you can own and operate an electrical business of your own.

## Opportunities to Earn Up to \$5, \$10 a Week or More While Training

With this amazingly easy, fascinating method of HOME SHOP TRAINING it is possible to start EARNING MONEY almost at once. Do not confuse E. I. Training with dry, theoretical text book courses. Electric Institute tells you exactly WHAT to do—THEN YOU DO the ACTUAL JOBS with ELECTRICAL EQUIPMENT and APPARATUS which comes with your training at no extra cost.

Become a TRAINED man without leaving home or your present job—then be ready to step into a REAL ELECTRICAL JOB.

## Money Back If Not Satisfied

You must be satisfied. I give you an agreement to return every cent you pay on tuition if, after completing my training, you are not satisfied in every way with my instruction, equipment or other services given you.

With my training, my graduates receive life time consultation service, employment service and many other features to help them succeed in Electricity.

Electric Institute is ready to show you the way in the great, growing field of ELECTRICITY—where trained men are ALWAYS NEEDED. Mail coupon TODAY—for big, free book of facts about this revolutionary Practical Home Shop Training and the tremendous opportunities in ELECTRICITY.

## DIESEL ELECTRIC POWER, RADIO and REFRIGERATION

Take advantage of the opportunities awaiting trained men in these and many other branches of Electricity, with ELECTRIC INSTITUTE practical training. Mail coupon for complete facts about ELECTRIC INSTITUTE— it may be the turning point in your life.

**FREE**  
ELECTRICITY  
Practical Training

**RUSH the COUPON-TODAY-BIG BOOK FREE**  
H. W. Petersen, President  
Electric Institute, Inc., Dept. 166-F,  
5840 Addison St., Chicago, Ill.  
Send Free Book with all facts about E. I. Home Shop Training.

Name ..... Age .....  
Address .....  
City ..... State .....

may gain the impression that the receiver tunes very broadly. A superregenerative receiver is, of course, less selective than other types used on lower frequencies but selectivity cannot be judged by the dial space covered by a given signal unless the total equivalent scale length is remembered. Since the dial makes ten revolutions to cover any one coil range, the scale length is approximately 12 feet.

### Maintenance

There are no circuit adjustments or trimmer settings to be made, other than those which are brought out to the front panel and which have been previously discussed.

The effect of decreasing battery voltages (both A and B) and ageing tubes will first be noticed when using the "A" coils, particularly at the extreme ends of the range. A 955 detector tube which will no longer operate on the "A" range will still give good performance at lower frequencies. Similarly, any poor connection at the tube

socket or coil socket will be especially noticeable at the highest frequencies. In fact, the detector may refuse to go into superregeneration unless the coil contacts, etc., are perfectly clean.

It will be noted that the variable condenser supports, coil sockets, and coil bases, etc. are made of Vietron, and while this material has exceptional electrical characteristics, it is similar to hard rubber in mechanical strength and its inability to withstand heat. The receiver should not, therefore, be subjected to high temperatures and the Vietron parts must be handled with reasonable care to prevent breakage.

The C-battery does not supply any current and will require replacement but about once a year.

Additional coils for extending the range in either direction are not available.

This article has been prepared from data supplied by courtesy of the National Company.

## One-Meter Transmitter and Receiver Used By NBC

(Continued from page 71)

direct to listeners' radio sets, but for actual program service at any point of origin, to extend the scope of pick-up for present radio networks.

Announcement of the midget transmitter marks the first NBC disclosure of results of more than two years experiment in the micro-wave field, as part of the extended series of ultra-short wave propagation tests conducted in the field and from the tops of skyscrapers in New York.

The new micro-wave unit, Hanson reveals, is the result of a two-year search for a "coat-pocket transmitter" to enable foot-loose announcers, to carry a microphone to any desired point, or circulate at will among large assemblages, for purposes of broadcasting or to feed a public address system from the floor.

"Investigations in the micro-wave field," Hanson explained, "suggested that work in this band of 300,000,000 cycles and more would permit the midget antenna equipment necessary for the compactness we sought. Micro-waves also offered a phenomenal degree of penetration through intervening structures, so the tiny waves

were employed in developing the new portable transmitter."

Earlier units of portable type, more cumbersome in size and operating on "longer" waves of the order of 7 to 10 meters, were tested by NBC during the Horse Show at Madison Square Garden last fall, where they worked with marked success in relaying instantaneously to the gallery the decisions of the judges on the floor.

The new micro-wave transmitter proves the possibility of a practical "coat-pocket" size unit, and further laboratory work is now in progress to rush completion of the still smaller-size design.

In its present stage, the micro-wave set is a three-inch cube, with two ten-inch rods as antenna to release the tiny radio waves. It transmits at a power of two-tenths of a watt, employing the latest type of tiny "acorn" tube developed by RCA.

Current is fed to the midget set by an extremely small battery unit of 90 volts, also newly-developed in cooperation with NBC. The complete battery unit weighs less than 4 pounds, and the transmitter proper, less than a pound.

## Candle Flame in England Lights Lamp Here By Short Waves

(Continued from page 71)

apparatus which carried the signal to this country over short-wave radio which carried Sir Bragg's address to the gathering of notable scientists here.

On this side the sound of the candle flame was filtered out from the voice of Sir William Bragg and relayed to the Museum in Radio City, there to turn on an original Stopper lamp such as George Westinghouse used to illuminate the Columbian Exposition in 1893 in Chicago.

The light of this Stopper lamp was picked up by an "electric eye" which actuated electric switches that turned on two banks of High Intensity mercury vapor lamps bordering the entrance inside the museum. Thus, in a split second, a cavalcade of lighting was enacted as though to pay homage to Faraday and the tremendous electrical progress which his early experiments made possible, at the same time commemorating the golden jubilee of the company which George Westinghouse founded.

The candle flame represented a combustion source of illumination which preceded those of electrical character. Next, a Westinghouse Stopper lamp represented the work of mankind in developing the first practical electric illuminant, at the same time representing the first application of alternating current which was used for the first time on a large scale at the World's Fair of 1893 and which is regarded by many as the first big step in the beginning of the electric industry in this country.

Finally, the High Intensity mercury vapor lamp constitutes the latest important advancement in artificial illumination, rivaling that of the first incandescent lamp. It produces light by sending electricity through a metallic or gaseous vapor and, in so differing from the method of producing light by sending electricity through a filament wire, represents a development which future historians will record as revolutionary as the first incandescent lamp.

Dr. Arthur Compton, noted scientist of Chicago University and brother of Karl Compton, President of Massachusetts Institute of Technology and one of the distinguished guests at the dedication ceremonies, figured prominently in early research work, nearly twenty years ago, which has made the phenomenon of vapor illuminants possible today.

In 1917 Dr. Compton and Dr. Harvey C. Tentschler, present Director of Research of the Westinghouse Lamp Company, established a research department for that company in East Pittsburgh. Dr. Compton's first scientific investigation in that capacity was to delve into the possibilities of metallic and gaseous vapors as a possible source of artificial light. His early research work was later patented by Westinghouse and has ultimately resulted in the practical sodium vapor and High Intensity mercury vapor lamps of today. These are the lamps which, after some 57 years since the first incandescent lamp, mark an important milestone in artificial electric illumination.

Please mention SHORT WAVE CRAFT when writing advertisers

# 3 1/2 Inch Waves Transmitted 16 Miles!

(Continued from page 70)

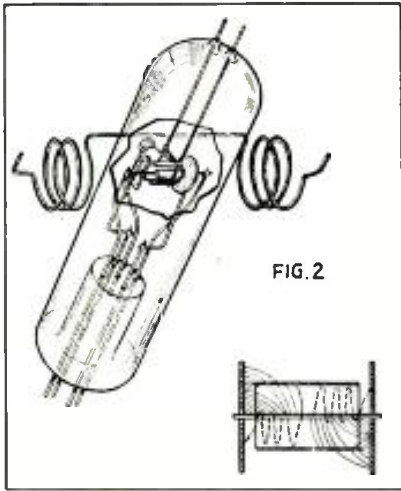

Fig. 2—Detail of the special magnetron tube which was used with a half-wave antenna placed in the focus of a 4 ft. parabolic reflector.

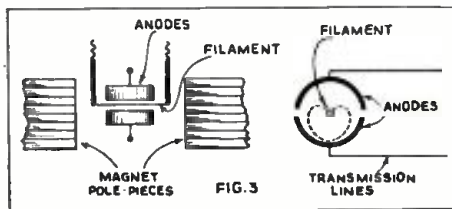

Fig. 3—Shows the split-anode magnetron used for producing the 9 cm. waves.

to make a complete circuit in the tube from cathode in the direction of the anode and back to cathode again, is equal to the period of the wave it is desired to produce. This adjustment is quite critical. The oscillations which depend on adjusting the electron speed to the period of the wave have been called "electronic oscillations." The time that it takes the electron to go from cathode to anode has been called the "transit time."

### Split Anode Magnetron Used

The tube which was used for the transmission tests was an improved type of split anode magnetron in which an electric field in the direction of the magnetic field was added in addition to the transverse electric field between cathode and anode. This electric field was obtained by placing two metallic discs at the open end of the cylindrical anodes and supporting them so that they are insulated from the cathode. They were both operated at a potential approximately three-quarters that of the anode potential. Their function was to draw electrons from the inside of the cylinder. A theoretical and experimental consideration had shown that a tilting of the tube without end plates was required to allow electrons to spiral out from the region inside the anodes, so as to obtain proper space charge conditions for maximum oscillation. In the case of the ordinary split anode magnetron, the relative adjustment of angle of tilt and plate voltage is very critical and if either one is changed the other must be changed to some new value, in order to continue oscillation. In a tube using the end plates, stability of operation is much better. This is due to the fact that the anode and end plate potentials may be taken from the same voltage supply and therefore will vary proportionately. It has been found that when the anode potential is varied the end plate potential, which is

required in order to maintain oscillation at the maximum value, is very nearly that which keeps this proportionality constant.

Since the output of the tube depends on the ratio between end plate and anode potential, modulation can be easily obtained by varying either one of these independently of the other. In order to modulate the transmitter, we therefore place the secondary of the modulation transformer in series with the anode supply, and adjust the anode potential so that oscillation amplitude for no modulation is approximately one-half the maximum. This allows the output of the tube to swing from close to zero to maximum for full modulation. A diagram showing the modulation system, the antenna, and the reflector used with the transmitter is shown in Figure 4. It will be noted on this diagram that the anode supply is brought in across a line which appears to be shorted directly across the transmission line. This bar has two purposes. In the first place, it acts as a short circuit for long wave parasitic oscillations which the tube would like to generate, if it were not prevented from doing so. In the second place, its position is adjusted so that the capacity between the halves of the anodes and the inductance of the small loop circuit is correct to tune to the frequency of oscillation.

### Receiver

The receiver consisted of an iron pyrites crystal attached to a small loop, which was

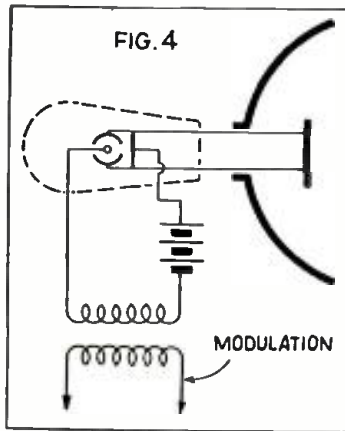

Fig. 4—Diagram showing the modulation system, the antenna and reflector for the 9 cm. transmitter.

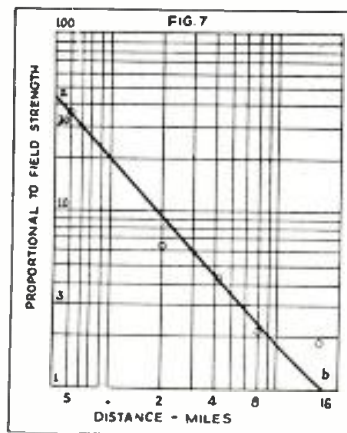

Fig. 7—Curve above shows relation between signal field strength and distance.

## Again..MIDWEST STARTLES THE RADIO WORLD

with a Marvelous New  
**14-TUBE**  
FIVE WAVE BAND  
WORLD-WIDE RADIO

**\$49.50**

with New Auditorium-Type SPEAKER (Last years)

**30 DAYS FREE TRIAL**



TERMS AS LOW AS **15¢ A DAY**

Buy Direct from **MIDWEST Laboratories.. SAVE UP TO 50%**



EVERYWHERE, radio enthusiasts are praising this amazingly beautiful, bigger, better, more powerful, super selective 14-tube 5-band radio. Out-performs \$150 to \$200 radios on a side-by-side test—and will thrill you with its glorious Acusti-Tone, crystal-clear "concert" realism—and magnificent foreign reception. Never before so much radio for so little money! Before you buy any radio, write for the FREE 40-page 1936 catalog.

**50 Advanced 1936 Features**  
Scores of marvelous features, many of them exclusive, explain Midwest super performance and thrilling world-wide reception...and prove why nationally known orchestra leaders like Ted Weems, Fred Waring, etc., use Midwest in preference to more costly makes. This advanced 5-band set enables you to switch instantly from American programs to Canadian, police, amateur, airplane and ship broadcasts —to the finest and most fascinating programs from Europe, Asia, Africa, Australia, and South America.

### DEAL DIRECT WITH LABORATORIES

No middleman's profits to pay—you buy at wholesale price direct from laboratories... saving 30% to 50%.

Increasing costs mean higher prices soon. Take advantage of Midwest's sensational values. As little as \$5.00 down puts a Midwest in your home on 30 days free trial. You are triply protected with: Foreign Reception Guarantee, Parts Guarantee, Money-Back Guarantee!

**MAIL COUPON TODAY for**  
**Free 30-DAY TRIAL OFFER**  
**and 40-PAGE FOUR-COLOR Free CATALOG**

**MIDWEST RADIO CORPORATION**  
Dept. 14N, Cincinnati, Ohio

Without obligation on my part, send me your new FREE catalog and complete details of your liberal 30-day FREE trial offer. This is NOT an order.

Name \_\_\_\_\_  
Address \_\_\_\_\_  
Town \_\_\_\_\_ State \_\_\_\_\_

Check  if interested in a Midwest All-Wave Battery Radio

User-Agents Make Easy Extra Money Check Here for details.

Please mention SHORT WAVE CRAFT when writing advertisers

# BRUSH Hand Microphone

For describing athletic events, parades, crowds, etc., from press boxes, balconies, the tops of sound cars, etc., and for commercial interstation, police and amateur transmission work. Priced low. Fits the hand perfectly. Wide frequency response and typical Brush sound cell operation. No button current or polarizing voltage and no input transformer is required.

Size only 3 1/4 inches x 1 1/2 x 1/2 inches. Weight 3 oz. Output level minus 66 D. B. Shipped complete with 15 feet of cable. Can be furnished on special order with locking type plug and socket for stand connection. Details—Data Sheet No. 8. Free. Send for one.



# BRUSH Headphones



—meet every headphone requirement. Response 60 to 10,000 cycles. No magnets to cause diaphragm chatter. Specially designed cases minimize breakage. Light in weight—Only 6 oz. complete with headband and cords. A quality product at a low price. Details—Data Sheet No. 10. Free. Send for one.



## TWO-TUBE SHORT WAVE RADIO Only \$3.00



less tubes, phones, unwired

A REAL, powerful 2 tube short wave set that readily brings in amateurs, police calls, broadcast stations, experimental and foreign stations under fair conditions. THE WORLD AT YOUR DOOR!

A DEPENDABLE RECEIVER which is guaranteed to give RESULTS. Operates entirely from the AC or DC house current. Simple to build and easy to operate. Beautiful, black shrivel finished cabinet and instructions furnished. Wavelength range 10 to 600 meters.

ONE TUBE BATTERY SET operates from inexpensive dry batteries, less tubes, phones. \$1.25  
Two tube battery set, less tubes, phones. \$2.00  
batteries, unwired.

Kits wired, extra \$0.75. Tubes, each..... \$0.75  
Cannonball double headphones..... \$1.25

EILEN RADIO LABORATORIES  
136 LIBERTY STREET  
(Beginner's Section)  
NEW YORK, NEW YORK

## Build YOUR OWN Slow Speed Wind Charger



from old auto generator. We show you how. Make money building for others. Light your buildings and play radio. Dime brings complete plans and catalog, with 20 other generator changes. Satisfaction guaranteed or dime refunded.

LEJAY MANUFACTURING CO.  
1417 W. Lake St., Minneapolis, Minn.

WATCH FOR THE JULY "HAM" NUMBER

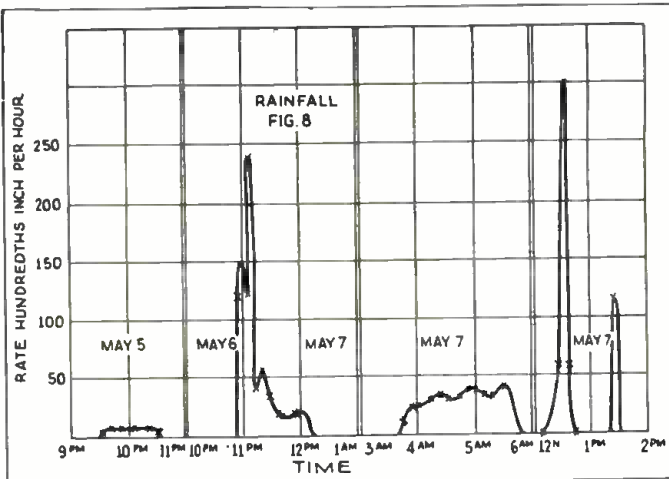

that the output of the crystal detector was proportional to the square of the signal strength. This fact, along with the amplifier gain control setting, made it easy to calculate the relative field strength at each one of the points where the receiver was set up. In Fig. 7 the relative field strengths are plotted against the distance on log-log

Fig. 8—Shows variations in rainfall over the time during which the tests were conducted.

Fig. 9—Shows the signal field strength (full black line), while the dotted line shows the rainfall. Results of the test indicated that rain has had a slight effect on the 9 cm. waves; so that in a clear atmosphere the attenuation is negligible up to a distance as great as 16 miles.

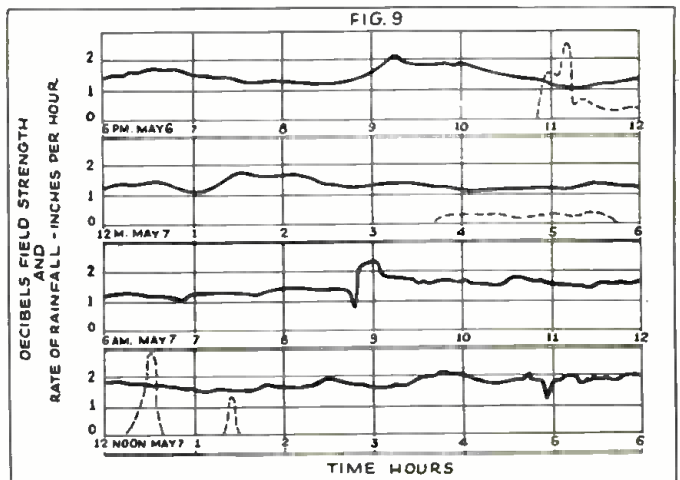

placed in the focus of a 4-foot reflector and does not require further explanation. The output of the crystal was attached to an audio amplifier, which in turn was fed into a tube detector and microammeter for the first tests, and into an Esterline recording meter for the tests which were made to determine the transmission through rain.

In the tests that were made at Atlantic Highlands, the transmitter was placed close to Navesink Light House which is on a hill about 200 feet above sea level.

The transmitter as set up for the tests is shown in Fig. 5. The receiver, mounted on the stern of the test ship is shown in Fig. 6.

### 40 Mile Range Possible

These pictures are supplied through the courtesy of the Signal Corps Laboratories at Fort Monmouth. The line of sight range to the horizon from this point was approximately 17 1/2 miles. A number of readings were taken at different distances from the transmitter. The transmission distances were from one-half to five and one-quarter miles over land, and eight to sixteen miles over water. The signal which was received at the 16 mile distance was sufficiently strong so that it would have been possible to move the receiver out to 40 miles before the signal intensity became equal to the amplifier noise.

Some previous measurements had shown

coordinate system. If attenuation in the atmosphere is negligible, the signal strength should decrease inversely as the distance from the transmitter, since the radiation is in the form of a cone starting at a relatively short distance from the transmitter. The points should lie along a straight line of slope—1. The line a-b has been drawn through the half-mile point with this slope. There is no indication that there is any attenuation other than that due to the spreading of the energy. There was considerable uncertainty in the readings since the crystal had to be readjusted at each point, and the transmitter output may have shifted somewhat. Nevertheless, we can safely say, that attenuation in the clear atmosphere for 3,000 megacycle electromagnetic waves is negligible up to distances of 16 miles, and probably more.

### Rain Tests

The measurements which were made at Atlantic Highlands were all conducted when the weather was clear, although at the time of the 16-mile test there was sufficient haze so that the transmitting point could not be seen from the receiving point. In the next series of tests, an attempt was made to determine whether the water in the atmosphere during heavy rain or fog would be sufficient to attenuate the 3000 megacycle signal. Although the amount of water pres-

TABLE I. DROP SIZE AND SPACING FOR DIFFERENT TYPES OF RAINFALL, MIST AND FOG.

(1)	(2)	(3)	(4)	(5)	(6)	(7)	(8)	(9)	(10)
	Precipitation mm. hr.	Diam. of drop mm.	Mass of drop grams	Velocity of fall m per sec.	Water mg. per m <sup>3</sup> air	No. of drops per m <sup>3</sup>	Drop spacing (cm)	Frac. of water by vol. in air	Thickness of water layer in cm. in 2 mi. path
Fog	.05	.01	5.2 · 10 <sup>-10</sup>	.003	6.	1.2 · 10 <sup>7</sup>	.43	6 · 10 <sup>-9</sup>	1.9 · 10 <sup>-2</sup>
Mist	.25	.1	5.2 · 10 <sup>-7</sup>	.25	55.5	1.1 · 10 <sup>8</sup>	2.1	5.5 · 10 <sup>-8</sup>	1.8 · 10 <sup>-2</sup>
Drizzle	.5	.2	4.2 · 10 <sup>-6</sup>	.75	92.6	2.2 · 10 <sup>8</sup>	3.6	9.3 · 10 <sup>-8</sup>	3.0 · 10 <sup>-2</sup>
Light Rain	1.00	.45	4.8 · 10 <sup>-5</sup>	2.00	138	2.9 · 10 <sup>8</sup>	7.0	1.4 · 10 <sup>-7</sup>	4.4 · 10 <sup>-2</sup>
Moderate Rain	4.00	1.0	5.2 · 10 <sup>-4</sup>	4.00	277	5.3 · 10 <sup>8</sup>	12.3	2.8 · 10 <sup>-7</sup>	8.9 · 10 <sup>-2</sup>
Heavy Rain	15.00	1.5	1.8 · 10 <sup>-3</sup>	5.00	833	4.6 · 10 <sup>8</sup>	13.0	8.3 · 10 <sup>-7</sup>	2.7 · 10 <sup>-1</sup>
Excessive Rain	40.00	2.1	4.9 · 10 <sup>-3</sup>	6.00	1850	3.8 · 10 <sup>8</sup>	13.8	1.8 · 10 <sup>-6</sup>	5.9 · 10 <sup>-1</sup>
Cloudburst	100.00	3.0	1.4 · 10 <sup>-2</sup>	7.00	5400	3.9 · 10 <sup>8</sup>	13.7	5.4 · 10 <sup>-6</sup>	1.7
Snow (Heavy) estimated melted	4.00			.25 1.00	1100 4500				

Please mention SHORT WAVE CRAFT when writing advertisers

ent in a heavy rain storm over a distance of 20 miles, if concentrated into a single sheet, would definitely be sufficient to affect the transmission, we should expect a smaller effect to be caused by the rain because of the relatively small size of the rain drops compared to the wavelength.

In Table 1, various data on fog and rain are given. Columns 1, 2, 3, 5, and 6 were taken from Humphreys' "Physics of the Air." Columns 4, 7, 8, 9 and 10 have been computed from Humphreys' data. The data on snow are our own estimates.

Since the effect of water in the atmosphere may be considered as an attenuation phenomenon, and therefore exponential with respect to distance, the measurements had to be made over as large a distance as possible, in order to obtain sufficient accuracy. In view of the fact, that any surfaces when wet might have reflected the waves differently than when dry, it was also desirable that not only the test location be *line-of-sight* from the transmitter, but that there be a minimum of buildings or other objects on the side of the beam, particularly near the line joining the receiver and transmitter. This meant approximately that there should be as few objects as possible in the circular cone of vertex angle 10 degrees, whose vertex was on the transmitter, and whose axis was the line joining the receiver and transmitter.

An inspection of the available locations in the neighborhood of Camden showed that these conditions could be most effectively and conveniently met by installing the transmitter on one of the upper floors of the engineering building, and the receiver in one of the tall buildings in Philadelphia, as far from the transmitter as possible. The location on the 34th floor of 12 S. 12th St., Philadelphia, was found suitable for the receiver. This was *two miles from the transmitter.*

The transmitter-receiver system was first maintained in operation during several clear days, so that an idea of the constancy of output to be expected could be measured. Having obtained these data, we hoped that several rainy periods would occur and permit a determination of the difference in transmission, after which an additional calibration could be made in clear weather to determine whether any change had taken place in the equipment.

On May 6 and 7, 1935, conditions were very favorable for determining the effect of rainfall on the transmission. Some very heavy short showers took place, followed by periods of no rainfall. The chart of rainfall for these days taken from the tipping bucket chart of the U. S. Weather Bureau at Philadelphia through the courtesy of Mr. Bliss is shown in Fig. 8. The place where the rainfall was recorded was very nearly on the straight line joining the transmitter and receiver points, and about one-half way between them. It was also fortunate that the transmitter and receiver had been in continuous operation for several days previous to these dates.

The meter record from 6 p.m., May 6 to 6 p.m., May 7, is shown on Fig. 9. The heavy line represents the field strength, the dotted line the rainfall. The maximum fluctuation in output was 1 db. This, however, was not connected with rainfall and also was recorded on clear days. The sharp rise at 8:15 a.m. was caused by a change which was made in the transmitter magnetic field. The first rainfall took place at about 11 p.m., reaching a maximum intensity of 2.4 inches an hour, which is what Humphreys calls an *excessive* rain. There were other showers from 3:15 to 5:30 a.m., and shortly after noon. The one at 12:30 reached almost *cloudburst* intensity. With the exception of the early morning shower the short duration of the rainfall makes it improbable that the whole region between the transmitter and receiver was filled with rainfall of maximum intensity at any one time. Comparison of the curves for field intensity and rainfall show that the maximum amplitude attenuation, if any, is less than .1 db. per mile.

On the basis of the data which were obtained, and Table I we are able to decide whether the lighter forms of rain and fog,

mist, or snow should affect the transmission. To do this we will consider the amount and distribution of water in the air separately. Table 1 shows that the mass of water per unit volume was greater for the rains which were tested than for any other form of precipitation and therefore on this basis alone should have caused the greatest effect. As the rain becomes lighter the mass of water decreases and the drop size becomes smaller, but the spacing decreases also. Conditions approach closer to that of water vapor. It is, therefore, interesting to compare the mass of water vapor per cubic meter in saturated air with the water in the air due to the rainfall. (It seems fair to assume that the air is near saturation during all forms of rainfall.) The Smithsonian tables give the water vapor as 22 gms. per cu. meter at 20 degrees C. and 760 mm. mercury pressure. It is rather surprising that this is four times the amount of water due to a heavy rain, and almost 4000 times that of the droplets in a fog. It therefore appears as if the effect of the water vapor should be greater than that of the free water when it is very finely divided and closely spaced and that, therefore, by making the measurement in a heavy rain, the most severe conditions have been encountered.

The comparatively large amount of water in a saturated atmosphere points to the possibility that more effect on transmission might be expected under conditions where the path traverses regions of variable vapor content, than during times of precipitation when humidity is relatively constant. A calculation of the relative index of refraction of moist and dry air, assuming that there is no anomalous change in the dielectric constant at 300 megacycles, compared to lower frequencies, indicates that it should be of the order of 1.0001. The figure of 1.0001 requires either many transitions, or interfaces at very glancing angles to cause noticeable variations in transmission.

In conclusion we may say that the tests, both at Sandy Hook and at Camden, have shown for 3000 megacycle electromagnetic waves: (1) that the attenuation in a clear atmosphere is negligible up to a distance as great as 16 miles, and (2) that the attenuation of the field caused by heavy rain, is less than .1 db. per mile; (3) that an investigation of the water content and drop size of fog, mist and light rain show that their effect on the transmission should be less than that of heavy rain.—*Courtesy of "Broadcast News."* (RCA Victor.)

## New German Zeppelin LZ-129 Contacts U. S. on Short Waves

(Continued from page 72)

an interesting report from the Radio Marine Corp. of America, verifying reception of signals on the 24-meter wave from the LZ-129 and the RCA station located at Chatham, Mass., "worked" the Zeppelin on this wave length. Two way contact was established at 7:20 a.m., E.S.T., on March 5th. The report mentions that the signals from the Zeppelin were good and seemed reliable for commercial operation. The call letters of the LZ-129 are DEKKA.

The huge LZ-129 has nearly twice the gas capacity of the Graf Zeppelin and is 30 feet longer than the ill-fated Akron and the Macon. This new Zeppelin is the largest lighter-than-air craft ever built. She is powered with four 1,100 horsepower Diesel engines, and her top speed is about 84 miles per hour; she can travel 8700 miles without refueling.

**Awards in the \$50.00 Prize Letter Contest which closed March 31, will be published in the July number.**



# Great CATALOG with Everything in RADIO

4 great books in one—not merely an "Amateurs' Supply" pamphlet—nor a " Servicemen's Supplies" leaflet or a "Public Address" circular—or a "Set-Builders' Booklet"—but **Radio's** Leading Supply Guide—**COMPLETE** with **EVERYTHING** for **EVERYONE** in radio—that's the new **ALLIED** Spring and Summer Catalog for 1936. A complete book, a man's-size book, an honest book, with 136 value-loaded pages. 4 complete handy sections—a luxurious Public Address section, an elaborate "Ham" section, a newly revised Set-Builders' section, a handy Service Section—all combined to make your radio buying easier and more economical. For real convenience, for genuine value, for low price—shop your new **ALLIED** Catalog.

Read the elaborate Amateur section—a tremendous assortment of receivers and transmitters to meet every Ham requirement. Also dozens of build-your-own kits. Servicemen! Extraordinarily complete lines of standard, nationally known test equipment; thousands of parts, tools, accessories, books, etc.

P.A. men! Pages 19-36—a panorama of the finest assortment of sales-clinchers, profit-making sound outfits and P.A. equipment that you ever laid eyes on. 4 to 50 watts; permanent and mobile—a sound system for every need. Send your specifications to our Sound Engineering Division for valuable advice and low cost estimates, free of charge.

Radios—page after page of the newest, finest sets ever offered. Actual 1937 models, 4 to 11 tubes; short wave, dual wave, all wave, auto, 6 volt and battery sets. Astounding new "Teletve" sets; deluxe phono-radio combinations in beautiful table and console models. And—special—the amazing new Farm Power units. **WRITE NOW FOR YOUR COPY.**



**ALLIED RADIO CORP.** Dept. E  
833 W. Jackson Blvd., Chicago, Ill.

Send me your **FREE** Spring & Summer Catalog.

I am especially interested in.....

Name .....

Address .....

City ..... State .....

Please mention **SHORT WAVE CRAFT** when writing advertisers



# Oil-Filled CONDENSERS



AEROVOX transmitting condensers are oil-filled and so labelled. • That means an oil-impregnated section placed in a hermetically-sealed seepage-proof metal can filled with oil. • Thus the section is constantly bathed and permeated with oil for constant, cool, safe operation over the longest service life. • So insist on AEROVOX oil-filled (note exact term) condensers. They cost less in the long run.

**DATA** Latest catalog describes superior characteristics of oil-filled condensers. Write for copy and sample of monthly Research Worker.

**AEROVOX**  
CORPORATION  
72 Washington St. Brooklyn, N. Y.

**UNCLE DAVE'S**  
RADIO SHACK  
130 BROADWAY ALBANY, N. Y., U.S.A.

Liberal allowances on your old receivers towards the purchase price of any of the following new receivers:

NATIONAL HRO	RME-69
HAMMARLUND SUPER PRO	RCA ACR-175
PATTERSON PR-12	SUPER SKYRIDER

JUST A FEW LEFT! Peerless 3-tube 3 1/2 watt high gain amplifiers, less speaker, microphone and tubes only \$3.20

LIMITED SUPPLY ORDER NOW!  
BLILEY 20-meter type HF-2 crystals, fully mounted in stock, net \$7.50

Cable Address "Uncle Dave"  
Long Distance Phone 4-5746  
Include 20% deposit with c.o.d. orders  
Prices F.O.B. Albany Foreign Trade Solicited  
Send for new Ham Catalogue—just out!

Send today for your copy of new 16-page booklet crammed full of valuable and vital information on

**"AERIALS AND HOW TO USE THEM"**

Contains diagrams and complete information for eliminating noise on all bands, improving foreign reception, use of antenna couplers, balanced line filters, ultra high frequency transmission and reception, ham operation, and multiple installations for apartment houses and store demonstration hook-ups.

Sent postpaid for a dime  
Arthur H. Lynch, Inc., Dept. S, 227 Fulton St., N.Y.C.

**"HAM" SPECIAL** Standard Teleplex

A highly efficient code teacher using heavy specially prepared waxed paper tape, having two rows of perforations. Write for Free folder "S.W. 4" DEALER—Correspondence invited with dealers for protected territories.

We are the originators of this type instrument.  
TELEPLEX CO.  
72 Cortlandt St., New York City

Instrument, with tapes prepared by expert and complete course of lessons: all for \$11.95

**We Make to Your Specifications**

Metal Cabinets, Chassis, Shield Cans to fit Chassis, Panels—Aluminum or steel.

Send us your drawing for estimates.

**KORROL MFG. CO. Inc., Dept. S-6**  
232 Greenwich St., New York City

# How Hams Sent Flood Warnings

(Continued from page 68)

in the field by commercial companies. If such was the case, it is important to note at this point that the amateur stations would not interfere in any case with any such emergency short-wave station set up by the commercial telegraph and telephone companies, as these stations would operate on special frequency assignments which are entirely out of the amateur frequency bands.

Of course there has always been, and probably always will be, a considerable amount of jealousy on the part of the commercial interest, and in view of the fact that the telegraph and telephone communication lines in the flood districts were practically all out of commission, at least for a time, and in view of the fact that these "Ham" stations could be called upon by any one to transmit a message, it is not improbable that there were more reasons why the Mayor found it desirable to attempt shutting down "Ham" station operations in Johnstown.

A layman might throw up his hands in horror if he were confronted with the whole picture, and think off-hand that it would be a good thing to issue an order shutting down "Ham" stations operating in such a flood district as the Johnstown or other areas, and—being unfamiliar with the technical facts in the case—he might very easily think that a "Ham" station could easily enough interfere with a commercial short-wave station.

Be it said, however, to the credit of the American "Ham" that he obeys the law which permits him to operate his licensed station, and practically all of the stations with any transmitting power worth speaking of, all have their frequencies or wavelengths controlled by a crystal and they are so sharply tuned that there is slight, if any, chance of the "Ham" stations wandering from its frequency or wavelength assignment.

Another important factor bearing on this whole situation, is the fact that the "Ham" station operator is not allowed to accept any fee or transmit a message for pay, and when in an emergency, such as the Johnstown or other flood, he accepts a message from a flood victim, don't forget that if this message gets through, that the person originating the message has had it put through *without charge!* Under the stress of heavy traffic but few commercial telephone circuits were possibly available to carry traffic, and it is problematical what would happen to a flood victim who desired to put through a message either by phone or telegraph, especially if he did not have the money to pay for the telegram or use of the phone circuit.

If the "Ham" needs any further recognition of the excellent service performed by his fraternity, let the public learn that for a considerable time after the flood waters had receded, it was frequently impossible to put through a commercial telephone call to many parts of the flood districts.

Short waves, aside from the amateur angle, provided particularly useful service to the broadcast companies. Many of the exciting broadcast descriptions came from announcers at the actual scenes of the flood, and were picked up on a portable short-wave transmitter and were then relayed through a pickup station located half a mile or so away, and finally found their way on to the national broadcast networks. Some of the apparatus in the broadcast stations located in the flood districts were operated by storage batteries picked up at various stores and garages around town and brought into the station headquarters by row boats.

Communication, essential if relief work was to be carried on and news disseminated, was taxed to the breaking point, and the telephone and telegraph services of necessity had to refuse any but the most important messages. In many instances, the

# INVALUABLE

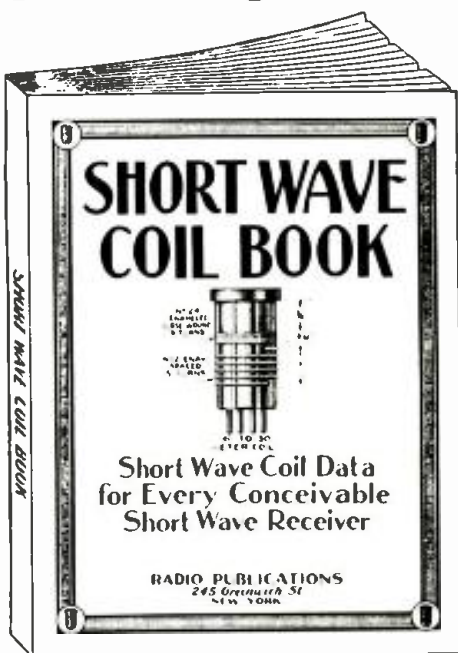

## SHORT WAVE SET BUILDERS MUST HAVE THIS BOOK

It is now possible for the experimenter and short wave enthusiast to obtain the most exhaustive data on short wave coil winding information that has ever appeared in print.

As every experimenter who has ever tried to build a short wave set knows only too well by experience, the difference between a good and a poor receiver is usually found in the short wave coils. Very often you have to hunt through copies of magazines, books, etc., to find the information you require.

Between the two covers of this book you now find every possible bit of information on coil winding that has appeared in print during the past two years. Only the most modern "dope" has been published here.

No duplication. Illustrations galore, giving not only full instructions how to wind coils, but dimensions, sizes, of wire, curves, how to plot them, by means of which any coil for any particular short wave set can be figured in advance, as to number of turns, size of wire, spacing, etc.

There has never been such data published in such easy accessible form as this.

### FRIENDS PESTER HIM

Dear Sirs:

I received your Short Wave Coil Book and am very well pleased. I showed it to my radio friends and now they are always pestering me for coil data. hi hi!

BERNARD A. DECKELMANN,  
11348 So. State St.,  
Chicago, Ill.

**RADIO PUBLICATIONS**  
97 HUDSON STREET  
NEW YORK, N. Y.

Radio Publications 6-36  
97 Hudson Street,  
New York, N. Y.

Please send immediately your Short Wave Coil Book, for which I enclose 25¢ herewith (incl. U. S. stamps or money order acceptable). Book is to be sent prepaid to me.

Name .....

Address .....

City and State .....

Please mention SHORT WAVE CRAFT when writing advertisers



have wrought by the flood destroyed the regular lines, and it was then that the amateur stepped in. Working with hastily constructed emergency sets and handicapped by the necessity of operating from batteries because of power line failures, amateurs were quick to cooperate and organize smooth-running networks, working with clock-work precision on split-second schedules. News collected and sent out over the amateur airways provided the world with first-hand information of flood conditions and property damage.

The short-wave bands of the amateur provided a ringside seat at all of the emergency communications work. In Johnstown, Gerald D. Coleman, R. K. Dixon, and Clarke Olney, operators of W8FRC, W8DY, and W8LNZ respectively, kept their city in contact with the outside world at great risk to themselves. At one time Coleman had to interrupt his work to send out a plea for help because of the rising waters threatening him, and his call was answered by the Johnstown police, who moved him to higher ground. Telephone operators had to leave their posts because of the swirling waters, and for many hours these amateur stations provided the only link with the outside world.

Williamsport, Pa., completely isolated, was served well by the amateur station of Elmer Bond, W8MAH. At Allentown, Pa., Dr. H. A. D. Baer, operating W3EY, relayed many messages from the flooded areas. Dr. Joseph P. Vancheri, of Punxsutawney, Pa., well-known in amateur circles as the owner and operator of W8BWH, worked steadily for the first 56 hours of the flood, relaying relief messages and directions, for the authorities, from devastated Clearfield, 38 miles away.

In New England, at Concord, N.H.,

where all communication was cut off except through the amateur stations of Basil Cutting and C. B. Evans, W1APK and W1BFT, battery power was employed and the city kept in touch with relief agencies for a period of over forty hours until other communications channels were reopened. In Hartford, Conn., the power company, eager to serve their customers, asked the "amateurs" to try and contact their northern power plants! In less than an hour the amateurs had organized a phone net, operating on a wavelength of five meters and with John Reinartz, W1QP, of Manchester, Conn., acting as control station, that ran back and forth throughout Connecticut and Massachusetts, tying in the many substations and keeping officials informed of water levels and power load conditions. When the power finally failed, this net was invaluable in directing the emergency work that brought back power to the city. Al Bisbee, power company employee, operating W1FZA in his automobile, had to be rescued in a boat when the water came up to the seat level of his car.

A peculiar situation arose in Hartford when the telephone lines in Hartford and East Hartford were put out of order by the rising waters. Communication from outside into West Hartford by telephone was not interrupted, but there was no speedy way of relaying messages in to Hartford proper, until amateurs stepped in and supplied a five meter link, tying in the Hartford Red Cross and the East Hartford relief headquarters with the offices of the American Radio Relay League, national amateur organization, whose many amateur networks were furnishing valuable news and relief links.

## Some Little-Known Facts About Short and All-Wave Aerials

(Continued from page 98)

rect derivation from the two quarter-wave antennas, shown in Figure 1. At the center, between D and E, a suitable insulator is provided and the two ends of the twisted pair are connected to the portions of the antennas C-D and E-F. As is the case with the twisted pair, employed in Figure 4, the length of the transmission line, illustrated in Figure 5, is relatively unimportant. An antenna of this nature will function very satisfactorily on all of the short-wave bands, if the two portions of the antenna are cut 20½ feet each or, in other words, have a total over-all length of approximately 41 feet.

Where this type of antenna is to be used for broadcast-band reception as well, it is desirable to provide a special type combination transformer and insulator, which is inserted between the points D and E.

It will be observed in Figure 5, that a rather unique type of coupling device is shown between the end of the transmission line and the Antenna and Ground posts of the receiver. This particular type of transformer has been found to be most effective in reducing noise for the reason that the two windings are made very close to each other and are actually wound in opposite directions. The center tap, running to the ground, provides a means of having any interference picked up by the transmission line introduced to the turns of the receiver transformer in opposite directions, resulting in its complete neutralization, without in any way affecting the strength of the signals picked up by the two portions of the antenna C-D and E-F.

Obviously, a transformer, arranged in this fashion, cannot be made to match the input impedance of all receivers. In order to provide such an impedance match, a variable resistor is introduced between the center tap on the transformer shown by X, and the regular ground connection. This brings about a condition where it is possible to combine the impedance of the winding in the transformer with a variable

impedance, so that together they can be made to form an absolute impedance match with the input winding of the receiver.

### Line Filters

In the past it has been thought that radio interference, commonly referred to as "line noise," was passed up through the electric light line and into the receiver, itself, through the power transformer of the various tube circuits. This premise is not entirely correct. What actually happens is that the interfering parasitic radiations from the electric light or telephone lines create a field around the wires which carry them and since the antenna or the lead-in may be in that particular field, the radiations are then picked up by the antenna or the lead-in and carried to the receiver at the same time as the desired signal. If these radiations are as strong or stronger than the signal, our reception is broken up in a most disagreeable fashion.

In order to prevent radiations of this character reaching the antenna, various types of quenching devices, generally called line-filters, have been developed. Some of them are very elaborate, bulky and expensive. More recently, a new type of line-filter, shown diagrammatically in Figure 6, has been introduced. This filter is designed along exactly the same principles as the noise-reducing antenna, itself. In other words, any disturbances existing on the electric light line passes through the coils and the condensers of this filter and the variable resistance to ground is so arranged that the actual electrical center of the circuit is provided. Since the interference in both sides of the line is identical, it is neutralized at the ground connection and, therefore, the line does not radiate. In a great many cases, it is desirable to try a filter of this nature before any attempt is made to install a noise-reducing antenna. The filter and an ordinary antenna will sometimes do the whole job.

Train at Home Under  
**FACTORY ENGINEERS**  
for **GOOD PAY Spare-Time**  
and **Full-Time Jobs in**  
**RADIO**



LEARN TO EARN  
UP TO **\$75** A WEEK

If you're dissatisfied with small pay—and an uncertain future, get my big FREE book, "RADIO'S FUTURE AND YOURS." This book tells how you can learn at home under the supervision of factory engineers to make more money almost at once in Radio—how to make Radio your life's work, or how to earn \$5 to \$20 a week extra in your spare time.

**MORE OPPORTUNITIES THAN EVER BEFORE**

1935 was Radio's biggest year. Over 5 million new sets sold. Over 30 million dollars paid for service alone. Where only a few hundred men were employed a short time ago, thousands are employed today. And where a hundred jobs paid up to \$75 a week—there are thousands of such jobs today—many paying even more. New full-time jobs and spare-time jobs are being created all the time.

**"SHOP TRAINING" FOR THE HOME**

R-T-I Training is different. It comes to you right out of the factories where Radio sets and other vacuum-tube devices are made. It was planned and prepared and is supervised by radio engineers in these factories—by men appointed for the purpose. R-T-I will train you as the Radio Industry wants you trained.



**BIG MONEY IN AUTO AND POLICE RADIO WORK**

W. H. Carr, 402 N. 16th St., Kansas City, Kans. R-T-I student has charge of 35 radio equipped Police cars. He gets \$200.00 a month and free auto, gas, oil, etc. He says, "If I had not taken your course I would not be able to hold this job."



**MAKES \$600 IN ONE MONTH**

Herbert B. Thomson, Gorman, Texas, started making money with 12 lessons finished. He says, "Because of my R-T-I Training I made \$450 in September and over \$600 in October, 1935. It pays to be R-T-I Trained."

TELEVISION. PHOTO  
ELECTRIC CELLS.  
PUBLIC ADDRESS  
SYSTEMS INCLUDED

Radio service work is plentiful but it's only the starting point in R-T-I Training. From there you'll go through the whole field of Radio and Electronics. You will learn about every new development, including Television so you'll be ready when Television breaks.

**4 WORKING OUTFITS FURNISHED**

Start almost at once doing part-time radio work. I furnish 4 outfits of apparatus that you build into test equipment with which you can do actual jobs and earn extra money. My training pays its own way, and you get your money back if not satisfied. Age or lack of experience is no handicap.

**FREE BOOK**

Find out why R-T-I Trained men get "Quick Results" and "Big Results." Send for "Radio's Future and Yours" today. It tells about Radio's amazing opportunities. It describes my approved training—what R-T-I students are doing and making. It gives the names of 20 firms who endorse and recommend R-T-I. It's FREE.

Ray D. Smith  
President Radio and  
Television Institute  
Dept. 21-A  
2150 Lawrence Ave.,  
Chicago

**MAIL COUPON FOR FREE BOOK**

RAY D. SMITH, President  
Radio and Television Institute (R-T-I)  
2150 Lawrence Ave., Dept. 21-A  
Chicago, Ill.

Without obligating me, send FREE Book about spare-time and full-time Radio opportunities and how I can train for them at home.

Name .....

Address .....

City..... State.....

Please mention SHORT WAVE CRAFT when writing advertisers

**Genuine Aladdin Polyiron Air-Tuned Transformers**



Type G

Provide high gain and sharp tuning in your communication receivers!

Type G air-tuned shielded Aladdin Polyiron i-f transformers for 456-465 kc. Size 4"x1-7/16"x1-7/8".

G101, gain 75, used between converter and i.f. G201, gain 175, i.f. to diode 1/2 megohm load. G101m, gain 65, 6L7-6L7 (Same as Aladdin S2242A). G201m, gain 80, 6L7-6H6 (Same as Aladdin S2242B).

List price each \$5.50  
G101C, crystal filter, center tapped with input for 6C6 or similar tube. List price each \$6.25  
(Gain figures subject to circuit constants)

Send for Polyiron data sheet No. 1135.

**Aladdin Radio Industries, Inc.**  
Licencees of Johnson Laboratories, Inc.

466-sw West Superior Street Chicago, Ill.

These devices are manufactured under one or more of the following U. S. Letters Patents: 1887380, 1940228, 1978568, 1978599, 1978600, 1982689, 1982690, 1997453, 2002500, 2005203, 2018626, 2028534, 2032580, 2032914. Other patents pending.

**STOPPANI COMPASS**

Thousands have been sold in all parts of the world. Cost the U. S. gov't. over \$30.00 each.



**STOCK IS LIMITED**

Rush your order before they are all sold.

Our price prepaid **\$4.50 each**  
**Gold Shield Products Co.**  
17 West 60th St. New York City

**Short Wave League Members**



**IDENTIFY THEMSELVES WITH THE ORGANIZATION**

In order that fellow members of the LEAGUE may be able to recognize each other when they meet, we have designed this button, which is sold only to members and which will give you a professional appearance.

If you are a member of the LEAGUE, you cannot afford to be without this insignia of your membership. It is sold only to those belonging to the LEAGUE and when you see it on another, you can be certain that he is member. See Page 122.  
Lapel Button, made in bronze, gold filled, not plated, prepaid..... **35c**  
Lapel Button, like one described above, but in solid gold, prepaid..... **\$2.00**

**New Battery Type B. C. and S. W. Receiver**

(Continued from page 87)

voice coils with double suspension and diemolded cones, produce fine tone, with a pleasing mellowness essential to good music. This speaker gives volume at any magnitude without blur or distortion; tone that reproduces every measure of melody with its true depth and brilliance; tone as real as life itself.

The new Kadette battery "permanent dynamic" Superheterodyne Model 400 is completely portable, with aerial attached and batteries entirely self-contained, weighing approximately 25 lbs. Uses three ordinary 1 1/2 volt ignition dry cells for "A" supply, giving approximately 300 hours of service. Three portable size B batteries are used, supplying 135 volts and giving extremely long life because of exceptionally low battery drain.

Two distinct tuning ranges cover both standard Broadcast and Short Wave. A superheterodyne circuit is employed, using the following tubes: one 1C6, one 34, one 1B5, and one 950.

The cabinet is in a striking modern design of rich, selected walnut. Completely portable, with aerial attached, and suitable for use on boats, in camps, farms or cottages, or even in automobiles.

This article has been prepared from data supplied by courtesy of International Radio Corp.

**Iron-Core I. F., H-46**

(Continued from page 87)

high-gain super-heterodyne receiver should be especially interested in these transformers.

**MIDGET RELAY RACK, H-47**

● BUD RADIO, Inc., have recently introduced a table model relay-rack, which should be of special interest to our amateur readers. Two sizes are available: One has an over-all height of 25"; a width of 20"; a base depth of 10"; with a panel space of 21". Another model has an over-all height of 32"; width 20"; base depth 12"; and a panel space of 28". Both of these racks are made of heavy gauge sheet steel, finished in baked-on black crackle enamel and drilled to fit standard 19" rack panels. They are shipped knocked down with the necessary self-tapping screws, and offer no difficulty in assembling.

**CABINET TYPE RACK, H-48**

● BUD RADIO have also announced recently a cabinet type relay rack which is shown in the accompanying sketch. This is ideal for power amplifier systems or amateur transmitters. The advantages of this type of rack is that being enclosed there is little likelihood of someone coming in contact with the live apparatus, and also keeps the dust out, thus reducing the losses encountered from the usual dirt that accumulates in radio apparatus.

This is also finished in black crackle enamel and is drilled to accommodate standard 19" panels. The back of this cabinet is made of perforated sheet steel, providing ample ventilation. This unit is also shipped knock-down and has the following dimensions: Over-all height, 36"; width, 20"; depth, 15".

**WAKE UP! FELLOWS!**

\$20.00 Prize Monthly for Best Set

● THE editors are looking for "new" receiving circuits—from 1 to 5 tubes preferably. A \$20.00 monthly prize will be awarded to the best short-wave receiver submitted. The closing date for each contest is 75 days preceding date of issue (May 15 for the August issue, etc.). In the event of a tie, an equal prize will be given to each contestant so tying. Address all entries to: Editor, SHORT WAVE CRAFT, 99 Hudson St., New York City.

**SPRAYER OUTFIT**

ELECTRICAL—PORTABLE **\$32.50** Complete with Gun, ready for Service



This is the ideal Outfit for all around spraying work wherever Current is available. Sprays everything: Lacquers, Oil, Cold Water Paints, Enamels, Varnish, Insecticides, Disinfectants, Shoe Dyes, etc. The Unit is compact, completely self-contained.

Ideal for spraying Furniture, Radiators, Screens, Machinery, and other maintenance paintings in Homes, Schools, Clubs, Hospitals, Stores, Factories, and office Buildings.

The Gun furnished with this Unit is of Pressure Cup type; requires but 2 cu. ft. of Air per minute. Has Bleeder type construction which assures uniform pressure at all times without clogging the Air Passage which is easily cleaned. Furnished with 3 Nozzles which produce Fan, Round, and Right Angle Spray respectively.

Complete Unit consists of Air-cooled Compressor with machined Fan-cooling Pulley, V-Belt Drive; Pressure type Gun with 1 quart Aluminum Paint Cup; 3 Tips; 1/4 H.P. Heavy Duty Motor, 110/120 volt, 60 cycle, AC; 15 ft. rubber covered 2 1/2" Air Hose; 8 ft. Cord & Plug; Filter Tank; Entire Unit mounted on Base with Ball Bearing Casters.

A low priced Power Sprayer; the kind of Machine that usually sells for \$50.00 to \$60.00.

- Price of complete outfit, shipping weight, 60 lbs. **\$32.50**
- Price of outfit complete, less Motor, shipping weight—35 lbs. **\$25.50**
- Price of Gun only with 3 nozzles, shipping weight, 7 lbs. **\$7.50**
- Price of Compressor only, shipping weight 15 lbs. **\$9.50**

**Our Old Customers Know That Our Merchandise Is Sold on a Strict Money-Back Guarantee**

All Shipments will be forwarded by Express Collect if not sufficient postage included with your order.

**WELLWORTH TRADING CO.**

560 W. Washington Bd. Dept. SW-636, Chicago, Ill.

**"Do You Know the Answer?"**

How to Go About Looking for a Job?

How to Better Your Position?

How to Plan Your Career?

The answer to these and many other questions, such as: How to earn money in spare time jobs, what occupation to choose, inside stories of how the other fellow has done it, statistics, facts, will be found in the new monthly magazine

**JOBS & CAREERS**

For Sale at all Newsstands NOW.

Leading articles by vocational experts, personnel directors, leaders of industry tell you how to tackle your problems and how to increase your chances of success.

**IF YOU WANT TO LEARN WHY MOST FELLOWS FAIL, WHERE OTHERS SUCCEED, READ**

On all Newsstands 25c a copy.

If your dealer cannot supply you, send a quarter and we will forward a copy at once.

**JOBS & CAREERS**

520 N. Michigan Avenue. SW6. Chicago, Ill.

# A De Luxe A. F. Amplifier With Triple Tone Control

(Continued from page 75)

amplitude of the frequencies between 4000 and 6000 cycles and especially those frequencies in the vicinity of 5000 cycles.

By proper adjustment of these controls many different frequency response characteristics can be obtained. To note a few, it is possible to eliminate all the low frequencies—leaving only the middle and high frequencies; or, if desired, the *highs* can be eliminated—leaving only the lows and middle frequencies. Another combination eliminates the *middle frequencies* and leaves only the *highs* and *lows*.

The versatility of such an arrangement is obvious. Under some conditions of short-wave reception, the elimination of certain audio frequencies will reduce background noise and improve intelligibility. Some stations have poor modulation and send out muffled signals due to poor high note response in the transmitter. By adjusting this amplifier so that the "highs" are emphasized, this muffled effect can be partially overcome.

Listeners using loudspeakers whose response may be deficient in certain parts of the audio spectrum (generally either the high frequencies or the lows) may, by proper adjustment of the controls of the amplifier, counteract to a considerable extent the shortcomings of the reproducers.

### Useful for Phonograph Pick-up Also

This amplifier may be used also for amplifying the output of a phonograph pickup. For this reason the unit was constructed with a double input arrangement and a transfer switch arrangement so that both a radio and a phono pickup could be left permanently attached to it. By means of the transfer switch one or the other may be used by a flip of the switch.

In addition to the 3 tone controls there is a master volume control (P1).

### 5 Metal Tubes Used

The amplifier consists of 5 metal tubes, in the following arrangement. A 6J7 pentode as first audio amplifier; 6C5 triode as phase inverter; 2-6F6 power pentodes in push-pull as the last audio stage; a 5Z4 as rectifier in the power supply unit. The power output (undistorted) is about 7 watts. As a form of resistance or impedance coupling is used, it is necessary to employ a phase reversing tube to feed the output of the single plate of the 6J7 to the push-pull grids of 6F6 tubes. This is done by the 6C5 tube. It should be noted that the 6C5 contributes no amplification when used as a *phase inverter*. In fact there is a slight loss of amplification through this tube, as its amplification factor under these circumstances is only about 0.7 which is of course less than unity. This loss is not serious as the gain of the 6J7 and the 6F6's is so high that more than enough amplification is available for all normal requirements.

### The Tone Controls—How They Work

The so-called tone controls are potentiometers. In the plate circuit of the first audio tube (the 6J7) there are two resonant circuits consisting of inductances shunted by fixed condensers. The values of the condenser and inductance in shunt determine the frequency at which the combination resonates. The high frequency circuit consists of a 250 mh. R.F. choke shunted by an .004 mf. condenser. This combination resonates at approximately 5000 cycles. This circuit is shunted by a 0-4000 potentiometer (P4). This potentiometer controls the gain of the 5000 cycle circuit. It also serves to "damp" the oscillatory circuit to prevent undesirable howling effects when the gain of this circuit is advanced.

The low frequency circuit consists of a 30 henry filter choke. (This choke is a 22 henry choke designed to pass 35 ma. but as only 1 ma. is passed the inductance

is close to 30 henries.) shunted by a .15 mf. condenser and a 0-3000 ohm potentiometer (P2). This resonant circuit *peaks* at about 70-80 cycles. The potentiometer serves the same purpose as the one in the high frequency circuit. The third tone control is merely a 0-50,000 ohm potentiometer (P3) in series with the *high* and *low* frequency circuits. It is non-resonant but due to its relatively low value as the plate load of a pentode, it does not permit amplification of the low and high frequencies as well as it does the middle range frequencies. The amplification obtained with this resistor alone in the plate circuit thus falls off at the point where the two resonant circuits *peak*.

### Phase Inverter

The phase inverter tube follows conventional practice. Note how the grids of the 2 push-pull output tubes are fed. One feeds from the plate of the 6C5 in conventional manner and the other is fed from the *cathode* circuit of the 6C5.

### Power Supply

The power transformer used is rated to supply 350 volts each side of center tap, with a current drain of 70 ma. As the drain is actually about 80 ma. the voltage delivered is slightly less.

In the schematic diagram it will be noted that the filter condenser in the power supply unit marked C2 appears in 2 places, once in solid and once in dotted lines. If the amplifier is used with a speaker having its own field supply, C2 should be connected as shown by the solid line. This arrangement gives *choke input* to the filter system and reduces the available plate voltage. This is done to keep the voltage applied to the tubes down to 250. If it is desired to excite the field of a loud speaker from the amplifier, then C2 should be connected as shown in the dotted lines. This arrangement will raise the available plate voltage and thus counteract the voltage drop in the field coil of the loud speaker. When C2 is 10 mf. and when the plate transformer and the 15 henry filter choke are nearly identical to the ones used in the original unit, the field coil resistance of the loud speaker should be about 1500 ohms to deliver 250 volts to the plates of the amplifier tubes.

The speaker field should also be able to safely pass a current of 85 ma. If an 800 ohm field is used, the value of C2 should be experimentally reduced to about 2 to 4 mf. in order to reduce the plate voltage to its proper value.

If a high resistance voltmeter is available it should be connected between the plate and *cathode* of one of the 6F6 tubes and different values of C2 tried, till the voltmeter gives a reading of approximately 250 volts. The field coil should be connected at point X in the diagram.

### Parts List

- Fixed Resistors (1/2 watt)**  
 2—5000 ohm insulated (IRC)  
 1—50000 ohm insulated (IRC)  
 2—100000 ohm insulated (IRC)  
 3—.5 meg. insulated (IRC)  
 1—20000 ohm insulated (IRC)  
 1—1. meg. insulated (IRC)  
 1—200 ohm wire wound 10 watt resistor (IRC)  
 1—0-50000 ohm potentiometer with 110 v. power switch (Electrad type 205) P3  
 1—0-3000 ohm potentiometer (Electrad type 233W) P2  
 1—0-4000 ohm potentiometer (Electrad type 277W.) P4  
 1—0-1. megohm potentiometer (Electrad type 206) P1
- Condensers**  
 1—10 mf. can type electrolytic cond. 450 volt working. C2 (Cornell-Dubilier)  
 1—16 mf. can type electrolytic cond. 450 volt working C1 (Cornell-Dubilier)  
 4—1 mf. 400 v. paper cond. (Cornell-Dubilier)  
 1—.15 mf. 400 v. paper cond. (Cornell-Dubilier)

(Continued on page 119)

## ADVANCED . . .

### AMATEUR—PROFESSIONAL RECEIVER

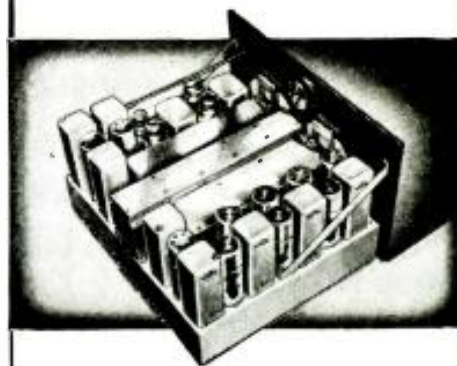

## HAMMARLUND "SUPER-PRO"

The "Super-Pro", the new, outstanding HAMMARLUND amateur-professional receiver is truly the model unit. With more striking features than have ever been incorporated in any receiver, the "Super-Pro" easily will more than provide that exacting efficiency you want! Its performance under the severest of tests by leading authorities in government, airway, police, etc., services has been so remarkable that installations of "Super-Pros" have been enthusiastically authorized for this very important work.

The "Super-Pro" is the only receiver with the exclusive HAMMARLUND, silver-plated, five-band, cam switch that is positively fool-proof and noiseless. The "Super-Pro" is the only receiver with a 12-gang band spread condenser. There are hundreds of other unusual features in the "Super-Pro". Mail the coupon below for the special illustrated bulletin containing a complete description of these features.

Send for your copy today!

Hammarlund Manufacturing Co., Inc. 424-438 W. 33rd St., New York N.Y.

Check here for complete data on the new Hammarlund "Super-Pro"

Check here for the 1936 Hammarlund catalog

Name \_\_\_\_\_

Address \_\_\_\_\_

## AMATEURS



played a very important part in keeping the entire world informed during the recent disastrous floods—when all other means of communication failed.

Trimm Headsets deserve praise for unflinching performance. Write for Catalog 8-6

**TRIMM RADIO MFG. CO.**  
 1770 W. Berteau Ave., Chicago, Ill.

See Page 128 for Remarkable Subscription Offer

Please mention SHORT WAVE CRAFT when writing advertisers

# RADIO INSTRUCTION

## "Go on the Air" as a RADIO AMATEUR

Learn Code and Radio Fundamentals in Spare Time at Home the Famous Candler Way. It's Easy!

CANDLER teaches you Code quickly and easily; how to build and operate your Amateur Station; and go on the air. If you're "stuck" and need help, write for FREE BOOK OF FACTS. It Shows You The Way!

If you already know the necessary Fundamentals of Radio, but need to learn code or develop your speed, write for 1936 BOOK OF FACTS containing helpful information and stories of Candler trained Champions. Your questions answered promptly. No obligation.

9 Year Old Candler Student Received 30 wpm. On Her Typewriter.



JEAN HUDSON, W3BAK Official Champion of the World in Class E.

**CANDLER SYSTEM CO.**  
Dept. S-6, Asheville, N. C.

MAC KEY @ \$7.95 finest speed key built; MAC OSC @ \$3.95 ac/dc oscillator. Tone control; MAC CORD \$1.00 navy spfn speed key cord; MAC MARINE receiver 550-850 meters. r u intd? Few deluxe MAC KEYS @ \$15.00 fm me di. Wri me. T. R. McElroy, 23 Bayside St., Boston, Mass. If u hv May Key wri me for amy ipt & dsrb ifn.

## INSTRUCTOGRAPH

### THE PRACTICAL CODE TEACHER

Radio Or Morse

It's easy to learn code with this sturdy, well-made machine. Book of Instructions shows you how to study to best advantage; you practice at your convenience, and at the speed you want. For Rent—on attractive terms. Rental paid may be applied toward purchase price if desired. For Sale—cash or terms. A descriptive folder and price list are yours for the asking—no obligation. Just send post-card to



INSTRUCTOGRAPH COMPANY, Dept. SW-6  
912 Lakeside Place, Chicago, Ill.  
Canadian Representatives  
Radio College of Canada, Ltd., 863 Bay St. Toronto

## TRI-STATE COLLEGE



Degree in 2 Years

Complete Radio Engineering course in 96 weeks. Bachelor of Science Degree. Radio (television, talking pictures and the vast

electronic field) offers unusual opportunities for trained radio engineers. Courses also in Civil, Electrical, Mechanical, Chemical, Aeronautical, Engineering; Business Administration and Accounting. Low tuition, low living costs. World famous for technical two-year courses. Those who lack high school may make up work. Students from all parts of the world. Located in picturesque hill and lake region of northern Indiana. Enter September, January, March, June. Write for catalog.

2566 COLLEGE AVE.

ANGOLA, IND.

## Radio Amateur Course

(Continued from page 89)

difference in output voltage during changes from minimum to maximum load, is better than the condenser input system. The input chokes CH1 should be of the swinging type. The second choke CH2 can be of the usual 30-henry type; or, in fact, anything from 15 to 30 henries seems to work well, where the input power is obtained from a 60-cycle source. When the power supply is to be operated from a 25-cycle source, the choke inductance and capacities of the condensers should be increased approximately 2.5 times to obtain the same amount of filtering at the output of each one of the filter systems shown.

### Bleeder Resistor

In Figs. 2 A, B, and C, we must employ a so-called *bleeder resistor* or what might be called a "buffer load." The amount of power consumed by the bleeder resistor bears a definite relation to the variation of the power taken from the filter. However, values which give satisfactory results under known conditions are as follows: for 300 volts a 15,000-ohm, 25 to 35-watt resistor; 500 volts 20,000 ohms, 50 watts; for 1,000 volts 25,000 ohms, 100 watts; 1,500 volts 35,000 ohms, 150 watts; 2,000 volts, 100,000 ohms, 200 watts. In some cases, the amateur may find that he has, for instance, two 1,000-volt condensers and desires to employ them in a filter circuit of 2,000-volt power supply.

In Fig. 2 D, we have shown a method of connecting condensers in series and in order to obtain equal voltage across each one of these condensers a voltage divider must be connected across the condensers, as shown in 2 Fig. D. This is also necessary if electrolytic condensers are used in series and the polarity has been indicated. The value of R is not critical, and may be anywhere from 250,000 to 500,000 ohms each. This parallel resistor reduces the effective filtering capacity of the condenser slightly, but can be ignored for all general purposes.

### 3 Power Supply Line-Ups

In Fig. 3, we have three complete power supplies. Fig. 3A, shows the receiving type power supply using the type 80 tube. This circuit is satisfactory for voltages up to around 400. The two condensers marked C1 are used solely to reduce *tunable hums*, and the capacity is not critical. Something in the order of .002 to .006 mf. seems to work satisfactory. The ratings of the chokes depend upon the amount of current taken from the power supply, and also the current drawn by the bleeder R. The inductance, however, should be 30 henries, and the capacity of the condensers C should be 8 mf., electrolytics being the most economical.

In Fig. 3B, we have a full-wave power supply, using separate half-wave rectifiers. If the type 81 vacuum type tubes are used, condensers CX may be employed; that is, *condenser input* may be used to the filter, 1 to 2 mf. being the proper capacity of this condenser. For the mercury vapor type tubes, condenser CX should be eliminated. CH1 should be a *swinging choke* having an inductance of approximately 20 to 100 henries. CH2 may be in the order of 15 to 30 henries. Separate transformers are used for the high-voltage and filament supplies. In all cases, the filaments of the tubes should be switched on several minutes before the switch SW2 is closed.

In Fig. 3C, we have the Bridge rectifier circuit used in a power supply capable of delivering two voltages; this is really two power supplies in one. Here we have uti-

THE PERFECT

## CODE TEACHER!

NEW MASTER TELEPLEX

For beginners, experienced operators, and schoolroom. The sure easy to learn code and to step up your speed. This amazing new instrument will record your own sending on double row perforated paper and repeat it back to you at any speed you desire. 10,000 words can be recorded on one tape.

**NO BATTERIES  
NO WINDING  
ALL ELECTRIC**

**BUY IT OR  
RENT IT**

It is the same in principle and in operation is equal to the Wheatstone Perforator and Transmitter, which cost over \$1,000.

Send for Folder 86 which tells you how to get the use of this instrument without buying it. No obligation. We furnish complete course and personal instruction with a money back guarantee. Low cost, easy terms. Write today for information.

## TELEPLEX CO.

72 Cortland St.

New York City

The New Master Teleplex—"The Choice of Those Who Know"



## RADIO'S LIVEST MAGAZINE

Edited by HUGO GERNSBACK

RADIO-CRAFT is devoted to general Radio in all its phases, to Radio Servicing and to the advanced set builder and Radio Technician. Kinks show simple ways out of difficult problems. The latest radio equipment is illustrated and described.

8

Months for \$1.00

RADIO-CRAFT is fully illustrated with photographs, diagrams and sketches. Each issue contains over 150 illustrations. Sample copy—15c.

## RADIO-CRAFT

39C Hudson Street

New York, N. Y.

## RADIO ENGINEERING



RCA Institutes offers an intensive course of high standard embracing all phases of Radio. Practical training with modern equipment at New York and Chicago schools. Also specialized courses and Home Study Courses under "No obligation" plan. Catalog. Dept. 8W-36.

**RCA INSTITUTES, Inc.**

75 Varick St., New York.

1154 Merchandise Mart, Chicago

Recognized Standard in Radio Instruction. Since 1909

## QUICK WAY to make money in RADIO



Modern receivers are demanding men with modern training for service work. New training method and service equipment offer starts you earning almost at once. 1 1/2 to \$3 an hour easy in a short time. Write today for FREE book of details.

Radio Training Association of America  
Dept. S.W.C.-66  
4521 Ravenswood Ave., Chicago

## RADIO ENGINEERING,

broadcasting, aviation and police radio, servicing, marine radio telegraphy and telephony, Morse telegraphy and railway accounting taught thoroughly. Engineering course of nine months' duration equivalent to three years of college radio work. All expenses low. Catalog free. School established 1874. Dodge's Institute, Turner St., Valparaiso, Ind.

## Be a TELEVISION EXPERT

LEARN TELEVISION WITH RADIO NOW!



Here's opportunity! Get ready for the best paid jobs in Radio as Television sweeps the country. Train at top-rate broadcasting stations. Get actual experience over our Television Station W9XL and commercial station W9WH. Write today for free folder and literature showing actual photos of Television broadcasting, opportunities, etc.

**FIRST NATIONAL TELEVISION, INC.**  
Dept. B-6, Power & Light Bldg., Kansas City, Mo.

Please mention SHORT WAVE CRAFT when writing advertisers

# DATA PRINTS

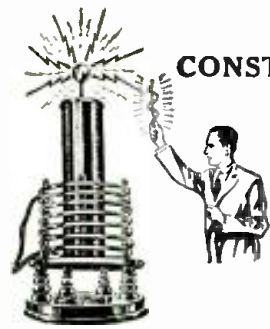

**Just the CONSTRUCTION Information You Need To Build Electrical Apparatus**

**TESLA OR OUDIN COILS**  
Dataprint containing data for constructing this 3 ft. spark Oudin-Tesla coil. Requires 1 K.W. 20,000 volt transformer as "exciter". See list below. Includes condenser data. . . . . **\$ .75**

- 8 inch spark, data for building, including condenser data; requires 1/2 K.W. 15,000 volt transformer; see list below. . . . . **0.50**
- Violetta type, high frequency coil data; 110 volt A.C. or D.C. type; 1" spark; used for "violet ray" treatments and "Experiments" . . . . . **0.50**
- How to operate Oudin coil from a vacuum tube oscillator . . . . . **0.50**
- 3 inch spark Tesla coil; operates on Ford ignition coil . . . . . **0.50**
- 3 inch spark Oudin coil; 110 volt A.C. "Kick-Coll" . . . . . **0.50**
- 20 Tricks with Tesla and Oudin Coils. . . . . 0.60**

- TRANSFORMER DATA**
- 1 k.w. 20,000-volt transformer data, 110-volt, 60-cycle primary. Suitable for operating 3 ft. Oudin coil . . . . . **0.50**
  - 1/2 k.w. 15,000-volt transformer data, 110-volt, 60-cycle primary. Suitable for operating 8-inch Oudin coil . . . . . **0.50**
  - Electric Welding Transf. (2 K.W. 110 Vt. Prim. 18 Vt. Sec. Other Sec. Vt. data given.) . . . . . **0.50**
  - Induction Coils—1 to 12 inch spark data. . . . . **0.50**
  - ARTIFICIAL FEVER Apparatus. . . . . 0.75**
- (Low, Medium & High Power Data Given)



**SLIDE RULE MIDGET**  
Metal 4" Dia.  
Price \$2.00 Net.

This rule solves any problem in multiplication, division, addition, subtraction, and proportion; it also gives roots and powers of numbers, sines, cosines, tangents and cotangents of all angles; also logs of numbers. Adds and subtracts fractions. Approved by colleges.

8" Dia. 25" Scale "Special" Rule. \$5.00 Net.

**TELEGRAPHONE** — Records Voice or "Code" signals on steel wire by magnetism. Code can be recorded "fast" and translated "slow." Construction data (special) . . . . . **\$0.50**

- MAGNET COIL DATA**
- Powerful battery electro-magnet; lifts 40 lbs. . . . . **\$0.50**
  - 110 Volt D.C. magnet to lift 25 lbs. . . . . **0.50**
  - 110 Volt D.C. 300 lb. Lift electromagnet. . . . . **0.50**
  - 110 Volt D.C. solenoid; lifts 2 lb. through 1 in. . . . . **0.50**
  - 110 Volt D.C. solenoid, lifts 6 lb. through 1 in. . . . . **0.50**
  - 12 Volt D.C. solenoid, lifts 2 lb. through 1 in. . . . . **0.50**
  - A. C. Solenoid, powerful, 110-volt, 60-cycle. . . . . **0.50**
  - MOTOR—1/16 H.P., 110 volt A.C., 60 cycle** (suitable for driving 12" fan, etc.)—Data. . . . . **0.50**
  - 60 or 1,200 cycle Synchronous motor Data. . . . . **0.50**

- MISCELLANEOUS DATAPRINTS**
- Electric Refrigerator Data . . . . . **\$0.50**
  - Treasure Locator . . . . . **0.50**
  - Water Turbine . . . . . **0.50**
  - 20 motor circuits—hook-ups. . . . . **0.35**
  - 20 practical telephone hook-ups. . . . . **0.35**
  - 100 mechanical movements for inventors. . . . . **0.50**
  - Polarized Relay—Ultra Sensitive. . . . . **0.50**
  - Electro-medical coil (shocking coil). . . . . **0.50**
  - Water-Wheels—How to Build and Light your house . . . . . **0.50**
  - 20 Electric Bell circuits. . . . . **0.50**
  - Public Address System . . . . . **0.50**
  - Electric chime ringer; fits any clock. . . . . **0.50**

**20 "Electrical Tricks" for LODGES and PARTIES . . . . . \$0.50**

How to Fry Eggs on Cake of Ice Electrically. . . . . **\$0.50**  
"Re-winding" Small Motor Armatures. . . . . **0.50**

**"ENGINEERING SERVICE BY MAIL"**  
(20% off on orders for \$3.00 or more. No C.O.D.)

**The DATAPRINT COMPANY**  
Lock Box 322 RAMSEY, N. J.

lized a center-tap transformer giving approximately 600 volts each side of the center tap. This delivers 1,000 volts through the filter on one side of the B negative, and 500 volts on the other side of B negative. A filament transformer having three separate filament windings is required. The tubes used are three types "83" mercury vapor rectifiers. CH1 in both cases should be *swinging chokes* and CH2 may be from 15 to 30 henries, the same as in 3B. The condensers C, of course, will have to have a rating high enough to safely stand the 1,000 volts, but condensers C1 will require only one-half this rating. If the power transformer, T1, is capable of supplying 300 to 400 ma., this power supply makes an excellent combination to run an entire transmitter, including the low-power stages as well as the final amplifier. We might include a word of warning by saying that all power supplies, regardless of their voltage, are more or less dangerous, and extreme caution should be exercised when working with them. By all means, do not attempt to make any adjustments or connections on or to the power supply *while the unit is in operation*, with the high-voltage being applied to the tubes.

## Foreign Stations

(Continued from page 81)

- DJB—15200 kc.—Zeeseu, Germany.
- DJC—6020 kc.—Zeeseu, Germany.
- DJD—11770 kc.—Zeeseu, Germany.
- DJE—17760 kc.—Zeeseu, Germany.
- EAQ—9860 kc.—Madrid, Spain.
- HBI—9595 kc.—Radio Nations, Geneva, Switzerland.
- HBP—7799 kc.—Radio Nations, Geneva, Switzerland.
- HVJ—15121 kc.—Laudetur Jesus Christus, Vatican City, Italy.
- 2R0—9635 kc.—Prato Smeraldo, Rome, Italy.
- GRK—10330 kc.—Radio Ruysselede, West Flanders, Belgium.
- PCJ—15220 kc.—Eindhoven, Holland.
- PHI—11730 kc.—Radio Hilversum, Eindhoven, Holland.
- TPA3—11880 kc.—Radio Coloniale, Paris, France.
- TPA4—11715 kc.—Radio Coloniale, Paris, France.
- COCD—6130 kc.—La Voz Del Aire, Havana, Cuba.
- COCH—9428 kc.—Havana, Cuba.
- COCO—6010 kc.—Havana, Cuba.
- HHH—6814 kc.—La Voz Del Higuamo, San Pedro de Macoris, Rep. Dom.
- HIL—6528 kc.—Ciudad Trujillo, Dominican Republic.
- HIX—5980 kc.—Ciudad Trujillo, Dominican Republic.
- HIZ—6316 kc.—Ciudad Trujillo, Dominican Republic.
- HIJ—5865 kc.—San Pedro de Macoris, Dominican Republic.
- HP5H—6030 kc.—Miramar, Panama City, Panama.
- HP5J—9590 kc.—La Voz de Panama, Panama City, Panama.
- TGS—5713 kc.—Guatemala City, Guatemala.
- TIPG—6410 kc.—La Voz de la Victor, San Jose, Costa Rica.
- TIRCC—6550 kc.—Radioemisora Catolica Costarricense, San Jose, Costa Rica.
- XEBT—6000 kc.—Mexico City, Mexico.
- HC2RL—6660 kc.—Guayaquil, Ecuador.
- HJABE—6115 kc.—La Voz de "Los Laboratorios Fuentes," Cartagena, Col.
- HJ1ABG—6042.5 kc.—Enisera Atlantico, Barranquilla, Colombia.
- HJ3ABH—6012 kc.—La Voz de la Victor, Bogota, Colombia.
- HJ4ARA—11710 kc.—Ecos De La Montana, Medellin, Colombia.
- HJ4ABE—5950 kc.—La Voz de Antioquia, Medellin, Colombia.
- HJ5ABC—6150 kc.—La Voz de Colombia, Cali, Colombia.
- PRADO—6618 kc.—Riobamba, Ecuador.
- YV2RC—5800 kc.—Broadcasting Caracas, Caracas, Venezuela.
- YV3RC—6150 kc.—Radiodifusora Venezuela, Caracas, Venezuela.
- YV6RV—6520 kc.—La Voz de Carabobo, Valencia, Venezuela.
- VK2ME—9590 kc.—The Voice of Australia, Sydney, Australia.
- VK3LR—9580 kc.—Lyndhurst, Australia.
- VK3ME—9518 kc.—Melbourne, Australia.

## Girl Operators, Attention!

Listen "YL's" and "XL's"! Why not send the Editor a good photo of your "Rig"—and don't forget yourself. A separate photo of yourself will do, with a "clear" photo of that station! \$5.00 for best "YL" photo.—Editor. See page 649 March issue for details.

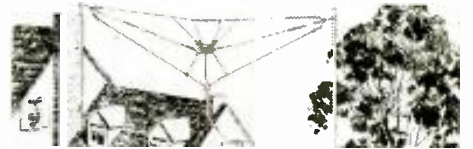

## RCA SPIDERWEB ANTENNA CATCHES ALL SIGNALS

12 to 2100 and 4 to 2100 meters

Here is the first truly all-wave antenna, multiple-tuned to all bands, with built-in coupling transformer that automatically selects the proper segments for the desired band. Provides a tremendously increased signal to the receiver, reduces noise on all short wave bands, and brings in stations you have never heard before.

The RCA Spiderweb Antenna comes complete, all connections soldered, ready to erect. Requires a span of only 38 feet, clearance of 12 feet. Stock No. 9685, 12 to 2100 meters, \$8.95. Kit Stock No. 9689, extending range to 4 meters, making 5 antennas in 1, \$1.50. Write for details.



**SPIDERWEB ANTENNA**  
RCA Parts Division

**RCA MANUFACTURING CO., INC.**

Camden, N.J. A Service of the Radio Corporation of America

## MAILING LISTS

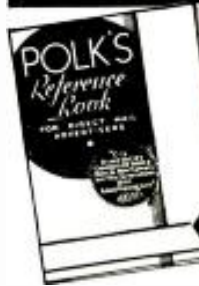

GET OUR FREE REFERENCE BOOK and MAILING LIST CATALOG

**FREE**

Gives counts and prices on accurate guaranteed mailing lists of all classes of business enterprises in the U. S. Wholesalers—Retailers—Manufacturers by classification and state. Also hundreds of selections of individuals such as professional men, auto owners, income lists, etc.

Write today for your copy

## R. L. POLK & CO.

Polk Bldg.—Detroit, Mich.

Branches in Principal Cities

World's Largest City Directory Publishers  
Mailing List Compilers, Business Statistics, Producers of Direct Mail Advertising.



**SPECIAL OFFERING on 1935 Model X power packs**

325 Volts PURE DC at 50 Milli-amperes and 2 1/2 Volts AC CT 5 Amps. Completely wired and tested. Built on heavy steel chassis. Finished in brown crackle. A rare bargain. Uses type 80 tube. Hurry, only 100 left at our

**SPECIAL PRICE of only \$3.48** (tube included)  
General Engineering Corp., Dept. S-6, Charlotte, Michigan

Have you the six best short wave radio books? See our ad on page 124.

# Cut Prices on Many Popular Radio Books

**IMPORTANT—All prices have been drastically reduced—many new books included!**

We herewith present a selected collection of recent important radio books. We have, after an exhaustive study, selected these volumes because they represent the foremost radio books of their kind in print today. There is such a great variety that we are sure it will satisfy any taste as well as any requirement that the student of radio might have. We publish no catalog and ask you to be kind enough to order direct from this page. Prompt shipments will be made to you direct from the publishers. We merely act as a clearing house for a number of radio publishers and **OUR PRICES ARE AS LOW OR LOWER THAN WILL BE FOUND ANYWHERE.** Remit by money order or certified check. Register all letters containing cash.

**AUDEL'S RADIOMAN'S GUIDE.** by Frank D. Graham. Cloth covers (flexible), size 5 1/2 x 7 1/2, 220 pages, 300 illustrations. Price ..... **\$ .89**

A practical, concise book presenting the theoretical and practical information for the proper operation, maintenance and service as applied to modern radio practice.

**EXPERIMENTAL RADIO.** by R. H. Ramsey, Prof. of Physics, Indiana University. Cloth covers, size 7 1/2 x 5 1/2, 256 pages, 168 illustrations. Price ..... **\$2.69**

A marvelous book for the experimenter. Experiments set in easy comprehensible language.

**MODERN RADIO SERVICING** (2nd Revised and Greatly Enlarged Edition of Radio Servicing Course) by Alfred A. Ghirardi. Cloth covers, size 8 x 6 1/2, 1300 pages, over 700 illustrations. Price ..... **\$4.00**

One of the greatest text books in radio servicing. Contains hundreds of facts on up-to-date servicing methods—construction and operation of latest test equipment, auto radios, all-wave receivers, etc.

**DRAKE'S CYCLOPEDIA OF RADIO AND ELECTRONICS.** by H. P. Manly. Cloth covers, size 6 1/2 x 7, 1050 pages, 1080 illustrations, 1932 Edition. Price ..... **\$4.88**

The largest work of its kind ever put between two covers. New and up-to-date; a standby for every radio man.

**FUNDAMENTALS OF RADIO.** by R. H. Ramsey, Professor of Physics, Indiana University. Cloth covers, size 9 1/2 x 6, 372 pages, illustrated. Price prepaid..... **\$3.46**

The backbone of the radio art. This book gives you the foundation on radio from A to Z.

**ELECTRICITY AT HIGH PRESSURES AND FREQUENCIES.** by Henry L. Transom. Paper covers, size 7 1/4 x 5 1/4, 248 pages, 111 illustrations. Price Prepaid ..... **\$1.89**

A marvelous book for the student in electricity and radio. General fundamentals lead up to a complete discussion of every type of Tesla and Oudin high-frequency coils, Geissler tubes, etc.; construction details of Tesla coils are given in great profusion. **THE ONLY BOOK OF ITS KIND.**

**RADIO CONSTRUCTION AND REPAIRING.** by James A. Moyer and John F. Westrod. Cloth covers, size 8 1/2 x 7, well illustrated, new revised fourth edition, containing 444 pages, still remaining **\$2.50** at the same price.

A handbook that every radio set tester and general student must have. The diagrams alone are worth the price of the book.

**THEORY OF VACUUM TUBE CIRCUITS.** by Leo James Peters. Cloth covers, size 6 1/2 x 7, 226 illustrations, 226 pages. Price..... **\$2.98**

It is one thing to "connect green lead No. 1 to pink lead No. 1," but it is another to know why the connections are made. Read this book and learn the design factors in tube circuits.

**HOW TO PASS U. S. GOVERNMENT RADIO LICENSE EXAMINATIONS.** by R. L. Duman and C. E. Drew. Flexible covers, size 6 1/2 x 7, 170 pages, 92 illustrations, appendix. Price ..... **\$1.89**

The most important book on the subject ever published. Gives every conceivable angle which will help you to pass a radio license examination successfully.

**THE RADIO MANUAL.** by George E. Sterling and Robert S. Kruse, E.E. 2nd enlarged edition. Flexible faircloth covers, size 5 3/4 x 7, 805 pages, 318 illustrations. Price ..... **\$5.88**

A complete Radio Course for the operator, the technician, the amateur, the student and experimenter. Everything imaginable in the whole radio art is covered in this great book, the "Radio Bible" of the amateur. **DON'T MISS THIS.**

**OFFICIAL RADIO SERVICE MANUAL.** Volume 4, by Hugo Gienzbach and C. Walter Palmer. Flexible, looseleaf, leatherette cover, size 9 1/2 x 12, over 2,000 illustrations, over 400 pages. Price Prepaid ..... **\$3.00**

Whether for public address work, receiver diagrams or tube data, every conceivable kind of radio set information needed will be found in this great service manual.

**OFFICIAL RADIO SERVICE MANUAL.** Volume 5, by Hugo Gienzbach and C. Walter Palmer. Flexible, looseleaf, leatherette cover, size 9 1/2 x 12, over 3,000 illustrations, over 1,000 pages. Printed on thin Bible paper. Price prepaid ..... **\$5.86**

This 1935 Manual is the most authentic and elaborate service guide ever used in the radio field. There has never appeared such a complete radio manual as this one.

**PRINCIPLES OF RADIO COMMUNICATION.** by J. H. Morecroft, Prof. of Electrical Engineering, Columbia University. Cloth covers, size 9 1/2 x 6, 988 pages, profusely illustrated. Price..... **\$7.35**

THE radio classic, by the dean of radio. Covers entire radio art as does no other book.

**RADIO ENGINEERING.** by Frederick Emmons Terman. Cloth covers, size 6 1/2 x 9, 700 pages, 425 illustrations. Price..... **\$4.88**

Not a book for the beginner in radio, but a reference volume for the technician who wants modern information on the design and use of band-selectors, automatic volume control diode detectors, and the thousand-and-one units and circuit arrangements which have been recently developed.

## HOW TO ORDER

We cannot ship C.O.D. Our prices are net, as shown. Some of the books sent prepaid (in U. S. only). Those that are not thus listed will be shipped by express collect if sufficient postage is not included by you.

**EXPERIMENTAL RADIO ENGINEERING.** by John H. Morecroft. Cloth covers, size 6 1/2 x 7, 316 pages, 250 illustrations. Price ..... **\$3.46**

A student's book; devoted to the principles of radio apparatus; intended to accompany a course in electricity. The best of its kind.

**RADIO OPERATING QUESTIONS AND ANSWERS.** (Revised Fifth Edition), by Nilson and Hornung. Cloth covers, size 5 1/2 x 8 1/2, 390 pages, 96 illustrations. Price..... **\$2.47**

Contains over 600 questions and answers covering all phases of licensed radio operation. Revised to contain much new material. Nothing better in print.

**5 METER RADIOTELEPHONY.** by Frank Jones. 52 pages, 89 illus. Per copy. Price ..... **\$ .25**

Here you learn to construct a variety of 5 meter transmitters and antennas. Written by the designer of the 5 meter equipment for the San Francisco Bay Bridge.

**RADIO PUBLICATIONS, 97 HUDSON ST., NEW YORK, N. Y.**

# A Modulator for the Modern 5-m. Xmitter

(Continued from page 80)

midget power transformer may be used here, to save the trouble of putting on the extra winding. A single midget choke and an 8-16 mf. dual electrolytic condenser furnish adequate filtering.

The main control is an anti-capacity switch which controls the operation of the entire transmitter, and a receiver as well, if desired. The A.C. power lead from the R.F. unit and the receiver are plugged into the A.C. outlet at the rear of the lower chassis. Connections are made to the center-tap of the high voltage supply on the R.F. unit, and to the last audio stage of the receiver, the latter connection functioning to short the audio tube grid to ground, when the switch is in the transmit position. When the knob is in the right-hand position, the entire station is off; when in the center, the receiver is turned on and into operation while all filaments and heaters of the entire transmitter are on, as are both bias supplies; in the left position, the center tap or "B"—connections are closed, putting the transmitter fully in operation, and the receiver is cut off to prevent acoustic feedback.

A toggle switch on the panel opens the plate circuit, while another cuts off the bias supply. The latter also opens the plate circuit, since it would be disastrous to leave the high voltage on with no bias.

The construction is very similar to that of the R.F. unit already described, since an identical wooden rack made of 3/4" square pine is used, together with 1/4" thick pressed wood panels, and 12" x 8" steel chassis. It is, however, straightforward, and proceeds a lot faster than did the R.F. unit, since there are no coils, flexible connections, etc., to be fussed with. The output transformer is rather large, and if mounted on the modulator chassis, would

crowd the other components, so it is simply set on the table behind the rack.

Extensive use is made of lead-covered cable, both single and double. All filament and heater wires are run with it, as are most of the grid and plate leads. This latter probably cuts the overall high frequency response a little, but it is a great help when there is a lot of R.F. floating around, as is inevitable at the ultra high frequencies. The use of this cable incidentally, adds greatly to the neat appearance of the units.

If all work has been properly, and connections correctly made, the unit will work immediately. The "C" bias for the driver stage is set at about 50 volts, while that of the output 45's is varied until the plate current on no-signal conditions is around 90 ma. This current should then swing to about 250 ma. "peaks." The "C" bias voltage will probably be around 80 volts.

The button current of the microphone will be about 20 ma. maximum, although the manufacturer's specifications should be closely followed on individual microphones.

It should be pointed out that 35 watts is a lot of audio power, and is quite capable of ruining equipment if not correctly used; never operate the amplifier without load. For testing, a 5,000 ohm, 100 watt resistor may be connected across the secondary of the output transformer.

## List of Parts

- 1—Power Transformer—T7, Thordarson
- 1—Bias Power Transformer—T6, Thordarson
- 1—Mike input Transformer—T1, Thordarson
- 1—30 H. 150 ma. Filter Choke, Thordarson
- 1—High Impedance A.F. Choke—T2, Thordarson
- 1—15 H. 300 ma. Filter Choke, Thordarson
- 1—3-1 Audio Transformer—T3, Thordarson

- 1—30 H. 50 ma. Choke, Thordarson
- 1—Driver Transformer—T4, Thordarson
- 1—Class AB Output Transformer for 4—45's to 5,000 ohms—T5, Thordarson
- 1—Electrad 2,000 ohm W.W. variable Resistor
- 1—Electrad 500,000 ohm Volume Control
- 1—Electrad 500,000 ohm Tone Control
- 1—Aerovox 5,000 ohm 75 W. Resistor
- 2—I.R.C. 50,000 ohm 2 W. Resistor
- 2—I.R.C. 250,000 ohm 1/2 W. Resistor
- 2—I.R.C. 100 ohm 1/2 W. Resistor
- 1—I.R.C. 4,000 ohm 1 W. Resistor
- 1—I.R.C. 2,000 ohm 1 W. Resistor
- 2—I.R.C. 50,000 ohm 1 W. Resistor
- 2—Aerovox 10 mf. 50 V. Electrolytic Condenser
- 6—Aerovox 1 mf. 400 V. Paper Condenser
- 3—Aerovox 8 mf. 525 V. Electrolytic Condenser
- 1—Aerovox 8—16 mf. 250 V. Electrolytic Condenser with separate leads.
- 1—Aerovox .05 mf. paper Condenser.
- 1—Aerovox .004 mf. paper Condenser.
- 1—Aerovox 30 ohm C. T. Resistor
- 1—50 ma. meter, Triplett
- 1—300 ma. meter, Triplett
- 3—Pilot Lamp Brackets with Jewels
- 2—I.C.A. Double-Pole, Double-Throw Toggle Switches
- 1—Double-Throw, 4 pole, anti-capacity Switch
- 1—I.C.A. Outlet Socket
- 5—I.C.A. 4-prong Wafer Sockets.
- 1—I.C.A. 5-prong Wafer Sockets.
- 1—I.C.A. 6-prong Wafer Sockets.
- 1—I.C.A. 7-prong Wafer Sockets.
- 1—I.C.A. 7-prong Plug.
- 1—I.C.A. 3 Circuit Jack.
- 3—I.C.A. Double Terminal Strips.
- 3—I.C.A. Dial Plates with Knobs, Crowe
- 2—I.C.A. Tube Shields
- 1—I.C.A. 3 Terminal Strip.
- 1—I.C.A. Grid Clip
- 2—Steel Chasses 8" x 12" ICA
- 1—Wood Rack, see text
- 2—Pressed Wood Panels
- Lead Shielded Cable, Connecting Wire
- 5—R.C.A. Type 45's
- 1—R.C.A. Type 2A6
- 1—R.C.A. Type 56
- 1—R.C.A. Type 5Z3
- 1—R.C.A. Type 71A

Please mention SHORT WAVE CRAFT when writing advertisers

**New!** 1936 EDITION

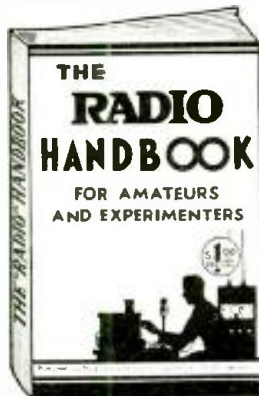

**360 PAGES**  
**OVER 400**  
**ILLUSTRATIONS**  
**AND**  
**DIAGRAMS**

**Complete**  
**Radio Course**  
**AND**  
**Valuable**  
**Reference**  
**Guide**



- ★ Amateurs and experimenters "swear" by the facts in this new Handbook. No space has been wasted on matter which is not of practical use. Nothing of value has been omitted. The book is concise, to the point and profusely illustrated. **PARTIAL LIST OF CONTENTS:** Learning the Code, Fundamental Theory of Electricity, Theory of Vacuum Tubes, both receiving and transmitting, Receiver Design, Crystal Filters, A.V.C., Audio Circuits, Construction and Operation of transmitters, Famous Jones Exciter, Numerous Coil Winding Charts, Radio Telephony, Controlled Carrier Modulation, Complete 53 page chapter of Hi Meter and Ultra-High Frequency Equipment, Complete 25 page chapter on All Types of Antennas, Power Supplies, Test Instruments, Cathode Ray Oscilloscope and Its Application to Short-Wave Receivers and Transmitters, Regulations of the Federal Communication Commission and Board of Fire Underwriters, Complete List of "Q" signals, etc., etc. Size 6"x9". Flexible cardboard covers.
- ★ **ORDER TODAY.** Send \$1.00 plus postage (weight, 2 lb.). Check or money order accepted. Register letter if you send cash or unused U. S. postage stamps.

**RADIO PUBLICATIONS**  
101 Hudson Street New York

**EVERYDAY SCIENCE AND MECHANICS**  
*Is internationally popular for its many scientific and technical articles—*

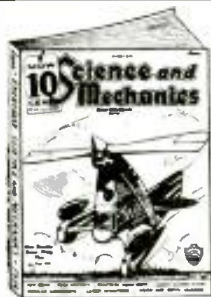

**EVERYDAY SCIENCE AND MECHANICS** is the finest scientific-technical—mechanical—construction magazine in the field. Up-to-the-minute with news flashes of scientific events, dozens of constructional articles and many popular experiments. Ideas from which you can make things to sell.

Edited by **HUGO GERNSBACK**  
*A Host of Interesting Subjects Covered*

Over 150 Illustrations  
Woodworking—Photography—Magic—Patents and Inventions—Book Reviews—Metal-Working—Chemistry—Engineering—Microscopy—Electrical Experiments—Household Hints—Astronomy—Prize Contests—and other subjects.

**10c** copy  
(On all newsstands)  
99-C Hudson St. New York, N. Y.

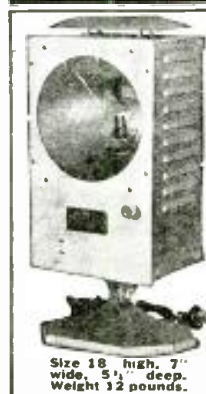

**Professional MODEL CARBON SUN LAMP**

This is a large Chromium plated lamp using standard carbons, emitting rays of ultra violet and infra red. If sun tan is desired, specify **SUN TAN CARBONS**

Complete with screen and goggle \$7.50

Descriptive circular sent FREE.  
**Gold Shield Products Co.**  
17 W. 60th St. N. Y. City

**Book Review**

The Handbook of Applied Mathematics, 728 pages, by Martin E. Jansson, Consulting Engineer, illustrated with diagrams and halftones, cloth covers, Size 5½ by 8 inches, price \$6.00. Published by D. Van Nostrand, New York, N.Y.

This book is quite out of the ordinary in that the author has given a large number of practical examples with illustrations for different types of mathematical problems, such as those met with in mechanical, electrical and other vocations.

Some of the problems presented cover, for example, how to compute the amount of paint required for a certain size building, how to calculate the size of pipes necessary for the distribution of hot and cold water in buildings of various sizes, calculations for size and number of radiators required to heat various areas, machine-shop problems on gears, threads, etc., including a section on automobile shopwork.

The section on electricity is very well written and includes calculations of unknown resistance by means of the Wheatstone bridge, horsepower and kilowatt calculations, watt-hour and kilowatt-hour problems, batteries connected in various forms of series and parallel circuits, etc., also calculation of impedance in alternating current circuits, wire-size calculations, etc.

One chapter is devoted to printing shop measurements, the sizes of type, number of characters per line, etc. A good-size chapter is presented on "Business Mathematics," explaining how to make out statements of assets and liabilities, etc. The book has a comprehensive and valuable index.

Pan-American Dictionary and Travel Guide, 232 pages, cloth covers, size 4 inches by 6 inches by 1½ inches, price \$2.50. Published by International Dictionary Co., New York.

A very valuable and handy English-Spanish, Spanish-English dictionary. There is also provided a general index which helps greatly to locate rapidly the more common Spanish names such as the names of islands, waterfalls, rivers, etc. This dictionary will prove very useful indeed to every short-wave ham and fan, as many South and Central American stations are on the air, both amateur and commercial, over which Spanish is used. Of course, Spanish is used on the short-wave broadcast station in Spain, another reason for studying this book.

**De Luxe A.F. Amplifier**

(Continued from page 115)

- 1—004 mf. 400 v. paper cond. (Cornell-Dubilier)
- 1—25 mf. 20 v. electrolytic cond. (Cornell-Dubilier)
- 1—50 mf. 20 v. electrolytic cond. (Cornell-Dubilier)
- 1—Dual 8mf.-4mf. electrolytic cond. cardboard cased 450 v. working (Cornell-Dubilier)
- 5—Octal wafer tube sockets
- 1—250 mh. R.F. choke (Hammarlund)
- 1—Power transformer with 350-350 v., 70 ma. hi-voltage secondary; 5 volt 2 amp. and 6.3 volt 3 amp. secondaries (Thordarson)
- 1—15 henry filter choke, 85 ma. 375 ohms resistance, cased. (Thordarson)
- 1—22 henry 35 ma. choke (marked 30 henry on diagram) open mounting (Thordarson)
- 1—chassis and cover (Thor Radio)
- 1—6J7 metal tube (RCA)
- 1—6C5 metal tube (RCA)
- 1—5Z4 metal tube (RCA)
- 2—6F6 metal tubes (RCA)
- 1—Single-pole double-throw transfer switch.
- 4—control knobs
- 4—gain control escutcheon plates, marked 1-10.
- 1—pilot light bracket for rear panel mount.
- 1—Ruby "eye" for above.

**SPRING CATALOG**  
**New**  
**FREE**



Right up to the minute! Every last minute price change! Every latest development! All leading manufacturers represented! What more can anyone ask from a catalog?

You'll find a large selection of Lafayette Public Address Equipment . . . amplifiers from 3½ to 100 watts for every conceivable occasion, complete systems, portable and mobile. There are auto radios, aerials, parts and accessories, while a big section is devoted to receivers from 4 to 24 tubes.

Remember—NO non-essentials; only fast selling, profit-making summer sellers! Be sure to get your copy of Catalog No. 63 today—Just address Dept. SW-66.

**NEW LAMB NOISE SILENCER**

We carry all the parts for this new development . . . at lowest WHOLESALE prices.

**WHOLESALE RADIO SERVICE CO.**  
NEW YORK, N.Y.  
100 SIXTH AVE.  
CHICAGO, ILL. 410 W. PEACHTREE ST. N.W.  
301 W. JACKSON BLVD. NEWARK, N.J.  
BRONX, N.Y. 447 E. BROADWAY

**Everything the Short Wave Listener Needs!**  
**The SUPER SKYRIDER**

America's Leading Short Wave Receiver!

It's all there—in one compact cabinet—everything you need to get any signal you want! Complete set average 7.3 to 560 meters in 5 bands—simple positive Band Switch, no tube to coil—9 Metal Tubes—Electro-Mechanical Band Spread—Beat Oscillator—Crystal Filter Circuit—All at a price even you can afford.



ASK YOUR JOBBER OR WRITE TODAY FOR FULL DETAILS.

**the hallicrafters**  
3001-U Southport Ave., Chicago, U. S. A.  
Cable Address LIKEX New York

**PATENTS — TRADE MARKS**  
All inventions submitted held confidential and given personal attention by members of the firm.  
Form "Evidence of Conception" and instructions  
"How to Establish Your Rights"—Free  
**LANCASTER, ALLWINE & ROMMEL**  
PATENT LAW OFFICES  
475 Bowen Bldg. Washington, D. C.

**OXFORD**  
**NEW SPEAKERS**  
with interchangeable Field Coils and Universal Transformer, bring you the outstanding development in Replacement Speakers for 1936. Write TODAY for Bulletin 3615  
**OXFORD-TARTAK RADIO CORP.**  
917 W. VAN BUREN ST., CHICAGO, U.S.A.

Manufacturers of  
**VITREOUS TRANSMITTING GRID LEAKS**  
**VOLUME CONTROLS • POWER RHEOSTATS**  
Write for Complete Free Catalog  
**ELECTRAD, Inc.**  
175 Varick Street, New York

### H. G. Cisin's 2-Tube Metal Tube AIR SCOUT All Electric ALL WAVE



Only Set of its kind in the world

Pat. Pending U. S. Serial No. 592,586. Operates on A.C. or D.C. Self-Contained Power Supply.

POWERFUL—W. C. Ansell, Jr., of Providence, R.I., logged 12 foreign stations the first week. Many Air Scout owners report reception from Spain, England, Germany, Rome and even Australia and Japan. Broadest reception of indoor aerial. Police calls, amateurs, code, weather report, airplane and Trans-Atlantic phone conversations. Speaker on strong stations.

COMPLETE ASSEMBLED KIT, all necessary parts, instructions, picture diagram, less coils, tubes, long wave unit and earphone. ready to wire. \$2.95

Set of four short wave coils, 12 to 200 meters, \$1.25 Earphone (Single) \$1.85 Special long wave unit w/ coil .95 2 Broadcast Coils \$1.45 Total \$9.45

SPECIAL COMBINATION OFFER—Assembled Kit, not wired, \$8.40 2 metal tubes, 6 coils, including Long Wave Unit, earphone. Above, Custom-Built, Wired and Laboratory Tested, ready to use, \$1 extra

H. G. CISIN, Chief Engineer ALLIED ENGINEERING INSTITUTE Dept. S-25 98 Park Place, New York, N. Y.

## World-Wide Short-Wave Review

(Continued from page 83)

A novel way to produce this vernier action or spreading of the critical section of the regeneration control was shown in *Practical and Amateur Wireless* (London) in a late issue.

This consists of cutting the plates of the feed-back condenser in a "fan" shape, leaving only one plate complete and cutting back on successive plates. This allows a more gradual increase in capacity—which is the desired characteristic.

## A 2-Tube, Band-Switching Receiver—for the S-W Fan

(Continued from page 77)

change switch, and the detector tube is located as near these coils as possible. It is advisable to keep the wave-band switch, the two coils, and the detector tube in a group, so that the leads are very short. Either the 6C6 and 76 tube combination may be used for 6.3 volt operation, or the 57 and 56—for 2.5 volt operation.

Power-supply diagrams which may be used with this receiver, may be found in nearly every issue of *Short Wave Craft*, particularly the "Question Box."

### Coil Data

#### Coil 1

Grid: 7 Turns, No. 24 enamelled copper wire, spaced to length of 3/4"; tickler 3 turns No. 30 enamel, close-wound.

#### Coil 2

Grid: 15 Turns, No. 28 enamelled wire spaced to length of 9/16"; tickler 5 turns No. 30 enamel, close-wound. Space between grid and tickler coils 1/4". Coil diameter 3/8".

### Parts List

- 1—2 meg. 1/2-watt resistor, I.R.C.
- 3—1/4 meg. 1/2-watt resistors, I.R.C.
- 1—2,000 ohm 1/2-watt resistor, I.R.C.
- 1—50,000 ohm potentiometer, No. 205, Electroad
- 2—Miller coils (see text for details)
- 1—Yaxley 4-pole double throw rotary switch
- 1—APC 50-mmf. condenser, Hammarlund
- 1—200 mf. tuning condenser, Hammarlund
- 1—.0001 mf. mica condenser, Cornell-Dubilier
- 2—.0005 mf. mica condensers, Cornell-Dubilier
- 2—1 mf. by-pass condensers, Cornell-Dubilier
- 1—.1 mf. by-pass condensers, Cornell-Dubilier
- 1—.006 mf. mica condenser, Cornell-Dubilier
- 1—2.1 mh. R.F. choke, Hammarlund
- 1—6 prong isolantite socket, Hammarlund
- 1—5 prong wafer socket, Eby
- 1—4" vernier dial, I.C.A.
- 1—panel and chassis (see text), I.C.A.
- 1—6C6 or 57 tube, R.C.A.
- 1—76 or 56 tube, R.C.A.

## Universal A.C. Bridge

(Continued from page 87)

to within 5 per cent over all. The frequency of the audio oscillator in the bridge is 1,000 cycles, plus or minus 10 per cent. The "null indicator" is a high impedance headphone of 2,000 ohms resistance or more, which is not included with the bridge. The bridge has phasing controls which makes accurate balancing easy. A common scale—1 to 10—is easily interpreted on all ranges. For the ranges already cited, the bridge will make these measurements with no additional standards to purchase. The bridge comes with all tubes, power supply and standards.

This article has been prepared from data supplied by the courtesy of RCA Manufacturing Co.

Short Wave Fans will find many valuable articles in the next issue.

Don't Miss It!

Please mention SHORT WAVE CRAFT when writing advertisers

# TWO GREAT S-W BOOKS

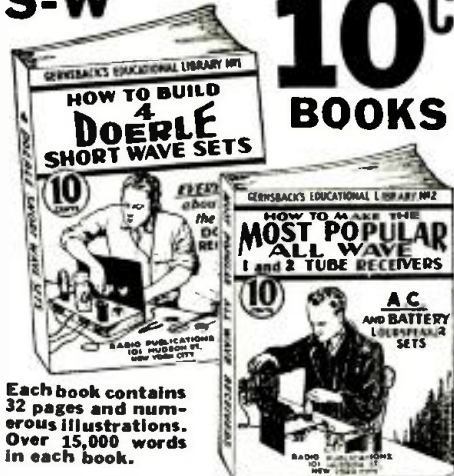

Each book contains 32 pages and numerous illustrations. Over 15,000 words in each book.

### HOW TO MAKE FOUR DOERLE SHORT WAVE SETS

LITERALLY thousands of radio fans have built the famous DOERLE Short Wave Radio Receivers. So insistent has been the demand for these receivers, as well as construction details, that this book has been specially published.

Contains EVERYTHING that has ever been printed on these famous receivers. These are the famous sets that appeared in the following issues of SHORT WAVE CRAFT: A 2-Tube Receiver that Reaches the 12,500 Mile Mark, by Walter C. Doerle (Dec., 1931-Jan., 1932); "A 3-Tube 'Signal-Gripper,'" by Walter C. Doerle (November 1932); "Doerle '2-Tube' Adapted to A. C. Operation" (July 1933); "The Doerle 3-Tube 'Signal-Gripper' Electrified," (August 1933) and "The Doerle Goes 'Hand-Spread'" (May, 1934).

Due to a special arrangement with SHORT WAVE CRAFT, we present a complete 32-page book with stiff covers, printed on an extra heavy grade of paper with numerous illustrations. Nothing has been left out. Not only are all the DOERLE sets in this book, but an excellent power pack if you wish to electrify any of the DOERLE sets, is also described.

### HOW TO MAKE THE MOST POPULAR ALL-WAVE 1- and 2-TUBE RECEIVERS

THERE has been a continuous demand right along for a low-priced book for the radio experimenter, radio fan, Radio Service Man, etc., who wishes to build 1- and 2-tube all-wave sets powerful enough to operate a loudspeaker.

This book contains a number of excellent sets, some of which have appeared in past issues of RADIO-CRAFT. These sets are not toys but have been carefully engineered. They are not experiments. To mention only a few of the sets the following will give you an idea.

The Megadyne 1-Tube Pentode Loudspeaker Set, by Hugo Grunback. Electrifying The Megadyne. How To Make a 1-Tube Loud-speaker Set, by W. P. Chesney. How To Make a Simple 1-Tube All-Wave Electric Set, by F. W. Harris. How To Build A Four-In-Two All-Wave Electric Set, by J. T. Bernsley, and others.

Not only are all of these sets described in this book, but it contains all of the illustrations, hookups, etc.—And believe it or not, each book contains over 15,000 words of new legible type. Each book is thoroughly modern and up-to-date. All the latest improvements have been incorporated into the sets.

Remember, these books sell at the extraordinary low price of ten cents; you can not possibly go wrong in buying them. Despite its low cost, our usual guarantee goes with this book as well!

IF YOU DO NOT THINK THAT THESE BOOKS ARE WORTH THE MONEY ASKED FOR THEM RETURN THEM WITHIN TWENTY-FOUR HOURS AND YOUR MONEY WILL BE INSTANTLY REFUNDED.

There has never been such a wealth of data published in low-priced radio books of this type in the history of the radio publishing business. Take advantage of the special offer we are making and use the coupon below.

RADIO PUBLICATIONS 101 Hudson Street New York, N. Y.

RADIO PUBLICATIONS SW-6-36 101 Hudson Street New York, N. Y.

Please send immediately books checked: [ ] How to Build Four Doerle Short-Wave Sets.....10c [ ] How to Make the Most Popular All-Wave 1- and 2-Tube Receivers.....10c I am enclosing.....c; the price of each book is 10c. (Coin or U.S. Stamps acceptable.) Books are sent post-paid.

Name ..... Address ..... City..... State.....

### UNIVERSAL VELOCITY AND CARBON MICROPHONES

Universal's latest achievement—Ideal for stage use—Not affected by temperature or humidity—Flat frequency response curve from 40 to 10,000 c.p.s.; Output 43 db; Low impedance or direct to grid types. Compact 2 3/4 x 3 1/2 in. by 1 1/2 in. thick—Weight, less than 18 oz.—Hood swings to any desired angle—Beautifully finished in black enamel and artistic chrome plate—ask for new catalog sheet describing models RL, RP, RH and CB—List \$22.50—Latest model music type sectional stand for above microphones—List \$10.00.

UNIVERSAL MICROPHONE CO., Ltd. 424 Warren Lane Inglewood, Calif., U.S.A.

## HAVE YOU EVER TRIED OUR QUICK SERVICE?

WE STOCK A COMPLETE LINE OF NATIONALLY ADVERTISED RADIO FOR THE DEALER THE SERVICEMAN PARTS AND THE AMATEUR

Our catalog on request only to those living in Pennsylvania—Ohio—W. Virginia.

# CAMERADIO

601-3 GRANT ST., PITTSBURGH, PA. 30 TWELFTH ST. WHEELING, W.VA. Established 1919

## RADIOS..SAVE UP TO 50%

DEAL DIRECT: Factory Price. Many models to select from A.C.-D.C. All-wave, Farm, Car and new metal Tube Models. Your name and address on postcard brings you N.W. 24-page 1936 Barasin Catalog in colors FREE. Get details of 30-DAY TRIAL plan and Agent-User proposition. Goldstone Radio Co., Dept. 285 8780 Grand River, Detroit, Mich.

Free Catalog

30 DAY TRIAL \$6.98

## THE NEW "Rebroadcast" EXPLORER

Makes any Radio a Complete All-purpose Amplifying System. Attach phonograph pick-up, microphone, or short wave set to its input—for amplification by the entire radio receiver and loud-speaker reproduction with tremendous volume! Also operates as best oscillator, wave-meter, etc. Many amazing features. Net Price, \$8.95 complete less tube. Send now for FREE Literature.

RIM RADIO MFG. CO., 683 Grand St., Brooklyn, N. Y.

### QUALITY PARTS FOR HAMS SERVICEMEN RADIO INDUSTRY

Complete facilities to meet every requirement in drilling and engraving of panels, and an all insulating materials and metals. Write today for complete descriptive catalog on parts of standard manufacture. Send 10c in stamps or coins to cover cost of handling and mailing.

INSULINE CORP. OF AMERICA 25 PARK PLACE NEW YORK, N. Y.



# New! - GREATEST

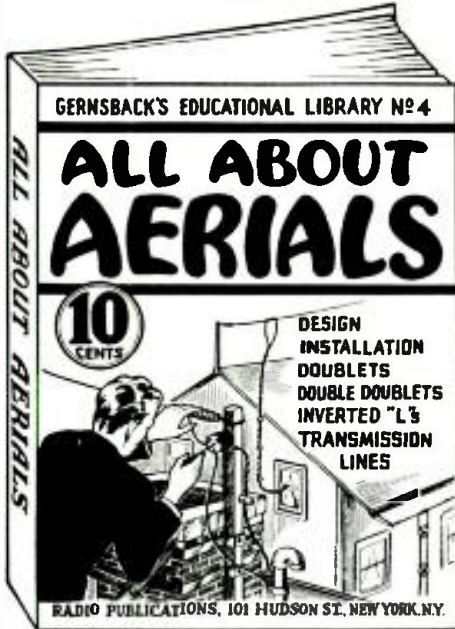

IN recent months the radio public has been made aerial-conscious by virtue of the many articles and advertisements on Aerial Equipment which have appeared in many radio magazines and literature. These articles have been so diversified, and in many cases so conflicting, that the radio experimenter, fan and Service Man are beginning to scratch their heads and ask: "What's it all about?" As a consequence, the demand for a low-priced book explaining in a clear, lucid manner the principles underlying the design and installation of efficient aerials has become a crying need. Furthermore, the steadily increasing nuisance of man-made static, resulting in noisy radio reception—particularly in connection with short-wave receivers—has made the importance of a good antenna a paramount issue. For the thousands of radio fans, both short-wave and broadcast, who wish to know just what type of antenna they should use and why, this book has been especially published.

### ALL ABOUT AERIALS

In simple, understandable language this book explains the theory underlying the various types of aerials; the inverted 'L', the Doublet, the Double Doublet, etc. It explains how noise-free reception can be obtained, how low-impedance transmission lines work; why transposed lead-ins are used. It goes into detail on the construction of aerials suitable for long-wave broadcast receivers, for short-wave receivers, and for all-wave receivers. The book is profusely illustrated in a manner which will appeal to the most inexperienced in radio; clear, self-explanatory; it is written in so simple a style that it will clear up the aerial situation in your mind, once and for all. Such a wealth of information is presented in this book that you will wonder how it can be done at this low price.

Believe it or not, the book contains over 15,000 words of clear, legible type, it is thoroughly modern and up-to-date.

Remember that this book sells at the extraordinary low price of 10c; you cannot possibly go wrong in buying it. Despite its low cost, our usual guarantee goes with this book.

**IF YOU DO NOT THINK THAT THIS BOOK IS WORTH THE MONEY ASKED FOR IT, RETURN IT WITHIN 24 HOURS AND YOUR MONEY WILL BE INSTANTLY REFUNDED.**

There has never been such a wealth of data published in a low-priced radio book at this price in the history of radio business. Take advantage of this special offer we are making and use the coupon below.

**RADIO PUBLICATIONS  
101 Hudson Street  
New York, N. Y.**



RADIO PUBLICATIONS (No. 4) SW-6-36  
101 Hudson Street  
New York, N. Y.

Please send immediately your book "ALL ABOUT AERIALS," for which I enclose 10c (coin or U. S. stamps, acceptable). Book is to be sent prepaid to me.

Name .....

Address .....

City..... State.....

## Ham "Net" to Report Sailboat Races

(Continued from page 73)

boats, so that a record of progress can be kept on a "Master Chart." In this way those enthusiasts remaining ashore will be able to follow the race over its entire course. Not only will such broadcasting create a new interest in long distance sailboat racing but it will give the Amateur Radio Operators in this area a new experiment that should prove most interesting. And of course those volunteer recruits selected to operate the sets aboard the boats will find themselves taking active part in one of the cleanest and most fascinating sports of this day.

Each Radio Amateur or "Ham" desirous of taking part in this new FUN will be expected to furnish his own set and the boat-owners will do the rest. There are about eighteen entries in each race and this, multiplied by four, will give you the number of Hams that will sail during the season.

We have had a most satisfactory response from the "boys" so far, but there is still room for more applicants, so I suggest that you, who have your sea-legs and would like to take part, correspond with Arthur Lynch of the Garden City Radio Club, Garden City, L.I. Mr. Lynch will be glad to answer questions regarding the mechanical problems, as well. His station call, by the way, is W2DKJ portable. I assure you that this is the first leg on a venture that is going to develop more and more angles of equal importance to the Amateur Radio World.

The shore relay system has been organized up to a fairly efficient point, but we can still use a few more recruits in that section. The "net-work" so far includes the following localities:

North Pelham, Nuroton Heights, Fairfield Beach, Locust Valley, Garden City, East Northport, Port Jefferson, Riverhead, Montauk Point, Amaganset, East Hampton, and Babylon.

In addition to the "shore net-work," a power boat equipped with 110 D.C. power supply will follow the fleet to pickup signals from boats that might get out of range of the nearest shore station. Incidentally, several operators may sail aboard this boat, due to its increased accommodations over that of a sail-boat.

According to one of the questions I have been asked, it seems that some of the boys are worried about wardrobe. If anyone believes that the races are "dressy affairs" because they come under the head of Yachting, discard the idea at once. Wear any old outfit that will keep you warm.

The two longest races of the season will be from Execution Light, at the upper end of the Sound around Block Island and return, also the competition starting from Larchmont Y.C., Larchmont, L.I., and continuing around Fire Island Light-Ship and return.

Both of these races are approximately *three hundred miles long!* They are purposely held over the week-ends, so that owners and crews can be back at the office on Monday morning. We have until around the middle of June to complete preparations, so let's get busy! Mr. Lynch and I will be sailing up and down the Sound around May first, in order to test out the system, so be "listening in."

In the *New York Sun* of Friday, March 20th, there was a complete outline of a radio transmitting and receiving set that was specially designed for the plan we have in mind. The 5-meter transmitter and receiver will be described in the next issue of *Short Wave Craft*.

(P.S.—May I express my admiration for those Amateurs taking part in the broadcasting of Flood news.)

**HAMS!**  
**Don't Miss That JULY**  
**Number**

# New! - 10c BOOKS

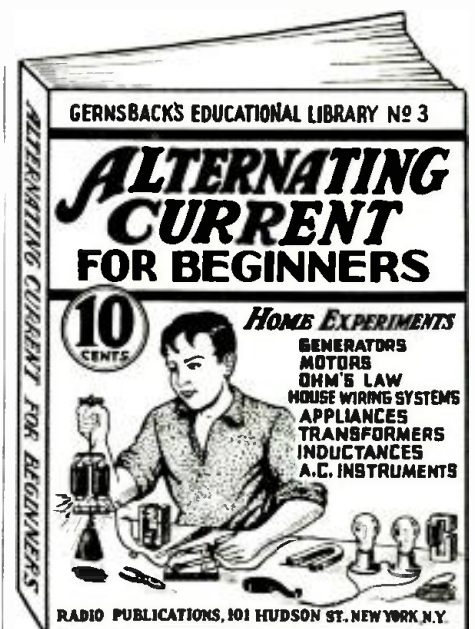

LITERALLY thousands of beginners each year ask the question: "HOW CAN I GET STARTED IN RADIO?" In order to understand the theory of radio, it is necessary first of all to have a fundamental knowledge of electricity and, particularly of alternating currents. We stress this point because radio is a study of alternating currents of a very high frequency nature.

In this book, which is prepared especially for new beginners, we explain in a simple, lucid manner: How Alternating Current is Generated; What its Properties Are; What The Laws Governing It Are, and How It is Applied to Everyday Household Use. Furthermore, we give in simple language detailed instructions on how to perform practical experiments with alternating current in the home.

### ALTERNATING CURRENT FOR BEGINNERS

This book contains everything necessary to give the beginner his first foothold in the study of electricity and Radio. Electric circuits are explained with simple analogies to hydraulic systems. Ohm's Law, one of the fundamental laws of radio, is thoroughly explained; the generation of alternating current; sine waves; the units—volts, amperes, and watts are explained. Condensers, transformers, A.C. instruments, motors and generators—all these are thoroughly discussed. Home-wiring systems, electrical appliances and electric lamps nothing has been left out.

Here are some of the practical experiments which you can perform at home. Simple tests for differentiating between alternating and direct current; how to light a lamp by induction; how to make a simple electric horn; how to demagnetize a watch; how to test motor armatures; how to charge storage batteries from A.C.; outlet; how to test condensers with A.C.; how to make A.C. electro magnets; how to fry eggs on a cake of lee; how to make simple A.C. motors and many others.

The book contains 32 pages, profusely illustrated with clear, self-explanatory diagrams. It contains over 15,000 words of clear, legible type. It is an education in itself and lays the groundwork for a complete study of radio and electricity.

At the extraordinary price of 10c, you cannot possibly go wrong. Despite its low cost, however, our usual guarantee goes with this book.

**IF YOU DO NOT THINK THAT THIS BOOK IS WORTH THE MONEY ASKED FOR IT, RETURN IT WITHIN 24 HOURS AND YOUR MONEY WILL BE INSTANTLY REFUNDED.**

There never has been such a wealth of data published in a low-priced radio book of this type in the history of the radio publication business. Take advantage of this special offer we are making and use the coupon below.

**RADIO PUBLICATIONS  
101 Hudson Street  
New York, N. Y.**

RADIO PUBLICATIONS (No. 3) SW-6-36  
101 Hudson Street  
New York, N. Y.

Please send immediately your book "ALTERNATING CURRENT FOR THE BEGINNER," for which I enclose 10c (coin or U. S. stamps acceptable). Book is to be sent prepaid to me.

Name .....

Address .....

City..... State.....

# ••• SHORT WAVE ESSENTIALS FOR MEMBERS OF THE SHORT WAVE LEAGUE •••

**Application for Membership SHORT WAVE LEAGUE**

SHORT WAVE LEAGUE 6-36  
99-101 Hudson Street, New York, N. Y.

I, the undersigned, herewith desire to apply for membership in the SHORT WAVE LEAGUE. In joining the LEAGUE I understand that I am not assessed for membership and that there are no dues and no fees of any kind. I pledge myself to abide by all the rules and regulations of the SHORT WAVE LEAGUE, which rules you are to send to me on receipt of this application.

I consider myself belonging to the following class (put an X in correct space): Short Wave Experimenter  Short Wave Fan  Radio Engineer  Student  I own the following radio equipment:

Transmitters .....  
Call Letters .....  
Receiving .....  
Name .....  
Address .....  
City and State .....  
Country .....

I enclose 10c for postage and handling for my Membership Certificate.

**A FEW WORDS AS TO THE PURPOSE OF THE LEAGUE**

The SHORT WAVE LEAGUE was founded in 1930. Honorary Directors are as follows: Dr. Lee de Forest, John L. Reinartz, D. E. Replogle, Hollis Baird, E. T. Somerset, Baron Manfred von Ardenne, Hugo Gernsback, Executive Secretary.

The SHORT WAVE LEAGUE is a scientific membership organization for the promotion of the short wave art. There are no dues, no fees, no initiations, in connection with the LEAGUE. No one makes any money from it; no one derives any salary. The only income which the LEAGUE has is from its short wave essentials. A pamphlet setting forth the LEAGUE'S numerous aspirations and purposes will be sent to anyone on receipt of a 3c stamp to cover postage.

**FREE MEMBERSHIP CERTIFICATE**

As soon as you are enrolled as a member, a beautiful certificate with the LEAGUE'S seal will be sent to you, providing 10c in stamps or coin is sent for mailing charges.

Members are entitled to preferential discounts when buying radio merchandise from numerous firms who have agreed to allow lower prices to all SHORT WAVE LEAGUE members.

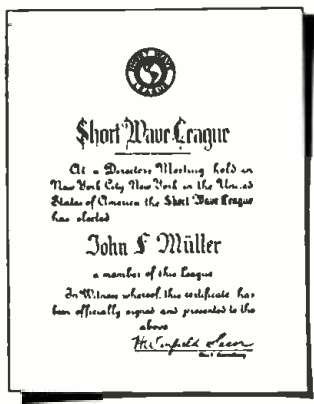

If you wish your name engraved on the Free membership certificate, as illustrated above, please send 25c to cover cost.

**SHORT WAVE ESSENTIALS LISTED HERE SOLD ONLY TO SHORT WAVE LEAGUE MEMBERS**

They cannot be bought by anyone unless he has already enrolled as one of the members of the SHORT WAVE LEAGUE or signs the blank on this page (which automatically enrolls him as a member, always provided that he is a short wave experimenter, a short wave fan, radio engineer, radio student, etc.).

Inasmuch as the LEAGUE is international, it makes no difference whether you are a citizen of the United States or any other country. The LEAGUE is open to all.

**SHORT WAVE LEAGUE LETTERHEADS**

A beautiful letterhead has been designed for members' correspondence. It is the official letterhead for all members. The letterhead is invaluable when it becomes necessary to deal with the radio industry, mail order houses, radio manufacturers, and the like; as many houses have offered to give members who write on the LEAGUE'S letterhead a preferential discount. The letterhead is also absolutely essential when writing for verification to radio stations either here or abroad. It automatically gives you a professional standing.

**A—SHORT WAVE LEAGUE letterheads, per 100..... 50c**

**OFFICIAL SHORT WAVE LISTENER MAGAZINE**

The finest magazine of its kind ever published—totally different in get-up and contents from any other. Contains the largest listing of short wave stations in the world, up-to-the-minute, including "Police," "Television" and short-wave stations, as well as a special list of the star short-wave stations with their frequencies and call letters. Also contains photos and descriptions of short-wave broadcasting stations in various parts of the world with photos of short wave studio artists—How to locate "weak" distance stations, and other hints for the "short-wave listener"—Question and Answer Department for the "listener"—Silver Cup Trophy for best photo of readers' listening "Posts," etc.

**B—Official Short Wave Listener Magazine.....Prepaid 15c**

**RADIO MAP OF THE WORLD AND STATION FINDER**

The finest device of its kind published. The world's map on heavy board is divided into 23 sections, while the rotary disc shows you immediately the exact time in any foreign country. Invaluable in logging foreign stations. Also gives call letters assigned to all nations. Size 11"x22".

**C—Radio Map of the World and Station Finder.....Prepaid 25c**

**GLOBE OF THE WORLD**

This highly important essential is an ornament for every den or study. It is a globe, 6 in. in diameter, printed in fifteen colors, glazed in such a way that it can be washed. This globe helps you to intelligently log your foreign stations. The base is of solid walnut, and the semi-meridian of a nickel-like metal. Entire device substantially made, and will give an attractive appearance to every station, emphasizing the long-distance work of the operator.

**D—Globe of the World.....Prepaid 89c**

**SHORT WAVE LEAGUE LAPEL BUTTON**

This beautiful button is made in hard enamel in four colors, red, white, blue and gold. It measures three quarters of an inch in diameter. By wearing this button, other members will recognize you and it will give you a professional air. Made in bronze, gold filled, not plated. Must be seen to be appreciated.

**E—SHORT WAVE LEAGUE lapel button.....Prepaid 35c**

**EE—SHORT WAVE LEAGUE lapel button, like the one described above but in solid gold.....Prepaid \$2.00**

**SHORT WAVE LEAGUE SEALS**

These seals or stickers are executed in three colors and measure 1 1/4 in. in diameter, and are gummed on one side. They are used by members to affix to stationery, letterheads, envelopes, postal cards and the like. The seal signifies that you are a member of the SHORT WAVE LEAGUE. Sold in 25 lots or multiples only.

**G—SHORT WAVE LEAGUE seals.....per 25, Prepaid 15c**

**SHORT WAVE MAP OF THE WORLD**

This beautiful map, measuring 18x26 in. and printed in 18 colors is indispensable when hung in sight or placed "under the glass" on the table or wall of the short wave enthusiast. It contains a wealth of information such as distances to all parts of the world, political nature of the country in which a broadcast station is located, etc., and from the manner in which the map is blocked off gives the time in different parts of the world at a glance.

**F—SHORT WAVE Map of the World.....Prepaid 25c**

**PLEASE NOTE THAT ABOVE ESSENTIALS ARE SOLD ONLY TO MEMBERS OF THE LEAGUE—NOT TO NON-MEMBERS WITH EXCEPTION OF ITEM B.**

Send all orders for short wave essentials to SHORT WAVE LEAGUE, 99-101 Hudson Street, New York City.

If you do not wish to mutilate the magazine, you may copy either or both coupons on a sheet of paper.

**SHORT WAVE LEAGUE 99-101 Hudson St., New York, N. Y.**



**G—15c for 25**



**F—25c each**



**C—25c each**



**D—89c each**



**E—35c each**

SHORT WAVE LEAGUE, 99-101 Hudson Street, New York, N. Y.

Gentlemen:

I am already an enrolled member in the SHORT WAVE LEAGUE

I am a new member and attach my application to this coupon.

Please send me the following short wave essentials as listed in this advertisement:

.....  
.....  
.....

for which I enclose \$..... herewith.

(The LEAGUE accepts money order, cash or new U. S. Stamps in any denomination. Register cash and stamps.)

Name.....  
Address.....  
City and State.....  
Country.....

6-36

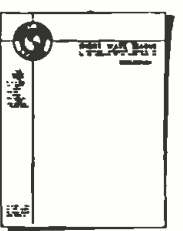

A—50c per 100



B—15c per copy



ROTARY DISC



C—25c each



D—89c each



E—35c each

Please mention SHORT WAVE CRAFT when writing advertisers

**NO ONE READS AND THEN DISCARDS SHORT WAVE CRAFT**

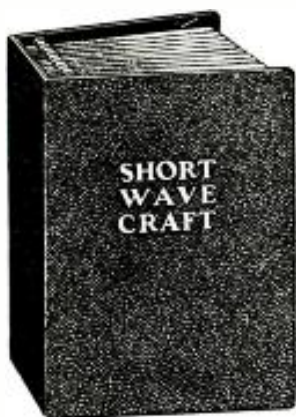

Readers keep their copies for years as a steady reference and thousands of letters attest to this.

It is now possible to save your copies and for this purpose we designed a splendid binder for you which holds twelve copies. It is made of heavy substantial material and is covered with black grain leatherette. The name of the magazine is stamped in gold on the cover.

An ingenious mechanical arrangement is provided which makes it possible to hold the copies flat when reading from the binder.

SHORT WAVE CRAFT Binder as described, prepaid in the United States **\$1.25**

Canada and foreign countries 25c extra. We accept money order, check, stamps or cash.

**SHORT WAVE CRAFT**

99-101 HUDSON ST., NEW YORK, N. Y.

**Short Wave League Letter-heads**

Designed for Members



This is the official letterhead

It is invaluable when it becomes necessary to deal with the radio industry, mail order houses, radio manufacturers. It can be used in many ways and gives you a professional standing. No member of the LEAGUE can afford to be without this letterhead.

This can only be used by members of the LEAGUE. No one else can purchase it.

Take advantage of this opportunity to handle your LEAGUE correspondence in a business-like manner.

See Page 122 for order blank.

**SHORT WAVE LEAGUE**

99-101 Hudson St., New York, N. Y.

**Short Wave Craft Presents Silver Trophy**

(Continued from page 74)

**W8FRC "On the Air" Continuously 66 Hours!**

From 4 p.m. Tuesday until 10 a.m. Friday morning, when Mayor Shields sent the police out for W8FRC, the station was operating continuous and without a relief operator. During this time W8FRC handled hundreds of messages for such services as Red Cross, Pennsylvania National Guard, Telephone companies and the citizens of Johnstown. To keep a transmitter on and stay at the controls for that length of time is no child's play; but as an amateur operator I was doing and giving all that was in me. More than that I was anxious to serve the people of this community and place before them the facilities of my amateur radio station.

**Washington Grants Permission for "Broadcast" Tie-in**

During Tuesday and Wednesday, March 17th and 18th, W8FRC was, at certain times, "tied-in" with the National Broadcasting Company through KDKA at Pittsburgh. Permission to broadcast from this station to the networks was granted by Washington. During these broadcasts I would describe the condition of the flooded area and the extent to which the city was damaged. These descriptive reports were made, only, after your writer had made a personal visit to the stricken area.

On Wednesday afternoon, after the water had receded from most of the downtown streets, I made a trip in town to see what damage was done by the flood waters. While on my way home, from the downtown section, reports were circulated that the Quemahoning dam had let go. These reports were being carried by police and firemen as well as the civilians and naturally the town was in a panic.

**Telephone System Disorganized**

I returned home and was in touch with KDKA, at least, thirty minutes after such reports were spread all over the city. I merely passed on, to those "listening in," the facts that were being carried by police and everyone else. From my radio room I could see people running to the hills and the steady stream of cars going to high ground was enough to make me think that it was true. To top it off the local telephone exchange, four blocks away, called and told me that all the operators were leaving, because they were ordered out as the dam had broken! The telephone exchange mentioned was not completely out of order, but about 95 lines out of 1500 were still working and to help us with our flood traffic, they gave W8DYY and myself priority in making calls. It must be remembered that there was no telephone service to Johnstown, except one line of the Bell system, and that there was no electric current in the central part of the city.

After the call from the telephone exchange I told KDKA operators that things looked bad and that I was going to leave my station and seek higher ground, I was absent from the station, sitting on the hill, for nearly thirty minutes. Nothing happened and I was convinced that it was just a rumor. I walked home, passing many people still fleeing to the hills, and contacted KDKA and passing the information along that nothing had happened and I thought that it was just a rumor, although I had nothing "official" on the matter. At that time I did not know exactly how long it would take for the water to reach town.

**Police Take Him Before Mayor**

I continued the operation of my station till 10 a.m. Friday, when the police came after me and took me before Mayor Shields for my sentence—without a trial! He asked me one question. "Did you broadcast about the Quemahoning dam breaking?" I said, "Yes Sir." He, in a very angry voice, told me not to operate my station anymore—

(Continued on page 125)



**X-MITTING CONDENSERS**

DYKANOL impregnated and filled, the Type TD Series of hi-voltage transmitting condensers are hermetically sealed in non-corrosive metal containers. Supplied with high porcelain insulators, "Hams" and "Experimenters" have found them most dependable—handy and inexpensive for their work.

Working Voltage 1000 V.D.C. 660 V. R.M.S. Rect.A.C.

- 1 MFD. TD 10010 2 1/4" x 1 13/16" x 1 1/16" List \$2.50
- 2 MFD. TD 10020 4" x 1 13/16" x 1 1/16" List 4.50
- 4 MFD. TD 10040 4 3/4" x 1 13/16" x 1 1/16" List 7.00

For complete listing see your local C-D distributor or write direct for catalog No. 128.

**CORNELL-DUBILIER CORPORATION**  
4375 BRONX BOULEVARD  
NEW YORK

**Westinghouse Power Generator**

Manufactured for U. S. Signal Corps

200 Watt 110 V. AC

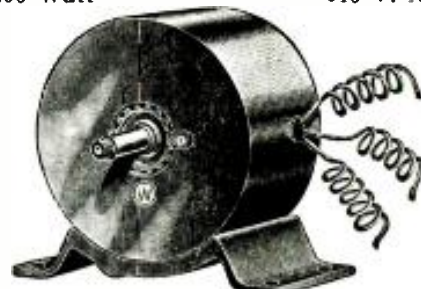

**A. C. ELECTRICAL POWER**

from a Windmill, from available Waterpower, from your Automobile, from your Motorcycle, from your Bicycle, Foot-pedals or Handcrank (for transportable Radio Transmitters, Strong Floodlights, Advertising Signs); do you want to operate AC Radio sets from 32 V. DC farm light systems; operate two generators in series to get 200 V. AC; obtain two phase and three phase AC, etc., etc.

There Are Over 25 Applications Some of which are:

- A.C. Dynamo lighting from eight to ten 20 Watt 110 Volt lamps, Short Wave Transmitter supplying 110 Volts AC for operating "Ham" transmitter, Operating 110 V. AC 60 Cycle Radio Receiver in DC districts, Motor Generator, Public Address Systems, Electric Sirens on motor boats, yachts, etc., Camp Lighting, Short Wave artificial "fever" apparatus, Television, Edison Water-wheel for lighting or other purposes, Airplane; for lighting strong search light or electric signs, Laboratory work, etc., etc.
- 1/4 to 1/2 H.P. needed to run generator

BLUE-PRINT 22 x 28 in. and Four-Page 8 1/2 x 12 in. INSTRUCTION SHEETS FREE with Generator.

Generator, as described, including four replacement carbon brushes, Blue-print and Instructions **\$7.90**

Send \$2.00 deposit balance C.O.D. Shipping weight 18 lbs.

(Replacement carbon brushes bought separate \$1.50 per set of four. Set of instructions bought separate \$1.00.) MONEY-BACK GUARANTEE

**WELLWORTH TRADING COMPANY**  
560 West Washington Blvd., Dept. SW636, Chicago, Illinois

# Here are the Six BEST SHORT-WAVE RADIO BOOKS!

Without doubt you will have to go a long way to buy better books on short waves than you find on this page. Each book is written by a well-known authority on short waves . . . each book has been carefully illustrated with photographs and diagrams to

make the study of this field of radio much simpler. The volumes on this page are the finest books on short-waves which are published anywhere today. Order one or more copies today . . . find out for yourself how fine they are. Prices are postpaid.



**How to Get Best Short-Wave Reception**  
By M. HARVEY GERNSBACK

This book tells you everything you ever wanted to know about short-wave reception. The author, a professional radio listener and radio fan for many years, gives you his long experience in radio reception and all that goes with it. Why is one radio listener enabled to pull in stations from all over the globe, even small 100 watters, 10,000 miles away, and why is it that the next fellow, with a much better and more expensive equipment, can only pull in the powerful stations that any child can get without much ado? The reason is intimate knowledge of short waves and how they behave. Here are the chapters of this new book:

1. What are Short Waves and what can the listener hear on a short-wave receiver or converter?
2. How to tune and when to listen in on the short waves.
3. How to identify short-wave stations.
4. Seasonal changes in short-wave reception.
5. Types of receivers for short-wave reception.
6. Aerial systems for short-wave receivers.
7. Verifications from short-wave stations.

The book makes excellent reading matter. There are many tricks in short-wave reception that even some of the "old-timers" do not know. Be sure to get it.

**40 Illustrations, 72 Pages. Stiff, flexible covers 50c**

**HOW TO BUILD AND OPERATE SHORT-WAVE RECEIVERS**

THIS is the best and most up-to-date look on this subject. It is edited and prepared by the editors of SHORT WAVE CRAFT, and contains a wealth of material on the building and operation, not only of typical short-wave receivers, but short-wave converters as well. Dozens of short-wave sets are found in this book, which contains hundreds of illustrations: actual photographs of sets built, hookups and diagrams galore.

This book is sold only at a ridiculously low price because it is our aim to put this valuable work into the hands of every short-wave enthusiast.

We know that if you are at all interested in short waves you will wish to do without this book. It is a most important and timely radio publication.

**150 Illustrations, 72 Pages. Stiff, flexible covers 50c**



**THE SHORT-WAVE BEGINNER'S BOOK**

HERE is a book that solves your short wave problems—leading you in easy stages from the simplest fundamentals to the present state of the art as it is known today. It is the only low-priced reference book on short waves for the beginner. The book is profusely illustrated—it is not "technical." It has no mathematics and no technical jargon. It also gives you a tremendous amount of important information, such as time conversion tables, all about aerials, noise elimination, all about radio tubes, data on coil winding and other subjects.

**Partial List of Contents**

Getting Started in Short Waves—the fundamentals of electricity. Study the Short List of Radio—how to read schematic diagrams. Short Wave Coils—various types and kinds in making them. Short Wave Aerials—the points that determine a good aerial from an inefficient one. The Transposed Lead-in for reducing static. The Beginner's Short-Wave Receiver—a simple one tube set that anyone can build. How to Tune the Short-Wave Set—telling the important points to get good results. Audio Amplifiers for S-W Receivers. Learning the Code—for greater enjoyment with the S-W set. Wave length to Kilocycle Chart. Wire Chart—to assist in the construction of coils.

**25c 75 Illustrations, 40 Pages. Stiff, flexible covers**



**101 SHORT-WAVE HOOKUPS**

Compiled by the Editors of SHORT WAVE CRAFT

EACH and every hook-up and diagram illustrated is also accompanied by a thorough explanation of what this particular hook-up accomplishes, what parts are required, coil-winding information, values of resistors, etc. In fact, everything you want to know in order to build the set or to look up the data required.

To be sure, all of the important sets which have appeared in print during the past five years are in this valuable book. Sets such as the Doerle, Blumore, the "10" Twinplex, Oscillodyne, Denton "Stand-by," Megadyne Triples 2; Globe Trotter, 2-Tube Superhet, Mindynde, Loop Receiver, "Doerle" 2-tube Battery, "Doerle" 3-tube Battery, "Doerle" 2-tube A.C., "Doerle" 3-tube A.C. Doerle "Signal Gripper," Don R.F. 4-tube Receiver, The Sargent 9-32 Tapped Coil Receiver, Globe-Circler 7, The 2-Tube "Champ"—2 Tube Equal 3, Ham-Band "2-Tube Peewee" Wyeth All-Way 6, Denton Economy 3, 2-Tube "Regenerative-Oscillodyne" will be found here, with full descriptions. In many cases, we have also included a picture hook-up for those who do not wish to follow the regular symbolic hook-up, but wish to have a regular wiring diagram. This is a very handy volume, especially for those "fans" who wish to study the best sets in the short-wave art, from one tube up to ten tubes.

**100 Illustrations, 72 Pages, 50c Stiff, flexible covers**

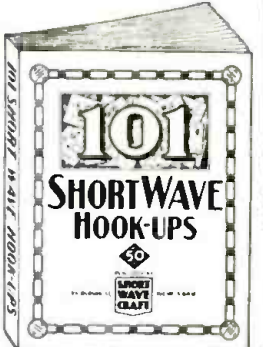

**HOW TO BECOME AN AMATEUR RADIO OPERATOR**

Write three Lieut. Myron F. Eddy to write this book because his experience in the amateur field has made him prominent in this line. For many years he was instructor of radio telegraphy at the I.R.C.A. Institute. He is a member of the I.R.E. (Institute of Radio Engineers), also the Veteran Wireless Operators' Association.

If you intend to become a licensed code operator, if you wish to take up phone work eventually—this is the book you must get.

**Partial List of Contents**

Ways of learning the code. A system of sending and receiving with necessary drill words is supplied so that you may work with approved methods. Concise, authoritative definitions of radio terms, units and laws, brief descriptions of common types of radio equipment. This chapter gives the working terminology of the radio operator. Graphic symbols are used to indicate the various parts of radio circuits. General radio theory, particularly as it applies to the beginner. The electron theory is briefly given, then waves—their creation, propagation and reception. Fundamental laws of electric circuits, particularly those used in radio are explained next and typical basic circuits are analyzed. Descriptions of modern receivers that are being used with success by amateurs. You are told how to build and operate these sets. Amateur transmission. Diagrams with specifications are furnished so construction is made easy. Power equipment that may be used with transmitters and receivers, rectifiers, filters, batteries, etc. (Calculations that apply to amateur operators. Appendix which contains the International "Q" signals, conversion tables for reference purposes, etc.

**150 Illustrations, 72 Pages, Stiff, flexible covers 50c**

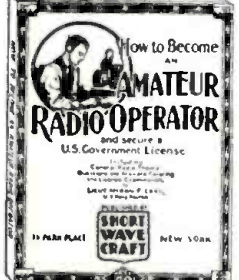

**TEN MOST POPULAR SHORT-WAVE RECEIVERS**

—HOW TO MAKE AND WORK THEM

THE editors of SHORT WAVE CRAFT have selected ten outstanding short-wave receivers and these are described in the new volume. Each receiver is fully illustrated with a complete layout, pictorial representation, photographs of the set complete, hookup and all worth-while specifications. Everything from the simplest one-tube set to a 5-Tube T. R. F. receiver is presented. Complete lists of parts are given to make each set complete. You are shown how to operate the receiver to its maximum efficiency.

**CONTENTS**

The Doerle 2-Tube Receiver That Reaches the 12,500 Mile Mark, by Walter C. Doerle.  
2-R.F. Pentode S-W Receiver having two stages of Tuned Radio Frequency, by Clifford E. Denton and H. W. Seor.  
My de Luxe S-W Receiver, by Edward G. Ingraham.  
The Binnewee 2-Tube 12,000 Mile DX Receiver, by A. Binnewee, Jr.  
Build a Short-Wave Receiver in your "Brief-Case," by Hugo Gernsback and Clifford E. Denton.  
The Denton 2-Tube All-Wave Receiver, by Clifford E. Denton.  
The Denton "Stand-By" by Clifford E. Denton.  
A COAT-POCKET Short-Wave Receiver, by Hugo Gernsback and Clifford E. Denton.  
The S-W PENTODE-4, by H. G. Cisin, M. E.  
Louis Martin's Idea of a GOOD S-W RECEIVER, by Louis Martin.

**75 Illustrations, 40 Pages. 25c Stiff, flexible covers**



All the books shown on this page are published exclusively by

**SHORT WAVE CRAFT**

99-101 Hudson Street, New York, N. Y.

**CLIP-MAIL**

SHORT WAVE CRAFT, 99-101 Hudson Street, New York, N. Y. SW.6-36

Gentlemen: I enclose herewith my remittance for the amount of \$..... for which you are to send me, postpaid, the books checked below.

How to Get Best Short-Wave Reception..... 50c each

101 Short-Wave Hook-ups..... 50c each

How to Build and Operate Short-Wave Receiver..... 50c each

How to Become an Amateur Radio Operator..... 50c each

Ten Most Popular Short-Wave Receivers. How to Make and Work Them..... 25c each

The Short Wave Beginner's Book..... 25c each

Name.....

Address.....

City..... State.....

(Send remittance in form of check or money order. If letter contains cash or unused U. S. Postage Stamps, register it.)

**OVERSEAS READERS!**

These books can be obtained from the following houses:

**GREAT BRITAIN**  
Gorringe's  
9a, Green Street, Leicester Square  
London, England

**FRANCE**  
Editions Radio  
42 Rue Jacob  
Paris

**AUSTRALIA**  
McGill's  
183-195, 218 Elizabeth St.  
Melbourne, C. I.

Please mention SHORT WAVE CRAFT when writing advertisers

## Short Wave Craft Presents Silver Trophy

(Continued from page 123)

that the town was under Martial Law (our town was never under Martial Law) and that he would throw me in jail without bail, should I disobey his orders. He would not let me explain and I was ordered out of the room.

At that time I did not know that we were not under martial law and I figured that I could do more out of jail than I could in—so I did not argue or talk back to the Mayor. Although I discontinued the use of radiophone, I did not leave the air. W8DYY was also called in and told to "get off the air" by Shields. A little bit later on, or in a few hours, W8DYY was taken over by the National Guard and with W8GYB as relief operator, they operated on 3665 kcs. This change in frequency allowed me to drop to 3610 kcs. to guard our Naval reserve circuit. I have been on that frequency ever since.

### Reaction Not What the Mayor Expected

This contemptible action, taken by the Mayor, reached the outside world and the "reaction" was not what the Mayor was looking for. He thought he had better get rid of me by accusing me of killing several old people—who died of fright during the Dam rumor. The case was placed in the hands of the District Attorney and they are preparing a charge of Involuntary Manslaughter against W8FRC.

I might mention that no praise or recognition has been given the amateurs of Johnstown by its two newspapers and it, so far, has been impossible to get the "local press" to print our story. The amateurs of this city and nation will fight this thing to a finish, and we hope that the Mayor is driven from this town in shame.

The following was printed in the *Johnstown Democrat* March 21st. It is false and a deplorable lie!

### MAYOR ORDERS AMATEUR OPERATORS OFF THE AIR AFTER RUNNING DOWN "QUE" REPORT

Mayor Daniel J. Shields ordered all amateur radio stations to close here yesterday after one operator allegedly had admitted he was responsible for the report that Quemahoning Dam had broken which caused a panic last Wednesday.

The Mayor said the order closing all Amateur stations had been issued to prevent possible spread of further alarming rumors through their broadcasts. He warned operators that they would be jailed and held without bail if they ignored the warning.

Gerald Coleman of 528 Highland Avenue was the operator who, Mayor Shields said, admitted responsibility for the false alarm last Wednesday. According to the Mayor, Coleman later apologized publicly for the warning, which was sent to Radio Station KDKA in Pittsburgh and rebroadcast. Coleman was not held however.

"He is the man who caused that unreasonable panic here," Mayor Shields said, scoring Coleman roundly.

I have tried to make this story as brief as possible, but with so much to tell it is rather difficult to limit it to any degree. Thanking everyone for their kind support in this matter—I sign off by saving 73.

GERALD D. COLEMAN, W8FRC.

### "Hams" Handle 50,000 Messages!

● A recent survey by the A.R.R.L. would seem to indicate that "Ham" operators and their stations handled close to 50,000 messages during the flood period. This enormous amount of short-wave traffic was partly official and some of it for individuals. All of the traffic was of an unusual nature, in that the messages were flashed between points where there was no other means of communication, such as telephone and telegraph, available. The A.R.R.L. officials give special credit to the U. S. Naval Communications Reserve and to the Army Amateur Radio System.

# CLASSIFIED

Advertisements are inserted at 5c per word to strictly amateurs, or 10c a word to manufacturers or dealers. Each word in a name and address is counted. Cash should accompany all orders. Copy for the July issue should reach us not later than May 5.

<p><b>GENERATORS</b></p> <p>TURN SCRAP INTO MONEY. Autopower shows you how easily and economically auto generators can be converted into A.C. or D.C. generators and D.C. motors, 2 to 1000 volts; for sound, radio, power, light, or welding. No previous experience necessary—complete information all in new book, with simple instructions and illustrations. Endorsed by thousands. Only \$1.00 postpaid. Autopower, Inc., 111 S. Hoyne Ave., Chicago.</p>	<p><b>INSTRUCTION</b></p> <p>ANY QUESTION PERTAINING TO radio answered in clear concise language. Blue-prints or diagrams supplied when necessary. Enclose \$1.00 to cover stenographic expense. Radio Reference Library, 1791 Alpha, Lansing, Michigan.</p> <p>AMATEUR LICENSES, COMPLETE training. Resident and correspondence courses. Every graduate a licensed operator. \$1.50 weekly. Booklet, New York Wireless School, 1123 Broadway, New York.</p>	<p>QSL CARDS, NEAT, ATTRACTIVE, reasonably priced, samples free. Miller, Printer, Ambler, Pa.</p> <p><b>RADIO ENGINEERING</b></p> <p>EXACT COPIES OF APPARATUS described in this magazine or any other radio equipment—custom built with parts bought at lowest prices anywhere! Expert workmanship. Results guaranteed. Quotations cheerfully given. Custombuilders, Dept. A, 113 West 57th, New York City.</p>
<p><b>"HAM" OFFERS AND WANTS</b></p> <p>FOR SALE MY SHORT WAVE outfit, including two power packs, B eliminator, receiver CW transmitter, cabinet and enough other junk to build phone outfit. Am dubiting and need cash. What will you give? L. C. Fox, Osakis, Minn.</p>	<p>RADIO ENGINEERING, BROADCASTING, aviation and police radio, Servicing, Marine and Morse Telegraphy taught thoroughly. All expenses low. Catalog free. Dodge's Institute, Col. St., Valparaiso, Ind.</p>	<p><b>SHORT WAVE COMPONENTS</b></p> <p>4 BAKELITE PLUG-IN COILS, wound on tube bases .30, tall forms .10, six prong .60. Noel, 728 Birch, Scranton, Pa.</p>
<p>WANTED COPY OF LODGE'S "Signalling Through Space Without Wires." State price and condition. H. W. Seear, % Short Wave Craft, 99 Hudson St., New York City.</p>	<p><b>MISCELLANEOUS</b></p> <p>OHM'S LAW CALCULATOR—Lightning Slide Rule; solves all problems of Voltage, Current and Resistance, Power, Wire Sizes, etc. Range: 1 micro-amp. to 1000 amps.; 1 micro-volt to 10,000 volts; 1 micro-ohm to 10 meg-ohms; 1 micro-watt to 10 megawatt; wire sizes 0 to 36 B. &amp; S. gauge. Introductory price \$1.00 prepaidd. The Dataprint Co., Box 322, Ramsey, N.J.</p>	<p><b>SHORT WAVE RECEIVERS</b></p> <p>RECEIVERS—NEW AND USED, sold and traded in. Hammarhins, Nationals, RAB, Skyrdor, Schwarz Radio Service, 15 Lawrence Ave., Dumont, N. J.</p>
<p>SALE TRADE CUSTOM BUILT Silver Masterpiece all-wave superheterodyne receiver, Motorola car radio. Public address amplifier. Glenn Watt, Chanute, Kansas.</p>	<p>CALL LETTERS, FOR EQUIPMENT, black on aluminum 1" gummed Metalettes, 25c set, stamps, J. F. Satterthwaite, 111 Summit St., Toledo, O.</p>	<p>INSTRUCTIONS IN DISTANCE Crystal Sets—record 2100 miles; "Radio-builder" sets; 25c. Laboratories, 131-A Liberty, San Francisco.</p>
<p>FOR SALE OFFICIAL DOERLE Hamspread De-Luxe, 1A-5, Complete \$15. Write Albert Janssen, 570 E. 137 St., N.Y.C.</p>	<p>QSL—CARDS—SWL</p> <p>SHORT WAVE LISTENER'S, QSL Cards, Attractive, Reasonable, Samples (Stamps), W-8-E-8-N, 1827 Cone, Toledo, Ohio.</p>	<p><b>TELEVISION</b></p> <p>TELEVISION \$6.00, KIT \$1.00, Arthur Pohl, 2131 Palms, Detroit, Mich.</p>
<p>TRANSCIVER "19" 5 METER. Submit offer. Walter Winkler, Weyauvega, Wisconsin.</p>	<p>QSL'S! SWL'S! SNAPPY! BRIGHT! 200 Jan colors \$1.00. Samples (stamps), WEAUL, Tupelo, Miss.</p>	<p><b>TRANSMITTING EQUIPMENT</b></p> <p>ALL METAL CRYSTAL HOLDER for Transmitters, guaranteed \$1.15, Schwarz Radio Service, Dumont, N. J.</p>

THE ONE AND ONLY

## Encyclopedia on Short Waves

By C. R. Leutz and R. B. Gable



"SHORT WAVES" is written by Leutz and Gable, two foremost radio authorities. You will remember Charles R. Leutz as one of the pioneers in radio, also designer and manufacturer of the famous LEUTZ Transoceanic Receivers. Mr. Robert Gable owned and operated one of the finest low power broadcasting stations in the country. He is well known as an experimenter and research worker in scientific fields. Considering the value of this book for data alone, its cost should really be more than originally asked. But when you see the illustrations in the book you will marvel at how this book could be sold for ONE DOLLAR. It originally sold for \$2.98. The book is printed on a very expensive super-calendered paper. It contains 384 pages with over 315 photographic illustrations and diagrams. The supply of these books is not expected to last long. Once they are gone no additional copies will be available. ORDER NOW—be sure to tell your friends about this remarkable book value. Send the coupon today for your copy of "SHORT WAVES" by Leutz and Gable.

YOU SAVE \$1.98 JUST AS LONG AS THE SUPPLY OF THIS BOOK LASTS! THIS BOOK ORIGINALLY SOLD FOR \$2.98

"SHORT WAVES" is the most important and comprehensive volume of short-waves ever published. This book has EVERYTHING on short-waves—it literally contains a complete education on short-waves.

### Partial Contents of "Short Waves"

HISTORICAL REVIEW  
 SHORT WAVE PROPAGATION  
 COMMERCIAL RADIO TELEPHONY AND TELEGRAPHY  
 SHIP TO SHORE RADIO TELEPHONY  
 DIRECTIONAL ANTENNAE  
 TELEVISION  
 AIRCRAFT RADIO EQUIPMENT  
 SHORT WAVE BROADCAST RECEIVERS  
 ULTRA SHORT WAVES (Medical and Surgical Applications)  
 AMATEUR SHORT-WAVE EQUIPMENT

Don't forget that this comprehensive volume is sold on a MONEY-BACK GUARANTEE. If you are not satisfied with it, return it within three days for refund. Use the coupon at the left for ordering your copy of "SHORT WAVES" by Leutz and Gable.

**RADIO PUBLICATIONS**  
 103 Hudson St. New York, N. Y.

### MAIL COUPON TODAY!

RADIO PUBLICATIONS, Dept. SWC-6-36  
 103 Hudson Street, New York, N.Y.

Gentlemen: Enclosed you will find my remittance of One Dollar \$1.00 (cash money order or new U.S. stamps) for which send me One Copy of "SHORT WAVES" by Leutz and Gable. I understand this book may be returned to you within three days if I am not completely satisfied and my money refunded.

NAME .....

ADDRESS .....

CITY ..... STATE .....

(include 15c extra to cover mailing charges) (25c foreign mailing)

Please mention SHORT WAVE CRAFT when writing advertisers

**New MANAGEMENT** ★ **24 HOUR SERVICE**  
**New MERCHANDISE** ★ **Compare**  
**New PRICES** ★ **Our Prices With Others**

**G. E. Power Transformer**



Manufactured by General Electric for R.C.A. Victor. A sturdy, well designed transformer for modern receivers. Has 6.3 volt filament winding for the new octal metal tubes and glass tubes. Designed for 110-125 volts, 50-60 cycle, A.C. Specifications: 6.3 volts, 2 1/2 amp.; 5 volts, 2 amps. for filament of 80 tubes, 7.5 volts, recentered, 75 mils for plate current. Thoroughly shielded.

In black enamel metal case. Ship. wt., 5 lbs.  
**No. AD-101, 6 to 7 tube transformer, 100 YOUR PRICE 99c**  
**No. AD-102, 7 to 8 tube transformer, 100 YOUR PRICE \$1.49**  
**No. AD-103, 8 to 10 tube transformer, 125 YOUR PRICE \$1.96**  
 Specify if half-shunt mounting is desired. \*Can be had with 2 1/2 volt winding instead of 6.3 volts. Please specify.

**Type R.C.A. Photophone Universal Output Transformer**

A genuine R.C.A. product especially designed for R.C.A.-Victor high class amplifiers and public address systems. A heavy duty, high current, excellent response unit whose secondary winding impedance is variable from 1/2 ohm up to 500 ohms by gradual steps. The primary winding will match any type triode or pentode in parallel, push-pull, push-pull parallel or single output arrangement. Measures 4 x 3". 2-pages of detailed data and color code chart supplied with each unit. Ship. wt., 5 lbs.  
**No. AD-104 YOUR PRICE \$1.49**

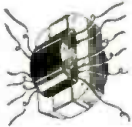

**Output Transformer for Dynamic Speakers**



This well made unit will match any dynamic speaker, having a voice coil impedance of from 5 to 15 ohms, to any radio set using push-pull 43's, 11's, 41's, 2A3's or single 2A5, 42, 47, 50, 58, 33 and 89 tubes. Makes an excellent replacement transformer. Supplied with convenient mounting strap, with mounting holes 2 1/4" apart. Ship. wt., 2 lbs.  
**No. AD-105 YOUR PRICE 25c**

**Genuine R.C.A. Phonograph Motor**

**Induction Type**

This is the same sturdy motor used in the highest quality phonographs and combinations made by R.C.A. Victor. List Price \$18.92. Never before has this motor been available at such a ridiculously low price. Sold complete with turntable. Designed for 110-120 volts, A.C., and available for either 25 or 60 cycles (please specify which when ordering). This motor will not cause noise or other interference in radio receivers since it uses no commutator or brushes, and therefore cannot spark. Small, compact, easily mounted. Smooth and quiet in operation. For 78 RPM records. Ship. wt., 10 lbs.  
**No. AD-106 YOUR PRICE \$3.95**



**TERMS:** Merchandise on this page subject to prior sale; so please RUSH your orders. We buy and sell for cash only. Send complete remittance by money order, certified check or cash (register letter when sending cash). For C.O.D. shipments, send 20% deposit, balance C.O.D. 24 hour service on all shipments. 100% SATISFACTION GUARANTEED ON ALL TRANSACTIONS.

**"Vest Pocket" Electric Soldering Iron**



The smallest GOOD soldering iron ever designed. Actually supplies 40 watts of heat—more than sufficient for ordinary radio soldering work. Measures but 9" from tip to handle. Supplied with 3-foot cord and plug. Conveniently carried in the pocket or tool box. Fully guaranteed. Ship. wt., 1/2 lb.  
**No. AD-107 YOUR PRICE 39c**



**Faraday 2-Button Carbon Mike**  
 Fine frequency response. 3 1/4" diameter by 2" thick. Damped diaphragm diaphragm. Gold-spotted centers. 200 ohms per button. Heavy cast frame, chromium plated. A real professional appearing microphone. Ship. wt., 5 lbs.  
**No. AD-109 YOUR PRICE \$2.25**

**SPECIAL OFFER**

**DILCO R. C. A. Licensed 100% Triple Tested TUBES**  
**YOUR CHOICE ANY GROUP ONLY \$1.00**

Quan.	Type	Quan.	Type
3	50	4	24A
2	12A7	4	35-51
3	2A3	4	36
12	27	4	47
6	26	4	85
6	01A	3	8D6
6	12A	4	5Z3
4	30	6	20
4	31	4	33
6	71A	5	46
4	56	4	1A6
2	10	3	184
		3	59

866 RECTIFIERS, ea. 89c

**A.C.-D.C. Filter Chokes**

Small, compact units designed for use in A.C. D.C. midget sets. Will pass 60 mils. Available in sizes from 200 to 500 ohms. Size 2" x 1 1/4" x 3/4". Mounting holes 2 3/8". Ship. wt., 1 lb.  
**No. AD-110 YOUR PRICE 25c**

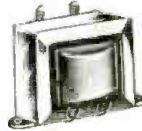

**Yaxley Band-Changing Switch**

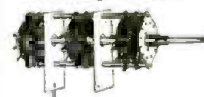

Designed especially for R.C.A. Victor all-wave sets. Heavy silver plated contacts. Consists of six 2-gang decks—12 gangs in all. Four positions. Excellent for short-wave and all-wave receivers as well as for analyzers. List price \$1.32. Never before offered at the low price shown below. Ship. wt., 1 lb.  
**No. AD-111 YOUR PRICE 29c**

**Short-Wave Plug-In Coils**

Designed for use with the Doerle or other standard regenerative circuits using .0011 mf condensers. Range 15 to 200 meters. 5-prong 2-winding coils. Ship. wt., 1 lb.  
**No. R-100 Set of 4 Coils 49c**  
**No. R-101 Set of 4 Coils for Electron Coupled Circuit described in QST Handbook 79c**  
 Ribbed Low-Loss Coils  
**No. R-102 4-Prong Coils 79c**  
**No. R-103 5 or 6-Prong Coils \$1.19**  
**No. R-104 4 to 6-Prong Coil Form only 8c each**



**4-Tube 7 1/2 Watt Amplifier Kit**

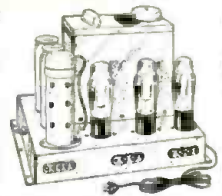

A beautifully designed amplifier, conservatively rated at 7 1/2 watts. Comprises two stages—one utilizing a 57 input tube and the other a parallel stage using 2-2A5's. Uses an 80 rectifier. Input to grid of 57. Output from plates of 2A5. Designed for 100 to 130 volts, 50-60 cycles. A.C. Entire system fuse protected. Sold complete with all parts; chassis, wire, hardware, etc., ready to assemble and wire. Detailed diagram included. Ship. wt., 15 lbs.

**No. AD 112 7 1/2 Watt Amplifier Kit, less tubes, unwired. \$4.95**

**Amplifier, Completely Wired—\$1.00 extra**

**Complete Public Address Combination**

This combination comprises:  
 Completely Wired and Tested 7 1/2 Watt Amplifier, described above \$5.95  
 1—Faraday Double Button Professional Carbon Mike \$2.25  
 1—Telesopic Chromium Plated Microphone Floor Stand \$3.95  
 1—6" Dynamic Speaker \$1.95  
 1—Microphone Input Box \$2.50  
 1—Set of Matched Tubes \$1.95  
 All components accurately matched to one another  
 Total \$18.55  
**Special Price for Complete System \$16.50**

**Three-Gang Midget Tuning Condensers**

Capacity .000365 mf. Excellent for compact and portable receivers. Measure 3 1/4" wide x 1 1/4" high x 3 3/8" back of panel depth. 3/8" shaft. Each section with compensating condenser. May be had with vernier gears (10c additional) or plain, as illustrated. Ship. wt., 2 lbs.  
**No. AD-113 YOUR PRICE 69c**  
 Reducing Bushing 3/8" to 1/4" 10c extra  
**No. AD-114 Two-Gang Condenser with 165 K.C. Superhet Tracking Section, Geared YOUR PRICE 35c**

**Four-Gang Tuning Condenser**

Capacity .000365 per section. Sturdy construction. Solid brass plates. Excellent for high quality substantially built receivers. Ship. wt., 5 lbs.  
**No. AD-115 YOUR PRICE 20c**

**BANDSPREAD VARIABLE CONDENSERS**

Consist of two sections; one main tuning section and one vernier or bandspread tuning section. Available with 11 plates, (approx. .00025 mf); 13 plates, (.0003 mf); 17 plates, (.000365 mf); 23 plates, (.0005 mf); 46 plates, (.001 mf). Stator plates can be removed to change capacity. Excellent for short-wave bandspread receivers as well as for standard broadcast and long-wave receivers. Complete with 3" dial, ship. wt., 2 lbs.  
**No. AD-116 Vernier Tuning Variable Condensers Specify number of plates when ordering. YOUR PRICE 25c**

**Midget Variable Condensers**

Excellent for use as antenna trimmers in short-wave sets and as vernier tuning condensers. Capacity approximately 20 mmf. Sold complete with knob and pointer. Single hole mounting. 9 solid brass plates. Ship. wt., 1/2 lb.  
**No. AD-117 YOUR PRICE 25c**

**FREE 64-page catalog and treatise.** Send stamp and postage in return for our FREE treatise and catalog which contains much valuable data and radio information. There is no obligation involved. Absolutely free. Book sent by return mail.



**UNITED RADIO COMPANY**  
 Successors to Radio Trading Company  
 58 MARKET STREET Dept. S-6 NEWARK, N. J.



Please mention SHORT WAVE CRAFT when writing advertisers

Index to Advertisers

A	
Ace Radio Laboratories.....	107
Aerovox Corporation.....	112
Aladdin Radio Industries, Inc.....	114
Allied Engineering Institute.....	120
Allied Radio Corp.....	111
American Microphone Co.....	105
B	
Breakers, The.....	107
Brush Development Co., The.....	110
Bud Radio, Inc.....	105
C	
Cameradio Co.....	120
Candler System Co.....	116
Cannon, C. F., Co.....	127
Chicago Radio Apparatus Co., Inc.....	105
Classified Advertisements.....	125
Cornell Dubilier Corporation.....	123
Coyne Radio & Electrical School.....	65
Crowe Name Plate & Mfg. Co.....	102
D	
Dataprint Company.....	117
Dodge's Institute.....	116
E	
Eagle Radio Co.....	127
Eby, Hugh H., Inc.....	102
Ellen Radio Laboratories.....	101, 110
Electrad, Inc.....	119
Electric Institute, Inc.....	108
Everyday Science & Mechanics.....	119
F	
First National Television, Inc.....	116
G	
General Engineering Corp.....	117
Goldstone Radio Co.....	120
Gold Shield Products Co.....	104, 114, 119
Guy Stokely Radio Corp.....	Inside Front Cover
H	
Hallcrafters, The.....	119
Hammarlund Manufacturing Co., Inc.....	115
Harrison Radio Company.....	104, 106
I	
In-structograph Company.....	105, 116
Insuline Corp. of America.....	120
J	
Jobs & Careers.....	114
K	
Korrol Mfg. Co., Inc.....	112
L	
Lancaster, Allwine & Rommel.....	119
Lejay Manufacturing Co.....	110
Lynch, Arthur H., Inc.....	112
Mc	
McElroy, T. R.....	116
M	
M. & H. Sporting Goods Co.....	104
Midwest Radio Corp.....	109
N	
National Company, Inc.....	Inside Back Cover
National Radio Institute.....	Back Cover
O	
Oxford-Tartak Radio Corp.....	119
P	
Polk, R. L., & Co.....	117
R	
Radio & Television Institute, Inc.....	113
Radio Constructors Labs.....	103
Radio-Craft.....	116
Radio Handbook, The.....	119
Radio Publications.....	118, 120, 121
Radio Training Assn. of America.....	116
RCA Institutes, Inc.....	116
RCA Manufacturing Co., Inc.....	117
Rim Radio Mfg. Co.....	120
S	
Sargent, E. M., Co.....	107
Short Wave Coil Book.....	112
Short Wave League.....	114, 122, 123
Short Waves.....	125
Sundt Engineering Co.....	107
T	
Teleplex Co.....	112, 116
Trimm Radio Mfg. Co.....	115
Triplett Electrical Instrument Co.....	102
Tri-State College.....	116
Try-Mo Radio Co., Inc.....	102
U	
Ultra High Frequency Products Company.....	105
Uncle Dave's Radio Shack.....	112
United Radio Company.....	126
Universal Microphone Co., Ltd.....	120
Uno All-Wave Coil Co.....	102
W	
Wellworth Trading Company.....	114, 123
Wholesale Radio Service Co., Inc.....	119
Wright-DeCoster, Inc.....	104
X	
X.L. Radio Laboratories.....	102

(While every precaution is taken to insure accuracy, we cannot guarantee against the possibility of an occasional change or omission in the preparation of this index.)

## Short Wave Scout News

(Continued from page 90)

as, has been heard with good strength between 9 and 11 p.m. Look for it on Saturdays.

HIG, about 6280 kc., Ciudad Trujillo, D.R., is heard with excellent strength between 8 and 10 p.m. HIG identifies itself with a sound like a cow bawling.

TGWA, 6 mc., Guatemala City, Guatemala, was heard several times around 12:30 a.m. on Sundays.

RK1, 15090 kc., Moscow, U.S.S.R., was heard testing several Sundays at 10 a.m. with excellent strength.

PCJ, 9590 kc., Eindhoven, Holland, heard with very good strength on Sundays between 7 and 8 p.m.

HH2S, 5910 kc., Port au Prince, Haiti, heard with good strength, but is generally bothered with code interference.

HJU, around 9500 kc., Buenaventura, Colombia, heard several times on this frequency with musical programs, good strength-broadcasts between 9 and 10 p.m. Announces in Spanish and English.

A station in Rome heard contacting Asmara around 10 a.m. on about 16000 kc, with excellent strength.

CO9WR, around 6270 kc., Sancti Spiritus, Cuba, heard until 11 p.m. with good strength and quality.

Cuba seems to now have several active commercial stations, CMA, CMA 2 (10890 kc.) and CMA3 contacts WTG and WKP (6950 kc.) New York, heard several times. CMA is used in the evenings, the other two for daylight.

W9XAA, 11830 kc., Chicago, Ill. May be heard at all hours of the day with very good strength; good for "foreign" listeners.

The schedule of H1IA is now 7:40 to 9:40 p.m. daily. H1IA uses 50 watts.

T14NRH is still in operation and uses 150 watts on 9675 kc. and broadcasts from 5:30 to 6:30 p.m. daily; on Sundays until 7 p.m. Send all letters to Amando Cespedes Marin, Heredia, Costa Rica.

JVN, Japan, is now coming in excellent, around 7 a.m. daily.

The Australian stations 2ME, 3ME and 3LR are also heard good.

FLETCHER W. HARTMAN,  
365 John Street,  
South Amboy, New Jersey.

### Report from Official Listening Post in Trinidad, B.W.I.

● RECEPTION for the past month has been excellent on all bands.

HH3W, Port au Prince, Haiti, on 9.57 mc. was heard on Sunday, Feb. 22, giving a musical program, and coming in with an R-7 signal. Announcements were made in French, English and Spanish, the daily schedule being given as 1-2 p.m. and 7-8 p.m. EST. Time heard was 2 p.m.

H1BC, Radiodifusora, "La Voz de la Romana, Dominican Republic was heard on 6.90 mc. on Feb. 22 at 7 p.m. E.S.T., with an R9 signal, signing off with a march at 7:30 p.m.

The new Argentine station, LRU, Buenos Aires, on 15.29 mc. was heard with a musical program on Feb. 23, at 4:30 p.m. E.S.T. This station is the short-wave relay of LRI, Radio el Mundo. Signals QSA5, R 7-8.

HJU Buenaventura, Colombia, "La Voz del Pacifico," on approximately 9.50 mc. was heard testing with HJ4ABJ, Ibaque at 2:14 p.m. on Feb. 24. This station has since then been heard several nights with programs.

H1IS, Puerta Plata, "La Voz de Hispaniola" was heard on an announced frequency of 6420 kilocycles at 6:25 p.m. on Feb. 29.

A station, HRV, Honduras calling itself "La Voz de Atlantilla" was heard testing at 10:15 p.m. on 6.25 mc. on Feb. 29.

TG2X, Guatemala City, was heard one night at 10:35 p.m. on a frequency of 5.94 mc. Signals were coming in QSA 5, R 6-7, but there was some interference from HJ4ABE, Medellin.

ALBERT J. YOUNG,  
"Trophy Winner 24"  
Port of Spain, Trinidad, B.W.I.

## Calling All Listeners



"I heard your call, you need not repeat. I'm using the MINUTEMAN, the world's at my feet."



**EAGLE MINUTEMAN**  
DESIGNED BY W2CQI AND W2DHN

2-Tube amateur band receiver for consistent reception on the loud speaker. 2 1/2-5-10 meters

**LOTS OF FUN FOR LITTLE MONEY**

<b>MINUTE MAN KIT</b> less tubes, power supply, speaker, cabinet, unwired.	<b>\$4.75</b>	Just the receiver for duplex work. The most sensitive and delicate super regenerative receiver known, uses metal or glass tubes. The last word in performance and simplicity of design. The 1st 2 1/2 to 10 meter receiver ever offered to the amateur at such a ridiculously low price. No trouble necessary to operate it.	<b>FOR A.C. OPERATION</b> 1-Tube <b>POWER SUPPLY</b> less tube, speaker, cabinet, unwired.
<b>2 TUBES</b> 6CS & 42	<b>\$1.50</b>	<b>80 RECTIFIER</b> TUBE 30c EXTRA 3-in. loud speaker	<b>\$1.19</b>
<b>WIRING CHARGE (OPTIONAL)</b>	<b>\$1.25</b>	<b>Power Supply Wired</b>	<b>50c</b>
<b>MINUTEMAN CABINET 17x9</b> , for receiver and power supply, hinged cover—black crackle finish, regular \$6.50 value			<b>\$2.50</b>

Order direct from this ad—Free circuits on request. All parts unconditionally guaranteed.

**EAGLE RADIO CO.**  
84 CORTLANDT ST., Dept F, NEW YORK CITY

## CANNONBALL HEADSETS

were used by a large number of amateurs during the recent floods. In several localities Short Wave Radio was the only means of communication with the outside world. Cannon Ball headsets are RELIABLE. Always have a headset ready for any emergency.



Send for circular S-6.  
**C. F. CANNON CO., Springwater, N. Y.**

## 6 Copies of SHORT WAVE CRAFT 70c PREPAID

For a limited time only, and as long as they last, we will send you six back numbers of SHORT WAVE CRAFT assorted, your choice, for 70 cents.

The usual price for six copies would be \$1.50 and most publishers charge a higher price for back numbers over one year old.

We can supply only the following back numbers: Dec. 1930; Feb., April, June, Oct. 1931; Sept. 1932; Sept., Nov., Dec. 1933; Jan., Feb., Mar., April, May, June, July, Aug., Sept., Oct., 1934; 1935—All issues; 1936—All issues to date.

If you do not specify copies we will use our own judgment in sending assorted numbers to fill your order. Note we cannot exchange the copies for ones that have been sent to you.

Practically every copy of SHORT WAVE CRAFT contains important information that you should have. Here is a chance to get those copies.

As we have only a small supply of back numbers on hand, this offer will be withdrawn as soon as they have been sold.

We accept U.S. stamps, U.S. coin, or money order. Rush your order today.

**SHORT WAVE CRAFT**  
99-101 Hudson Street New York, N. Y.

SHORT WAVE CRAFT 99-101 Hudson Street, New York, N. Y. 6-36  
Gentlemen: I enclose herewith 70c. for which you are to send me six back number copies of SHORT WAVE CRAFT as follows:

Name \_\_\_\_\_  
Address \_\_\_\_\_  
City \_\_\_\_\_ State \_\_\_\_\_

Please mention SHORT WAVE CRAFT when writing advertisers

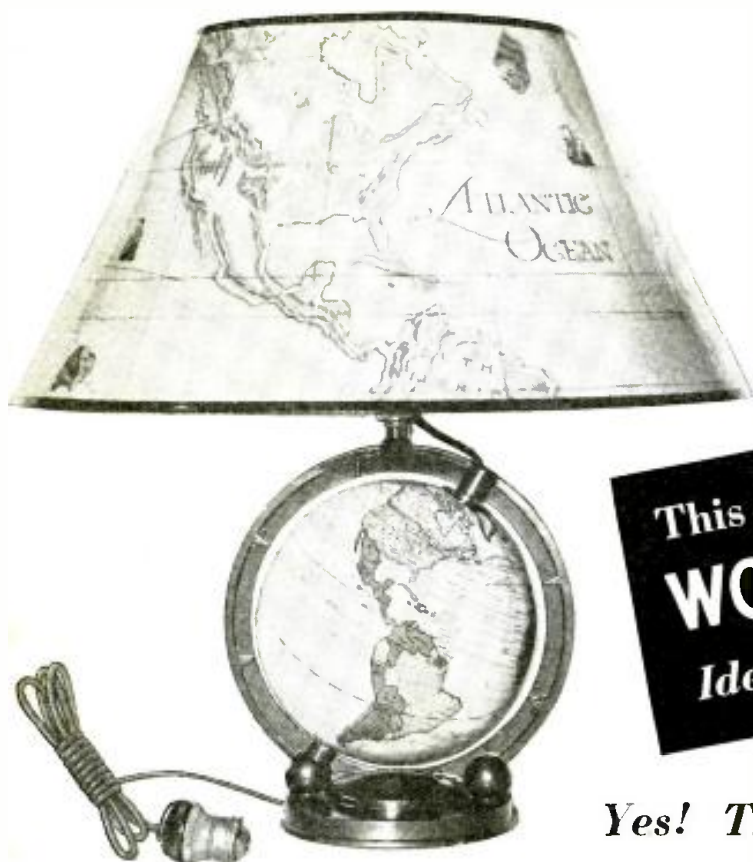

*Free!*

This useful and ornamental  
**WORLD-GLOBE LAMP**  
 Ideal for short wave fans

*Yes! The globe revolves!*

**N**EVER in the six years that SHORT WAVE CRAFT has been published, have we found *anything* that is as *useful* and *ornamental* as the WORLD-GLOBE LAMP we now offer free to our readers.

This beautiful WORLD-GLOBE LAMP measures 17½" high. The attractively colored shade, with nautical and map designs, is 8" in height and 16" in diameter. It is made of fine quality parchment, highly glazed, to assure long life. A slightly damp cloth quickly removes dust from the shade. The 6¼" globe, printed in many colors, has a full meridian, and rotates. Hundreds of names—countries, cities, rivers, oceans and others are clearly printed on the globe.

Another feature on this WORLD-GLOBE LAMP is the movable hour scale found at the north pole. This permits determining the correct time in any part of the world.

The metal parts are finished in antique bronze. A piece of heavy green felt is glued under the base, therefore it may be placed *anywhere*, without fear of marring table, desk, etc.

The weight of the WORLD-GLOBE LAMP is nearly three pounds. When packed for shipping, six pounds.

Here is the way to get this beautiful prize. Fill in the coupon in the left hand corner—cut it out and mail it to us together with your remittance of \$2.50. You will receive a full year's subscription (12 months) to SHORT WAVE CRAFT—the greatest short-wave magazine in the world today. In addition, we will send you absolutely FREE one of these handsome WORLD-GLOBE LAMPS. Old subscribers may renew their subscription now for another year following expiration of their present one and still receive this WORLD-GLOBE LAMP.

Only a limited number of WORLD-GLOBE LAMPS are available. Take advantage of this offer *without delay* in order to insure receiving *your free gift*. RUSH THE COUPON TODAY.

**MAIL  
 COUPON  
 TODAY!**

**Just a Word About SHORT WAVE CRAFT**

The magazine you are now reading clearly indicates the contents of future issues. Over a quarter of a MILLION of the most successful SHORT WAVE technicians in all parts of the world obtained their radio education through the

- Regular departments appearing in each issue
- Hugo Gernsback's Editorials—forward looking
- Radio Amateur Course—complete series.
- World Wide Short Wave Review—exclusive.
- Short Wave Scout News.
- What's New in Short Wave Apparatus.
- Constructional articles on tested and approved sets.
- Short Wave Stations of the World—corrected monthly.
- Short Wave Questions and Answers—educational.
- Short Waves and Long Raves—our readers' FORUM.
- Short Wave "Kinks"—with prize offerings.
- Short Wave League—discussions of our members.
- When to Listen In—naming the best foreign programs.

Every issue contains over 150 photographs and wiring diagrams. Read SHORT WAVE CRAFT every month to keep abreast with new things happening in this field.

**How to Order Your WORLD-GLOBE LAMP**

Simply fill in the coupon at the left and mail together with check or money order. Register letter if cash or coin is sent. To cover shipping charges on WORLD-GLOBE LAMP, add to your remittance the amount indicated. If you are located: East of the Mississippi add 17 cents. Between the Mississippi and the West Coast add 70 cents; Foreign Countries add 81 cents. Any excess remittance will be refunded.

**SHORT WAVE CRAFT**

99 HUDSON STREET

NEW YORK, N. Y.

SHORT WAVE CRAFT SWC-636  
 99 Hudson Street, New York, N. Y.

Gentlemen: Enclosed you will find my remittance of \$2.50 (plus cents shipping charges) for which enter my subscription for SHORT WAVE CRAFT for one year (12 issues). This amount entitles me to a WORLD-GLOBE LAMP free. See chart next to coupon for shipping charges on WORLD-GLOBE LAMP.

( ) Enclosed find my remittance of \$2.50, please send me the WORLD-GLOBE LAMP by express, collect.

Name \_\_\_\_\_

Address \_\_\_\_\_

City \_\_\_\_\_ State \_\_\_\_\_

Send remittance in form of check or money order—register letter if it contains cash, stamps, or currency.

Please mention SHORT WAVE CRAFT when writing advertisers

KABE PROS. CO., PRINTERS



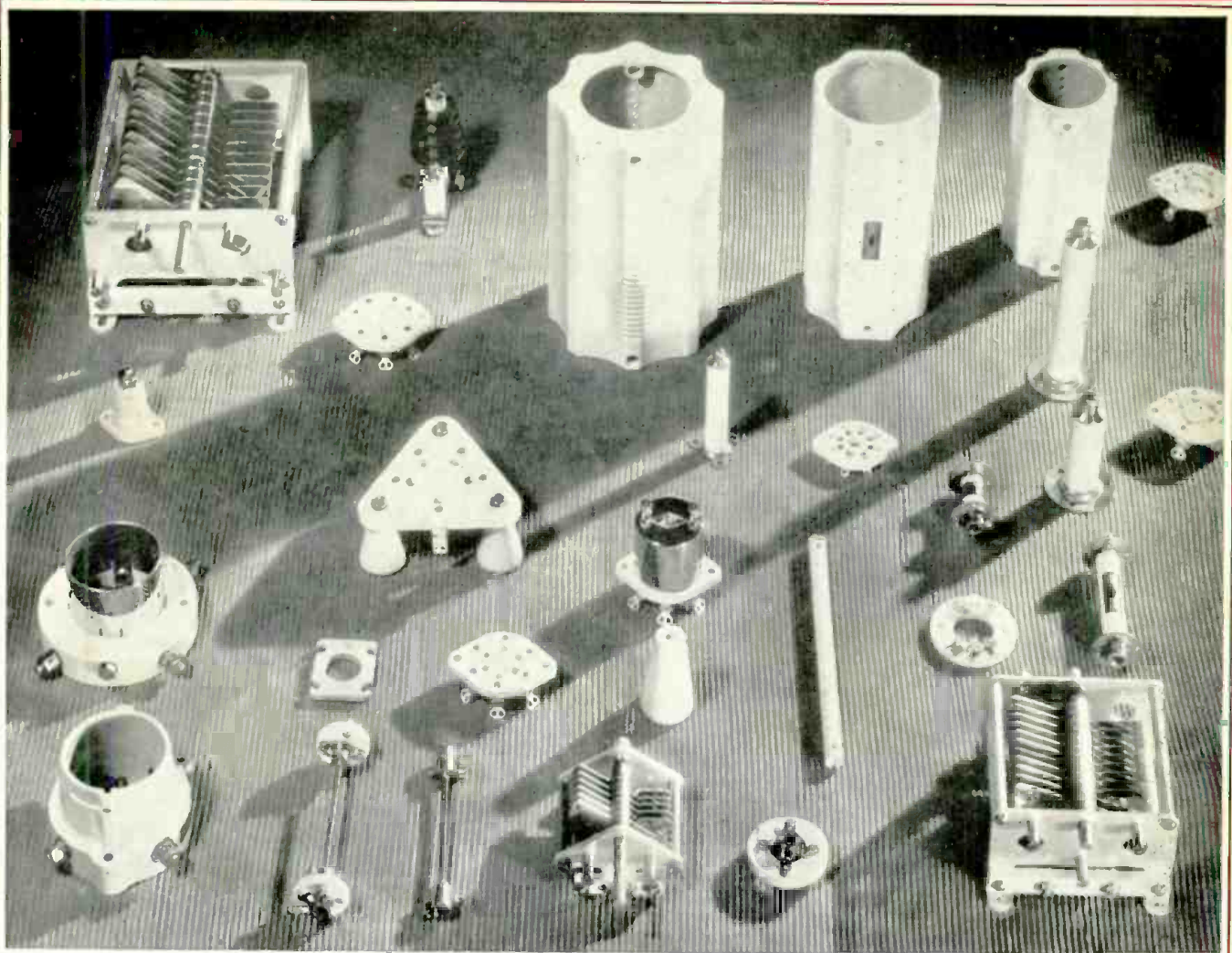

National offers a thoroughly engineered part for nearly every radio purpose. The entire line cannot be compressed into our twenty-page catalogue, much less a single page. But look over the group above. Transmitting condensers from the little 1000 volt TMS in the foreground to the 12,000 volt TMA at the rear. Low loss ceramic coil forms for every amateur band. Low loss sockets for nearly every tube type, from acorns to power pentodes. Flexible couplings from the little TX-12, which will work around a corner, to the big fellows for heavy condensers, high voltages, and low-losses. Strain insulators, spreaders, lead-ins for the antenna: stand-offs, chokes, dials for the rig. National has what it takes.

**NATIONAL**  
61 SHERMAN STREET



**COMPANY**  
MALDEN, MASS.

# How I Got My Start in RADIO

And Established My Successful

## RADIO SERVICE BUSINESS WITHOUT CAPITAL



Read This True Story By  
**E. LAMAR JOHNSTON, ROME, GEORGIA**

**E. LAMAR JOHNSTON, Rome, Georgia**

Graduated from the National Radio Institute on February 25, 1929. Today Mr. Johnston owns a profitable Radio Sales and Service business. Maybe you too should get into Radio. Read what Johnston says—then find out what Radio offers. Mail coupon.

"I WAS an untrained worker, with no regular job—sick and tired of skimping along, working for low wages when I could find work—and going farther in debt. One day I saw an advertisement of the National Radio Institute which said that they would train me at home to make more money in Radio.

"Frankly, at first I was doubtful whether I could learn Radio at home, as I knew nothing about electricity or Radio. But I knew that I needed training to get ahead, and Radio struck me as an industry which offered plenty of opportunity for trained men to make good money.

"So I sent for their Free Book, 'Rich Rewards in Radio'—and after reading it and

"Working with the Radio parts and equipment which I received as part of the Course showed me exactly how to do actual Radio work. I actually built the circuits and testing apparatus which were described in the Lessons. This made earning money easier and quicker.

"Since that time I have spent all my time in Radio work. I have married, bought my own home—a nice place valued at \$3,500—and have the nicest, most pleasant type of work in the world. My Radio business brings me a good income—and I am my own boss.

"I started my present business—now one of the largest and most profitable Radio firms in Rome, Georgia—with money I made servicing and selling sets. I had to have training to do this—training which goes far beyond the usual sort—training in ALL branches of Radio.

"That is the kind of training the National Radio Institute gives—the kind a man must have to get ahead in Radio. I honestly feel that any man who wants to make more money—and who is willing to spend a little of his spare time, training—will find success in Radio. Find out what Radio offers you. Send for

the National Radio Institute's Free Book today." (Signed) **E. LAMAR JOHNSTON**

**Many Make \$30, \$50, \$75 a Week in their Own Business or in Radio Jobs Like These**

The world-wide use of Radio sets has made many opportunities for you to have a spare time or full time Radio business of your own. Over 20,000,000 Radio sets are now in use in the U.S. More than \$235,000,000 worth of sets and parts were sold in 1934! Millions of sets are going out of date and must be rebuilt or replaced! About \$60,000,000 are spent EACH YEAR for repairs, servicing, new tubes, etc. Radio Sales and Servicing is a TREMENDOUS BUSINESS—with many opportunities for well trained Radio Experts! And Radio offers many job opportunities, too. Broadcasting stations use engineers,

operators, station managers and pay up to \$5,000 a year. Radio manufacturers use testers, inspectors, foremen, engineers, servicemen and buyers and pay up to \$6,000 a year. Radio Dealers and Jobbers employ hundreds of servicemen, salesmen, managers, for jobs up to \$75 a week.

**Many N. R. I. Men Make \$5, \$10, \$15 a Week in Spare Time While Learning**

The day you enroll, N. R. I. starts sending you Extra Money Job Sheets which quickly show you how to do Radio repair jobs. You get plans and ideas that have made good spare time money for hundreds of fellows.

**Money Back if not Satisfied**

When you enroll, you get an agreement to refund every penny of your tuition if you are not satisfied with N. R. I. Lesson and Instruction Service when you graduate.

**64-Page Book of Facts Sent FREE —MAIL COUPON**

Mail the coupon for your copy of "Rich Rewards in Radio"—the same book which started E. Lamar Johnston towards success in Radio. It's free to anyone over 15 years of age. It tells you all about Radio's spare time and full time opportunities; about N. R. I. Training; what others who have taken it are doing and earning. Mail the coupon now—in an envelope or paste it on a penny postcard.

J. E. Smith, Pres.

**National Radio Institute,**

Dept. 6FB3  
Washington, D. C.



**JOHNSTON'S MODERN SERVICE DEPARTMENT** in Rome, Georgia. All equipment was bought from Radio servicing profits. Johnston is on the left—his helper on the right.

learning about their practical Course, and after reading the letters from N. R. I. men who had made good—I enrolled right away. I have never regretted it since.

"The very first lessons I received showed

many ways that I could make money. I could start just as soon as I learned them. In a few weeks, I worked three hours and made one five dollar bill clear profit. Every lesson taught me more ways to make money that I could cash in on just as soon as I learned them.

### GET FREE LESSON on Radio Servicing Tips

Here's proof that N. R. I. Training is practical, money-making information, that it is easy to understand—that it is just what you need to master Radio. The sample lesson text, "Radio Receiver Troubles—the Cause and Remedy," covers a long list of Radio receiver troubles in A. C., D. C., battery, universal, auto. T. R. F., superheterodyne, all-wave and other types of sets. Get this lesson free. Mail coupon.

If you do not want to cut this cover—simply write us on a postcard

**J. E. SMITH, President  
National Radio Institute, Department 6FB3  
Washington, D. C.**

Dear Mr. Smith: Without obligation, send me the Sample Lesson and your free book about spare time and full time Radio opportunities, and how I can train for them at home in spare time. (Please write plainly.)

Name..... Age.....

Address.....

City..... State.....

14x1