

HUGO GERNSBACK  
Editor

# SHORT WAVE CRAFT

March 1935

WORLD'S  
LARGEST  
SHORT WAVE  
CIRCULATION

**\$500<sup>00</sup>**  
**IN PRIZES**  
**FOR BEST TITLE**  
**OF THIS COVER**  
*See Page*  
**650**



25

NRA  
CODE

# WORLD GLOBES

## FOR SHORT WAVE ENTHUSIASTS

### NOW AT LOW PRICES

THESE remarkable globes, executed in fourteen colors, are absolutely indispensable for short wave fans. Notable among the numerous features of these world globes, is that a damp cloth quickly removes all dust and water does not harm the surface.

Short Wave fans are enabled to determine correct time in various centers of the world with the aid of these maps; distances from city to city can be accurately established.

There is a graduated "Meridian" scale of black enameled metal with the 9" and 12" globes. An additional feature is the movable hour scale found at the north pole—this facilitates determining the hour in any part of the world.

Only on a globe of this size is it possible to get an accurate picture of countries and their relative positions to each other. You will actually be amazed when you compare distances—from New York to Moscow; from Cape Town to Tokio; from Los Angeles to Rio de Janeiro, etc. A flat map is deceptive for measuring, but take a small string and stretch it across the globe, from city to city, and you have the correct distances.

Here are globes that add dignity to home, office, studio or laboratory—a globe that everyone would be proud to possess.

Each world globe contains a listing of over 7,500 cities in nations the world over—spellings conform to International Geographic standards—all globes are of 1934 production. GET ONE OF THESE FINE WORLD GLOBES TODAY!



**World Globe No. 147**

12" Globe. New model—equipped with wooden floor stand finished in walnut. Height overall 35". Globe constructed with half meridian. New World Globe Handbook included FREE. A marvelous buy. Never has a floor model Globe been sold at such a low price. Shipping weight 9 lbs. **PRICE**

**\$4.15**

F.O.B. Chicago.

No. 147

Gentlemen:

I received the World Globe and am certainly well pleased with its completeness, appearance and its usefulness.

Short wave listening has become a hobby with me, and this World Globe is a necessary accessory to any short wave listener or, for that matter, to any home.

P. C. ELLIS, Supt.  
Laboratory—19th and Campbell Streets, Kansas City, Mo.

## ORDER YOUR GLOBE TODAY!

SHORT WAVE CRAFT SWC-3-35

59 Hudson Street, New York, N. Y.

Gentlemen: Enclosed you will find my remittance of \$..... for which please ship me the following World Globe.

- ( ) World Globe No. 99 @ \$2.05
- ( ) World Globe No. 147 @ \$4.15
- ( ) World Globe No. 47 @ \$0.90
- ( ) World Globe No. 139 @ \$2.95

Name .....

Address .....

City ..... State .....

Send remittance in check or money order—register letter if it contains cash, stamps or currency. GLOBES ARE SHIPPED FROM OUR WAREHOUSE IN CHICAGO—F. O. B. FROM THAT CITY.



No. 99

**World Globe No. 99**

9" Globe, equipped with sturdy, black metal base and full meridian. Same ball as our No. 139 but reduced 1/4 in size and scale. Included with globe is newly printed World Globe Handbook FREE. Shipping weight 6 lbs.

**PRICE**

**\$2.05**

F.O.B. Chicago.

**World Globe No. 47**

7" Globe, equipped with sturdy metal base and half meridian. Index to countries of the world by latitude and longitude shown on base. Shipping weight 2 lbs.

**PRICE**

**\$0.90** F.O.B. Chicago.

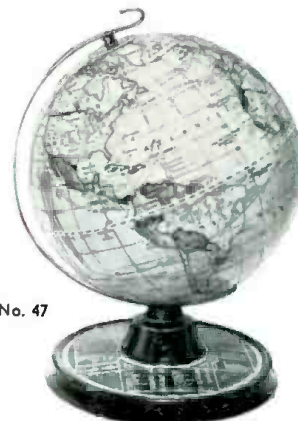

No. 47



No. 139

## SPECIAL THIS MONTH

**World Globe No. 139**

12" Globe, equipped with sturdy, black metal base and half meridian. Contains over 7,500 names and cities. Spellings conform to authoritative world standards. Hundreds sold to many short wave fans during the last year. Copy of World Globe Handbook included FREE. Shipping weight 8 lbs. **PRICE**

**\$2.95**

F.O.B. Chicago.

sufficient postage for delivery by parcel post. Globes are shipped from our Chicago warehouse. Register letter if it contains cash, or currency or stamps. If preferred, specify that shipment be sent express collect. ALL ORDERS ARE FILLED PROMPTLY.

ALL GLOBES SHIPPED IMMEDIATELY

**SHORT WAVE CRAFT** 99 HUDSON STREET, NEW YORK, N. Y.

# I will send you a Lesson Free



J. E. SMITH, President, National Radio Institute, Washington, D. C. — the man who has directed the training of more men for the Radio industry than any other man in America.

to show how easy it is to learn at home in spare time to fill a

# Good Radio Job

Clip and mail the coupon. I'll send you a FREE lesson. I'll show you that Radio is fascinating; that I give you practical money-making information, easy to learn, easy to put into use. See for yourself why many men with less than a grammar school education and no Radio experience have become Radio experts at two and three times what they were making before they enrolled with me. Get the facts about Radio's spare time and full time job opportunities.

### Many Radio Experts make \$40, \$60, \$75 a week. Get ready for Jobs like these

Broadcasting stations employ engineers, operators, managers, and men for other jobs that pay up to \$5,000 a year. Radio factories employ testers, inspectors, foremen, engineers, servicemen, salesmen, buyers, and pay up to \$7,500 a year. Radio dealers and jobbers employ servicemen, salesmen, buyers, managers, and pay up to \$100 a week. There are many opportunities to have a spare time or full time service or retail Radio business of your own. Radio business is picking up. It's a big business—big enough to absorb many more well trained men—growing bigger all the time. Get ready for Radio. Be a Radio Expert. I'll train you at home in spare time.

### Many make \$5, \$10, \$15 a week Extra in Spare Time almost at once

Nearly every neighborhood needs a good spare time serviceman. Find out how I help you cash in—how I send you directions, the day you enroll, for doing 28 Radio jobs. How, when you get underway, I send you much more information for servicing sets and for doing other spare time jobs for extra money. Many make \$200 to \$1,000 while learning.

### Short Wave, Loud Speaker Systems Television, Auto Radio, etc., included

Radio is growing. Loud speaker systems, police, auto and aviation Radio, are recent new uses that have been found for it. Television promises many good jobs soon. Here is a field with a future. Get full information about it—how I train you at home in spare time to be a Radio Expert. My 50-50 method of training—half with printed and well illustrated lessons, half with Radio equipment and directions for conducting experiments—gives you broad practical experience while learning—makes learning at home interesting, fascinating, practical.

### Money Back Agreement Protects You

I make this agreement with you in writing—if you are not entirely satisfied when you finish my Course, with the lesson and instruction service I have given you, every penny you have paid me for tuition will be refunded.

### Get my book on Radio's Opportunities. Get a Free Lesson too

Mail coupon now. I'll send you "Rich Rewards in Radio" and a FREE lesson at once. Find out about Radio's spare time and full time opportunities; read what others who have taken my Course are doing and making. Read the lesson, decide for yourself whether my training is clear, interesting, practical. There is no obligation. Act at once. Mail coupon in an envelope or paste on a 1c card. Do it right now.

J. E. SMITH, President  
National Radio Institute, Dept. 5CB3  
Washington, D. C.

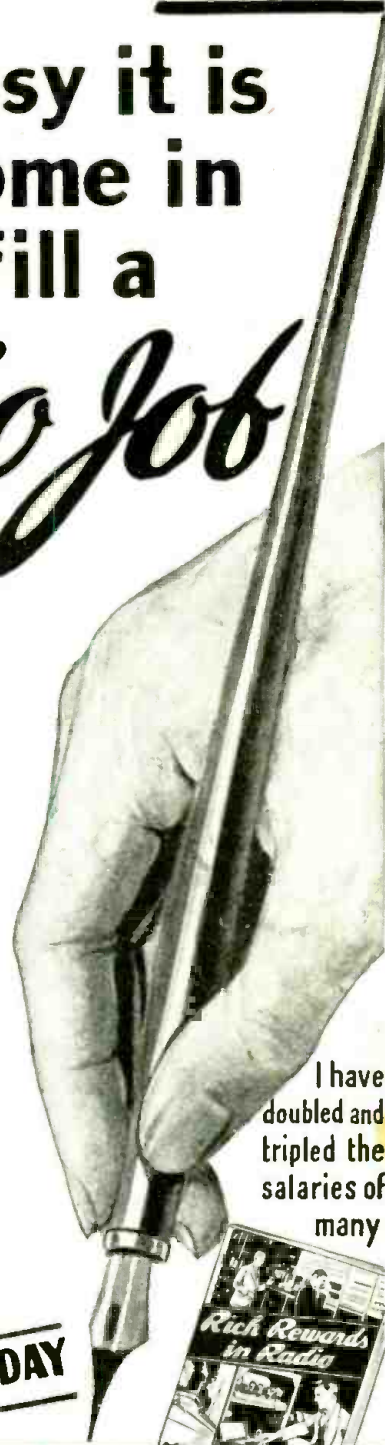

I have doubled and tripled the salaries of many

**MAIL THIS TODAY**

**Good for FREE SAMPLE LESSON and BOOK on RADIO'S OPPORTUNITIES**

J. E. SMITH, President  
National Radio Institute, Dept. 5CB3  
Washington, D. C.

I want to take advantage of your offer. Without obligating me, send me your Free Sample Lesson and your book, "Rich Rewards in Radio." (Please print plainly.)

NAME ..... AGE .....

ADDRESS .....

CITY ..... STATE ..... "R"



SET SERVICING has paid many N.R.I. men \$5, \$10, \$15, a week extra for their spare time. Full time men make as much as \$40, \$60, \$75 a week.



BROADCASTING STATIONS employ many technically trained men for interesting, fascinating jobs paying up to \$100 a week.



LOUD SPEAKER SYSTEMS, one of Radio's newest developments, gives interesting, well-paying jobs to many.

**The Tested Way to BETTER PAY**

Please mention SHORT WAVE CRAFT when writing advertisers

IN THIS ISSUE: PROMINENT SHORT-WAVE AUTHORS

Millen • Humphries • Felstead • Shuart • Brasfield • Friese

**HUGO GERNSBACK**  
Editor



**H. WINFIELD SECOR**  
Managing Editor  
**GEORGE W. SHUART,**  
W2AMN  
Associate Editor

**Contents For March, 1935**

Editorial—"Mysterious Short Waves," by Hugo Gernsback ..... 645

Japan S-W Phone to America Open, by H. Winfield Secor ..... 646

A Free-Wheeling Dial for your short-wave set, by William G. Wheat..... 648

Dial Selects Any One of 10 Frequencies..... 649

9500-Mile Contact between Plane and Land Station..... 649

\$500.00 Prize Contest for Best Title for This Month's Cover ..... 650

1-Tube All-Electric Oscillodyne, by Art Gregor..... 651

The "Regenadyne 5"—A Smooth-Tuning Receiver, by W. R. Humphries..... 652

B-S 4 Works Loudspeaker and Has Band-Spread Tuning, by Albert Friese, Jr..... 654

10-Tube S-W. Super-Het. with 2-Stage Pre-Amplifier, by Charles T. Brasfield, Jr., B.S. in E.E..... 655

World-Wide Short-Wave Review, edited by C. W. Palmer ..... 656

SHORT WAVE SCOUT "NEWS"..... 658

13th Trophy Award in SHORT WAVE SCOUT Contest... 659

Short Waves and Long Raves..... 660

The ALL-STAR JUNIOR Band-Spread 5..... 662

A Really New COMMUNICATION Receiver, by James Millen ..... 664

The New 1935 Denton DISCOVERER..... 665

New Short-Wave Apparatus..... 666

\$5.00 for Best Short-Wave "Kink"..... 668

Short-Wave Stations of the World, Complete List, including "Police" and "Television" stations, edited by M. Harvey Gernsback..... 669

When to Listen In, edited by M. Harvey Gernsback..... 672

Short Wave League..... 673

Short Wave QUESTION BOX..... 674

Low-Power Rack and Panel Xmitter, by George W. Shuart, W2AMN..... 676

"Long Lines" Xmitter with 800's..... 676



**Certified Circuits**

● **SHORT WAVE CRAFT** goes to a large expense in verifying new circuits. When you see this seal it is your guarantee that such sets have been tested in our laboratories, as well as privately, in different parts of the country. Only "Constructional-Experimental" circuits are certified by us.

When you see our certified seal on any set described, you need not hesitate to spend money for parts, because you are assured in advance that the set and circuit are bona fide and that this magazine stands behind them.

**SHORT WAVE CRAFT** is the only magazine that certifies circuits and sets.

**OUR COVER**

● \$500.00 worth of short-wave apparatus, including sets, etc., will be awarded by the Editors for the 50 best titles submitted by our readers and describing in not more than seven words, the situation illustrated on this month's front cover. "Hubby" adopted headphones so as not to bother "Wifey," but still she seems highly irritated! Why? That's for you to answer, and perchance win some part of the \$500.00 in prizes offered. See page 650.

COPYRIGHT, 1935, BY H. GERNSBACK

Published by **POPULAR BOOK CORPORATION**

HUGO GERNSBACK, President - - - H. W. SECOR, Vice-President  
EMIL GROSSMAN - - - - - Director of Advertising  
Chicago Adv. Office - - - - - L. F. McCLURE, 919 No. Michigan Ave.  
Publication Office - - - - - 404 N. Wesley Avenue, Mount Morris, Ill.  
Editorial and General Offices - - - - - 99-101 Hudson St., New York, N. Y.  
London Agent: HACHETTE & CIE., 16-17 King William St., Charing Cross, W.C.2  
Paris Agent: HACHETTE & CIE., 111 Rue Reaumur  
Australian Agents: MCGILL'S AGENCY, 179 Elizabeth St., Melbourne

**Features in the April Issue**

- Low-Power Rack and Panel Transmitter, Part 2—R.F. Amplifier Construction, by George W. Shuart, W2AMN.
- 3-Tube Super-Het.—With complete drawings and circuit details, by H. Dobrovolny.
- A 7-Tube Super-Het. For the Ham, by Ernest Kahlert—a real de luxe set.
- High Fidelity—How to Get It on Your "Old" Loudspeaker! By Wilhelm Schrage.
- All-Wave Adapter for Short-Wave Set, by J. A. Worcester, Jr.

SHORT-WAVE CRAFT—Monthly. Entered as second class matter May 7, 1930, at the post office at Mount Morris, Illinois, under the act of March 3, 1879. Trademarks and copyrights by permission of H. Gernsback, 99-101 Hudson St., N. Y. C. Text and illustrations of this magazine are copyrighted and must not be reproduced without permission. **SHORT WAVE CRAFT** is published on the 1st of every month. Twelve numbers per year. Subscription price is \$2.50 a year in the United States and possessions. Canada and foreign countries, \$3.00 a year. Single copies 25c. Address all contributions for publication to Editor, **SHORT WAVE CRAFT**, 99-101 Hudson St., New York, N. Y. Publishers are not responsible for lost manuscripts. Contributions cannot be returned unless authors remit full postage. **SHORT WAVE CRAFT** is for sale at all principal newsstands in the United States and Canada. European agents: Brentano's, London and Paris. Printed in U. S. A. Make all subscription checks payable to Popular Book Corporation.

# SAY FELLOWS

I'll FINANCE YOUR TRAINING  
IN THE GREAT FIELD OF

# RADIO

LEARN BY DOING IN 10 WEEKS



mail the coupon below and I'll give you all the facts about my plan to finance your training - and let you pay for this training in easy monthly payments, which won't start until 60 Days AFTER your 10 weeks training period is over - then you will have over a year to complete your payments.

Then after you have completed your training my employment department will get ahead you and give you assistance to help you locate the job for which you have been trained.

Here at COYNE you are trained on actual RADIO-TELEVISION and TALKING PICTURE machinery and equipment, and not by books or lessons - ALL PRACTICAL WORK with only the necessary theory which is given in a practical way. you don't need advanced education or previous experience.

Right now I'm including, at no extra cost, my big new course in ELECTRIC REFRIGERATION AND AIR CONDITIONING.

If you write me today or send coupon I will send you complete details of my sensational new plan and my big Free illustrated book telling all about Coyne and how many EARN WHILE LEARNING.

## MAIL THIS COUPON FOR ALL FACTS

H.C. LEWIS PRES. DEPT. 35-2K  
COYNE ELECTRICAL AND RADIO SCHOOL  
500 - SOUTH PAULINA ST.  
CHICAGO ILLINOIS.

Please send me your big Free book and all the facts.

NAME \_\_\_\_\_  
ADDRESS \_\_\_\_\_  
CITY \_\_\_\_\_ STATE \_\_\_\_\_

H.C. Lewis Pres.  
COYNE ELECTRICAL AND RADIO SCHOOL  
500 - SOUTH PAULINA ST  
CHICAGO ILLINOIS DEPT. 35-2K

Please mention SHORT WAVE CRAFT when writing advertisers

● IT IS always the well-trained man who wins out over the horde of thousands of superficially trained and incompetent men. You are reading this magazine because you are interested in radio. Sooner or later, the time will come when you will wish to cash in on your knowledge. Your chance may come over night, and then the big and vital question will be, "How well equipped am I to fill the job?" You are in radio because you like it. You also realize that, at the present time, there are many branches of the radio art which you do not know as thoroughly as you should. Knowledge, these days, can be gotten cheaper than ever before. It isn't necessary

# CUT PRICES ON RADIO BOOKS

for you to go to college to become proficient in radio. Start today, to build a REAL radio library and become acquainted with all branches of this great and growing art. In this page are listed the world's best radio books. We have combed the market for the really important books in radio; so that, no matter what branch you are interested in, you can pick out the best books that are now printed. Start now, to build a complete radio library. You do not have to get all the books at once, but make up your mind to get one book a month; so that, when your chance comes, you will be fully equipped to win out over the others not so well equipped.

**IMPORTANT—All prices have been drastically reduced—many new books.**

**SHORT WAVE WIRELESS COMMUNICATION.** by A. W. Ladner and C. R. Storer. Cloth covers, size 6x9". 348 pages, 200 illustrations, 12 plates. Price ..... **\$3.46**

Short wave experimenters who have grown out of I-tube sets will revel in this book, which tells the "how come" of short-wave operation. A good portion of the volume is devoted to the amateur and commercial aspects of S. W. transmission.

**THE RADIO AMATEUR'S HANDBOOK (Twelfth Edition).** 237 illus. 208 pages. Price ..... **\$1.00**

A manual of high-frequency communication, radio and electrical fundamentals are delved into in considerable detail and pleasurable accuracy. Message handling and other items of interest to the transmitting amateur are given special consideration.

**PRACTICAL TELEVISION.** by E. T. Lerner. Cloth covers, size 5½x8½". 223 pages, 127 illustrations. Price **\$3.69**

This book explains television in full, including elementary principles, photo-electric cells, and all important types of television sets as well as basic principles of optics, images, mirrors, lenses, etc.

**OFFICIAL SHORT-WAVE RADIO MANUAL, Volume 1.** by Hugo Gernsback and H. W. Secor, with 352 pages, illustrations. Flexible, looseleaf leatherette binder. Size 9½x12". Price **\$2.00**

The one and only short-wave manual published. Contains constructional information on the most important Short-Wave Receivers, sections on S.W. Transmitters, Ultra Short Waves, S.W. Beginner's section, coil winding, A.C.-S.W., Power Parks, kinks, etc., for S.W. Experimenters, sections on S.W. Converters, Antennae, Superheterodynes, Amateur Phone Transmitters, Super Heterodyne in S.W. Receivers, S.W. Therapy, S.W. Physics, etc.

**ELEMENTS OF RADIO COMMUNICATION (Second Edition).** by John H. Morecroft. Cloth covers, size 6 x 9½". 286 pages, 11 illustrations. Price **\$2.98**

An introductory volume, written in easily understandable style, to the more comprehensive, "Principles of Radio Communication."

**AUDEL RADIOMAN'S GUIDE.** by Frank D. Graham. Cloth covers (flexible), size 5½x8½". 220 pages, 300 illustrations. Price **\$.89**

A practical, concise book presenting the theoretical and practical information for the proper operation, maintenance and service as applied to modern radio practice.

**EXPERIMENTAL RADIO.** by R. H. Ramsey, Prof. of Physics, Indiana University. Cloth covers, size 7½x5½". 256 pages, 108 illustrations. Price. **\$2.69**

A marvelous book for the experimenter. Experiments galore in easy comprehensible language.

**THE RADIO AMATEUR'S HANDBOOK.** (New Revised Edition), by A. Frederick Collins. Cloth covers, size 5½x7½". 394 pages, 116 illustrations. Price ..... **\$1.97**

If you wish to become a radio amateur (radio ham) this book tells you how. Everything in receiving and transmitter sets and how to build them.

**RADIO THEORY AND OPERATING.** by M. T. Loomis, 5th revised Edition. Cloth-bound; size 5½x8½" thick; 1,000 pages; over 800 illus.; 450 review questions and answers. Price **\$4.38**

Written in textbook style, a tremendous amount of useful information has been crammed into this thin-paper, compact reference work. Radio transmission and reception have been covered, "from soup to nuts." A truly great book.

**SHORT WAVE RADIO HANDBOOK.** by Clifford E. Denton. Paper covers, size 6½x8½". 128 pages, 150 illustrations. Price **\$1.00**

Circuit data, circuit data, testlink data, etc., let us say, "data of every imaginable sort—in connection with short-wave radio reception."

**DRAKE'S CYCLOPEDIA OF RADIO AND ELECTRONICS.** by H. P. Manly. Cloth covers, size 6x9". 1050 pages, 1080 illustrations. New 1932 Edition. Price **\$4.88**

The largest work of its kind ever put between two covers. New and up-to-date; a standby for every radio man.

**FUNDAMENTALS OF RADIO.** by H. B. Ramsey, Professor of Physics, Indiana University. Cloth covers, size 9½x6". 372 pages, illustrated. Price prepaid **\$3.46**

The backbone of the radio art. This book gives you the foundation on radio from A to Z.

**OFFICIAL RADIO SERVICE MANUAL, Volume 4.** by Hugo Gernsback and C. Walter Palmer. Flexible, looseleaf leatherette cover, size 9½x12", over 2,000 illustrations, over 100 plates. Price **\$3.00**

Whether for public address work, receiver diagrams or tube data, every conceivable kind of radio set information needed will be found in this great service manual.

**OFFICIAL RADIO SERVICE MANUAL, Volume 5.** by Hugo Gernsback and C. Walter Palmer. Flexible, looseleaf leatherette cover, size 9½x12", over 3,000 illustrations, over 1,000 pages. Printed on thin bible paper. Price prepaid. **\$5.86**

This 1935 Manual is the most authentic and elaborate service guide ever used in the radio field. There has never appeared such a complete radio manual as this one.

**RADIO CONSTRUCTION AND REPAIRING.** by James A. Moyer and John F. Wostrel. Cloth covers, size 8½". Well illustrated, new revised fourth edition, containing 414 pages, still remaining at the same price. Price **\$2.50**

A handbook that every radio set tester and general student must have. The diagrams alone are worth the price of the book.

**THEORY OF VACUUM TUBE CIRCUITS.** by Leo James Peters. Cloth covers, size 6x9". 226 illustrations, 226 pages. Price **\$2.98**

It is one thing to "connect green lead No. 1 to pink lead No. 4," but it is another to know why the connections are made. Read this book and learn the design factors in tube circuits.

**PRINCIPLES OF RADIO COMMUNICATION.** by J. H. Morecroft, Prof. of Electrical Engineering, Columbia University. Cloth covers, size 9½x6". 988 pages, profusely illustrated. Price **\$7.35**

The radio classic, by the dean of radio. Covers entire radio art as does no other book.

**RADIO ENGINEERING HANDBOOK.** by Keith Henney. Flexible Leatherette, size 1½x7". 581 pages, 482 illustrations. Price..... **\$4.88**

Each of the 23 sections has been written by a specialist! Includes valuable data on talkies and short waves.

**RADIO SERVICE MAN'S HANDBOOK WITH ADDENDA DATA SHEETS.** Flexible covers, size 9½x12", 200 pages, 100 illustrations. Price prepaid. **\$1.49**

The Service Man's standby. Contains the latest practical information on radio servicing.

**HOW TO PASS U. S. GOVERNMENT RADIO LICENSE EXAMINATION.** by H. L. Duncan and C. E. Draw. Flexible covers, size 9½x7". 170 pages, 92 illustrations, appendix. Price..... **\$1.89**

The most important book on the subject ever published. Gives every conceivable angle which will help you to pass a radio license examination successfully.

**RADIO OPERATING QUESTIONS AND ANSWERS.** (Revised Fifth Edition), by Nilson ed. Horning. Cloth covers, size 5½x8". 390 pages, 96 illustrations. Price..... **\$2.47**

Contains over 600 questions and answers covering all phases of licensed radio operation. Revised to contain much new material. Nothing better in print.

**RADIO PHYSICS COURSE (2nd enlarged edition).** by Alfred A. Ghirardi. Cloth covers, size 7½x9½". 992 pages, 510 illustrations, numerous tables. Price..... **\$3.89**

The finest and most popular book on electricity and radio. Each subject is clearly discussed, with the aid of dozens of excellent drawings. Chapters on talkies, television, electronics and service work, etc. Biggest buy in radio.

**5 METER RADIOTELEPHONY.** by Frank Jones. 32 pages, 39 illus. Per copy postpaid. Price **\$.25**

Here you learn to construct a variety of 5 meter transmitters and antennas. Written by the designer of the 5 meter equipment for the San Francisco Bay Bridge.

We herewith present the most complete collection of recent important radio books. We have, after an exhaustive study, selected these volumes because they represent the foremost radio books of their kind in print today. There is such a great variety that we are sure it will satisfy any taste as well as any requirement that the student of radio might have.

We publish no catalog and ask you to be kind enough to order direct from this page. Prompt shipments will be made to you direct from the publishers. We merely act as a clearing house for a number of radio publishers and OUR PRICES ARE AS LOW AS LOWER THAN WILL BE FOUND ANYWHERE. Remit by money order or certified check. Register all cash.

**ACTUAL TROUBLES IN COMMERCIAL RADIO RECEIVERS.** by Bertram M. Freed, Sturley Paper covers, size 6½x8½". 123 pages, 190 pages. Price **\$1.00**

Over 500 models of foremost manufacturers are represented, and discussed in connection with 37 diagrams. No Service Man should be without this handy, self-indexed volume of "operating notes" that analyze set faults by their symptoms.

**FIRST PRINCIPLES OF TELEVISION.** by A. Dinsdale. Cloth covers, size 6x9". 242 pages, 130 illustrations. 38 plates. Price **\$3.46**

A real review of television in design, construction and operation. This amazingly comprehensive book contains many heretofore unpublished facts on this absorbing topic.

**RADIO RECEIVING TUBES.** by Moyer and Wostrel. Cloth covers, size 7½x5½". 298 pages, 181 illustrations. Price..... **\$2.47**

One of the finest books on vacuum tubes. Everything worthwhile on the subject treated in a masterful manner.

**PHOTOCELLS AND THEIR APPLICATION.** (Second Edition), by V. K. Zvonik and E. D. Wilson. Cloth covers, size 5½x8". 332 pages, 140 illustrations. Price..... **\$2.88**

Does this book tell you why and how to use light-sensitive cells? The answer is that the first edition has a sell out, and the second edition, brought right up to date, is even a better volume. Enough said.

**ELECTRONICS.** by K. C. Hudson. Cloth covers, size 6x9". 131 pages, 45 illustrations. Price..... **\$1.95**

This book is written for the reader who may wish to know something about what is going on and who has not heretofore, given the matter much attention, says the author. Read it and learn how dry rectifiers, vacuum tubes, batteries, television tubes, and other apparatus, work; get the "low down" on electronics and atoms.

**RADIO SERVICING COURSE.** by Ghirardi and Freed. Cloth covers, size 5½x7½". 192 pages, 124 illustrations; 114 test questions; 28 test-instrument circuits. Price..... **\$1.67**

A practical book beginners and old-timers in radio service will find useful. Nine chapters discuss measuring instruments and tests, and trouble-shooting; the chapter, "Useful Information for Servicemen," closes the book.

**RADIO ENGINEERING.** by Frederick Emmons Terman. Cloth covers, size 6x9". 700 pages, 425 illustrations. Price..... **\$4.88**

Not a book for the beginner in radio, but a reference volume for the technician who wants modern information on the design and use of band-selectors, automatic volume control, diode detectors, and the thousand-and-one units and circuit arrangements which have been recently developed.

**PRINCIPLES OF RADIO.** by Keith Henney, M. A. Cloth covers, size 8½x5½". 478 pages, 306 illustrations. Price **\$3.46**

A marvelously written textbook with the latest radio principles, including screen grid and pentode, amplifiers, etc.

## NEW LOW PRICE RADIO BOOKS

Here are 14 new, up-to-date books on every conceivable radio subject just published in Modern in every sense. ALL BOOKS UNIFORM from 64 to 72 pages; 50 to 120 illustrations. All books written by well-known radio authors. Order by Number.

No. 1 **RADIO SET ANALYZERS**  
No. 2 **MODERN RADIO VACUUM TUBES**

No. 3 **THE SUPERHETERODYNE BOOK**

No. 4 **MODERN RADIO BOOK-UPS** by B. D. Washburn

No. 5 **HOW TO BECOME A RADIO SERVICE MAN**

No. 6 **BRINGING ELECTRIC (RADIO) SETS UP TO DATE**, by C. E. Denton

No. 7 **RADIO KINKS & WRINKLES (for Experimenters)**

No. 8 **RADIO QUESTIONS & ANSWERS**, by R. D. Washburn

No. 9 **AUTOMOBILE RADIO & SERVICING**

No. 10 **HOME RECORDING AND ALL ABOUT IT**, by Geo. J. Sedgwick

No. 11 **POINT-TO-POINT RESISTANCE MEASUREMENTS** by C. E. Denton

No. 12 **PUBLIC ADDRESS INSTALLATION AND SERVICING**

No. 13 **HOW TO BUILD AND OPERATE SHORT WAVE RECEIVERS.** by the Editors of SHORT WAVE CRAFT

No. 14 **HOW TO BECOME AN AMATEUR RADIO OPERATOR.** by M. P. Edly

PRICE PREPAID EACH BOOK **\$6.45**  
PRICE PREPAID FOR **\$6.00**  
ALL 14 BOOKS

## HOW TO ORDER

We cannot ship C. O. D. Our prices are net, as shown. Some of the books sent prepaid will be shipped by express collect if sufficient postage is not included by you.

**FOUNDATIONS OF RADIO.** by Rudolph L. Duncan. Cloth covers, size 5½x8½". 246 pages, 145 illustrations. Numerous tables. Price **\$2.47**

This textbook gives you the fundamentals of electricity as applied to radio. It equips you for further study in the field of radio.

**EXPERIMENTAL RADIO ENGINEERING.** by John H. Morecroft. Cloth covers, size 6x9". 346 pages, 250 illustrations. Price **\$3.46**

A student's book; devoted to the principles of radio apparatus; intended to accompany a course in electricity. The best of its kind.

**ELECTRICITY AT HIGH PRESSURES AND FREQUENCIES.** by Henry L. Transstrom. Paper covers, size 7½x5½". 248 pages, 141 illustrations. Price **\$1.89**

A marvelous book for the student in electricity and radio. General fundamentals lead up to a complete discussion of every type of Tesla and Oudin high-frequency coils, Geissler tubes, etc.; construction details of Tesla coils are given in great profusion. THE ONLY BOOK OF ITS KIND.

**THE RADIO MANUAL.** by George E. Sterling and Robt. S. Kruse. E. 2nd enlarged edition. Flexible, fabricoid covers, size 5½x8". 805 pages, 348 illustrations. Price **\$5.88**

A complete Radio Course for the operator, the technician, the amateur, the student and experimenter. Everything imaginable in the whole radio art is covered in this great book—"the radio Bible" of the amateur. DON'T MISS THIS.



# RADIO PUBLICATIONS 97 Hudson St. New York, N. Y.

Please mention SHORT WAVE CRAFT when writing advertisers



# Mysterious Short Waves

An Editorial By HUGO GERNSBACK

● IT IS a well-known fact that the more we learn about a given subject, the less we know about it in the end. Ten years ago, any radio engineer would have been cocksure that radio waves, the same as all electro-magnetic waves, traveled at the speed of light, that is, 186,000 miles per second. These were known as facts, and no one ever seriously questioned these "facts." But our latter-day scientists have the habit of pulling out the props from almost any so-called "fact" and many of our preconceived notions have a habit of tumbling about our ears in a most disconcerting fashion of late.

Thus, for instance, Dr. Harlan T. Stetson told the American Association for the Advancement of Science recently that radio waves, which had been assumed to travel always at the speed of 186,000 miles a second, did *not always* do so! Indeed, he found that sometimes they traveled at only *half this speed*, that is, about 93,000 miles a second.

Dr. Stetson found that signals from Rugby, England, transmitted to Annapolis, Md., varied greatly in speed, while those from Bordeaux, France, to Annapolis did not vary. These variations immediately raised havoc in several fields. In the first place, scientists had become used to the idea that they had a most accurate and unvarying "yardstick" in the speed of radio waves, which they assumed to be 186,000 miles a second. They now found this yardstick no longer accurate.

To illustrate, radio has been used right along to plot the exact longitude, that is, in other words, east and west position of any point of the earth's surface. Thus, for instance, we are not certain now what the *exact* longitude of New York is, and, as a matter of fact, it is no more exact now than before the advent of radio.

In astronomy, where exact results are of paramount importance, the radio yardstick is now found not to be accurate any longer, and this may have important considerations and effects on astronomy. Of course, as far as the radio listener is concerned, it makes very little difference if the program is delayed a fraction of a second, and he does not particularly care about a slight delay, but to science in general, it raises absolute havoc!

What are the reasons behind this apparent mysterious behavior of radio waves? The answer is probably in the Heaviside Layer, or rather the electrified or conducting air in the upper regions of our atmosphere. Thus, Dr. Alfred N. Goldsmith thinks that waves from Europe to America traveling the *southern* route, encounter more normal atmospheric conditions and travel at the usual velocity, that is, 186,000 miles a second; while, on the other hand, other radio waves sent from Europe to the United States travel through the Arctic regions, where they encounter an elec-

*trified or conducting air*, in the upper regions, which may have the effect of slowing up the flight of the waves.

I personally have no fault to find with this theory and it probably will hold true to a large extent. On the other hand, there is nothing absolutely original with these findings, if we consider the following:

It has been known for many years that if you send a signal by cable across the Atlantic there is a delay of about 1/10 of a second. The delay is caused by the fact that the cable has a certain electrical capacity. We have a conductor inside of the cable, then the insulation, and outside the ocean. This gives us a huge electrical condenser. When trying to get a signal through this condenser we must first charge the condenser. Now, as anybody knows who has done much work with condensers, it takes a certain *time* to charge the condenser, and this accounts for the delayed action of the signal. After all, the signal is only an electrical current and if you try to push the signal through the condenser, you meet with a certain resistance. Indeed, it is most interesting to know that the time delay increases as the square of the distance, in other words, if you had a submarine cable going around the world, that is, 24,000 miles, it would actually take 17.3 seconds to get the signal through the cable.

If we consider the earth and the Heaviside layer as the two members or plates of a huge condenser, and knowing further that the velocity of transmission of a wave through a highly attenuated gaseous medium, such as that existing between the earth and Heaviside layer, varies with the degree of ionization of such a medium, it is apparent that there can be quite a radical change in the velocity of the wave or signal transmitted between two such widely separated points as New York and London. As pointed out by Ladner and Stoner in their excellent treatise, "Short Wave Wireless Communication" "the reduction in the group velocity (referring to the transmission of waves through an ionized medium, such as gas) is dependent upon the electron density of the medium through which the group is travelling." Further these authorities state—"The importance of atmospheric pressure (in regard to radio transmission) lies in the fact that pressure determines conductivity and dielectric constant, for although air at atmospheric pressure is almost a perfect insulator, at low pressure it becomes ionized by the sun's action. The effect of ionization is to reduce the dielectric constant and increase the conductivity of the gas in different ways to different frequencies. A removal of the cause of ionization allows the gas to return to its un-ionized condition, due to the recombination of charged particles, and it is to be observed that the time of recombination and ionization may be a *slow process* if the gas pressure is very low.

**SHORT WAVE CRAFT IS PUBLISHED ON THE 1st OF EVERY MONTH**

This is the March, 1935, Issue—Vol. V, No. 11. The Next Issue Comes Out March 1

Editorial and Advertising Offices, 99-101 Hudson Street, New York City

# JAPAN S-W Phone To

• TOKYO is now a next-door neighbor—thanks to the magic of *short-waves*. A few weeks ago the new Japanese *short-wave* telephone service with America was officially opened, officials in both Japan and the United States participating in the inaugural ceremonies. This newest link in the widespread short-wave-wire telephone connections of the A.T.&T. Company to foreign countries, bridges a distance of 5,130 miles across the Pacific. The subscriber's telephone conversations travel on wavelengths varying between 18 and 45 meters, the frequency depending upon the transmission conditions and the season of the year, the extent of daylight over the Pacific, etc.

Japanese engineers, many of them educated in American universities, are in charge of the 20 K.W. Japanese transmitter located near Tokyo, at Nazaki. An engineer of the Bell Telephone Laboratories, George W. Gilman, has spent considerable time in Japan with their engineers and his wife helped the twenty-two Japanese operators to perfect the English they are now using in dealing with their American sisters in San Francisco. The San Francisco girl operators have only to speak English therefore in setting up subscribers' calls.

The Japanese trans-Pacific receiving station is located at Komuro, a short distance from Tokyo, both the transmitting and the receiving stations being connected, of course, by telephone lines

A few weeks ago the newest link in the combined wire and short-wave telephone service to foreign countries was officially opened by the American Telephone and Telegraph Company. This service involves a short-wave transmission link across the Pacific Ocean from San Francisco to Tokyo, a distance of 5,130 miles, or about 9,000 miles by wire and short wave from Tokyo to New York. One of the S.W. transmitting units at Nazaki, Japan, is used for regular S.W. broadcasting daily.

with Tokyo. By means of this new short-wave radio telephone service, Bell and Bell-connecting telephone subscribers in the United States, Canada, Cuba, and Mexico, can now be interconnected with telephone subscribers in Honshu, the principal island of the Japanese Archipelago and in places on other islands of the group. This is the fourth radio telephone circuit to be set up connecting Bell System subscribers

with countries on the other side of the Pacific, the other short-wave phone channels spreading out over the broad Pacific connecting with Honolulu, in the Hawaiian Islands; Java and Manila in the Philippine Islands.

The short-wave messages from Japan are picked up at the special American Telephone and Telegraph Co.'s receiving station, located at Point Reyes, near San Francisco, the outgoing phone messages passing through the twenty K.W. transmitter located at Dixon, a short distance from San Francisco.

The subscribers' telephone *voice currents* in either direction are passed through *speech inverters*, which "scramble" the words or rather syllables, turning them into unintelligible jargon for their flight through the ether.

As the accompanying diagram shows, the route of the Japanese subscriber's voice, when the connection with America is established, is as follows: The voice currents pass over the subscriber's telephone to his local telephone exchange, and then to the international operator in Tokyo. From there the voice passes through the technical operator's control board, then through a volume control panel, a "time delay" network, then through a voice-operated relay or "Vodas", and from this point the outgoing speech to America passes through "speech-inverter apparatus." Next it passes to the transmitting station where it modulates the carrier,

(Continued on page 677)

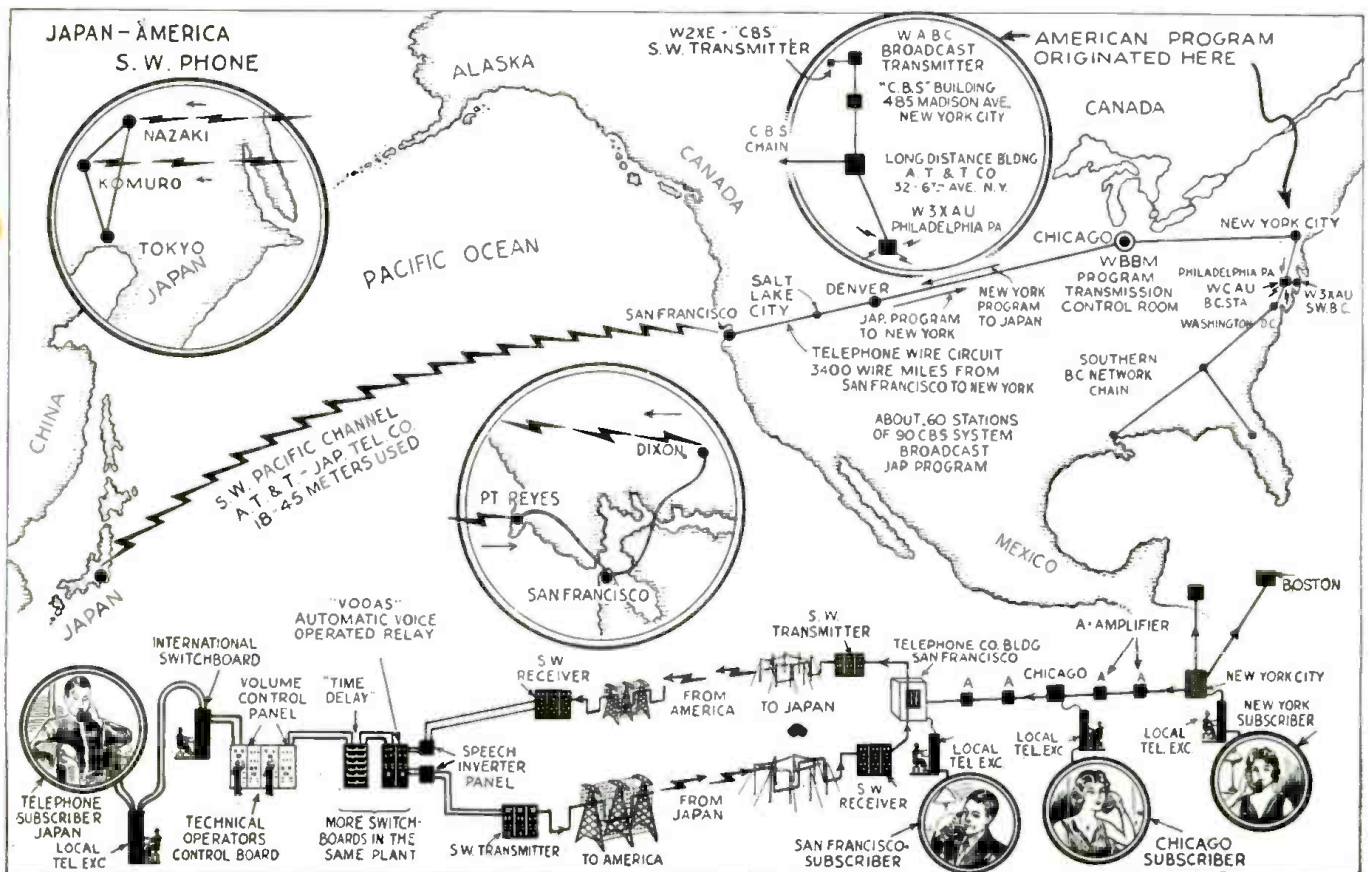

The drawing above shows graphically the important links in the short-wave and wire telephone system recently opened by the A.T. & T. Company between Japan and America. The voices are "scrambled" to insure privacy.



# AMERICA Open

By H. WINFIELD SECOR

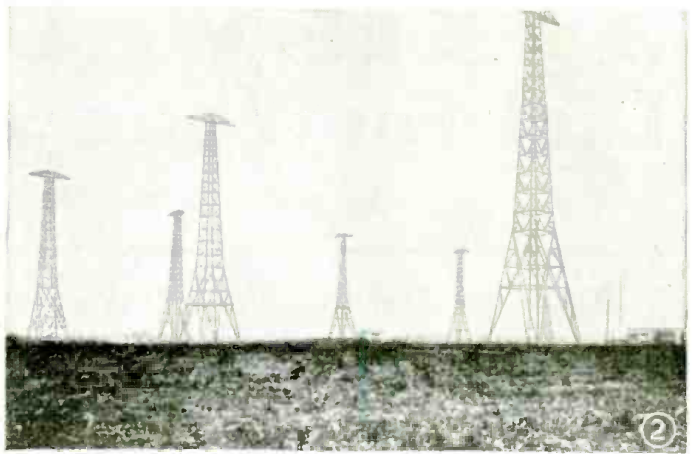
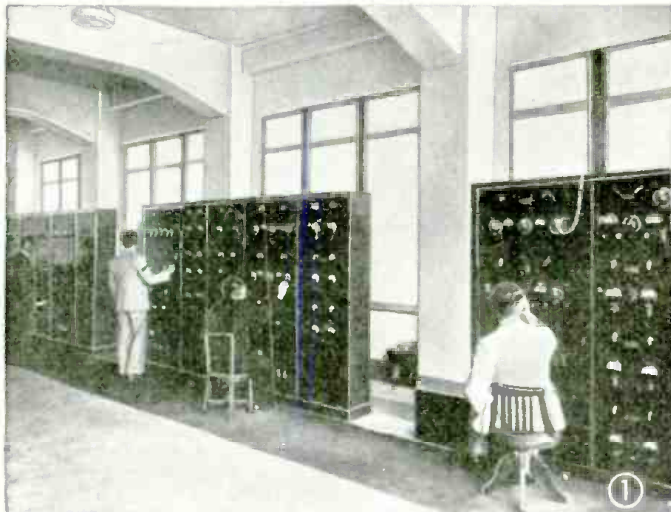

Fig. 1, at left, shows elaborate short-wave receivers at the Japanese station located at Komuro. Here the short-wave telephone signals from the San Francisco transmitter are tuned in. Japanese technical operators are in charge and one American engineer co-operated with them in establishing the new short-wave telephone transpacific stations. Fig. 2, above, shows the 280-foot steel towers supporting the antenna array at the short-wave transmitting station located at Nazaki, Japan. Building, at right, houses 20 kw. transmitter.

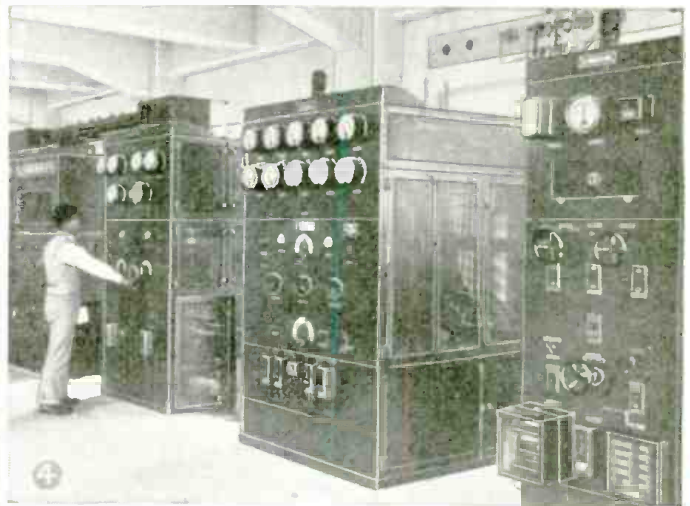
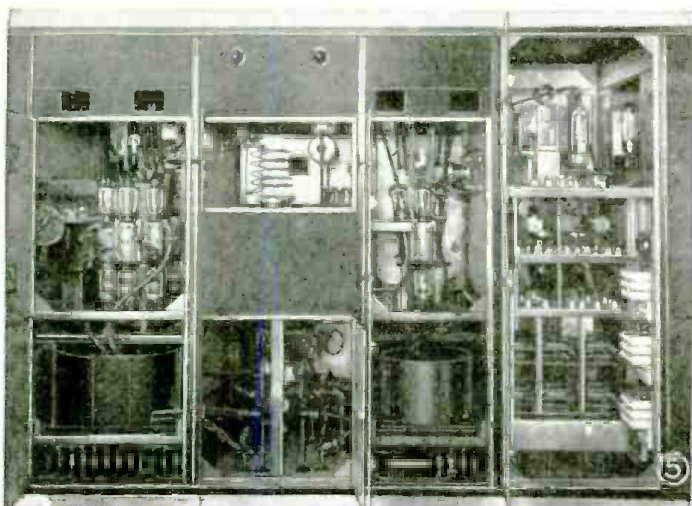

Fig. 3, above—Here we have an interesting view of the building housing the Receivers and auxiliary equipment for the short-wave phone service to America and located at Komuro, Japan. The antenna arrangement is supported by the masts shown, which are somewhat lower than those used for supporting the transmitting aerials. Fig. 4, to the right, shows Japanese engineer tuning one of the 20 kw. short-wave phone transmitters at Nazaki.

Fig. 5, at left, shows rear view of one of the transmitters at Dixon, Calif. Beginning at right, we have R.F. input apparatus; first amplifier stage; inter-stage unit showing tuned circuit and water flow alarms; water cooled vacuum tubes for second stage of amplification.



Right, Dixon, Calif., (transmitting station) line terminal equipment in copper-shielded room.

Left of photo—Line terminals.

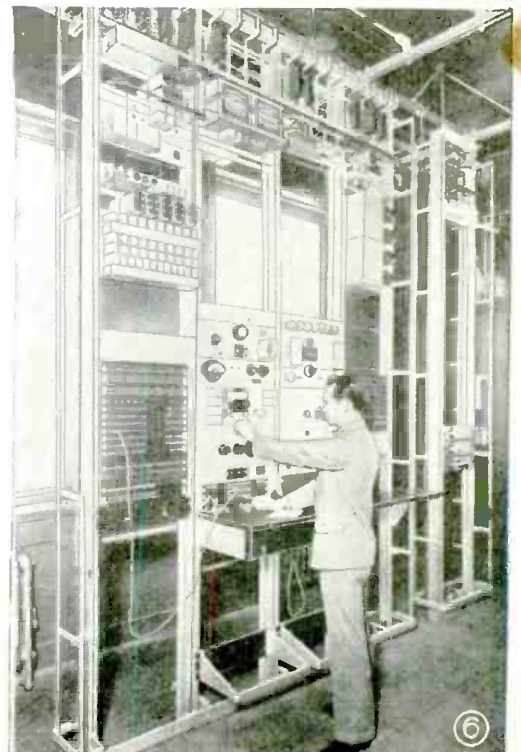

# A FREE-WHEELING Dial For Your S-W Set

By WILLIAM G. WHEAT

● Rapid tuning, coupled with the advantages of "band-spread," are afforded by this ingenious balance-wheel tuning dial. The main dial is "loaded" so as to act like a fly-wheel.

● THE free-wheeling thumb dial was developed after three complicated electrical and mechanical set-ups had been tested and discarded.

The first attempt was a 6-volt electric motor drive on the dial. It was

high ratio vernier tuning dial.

The fourth and successful attempt was developed from the principle of the toy locomotive engine, which, when operated, is given several quick pushes on the floor and then released to run a considerable distance, due to the momentum of the heavy fly-wheel attached to the driving wheels. Several experiments proved the practicability of this principle when applied to radio variable condensers, with the result that a full-size working model receiver and dial mechanism was constructed.

The physical appearance of the receiver is somewhat out of the ordinary, due to the upright or vertical construction instead of the customary horizontal method.

The base is made of a piece of galvanized iron 1/16 inch thick and 8 1/2 inches square. Notches are cut out of each corner, 1 inch square, to allow the flanges to be bent down, thus forming the sides of the base. The corners are filled with solder and filed smooth. (See Fig. 1.)

The metal cabinet is made from 1/16 inch brass, 6x12 inches all around. At the back is a door which opens full length and width of the cabinet for

the purpose of installing or replacing the tubes, said door being hung on piano hinges taken from an old (Continued on page 684)

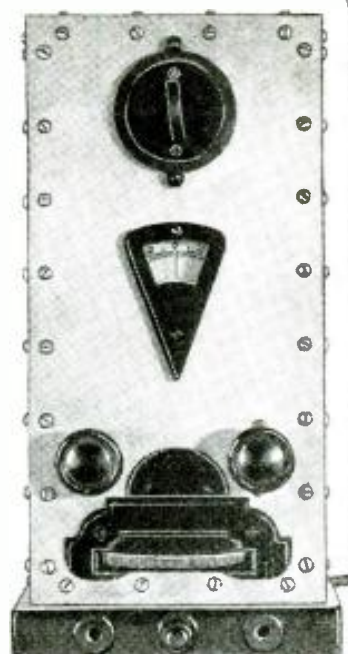

Front view of the "free-wheeling" short-wave set here described by Mr. Wheat. A touch of the finger spins the dial easily.



Photos, above and at right, show close-ups of the free wheeling dial and condenser as worked out by the author, and which provide rapid tuning with the equivalent of "band-spread."

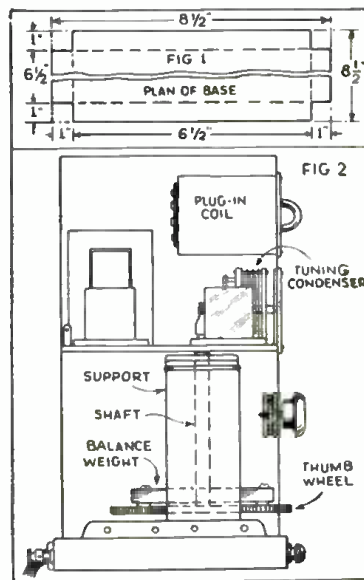
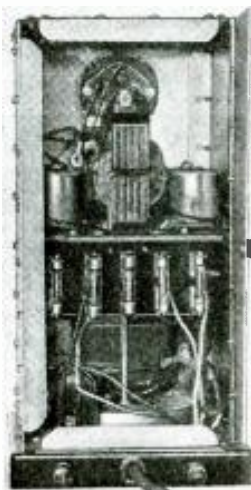

Drawing above shows detailed view of the "free-wheeling" tuning dial and how it is constructed. The secret of this dial lies in the extra weight "loading."

found to be jumpy in operation. The electrical noise of the brushes on the commutator and the reversing switch could not be entirely eliminated, thereby destroying clear reception.

The second attempt embodied the use of a discarded phonograph motor—spring type. It was seemingly impossible to design a reversing clutch and brake which would work. And, too, when it did get going good the spring motor would run down, necessitating rewinding.

The third attempt was made with falling weights attached to cords running over a derrick-like structure fastened to and above the receiver. This principle worked fairly well but the weights had to be rewound up to the top of the derrick about every 20 degrees of the dial revolution, due to gear reduction; this was as bad, if not worse than twisting the knob of a standard

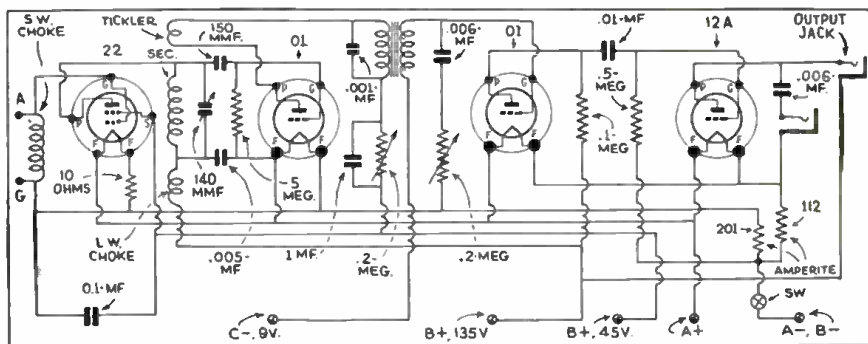

Wiring diagram used by the author in connection with his new "free-wheeling" idea for the tuning dial of his short-wave set.

## Dial Selects Any One of 10 Frequencies

● **SELECTING** any one of ten frequencies rapidly by merely *twirling a telephone dial*, waiting an instant for it to return and automatically put the carrier on the air, is a feature of the latest radio transmitter designed for aviation ground stations and for coastal and ocean-going vessels. The frequency shifting device resembles a miniature telephone board serving ten *dial* type telephones. Automatic control is so complete that the user's voice may be made to put the transmitter on or off the air instantly or to shut it down completely after an interval of from 1 to 15 minutes.

Any ten frequencies in the range of 2 to 18 megacycles (16.6 to 150 meters) are available and the transmitter is pre-adjusted to those desired. Shifting from one to another merely involves the re-dialing of a single digit. The dial controls a standard telephone selector switch which closes the proper latching relay on one of ten vertical rods. This rod is then raised by a solenoid relay, closing the circuits to the tuning unit in each amplifier stage, which has been pre-adjusted to operate on the desired frequency. The dial can be located at any convenient place thus providing a simple and effective remote control.

Ten quartz plates, one for each frequency, maintain the carrier within .025 percent of the assigned frequency. The transmitter delivers from 300 to 400 watts depending upon the operating frequency, with a total input power of approximately 3500 watts and can be operated on CW, MCW, or phone with 100 percent modulation.

The system consists of two units. The rectifier unit contains a 200 volt grid bias rectifier, 800 volt and 2500 volt plate rectifiers employing mercury vapor tubes, an audio amplifier and all the control relays. The transmitter unit contains all the radio frequency generating and amplifying apparatus, together with the dialing and switching mechanism. The entire equipment is completely self-contained and employs no rotating machinery, except a small fan which is used for circulating air about the power amplifier tube in the transmitter.

This equipment has been designed by Bell Telephone Laboratories for Western Electric Company for use at radio stations where it is necessary to operate on a number of different frequencies with a minimum of lost time in chang-

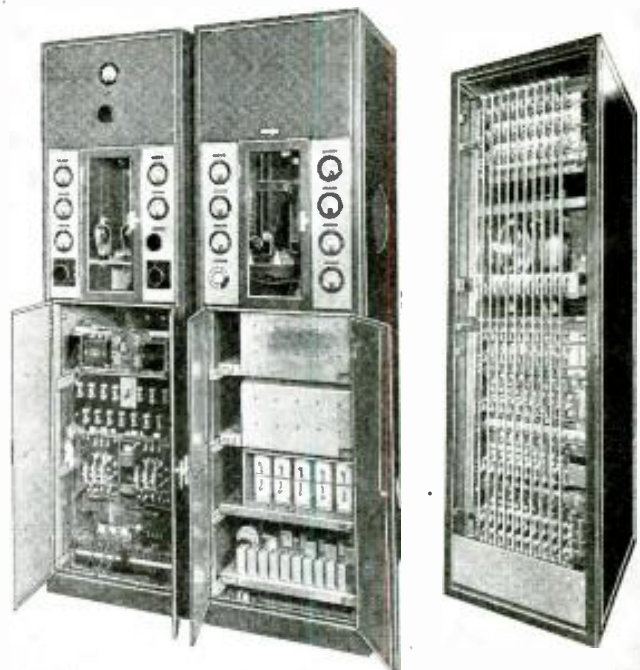

—Photos Courtesy Western Electric Company.

Photo, at left, shows front view, partly open, of the 10 frequency, quick-shift, radio transmitter for coast and ocean-going ships and aviation ground stations, showing the rectifier at the left and the transmitter at the right. Right photo—open rear view of transmitting unit, showing the "frequency selecting" equipment.

ing from one frequency to another. This feature is of great importance in aviation ground stations and ship-to-shore service where transmission conditions frequently require rapid frequency changes.

## New Portable Frequency Standard



● **PHOTO** above shows Mr. J. D. Booth, Westinghouse Radio Engineer, conducting laboratory tests on the newest portable frequency standard, designed and built for the Federal Communications Commission. This elaborately built portable frequency meter will be used by the radio engineers of the F.C.C., for the purpose of checking up the various radio transmitting stations on different wavelengths, to see that they are operating exactly on their assigned or licensed frequency.

## Plane Sends Greetings 8,905 Miles

● **WHAT** appears to be a record short-wave code contact between a plane in flight and a land station was established recently when holiday greetings were flashed across 8,905 miles of space, between a radio station at Chatham, Mass., and an airplane flying over Persia. The holiday greetings were exchanged between a British mail pilot flying over Persia and an operator at the Radiomarine Corporation station located at Chatham. The marine operator was sitting through the "dog watch" in the dark early morning hours on Cape Cod, while the plane over

Persia was flying through the early morning sunshine.

The contact was established on a wavelength of 54 meters and the Chatham operator contacted the pilot in the British plane just before he landed at Jask, Persia. The radio reception from the plane, nearly 9,000 miles away was "excellent" at Chatham. The Chatham operator flashed *Merry Christmas* in code—and a *Happy New Year to You*—came the reply from the plane's pilot. The Chatham operators have made many long distance contacts on various wave-lengths at their famous station, one of the longest distance radio conversations with a plane in flight made heretofore having been that established when Mrs. Charles A. Lindbergh was flying over the Southern Pacific Ocean, with her husband, at a distance of 5,000 miles! The new long distance short-wave contact of nearly 9,000 miles, is all the more remarkable when we stop to consider that the message flashed to the land station was sent from a plane, and usually the range of the plane's transmitter is rather limited, owing to the peculiar operating conditions.

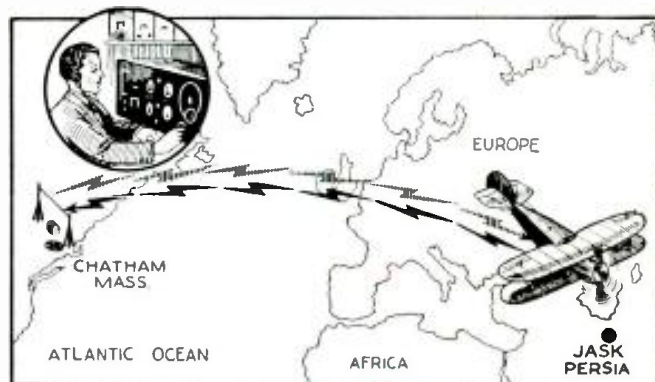

Recently a plane maintained contact by short waves with a land station over a distance of 8,905 miles, as indicated in the above drawing.

# \$500.00 PRIZE CONTEST

## For the Best Title Describing Our Cover

● NOT so long ago, one of our non-technical readers wrote in and asked us to solve, what was to him, a knotty problem. It seems that this man had a new *all-wave* radio set in his home which was kept in the bedroom. He soon became an addict for DX (distance hunting to you) and it became necessary for him to operate the set at all times of the night and the wee hours of the morning. Naturally, this began to irritate his "better half" because she could not get her necessary beauty sleep while the radio was going full blast and hubby listening to the Antipodes, particularly in the early morning hours when Australia "rolled in." Finding it necessary to compete in the SHORT WAVE SCOUT TROPHY CONTEST, naturally all hours, "earthly" and "unearthly," were called upon to bring in those elusive calls and more elusive "veris" (verification cards to you).

What to do? The answer, of course, was simple. We suggested to our friend that the only thing to do in order to save his happy home was to have a Service Man put a phone jack in the front of his set, where he could plug in a pair of earphones, and then do all his "DX" listening in bed, without the sound bothering "friend wife" who could lay in bed alongside, blissfully ignorant that hubby had a one-way conversation with Sydney or Shanghai. In due time a letter of thanks was received and everything was working out FB (fine business to you) and the peace of the household had been preserved eternally, so it seemed.

But there is no pleasing certain people, because a few days ago we received another letter from our worthy friend stating that everything was all out of gear again, that violent oscillations were taking place once more. It seems that while friend husband is listening in, he is not content in just listening in a dark room, with the radio silenced by virtue of the earphones. The real DX listener evidently does not like to go DX hunting in total darkness, so hubby rigged up a lamp, which kept him illuminated but wifey in the dark

by having the shade askew. This was necessary because he had to check up the stations in SHORT WAVE CRAFT and make his notes. But you see that irritated his better 50% and every so often at 3 or 4 in the morning, she would sit up and raise an awful

any too much about marital relations, so after having told Artist Brown about the situation, he fulfilled his obligations in turn and painted the cover which adorns this month's issue of SHORT WAVE CRAFT. After we looked at it for a while, we came to the conclusion that here indeed was quite a long story to tell in a few words, and with Christmas and the New Year holidays in the offing, we thought we had better chuck the whole thing into *your* laps and have you supply the title, as it was beyond us to get up a good title in a hurry.

So that is the situation in a nutshell. You know the story, and you have looked at the cover. Just what does it mean to you? Of course, such obvious titles as "*She Regenerates Too Loudly*," "*The Human Audio Oscillator*," "*A Bedtime Radio Story*," are perhaps a bit too obvious.

But we know you will supply many good titles, which not only are descriptive for the situation, but are human as well.

What then is wanted is a good title of *not more than seven words* to describe accurately as well as humorously, the action expressed on our front cover for this month. A large number of prizes have been set aside for the winners.

Now then, before you jump to any conclusion, please read the following rules carefully, because entries received which do not comply with these rules will be automatically rejected.

### Rules Pertaining to this Contest:

1.—A suitable title is wanted for the front cover of this month's issue.

2.—The title should be self-explanatory and should have in it some reference to radio, short-waves, or both. It should be humorous, if possible.

3.—You may submit as many titles as you wish. There is no limit.

4.—Titles must be submitted on slips of paper size of a postal card.  $3\frac{1}{4} \times 5\frac{1}{2}$  inches, or you can send your title on a one-cent postal card if you prefer to do so. Only one title must go on one sheet

(Continued on page 689)

## 50 PRIZES!

● A total of fifty prizes will be awarded for the best title suggested for this month's front cover. Numerous radio manufacturers have kindly donated many valuable pieces of short-wave apparatus, and besides there will be prizes of books, subscriptions to SHORT WAVE CRAFT, etc. Full list of prizes offered for the best title to this cover will appear in next issue.

"squawk" that heterodyned fearfully in his earphones. Again he asked us what to do.

The Editors Decide to Let You Name the Cover

Now, we are only editors of a short-wave magazine, and we do not know

## Treatment of Frost-Bites with Short Waves

By Albert Burkmann, M.D.,  
(Leipzig, Germany.)

● FOR over a year treatment with short waves has found its way into various fields of medicine and it is not surprising that it should also have entered into dermatology.

Schliephake, as well as Schweitzer, has in his most recent work gone exhaustively into the discussion of short wave therapy as compared with diathermy so that it is unnecessary to say much about it here except to emphasize its advantages, its widened field of indications and its convenience of application. The condenser-electrodes fit easily into every unevenness of the part of the body to be treated and burns thereby are prevented. Further-

more, sharply localized areas can be treated so that throughout the whole period of treatment the part can be strictly localized. As to the type of apparatus, whether spark or condenser, that works best, will not be discussed here. Probably in the future some differences will be found but that is at present beside the point.

A perusal of the literature that I have had an opportunity to make, up to the end of January, has shown that nobody thus far has treated frostbites with short waves. Even Schweitzer

makes no mention of it. Only in Laqueur and Riza Remzi was I able to find a remark on a case of frost-bite symptoms following acrocyanosis treated with short waves, without, however, any improvement. The suspicion is there, nevertheless, that frost-bites would fall into this field of therapeutics, even though the results were not favorable. Otherwise I have not discovered any references to mal-results.

On the other hand, I am in a position to be able to report on ten cases of frost-bites, in which I employed the Siemens-Reiniger apparatus for short-wave treatment, with very good results.

(Continued on page 689)

# 1-Tube All-Electric OSCILLODYNE

By ART GREGOR

Thanks to the use of the single 12A7 tube, the famous Oscillodyne receiver has been brought up to date; in the new model here described, the 12A7 rectifies its own plate current. This set works on 110 volts A.C. or D.C.

- BELIEVE it or not, this is really an *all-electric* short-wave receiver that employs but ONE tube! So far, we have had three tubes do the work of six, two tubes that work as well as four, but—this is the first *1-tube all-electric* receiver that we have seen. Of course, the



Rear view of the 1-tube Oscillodyne which has been made "all electric," thanks to the 12A7-type tube used, one element of which serves as the regenerative detector and the other element as a half-wave rectifier. This is essentially a headphone job.

many novel sets described in this magazine could not have been built if it were not for the accomplishments of the tube engineers—they have done a remarkable job. And this set, too, owes it success to the newer tube developments.

### Uses 12A7 Tube As Det. and Rectifier

The tube used in this receiver is known as the 12A7. It consists of a *pentode* and a *half-wave rectifier* all inclosed in a single glass envelope! The pentode portion is intended for audio frequency amplification; however we have still to see a tube that could only be used for a single purpose! After many tests and experiments it was found that this tube will do a great many things its inventors never thought of and you can look forward to seeing this tube in other rôles. As we started to say, the pentode section can be used as a *regenerative detector* and will perform as well as any other type. The great question in building a 1-tube set is—what circuit shall we use in order to obtain the utmost efficiency. This question I think can best be left for the reader to answer. How are we going to work that? Easy enough, we'll give all the dope and some pointers as to what may be expected and let the reader choose for himself.

Why the sudden burst of generosity? Hi—as this is being written it's only a few day to Christmas—probably that explains it. Anyway, let's get started. The option left to the reader is whether he wants to use a straight regenerative circuit or make the set a "self-quenching" super-regenerator; both have their advantages and they will be clearly explained.

Many will ask "What about *hum* in such a receiver, wherein only half-wave rectification is used and the two parts of the circuit placed so close together?" Well, the truth of the matter is that in one instance we are troubled with *hum* of a peculiar sort, and in the other we have no *hum*! When the receiver is a straight regenerative one, we have no *hum*, insofar as the *power supply* is concerned, but we have a slight modulation of signals as the detector is brought right on the edge of oscillation. When the regeneration control is *backed off* slightly, the voice or music comes in very clearly and no objectionable *hum* or modulation exists! This *hum* or modulation is caused by pick-up



The 1-Tube All Electric Oscillodyne will find hundreds of everyday applications—it is ideal for travelers.

on the grid of the detector due to its close proximity to the rectifier. It can be eliminated entirely by reducing the value of the grid-leak, but this reduces our sensitivity.

When used as a super-regenerator the detector is *humless*; the overall volume is far greater, but we have that characteristic hiss present in all super-regenerators. And it is because of the above-mentioned facts that we give the reader his choice of circuits. With either of the two methods mentioned all the "foreign" stations heard on any short-wave receiver were pulled in very easily, the super-regenerative circuit providing about *four times the audio volume* of the regular regenerative method of detection.

(Continued on page 681)

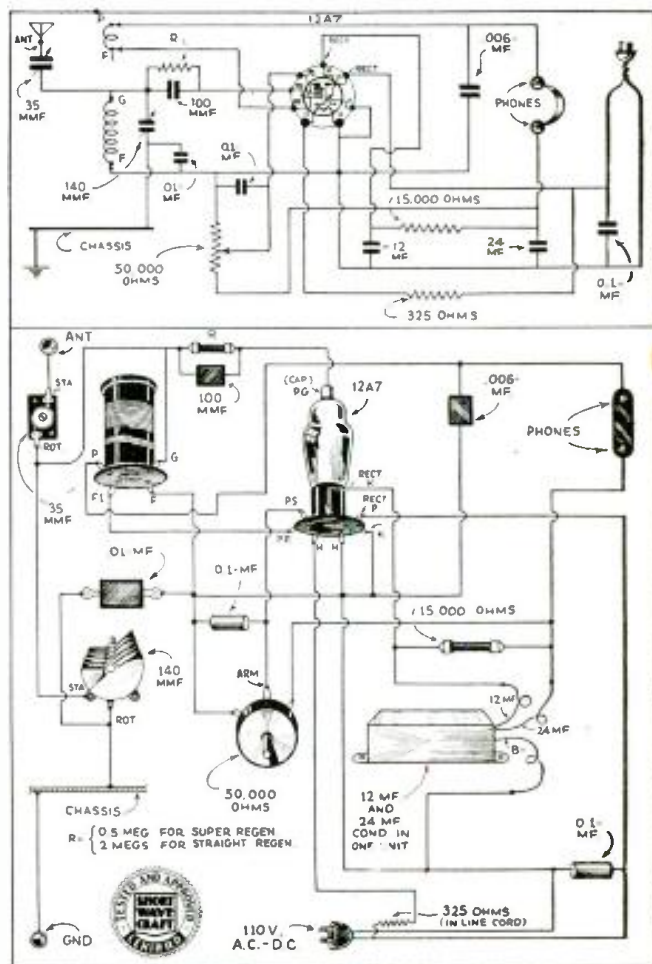

Anyone with the slightest mechanical skill can easily build the 1-tube All-Electric set here described, which can be plugged into any 110-volt A.C. or D.C. lamp socket. It needs no batteries or eliminators.

# The "REGENADYNE 5"-A

By W. R. HUMPHRIES



The author listening to a "foreign" short-wave program on the "Regenadyne 5"—yes, it works a loud speaker!

Mr. Humphries deserves a medal for designing this smooth-working 5-tube short-wave receiver, in which he has eliminated "irregular" regeneration control—the "bugaboo" of many receiving sets. This set employs 2-volt tubes and can be used on 2-volt storage or dry "A" battery, the plate supply being from batteries, "B" eliminator, or power-pack. A separate regeneration tube accounts for the extremely smooth control.

BECAUSE of limited finances there are a number of us who cannot afford one of the excellent multi-tube short-wave receivers which grace the market today. In securing the best from what we can ably afford our probable choice will be a receiver of the *regenerative* type. Unless serious thought is given to design, construction, and placement of parts, this type of receiver is likely to prove noisy in operation. The familiar hiss of a regenerative detector in oscillation may often exceed the level of a fairly weak signal, which might otherwise be heard were this noise minimized.

In the design and construction of the receiver herein described the author kept the following points in mind: First, to keep the level of noises originating within the receiver itself as low as possible. Second, economy of construction and operation. Third, to provide sufficient audio power for loud-speaker operation. Fourth, to provide output coupling for the operation of headphones, magnetic, and dynamic speakers. There is nothing original or radically new incorporated in the *Regenadyne*. It consists of a well-chosen combination of standard circuits, selected after considerable experimentation. For economy and quietness of operation the low-drain two-volt series of tubes were employed in the *Regenadyne*.

## The Circuit

The benefits of a radio frequency stage were more than adequate to justify its use. For simplicity and economy of construction a conventional untuned stage was used. This stage employs a type 34 tube. The grid resistor  $R_1$  proved more efficient than the usual R.F. choke. Since only one R.F. stage is used, variable grid bias for volume control purposes was not deemed practical. A fixed bias of  $-3$  volts is used. A separate bias supply is advisable here; and a couple of standard flashlight cells connected in series and mounted under the chassis was used. This scheme provides for short direct leads, thereby lowering the losses in the grid circuit and reducing the possibility of induction of noises where long external leads were used for this purpose. The use of a R.F. choke and condenser  $C_2$  in the screen-grid lead of the 34 is important in keeping R.F. currents out of the power supply and preventing stray coupling with other portions of the receiver.

Inductive coupling of the detector grid circuit to the plate of the R.F. tube is the most efficient means. If you possess a set of coils having primary windings, their use here is advisable. Since the author had coils having only secondary and tickler windings some other method had to be employed. Although the circuit illustrated in Figure A gave slightly greater signal strength than that of Figure B, the impressing of the R.F. plate voltage on the detector grid condenser proved exceptionally noisy in operation. The circuit in Figure B was selected for its quietness of operation.

## Positive and Smooth Regeneration Control

The *Regenadyne* employs a separate tube for regeneration

and oscillation purposes. The use of a *separate* regeneration tube may seem a needless expenditure of apparatus and battery energy, when both regeneration and detection could be accomplished by the detector tube alone. However it is a difficult task for one tube to perform both functions efficiently; so the regenerative action is allotted to a *separate* tube in this receiver.

Some of the advantages of this system are: (1) Often in the usual regenerative detector an audio howl is set up

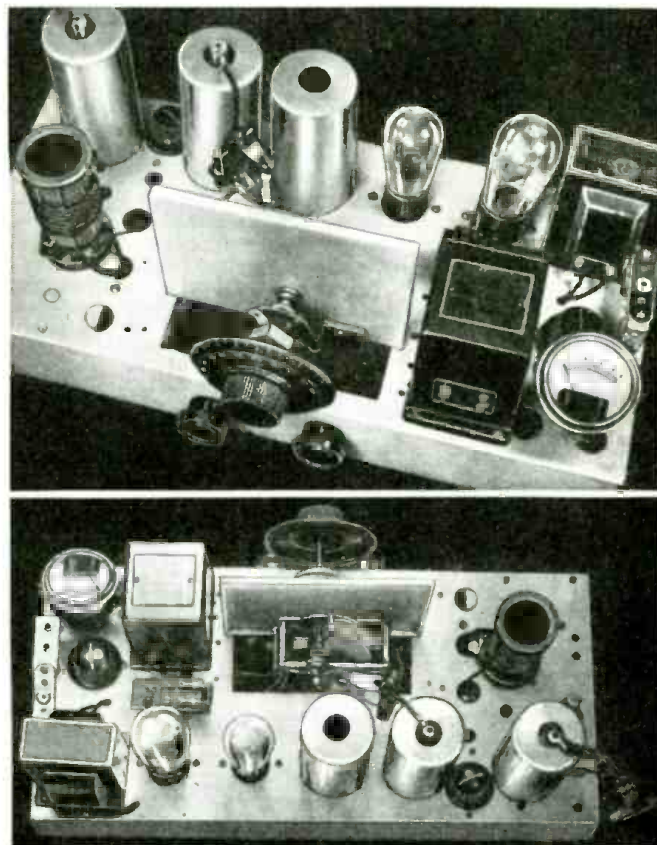

Two views of the neatly designed chassis of the "Regenadyne" 5-tube receiver, which employs a separate regeneration tube to provide extremely smooth control.

# Smooth-Tuning Receiver

as the point of oscillation is approached, proving inoperative at the maximum point of regeneration or the point of greatest sensitivity to modulated signals. This is commonly known as "threshold" or "fringe" howl. Use of a separate regeneration tube, its plate circuit including the tickler coil and regeneration control and being isolated from the audio amplifier input, eliminates this troublesome howl. (2) When one tube performs both detection and regeneration, a variation of voltages or circuit constants is necessary in order to keep the circuit at its *maximum point of regeneration*. This point will probably not be the point of maximum sensitivity for rectification. Thus the efficiency of the tube as a detector must necessarily be lowered in order to maintain *oscillation and regeneration*.

A separate regeneration tube allows the applied voltages of the detector to be adjusted for the point of highest sensitivity and no variation from this point is necessary. (3) The familiar hiss of oscillation has practically vanished, greatly decreasing the noise level of the receiver. (4) Detuning of the detector circuit from variation of the regeneration control is at a minimum. (5) Excessive oscillation on the high frequency end and weak oscillation on the low frequency end of the coils are (Continued on page 685)

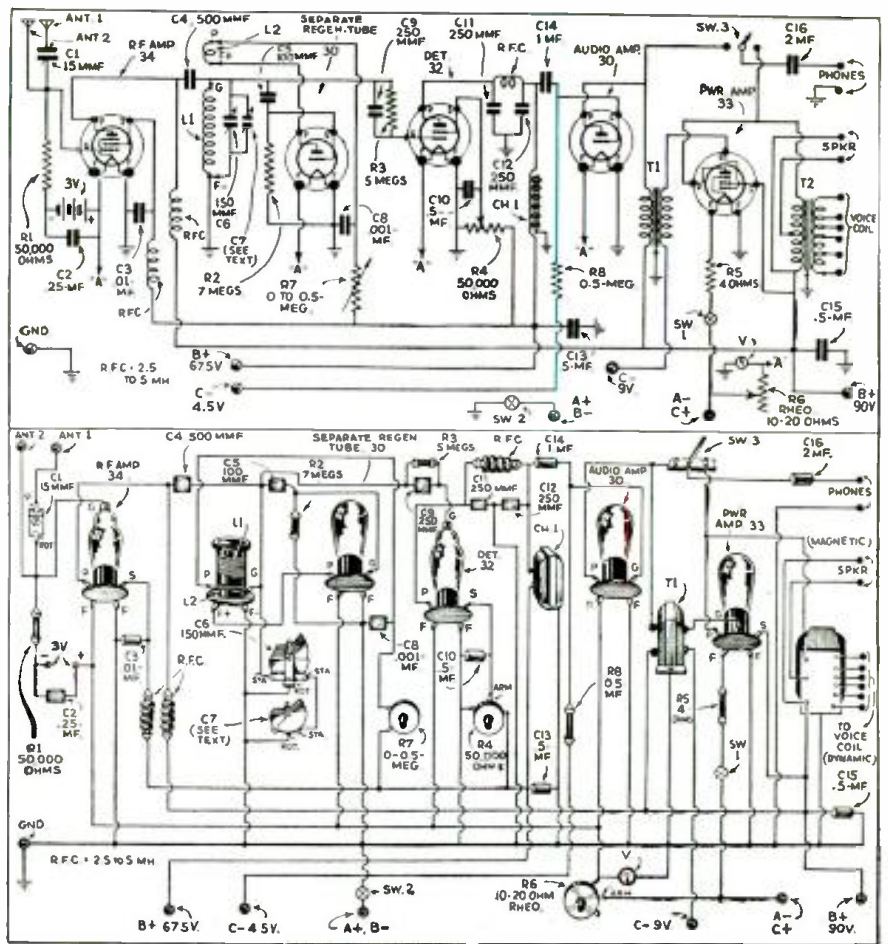

Schematic and picture wiring diagrams are reproduced above for the "Regenadyne 5."

# The Transmitting Rheostat—How to Connect It

By

**CHARLES FELSTEAD, W6CU**

● IN most amateur radio transmitters, the alternating current from the electric light lines is stepped down by a suitable transformer from 110 volts to about 10 volts for heating the filaments of the transmitting tubes. Direct current from a battery or generator is not commonly used except for small transmitters, or for transmitters located at points distant from electric light lines. It is necessary that this voltage applied to the filament terminals of a tube be accurately adjusted, for a slight increase above normal in filament volt-

age will greatly shorten the life of a tube. If a tube filament is operated much below its rating, on the other hand, it will not furnish the full power output of which it is capable. To provide this control of the filament voltage, a heavy-duty rheostat is sometimes connected in one of the filament leads, as shown in Figure 1-A; but, although this connection is excellent when direct current is used on the filament, it is not satisfactory when

alternating current is employed. The proper position for the rheostat controlling the filament supply of a transmitting tube in an a-c. installation is in the primary circuit of the filament supply transformer, as may be seen in Figure 1-B. The reason for this is that when the rheostat is connected as in Figure 1-A, one side of the filament is thrown out of balance with the other side, which causes an a-c. hum from the filament circuit of the transmitter that modulates the tone and is very annoying at the receiving station. If it was necessary to have the rheostat in the secondary circuit of the filament transformer, two rheostats connected as in Figure 2-A. could be employed. Then both rheostats would have to be regulated simultaneously; or the resistance in one leg of the filament would be greater than in the other leg, and the voltage drop between the mid-point, M, of the tube filament in the center tap, X, on the filament transformer would be greater by way of R-1, than by way of R-2, or vice versa, causing a lack of electrical balance.

When several tubes requiring different filament voltages are to be operated from the same filament transformer, individual rheostats must be provided in the filament circuit of each tube. Then the circuit may be like that shown in Figure 2-A; or the center tap, X, on the transformer can be dis-

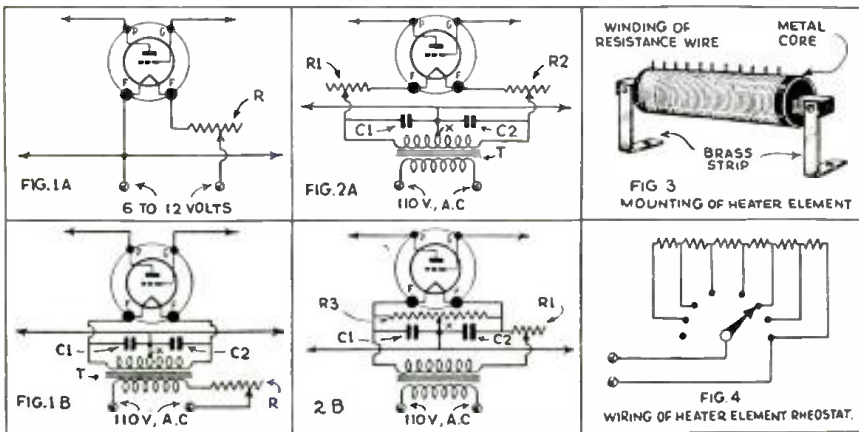

Best ways to connect transmitting rheostats.

(Continued on page 691)

● This simple 4-tube A.C. receiver operates from 110 volt A.C. and needs a power supply unit to furnish the plate and heater potentials. It has band-spread tuning, works a loud-speaker, has an untuned R.F. stage, regenerative detector, and 2 audio stages employing 56 and 47 tubes respectively.

# B-S4



## Works LOUD-SPEAKER and Has BAND-SPREAD Tuning

By ALBERT FRIESE, Jr.

● THE receiver about to be described was constructed with the following considerations in mind; it should be a simple and efficient receiver, capable of operating efficiently on all short-wave bands. It should be sensitive and fairly selective, easy-to-tune, and capable of working a midget dynamic speaker on all signals with only four tubes.

With these considerations in mind, pentode tubes were selected for use in the radio frequency stage, detector, and output stages, while a triode was used in the first audio stage. In the construction of the receiver an untuned radio frequency stage was used, as it gave the necessary gain wanted and it isolated the detector from the antenna. The untuned radio frequency stage was used instead of a tuned stage for the following reasons: An untuned stage has the advantage that it is easy to construct and does not need additional shielding and parts. While a tuned stage would give slightly more gain, and make the receiver somewhat more selective, the additional cost and work involved does not make it worth the trouble unless the receiver is to be a precision instrument or one wishes to get the maximum gain obtainable from the receiver. In the radio frequency stage a 58 pentode tube designed for the radio frequency stage is used. This tube is designed to give maximum gain without cross-modulation in the radio frequency stage and is very efficient indeed.

The gain control is used not only as a volume control,

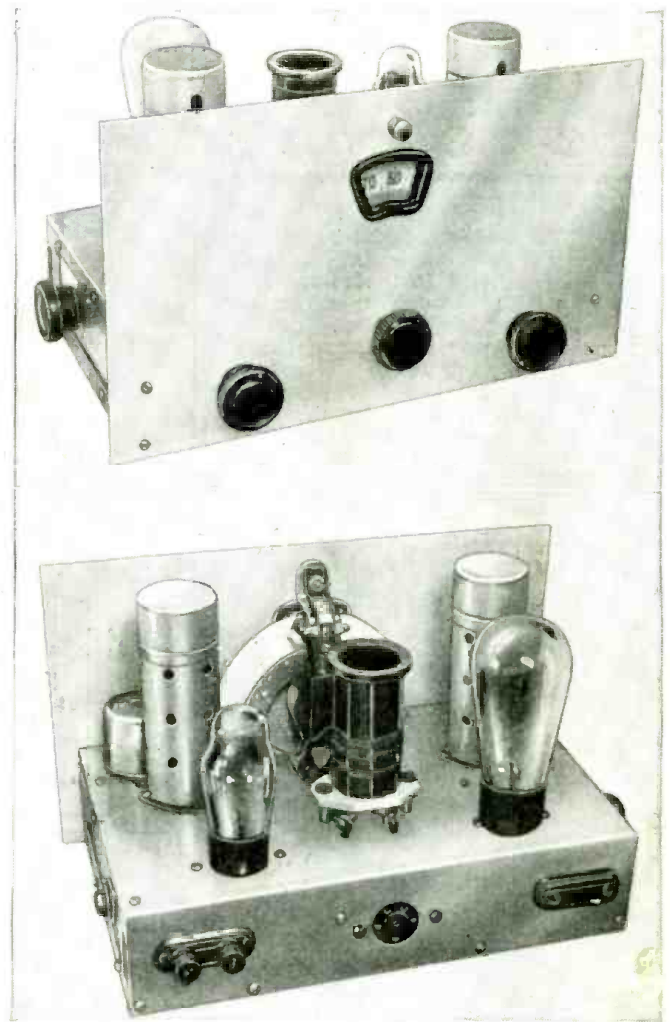

Above—Front and rear views of the "B-S4" receiver which is capable of operating a loud-speaker on the average strength signal. A simple and inexpensive set for the beginner.

but also as a signal input control. The gain control is used also to prevent blocking of the detector on extremely strong signals; it is located in the cathode (Continued on page 682)

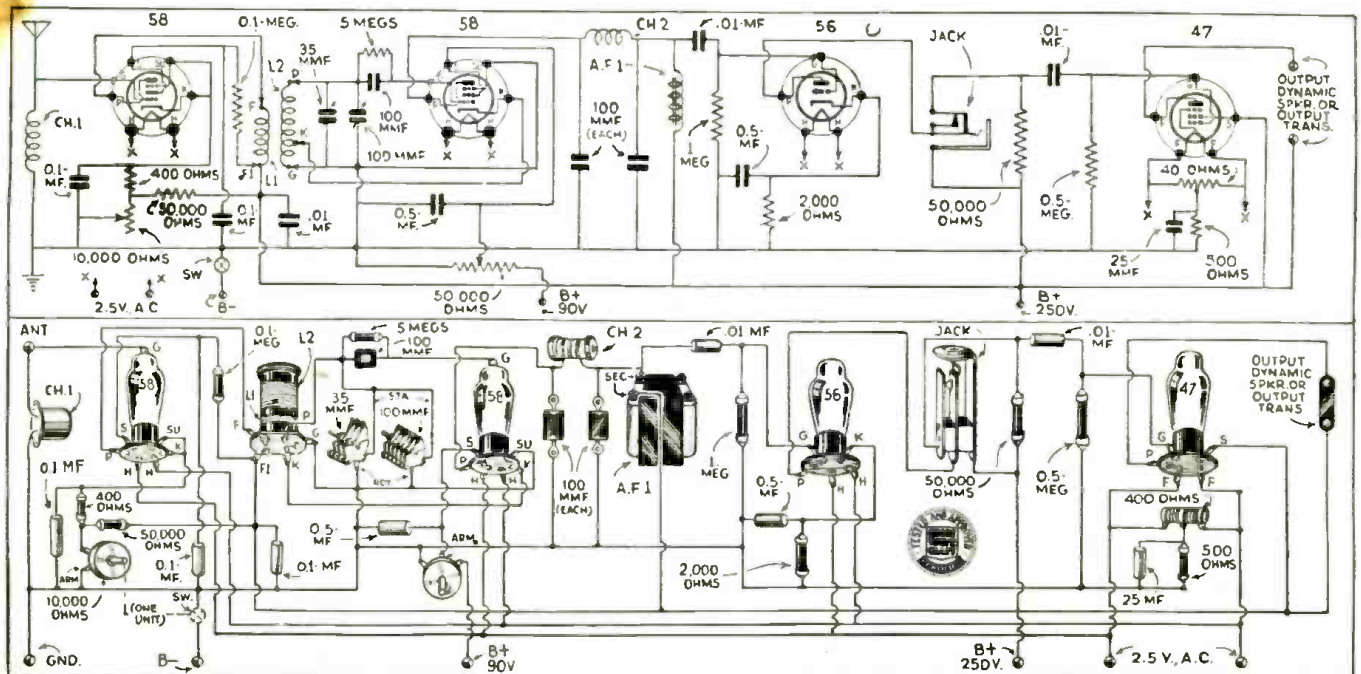

Schematic and picture wiring diagrams showing how simple it is to build the "B-S4" short-wave receiver, which features "band-spread" tuning—so desirable for European reception.



# 10 TUBE S-W SUPER-HET

## With 2 Stage Pre-Amplifier

By

**Charles T. Brasfield, Jr.**  
B.S. in E.E.

This Month's \$20.00 Prize Winner

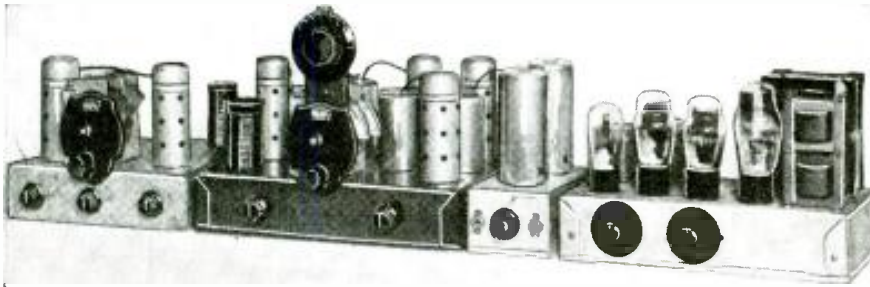

Here we have photograph of the complete 10-tube short-wave superhet.

● THE average short-wave "fan" starts out as a builder of one-tube and two-tube regenerative receivers. With these receivers, after considerable practice, he finds that he can perhaps "tune in" the far corners of the world; but after a time he becomes dissatisfied with the volume and quality of the programs received, "body capacity" becomes a nuisance and poor selectivity in "crowded" bands makes it impossible for him to receive certain distant stations. By this time, however, he has learned many things about the short waves and has also acquired fair constructional ability. He graduates to the *superheterodyne*, with its great sensitivity and razor-edge selectivity, with accompanying good volume and quality. With his "superhet" properly constructed, he is astonished to find that "body capacity" is a thing of the past, and that this is true even on the 17 meter broadcast stations and the 21 meter amateur band! If he is a confirmed experimenter, however, he finds that there are still a few improvements he would like to make. He would like to get the programs with less noise in the background, improve the tone qual-

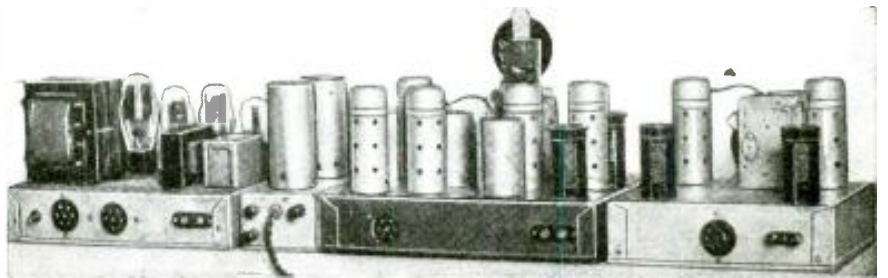

Rear view of Mr. Brasfield's 10-tube super.

ity and eliminate the annoyance of "repeat points." He constructs a sensitive two-stage tuned radio frequency amplifier and places this in service ahead of his "superhet." He now finds that he has the last word in short-wave receivers, *the world is his—at the twist of a wrist!*

The set here described was evolved in the manner just outlined. If carefully constructed, it can be depended upon to *bring them in if they are on the air!*—barring peculiar atmospheric conditions of course, which no set can over-

Here's a 10-tube receiver "De Luxe." The entire receiver is built in "unit" fashion with a separate chassis for each section, such as the pre-amplifier, low frequency R.F. portion and the audio amplifier. Mr. Brasfield, who is an expert at short-wave set construction, clearly explains how a good short-wave superhet can be constructed.

come. It has never yet failed to produce the "Australians" with good volume each time they have been sought. Europe and South America are received with great volume!

You will notice from the photos that the set, as now operating in the writer's laboratory, was constructed in four separate units. This is an ideal way to construct such a set as it gives the utmost flexibility of design and allows changes and experiments with one unit without disturbing the others. All con-

(Continued on page 680)

## This Beat Oscillator Helps Find Stations

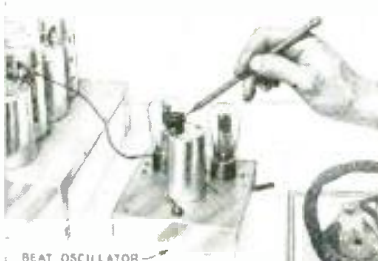

Two photographs showing the construction of this very handy "beat oscillator," which aids considerably in finding stations. The wiring diagram is shown to the extreme right of this page.

"fan" could own. That is, the "fan" who has a superheterodyne receiver. While a good many of the commercial receivers are equipped with an oscillator to provide an audio beat note on a CW signal, there are many that are not. The fan who builds his own super does not always incorporate this feature either.

The purpose of a beat oscillator is to provide some form of audible tone on an unmodulated continuous wave signal. This is accomplished by beating the oscillator against a signal at a frequency sufficiently removed from its frequency to cause a third sound. The difference between the two frequencies is the frequency of the third sound. For instance

—if we have a CW signal of 465 kc. frequency and we heterodyne or beat another against it, having a frequency

(Continued on page 699)

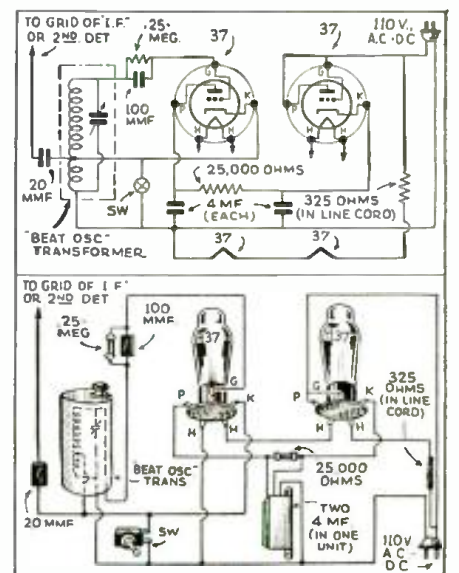

● THE much discussed beat oscillator, while being a very simple piece of apparatus, is one of the most useful pieces of equipment that a short wave

# WORLD-WIDE SHORT-

## An Experimental Solodyne

● SOME years ago, a circuit appeared which operated without a "B" battery, the slight positive potential of the filament battery being sufficient to polarize the plate and thus produce a degree of detection.

While the *Solodyne*, as this circuit was named, did not achieve any great degree of popularity, it has always been considered of technical interest and *Ciencia Popular*, a magazine published in Argentine, has just found it of sufficient interest to develop a Solodyne for short waves, operating from the A.C. power line.

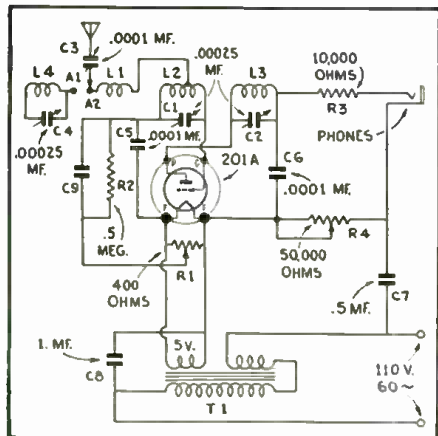

A very interesting new circuit showing how to hook up the "Solodyne" receiver. It requires no "B" battery or plate supply.

This circuit is of particular interest, as it is a 1-tube A.C. circuit, requiring no rectifier or filter system.

The circuit is shown here, and while the values of all condensers and resistors, etc., are given, unfortunately no coil details are supplied. The original called for a coil commercially available in South America and for this reason, the builder will have to experiment with coils. The grid and plate windings can no doubt be wound as ordinary secondary and tickler for the various bands desired, and the primary and trap circuit can be found with a little cut-and-try work.

## The Luxembourg Effect

● EUROPEAN magazines, notably *World Radio*, have been publishing much material in their recent issues regarding a mysterious effect in the reception of broadcast programs. While this effect was

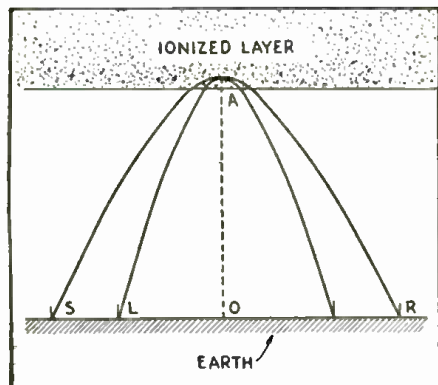

Diagram illustrating how one wave may superimpose itself on another in a highly ionized atmospheric layer through which the signals from two different stations are passing.

● The Editors have endeavored to review the more important foreign magazines covering short-wave developments, for the benefit of the thousands of readers of this magazine who do not have the opportunity of seeing these magazines first-hand. The circuits shown are for the most part self-explanatory to the radio student, and wherever possible the constants or values of various condensers, coils, etc., are given. Please do not write to us asking for further data, picture-diagrams or lists of parts for these foreign circuits, as we do not have any further specific information other than that given. If the reader will remember that wherever a tuned circuit is shown, for instance, he may use any short-wave coil and the appropriate corresponding tuning condenser, data for which are given dozens of times in each issue of this magazine, he will have no difficulty in reconstructing these foreign circuits to try them out.

found on the broadcast band, there is every reason to believe that the same effect takes place on the short waves, and an explanation by as eminent an authority as Prof. E. V. Appleton should interest every short-wave enthusiast.

Briefly, the effect is the reception of a background of a long-wave station when a short-wave station is being picked up. In other words, in Europe, if a station such as Radio-Paris on the broadcast band is heard, a background of the powerful Luxembourg station is heard between loud passages in the former program. The wavelengths of the two stations differ by over 700 meters, so adjacent channel interference or cross-modulation cannot account for the effect.

For a while, engineers and scientists were greatly puzzled by the phenomenon, but Prof. Appleton assisted by others, such as Dr. Van der Pol, Prof. V. A. Bailey and Dr. D. F. Martyn have at last arrived at a reasonable solution or explanation.

Professor Appleton says: "We have during the last 10 years or so, repeatedly been encountering results which we have been able to explain as being due to the influence of the ionized layers (the Kennelly-Heaviside and Appleton layers) on radio waves. Now for the first time we meet the reverse phenomenon, namely, an effect of the waves on the layer itself, the reflecting properties of a portion of the layer being, in fact, altered by the emission of waves from a neighboring high-power long-wave station.

"The essential feature of the theory of Bailey and Martyn can be explained in simple terms. The reflecting layer is always accompanied by a certain amount of absorption. For example, the reflecting coefficient is always less than 100 percent in such cases as we are considering. Bailey and Martyn suggest that the long-wave program impresses its modulation on the absorptive action of the reflecting medium, and that it is through this variable absorption that the shorter waves acquire the long-wave modulation.

"Bailey and Martyn have worked on their ideas in great mathematical detail. From their formulae the following consequences of the theory may be deduced:

(1) The imposed modulation on the medium (short) wave signals should vary as the square of the strength of the long-wave station. (This should explain why the effect is noticed only as due to powerful stations such as Luxembourg, Droitwich and Athlone.)

(2) The interfering program should be distorted for the modulation imposed should suffer from "high-note" loss. (This is, I believe, in accordance with the facts as recorded.)

(3) The distance between the wanted stations and the receiving station must be greater than the distance of the midpoint of this transmission path from

the longer-wave interfering station. (This rule I do not think is violated by any of the observed instances of the effect recorded.)

"The last point (3) mentioned above can best be explained with the aid of the accompanying illustration. An essential feature of the theory is that the paths of the two sets of waves must overlap somewhere in the layer. Bailey and Martyn assume that the *overlap* takes place at the top of both trajectories as shown. If L represents the long-wave station Luxembourg and S is the short-wave station, it is easy to show that this overlap at the top of the trajectory A can take place only when SO is greater than LO."

Short-wave listeners who are annoyed by interfering stations when listening to short-wave signals should investigate where the interfering programs are coming from. Quite possibly they are longer-wave stations which are being heard through this phenomenon which has been causing such a stir among scientists and radio engineers.

## Short-Wave Adapters and Converters

● WHILE short-wave converters and adapters are not much in vogue in this country as they were several years ago, they still find much favor in Europe. With the idea in mind that some short-wave fans may find several adapters of simple and effective design to be of interest, we are printing the circuits of two which recently appeared in *Amateur Wireless* magazine.

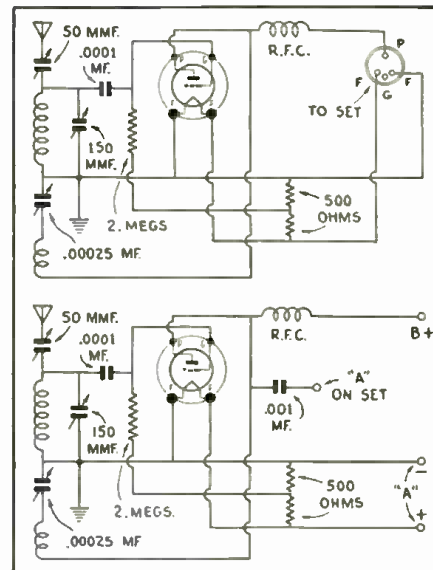

Two circuits of English origin for short-wave adapters. The adapter plug indicated in the upper diagram is of European type; the connections can be followed through for our plugs by noting the symbols.

The two circuits are very similar in design, with the exception that the first is equipped with a plug to fit into the detector socket, thus using the A.F. amplifier and power supply of the broadcast receiver and supplying a regenerative detector of the type which has been more or less standard in short-wave set construction.

The second circuit does not have the plug, but is equipped with a coupling condenser and a terminal which is connected to the aerial binding post of the receiver, and several other terminals for the filament and plate supply. This unit is operated in an *oscillating* condition and the broadcast set is tuned to a point at which no station is heard. Thus the combination

# WAVE REVIEW

Edited by  
**C. W. PALMER**

of the broadcast set and the converter form a simple *superheterodyne* receiver.

The similarity of the two circuits lends them particularly well to experimental work by radio beginners and experimenters who wish to try various circuits and learn more about operation of short-wave sets.

The values of the parts are indicated in the diagram. The coils may be any suitable plug-in coils which may be purchased at any radio store. The layout of the parts is not critical and may be suited to the requirements of the individual parts used.

## Special Tubes for Ultra-Short Waves

THE circuits and other requirements for ultra-short wave transmitters necessitate special tubes, if efficient results are to be expected. For example, the internal capacity between the leads in an ordinary tube is more than sufficient to by-pass the R.F. currents generated by the tube as well as to prevent tuning to very high frequencies with external circuits.

As a means of overcoming these difficulties and furthering the development of the micro-wave field, several manufacturers in Europe have developed special tubes which permit more flexible operation, as well as efficient generation of these waves.

In a recent issue of *Radio Fur Alle*, a magazine published in Stuttgart, Germany, several of these special tubes were described with suggested circuits. Two of these are reproduced here for our readers who may be interested. The first is a triode in which the plate, grid and cathode are terminated in binding posts on the top of the glass bulb. The regular heater terminals are connected to the pins on the base, thus permitting the use of ordinary sockets, but facilitating operation in the very high frequency spectrum. This tube can be used in any of the circuits developed for triodes, such as those shown in previous issues.

The second tube is also a *triode*, but of rather special construction. Circuits for some ultra-short-wave oscillators require coils and condensers used for tuning to be situated in such a way that the leads are kept extremely short. To permit such a condition, this tube has the grid and plate leads brought out on both sides, through glass "presses" which keep the leads well separated.

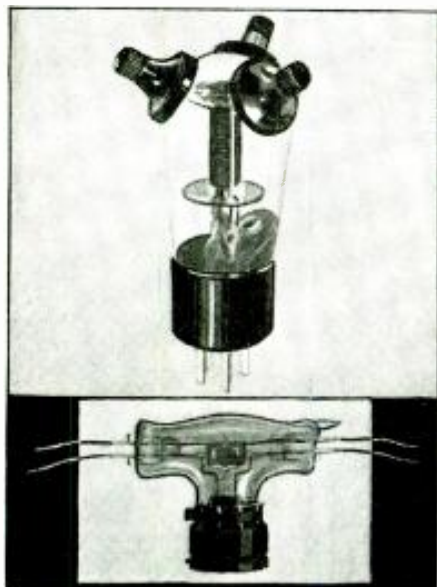

Above—Two new European tubes for ultra high-frequency circuits.

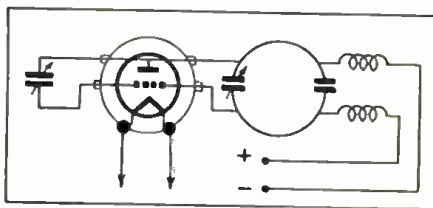
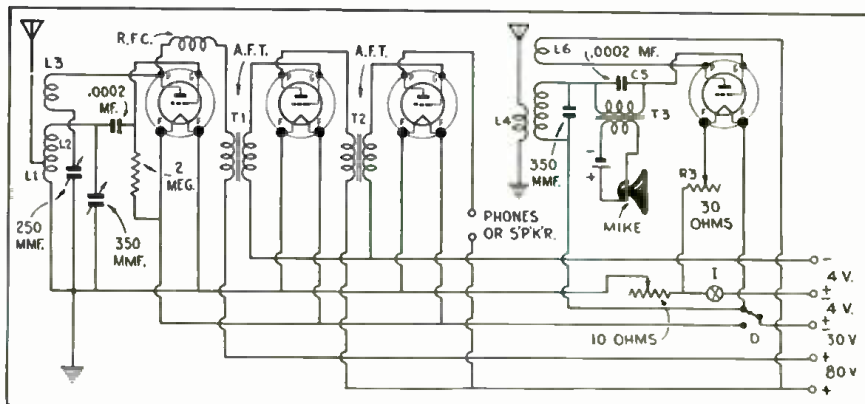

Diagram showing connection for new ultra short-wave tube having grid and plate lead brought out through both sides of the tube.

## A Portable Short-Wave Transmitter and Receiver

THE many possible uses of a combined radio transmitter and receiver which is really portable are pointed out in an article which described the construction of such a device in a recent issue of *La Radio per Tutti*, an Italian Radio magazine.

The circuit of the combined unit is shown here, with values. As you will notice, the receiver is a 3-tube regenerative set of ordinary design, completely battery operated and using tubes which are economical in



A novel circuit of Italian origin, showing connections of a portable short-wave transmitter and receiver.

## A Micro-Wave Demonstration Set

THE generation of radio waves shorter than one meter in length has for some years occupied the attention of radio engineers, and the progress that has been made in this field has often been recorded in the pages of *SHORT WAVE CRAFT*. For example, there is the 17 cm. radio telephone service between Lymnpe and St. Ingelvert across the English Channel.

The development of efficient and stable oscillators (some of which have been described on this page) has, however, provided the physicists and research workers with a useful tool for investigating in the laboratory the phenomena of short wave propagation and as a means of demonstrating some of the facts which have been discovered, the interesting set-up shown here was made.

This device which consists of 2 miniature aerials with reflectors mounted on a curved frame to represent the earth's surface, but exaggerated in comparison with the height of the aerials, was recently described in *The Wireless Engineer*—an English publication.

By the use of this device, signal strength within and beyond the optical range could be recorded on a meter, and also the effects of reflection from a metal plate held at different heights.

The photo at the right shows an ingenious micro-wave demonstration apparatus. Owing to the unique arrangement of the reflector-aerials on a curved plate to imitate the curvature of the earth, the change in strength of signal received "beyond the horizon" can be indicated.

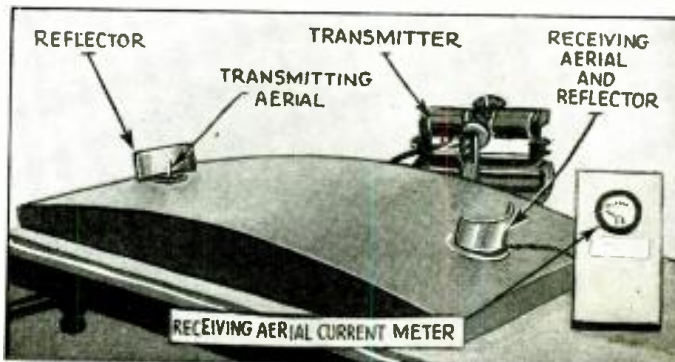

filament and plate requirements. The transmitter is also a straight regenerative circuit of the *feed-back* type, having a modulation transformer (mike trans.) in the grid circuit in place of the usual grid-leak. The transmitter is also battery operated and in fact is run from the same batteries which operate the receiver. The transmitter uses a tube of the receiving type, and naturally has a rather limited range. However, for the purposes to which a portable transmitter is usually put, this is an advantage rather than the reverse.

A carbon mike of the single-button type is needed for the transmitter and it is advisable to use a separate battery for the mike current, so as to avoid overloading the filament supply.

**In Next Issue**  
A very efficient and highly selective  
**3-TUBE SUPERHET**  
Will be described by  
**H. DOBROVOLNY**

# Short Wave SCOUT NEWS

## Oliver Amlie's Post Has Distinguished Visitor

● RECENTLY the Short-Wave Listening Post operated by Oliver Amlie, of Philadelphia, had the distinct honor of receiving a visit from Captain and Mrs. Leonard F. Plugge. Captain Plugge is well known to many thousands of Short-Wave fans in various parts of the world and he is president of the International Broadcasting Company of London, England, which numbers 250,000 members.

Mr. Amlie is particularly proud of the fact that Captain and Mrs. Plugge journeyed all the way from Washington, D. C., to pay a visit to him and Mrs. Amlie. The visitors were particularly pleased with the handsome appearance of the SHORT WAVE SCOUT Trophy Cup, which was recently awarded by this magazine to Mr. Amlie for his prize-winning log of verified Short-Wave Stations heard at his post.

Herewith his report of reception:

Cuba. COH 31.8 meters, daily 10-12 noon, 5-6 p. m. COC 49-92 daily 5-6 p. m.

Manila. Sundays, KZRM 31.33 8-9 a. m. KAY 20.03 irregular testing 10 a. m.

Holland. PCJ, Sun., 1971 meters, 8-10 a. m.

New York, W2XAD-19.67-W2XAF 31.48 meters. Sat. 6:15-11 p. m.

Boston. Mass. W1XAL 49.67 meters, Sun.-Tues.-Thurs. 7:30 p. m. 25.45 meters Sat. 10-12 mid.

Australia. Reports sent to Radio Commission, Sydney, on VK2ME-3ME-3LR; again VK3LR heard 10-12 mid.

Ecuador. HCJB. 73 meters. Fri. 9-11 p. m.

Venezuela. YV4RC 20.25 meters 8-10 p. m.

California. KKQ, 25.10 meters testing Dec. 9 7:40-8 p. m.

Bolivia. CP7, 19.06 meters, Dec. 23, 8-10 a. m.

Mystery station heard 7 months, no call letters, Sundays 6:30-7 a. m. around 46 meters. All time Eastern Standard.

## Frank Hogler of Brooklyn Reports

● HERE'S latest report on Short-Wave Stations, heard at this post during the past month.

HJN-6.07 M.C. was heard Dec. 21, 1:30 a. m. to 3:00 a. m. They announce in Spanish and English, and should be addressed Biblioteca Nacional, Bogota, Col., S.A.

YDA-6.12 M.C. Batavia, Java is heard every morning, best from 6 to 7:30 a. m. They announce in Dutch and English.

JVT-6.75 M.C. Nagasaki, Japan, is heard about twice a week, usually Friday and Saturday morning. 7:30 a. m. They give time; gongs or bells; best received 5:30 a. m. to 8 a. m.

VK2ME, VK3ME, and VK3LR were all heard in December; best heard from 6 a. m. to 7 a. m.

COH-9.43 MC. was heard in the morning 10 a. m. to 11 a. m. December 20 and 21, but signal strength was not quite as good as in the evening.

I2RO-9.78 M.C. was heard Dec. 21 from 10 to 11 a. m. They also broadcast quite regularly in the afternoon.

LSN-9.90 M. C. was heard Dec. 23 at 12:45 on, broadcasting a program of Christmas carols and music.

25-meter stations not so well received just now; best received are: FYA-DJD-GSD in the afternoon, and PHH in the morning. Signals above mentioned are received poorly.

19 meters is coming in fine now. In the morning best heard are: FYA-DJB-GSF and PCJ; best heard from 8 to 11 a. m.

Just to see if your set can tune down to 9 meters, there's a Police Radio Alarm station on the air all the time, with plenty of power.

As a whole, reception in December was fair, at this "Listening Post."

## Report from O. I. Noda

● MANY thanks for the letter. This is a brief report from the S.W.L. Post in the State of California: December 1, CJRX and CJRO came in QSA5-R9 signals. December 2, a new station KEE is transmitting to Koko, Hawaii (8:00 p. m. 9:00

## Latest "Hot" Tips for Short-Wave Listeners from our "OFFICIAL LISTENING POSTS"

P.S.T.) This station operates on around 39 meters, very strong and clear. December 3, heard Havana, Cuba, COH 6 p. m. 6:30 p. m., P. S. T., also new station on 31.6 meters (very clear and strong). This station speaks both English and Spanish. KEE came in R9 signal. December 7 JVE came in fine this afternoon calling Manila and Philippines. December 8 JVN came pounding in around 8 p. m., P.S.T. December 10 KEE came in very good (8 to 9 p. m., P.S.T.) December 11 KEE came in very good (8 to 9 p. m., P.S.T.). Dec. 12 heard WGY (4:15 p. m. P.S.T.) JVF was testing with San Francisco, Calif., this afternoon. December 13, heard KPO Manila, P.I. calling Tokyo at 3:56 p. m., P.S. T. Heard PLE at 4:16 p. m. on 18830 K.C. KKH was testing (9:23 p. m. 10:05 p. m. P.S.T.) and broadcasting music to KAA around 38 meters. December 14, CJRX came in fine this morning around 8 a. m. 8:40 a. m. P. S. T. COH (from 5 on) came in fine. Heard WXH (8:05 p. m.) (KKH 9:30 p. m.) (KEE 9:30 p. m.)

Dec. 17 COH, 5 p. m. P.S.T. Very good R9 signal. KEE is heard R9 signal again (8 p. m. 9 p. m.) JVM-R9 9:52 p. m. P.S.T. December 18 heard COH again at 5:30 p. m. Heard KEE 9 p. m. P.S.T. December 19 PMC 5:09 p. m. P.S.T. very strong signal. Was speaking Spanish I think, and in the end they announced in English.

This is brief report from Dec. 1 to 19.

Many S. W. listeners in U.S.A. and from many other countries are sending me a number of QSL cards. Many thanks. I send all hams and SWL's a beautiful "duck" card. Send me one of your QSL cards and I'll send one! I received and logged 1,027 stations already. Still listening!

## Report from E. M. Heiser

● SHORT WAVE reception for the last few weeks has been rather freakish. There have been days when harmonics of stations operating in the broadcast band, have been heard on all short wave bands.

The 19-meter broadcast band has been exceptionally poor, although commercial phone and amateur stations have been heard well.

The 25 and 31-meter bands have also been very poor, with one or two exceptions.

The 49-meter band has been the best, although it is rather crowded. IRA on 49.20 meters was the best station heard, but it has developed a very bad hum.

The new Cuban station COH and the Costa Rican station TIEP have been coming in very consistently.

In the January issue of SHORT WAVE CRAFT TIEP is listed as operating on 45.05 meters. I receive them below HC2RL, which operates on 45 meters. Evidently one of these stations must be off their wave length.

A Spanish-speaking station has been heard operating between DJC and COC. The station could not be identified. They signed off at 8:00 p. m. It was not XEB7 as they were on the air at the same time.

FTA on 25.13 meters uses an identification signal of three notes. Each note is struck five times, that is five times for the first note, five times the second note and five times the third note.

I am enclosing a log of the stations heard this month.

(Continued on page 678)



## Frank Hogler Proud of His "Short-Wave Scout" Trophy

● FRANK HOGLER of Brooklyn, N.Y., was the proud recipient of the eleventh SHORT WAVE SCOUT Trophy. The editors had the pleasure of presenting the handsome silver trophy to Mr. Hogler in person, and they hope to enjoy the privilege of presenting many more of these beautiful Silver Trophies to future winners in the monthly contest for bigger and better short-wave station logs. Mr. Hogler, in rolling up his magnificent list of 110 short-wave stations heard, used a Model A, 16-tube MIDWEST All-Wave Receiver; the antenna he used had a 50-foot length of No. 12 enameled copper wire, with a 20-foot transposed lead-in. The antenna was located 15 feet above the roof of the house.

# SHORT WAVE SCOUTS

**13th "TROPHY" WINNER**  
**Bernard Kinzel, 869 Elton Avenue,**  
**Bronx, New York**  
**128 Stations; 64 Verified**

● WE are very pleased to announce that the thirteenth "Trophy Cup" goes to Mr. Bernard Kinzel of the Bronx, New York, who had a very nice total of 128 stations, 64 of which were verified.

Mr. Kinzel informs us that his receiving equipment consists of an R.C. A. Victor, Model 140 all-wave set and a 4-tube home-made T.R.F. receiver. The antennas are a Lynch "Cage" Doublet antenna, 20½ feet in each section and another L-Type, flat-top antenna, with a single-wire lead-in. Both antennas are located 20 feet above the roof of his residence, making a total height of approximately 110 feet. *Very nice work, Mr. Kinzel, and we offer you our congratulations.*

Do not forget that all entries submitted after March 1 will come under the new set of rules, and these will be found following the list of stations. Briefly they are: The Trophy will go to the person submitting the "greatest number of verifications!" No unverified stations are required! Also, at least 50 per cent of the verifications submitted must be for stations located OUTSIDE of the country in which the entrant resides. Only letters or cards specifically verifying reception of a given station will be considered.

**MR. KINZEL'S LIST OF VERIFIED STATIONS**  
**Europe**

- CT1AA—9600 kc. Lisbon, Portugal.
- DJB—15200 kc. Berlin, Germany.
- DJD—11760 kc. Berlin, Germany—see card DJC.
- DIQ—10285 kc. Berlin, Germany.
- DJA—9560 kc. Berlin, Germany.
- DJC—6020 kc. Berlin, Germany.
- GSH—21470 kc. Daventry, England.
- GSG—17790 kc. Daventry, England.
- GSE—15140 kc. Daventry, England.
- GSE—11860 kc. Daventry, England.
- GSD—11750 kc. Daventry, England.
- GSC—9585 kc. Daventry, England.
- GSB—9510 kc. Daventry, England.
- GSA—6050 kc. Daventry, England—all on one card, four reports.
- EAQ—9860 kc. Madrid, Spain.
- FTK—15880 kc. St. Assise, France.
- FYA—11720 kc. Paris, France.
- HBL—9595 kc. Geneva, Switzerland.
- HBP—7799 kc. Geneva, Switzerland.
- IRM—9830 kc. Rome, Italy.
- LKJ1—9540 kc. Oslo, Norway.
- ORK—10330 kc. Brussels, Belgium.
- PHI—17775 kc. Huizen, Holland.

**Africa**

- SUZ—13820 kc. Abu Zabal (Cairo) Egypt.

**Asia**

- FZR—16200 kc. Saigon, Indo-China.

**Australia**

- VK2ME—9590 kc. Sydney, Australia.
- VK3LR—9580 kc. Lyndhurst, Victoria.
- VK3ME—9510 kc. Melbourne, Australia.

**South America**

- COC—6010 kc. Havana, Cuba.
- CP5—6080 kc. La Paz, Bolivia.
- El Prado—15440 kc. Riobamba, Ecuador.
- El Prado—6620 kc. Riobamba, Ecuador.
- HCB—4107 kc. Quito, Ecuador.
- HJ2ABC—5970 kc. Cucuta, Colombia.
- HJ4ABE—5930 kc. Medellin, Colombia.
- HJ5ABD—6490 kc. Cali, Colombia.



## THIRTEENTH "TROPHY CUP" WINNER

Presented to  
**SHORT WAVE SCOUT**  
**BERNARD KINZEL**  
**869 Elton Avenue, Bronx,**  
**New York**

For his contribution toward the advancement of the art of Radio

by



Magazine

● ON this page is illustrated the handsome trophy, which was designed by one of New York's leading silversmiths. It is made of metal throughout, except the base, which is made of handsome black Bakelite. The metal itself is quadruple silver-plated, in the usual manner of all trophies today.

It is a most imposing piece of work, and stands from tip to base 22½". The diameter of the base is 7¾". The diameter of the globe is 5¼". The work throughout is first-class, and no money has been spared in its execution. It will enhance any home, and will be admired by everyone who sees it.

The trophy will be awarded every month, and the winner will be announced in the following issue of SHORT WAVE CRAFT. The winner's name will be hand engraved on the trophy.

The purpose of this contest is to advance the art of radio by "logging" as many short-wave commercial phone stations, in a period not exceeding thirty days, as possible by any one contestant. The trophy will be awarded to that SHORT WAVE SCOUT who has logged the greatest number of short-wave stations during any 30-day period; at least 50 percent must be "verified."

### HONORABLE MENTION AWARDS

There were no Honorable Mention awards this month as the other entries besides Mr. Kinzel's failed to have the qualifying 50 percent verifications.

### Trophy Contest Entry Rules

● NOTE that we have amended our rules, so that they now read:

In order to protect everyone, the rules have been amended that a sworn statement before a Notary Public, which only costs a few cents to get, must be sent in at the same time.

For the complete article of the Purpose of the SHORT WAVE SCOUTS, we refer to page 393 of the November 1933, issue.

Here are the rules amended:

You wish to know how you can win this valuable trophy, and here are the simple rules. *Be sure to read them carefully. Do not jump at conclusions.*

1.—A monthly trophy will be awarded to one SHORT WAVE SCOUT only.

2.—The purpose of this contest is to advance the art of radio by "logging" as many short-wave phone stations, in

(Continued on page 703)

- LSN—9890 kc. Hurlingham, Argentina.
- LSX—10350 kc. Monte Grande, Argentina—see card from LR4.

- PSK—8185 kc. Rio de Janeiro, Brazil—see card PRA3.

- PSZ—7780 kc. Rio de Janeiro, Brazil.
- TIEP—6710 kc. San Jose de Costa Rica.
- YV3RC—6150 kc. Caracas, Venezuela.
- YV2RC—6112 kc. Caracas, Venezuela.
- YV4RC—6000 kc. Caracas, Venezuela.
- YNLF—6950 kc. Managua, Nicaragua.

**North America**

- CJRX—11720 kc. Winnipeg, Canada.
- CJRO—6150 kc. Winnipeg, Canada.
- W2XE—15270 kc. Wayne, N.J.
- W2XE—11830 kc. Wayne, N.J.
- W2XE—6120 kc. Wayne, N.J.
- W2XAD—15330 kc. Schenectady, N.Y.
- W2XAF—9530 kc. Schenectady, N.Y.
- W3XAU—9590 kc. Newtown Square, Pa.
- W3XAL—17780 kc. Boundbrook, N.J.
- W3XAL—6100 kc. Boundbrook, N.J.
- W3XL—6425 kc. Boundbrook, N.J.
- W8XK—21540 kc. Pittsburgh, Pa.
- W8XK—15210 kc. Pittsburgh, Pa.
- W8XK—11870 kc. Pittsburgh, Pa.
- W8XK—6140 kc. Pittsburgh, Pa.
- W9XAA—6080 kc. Chicago, Ill.
- W9XF—6100 kc. Chicago, Ill.
- W8XAL—6060 kc. Cincinnati, Ohio.
- VE9GW—6095 kc. Bowmanville, Canada.

# SHORT WAVES and

## T. J. Taaffe, Jr., Goes After "Veris"—And How!

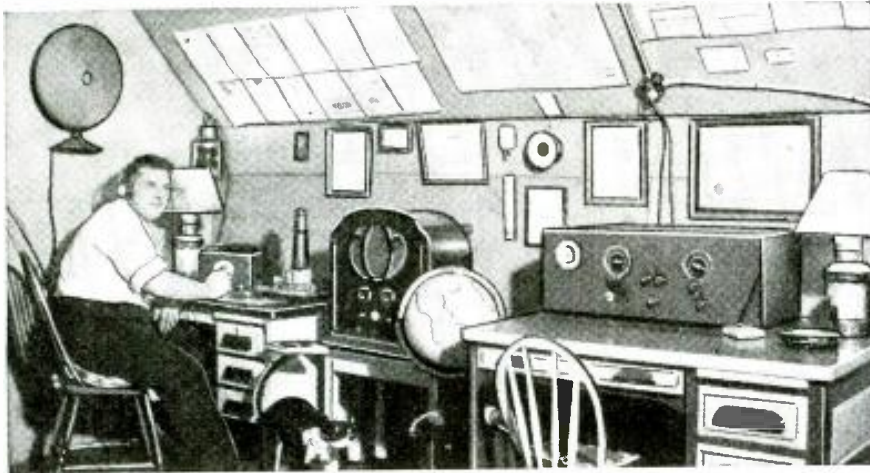

Here is Thomas J. Taaffe of Elmsford, N.Y., in his station. Mr. Taaffe has received "veris" from many foreign stations, and we note that he has a large globe handy to help locate the many distant stations he hears.

### Editor, SHORT WAVE CRAFT:

I have noticed that you are running a contest for station photos! The only thing that kept me from writing before, was the fact that I did not have a picture of my rig. I have been a reader of your magazine since "way back when." I still have a membership certificate of the *Radio League of America*—Hi! This is dated April 10, 1924, and of course was managed by Hugo Gernsback. Today, I prefer SHORT WAVE

*Craft*. I am also a member of your SHORT WAVE LEAGUE; a member of the *International DX-ers Alliance*; and a very proud member of the *Society of Wireless Pioneers*. I was credited with 16 years experience in this organization. I noticed in your November issue, a picture of Mr. Wadia—a brother member of mine—some boy—eh, what?

The set on the extreme right is a revamped 8-tube superhet, 10-200 meter

range. Above this on the wall, is my membership to the *Radio League of America*—1924; and the SHORT WAVE LEAGUE. To the left is a Kolster-8-tube superhet, range 10-200 meters. The one that I am tuning in is one of your 3-tube regenerative jobs.

On the wall, you see a few "veris" and my "weather bureau." I have received "veris" from all the D's in Germany; letters from the G's in England; (they will not verify). I have a letter from Birmingham, England, 475 meters, dated May 15, 1924, verifying reception of their program. I have received "veris" from the following stations: VK2ME, VK3ME, VE9GW, VE9HX, CJRX, CJRO, FYA, EAQ, I2RO, HBP, HBL, CT1AA, YV1BC, YV2BC, YV3BC, PRA3, LSX, XEB. I have logged most all the prominent stations and am waiting for more "veris." Some of the stations logged, but not verified as yet, are: JVM, ORK, PCJ, XGBC, PRF5, CT3AQ, SRI, PRADO, F31CD, HKD, HKF, PHI, KJPY, KEE, YVQ, LSN, LSL, KEJ, PSK, RVG, and DENNE—Graf Zeppelin—flying over West Indies. (They did not verify).

Although I have been at the game for a number of years, it is only recently that I have been going after verifications.

THOMAS J. TAAFFE, JR.,  
29 Valley Avenue,  
Elmsford, N.Y.

(Glad to hear from you, Thomas, and you seem to have a mighty fine touch when it comes to tuning in those elusive DX stations. You have a very complete set of equipment, we note from the photo, including a handy globe, so very essential in logging foreign stations. Undoubtedly you find the barometer and other weather apparatus useful in many ways in your short-wave listening post.—Editor.)

## Bill Wetzel Has Cracker-Jack "Ham" Station

### Editor, SHORT WAVE CRAFT:

Since you are offering a year's subscription for the best station photo, I desire to compete by enclosing under separate cover photo of my small layout.

The transmitter is a homemade, 5-stage crystal controlled rig designed exclusively for 20-meter C.W. operation. It is mounted

on casters in a frame 4 feet high, 20 inches wide and about 9 feet long and located in the attic. It will be readily noticeable why it was not built rack-and-panel style, since vertical head-room was not available and my suggestion of cutting a hole through the roof for such a rig met with O.W. difficulties. Some like them long and here's one of

that variety; this construction eliminating also the necessity of shielding between the various stages. The R.F. portion is mounted on the main hinged top board while the several power supplies are directly underneath. Meters are used in all plate and filament circuits and Jacks are provided for plugging into the various grid circuits.

To the right of the homemade receiver is the switching arrangement, in which case is mounted the "key-click filters, while directly on top of it is the monitor. The entire operation is controlled by a single push-button switch, although a number of auxiliary switches are used for tuning and making adjustments only. The rig is very stable in operation and constructed so simply that even the novice encounters no difficulty in its operation. Thirty-six foreign countries have been contacted with this outfit, giving the writer some real pleasure.

Surely enjoy reading SHORT WAVE CRAFT, which I assure you has given the O.T. many an hour of pleasure.

Beaver Falls, Pa.  
BILL WETZEL,

(Quite a novel idea, Bill, and under the circumstances you have done a fine job. It might be a good idea if you sent us a diagram showing how you have arranged the single push-button switch control.—Editor.)

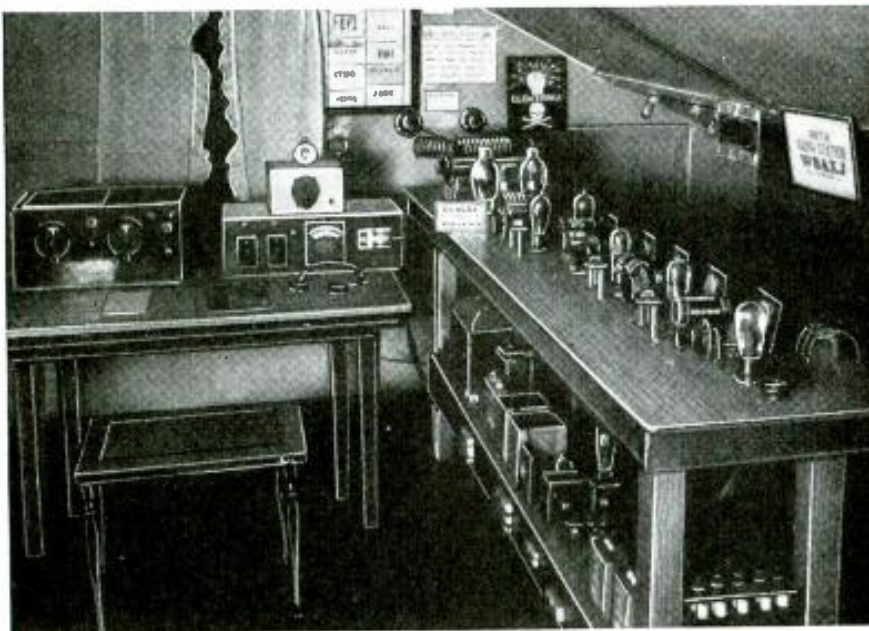

Bill Wetzel sports a swell ham station. The elaborate transmitter set-up is built on a frame mounted on casters, as shown at the right. The entire outfit is controlled by a single push-button switch.

One Year's Subscription to  
Short Wave Craft  
FREE

for the "Best" Station Photo

Closing date for each contest—60 days preceding date of issue; Jan. 1 for March issue, etc. The editors will act as judges and their opinions will be final. In the event of a tie a subscription will be given to each contestant so tying.

# LONG RAVES • • • OUR READERS' FORUM

## OUR "POCKET SET" WORKS SPEAKER!

Editor, SHORT WAVE CRAFT:

It has been some time since I have written to your department; however, the writer desires to mention the fact that in the December issue of your wonderful magazine, there appeared a description of a "1-tube Pocket Radio Set," which was indeed very interesting. It was noted that the well-known Super-Regenerative Circuit was employed in the hookup of this receiver.

This circuit and set so appealed to the writer, that he immediately decided to build the 1-Tube Pocket Set. The writer built this receiver and mounted it in a cigar box. Not having one of the new RCA "Acorn" tubes, recently placed on the market, the writer, to economize for lack of space, used the U. S. SIGNAL CORPS 2-volt VT-5 type of tube, which is very small—about 2 inches high by ½ inch in diameter, in place of the "Acorn" tube, as detector and oscillator combined, which it really is in this circuit.

The receiver in question was built from discarded parts from my junk box. It was assembled and wired in one evening, and at 10 p.m. Nov. 24, I hooked it up, using one 2-volt drycell battery for the filament supply, and one 45-volt standard Burgess "B" battery for the plate supply. A loud-speaker was connected to the telephone binding posts, or "B" battery clips.

Having no idea that this receiver would work a loud-speaker of the magnetic type, the current was turned on, and signals began to pour in, loud enough to be heard all over the "operations building" through the loud-speaker! No audio amplification was incorporated in the receiver whatsoever, and I received the thrill of my life!

The writer wound a coil on a tube base for the frequency of 40.90 kilocycles or the 72-meter band, which band is used by this station (WYY) for communication daily with WVB, Army Radio Station controlling the Eighth Corps Area network, located at Fort Sam Houston, San Antonio, Tex., it being desired to use this pocket set as a monitor in addition to a receiver. Incidentally, this receiver makes an excellent monitor, as it is very light and portable, weighing hardly 3 pounds, (without batteries), and no shielding required. There is no body capacity effect whatsoever.

No antenna nor any ground connection was used during the test whatsoever, and did it work! AND HOW! It can really take it! The first station heard on the Pocket Set was the Dallas Police Department radio station "calling all cars." The Airways station at Fort Worth and Albuquerque, N.Mex., were also heard broadcasting weather reports, in code and by voice. These reports were copied on our typewriter, by the writer, and are used locally for flying fields of this area, in addition to our own weather reports.

The writer is so well pleased with the Pocket Set described by George Shuart in the December issue, that he has decided to use this circuit in the future for all radio construction, relative to reception. Barring none, it is supreme! Many thanks to Geo. W. Shuart, the designer.

In addition, you might mention in your magazine, that any amateurs, or any one desiring to obtain practice on the code, may avail themselves of the opportunity by listening daily from 7:30 a.m. to 6:00 p.m. except Sundays and holidays, at which times our stations are open for business from 8:30 a.m. until 10:30 a.m. approximately, for weather reports. These weather reports are broadcast by the control station, (WVB) Fort Sam Houston, San Antonio, Tex., on the 50-meter band, on long wave and on several other short-wave bands simultaneously, all transmitters being connected in parallel, both long and short wave.

The writer is a regular purchaser of your

## A Crack "Net Control" Station

"Prize-Winning" Station Photo Awarded One Year's Subscription To SHORT WAVE CRAFT.

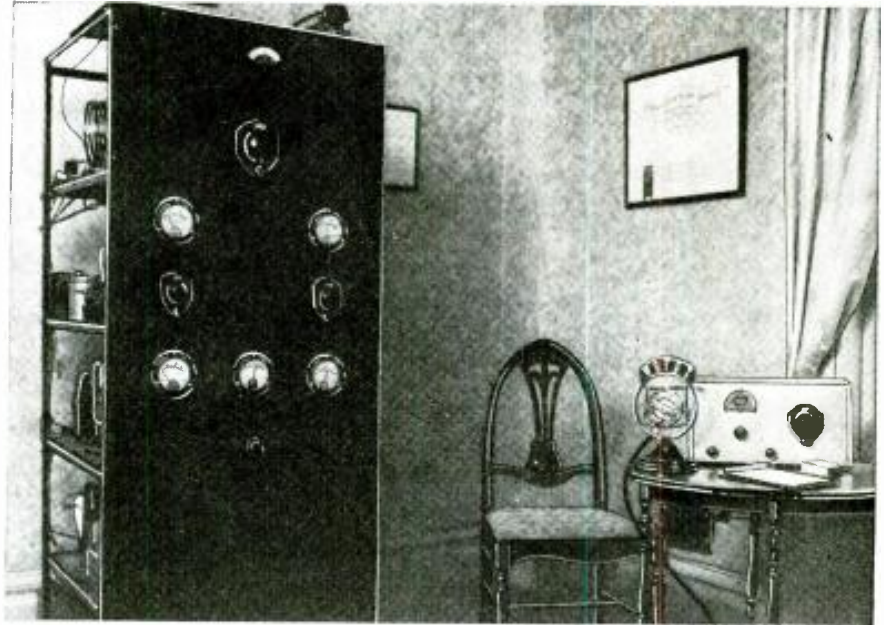

Murray D. Farmer of Norwood, N.Y., should be justly proud of the very fine layout at his transmitting and receiving station, W8FSY. The rack and panel transmitter, at the left, is rated at 500 watts.

Editor, SHORT WAVE CRAFT:

The transmitter, when operated on 1919 kc., is rated at 250 and 500 watts input. It consists of a '47 oscillator, a '46 first buffer, parallel '46's second buffer, and two 503A's push-pull as a final amplifier. (Class "B" 503A's, a Pam PA amplifier, 2-stage resistance coupled pre-amplifier, and crystal microphone complete the lineup.)

The receiver is a Stewart-Warner converter and Crosley 10 tube superheterodyne (not shown in the photograph; I am at present using a Patterson PR-10 with pre-selector).

During the winter months W8FSY is on

the air several hours each day, for the purpose of "rag chewing" and message handling. This station is the northern New York "net control" station of the Army "Amateur Phone Net."

MURRAY D. FARMER,  
Norwood, N.Y.

(Congratulations on your excellent ham station, Murray, and your layout looks very businesslike indeed. If more of our amateur station owners assembled their scattered apparatus into a neat panel job such as you have done, they would be surprised at the greater ease and efficiency of operation all around.—Editor.)

wonderful magazine, which is pre-eminent to them all, barring none. I make a regular monthly sojourn to the newsstand; it is worth its weight in gold and far more than the price asked for it. The writer also enjoys your editorials very much and never fails to read them. Isn't it about time that someone thought of a new name or term for "Short and Long Waves"? It was not so very long ago that radio was known as "wireless." And as Ed Wynn would say, "the term 'loud-speaker' is so common, don't you think so, Graham?" Why not conduct a contest?

Best wishes for continued success of SHORT WAVE CRAFT.

S. H. BUCHANAN,  
U. S. Army Airdrome,  
(P. O. Box 29) Dryden, Texas.

(Great results, S. H. B., and if your letter had been the only one we had received concerning the surprising DX results obtained with Mr. Shuart's POCKET RECEIVER, described in the December number of SHORT WAVE CRAFT, we would have been a little bit suspicious; however, yours is the first real official report on a test with this 1-tube POCKET RECEIVER where stations were heard in on a LOUD-SPEAKER! Many thanks for this very interesting and timely report.—Editor.)

## "TWINPLEX" A PEACH!!

Editor, SHORT WAVE CRAFT:

Having built the Twinplex described in one of your issues of SHORT WAVE CRAFT I find it most satisfactory in many ways,

having started in radio, back in 1920, when a one-half K.W. spark was the zenith of a ham's ambition and building a set was mostly guesswork and providence that enabled us to get a few manufactured parts—if we could raise the price! Of course, there were a chosen few who could boast of a tube—usually a double filament Audiotron.

To date, in five days operation of the Twinplex I have received: JVC, JVN, VK3ME, CJRO, W9XF, W8XAL, W8XK, W3XAL, W1XAL, W2XAF, KGE, KEE, 26JABD and a number of police and amateur stations in the fifth and sixth, seventh, eighth, and ninth districts, including Alaska and Honolulu.

I made several changes, however, but they are minor—for instance the plate control condenser was changed to .0002, and 75,000 ohms was used in series with the screen-grid control. This seemed to make the set more stable in operation and in all I am well pleased, as the set is simple in operation, so necessary in high frequency!

EDWARD NUNES,  
666 9th Street,  
Oakland, Calif.

(The "Twinplex" has made many friends among short-wave fans, Edward, and we are glad to note that you are so highly pleased with the results you have obtained with it. The Twinplex strikes a very popular chord among the short-wave enthusiasts today, particularly in view of the fact that it gives 2-tube performance on only one tube—a maximum of economy and efficiency.—Editor.)

# The ALL-SUPER

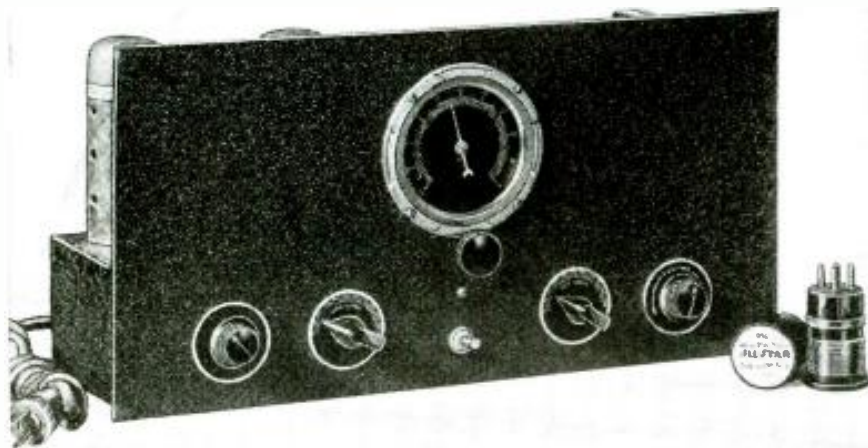

Front view of the very newest all-wave superhet receiver—the "All-Star Junior Super Band-Spread 5."

● HERE is a fine combination of good design, simplicity, and performance in a radio receiver any experimenter can build! If you are looking for an efficient but simple circuit embodying good parts and advanced design, a receiver capable of reaching out beyond the usual limits of radio reception, the ALL-STAR JUNIOR is heartily recommended. This is one all-wave superheterodyne which you can brag about and prove your claims with a demonstration, say its sponsors.

#### Designed by Group of Engineers

The ALL-STAR JUNIOR circuit is the result of scientific design and cooperation between the engineers of the several prominent radio parts manufacturers whose products are recommended in its construction. Economy and efficiency go hand in hand in this set. Anyone familiar with a soldering iron, screw-driver, and pliers, can assemble the JUNIOR in a few hours. A complete set of plans, including schematic, pictorial, and step by step assembly data, accompany the foundation unit. The foundation unit is a drilled, lacquered front panel and chassis deck. The panel is neatly etched with the necessary markings for the controls.



The dynamic loudspeaker specified for the "All-Star Junior" superhet, with its cord and plug.

#### Has "Beat Oscillator" and "Band-Spread" Tuning

Two features which assure the builder of better performance from the ALL-STAR JUNIOR than is possible with "ready-made" sets, are the "Beat-Frequency-Oscillator" and the Band-Spread Tuning System. The former permits tuning in the carrier of distant stations even though no signal is being transmitted at the moment. As many Asiatic and European stations have long

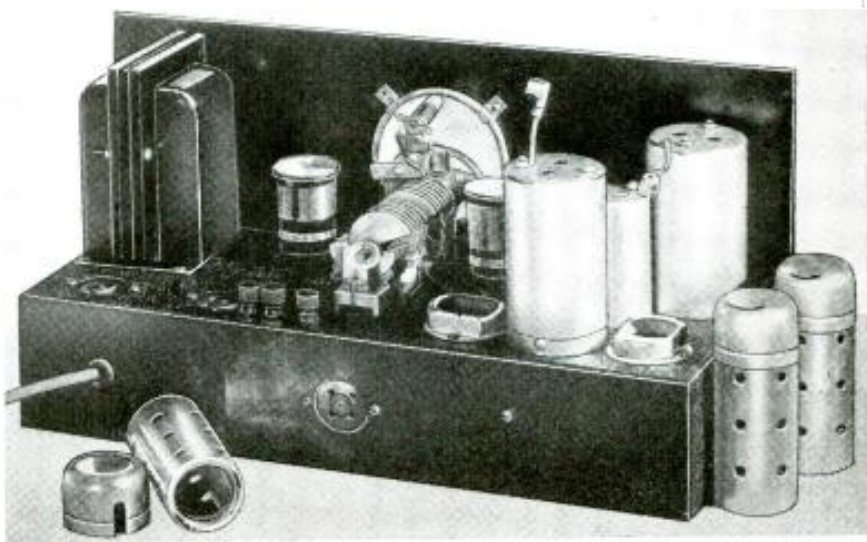

Rear view of the "All-Star Junior" superhet showing the carefully laid out arrangement of the parts to avoid feedback between the circuits.

silent periods between announcements, this is the only method by which the listener can "detect" the presence of the station's carrier wave. The *Band-Spread Tuning* system spaces stations over the main tuning dial and permits accurate logging of the congested channels. Often ten or twelve stations will be on, say, the 49 meter-band simultaneously. No ordinary short-wave set can possibly select a particular station in this important international channel and "log" its position accurately. With the *band-spread* method of tuning, every signal has a definite spot on the dial scale!

● The sponsors of this newest all-wave, band-spread 5 tube superhet receiver have kindly consented to supply free to those vitally interested in this set, complete instructions for assembly—together with layout diagrams. Therefore, if you desire a copy of these assembly instructions, together with complete specially drawn diagrams, simply drop a postcard or letter to us requesting this information. Write; do not call!

Ask for Instruction No. 505 and address your request to:

Service Department  
SHORT WAVE CRAFT  
99-101 Hudson St.  
New York City

#### 6A7 Acts as Oscillator and Mixer

The circuit employs a 6A7 tube as a combination oscillator and mixer. A 6F7 pentode-triode functions as an I.F. amplifier on a frequency of 370 kc. The triode part of the 6F7 is connected as a *beat frequency oscillator* with a control switch on the front panel. A 77 pentode detector is resistance coupled to a type 42 pentode power tube. A standard 80 rectifier tube is used in the well-filtered power pack of the "B" supply. The circuit calls for a dynamic speaker with a 1000 ohm field, an inductive "humbucking" field shunt, and a transformer to match the speaker's voice coil to the type 42 tube. The



# STAR JUNIOR

## BAND-SPREAD 5

speaker must have a 4-prong plug, wired to match the 4 hole socket on the back of the chassis.

Pretuned 370 kc. I.F. transformers are specified in the design, with a small insulated trimmer "wrench" for the experimenter who wishes to make minor adjustments after the set is complete.

### Step-by-Step Plans Furnished

The assembly has been simplified through the use of step-by-step layout and wiring plans. The parts are mounted on the chassis deck as the assembly progresses, the front panel being mounted last as a precaution against marring the finish or breaking the glass window of the airplane type tuning dial.

The first step is to mount the wafer type sockets with 6/32 1/2-inch bolts and lock washers. The power transformer and choke, are mounted next. With these parts in place, the preliminary wiring may be installed, following the plan shown in the first wiring layout diagram supplied with the Foundation Unit.

The second series of assembly operations involves the controls which appear on the front of the panel. From left to right these are: the "local-distance" switch, the oscillator tank condenser, the detector tank condenser, and the logarithmic tapered 25,000 ohm potentiometer and power-switch combined. The 370 kc. I.F. transformers and the beat-frequency oscillator mount on the chassis deck. With these parts in place, the second wiring plan is used. As all the leads from the I.F. transformers and BFO coil are color-coded, no difficulty may be anticipated with

the wiring of these units. The third wiring layout shows the positions of the condensers and the resistors. All the wiring is made with standard flexible "hookup" wire. The power cord and plug are standard items.

### Tube Shields Prevent Feed-back

The circuit is not critical with respect to tubes; any make of tubes which test good may be expected to give equal satisfaction. The 6A7, 6F7, and 77 tubes must be shielded. Shields with mounting bases punched for 1 1/2" centers were used on the "laboratory" models, and proved successful in suppressing all oscillation resulting from coupling between tubes.

Six pair of coils are recommended for "all-wave" reception. Coils wound on a special low loss dielectric are recommended for this portion of the set. The oscillator coils have five prongs and the detector coils have four prongs. The frequency range is from 540 kc. to 30 mc. or 550 meters down to 10 meters. While any good aerial will work, the "doublet" gave the strongest signals and the least noise in the laboratory tests of the ALL-STAR JUNIOR.

Complete operating instructions accompany the "Foundation Unit."

### LIST OF ALL-STAR JUNIOR PARTS

Thorndarson Electric Mfg. Co.

- 1—Foundation Unit Diagrams, Construction details, etc.
- 1—T-7078 Power Transformer
- 1—T-4402 Choke

Ohmite Mfg. Company

- 1—R1—300 ohm resistor—Wirewatt
- 1—R2—3000 ohm resistor—Wirewatt
- 1—R3—50,000 ohm resistor—Carbuhm
- 2—R4—20,000 ohm resistor—Wirewatt

(Continued on page 696)

## ALL-STAR JUNIOR

### Technical Features

● **CHARACTERISTICS**—A 5-tube, superheterodyne, all-wave, all-electric, band-spread receiver which can be assembled by anyone familiar with a screw-driver, pliers, and soldering iron. This receiver is capable of tuning in the majority of radio stations, throughout the entire world, whose transmission frequencies lie between 30 megacycles and 545 kilocycles. (10 to 550 meters.)

● **THE CIRCUIT ANALYSIS**—The latest, most powerful superheterodyne circuit is used. With this excellent circuit, only 5 tubes are required to produce very superior results. The tubes used are: 1—6A7 Mixer and electron-coupled oscillator; 1—6F7 Pentode Intermediate Frequency amplifier and triode beat frequency oscillator; 1—77 Detector and amplifier; 1—42 3000 milliwatt power output tube; 1—80 Full-Wave Rectifier Power Supply.

The I.F. is pretuned to 370 kilocycles and requires no adjustment, unless the constructor wishes to experiment with the slotted trimmer adjustments on each high gain I.F. coil.

● **CONTINUOUS BAND-SPREAD**—A method of tuning which proved highly successful in the ALL-STAR SIX is duplicated in the ALL-STAR JUNIOR. Two "tank" condensers are used for the initial selection of any particular wave-band within the range of the coils being used. After setting the tank condensers, the main tuning dial which operates two sections of the gang tuning condenser is used to select the desired station. The vernier reduction mechanism of this dial spreads the scale over 270 degrees of an illuminated airplane type dial. Stations may be logged for future reference with the same accuracy as expected from precision built wavemeters. On the JUNIOR, these stations may be spread over a dozen points, and with the aid of the "beat-frequency" oscillator, each may be tuned in accurately. In trans-oceanic reception, stations in several countries may be within a wave-band of two or three meters. The "band-spreading" device separates these stations.

● **ALL-WAVE RECEPTION**—30 megacycles to 545 kilocycles, or 10 to 550 meters, is the tuning range of the ALL-STAR JUNIOR. This is accomplished with six pair of "plug-in" coils. These individual coils are extremely efficient.

● **TONE QUALITY**—The selection of a speaker and a baffle or housing for it largely determines the tone quality. The electrical output of the receiver is uni-

(Continued on page 696)

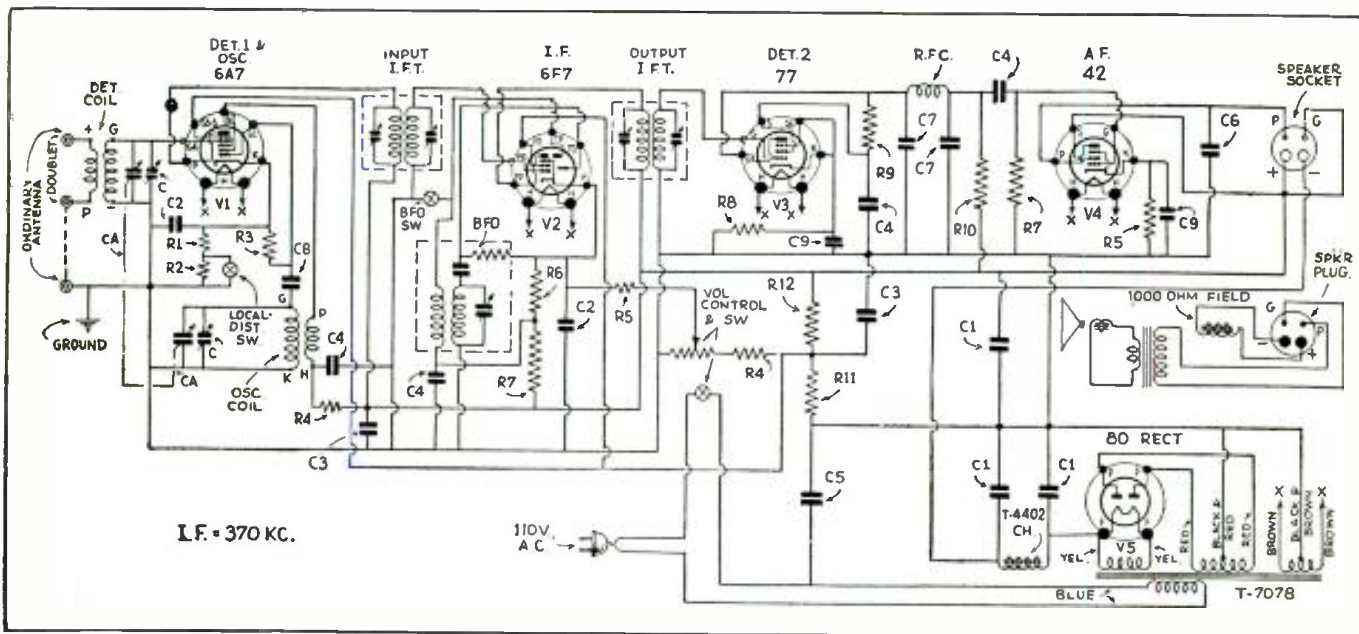

Wiring diagram of the "All-Star Junior" which features band-spread, beat oscillator, and but 5 tubes in all—which certainly spells both "efficiency" and "economy."

# WHAT'S NEW

The short-wave apparatus here shown has been carefully selected for description by the editors after a rigid investigation of its merits

# In Short-Wave Apparatus

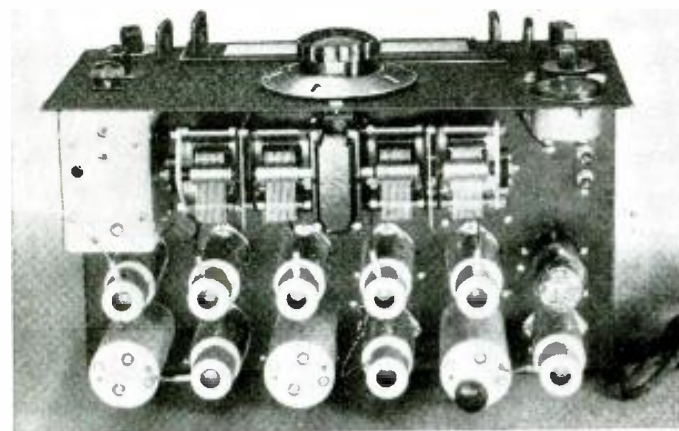
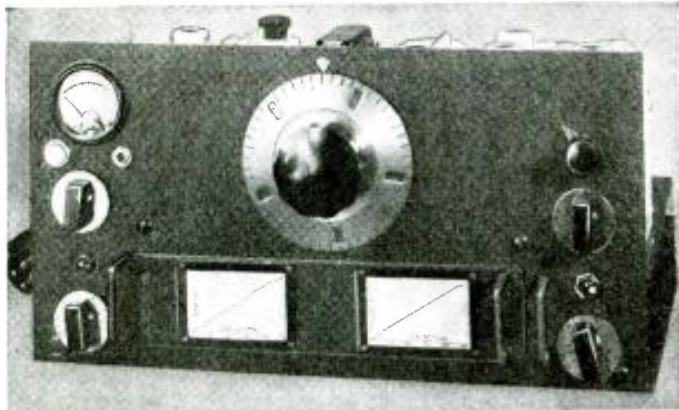

Here we have front and top views of the new HRO Receiver. Note the calibration curves on the plug-in inductor box.

● IN A brief description of a radically new type short-wave communication receiver such as the National HRO, it is next to impossible to more than make brief mention and comment of some of the more unusual features. The accompanying photographs will best serve to indicate in a general way

\*The National Co.

## A Really New COMMUNICATION RECEIVER

By JAMES MILLEN\*

some of the more outstanding of the mechanical design details that differ so much from standard practices of the past. Perhaps most noticeable is the dial itself. The numbers in the small windows stay stationary during that part of each revolution during which they are visible, but automatically shift during the bottom part of their travel. As a result, the dial is direct reading from 0-500 through a number of revolutions, and each division is separated from the next by one quarter of an inch, making a total equivalent length of dial scale of 12 feet! The manner in which this new type of dial drives the gang condenser is also quite unique in that the ordinary type of friction reduction vernier mechanism is not employed but instead a real machined steel worm engaged in a so-called "preloaded" machined driven gear which completely eliminates slippage, backlash, lack of rigidity, and the many other complaints of the less expensive but more common type construction as employed generally in broadcast receivers. The gears are housed in a very rugged diecast gear box on each side of which are mounted the straight frequency line condenser units. In addition to being thoroughly shielded from each other and mounted on a low loss Steatite-Isolantite dielectric, both the rotors and stators are insulated from ground and from each other, making possible the entire and complete isolation of each tuned circuit, and the complete elimination of so-called "common coupling."

### The Inductors

Another unique mechanical detail is the interchangeable inductance construction. As will be seen from the illustrations, each coil has its own individual air dielectric tracking and compensating condensers, and is individually shielded yet mounted on a common face plate which also carries the accurately calibrated tuning curves. By merely shifting a small screw located on the terminal block of each inductor, it is possible to readily change from calibrated band-spread to calibrated general coverage operation of the receiver; no auxiliary verniers, trimmers, or other such devices being used which would eliminate the value of calibration. The ranges covered by the different coils are as follows:

*(Continued on page 683)*

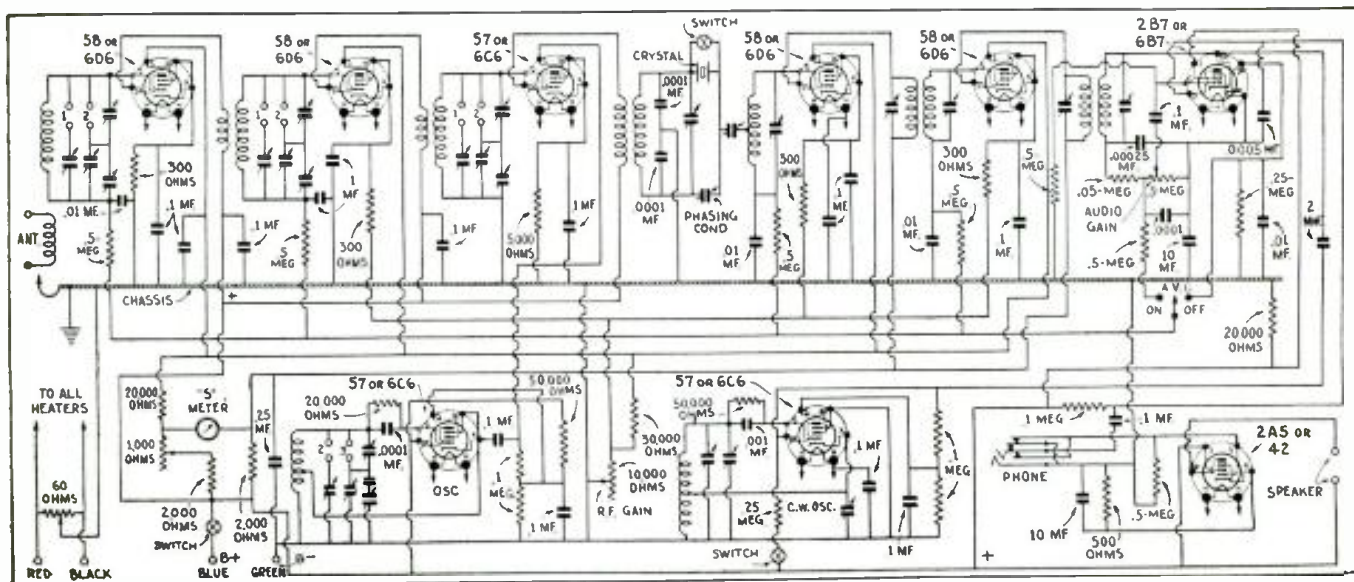

Detailed diagram of the elaborate National HRO Communication Receiver.

Names and addresses of manufacturers of sets described on this and following pages furnished upon receipt of stamped envelope; mention No. of article.

# Denton 1935 "DISCOVERER" 6-TUBE SET IN KIT FORM By CLIFFORD E. DENTON\*

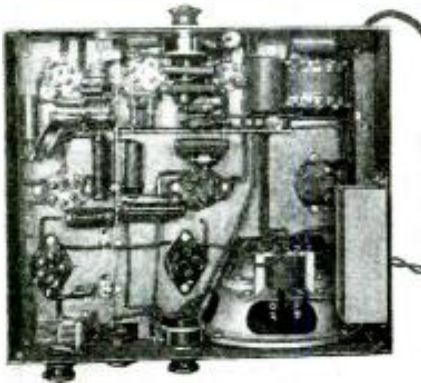

Rear and bottom views of the "Discoverer" 6-tube superhet, available in kit form. (No. 262).

● DURING the past few years the *superheterodyne* circuit has received the undivided attention of the majority of receiving engineers until, at the present time, it is without doubt the most sensitive and the most selective circuit available for receiving purposes. The radio experimenter realizes this fact, but is rather reluctant about building one in most cases, because of the complex designs usually offered him. Optimistic claims about finishing and testing the entire set "in an hour" have somewhat dimmed his enthusiasm about the *superheterodyne*.

The writer, realizing this fact, had set about revising the usual conglomeration of radio circuits with the idea of designing

\*Chief Engineer, Federated Purchaser, Inc.

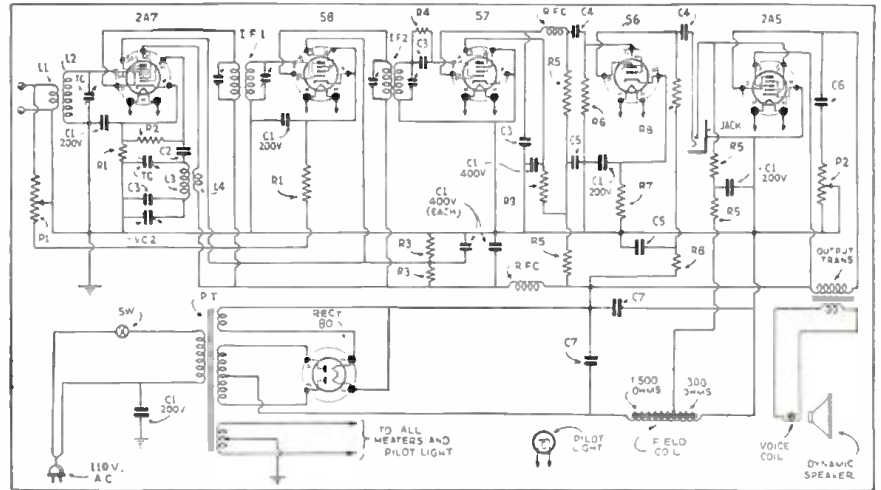

Wiring diagram of the 6-tube superhet—Denton 1935 "Discoverer", a well-designed and smooth-working job.

a really simple superheterodyne that can be built by the man with few tools and no extensive drilling facilities. He wanted a receiver that is as simple as possible, and yet one that will retain all the fine advantages of the superheterodyne circuit. The 1935 *Discoverer*, he believes, represents that set.

### The Circuit Diagram

The schematic circuit of Fig. 1 substantiates these claims. The antenna system connects to the input section of a 2A7; the oscillator coils connect to the triode section of this same tube. Thus, *electron modulation* of the signal takes place and the difference frequency is selected by I.F.1, the first I.F. transformer, which resonates at 465 kc. This transformer is further tuned by the secondary trimmer condenser and amplified by a high-gain type 58 tube. The output of this tube feeds a type 57 detector, which is connected for square-law detection. The output of the 57 is resistance-coupled into a 56, and the audio signal is still fur-

ther amplified by the 2A5 before being fed to the speaker.

### New Features

There are several excellent features that are well worthy of discussion, and which are found in very few, if any, other short-wave receivers. Everyone is familiar with the fact that the experimenter has great difficulty in lining up the oscillator and signal-circuit condensers. Unless a laboratory is available, it cannot be accomplished accurately. The *Discoverer* has eliminated the necessity for high-frequency alignment on any of the bands. As shown by the schematic, C3 and VC2 are in parallel, and the combination in series with the main oscillator tank condenser TC. Since C3 is large compared to VC2, the oscillator frequency may be shifted within required limits by merely varying the setting of VC2. Thus, for any setting of the signal-circuit condenser TC, a position of VC2 is found for which the I.F. is exactly 465 kc. The adjustment of VC2 is not critical; it is  
(Continued on page 694)

## Low-Power Screen-Grid Xmitter Pentode



New RCA 802 screen-grid pentode for transmitters. (No. 263)

● THE new RCA 802 screen-grid transmitting tube is one of the latest in the tube family and should find many uses among the transmitting amateurs.

- Its operating conditions are as follows:
- DC plate voltage, 200 maximum.
- Screen voltage, 250 maximum suppressor voltage, 40 volts maximum.
- DC plate current, 60 milliamperes maximum.
- DC grid current, 7½ milliamperes maximum.
- Plate input, 25 watts, maximum.
- Plate dissipation, 10 watts maximum.
- Screen dissipation, 6 watts, maximum.
- Heater voltage, 6.3 volts at 95 amperes. Grid-plate capacitance, .15 mmf.
- Screen plate capacitance, .5 mmf.
- Input capacitance, 12 mmf.
- Output capacitance, 8.5 mmf. Bulb style, ST 16 (this is the same size envelope as the 83 or 59).

The tube-base terminals are shown in the drawing. This is the TOP view. The 802 is a 7-prong, screen-grid tube having the suppressor and shield both brought out to separate terminals. The suppressor is brought out in order to enable suppressor-grid modulation and the shield is brought out in order that it may be grounded along with the cathode, or if the cathode is operated above ground R.F. potentials, the shield can be grounded. The plate terminal of the tube is brought out to a metal terminal at the top of the glass envelope. During experiments, this tube proved to work very well on the ultra high frequencies. Tests have shown that it can be operated at maximum rated input at wavelengths as low as 7.5 meters. We imagine that it will

work in the 5-meter amateur band very well, with slightly reduced input. The 802 can be used in the electron-coupled oscillator circuits, in frequency multiplier  
(Continued on page 695)

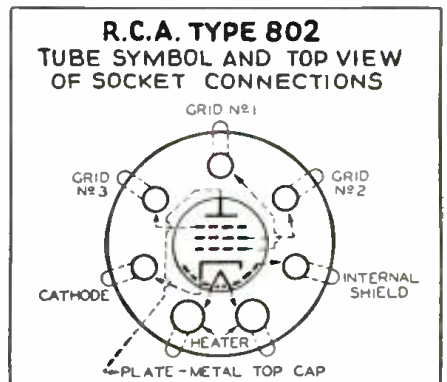

Socket hook-up for the new 802 transmitting pentode.

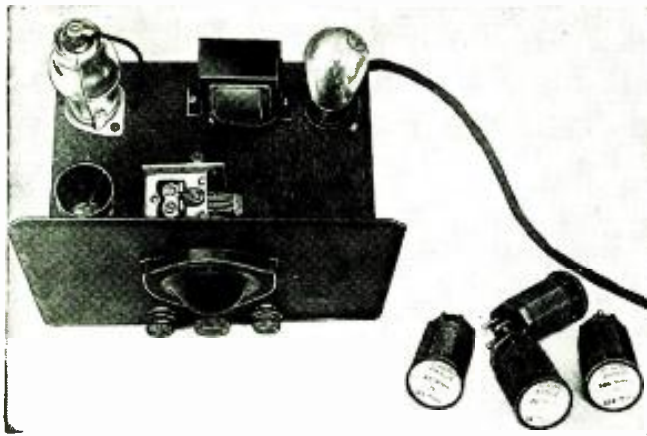

Appearance of the "RGH 2," the new Thor headphone set—very practical for beginners. (No. 264)

# The JUNIOR RGH 2

A 2-tube Head-phone Job

By ROBERT G. HERZOG, B.S.—E.E.\*

● FOR the beginner in the short-wave field, The Junior RGH 2, represents a complete self-powered radio in "kit" form. The circuit is the old stand-by, the grid-leak type regenerative adapted to modern tubes and equipment. No feature of design has been overlooked to obtain the utmost from this simple circuit. The 6F7 serves a dual purpose. Its pentode section is used as the regenerative detector and the triode section as an audio amplifier.

In wiring the set all the ground leads are connected together, as well as to lugs on the chassis itself. The filament, screen, and B plus leads, are run around the edges of the chassis to leave the center clear for the small parts and more important

\*Chief Engineer—Thor Radio Co.

wires. All soldered connections should be solid, made with a clean hot iron. Use only rosin core solder. The antenna leads, the R.F. and detector plate and grid leads should be wired with heavy bus bar from point to point. The lead to the cap of the tube should be short as possible and No. 18 flexible wire.

The resistors are mounted on a small rack located near the 6F7 socket. This adds to the neatness as well as the efficiency of the receiver.

The Junior RGH 2 can be wired even by the novice in an hour or so. After wiring check over the diagram and make sure no connections have been omitted or mistakes made. See that all connections are soldered firmly and that no loose splashes of solder are lodged about the underchassis. After having checked the wiring, plug in the tubes, ground, and the line. The set is now ready for tuning. No complicated alignment is necessary, for when wired correctly, the RGH 2 will play immediately. Try the 200 meter band first. This should be easiest to tune.

Because of certain inherent characteristics regenerative sets even as small as the RGH 2 are capable of receiving signals over long distances with considerably less noise than much larger and more powerful superheterodyne sets. It is often said, however, that regenerative receivers are harder to tune. This may be the case to those totally inexperienced with this type of set. When once familiar with tuning the RGH 2, it will prove simpler and easier to tune than the simplest super. (Continued on page 689)

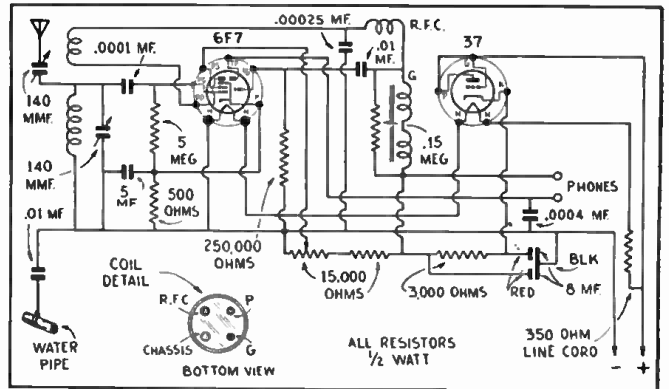

How the various parts in the simplified RGH-2 Receiver are connected.

## Crystal "Mike" Eliminates Hiss!

## Variable Impedance Matcher

● IN THE accompanying photograph we have two of the new Astatic, piezo-electric instruments. The microphone, in order to make it show well in the photograph, was placed in the inexpensive chromium-plated stand. This is not part of the crystal microphone. Besides having excellent response characteristics, the use of a crystal microphone of this type entirely eliminates hiss and crackling noises, apparent in the ordinary carbon microphone. When using a crystal microphone it is desirable to add one stage of audio amplification to that commonly used with the regular double-button carbon microphone.

The crystal phonograph "pick-up," an advance toward high fidelity reproduction, has considerably more "gain" than the

usual magnetic type and its frequency fidelity is within 8 decibels from 30 to 8000 cycles. No resonant points appear in the pick-up at any frequency and rattling and other sounds are completely eliminated by the use of self-compensating double ball-bearing swivel and hardened steel trunnion points. Non-magnetic material is used in constructing the instrument and no difficulty is experienced by the armature adhering to the pole-piece or becoming clogged with iron particles attracted by the pole-pieces. The input impedance of this "pick-up" is 150,000 ohms and it should, like the microphone, be connected into the grid circuit of the first amplifier. A load resistor is connected between grid and "B" negative, or directly across the output of the microphone at the tube socket.

● Impedance—that matching factor encountered from loudspeaker end clean back to the antenna system itself—makes all the difference between loud, clear, high-quality reception and weak, muddled, and indistinct reception. The importance of proper impedance matching is pretty generally realized in the usual all-wave set. There remains, however, a missing link in connection with the conventional "doublet" type antenna—the proper impedance match between the down-lead and the set. And it is that missing link which is now supplied in the form of the impedance matching and noise-rejecting device shown.

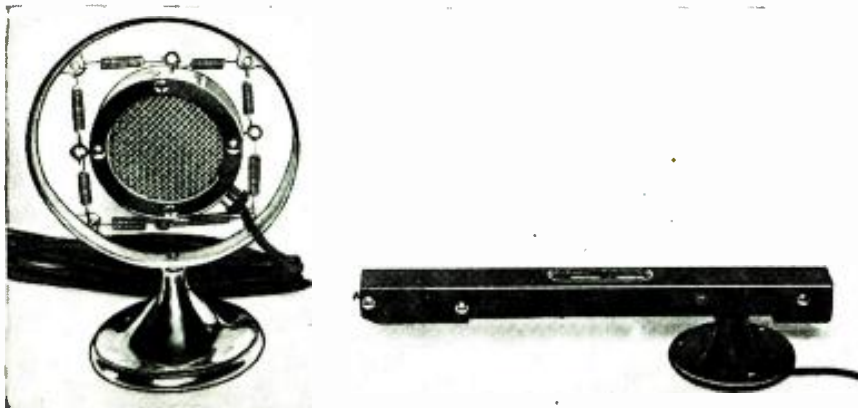

Two of the newest devices of interest to short-wave enthusiasts are the crystal microphone and the crystal phonograph "pick-up" shown above. (No. 265)



Newest antenna impedance matching device No. 266

Names and addresses of manufacturers of sets described on this and following pages furnished upon receipt of stamped envelope; mention No. of article.

# 5-Tube All-Wave Set Has "World Map" on Grille

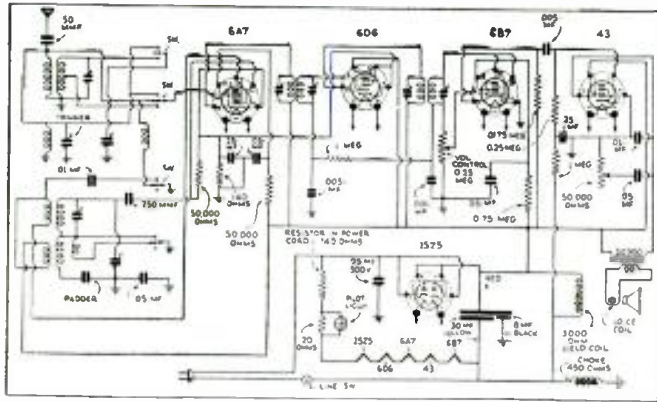

Wiring diagram of the model 65 Kadette "short" and "broadcast" wave receiver.

● HERE is one of the latest 5-tube *all-wave* receivers, the well-known Kadette model built by the International Radio Corporation. This receiver has a brand new feature—a complete map of the world is mounted over the grille opening in the front of the cabinet as shown. This is a very handy adjunct to every short-wave "fan" and "listener," and it is a wonder that it has not been used in conjunction with a short or all-wave receiver before.

This receiver is mounted in a very attractive hardwood cabinet and has all the necessary control knobs on the front of it, which provide switch and volume control, tone control, *short-wave* and *broadcast* band switch, also vernier tuning dial. The main tuning dial, controlled by the lower center knob, is quite unique and it contains no ordinary indicating needle such as found on the aver-



At Last! A map of the world right on the front of an all-wave receiver—the International Kadette Model 65.

age set, but instead, when the set is turned on, a spot of light flashes on the dial from behind, a fine black line appearing across the target of light. As the tuning dial control knob is turned, the target of light and its black center line moves around the dial. The dial itself is calibrated in meters and kilocycles for the short-wave and broadcast bands. The loud-speaker is of ample size to give room volume, and actual tests have shown very superior quality, on both the broadcast as well as short-wave reception.

A 6A7 tube is used as first detector and oscillator, a 6D6 tube as I.F. amplifier, a 6B7 as second detector and automatic volume control, a 43 tube as the audio frequency output tube, while the rectifier is a 25Z5. A great deal of laboratory research work has been carried on in order to find the very best combination of coils and condensers, and the proper arrangement of these parts, so as to provide a superheterodyne which would tune in both *short* and *broadcast* waves with high "gain" as well as good selectivity. This set operates on 110 volts A.C. or D.C.

By glancing at the diagram you will find that a very simple coil switch arrangement is used to shift from short-wave to long-wave reception. Plenty of by-pass condensers and resistors are used in order to reduce feedback, and prevent interstage reaction coupling. The automatic volume control is applied to the grid of the 6D6, I.F. amplifier. Needless to say automatic volume control, aids considerably in receiving distant short-wave stations because of the prevalent fading characteristics of such stations. Another aid to comfortable short-wave reception is the tone control. When properly adjusted, this can be used to suppress much of the hissing and crackling background noises usually heard in short-wave receivers. Full speaker volume is obtained on all of the prominent short-wave broadcasters.

## An Italian Short-Wave Converter

● AS WE have pointed out before on this page, certain European and South American countries use American tubes and many of their sets which appear in their local magazines resemble very closely American designs.

A short-wave converter using American tubes was described recently in *LA RADIO PER TUTTI*, an Italian magazine. The converter consists of an untuned R.F. amplifier using a type 58 tube capacitatively

coupled to another type 58 used as the first detector of the superhet converter. A type 27 tube is used as the oscillator which is coupled to the cathode circuit of the first detector.

The converter unit was designed to operate from a 220 volt D.C. line, which is available in most of the cities in Italy and for this reason no rectifier tube or power supply is included. Two sets of plug-in coils are required for the set. One coil

contains a single winding for the grid circuit of a first-detector while the second coil contains two windings, the grid-plate coil and the coupling coil. These two coils are

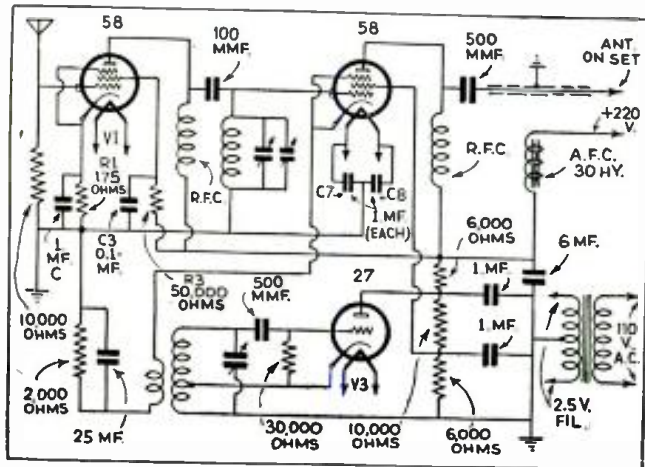
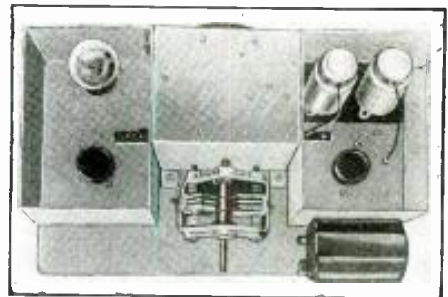

Photo at right shows appearance of Italian short-wave converter built to use American tubes. It was designed to operate from a 220 volt D.C. line, which current is commonly available in Italy.



Left: Diagram for the Italian short-wave converter here described and which uses American type tubes. No rectifier tube is required, the converter working from the 220 volt D.C. supply.

plugged into the shielded compartments at the ends of the chassis shown in the accompanying illustration. The value of the remaining parts are all shown in the diagram.

As short-wave converters are rapidly coming back into the short-wave fold, particularly due to the fact that they make a superheterodyne out of a T.R.F. "broadcast" receiver, when used in conjunction with it, this hook-up will undoubtedly prove of more than passing interest to short-wave experimenters. The plate current for these converters can be supplied from batteries or a well-filtered "B" eliminator when desired.

**\$5.00 Prize  
NOVEL COIL CONSTRUCTION**

Instead of grid wire going down from the coil and up to the variable condenser, a cap from an old screen grid tube, together with a screen grid clip arrangement can be used as shown in the drawing. This will shorten the lead considerably and eliminate the losses which undoubtedly are encountered when the lead is run over comparatively long distances and through the metal chassis.—Ernest E. Nason.

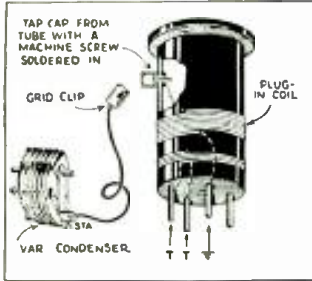

**COIL HANDLES**

By securing a 1 1/2" round piece of hardwood, the length depending upon the number of handles you wish to make, and taking it to a machine shop, very nice handles for plug-in coils can be made at a slight cost. All that is necessary is to have the machine shop make the cuts as shown in the diagram and you can saw them apart yourself and fasten the handles to the coil forms. On the flat top of the handle which is formed when they are sawed apart, you can place a round piece of paper on which is indicated the meter or frequency coverage of the coil.—Raymond Howes.

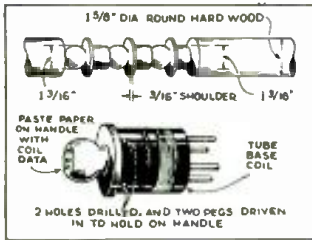

**HOMEMADE TUBE SOCKET**

Here's a very handy homemade tube socket, which can be used as a substitute for a ready made affair. The drawing clearly shows just how to construct it. In order that the pin holes will be in the proper position, first cut the pins from the base of an old tube and drill the holes to fit the standard tube terminals.—Myron Stahl.

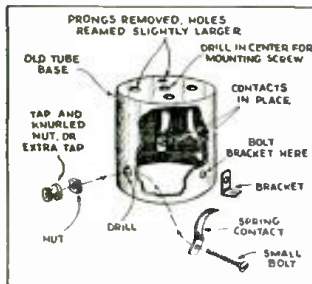

**PILOT LIGHTS FOR CENTER TAP**

This kink not only provides the much desired center tap resistor for the 2.5 volt filament windings but also provides panel lighting. In sets having two tuning controls and therefore two pilot lights, the bulbs are connected in series as shown in the diagram eliminating the center tap resistor and its current drain on the windings.—R. Sherburn.

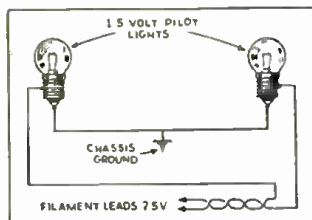

**\$5.00 FOR BEST  
SHORT WAVE KINK**

The Editor will award a five dollar prize each month for the best short-wave kink submitted by our readers. All other kinks accepted and published will be awarded eight months' subscription to SHORT WAVE CRAFT. Look over these "kinks" and they will give you some idea of what the editors are looking for. Send a typewritten or ink description, with sketch, of your favorite short-wave kink to the "Kink" Editor, SHORT WAVE CRAFT.

**TERMINAL LUGS MADE FROM HEAVY WIRE**

Once when I needed a wire terminal, and I had none available, I conceived this method of making them of some old wire that I had on hand. I hope it will help others as it has me. To make the terminals, I first scraped some No. 16 copper wire of

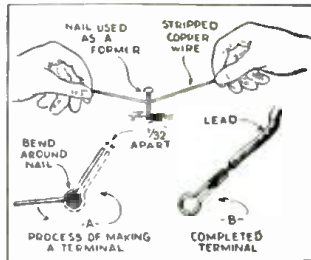

its insulation and made it bright, then I first bent about 1/2" of it almost at right angles to the remainder of the wire, then placing a nail, or some other piece (A) to form the hole the right size, I bent the wire around the form and made the two ends parallel about 1/32" apart. The finished terminal is shown at B. To use it, place the wire in slot X and solder it fast on both sides. Of course, if you wish to put terminals on small wire, make the terminals of wire about four sizes larger than the wire used.—Carl B. Spensler.

**HANDY TUBE SHIELD SUBSTITUTE**

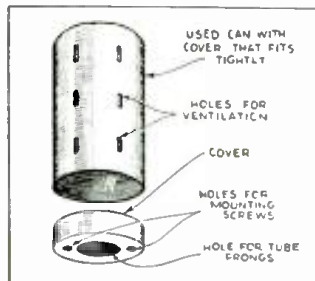

Having no tube shield I obtained some old cans with covers that fitted tightly, and then made a hole in the cover of the can the same as the hole in the sub-panel and two small holes that lined up with the mounting holes of the tube socket. A few holes in the side of the can allow sufficient ventilation for a tube. If it is to be used with screen grid tubes, the shield should have a hole in the top through which the grid connection can be made.—Jack Foster.

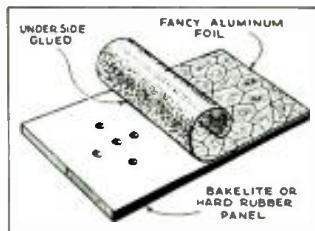

**SHIELDING FOR BAKELITE PANELS**

By securing some fancy aluminum foil and sticking it to your present bakelite panel, you can not only introduce very effective shielding, but enhance its appearance tremendously. Various shades and designs can be obtained from your local Variety Shop.—Joseph Jacobs.

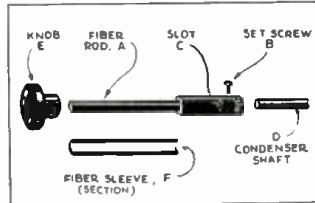

**EXTENSION SHAFT**

When using a 5-meter receiver, or any other receiver for that matter, with which you have trouble caused by body capacity effects, this extension will overcome the difficulty. A homemade one was constructed as follows from an old "aligning" tube. This should be drilled and tapped for set screw "B". The slot marked "A" is the proper size for the standard 1/4-inch condenser shaft. A 1/2-inch fiber shaft is used, and will take any standard tuning knob or dial.—C. C. Leininger.

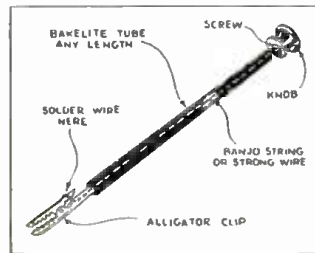

**SIMPLE RETRIEVING TOOL**

This handy instrument can be constructed from equipment found in the average "junk box." It consists of an "alligator clip," a short length of bakelite tubing, some strong wire, and a knob. The diagram is self-explanatory. In order to open the jaws of the clip, it is only necessary to pull upward on the knob, and release it when the jaws are to be closed. This has been used for retrieving nuts, screws, etc., in tight places where the hand or fingers cannot reach.—George D. Rodgers.

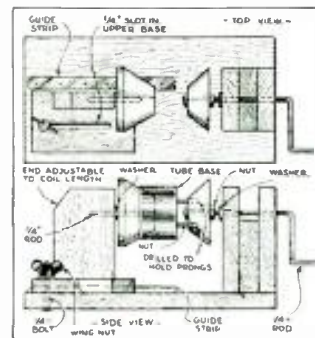

**HOMEMADE COIL WINDING MACHINE**

This coil winding machine is really very simple to build and will save much time and patience in constructing and winding coils of all descriptions. Nearly everything is constructed of wood except the crank and the wing nut. The "fall stock" is made to slide backward and forward in order that varying lengths of coils can be wound. No dimensions are given for the length of base as this will depend upon the size and type of coils you wish to wind. All the details are clearly illustrated in the drawing.—George Letell.

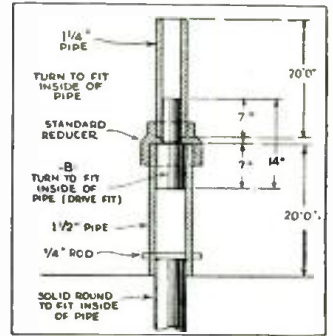

**ANTENNA MASTS**

Here you will find a kink in putting up antenna poles. I have two 40-ft. steel pipe poles. I drive a steel rod marked "A" into the ground, which is solid; if I had to dig a hole the ground would be very loose. The wind will sway or lee or rain will break the guy wire and the pole will sway back and forth. It may break the cat from coupling and fall and someone may get hurt, so I had a solid piece of metal turned down to drive fit in the 1 1/2" pipe marked "B", the other end turned down for a snug fit for the 1 1/2" pipe. This makes it like a solid pipe; you can get on top of the pole. It will bend but will not break. Last winter's lee broke my guy and the pole bent very badly; if it were not for the inside steel it would have raved in on my roof.—Gilbert G. Galambus.

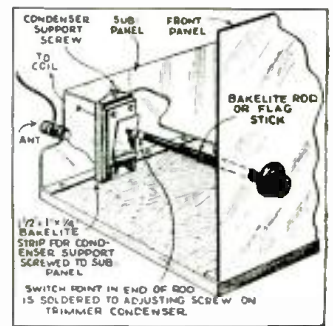

**PANEL KNOB FOR TRIMMER**

Every time a condenser is approached by the hand to do any adjusting, the station generally fades, due to body capacity, which is the big "bugaboo" with the beginners. Adjusting the antenna trimmer condenser from the front panel without body capacity is the purpose of this kink. The trimmer condenser is mounted on a piece of bakelite 1" wide by 1 1/2" long by 1/4" thick, a hole 1/2" drilled in the center, to allow the adjusting screw to pass through. The strip of bakelite is then mounted on the underside of the sub-panel, as shown in the diagram. Secure a bakelite rod 1/4" in diameter or a wooden dowel that has been boiled in paraffine for 10 minutes. It should be about 5" or 6" long. Now get a switch point or similar kind of a bolt, then drill a small hole in the end of the rod, so the switch point or bolt can be forced in tight; drill a hole in the front panel so the rod can be pushed through to the head of the screw on the condenser. Solder both bolt heads together, and the job is finished except mounting a tuning knob on the other end of the rod, to be used for adjusting.—Leo De Wan.

**SPACE WOUND COILS**

Here is a simple method for correctly spacing the winding on coils. All that is needed is a small weight such as a bolt and a short piece of cord or wire, the size of the cord or wire determining the spacing. Make a loop of the cord and slip over coil form. Start winding wire which is fastened at one end to bolt taut and the cord will follow along and space each one the same. When the end is reached simply lift loop of cord off and a professional looking job will be the result.—Harold Bergquist.

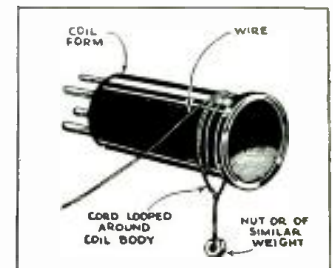

# Short Wave Stations of the World

## Complete List of Broadcast, Police and Television Stations

We present herewith a revised list of the short-wave broadcasting, experimental and commercial radiophone stations of the world. This is arranged by frequency, but the wavelength figures are also given for the benefit of readers who are more accustomed to working with "meters." All the stations in this list use telephone transmission of one kind or another

and can therefore be identified by the average listener. Herewith is also presented a very fine list of police as well as television stations. Note: Stations marked with a star ★ are the most active and easily heard stations and transmit at fairly regular times. Please write to us about any new stations or other important data that you

learn through announcements over the air or correspondence with the stations themselves. A post card will be sufficient. We will safely return to you any verifications that you send in to us. Communications of this kind are a big help. Stations are classified as follows: C—Commercial phone. B—Broadcast service. X—Experimental transmissions.

## Around-the-Clock Listening Guide

Although short wave reception is notorious for its irregularity and seeming inconsistency (wherein lies its greatest appeal to the sporting listener), it is a good idea to follow a general schedule as far as wavelength in relation to the time of the day is concerned. The observ-

ance of a few simple rules will save the short wave fan a lot of otherwise wasted time. From daybreak till 4 p. m. and particularly during bright daylight, listen between 13 and 19 meters (2150 to 1580 kc.). To the east of the listener, from about 3 a. m.-6 p. m., the 25-35 meter will be found very

productive. To the west of the listener this same band is best from about 7 P.M. until shortly after daybreak. (After dark, results above 35 meters are usually much better than during daylight.) These general rules hold for any location.

## Short-Wave Broadcasting, Experimental and Commercial Radiophone Stations

<b>21540 kc. W8XK</b> -B- 13.93 meters WESTINGHOUSE ELECTRIC PITTSBURGH, PA. 7 a. m.-2 p. m.; relays KDKA	<b>19220 kc. WKF</b> -C- 15.60 meters LAWRENCEVILLE, N. J. Calls England, daytime	<b>17810 kc. PCV</b> -C- 16.84 meters KOOTWIJK, HOLLAND Calls Java, 6-9 a. m.	<b>15880 kc. FTK</b> -C- 18.90 meters ST. ASSISE, FRANCE Phons Saigon, morning	<b>15270 kc. ★W2XE</b> -B- 19.65 meters ATLANTIC BROADCASTING CORP. 485 Madison Av., N.Y.C. Relays WABC daily, 11 a. m.-1 p. m.
<b>21420 kc. WKK</b> -C- 14.01 meters A. T. & T. CO. LAWRENCEVILLE, N. J. Calls Argentina, Brazil and Peru, daytime	<b>19160 kc. GAP</b> -C- 15.66 meters RUGBY, ENGLAND Calls Australia, early a. m.	<b>17790 kc. GSG</b> -B- 16.86 meters BRITISH BROAD. CORP. DAVENTRY, ENGLAND See "When to Listen In" Column	<b>15810 kc. LSL</b> -C- 18.98 meters HURLINGHAM, ARGENTINA Calls Brazil and Europe, daytime	<b>15250 kc. W1XAL</b> -B- 19.67 meters BOSTON, MASS. Irregular, in morning
<b>21060 kc. WKA</b> -C- 14.25 meters LAWRENCEVILLE, N. J. Calls England noon	<b>18970 kc. GAQ</b> -C- 15.81 meters RUGBY, ENGLAND Calls S. Africa, mornings	<b>17780 kc. ★W3XAL</b> -B- 16.87 meters NATIONAL BROAD. CO. BOUND BROOK, N. J. Relays WJZ, 10 a. m.-4 p. m. every day	<b>15760 kc. JYT</b> -X- 19.04 meters KEMIKWA-CHO, CHIBA. KEN, JAPAN Irregular in late afternoon and early morning	<b>15243 kc. ★FYA</b> -B- 19.68 meters "RADIO COLONIAL" PARIS, FRANCE Service de la Radiodiffusion 103 Rue de Grenelle, Paris 7:00-11 a. m. or 1 p. m.
<b>21020 kc. LSN6</b> -C- 14.27 meters HURLINGHAM, ARG. Calls N. Y. C. 8 a. m.-5 p. m.	<b>18830 kc. PLE</b> -C- 15.93 meters BANDOENG, JAVA Calls Holland, early a. m.	<b>17760 kc. DJE</b> -B- 16.89 meters BROADCASTING HOUSE BERLIN, GERMANY Irregular 8 a. m.-2 p. m.	<b>15660 kc. JVE</b> -C- 19.16 meters NAZAKI, JAPAN Phons Java 3-5 a. m.	<b>15220 kc. PCJ</b> -X- 19.71 meters N.Y. PHILIPS' RADIO EINDHOVEN, HOLLAND Broadcasts relaying PHI
<b>20700 kc. LSY</b> -C- 14.49 meters MONTE GRANDE ARGENTINA Tests irregularly	<b>18620 kc. GAU</b> -C- 16.11 meters RUGBY, ENGLAND Calls N. Y., daytime	<b>17760 kc. IAC</b> -C- 16.89 meters PIZA, ITALY Calls ships, 6:30-7:30 a. m.	<b>15620 kc. JVF</b> -C- 19.2 meters NAZAKI, JAPAN Phons U.S., 5 a.m. & 8 p.m.	<b>15210 kc. ★W8XK</b> -B- 19.72 meters WESTINGHOUSE ELECTRIC & MFG. CO. PITTSBURGH, PA. 10 a. m.-4:15 p. m. Relays KDKA
<b>20380 kc. GAA</b> -C- 14.72 meters RUGBY, ENGLAND Calls Argentina, Brazil, mornings	<b>18345 kc. FZS</b> -C- 16.35 meters SAIGON, INDO-CHINA Phons Paris, early morning	<b>17310 kc. W3XL</b> -X- 17.33 meters NATIONAL BROAD. CO. BOUND BROOK, N. J. Relays WJZ irregularly	<b>15415 kc. KWO</b> -C- 19.46 meters DIXON, CAL. Phons Hawaii 2-7 p.m.	<b>15200 kc. ★DJB</b> -B- 19.73 meters BROADCASTING HOUSE BERLIN, GERMANY 12:30-2, 3:45-7:15 a.m.
<b>19900 kc. LSG</b> -C- 15.08 meters MONTE GRANDE, ARGENTINA Tests irregularly, daytime	<b>18340 kc. WLA</b> -C- 16.36 meters LAWRENCEVILLE, N. J. Calls England, daytime	<b>17120 kc. WOO</b> -C- 17.52 meters A. T. & T. CO., OCEAN GATE, N. J. Calls ships	<b>15355 kc. KWU</b> -C- 19.53 meters DIXON, CAL. Phons Pacific Isles and Japan	<b>15140 kc. ★GSF</b> -B- 19.82 meters BRITISH BROAD. CORP. DAVENTRY, ENGLAND See "When to Listen In" Column
<b>19820 kc. WKN</b> -C- 15.14 meters LAWRENCEVILLE, N. J. Calls England, daytime	<b>18310 kc. GAS</b> -C- 16.38 meters RUGBY, ENGLAND Calls N. Y., daytime	<b>17080 kc. GBC</b> -C- 17.56 meters RUGBY, ENGLAND Calls Ships	<b>15340 kc. DJR</b> -X- 19.56 meters BROADCASTING HOUSE BERLIN, GERMANY Testing irregularly	<b>15120 kc. HVJ</b> -B- 19.83 meters VATICAN CITY ROME, ITALY 5:00 to 5:15 a. m., except Sun- day. Also Sat. 10-10:30 a. m.
<b>19650 kc. LSN5</b> -C- 15.27 meters HURLINGHAM, ARGENTINA Calls Europe, daytime	<b>18250 kc. FTO</b> -C- 16.43 meters ST. ASSISE, FRANCE Calls S. America, daytime	<b>16270 kc. WLK</b> -C- 18.44 meters LAWRENCEVILLE, N. J. Phons Arg., Braz., Peru, daytime	<b>15330kc. ★W2XAD</b> -B- 19.56 meters GENERAL ELECTRIC CO. SCHENECTADY, N. Y. Relays WGY daily, 2:30-3:30 p. m.	<b>15090 kc. RKI</b> -C- 19.88 meters MOSCOW, U.S.S.R. Phons Tashkent near 7 a.m. and relays RNE on Sundays irregularly
<b>19600 kc. LSF</b> -C- 15.31 meters MONTE GRANDE, ARGENTINA Tests irregularly, daytime	<b>18200 kc. GAW</b> -C- 16.48 meters RUGBY, ENGLAND Calls N. Y., daytime	<b>16270 kc. WOG</b> -C- 18.44 meters OCEAN GATE, N. J. Calls England, morning and early afternoon	<b>15280 kc. DJQ</b> -B- 19.63 meters BROADCASTING HOUSE BERLIN, GERMANY 12:30-2 a. m.	<b>15055 kc. WNC</b> -C- 19.92 meters HIALEAH, FLORIDA Calls Central America, daytime
<b>19380 kc. WOP</b> -C- 15.48 meters OCEAN GATE, N. J. Calls Peru, daytime	<b>18135 kc. PMC</b> -C- 16.54 meters BANDOENG, JAVA Phons Holland, early a. m.	<b>16233 kc. FZR3</b> -C- 18.48 meters SAIGON, INDO-CHINA Calls Paris and Pacific Isles		
<b>19355 kc. FTM</b> -C- 15.50 meters ST. ASSISE, FRANCE Calls Argentine, mornings	<b>18115 kc. LSY3</b> -C- 16.56 meters MONTE GRANDE, ARGENTINA Tests irregularly			
	<b>18040 kc. GAB</b> -C- 16.63 meters RUGBY, ENGLAND Calls Canada, morn. & early aftn.			

(All Schedules Eastern Standard Time)

<p><b>14980 kc. KAY</b> -C- 20.03 meters MANILA, P. I. Phones Paeñfe Isles</p> <p><b>14950 kc. HJB</b> -C- 20.07 meters BOGOTA, COL. Calls WNC, daytime</p> <p><b>14590 kc. WMN</b> -C- 20.56 meters LAWRENCEVILLE, N. J. Phones England morning and afternoon</p> <p><b>14535 kc. HBJ</b> -B- 20.64 meters RADIO NATIONS, GENEVA, SWITZERLAND Broadcasts irregularly</p> <p><b>14500 kc. LSM2</b> -C- 20.69 meters HURLINGHAM, ARGENTINA Calls U. S., evening</p> <p><b>14485 kc. TIR</b> -C- 20.71 meters CARTAGO, COSTA RICA Phones Cen. Amer. &amp; U.S.A. Daytime</p> <p><b>14485 kc. HPF</b> -C- 20.71 meters PANAMA CITY, PAN. Phones WNC daytime</p> <p><b>14485 kc. TGF</b> -C- 20.71 meters GUATEMALA CITY, GUAT. Phones WNC daytime</p> <p><b>14485 kc. YNA</b> -C- 20.71 meters MANAGUA, NICARAGUA Phones WNC daytime</p> <p><b>14470 kc. WMF</b> -C- 20.73 meters LAWRENCEVILLE, N. J. Phones England morning and afternoon</p> <p><b>14440 kc. GBW</b> -C- 20.78 meters RUGBY, ENGLAND Calls U.S.A., afternoon</p> <p><b>13990 kc. GBA</b> -C- 21.44 meters RUGBY, ENGLAND Calls Buenos Aires, late afternoon</p> <p><b>13610 kc. JYK</b> -C- 22.04 meters KEMIKAWA-CHO, CHIBA- KEN, JAPAN Phones California till 11 p. m.</p> <p><b>13585 kc. GBB</b> -C- 22.08 meters RUGBY, ENGLAND Calls Egypt &amp; Canada, afternoons</p> <p><b>13420 kc. TIEP</b> -B- 22.35 meters LA VOZ del TROPICO APARTADO 257 SAN JOSE, COSTA RICA Sun. 1-4 p. m.</p> <p><b>13415 kc. GCJ</b> -C- 22.36 meters RUGBY, ENGLAND Calls Japan &amp; China early morning</p> <p><b>13390 kc. WMA</b> -C- 22.40 meters LAWRENCEVILLE, N. J. Phones England morning and afternoon</p> <p><b>12840 kc. WOO</b> -C- 23.36 meters OCEAN GATE, N. J. Calls ships</p> <p><b>12825 kc. CNR</b> -B-C- 23.39 meters DIRECTOR GENERAL Telegraph and Telephone Stations, Rabat, Morocco Broadcasts, Sunday, 7:30-9 a. m.</p> <p><b>12800 kc. IAC</b> -C- 23.45 meters PIZA, ITALY Calls Italian ships, mornings</p>	<p><b>12780 kc. GBC</b> -C- 23.47 meters RUGBY, ENGLAND Calls ships</p> <p><b>12290 kc. GBU</b> -C- 24.41 meters RUGBY, ENGLAND Calls N.Y.C., afternoon</p> <p><b>12150 kc. GBS</b> -C- 24.69 meters RUGBY, ENGLAND Calls N.Y.C., afternoon</p> <p><b>12000 kc. RNE</b> -B- 25 meters MOSCOW, U. S. S. R. Sat. 10-11 p. m. Sun. 6-7 a. m., 10-11 a. m.</p> <p><b>11991 kc. FZS2</b> -C- 25.02 meters SAIGON, INDO-CHINA Phones Paris, morning</p> <p><b>11950 kc. KKQ</b> -X- 25.10 meters BOLINAS, CALIF. Tests, irregularly, evenings</p> <p><b>11940 kc. FTA</b> -C- 25.13 meters STE. ASSISE, FRANCE Phones CNR morning, Hurlingham, Arge. nights</p> <p><b>11875 kc. FYA</b> -B- 25.25 meters "RADIO COLONIAL" PARIS, FRANCE 11:15 a. m.-2:15 p. m., 3-6 p. m.</p> <p><b>11870 kc. W8XK</b> -B- 25.26 meters WESTINGHOUSE ELECTRIC &amp; MFG. CO., PITTSBURGH, PA. 4:20-10:00 p. m. Sat. till 1 a. m. Relays KDKA</p> <p><b>11860 kc. GSE</b> -B- 25.29 meters BRITISH BROAD CORP. DAVENTRY, ENGLAND See "When to Listen In" Column</p> <p><b>11855 kc. DJP</b> -X- 25.31 meters BROADCASTING HOUSE BERLIN, GERMANY Tests irregularly</p> <p><b>11830 kc. W2XE</b> -B- 25.36 meters ATLANTIC BROADCASTING CORP. 485 MADISON AVE., N. Y. C. 3-5 p. m. Relays WABC</p> <p><b>11811 kc. I2RO</b> -B- 25.4 meters E. I. A. R. Via Montello 5 ROME, ITALY Reported on at 8 a. m.</p> <p><b>11795 kc. DJO</b> -X- 25.43 meters BROADCASTING HOUSE BERLIN, GERMANY Tests irregularly</p> <p><b>11790 kc. W1XAL</b> -B- 25.45 meters BOSTON, MASS. Irregularly in the evening</p> <p><b>11770 kc. DJD</b> -B- 25.49 meters BROADCASTING HOUSE, BERLIN, GERMANY 12-4:30 p. m.</p> <p><b>11750 kc. GSD</b> -B- 25.53 meters BRITISH BROAD CORP. DAVENTRY, ENGLAND See "When to Listen In" Column</p> <p><b>11730 kc. PHI</b> -B- 25.57 meters HUZEN, HOLLAND Daily ex. Tue. &amp; Wed. 8:00-10 a. m.; Sat. till 10:30; Sun. till 11 a. m.</p>	<p><b>11720 kc. CJRX</b> -B- 25.6 meters WINNIPEG, CANADA Daily, 8 p. m.-12 m. Sunday, 3-10:30 p. m.</p> <p><b>11720 kc. FYA</b> -B- 25.6 meters "RADIO COLONIAL" PARIS, FRANCE 7-10 p. m. 11 p. m.-1 a. m.</p> <p><b>11680 kc. KIO</b> -X- 25.68 meters KAHUKU, HAWAII Tests in the evening</p> <p><b>10770 kc. GBP</b> -C- 27.85 meters RUGBY, ENGLAND Calls Sydney, Austral. early a. m.</p> <p><b>10740 kc. JVM</b> -C- 27.93 meters NAZAKI, JAPAN Phones California evenings</p> <p><b>10675 kc. WNB</b> -C- 28.1 meters LAWRENCEVILLE, N. J. Calls Bermuda, daytime</p> <p><b>10660 kc. JVN</b> -C- 28.14 meters NAZAKI, JAPAN Tests 2-7 a. m.</p> <p><b>10550 kc. WOK</b> -C- 28.44 meters LAWRENCEVILLE, N. J. Phones Arge., Braz., Peru. nights</p> <p><b>10520 kc. VLK</b> -C- 28.5 meters SYDNEY, AUSTRALIA Calls Rugby, early a. m.</p> <p><b>10430 kc. YBG</b> -C- 28.76 meters MEDAN, SUMATRA 5:30-6:30 a. m., 7:30-8:30 p. m.</p> <p><b>10420 kc. XGW</b> -C- 28.79 meters SHANGHAI, CHINA Calls Manila and England, 6-9 a. m. and California late evening</p> <p><b>10410 kc. PDK</b> -C- 28.80 meters KOOTWIJK, HOLLAND Calls Java 7:30-9:40 a. m.</p> <p><b>10410 kc. KES</b> -X- 28.80 meters BDLINAS, CALIF. Tests evenings</p> <p><b>10350 kc. LSX</b> -C- 28.98 meters MONTE GRANDE, ARGENTINA Tests irregularly 8 p. m.-12 mid- night. Used in Byrd Broadcasts</p> <p><b>10330 kc. ORK</b> -C- 29.04 meters RUYSELEDE, BELGIUM Broadcasts 2:45-4:15 p. m.</p> <p><b>10300 kc. LSL2</b> -C- 29.13 meters HURLINGHAM, ARGENTINA Calls Europe, evenings</p> <p><b>10290 kc. DIQ</b> -X- 29.16 meters KONIGSWUSTERHAUSEN, GERMANY Broadcasts irregularly</p> <p><b>10260 kc. PMN</b> -C- 29.24 meters BANDUNG, JAVA Calls Australia 5 a. m.</p> <p><b>10250 kv. LSK3</b> -C- 29.27 meters HURLINGHAM, ARGENTINA Calls Europe and U. S., after- noon and evening</p> <p><b>10220 kc. PSH</b> -C- 29.35 meters RIO DE JANEIRO, BRAZIL</p>	<p><b>10055 kc. ZFB</b> -C- 29.84 meters HAMILTON, BERMUDA Phones N. Y. C. daytime</p> <p><b>9950 kc. GCU</b> -C- 30.15 meters RUGBY, ENGLAND Calls N.Y.C. evening</p> <p><b>9890 kc. LSN</b> -C- 30.33 meters HURLINGHAM, ARGENTINA Calls New York, evenings</p> <p><b>9870 kc. WON</b> -C- 30.4 meters LAWRENCEVILLE, N. J. Phones England, evening</p> <p><b>9860 kc. EAQ</b> -B- 30.43 meters P. O. Box 951 MADRID, SPAIN Daily except Saturday, 5:15-7 p. m.; Saturday, 1-3 p. m.; 5:15-7:30 p. m.; Tues., Thurs. and Sun. 5:15-7:30 p. m.</p> <p><b>9840 kc. JYS</b> -X- 30.49 meters KEMIKAWA-CHO, CHIBA- KEN, JAPAN Irregular, 4-7 a. m.</p> <p><b>9800 kc. LSE</b> -C- 30.61 meters MONTE GRANDE, ARGENTINA Tests irregularly</p> <p><b>9790 kc. GCW</b> -C- 30.64 meters RUGBY, ENGLAND Calls N.Y.C., evening</p> <p><b>9780 kc. I2RO</b> -B- 30.67 meters E. I. A. R., ROME, ITALY Daily 2:30-5 or 6 p. m.</p> <p><b>9760 kc. VLJ-VLZ2</b> -C- 30.74 meters AMALGAMATED WIRELESS OF AUSTRALIA SYDNEY, AUSTRALIA Phones Java and N. Zealand early a. m.</p> <p><b>9750 kc. WOF</b> -C- 30.77 meters LAWRENCEVILLE, N. J. Phones England, evening</p> <p><b>9710 kc. GCA</b> -C- 30.89 meters RUGBY, ENGLAND Calls Arge. &amp; Brazil, evenings</p> <p><b>9600 kc. CT1AA</b> -B- 31.25 meters LISBON, PORTUGAL Tues. and Friday, 4:30-7 p. m.</p> <p><b>9595 kc. HBL</b> -B- 31.27 meters LEAGUE OF NATIONS GENEVA, SWITZERLAND Saturdays, 5:30-6:15 p. m.</p> <p><b>9590 kc. VK2ME</b> -B- 31.28 meters AMALGAMATED WIRELESS, LTD., YORK ST. SYDNEY, AUSTRALIA Sundays 1-3, 5-11 a. m.</p> <p><b>9590 kc. PCJ</b> -X- 31.28 meters N.V. PHILIPS' RADIO EINDHOVEN, HOLLAND Broadcasts irregularly</p> <p><b>9590 kc. W3XAU</b> -B- 31.28 meters NEWTOWN SQUARE, PA. Relays WCAU 12 noon-7:50 p. m.</p> <p><b>9580 kc. GSK</b> -B- 31.32 meters BRITISH BROAD CORP. DAVENTRY, ENGLAND See "When to Listen In" Column</p>	<p><b>9580 kc. VK3LR</b> -B- 31.32 meters Research Section, Postmaster Gen'l. Dept., 61 Little Collins St., MELBOURNE, AUSTRALIA 3:15-7:30 a. m. except Sun.</p> <p><b>9570 kc. W1XAZ</b> -B- 31.35 meters WESTINGHOUSE ELECTRIC &amp; MFG. CO., SPRINGFIELD, MASS. Relays WBZ, 7 a. m.-1 a. m.</p> <p><b>9565 kc. VUB</b> -B- 31.36 meters BOMBAY, INDIA 11 a. m.-12:30 p. m., Wed., Sat.</p> <p><b>9560 kc. DJA</b> -B- 31.38 meters BROADCASTING HOUSE, BERLIN 8-11:30 a. m., 5:15-9:15 p. m.</p> <p><b>9540 kc. DJN</b> -B- 31.45 meters BROADCASTING HOUSE BERLIN, GERMANY 3:45-7:15 a. m., 8-11:30 a. m., 5:15-10:45 p. m.</p> <p><b>9540 kc. LKJ1</b> -B- 31.45 meters JELOY, NORWAY Relays Oslo 5-8 a. m.</p> <p><b>9530 kc. W2XAF</b> -B- 31.48 meters GENERAL ELECTRIC CO., SCHENECTADY, N. Y. Relays WGY 6:25-11 p. m. Sundays, 6:25 p. m.-12:30 a. m.</p> <p><b>9510 kc. GSB</b> -B- 31.55 meters BRITISH BROAD CORP. DAVENTRY, ENGLAND See "When to Listen In" Column</p> <p><b>9510 kc. VK3ME</b> -B- 31.55 meters AMALGAMATED WIRELESS, Ltd. G. P. O. Box 1272L MELBOURNE, AUSTRALIA Wed., 5-6:30 a. m.; Saturday, 5:00-7:00 a. m.</p> <p><b>9500 kc. PRF5</b> -B- 31.58 meters RIO DE JANEIRO, BRAZIL Daily except Sun. 5:30-6:15 p. m.</p> <p><b>9428 kc. COH</b> -B- 31.8 meters 2 B ST., VEDADO, HAVANA, CUBA 10-11 a. m., 5-6, 8-9 p. m. also 11 a. m.-12 N. Thurs.</p> <p><b>9415 kc. PLV</b> -C- 31.87 meters BANDONG, JAVA Phones Holland, 7:40-9:40 a. m.</p> <p><b>9330 kc. CJA2</b> -C- 32.15 meters DRUMMONDVILLE, CANADA Phones England irregularly</p> <p><b>9280 kc. GCB</b> -C- 32.33 meters RUGBY, ENGLAND Calls Can. &amp; Egypt, evenings</p> <p><b>9170 kc. WNA</b> -C- 32.72 meters LAWRENCEVILLE, N. J. Phones England, evening</p> <p><b>9020 kc. GCS</b> -C- 33.26 meters RUGBY, ENGLAND Calls N.Y.C., evenings</p> <p><b>8775 kc. PNI</b> -C- 34.19 meters MAKASSER, CELEBES, D. E. I. Phones Java around 4 a. m.</p> <p><b>8760 kc. GCQ</b> -C- 34.25 meters RUGBY, ENGLAND Calls S. Africa, afternoon</p> <p><b>8730 kc. GCI</b> -C- 34.36 meters RUGBY, ENGLAND Calls India, 8 a. m.</p>
--	--	--	--	---

(All Schedules Eastern Standard Time)



<b>8680 kc. GBC</b> -C- 34.56 meters RUGBY, ENGLAND Calls ships	<b>6620 kc. PRADO</b> -B- 45.30 meters RIOBAMBA, ECUADOR Thur. 9-11:30 p. m.	<b>6120 kc. YDA</b> -B- 49.02 meters N.I.R.O.M. BANDONG, JAVA 10:40 p.m.-1:40 a.m., 5:40-9:40 a.m.	<b>6070 kc. VE9CS</b> -B- 49.42 meters VANCOUVER, B. C., CANADA Sun. 1:45-9 p. m., 10:30 p. m.-1 a. m.; Tues. 6-7:30 p. m., 11:30 p. m.-1:30 a. m. Daily 6-7:30 p. m.	<b>5940 kc. TGX</b> -B- 50.5 meters BR. M. NOVALES GUATEMALA CITY, GUAT. Daily except Sun., 8-10 a.m., 1-2:30 p.m., 8 p.m.-12m.
<b>8560 kc. WOO</b> -C- 35.05 meters OCEAN GATE, N. J. Calls ships irregular	<b>6611 kc. RW72</b> -B- 45.38 meters MOSCOW, U. S. S. R. 1-6 p. m.	<b>6120 kc. W2XE</b> -B- 49.02 meters ATLANTIC BROADCASTING CORP., N. Y. C. 485 MADISON AVE., N. Y. C. Relays WABC, 6-11 p. m.	<b>6060 kc. OXY</b> -B- 49.50 meters SKAMLEBOAEK, DENMARK 1-6:30 p. m.; also 11 a. m.-12 n. Sunday	<b>5930 kc. HJ4ABE</b> -B- 50.8 meters MEDELLIN, COLOMBIA Mon., 7-11 p. m.; Tues., Thurs., Sat., 6:30-8:00 p. m.; Wed. and Fri., 7:30-11:00 p. m.
<b>8380 kc. IAC</b> -C- 35.8 meters PIZA, ITALY	<b>6500 kc. HI4D</b> -B- 46.15 meters SANTO DOMINGO DOMINI- CAN REPUBLIC Except Sun. 11:55 a.m.-1:40 p.m.; 4:40-7:40 p.m.	<b>6115 kc. HJ1ABE</b> -B- 49.05 meters CARTAGENA, COL. P. O. Box 31 Daily 11:15 a. m.-1 p. m.; Sun. 9-11 a. m.; Mon. at 10 p. m. Wed., 8-10 p. m.	<b>6060 kc. W8XAL</b> -B- 49.50 meters CROSLY RADIO CORP. CINCINNATI, OHIO 7:30 a. m.-8 p. m.; 11 p. m.-1 a. m. Relays WLW	<b>5853 kc. WOB</b> -C- 51.26 meters LAWRENCEVILLE, N. J. Calls Bermuda, nights
<b>8185 kc. PSK</b> -C- 36.85 meters RID DE JANEIRO, BRAZIL 7-7:30 p. m. irregularly Relays PRA3	<b>6490 kc. HJ5ABD</b> -B- 46.22 meters MANIZALES, COL. 12-1:30 p. m., 7-10 p. m.	<b>6112 kc. YV2RC</b> -B- 49.08 meters CARACAS, VENEZUELA Sun. 1:30-10:30 p. m. Daily except Sun. 11 a. m.-1:30 p. m.; Mon., Thurs., Sat. 4:45-10 p.m.; Tues., Wed., Fri. 4:45-9:30 p.m.	<b>6060 kc. VQ7LO</b> -B- 49.50 meters NAIROBI, KENYA, AFRICA Mon., Wed., Fri., 5:45-6:15 a. m., 11 a. m.-2 p. m. Tues., 3-4 a. m., 11 a. m.-2 p. m. Thurs., 8-9 a. m., 11 a. m.- 2 p. m., Sat., 11 a. m.-3 p. m., Sun., 10:50 a. m.-2 p. m.	<b>5792 kc. OAX4D</b> -B- 51.8 meters RADIO DUSA LIMA, PERU Irregularly 9-11:30 p. m.
<b>8036 kc. CNR</b> -B- 37.33 meters RABAT, MOROCCO Sunday, 2:30-5 p. m.	<b>6447 kc. HJ1ABB</b> -B- 46.53 meters BARRANQUILLA, COL., S. A. P. D. BOX 715. 11:30 a. m.-1 p. m.; 5-10 p. m.	<b>6110 kc. VE9HX</b> -B- 49.10 meters HALIFAX, NOVA SCOTIA 9:30 a. m.-1 p. m.; 6-12 p. m.	<b>6060 kc. W3XAU</b> -B- 49.50 meters NEWTOWN SQUARE, PA. Relays WCAU, Philadelphia 8 p. m.-11 p. m.	<b>5614 kc. HCK</b> -B- 52.5 meters QUITO, ECUADOR, S. A.
<b>7901 kc. LSL</b> -C- 37.97 meters HURLINGHAM, ARGENTINA Calls Brazil, night	<b>6425 kc. W3XL</b> -X- 46.70 meters NATIONAL BROADCASTING CO. BOUND BROOK, N. J. Tests irregularly	<b>6110 kc. VUC</b> -B- 49.1 meters CALCUTA, INDIA Daily except Sat., 3-5:30 a. m., 9:30 a. m.-noon; Sat., 11:45 a. m.-3 p. m.	<b>6050 kc. GSA</b> -B- 49.59 meters BRITISH BROADCAST CORP. DAVENTRY, ENGLAND See "When To Listen In" Col.	<b>5660 kc. HJ5ABC</b> -B- 53 meters CALI, COLOMBIA 11 a. m.-12 N. Tues. and Thurs. 8-10 p. m. Sun. 12 N.-1 p. m.
<b>7880 kc. JYR</b> -B- 38.07 meters KEMIKAWA-CHO, CHIBA- KEN, JAPAN 4-7:40 a. m.	<b>6375 kc. YV4RC</b> -B- 47.06 meters CARACAS VENEZUELA 7:30-9:30 p. m.	<b>6100 kc. HJ1ABD</b> -B- 49.18 meters CARTAGENA, COL. 11:30 a. m.-12:30 p. m.; 7-9 p. m.	<b>6040 kc. W1XAL</b> -B- 49.67 meters BOSTON, MASS. Tues., Thurs., Sun. 7:30-9 p. m.	<b>5077 kc. WCN</b> -C- 59.08 meters LAWRENCEVILLE, N. J. Phones England irregularly
<b>7799 kc. HBP</b> -B- 38.47 meters LEAGUE OF NATIONS GENEVA SWITZERLAND 5:30-6:15 p. m., Saturday	<b>6316 kc. HIZ</b> -B- 47.5 meters SANTO DOMINGO DOMINICAN REPUBLIC Daily except Sat. and Sun. 4:40-5:40 p. m.; Sat., 9:40- 11:40 p. m.; Sun., 11:40 a. m.-1:40 p. m.	<b>6100 kc. W3XAL</b> -B- 49.18 meters NATIONAL BROADCASTING CO. BOUND BROOK, N. J. Relays WJZ Monday, Wednesday, Saturday, 5:30 p. m.-1 a. m.	<b>6040 kc. YDB</b> -B- 49.67 meters N.I.R.O.M. SOERABAJA, JAVA 10:40 p.m.-1:40 a.m., 5:40-9:40 a.m.	<b>5025 kc. ZFA</b> -C- 58.7 meters HAMILTON, BERMUDE Calls U.S.A., nights
<b>7400 kc. HJ3ABD</b> -B- 40.54 meters P. O. Box 509 BOGOTA, COLOMBIA Daily 12-2 p. m.; 7-11 p. m. Sunday, 5-9 p. m.	<b>6272 kc. HI1A</b> -B- 47.84 meters P. D. BOX 243, SANTIAGO, DOMINICAN REP. 11:40 a. m.-1:40 p. m. 7:40-9:40 p. m.	<b>6100 kc. W9XF</b> -B- 49.18 meters DOWNERS GROVE, ILL. Relays WENR, Chicago Daily except Mon. Wed. & Sat., 2:30 p. m.-2 a. m.	<b>6025 kc. HP5B</b> -B- 49.81 meters P. O. BOX 910 PANAMA CITY, PAN. 10 p.m.-12:15 a.m. irregularly	<b>4975 kc. GBC</b> -C- 60.30 meters RUGBY, ENGLAND Calls Ships, late at night
<b>7220 kc. HKE</b> -B- 41.55 meters BOGOTA, COL. S. A. Tue. and Sat. 8-9 p. m.; Mon. & Thurs. 6:30-7 p. m.	<b>6175 kc. HJ2ABA</b> -B- 48.58 meters TUNJA, COLOMBIA 1-2; 7:30-9:30 p.m.	<b>6095 kc. VE9GW</b> -B- 49.22 meters BOWMANVILLE, ONTARIO, CANADA Sun. 1-9 p. m.-12 m. Mon.-Wed., 3 p. m.-12 m. Thurs.-Sat., 7 a. m.-12 m.	<b>6020 kc. DJC</b> -B- 49.83 meters BROADCASTING HOUSE, BERLIN 12 N.-4:30 p.m., 5:30-10:30 p. m.	<b>4820 kc. GDW</b> -C- 62.24 meters RUGBY, ENGLAND Calls N.Y.C., late at night
<b>7140 kc. HJ4ABB</b> -B- 42.02 meters MANIZALES, COL., S. A. P. O. Box 175 Mon. to Fri. 12:15-1 p. m.; Tues. & Fri. 7:30-10 p. m.; Sun. 2:30-5 p. m.	<b>6160 kc. YV3RC</b> -B- 48.7 meters CARACAS, VENEZUELA Generally 4:00-10:00 p. m.	<b>6090 kc. VE9BJ</b> -B- 49.26 meters SAINT JOHN, N. B., CAN. 7-8:30 p. m.	<b>6012 kc. ZHI</b> -B- 49.9 meters RADIO SERVICE CO., 20 ORCHARD RD., SINGAPORE, MALAYA Mon., Wed., Thurs., 5:40-8:10 a. m.; Sat., 12:10-1:10 a. m., 10:40 p. m.-1:10 a. m. (Sunday)	<b>4752 kc. WOO</b> -C- 63.1 meters OCEAN GATE, N. J. Calls ships irregularly
<b>6905 kc. GDS</b> -C- 43.45 meters RUGBY, ENGLAND Calls N.Y.C. evening	<b>6150 kc. CJRO</b> -B- 48.78 meters WINNIPEG, MAN., CANADA 8 p. m.-12 m. Sun. 3-10:30 p. m.	<b>6085 kc. I2RO</b> -B- 49.3 meters E.I.A.R. Via Montello 5, ROME, ITALY Mon., Wed., Fri., 6-7:30 p. m.	<b>6010 kc. COC</b> -B- 49.92 meters P. O. BOX 98 HAVANA, CUBA Daily 9:30-11 a.m., 4-6 p.m. Sat. also at 11:30 p.m.	<b>4320 kc. GDB</b> -C- 69.44 meters RUGBY, ENGLAND Tests, 8-11 p. m.
<b>6860 kc. KEL</b> -X- 43.70 meters BOLINAS, CALIF. Tests Irregularly	<b>6140 kc. W8XK</b> -B- 48.86 meters WESTINGHOUSE ELECTRIC & MFG. CO. PITTSBURGH, PA. Relays KDKA 4:30 p. m.-1 a. m.	<b>6080 kc. CP5</b> -B- 49.34 meters LAPAZ, BOLIVIA 7-10:30 p. m.	<b>6005 kc. VE9DN</b> -B- 49.96 meters MONTREAL, CAN. Saturday 11:30 p.m.-12:30 a.m.	<b>4273 kc. RW15</b> -B- 70.20 meters KHABAROVSK, SIBERIA, U. S. S. R. Daily, 3-9 a. m.
<b>6800 kc. HIH</b> -B- 44.12 meters SAN PEDRO DE MACDRIS DOMINICAN REP. 4-7:30 p. m.	<b>6130 kc. ZGE</b> -B- 48.92 meters KUALA LUMPUR, FED. MALAY STATES Sun., Tue., and Fri., 6:40-8:40 a. m.	<b>6080 kc. W9XAA</b> -B- 49.34 meters CHICAGO FEDERATION OF LABOR CHICAGO, ILL. Relays WCFL Sunday 11:30 a. m.-9 p. m. and Thurs., Thurs., Sat., 4 p. m.-12 m.	<b>6000 kc. RW59</b> -B- 50 meters MOSCOW, U. S. S. R. Daily 3-6 p.m.	<b>4272 kc. WOO</b> -C- 70.22 meters OCEAN GATE, N. J. Calls ships irregularly
<b>6755 kc. WOA</b> -C- 44.41 meters LAWRENCEVILLE, N. J. Phones England, evening	<b>6128 kc. LKJ1</b> -B- 48.94 meters JELOY, NORWAY Relays Oslo, 10 a.m.-6 p.m.	<b>6079 kc. DJM</b> -X- 49.35 meters BROADCASTING HOUSE BERLIN, GERMANY Tests Irregularly	<b>5980 kc. HIX</b> -B- 50.17 meters SANTO DOMINGO, DOMINI- CAN REP. Tues. and Fri. at 8:10 p.m.	<b>4107 kc. HCJB</b> -B- 73 meters QUITO, ECUADOR 7:14-10:15 p. m., except Monday
<b>6750 kc. JVT</b> -X- 44.44 meters NAZAKI, JAPAN Relays JOAK, Tokio 2-7:45 a.m.	<b>6666 kc. HC2RL</b> -B- 45.00 meters P. O. BOX 759, CUAYAQUIL, ECUADOR, S. A. Sunday, 5:45-7:45 p. m. Tues., 9:15-11:15 p. m.	<b>6072 kc. OER2</b> -B- 49.41 meters VIENNA, AUSTRIA 9 a. m.-5 p. m. daily	<b>5970 kc. HJ2ABC</b> -B- 50.27 meters CUCUTA, COL. 11 a. m.-12 n.; 6-9 p. m.	<b>4098 kc. WND</b> -C- 73.21 meters HIALEAH, FLORIDA Calls Bahama Isles
<b>6660 kc. TIEP</b> -B- 45.05 meters LA-VOZ DEL TROPICO SAN JOSE, COSTA RICA APARTADO 257, Daily 7-10 p.m.	<b>6650 kc. IAC</b> -C- 45.1 meters PIZA, ITALY Calls ships, evenings		<b>5968 kc. HVJ</b> -B- 50.27 meters VATICAN CITY (RDME) 2-2:15 p. m., daily, Sun., 5:53:30 a. m.	<b>3600 kc. CT2AJ</b> -B- 83.5 meters PDNTA DELGADA, SAO MIGUEL, AZORES Wed. and Sat. 5-7 p. m.

(All Schedules Eastern Standard Time)

# Television Stations

2000-2100 kc.

W2XDR—Long Island City, N.Y.  
W8XAN—Jackson, Mich.  
W9XX—Iowa City, Ia.  
W9XAK—Manhattan, Kansas.  
W9XAO—Chicago, Ill.  
W6XAH—Bakersfield, Calif.

2750-2850 kc.

W3XAK—Portable  
W9XAP—Chicago, Ill.

W2XBS—Bellmore, N.Y.  
W6XS—Los Angeles, Calif.  
W9XAL—Kansas City, Mo.  
W9XG—W. Lafayette, Ind.  
W2XAB—New York, N.Y.

42000-56000, 60000-86000 kc.

W2XAX—New York, N.Y.  
W6XAO—Los Angeles, Calif.  
W9XD—Milwaukee, Wis.  
W2XBT—Portable  
W2XF—New York, N.Y.

W3XE—Philadelphia, Pa.  
W3XAD—Camden, N. J.  
W10XX—Portable & Mobile (Vicinity of  
Camden)

W2XDR—Long Island City, N.Y.  
W8XAN—Jackson, Mich.  
W9XE—Chicago, Ill.  
W9XAT—Portable  
W2XD—New York, N.Y.  
W2XAG—Portable  
W1XG—Boston, Mass.

# Police Radio Alarm Stations

CGZ	Vancouver, B.C.	2452 kc.	KGZU	Lincoln, Neb.	2490 kc.	WPEN	Woonsocket, R.I.	2466 kc.
CJW	St. Johns, N.B.	2416 kc.	KGZW	Lubbock, Tex.	2458 kc.	WPEP	Arlington, Mass.	1712 kc.
CJZ	Verdean, Que.	2452 kc.	KGZX	Albuquerque, N.Mex.	2414 kc.	WPES	Saginaw, Mich.	2442 kc.
KGHG	Las Vegas, Nev.	2474 kc.	KGZY	San Bernardino, Cal.	1712 kc.	WPET	Lexington, Ky.	1706 kc.
KGHK	Palo Alto, Cal.	1674 kc.	KMFE	Duluth, Minn.	2382 kc.	WPEW	Northampton, Mass.	1666 kc.
KGHM	Reno, Nev.	2474 kc.	KSW	Berkeley, Cal.	1658 kc.	WPIA	Newton, Mass.	1712 kc.
KGHO	Des Moines, Iowa	1682 kc.	KVP	Dallas, Tex.	1712 kc.	WPFC	Muskegon, Mich.	2442 kc.
KGHX	Santa Ana, Cal.	2430 kc.	VYR	Montreal, Can.	1712 kc.	WPFK	Reading, Pa.	2442 kc.
KGHY	Whittier, Cal.	1712 kc.	VYW	Winnipeg, Man.	2452 kc.	WPIF	Jacksonville, Fla.	2442 kc.
KGHZ	Little Rock, Ark.	2406 kc.	WCK	Belle Island, Mich.	2414 kc.	WPII	Baltimore, Md.	2414 kc.
KGJX	Pasadena, Cal.	1712 kc.	WEY	Boston, Mass.	1558 kc.	WPIJ	Columbus, Ga.	2414 kc.
KGLX	Albuquerque, N.M.	2414 kc.	WKDT	Detroit, Mich.	1558 kc.	WPIK	Hammond, Ind.	1712 kc.
KGOZ	Cedar Rapids, Iowa	2466 kc.	WKDU	Cincinnati, Ohio	1706 kc.	WPIJ	Hackensack, N.J.	2430 kc.
KGPA	Seattle, Wash.	2414 kc.	WMDZ	Indianapolis, Ind.	2442 kc.	WPIJ	Gary, Ind.	2470 kc.
KGPC	St. Louis, Mo.	1706 kc.	WMFP	Niagara Falls, N. Y.	2422 kc.	WPIJ	Birmingham, Ala.	2382 kc.
KGPD	San Francisco, Cal.	1674 kc.	WMJ	Buffalo, N.Y.	2422 kc.	WPIJ	Fairhaven, Mass.	1712 kc.
KGPE	Kansas City, Mo.	2422 kc.	WMO	Highland Park, Mich.	2414 kc.	WPIJ	Knoxville, Tenn.	2474 kc.
KGPG	Vallejo, Cal.	2422 kc.	WMP	Framingham, Mass.	1666 kc.	WPIJ	Clarkshurg, W. Va.	2490 kc.
KGPH	Oklahoma City, Okla.	2450 kc.	WPPA	Tulare, Cal.	2414 kc.	WPIJ	Swathmore, Pa.	2474 kc.
KGPI	Omaha, Neb.	2466 kc.	WPDB	Chicago, Ill.	1712 kc.	WPIJ	Johnson City, Tenn.	2470 kc.
KGPI	Beaumont, Tex.	1712 kc.	WPDC	Chicago, Ill.	1712 kc.	WPIJ	Asheville, N.C.	2474 kc.
KGPK	Sioux City, Iowa	2466 kc.	WPDD	Chicago, Ill.	1712 kc.	WPIJ	Portland, Me.	2422 kc.
KGPL	Los Angeles, Cal.	1712 kc.	WPDE	Louisville, Ky.	2442 kc.	WPIJ	Pawtucket, R.I.	2466 kc.
KGPM	San Jose, Cal.	1674 kc.	WPDE	Flint, Mich.	2466 kc.	WPIJ	Palm Beach, Fla.	2442 kc.
KGPN	Davenport, Iowa	2466 kc.	WPDE	Youngstown, Ohio	2458 kc.	WPIJ	Miami, Fla.	2442 kc.
KGPO	Tulsa, Okla.	2450 kc.	WPDI	Richmond, Ind.	2442 kc.	WPGA	Bay City, Mich.	2466 kc.
KGPP	Portland, Ore.	2442 kc.	WPDI	Columbus, Ohio	2430 kc.	WPGA	Port Huron, Mich.	2466 kc.
KGPP	Honolulu, T.H.	2450 kc.	WPDK	Milwaukee, Wis.	2450 kc.	WPGC	S. Schenectady, N.Y.	1658 kc.
KGPR	Minneapolis, Minn.	2430 kc.	WPDL	Lansing, Mich.	2442 kc.	WPGD	Rockford, Ill.	2458 kc.
KGPS	Bakersfield, Cal.	2414 kc.	WPDN	Dayton, Ohio	2430 kc.	WPGF	Providence, R.I.	1712 kc.
KGPW	Salt Lake City, Utah	2406 kc.	WPDN	Auburn, N.Y.	2382 kc.	WPGG	Findlay, Ohio	1596 kc.
KGPX	Denver, Colo.	2442 kc.	WPDN	Akron, Ohio	2458 kc.	WPGH	Albany, N.Y.	2414 kc.
KGPY	Baton Rouge, La.	1574 kc.	WPDO	Philadelphia, Pa.	2474 kc.	WPGI	Portsmouth, Ohio	2430 kc.
KGZ	Wichita, Kans.	2450 kc.	WPDR	Rochester, N.Y.	2382 kc.	WPGJ	Utica, N.Y.	2414 kc.
KGZA	Fresno, Calif.	2414 kc.	WPDS	St. Paul, Minn.	2430 kc.	WPGK	Cranston, R.I.	2466 kc.
KGZB	Houston, Tex.	1712 kc.	WPDT	Kokomo, Ind.	2490 kc.	WPLG	Binghamton, N.Y.	2442 kc.
KGZC	Topeka, Kans.	2422 kc.	WPDU	Pittsburgh, Pa.	1712 kc.	WPGN	South Bend, Ind.	2490 kc.
KGZD	San Diego, Cal.	2490 kc.	WPDV	Charlotte, N.C.	2458 kc.	WPGO	Huntington, N.Y.	2490 kc.
KGZE	San Antonio, Tex.	2482 kc.	WPDW	Washington, D.C.	2422 kc.	WPGP	Columbus, Ohio	1596 kc.
KGZF	Chanute, Kans.	2450 kc.	WPDX	Detroit, Mich.	2414 kc.	WPGS	Mincola, N.Y.	2490 kc.
KGZG	Des Moines, Iowa	2466 kc.	WPDY	Atlanta, Ga.	2414 kc.	WPGT	New Castle, Pa.	2470 kc.
KGZH	Klamath Falls, Ore.	2382 kc.	WPDZ	Fort Wayne Ind.	2490 kc.	WPGU	Boston, Mass.	1712 kc.
KGZI	Wichita Falls, Tex.	2458 kc.	WPEA	Syracuse, N.Y.	2382 kc.	WPGW	Mobile, Ala.	2382 kc.
KGZJ	Phoenix, Ariz.	2430 kc.	WPEB	Grand Rapids, Mich.	2442 kc.	WPGX	Worcester, Mass.	2466 kc.
KGZL	Shreveport, La.	1712 kc.	WPEC	Memphis, Tenn.	2466 kc.	WPHC	Massilon, O.	1596 kc.
KGZM	El Paso, Tex.	2414 kc.	WPEE	Arlington, Mass.	1712 kc.	WPHD	Steubenville, O.	2458 kc.
KGZN	Tacoma, Wash.	2414 kc.	WPEE	New York, N.Y.	2450 kc.	WPHF	Richmond, Va.	2450 kc.
KGZO	Santa Barbara, Cal.	2414 kc.	WPEF	New York, N.Y.	2450 kc.	WPHI	Charleston, W. Va.	2490 kc.
KGZP	Coffeyville, Kans.	2450 kc.	WPEG	New York, N.Y.	2450 kc.	WPHK	Wilmington, O.	1596 kc.
KGZQ	Waco, Tex.	1712 kc.	WPEH	Somerville, Mass.	1712 kc.	WRBH	Cleveland, Ohio	2458 kc.
KGZR	Salem, Ore.	2442 kc.	WPEI	E. Providence, R.I.	1712 kc.	WRDQ	Toledo, Ohio	2474 kc.
KGZS	McAlester, Okla.	2458 kc.	WPEK	New Orleans, La.	2430 kc.	WRDR	GrossePt.Village, Mich.	2414 kc.
KGZT	Santa Cruz, Cal.	1674 kc.	WPEL	W. Bridgewater, Mass.	1666 kc.	WRDS	E. Lansing, Mich.	1666 kc.

## When to Listen In

By M. Harvey Gernsback

### Berlin

● The German stations are at present making considerable changes in their schedules on the first of each month. The program service to the Far East and to Central America is being considerably improved. The January schedule (the latest at hand) follows: 12:30-2 a.m. on DJB, 19.74 met. (meters) and DJQ, 19.63 met. (for Asia and Australia); 3:45-7:15 a.m. on DJB and DJN, 31.45 met. (for Australia and New Zealand); 8:11-30 a.m. on DJA, 31.38 met. and DJN (for Western Asia and Australia); 12 n.-4:30 p.m. on DJD, 25.49 met. and DJC, 49.83 met. (for Africa); 5:15-9:15 p.m. on DJA (for South America); 5:15-10:30 p.m. on DJN (for Central

America); 5:30-10:30 p.m. on DJC (for North America). It is noteworthy that DJQ is now in regular service and DJD has changed its wavelength slightly. It was formerly 25.51 met. (11760 kc.). It now is 25.49 met. (11770 kc.). This change was made in order to reduce interference between DJD and Daventry GSD on 25.53 met. (11750 kc.). DJE on 16.89 met. has been heard operating irregularly during the last month from 8-11:30 a.m. sending the same program as DJA and DJN.

### Daventry

The February schedule for Daventry is as follows: Trans (Transmission) 1 on GSD and GSB from 3-5 a.m. (till Feb. 17),

2:15-4:15 a.m. after Feb. 17; Trans. 2 on GSE and GSF daily (except Sunday) from 6-7:30 a.m.; every day on GSF and GSE from 7:30-9 a.m.; Trans. 3 on GSE and GSB from 9:15-10:45 a.m., on GSB and GSA from 10:45 a.m.-12:15 p.m., on GSA and either GSD or GSB from 12:15-12:45 p.m.; Trans. 4 on GSD and GSB from 1-4:30 p.m., and on GSA and GSB from 4:30-5:45 p.m.; Trans. 5 on GSC and GSA from 6-8 p.m.

### Rome

Rome is now engaged in changing call letters, the 49.3 met. transmitter sending an American program from 6-7:30 in the evening, was first called IRA but it is now (Continued on page 690)

# SHORT WAVE LEAGUE



## HONORARY MEMBERS

Dr. Lee de Forest  
 John L. Reinartz  
 D. E. Replogle  
 Hollis Baird  
 E. T. Somerset  
 Baron Manfred von Ardenne  
 Hugo Gernsback  
*Executive Secretary*

## An Ex-Ham's Opinion of "No-Code" Test

From An Ex-Ham

Editor, SHORT WAVE CRAFT:

In regard to the *No Code Test* for a license below 6 meter phone or any phone "rigs," I find it is all "baloney" anyway. I have never heard of such selfishness from persons professing loyalty to the art of Radio Amateurs, by opposing such a thing when it could not possibly harm anyone on account of the short distance you are able to work on 5 meters. Most of those opposing the *No Code below 6 Meters* have no intention of working below 10 meters, anyway.

I was one of those who signed the first petition to have our Government control the Amateurs, on account of the terrible QRM (interference) some were causing by putting 5 kw. (5,000 watts) on the air for "playing" purposes only, rather than "getting down to business." At that time there was no intention on the part of those signing the petition that there should be any examination of any kind.

The main purpose was to stop any unnecessary interference. Certain parties who would like to get rid of the Hams, have pulled strings with those who have been put in charge by the President. They, not knowing anything about wireless, were easily convinced that the Hams should pass an examination, so the examination for the Hams each year is being made harder. If you Hams cannot read the "hand-writing on the wall" you better quit squabbling or it won't be long before there won't be any more Hams.

THOS. J. P. SHANNON, *Ex-Ham*,  
 (formerly GQG),  
 6232 S. Alamo Blvd., Bell, Calif.

### Why a Code Test? Says This "Amateur Operator"

Editor, SHORT WAVE CRAFT:

As a reader of the SHORT WAVE CRAFT magazine and also an amateur radio op-

erator, believe that any short-wave or radio "fan" that desires to become an amateur radio broadcaster on the phone band of only five or ten meters, should not be forced to pass a code test for the reason that he does not want or care to use code. I know what a stumbling block it was for me to pass a code test of only ten words per minute. I don't mind any theoretical questions on radio but when it comes to the code part, I feel tuff. Hi, Hi. HERSHEL TALBOT WALTON, 711 Wyoming Avenue, East Liverpool, Ohio.

### Code Must Stay, He Says

Editor, SHORT WAVE CRAFT:

I sincerely believe, and and so do many others, that all this argumentation on this "codeless phone license" below 6 meters is entirely foolish. Why should any one with a phone transmitter clutter up a useful and already crowded band? Why shouldn't they pass a slow code exam. and thus be eligible? Why, there's nothing to learning code, once you set your mind upon it. And also, I believe that the exam. should be kept very stiff to prevent "hobbyists" from crowding this band. And how could the fellows who are actually trying to do something with radio do anything, when there are a lot of fellows that have been "thrown together" and chewing the rag with their friends and causing a lot of unnecessary QRM? Such Hams as these should and MUST be kept off the air! Radio isn't a *plaything*. It's a very serious and grave business for fellows who are sincere in their ambitions.

I am not a Ham yet, but I know my code throughout; plus of course the "Q" signals. By this summer I expect to pass the exam. and have my own code transmitter.

Wishing your magazine continued success, I remain,

Sincerely yours,  
 ALVIN C. SIEGLER,  
 73 Elwood Street,  
 New York City.

### "Code Will Never Die," He Says

Editor, SHORT WAVE CRAFT:

I have read all the letters in the SHORT WAVE LEAGUE page for the past few months and the best to date was Mr. Worcester's. I do not think the mathematical part was



## Short Wave League

At a Directors Meeting held in New York City, New York, in the United States of America, the Short Wave League has elected

John F. Müller

a member of this League

In Witness whereof, this certificate has been officially signed and presented to the above.

*H. W. Secor*  
 Club Secretary

This is the handsome certificate that is presented FREE to all members of the SHORT WAVE LEAGUE. The full size is 7 1/4" x 9 1/2".

See page 700 how to obtain certificate.

## Get Your Button

The illustration herewith shows the beautiful design of the "Official" Short Wave League button, which is available to everyone who becomes a member of the Short Wave League.

The requirements for joining the League are explained in a booklet, copies of which will be mailed upon request. The button measures 3/4 inch in diameter and is inlaid in enamel—3 colors—red, white, and blue.



Please note that you can order your button AT ONCE—SHORT WAVE LEAGUE supplies it at cost, the price, including the mailing, being 35 cents. A solid gold button is furnished for \$2.00 prepaid. Address all communications to SHORT WAVE LEAGUE, 99-101 Hudson St., New York.

very important, but the few pertinent facts he stated were. The mathematical part was pure theory (to which I adhere closely) and is merely meeting extremes.

As my contribution to the "festivities" I will attempt to answer herein every letter published in the July issue. My repudiations are as follows:

When in letter No. 1 J. B. F. asks as to the whereabouts of broadcasting, if it were not for the help of amateur radio-telephony, I counter: Where would radio-telephony be if code transmission were not developed first. J. B. F. should remember that we first had to progress in voice transmission, before we even thought of television.

Approaching letter No. 2 which remarks about "selfish" Hams, I will refer J. O. R. to *Radio-Craft* for the month of June, wherein the author of the article on page 725 states that if a person has enough interest and sufficient determination to master a 20 W. P. M. speed in code, he will un-

(Continued on page 699)

# Short Wave

## AMPLIFIER FOR CLIP COIL TWO

Homer Nibel, Gowrie, Iowa.  
 (Q) Will you please publish a diagram of a 33 screen-grid pentode audio amplifier which can be added to the *Clip Coil Two* in order that I may operate a loud-speaker.  
 (A) We are very pleased to print the circuit of the 33 power amplifier which you can add to "Clip Coil Two." The terminals marked "input" on the amplifier should be

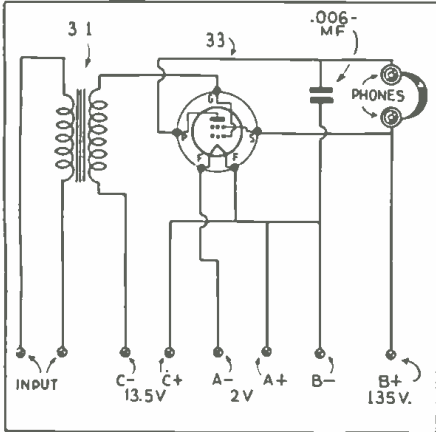

One stage audio amplifier.

connected to the phone posts of the "Clip Coil Two." Do not forget to use the .006 mf. condenser in the plate circuit of the 33.

## 5 ALL-ELECTRIC S.W. SET

P. S. Paoli, Charlottetown, P.E.I., Canada.  
 (Q) Would you be kind enough to publish a diagram of a complete A.C.-operated receiver; also coil data. This should use a 58 tuned R.F. stage and 57 regenerative detector resistance coupled to a 56 audio amplifier and a 2A5 transformer coupled power amplifier with a 280 rectifier.  
 (A) This 5-tube short-wave A.C. set will give full loud-speaker volume on any of the short-wave stations and we advise that our readers save this diagram for future reference. If the two tuning condensers are "ganged," then a 35 mmf. con-

denser should be connected in parallel with the tuning condenser of the R.F. stage for trimming and keeping the stages in resonance. Coil data will be found in the July 1934 "Question Box."

## OLD BATTERY SETS FOR S.W.'s

Fred E. Smyser, York, Pa.  
 (Q) Would you kindly advise me where I could secure several detailed 5-tube S.W. receiver hookups, using different types of tubes?  
 I have recently acquired several battery-operated long-wave receivers out of which I can salvage quite a few of the necessary parts to build such a set. Several years ago I constructed the "Globe Trotter" S.W. receiver from your *SHORT WAVE CRAFT* magazine, for a few dollars, using parts out of L.W. sets and it worked beautifully, bringing in stations from all parts of the world! It required quite a bit of experimenting with various home-wound coils and so forth, but eventually did the trick. Along with one of the L.W. receivers I acquired 5-201 tubes. Is it advisable to use these tubes in a S.W. receiver? If so I would appreciate a hookup using this particular type of tube.

(A) We have had many reports from readers who have constructed short-wave sets using parts from old broadcast receivers and some of them have had fine results; however, about the only parts which can be used in the receiver are the fixed condensers, resistances, and transformers. The tuning condensers can be remodeled, of course, by removing some of the plates. We do not recommend that you rebuild a broadcast (200 to 550 meters) receiver nor adapt it to short-wave reception; we would rather suggest that you select a suitable circuit from the various issues of *SHORT WAVE CRAFT* and use as many parts from your broadcast set as possible. 201A tubes can be used, although after they have given years of service in the broadcast receiver, we do not believe that they would be of much value for short-wave work.

## AUDIO AMPLIFIER FOR 3-TUBE DX'er

H. Gee, Victoria, B.C., Canada.  
 (Q) Will you please publish a diagram

## EDITED BY GEORGE

Because the amount of work involved in the drawing of diagrams and the compilation of data, we are forced to charge 25c each for letters that are answered directly through the mail. This fee includes only hand-drawn schematic drawings. We cannot furnish "picture-layouts" or "full-sized" working drawings. Letters not accompanied by 25c will be answered in turn on this page. The 25c remit-

showing how I may hook another 56 audio amplifier to the "3-tube DX'er that hauls

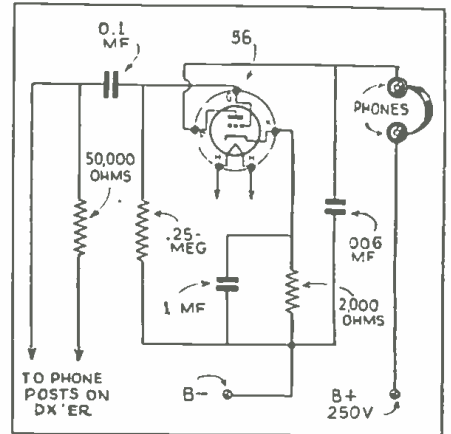

56 Audio amplifier for DX'er.

'em in," shown on page 18 of the May 1933 issue. I would like to use a 56 tube for this purpose.

(A) On this page you will find printed a circuit diagram of the 56 audio amplifier with resistance coupling. The two input terminals should be connected to the phone terminals of the "DX'er."

## COIL DATA

Bob Brokop, Winnipeg, Man.  
 (Q) I would like to have some information regarding the construction of plug-in coils for the receiver described on page 68

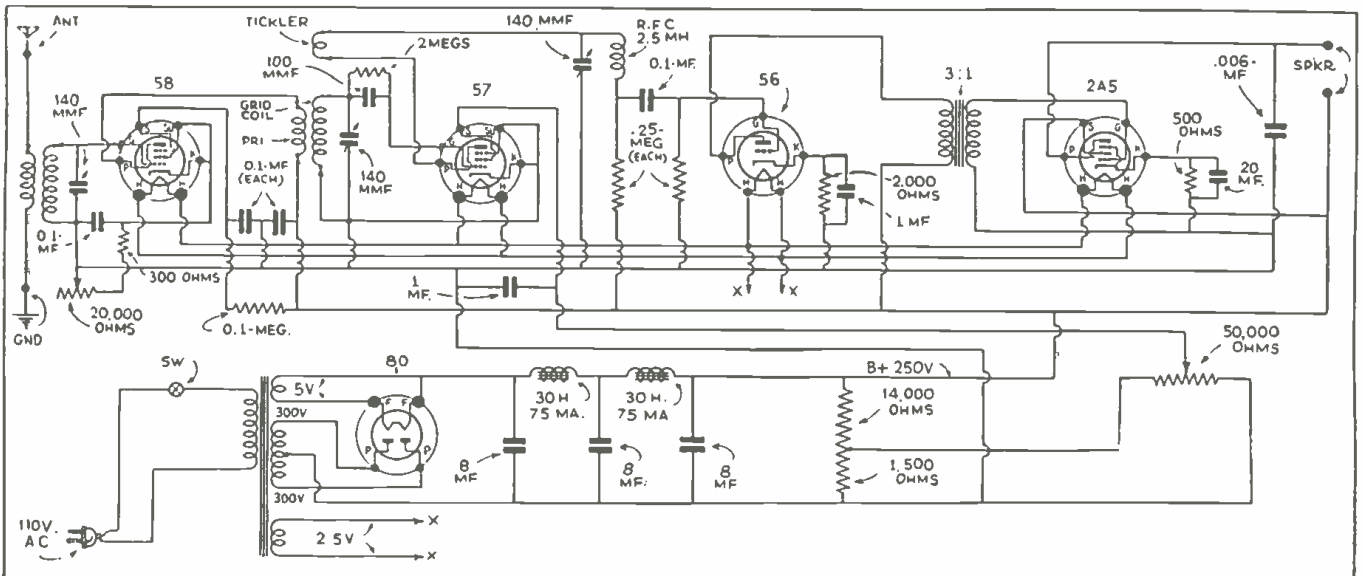

5-tube All-Electric Short-Wave Receiver.

# QUESTION BOX

## W. SHUART, W2AMN

tance may be made in the form of stamps or coin.

Special problems involving considerable research will be quoted upon request. We cannot offer opinions as to the relative merits of commercial instruments.

Correspondents are requested to write or print their names and addresses clearly. Hundreds of letters remain unanswered because of incomplete or illegible addresses.

of the book called, "How to Build and Operate S.W. Receivers."

(A) In the July 1934 QUESTION BOX, we published complete data regarding the construction of plug-in coils of both the 4- and 6-prong variety. A physical drawing was given, showing the method of winding, together with the size of wire and number of turns.

## FREQUENCY METER

Robert T. Smith, Sac City, Iowa.

(Q) I wish to build a compact frequency meter and would like to have you print a diagram of one which should be preferably electron-coupled to obtain greater stability. Also, I would like to have you use 2-volt tubes and as low "B" voltage as possible also give the coil specifications for 1750 kc.

(A) The new type 15-battery type tube which has an indirectly heated cathode offers a distinct advantage in building a battery-operated frequency meter. This tube requires two volts for the heater and a current of .22 amperes. We show a suitable

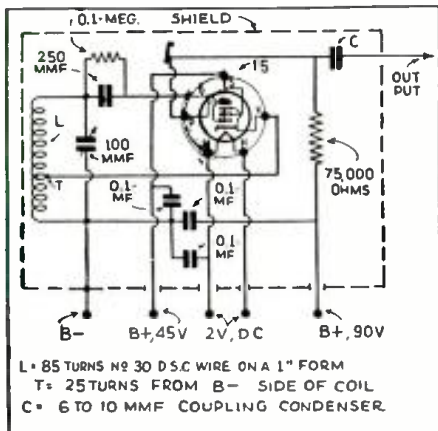

"Ham" frequency meter.

circuit together with the coil specifications. The entire instrument should be mounted inside a metal shield box.

## MODERN TRANSMITTER

Roy Pitzer, Georgetown, Ohio.

(Q) I would like to have complete data on a modern transmitter for an amateur station which I hope to own soon.

(A) In this issue you will find Part 1 of a series of articles, covering the design of modern low-power amateur transmitters.

## CODE RECORDER

J. Hackett, Philadelphia Pa.

(Q) I can copy code up to 20 words, but as most hams sound a bit faster, I have for some time tried to make an apparatus to print the code on a slip of paper telegraph tape, but I have so far been unsuccessful. My main trouble lies in making a device that will take the current, coming from the last amplifier and relay it

so it has enough strength to work the arm of the printer. In my despair I turn to you to give me some suggestions, which I would appreciate very much—maybe other readers would be interested too.

(A) In order to have a relay or any other mechanical instrument operate from the output of a power amplifier, it is necessary to bias the power amplifier tube sufficiently to bring the plate current to zero when no signal is applied to the grid. A signal will then cause plate current to flow and this fluctuation can be utilized to operate the recording device.

A lot of fellows have merely amplified the incoming signal to a great extent and

## 3-TUBE A.C. SET

Jack Capps, Chicago, Ill.

(Q) I would be very pleased to have you publish a diagram of a 3-tube short-wave receiver, using a 24 regenerative detector, a 27 first audio amplifier and a 45 output amplifier. I would also like to have coil data.

(A) A 3-tube receiver such as you mentioned in your letter should give excellent results and we are printing the diagram which uses a 24 detector, 27 first audio amplifier, and a 45 power amplifier. Standard values are used and coil data will be found in the July 1934 "Question Box."

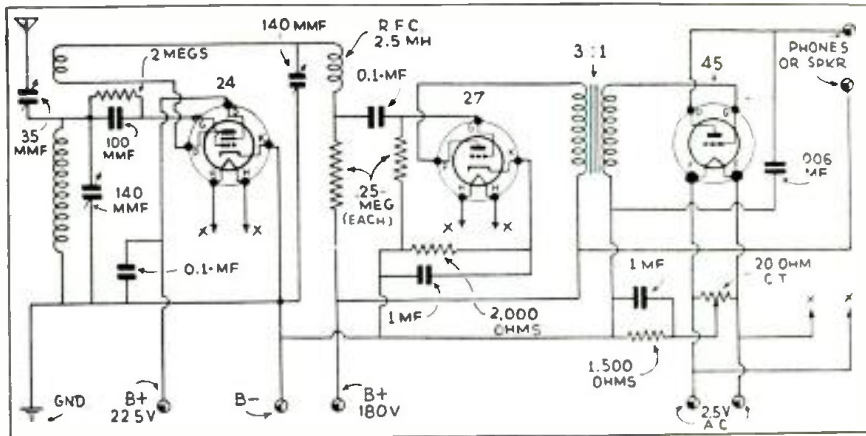

3-Tube A.C. Short-Wave Hook-Up.

then coupled some sort of recording device or relay in place of the phones or loud-speaker. With the output amplifier tube normally biased, the plate current will be practically constant regardless of the signal strength, and this will not work.

## ELECTRON COUPLED DETECTOR

Harold Johnson, North Plainfield, N.J.

(Q) Please publish a circuit for a 3-tube receiver using a 58 untuned amplifier. I want to control the amplification of the R.F. tube by varying the bias of the R.F. tube.

(A) We are printing your diagram using an electron-coupled detector together with an untuned stage, the volume is controlled with a variable resistor in the cathode circuit of the 58. This should make a very fine receiver; of course a tuned R.F. stage would give much better results than the untuned stage.

## VOLTAGE DIVIDER PROBLEM

L. W. Parrish, Scranton, Pa.

(Q) I have built the power-supply unit described by Mr. Victor on page 221 of the August 1934 issue of SHORT WAVE CRAFT. Is it possible to secure various intermediate voltages with this power supply? For instance such as B+250; B+180; B+135, etc. If it is possible to secure above voltage values from Mr. Victor's Power-Pack, will you please print a diagram of such an arrangement, showing value of parts to be used and the method of hooking them up?

(A) We suggest that you obtain a voltage divider having a total resistance of approximately 15,000 ohms, with variable sliders, the number of which would depend on the different voltages you wished to secure. The Electrad Company manufacture a unit on which any number of slide-s can be fastened; this should serve very nicely.

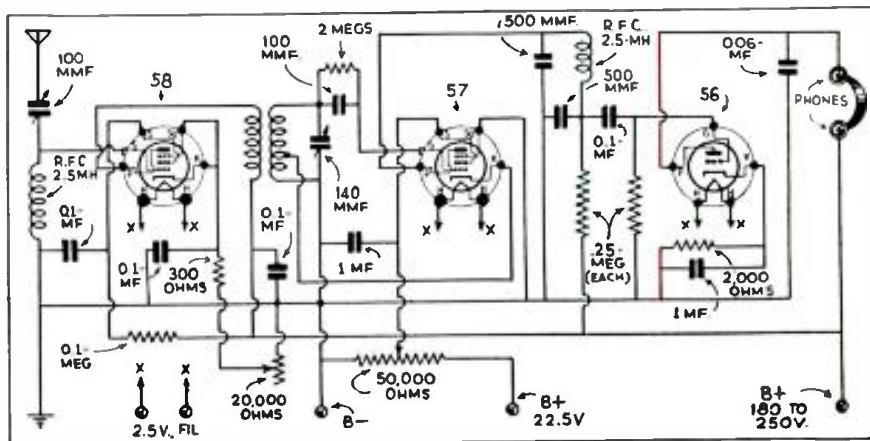

3-Tube Receiver with an electron coupled detector.

# LOW-POWER Rack & Panel Xmitter

By GEORGE W. SHUART, W2AMN.

First of a Series Describing Construction of High-Class "Ham" Transmitter



General appearance of the finished Rack and Panel Transmitter, the first unit of which is here described.

● THIS is the first of a series of articles which will describe a complete ham station transmitter. This transmitter will be up-to-date in every respect, except that it will not be high power, which, incidentally, is not what we would call a ham transmitter. High power outfits, such as some of the hams are using, belong in the commercial field and not in



Front view of the oscillator-amplifier, which includes crystal control. This will serve as an exciter unit for the finished transmitter.

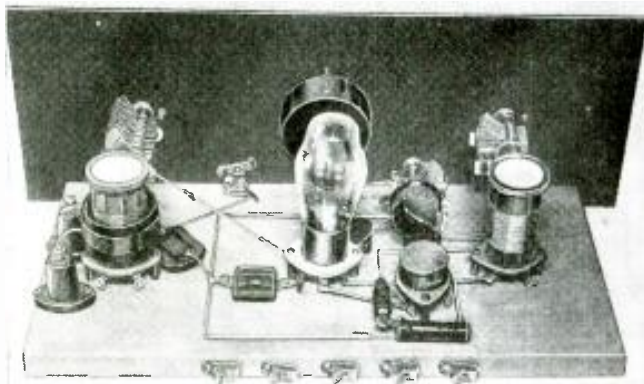

Rear view of the 1-tube oscillator-amplifier.

the ham bands! At any rate, that's the way we feel about it.

The transmitter in question will be described in progressive form, any unit of which can be built or added whenever you like. The unit described in this installment is primarily the exciter unit, but it can be used as a low-power crystal-controlled transmitter. Each unit, as this one is, will be built on a 7x19 inch bakelite panel in order that it will fit a standard steel rack in case the reader wishes to obtain one. There will be four units to the whole transmitter. The others, besides this one, are the power supply, an amplifier to be used as the output stage, and a suitable modulator and its power supply. All these in the finished transmitter will be mounted on a neat and easy to build wood frame. The frame and its construction will also be covered thoroughly in another article.

The unit shown in the pictures is a 1-tube oscillator-amplifier affair using what has been named the "Les-Tet" circuit, and recently introduced by Frank Lester, W2AMJ.

The tube used is a 2B6 which consists of two triodes in (Continued on page 692)

## "LONG LINES" Xmitter With 800's

● SINCE the description of the "Long Lines" ultra high frequency transmitter in the October issue of this magazine, we have had innumerable requests for more dope regarding the construction and tuning. Many of the "Boys" who have a "yen" for high power have asked why we haven't used tubes such as the 800's or the 304A's. The truth of the matter is that we have been using 800's for three or four months and obtaining excellent results. The transmitter referred to is shown in the photographs and will be described in detail.

### What Is "Long Lines" Oscillator?

For those less familiar with the subject it may be a good idea to explain just what we mean by a "Long Lines" oscillator. It consists merely of adjusting the length of two copper pipes which are placed fairly close together, so that they, together with the tube elements and leads, will resonate at the

desired frequency. The advantage of a circuit of this type is that greater stability can be obtained with very high plate efficiency. The line is constructed so that the spacing between the pipes is equal to the diameter of the pipes; this seems to be the best all-round adjustment. One of these lines is used in the plate and one in the grid circuit of a push-pull oscillator.

The material used in building this transmitter is one-half inch copper pipe—not tubing! The difference being that the pipe is hard drawn and straight while the tubing is flexible and not so straight.

Right away it will be seen that there is need of a fairly sturdy base, if we expect this outfit to "stand on its own feet." The base of this one is made of wood stock, one and one-quarter inch thick. This base is 13 inches long and 8 inches wide. On this base there are mounted two 2 3/4 x 4 1/2 x 1 1/4 inch uprights. These are for supporting the long copper pipes and it is necessary that they be doweled to the base plate with 3/8 inch dowels. Follow the drawing and use plenty of glue if you want a solid job. In order to fasten (Continued on page 691)

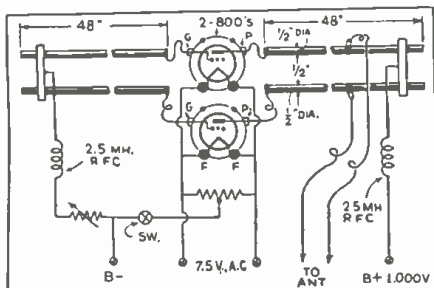

Left—Wiring diagram of the copper tubes, also the vacuum tube, etc., for the "Long-Lines" Transmitter here described by Mr. Shuart.

Right—Close-up view of the base of the "Long-Lines" Transmitter; it employs two 800-type tubes.

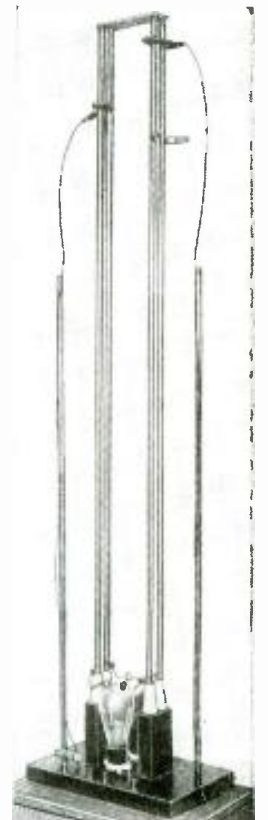

Highly efficient "Long-Lines" oscillator.

### Japan S-W Phone

(Continued from page 646)

continues to the antenna and is sent winging its way 5,130 miles across the vast Pacific to the receiving station at Point Reyes, Calif.

Let us follow the path of the incoming phone talk from Japan; after it has been received at Point Reyes, it is transmitted over a wire telephone circuit to the Telephone Building in San Francisco. From this point the telephone currents pass out over regular telephone circuits to the town or city of the United States, Canada, Cuba, or Mexico, to which the connection is made. If the conversation is with a telephone subscriber in San Francisco, he talks through his local switchboard, which in turn connects with the overseas operator's switchboard and thence with the overseas technical control board, both of which are in the Telephone Company building in San Francisco. If the American telephone subscriber is at a point other than San Francisco, then the voice currents are suitably amplified by the vacuum tube repeater stations located at regular intervals along the telephone line to the cities concerned. These repeaters or amplifiers are usually located in telephone exchange buildings in the various cities.

The route of the telephone conversation from a point in America to Japan is interesting: It passes over the usual telephone circuit to Frisco, being suitably amplified at regular intervals along the wire line as required. The voice passes through the technical operator's control board in San Francisco and then passes on to the short-wave transmitter located at Dixon, where it is radiated in the form of short waves, 18 to 45 meters in length, depending on the season and the time of day, etc., on its way to Japan.

Of particular interest to our readers was the entertaining program recently broadcast from Japan over the Columbia Broadcasting System. Those in this country who heard it were undoubtedly astonished at the clearness of the voices and music from Japan. They sounded just like those from a local station. Incidentally, one of the short-wave transmitters located at Naza-ki is used by the Japanese for broadcasting regular short-wave programs at a certain time each day.

When WABC and about 60 other broadcast stations of the 90 stations in the CBS System broadcast the program from Japan at 5 p.m. on Dec. 8 (it was then 7 a.m. in the morning of the next day in Japan) the incoming music and voice currents from Japan came over the Transcontinental telephone line through San Francisco, Denver to Chicago. Here it was fed to station WBBM the CBS broadcast station located at Chicago, and thence to other stations connected to the telephone lines constituting the Columbia network, which broadcast the program to and from Japan. The program from America, comprising music and a talk, originated in the Columbia Studios at 485 Madison Avenue, New York City. It is interesting to note that the main control boards for the Columbia as well as the NBC network, are located in the "Long Distance" building at 32 Sixth Avenue, these switch boards being under the supervision of the experts of the "Long Lines Department" of the A.T.&T. Company.

When the program from Japan was heard by American listeners on the date mentioned, the incoming voice and music was received at the control board of the Telephone Company at Chicago; thence it passed over a private telephone (leased) line to Station WBBM and simultaneously over the telephone lines that form the Columbia network. It is interesting to note that, at this point, two rebroadcasts occurred on short waves, one from W2XE, the short-wave transmitter associated with WABC, and the short-wave transmitter W3AU, associated with the Philadelphia CBS Station WCAU.

## WORLD ACCLAIMED!

OUT ONLY THREE SHORT MONTHS AND BREAKING EVERY RECORD FOR DISTANT AND LOUD RECEPTION!

ALREADY—HUNDREDS OF LETTERS FROM FANS EVERYWHERE, ATTESTING TO THE RELIABILITY OF THE FULTONE V.

RECEIVED CONSISTENTLY ON THE LOUD SPEAKER—RUSSIA, JAPAN, AUSTRALIA, FRANCE, ENGLAND, SPAIN, GERMANY,—AND OF COURSE AMATEURS THE WORLD OVER!

SEND FOR YOUR FULTONE V TODAY!

Complete kit including all necessary parts, crystal finished metal chassis with all holes drilled, 4 coils tuning 15-200 meters, and complete easily followed instructions.....

\$12<sup>75</sup>

**SPECIAL COMBINATION OFFER**  
Complete kit, tubes, speaker, cabinet and broadcast coils.  
(Wired and Tested add—\$1.25)

Set of Matched Sylvania Tubes.....\$2.20  
Metal Cabinet, as illustrated.....1.25  
Special Loudspeaker.....1.45  
Two Broadcast Band Coils.....1.25

**\$7<sup>45</sup>**

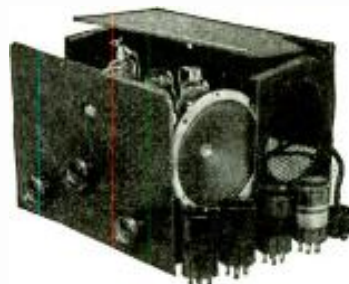

## FULTONE V FIVE-IN-THREE

All Electric—AC—DC—6F7—76—12A7

### A Mighty Mite!!



### The FULTONE "DUETTE" ALL-ELECTRIC TWO-IN-ONE

2 1/2 pounds complete  
A powerful handful of radio that will surprise you with its volume and reception ability. European S.W. Broadcast stations are easily picked up with excellent headphone volume! Uses the new two-in-one type 12A7 Tube! High gain pentode detector and power rectifier. A real, powerful

two tube receiver! This set is certainly no toy. Small enough to fit in the palm of the hand! Very very inexpensive! Yet—the Fultone "Duette" has features found only in much higher priced receivers—

Smooth acting friction drive variable dial—Quiet regeneration control—Built-in power supply, providing all voltages needed (Set turns into any 105 to 130 volt AC or DC house line)—Line noise and hum filter—Power switch—Attractive, durable metal chassis and cabinet—Complete coverage from 15 to 625 meters (It gets everything!) Easy construction kit includes all necessary parts, drilled chassis and cabinet, 15 to 200 meters Sylvania 12A7 tube.....\$4.45  
Complete Kit, tube, and BC coils.....\$1.95  
Sylvania 12A7 tube.....\$1.25

**SPECIAL COMBINATION OFFER \$6.25**

Complete Kit, tube, and BC coils.....\$6.25

**FULTONE "DUETTE" BATTERY MODEL**

Use the new type 19 tube—two separate tubes in one bulb! Detector and one stage audio amplifier. Economical operation on two dry cells and one or two B batteries.

Complete easy construction kit, as above.....\$3.75

**COMBINATION OFFER \$5.50**

Complete Kit, tube, and BC coils.....\$5.50

### ACCESSORIES

Neat black crystal finished metal cabinet with hinged lid for the 12,500 Mile receiver. Fits two tubes, coils, and wiring from damage and dust.....\$1.00

Set of two broadcast band coils for any of the sets described above. Tune from 200 to 625 meters. Enable you to hear all the regular broadcast stations and the long wave ship and press transmissions merely by plugging in these coils. Make your set a real All-Wave Receiver.....\$1.25

AC Power Pack for AC model. Delivers 250 volts and 2 1/2 volts. Also excellent for amplifier or transmitter. Complete kit \$3.45

Speak free light weight Headphones 2000 Ohms \$1.05 \$4.00 ohms \$1.45  
Complete Antenna kit—includes antenna wire, lead-in wire, insulators, ground clamp, knobs, etc.....75c

### THE HARRISON ORIGINAL 12,500 MILE TWO TUBE SETS



Here's the set that everyone is talking about! We have sold thousands since we first introduced this excellent receiver over two years ago. Every S.W. station in the world has been received with these sets!

The remarkable performance, neat appearance, and low cost make this the outstanding value today! No skimping! The finest parts throughout!

Heavy chassis—audio transformer—four coils 15 to 200 meters—variable dial—modern, eminent design. The simplicity of construction and ease of operation make it the ideal Beginner's Set!

Battery Model uses two type 30 tubes and inexpensive long life dry batteries.

AC Model uses two 27 or 56 tubes. **\$4<sup>45</sup>**

Either Model COMPLETE KIT—Set of two Sylvania Tubes—\$1.10

### AC-DC ALL-ELECTRIC MODEL

The world famous Harrison 12,500 mile set with a built-in hum free power pack supplying all necessary heater and plate voltages. Entirely self-contained! No batteries! Just plug into the 110 volt house line. Complete kit including drilled metal chassis, all parts, and clear picture diagrams. **\$5<sup>95</sup>**



Set of three matched Sylvania tubes. \$1.50.

Any Kit on this page Assembled—Wired—and Tested. **\$1<sup>25</sup>**

**HARRISON RADIO CO.** Dept. C-3 New York City  
142 Liberty Street  
★ ★ THE HOME OF FOUR STAR SERVICE ★ ★

SEND FOR THIS **FREE CATALOG**

Check full of BARGAINS in RADIO SETS, Long and Short Wave, Apparatus, Servicemen's Repair and Replacement Parts, Electrical Appliances and hundreds of miscellaneous specials at TREMENDOUS SAVINGS.

Get this big new Bargain Book. It's absolutely FREE without obligation—just send us your Name and Address on a post card

WRITE FOR YOUR COPY NOW.

**JUST OFF THE PRESS**

**RADIO CIRCULAR CO., INC.**  
225 SW VARICK ST., NEW YORK

### HOW TO LEARN CODE

Thousands of operators across no system of printed sheets can teach you the Code. TELEPLEX has taught Code to more operators in past 10 years than all other methods combined. YOU can learn Code—or step up your w.p.m. amazingly—this surer way. No experience needed. Beginners, amateurs, experienced ops get ahead faster with Teleplex. It doesn't merely "show" you code—it IS Code! You actually HEAR dot-dash as you spend you want. Send us training messages and SENDS BACK your own key work, which no other system can do.

For quicker license find out about this better way used by U. S. Army, Navy, R. C. A., A. T. & T. and many others. We give you complete course, lend all equipment, give personal service on MONEY-BACK GUARANTEE. Low cost, easy terms. Without obligation, write for booklet S. 27.

**TELEPLEX COMPANY**  
76 Cortlandt Street New York, N. Y.

Please mention SHORT WAVE CRAFT when writing advertisers

**ALLIED RADIO** Presents the new **RCA ACR 136 COMMUNICATIONS RECEIVER**



**FOR "DX" RECEPTION!**

The ideal receiver for the Amateur and the DX Short Wave (and Broadcast Band) listener. The ACR-136 is a seven tube All-Wave Superhet covering 10-50 meters (530-18,000 K.C.). It is packed with attractive features: built-in crystal frequency discriminator, true A.V.C., front panel band switching, independent band spread system, and separate r.f. and a.f. gain controls. Has low image-frequency response, and high signal-to-noise ratio. Exceptionally good fidelity and far unusual selectivity. Has separate band oscillator switch for copying code signals. Speaker is built-in and jack is provided on front panel for phones, automatically muting speaker. Circuit is built around the famous RCA "Magic Brain". Easy to tune. Comes complete with built-in power supply and tubes at an outstanding low price. Write for FREE descriptive bulletin and quotation.

**SEND FOR FREE BULLETIN!**

**FREE Radio's Leading CATALOG**

Send for your copy of the complete 1935 ALLIED Radio Catalog—the most valuable book in Radio, packed with Set-Building Kits, Short Wave Transmitting and Receiving gear, All-Wave, Dual Wave and Short Wave sets; Sound Equipment; Test Apparatus; thousands of parts, etc. Write now!

**BUILD YOUR OWN ALL-STAR JR. ALL-WAVE Superheterodyne**

Build the new lower-priced ALL-STAR ALL-WAVE JR. (Tunes 10-550 meters. A great 5 tube Superhet that can be assembled at an amazing low price. Features Band-spread tuning, world-wide reception, pre-adjusted coils, heat-noise oscillator, excellent tone quality, etc. Easy to build. ALL-STAR is first with the Foundation Kit at \$2.25. Send for our FREE ALL-STAR JR. Wiring Diagram and Parts List.

**ALLIED RADIO CORPORATION**

833 W. JACKSON BLVD., CHICAGO, ILL. Dept. E.

Please send me:  
 FREE RCA-ACR 136 Bulletin.  
 FREE ALL-STAR JR. Diagram & Parts List.  
 FREE 1935 ALLIED CATALOG.

Name.....  
 Address.....  
 City..... State.....

**S-W Scout News**

(Continued from page 658)

**SHORT-WAVE LOG—TIME IS EASTERN STANDARD**

Date	Time	Call	W. L.	Location	Remarks
Nov 30	6.40				
30	7.30	GSA	40.50	Daventry, Eng	Very Loud and Clear
30	8.00	DJC	49.83	Zoswen, Ger	Exceptionally Loud and Clear
30	8.10	HJ1ABH	46.53	Bargela, Cal	Very Weak for Post Week
30	8.20	CFC	49.92	Havana, Cuba	Fair Faded a Lot
30	8.30	YV4RC	50.25	Caracas, Ven	Very Weak
30	8.40	W1XAZ	31.34	Spring Mass.	Could Just be Heard
Dec 1	5.00	IRO	30.67	Rome, Italy	Could Just be Understood
1	5.10	GSB	31.55	Daventry, Eng	Could be Heard. Very Choppy
1	5.15	COH	31.80	Havana, Cuba	Very Loud
1	5.20	HRL	31.27	Genoa, Italy	Came in Fair
1	7.10	L8X	28.98	Buenos Aires, Arg.	Special Program Very Choppy
1	7.20	TIEP	44.75	San Jose, C.R.	Very Loud. Some Static
1	7.40	HJ3ABC	49.27	Caracas, Cal	Very Loud but Faded
3	8.10	COH	31.80	Havana, Cuba	Very Loud, Slight Fading
3	11.20	WON	30.4	Lawville, N.J.	Testing with New York
3	9.40				
3	9.50	HJY	16.5	Bogota, Col	Working CEC
4	10.40	COH	31.80	Havana, Cuba	Very Loud. W1XAZ Very Weak
6	1.40	KKP	18.25	Koblenz, Hsw in	Very Loud. Working KWO
6	1.30	KWO	19.40	Dixon, Cal	Very Loud. Working KKP
6	1.45	W8NK	19.72	Pittsburgh, Pa	Could Just be Heard
6	7.05	DJC	49.83	Zoswen, Ger	Very Loud. First Eve. Heard this Week. Exceptional Intensity
8	7.30	HJ1ABH	46.53	Bargela, Cal	Very Loud
8	7.35	YV2RC	49.08	Caracas, Ven	Best of Come in for Some Time
8	7.40	GSA	40.50	Daventry, Eng	Exceptionally Loud
8	7.50	HJC	41.83	Zoswen, Ger	Very Very Loud and Clear
8	7.55	YV5RMO	50.25	Maracaibo, Ven.	Highly New Wave Length All Bands Very Poor
9	3.00	IRO	30.67	Rome, Italy	Loud, but Faded
10	0.50	HJ1ABH	46.53	Bargela, Cal.	Very Very Loud
10	7.00	DJC GSA	49.83	Zoswen, Ger	All Come in Good
10	7.15	HJ3ABF	47.81	Bogota, Col	Very Loud. But Faded Quite a Bit
10	7.25	IRA	49.20	Rome, Italy	Loud but Address Good Quality. Address America Home. Via Montreal, S. Rome, Italy.
11	10.20	COH	31.80	Havana, Cuba	Very Good
11	10.40	GSB	25.3	Daventry, Eng	Very Loud. Test Program
11	6.40				
11	5.00	CTIAA	31.25	London, Port.	Very Good
11	5.00	IRO	30.67	Rome, Italy	Came in Fair. All Afternoon
11	7.00	GSA	40.50	Daventry, Eng	Very Good. S. A. and Europe Good signals
12	8.15	GSB	25.1	Daventry, Eng	Very Loud. Test Program
12	10.00	HJB	20.07	Bogota, Col	Working W.C.
13	0.10	FYA	25.25	Paris, France	Came in Good
13	1.10	GSB	25.51	Daventry, Eng	Very Loud
13	1.20	GSB	31.55	Daventry, Eng.	Could Just be Understood
13	1.30	HJA	31.48	Zoswen, Ger	Very Loud. Understood
14	7.30	IRA			Loud. Very Poor. DJC Only Clear Station
14	7.40	HJ1ABH	42.92	Manados, Cal	Very Loud. But Faded Quite a Bit
16	11.20	DFR	19.50	Nauen, Ger.	Very Loud. Working W.C.
16	12.00	WCC	28.80	New York	Very Loud. Working
16	12.25	HQZ	29.15	kg. Wuster, Ger.	Very Loud. Working
16	12.30	HJD	25.50	Zoswen, Ger.	Very Loud. Working W.C.
16	5.30	IRO	30.67	Rome, Italy	Very Loud. But Faded Fast
17	8.05	HJ1ABH	40.51	Bogota, Col	Very Good
17	7.20	IRA	49.20	Rome, Italy	Very Loud. But Bad Hum Distorted
17	7.30	GSA	40.50	Daventry, Eng	Clear, but Weak
17	7.45	HJC	41.83	Zoswen, Ger	Very Loud and Clear
17	7.50	YV2RC	50.90	Maracaibo, Ven.	Very Loud
17	8.40	CFC	49.92	Havana, Cuba	Very Loud
17	8.45	W1XAZ	49.87	Boston, Mass.	Tested. Loud. But Faded
18	1.15	KWO	19.40	Dixon, Cal.	Working KKP
18	1.35	FIA	25.13	St. Asmer, France	Working N. Y. and Boston Area
18	1.45	FYA	25.25	Paris, France	Very Loud and Clear
18	1.55	G8D	25.23	Daventry, Eng.	Excellent. Loud
18	2.40	GSB	31.55	Daventry, Eng.	Loudest Heard for Some Time
18	2.55	HJK	29.04	kg. Wuster, Ger	Could Just be Understood
18	3.35	HQZ	29.15	kg. Wuster, Ger	Very Good

**Harold Hansen's Report**

As the month of December is here and the temperature has dropped, I find short wave reception here in the Middle West very good. There is little or no static and the "foreigners" come rolling in with good volume, especially the South American stations, which are heard here better than at any time since last January.

Those heard here nearly every night are: TIEP, HJ1ABH, XERT, HJ3ABF, YV4RC and YV2RC. HC2RL and PRADO are heard very well at their respective times.

The European stations are coming in fairly good on the 19-meter band. But the 25- and 31-meter bands are not so good.

Even the eastern U.S. stations fade out on this band at this time of the year here.

The Big Australians—VK2ME, VK3ME and VK3LR—are coming in fair, at present. JVT on 44 meters at Nazaki, Japan, is coming in with good volume.

A verification from I2RO, which I reported as IRA last month, states they are on 30.67 meters and 49.3 meters.

CFU, CFN and CFO, the network of stations owned by the Consolidated Mining and Smelting Co., of Rossland, B.C., Columbia, Canada, may be heard almost nightly

**FREE PARTS LIST**

**Data—Schematic**  
**BUILD YOUR OWN**  
**ALL-STAR JR**  
**ALL-WAVE Superheterodyne**

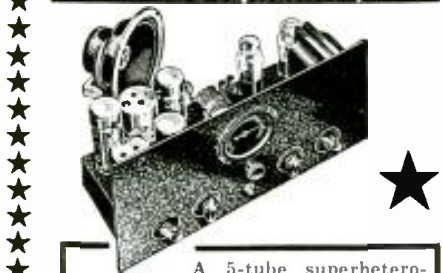

A 5-tube superheterodyne, all-wave receiver capable of world-wide radio reception. Its range is from 10 to 550 meters. Sponsored by 11 world-famous manufacturers of radio equipment.

Kit of Parts.....\$27.50  
 Oxford 6" speaker..... 2.50  
 Sylvania Tubes..... 3.95

Send for 1935 184-page Radio Catalog.

**TRY-MO RADIO CO., INC.**

85 S Cortland St., New York City. 179 S Greenwich St., New York City.

**FREE CIRCUIT DIAGRAM AND PARTS LIST**

**BUILD YOUR OWN**  
**ALL-STAR JR**  
**ALL-WAVE Superheterodyne**

**Build the Latest Radio Sensation**

We furnish all necessary information How to start, continue and complete the job. We can make immediate delivery of all parts shown on list.

**W. H. EDWARDS & CO.**

32 BROADWAY Dept. S. PROVIDENCE, R. I.

**Let GROSS Supply You With FREE CIRCUIT DIAGRAMS AND PARTS LIST FOR**

**BUILD YOUR OWN**  
**ALL-STAR JR**  
**ALL-WAVE Superheterodyne**

**SHORT WAVE RADIO'S NEWEST SENSATION**

All Star Super Kit. Prompt deliveries. Write for prices.

**GROSS RADIO, INC.**  
 51 VESEY STREET (Dept. C) NEW YORK CITY

**Phila. Headquarters**

**BUILD YOUR OWN**  
**ALL-STAR JR**  
**ALL-WAVE Superheterodyne**

**Short-Wave Receiver Kit**

Tour the Globe—Build this receiver now from the exact specified kit of parts as designed by the country's leading Short Wave Engineers.

Write in for your copy of our New 1935 Catalog —Everything New, with an exclusive showing of the latest in

**CUSTOM-BUILT SHORT-WAVE RECEIVERS**

Name.....SW  
 Address.....  
 City..... State.....

**M. & H. SPORTING GOODS CO., 512 Market St., Phila., Pa.**

Please mention SHORT WAVE CRAFT when writing advertisers



# HERE

Is the Place to Buy



Here's the Little Brother to the famous ALL STAR! It costs much less to build but it's a Giant in performance. Even a novice can build it! The most amazing All-Wave superhet ever developed for home construction.

**NOTE THESE FEATURES:**

- Latest 5 tube circuit with multi-purpose tubes.
- Continuous Band Spread.
- All-Wave Reception from 10-550 meters.
- Pre-Adjusted Coils.
- Beat Note Oscillator.
- Complete Kit of Parts, less tubes and speaker.

**\$27<sup>03</sup>**



**FREE**

Circuit diagram, parts list and data sheet at once. Free lesson. Foundation Unit, general technical, plenty drilled front and sub-board and other information. Address: Peoria, Ill. 61601.

**WHOLESALE RADIO SERVICE CO.**  
NEW YORK ATLANTA  
100 Sixth Avenue 430 W. Peachtree St. N.W.  
Local Branch 219 Central Ave., Newark, New Jersey.



Prompt Delivery

We carry the following amateur lines:

- |            |                  |
|------------|------------------|
| RCA        | Aerovox          |
| National   | Cornell Dubilier |
| Hammarlund | Ohmite           |
| Thordarson | Yasley           |
| ICA        | Stancor          |

**KLAUS RADIO & ELECTRIC CO.**

707 Main St. Peoria, Ill. Amateur Radio Dept.

**FREE CIRCUIT DIAGRAM AND PARTS LIST**



**RECEIVER**

Send For Free Catalog

**Radio Electric Service Co.**

N.E. Cor. 7th & Arch Sts. Phila., Pa.  
811 Federal St., Camden, N. J.

**ONE CENT A DAY PAYS UP TO \$100.00 A MONTH**

The Sterling Casualty Insurance Co., 2561 Insurance Center Bldg., Chicago, Ill., is offering a NEW accident policy that covers every accident. Pays up to \$100 a month for 24 months for disability, and \$1,000 for death for 1c a day—only \$3.65 a year. A NEW policy issued by an OLD company that has already paid more than \$175,000.00 in cash benefits. Open to any one, ages 10 to 70, without doctor's examination. They will send you a policy for 10 days' FREE inspection. Send no money. Just mail them your age and beneficiary's name and relationship. This offer is limited. Write today.—Advertisement.

working each other and occasionally re-broadcasting a long-wave program.—Harold W. Hansen, Rt. 5, Box 169, Omaha, Nebr.

**O. L. P. Report from Edward Schmeichel**

The 19-meter band has been very good. The French, German, English, Dutch, stations have been received with excellent volume and quality. RKL, Moscow, can be heard every Saturday morning between 7-10 a.m. E.S.T., with remarkable volume. Try for them.

The 25-meter band has been quite hazy this month. No special DX catches on this band. Between 25 meters and 31 meters, stations can be heard that are often heard in this part of the U.S. Between midnight and 6 a.m. stations can be heard from the "Far East" with exceptionally good volume.

On the 31-meter band COH, Cuba, reaches this post with R-9 volume.

CT1AA can be heard very loudly every Tuesday and Friday between 5 and 6 p.m.

PRF5 has now abandoned its music shyness and is radiating musical programs.

The 49-meter band has been the best at this post. On this band a new station is identified almost every evening. Among them are:

TIEP—44.71 mtrs. or 6.71 megs. Send a beautiful oil-painted verification card and a personal letter with a seal from the company which sponsors the program.

HI4D—46.25 mtrs. or 6.48 megs. is heard between HJ1ABB and HJ5ABB and HJ5ABD at 5 and 8 p.m., E.S.T.

HIX—50.17 mtrs. or 5.98 megs. is heard very clear and loud since moving on this new wavelength. They formerly were on 49.50 mtrs.

YV4RC—47.19 mtrs. or 6.37 megs. is received with tremendous volume since moving to this wavelength. They were formerly on 50.28 mtrs.

YV5RMO—51.28 meters or 5.85 megs. is heard every night regardless of weather since moving to this wave.

HI1A—47.80 meters or 6.23 megs. has increased its power to 50 watts and is received clearly every night. They send a new card.

YDA—49.02 meters or 6.12 megs. can be received on a clear, cold night quite well. They can be easily identified because they spell out the words and announce in English.

RV15—70.65 meters or 4.25 megs. is again reaching the U.S. with fair volume. This station is in Siberia and broadcasts between 2-6 a.m., E.S.T. They usually fade out around 5 a.m.

HI2ABA—48.60 meters or 6.17 megs. is received each night between 6-10 p.m. Quite loud since moving to their new wavelength.

OR2—49.42 meters or 6.07 megs. was heard Dec. 26 with good volume at 2 p.m., E.S.T.

OXY—49.40 meters or 6.07 megs. was heard Dec. 17 sending a "test program" to the U.S. They were playing music about 2 hours, while calling Rocky Point, N.Y.—Edward E. Schmeichel, Chicago, Ill.

**Report of Heinie Johnson, SHORT WAVE CRAFT'S Official Dial Twister "Down in Texas"**

● THE "49-ers" again are the center of interest, but this time it's world-wide short-wave stations and not California gold rushes. Between 40 meters and 55 meters are the stations referred to and quite properly since these bands are so closely related in seasonable activity. It's a good plan to concentrate on this bunch of signals in the winter months if you want to fully realize the beauty of the programs sent out over these frequencies. Russia, Germany, England, China, Japan and South American countries galore are to be found there. And we want to rave over the rare quality of YDA, the NIROM signal from Java, that is now to be heard almost daily between daylight and 9 a.m., central standard time on 49.02 meters.

(Continued on page 698)



**for World-Wide Reception 10 to 550 meters or 30 m. c. to 5.15 k. c.**

Easy to build—splendid performance

Sponsored by 11 Prominent Radio Parts Manufacturers: Belden, Cornell-Dubilier, Crowe, Electrad, Erie, Hammarlund, Meissner, Oak, Ohmite, Oxford and Thordarson . . .

**Sensational Design!**

A truly professional communication receiver that can be readily assembled without the use of special tools or test equipment. A soldering iron, screw-driver, and pliers are all you need to build the ALL-STAR JUNIOR.



**CONTINUOUS BAND SPREAD**—over the entire tuning range makes possible the separation of hundreds of stations that are jammed together at a single spot on the ordinary receiver dial.

**BEAT-NOTE OSCILLATOR**—using the new 6F7 tube, brings in DX carrier waves inaudible on any other short wave receiver.

**SUPERHETERODYNE CIRCUIT**—Five tubes in the latest design; does the work of 7 tubes!

**PRE-ADJUSTED I. F. COILS**—Tuned at the factory to 370 k.c. No adjustment required.

**ALL ELECTRIC**—For 110-120 volt, 60 cycle, standard A. C. house current.

**STANDARD PARTS**—Ask your radio dealer or jobber for the ALL-STAR JUNIOR Foundation Unit that includes drilled sub and front panels, enlarged drawings of wiring and pictorial diagrams, three step assembly, and all instructions. Start with the Foundation Unit. Buy the remaining parts as you need them. For further information send for the

**FREE Circuit Diagram and Parts List!**



**ALL STAR HEADQUARTERS**  
360 N. Michigan Ave., Chicago, Ill.

Name \_\_\_\_\_  
Address \_\_\_\_\_

# 10 Tube S-W Super-Het and Pre-Amplifier

(Continued from page 655)

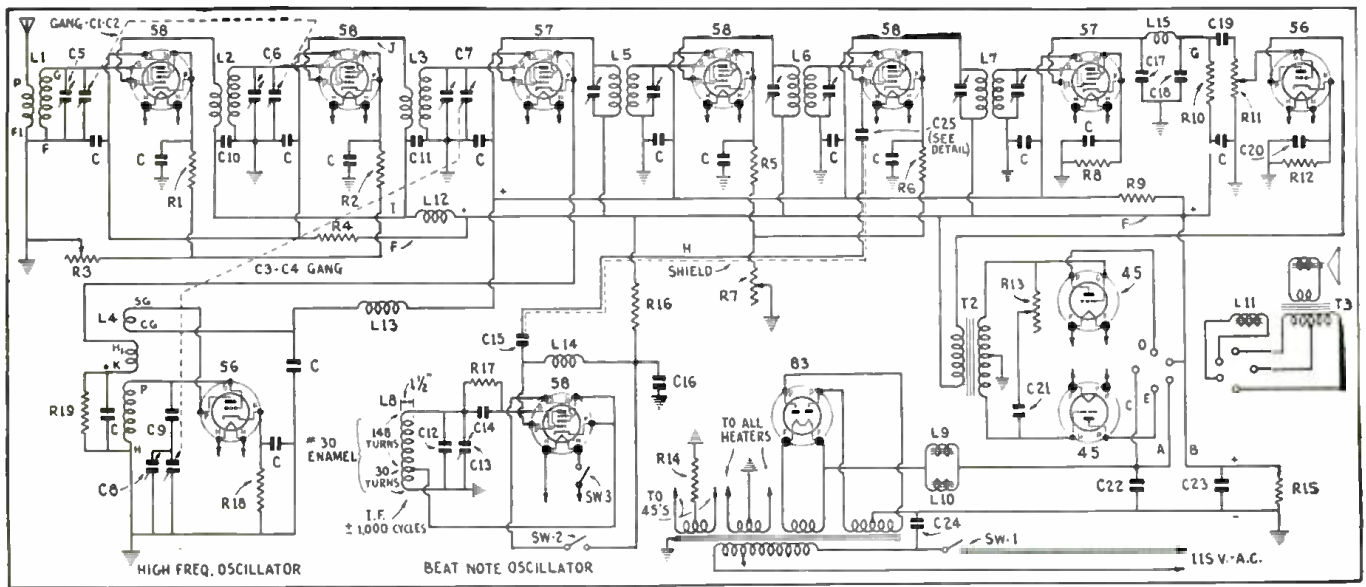

Complete wiring diagram of the Brasfield 10-tube short-wave superhet, which has two stages of preamplification.

nections are made at the back, in most cases with multi-plugs which are a great convenience. This set was not designed for "parlor service" and, therefore, no front panel or cabinet was necessary. However, it can be very neatly built into a cabinet, if desired, by placing the two tuning units in upper portion of cabinet with the beat oscillator, audio amplifier, power supply, and dynamic speaker in lower portion. The cabinet must have a hinged top to facilitate coil changes. This set uses "plug-in" coils, as it is the writer's opinion that greater efficiency is obtained in this way and he feels well repaid for the 30 seconds required to change coils. The four separate units are: Two stage TRF pre-amplifier, superheterodyne tuner, beat oscillator, and combination audio amplifier and power supply. These units will be discussed separately. A recommended chassis layout and rear connection system between units is given in the drawing. The rear connections are indexed with small letters for convenient reference to the diagram. Complete coil information is also given in the drawing.

### Two-Stage TRF Pre-Amplifier

This unit is very simple to build. The two gang condenser C1-C2 (dual .00015 mf.) in this unit should be identical with

C3-C4 in the "superhet" tuner in order to obtain reasonably close "tracking." No inter-stage shielding is used other than the customary tube shields. This unit is built on a rather large chassis to allow plenty of space between components, particularly the two coils. It was found that 1 1/2-inch standard coil forms spaced 6 inches center to center as shown, gave excellent results. No inter-stage coupling was noted.

The coils L1 and L2 are identical with L3 in the "superhet." The "Plate" and "Grid" sections of each coil are wound in the same direction on the coil form and connected and spaced as shown in the detailed drawing.

This amplifier tunes rather sharply and affords tremendous amplification. A volume control is a necessity to prevent serious overloading of the first detector in the "superhet." This is obtained by means of variable cathode bias on the two "58" tubes, in the conventional way. This is shown in the circuit diagram as R1-R2 and R3.

The trimmer condensers C5 and C6 are very valuable in this circuit. They make it possible to absolutely line up the two stages on weak signals, particularly in the high frequencies around 20 meters and obtain maximum signal strength at all times. Such precise tuning is well worth while. It makes the difference between success and failure at high frequencies.

The writer has often heard the opinion expressed that pre-amplifiers were too hard to tune and line up with the set. This is certainly not true of this one, and it has been used with several receivers. Tuning is easy, as the great increase in sensitivity is at once apparent in the loud-speaker when the pre-amplifier is tuned into resonance with the set. All that is necessary is to "follow" the set with the pre-amplifier so that the background or "swishing" sound in the speaker remains loudest. This indicates that the two units are operating in resonance and when a station is reached it will be brought in with great volume. When tuned in this manner no repeat points will be found. Peak resonance with maximum volume can then be obtained with the trimmers, C5 and C6. The main dial readings of the pre-amplifier and the set may not be exactly the same for a given station. This does not matter. Simply follow the tuning rules given above.

### Superheterodyne Tuner

This superhet circuit gives excellent results. The "57" first detector and "56" high-frequency oscillator make an excellent and highly sensitive combination. Three Hammarlund, 465 K.C., intermediate frequency transformers are used with two "58" tubes in the I.F. amplifier. A "57" is also used as the second detector. Volume and sensitivity are controlled by variable cathode bias on the "58" tubes as in the pre-amplifier.

The "56" oscillates at 465 K.C., higher frequency than the incoming signal frequency, thereby producing the intermediate frequency of 465 K.C. This is accomplished by the series padding condenser C9, which must be .001 mf.-capacity. A high-grade moulded bakelite mica condenser is satisfactory.

Band-spread on any band or at any point on the dial is provided by C8, a 20 mmf. high-grade midget condenser, operating in parallel with the oscillator section of the C3-C4 gang. In the photograph C8 is the condenser mounted directly above the main tuning dial and controlled by the large knob type dial. Normally C8 is left with its dial set on "10" when tuning with the main dial. Band-spread can then be had starting at the high frequency end of any band. For instance, with 23 to 50 meter coils and main dial on "94" the (Continued on page 687)

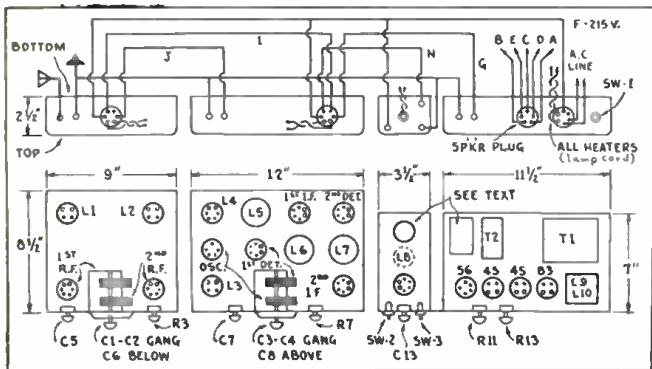
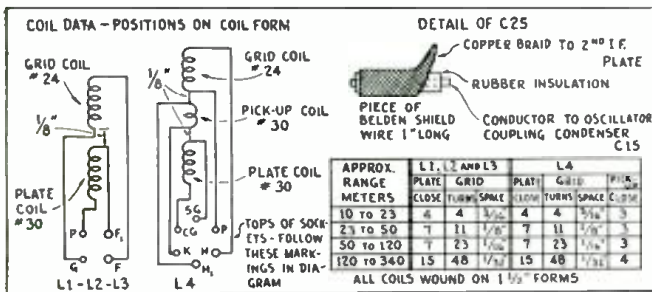

Here we have the chassis layout, together with coil data for this up-to-date multi-tube superhet.

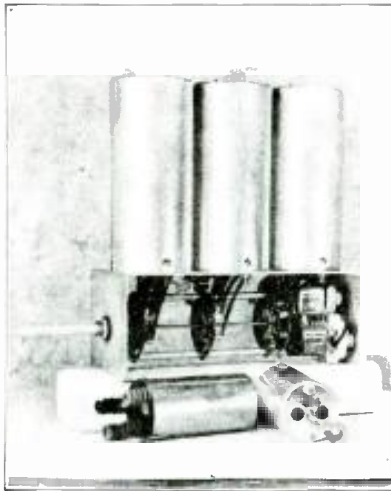

## GEN-RAL MULTI-WAVE UNIT

for

### Combination No. 28

Three Short Wave Bands and Broadcast

### Combination No. 29

Two Short Wave Bands—Broadcast and Long Wave

Request Prints S.C.3

# ANNOUNCEMENT

an addition of a

## SHORT WAVE SPECIAL

to

# GEN-RAL COILS

Reg. U. S. Pat.

Ten Years of Service

### COMBINATION No. 34

The approval and interest manifested in the multi-wave unit in combinations Nos. 28 and 29 have prompted the development of this special unit for short wave only.

May be purchased from all leading jobbers.

features **MANUAL AND AUTOMATIC VOLUME CONTROL**

One Multi-Wave Unit.....

- Band 1. 18-9 Meg. Cy.
- Band 2. 9½-4½ Meg. Cy.
- Band 3. 5 -2½ Meg. Cy.
- Band 4. 3 -1½ Meg. Cy.

One LCX200D.V.M.-I.F. 507 K.C.—Top Grid

One LCX200D.V.M.-I.F. 507 K.C.—Bottom Grid shielded 2 1/16" x 5"

One Hetro-dyne Oscillator

## GENERAL MANUFACTURING COMPANY

Electrical & Radio Coils  
8066 South Chicago Ave.

Cable address "GEN-RAL"  
Chicago, Ill. U.S.A.

A glance at the circuit will reveal that it is of the A.C.-D.C. variety, making it very simple to build and its constructional cost quite nominal. The filter consists of a 15,000-ohm 1-watt resistor and two electrolytic condensers having a capacity of 24 mf in one section and 12 in the other. These condensers are both mounted in a small cardboard container and have a working voltage of 200 volts. A .1 mf. by-pass condenser is needed across the line to reduce noise to a minimum. The heater voltage is obtained with a line cord having incorporated in it a 325-ohm voltage dropping resistor. The entire receiver is mounted on a metal chassis, the dimensions of which are given in the drawing; this is necessary if we are to be rid of the hum.

There are only two changes in the circuit in order to change from one to the other is in the size of the grid-leak and the number of tickler turns of the coils, the values of the remaining components remaining the same. The circuit shown is for super-regeneration and the values are correct for either method of reception. With super-regeneration the grid-leak value is one half megohm. The tickler coils should be changed according to the data given in the coil table. For the straight regenerative circuit any of the standard plug-in coils on the market will give satisfactory results. One thing is really very important in constructing the receiver, and that is the wires of the A.C. line and those of the rectifier and filter should be kept a good distance from all other parts of the circuit and the rest of the wiring, in order that there be a minimum of induction hum. Carelessly placed wires will produce so much hum that the set will be just about useless. Then another important thing to remember is not to attach an external ground to the "B" negative part of the circuit; otherwise the house fuses will be blown. In connecting up the receiver you will find that we have isolated the chassis from the "B" minus. In this way we can have a grounded chas-

## 1-Tube Oscillodyne

(Continued from page 651)

sis and condenser rotor which help to eliminate body capacity effects. In order to bring the "B" minus circuit to ground R.F. potential, we have by-passed it to the chassis with a large condenser. This condenser should be able to stand the 110-volts A.C. or D.C. without breaking down. It is advisable to use a condenser rated at 200 or 300 volts A.C.

Operation of the receiver is so very smooth and the construction so simple, that the reader should have no trouble and the set should work "right off the bat." When first connecting the set to the power line try reversing the line plug, because inserting it in one direction will give less hum than the other. Attach a good antenna and ground; the antenna should be at least 75 feet long and high above the ground. Don't run the antenna near any power lines or considerable induction hum may be encountered due to the A.C.-D.C. circuit. If you have made it a super-regenerative set, turn the regeneration control full on, and you will notice a strong hissing sound. This will disappear when a station is tuned in. The set should hiss all over the dial and if it does not, then reduce the capacity of the antenna trimmer. If you have made it a regular regenerator, then the regeneration control will be quite critical and will have to be adjusted in the usual manner. As stated before, if the tube is operated too near the oscillation point, the signal will be modulated at 60 cycles; back off the regeneration control slightly after the station is tuned in. During tests with this receiver, all the foreign stations in Europe and South America were tuned in with ease and with surprising volume; the volume, as mentioned before, was greatest with *super-regeneration*. If the reader tries both methods, he will soon be

able to decide for himself which is best.

### PARTS LIST FOR 1-TUBE A.C. SET

- 1—½ or 2 meg. grid-leak, see text. Lynch.
- 1—50,000-ohm potentiometer; Electrad.
- 1—15,000-ohm, 1 watt, resistor; Lynch.
- 1—line cord with 325-ohm voltage dropping resistor.
- 1—100 mmf. mica condenser; Aerovox.
- 1—.01 mf. mica condenser; Aerovox.
- 1—.006 mf. mica condenser; Aerovox.
- 1—.1 mf. condenser, 300-volt rating.
- 1—Dual electrolytic condenser, 12 and 24 mmf. working voltage, 200.
- 1—35 mmf. antenna trimmer, I.C.A.
- 1—140 mmf. tuning condenser, Bud.
- 1—7-prong (small) wafer socket.
- 1—4-prong (small) wafer socket.
- 1—antenna ground terminal strip. I.C.A.
- 1—phone terminal strip. I.C.A.
- 1—small chassis; Blan.
- 1—12A7 tube; Sylvania.
- 1—pair of earphones; Trimm.

### Parts List for 1-Tube A.C. Set Na-ald Plug-in Coil Data

Meters Wave-length	Grid coil turns	Tickler turns	Distance between 2 coils
200-80	52 T. No. 28 En. Wound	19 T. No. 30 En. Close wound (C.W.)	¾"
80-40	32 T. per inch. 23 T. No. 28 En. Wound	11 T. No. 30 En. C. W.	1½"
40-20	16 T. per inch. 11 T. No. 28 En. 3-32" between turns C. W.	9 T. No. 30 En. C. W.	¾"
20-10	5 T. No. 28 En. 3-16" between turns C. W.	7 T. No. 30 En. C. W.	1½"
	Coilform—2¼" long by 1¼" dia. 4-pin base.		

The above coil data is correct when using a straight regenerative circuit. When using a super-regenerative circuit, the following tickler coils will be necessary:

Coil	Tickler turns
200-80	25 turns
80-40	15 turns
40-20	12 turns
20-10	10 turns

Please mention SHORT WAVE CRAFT when writing advertisers



## The B-S 4

(Continued from page 654)

lead of the radio frequency tube and serves to change the bias of the tube.

The type of detector used is extremely stable in spite of large variations in plate voltage. A type 58 tube was also used as a detector tube as it seemed to perform better than the 57, which was designed for the purpose. *Band-spread* tuning, which makes the tuning much easier, is used. The *band-spread* method makes the tuning of amateur stations much easier, as they are spread over the dial instead of "bunched" all together. Variation of the screen-grid voltage is used to control regeneration as it does not detune the signal received and is noiseless in operation. The output of the detector is well-filtered by a choke and two condensers and prevents the radio frequencies from getting into the audio section of the receiver.

The output of the detector is fed into a 56 triode which is the *first audio stage*. The coupling is an audio transformer with its secondary and primary coils connected in series to form an A.F. choke for the plate voltage of the detector with a condenser and a resistor for the grid of the 56. The output of the 56 is fed either into earphones or the last audio tube, which is a 47 pentode. The 56 is resistance-coupled to the 47 which feeds into a dynamic speaker. The 47 operates efficiently and drives the dynamic speaker on all signals.

### Parts List

- 1—.000035 mf. midjet variable condenser, C12, Hammarlund.
- 1—.0001 mf. midjet var. condenser C13, Hammarlund.
- 2—.1 mf. fixed by-pass condenser C, C2, Aerovox.
- 3—.001 mf. fixed condenser, C6,C7, C5, Aerovox.
- 2—.5 mf. fixed by-pass condensers, C4, C10, Aerovox.
- 3—.01 mf. fixed condensers, C8, C9, C3, Aerovox.
- 1—25 mf. 25 volt fixed by-pass condenser (Electrolytic) C11, Aerovox.
- Resistors:
- 1—40 ohm center-tapped resistor, R8, Aerovox (Electrad).
- 1—400 ohm 5 watt resistor, R1, Aerovox.
- 1—500 ohm 10 watt resistor, R7, Aerovox.
- 1—2,000 ohm 2 watt resistor, R9, Aerovox.
- 1—10,000 ohm tapered wire-wound potentiometer with S.W., R10, Electrad.
- 1—50,000 ohm potentiometer, R11, Electrad.
- 1—100,000 ohm 2 watt resistor, R2, Aerovox.
- 1—500,000 ohm 2 watt resistor, R6, Aerovox.
- 1—1 megohm, 2 watt resistor, R4, Aerovox.
- 1—5 megohm, 2 watt resistor, R3, Aerovox.
- Chokes:
- 1—Hammarlund shielded R.F. choke Code CH-10-S, CH1.
- 1—Hammarlund Isolantite R.F. Choke, Code CH-8, CH2.
- 1—Audio Transformer with primary and secondary connected in series, A.F.1.

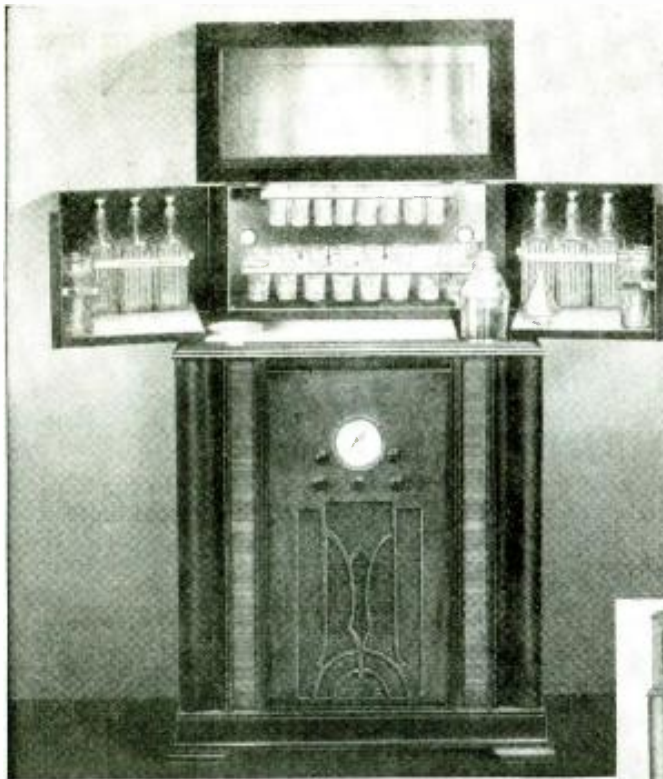

MODELS 505-506-508 OPEN

America's New Radio Sensation!

# Radiobar . . . . .

REG. U.S. PAT. OFF.

"RADIOBAR" is America's greatest value in radio. It gives you a handsome piece of furniture, a fine radio, and when opened a cocktail bar!

Model 105 and 106—"RADIOBAR" Walnut Finish Cabinet. Size when closed 43 1/2" high, 27" wide, 13" deep. When opened it is 54" high, 45" wide. The equipment includes six highball glasses, six cocktail glasses, four whiskey glasses, four liquor decanters, one ice container and one electric light. Fittings are of heavy chromium plate.

Model 505, 506, and 508—"RADIOBAR" Walnut Cabinet. Beautiful matched grain Oriental and Butt Walnut. Size when closed 45 3/4" high, 30 1/2" wide, 16" deep. When open it is 58 3/4" high, 54 1/4" wide.

The equipment includes eight cocktail or small highball glasses, eight liquor glasses and six large highball glasses, six liquor decanters, one ice container, one refuse container, two electric lights, cocktail shaker, funnel, stainless steel knife and special corkscrew and bottle opener. Space is provided for seltzer water and ginger ale bottles.

Model 105—"RADIOBAR" The radio is the latest 5-tube short wave (19 to 50 meters). American

and foreign broadcast. RCA licensed chassis. Price complete, \$99.50. Less Radio, \$69.50.

Model 106—"RADIOBAR" The radio is the latest 6-tube full all wave (15 to 575 meters). RCA licensed chassis. Price complete \$119.50. Less Radio, \$69.50.

Model 505—"RADIOBAR" The radio is the latest 5-tube short wave (19 to 50 meters). American and foreign broadcast. RCA licensed chassis. Price complete, \$139.00. Less Radio, \$109.00.

Model 506—"RADIOBAR" The radio is the latest 6-tube full all wave (15 to 575 meters). RCA licensed chassis. Price complete, \$159.00. Less Radio, \$109.00.

Model 508—"RADIOBAR" The radio is the latest 8-tube full all wave (15 to 575 meters). RCA licensed chassis. Price complete, \$189.00. Less Radio, \$109.00.

OTHER MODELS No. 528, \$249; No. 510, \$295; No. 526, \$219.

WRITE FOR DETAILED INFORMATION. DISTRIBUTORS AND DEALERS FULLY PROTECTED.

## RADIOBAR COMPANY OF AMERICA

13 East 47th St.  
New York, N.Y.

Dept. S.

7100 McKinley Ave.  
Los Angeles, California, U.S.A.



Battery Operated

# LEOTONE WEEK-ENDER

1 tube S.W. Receiver

PORTABLE

HERE is a modern short-wave receiver that serves the requirements of the most critical fan—a set that has been thoroughly tested and which gives results so gratifying to every set owner.

The Leotone PORTABLE (battery operated), 4-tube short-wave receiver, covers 15 to 200 meters. With plug-in coils, it uses the following tubes: 1—31 as R.F.; 1—32 as detector; 1—32 screen grid high gain resistance coupled first audio, assuring adequate volume on all signals; 1—30 as second audio.

This receiver draws less current than a single 201-A assuring exceptionally long life to batteries. (Only standard, high quality parts are used, including Benjamin sockets. Set battery requirements include

- 3 portable small type 45 volts and 2—4 1/2 volt batteries.
- Full vision dial, in brown morocco leather case with sufficient room for headphones and serial wire. Any suitable ground or antenna system can be used. Complete kit, including
- Brown Morocco Leather Case and set of four coils covering 15-200 meter band.

**\$9.25**

Less the tubes and batteries

Address all inquiries and orders to Dept. SW-335.

**LEOTONE RADIO CO. 63 Deu St. New York, N.Y.**

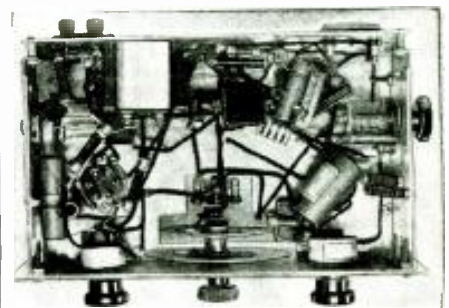

Bottom View of Receiver

Please mention SHORT WAVE CRAFT when writing advertisers

## What's New in S-W Apparatus

(Continued from page 664)

- A 10 to 20 meters
- B 20 to 40 meters
- C 40 to 80 meters
- D 80 to 160 meters
- E 160 to 300 meters
- F 300 to 600 meters

Thus it is possible with one receiver to cover completely the range of from 10 meters (or 28 megacycles) to 600 meters (or 500 kilocycles). It will also be noted that the frequency range is such that any one inductor takes in two adjacent amateur bands.

### The Circuit

From a circuit point of view, the outstanding points are the use of two stages of signal frequency amplification preceding the first detector at all ranges; the use of a new bridge type of carrier-intensity measuring circuit whereby it is possible to

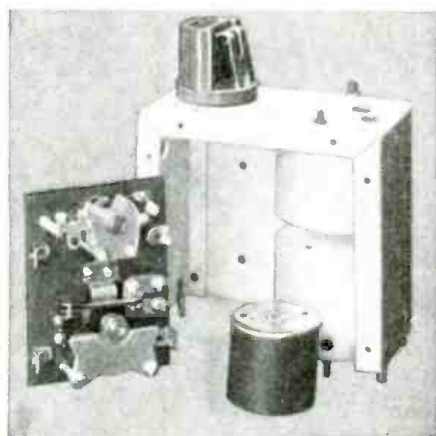

This view shows method by which the four separate inductors are grouped together behind a single "plug-in" panel, with corresponding calibration curves.

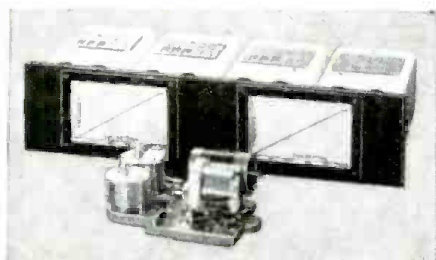

Crystal filter assembly for HRO Receiver.

read directly from the meter on the front panel the intensity of the carrier of the received signal; the incorporation of automatic volume control with front panel switch permitting its use at will; dual volume control permitting separate adjustments of audio and R.F. gain; front panel control of beat frequency oscillator, including the pitch of the beat frequency; front panel control of the quartz crystal single signal filter system, including heterodyne elimination adjustment for phone reception and variable selectivity control which permits front of panel adjustment of the effective frequency width of the I.F. amplifier for phone and modulated code reception. It will also be noted that all of the sockets bear double tube markings. This means that either the 6.3 or 2.5 volt heater type tubes may be used with one and the same receiver, making it readily available for both battery or A.C. operation.

## USERS Say: "THEY'RE GREAT!"

WHEN leading experimenters say they get more stations, louder signals and sharper tuning with these low-priced Hammarlund Coils than with any other coils, at any price, you know they're RIGHT! RIGHT in performance—RIGHT in price.

Four-coil Set (2 windings, 15-270 meters) \$3.00. Four-coil Set (3 windings, 15-270 meters) \$3.75. 40% discount to experimenters.

Hammarlund Coil Forms are ribbed for air-spacing, have easy-grip flanges and "Meter-Index" inserts. Molded from "XP-53," the sensational new low-loss dielectric, without artificial coloring. 4 or 5 prongs, 35c each. 6 prongs, 40c each. 40% discount to experimenters.



Low-Loss  
**COIL FORMS  
and COIL SETS**

### The Smallest and Lightest R. F. CHOKE

Unlike any other. Only 1/4" x 1 1/2" - fits tight places. Low distributed capacity. Priced low for generous use in detector plate circuits all B+ and grid leads, etc. Tinned copper leads from center of end caps aid neater wiring and require no other supports. 75c each, less 40% to experimenters.



For Better Radio  
**Hammarlund**  
PRECISION  
PRODUCTS



HAMMARLUND MANUFACTURING CO.,  
424-438 W. 33rd St., New York, N. Y.

Check here and attach 10c for 1935 S-W Manual of 12 most popular circuits.  Check here for 1935 General Catalog.

Name.....  
Address.....

SW-3

## Most Amazing Typewriter Bargain EVER OFFERED

**NEW REMINGTON PORTABLE  
ONLY 10c A DAY**

FIRST TIME! Remington's new purchase plan now lets you buy a genuine latest model Remington Portable No. 5 direct from the factory for only 10c a day. Not used or rebuilt. Not incomplete. A beautiful brand new regulation Remington Portable. Standard 4-row keyboard, standard width carriage, margin release on keyboard, back spacer, automatic ribbon reverse, every essential feature found in standard typewriters.

**FREE** With your machine we send you free a 19-page course in typewriting. Teaches touch system quickly, easily. Soon you dash off letters quicker than with pen and ink. You also get a handsome, sturdy carrying case, free.

### BIG PRICE REDUCTION

The amazing low price and easy terms now make it possible for you to buy this genuine, complete Remington Portable for only 10c a day. But we cannot guarantee present prices long. Higher wage scales, rising cost of materials, everything points to higher prices. So we say, "Act now... while our liberal offer still holds good!"

### YOU DON'T RISK ONE CENT

Try this typewriter in your home or office on our 10-day FREE TRIAL OFFER. Then if you do not agree that it is the



**10 DAY  
FREE  
TRIAL  
OFFER**

finest portable at any price, return it at our expense. You don't even risk shipping charges. It's the best chance you've ever had to own so complete a machine for so little money. So don't delay. Mail the coupon NOW!

### CLIP COUPON

Remington Rand Inc., Dept. 214-3, Buffalo, N. Y.  
Please tell me how I can buy a new Remington Portable typewriter for 10c a day. Also send your new catalog.

Name.....  
Address.....  
City..... State.....

## Vest Pocket SOLDERING IRON



Smallest good iron now on the market. Will do the work of irons twice its size. Only 10 inches long, 1/2 inch in diameter. By using the highest grade elements, it heats up in half the time of ordinary irons. Guaranteed to give satisfaction or money back. We issue no catalog on this item. Enclose \$1.20 and iron will be sent postpaid in U.S. 10c extra in Canada.  
Gold Shield Products Co., 98 Park Place, N.Y. City

Just Off the Press!

**RADIO'S  
GREATEST  
VALUES**

132 Pages. Filled with Latest Design Portable, Mobile and Rack & Panel, Public Address Amplifiers, Short-Wave and All-Wave Receivers and Converters, Inter-Office Call Systems, Test Equipment, Replacement Parts, Kits, Tubes, and Accessories—all at Unbeatable Rock Bottom Prices! Send For Your Copy To-Day!

**NEW  
1935  
Radio  
Bargain  
Catalog**

**free**

COAST TO COAST RADIO CORP.  
5595 SIXTH AVE., NEW YORK, N. Y.

Please mention SHORT WAVE CRAFT when writing advertisers

100% Short Wave Book and it's

**FREE!**

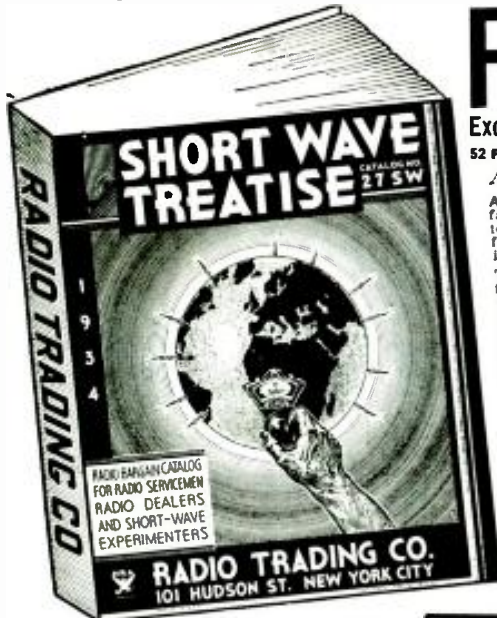

Exclusively Short-Waves From Beginning to End  
52 PAGES 50 HOOK-UPS 500 ILLUSTRATIONS

**A Real Text Book On Short-Waves**

**ANOTHER GREAT EVENT!** This special edition of our famous Treatise is exclusively short-wave from beginning to end. Packed between its two covers is a wealth of information covering the entire short-wave field. Every word in it is new.

This Short-Wave Treatise contains 52 solid pages of useful short-wave information, diagrams, illustrations, short-wave kinks and real live short-wave radio merchandise. It contains more valuable short-wave radio information—more real live "meat"—than many text books on the subject. Special attention has been given to the short-wave beginner. Numerous articles are devoted entirely to his interest. Yet, we have not forgotten all you old-timers. There is plenty of real "dope" for you too.

**PARTIAL LIST OF CONTENTS**

Getting Started in Short-Waves—Helpful Short-Wave Kinks—Principles Of Short-Wave Converter Operation—Bandspreading Explained—How to Build the "19" Unimount Twins For Less Than \$5.00—How to Tune For Foreign Short-Wave Stations—How to "Bandspread" the 2-Tube Electrified Doerle Set—How to Build a 5 and 10 Meter Phone and C.W. Push-Pull Transmitter—How to Build a Medium Power Transmitter Using the New 203-A Tubes—All About the New Short-Wave Transmittink and Receiving Antennas—Notes On Short-Wave Operation (Effect of Time of Day and Season of Year on Short-Wave Reception)—Complete Up-to-Date Characteristics of Transmitting Tubes, etc., etc.

**WRITE TO-DAY**

Just send a postal card—Treatise sent by return mail. PRINT NAME AND ADDRESS CLEARLY

**RADIO TRADING CO.**

101A Hudson St.

New York City

**5-TUBE 1935 SUPERTONE BANDSPREAD RECEIVER**



Our 1935 receiver is truly a new one. New circuit, revised to use a two gang condenser, band spread condensers on both radio frequency and detector stages to afford true bandspread. Regeneration control placed in screen lead to afford more positive and

smoother regeneration. New 6D6 in the radio frequency stage, 6F7 for detector and first audio, 37 second audio and 41 in the last audio, to give tremendous volume on all stations.

Laboratory tests have brought in GSA England, FYA France, EAQ Madrid, DJD Germany, EAQ Spain, VK2ME Australia. All South American stations, Mexico and Canada. Hams and police calls throughout the country with R8 and R9 volume.

Set is housed in a beautiful black wrinkled metal cabinet with vernier airplane dial and hinged top to facilitate removal of coils.

Power pack with brute force filter using 30 mf. external voltage terminals and speaker field outlet gives a hum proof power supply which is so vital to every short wave set.

- Chassis, wired and tested with coils.....
- Power pack wired and tested.....
- 5-Tube and 6" Dynamic speaker.....
- Complete kit of parts, tubes, speaker and power supply.....
- Cabinet for receiver.....

**\$10.00**

**SUPERTONE PRODUCTS CORP.**

35 Hooper Street,

Dept. S-3 35,

Brooklyn, N. Y.

**TRANS-CEIVER!**

NEW! A complete Midget Transmitter and Receiver combined in this simple one-tube set. Foreign reception, local transmission. Tunes 4 to 200 meters. Uses two small inexpensive batteries, (3 and 45 volt) key and phones. Results Guaranteed.

**\$3.95**

Prepaid, ONLY  
Wired, tested, with coil and instructions; less 230 tube. Extra coils 50c ea. Remit \$1.00. C.O.D. \$2.95.



**THE BURKS RADIO CO.**  
1448 W. Decatur St. Decatur, Ill.

**CABINET for ALL-STAR SR. & JR.**



With hinge cover finished to match the ALL-STAR set.

**\$3.95**

Our low price

We also make chassis and metal cabinets for any make receiver. Send drawing or give complete dimensions for estimate.

Dealers and Jobbers: Write for special price  
**KORROL MFG. CO., Inc.** Dept. S-3  
232 GREENWICH ST. NEW YORK CITY

**Performance**

From a performance angle, it might be well to mention that the sensitivity is of course better than one microvolt. The I.F. selectivity alone is better than "10 K.C. at 1,000 down" without using the quartz filter. The R.F. gain on the different coil ranges due to a unique system of coupling developed in our laboratory especially for this receiver and employing a third or "resonant-winding" in the R.F. stages is essentially level for each range. Each amateur band is uniformly spread over 400 of the 500 dial divisions.

**Free-Wheeling Dial**

(Continued from page 648)

radio cabinet. The sides of the cabinet are held together by brass bolts which fasten into brass angle strips on the inside. The bolts are spaced 1½ inches apart. The schematic plan of the interior is shown in Fig. 2.

The left-hand knob is the tone control. The right-hand one is the regenerative control. The "free-wheeling" dial is shown below these two knobs.

In constructing the free-wheeling dial, it is necessary to first procure a variable condenser of the capacity desired. However, an old B-C-L condenser may be cut down, as in this instance, the one shown being an old G. R. Co. Two stator and three rotor plates only were used. The end plate of the condenser was pushed up into position and the ends of the shaft and spacer bolts cut off. Be sure, however, not to cut the condenser shaft too short as the celluloid dial must be fastened to it. Of course, the shaft is drilled and tapped for this purpose. (If standard short-wave coils such as Na-ald are used, then the tuning condenser should have a capacity of .00014 or .00015 mf.; either will do.

The geared dial mechanism was taken from a Marco DeLuxe Dial. It has straight cut gear teeth which makes it free running. The ratio is about 10 to 1.

Attached to the knob shaft is a bakelite pinion gear which meshes with a steel worm gear fastened to the shaft of the weighted thumb dial. The worm gear has a ratio of 12 to 1, which gives a total ratio of 120 to 1. The gears shown in the photograph are from an old "Moore" hair clipper.

The holder for the steel worm gear is made from the brass bushing of an old bakelite tuning dial. The ball bearing is from a Model "T" Ford generator. The shaft is bushed to fit the opening in the bearing. The lower bearing, not shown in the photograph, is a common ball thrust-bearing obtainable at most any hardware store.

The thumb dial used was taken from an old wrecked "Radiola" receiver. The diameter is 5½ inches. If a dial of this type is not obtainable, one can be made from a piece of 3/16 or ¼ inch bakelite. First cut out the disk and then with a sharp knife mark ¼ inch spaces around the outside edge. Then, with a three-sided file, cut the notches.

The weight used was an iron casting that the writer had on hand and was the exact size needed. It was 4¾ inches in diameter by ½ inch thick. This should be bolted solidly to the bakelite thumb dial. However, a good wheel can be cast from lead in a coffee can lid. Before using the free-wheeling dial it should be checked over thoroughly to remove all binding which may cause friction and cut the coasting speed of the weighted dial. All parts should be snug, but thoroughly free to turn.

In operation it is only necessary to flick the dial with the thumb in either direction and it will coast along for 20 or 30 degrees of the dial scale. This is the method for rapid scale change. For slower tuning it is only necessary to flick the dial in little "jabs" until a station is heard. Then, the dial is handled as a straight vernier.

# The "Regenadyne 5"

(Continued from page 653)

eliminated in the *Regenadyne* because the separate regeneration tube provides smooth controllable oscillation over the entire frequency range of the receiver.

### The Regeneration Tube

There are a number of other advantages involving more technical explanations, but space will not be taken here to list these as the aforementioned advantages are sufficient to justify the use of a separate regeneration tube. The main factor in the selection of a tube for the regenerative portion of the circuit is its ability as an oscillator. The type 30 tube proved to be an efficient oscillator and provided smooth regeneration over the entire range of the receiver. The smoothness of oscillation and regeneration depends somewhat upon the combination of grid-leak and grid-condenser used. The values—.0001—mf. and 7—megohms gave the most desirable results in this receiver; however these are best chosen by experiment. All connections are plainly illustrated in the diagram.

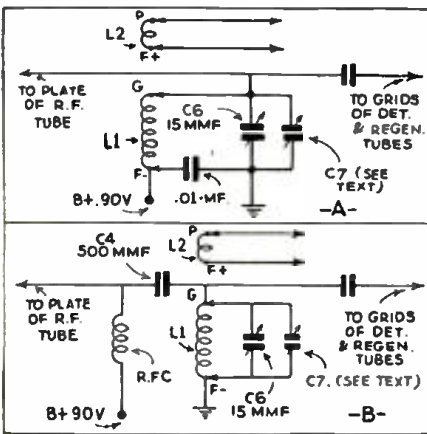

Two Methods of Coupling R.F. to Detector

### Why Screen-Grid Tube Was Chosen for Detector

The conventional grid leak-grid condenser detector employing a type 32 screen-grid tube was used because of its greater sensitivity to weak signals, over that of other methods of rectification. Also the screen-grid tube is a far more sensitive detector than the ordinary triode. Getting the correct ratio of screen-grid voltage to plate voltage of the detector is greatly simplified by the use of a separate regeneration tube. Adjustment of both is made by experiment and once set no further variation is necessary. Resistance  $R_1$  controls the screen-grid volt-

age. Since only one adjustment is necessary this resistance is mounted under the chassis close to the detector, thus allowing short leads. Plate voltages of 45 to 180 were tried but greatest sensitivity resulted at 67½ volts. This value, however, may vary in individual cases and it is best to try all of these values.

No band-spread system is used in the author's receiver, however any of the conventional band-spread methods may be instituted at the constructor's wish, with a minimum of changes in the circuit.  $C_1$  is a vernier condenser consisting of a midget cut down to one rotor and one stator, spaced about ¼ of an inch. This is a great aid for fine tuning. The filter, consisting of a r.f.c. and two condensers, in the detector plate circuit is important in keeping radio frequency currents out of the audio amplifier and power supply.

### The Audio Amplifier

Considerable experimenting was done with the audio end of this receiver. A screen-grid 32 was tried in an attempt to effect a high voltage amplification in the first stage. Its exceptionally high microphonic noises, when amplified by the power stage proved unsatisfactory. The general purpose type 30 tube adequately filled the bill for the first stage. Neither transformer nor resistance coupling gave the desired results for quality and quietness of operation. After a little experimenting an impedance-coupled stage effected excellent results.  $Ch_1$  is the secondary of an audio transformer. This should be a good quality high-inductance unit. A 500-800 henry choke will give equal or better results. The usual .01mf. condenser and 2 meg. leak did not give the desired frequency response. The lower frequencies were attenuated to a noticeable degree. Substituting a 1 mf. condenser minimized this effect. In regard to the grid circuit the leak should be of sufficient size to prevent the condenser's discharge taking place too quickly and leaking through the resistance before it has affected the grid of the tube. On the other hand if the resistance is too high, the discharge of the condenser will not have sufficient time before the next cycle charges it and might block the grid of the tube with a fairly strong signal. Reducing this resistance from 2 meg. to 500,000 ohms gave very fine results.

### The Power Amplifier

The new 19 tube was first tried in a class B arrangement for which this tube was designed; but, because of the grid power consumption of this arrangement, this receiver, having only one tuned circuit, did not supply sufficient input for satisfactory operation. This is not discrediting the 19 in any way. It will give excellent results in a properly designed arrangement.

The type 33 pentode was resorted to and gave passable results. Since distortion and noise developed in this stage will not be amplified by a succeeding stage, transformer coupling was used in order to boost the overall gain. However this transformer should be a high quality unit having good frequency characteristics.

A 2 mf. condenser in conjunction with switch  $SW_2$  is used to effect operation from either stage for head-phone use. The author possessed both a dynamic and a magnetic speaker, each having built-in output transformers designed to operate on loads in the nature of 3500 ohms. This was a poor match for the 33 whose recommended load resistance is 7000 ohms. Not wishing to destroy any portion of these speakers for this special use, the output arrangement illustrated in the diagram was resorted to and gave fine results.  $T_2$  is an output transformer designed for use between two 45's connected in push-pull and a voice coil. The speaker output transformers were then connected

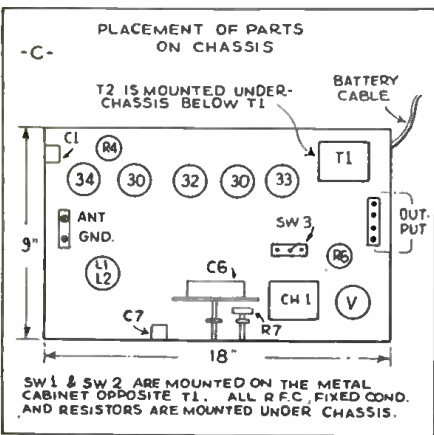

Plan View of Set.

# Need Batteries for a "Doerle" Acorn Tube Midget?

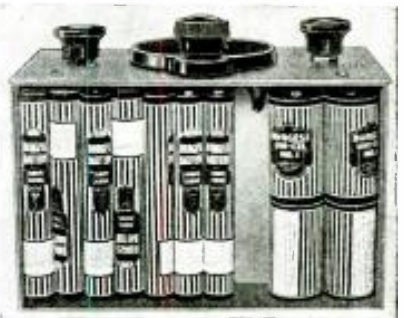

for an "Economy 2"?



for any other battery operated Set?

## LOOK

for the amateur-preferred batteries with the familiar Black and White Stripes. You'll find a wide range of sizes and capacities, from tiny "fountain-pen" types to the big POWER HOUSE, popular 400 Hour DRY "A" designed for use with 2 volt tubes.

GIVE your set the steady, reliable power of long life Burgess Batteries and it will give you the quiet, sensitive, powerful performance you have built into it. BURGESS BATTERY COMPANY, Freeport, Illinois.

# BURGESS

BATTERIES AND FLASHLIGHTS

Please mention SHORT WAVE CRAFT when writing advertisers

# RGH Jr. 2



A self powered A.C.-D.C. Receiver as described in this issue.

**COMPLETE KIT**

of Quality Parts Including 4 s.w. coils. Phones 95c extra.



# RGH 4

PRIZE WINNER



Exhaustive tests by Radio Engineers prove the RGH 4 to be superior to many more expensive kits.

**COMPLETE KIT \$10.95**

of Quality Parts including 8 s.w. Coils. Dynamic Speaker \$2 extra.

IT'S A CINCH TO BUILD THEM

MAIL ORDERS FILLED DEPT. V

**FREE KITS MOUNTED FREE DATA**

**THOR RADIO CO., 167 Greenwich St., N. Y. C.**

in parallel with the lower half of the primary of  $T_2$ . This method offers an efficient power transfer to the speaker output transformers and contains sufficient impedance to effectively match that of the 33. The secondary of  $T_2$  is tapped in order to match directly the impedance of the voice coil of any dynamic speaker.

The receiver is mounted on an aluminum chassis measuring 18" by 9". Figure C illustrates the general order in which the parts are placed. The entire receiver, power supply excepted, is placed in a steel cabinet measuring 18" by 9" by 9". Although aluminum would probably have given better results, steel was used to keep the initial cost of the receiver as low as practical.  $C_6$  and  $R_7$  are mounted on a small aluminum sub-panel and control dials connected by means of bakelite rods and flexible coupling units. Batteries are connected to the receiver by means of a cable.

### Operation

The operation of the *Regenadyne* is very similar to that of the ordinary regenerative type of receiver. The familiar hiss of the detector in oscillation has practically vanished; however there is a slight dull thud produced at the point of oscillation. Although any of the conventional regeneration control methods may be used; variation of the regeneration tube's plate voltage, by means of  $R_2$ , gave the most effective results. The filament voltage is adjusted by  $R_0$  with the aid of the voltmeter V. This voltmeter is not an absolute necessity but will pay for itself in added tube life. A separate switch  $SW_1$  and fixed resistor  $R_5$  are used for the 33 in order to conserve battery energy when not in use.

A good antenna system is an absolute necessity for good results. Two antenna systems are maintained by the author. One is a conventional single wire having a 50 ft. flat-top and when in use is connected to post Ant<sub>1</sub>. This is used in conjunction with a ground connected to the water pipe. This system will give good signal strength but picks up an excessive amount of noise. The other system is of the *doublet* type, having 30 ft. in each flat-top section and using a twisted lamp cord, 60 ft. in length, as a feeder. The two feeders are connected to posts Ant<sub>2</sub> and Gnd.

### Regenadyne Parts List

- L1—Short Wave inductances (Octo-coils used by author, although any standard make will do.)
- L2—Short Wave inductances (Octo-coils used by author, although any standard make will do.)
- C1—.000015 mf. condenser, Hammarlund.
- C2—.25 mf. condenser, Aerovox.
- C3—.01 mf. condenser, Aerovox.
- C4—.0005 mf. condenser, Aerovox.
- C5—.0001 mf. condenser, Aerovox.
- C6—.00015 mf. condenser, Hammarlund (.00014 mf. suitable.)
- C7—see text.
- C8—.001 mf. condenser, Aerovox.
- C9—.00025 mf. condenser, Aerovox.
- C10—.5 mf. condenser, Aerovox.
- C11—.00025 mf. condenser, Aerovox.
- C12—.00025 mf. condenser, Aerovox.
- C13—.5 mf. condenser, Aerovox.
- C14—1 mf. condenser, Aerovox.
- C15—.5 mf. condenser, Aerovox.
- C16—2 mf. condenser, Aerovox.
- R1—50,000 ohms, Aerovox.
- R2—7 megohm, Aerovox.
- R3—5 megohm, Aerovox.
- R4—50,000 ohms potentiometer, Electrad.
- R5—4 ohms fixed resistor, wire-wound.
- R6—Rheostat 10-20 ohms, Electrad.
- R7—0 to 500,000 ohms potentiometer, Electrad.
- R8—500,000 ohms.
- RFC—short-wave radio frequency chokes 2.5 mh. Hammarlund.
- Ch1—sec. of an audio transformer (any good make.)
- T1—audio transformer 3½ to 1 (any good make.)
- T2—output transformer (see text.)
- SW1—s.p.s.t. toggle type.
- SW2—s.p.s.t. toggle type.
- SW3—s.p.d.t. toggle type.

## YOU DON'T

READ AND THEN DISCARD SHORT WAVE CRAFT

Readers keep their copies for years as a steady reference and thousands of letters attest to this.

It is now possible to *save your copies* and for this purpose we designed a splendid binder for you which holds twelve copies. It is made of heavy substantial material and is covered with black grain leatherette. The name of the magazine is stamped in gold on the cover.

An ingenious mechanical arrangement is provided which makes it possible to hold the copies flat when reading from the binder.

SHORT WAVE CRAFT Binder as described, \$1.25 prepaid in the United States.

Canada and foreign countries 25c extra. We accept money order, check, stamps or cash.

### SHORT WAVE CRAFT

99-101 HUDSON STREET NEW YORK, N. Y.

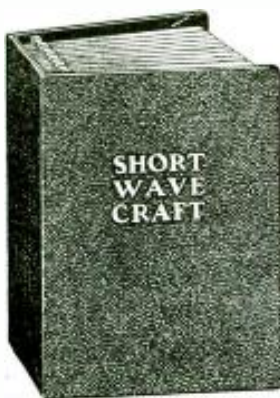

## SERVICEMEN!

You may not be a "Coupon Clipper" . . . BUT HERE'S ONE YOU CAN'T AFFORD TO MISS

F. L. SPRAYBERRY, 2548 University Pl., N.W., Washington, D.C.

Please rush—FREE—complete details of PRACTICAL MECHANICS OF RADIO SERVICE—also state how I can get the New Series of DATA SHEETS (worth \$3) at no extra cost.

Name \_\_\_\_\_ SWC-3, 35

Address \_\_\_\_\_

City \_\_\_\_\_ State \_\_\_\_\_

If a recognized authority told you he could save you time, money and help you build a better, more profitable service business, you'd surely spend the price of a stamp to learn the facts. And that is exactly what F. L. Sprayberry is telling you now. His ADVANCED TRAINING system explains the easiest way of doing hard jobs—testing parts—modernizing Set Analyzers. It covers super-hot circuits, auto radio, A.V.C., P.A., latest tubes, etc. New lessons on the CATHODE RAY TUBE or OSCILLOGRAPH—the most modern service method—have just been added. And the course comes at a low price which will amaze you.

**INVESTIGATE!**

## ANT TELEVISION JOB?

Radio and Television are packed with romance. Every hour interesting and immensely profitable. For free details write First Nat'l Television, Power & Light Bldg. Kansas City, Mo., Dept. BB-3

## Short Wave League Letter-heads

Designed for Members



This is the official letterhead

It is invaluable when it becomes necessary to deal with the radio industry, mail order houses, radio manufacturers. It can be used in many ways and gives you a professional standing. No member of the LEAGUE can afford to be without this letterhead.

This can only be used by members of the LEAGUE. No one else can purchase it.

See page 700 of this issue for order blank. Take advantage of this opportunity to handle your LEAGUE correspondence in a business-like manner.

### SHORT WAVE LEAGUE

99-101 Hudson St., New York, N. Y.



## 10 Tube S-W Super-Het

(Continued from page 680)

congested 49 meter band spreads out as follows:

Station	Location	Kilocycles	C8-Dial
VV3RC	Caracas	6150	10
W8XK	Pittsburgh	6140	20
W2XF	New York	6120	28.5
W2XF	Chicago	6100	36
VE9GW	Bowmanville	6095	38.5
W8XAL	Cincinnati	6060	54
GSA	London	6050	58.5
W1XAL	Boston	6040	64
DJC	Berlin	6020	74
COC	Havana	6010	87

To anyone who has tried to separate the stations in this band with a regenerative receiver or with a superhet without band-spread, such tuning as the above with "clear-cut" separation (even on 5 K.C. difference) is a real pleasure. On the 20 meter amateur band, with the set tuned to maximum sensitivity, no other adjustments are necessary except to turn the dial of C8 from station to station. This feature should never be omitted from a modern receiver.

The 35 mmf. condenser, C7, trims the first detector section of the C3-C4 gang so that when the oscillator frequency mixes with the signal frequency in the "57," a good sharp 465 K.C. intermediate frequency signal will be put into the I.F. amplifier. The adjustment of C7 is more critical at some points than at others, but it does not affect the main dial setting, as does C8.

No oscillation or feed-back troubles have been experienced with the I.F. amplifier, although you will note that no R.F. chokes or by-pass condensers are provided in the plate leads. It can be worked at maximum amplification, by so adjusting R7, without any troubles of this sort.

Many "fans" who have never worked with a superhet circuit, consider it complicated and hard to line-up and adjust. In the writer's judgment the superhet is easier to adjust than the regenerative circuits and is far less "tricky" than the latter. As a rule, the I.F. transformers are already "peaked" at the proper frequency. When the set is turned on for the first time, insert the coils which reach the broadcast stations, set C8 dial on "10," and tune both the pre-amplifier and the superhet main controls to some strong signal. Now slowly rotate the knob controlling C7. This should vary the signal strength to a definite "peak." This peak indicates that the oscillator and first detector are properly tuned into the I.F. amplifier. In some cases a slight adjustment of the plate tuning condenser in the first I.F. transformer, L5, may be necessary to produce this peak. With C7 set at its peak adjustment for a given signal, you can line up L5, L6 and L7 in five minutes. Use an insulated screw driver and adjust first the plate and then the grid condenser of each in turn for maximum signal, starting with the grid condenser of L5, since its plate has already been set. You will find the grid condensers much more sensitive than the plate condensers.

### Beat Oscillator Finds Those "DX" Stations

This little unit, like the pre-amplifier, may be used with any superhet. The only condition in the case of the beat oscillator is that the superhet must have an I.F. of 465 K.C., since the oscillator is designed for 465 K.C., plus or minus 1000 cycles, in order to produce a good audible beat note or whistle.

A beat oscillator is virtually indispensable if code (CW) and time signals are desired. It has another important use for the layman (even as you and I). This is as an aid to DX (distant station) tuning. The switch SW-2 is normally left "open," which breaks the oscillation of the "58." When tuning DX simply close SW-2 and tune the set as before. You will find that when a phone station is approached the speaker will whistle loudly and if you continue to tune past the station, the whistle will stop and then start sharply and fade away as you leave the station.

The point is to tune for that "stop" or zero point then open SW-2 and your phone station will be there. This is of no value on U.S. locals but it aids greatly in locating distant weak stations that may be on a fading cycle when you pass them and you would never know of their presence, but for the beat oscillator.

The construction of this unit is not difficult but the coil L8 must be wound on a 1 1/2"x2 3/8" tube exactly as shown in the diagram, C12 must be .0001 mf., and C13 must be .000035 mf. (35 mmf.) in order to tune 465 K.C. plus or minus 1000 cycles. In other words it must match the I.F. within 1 K.C. or no beat note will be heard.

The coil L8 is suspended vertically within the chassis by means of a long brass (not iron) bolt in the center of the chassis just behind the "58" tube socket. All parts are enclosed in the chassis and the coupling line from C15 to the special coupling condenser C25 must be copper shielded conductor! The oscillator must be coupled very loosely to the superhet circuit, that is, the coupling capacity must be very small. A piece of shield wire one inch long arranged and coupled as shown worked perfectly, after numerous other trials had failed.

The switch SW-3 is optional in case it is desired to cut off the heater current of the "58" when not in use. It is desirable for quick use, however, to leave this switch closed.

The rear tube shown on this chassis is there for future experiments. It has nothing to do with the circuit discussed here.

### Audio Amplifier and Power Supply

After experimenting with various audio circuits, the writer came back to the good "old reliable" circuit as shown in the diagram. It is not practical to raise the output of a short-wave receiver by installing a super-powerful audio system. Attempts along this line invariably raise the background noise to impractical levels. If a good signal to noise ratio in the output is desired, it must be obtained by proper design in the R.F. and I.F. stages, so that with reasonable amplification in the audio system, good volume and tone may be realized. Another point which is sometimes overlooked, is the importance of carefully matching the output transformer, T3, to the out-put tubes. Improper impedance matching always produces poor quality out-put.

This receiver will operate a 12-inch dynamic speaker in a 48-inch square baffle, with enough volume to comfortably fill a medium-size auditorium and this with good signal-to-noise ratio.

Some authorities recommend a high impedance choke in place of the 250,000 ohm register, R10, in the plate circuit of the "57" second detector. Such a choke may be seen in the photos mounted behind the "56" first audio. In the writer's judgment, however, R10 works better. Therefore, the choke is not shown in the diagram.

The coupling condenser C19 is important, as the entire audio out-put of the tuner must pass through it into the audio amplifier. The bass instruments in an orchestra often emit deep notes of 100 cycles per second and less, while 1000 cycles is a good average for the whole orchestra. Compare the approximate reactance in ohms of two coupling condensers at 100 cycles and 1000 cycles:

	.01 mf.	.5 mf.
1000 cycles	16,000 ohms	325 ohms
100 cycles	160,000 ohms	3250 ohms

It is obvious that the .5 mf. coupling condenser offers a much lower impedance to the audio frequency, particularly on the low notes.

The power supply is exceptionally quiet! There is no noticeable hum. A type "83" rectifier is used because of its better voltage regulation under heavy load. The "83" delivers 305 volts to the "45" plates and 215 volts to the other tubes. A test on an

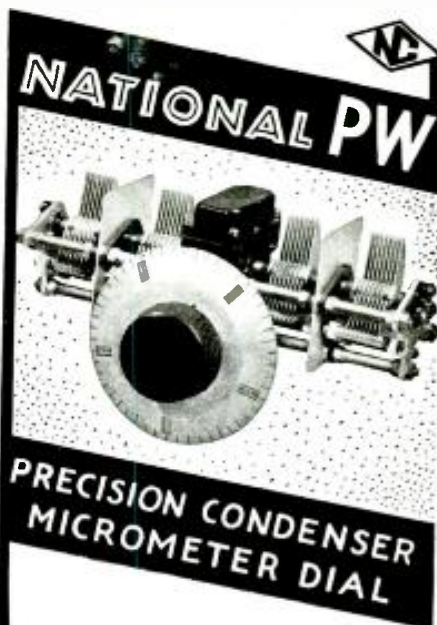

**NATIONAL PW**  
**PRECISION CONDENSER MICROMETER DIAL**

A remarkable new unit, electrically and mechanically far in advance of anything of its kind ever offered before. It overcomes the drawbacks of ordinary ganged condensers when used in Short Wave Receivers, combining electrical design of exceedingly low-loss characteristics, with a rigidity and accuracy of construction that is comparable to that found in a fine microscope or a tool-maker's lathe.

Has 20:1 ratio pre-loaded worm-gear drive in enclosed die-cast gear housing; 3/8" steel rotor shaft on 4 insulated bearings. Rigid 180° S.L.F. type Condenser sections with rotor sections separately insulated with Streatite-Isolantite, are mounted directly on gear housing; Micrometer Dial has 50 divisions and makes 10 revolutions in covering tuning range, reading directly to 1 part in 500. Numbers every 10 divisions on dial rotate with it but change automatically every revolution. Quality—not price, comes first in every detail of this outstanding unit.

List Price (subject to 40% discount when purchased through an Authorized NATIONAL DISTRIBUTOR), PW-1, Single Section, \$13.50; PW-2, Two Section \$17.00; PW-3, Three Section, \$20.50; PW-4, Four Section \$24.00.

**USE COUPON BELOW**

 **National Company, Inc.**  
 Malden, Massachusetts

Gentlemen:

Please send me your new catalogue No. 240. I enclose 6c to cover mailing costs.

Name .....

Address .....

SWC 3.35

# 2 new BOOKS on SHORT WAVES

HERE are two brand new books which you have been looking for for a long time. They contain everything that you have been asking for for many months. These new books will give you the latest information of everything you wish to know in two respective fields. Be sure to order them today. You will not regret it.

They make excellent companions to our other handbooks, which you may have.

7" x 10"

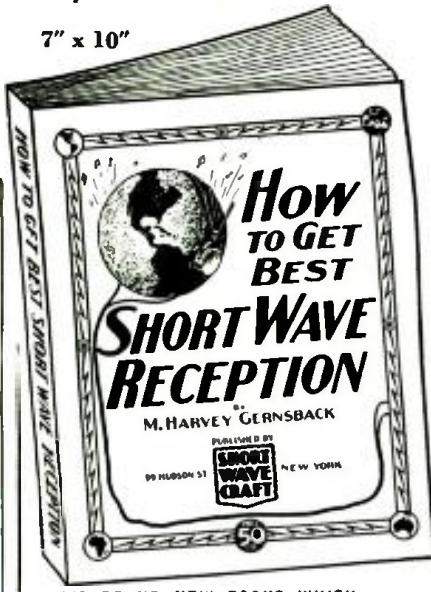

TWO BRAND NEW BOOKS WHICH EVERY ALERT SHORT-WAVE FAN SHOULD HAVE IN HIS LIBRARY

7" x 10"

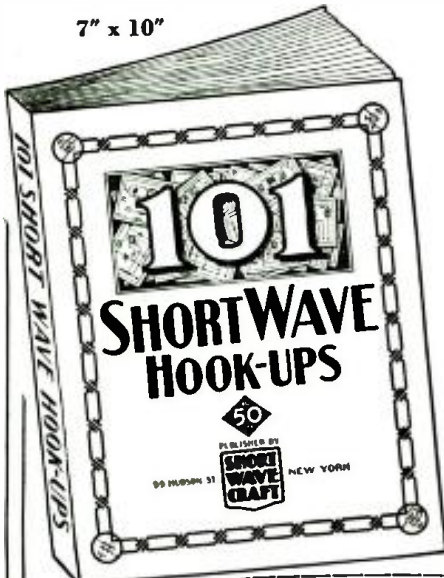

SHORT WAVE CRAFT, 99 Hudson Street, New York City.

Gentlemen: I enclose \$ for which you are to send to me, postpaid, immediately upon publication, the books checked below:

"How to Get Best Short Wave Reception"  
"101 Short Wave Hookups"

Name .....

Address .....

City and State .....

(Send check or money order. If you send cash or uncancelled U. S. Postage Stamp, register it.)

SWC-3-35

## "How to Get Best Short Wave Reception"

By M. HARVEY GERNSBACK

Here is a book that gives you everything you have ever wanted to know about short-wave reception.

The author, a professional radio listener and radio fan for many years, gives you his long experience in radio reception and all that goes with it.

Why is one radio listener enabled to pull in stations from all over the globe, even small 100 watters, 10,000 miles away, and why is it that the next fellow, with a much better and more expensive equipment, can only pull in the powerful stations that any child can get without much aid?

The reason is intimate knowledge of short waves and how they behave. Here are the chapters of this new book:

1. What are Short Waves and what can the listener hear on a short-wave receiver or converter?
2. How to tune and when to listen in on the short waves.
3. How to identify short-wave stations.
4. Seasonal changes in short-wave reception.
5. Types of receivers for short-wave reception.
6. Aerial systems for short-wave receivers.
7. How to get verifications from short-wave stations.
8. Short-wave hints.

The book is profusely illustrated with the best kind of illustrations that it was possible to obtain.

Please note that this is not a re-hash of anything that has appeared before. Everything in the entire book has been written to order, and there is no duplication of anything here that has appeared in print before.

The book will make excellent reading matter, whether you are a rank beginner or whether you have been at it for a long time. There are many tricks in short-wave reception that even some of the "old-timers" do not know. That is the reason for this book. Be sure to get it.

Place your order at once.  
72 pages, over 40 illustrations.

## 101 SHORT WAVE HOOKUPS

Compiled by the Editors of SHORT WAVE CRAFT

Here is a worthwhile book that every short-wave listener, every short-wave fan, and every short-wave amateur has wanted for a long time. It gives you the 101 best short-wave hook-ups which have appeared heretofore. It is a veritable encyclopedia of the best in short-wave when it comes to hook-ups.

And do not run away with the idea that we just give you a few plain hook-ups. Each and every hook-up and diagram illustrated is also accompanied by a thorough explanation of what this particular hook-up accomplishes, what parts are required, coil-winding information, values of resistors, etc., in fact, everything you want to know in order to build the set up to hook up the set.

To be sure, all of the important sets which have appeared in print during the past five years are in this valuable book. Sets such as the Doerle, Jinsmore, the "19" Twitplex, Oscillodyne, Duo-Adlidyne, Denton "Stand-by," Megadyne Triplex 2, "Globe-Trotter," 2-Tube Superhet, Minidyne, "Loop" Receiver, "Doerle" 2-tube Battery, "Doerle" 3-tube Battery, "Doerle" 2-tube A.C., "Doerle" 3-tube A.C., Doerle "Signal Gripper," "Unlrol" Band-Spread 2-tube Receiver, 1/2 Meter Portable Transmitter and Receiver, Duo R.F. 4-tube Receiver, The Sargent 9-33 Tapped Coil Receiver, Globe-Girdler 7, The 2-Tube "Champ" - 2 Tubes Equal 3, Han-Band 2-tube Pee-Wee, Weyth All-Wave 6, "Tee" Portable Super-het Receiver, The "53" 1-tube Twitplex, Shuart Band-Spread S.W. Converter, The "Ace" Band-Spread 3, Denton Economy 3, 2-Tube "Regenerative-Oscillodyne" will be found here, with full descriptions. In many cases, where it was necessary, we have also included a picture hook-up for those who do not wish to follow the regular symbolic hook-up, but wish to have a regular wiring diagram.

Also note, that in many cases, we have not just reproduced old hook-ups or diagrams. In many cases they have been brought up-to-date, to give you the latest information available in such sets.

This is a very handy volume, especially for those "fans" who wish to study the best sets in the short-wave art, from one tube up to ten tubes, instead of leafing through a dozen magazines and going through bank numbers.

The present volume brings you everything in a clarified manner, leaving nothing to your imagination. The book is thorough, and up to date, and will be a welcome addition to your radio library.

72 pages, over 100 illustrations.

Price .....

50c

50c

"80" indicated 270 volts to the "45's" and 180 volts to the others. The measured bias on the "45's" is 50 volts across R14.

Due to the heavy drain of a set of this type, a good power transformer, T1, should be used. The specifications on T1 are as follows:

- High voltage, 750 Volts @ 125 MA.—CT.
- Rectifier filament, 5 Volts @ 3 Amps.
- Heaters, 2.5 Volts @ 12.25 Amps.—CT.
- "45" Filaments, 2.5 Vols, @ 3 Amps.—C.

Too much emphasis cannot be placed on careful workmanship! Make all soldered joints carefully. Test all fixed condensers for short-circuit before installing them. Do the job well and you will have an outfit which you will be proud to own.

## Parts List for Brasfield Super-Het

- L1, L2, L3—R.F. coils, see table.
- L4—Oscillator Coil, see table.
- L5, L6, L7—Double Tuned, I.F., transformer. Hammarlund.
- L8—Beat Oscillator Coil, as detailed.
- L9, L10—30 H. Filter Chokes.
- L11—2500 ohm speaker Field.
- L12-L15—85 MH., R.F., chokes. Hammarlund.
- L13—10 MH, R.F. choke. Hammarlund.
- L14—30 MH, R.F. choke. Hammarlund.
- T1—Main Power Transformer.
- T2—P.P. Audio input transformer.
- T3—P.P. Audio Output transformer (on speaker).
- R1, R2—300 ohm, fixed, bias. Aerovox.
- R3—15,000 ohm, variable bias. Electrad.
- R4—25,000 ohm, voltage dropping. Aerovox. (Lynch.)
- R5, R6—350 ohm, fixed bias. Aerovox.
- R7—10,000 ohm, variable bias. Electrad.
- R8—30,000 ohm, fixed bias. Aerovox. (Lynch.)
- R9—25,000 ohm, voltage dropping. Aerovox. (Lynch.)
- R9—25,000 ohm, voltage dropping. Aerovox. (Lynch.)
- R10—.25 meg., plate load. Aerovox. (Lynch.)
- R11—.5 meg., audio vol. control. Electrad.
- R12—3000 ohm, fixed bias. Aerovox. (Lynch.)
- R13—50,000 ohm, tone control. Electrad.
- R14—750 ohm, output bias. Aerovox. (Lynch.)
- R15—20,000 ohm voltage divider. Aerovox.
- R16—.15 meg., voltage dropping. Aerovox.
- R17—70,000 ohm, grid resistor. Aerovox. (Lynch.)
- R18—500 ohm, fixed bias. Aerovox.
- R19—25000 ohm, fixed bias. Aerovox. (Lynch.)
- C—1 mf. by-pass condensers. Aerovox.
- C1, C2, C3, C4—identical dual .00015 granx. Bud.
- C5-C6—30 mmf. trimmers. (35 mmf. will do.) Bud.
- C7—35 mmf. trimmer. Bud.
- C8—20 mmf. band-spread condenser. Bud.
- C9—.001 mf. padding condenser.
- C10-C11—.05 mf. by-pass condensers. Aerovox.
- C12—.0001 mf. Aerovox.
- C13-35 mmf., "beat note" adjustment. Bud.
- C14—.0001 mf. grid condenser. Aerovox.
- C15—.00015 mf. coupling condenser (see also special C25).
- C16—.003 mf. by-pass condensers. Aerovox.
- C17-C18—.00025 mf.. R.F. filters. Aerovox.
- C19—.5 mf. audio coupling condenser. Aerovox.
- C20—25 mf. by-pass condenser. Aerovox.
- C21—.01 mf. tone control. Aerovox.
- C22, C23—16 mf. filter condensers. Aerovox.
- C24—.1 mf. by-pass on electric line. Aerovox.
- C25—Low capacity, best oscillator coupler.

## \$20.00 PRIZE MONTHLY FOR "BEST" 1-TUBE SET

Or other short-wave set article accepted and published. Send diagram first or set if you prefer.

Sets must be sent PREPAID and should be CAREFULLY PACKED in a WOODEN box!

The closing date for each contest is sixty days preceding date of issue (Mar. 1 for the May issue, etc.). In the event of a "tie" an equal prize will be paid to each contestant so tying.

The judges will be the editors of SHORT WAVE CRAFT, and George Shuart and Clifford E. Denton, who will also serve on the examining board. Their findings will be final.

Address your entries to:

Editor,  
SHORT WAVE CRAFT,  
99-101 Hudson St.,  
New York City.

*new* RADIO INVENTION



**KADETTE Jewel**

Another sensational creation by the inventors of the original AC-DC radio. Patented, simplified circuit permits housing this powerful, long-distance receiving set in a cabinet only 5½ x 7½ x 3¾ inches and weighing only 3¼ lbs. Tunes 176 to 550 meters, AC or DC, 110 volts, with the purest tonal fidelity. Molded cabinets of bakelite, plaskon and beetle in 7 attractive colors to match any room \$1350 to \$1750 settings. Priced from .....

● Parcel Post Factory Service — 1 Year - \$1

**World-Wide Kadettes**

● Superheterodyne, automatic volume control, tone control, auxiliary condenser for ultra short-wave, dynamic speaker, illuminated dial, tunes 18 to 550 meters. Size 14¾" high... 11½" wide... weight—10¼ lbs. Complete with tubes, factory tested on foreign reception.



Model 65—All-Wave, AC-DC . . . \$3450  
Model 60—2-Band, AC-DC . . . \$2995

**Kadette Battery Set**



5-tube superheterodyne Powerful, sensitive, yet uses 1/3 less battery voltage than any set of comparable performance. No "C" battery and only 2 "B" batteries required. Chassis and batteries completely housed inside beautiful inlaid cabinet size 17½ x 13¾ inches. Only \$2995 (Batteries extra)

● DEALERS: Get information on complete Kadette line from nearest jobber or direct from factory.

**INTERNATIONAL RADIO CORP.**  
(Dept. C) ANN ARBOR, MICHIGAN

**UNCLE DAVE'S**  
UNCONDITIONAL GUARANTEE ON ALL OUR RADIO SUPPLIES  
RADIO SHACK  
135 BROADWAY, ALBANY, N. Y., U.S.A.  
Cable Address: "UncleDave."  
Write for new Ham Catalog—just off the press!  
Peerless "40-DX" Transmitter. 35 watts output CW—10 watts phone, a beautiful job at an extremely low price. Write for details.  
**5-METER SPECIALS**  
Kit for the 5-meter transmitter as per QST, using two 1B5 and one 30 tube, less tubes, mike and batteries, net \$10.33  
Tubes for the above, net 1.73  
5-meter xformers, compact for the 30-33 transmitter 2.45  
Same but for 19 tubes, high power portable outfit 2.75  
5-meter coil kit, per set 1.30  
11" buzzers, net .49  
Write for Quotations on Any 5-Meter Apparatus Wanted—1-Ed Teletypes

**Frost-bites and Short Waves**

(Continued from page 650)

The technique employed in treatment was along the following lines: Upon a pad that is not too soft the condenser-electrode is placed upon which is placed the finger (or toes) to be treated. If both hands (or feet) are involved they are placed crosswise over each other and the other electrode is placed on them. The whole is held in position by means of a rubber bandage and it is best to obtain a certain amount of compression by means of a sand-bag placed thereon, but without producing any ischemia. In most cases, in order to keep the parts homogeneous, I have inserted a layer of felt between the electrode and skin, the felt being about 5 mm. thick. In this position no danger is involved in the process.

To begin with, the treatment lasts 15 minutes, with rest intervals of four or five days; then it is increased to 20 minutes and even to 25 minutes. Usually but six treatments, very rarely more, were given.

In the treatment of the leg the procedure was such that the electrodes were applied laterally outside and within the focus.—*The Urologic and Cutaneous Review.*

**\$500.00 Prize Contest**

(Continued from page 650)

- of paper. Use only one side of the paper. If the paper or postal card is larger than that size the entry will be thrown out automatically.
- 5.—Write in "ink" or "typewrite" the title; no penciled matter considered.
- 6.—Name and address must be given on each title, no matter how many you send in.
- 7.—This contest is open to everyone whether you are a newstand reader or subscriber.
- 8.—From the contest are excluded employees of SHORT WAVE CRAFT and their families.
- 9.—The contest closes on Apr. 30, at which time all entries must have been received.
- 10.—The editors of SHORT WAVE CRAFT will be the judges of this contest, and their findings will be final.
- 11.—No correspondence can be engaged in on this contest, nor letters answered, nor the entries returned.
- 12.—In the event of "ties," prizes of identical value will be awarded to each tying contestant.

Address all entries to **TITLE CONTEST EDITOR, SHORT WAVE CRAFT, 99 Hudson Street, New York City.**

In the next issue the full list of prizes will be given. The prizes will be sent from the radio manufacturers and radio men to the winners at the end of the contest, and the results giving the winners' names will be published in our July issue.

**The Junior RGH 2**

(Continued from page 666)

**List of Parts**

- Coils**
  - 1 set of 4-prong coils (4 coils)
  - 1 Thor R.F. (choke for 2.5 mh.)
  - 1 Thor audio transformer
- Condensers**
  - 1 Thor filter condenser block (R-R-5 mf.)
  - 1 Thor single .00014 mf. variable condenser
  - 1 Thor 140 mmf. (.00014 mf.) semi-variable con.
  - 1 dual .1 mf.—200 volt condenser
  - 2 .01 mf. condensers
  - 1 .00025 mf. mica condenser
  - 1 .0001 mf. mica condenser
  - 1 .0004 mf. mica condenser
- Resistors**
  - 1 15,000 ohm potentiometer
  - 1 250 ohm line cord
  - 1 5 meg ½ watt resistor
  - 1 250,000 ohm ½ watt resistor
  - 1 150,000 ohm ½ watt resistor
  - 1 15,000 ohm ½ watt resistor
  - 1 3,000 ohm ½ watt resistor
  - 1 500 ohm ½ watt resistor
- Miscellaneous**
  - 1 Thor RGH 2 chassis, with panel attached
  - 1 3" vernier dial
  - 2 knobs
  - 2 wafer sockets
  - 1 4-prong coil socket
  - 1 rotary switch
  - 1 Antenna posts
  - 1 Phone posts
  - 1 screen grid clip
  - 1 Hook-up wire
  - Hardware and solder
  - Bus bar
  - Tube shield

*Shhh! Shhh!*  
**QUIET**  
*Please!*

*Individually TESTED for NOISE*

**It Banishes Noise For Life!**

**ELECTRAD**  
*New* **QUIET**  
**VOLUME CONTROL**

*Standard Replacement Unit with Power Switch attached*

**NEVER** before was such uncanny quietness made possible in a volume control. It required a radically new engineering principle and *individual testing* at the factory to assure its amazingly smooth, noiseless operation, which actually *improves* with use.

Current is evenly distributed over the flat outer rim of a rigid Bakelite ring, upon which gently glides a special—alloy floating contact shoe.

Molded Bakelite case, when mounted, extends only ½ inch back-panel. New-type power switch (approved by underwriters) may be instantly attached or removed by a single screw. Long, easy-to-cut aluminum shaft. All standard replacement values.

*Resistance element baked on flat outer rim of Bakelite ring*

*Floating contact shoe glides over resistance element in straight path*

Mail Coupon for FREE Descriptive Folder, and 1935 General Catalog of Resistors for Every Purpose.

*from*  
**RESISTOR**  
*Headquarters*

**ELECTRAD** 1935 CATALOG

**Electrad, Inc.**  
175 Varick St., New York, N. Y.

Please send new 1935 Resistor Catalog. Check here for folder on new QUIET Volume Control.

Name \_\_\_\_\_  
Address \_\_\_\_\_

SW-3

Please mention SHORT WAVE CRAFT when writing advertisers

**This Mark of Quality**  
**INSURES Dependability**  
**To HAMS and SERVICEMEN**



Today when so many Amateurs are building their own receivers, transmitters & "Special jobs," it is only natural that they should insist on ICA parts. They know that they are engineered to render the best possible service. Next time be sure you ask for ICA!

**5 Meter Transceiver Kits**

Choice of 3 models: 2 volt, 6 volt or A.C. model. Made completely of ICA parts. Easy to build. Complete instructions, diagrams. List prices (respectively):

**\$19.50**    **\$19.25**  
**\$19.75**

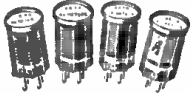

**S. W. COILS**

Wound on Small Bakelite Ribbed Forms

4 prong, 2 windings. 4 coils cover 16-217 meters.

Have low-loss wire for primary and tickler. Will tune with 140 mmfd. condenser. List price..... **\$1.90**

6 prong, 3 windings. List price..... **\$2.75**

**ICA SHORT WAVE RECEIVERS**

A whole line to choose from: 1 and 2 tube battery sets, and 3, 4 and 5 tube All Electric models. Here are the world's easiest kits to build. Each comes complete with point to point diagrams. Licensed under ICA and Hazeltine Patents. List prices \$9.95 and up. Write for facts before you build!

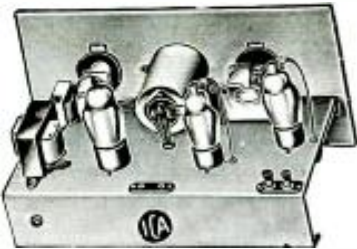

**Coils for 5 Meter Transceivers (QST Specifications)**

Interuption Frequency Oscillator with 4 Lugs. List price \$1.00. 5 Meter RF Choke with two mounting feet. List price 60c. 5 Meter Dual mounting base. List price 75c. Complete as above with blue print. List price..... **\$2.25**

**Universal Midget Condensers**

Removable shaft with lock nut brockle, permanent condenser filament. Insulux insulation. Spacing .026", 15, 25, 50, 100 and 140 mmfd. capacities. List prices:

**85c, 95c, \$1.05, \$1.15, \$1.50**



**Flexible Coupler**

Efficient and inexpensive. Of flexible fiber. Diam. 3/8"; two 1/4" bushings mounted on flexible phosphor bronze spring. List price **35c**



**Dial and Pointer Knobs**

Direct drive. Heavy aluminum, black finish, silver etched lines and numerals. 3 3/4" diam. Calibration 100 to 0 or 0 to 100. List price 72c. 2" diam. Calibration 100 to 0 or 0 to 100. List price..... **50c**



**New All Wave DOUBLE Doublet Antenna**

New type noise reducing system for all-wave and short wave receivers. Big improvement over ordinary doublet antennas. 60 ft. span; List price, \$5.50. Special 34 ft. span where there are space limitations. List Price..... **\$6.00**



**A DISCOUNT OF 40%**

applies on all items shown here when purchased through your favorite Mail Order House or Jobber. If he cannot supply you, write us giving his name and address and we will see that you are supplied.

**BIG NEW 1935 CATALOG**

Send 10c stamps or coin to cover cost of handling and mailing big new 1935 catalog listing hundreds of parts and accessories as well as our complete line of receiver kits. Supply limited. Send now to avoid disappointment!

**INSULINE CORP. OF AMERICA**  
 23-25 Park Place, Dept. W-35, New York, N. Y.

**When To Listen In**

(Continued from page 672)

being announced as 2RO or I2RO once more. 2RO also operates daily from 2:30-5 or 6 p.m. on 30.67 met. relaying the programs from the broadcast station at Rome.

**Java**

A new station in Java, according to Australian reports, is now being heard at good strength on about 78.6 meters simultaneously with YDA on 49.02. The N.I.R.O.M. is now conducting tests of their new 10,000 watt short-wave broadcasting station.

**Panama**

The new Panama station at Panama City is now being frequently heard in the evening. The call used is HP5B. The station operates anywhere from 5950 to 6030 kc.

**Portugal**

There is now a new station at Parede, Portugal, operated by the Portuguese Radio Club. It is a 300 watt and operates on either 12,396 kc or 6,198 kc. The call used is CT1GO.

**Budapest**

HAT at Szekesfeharvar, near Budapest in Hungary on 5,400 kc. (55.56 met.) now broadcasts on Mondays from 8-9 p.m. HAS3 at the same place broadcasts on 15,370 kc. (19.52 met.) each Sunday from 8-9 a.m. Announcements in English are frequently made. The power of both transmitters is 20,000 watts, the same as Daventry.

**LKJ1**

The station at Jeloy, Norway, is supposedly operating on 2 different waves at present. It is on 31.45 met. from 5-8 a.m. and on 48.94 met. (6128 kc.) from 10 a.m.-6 p.m.

**Bombay**

VUB at Bombay is now operating irregularly in the early morning hours in addition to its regular schedule. It has been frequently reported on around 5-7 a.m. relaying the long wave station in Bombay. It operates on 9565 kc. Only 5 kc. from DJA on one side and 5 kc. from W1XAZ on the other side.

**France—New 120,000 Watt Station!**

The new high-power station located at Villejust, will probably begin testing in March, and is under the supervision of the Minister of Posts and Telegraph at Paris. Six new waves have been assigned to this station in the 49,31.25, 19.16 and 13 meter broadcast bands. The exact frequencies are as follows: 6,145, 9,585, 11,845, 15,295, 17,765 and 21,490 kc. On the 49 and 31 meter waves the transmitter will have a power of about 120,000 watts!

**HIX**

HIX at Santo Domingo has shifted its wavelength and is now on about 5,980 kc.

**HI4D**

HI4D in the Dominican Republic operates on about 6,500 kc. on Mon. and Sat. from 4:40-7:40 p.m.

**TIEP**

This station in Costa Rica now operates on 22.35 meters (13,420 kc.) on Sundays from about 1-4 p.m. in addition to the regular schedule on 44.7 meters.

**Paraguay**

Two stations in Asuncion, Paraguay, S.A., will soon be on the air. They are ZP10 on 6,666 kc. and ZP11 on 3,800 kc.

**W2XAF**

W2XAF at Schenectady, N.Y., is now on the air on Saturday afternoon from 2:45 to about 4:30—broadcasting the Metropolitan Opera performances from New York City.

**Sydney**

VK2ME at Sydney, Australia, operates from 1-3 and 5-11 a.m. each Sunday in February and from 1-3, 5-9 and 9:30-11:30 a.m. each Sunday in March. All Schedules in Eastern Standard Time.

**HERE IT IS**

**SHORT WAVE SET BUILDERS MUST HAVE THIS BOOK**

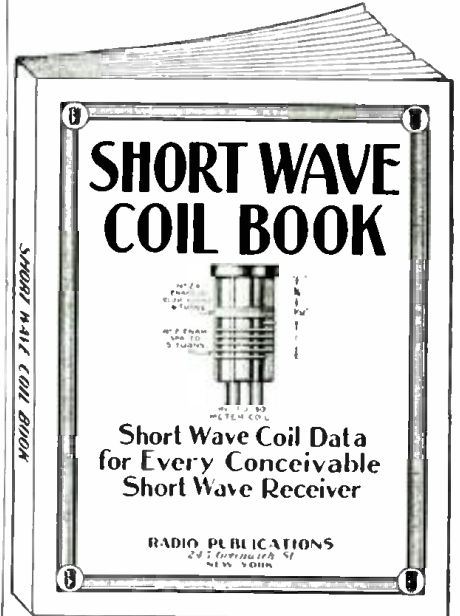

**FOR** the first time, it is now possible for the experimenter and short wave enthusiast to obtain the most exhaustive data on short wave coil winding information that has ever appeared in print.

As every experimenter who has ever tried to build a short wave set knows only too well by experience, the difference between a good and a poor receiver is usually found in the short wave coils. Very often you have to hunt through copies of magazines, books, etc., to find the information you require. The present data has been gotten up to obviate all these difficulties.

Between the two covers of this book you now find every possible bit of information on coil winding that has appeared in print during the past two years. Only the most modern "dope" has been published here.

No duplication. Illustrations galore, giving not only full instructions how to wind coils, but dimensions, sizes of wire, curves, how to plot them, by means of which any coil for any particular short wave set can be figured in advance, as to number of turns, size of wire, spacing, etc.

There has never been such data published in such easy accessible form as this.

Take advantage of the special offer we are making today, as due to increasing costs, there is no question that the price will increase soon.

**RADIO PUBLICATIONS**  
 97 HUDSON STREET  
 NEW YORK, N. Y.



Radio Publications,  
 97 Hudson Street,  
 New York, N. Y.

3-35

Please send immediately, your Short Wave Coil Book, for which I enclose 25c herewith (coin, U. S. stamps or money order acceptable). Book is to be sent prepaid to me.

Name.....  
 Address.....  
 City and State.....

Please mention SHORT WAVE CRAFT when writing advertisers





# MICA CONDENSERS ...AEROVOX Engineered

There's good reason why Aerovox Types 1455, 1456 and 1457 Transmitting Condensers depart from conventional design. Here's why:

- Flat top and bottom permit perfect stacking for compact assemblies or condenser banks.
- Insulated mounting holes permit any mounting independent of electrical connections.
- And insulated terminals permit any combination or individual arrangements, series or parallel connections.
- Special terminals permit soldered connections without harmful heat transfer to encased section.

Available in 1000, 2500 and 5000 Volt D.C. ratings, and widest range of capacities. Values plainly stamped on each unit.

DATA FREE: New 1935 catalog describing complete line of condensers and resistors, on request. Also sample copy of monthly Research Worker.



72 Washington Street : Brooklyn, N.Y.

## The DX2 ALL-WAVE RECEIVER



Hear foreign short wave broadcasts, police calls, amateur telephone stations, transmitters and experimental stations, radio telegraph as well as regular broadcast stations in the U.S. with this receiver. Use one type 30 and 33 tube as regenerative detector and pentode amplifier. Great scheme. Beautiful black crackle finish metal chassis and panel. Two 2-drv cells and 1.45V. battery, and 1C battery. Coils for 10-200 meters, and instructions included. *Complete Reception is Guaranteed.*

**Kit \$4.35**  
 Wired and tested, extra \$1.25  
 Arrangements taken, 1.50  
 Residual profit, .60  
**Special offer: Complete receiver, ready to use, less phone and batteries, \$7.75**

## THE SIMPLEX RECEIVER

An extremely simple electrical receiver for the radio beginner. Requires no batteries. Operates entirely from the 110 volt house lighting current. Works on short aerial. No ground connection needed. Use one 12A7 (2 tubes in 1 bulb) as regenerative receiver and separate power supply. Built in neat, black crackle finished metal cabinet. Volume dial and smooth regeneration control. *Consistently good value for the money.* 2 coils covering 30-300 meters and instructions included. 3 extra coils extending range down to 10 meters, extra \$0.60.

**Kit \$3.95**  
 Wired and tested, extra \$1.00  
 Arrangements tube, .95  
**Special offer: Complete receiver, ready to use, less phone, at only \$5.65 (2 coils)**

Headphones, 2000 ohm, \$1.35  
 C.O.D. orders filled promptly.

**CENTRALLION ENGINEERING CO.**  
 Dept. Sw3, 451 Fourth Ave., New York, N.Y.

See Page 696 for Special Subscription Offer on SHORT WAVE CRAFT

## Low-Power Rack-Panel Xmitter

(Continued from page 676)

a single envelope and intended for audio amplification. One section of the tube operates on low voltage and the other at voltages as high as 600. Needless to say the crystal-oscillator part is the low voltage section on which only 150 to 200 volts are necessary to obtain full output of the high voltage section. This is undoubtedly due to the direct coupling of the tube elements. It will be noticed by referring to the diagram of the tube that the cathode of the small triode is connected to the grid of the larger triode. This tube is ideal for a crystal stage as the second harmonic is fully 80 per cent as strong as the fundamental, which makes it valuable when a single crystal is to be used on more than one band.

This transmitter, for it is really that, was used at the writer's station and performed very nicely. Communication over several hundred miles was possible on either 80 or 40 meters with an 80-meter crystal. So this can be truly called a low-power "two-hand" transmitter. The coils are standard Hammarlund plug-in coils, with the turns adjusted and tapped according to the data given in the appended coil table. The ticklers of these coils are not needed and are removed. The oscillator coil is tapped approximately one-third the number of turns from one end, in order to obtain the neutralizing voltage for the large triode when it is tuned to the crystal frequency. As we cannot

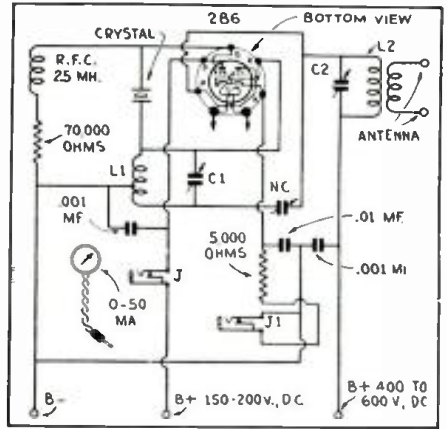

Hook-up of Transmitter

get at the grid of the large triode, it is necessary to obtain bias for it via the cathode; this is accomplished with the aid of the 5000-ohm resistor.

Looking at the front of the panel we find that the oscillator condenser and coil are on the left and the amplifier tuning condenser and coil are on the right-hand side. If the reader wishes to reverse the arrangement for some reason, just turn the socket of the tube around so that the heater terminals are facing the rear edge of the wood baseboard instead of the front panel. The antenna coil is wound on a bakelite tube large enough to fit around the plate coil and is wound with 12 turns of No. 14 enameled antenna wire. The coil is supported by the two antenna insulators which also serve as the antenna connections. The meter in the center of the panel is used for indicating the plate currents of both triodes. A plug is connected to the meter and the two jacks are used for the different readings. One jack is in the plate lead of the oscillator and the other jack in the cathode of the amplifier. This last mentioned jack is also used for "keying" the transmitter.

The oscillator coil which is placed in the cathode circuit of the small triode, is

**Announcement by HUGO GERNSBACK**

**I ASK YOU A FAVOR**

YOU HAVE BEEN AN ENTHUSIASTIC READER OF SHORT WAVE CRAFT AND YOU WANT TO BE HERE ALWAYS. SHOW ME A SPECIAL FAVOR TO ME, THAT ON OR AFTER JANUARY 27TH, 1935, SEND ME YOUR BEST NEWSSTAND A COPY OF THE SHORT WAVE CRAFT MAGAZINE. TAKE IT HOME AND TAKE CARE OF IT CAREFULLY.

IF AFTER YOU HAVE BOUGHT YOUR FIRST COPY AND HAVE READ IT, YOU ARE NOT FULLY SATISFIED WITH THE MAGAZINE, I AUTHORIZE YOU HEREWITH TO RETURN THE COPY TO THE PUBLISHERS TO BE EXCHANGED FOR A REFUND. THE REASON WHY YOU DO NOT LIKE THE MAGAZINE OR IF YOU DO NOT WANT TO TAKE CARE OF IT IS ORTHO THE MONEY I ASK FOR IT.

THIS IS MY SPECIAL PROMISE TO YOU

*Hugo Gernsback*

P. S.—If you cannot get the magazine at your newsstand, drop to sell-out, send 25c in cash, stamps, or money order, and we will send the magazine to you direct, prepaid.

OFFICIAL SHORT WAVE LISTENER MAGAZINE  
 90 Hudson Street, New York.

IT IS NOT A TECHNICAL MAGAZINE. It is designed for the short wave listener only. The first, the February-March issue, which is now on all newsstands, contains the following material:

**What You Will Find in the New Official SHORT WAVE LISTENER MAGAZINE**

Over 800 short-wave stations in various parts of the world await the touch of a finger on the tuning dial of your "short" or "all wave" receiver.

Among the 800 odd short-wave stations there are many aboard ocean going ships, and counting the "individual" S-W stations calls, you may hear from the short wave broadcast points in England, the United States, and South America.

There are nearly 300 stations calls, giving regular short-wave program service.

The new SHORT WAVE LISTENER magazine contains the following valuable features, which every short-wave "fan" cannot afford to miss!

Plots and descriptions of short wave broadcasting stations all over the world, with photos of short wave studio artists.

Where to find the important short-wave "DX" stations on the dial of your receiver.

Verification cards, what they are and how to get them.

Up-to-the-minute brand list of short-wave stations of the world with call letters and frequencies, including "Police,"

THE OFFICIAL SHORT WAVE LOG AND CALL MAGAZINE, of which two issues have been published, will hereafter come out every other month under the name of

**Short Wave Listener MAGAZINE**

OFFICIAL HUGO GERNSBACK

I have created an entirely new magazine for the short wave listener, such an excellent improvement on the magazine formerly published in the name of the former magazine, and nothing like it has ever been published before.

To begin with, the new magazine comes with a four-color cover, and it is beautifully printed throughout. It contains a great variety of material, all of which is essential today to the short wave listener.

Please mention SHORT WAVE CRAFT when writing advertisers

**PROVEN DEPENDABLE • PROFESSIONAL BAND-SPREAD DX5**



- BUILT-IN DYNAMIC SPEAKER
- CONTINUOUS BAND SPREAD
- SELF CONTAINED AC POWER SUPPLY
- 5 DISTINCT WAVE BANDS
- ALL WAVE
- BUILT-IN COIL HOLDER RACK
- HIGH SENSITIVITY AND SELECTIVITY
- AEROPHAME DIAL
- MANUAL ANTENNA CONTROL
- HIGH FIDELITY
- 5 NEW TUBES USED
- VERY EASY TO CONSTRUCT

Complete kit including Dynamic speaker, power supply, coils from 14 to 200 meters, coil holder rack and complete instructions. **Special Offer.**

Black crackle finished metal cabinet ..... \$2.50  
 Kit of matched ARCTURUS tubes ..... 3.10  
 Broadcast coil, 200-550 Meters ..... .95  
 If you prefer it Custom Built, add ..... 2.60

Send 6c in stamps for descriptive circular  
**Order From This Ad Now While We Can Guarantee These Low Prices!**

**WORLD TROTTER RADIO LABS.**  
 168 Washington St., Division C5, New York, N. Y.

**SEND FOR YOUR COPY**

Every short wave fan, experimenter, amateur and serviceman should have a copy of this NEW catalog showing the line of Na-Alo quality products. Send your dealer's name today and get your copy.

**NA-ALO PROCESS VICTRON "A"**

**702RV List 70c**

C15-15 mmf. 5 meter Condenser, List ..... \$2.30  
 75V-NEW 5 meter Choke Coil, List ..... .70  
 700V-Victron Coil Selector, List ..... 7.50  
 Victron Coil Forms and Iso Rets., List ..... 1.00  
 72V-Victron Stand-off Insul., List ..... .35  
 LW2-VICTRON coil Dope, List ..... .35  
 704 SWS-15-200 meter coils, List ..... 2.00  
 704BCS-150-550 meter coils, List ..... 1.50  
 704LWS-150-2000 meter coils, List ..... 2.00  
 Victron's loss factor is only .0008—fused quartz is .001%. Victron is easily machineable. What more need be said?

Na-Alo items are widely stocked—try your regular supplier—if he hasn't them and does not care to get the genuine Na-Alo products order direct from us.

**ALDEN PRODUCTS CO.**  
 Dept. SW 3 715 Center St. MASS.  
 BROCKTON.

**THE NEW MERRIAM-WEBSTER**  
 REG. U.S. PAT. OFF.

**WEBSTER'S NEW INTERNATIONAL DICTIONARY**  
 Second Edition

600,000 Entries. Thousands of New Words. 12,000 Terms Illustrated. Thousands of Encyclopedic Articles. 35,000 Geographical Entries. 13,000 Biographical Entries. 200 Valuable Tables. 3,350 Pages. Cost \$1,300,000. At Bookstores or Write for Booklet.

**G. & C. MERRIAM CO.**  
 Springfield, Mass.

**PATENTS — TRADE MARKS**  
 All inventions submitted held confidential and given personal attention by members of the firm.  
 Form "Evidence of Conception" and instructions  
 "How to Establish Your Rights"—Free  
**LANCASTER, ALAWINE & ROMMEL**  
 PATENT LAW OFFICE  
 475 Bowen Bldg. Washington, D. C.

tapped and this tap is connected to the "B" minus. The neutralizing condenser "nc" is connected between the low side of the coil and the plate of the large triode. This is a 50 mmf. midget variable. When frequency doubling, the adjustment of this condenser is not critical.

After the transmitter is wired and checked to make sure that no errors have been made, we are ready for the preliminary adjustments. Apply the heater voltage to the tube and insert the oscillator coil—leave the amplifier coil out of the socket. Then apply the low voltage to the plate of the oscillator section and plug the meter into jack "J"; the reading on the meter should be around 15 milliamperes. Now rotate the oscillator tuning condenser until a "dip" is noticed; during this "dip" the current should fall to 10 milliamperes. This dip in current indicates resonance with the crystal frequency. Leave the dial set for minimum current reading on the meter and plug in the amplifier coil—do not apply the plate voltage to the amplifier at this stage of the operation, and we are ready to neutralize the amplifier. Swing the amplifier tuning knob from one of the scales to the other and note that there is a change in plate current of the oscillator at one setting of the amplifier tuning condenser setting. In order to effect this effect, adjust the neutralizing condenser until there is no change in the oscillator plate current when the amplifier condenser is swung back and forth. This operation should be done very carefully to insure proper results. The transmitter is now ready for operation.

The plate voltage should now be applied to the amplifier; remove the meter plug from the oscillator jack and insert it into jack J1. Rotate the amplifier condenser until the plate current is at a minimum. This indicates resonance between the two circuits. The antenna can now be connected and the amplifier "loaded" until the meter reads 40 milliamperes. Always readjust the amplifier condenser for minimum plate current under load; the antenna will detune it slightly.

So far we have confined ourselves to operating on the crystal frequency. Further notes on doubling to higher frequencies with the same crystal will be given in following articles. Complete information will also be given on the construction of antennas.

**Parts List for Panel Transmitter**

- 1—140 mmf. midget condenser, Hammarlund, Bud. (C1)
- 1—50 mmf. double-spaced, midget condenser, Hammarlund, Bud. (C2)
- 1—50 mmf. midget condenser, Hammarlund, Bud. (NC)
- 2—.001 mf. mica condensers, 1,000 volts, Aerovox.
- 1—.01 mf. mica condenser, Aerovox.
- 1—70,000 ohm wire wound Resistor, 5 or 10 watts, Aerovox.
- 2—single closed circuit jacks, I.C.A. (J-J1)
- 1—phone plug for meter, I.C.A.
- 2—prong ceramic sockets, Bud.
- 1—7 prong large ceramic socket, Bud.
- 1—5 prong ceramic socket, Bud.
- 2—sets of Hammarlund plug-in coils (see coil table for alteration).
- 1—2.5 mh. R.F. Choke, Hammarlund.
- 2—stand-off insulators, ICA.
- 1—7"x19"x3/16" bakelite panel, ICA.
- 1—0-50 milliammeter.
- 2—metal dials and pointers, ICA.
- 1—crystal and holder, Bliley.
- 5—Fahnestock clips.

**COIL DATA**

Band Osc.	Tap	LW*	Amp.	Wire	LW
80	30T.	10th	1 3/4"	80 No. 20	1 3/4"
40	14T.	4th	1 1/4"	16 No. 18	1 3/4"
20				9 No. 14	1 1/4"

\*—Length of Winding.

**How To Get "High Fidelity" from Your Old Loud-Speaker! Described in Next Issue.**

**In Stock—Immediate Delivery The NEW PATTERSON PR-12**

- 56 Features . among them are:**
- Pull range 8 to 550 meters.
  - Patterson Selector-Band Dial: airplane type; shows only band in use; microthermic 2 speed tuning; 10 to 1 and 50 to 1 reduction; anti-backlash rubber drive.
  - New 6 section tuning gang condenser gives an exceptionally low C tuned circuit, resulting in extremely high gain (approximately twice) on the short-wave bands, equalizing or surpassing plug-in coils.
  - Newly designed coils, with new type of switch, lowering the amount of dielectric loss and skin effect in tuned circuit.
  - Pre-selection ahead of first detector results in higher signal to noise ratio, decreasing amount of inance response to a minimum; increasing sensitivity, overall gain and selectivity.
  - Modulation and R meter.
  - Crystal filter, which can be cut in as a series or parallel filter; affords two degrees of selectivity, further raising signal to noise ratio and increasing selectivity.
  - Monitor switch, for use in checking quality of your own transmission percentage of modulation, indicated visually and orally.

NOTE: ● indicates NEW; ●●● indicates NEW and EXCLUSIVE!  
**NET DELIVERED PRICES**  
 Complete (absolutely nothing else to Buy!)  
 PR-12 Crackle cabinet without crystal..... \$82.00  
 PR-12 Console without crystal..... 99.65  
 PR-12 Crackle cabinet with crystal..... 87.90  
 PR-12 Console with crystal..... 105.55

Chassis also available  
**SARGENT**  
 8-34-15 to 560 meters, R tube super-het complete with tubes, speaker, etc. \$54.50  
 "Marine" model—same as 8-34 except for tuning range 15 to 1500 meters, complete \$62.50  
 Peak Pre-Selector \$19.80  
 Patterson Pre-Selector \$17.64  
**NEW "MARINE" 100 Watt Phone-C.W. XMITTER**  
 Many exclusive features including Visual distortion Indicator-Modulation Percentage Indicator. Send stamp for descriptive folder and details.

**SHIPPED PREPAID** If full purchase price accompanies your order.  
 Send for our bulletin "Amateur Transmitter," which lists and describes "Everything for the Ham!"  
**L. I. MARINE & ELECTRIC CO.**  
 W 2 G O Y — W 2 R G Q  
 163-18 Jamaica Ave., Dept. S335, Jamaica, N. Y.  
 CABLE ADDRESS "ELECTMARINE NEW YORK"

**Learn CODE The CANDLER Way PRACTICE EQUIPMENT Furnished FREE With SCIENTIFIC CODE COURSE**

Complete Training in Code, Radio Fundamentals and Theory to enable you to pass the Exam., build your own station and operate it. All skilled amateurs and radio men will tell you CANDLER Training is the best that can be had, and that our students' real fast press and traffic as easily as they read a newspaper, and copy behind with "init" or pencil.

**FREE—CSCG SCHEDULE.** Listing all CSCG stations broadcasting daily practice programs from every district. Listen to CANDLER trained ops on your s. w. receiver.

**Work your former student, Watson, Chief Op, BEAK OF OAKLAND, NEW, every night. One of finest ops I ever worked. We hit up to 45wpm right alone. I work Candler men in all parts of world. They're fast—many! CANDLER COURSE best investment I ever made." 73 L. S. HENDERSON, Op., KFS, M.R.T. Half Moon Bay, Calif.**

**CANDLER GUARANTEE** (not promise) protects you. Money back if you "hunk". Get your training where the champions and world's fastest ops got theirs. Small cost, easy payment plan. **FREE BOOK OF FACTS** gives details. A card will bring it.

**CANDLER SYSTEM Co.** Dept. S-3  
 6343 S. Kedzie Ave., Chicago

Please mention SHORT WAVE CRAFT when writing advertisers



## AC 6 Tube Super-Heterodyne

**"SWOOPS" ACROSS THE CONTINENTS—AND IT TAKES A SUPER TO DO IT!**  
See Feb. Issue Short Wave Craft, page 600.

Complete Kit of Parts Less **\$17.95**  
tubes and Speaker  
Rola Dynamic Speaker \$3.45

an EAGLE All-Wave is a Round Trip Ticket for Everyone at Home. Visit Germany, England, France, Japan, China, Australia, Brazil, San Domingo, etc.  
WIRED—READY TO OPERATE, \$7.00 EXTRA.

### LOUD SPEAKER VOLUME ON 2 TUBES

## EAGLE AC-DC QUADRODYNE



Complete Receiver—Range 10-600 Meters 2 Raytheon Tubes, 47 Tubes, \$2.25  
1 1/2 inch Loud Speaker \$1.45  
RECEIVER WIRED—READY TO OPERATE, \$1.00 EXTRA

### 5 Meter Tranceiver Kits

Choice of 3 models—2 volt, 6 volt or A.C. model. Made completely of ICA parts. Easy to build! Complete instructions, diagrams. Your choice of any model **\$11.40**



## EAGLE RADIO CO.,

84 Cortland St., Dept. S-3, N. Y. C.

Technical Data on All Kits FREE.

## WHEN CHOOSING A RADIO SCHOOL

RCA Institutes, with its reputation firmly established by 25 years service, is an institution recognized as an important factor in the radio industry.

Whether elementary radio principles or advanced subjects, sound applications, mathematics or practical radio engineering, RCA Institutes is prepared to give you the instruction you need.

**Resident Schools at New York and Chicago**  
Modern Apparatus and Laboratory Equipment—Conveniently Located—Day and Evening Classes—Tuition Rates \$3 to \$10 Weekly.

Extension courses for home study on convenient "no obligation" plan. Examination and technical advisory services. Free post-graduate practical training at resident school with modern equipment under instructing engineers.

Write for Catalog.

## RCA INSTITUTES, Inc.

Dept. SW-35

75 Varick Street  
NEW YORK

1154 Merchandise Mart  
CHICAGO

Recognized Standard in Radio Instruction Since 1909.



## Denton 1935 "Discoverer"

(Continued from page 665)

manipulated after the station has been tuned in.

Control of volume is effected by varying the cathode resistance of the type 58 tube. This method of bias variation is usually not sufficient for really smooth control, so that it is combined with an antenna control, as shown. Thus, the cathode current of the 58 flows through the resistor R1, through the potentiometer P1, through the antenna coil to ground. Moving the arm up or down shunts more or less of the current through the antenna coil, at the same time varying the amount the antenna coil is short circuited. The control of volume by this composite scheme has been found to be most effective for short-wave work.

### Phone-Jack Provided

A phone-jack is provided for reception with earphones. Those experimenters who have had occasion to hunt for distant stations late at night with the sensitivity of the receiver "full on" will appreciate this feature—especially when "friend wife" objects to the noise!

In this set the tone control is placed in the output stage, from plate to ground of

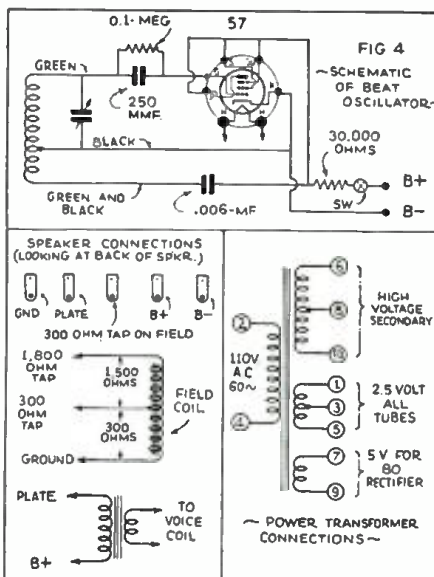

### Beat Oscillator Hook-up.

the 2A5. Continuous, rather than step-by-step, variation of tone is much to be preferred.

### Speaker Field As "Choke"

The power-unit is of rather conventional design, though not by any means "standard." The speaker field, which should have a total resistance of 1800 ohms and tapped at 300 ohms, is used as the filter choke. The 300-ohm section supplies the bias for the 2A5, and is preferred over the self-bias method because the bias is more fixed, and so more independent of signal fluctuations. This insures a minimum of audio degeneration and increased low-frequency response.

The parts available for this receiver may be obtained in kit form, and include a drilled and finished chassis and panel. The chassis is cadmium plated steel, and the front panel is black crackle finished. The cadmium plating has been found very effective in reducing oscillation in the I.F. amplifier. Steel, unplated, must not be used because of its high resistance.

It is wise to first mount the electrolytic condensers, tube sockets, I.F. transformers, gang-tuning condenser, and other large units first. Then place the phone-jack, tone control resistance and antenna-ground strip at the rear edge of the chassis and bring out the lead which connects from the second I.F. transformer to the grid of the type 57 tube.

# WESTINGHOUSE

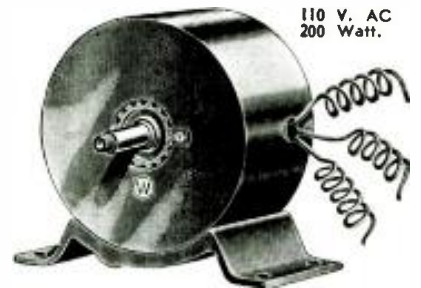

## Power Generator

MANUFACTURED FOR U. S. SIGN. CORPS

SPECIFICATIONS

WEIGHT—14 1/2 lbs.  
HOUSING—Aluminum (Diameter—6 1/4 in. Length—5 1/4 in.)  
SHAFT—2 3/16 in. (driving end) (diameter 9/16 in.—the end is threaded for a distance of 1/4 in.)  
BASE—Cast Iron. (Length—7 1/2 in. Height—1 9/16 in. Width—4 1/4 in.)  
OUTPUT—200 Watt 110 volts AC (speed 4500 R.P.M.)  
STATORS—Two pairs (two North and two South)  
ROTOR—12 tooth inductor. Built in commutator. Rotor turns in ballbearings.

(GENERATORS HAVE NEVER BEEN USED)

**FREE** With each Westinghouse Generator we supply free of charge a set of diagram-blue prints and instructions showing twenty-five different uses, giving technical information, electrical hookups and installing explanations. We also include free of charge a set of four replacement carbon brushes.

## THERE ARE OVER 25 APPLICATIONS SOME OF WHICH ARE:

- A.C. DYNAMO lighting from eight to ten 20 Watt 110 Volts lamps
  - SHORT WAVE TRANSMITTER supplying 110 Volts AC for operating "Ham" transmitter.
  - OPERATING 110 V. AC 60 CYCLE RADIO RECEIVER in DC districts.
  - MOTOR GENERATOR.
  - PUBLIC ADDRESS SYSTEMS.
  - ELECTRIC STRENS on motor boats, yachts, etc.
  - CAMP LIGHTING.
  - SHORT WAVE artificial "fever" apparatus.
  - TELEVISION.
  - FELTON WATERWHEEL for lighting or other purposes.
  - AIRPLANE: for lighting strong search lights or electric signs.
  - LABORATORY WORK.
- Furthermore the following uses are explained:  
How to obtain electrical power:  
from a Windmill, from available Waterpower, from your Automobile, from your Motorcycle, from your Bicycle, Footpedals or Handcrank (for transportable Radio Transmitters, Strong Floodlights, Advertising Signs); how to operate AC Radio sets from 32 V.DC farm light systems; how to operate two generators in series to get 200 V.AC; how to obtain two phase and three phase AC., etc., etc.

Generator as described above including four replacement carbon brushes and folder containing instructions and uses **\$7.90**

Shipping weight 18 lbs.  
(Replacement carbon brushes bought separate \$1.50 per set of four. Set of instructions bought separate \$1.00.)

Remit by check or money order. Shipped Express Collect if sufficient money is not enclosed for parcel post. Money refunded if not satisfied.

**WELLWORTH TRADING COMPANY**  
560 W. Washington Blvd. CHICAGO, ILL.

WELLWORTH TRADING COMPANY, SW-3-35  
560 W. Washington Blvd., Chicago, Ill.

Enclosed you will find my remittance of \$..... for which please send me

( ) Power Generator, \$7.90 each.

Name .....

Address .....

City .....

State .....

Please mention SHORT WAVE CRAFT when writing advertisers



**"Satisfactory Short Wave Reception Under Worst Possible Conditions"**

**LYNCH**  
HI-FI  
TRADE MARK REGISTERED  
(High-Fidelity)  
**ANTENNA SYSTEMS**

"We are located on the ground floor of an eleven story office building. In this building are a number of doctors with X-ray equipment, etc., and within one hundred feet of us is another office building in which are over three hundred doctors with their associated electrical equipment. Reception conditions were so bad that in the daytime with a normal antenna, it was practically impossible to hear anything except local broadcast stations.

"We have installed two 20 1/2 foot eases and are using one of your new HI-FI Coupling Kits with 240 feet of Giant Killer Cable. The Q. is splendid, now comes through beautifully, with very little background noise. We have checked during the day and find that even if the X-rays are running, we are able to get sufficient decent reception to give a very convincing demonstration to a customer that a short wave radio will work satisfactorily with a LYNCH Antenna system."  
(None on Request)

**"No Radio Can Be Better Than Its Aerial—No Aerial Is As Good As a LYNCH Aerial."**

Full Information on Request  
Arthur H. Lynch, Inc., 227 Fulton St., N. Y.  
PIONEER OF NOISE-REDUCING AERIALS

For Real SHORT WAVE THRILL Get

**THE AMATEURS FAVORITE DX3**

**ALL-WAVE ALL-ELECTRIC AC-DC**

**Complete Kit \$6.50**

Custom built, extra for speaker, extra for cabinet, Aerials Tubes, Broadcast Coil.

Power supply built-in, Built-in speaker, Two 6J6, 70 and 38, Very easy to build because it uses only the best standard parts. The full size blue printed parts list shows all the connections so clearly that even if you have never built a short wave set before you will have no difficulty in assembling it correctly.

Foreign Reception Guaranteed  
ORDER NOW while we can guarantee this exceptionally low price! Or send 6c in stamps or coin for descriptive literature!

**WORLD TROTTER RADIO LABS.**  
168 Washington Street, Division C-6, New York, N. Y.

**RADIO'S LIVEST MAGAZINE**  
Edited by HUGO GERNSBACK

RADIO-CRAFT is devoted not only to the radio experimenter and technician, but also to the beginner in radio. Picture diagrams simplify construction of sets. Kinks about simple ways out of difficult problems. The latest radio equipment is illustrated and described.

**8 Months for \$1.00**

RADIO-CRAFT is fully illustrated with photographs, diagrams and sketches. Each issue contains over 150 illustrations. 15c for Sample Copy.

**RADIO-CRAFT**  
99C Hudson Street New York, N. Y.

**SEXOLOGY**  
THE MAGAZINE OF SEX SCIENCE

SEXOLOGY, foremost educational sex magazine, is written in simple language and can be read by every member of the family. It is instructive, enlightening—not a risqué book—contains no offensive matter.

Contains 25 important articles on Sex Science, 68 pages, with attractive two-color cover. Here are a few of the more important articles:

"Frigidity Often Curable"; Sex Life During Pregnancy (Illustrated); Homosexuality in Growing Girls (Illustrated); The Danger of Petting (Illustrated); Why Gonorrhea is Often Not Cured (Illustrated); Training Children for Sex Life (Illustrated); Operations on Female Breasts (Illustrated); The Latest Taboo: Alcohol and the Sex Organs; Similarity of Male and Female Organs (Illustrated); What Causes Prostitution? (Illustrated).

**SEXOLOGY**  
95 Hudson St. New York, N. Y.

Get a copy of SEXOLOGY on a try basis, or, if your dealer cannot supply you, send 25c cash or stamps for current issue.

The volume control is mounted on the left-center of the front panel and is also equipped with the line switch to shut the set on and off. The extreme right-hand control is the oscillator trimmer condenser.

**Beat Reception**

A novel device, which is optional, can be had to make beat reception possible. The right-hand ledge of the chassis has one large and two small holes drilled in it. By means of these small holes a special tubecoil assembly is mounted and wired to the receiver through the large hole. This special assembly, the circuit of which is shown in Fig. 4, is then an integral part of the chassis and permits beat reception. It is an oscillator of special construction for this receiver.

The design of this receiver is such that no difficulty should be had in tuning in many of the "foreign" short-wave stations on the air. Maximum sensitivity is assured by the use of plug-in coils having the following ranges:

frequency in mcgy.	wavelength in meters
1.55-4.6	193-65
3.80-8.0	67-37
7.90-17.0	38-17.6
16.00-24.5	18.7-12.3

From this table it is seen that sufficient overlap is provided between bands and the set may be tuned to almost 12 meters. A hint: when it is possible to tune in a station on two sets of coils (at the high end on one set and on the low end on another), use the coils that require the least tuning capacitance for greatest signal strength.

**List of Parts**

- 1 chassis, part No. 498, as described.
- 1 panel, part No. 499, as described.
- 2 condenser mounting brackets for TC, part No. 500.
- 1 dual-gang condenser, 140 mmf. per section, part No. 501, TC.
- 1 seven-prong "2A7" socket, part No. 287.
- 1 six-prong "5Y7" socket, part No. 295.
- 1 six-prong "57" socket, part No. 30.
- 1 five-prong "56" socket, part No. 31.
- 1 six-prong "2A5" socket, part No. 315.
- 1 four-prong "80" socket, part No. 1.
- 2 live-prong plain sockets, part No. 38.
- 2 resistors, 300 ohms each, 1/2 watt, part No. 77, R1.
- 1 resistor, 25,000 ohms, 1/2 watt, part No. 280, R2.
- 1 resistor, 2 megohms, 1/2 watt, part No. 78, R1.
- 2 resistors, 20,000 ohms each, 2 watts, part No. 296, R3.
- 1 resistor, 3,000 ohms, 1/2 watt, part No. 337, R7.
- 1 resistor, 500,000 ohms, 1 watt, part No. 271, R6.
- 4 resistors, 250,000 ohms, 1/2 watt, part No. 333, R5.
- 2 resistors, 50,000 ohms, 1 watt, part No. 65, R8.
- 1 resistor, 1 megohm, 1 watt, part No. 60, R9.
- 1 I.F. input transformer, part No. 521, 1F2.
- 5 condensers, .1 mf., part No. 417, 200 volt, C1.
- 3 condensers, .1 mf., part No. 81, 400 volt, C1.
- 2 condensers, .01 mf., part No. 80, C4.
- 2 condensers, .5 mf., part No. 440, C3.
- 1 condenser, .05 mf., 400 volts, part No. 519, C6.
- 3 condensers, .00025 mf., mica, part No. 87, C3.
- 1 condenser, .0005 mf., mica, part No. 539, C2.
- 2 r-f chokes, part No. 86, RFC.
- 1 phone-jack, part No. 85.
- 1 variable condenser, 100 mmf., part No. 288, VC2.
- 2 filter condensers, electrolytic, 8 mt. each, part No. 18, C7.
- 1 volume control, 15,000 ohms, part No. 389, P1.
- 1 tone control, 50,000 ohms, part No. 493, P2.
- 1 switch plate, part No. 406.
- 1 power transformer, part No. 277, P.T.
- 1 line cord, part No. 151.
- 3 tube shields, part No. 239.
- 4 knobs, part No. 331.
- 1 dial and hub, part No. 256.
- 1 dial driver, part No. 303.
- 3 pilot caps, part No. 90.
- 30 machine screws, part No. 131, 6 3/2x1/2".
- 40 hexagon nuts, part No. 117, 6 3/2x1/2".
- 6 soldering lugs, part No. 98.
- 4 hexagon nuts, part No. 111, 8 3/2x1 1/2".
- 4 machine screws, part No. 118, 6 3/2x1/2".
- 2 fiber washers, part No. 129.
- 16 feet of No. 14 wire, part No. 155.
- 1 dynamic speaker, part No. 293 with output transformer.
- 1 kit of eight coils, part No. 505.
- 1 antenna-ground strip, part No. 506.

**Low-Power Screen-Grid Xmitter Pentode**

(Continued from page 665)

and amplifier circuits and also will serve as an output amplifier which can be modulated either by suppressor grid modulation or the usual plate modulation. The power output obtainable with this tube as a Class C amplifier is 16 watts and with suppressor grid modulation, the carrier is reduced to approximately 3.5 watts, allowing a peak—during modulation—of 14 watts. Needless to say an excellent and inexpensive power amateur phone "rig" could be constructed around these tubes.

Now—a high-powered—

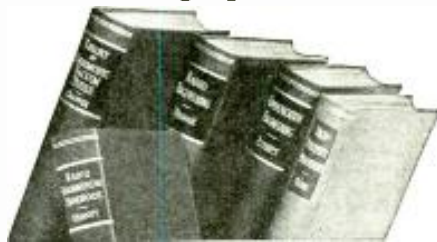

**Radio Engineering Library**

—especially selected by radio specialists of McGraw-Hill publications  
—to give most complete, dependable coverage of facts needed by all those fields are grounded on radio fundamentals  
—available at a special price and terms.

These books cover circuit phenomena, tube theory, networks, measurements, and other subjects—give specialized treatment of all fields of practical design and application. They are books of recognized position in the literature—books you will refer to and be referred to often. If you are practical designer, researcher or engineer in any field based on radio, you want these books for the help they give in hundreds of problems throughout the whole field of radio engineering.

5 volumes, 2981 pages, 2000 illustrations

1. Everitt's COMMUNICATION ENGINEERING
2. Terman's RADIO ENGINEERING
3. Chaffee's THEORY OF THERMIONIC VACUUM TUBES
4. Hund's HIGH-FREQUENCY MEASUREMENTS
5. Henney's RADIO ENGINEERING HANDBOOK

10 days' examination. Special price. Monthly payments, \$26.00 worth of books cost you only \$23.00 under this offer. Add these standard works to your library now; pay small monthly installments, while you use the books.

**SEND THIS ON-APPROVAL COUPON**  
McGraw-Hill Book Co., Inc.  
330 W. 42nd St., New York, N. Y.

Send me Radio Engineering Library, 5 vols. for 10 days' examination on approval. In 10 days I will send \$23.00 in five cents postage and \$3.00 monthly (bill \$23.50 in total, or return books post paid). We pay postage on orders accompanied by return of first installment.

Name.....  
Address.....  
City and State.....  
Position.....  
Company..... SW 3-35

**THE GREAT 35 POSTAL ALL-WAVE**

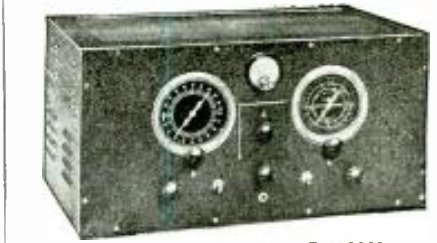

**EXCLUSIVE POSTAL DESIGN**  
The NEW POSTAL '35 now employs every feature necessary to receive the most distant short wave stations. Exclusive triple shielded drawer coils—T.R.F. Preselector on all bands—Continuous band spread—Audio beat oscillator—Electron coupled oscillator—A. V. C.—Manual Control—Precision Tuning meter. Custom built and many other important features. Sold with a 10 day trial money back guarantee. WRITE FOR INTERESTING DESCRIPTIVE LITERATURE AND SPECIAL PRICES.

**NEW 1935 POSTAL BOOSTER**  
Was used by Mr. Edward Schmeichel, the winner of the 12th Short Wave Craft DX Trophy.  
The Postal Booster is custom built. Completely self-powered, employs two genuine stages of R.F. and is guaranteed to improve short wave reception 100% or your money back. WRITE IMMEDIATELY FOR DESCRIPTIVE LITERATURE AND SPECIAL PRICES.

**POSTAL RADIO**  
135 E. LIBERTY ST. NEW YORK, N. Y.

Please mention SHORT WAVE CRAFT when writing advertisers

# NEW 1935 ALL-WAVE AIR SCOUT SPACE EXPLORER



## 10 STAR PERFORMANCE

- ★ Foreign, Short Wave Regular Broadcast and Long Wave Bands
- ★ 9 1/2 to 2000 Meters
- ★ Dynamic Speaker—Ample Volume—Fine Tone Quality
- ★ Five Powerful New-Type Tubes
- ★ Dual Regeneration and Antenna Controls
- ★ Ultra-Sensitivity and Selectivity But Easily Tuned
- ★ Maximum Flexibility and Efficiency.
- ★ Self-Contained Power Supply
- ★ Calibrated Dial
- ★ High Fidelity Performance

COMPLETE—wired, Tested, with Coils from 9 1/2 to 2000 meters. Kit of Five Matched Arcetron Tubes. \$4.00  
 Broadband Coil 0.95  
 Long Wave Assembly Unit (Coil and Condenser) 550 to 2000 Meters 2.00

# \$14.95

### ALLIED ENGINEERING INSTITUTE

98 Park Place Dept. S-18 New York, N. Y.

# Start to Send and Read RADIO CODE at Once!

Practice at Home with Instructograph



**Code Teacher**  
 CODE STUDENTS everywhere are turning to Instructograph, because there is no better way to get regular, systematic practice which is necessary to thoroughly master radio code. No talent or experience necessary. Simple as A B C. All you have to do is "listen" and imitate. Book of instruction explains how to practice and Instructograph sends you real code just like an expert operator would do. Failure impossible.

### Machines, Tapes, Book of Instructions For Sale or Rent

Made more progress in two months with Instructograph than in six months in school writes one Student. What others are doing with Instructograph—you can do. Machines, Tapes and Book of Instruction for sale or rent. Terms as low as \$3 per month. Special for three months rental. Rental applied on purchase price if desired. Rent for a month. If Instructograph meets your requirements buy it. If not, send it back. Write for full particulars. No obligation.

**INSTRUCTOGRAPH COMPANY** Dept. SW-15  
912 Lakeside Place Chicago, Ill.



## ONE OF THE SUPREME FIDELITY AMPLIFIERS

3 STAGE HIGH GAIN PUSH-PULL 46 6V. SOUND TRUCK AMPLIFIER

# 15 WATTS \$37.50 OUTPUT

Send for a copy of our new Less Tubes P. A. Sales Manual and general catalog.

- Uses 2—76, 2—77 and 2—46 Tubes
- Built-in Generator
- 6 V. Sound Truck Amplifier
- Tapped inputs for mike and phone
- Tapped outputs for any speaker combination
- Master gain control and tone control
- Mike current supply, Mike-Phone switch
- No external Transformers required

**Wholesale Merchandisers, Inc.**  
626 Broadway, Dept. S, New York City

# SPECIAL

FOR THIS MONTH

Send \$1.00 (\$1.25 Canada and foreign) and we will send you **SHORT WAVE CRAFT** for Eight months. **DO IT NOW!**

**SHORT WAVE CRAFT**  
99-101 Hudson Street New York

## All-Star Junior

(Continued from page 663)

form between 70 cycles and 5000 cycles. The larger the speaker baffle, the more efficiently the deep tones will be reproduced. A tone control is not used, because it merely reduces the intensity of the desirable higher frequencies which go to make "high fidelity" reproduction possible.

● **POWER SUPPLY**—Standard 110 to 120 volt, 60 cycle, A.C. is the only suitable source of power. The set is designed with low current consuming 6.3 volt tubes; hence it draws less than 60 watts from the electric system! A standard type 80 rectifier tube in a well-filtered "B" supply, using dry electrolytic filter condensers and the 1000 ohm field of the dynamic speaker as part of the filter, delivers "hum-free" power to the tubes. A line filter condenser in the transformer primary prevents outside interference from the A.C. line entering the receiver through the power circuit.

● **ACCESSORIES**—The dynamic loudspeaker must have 1000 ohms field resistance; within 10 per cent is satisfactory. It must be equipped with an output transformer which will match the 7,000 ohm recommended output load of the 42 power tube. A 4-prong plug, its size equivalent to the base and pin arrangement of a type 80 tube, is required to connect the loudspeaker to the output socket on the back of the chassis. The aerial may be a plain wire 40 to 80 feet long and from 10 to 40 feet above ground or metal roofing. It should consist of one piece of good copper aerial wire well insulated with glass or porcelain. A connection to the earth through a water pipe or buried metal plate is required with this type of aerial. In locations where interference is encountered, the doublet aerial system of two equal lengths of aerial pick-up wire should be connected to a twisted pair transmission wire lead-in and connected to the ALL-STAR JUNIOR without a ground wire. Special transformer-coupled "doublet" antenna systems will operate with the JUNIOR perfectly.

● **SOURCE OF PARTS**—All the parts specified in the design of this new receiver are available from radio jobbers and dealers. The parts are all standard components made by one or more manufacturers.

### Parts List (Continued)

- 2—R5—500 ohm resistor—Wirewatt
- 1—R6—200,000 ohm resistor—Carbohm
- 2—R7—500,000 ohm resistor—Carbohm
- 1—R8—25,000 ohm resistor—Carbohm
- 1—R9—1 megohm resistor—Carbohm
- 1—R10—250,000 ohm resistor—Wirewatt
- 1—R11—10,000 ohm resistor—10 watt Red Devil
- 1—R12—15,000 ohm resistor—10 watt Red Devil

### Crowe Name Plate Mfg. Company

- 1—No. 123 Dial
- 4—Nameplates

### Hammarlund Mfg. Company

- 2—Hammarlund Star SM140 (c) Variable Condenser

- 1—Dual MCD35X (ca) Variable Condenser

### Cornell-Dubilier Corp.

- 1—C1—3 sections each 4 mfd. 450 volt condenser EH-9444-1.
- 2—C2—.1 mfd. 400 volt condenser—DT-4P1
- 2—C3—.25 mfd. 400 volt condenser—DT-4P25
- 4—C4—.05 mfd. 400 volt condenser—DT-4S5
- 1—C5—.03 mfd. 400 volt condenser—DT-4S3
- 1—C6—.01 mfd. 400 volt condenser—DT-4S1
- 2—C7—.0005 mfd. mica condenser—2W-5T5
- 1—C8—.0001 mfd. mica condenser—2W-5T1
- 2—C9—10 mfd. 25 volt condenser—ED-2100

### Meissner Mfg. Company

#### Coils for each Frequency Band

- 540-1200 kc. range
  - Antenna Coil—D-4328
  - Oscillator Coil—D-4334
- 1100-2300 kc. range
  - Antenna Coil—D-4329
  - Oscillator Coil—D-4335
- 2200-4400 kc. range
  - Antenna Coil—D-1330
  - Oscillator Coil—D-4336
- 3800-8900 kc. range
  - Antenna Coil—D-4331
  - Oscillator Coil—D-4337
- 7750-16000 kc. range
  - Antenna Coil—D-4332
  - Oscillator Coil—D-4338
- 15.5—30 mc. range
  - Antenna Coil—D-4333
  - Oscillator Coil—D-4339
- Input I.F. Transformer—370 kc.—T-4327 (1 1/2" I.F. Adjustment Wrench included)
- Output I.F. Transformer—370 kc.—T-4327
- Beat-Frequency Oscillator Coil—D-4340
- R.F. Choke—16 millihenries—D-1995

### Electrad Inc.

- 1—R1—280—25,000 ohm potentiometer "log" taper, with Switch, Volume Control

# DATAPRINTS

## Just the CONSTRUCTION

## Information

## You Need

## To Build

## Electrical

## Apparatus

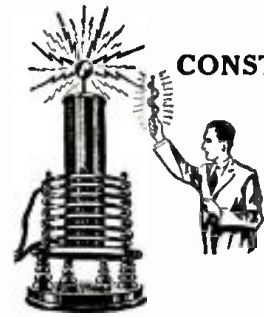

### TESLA OR OUDIN COILS

Dataprint containing data for constructing this 3 ft. spark Oudin-Tesla coil. Requires 1 K.W. 20,000 volt transformer as "exciter"; \$ .75 see list below. Includes condenser data. . .

- 8 inch spark, data for building, including condenser data; requires 1/4 K. W. 15,000 volt transformer; see list below. . . 0.50
- Violetta type, high frequency coil data; 110 volt A.C. or D.C. type; 1" spark; used for "violet ray" treatments and "Experiments" . . . 0.50
- How to operate Oudin coil from a vacuum tube oscillator . . . 0.50
- 3 inch spark Tesla coil; operates on Ford ignition coil . . . 0.50
- 3 inch spark Oudin coil; 110 volt A.C. "Klek-Cole" . . . 0.50
- 20 Tricks with Tesla and Oudin Coils . . . 0.50

### TRANSFORMER DATA

- 1 k.w. 20,000-volt transformer data, 110-volt, 60-cycle primary. Suitable for operating 3 ft. Oudin coil . . . 0.50
- 1/4 k.w. 15,000-volt transformer data, 110-volt, 60-cycle primary. Suitable for operating 8-inch Oudin coil . . . 0.50
- Electric Welding Transformer (State secondary voltage) . . . 0.50
- Induction Coils, up to 12 inch spark data . . . 0.50
- ARTIFICIAL FEVER Apparatus . . . 0.75

(Low, Medium & High Power Data Given)



## SLIDE RULE

### MIDGET

Metal 4" Dia. Price \$1.50.

Case 50c extra

This rule solves any problem in multiplication, division, addition, subtraction, and proportion; it also gives roots and powers of numbers, logs, cosines, tangents and cotangents of all angles; also logs of numbers, Adds and subtracts fractions. Approved by colleges.

10" Dia. 27" Scale "Special" Rule. \$2.75. Multiples and Divides, but has no "Trig" Scales.

**TELEGRAPHONE** — Records Voice or "Code" signals on steel wire by magnetism. Code can be recorded "fast" and translated "slow." Construction data (Special) . . . \$0.50

### MAGNET COIL DATA

- Powerful battery electro-magnet; lifts 40 lbs. . . \$0.50
- 119 Volt D.C. magnet to lift 25 lbs. . . 0.50
- 110 Volt D.C., 300 lb. Lift electromagnet . . . 0.50
- 110 Volt D.C. solenoid; lifts 2 lb. through 1 in. . . 0.50
- 110 Volt D.C. solenoid; lifts 5 lb. through 1 in. . . 0.50
- 12 Volt D.C. solenoid; lifts 2 lb. through 1 in. . . 0.50
- A. C. Solenoid, powerful, 110-volt, 60-cycle . . . 0.50
- MOTOR—1/16 H.P., 110 volt A.C., 60 cycle (suitable for driving 12" fan, etc.)—Data . . . 0.50
- 60 or 1,200 cycle Synchronous motor . . . 0.50

### MISCELLANEOUS DATAPRINTS

- Treasure Locator . . . \$0.90
- 2 K. W. 110 vlt. to 18 vlt. transformer data . . . 0.50
- 20 motor circuits—hook-ups . . . 0.35
- 20 practical telephone hook-ups . . . 0.35
- 100 mechanical movements for inventors . . . 0.50
- Polarized Relay—Ultra Sensitive . . . 0.50
- Electro-medical coil (shocking coil) . . . 0.50
- Water-Wheels—How to Build and Light your house . . . 0.50
- 20 Electric Bell Circuits . . . 0.50
- Public Address System . . . 0.50
- Electric chime ringer; fits any clock . . . 0.50

20 "Electrical Tricks" for LOGGERS and PARTIES . . . \$0.50

How to Fry Eggs on Cakes of Ice Electrically. \$0.50  
"Rewinding" Small Motor Armatures . . . 0.50  
**"ENGINEERING SERVICE BY MAIL"**  
Send Sketch of Your Problem for Estimate.  
(20% off on orders for \$3.00 or more. No C.O.D.)

### The DATAPRINT COMPANY

Lock Box 322 RAMSEY, N. J.

# FREE!

1935 EDITION  
108 Page RADIO

and  
SHORT WAVE  
TREATISE

Over 100  
Hook-Ups  
More Than  
1,500 Illustrations

A Veritable  
Text Book



**NOT JUST ANOTHER CATALOG**

This completely revised and enlarged 1935 edition contains 108 solid pages of useful radio information, diagrams, illustrations, radio kinks and real live radio men's homes. It contains more valuable radio information—more real live "meat"—than many textbooks on the subject. As usual considerable space has been devoted to the beginner in radio.

**PARTIAL LIST OF CONTENTS**

Chapter Two of "Fundamental Principles of Radio for the Beginner"—The New Tubes, Their Uses, and Their Fundamental Circuits—How to Make Money with Public Address Systems. How to Install and Maintain Them—How to Revamp Six-Volt Battery Sets to Use Two-Volt Tubes—Prize Winning Kinks and Short Cuts in Radio—How to Build the "R T" Beginner's Transmitter—How to Build the Famous Twinplex Short Wave Receiver—How to Construct an Amateur Radio Transmitter—A Most Modern and Complete Tube Chart Including Socket Connections for all Tubes—Numerous Free Offers, etc., etc.

**WRITE TODAY**

Just Send a letter or postal card.  
Treatise sent by return mail.

**RADIO TRADING CO.**  
101A Hudson Street, New York City

## Short Wave League Members

IDENTIFY THEMSELVES WITH THE ORGANIZATION



In order that fellow members of the LEAGUE may be able to recognize each other when they meet, we have designed this button, which is sold only to members and which will give you a professional appearance.

If you are a member of the LEAGUE, you cannot afford to be without this insignia of your membership. It is sold only to those belonging to the LEAGUE and when you see it on another, you can be certain that he is a member.

See Page 700

Lapel Button, made in bronze, gold filled, not plated, prepaid. . . . . 35c  
Lapel Button, like one described above, but in solid gold, prepaid. . . . . \$2.00

## Know Thyself!

Well illustrated

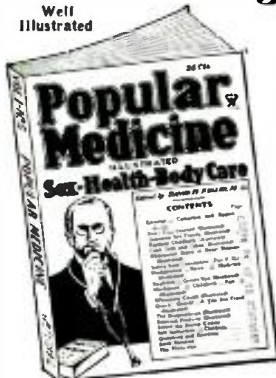

This new monthly magazine is also your own doctor. WHAT ALL YOU POPULAR MEDICINE tells and advises you thoroughly. Written for you by doctors. Non-technical yet authoritative for all laymen. Many anatomical illustrations.

Special Offer!

8 Months \$ 1

Send 15c for sample copy  
**POPULAR MEDICINE**  
97C Hudson St. New York, N. Y.  
On All Newsstands

- Oxford Radio Corp.  
1—"ALL-STAR"—6" speaker with output transformer and 24-inch cord and plug
- Belden Mfg. Company  
1—All-Wave Aerial No. 8916  
1—ALL-STAR JUNIOR Wiring Kit No. 8816
- Erie Can Company  
3—Tube shields and bases—1 1/2" mounting centers No. 3056
- Oak Mfg. Company  
8—Wafer sockets 1 1/2" mounting centers as follows: 2 7-prong sockets for 6A7 and 6F7 tubes; 2 6-prong sockets for 77 and 42 tubes; 3 4-prong sockets for the 80 tube, the speaker plug, and the antenna coil; 1 5-prong socket for the oscillator coil
- Miscellaneous Parts  
1—Rotary switch S.P. S.T.  
1—Toggle switch S.P. S.T.  
3—Binding posts (2 antenna 1 ground)  
3—Grid Clips  
4—Bar knobs for 1/4" shafts  
Miscellaneous nuts, bolts, soldering lugs  
1—6A7 Mixer Oscillator Tube  
1—6F7 Combination Triode-Pentode Tube  
1—77 High Mu Pentode Detector Tube  
1—42 Pentode Power Tube  
1—80 Rectifier Tube

**ALL-STAR Junior bandspread 5**  
Crowe Name Plate Manufacturing Company, 1749 Grace Street, Chicago, Ill., has announced a special cabinet No. 246 for the ALL-STAR Receivers, with a detachable ebony-finished wood cover. Base length 18"; overall height 9 1/2"; depth 8".  
They are providing a DeLux Panel No. 247 with all dials etched in silver color on a black background for the ALL-STAR JUNIOR. A DeLux Panel No. 248 with dials etched in silver on a black background for ALL-STAR 6 is also available. Both of these panels fit the No. 246 cabinet.

## DON'T FAIL TO VOTE FOR YOUR FAVORITE SUBJECTS

The editors desire to make SHORT WAVE CRAFT just the kind of a radio magazine you think it should be, and you can help them tremendously if you will be good enough to cut out the following ballot, or else make a copy of it (a postcard will do), and send it to the Editor of SHORT WAVE CRAFT, 99-101 Hudson Street, New York City.

SUBJECT	More	Less
Editorials		
Popular Articles Describing Short-Wave Events		
Medical Applications of Short Waves		
Television		
1 Tube Battery Short-Wave Receivers*		
2 Tube Battery Short-Wave Receivers*		
3 Tube Battery Short-Wave Receivers*		
1 to 3 tube A.C. Receivers*		
4 to 6 Tube A.C. Receivers*		
Transceivers, Construction Articles		
Transmitter, Construction		
Short-Wave Converters*		
Antenna, Construction and Theory		
Beat Oscillators, Construction		
Ultra Short-Wave Apparatus		
5 Meter Receivers*		
5 Meter Transmitters*		
World-Wide Short-Wave Review		
Short Wave Scout News		
Short Waves and Long Waves		
Condenser and Resistor Testing Apparatus*		
What's New in Short-Wave Apparatus		
Short-Wave "Kinks"		
Short-Wave Stations of the World		
When to Listen in		
Short-Wave League		
Short-Wave Question Box		
Articles on Short-Wave Theory		

\*Constructional Articles.  
Be Sure To Give Your Name and Address.

Please mention SHORT WAVE CRAFT when writing advertisers

# ANKER-CRUISER

3 TUBE A.C.-D.C. SET

WORLD-WIDE RECEPTION

KIT  
\$10.45 NET



**OUTSTANDING FEATURES**  
Electron coupled feedback, 3 tubes, 6C8, 43, and 2Z5, humfree built-in 110 V. AC-DC power supply, front panel plug-in coils, front panel phone plug, automatic speaker cutoff, hinged cover black crackled metal add-on 13 to 200 meters—complete kit of parts, including 1 front plug-in coils, hardware, diagram, instructions, etcetera. List, \$17.41; net \$16.45. Wiring and testing, list \$3.40; net \$2.05. Broadcast coil list, \$1.00; net \$.59. Kit of Arcturus Tubes, list, \$3.50; net, \$2.37. Ankerlite phone, list, \$1.75; net, \$1.05

# ANKER-CORSAIR

A.C.-D.C. SHORT-WAVE SET

\$5.95



The "Corsair" incorporates the following features hitherto unheard of in a one tube receiver sold at any price.

- 110-120 V. AC-DC built-in power supply (can also be used on 220 V. or batteries)
  - Compactness and lightness of weight.
  - 16 to 1 and 40 to 1 hairline vernier tuning (2 speeds) with 270 degree spread.
  - 15 to 200 meter coverage with four coils, broadcast coil at slight additional cost.
  - Completely enclosed and shielded by hinged cover, black wrinkle-finished metal cabinet.
- Complete Corsair kit, including cabinet and four coils. . . . . \$5.95  
Broadcast coil. . . . . .50  
Wiring, extra. . . . . 1.45  
Anker-lite headphones. . . . . 1.05

Order from this page.  
Free Anker Catalog on Request

**ANKER LABS**

172 Washington St., Dept. S-3-35, New York City

# WORLD WIDE RADIO ALL WAVE RADIO



A real powerful long and SHORT WAVE Radio Receiver that actually gets local and foreign broadcasts, police, amateur air-plane, etc. transmissions direct! Thousands now in use. Owners report reception of Foreign Stations with amazing volume. Works on two inexpensive batteries. Not a toy! RESULTS GUARANTEED!

Acc construction kits have all necessary parts mounted on attractive metal chassis and panel, all ready for wiring. Clear picture diagrams. Wire it yourself. It's easy. Range 15 to 600 meters. Complete Kits, with coil—  
● ONE TUBE KIT, \$1.95 ● TWO TUBE, \$2.85  
ALL ELECTRIC 105-125 Volt AC-DC two-tube house current set. No batteries needed! Complete Kit. \$3.65  
Kits wired, 75c extra. Tubes 25c ea. Double phones, \$1.25  
ORDER NOW. Send \$1. balance C.O.D., or if full remittance with order, we pay postage. Free literature.

FREE!! Large color map of the World, Valuable Short Wave data, etc.! Send 10c for handling. NOW!!

ACE RADIO LABORATORIES

1619 Broadway Dept. C-3 New York City

## RADIO COURSES



Radio Servicing  
Including short wave receivers.  
Radio Operating  
Prepare for Gov't. license exam.  
Radio Amateur Code

Resident Courses  
Write for Booklet

**New York YMCA Schools**  
6 West 64th Street New York City

# 1935 DOERLE - Standbys ★★ ★

## DOERLE 2-TUBE MODELS



**A.C.-2 VOLT  
and D.C. Models  
15 to 200 Meters  
3-Tube Performance**

**Only \$7<sup>70</sup>  
Less Tubes**

These 2-tube receivers are low in price—yet, inexpensive as they are, they pull in short-wave stations from all over the world, in practically any location, not only in this country but anywhere.

Available in three different models. The 2-tube AC Doerle employs a 6F7 duplex triode pentode (actually 2 tubes in one) as regenerative detector and first audio, followed by a 4I power pentode output tube. This model requires a suitable AC power pack for its operation. The 2-tube DC model employs the same complement of tubes but requires no power pack for its operation. It may be plugged in directly across the 110 volt DC line for immediate use.

The 2-tube battery model employs a type 30 as regenerative detector and a type 19 twin triode as two stages of AF amplification. Ship. wt. of all models—10 lbs.

### All Models on Same Chassis

No. 5007K. "Doerle AC 2" Short-Wave Receiver Kit including Coils and diagram but less tubes and cabinet. **YOUR PRICE \$9.55**

No. 5008K. "Doerle DC 2" Short-Wave Receiver Kit, including coils and diagram. Less tubes and cabinet. **YOUR PRICE, Less Tubes \$8.55**

No. 5009K. Doerle 2-Tube Battery Short-Wave Receiver Kit, less tubes, cabinet and batteries but including coils and diagram. **YOUR PRICE \$7.70**

Set of RCA Licensed Tubes for AC, DC, or 2-volt models..... per set \$1.70  
Accessories: 45 volt "B" batteries, 50c ea.; No. 6 Dry Cells, 30c ea.; No. 219 Hum-free Power Pack, \$5.50; Cabinet, 95c.

**WE WILL WIRE AND TEST ANY OF THESE KITS WHEN ORDERED FOR \$1.50**

SEE PAGE 704 FOR OTHER SHORT-WAVE SETS

## New 1935 Model

15 to 200 Meters

**DOERLE  
4-TUBE  
2-Volt  
BATTERY  
Receiver**

**\$16<sup>66</sup>  
less tubes  
& batteries**

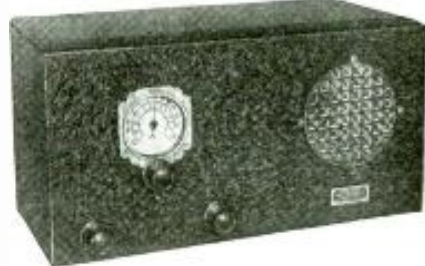

### Built-In Speaker & Battery Space

4 Tubes, but Equivalent To 5-Tube Performance. Another stride forward! The ideal set for farm and suburban use where electricity is not available. It is also the ideal portable set. Take it where you will, there are no trailing wires, no separate power packs or battery cables. Everything is conveniently built into a single cabinet, handsomely black crackle finished with airplane dial. Not only that, but all short-wave stations are received on the loud speaker which is mounted right in the cabinet. A Jack and switch arrangement in the back permits you to use earphones at will. The circuit is essentially the same as the "Doerle AC-5" shown on page 685 except that the equivalent tubes of the 2-volt type are employed. Namely: A type 31 variable-mu triode pentode followed by a type 30 regenerative detector; a type 19 twin triode tube (actually 2 tubes in one), and finally a 33 power pentode output tube. The 4" magnetic speaker is perfectly matched to this output tube. This receiver is capable of receiving both phone and code stations. It has built up for itself a very attractive log in its trial test. Requires 2 No. 4 dry cells (portable size), 3—45 volt (portable size) "B" batteries and 16 volts of "C" for operation. Ship. wt. (less batteries) 15 lbs.

No. 5003. Doerle 4-tube 2-volt Battery Receiver, including Magnetic Speaker and Plug-in Coils, less tubes and batteries. **\$17.96**

No. 5003K. Same Receiver in Kit Form, including Speaker, coils and diagram, less tubes and batteries. **YOUR PRICE \$16.66**

Complete Set of RCA Licensed Tubes..... \$3.85  
Complete Set of Batteries, portable type..... \$5.95

**FREE** See pages 681 and 697 for our free catalogs.

## RADIO TRADING CO., 101A Hudson St., New York City

This signal continues to be the best on the air at those hours and this in spite of the fact those hours are not commonly considered 49-meter hours.

We are having a Spanish or Italian signal on 30 meters almost as strong as its neighbor EAQ, but cannot get the call yet.

DJN is the call of a nice new German signal on 31 meter band. This station sends to South America but can be heard well here in the U.S.A.

Regardless of the seasons we can rely on the "Aussies," VK2ME and 3ME, to deliver up to standard and they do!

On the 25-meter band we find our attention divided between a couple of new Spanish-speaking signals (probably South Americans) GSE, GSD, FYA and PHI.

During the whole of December, DJB, on 19 meters has been outstanding because of its absence! We just can't locate it at this post. On the other hand, FYA and PCJ are heard well.

Our own "American Beauty," W3XAL, continues to be "it" on 16 meters, while the thing causing our gray hairs to show so plainly is "Why, oh why does that 14-meter W8XK insist on skipping over our heads so much "down in Texas." Among the month's new arrivals on short waves are several "Hi-Fidelity" carriers on about 195 meters. A W6 from West coast, a W5 out of K.C. and a W2 from New York have been heard and enjoyed here.

### Herman Borchers' Reception Report for December

● THE following stations were heard very good this month. EAQ—30.43 meters was very good from 1-4 p.m., R8; 12RO—30.67 meters, Rome, was broadcasting a number of times on this wavelength, Dec. 1, from 2-6 p.m., and Dec. 11, from 3-5 p.m., with an R8 signal. This station has the famous lady announcer. COC—50 meters—COH—31.8 meters very good (R8). HBP—HBL, Geneva, very strong signal (R9).

### S-W Scout News

(Continued from page 679)

PRF5—31.58 meters, very strong R9.  
DJA—31.38 meters, Germany, very weak R3.  
DJN—31.45 meters, German experimental station was on the air very often this month, during the afternoon hours from 2-5 p.m., but was on the air as early as 12:30 p.m. some days; signal was R6.  
XEBT—50 meters, strong signal (R8).  
DJC—49.83, Germany, was the best heard station here night after night—signal was R9.

12RO—49.2 meters, Rome, is broadcasting every Monday, Wednesday, and Saturday from 6-7:30 p.m. Announcements are made in English. The address is as follows: EIAR, via Montello, No. 5, Rome, Italy.

YDA—49.02 meters, at Batavia, is a new Dutch station in the East Indies. This station was heard several times between 5-6 a.m., announcing the call letters in Dutch and English.—Herman Borchers, 340 Federal St., Greenfield, Mass.

### Official Listening Post of Geo. D. Sallade, Sinking Spring, Pa.

● THE new Panama station announced in the January issue was heard testing recently. They announce in Spanish and English and use the call HP5B. Their station slogan is "Where the trade winds blow and the ocean waves flow." The station address is Radiodifusora HP5B, Miramar Club, Panama City, Republic of Panama. Usually this station has a terrible heterodyne whistle.

"Radio DUSA" was heard with only fair volume. Their programs are spoiled by poor modulation.

The Italian stations on 49.2 and 30.6 meters are heard consistently with very fine volume and magnificent programs.

Please mention SHORT WAVE CRAFT when writing advertisers

How many listeners heard the Budapest transmitter on 5400 kc. on Dec. 23?

Exceptionally fine reception is had on the 49-meter band at present. On Dec. 28, at 7:30 p.m. E.S.T., by slowly tuning this band I heard and identified the following stations: HJ3ABB, HJ4ABB, HJ5ABB, HJ1ABB, HJ4ABE, 2RO, DJC, GSA, YV4RC and YV3RC. Several others were heard but not definitely identified.

Recent verifications have been received from YV5RMO, ORK, HJ3ABB, HC2RL, and DFC. The letter from Nauen also stated that DFC is used only for special international rebroadcasts.

### John Sorensen Reports

● STATIONS heard 17-9, QSA 3-5 this month are: 49 and 31 meters (like locals!)—VK2ME, VK3ME, VK3LR, HBP, HBL, HBQ, FYA, 19 meters and 25.24 meters, PHI 25.6 meters. PCJ 19 meters, all good stations. DJB, DJA, DJN, DGU, DJC, CT1AA, EAQ, 12RO, IRA, IRM, HC2RL, YV2RC, YV3RC, YV4RC, YV5RMO—5850 kc. HJ4ABB, HJ3ABB, HJ5ABB, TIEP, HJ1ABB, PRADO, PRF5, COH, COC, XEBT, OA4XD, OA4XC, HC5B, CJRO, CJRX, WET, WON, WEZ, W3XL, W3XAL.

Stations heard: R3-6, QSA 2-3 are OXY, LKJ1, RW15, YDA, JVT, ORK, CP5, HJ1ABD, HI1A, RNE, W2XAD—locals on 19 and 25 meters. Heard many stations not identified; also two echoes heard from GSE Dec. 6 but not noted on, GSF and DJN, Dec. 12.

Verifications received are YV5RMO "Eas del Caribe," 5850 kc. Apartada de Carreas, 214 Maracaibo, Ven. S.A. From COH 9428 kc. Calle B No. 2 Vedado, Havana, Cuba, a white card with large red letters, COH. IRM—30.6 meters (letter) Halo Radio Roma. WEZ—8075 kc. WET—9470 kc. WEL—8950 kc. W2XAD—15,330 kc. from 2:30 to 3:30 p.m. are operating hours now E.S.T.

# Special Sale!

## SHORT-WAVE RECEIVER

Complete Kit of Parts with Instructions and 1 coil

**\$1.95**

Additional 3 coils 50c  
Wired and tested extra 50c  
RCA licensed tube 40c

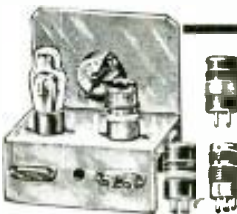

Accompanying prints and detailed instructions inform the builder the entire procedure as to how the receiver is to be assembled and wired.

Uses the low current consuming 230 tube; 1-45 volt and 2 No. 6 dry cells for operation. The receiver will cover the 15 to 200 meter bands.

**FREE** Catalog of many other Radio Bargains—Prices guaranteed LOWEST. Wait for our book before you purchase a receiver.

## FREE PARTS LIST AND SCHEMATIC



**PROMPT RADIO SERVICE CO.**  
130-S Cedar St., New York, N. Y.

## Here It Is! Martin JUNIOR

Think of it!  
A Genuine Martin Vibroplex for only \$10

For Limited Time ONLY

**\$10**

**BUY NOW**

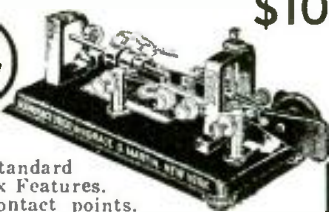

All Standard Vibroplex Features. Heavy contact points. 2 3/4 pound black Japanned base. The only difference is in size. A great bug for radio and a great bargain at this low price. Easy to use. Order now before it is too late. Money order or registered mail. Write for catalog.

**THE VIBROPLEX CO., Inc., Dept. SW-3**  
825 Broadway New York, N. Y.

## It's NOW

EVERYDAY SCIENCE AND MECHANICS is the finest scientific—technical—mechanical—constructional magazine in the field. Up-to-the-minute with news flashes of scientific events. Dozens of constructional articles and many popular experiments. Ideas from which you can make things to sell. A HOST OF INTERESTING SUBJECTS COVERED—Woodworking—Photography—Magic—Patents and Invention—Book Reviews—Metal-working—Chemistry—Engineering—Microscopy—Electrical Experiments Household Helps—Astronomy—Prize Contests—and other subjects.

**10c**

Edited by **HUGO GERNSBACK**

Get your copy today!  
On all newsstands

**10c**

the copy

Over 150 Illustrations



## Short Wave League

(Continued from page 673)

doubtedly be a success in his particular radio undertaking.

Next we overtake letter No. 3. Quote: "A good radioman should know every sound coming from a horn or pair of receivers." The above statement is unquestionably one of the best arguments ever published. I do not like H. R. C.'s appellation of "gas-bag artists." Even without code test, if a man can get a good radio telephone set on the air he is to be commended for his efforts.

Now I will backspace and refer to your editorial in the June issue of SHORT WAVE CRAFT. The part of it which remarks about the *drowning out of signals* also recalls the fact that interference and static generators will be used by enemy operators to prevent the hearing of signals legibly. It is a well-known fact that code can pierce interference and static more easily than can voice. Any good operator can understand the gist of a message by just receiving pieces of it. A little noise will make any voice conversation entirely unintelligible.

My last argument is one which probably has no place here, but I am giving it anyhow.

I still think sentiment has plenty to do with the development of amateur radio. It is for this reason that I think the "old-timers" in radio will not let code "die." It is for this reason (sentiment) that the old "Hams" regard the *no-code* advocates as "jelly-fish and sissies."

If I may make a prophesy: Code will still be as much a vital issue in radio for the next ten years as it is now, and it will never die out entirely!

JOSEPH ALINSKY, JR.,  
104 Schuykill Ave.,  
Shenandoah, Penna.

### HAMS

Will Be Happy!

When they read the article by Ernest Vablert in the NEXT Issue describing his "Ham's de Luxe 7 Tube Super-Het!"

## Oscillator Helps Find Stations

(Continued from page 655)

of 466 kc., we would have a resultant sound of 1,000 cycles. This 1,000 cycles can be heard by the human ear while the two previously mentioned frequencies 465 kc. and 466 kc.) cannot be heard. This provides us with a means of checking audibly, the character of an inaudible signal. We trust that the foregoing explanation, while brief, will give the reader the picture of *how and why* the beat oscillator works. Of course considering that both frequencies are received by some kind of rectifier and a pair of earphones.

True enough the incoming station on our short-wave super does make some sort of rushing sound in the speaker. But a very weak station which is not being modulated by voice or music, at the particular moment we are listening, may be easily passed over unnoticed. While if we were equipped with a beat oscillator we would hear in the speaker or phones, a squeal varying in pitch as we passed over even the weakest station. This squeal is only needed to locate the station, we don't want the squeal while voice or music is coming over. However, for the reception of continuous wave unmodulated code, we must have the separate heterodyne oscillator.

The instrument shown in the photographs is a 2-tube affair designed to work from either an A.C. or D.C. lighting supply. This oscillator operates entirely independent of the receiving set and has no effect upon the operation of the receiver whatsoever, except to provide the above-mentioned

(Continued on page 701)

# Beginners! Build Your Own TRANSMITTER

Now you can start building your own four panel 30 watt phone and C.W. Transmitter.

We carry the complete kit of essential parts for the popular and well known

## LES-TET 2B6 Oscillator Amplifier or Doubler

Here is a 1 tube M.O.P.A. low powered transmitter for beginners to which other stages may be added later to bring up its power. An easy, economical policy of building as you go along.

Kit includes all tuning and fixed condensers, coils, resistors, Bakelite panel, dial plates, Triplet meter, etc., etc.

Price, less tube and power supply \$19.50  
2B6 Tube . . . Your Cost . . . . . 1.35

**FREE!** Send for Parts List, Diagram and complete information to Dept. SWX-35.

**WHOLESALE RADIO SERVICE CO.**  
NEW YORK ATLANTA  
100 Sixth Avenue 430 W. Peachtree St. N.W.  
Local Branch 219 Central Ave., Newark, New Jersey

# "Keep Out"

Says the RCA  
Noise Reducing  
World-Wide Antenna  
To Man-Made Interference

No more need your short-wave reception be prey to every passing street car—every electrical gadget in your building! The new RCA double-doublet antenna says "No!" to man-made noises—and brings in far more foreign stations.

Ask your dealer or service engineer for a *Certified Installation*. Write for booklet, "Antenna Facts".

**\$6.00**

plus installation

RCA Parts Division  
Dept. W  
Camden, N. J.



**WORLD WIDE  
ANTENNA  
SYSTEM**

Please mention SHORT WAVE CRAFT when writing advertisers

# SHORT WAVE ESSENTIALS

## FOR MEMBERS OF THE SHORT WAVE LEAGUE . . .

### A FEW WORDS AS TO THE PURPOSE OF THE LEAGUE

The SHORT WAVE LEAGUE was founded in 1930. Honorary Directors are as follows:

Dr. Lee de Forest, John L. Reinartz, D. E. Replogle, Hollis Baird, E. T. Somerset, Baron Manfred von Ardenne, Hugo Gernsback, Executive Secretary.

The SHORT WAVE LEAGUE is a scientific membership organization for the promotion of the short wave art. There are no dues, no fees, no initiations, in connection with the LEAGUE. No one makes any money from it; no one derives any salary. The only income which the LEAGUE has is from its short wave essentials. A pamphlet setting forth the LEAGUE'S numerous aspirations and purposes will be sent to anyone on receipt of a 3c stamp to cover postage.

### FREE MEMBERSHIP CERTIFICATE

As soon as you are enrolled as a member, a beautiful certificate with the LEAGUE'S seal will be sent to you, providing 10c in stamps or coin is sent for mailing charges.

Members are entitled to preferential discounts when buying radio merchandise from numerous firms who have agreed to allow lower prices to all SHORT WAVE LEAGUE members.

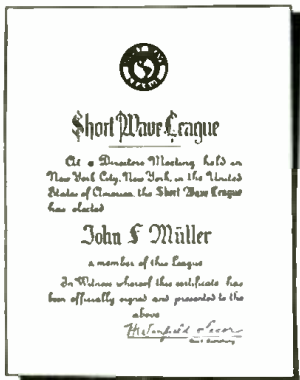

Illustration of engraved free membership certificate

### SHORT WAVE ESSENTIALS LISTED HERE SOLD ONLY TO SHORT WAVE LEAGUE MEMBERS

They cannot be bought by anyone unless he has already enrolled as one of the members of the SHORT WAVE LEAGUE or signs the blank on this page (which automatically enrolls him as a member, always provided that he is a short wave experimenter, a short wave fan, radio engineer, radio student, etc.).

Inasmuch as the LEAGUE is International, it makes no difference whether you are a citizen of the United States or any other country. The LEAGUE is open to all.

### Application for Membership SHORT WAVE LEAGUE

SHORT WAVE LEAGUE 3-35  
99-101 Hudson Street, New York, N. Y.

I, the undersigned, herewith desire to apply for membership in the SHORT WAVE LEAGUE. In joining the LEAGUE I understand that I am not assessed for membership and that there are no dues and no fees of any kind. I pledge myself to abide by all the rules and regulations of the SHORT WAVE LEAGUE, which rules you are to send to me on receipt of this application.

I consider myself belonging to the following class (put an X in correct space): Short Wave Experimenter  Short Wave Fan  Radio Engineer  Student  I own the following radio equipment:

Transmitting .....  
Call Letters .....  
Receiving .....  
Name .....  
Address .....  
City and State .....  
Country .....

I enclose 10c for postage and handling for my Membership Certificate.

### SHORT WAVE LEAGUE LETTERHEADS

A beautiful letterhead has been designed for members' correspondence. It is the official letterhead for all members. The letterhead is invaluable when it becomes necessary to deal with the radio industry, mail order houses, radio manufacturers, and the like; as many houses have offered to give members who write on the LEAGUE'S letterhead a preferential discount. The letterhead is also absolutely essential when writing for verification to radio stations either here or abroad. It automatically gives you a professional standing.

A—SHORT WAVE LEAGUE letterheads, per 100..... **50c**

### OFFICIAL SHORT WAVE LEAGUE LOG AND CALL MAGAZINE

Here is the finest book of its kind ever published. It contains the largest listing of short wave stations in the world, much larger in fact than the list published in SHORT WAVE CRAFT and other magazines. All experimental stations, no matter where located, are listed. A large section is provided where calls can be listed in a proper manner. This log section gives dial settings, time, date, call letters, location, and other information. Another section has squared-paper pages on which you can fill in your own frequency curve for your particular receiver. It helps you to find stations which otherwise you could never log. It is the only book of its kind published.

B—Official Log and Call Magazine.....Prepaid **25c**

### RADIO MAP OF THE WORLD AND STATION FINDER

The finest device of its kind published. The world's map on heavy board is divided into 23 sections, while the rotary disc shows you immediately the exact time in any foreign country. Invaluable in logging foreign stations. Also gives call letters assigned to all nations. Size 11"x22".

C—Radio Map of the World and Station Finder.....Prepaid **25c**

### GLOBE OF THE WORLD AND MAGNETIC COMPASS

This highly important essential is an ornament for every den or study. It is a globe, 6 in. in diameter, printed in fifteen colors, glazed in such a way that it can be washed. This globe helps you to intelligently log your foreign stations. Frame is of metal. Entire device substantially made, and will give an attractive appearance to every station, emphasizing the long-distance work of the operator.

D—Globe of the World.....Prepaid **\$1.25**

### SHORT WAVE LEAGUE LAPEL BUTTON

This beautiful button is made in hard enamel in four colors, red, white, blue and gold. It measures three quarters of an inch in diameter. By wearing this button, other members will recognize you and it will give you a professional air. Made in bronze, gold filled, not plated. Must be seen to be appreciated.

E—SHORT WAVE LEAGUE lapel button.....Prepaid **35c**

EE—SHORT WAVE LEAGUE lapel button, like the one described above but in solid gold.....Prepaid **\$2.00**

### SHORT WAVE LEAGUE SEALS

These seals or stickers are executed in three colors and measure 1 1/4 in. in diameter, and are gummed on one side. They are used by members to affix to stationery, letterheads, envelopes, postal cards and the like. The seal signifies that you are a member of the SHORT WAVE LEAGUE. Sold in 25 lots or multiples only.

G—SHORT WAVE LEAGUE seals.....per 25, Prepaid **15c**

### SHORT WAVE MAP OF THE WORLD

This beautiful map, measuring 18x26 in. and printed in 18 colors is indispensable when hung in sight or placed "under the glass" on the table or wall of the short wave enthusiast. It contains a wealth of information such as distances to all parts of the world, political nature of the country in which a broadcast station is located, etc., and from the manner in which the map is blocked off gives the time in different parts of the world at a glance.

F—SHORT WAVE Map of the World.....Prepaid **25c**

**PLEASE NOTE THAT ABOVE ESSENTIALS ARE SOLD ONLY TO MEMBERS OF THE LEAGUE—NOT TO NON-MEMBERS.**

Send all orders for short wave essentials to SHORT WAVE LEAGUE, 99-101 Hudson Street, New York City.

If you do not wish to mutilate the magazine, you may copy either or both coupons on a sheet of paper.

**SHORT WAVE LEAGUE 99-101 Hudson St., New York, N. Y.**



G—15c for 25



F—25c each



A—50c per 100



B—25c per copy



C—25c each



D—\$1.25 each



E—35c each

SHORT WAVE LEAGUE, 99-101 Hudson Street, New York, N. Y.

Gentlemen:

I am already an enrolled member in the SHORT WAVE LEAGUE

I am a new member and attach my application to this coupon

Please send me the following short wave essentials as listed in this advertisement:

for which I enclose \$ ..... herewith.  
(The LEAGUE accepts money order, cash or new U. S. Stamps in any denomination. Register cash and stamps.)

3-35

Name .....  
Address .....  
City and State .....  
Country .....

Please mention SHORT WAVE CRAFT when writing advertisers

## Oscillator Helps

(Continued from page 699)

features. This oscillator uses two tubes—one as the oscillator tube and the other as the rectifier which provides plate voltage for the oscillator tube; they are both type 37's.

The instrument is really quite simple to build and the constructional cost is very low; at the present prices it can be built for around five dollars without a doubt, and it is well worth the investment. The coil used in this model is a factory-made affair which can be purchased more cheaply than it can be built by the layman. The whole outfit is built on an aluminum chassis five inches square and one and one-half inches deep. Looking at the diagram we find that there are three leads from the coil, one is connected to the "B" negative, the other to the cathode of the 37 oscillator, and the third lead is connected through the grid-leak and condenser to the grid of tube.

On top of the coil shield is a knob which operates a small condenser and this serves to tune the oscillator to the intermediate frequency of our receiver. The value of the grid condenser in the oscillator circuit is .0001 mf. and the leak has a value of 250,000 ohms. The plate of the oscillator tube is connected to the "B" plus lead of the power supply portion. There has to be some means of beating the oscillator with the incoming signal and this is done by connecting a short length of wire to the cathode of the oscillator tube, through a 20 mmf. fixed condenser. The other end of this wire is placed near the grid of one of the "I.F." amplifiers in the receiver, preferably the one next to the second detector. The simplest method is to form a hook in the end of the wire and hang it over the grid-lead, right near the cap on the tube.

The heaters of the two 37's are connected in series and fed from a special resistor-line cord. The plate and grid of the rectifier are connected together as can be seen in the diagram. The filter which smooths out the current after it has passed through the rectifier, consists of a 25,000 ohm resistor and two 4 mf. 300 volt electrolytic condensers. A switch is connected between the cathode and B minus to serve as a silencer of the oscillator when it is not needed. This switch does not turn off the heaters of the tubes, the plug must be removed, or another switch can be incorporated. As the heaters take quite some time to heat up it is advisable to use the silencing switch. One warning do not attempt to "ground" the oscillator as the fuses in the house-lighting circuit will blow out. Also don't touch the metal chassis while near a radiator or other grounded object or you will be shocked.

After the oscillator has been built, connect it as previously explained and tune in a station on your receiver. Then adjust the knob of the oscillator until a squeal is heard on the station. Tuning from one station to another will reveal the squeal to be present on all of them. A slight adjustment may be needed from time to time to keep the oscillator in tune. Always leave the tubes in the oscillator on for at least two minutes before it is used because the frequency changes slightly as the tubes heat up. Build it and see if DX'ing isn't easier.

### Beat Oscillator Parts List

- 1—chassis 5"x5"x1 1/2". Blkn. (Korrol.)
- 1—.00025 mf. condenser. Aerovox.
- 1—20 mmf. condenser. Aerovox.
- 1—250,000 ohm resistor. Aerovox.
- 1—25,000 ohm resistor. Aerovox.
- 1—dual 4 mf. 300 volt electrolytic condenser. Aerovox.
- 1—Beat oscillator coil (frequency depending on that of the set.) National; Hammarlund; Gen-Win.
- 2—5 prong wafer sockets. NaAld.
- 1—line cord AC\*DC 325 ohms.
- 2—type 37 RCA Radiotrons.

# CLASSIFIED

Advertisements are inserted at 5c per word to strictly amateurs, or 10c a word to manufacturers or dealers. Each word in a name and address is counted. Cash should accompany all orders. Copy for the April issue should reach us not later than February 5th

AUTO SUPPLIES	MISCELLANEOUS	SHORT WAVE COMPONENTS
<p><b>FORD OWNERS — OVERHEAD</b> valve speed units, Winfield carburetors, camshafts. Dual ratio axle for V-8's. Blue valves, same Speedway Racing Magazine, catalog speed books, crash helmets, English racing, stock motorcycles, accessories. Plyner, 138 W. Pico, Los Angeles, California.</p> <p><b>"HAM" OFFERS &amp; WANTS</b></p> <p>\$100.00 RCA SUPERBET BATTERY type, "built-in" loop, speaker, etc. Bargain \$35.00; Victoreen 8-tube battery superbet, Weston meter, \$8.00; ME29 National Tuner with four S.G. and detector tubes, \$15.00; 45 push-out Thordarson Power-Pack with 27 first A.F. (with Tubes), \$15.00; "High Fidelity"; 6 ft. Victor Orthophonic (exponential) Horn, speaker unit, tone arm; also "magnetic" pick-up, \$15.00; RCA 210 power-pack with Rectifier (originally \$70.00) \$8.00. Harry Arkerston, Box 322, Ramsey, N.J.</p> <p><b>MY A.C. SUPER WAMP</b> 1 coupled to pentode amplifier, Pilot Pack, 5 sets coils, best offer gets all. C. Bodine, 1542 W. 39, Okla. City, Okla.</p> <p><b>ENTIRE EQUIPMENT, TUBES,</b> 100 Watt Transmitter, 30 Watt oscillator kit and more. Your Price. WHPZD, 20 Harrison St., Brookline, Mass.</p> <p><b>VARIABLE CONDENSERS — .00035</b> Mfd. Pyrex insulated, Low Loss, Good Condition. 35¢ each. 1 for \$1.00. WSRW, 208 N. Main, Bluffton, Ohio.</p>	<p><b>TEN PRACTICAL AND INEXPENSIVE</b> changes converting Dodge 12-V. Ford T.A., Chevrolet Delco 6-V generators, into 100-500 watt capacity A.C. generators, or into 32-110 volt 1414 motor or generator. Dodge 1/2 300-W. self-excited. All in one book illustrated with complete simplified instructions and drawings for only \$1. ATTOPOWER, 411 S. Hoyne Ave., Chicago.</p> <p><b>OHM'S LAW CALCULATOR—</b> Lightning Slide Rule; solves all problems of Voltage, Current and Resistance, Power, Wire sizes, etc. Range 1 micro-amp. to 1000 amps.; 1 micro-volt to 10,000 volts; 1 micro-ohm to 10 megohms; 1 micro-watt to 10 megawatts; wire sizes 0 to 36 B. &amp; S. gauge. Introductory price \$1.00 prebail. The Dataprint Co., Box 322, Ramsey, N.J.</p> <p><b>QSL—CARDS—SWL</b></p> <p><b>QSL CARDS, NEAT, ATTRACTIVE,</b> reasonably priced, samples free. Miller, Printer, Ambler, Pa.</p> <p><b>200 TWO COLOR QSLS, SWLS —</b> \$1.25, time limited offer. W-8-E-S-N, 1827 Cone, Toledo, Ohio.</p> <p><b>QSLS, 75¢ A 100 2 COLORS,</b> WPDGH 1816, N. 5 Ave., Minneapolis, Minn.</p>	<p><b>LO-LOSS COILS—FOUR PRONG,</b> tall form, four coils—15-200 meters .50—2 broadw. coils, 200-750 meters .10 — "List Free" Short Wave Accessories, 121 Derby Street, Valley Stream, New York.</p> <p><b>PLUG-IN COILS, WOUND ON</b> tube bases, .30 per set. Regular forms .30, 5 prong .75. Noel, 809 Alder, S.anton, Pa.</p> <p><b>SHORT WAVE RECEIVERS</b></p> <p><b>IN STOCK—LOWEST PRICES:</b> All Pattern-on, Silver, National, Hammarlund, RAIED, Skyriider receivers. All amateur apparatus. Trade-in your receiver. Code machines rented. Write Herby Radio Shop, Butler, Mo.</p> <p><b>FOR SALE NEW AND USED</b> Shortwave Receivers, sets of all types, Hammarlund—Nationals—Scotts—Pattern-on, etc. Edward Schwarz, Dumont, N.J.</p> <p><b>NEW LONG DISTANCE CRYSTAL</b> Receiver, Blueprint, 17 Others, 25¢ coin. Particulars Free. Modern Radiolabs, 134-A Liberty, San Francisco.</p> <p><b>SHORT WAVE SUPPLIES</b></p> <p><b>INSULATION, WIRE, VARNISHES,</b> supplies, etc. Send 3¢ stamp for bulletin. ATTOPOWER, 411 S. Hoyne Ave., Chicago.</p> <p><b>TRANSMITTING EQUIPMENT</b></p> <p><b>SELL USED BROADCAST AND</b> short wave transmitting equipment. Write for list. White Radio Laboratory, Sanipoint, Idaho.</p>

## 6 Copies of SHORT WAVE CRAFT 70¢ PREPAID

For a limited time only, and as long as they last, we will send you six back numbers of SHORT WAVE CRAFT assorted, your choice, for 70 cents.

The usual price for six copies would be \$1.50 and most publishers charge a higher price for back numbers over one year old.

We can supply all copies except the following: June-July, Aug.-Sept., 1930; Dec.-Jan., Feb.-Mar., April, May, June, July, Oct., Nov., 1932; Feb., Mar., June, July, 1933.

If you do not specify copies we will use our own judgment in sending assorted numbers to fill your order. Note we cannot exchange the copies for ones that have been sent to you.

Practically every copy of SHORT WAVE CRAFT contains important information that you should have. Here is a chance to get those copies.

As we have only a small supply of back numbers on hand, this offer will be withdrawn as soon as they have been sold.

We accept U. S. stamps, U. S. coin, or money order. Rush your order today.

**SHORT WAVE CRAFT**  
99-101 Hudson Street New York, N. Y.

**SHORT WAVE CRAFT** 3-35  
69-101 Hudson Street, New York, N. Y.

Gentlemen: I enclose herewith 70¢, for which you are to send me six back number copies of SHORT WAVE CRAFT as follows:

Name .....

Address .....

City..... State .....

**WORLD FAMOUS INTERNATIONAL DX 3 TUBE SHORT WAVE RECEIVER ALL ELECTRIC ALL WAVE**

**6.75**

Complete Kit containing all parts for the set and power supply, including speaker, 4 coils to cover bands from 11 to 230 meters and detailed diagram. Custom built extra \$1.75. Broadcast coil 75¢. 3 matched tubes 2.25. Metal Cabinet 1.95.

**INTERNATIONAL GABY-RADIO One Tube All Electric ALL WAVE**

Kit contains all parts for the set and power supply, with cabinet, 3 coils to cover bands from 40 to 500 meters and picture diagram. Custom built extra \$1.25. Double Purposetube 1.00. Headphone 1.50. FREE Circular 130, up to 5 tubes.

**4.95**

**EXPERIMENTAL RADIO LABS.**  
188 WASHINGTON STREET NEW YORK N. Y.

New Yorkers can hear them at 177 Greenwich St., Blkn. The Radio Man, Inc.

## RADIO ENGINEERING

broadcasting, aviation and police radio, servicing, marine radio telegraphy and telephony, Morse telegraphy and railway accounting taught thoroughly. Engineering course of nine months' duration equivalent to three years of college radio work. All expenses low. Catalog free. School established 1871.

**Dodge's Institute, Turner St., Valparaiso, Ind.**

**For Special Subscription Offer on Short Wave Craft See Notice on page 696**

Please mention SHORT WAVE CRAFT when writing advertisers

# The 4 ESSENTIAL SHORT WAVE BOOKS

'ROUND THE WORLD FANS USE THESE GREAT SHORT WAVE BOOKS

These great books contain everything on short waves that is really worth knowing—they are books which have been most enthusiastically welcomed by short-wave fans. The cost of the books is extremely low in comparison with the valuable material which they contain.

There is not a short-wave fan, experimenter or interested radio-minded reader who will not want these books. Right up-to-the-minute with new material on outstanding developments in the short wave field. The books are authoritative, completely illustrated and not too highly technical.

## Ten Most Popular Short Wave Receivers. How to Make and Work Them

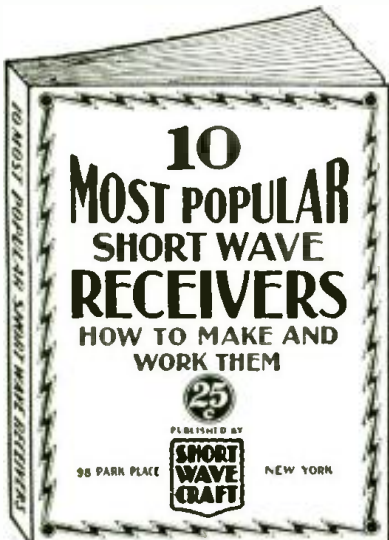

This new volume is a revelation to those who wish to build their own short wave receivers. The editors of SHORT WAVE CRAFT have selected ten outstanding short wave receivers and these are described in the new volume. Each receiver is fully illustrated with a complete layout, pictorial representation, photographs of the set complete, hookups and all worthwhile specifications. Everything from the simplest one tube set to a 5-tube T. R. F. receiver is presented. Complete lists of parts are given to make each set complete. You are shown how to operate the receiver to its maximum efficiency.

### CONTENTS

- The Doerle 2-Tube Receiver That Reaches the 12,500 Mile Mark, by Walter G. Doerle.
- 2-R.F. Pentode S-W Receiver having two stages of Tuned Radio Frequency, by Clifford E. Denton and H. W. Sever.
- Mx de Luxe S-W Receiver, by Edward G. Ingram.
- The Binneweg 2-Tube 12,000 Mile DX Receiver, by A. Binneweg, Jr.
- Build a Short Wave Receiver in your "Brief-Case" by Hugo Gernsback and Clifford E. Denton.
- The Denton 2-Tube All-Wave Receiver, by Clifford E. Denton.
- The Denton "Stand-By," by Clifford E. Denton.
- The "Stand-By" Electrified, by Hugo Gernsback.
- A COAT-POCKET Short Wave Receiver by Hugo Gernsback and Clifford E. Denton.
- Do They Roll In on this One Tube by C. E. Denton.
- The S-W PENTODE-4, by H. G. Cisin M. E.
- Louis Martin's Idea of A GOOD S-W RECEIVER, by Louis Martin.

40 PAGES  
OVER 75 ILLUSTRATIONS  
IMPORTANT

THERE IS NO DUPLICATION BETWEEN THIS BOOK AND OUR OTHER VOLUMES—HOW TO BUILD AND OPERATE SHORT WAVE RECEIVERS. ALL THE MATERIAL PUBLISHED IN THE NEW BOOK HAS NEVER APPEARED IN ANY BOOK BEFORE.

25c

## How to Build and Operate Short Wave Receivers

Is the best and most up-to-date book on the subject. It is edited and prepared by the editors of SHORT WAVE CRAFT, and contains a wealth of material on the building and operation, not only of typical short-wave receivers, but short-wave converters as well. Dozens of short-wave sets are found in this book, which contains hundreds of illustrations; actual photographs of sets built, hookups and diagrams galore.

The book comes with a heavy colored cover, and is printed throughout on first-class paper. No expense has been spared to make this the outstanding volume of its kind. The book measures 7½x10 inches.

This book is sold only at such a ridiculously low price because it is our aim to put this valuable work into the hands of every short-wave enthusiast.

We know that if you are at all interested in short waves you will not wish to do without this book. It is a most important and timely radio publication.

Over 150 Illustrations  
72 Pages 7x10 Inches

50c

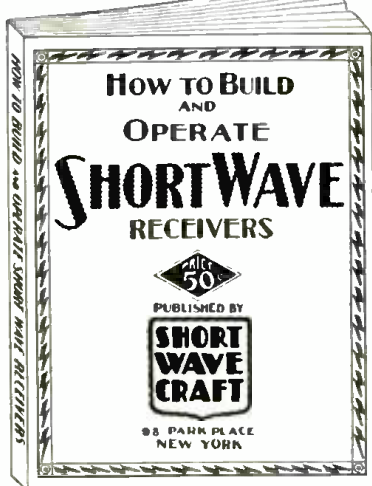

## The Short Wave Beginner's Book

Here is a book that will solve your short wave problems—leading you in easy stages from the simplest fundamental to the present state of the art as it is known today. It is the only low-priced reference book on short waves for the beginner.

The book is profusely illustrated with all sorts of photos, explanations and everything worth while knowing about short waves—the book is not "technical." It has no mathematics, no "high-faluting" language and much technical jargon. You are shown how to interpret a diagram and a few simple sets are also given to show you how to go about it in making them.

It abounds with many illustrations, photographs, simple charts, hookups, etc., all in simple language. It also gives you a tremendous amount of very important information which you usually do not find in other books, such as time conversion tables, all about aerials, noise elimination, how to get verification cards from foreign stations, all about radio tubes, data on coil winding and dozens of other subjects.

### Partial List of Contents

- Getting Started in Short Waves—the fundamentals of electricity. Symbols the Short Hand of Radio—how to read schematic diagrams. Short Wave Coils—various types and kinks in making them. Short Wave Aerials—the points that determine a good aerial from an inefficient one. The Transposed Lead-in for reducing Man-Made Static.
- The Beginner's Short-Wave Receiver—a simple one tube set that anyone can build. The Beginner's Set Ties an Amplifier—how the volume may be increased by adding an amplifier.
- How to Tune the Short-Wave Set—telling the important points to get good results. Regeneration Control in Short-Wave Receivers.
- Audio Amplifiers for S. W. Receivers.
- How to Couple the Speaker to the set.
- Learning the Code—for greater enjoyment with the S-W set.
- Wave Length to Kilocycle Chart.
- Wire Chart—to assist in the construction of coils.
- Kinks in the construction of S-W Receivers.

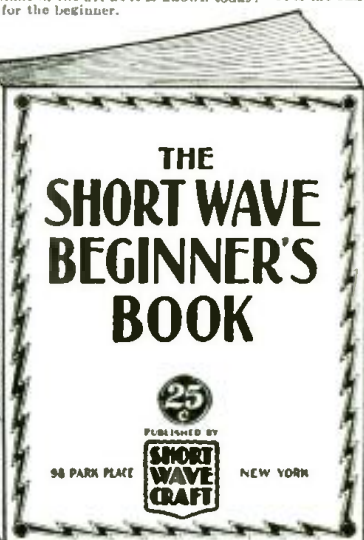

40 PAGES  
OVER 75 ILLUSTRATIONS

25c

## How to Become an Amateur Radio Operator

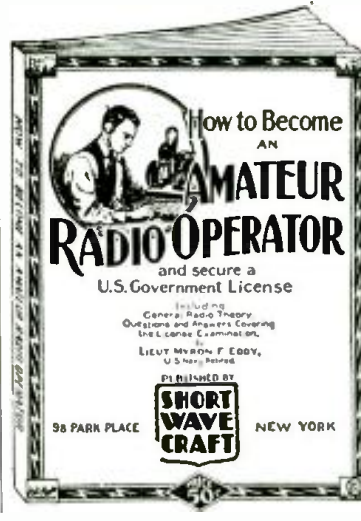

We chose Lieut. Myron F. Eddy to write this book because his long years of experience in the amateur field have made him pre-eminent in this line. For many years he was instructor of radio telegraphy at the R. C. A. Institute. He is a member of the I.R.E. (Institute of Radio Engineers), also the Veteran Wireless Operator's Association.

If you intend to become a licensed radio operator, if you wish to take up phone work eventually, if you wish to prepare yourself for this important subject—this is the book you must get.

**Partial List of Contents**  
Ways of learning the code. A system of sending and receiving with necessary drill words is supplied so that you may work with approved methods. Concise, authoritative definitions of radio terms, units and laws, brief descriptions of commonly used pieces of radio equipment. This chapter gives the working terminology of the radio operator. Graphic symbols are used to indicate the various parts of radio circuits. General radio theory particularly as it applies to the beginner. The electron theory is briefly given, then waves—their creation, propagation and reception. Fundamental laws of electric circuits, particularly those used in radio are explained neat and typical basic circuits are analyzed. Descriptions of modern receivers that are being used with success by amateurs. You are told how to build and operate these sets. Amateur transmitters. Diagrams with specifications are furnished so construction is made easy. Power equipment that may be used with transmitters and receivers, rectifiers, filters, batteries, etc. Regulations that apply to amateur operators. Appendix which contains the International "Q" signals, conversion tables for reference purposes, etc.

Over 150 Illustrations  
72 Pages 7x10 Inches

50c

All the books shown on this page are published exclusively by

### SHORT WAVE CRAFT

99-101 Hudson Street, New York, N. Y.

CLIP-MAIL

SHORT WAVE CRAFT  
99-101 Hudson Street, New York, N. Y.

Gentlemen: I enclose herewith my remittance for the amount of \$..... for which you are to send me, postpaid, the books checked below.

- Ten Most Popular Short Wave Receivers. How to Make and Work Them...25c each
- The Short Wave Beginner's Book.....25c each
- How to Build and Operate Short Wave Receivers.....50c each
- How to Become an Amateur Radio Operator.....50c each

Name.....  
Address.....  
City..... State.....

(Send remittance in form of check or money order. If letter contains cash or unused U. S. Postage Stamp, register it.)

SW-3-35

These Books are Authentic For All Short Wave Work and LOW in Price

COUPON TODAY!

Please mention SHORT WAVE CRAFT when writing advertisers



● Index to Advertisers ●

W

Wellworth Trading Company.....	694
Wholesale Merchandisers, Inc.....	696
Wholesale Radio Service Co., Inc.....	679, 699
World Trotter Radio Labs.....	693, 695

(While every precaution is taken to insure accuracy, we cannot guarantee against the possibility of an occasional change or omission in the preparation of this index.)

**Short Wave Scout Award**

(Continued from page 659)

a period not exceeding thirty days, as possible by any one contestant.

3.—The trophy will be awarded to that SHORT WAVE SCOUT who has logged the greatest number of short-wave stations during one month.

4.—In the event of a tie between two or more contestants, each logging the same number of stations, the judges will award a similar trophy to each contestant so tying.

5.—Verifications are necessary; these must be sent in with each entry. All cards or verification letters must be sent in at the same time, with a statement by the SHORT WAVE SCOUTS, giving the list of stations in typed or written form, with the station calls, wave-lengths, and other able information. (See below.)

6.—The winner each month will be the person sending in the greatest number of verifications. Unverified stations should not be sent in, as they will not count in the selection of the winner. At least 50 per cent of the verifications sent in by each listener must be for stations located *outside* of the country in which he resides! In other words, if the contestant lives in the United States, at least 50 per cent of his "veris" must be for stations *outside* of the United States. Letters or cards which do not specifically verify reception, such as those sent by the Daventry stations, and also by commercial telephone stations, will not be accepted as verifications. *Only letters or cards which "specifically" verify reception of a "given station," a given wave-length and a given day, will be accepted!*

7.—This is an *international* contest in which any reader, no matter where located, can join. It is allowable for SHORT WAVE SCOUTS to list stations in their own countries, if they desire to do so.

8.—SHORT WAVE SCOUTS are allowed the use of any receiving set, from a one-tuber up to one of sixteen tubes, or upwards.

9.—When sending in entries, note the following few simple instructions: Type your list, or write in ink, *pencilled matter is not allowed*. Send verification cards, letters and the list all in one package, either by mail or by express prepaid; *do not split up the package*. Verification cards and letters will be returned, at the end of the contest, to their owners; the expense to be borne by SHORT WAVE CRAFT magazine.

10.—In order to have uniformity of the entries, when writing or typing your list observe the following routine: **USE A SINGLE LINE FOR EACH STATION**; type or write the entries **IN THE FOLLOWING ORDER**: Station call letters; frequency station transmits at; schedule of transmission if known (all time should be reduced to Eastern Standard which is five hours behind Greenwich Meridian Time); name of station, city, country; identification signal if any. Sign your name at the bottom of the list and *furthermore state the type of set used by you to receive these stations.*

11.—Don't list amateur transmitters in this contest. *only commercial phone stations, no CW and no "code" stations.*

12.—This contest will close every month for the next twelve months on the first day of the month, by which time all entries must have been received in New York. Entries received after this date will be held over for the next month's contest.

13.—The next contest will close in New York, March 1.

<b>A</b>	
Ace Radio Laboratories.....	697
Aerovox Corporation.....	692
Alden Products Co.....	693
Allied Engineering Institute.....	696
Allied Radio Corporation.....	678
All-Star Headquarters.....	679
Anker Labs.....	697
<b>B</b>	
Burgess Battery Company.....	685
Burks Radio Company.....	684
<b>C</b>	
Candle System Co.....	693
Centrallion Engineering Co.....	692
Classified Advertisements.....	701
Coast-to-Coast Radio Corp.....	683
Coyne Electrical School.....	643
<b>D</b>	
Dataprint Company.....	696
Dodge's Institute.....	701
<b>E</b>	
Eagle Radio Co.....	694
Edwards, W. H. & Co.....	678
Eilen Radio Laboratories.....	691
Electrad, Inc.....	689
Everyday Science & Mechanics.....	699
Experimental Radio Labs.....	701
<b>F</b>	
Federated Purchaser, Inc.....	703
First National Television, Inc.....	686
<b>G</b>	
General Manufacturing Company.....	681
Gold Shield Products Co.....	683
Gross Radio, Inc.....	678
<b>H</b>	
Hammarlund Manufacturing Co.....	683
Harrison Radio Company.....	677
<b>I</b>	
Instructograph Company.....	696
Insuline Corp. of America.....	690
International Radio Corp.....	689
<b>K</b>	
Klaus Radio & Electric Co.....	679
Korrol Mfg. Co., Inc.....	684
<b>L</b>	
Lancaster, Allwine & Rommel.....	693
Leotone Radio Co.....	682
L. I. Marine & Electric Co.....	693
Lynch, Arthur H., Inc.....	695
<b>M</b>	
McGraw-Hill Book Company, Inc.....	695
Merriam Company, G. & C.....	693
M. & H. Sporting Goods Co.....	678
Midwest Radio Corp.....	Back Cover
<b>N</b>	
National Company, Inc.....	687
National Radio Institute.....	641
New York YMCA Schools.....	697
<b>P</b>	
Popular Medicine.....	697
Postal Radio Corp.....	695
Prompt Radio Service Co.....	699
<b>R</b>	
Radiohar Company of America.....	682
Radio Circular Co., Inc.....	677
Radio Craft.....	695
Radio Electric Service Co.....	679
Radio Publications.....	644
Radio Trading Co.....	684, 697, 698, 704
RCA Institutes, Inc.....	694
RCA Victor Co.....	699
Remington-Rand, Inc.....	683
Ross, A. H. & Company.....	703
<b>S</b>	
Sexology Magazine.....	695
Short Wave Coil Book.....	690
Short Wave League.....	686, 697, 700
Short Wave Listener.....	692
Sprayberry, F. L.....	686
Sterling Casualty Insurance Co.....	679
Supertone Products Corp.....	684
<b>T</b>	
Telex Co.....	677
Thor Radio Co.....	686
Trimmm Radio Mfg. Co.....	691
Try-Mo Radio Co., Inc.....	678
<b>U</b>	
Uncle Dave's Radio Shack.....	689
<b>V</b>	
Vibroplex Co., Inc.....	699

**1935 DENTON DISCOVERER**



The Ideal Short Wave Receiver for the Ham, the Amateur and the Experimenter—at an amazingly Low Price!

Be sure to read Clifford E. Denton's article in this issue. It will give you complete information on how to build this amazingly sensitive and powerful short wave receiver. A real professional job that you can build in a few hours.

**1935 DENTON DISCOVERER KIT—(110-129)**  
Volts, 50-60 cycles A.C. MODEL NO. 236. Your Cost less tubes complete with wiring diagram, 3 coils, speaker and instructions..... **\$21.50**

**1935 Denton Discoverer WIRE AND LABORATORY TESTED**, complete with speaker, 8 coils, MODEL NO. 237. Your Cost less tubes..... **\$31.50**

Kit of Rethon Tubes for above..... \$3.20

Send for your FREE copy of the latest 1935 Catalog—Just Released! The newest in Radios, Parts, Sound Equipment—at the Lowest Wholesale Prices!

**Federated Purchaser, Inc.**  
NEW YORK CHICAGO ATLANTA  
25 Park Pl. 1331 S. Mich. Av. 546 Spring St. N.W.  
Newark . Bronx . Jamaica . Phila . Pittsburg



**THE FINEST SHORT WAVE RADIO - Direct from Factory to You!**

Specifically designed for "discriminating" short wave users the NEW ROSS SPECIAL comes direct to you at a saving in price and improvement in quality that will amaze you. Covers 15 to 550 meters (20,000 to 550 kc.).—Has both AVC and manual control—band spread tuning—beat oscillator and many other features. Finest "tailor-made" precision workmanship. Sold under 5-day MONEY BACK GUARANTEE. Before buying "any" S.W. receiver, you owe it to yourself to investigate this one. "Write for folder."

**A. H. ROSS and COMPANY**  
Keswick Ave. & Waverly Rd., Glenside, Pa.  
(Near Philadelphia)



Please mention SHORT WAVE CRAFT when writing advertisers

# DOERLE *Globe Girdling* Official Receivers SHORT-WAVE 1935 MODELS

WE Guarantee RECEPTION of Foreign Speech and Music

## 5-TUBE DOERLE De Luxe A. C. Short-Wave RADIO



COMPLETE PRICE  
Chassis, Speaker,  
Tubes, Coils, Cabinet  
Nothing Else to Buy

**\$25<sup>96</sup>**

Features Found Only in More Expensive Receivers

- Doublet Antenna Input or
- Standard Antenna input
- 15-200 Meters
- Airplane Dial
- 8-Low Loss Ribbed Plug-in Coils
- Headset Jack
- 12,500 Mile Range
- Dynamic Speaker
- Beautiful Cabinet

### ACE OF ALL DOERLE RECEIVERS

Will Outperform Many 10-Tube Expensive Sets

A powerful 5-tube "rig" complete with its self-contained hum-free power pack and dynamic speaker; all mounted on a single chassis and contained in a large handsomely finished black crackle cabinet with patterned screen speaker grill.

Two tuned stages—regenerative detector. 3AF stages with powerful 41 pentode output and perfectly matched dynamic speaker; all these features contribute to the enormous power and superlative performance of this Doerle short-wave receiver.

All the fine features that you would expect to find in more expensive receivers are incorporated in this "ACE TOP-NOTCHER" of the entire Doerle line.

Either a short-wave doublet or standard antenna may be used. A new antenna-adjusting scheme permits perfect alignment of both tuned circuits without affecting the setting of the tuning dial. This means that all stations can be accurately logged on the single tuning dial and always found in their allotted places. Provisions are made to use headphones if desired, with a switch to cut out the dynamic speaker.

#### LOOK AT THIS DX-QSL LIST!

During its initial test, in one sitting, this receiver pulled in on its loud speaker, at good room volume, the following enclable log: W1XAL, W1XAZ, Boston; W3XAL, Boundbrook, N.J.; W8XAL, Cincinnati; W9XAA and W9XF, Chicago; GSC, GSD, GSE, GSF, Daventry, England; DJA, DJB, DJC, DJD, Zeesen, Germany; HBL, HBP, Geneva; VE9GW Ontario; V9DN Quebec; GE9DR Montreal; VE9HX Halifax; XEYE Mexico City; YU1BC, YV3BC Caracas; CP5 Bolivia; LSN Buenos Aires; COC Havana; EAQ Madrid; WQO and WEF, testing with the Byrd Expedition and a whole host of amateurs in practically every radio district of the United States. After that, we could no longer keep our eyes open so we "signed off" to bed.

Uses a simple regenerative circuit—so simple as to be entirely fool-proof. Tubes: 1—6D6, 1—6F7 (actually two tubes in one), 1—41, 1—41 power output tube and 1—80 full-wave rectifier. Two gang tuning condenser; single dial control; FULL-VISION ILLUMINATED AIRPLANE DIAL. Ship. wt. 35 lbs.

No. 5000. "DOERLE AC-5" Short Wave Receiver, Complete with Tubes, Speaker and 8 coils covering 15 to 200 meters. Completely wired and tested. (NOT SOLD IN KIT FORM) **\$25.96**  
YOUR PRICE

No. 5002. "DOERLE DC-5" SHORT-WAVE RECEIVER WITH SELF-CONTAINED POWER SUPPLY AND DYNAMIC SPEAKER. Same circuit as the "Doerle AC-5." Uses 1—6D6; 1—6F7; 1—37; and 2—41's in parallel. Completely wired and tested. Ship. wt. 30 lbs. **\$23.96**  
YOUR PRICE. Complete with Tubes and 8 coils covering 15 to 200 meters

## FREE 5 DAY TRIAL

You can now purchase this Doerle Deluxe 5-tube Short Wave Radio on a 5-day trial basis. If not convenient to pay all cash, send a deposit and pay the balance C.O.D. Prove to your own satisfaction that it will give you World Wide reception, and that our guarantee means exactly what it says. If at the end of five days after receiving the radio you are not perfectly satisfied, write us; shipping instructions. Upon receipt of the merchandise we will refund your purchase price in full.

### NEW 3-TUBE DOERLES

A.C.-2 Volt and D.C. Models 15 To 200 Meters—All Short-Wave Bands  
4-TUBE PERFORMANCE

If you are a Doerle fan, you will remember the tremendous popularity of the 1934 3-tube Doerle receivers. The 1935 instruments, however, are far superior in that they incorporate the latest developments in short-wave radio. Two-gang tuning condenser, single dial control, FULL-VISION ILLUMINATED AIRPLANE DIAL, two sets of plug-in coils (4 coils per set), loud speaker operation on many foreign stations. Only parts of first grade value are employed. For use with either short-wave doublet or standard antennas.

3-TUBE A.C. MODEL uses 1—6F7 (two tubes in one), 1—6D6 and 1—41 power output tube. Used with batteries OR A.C. power pack (listed below).

The 3-tube DC model uses the same tubes and has a built-in power supply so that it may be plugged in directly across the 110 volt AC line.

The 3-tube battery model employs a 34 variable-mu RF pentode, a 30 regenerative detector and a twin triode type 19 (actually 2 tubes in one) as two stages of AF amplification. Ship. wt. of all models 15 lbs.

#### ALL MODELS ON SAME CHASSIS

- No. 5004K. "Doerle AC-3" Receiver Kit including Coils, Cabinet and diagram, less tubes. **\$14.40** YOUR PRICE
- No. 5005K. "Doerle DC-3" Short-Wave Receiver Kit, including coils, cabinet and diagram. Less tubes. **\$12.40** YOUR PRICE
- No. 5006K. Doerle 3-Tube 2-Volt Battery Short-Wave Receiver Kit, less tubes but including cabinet, coils and diagram. **\$12.40** YOUR PRICE
- Complete Set of RCA Licensed Tubes for 3-Tube AC or DC or 2-Volt models. **\$2.68** YOUR PRICE
- No. 2149. AC Hum-Free Power Pack. **\$5.55** YOUR PRICE (wired), including tube. Any Kit Wired & Tested \$1.50 extra.

FREE!

To All  
SHORT-WAVE  
ENTHUSIASTS

Large 52-page book of short-wave facts, data, diagrams, circuits and illustrations. Contains short-wave sets and equipment of all kinds and descriptions.

Contains information not found anywhere else. **WRITE TODAY WITHOUT DELAY**

SEE PAGES 684 and 697 FOR MORE DETAILS



Including Cabinet and Coils **\$12<sup>40</sup>**  
Less Tubes

**RADIO TRADING CO., 101-A HUDSON ST., NEW YORK CITY**

Please mention SHORT WAVE CRAFT when writing advertisers

*Here's the new-Big*

# 1935 OFFICIAL SHORT WAVE RADIO MANUAL

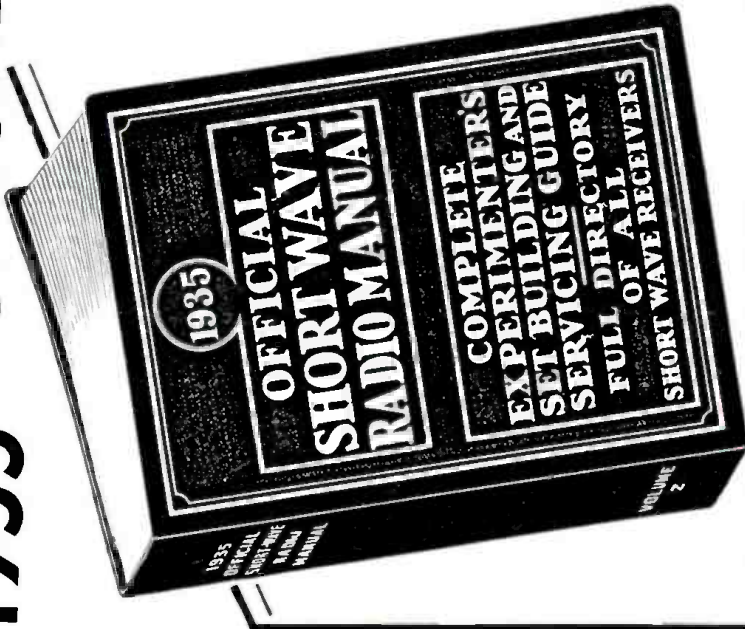

**CLIP AND MAIL THIS MONEY SAVING COUPON TODAY**

SHORT WAVE CRAFT  
99 Hudson Street,  
New York, N. Y.

Gentlemen: I enclose herewith my remittance of \$2.00 for which please send me one copy of the 1935 OFFICIAL SHORT WAVE RADIO MANUAL. I will pay the balance of the price of the book, \$2.00, when it is published. (Send remittance check or money order. Register letter if it contains cash or currency.)

Name

Address

City  State

When we brought out our 1934 OFFICIAL SHORT WAVE RADIO MANUAL, of which many thousands of copies were bought by short wave enthusiasts, we promised you that a new volume would be published every year.

In keeping with this promise, we now take great pleasure in announcing the 1935 OFFICIAL SHORT WAVE RADIO MANUAL. There has been tremendous progress and a great boom in short waves in the past year, and the art has made such rapid progress that no single book, up to now, has been able to keep up with this progress. The 1935 OFFICIAL SHORT WAVE RADIO MANUAL fills this need, and it fills it completely. All the progress made in short waves, whether it is in set building, whether it is in radio servicing, whether it is in new models, whether it is in new short wave discoveries, all are faithfully reported and chronicled in this great 1935 volume.

Like its predecessor, it is a BIG book, in which you will find literally EVERYTHING in short waves—nothing has been left out. Not only is it a complete manual, but it is a great encyclopedia of short wave facts, information, hookups, photographs, tables, maps, etc., etc. The wealth of material is so great that it would take several pages to list all the valuable data that has been included in this volume.

Similar to last year's volume, the new book has been edited by Hugo Gernsback, Editor of SHORT WAVE CRAFT and H. W. Secor, Managing Editor, and if you are and have been a reader of SHORT WAVE CRAFT, and particularly if you have seen the 1934 Manual, you will know just what you can expect from this, the greatest short wave manual ever put out by Mr. Gernsback.

Here are the star features of the book:

## 29 ★ Features:

- ★ 1—Short-Wave Beginners' Section—Dozens of new simplified circuits for 1-2 and 3 tube receivers, including famous "Doerle" and "Ocellotype," etc.
- ★ 2—Short-Wave Receivers—All types discussed with detailed instructions. The best types only, which have "stood the test" of actual operating service. Full details for constructing them, etc., "Hand-Spreading"; the Doerle, 5-tube T.R.F., etc.
- ★ 3—Battery Short-Wave Receivers—1-2, & 3 tube sets—all the way up to special 5-tube superheterodyne, designed especially for battery operation.
- ★ 4—"5-Meter" Department—All the latest "done" including newest transmitters, "Jong Line" oscillators, improved "high sensitivity" receivers. How to arrange best aerial to get greatest distance, 5-meter transmitters, book-tips, etc.
- ★ 5—Short-Wave "Artificial Fever" Apparatus—also newest fluorapatite and other allied applications of ultra short waves.
- ★ 6—Short-Wave Experimenter's Section—filled with Short-Wave "Kinks", Short-cuts, etc., of interest to every experimenter.
- ★ 7—Ultra Short Waves—Newest circuits, apparatus, and results obtained in this field.
- ★ 8—Commercial "Short-Wave" and "All-Wave" Receivers—Full Servicing Data for "Set-Overs" and "Service-men."
- ★ 9—How to build "Power Supply" Units for Short-Wave Receivers.
- ★ 10—Latest Short-Wave Converters—With servicing data on Commercial Models.
- ★ 11—The Short-Wave Antenna—including latest "Noise-Reduction" types, Transposed Lead-in systems, shielded cable, Double-Doublet, etc.
- ★ 12—Short-Wave Superheterodynes—From 3 to 11 tubes—latest descriptions and diagrams including commercial all-wave superhets.
- ★ 13—Phone Transmitters for Amateur Stations—How to build them.
- ★ 14—"Skip" Distance—Heavily illustrated and explained; physics of Short Waves.
- ★ 15—Super-Regenerative Short-Wave Receivers—latest circuits, etc.
- ★ 16—Recording "Foreign" and "Domestic" Short-Wave programs. All systems in use.
- ★ 17—"High Fidelity"—How to obtain it in Short-Wave Receivers.
- ★ 18—The best Short-Wave Questions and answers of the year.
- ★ 19—The best Short-Wave "Kinks" of the year.
- ★ 20—Foreign Short-Wave Review—New circuits, apparatus, etc.
- ★ 21—Tubes for Short-Wave purposes—including tables of latest tubes for Short-Wave Transmitters and Receivers.
- ★ 22—Short-Wave Transmitters—All about the new "Long Leaps" Oscillators as well as other "simplified" high-efficiency transmitters, Kark and Panel jobs, "Crystal Control," etc.
- ★ 23—Multi-Purpose Tubes—How to use them on Short Waves—Sets in which 2 tubes=4; 3 tubes=6; etc.
- ★ 24—"Audio Amplifiers" for Short-Wave Receivers, Circuits, etc.
- ★ 25—"Band-Spread"—How to spread the stations over the dial for easier tuning.
- ★ 26—"Plug-less" "Mono-Coil" Receivers—How to build efficient switch-type coils to eliminate plug-in coils; "Clip-Coil" Receivers, etc.
- ★ 27—Boosters, Pre-amplifiers and Beat Oscillators—How they work, with constructional data, diagrams, etc.
- ★ 28—Portable Short-Wave Receivers and Transmitters—Transmitter Power supply from Ford Coils, etc.

### AND FOR SERVICE MEN

- ★ 29—Every short-wave diagram, every short-wave all-wave set, EVERYTHING, whether it is an amateur or commercial set, has been included. It will be found in this special enlarged section. Hundreds of valuable diagrams, with tube layouts, resistor values, color codes of wiring cables, etc., and the purpose of each tube in each set clearly indicated on the diagram wherever this information can possibly be obtained.

**OVER 240 BIG PAGES • OVER 1000 Illustrations  
Size 9 x 12 Inches — Flexible Looseleaf Leatherette Binder**

### SPECIAL PRE-PUBLICATION OFFER

As has been customary with us in the past, we give our readers the opportunity to order the book before it comes off press and save money. The price of the new 1935 OFFICIAL SHORT WAVE RADIO MANUAL will be \$2.50 as soon as it comes off the press. No reduction in price will be made later. To you, who order this book before publication, the price is \$2.00. As soon as the OFFICIAL SHORT WAVE RADIO MANUAL is published, the pre-publication price will be immediately withdrawn. It is, therefore, to your advantage to order your copy today.

SAVE **50%** by BUYING YOUR RADIO *Direct from* MIDWEST LABORATORIES

Thrill to Guaranteed World-Wide HIGH FIDELITY Performance with This Amazing New **MIDWEST SUPER Deluxe 16-TUBE ALL-WAVE Radio!** (ALL FIVE WAVE BANDS)

Only Midwest Gives You These Exclusive Features

HERE are a few reasons why Midwest is generally accepted as the world's most "Universal" set. They explain why it is so popular in Africa, Spain, and other countries where reception conditions vary widely—illustrate why so many police, army, navy and consular officials as well as listening posts prefer it—prove why many "hams," who own a number of sets, use the Midwest in preference to any other.

**FIDEL-A-STAT**  
Three Taps  
No Gap  
No Stop

Absolutely new and exclusive with Midwest, this feature represents the only new departure in controlling potentials since about 1863. With the Midwest Fidel-A-Stat, the full beauty and rhythmic nature of modern music, together with the beautiful "lace work" of flutes, violins, piccolo and other reed instruments, may be brought out and accentuated to any degree desired. You'll be amazed and pleasantly surprised the first time you use this startlingly different control.

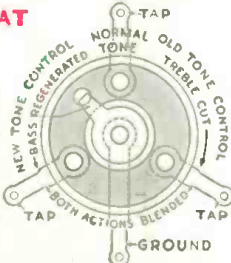

Only Midwest Gives you Multi-Function Dial

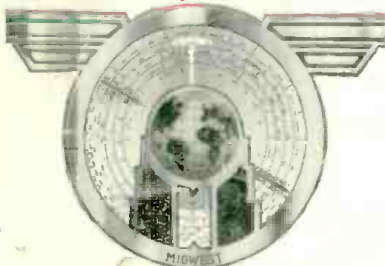

This dial is not an ordinary airplane dial. It is a many purpose unit that performs many functions. Send for FREE Miniature Dial showing these outstanding advantages:  
Dial calibrated in Kilocycles, Megacycles and Meters . . . Call letters of American Broadcast Stations printed on dial and illuminated . . . Slow-Fast, Smooth-Action Tuning . . . Station Group Locator . . . Simplified Tuning Guide Lights . . . Automatic Select-O-Band Indicator . . . Illuminated Pointer Indicator . . . Silent Shadow Tuning . . . Centralized Tuning.

**NEW STYLE CONSOLES**

The Midwest 36-page catalog pictures a complete line of beautiful, artistic deluxe consoles and chassis in four colors. Write for new FREE catalog . . . TODAY!

Midwest long-range prices are as low as **\$27.50**



TERMS AS LOW AS \$5.00 DOWN

**30 DAYS FREE TRIAL**

**BEFORE** you buy any radio, write for the new FREE Midwest "Fifteenth Anniversary" catalog and see how you can save from 1/3 to 1/2 by buying direct from Midwest Laboratories. Learn why Midwest outperforms sets costing up to \$200 and more. Midwest gives you triple protection with: **One-Year Guarantee, Foreign Reception Guarantee, Money-Back Guarantee.**

**50 ADVANCED FEATURES**

Exclusive "Invisible Hands" features include: High Level Automatic Volume Control Action, Discriminating Automatic Tone Control, Multi-Function Dial, Micro-Tenuator, Fidel-A-Stat, etc. Only Midwest covers a tuning range of 9 to 2400 meters (33 Megacycles to 125 KC)—enabling you to easily and successfully tune in even low-powered foreign stations up to 12,000 miles away—with crystal-clear, loud speaker, High Fidelity reception.

All 5 Wave bands enable you to enjoy today's finest High Fidelity American programs. In addition, you get Canadian, police, amateur, airplane broadcasts...commercial and ship signals...and delight in exciting world-wide broadcasts from England, France, Germany, Spain, Italy, Russia, Australia, etc. Send today for money-saving facts!

**Micro-Tenuator—Midwest Expanding and Contracting I. F. Transformer**



(U. S. Patent Pending, Serial No. 721,240)

This feature makes you master of your set's sensitivity. The "Electromagnetic Shield" is under your complete control at all times by means of the Micro-Tenuator lever on the front panel. By turning this lever entirely to the left, the "Electromagnetic Shield" cuts the coupling between the primary and secondary so low that the sensitivity of the set is barely sufficient to bring in local stations and powerful nearby stations. It is impossible to obtain any of the whistling heterodyne noises, static and other noises originating outside of the radio.

**ONLY RADIO COVERING 9 TO 2,400 METERS. 12,000 MILE TUNING RANGE**

**WORLD'S GREATEST RADIO VALUE**

**\$57.50** with New Deluxe Auditorium-Type **SPEAKER**

**EXPERIENCED RADIO MAN PRAISES MIDWEST**  
Trenton, N. J.—I am firmly convinced that I have received the most for my money in my 15 years' experience. My Midwest-16 brought in 12RO, Rome; EAQ, Madrid; FYA, France; GSA, GSB, Daventry; VK2ME, Sydney, etc. It has remarkable selectivity! With WCAU at 1170 KC and WOAI at 1190 KC, both 50,000-watt stations, transmitting at their peak, about 9 P.M., I have cut between these stations and received KOB, New Mexico, at 1180 K with loud speaker volume—and no interference. R. M. Scheid, Jr., 28 Boudinot Street.



**DEAL DIRECT WITH LABORATORIES**  
Increasing costs are sure to result in high radio prices soon. Buy before the big advance . . . NOW . . . while you can take advantage of Midwest's sensational values. No middlemen's profits to pay! You save 30% to 50% when you buy this popular way . . . You get 30 days FREE trial . . . as little as \$5.00 down puts a Midwest radio in your home. Foreign Reception, One-Year and Money-Back GUARANTEES protect you! Write for FREE catalog now . . . TODAY!

**SAVE UP TO 50%**

**MAIL COUPON TODAY! FOR FREE MINIATURE DIAL . . . FREE 30-DAY TRIAL OFFER . . . FREE CATALOG**

**MIDWEST RADIO CORP., Dept. 37A, Cincinnati, Ohio.**  
Without obligation on my part, send me your new FREE catalog, FREE Miniature Dial, and complete details of your liberal 30-day FREE trial offer. This is NOT an order.

User-Agents Make Easy Extra Money Check Here for Details

Name \_\_\_\_\_  
Address \_\_\_\_\_  
Town \_\_\_\_\_ State \_\_\_\_\_  
 Check here if interested in a Midwest World-Wide Battery Radio.

**MIDWEST RADIO CORP.**  
DEPT. 37A - CINCINNATI, OHIO, U. S. A.  
Established 1920 Cable Address Mirara . . . All Codes