

May

# SHORT WAVE CRAFT

Edited by  
HUGO GERNSBACK

**HE WON THE  
SHORT WAVE  
SCOUT TROPHY!**

See Page 23



25¢  
IN CANADA  
30¢



# Tune In..



## POWERTONE

Deluxe **6 Tube**

## ALL-WAVE SUPERHETERODYNE

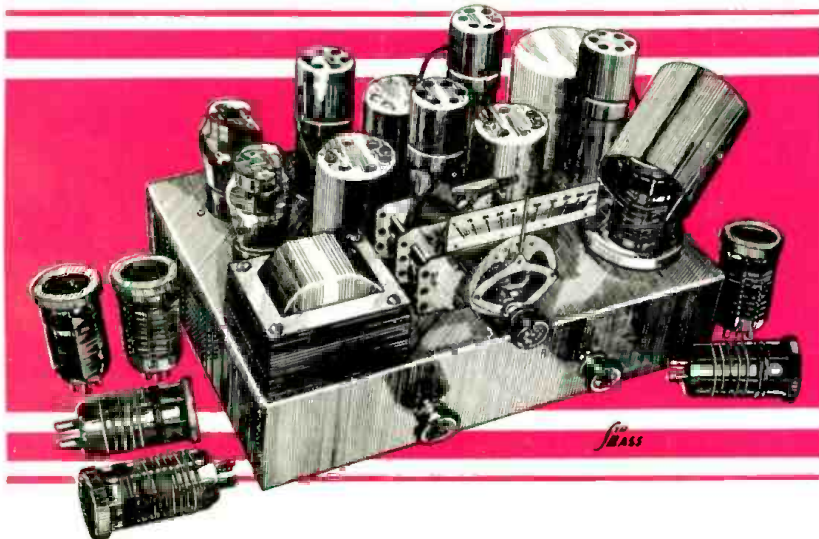

**J**OURNEY around the world via the new 1934 Powertone ALL-WAVE Superheterodyne Receiver. Every little nook on the globe can be "picked up"—from our own United States to the most distant Oriental short wave station. Listen to Mussolini's dynamic speeches to his Italian Fascist subjects; hear the latest news of warfare rumors in rebellious Europe; keep in touch with Germany and the Nazis' reorganization campaign; enjoy the talented broadcasts from the new Russian stations; travel with every adventurer, through the air or on land, all from your comfortable easy chair.

**D**OESN'T all this sound breath-taking? Remember, that every one of these foreign stations comes to you DIRECT, not relayed as many of the foreign musical programs are broadcasted today. As a superheterodyne it has the automatic volume control that is so important in tuning the weaker signals to a loud, audible tone on your loudspeaker. The All-Wave 6 is refined to the last degree, so that sideband cutting is reduced and maximum selectivity is retained.

Another indispensable feature is the powerful amplification due to the 2A5 tube driven by a '55. An '80 type rectifier tube is used to supply the plate current. Other tubes incorporated are 1-2A7 and 2-'58's.

**I**F YOU are not at the moment desirous of tuning stations on the short wave bands, just plug in a pair of Bruno broadcast coils and you have regular broadcast stations coming in with the perfect clarity and undistortion of an expensive superheterodyne broadcast receiver.

The All-Wave 6 comes in kit form for the many radio enthusiasts who want to build their own set. The kit includes everything from a nut to the transformer and dynamic speaker. To facilitate your labors we include a clear blueprint with both the schematic and pictorial diagrams and an instruction sheet.

### FREE

For a short time we are including a splendid Short Wave Manual and Servicing Guide with every purchase of an All-Wave 6. You will find this book will help you in many ways to find out the intricacies of the short wave spectrum.

Our low price includes 2 sets of BRUNO low loss plug-in coils (15 to 200 meters) and a dynamic speaker especially designed to reproduce the weakest signals audibly and clearly.

Model PSW-6 completely wired and tested extra 5.00  
 Set of matched Sylvania tubes..... 3.95  
 Set of Bruno broadcast coils (200 to 550 meters) 1.50  
 A special black crystal-finished, all-metal cabinet 2.95

**Complete**  
**KIT OF PARTS**  
 including  
**8 "Bruno" COILS**  
**\$24.50**  
 with DYNAMIC SPEAKER



**TRY-MO RADIO CO. INC. 85 Cortlandt St. New York**

SEND FOR NEW 1934 CATALOG—FREE—



# How a "Tip" got Tom a Good Job

**GEE, THERE'S D.J.C. IN BERLIN. THAT'S THE TENTH FOREIGN STATION TONIGHT. RADIO IS SURELY FUN.**

**HELLO, TOM. HOW'S EVERYTHING?**

**OH, NOT SO GOOD BILL, BUT I'M STILL HAVING FUN PLAYING WITH RADIO. HADDJ.C. LAST NIGHT ON A LITTLE SET I BUILT. IS RADIO STILL YOUR HOBBY TOO?**

**NO, TOM. I'VE BEEN TOO BUSY MAKING GOOD MONEY OUT OF RADIO TO SPEND TIME "PLAYING" WITH IT.**

**GOSH, BILL, YOU'RE SURE LUCKY. I NOTICED YOUR SWELL CLOTHES AND SNAPPY CAR. I THOUGHT YOU HAD INHERITED A MILLION. TELL ME ABOUT IT.**

**I AM LUCKY, TOM, BUT YOU HAD THE SAME CHANCE. REMEMBER ABOUT A YEAR AGO I SHOWED YOU A BOOK FROM NATIONAL RADIO INSTITUTE THAT TOLD ABOUT THE OPPORTUNITIES AND BIG FUTURE IN RADIO, AND HOW OTHERS HAD SUCCEEDED THROUGH THEIR HOME TRAINING? REMEMBER, I TRIED TO GET YOU TO ENROLL FOR THEIR COURSE WHEN I DID.**

**WELL, IT WAS THE SMARTEST MOVE I EVER MADE. I'M DOING SWELL. MARY AND I ARE TO BE MARRIED NEXT MONTH. TOM, WHY DON'T YOU SNAP OUT OF IT? DON'T STAY IN THAT DREARY LOW PAY JOB ALL YOUR LIFE. RADIO IS MORE THAN A PLAYTHING. IT'S A BIG BUSINESS. IT'S YOUR OPPORTUNITY. TAKE MY TIP. IT ISN'T TOO LATE. RADIO IS STILL YOUNG AND GROWING.**

**IF BILL SUCCEEDED I CAN TOO!**

**THEN I CAN MAKE REAL MONEY SERVICING RADIO SETS**

**OR INSTALL AND SERVICE LOUD SPEAKER SYSTEMS**

**OR MAKE GOOD MONEY IN ANY ONE OF THE MANY OTHER NEW AND GROWING BRANCHES OF RADIO. THERE'S NO END OF GOOD JOBS FOR A TRAINED RADIO MAN! YES, SIR, I'M GOING TO SEND FOR THAT FREE BOOK AND GET THE DOPE RIGHT NOW!**

**OR GET A JOB IN A BROADCASTING STATION**

**YOU CERTAINLY KNOW RADIO. I MINE NEVER SOUNDED BETTER**

**N. R. I. TRAINING CERTAINLY PAYS. I JUST STARTED A FEW MONTHS AGO AND I'M MAKING GOOD MONEY ALREADY. THIS SPARE TIME WORK IS SWELL FUN, AND SOON I'LL BE ALL SET FOR A GOOD FULL TIME JOB**

**THANKS!**

**OH, TOM! IT'S WONDERFUL—TO THINK HOW FAST YOU'VE GONE AHEAD SINCE YOU WENT INTO RADIO. WE NEVER COULD HAVE GOTTEN MARRIED ON WHAT YOU WERE GETTING BEFORE.**

**OUR WORRIES ARE OVER. I'M MAKING GOOD MONEY NOW, AND THERE'S A BIG FUTURE AHEAD FOR US IN THIS LIVE WIRE RADIO FIELD.**

..... I will help you start a spare time or full time Radio service business Without Capital



Many Radio Experts Make \$40, \$60, \$75 a Week

## HERE'S PROOF THAT N.R.I. MEN MAKE GOOD MONEY

**"MADE \$6,000 IN 2 YEARS"**  
 "Soon after the depression started, I found myself without a job, but I was well protected with N. R. I. training. I swung right to full time Radio servicing and I have made over \$6,000 in a little over two years."—Wm. Spartzent, Sparty Radio Service, 93 Broadway, Newark, N. J.

**"\$500 A YEAR IN SPARE TIME"**  
 "Although doing spare time Radio work only, I have averaged about \$500 a year extra in addition to my regular income. Full time Radio work would net me many times that amount."—Edw. H. Fawcett, Slough Rd., Ladner, B. C., Canada.

**"NOW OWNS OWN BUSINESS"**  
 "If I had not taken your Course I would be digging ditches instead of running my own business. One week I made \$75 on repairing alone, and this doesn't count sales. If a fellow wants to get into radio, N. R. I. is the starting point."—R. S. Lewis, Modern Radio Service, Pittsfield, Ill.

**"\$50 TO \$75 A WEEK"**  
 "The National Radio Institute put me in a position to make more money than I ever made in good times. I am in the Radio Service business for myself, where it is possible for me to make from \$50 to \$75 a week. Service work has increased because people, who in normal times would buy a new Radio, now are contented to have the old one "pepped up."—Bernard Costa, 150 Franklin St., Brooklyn, N. Y.

The world-wide use of Radio sets has made hundreds of opportunities for good spare time or full time Radio businesses. Many of the seventeen million Radio sets are only 25% to 40% efficient. I will show you how to cash in on this condition. I will show you how to install and service all types of receiving sets in spare time. I'll show you how to make enough money while learning Radio to start your own service business. Clip the coupon below. Get my free book, "Rich Rewards in Radio." Read how hundreds of N. R. I. students and graduates have made good money in spare time or full time businesses.

Many Make \$5, \$10, \$15 a Week Extra in Spare Time Almost at Once

The day you enroll I send you directions for doing 28 Radio jobs common in almost every neighborhood for spare time money. I give you plans and ideas that have made \$200 to \$1,000 a year for many N. R. I. men in spare time.

Get Ready Now for Jobs Like These

In just about 15 years Radio's growth has created over 300,000 jobs. Thousands more jobs will be opened by new Radio developments. Broadcasting stations use engineers, operators, station managers and pay up to \$5,000 a year. Manufacturers employ testers, inspectors, foremen, engineers, servicemen, buyers, for jobs paying up to \$7,500 a year. Dealers and jobbers employ servicemen, salesmen, buyers, managers and pay up to \$100 a week.

Television, Short Wave, Loud Speaker Systems Included

There's opportunity for you in Radio. Its future is certain. Television, short wave, loud speaker systems, ship Radio, police Radio, automobile Radio, aircraft Radio—in every branch, developments and improvements are taking place. Here is a real future for thousands of men who learn Radio—men with N. R. I. training. Get the training that opens the door to good pay and success.

**Money Back Agreement Protects You**  
 I am so sure N. R. I. can train you satisfactorily that I agree in writing to refund every penny of your tuition if you are not satisfied with my Lesson and Instruction Service upon completion. Get my 64-page book of facts. It's free to any ambitious fellow over 15 years of age. It tells you about Radio's opportunities; about my Course; what others are doing; and making.

**J. E. SMITH,**  
 President National Radio Institute,  
 Dept. 4EB3,  
 Washington, D. C.

Dear Mr. Smith: Without obligating me, send your book which points out the spare time and full time job opportunities in Radio and explains how amazingly practical \$5.00 method of training men quickly and inexpensively at home in their spare time to be Radio Experts.

**MAIL THIS for FREE 64 page book**

NAME..... ADDRESS..... CITY..... STATE.....



**IN THIS ISSUE: PROMINENT SHORT-WAVE AUTHORS**  
**Smith . Victor . Shuart . Andrews . Tinsel . Palmer**

**HUGO GERNSBACK**  
**Editor**



**H. WINFIELD SECOR**  
**Managing Editor**

**Contents for May, 1934**

Editorial—"The Best Short-Wave Set," by Hugo Gernsback .....	5
W3XAL—Short-Wave Voice of "N.B.C.".....	6
New 2-Way Police Radio Uses 7 to 10 Meter Waves, by Carl Oscar Arnberg .....	7
Station W8DKE Goes "Buggy Riding".....	8
How Radio Landing Beam Guides Aircraft, by J. A. Smith, .....	9
President, National Radio Institute.	
The Electrodyne 1-Tube "Band Spread" Receiver, by Leonard Victor and Ernest Kahlert.....	10
152 Miles on 600,000,000 Megacycles, by George W. Shuart and N. H. Lessem.....	11
W2XAF's Directive Aerial Gives Gain of 20.....	11
The Doerle Goes "Band Spread", by George W. Shuart, W2AMN .....	12
5-Tube T.R.F. Receiver, by M. Harvey Gernsback....	14
A 6-Tube S.W. Superhet, by Herman Cosman.....	16
Field Strength Measurements on 5 Meters, by Chris L. Schultz.....	18
Many Frequencies on One Crystal, by George W. Shuart .....	20
A Good 14-Tube Receiver—Part II, Conclusion, by Frank D. Andrews.....	22
Short Wave Scouts—Award of the 3rd Trophy Cup..	23
Our Readers' Forum—German 5-Meter Amateur Station; This "YL" Flies, Paints and CQ's.....	24
World-Wide Short-Wave Review, edited by C. W. Palmer .....	26
What's New In Short-Wave Apparatus.....	28
Transformer Construction Hints, by O. K. Tinsel....	30
Short Wave League—A reply to Mr. Worcester's "No-Code" Argument .....	31
\$5.00 Monthly for Best Short-Wave Kink.....	32
SHORT WAVE STATIONS OF THE WORLD—new complete "Grand" List—including Police, Television and Airplane stations; edited by M. Harvey Gernsback .....	33
Short-Wave QUESTION BOX, edited by "W2AMN"...	36
When To Listen In, by M. Harvey Gernsback.....	49



**Certified Circuits**

• **SHORT WAVE CRAFT** goes to a large expense in verifying new circuits published in this magazine. Whenever you see the seal shown here in connection with any of the sets published in this and future issues of **SHORT**

**WAVE CRAFT**, this will be your guarantee that this set has been tested in our laboratories, as well as privately, in different parts of the country to make sure that the circuit and selected parts are right. Only "Constructional-Experimental" circuits are certified by us.

When you see our certificate seal on any set described you need not hesitate in spending money for parts, because you are assured in advance that the set and circuit are bona fide and that this magazine stands behind it.

**SHORT WAVE CRAFT** is the only magazine that thus certifies circuits and sets.

**OUR COVER**

• **OUR** cover illustration shows the happiest moment in a certain young man's life—the day when he receives his **SHORT WAVE SCOUT "TROPHY"**. This handsome trophy, which is awarded each month to the Scout submitting the best list of short-wave stations heard, is described in detail—together with the rules of the monthly contest, on page .....

COPYRIGHT, 1934, BY H. GERNSBACK

**Published by POPULAR BOOK CORPORATION**

HUGO GERNSBACK, President - - - - H. W. SECOR, Vice-President  
 EMIL GROSSMAN - - - - - Director of Advertising  
 Chicago Adv. Office - - - - L. F. McCLURE, 919 No. Michigan Ave.  
 Publication Office - - - - 404 N. Wesley Avenue, Mount Morris, Ill.  
 Editorial and General Offices - - - 96-98 Park Place, New York, N. Y.  
 London Agent: HACHETTE & CIE., 16-17 King William St., Charing  
 Cross, W.C.2

Paris Agent: HACHETTE & CIE., 111 Rue Reaumur  
 Australian Agents: MCGILL'S AGENCY, 179 Elizabeth St., Melbourne

**Features in June Issue**

- The Duo-Amplidyne—A New 1-Tube Receiver That Does The Work of 2-Tubes, by George W. Shuart, W2AMN.
- Heinie Johnson's Receiver—with which he won the **SHORT WAVE SCOUT "TROPHY CUP"**.
- A Variable Wavelength Antenna.
- A 4-Tube Short-Wave Receiver that's different—The "R-G-H", by Robert G. Herzog, B.S., E.E.
- A D.C. Battery-Operated Short-Wave Converter, using but one tube, by W2AMN.
- Curtis E. Malsberger describes his latest improved "Ham" transmitter. The Victor "Easy-Tune" 2-Tube BAND-SPREADER.

# The 4 ESSENTIAL SHORT WAVE BOOKS

'ROUND THE WORLD FANS USE THESE GREAT SHORT WAVE BOOKS

These great books contain everything on short waves that is really worth knowing—they are books which have been most enthusiastically welcomed by short-wave fans. The cost of the books is extremely low in comparison with the valuable material which they contain.

There is not a short-wave fan, experimenter or interested radio-minded reader who will not want these books. Right up-to-the-minute with new material on outstanding developments in the short wave field. The books are authoritative, completely illustrated and not too highly technical.

## Ten Most Popular Short Wave Receivers. How to Make and Work Them

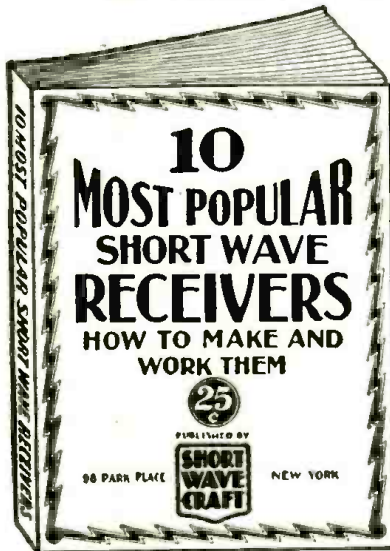

This new volume is a revelation to those who wish to build their own short wave receivers. The editors of SHORT WAVE CRAFT have selected ten outstanding short wave receivers and these are described in the new volume. Each receiver is fully illustrated with a complete layout, pictorial representation, photographs of the set complete, hookup and all worthwhile specifications. Everything from the simplest one tube set to a 5-tube T. R. F. receiver is presented. Complete lists of parts are given to make each set complete. You are shown how to operate the receiver to its maximum efficiency.

### CONTENTS

The Doerle 2-Tube Receiver That Reaches the 12,500 Mile Mark, by Walter C. Doerle.  
 2-R.F. Pentode SW Receiver having two stages of Tuned Radio Frequency, by Clifford E. Denton and H. W. Secor.  
 My de Luxe S-W Receiver, by Edward G. Ingram.  
 The Binneweg 2-Tube 12,000 Mile DX Receiver, by A. Binneweg, Jr.  
 Build a Short Wave Receiver in your "Brief Case," by Hugo Gernsback and Clifford E. Denton.  
 The Denton 2-Tube All-Wave Receiver, by Clifford E. Denton.  
 The Denton "Stand-By," by Clifford E. Denton.  
 The "Stand-By" Electrified.  
 The Short-Wave MEGADYNE, by Hugo Gernsback.  
 A COAT-POCKET Short Wave Receiver, by Hugo Gernsback and Clifford E. Denton.  
 Boy, Do They Roll In on this One Tubular, by C. E. Denton.  
 The S-W PENTODE-4, by H. G. Cain.  
 M. E. Louis Martin's Idea of A GOOD S-W RECEIVER, by Louis Martin.

25c

## The Short Wave Beginner's Book

Here is a book that will solve your short wave problems—leading you in easy stages from the simplest fundamentals to the present state of the art as it is known today. It is the only low-priced reference book on short waves for the beginner.

The book is profusely illustrated with all sorts of photos, explanations and everything worthwhile knowing about short waves—the book is not "technical." It has no mathematics, no "high-fluting" language and no technical jargon. You are shown how to interpret a diagram and a few simple sets are also given to show you how to go about it in making them.

It abounds with many illustrations, photographs, simple charts, lookups, etc., all in simple language. It also gives you a tremendous amount of very important information which you usually do not find in other books, such as time conversion tables, all about aerials, noise elimination, how to get verification cards from foreign stations, all about radio tubes, data on coil winding and dozens of other subjects.

### Partial List of Contents

Getting Started in Short Waves—the fundamentals of electricity. Symbols, the Short Hand of Radio—how to read schematic diagrams. Short Wave Coils—various types and hints in making them. Short Wave Aerials—the points that determine a good aerial from an inefficient one. The Transposed Leads for reducing Man Made Static. The Beginner's Short-Wave Receiver—a simple one tube set that anyone can build. The Beginner's Set Gets an Amplifier—how the volume may be increased by adding an amplifier. How to Tune the Short-Wave Set—telling the important points to get good results. Registration Control in Short Wave Receivers. Audio Amplifiers for S. W. Receivers. How to Couple the Speaker to the set. Learning the Code—for greater enjoyment with the S-W set. Wave length to Kilocycle Chart. Wire Chart—to assist in the construction of coils. Hints in the construction of S-W Receivers.

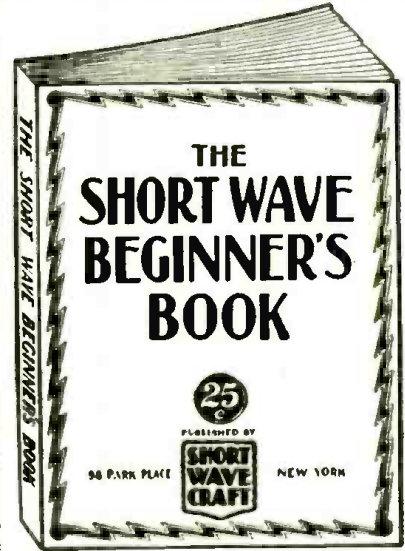

40 PAGES OVER 75 ILLUSTRATIONS

25c

## How to Build and Operate Short Wave Receivers

is the best and most up-to-date book on the subject. It is edited and prepared by the editors of SHORT WAVE CRAFT, and contains a wealth of material on the building and operation, not only of typical short-wave receivers, but short-wave converters as well. Dozens of short-wave sets are found in this book, which contains hundreds of illustrations; actual photographs of sets built, hookups and diagrams galore.

The book comes with a heavy colored cover, and is printed throughout on first-class paper. No expense has been spared to make this the outstanding volume of its kind. The book measures 7 1/2 x 10 inches.

This book is sold only at such a ridiculously low price because it is our aim to put this valuable work into the hands of every short-wave enthusiast.

We know that if you are at all interested in short waves you will not wish to do without this book. It is a most important and timely radio publication.

Over 150 Illustrations  
72 Pages 7x10 Inches

50c

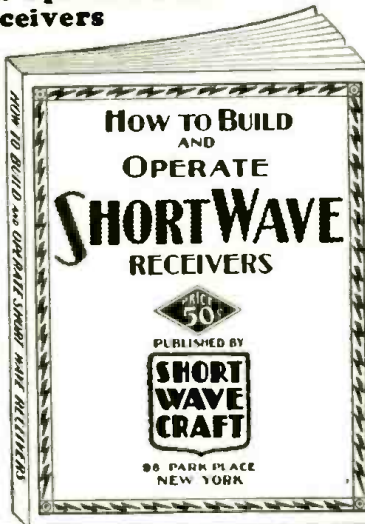

## How to Become an Amateur Radio Operator

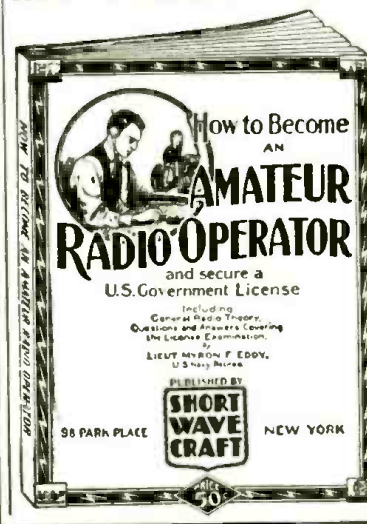

We chose Lieut. Myron F. Eddy to write this book because his long years of experience in the amateur field have made him pre-eminent in this line. For many years he was instructor of radio telegraphy at the R.C.A. Institute. He is a member of the R.E. Institute of Radio Engineers, also the Veteran Wireless Operators' Association.

If you intend to become a licensed code operator, if you wish to take up phone work eventually, if you wish to prepare yourself for this important subject—this is the book you must get.

### Partial List of Contents

Ways of learning the code. A system of sending and receiving with necessary drill words is supplied so that you may work with approved methods. Concise, authoritative definitions of radio terms, units and laws, brief descriptions of commonly used pieces of radio equipment. This chapter gives the working terminology of the radio operator. Graphic symbols are used to indicate the various parts of radio circuits. General radio theory particularly as it applies to the beginner. The electron theory is briefly given, then waves—their creation, propagation and reception. Fundamental laws of electric circuits, particularly those used in radio are explained next and types of basic circuits are analyzed. Descriptions of modern receivers that are being used with success by amateurs. You are told how to build and operate these sets. Amateur transmitters. Diagrams with specifications are furnished so construction is made easy. Power equipment that may be used with transmitters and receivers, rectifiers, filters, batteries, etc. Regulations that apply to amateur operators. Appendix which contains the International "Q" signals, conversion tables for reference purposes, etc.

Over 150 Illustrations  
72 Pages 7x10 Inches

50c

All the books shown on this page are published exclusively by

**SHORT WAVE CRAFT**

98-98 Park Place, New York, N. Y.

CLIP-MAIL

SHORT WAVE CRAFT  
98-98 Park Place, New York, N. Y.

Gentlemen: I enclose herewith my remittance for the amount of \$..... for which you are to send me, postpaid, the books checked below.

- ( ) Ten Most Popular Short Wave Receivers. How to Make and Work Them. 25c each
- ( ) The Short Wave beginner's Book..... 25c each

Name.....  
Address.....  
City..... State.....

(Send remittance in form of check or money order. If letter contains cash or unused U. S. Postage Stamps, register it.)

SW-5-34

These Books are Authentic For All Short Wave Work and LOW in Price

COUPON TODAY!



# CUT PRICES ON RADIO BOOKS

for you to go to college to become proficient in radio. Start today, to build a REAL radio library and become acquainted with all branches of this great and growing art. In this page are listed the world's best radio books. We have combed the market for the really important books in radio; so that, no matter what branch you are interested in, you can pick out the best books that are now printed. Start, now, to build a complete radio library. You do not have to get all the books at once, but make up your mind to get one book a month; so that, when your chance comes, you will be fully equipped to win out over the others not so well equipped.

**IMPORTANT.—All prices have been drastically reduced—take advantage of it.**

**SHORT WAVE WIRELESS COMMUNICATION.** by A. W. Ladner and C. R. Stoner. Cloth covers, size 6x9", 348 pages, 200 illustrations, 12 plates. **\$3.46**

Short wave experimenters who have grown out of 1-tube sets will revel in this book, which tells the "how come" of short-wave operation. A good portion of the volume is devoted to the amateur and commercial aspects of S. W. transmission.

**RADIO FREQUENCY ELECTRICAL REQUIREMENTS.** by Hugh A. Brown. Cloth covers, size 6x9", 386 pages, 235 illustrations. Price **\$3.90**

One of the few great books on this important subject. Everything from thermionic-tube coefficients to piezo-electric measurements.

**PRACTICAL TELEVISION.** by E. T. Lerner. Cloth covers, size 5 1/2 x 8 1/2", 223 pages, 127 illustrations. Price **\$3.69**

This book explains television in full, including elementary principles, photo-electric cells, and all important types of television sets as well as basic principles of optics, images, mirrors, lenses, etc.

**MAGNETIC PHENOMENA.** by Samuel Ickhous Williams. Cloth covers, size 6x9", 230 pages, 150 illustrations, and numerous tables. Price **\$2.98**

All electric motors, coupling coils, magnetic and dynamic loud speakers, transformers, choke coils, etc., are dependent on magnetic phenomena. This fine book is complete on the subject.

**CINEMATOGRAPHY.** by James R. Cameron. Stiff covers, size 7 1/2 x 5", 240 pages, 150 illustrations. Price **\$3.90**

Everything on the subject from "silent" and "talkie" 16 mm. film to its manufacture and to the final projection is in this marvelous volume.

**AUDELS RADIOMAN'S GUIDE.** by Frank D. Graham. Cloth covers (flexible), size 5 1/2 x 7 1/2", 220 pages, 800 illustrations. Price **\$ .89**

A practical, concise book presenting the theoretical and practical information for the proper operation, maintenance and service as applied to modern radio practice.

**THE RADIO AMATEUR'S HANDBOOK.** (New Revised Edition) by A. Frederick Collins. Cloth covers, size 5 1/2 x 7 1/2", 394 pages, 116 illustrations. Price **\$1.97**

If you wish to become a radio amateur (radio ham) this book tells you how. Everything in receiving and transmitter sets and how to build them.

**EXPERIMENTAL RADIO.** by R. R. Ramsey, Prof. of Physics, Indiana University. Cloth covers, size 7 1/2 x 5 1/2", 256 pages, 168 illustrations. Price, **\$2.69**

A marvelous book for the experimenter. Experiments follow in easy comprehensible language.

**HOW TO ORDER** We cannot ship C. O. D. Our prices are net, as shown. Some of the books sent prepaid (in U. S. only). Those that are not thus listed will be shipped by express collect if sufficient postage is not included by you.

**FOUNDATIONS OF RADIO.** by Rudolph L. Duncan. Cloth covers, size 5 1/2 x 8", 246 pages, 145 illustrations. Numerous tables. Price **\$2.47**

This textbook gives you the fundamentals of electricity as applied to radio. It equips you for further study in the field of radio.

**RADIO THEORY AND OPERATING.** by M. T. Loomis, 5th revised Edition. Cloth-bound; size 5 1/2 x 8 1/2" thick; 1,000 pages; over 800 illus.; 450 review questions and answers. **\$4.38**

Written in textbook style, a tremendous amount of useful information has been crammed into this thin-paper, compact reference work. Radio transmission and reception have been covered, "from soup to nuts." A truly great book.

**S. GERNSBACK'S RADIO ENCYCLOPEDIA** (Second Edition). Iteo Morocco Flexible Binder, 352 pages, 2201 radio definitions, 1253 illustrations, 34 tables. **\$3.19**

The most comprehensive encyclopedia of its kind in print. Remarkably up-to-date in every way, with marvelous illustrations.

**DRAKE'S CYCLOPEDIA OF RADIO AND ELECTRONICS.** by H. P. Manly. Cloth covers, size 6x9", 1050 pages, 1080 illustrations. New 1933 Edition. Price **\$4.88**

The largest work of its kind ever put between two covers. New and up-to-date; a standby for every radio man.

**FUNDAMENTALS OF RADIO.** by R. R. Ramsey, Professor of Physics, Indiana University. Cloth covers, size 9 1/2 x 8", 372 pages, illustrated. Price **\$3.46**

The backbone of the radio art. This book gives you the foundation on radio from A to Z.

**RADIO OPERATING QUESTIONS AND ANSWERS.** (Revised Fifth Edition), by Nilson and Hornung. Cloth covers, size 5 1/2 x 8", 390 pages, 96 illustrations. Price **\$2.47**

Contains over 600 questions and answers covering all phases of licensed radio operation. Revised to contain much new material. Nothing better in print for the transmitting and receiving amateur.

**OFFICIAL RADIO SERVICE MANUAL. Volume I.** by Hugo Gernsback and Clyde Fitch. Flexible loose-leaf binder, size 9x12", over 2,000 illustrations, 650 pages. **\$4.38**

The Service Man's Bible. Greatest book ever published on the subject. Contains all old circuits of every imaginable commercial radio set up to 1931.

**THE RADIO MANUAL.** by George E. Sterling and Robt S. Kuse, E. E. 2nd enlarged edition. Flexible fabricoid covers. Size 5 1/2 x 8", 805 pages, 348 illustrations. Price **\$5.88**

A complete Radio Course for the operator, the technician, the amateur, the student and experimenter. Everything imaginable in the whole radio art is covered in this great book—the "radio Bible" of the amateur. **DON'T MISS THIS.**

**HOW TO ORDER** We cannot ship C. O. D. Our prices are net, as shown. Some of the books sent prepaid (in U. S. only). Those that are not thus listed will be shipped by express collect if sufficient postage is not included by you.

**EXPERIMENTAL RADIO ENGINEERING.** by John H. Morecroft. Cloth covers, size 6x9", 346 pages, 250 illustrations. Price **\$3.46**

A student's book; devoted to the principles of radio apparatus; intended to accompany a course in electricity. The best of its kind.

**RADIO CONSTRUCTION AND REPAIRING.** by James A. Moyer and John P. Wostrel. Cloth covers, size 8x5", well illustrated, new revised fourth edition, containing 414 pages, still remaining at the same price. **\$2.50**

A handbook that every radio set tester and general student must have. The diagrams alone are worth the price of the book.

**THEORY OF VACUUM TUBE CIRCUITS.** by Leo James Peters. Cloth covers, size 6x9", 226 illustrations, 226 pages. **\$2.98**

It is one thing to "connect green lead No. 1 to pink lead No. 4," but it is another to know why the connections are made. Read this book and learn the design factors in tube circuits.

**PRINCIPLES OF RADIO COMMUNICATION.** by J. H. Morecroft, Prof. of Electrical Engineering, Columbia University. Cloth covers, size 9 1/2 x 8", 988 pages, profusely illustrated. **\$7.35**

THE radio classic, by the dean of radio. Covers entire radio art as does no other book.

We herewith present the most complete collection of recent important radio books. We have, after an exhaustive study, selected these volumes because they represent the foremost radio books of their kind in print today. There is such a great variety that we are sure it will satisfy any taste as well as any requirement that the student of radio might have. We publish no catalog and ask you to be kind enough to order directly from this page. Prompt shipments will be made to you direct from the publishers. We merely act as a clearing house for a number of radio publishers and OUR PRICES ARE AS LOW OR LOWER THAN WILL BE FOUND ANYWHERE. Remit by money order or certified check. Register all cash.

**SHORT WAVES.** by C. R. Leutz and R. B. Gable. Stiff Covers. Size 6x9", 384 pages, 358 illustrations. Price **\$2.98**

The biggest and most complete book on short waves. Covers every imaginable phase, including S. W. Superheterodynes. The authors are famous S. W. authorities.

**FIRST PRINCIPLES OF TELEVISION.** by A. Dinsdale. Cloth covers, size 6x9", 242 pages, 130 illustrations, 38 plates. **\$3.46**

A real review of television in design, construction and operation. This amazingly comprehensive book contains many heretofore unpublished facts on this absorbing topic.

**ORDER DIRECT FROM THIS PAGE**

**ELECTRICITY AT HIGH PRESSURES AND FREQUENCIES.** by Henry L. Transom. Cloth covers, size 7 1/2 x 5 1/2", 248 pages, 141 illustrations. Price Prepaid **\$2.33**

A marvelous book for the student in electricity and radio. General fundamentals lead up to a complete discussion of every type of Tesla and Oudin high-frequency coils, Geissler tubes, etc.; construction details of Tesla coils are given in great profusion. THE ONLY BOOK OF ITS KIND.

**OFFICIAL RADIO SERVICE MANUAL. Volume II.** by Hugo Gernsback, C. E. Denton and C. H. W. Nason, with 1932 Free Supplements, 1000 pages, 2000 illustrations. Flexible loose-leaf Binder, size 9x12". Price Prepaid **\$4.00**

The talk of the radio industry. This marvelous volume contains every thing in radio, circuits and radio developments, for 1932. Not a line of duplication between 1931 and 1932 volumes. (Vol. 1 and Vol. 2.)

**RADIO ENGINEERING HANDBOOK.** by Keith Henney. Flexible Leatherette, size 4 1/2 x 7", 584 pages, 482 illustrations. Price **\$4.88**

Each of the 23 sections has been written by a specialist! Includes valuable data on talkies and short waves.

**RADIO SERVICE MAN'S HANDBOOK WITH ADDENDA DATA SHEETS.** Flexible covers, size 9x12", 200 pages, 400 illustrations. Price prepaid **\$1.49**

The Service Man's standby. Contains the latest practical information on radio servicing.

**HOW TO PASS U. S. GOVERNMENT RADIO LICENSE EXAMINATIONS.** by R. L. Duncan and C. E. Brewer. Flexible covers, size 9 1/2 x 7", 170 pages, 82 illustrations, appendix. **\$1.89**

The most important book on the subject ever published. Gives every conceivable angle which will help you to pass a radio license examination successfully.

**RADIO MOVIES AND TELEVISION.** by C. Francis Jenkins. Cloth covers, size 9 1/2 x 8", 144 pages, profusely illustrated. Price **\$ .98**

A complete volume by the master of television, giving everything in television, including constructional details for building your own television sets.

**RADIO PHYSICS COURSE** (2nd enlarged edition), by Alfred A. Ghirardi. Cloth covers, size 7 1/2 x 9 1/2", 992 pages, 510 illustrations, numerous tables. Price **\$3.89**

The finest and most popular book on electricity and radio. Each subject is clearly discussed, with the aid of dozens of excellent drawings. Chapters on talkies, television, electronics and service work, etc. Biggest buy in radio books.

**ELECTRONS AT WORK.** by Charles R. Underhill. Cloth covers, size 6x9 1/2", 354 pages. **\$2.89**

The tremendous possibilities of electronics are made available to everyone. A real feature is its 40-page cross-index.

**RADIO RECEIVING TUBES.** by Moyer and Wostrel. Cloth covers, size 7 1/2 x 5 1/2", 298 pages, 181 illustrations. Price **\$2.47**

One of the finest books on vacuum tubes. Everything worthwhile on the subject treated in a masterful manner.

**PHOTOCELLS AND THEIR APPLICATION.** (Second Edition), by V. K. Zworykin and E. D. Wilson. Cloth covers, size 5 1/2 x 8", 332 pages, 130 illustrations. Price **\$2.88**

Does this book tell you why and how to use light-sensitive cells? The answer is that the first edition was a "sell out," and the second edition, brought right up to date, is even a better volume. Enough said.

**ELECTRONICS.** by R. C. Hudson. Cloth covers, size 6x9", 134 pages, 45 illustrations. Price **\$1.95**

"This book is written for the reader who may wish to know something about what is going on and who has not heretofore, given the matter much attention," says the author. Read it and learn how dry rectifiers, vacuum tubes, batteries, television tubes, and other apparatus, work; get the "low down" on electrons and atoms.

**RADIO SERVICING COURSE.** by Ghirardi and Freed. Cloth covers, size 5 1/2 x 7 1/2", 192 pages, 124 illustrations; 14 test questions; 28 test-instrument circuits. Price **\$1.67**

A practical book beginners and old-timers in radio service will find useful. Nine chapters discuss measuring instruments and tests, and trouble-shooting; the chapter, "Useful Information for Servicemen," closes the book.

**RADIO ENGINEERING.** by Frederick Emmons Terman. Cloth covers, size 6x9", 700 pages, 225 illustrations. Price **\$4.88**

Not a book for the beginner in radio, but a reference volume for the technician who wants modern information on the design and use of band-selectors, automatic volume control, diode detectors, and the thousand-and-one units circuit arrangements which have been recently developed.

**PRINCIPLES OF RADIO.** by Keith Henney, M. A. Cloth covers, size 8 1/2 x 5", 478 pages, 306 illustrations. Price **\$3.46**

A marvelously written textbook with the latest radio principles, including screen grid and pentode, amplifiers, etc.

## NEW LOW PRICE RADIO BOOKS

Here are 12 new, up-to-date books on every conceivable radio subject, just published. Modern in every sense. ALL BOOKS UNIFORM from 64 to 72 pages; 50 to 120 illustrations. All books written by well-known radio authors. Order by Number.

- No. 1 RADIO SET ANALYZERS, by L. Van Der Mel
  - No. 2 MODERN RADIO VACUUM TUBES, by Robert Hertzberg
  - No. 3 THE SUPERHETERODYNE BOOK, by Clyde Fitch
  - No. 4 MODERN RADIO HOOKUPS, by R. D. Washburne
  - No. 5 HOW TO BECOME A RADIO SERVICE MAN, by Louis Martin
  - No. 6 BRINGING ELECTRIC (RADIO) SETS UP TO DATE, by Clifford E. Denton
  - No. 7 RADIO KINKS & WRINKLES (for Experimenters) by C. W. Palmer
  - No. 8 RADIO QUESTIONS & ANSWERS, by R. D. Washburne
  - No. 9 AUTOMOBILE RADIO & SERVICING, by Louis Martin
  - No. 10 HOME RECORDING AND ALL ABOUT IT, by Geo. J. Saliba
  - No. 12 HOW TO BUILD AND OPERATE SHORT-WAVE RECEIVERS, by the Editors of SHORT WAVE CRAFT
  - No. 13 HOW TO BECOME AN AMATEUR RADIO OPERATOR, by M. F. Eddy
- PRICE PREPAID **\$ .45**  
 EACH BOOK  
 PRICE PREPAID FOR ALL 13 BOOKS **\$4.85**





## “The Best Short-wave Set”

An Editorial By HUGO GERNSBACK

● FOR several years now, I have been in receipt of hundreds of letters every month from short-wave readers who ask the question—“What is the best short-wave set?” Such a letter often contains advertisements and literature of various short-wave sets; and the reader asks my personal opinion as to what set he should buy. Still other readers send me long lists of short-wave receivers, with the request to mark the name of what, in my judgment, is the best receiver.

This is a most difficult, as well as thankless, undertaking, for a number of reasons; which I give herewith, in the hope that those readers who are interested in short-wave sets will read this and appreciate the difficulties in advising them as to the “best short-wave set.”

The question is similar to a man’s asking me, “Which is the best automobile?” It would be as difficult to make a brief, universal statement for automobile ratings, just as it is difficult to make one on short-wave sets. Too many factors enter into the problem.

There are, however, some rules by which we may go, and these rules may be followed by anyone. In the first place—to what use is a set to be put? If you are an experimenter, just starting in with short waves, and know nothing about the art, you probably do not wish to buy a \$200.00 set. You may start with a moderate-price battery job, which can be had from \$5.00 up. For this particular purpose, a low-price receiver may be the best.

If you have already been sold on short waves, and wish to listen to foreign countries, at practically all times—not only for your own enjoyment, but for the family and friends as well—you will naturally wish to get a more elaborate set. Perhaps the family wishes to listen to the usual broadcast stations too; in which case you will wish to acquire an *all-wave* set of more elaborate proportions; with a cabinet that will do credit to the appearance of your home.

These are the two extremes. Between them, range sets of all makes, and it now becomes a matter of personal likes and dislikes; of how much money can be spent; set performance, convenience, etc.

As a rule, it may be stated that those radio firms who have been in the business longest, who advertise regularly to the public, may be relied upon to put out good merchandise, behind which they will stand. Too many unknown firms, without technical qualifications, have recently gone into the short-wave set business simply to “crash” the market, and take advantage of the present short-wave radio boom. There are, unfortunately, a number of such firms of whom nobody ever heard before, and who have neither the technical experience nor other qualifications to design and sell short-wave sets; and such firms do a lot to hurt prospective customers by poorly-engineered sets. Of course, not every new firm is in this category, but many are.

Usually, firms who have advertised for many years, and who have been before the radio public a long time, can be

trusted to turn out a first-class product. If I personally were about to buy a set, my judgment would be that the established concerns know more about short waves than the others who have just started, and have, as yet, to learn the intricacies of the art.

And it makes little difference whether you replace the word “radio” by “automobiles” or “typewriters”—the conclusion would be exactly the same.

Given two sets made by *reputable* firms, which set should I buy? Both are probably equally good; it therefore becomes a question of personal liking, and your own preference must prevail. It is the same as though you saw two high-class ties in a haberdasher’s shop—which would you buy? Naturally, the one which appeals to your taste. It is equally so with the short-wave set.

The rule may be laid down that, given two sets made by two reputable manufacturers, each having a like number of tubes, both sets should perform about the same. There might be slight differences, due to variations of tubes, etc.; but, generally speaking, the results should be about alike.

We now come to other technical considerations; and one, for instance, is *location*. Not every location is good for short-wave reception. You may be in a “freak” neighborhood, where short-wave reception is at all times poor; there are some such spots. Naturally, if you are in such a location, you will require a set with more tubes than you would in a better location. We have seen it happen that a young fellow with a two-tube set was able to outperform a 5-tube set two miles away. These conditions must be taken into consideration and if you are in a bad spot, you naturally must use a set which is more sensitive, that is, in popular parlance, one more “powerful.”

In some locations, the aerial has a lot to do with reception, and it should also be borne in mind that *more tubes* does not always mean *better reception*; because more tubes also means more noise. There you must have a better aerial installation, of the shielded or transposition variety, as in a neighborhood abounding with “man-made” static.

I have often been asked the question, in connection with the “best set”: “Is it better to have a set with a *switching arrangement*, or the *plug-in coils*?”

Now, it is an established fact, well known by all short-wave engineers and professionals, that the plug-in coil set is more efficient than the band-switching type. If I had to choose between two 4-tube sets, one with a switching arrangement, and one with plug-in coils, I would, like most radio men, choose the *plug-in* job. If I were to choose between a 4-tube plug-in job and a 6-tube switch-over job, I would use the latter, for the following reasons:

You get more efficiency, tube-for-tube, with plug-in coils; but, where you have extra tubes, you usually have sufficient extra sensitivity to overcome the slight inefficiency of the switch job. There is no gainsaying that the switching arrangement is less time-consuming, less tiresome, and far more convenient.

**SHORT WAVE CRAFT IS PUBLISHED ON THE 5th OF EVERY MONTH**

This is the May, 1934, Issue—Vol. V, No. 1. The next Issue Comes out May 5th

Editorial and Advertising Offices - 96-98 Park Place, New York City





Radio frequency exciter equipment recently remodeled for W3XAL. Carl Dietsch at the controls. (Fig. 1.)

● A STATION well-known to the short-wave broadcast audience of the world is W3XAL of the National Broadcasting Company. This station is located at Bound Brook, New Jersey, approximately 30 miles west of New York City. The frequencies of transmission are 6,100 kilocycles and 17,780 kilocycles. One transmitter is used for maintaining schedules on these frequencies, suitable switching equipment being employed for changing from one frequency to another. Normally the 6,100 kilocycle frequency is used to cover transmission at night from this station, while the 17,780 kilocycle frequency is used for daylight transmission.

Regular NBC-WJZ network programs are transmitted during the short wave schedule. The high class quality of these programs is conveyed from the studios either at Radio City or other points of origin on the NBC-WJZ network to the transmitter over specially designed and constructed high  
(Continued on page 50)

# W3XAL

## Short-wave Voice of the National Broadcasting Company

One of the best known, American short-wave broadcasting stations is W3XAL, operated by the National Broadcasting Company at Bound Brook, N. J. The power output runs as high as 25 kilowatts.

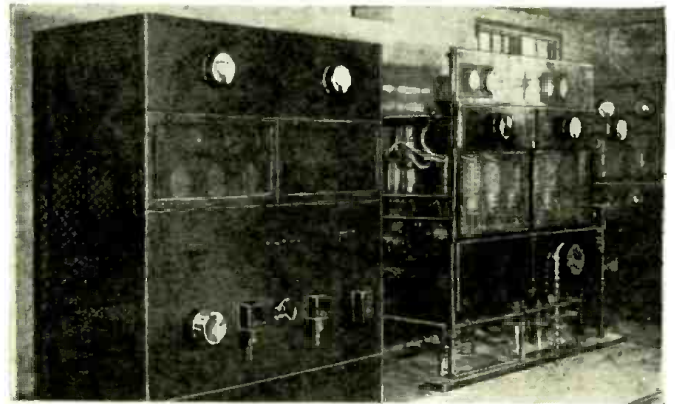

View of the main rectifier and modulator unit at W3XAL. (Fig. 3.)

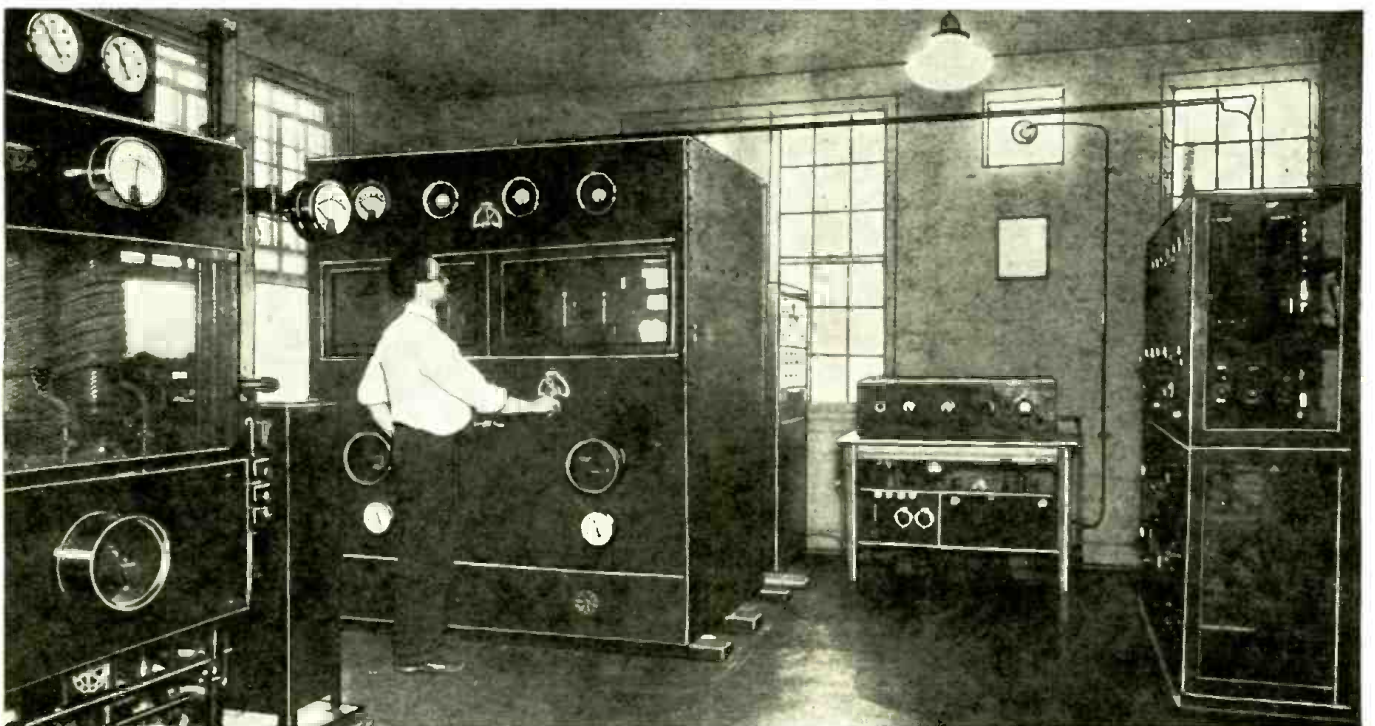

View of power amplifier unit at W3XAL, the National Broadcasting Company's station located at Bound Brook, N. J. (Fig. 2.)



# New 2-Way Police Radio Uses 7 to 10 Meters

By CARL OSCAR ARNBERG

A new ultra short-wave transmitting and receiving system intended for use by Police, which permits scout cars to talk back to headquarters. The car apparatus is extremely compact and efficient.

● THAT the present system in which police department headquarters call radio cars, but patrolmen in them are unable to "talk back" may be replaced by a new *two-way* radio telephone, is seen as a result of the recent installation of short-wave sending equipment in Piedmont, California, police department patrol cars.

According to radio engineers, the system marks a new advance in radio communication, as until recently, communication on ultra high frequencies of 7½ to 10 meters has not been considered commercially practicable. In addition to police use, this equipment is believed to have commercial possibilities for use between ships, from ships to shore, for aircraft, press reporting, fire department and other usages, including use by army and navy.

The equipment was designed by Elmer L. Brown, chief engineer of an Oakland, California, communication company, radio engineer and inventor. Mr. Brown was formerly research engineer for the Radio Corporation of America. With Chief of Police Fred Heere of Piedmont, Brown has been working on the development of the sets for two years, and the set had been under test in Piedmont for several months before its adoption.

Patrol cars in Piedmont are now permitted to communicate with each other, or to "talk back" to central station. The system was officially approved by the Federal Radio Commission, which has granted permits for construction and installation of the sets operating on frequencies between 30,000 and 40,000 kilocycles, as well as permission to operate them.

Third class radio operators' licenses have been granted to members of the Piedmont, California, police department so that they may operate legally the newly installed *two-way* radio telephone

Police headquarters at Piedmont, Cal., talking to a scout car on 7 meters. E. L. Brown, inventor; Fred Heere, Chief of Police, and Sergeant Cahill. Below—outside and inside views car.

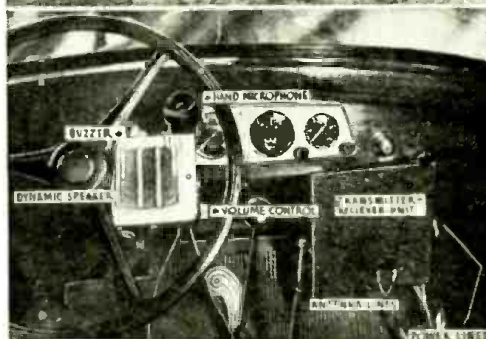
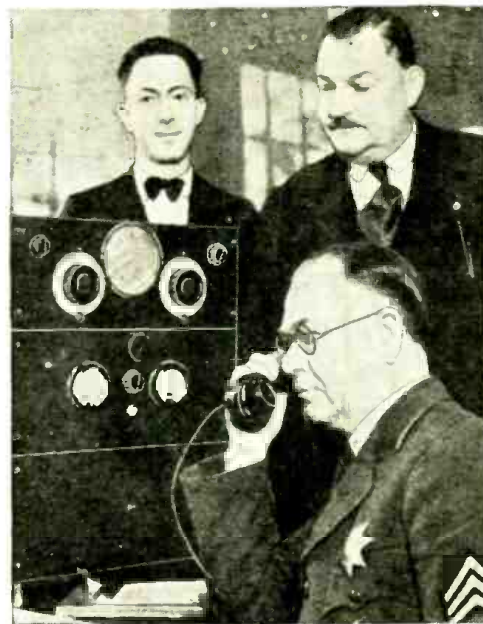

sets, following examinations conducted by F. L. Kellogg, inspector for the Federal Radio Commission. These tests were taken by Chief of Police Fred L. Heere, Captain Dan James, Captain William Pflaum, Inspector George Hansen, Sergeant William Cahill and 14 members of the patrol division.

Inspector Kellogg, after giving the examinations, made a tour of the city of Piedmont, testing the new apparatus designed by Brown. Kellogg said that the sets were ideal for police work, but that he had not yet had an opportunity to test them in large cities. The new phone sets which operate on ultra short-waves is able to broadcast through hills, in so-called *blind-spots*, or over areas in which ordinary short-wave radio has been considered impossible or cannot be received, and also under high tension electric power lines, according to Brown.

### 2-Way Car Set Very Small

The new 2-way sets are compact, weighing only 25 pounds, or about size of ordinary automobile radio sets. Conversation is carried on with regular "French" type telephones. The sets are also equipped with loud speakers. The set is so small and compact that it may be installed and operated on a motorcycle. They operate on 7½ to 10 meters, waves much shorter than those used on present police systems.

The 2-way conversation set is 10x10x6 inches in size, and operates from a light socket or a storage battery, the current drain being less than 4 amperes. A hand microphone resembling a cigar lighter, with a flexible cord attached to the dashboard of police cars, enables officers to talk to *headquarters* or with other cars, while spinning along at high speed. Heretofore the defect in 5 and 10 meter phone transmission was a tendency to fade at times. The waves were blotted out by intervening subjects, such as trees or buildings. Designers say that they have cured this defect in the Piedmont installation so cars may communicate with headquarters or vice-versa under all conditions.

The central control station is located  
(Continued on page 47)

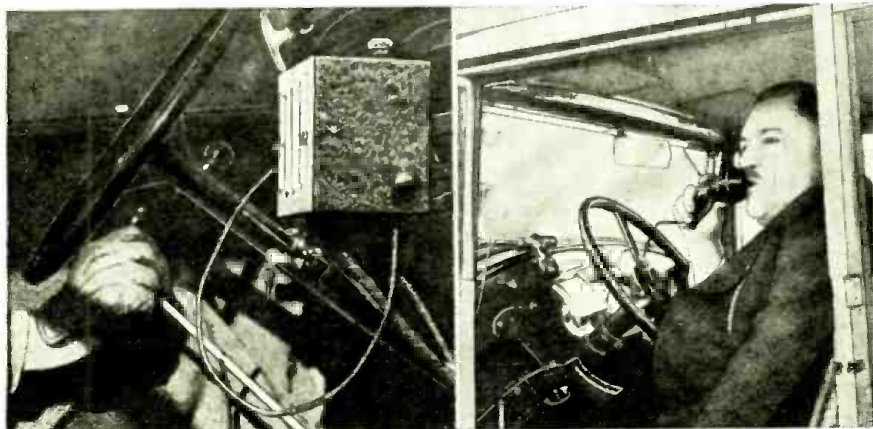

Left—Loud speaker and control buttons in squad car; the "transmitter-receiver" unit is mounted below. "Mike" and receiver, of French type, is shown in use by Chief of Police, Fred Heere of Piedmont, at right.



## Station W8DKE Goes "Buggy Riding"

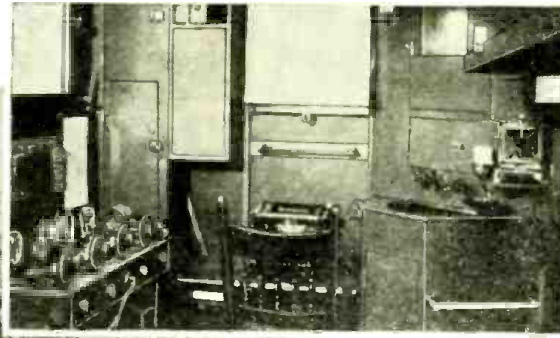

L. A. Morrow of Springfield, Ohio, who built and now operates portable station, W8DKE, on trips to Florida and other climes.



Interior and exterior views of the portable "ham" transmitting and receiving station appear at the left.

● W8DKE, the "radio station on wheels," has attracted a great deal of attention on its trip from Springfield, Ohio, to Miami, Florida. It was built by L. A. Morrow of Springfield, who intends to use the station on a long cross-country trip, starting in the spring, after operating it in Miami during the winter.

The station is complete with short-wave receiver, crystal-controlled transmitter and frequency meter.

The tubes used in the transmitter are 47, 46, 46 and 210. The 47 is the crystal oscillator and its frequency is controlled by a Y-cut crystal ground to oscillate at a frequency of 3585 kilocycles. When the station is operated at the crystal frequency, the first 46 is used as a neutralized buffer-amplifier and feeds directly into the neutralized 210 final amplifier, the second 46 not being used. On 7170 kilocycles, the first 46 acts as a doubler and again feeds directly into the 210. On 14,340 kilocycles, the first 46 again acts as a doubler to 7170 kilocycles; it feeds the

(Continued on page 51)

## 6.5 Inch Waves Span English Channel

● THE French Company, "Le Materiel Telephonique" conducted in 1931 a series of communication experiments between the French and the English coasts, i. e., between Dover and Calais, using ultra short waves having a length of a few centimeters (1 centimeter = .4 inch). The distance which was covered at that moment was in the order of 32 kms. (19.2 miles). Notwithstanding the fact that a very small amount of power was used, the application of a system of reflectors enabled the engineers from this moment on to maintain regular communications, a fact which was due to the well-known properties of ultra short waves, which can be transmitted in the shape of directed beams of little divergence, similar to beams of light. These first experimental tests were intended to assist in the development of real industrial apparatus, which would make possible an absolutely regular connection by telegraph and by telephone between the coasts of the English Channel. Distinguished French engineers such as Mr. Clavier, Chiroix and Ponte, perfected the various transmitting and receiving systems which were inaugurated the 26th of January by the French Air Minister and by the British Minister.

The transmitting and receiving apparatus are located at the airdrome of Saint-Inglevert, France, and at the Lympne Airdrome in England. The distance between them is 56 kms. (33.6 miles).

The length of the employed wave is 16 centimeters (6.4

inches). The receiver and transmitter are set up side by side on the top of a metal tower, which is 20 meters (64 ft.) high and which has a platform as shown. Two parabolic reflectors having an opening of 3 meters (9.6 ft.) are placed on the platform; one reflector is for transmission and the other for reception. The 8 centimeter (3.2 inches) long antenna is located in the center of the transmitting reflector, behind which is situated the transmitting tube. The same goes for the receiving system, the receiving tube being located behind the parabolic mirror. The necessary power is in the order of 20 watts, but the antenna-power is really a few tenths of a watt. These regular communications which on the other

(Continued on page 47)

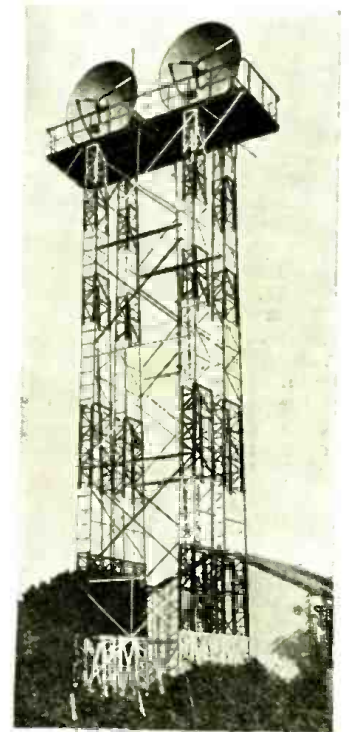

Above—a view of the 64 foot steel masts supporting the 3.6 foot diameter parabolic reflectors, in the focus of which the 6.5 inch apparatus is mounted.

Left—view of the transmitting and receiving equipment used on the ultra short-wave link across the English channel; a teleprinter is used.



# How Radio LANDING BEAM GUIDES Aircraft

By J. E. SMITH\*

• RIDING a slender, invisible radio ray is no longer a mere figure of speech as applied to aircraft. Airplanes are now started, guided and landed by radio. The latest device in the scheme of radio guidance is the provision of a safe system for landing planes during fog or other conditions of low or zero visibility.

Preceding reports on research and experiments have already described the first stage of development in this radio device, but Harry Diamond of the United States Department of Commerce, Bureau of Standards, relates that in a final stage, a both complete and workable system has been accomplished at both the transmitting and receiving ends of this apparatus.

Vertical guidance of the aircraft is given by a horizontally polarized very short wave-length landing beam directed at a small angle over the horizontal and employed in such a way as to furnish a most convenient gliding path for the landing aircraft. The frequency of operation is 90,800 kilocycles (3.3 meters).

## The Landing Beam Transmitter

\* President, National Radio Institute.

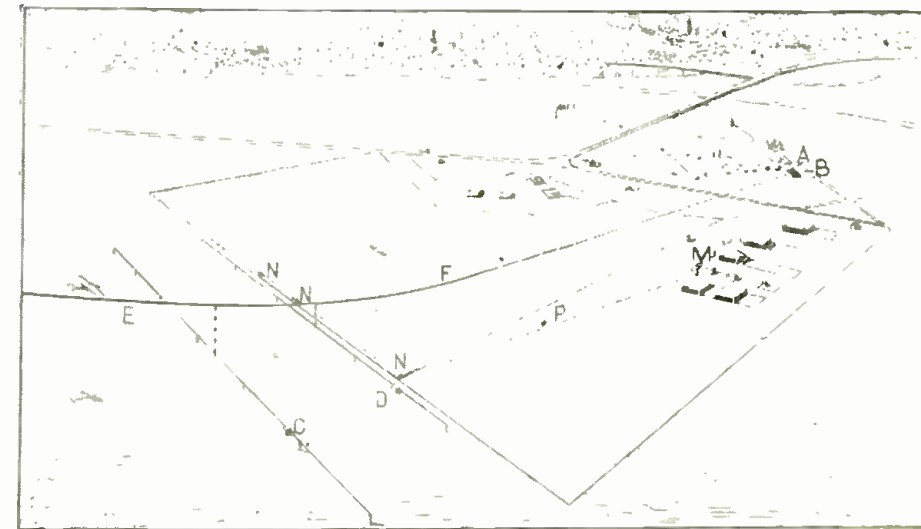

Landing field transmitting equipment at Newark, N. J. Airport. (a) landing beam station; (b) runway localizing beacon; (c) approach marker beacon; (d) boundary marker beacon; (e) spatial landing path; (f) point of contact with ground; (m) location of monitoring and 2-way communication equipment; (n) remote control stations for 2-way communication; (p) control cable.

may use any transmitting circuit device which can furnish about 500 watts to the directive antenna or ray. Sixty cycle modulation of the radio-frequency carrier is necessary for purpose of audio-amplification and filtering in the landing-beam receiving set on the plane.

The transmitter feeds power to the directive antenna set-up through a parallel-wire transmission line. A short-circuited or open-circuited loop at a distance, determined by trial, from the antenna end of the transmission line is used to avoid radiation from the line.

Antenna arrays vary in design, depending chiefly on the horizontal angle over which the landing-beam service is wished. The early Yagi array has been replaced because of the limited possible control of the space pattern in the horizontal plane.

A very simple antenna arrangement suggested by the *Deutsche Versuchsanstalt für Luftfahrt* may be used to give service in all directions. This includes a quarter-wave vertical antenna, grounded at one end, placed centrally in the airport. The part of the space pattern used is bowl-shaped, from the German name "teller" antenna. In an

Left—Receiving set used for picking up "marker beacon" as well as "landing beam" signals.

Right—Cockpit instrument board. Radio beam indicators at 1, 2 and 3.

Below—Three different aspects of the plane's indicator actuated by the "landing beam" radio signals.

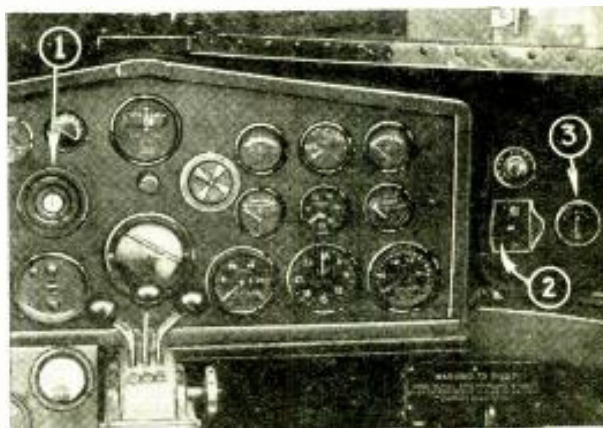

array of this type, the landing-beam transmitter may be placed in a pit in the middle of the field.

The objection to even a low antenna (2.7 feet for 3.3 meters wave-length) placed in the center of an airport, and also the dependence upon the dielectric constant of the ground of the shape of the space pattern made with vertically polarized waves are practical difficulties. Such dependence is slight with horizontally polarized waves, so that regardless of weather conditions, assurance of a fixed landing path can be had.

(Continued on page 40)

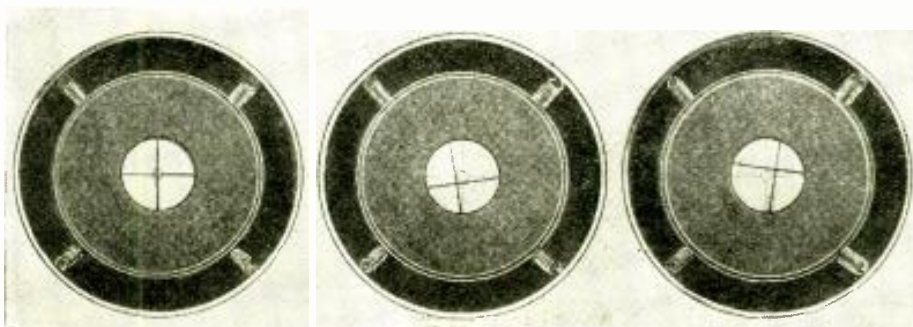



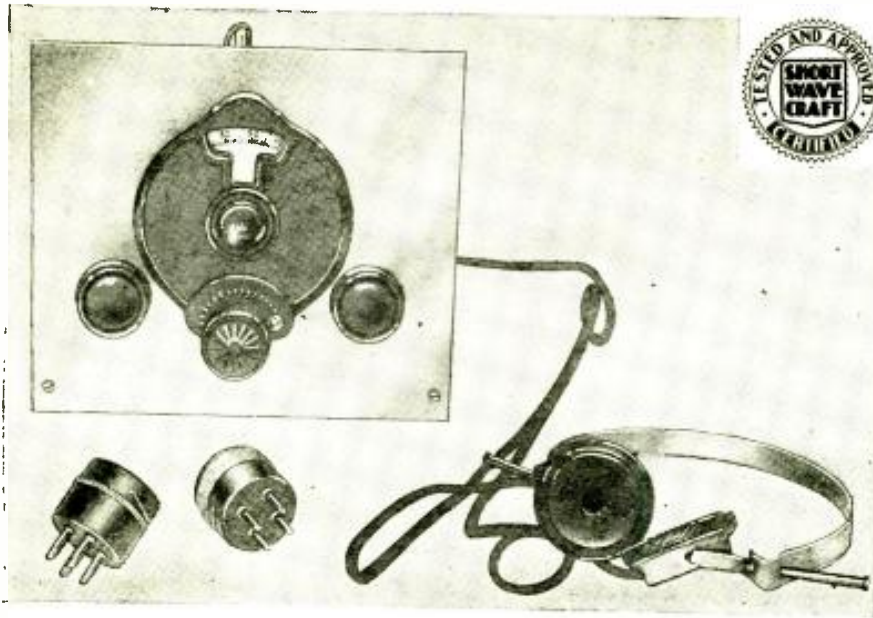

This attractive one tube receiver, of undoubted interest to every short-wave beginner, employs the latest electron-coupled circuit. Distant short-wave transmitters in practically every country were heard with this receiver.

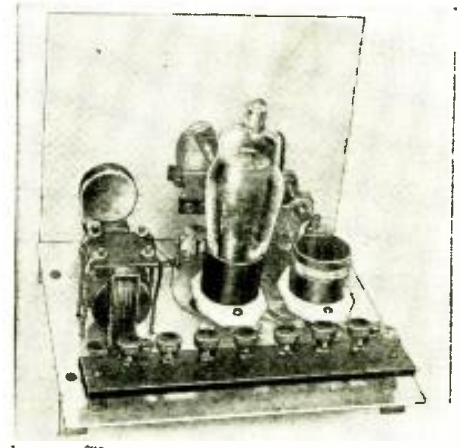

How the Electrodyne 1-tube receiver appears from the rear.

# The ELECTRODYNE 1-Tube "Band Spread" Receiver

By **LEONARD VICTOR** and **ERNEST KAHLERT**  
\$20.00 PRIZE WINNER

● SO MANY reports have been received on the excellent results obtained from the use of the electron-coupled detector circuit in the "Pee-Wee Ham-Band Receiver" that it was decided to try and adapt the same circuit for battery operation. After a good deal of experimentation, the circuit to be described, which is almost the simplest arrangement possible, was arrived at.

The electron-coupled oscillator, which was originally

designed by Lieut. Dow, has found numerous applications in radio work. Not the least of these is the fact that it is the most efficient and stable detector circuit known.

This particular application of the "E.C." circuit uses a type 32 screen grid two-volt tube as the detector. With this set sufficient volume was obtained to comfortably work a pair of earphones on quite a few "DX" stations. By this we do not mean the ten and twenty thousand watt short-wave broadcasters, but their little ten and twenty watt "brothers" in the "ham" bands. At one time during the test period, a fifteen minute conversation was held with SU1CH, 8,500 miles away in Alexandria, Egypt, using nothing but this little "one-tuber" at the receiving end! Other stations located on every continent on the globe, except Asia, were logged while the set was being tested.

### General Physical Features

The physical layout of the set is exceedingly simple and was designed with the cardinal rule of short wave work in mind—*short leads!* Two 7x8 inch pieces of aluminum are used as panel and subpanel. On the panel the controls, from left to right, are: band-finding, band-spreading, and regeneration. The layout on the chassis, from left to right: coil, 32 tube, and transformer. The plate R.F. choke is located on the subpanel directly below the band-spreading condenser. The filament choke and all the by-pass condensers are mounted under the subpanel. A binding post strip is used for the connections to antenna, batteries, and earphone, but if the constructor so chooses, some other form of connection, such as a cable plug and socket, and a phone plug could just as well be used.

### Doublet Antenna Advised

One of the most important things in a small set which it is desired to have working at optimum, is the antenna system. Provision is made for the use of a regular antenna-ground system, but if it is in any way possible, a doublet antenna should be used. The gain in signal-to-noise ratio is immediately noticeable when some such arrangement as the Lynch antenna doublet and transposed lead-in system is used. Various layouts for doublets have appeared in previous issues of this magazine.

This set having been built primarily for the amateur bands, a dual condenser arrangement is used for spreading

(Continued on page 54)

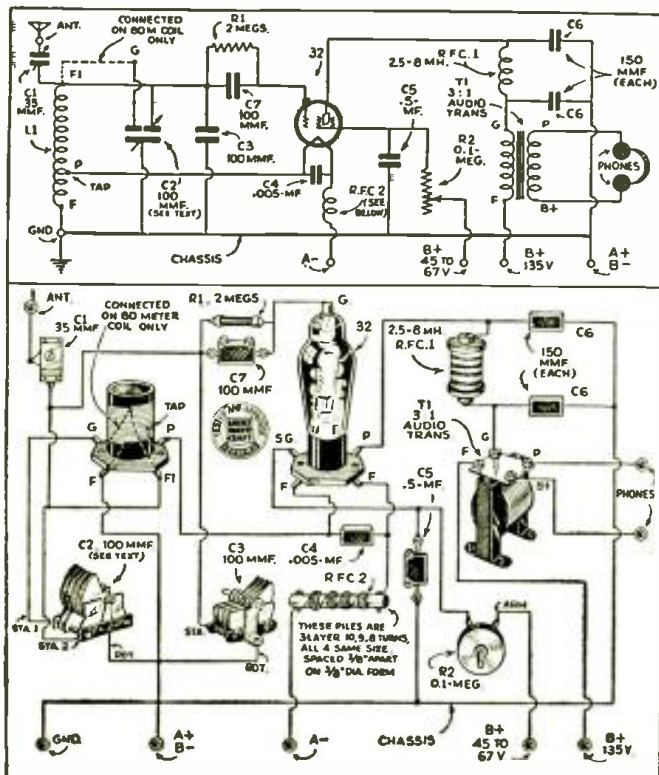

Both schematic and picture wiring diagrams for the Electrodyne 1-tube receiver are given above.





The super-high frequency transmitter.

● In these days of ultra high frequency transmitters with everyone working hard to develop apparatus that is workable over fairly great distances with extremely low power, developments have progressed rapidly. The transmitter and receiver shown in the photographs were designed to operate on 1/2000th of a millimeter! The figures alone confirm that this is real short-wave apparatus. Some years ago the U. S. Coast and Geodetic Survey held communication by signals picked up over distances of approximately 152 miles, using apparatus operating on the same general principle as those shown in the photograph. The power input to the transmitter as can be seen by the dia-

# 152 MILES ON 600,000,000 Megacycles

By G. W. SHUART and N. H. LESSEM

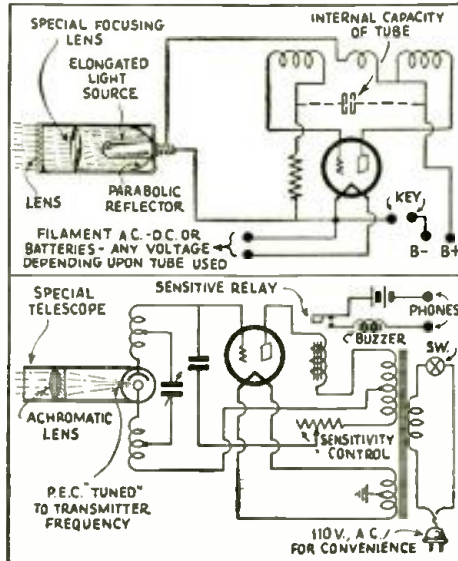

Hook-ups of extremely high frequency transmitter and receiver, the receiver utilizing a super-sensitive photo-cell.



Aiming the telescope on the ultra high frequency receiver requires extreme patience and accuracy.

gram is what we would call real low power. 4½ volts at 200 milliamperes is just 9/10ths of one watt. Some of our more advanced readers will probably be astonished at the capabilities of such a "low-power" transmitter. Of course, directional transmission is used and the waves must be very carefully focused in order to cover such extremely long distances. On the other hand, it is essential that the location of the transmitter and receiver be such that a barrier does not exist in between the two; or any other intervening objects which would hinder ordinary visibility. The frequency of a 1/2000 of a millimeter wave is 600 million million vibrations per second, which is a high frequency—and how! The apparatus shown in the photographs can easily be con-

(Continued on page 52)

## W2XAF's Directive Aerial Gives Gain of 20

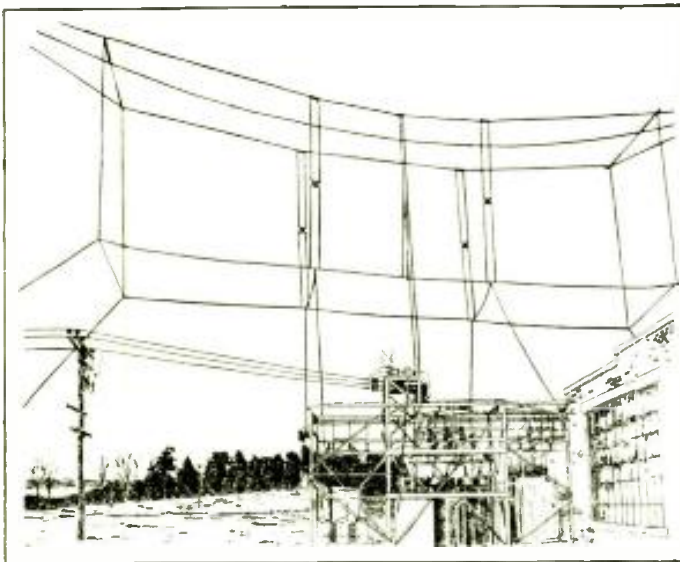

Picture of the Byrd transmitting antenna used by Station W2XAF at Schenectady.

● AN ANTENNA which increases the directional power of General Electric's short wave transmitter, W2XAF, 20 times, making this station equivalent to more than 400 kilowatts in effectiveness in one direction, is being used to broadcast the special programs to the Byrd Antarctic Expedition in Little America every other Sunday night.

This antenna, known as the Byrd antenna, is Dr. E. F. W. Alexanderson's contribution to the happiness of the expedition's personnel as the men winter through a year of hardships in the Antarctic. In erecting this special an-

tenna, General Electric engineers are bringing to the Byrd broadcasts the latest devices known to the art to promote reliability of reception. While it may be too much to hope that all programs will reach their Polar destination, the chances are very good, W2XAF was the one station reliably heard by Byrd on his last expedition to Little America.

The Byrd antenna is of the horizontal checkerboard type. It is one of a dozen or more antennas which sway above General Electric's 54 acre transmitter laboratory at South Schenectady. These antennas hang from steel masts from 150 to 300 feet high, from plain wooden masts and from masts with cross bars, not unlike scaffolds in appearance.

The Byrd antenna is actually twelve antennas in one, consisting of two sections of a checkerboard, each section made up of three squares. One section is known as a reflector. Only the horizontal wires of the system function as antennas, the vertical wires being for support or power

(Continued on page 52)

Below: View of the Western Hemisphere showing relative positions of W2XAF and "Little America". Right: W2XAF S-W transmitter.

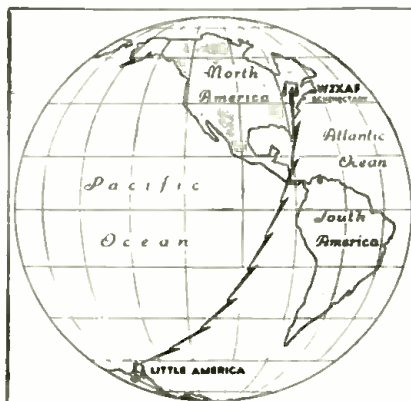



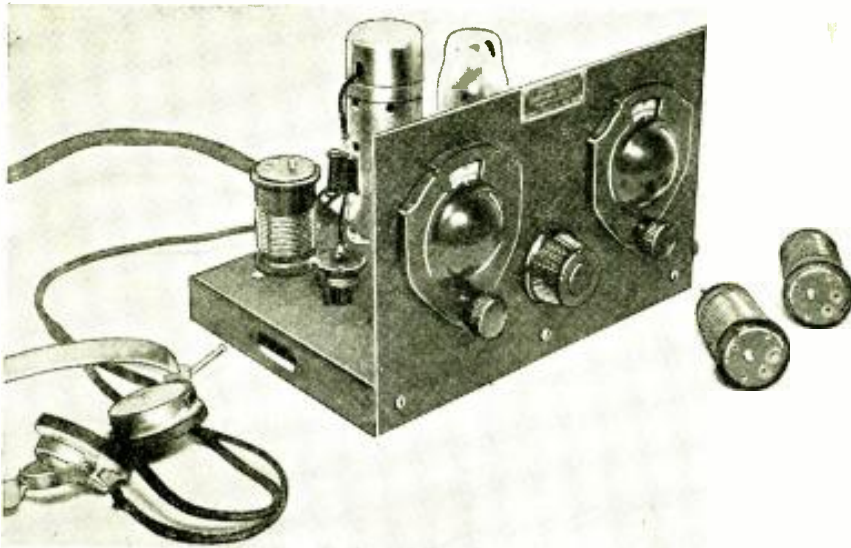

Band-spread tuning is now available on the 2-Tube Electrified A.C. Doerle Receiver—"good news" to thousands of S.W. Fans and Hams.



The famous Doerle short-wave receivers, especially the 2-Tube Electrified model, has served as the introductory medium to the magic of the short-waves for thousands of our readers. Those interested in a reliable, easy-tuning 2-tube A.C. set will find that the addition of the new Na-Ald "Band-Spread" coils to this receiver makes "DX" tuning a cinch!

# The DOERLE Goes "Band-Spread"

• IT HAS been proven by the hundreds of letters received from readers of this magazine, that the Doerle sets are among the most popular. Along with these letters have come the requests of a great number of amateurs asking that we describe the 2-tube Doerle set modified for amateur or "Ham" use. In order for any set to comply with amateur requirements it is necessary that the set spread the various "Ham bands" over a goodly portion of the tuning dial. Operation on the amateur bands with an ordinary receiver not having *band-spread* is just about impossible, as the forty meter band, for instance, occupies only about five or six divisions of the dial and with the great congestion on this band this condition would be prohibitive.

### Ham's Requirements Met

It is the purpose of this article to present a method by which the 2-tube electrified Doerle can be revamped to conform with the Ham's most rigid requirements, and also to serve as constructional information for any one wishing to build the set, if they have not already done so. For the amateur possessing a receiver of an older type and wishing to build something more satisfactory for his purpose, we can very highly recommend this little receiver. It is very economical to construct and will give most gratifying results.

The original receiver was described by the writer in the July, 1933, issue of this magazine. This set used a type 57 detector and a 56 as the audio amplifier. While this tube arrangement produced excellent results it was believed that there could be just a little more audio amplification to bring up those very weak signals. The new set utilizes a pentode amplifier, which will be discussed later.

### By GEORGE W. SHUART W2AMN

#### New "Band-Spread" Coils Used

To introduce *band-spread* use is made of the new Na-Ald coils recently introduced by the Alden Mfg. Co. The construction of these coils can be seen by referring to the drawing and also the wiring diagram. It will be noticed that they are five-prong coils, having the regulation tickler and grid coil. The grid coil has been tapped and to obtain *band-spread* the main tuning condenser is connected across only a portion of the inductance. A small *padding con-*

*denser* has been mounted in the top of the coil form and this capacity is connected across the entire coil in order to obtain a stabilized tuning circuit. This capacity is also used to tune the coil so the band will appear in the center of the tuning dial. In general these coils are the same as those described by the writer in the February, 1933, issue of SHORT WAVE CRAFT and used in the 2-Tube Band-Spread set described in that article.

The Alden concern manufacture another set of the same type coils, which are designed to be used on the various short-wave "broadcast" bands. With these coils the short-wave "Fan" can have greater tuning ease on his favorite

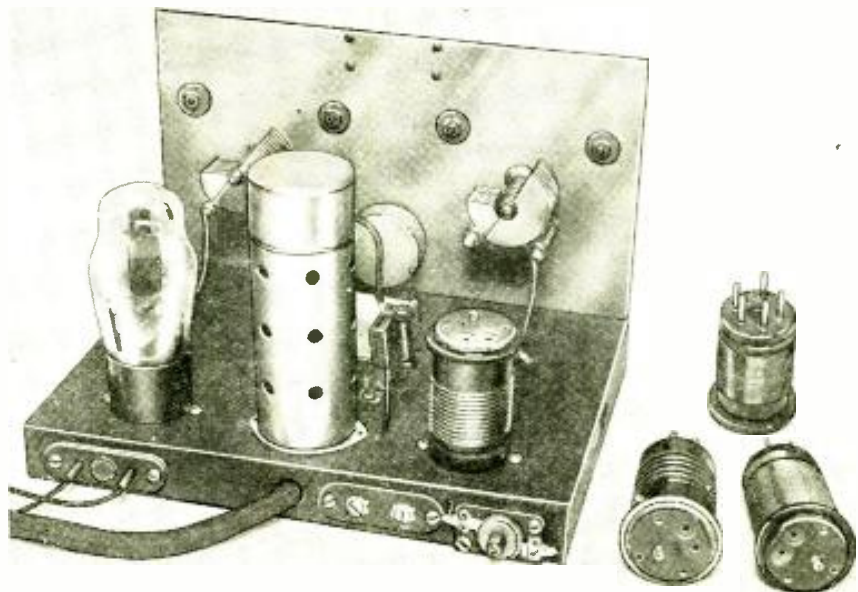

A peek at the rear of the 2-Tube Electrified Doerle Receiver fitted with the newly adopted Na-Ald "Band-Spread" coils



foreign broadcast band. The set described in this article, together with a set of the short-wave "broadcast" band-spread coils, would make an ideal combination.

For those who have already built the 2-tube electrified Doerle it will be a comparatively simple matter to make the simple changes outlined. The first procedure is to remove the four-prong coil socket and the five-prong tube socket. The four-prong socket will be discarded but the one used for the 56 tube will now be used for the five-prong band-spread coils, and is mounted where the four-prong socket was formerly located. It will be necessary to obtain a 6-prong wafer socket to accommodate the 2A5 pentode amplifier tube. This will be mounted in place of the one used before for the 56. Mount the six-prong socket so that the filament terminals are facing the end of the chassis. The five-prong socket will be mounted with the filament holes toward the rear of the base. Mounting the sockets in this manner will simplify wiring to quite an extent. The rest is easy, just wire up the two sockets according to the diagram.

For the "Fans" who have not constructed the 2-tube Doerle, this set offers about the ultimate in 2-tube receivers; the builder will be more than thrilled with the results obtainable with this little "bandsread" two-tuber.

**Chassis**

The metal chassis used in constructing this set is of the variety sold by nearly every mail-order house and comes completely drilled and finished in various colors of lacquer. These chassis are really cheaper to buy than to construct, and they present a more business-like appearance. The photos clearly show the placement of the various parts and this general layout should be followed as closely as possible in constructing the set.

It will be noticed that there are two more changes in the new version of the Doerle, viz.: the addition of a potentiometer in the screen-grid of the detector tube, and the 57 detector is provided with a shield. The potentiometer was added because various makes of 57 tubes require slightly different voltages on the screen-grid. And then again on the higher frequency bands, it has been found that a slight change in screen voltage is necessary to obtain smooth regeneration. Then in many cases the builder may not have provisions for adjusting the voltage from the power supply where the potentiometer permits the voltage to be set for maximum sensitivity. The regeneration is then controlled with the throttle condenser.

**Detector Tube Shielded**

When using a pentode, such as the 2A5 tube, it is necessary to shield the detector tube in order to prevent feedback between the two stages, which causes the pentode to howl. So don't forget to shield the detector tube! The same cathode biasing resistor that was used in the 56 amplifier of the original set is used for the 2A5. While 500 ohms is the proper value for the 2A5 tube, the 2,000 ohm unit was used to lighten the load on the earphones, when used directly in the plate circuit of the

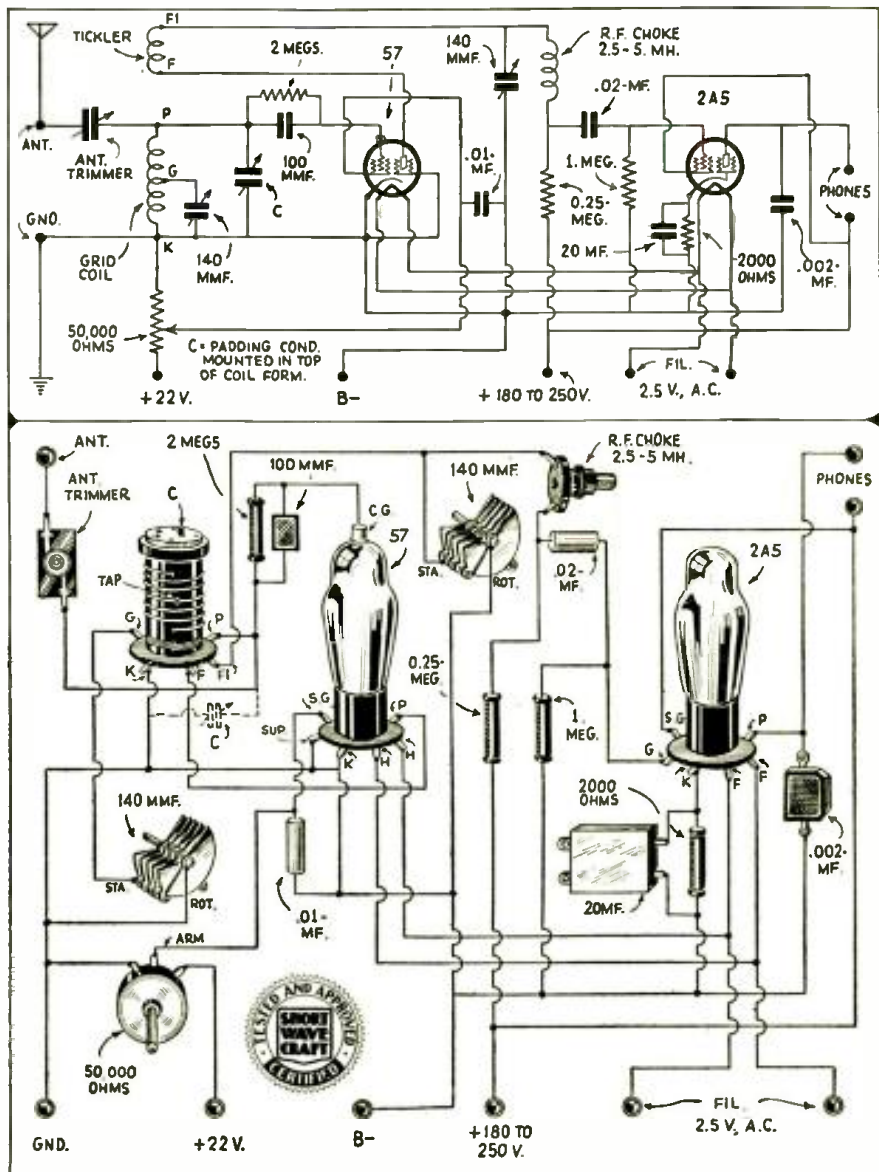

Wiring diagrams, both schematic and physical, showing the connections of the well-known 2-tube electrified Doerle receiver, as adapted to operation with the new Na-Ald Band-Spread coils. These coils serve to spread the stations over the dial and make short-wave tuning a real comfort.

pentode; the 2,000 ohm resistor provided less plate current to pass through the phones and the slight difference in volume is nothing to worry about.

However if an output transformer is available its use is preferred and then, of course, the 500 ohm resistor should be used. The by-pass condenser across this resistor should be one with a high capacity, around 20 mf. and with a working voltage of from 20 to 25. This condenser will be necessary if full volume and natural tone is expected from the pentode. Another item that stabilizes the pentode and eliminates "fringe howl" is the by-pass condenser from the plate to the B negative. This condenser also reduces tube hiss to a minimum.

**Check All Connections**

After the set is wired up it is advisable to check all connections to make sure everything is firm and in its right place. Connect the power supply to the set and we are ready to hear some real 2-tube performance. Tuning is exactly the same as in the original set, except

that the "band-setting" condenser mounted in the top of the coil form will have to be adjusted to bring the desired band within the range of the dial. This only needs to be done once on each coil; after the adjustment has been made no further attention need be given to it.

Any type of antenna will work with this set. The length can be anywhere from 25 to 100 feet. The antenna coupling condenser of course will have to be adjusted for best results. It is best in the beginning to set this condenser to minimum capacity and make adjustments after the "feel" of the set is acquired. As for results—the foreign broadcasts come in on the speaker in most cases and amateurs can be brought in with astonishing volume.

**Parts List—2-Tube Doerle Band-Spread**

- 1 set of Na-Ald "band-spread" coils.
- 1 drilled metal chassis. Radio Trading Co.
- 2 140 mmf. variable tuning condensers. Hammarlund. (National; I.C.A.).

(Continued on page 39)



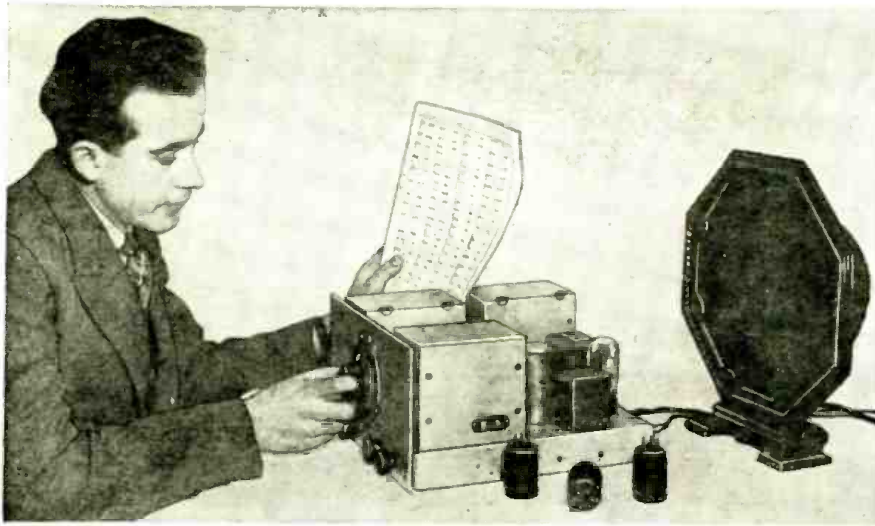

It's a pleasure to tune in "DX" stations on this high-gain 5-tube T.R.F. receiver, the result of many months experimentation by the author.



Many short-wave "Fans," especially those who neither count themselves beginners nor advanced experimenters, would rather tackle the building of a powerful short-wave receiver of the T.R.F. type than they would a superhet. To the T.R.F. enthusiasts we present this tested 5-tube receiver, employing two stages of tuned R.F.

# 5-Tube T.R.F. Receiver

M. Harvey Gernsback

• THE RECEIVER described here is the outcome of a search for one which would combine the good features of a superheterodyne and the conventional regenerative receiver with one stage of R.F. (radio frequency) amplification.

The "superhet" is undoubtedly very sensitive and very selective; however, unless the design is very carefully worked out the noise level is apt to be high. In addition there is the bother of

second channel pick-up unless the set incorporates a pre-selector stage of T.R.F. (tuned radio frequency), which also serves to complicate tuning and construction. The regenerative set, when correctly designed, has a very favorable signal-to-noise ratio. In addition it is simple to build and economical as well. Its greatest draw-back is lack of selectivity. This is a very seri-

ous factor on the congested short-wave broadcast and amateur bands. With two tuned R.F. stages preceding the detector much better selectivity can be obtained, providing a gain control for the R.F. stages is used. At the same time the noise-level will be low, except when the gain control is advanced toward maximum. It is seldom necessary to advance the control beyond half-way, so that the noise-level encountered in actual operation is very low.

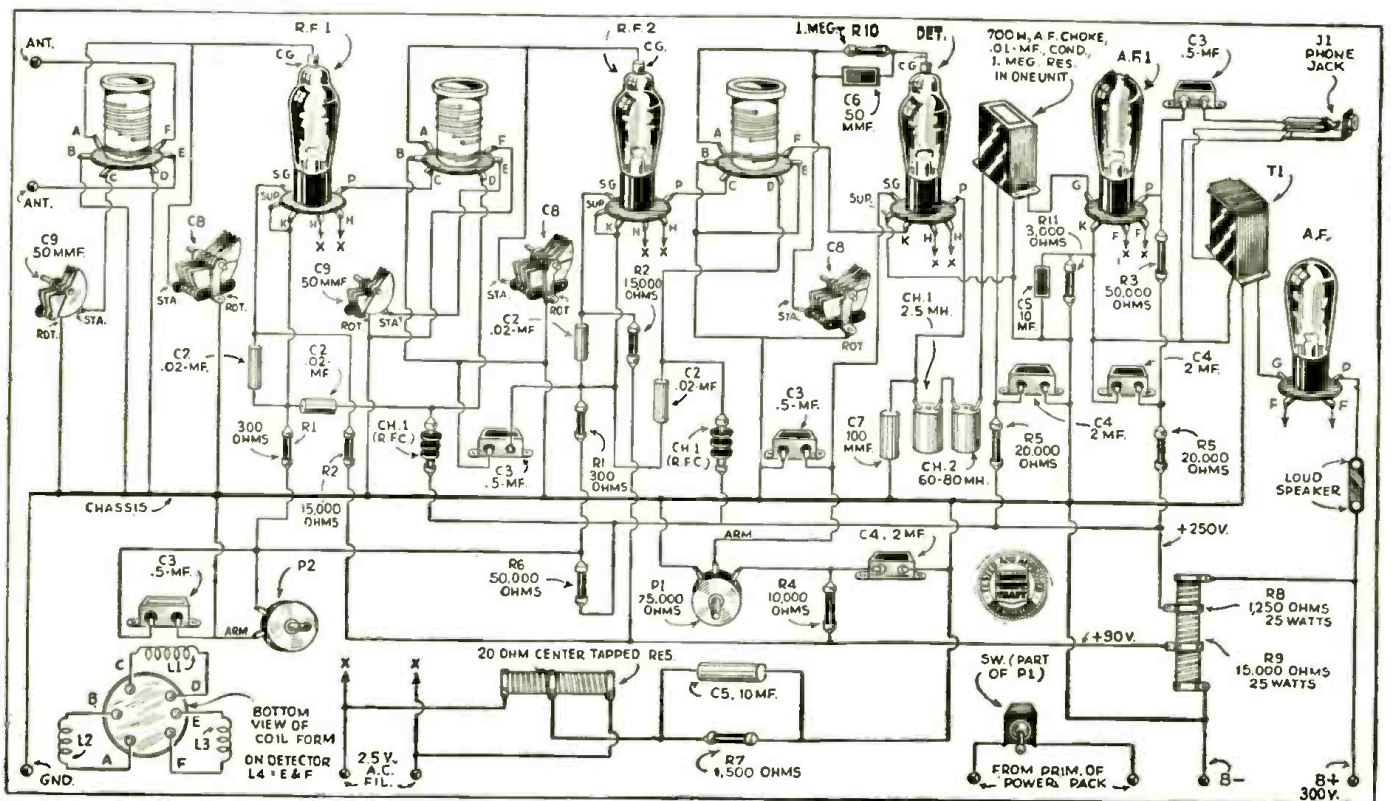

Here is a picture diagram for those not so expert in building receivers; by making a study of this in connection with the text no trouble will be experienced in building this set.



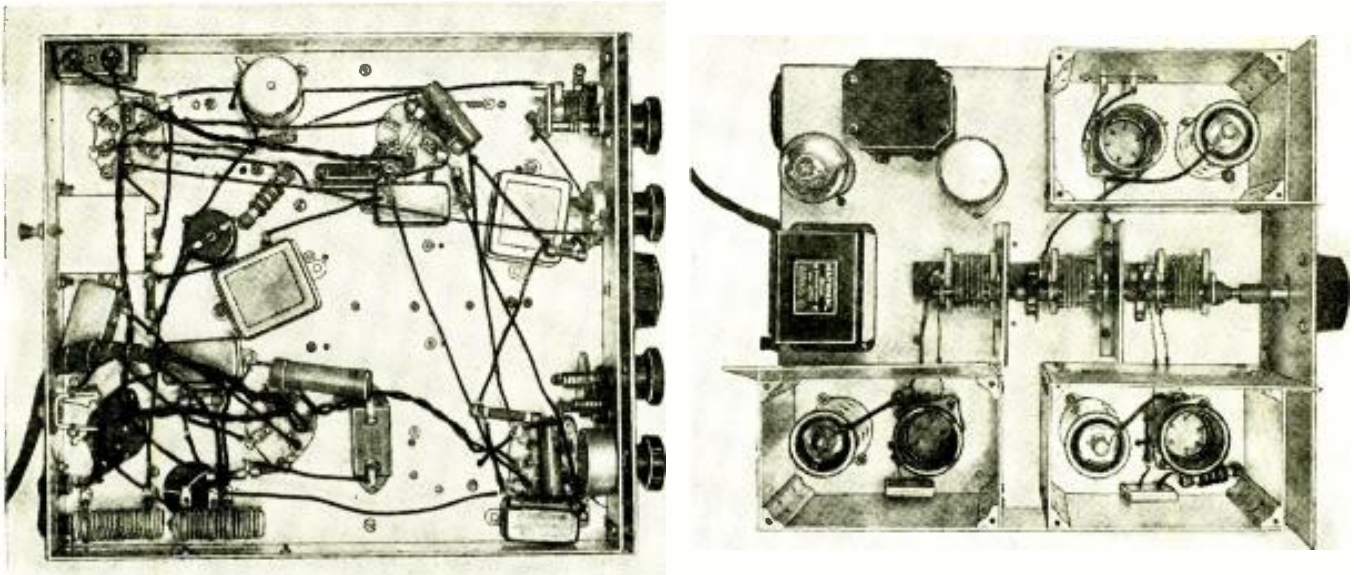

Photos. above, show top and bottom view of the 5-tube T.R.F. receiver here described by Mr. Gernsback. Many short-wave enthusiasts prefer the T.R.F. receiver ahead of the superhet.

**Set Uses 2 Tuned R.F. Stages**

This receiver includes two tuned stages of R.F. utilizing the *high-gain* variable- $\mu$  R.F. pentodes, together with a control for varying the available gain. The detector is also an R.F. pentode, using an electron-coupled regenerative circuit which insures smooth regeneration and very good sensitivity.

The audio amplifier system was designed solely to meet the author's personal requirements and can be altered, if desired, to meet particular requirements. As designed there are two stages of A.F. (audio frequency) amplification; the first is a general-purpose triode connected by transformer coupling to the second tube which is an ordinary power triode. It should be possible to eliminate one tube here by using an output pentode in place of these two, as there is enough signal to allow loud-speaker operation with the pentode, without the intermediate audio stage. The detector is coupled to the first audio stage through a special high impedance choke and a coupling condenser. There is provided a head-phone jack in the output of the first audio stage, so arranged that it cuts off the signal from the power stage when the phone plug is inserted. So much for the audio system. The input from the aerial is arranged so that a connection from a *doublet aerial* with *transposed lead-in*, such as the Lynch, can be used if desired.

**T.R.F. Stage Details**

Turning to details of the R.F. stages the coils are wound on low-loss plug-in forms and use isolantite sockets to further reduce losses. The midget tuning condensers have isolantite insulation and are constructed to give a more uniform spread of stations over the dial. The coil sockets are raised about three-quarters of an inch above the chassis to minimize losses. It should be noted that although the 3 tuning condensers are ganged, both rotor and stator plates are electrically insulated from each other. The rotors are ganged by means of insulated flexible couplings. The

reason for this insulation of the rotors from each other is to minimize inter-coupling between stages. The leads from the tuning condensers are brought straight into the terminals on the coil sockets in their respective shields. The ground connection for the coil and condenser is made right at the coil socket *and not at the condenser*. Although not apparent in the photos, the 3 tuning condensers are mounted on a bakelite strip about 7 inches long by  $\frac{7}{8}$  inches wide by  $\frac{1}{8}$  thick. This block is mounted on "stilts" at a height of  $\frac{1}{4}$  of an inch above the chassis by means of two pieces of bakelite tubing  $\frac{1}{4}$  inch long, with holes through the center to allow the passage of  $\frac{3}{4}$  inch screw for securing the block to the chassis. In addition there are small aluminum shields between the condenser to shield

the plates from each other. These shields are mounted on the bakelite block and should be grounded to the chassis. All connections from the coils and condensers should be as short as possible. The R.F. and detector tubes require individual close-fitting shields. In the photos it is seen that the first A.F. tube has a shield, but this is not necessary.

**Volume Control**

The *volume control* of the R.F. stages is accomplished by varying the bias applied to the control grids by means of a potentiometer in the cathode circuits of the R.F. tubes. One end of this is connected to a high voltage source; the circuit diagram is self-explanatory. The detector circuit, it should be noted,

(Continued on page 37)

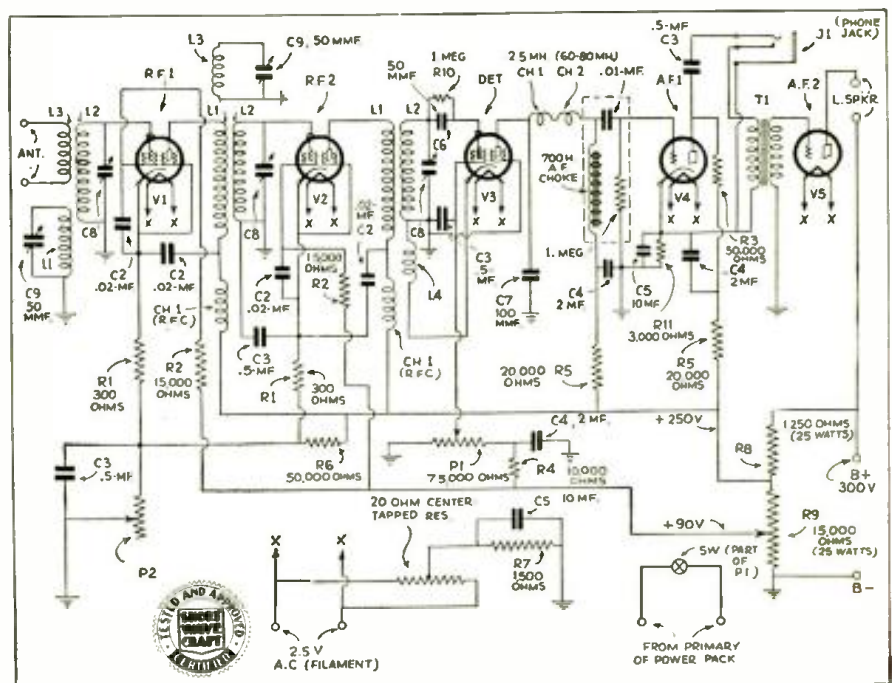

The more advanced short-wave set constructors usually prefer to wire a set by following the schematic diagram shown above.



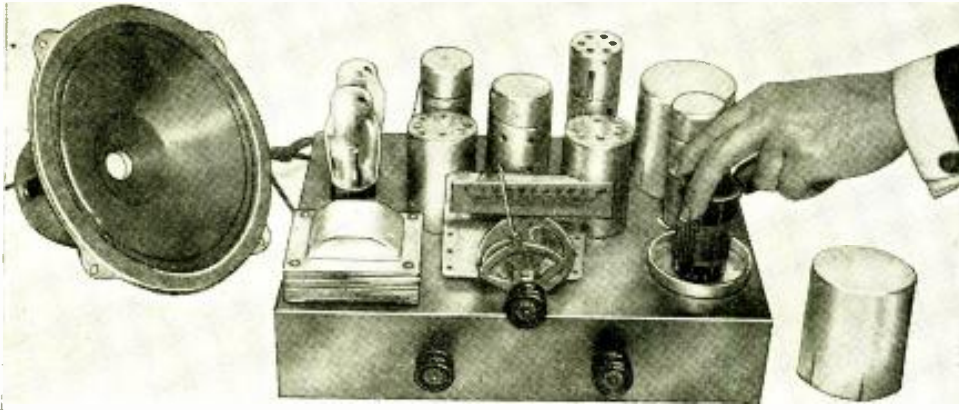

This superhet S.W. receiver works a loud-speaker in excellent fashion and the tuning controls are very simple to operate.

Here's a dandy 6-tube superhet receiver designed for 110 volt A.C. operation and which works a loud-speaker with plenty of "pep," even on the DX stations from across the "big pond!" This receiver utilizes well-chosen tubes in a carefully designed circuit and realizes the highest possible efficiency.

# A 6-Tube S-W Superhet

By HERMAN COSMAN

• THIS 6-tube superheterodyne can be constructed by the beginner at a very nominal cost and is capable of providing short-wave entertainment comparable to some of the more elaborate receivers now gracing the short-wave fans' parlor or den. Plug-in coils are used to cover a range of from 15 to 200 meters. The tube line-up consists of a 2A7 pentagrid-converter, which functions as first detector and local oscillator. The intermediate frequency amplifier consists of two stages, using a pair of 58's operating on 465 kc. The second detector is a 55 duplex diode-triode, functioning as the second detector, automatic volume control and first stage of audio.

The power output is obtained from 2A5 pentode power amplifier in a resistance coupled circuit. The plate power is obtained from a 280 full wave rectifier, the output of which is filtered by an 1,800 ohm speaker field, tapped at 300 ohms to obtain bias for the 2A5 amplifier. Two 8 mf. electrolytic condensers are connected one on each side of the speaker field, resulting in a minimum of hum. A glance at the photograph will reveal the location of the various parts on the chassis, which measures 3x10x14 inches. The two plug-in coils are housed in large removable coil shield cans which effectively eliminates coupling between the first detector and high frequency local oscillator. Shielding the coils also prevents any electrical energy being picked up and fed through the amplifier other than that introduced into the primary of the first detector coil via the antenna.

## Tuning Adjustment

The two-gang 140 mmf. tuning condenser, together with the single 140 mmf. padding condenser, which is shunted across the first detector tuning unit, serves as the only tuning adjustments. The grid returns of the two R.F. amplifiers are connected together and run through a one megohm re-

sistor and to the center-tap of the second detector grid coil. A one megohm potentiometer is connected between this point and the B negative; the rotor of the potentiometer goes to the grid of the triode of the 55. In this manner automatic control of volume can be obtained at any given setting on the volume-control potentiometer. It is only necessary to set the manual volume control to the desired volume and the automatic action will then take care of the usual "fading" conditions and a signal will remain at a more or less constant volume level. Complete data is given in the coil table for the various plug-in coils. The oscillator and first detector coils are identical in construction and should the builder desire to use factory-

made coils rather than construct them himself, it can be safely stated that any of the standard short-wave plug-in coils of the 4-prong variety will give satisfactory results; and there is no necessity for altering the windings.

## Construction Hints

Little need be said regarding the construction of this set. The diagrams clearly show all connections and the values of every part in the receiver. It is only necessary to judiciously place the parts so that each connecting lead will be as short as possible. These, in particular, should be kept from running long distances—the grid and plate leads of the R.F. tubes and the coil connections to the 2A7 converter. If the builder does not wish to use a dynamic speaker with this receiver it is

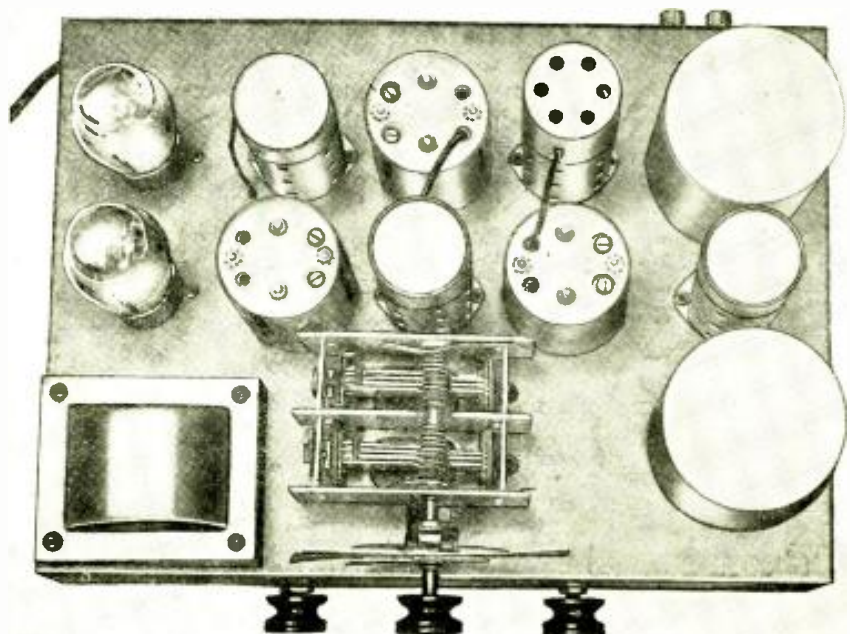

And here's a top view of the 6-tube short-wave superheterodyne receiver here described in complete detail.







# Field Measure- on Five

By CHRIS L.

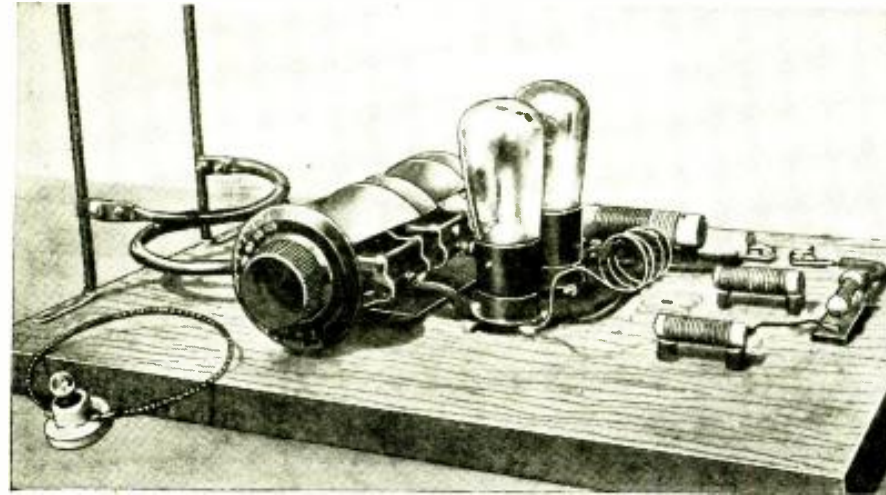

Appearance of the 5 meter transmitter used in the field intensity measurements here described by Mr. Schultz.

● MUCH has been published about 5-meter work but for the most part the articles have been concerned with various receivers and transmitters best suited for operation in that band of frequencies. Comments have been made on the effects found at these frequencies but they have been entirely quantitative in nature.

Three seniors at Rose Polytechnic Institute in choosing a thesis subject took this latter fact into consideration. They believed that qualitative tests made to determine the effects of certain objects on the propagation of ultra-radio frequency oscillations would be very interesting as well as valuable. Consequently, T. Elmer Davis, Albert N. Porter, and the writer, chose that subject for their graduation thesis.

The topography of the Rose Poly campus is such that the effect of many intervening objects such as buildings, hills, hollows, and trees may be found. For this reason, the scope of the investigation was limited to the area of the campus, about 132 acres, and to that phase of the subject. No attempt was made to determine the field strength in the usual terms of micro-volts per meter, all intensities being relative but nevertheless of value.

\* W9LVO, Brazil, Indiana.

## Type of Transmitter Used

For making such measurements it was necessary to have a transmitter and some means of measuring the field strength at the various points. For the former requirement, the low powered 5-meter transmitter, Fig 1, was built. Type '12-A tubes with 135 volts on the plates were used, chiefly because no A.C. was available at the location of the transmitter for higher-powered tubes. The best measuring conditions require a steady modulated note, and to accomplish that purpose a 1000 cycle microphone hummer was placed in the grid return. The result was the transmission of a clear and steady note, although not always received with the same tone—but more about that later.

The radiating system for the transmitter was a vertical half-wave antenna fed at the middle point. No elaborate antenna system being desired, the antenna was supported by a 14-foot pole in the open away from all buildings. When completed, the lower end of the antenna was about three feet above the ground. The transmitter was supported at the required height and about three feet from the antenna by an old transmitter frame. A view of the antenna is shown in Fig. 2.

Because the Lecher wire system un-

der ordinary conditions is accurate to within 1%, this method was used to measure the wave length of transmission. The wires were No. 12 bare copper, 10 feet long and spaced 10 inches, stretched tightly between supports. The short-circuited end of the wires was located about 30 inches from the transmitter, the coupling having been found to be sufficient. The indicating device was a 0-125 thermal galvanometer, maximum reading being about three-quarter scale with the coupling used.

## The Receiver

In choosing the method of measuring the field strength, the fact that it would be desirable to *hear the signal* as well as *seeing its effect* on the measuring device was taken into consideration. Several types of receivers were tried but Fig. 3 shows the receiver finally chosen. To facilitate the carrying of the receiver, type '30 tubes were used, since flash-light cells could be used for filament supply. The "B" batteries were the small portable size and were contained in a box to which the re-

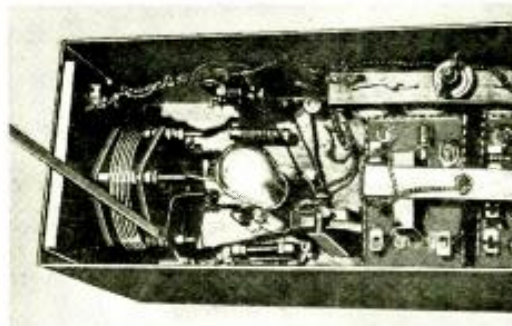
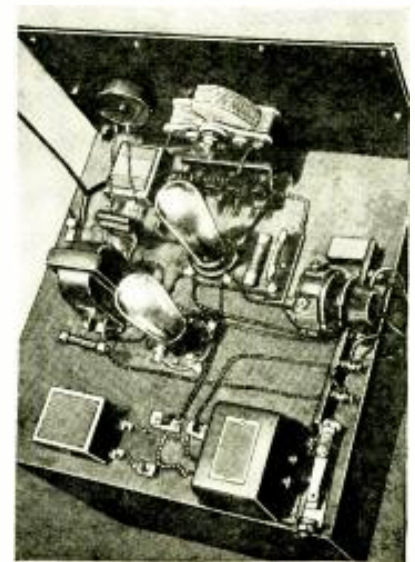

Photo. above, shows the appearance of the "local oscillator" used in making the field intensity measurements. Fig. 5.

Photo. at left, shows supporting arrangement for vertical 5 meter antenna. Fig. 2.

The appearance of the 5 meter receiver used in making the measurements outlined, is shown in the photo at the right.





# Strength ments Meters

SCHULTZ

The effect on the signal strength of 5 meter waves when hills, steel frame buildings, and other objects separate the transmitter and receiver are very interesting and the results of measurements under such conditions are here given by the author. Intervening objects markedly change the signal tone.

ceiver acted as a lid, while the box in turn served as a support for the receiver while making the measurements.

The receiving antenna was a 1/4 inch diameter brass rod two feet long screwed permanently in a vertical position to the base of the receiver. A longer antenna was tried but it was found that a greater length was easily put into vibration causing the output of the receiver to vary over very wide ranges.

A vacuum tube voltmeter was constructed to measure the output of the receiver. This voltmeter read the voltage across the secondary of a 3 1/2 to 1 audio transformer whose primary was connected in the plate circuit of the audio tube of the receiver. The voltmeter read a maximum of 15 volts, a 0-200 micro-ammeter giving full deflection at that voltage.

### Comparison of Signal Strengths

For the comparison of the different signal strengths a standard of measurement was required. To fill that requirement a local oscillator was built. Fig. 4 shows a schematic diagram of

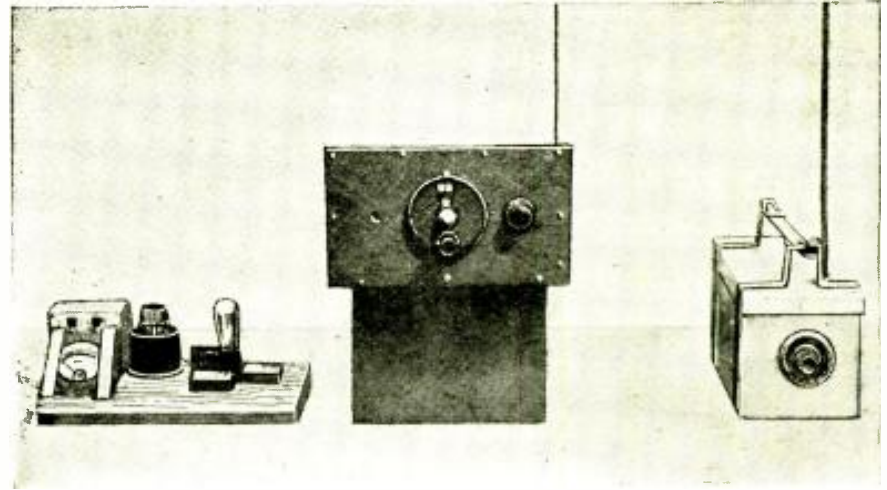

Above, the 5 meter apparatus as set up for making the "field intensity" measurements.

the local oscillator. A type '30 tube was used because of the small filament supply required. Since that source of signal also had to be modulated so that it could be compared with the main signal, several ways of modulation were tried. The first, which was finally abandoned, was of self modulating the tube, that is, to have the one tube produce both the audio and radio frequency oscillations. Although both frequencies could be produced separately, several days were spent in trying to get both at once. After convincing ourselves that for the present investigation self-modulation was impossible, and not wanting to add another tube, buzzer modulation was resorted to. A buzzer operating from 1 1/2 volts was obtained for that purpose.

To attenuate the signal from the local oscillator it was thought at first that a non-inductive, wire-wound potentiometer arrangement would be used. However, because of the high inductance at these frequencies, another means of attenuating the signal was desired. But what to use was the question. While tinkering with the local oscillator it was found that the signal died out rather rapidly as the oscillator was taken from the receiver. There was the answer. The local oscillator would be removed from the receiver

until the output from that source was the same as from the transmitter. Then the distance between local oscillator and receiver measured, and from a calibration curve of the local oscillator—distance versus receiver output—the relative intensity at the various points could be determined. A calibration curve made on the local oscillator showed that the variation of field was almost exactly proportional to the inverse of the distance between receiver and oscillator.

The radiating system of the local oscillator was a 14-inch length of 1/4 inch copper tubing connected to the grid side of the tuning coil and extending through the metal case. The whole outfit, including the batteries and buzzer, was contained in a metal box 6 by 6 by 13 inches, and was easily carried by means of a home-made handle. A battery switch was arranged so that the filament and buzzer could be turned off without removing the lid of the box. Fig. 5 shows the local oscillator with lid off.

### How Measurements Were Taken

So much for the apparatus. Now for the method of making the measurements. The greatest advantage was taken of the buildings, hills, hollows,

(Continued on page 42)

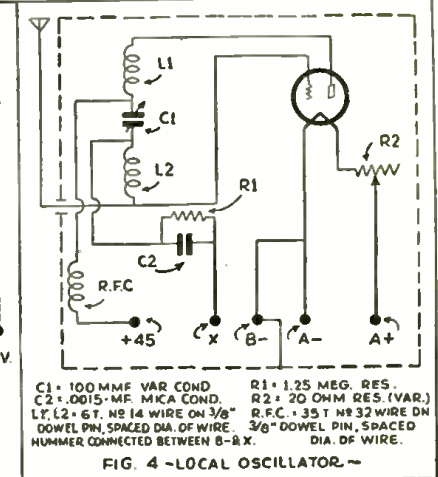
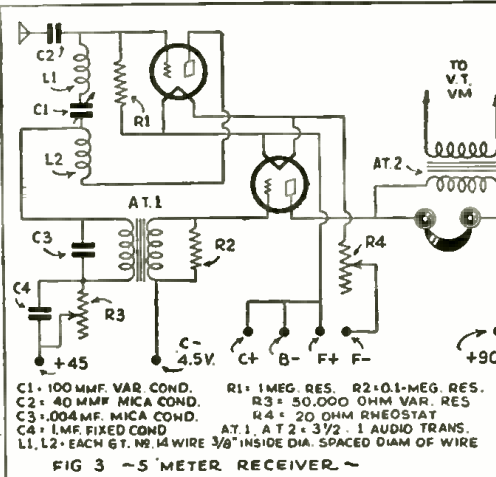
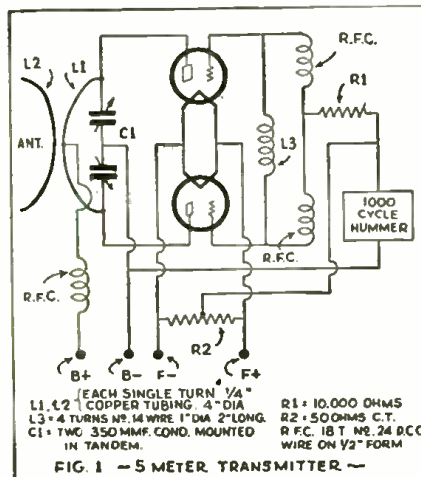

Diagram, Fig. 1, above at left, shows circuit of the 5 meter transmitter; center diagram, Fig. 3, shows hook-up of the 5 meter receiver, and diagram, at right, Fig. 4, illustrates circuit of the local oscillator.





# Many Frequencies on 1

By **GEORGE W. SHUART**  
**W2AMN**

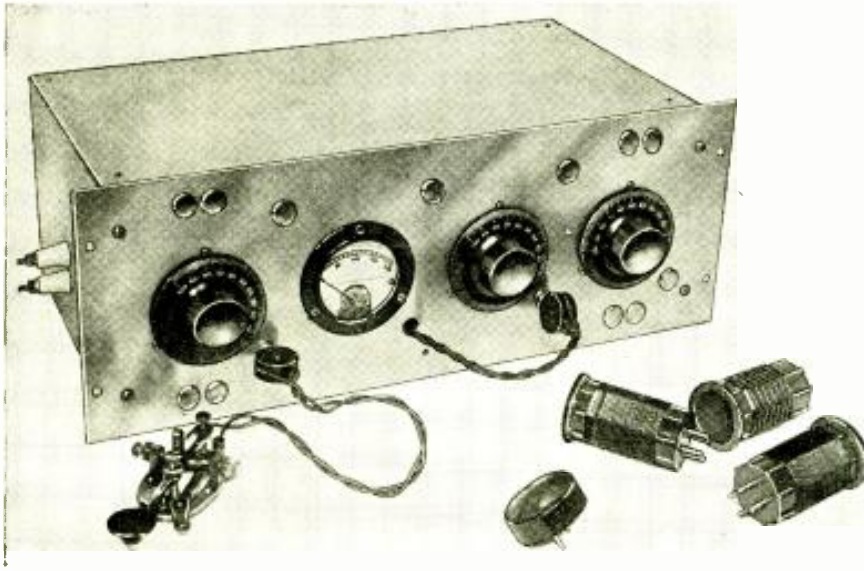

Handsome appearance of the Dual Oscillator Transmitter here described by Mr. Shuart—it involves a "brand new" circuit which permits operation on different frequencies with the same crystal. The name and address of the manufacturer of the new metal cabinet shown will be furnished upon request; Refer to No. 152.

● **CRYSTAL-CONTROLLED** amateur transmitters are becoming so common that it is no longer considered a compliment to receive an "xtal" (crystal) report; therefore we do not have to introduce the *crystal* and take up a lot of valuable space discussing its merits. However, there are a few draw-backs connected with crystal-controlled transmitters. These are: it takes quite a lot of equipment and money if the station is to be operated on amateur bands other than that for which the crystal is ground. Then again the crystal has been considered useless on bands of lower frequency than that of the crystal.

A good many months have been spent by the writer experimenting with various crystal circuits in order to find something that would be a worthwhile improvement over the older and well-known circuits. Choosing an 80 meter crystal, the *objective* was to build an exciter unit that could be used with a low or medium power final amplifier. That meant that the unit would have to furnish enough power to run a 50 watt tube on the *twenty meter band*! And be generally adjustable to any of the other frequencies as well! Various methods of *doubling* the frequency within the oscillator circuit were tried and these all suffered from a *serious loss of power* on the *second harmonic*. So much so in fact that it was necessary to use a *buffer amplifier* in order to obtain enough power to run a second frequency doubler to get down to the *twenty meter band*.

It is quite a well-known fact that two oscillators operating on the same frequency and coupled together will "lock-in" with each other, and that one will tend to stabilize the other. With the proper circuits and tubes it is also possible to tune one of these to a harmonic of the other and if the main oscillator is a strong harmonic generator, there

will also be a tendency to "lock-in" the same as on the fundamental frequency. This "lock circuit" was originally discovered in England, so far as the writer has been able to learn. This method of obtaining the *second harmonic* is better than plain frequency doubling with an amplifier, or trying to double directly in the oscillator circuit. It provides the same power output on the harmonic as on the fundamental and still has the advantage of being a strong harmonic generator. The second harmonic of a frequency doubler is away below that of the oscillator, so far as the power obtainable from its plate circuit is concerned.

So far we have made a decided improvement where frequency quadrupling is desired. With this method we can use at least one sub-harmonic of the crystal and still maintain a signal that

is identical to that produced by the crystal. But! We still have to use that extra tube! The exciter, or transmitter we might call it, as will be pointed out later, makes use of the type 53 tube.

Let's say right here that the twin-triode tubes offer the experimenter the greatest opportunity he has had in "many a moon". The 53 consists of two very high-mu triodes in a single glass envelope. Now, high-mu tubes are the best harmonic generators and that takes in frequency doubling too. There is no tube other than the 46, made of the single type that even approaches the mu of the 53. It is intended for Class "B" audio amplification.

In this outfit we use the 53 as the *crystal oscillator* and the "*oscillator doubler*", each triode functioning separately. With this tube and the method outlined before, it is possible to obtain the *same output on the harmonic of the crystal as on the fundamental*, with the fourth harmonic strong enough so that the second frequency doubler works very efficiently. Of course doubling is done in the plate circuit of the doubler, but tests have proven that greater efficiency is obtained from the multiplier tube, if the driving tube or stage has a high harmonic output. For the sake of eliminating confusion we will call the crystal oscillator, triode No. 1 and the other oscillator, triode No. 2. In the crystal triode No. 1, we have a 50,000 ohm grid-leak, which limits the plate current when the tube is oscillating (excitation from the crystal drives the plate current up on the 53—not down), shunted across the crystal through an R.F. choke.

The plate circuit of this stage is tuned with a .00014 mf. midget condenser. The circuit in triode No. 1 is conventional.

In triode No. 2 we have a decidedly

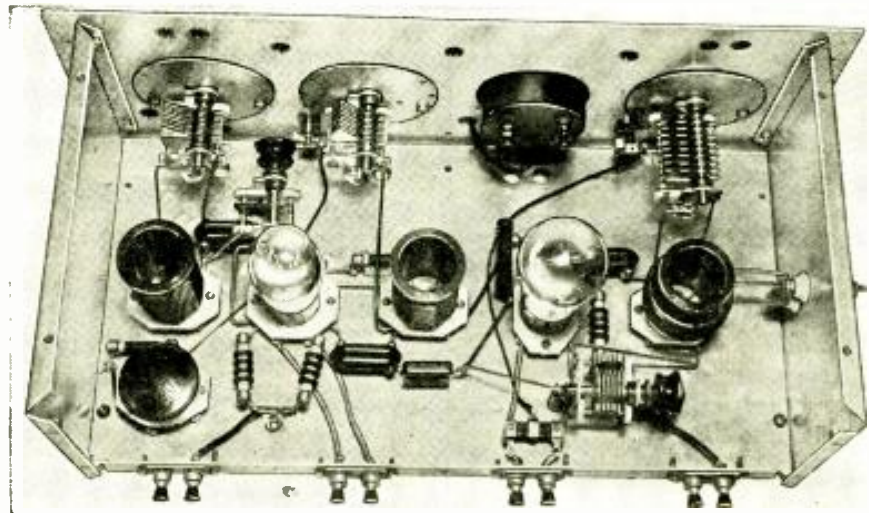

Rear view of the "Dual Oscillator" transmitter, which utilizes receiver type plug-in coils and tubes. The Billey crystal is seen in the lower left-hand corner.



# Crystal

different arrangement. The plate coil is tuned with a similar condenser but the grid is connected to the tickler winding of the plug-in coil! This is done in order that the plate circuit may be tuned to deliver power. The tickler being connected in the grid circuit eliminates an extra plug-in coil. This grid feed-back winding is rather critical and the specified number of turns should be used. There is a 20 mmf. midget variable condenser connected between the plate of triode No. 1 and the grid of triode No. 2 in order to introduce sufficient coupling so that the two circuits will "lock-in". Due to the use of a metal cabinet it was necessary to use shunt plate feed in order that the tuning condensers could be mounted directly to the panel without the use of insulating washers.

The second doubler is a type 46, with its two grids tied together. A 10,000 ohm grid-leak is used to stabilize the tube and make it an efficient doubler. Plate current is measured in the cathode circuit of both the tubes. Jack J1 is in the common cathode of both triodes in the oscillator stages, and measures the entire plate current for both oscillators. The Jacks J2 and J3 are for "keying" and plate current measurement of the 46. The meter mounted on the panel is used for both tubes.

The cathode is the proper place for the meter jacks when a metal panel is used, as it insures us against burns should the hand touch the panel and jack at the same time. The 46 second doubler is neutralized to reduce "reaction" between it and the second oscillator, triode No. 2, when the 46 is "keyed". All the parts used are mounted above the base and wired with No. 12 tinned bus-bar; no connections to either oscillators should be allowed to be anything but the most rigid.

The tuning condenser in the 46 stage is a 50 mmf. double-spaced midget. Very low capacity and high inductance is used, in order that highest efficiency may be obtained. Power is taken from the 46 via the coil mounted on the two "through" stand-off insulators on the side of the cabinet. This coil is mounted so that it encircles the plate coil of the 46. The plug-in plate coil can be changed without disturbing this pick-up, or antenna coil. When the unit is used as a transmitter in itself, this is the antenna coil. When an amplifier is added, this coil forms one-half of a low-impedance link between the two. (From four to six turns is sufficient for either, due to the close coupling.)

Three hundred volts are used on the plates of the two oscillators, while the total plate current of the two is around 45 milliamperes. The 46 should have from 500 to 600 volts on the plate. High plate voltage, high bias and low "C" make for an efficient doubler stage. Careful tuning of course is necessary with a tube operating under these conditions. With no plate load the plate current with 600 volts will be 20 mills on 80 meters, 25 on 40 meters and 30 on 20 meters.

The Editors of SHORT WAVE CRAFT are very glad to announce a really new discovery—how to stabilize different frequencies from any one crystal. Mr. Shuart deserves high credit for his persistence in solving this extremely knotty problem. With the system here described and by utilizing the new 53 tube in a cleverly devised stabilizing tank circuit, it now becomes possible at last to operate with high efficiency and plenty of power on 20, 40, 80 or 160 meters from an 80 meter crystal, for example. This circuit is so important that we caution every reader to clip this article and keep it for future reference.

It would seem logical to operate the 46 as an amplifier on 40 meters with triode No. 2 on 40 meters as the driver. This, however, should not be done as there is always danger of the amplifier throwing the second oscillator out of tune with the harmonic of the crystal. The way the entire unit is operated is as follows (with an 80 meter crystal): 160 meters—triode No. 2—160 meters and the 46 on 160 also. 80 meters—triode No. 2 on 80 and 46 on 80 also, on 80 the "locking" between the two oscillators is so strong that it is impossible for the 46 to throw the second oscillator out of resonance! On 40 meters the triode No. 2 will be tuned to 80 and the 46 as a doubler tuned to 40. The output is 90 per cent as great as on 80! For 20 meter operation the second oscillator will be tuned to "lock" with the second harmonic of the crystal, and the 46 will double down to 20 meters with better than 10 watts output!

Tuning the "twin oscillators" needs a little more care than is usually given to the rest of the set. Listen to the crystal triode on the monitor, then tune triode No. 2 to the oscillator frequency slowly. When it gets within about 50 kc. of the crystal frequency, it will "lock" right in and no sign of the second oscillator will be found. Turn the dial back and forth and note the movement of the milliammeter; it should

show a decided dip at resonance when they "lock"! The note of the second oscillator will be unsteady RAC before it locks with the crystal oscillator; and on so doing it will assume the same tone as the crystal. When tuning the second oscillator to the second harmonic of the crystal, there will be slightly less dip in the plate current and it will have to be within about 20 to 30 kc. before it locks in. The only time it is tuned to 40 meters is when operating on 20. Be sure to adjust the neutralizing condenser so that turning the 46 tuning dial will have no effect on the second oscillator plate current, with the key circuit of the 46 open.

The unit as shown in the photos and as described, can be operated as a complete transmitter with the 46 feeding the antenna. The plate current of the 46 under load should not exceed 80 mills (M.A.) for stable operation. Operated in this manner, stations in the middle west were "worked" consistently from the writer's station located in New Jersey, with very fine reports on the 80, 40 and 20 meter bands. All reports were "xtal PDC".

As an "exciter" it is capable of driving a pair of 830's or 800's to the tune of 100 watts in the antenna on 20 meters and more on the lower frequency bands! A pair of 10s or 46s could also

(Continued on page 39)

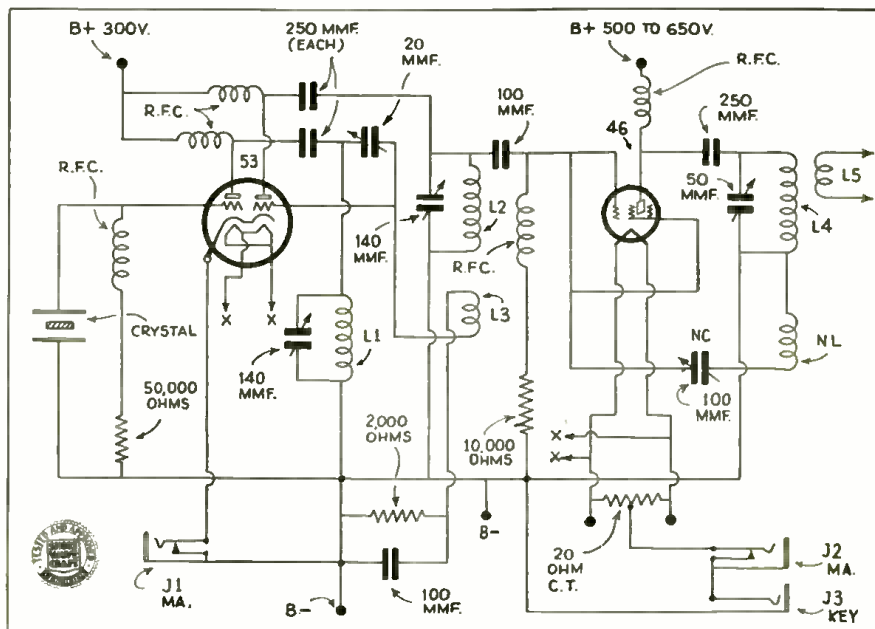

Simple hook-up of the Dual Oscillator transmitter circuit, which marks a new epoch in transmitter history. Different frequencies can now be worked from one crystal by means of this unusual, yet simple, circuit.





The author making tests on the 14-tube superhet.

# A Good 14 Tube Receiver

## Part II Conclusion

By Frank D. Andrews

Last month the first part of Mr. Andrews' article appeared; a number of valuable points of further information to those interested in building this superhet with pre-amplifier are here given.

In a transmitter where push-pull circuits are used, they are designed to operate on a definite frequency and are neutralized and perfectly balanced to radiate that frequency with a true cycle.

These detectors are so arranged that each grid will respond in alternate action through an untuned coil of perfectly balanced proportions, made of large enough wire and small enough in inductance, that this balance can be maintained mechanically. This coil is made of copper rod  $\frac{3}{16}$  inch in diameter, polished and lacquered. This rod is  $9\frac{1}{2}$  inches long and while straight, a flexible lead with a grid cap on it is soldered to each end.

The exact center of the rod is found and a small hole is drilled in it for mounting and contact with the last R.F. grid. This rod is then formed into a coil over a piece of 2 inch OD. pipe, winding from the middle, wrapping each end equally around and bringing the ends straight up, making  $1\frac{3}{8}$  turn from the center tap to the flexible grid lead, for each tube. The heavy construction for the coil is used in order to do away with any "form" material, and so it will hold its shape.

The two detectors are set up in a unit the same as the R.F. tubes. The chokes and condensers and resistors are

all self-contained, and the whole thing is screwed flush to the top of the base, giving it the same method of shielding as the R.F. unit. The single plate lead is brought out and inserted directly into the side of the first intermediate transformer.

The two detectors are arranged so the lead from the R.F. amplifier grid is shortest to the center tap of the push-pull coil. This coil is set at right-angles with the panel and placed in the extreme left center of the oscillator-detector tank.

The inductance switch is then mounted in a bakelite platform of the same type as those in the R.F. stages, but this time the switch must be placed in the extreme right-hand corner nearest the panel.

### Oscillator Mounting

Underneath the base, the oscillator tube is mounted directly under the inductance switch. The tube is mounted inside of a copper shield  $2\frac{1}{2}$  inches in diameter, sealed up tight at the bottom with a strong flange for mounting to the base. Three holes are in the bottom, one for the heater wires and one for the plate and grid lead respectively. The grid and plate leads are threaded through the base and brought up taut

(Continued on page 43)

### Detector Circuit

● THE detector circuit in this receiver, following a three-stage radio frequency amplifier, must be designed to handle extra strong signals. It takes about a third of rectification sensitivity in the detector alone to accomplish good frequency conversion with full modulation to the I.F. amplifier.

This is particularly true at high frequency conversion and even the 2A7 in the circuit alone will not reach the peak of sensitivity while handling overloads from an amplifier made up of 58 tubes.

We therefore balanced two tubes in the circuit, the 58 is chosen as the best mixer and in addition some *voltage gain* can be realized from this tube. As the 58 is not as good a rectifier as the 57, we use a 57 tube biased as a detector

Both tubes are placed in the same inductive relation to the oscillator, each biased to fulfill the function it is placed in the circuit for. The plate load of these tubes is varied in order to have them work independently, and not in parallel. They form an untuned detector circuit fed with a pre-tuned, filtered, and pared down frequency, acting only as a link in the conversion of said frequency to 465 kc.

Number two choke on the diagram is a 40 millihenry and number one is also a 40 millihenry, with about 75 turns removed.

Space will not permit the treatment of push-pull at radio frequencies, but in order to have the proper reciprocal action on the cycle, it is necessary to have perfectly balanced LC (inductance-capacity) ratio to each tube. It would be a highly technical mechanical problem to wind an efficient center-tapped radio frequency transformer, as the slightest fraction of difference between the two halves each side of the center tap, caused by non-uniform insulation or spacing of turns or diameter of wire from stretching, (or the form being thicker on one side than another) and a thousand other such defects beyond our control without machinery, will throw the whole unit out of balance, and there is no way to restore it to exact balance without an elaborate filter system. High frequencies are a vastly different problem to deal with than audio frequencies.

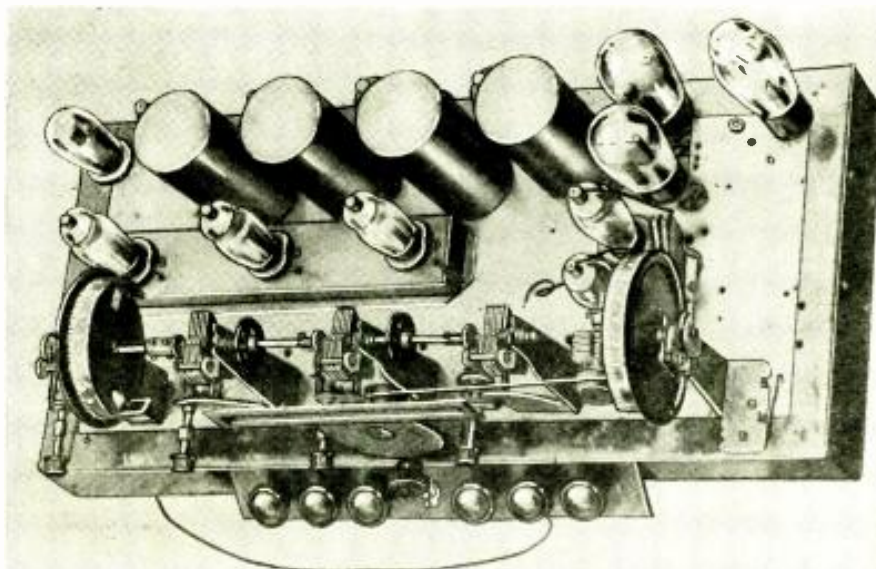

Another view of Mr. Andrews' 14-tube superheterodyne receiver, which has three stages of pre-amplification ahead of the first detector—thus ensuring the maximum amplification of the weakest "DX" signals.



# SHORT WAVE SCOUTS

Third "Trophy Cup" Winner—Charles Guadagnino, Detroit, Mich.

● IT gives the editors great pleasure to announce the award of the third "Trophy Cup" to Mr. Charles Guadagnino, who submitted the longest list of short-wave stations with the required number of verifications, for the month of February. It is interesting to note that Mr. Guadagnino used one of the well-known National "S.W. 45" A.C. sets in rolling up this magnificent roster of short-wave stations. Mr. Guadagnino's "trophy-winning" list of stations, as well as his letter accompanying the "log" appears below, together with the names of those to whom the judges awarded "Honorable Mention."

**"HONORABLE MENTION" Awards**

- Ralph M. Cecil, Box 64, Tiptecanoe, Ohio. 24S; 12V.
- Eugene Leal, Burney, Calif. 14S; 7V.
- Harold Hansen, Route 5, Box 169, So. Omaha, Nebr. 8S; 4V.
- W. L. Hawey, Jr., 1002 W. First St., Sanford, Fla. 4S; 2V.
- Everett Shirley, R.F.D. No. 2, Tarentum, Pa. 20S; 9V.
- Oliver Amlie, 56th City Line Ave., Overbrook, Phila., Pa. 34S; 13V.
- E. M. Heiser, Route 2, Box 124, Brecksville, Ohio. 41S; 15V.
- William T. Cree, P. O. Box 223, Chepachet Road, Harrisville, R. I. 30S; 8V.

(S = Total No. Stations; V = Verifications.)

**Judges, SHORT WAVE SCOUT Award:**

I submit herewith my list of stations for entry in the SHORT WAVE SCOUT Monthly Contest. I have enclosed with my letter, verifications for all the stations marked (55%—Editor). I should have received more verifications from other stations that I wrote to, but to date I have not heard from them.

The receiving set used in working up this "log" of short-wave stations is a National (A.C.) S.W. 45. The antenna is a single wire about 30 feet long. I used no ground connection. All of the stations were heard on an RCA loud-speaker. The Daventry station, of course, sends out only one verification for reports on all of their stations.

Sincerely yours,  
 CHARLES GUADAGNINO,  
 15,226 Mack Ave.,  
 Detroit, Mich.

**Entry for Short-Wave Award**

- RNE—Moscow, U. S. S. R.; 25 meters; Sundays, 8 to 9 and 10 to 11 a.m. Hello, this is Moscow.
- I2RO—Rome, Italy; 25.4 meters; 11:30 a.m. to 12:30 p.m. and 1:15 p.m. to 6:00 p.m.; lady saying Radio, Roma-Naples.
- P111—Huizen, Holland; 25.5 meters; Monday, Wednesday, Friday, 7:30 a.m.-9:30 a.m.; Saturday and Sunday, 7:30-10:00 a.m.
- E.AQ—Madrid, Spain; 30.4 meters; Daily, 5:30 p.m. to 8:00 p.m.; Saturday, 1:00 to 3 p.m.
- EL PRADO—Riobamba, Ecuador; 45.3 meters; Thursdays, 9:00 p.m. to 11 p.m.
- HIZ—Santo Domingo, Rep. of Dominicana; 47.5 meters; 4:40-5:40 p.m. Daily.
- HBP—Geneva, Switzerland; 38.4 meters; Saturdays, 5:30 to 6:15 p.m.
- HBL—Geneva, Switzerland; 31.2 meters; Saturdays, 5:30 to 6:15 p.m.
- RADIO COLONIALE—Pontoise, France; 19.6 meters; Daily, 8:00 a.m. to 11:00 a.m.
- RADIO COLONIALE—Pontoise, France; 25.6 meters; Daily, 3:00 p.m. to Midnight.
- PRA3—Rio de Janeiro, Brazil; 36.6 meters; Daily, 6:00 p.m. to 7:30 p.m.
- HVJ—Vatican City, Italy; 19.8 meters; 5:00 to 5:15 a.m.
- VEGW—Rowmanville, Canada; 49.2 meters; see card.
- WSXK—Pittsburgh, Pa.; 19.72 meters; see card.
- WSXK—Pittsburgh, Pa.; 25.27 meters; see card.
- WSXK—Pittsburgh, Pa.; 48.86 meters; see card.
- W3XAU—Philadelphia, Pa.; 31.25 meters; see card.\*
- W3XAU—Philadelphia, Pa.; 49.5 meters; see card.\*

\* 1 card for both stations.

- W3XAL—Boundbrook, N. J.—49.1 meters; 4:30 p.m. to 1 a.m.
  - J1AA—Kemikawa-Cho, Japan; 30.4 meters; 4 a.m. to 7 a.m., irregular.
  - GSG—Daventry, England; 16.8 meters; Daily, 11 a.m. to 5 p.m.\*
  - GSE—Daventry, England; 19.8 meters; Irreg., 9 a.m. to 11 a.m.\*
  - GSE—Daventry, England; 25.2 meters; Irreg., 7 a.m. to 11 a.m.\*
  - GSD—Daventry, England; 25.5 meters; 1 p.m. to 6 p.m.\*
  - GSE—Daventry, England; 31.5 meters; 9 a.m. to 6 p.m.\*
- \* 1 verification card was sent for these 5 stations reported.
- CP-5—La Paz, Bolivia; 19.6 meters; 7:30 p.m. to 10:30 p.m.
  - DJD—Zeesen, Germany; 25.5 meters; 8 p.m. to 11 p.m.; broadcasts music and talk.
  - DJA—Zeesen, Germany; 31.3 meters; 4 p.m. to 8 p.m.; broadcasts music and talk.
  - DJC—Zeesen, Germany; 49.8 meters; 8 p.m. to 11 p.m.; broadcasts music and talk.
  - HSP—Bangkok, Siam; 16.9 meters; 4:30 a. m. to 6:30 a.m.; phoning Germany; works German in German and English.
  - HJ1ARB—Barranquilla, Colombia; 46.5 meters; 6 p.m. to 10 p.m.; broadcasts musical program.
  - LSX—Buenos Aires, Argentina; 28.9 meters; 8 p.m. to 9 p.m.; relays programs of LRA.
  - RV-59—Moscow, U. S. S. R.; 50 meters; 4 p.m. to 6 p.m.; good talks and record music.
  - COC—Havana, Cuba; 50 meters; 4 p.m. to 6 p.m.; new one; broadcasts music.
  - CP-5 (Verified)—La Paz, Bolivia; 49.3 meters; 7:30 p.m. to 11:30 p.m.; broadcasts music.
  - VK3ME—Melbourne, Australia; 31.5 meters; Wednesday and Saturday only, 5 a.m. to 7 a.m.; phono. records.

(Continued on page 59)

## THIRD "TROPHY CUP" WINNER

Presented to  
 SHORT WAVE SCOUT  
 Charles Guadagnino  
 Detroit, Mich.

For his contribution toward the advancement of the art of Radio by



Magazine



● ON this page is illustrated the handsome trophy, which was designed by one of New York's leading silversmiths. It is made of metal throughout, except the base, which is made of handsome black Bakelite. The metal itself is quadruple silver-plated, in the usual manner of all trophies today.

It is a most imposing piece of work, and stands from tip to base 22 1/4". The diameter of the base is 7 3/4". The diameter of the globe is 5 1/4". The work throughout is first-class, and no money has been spared in its execution. It will enhance any home, and will be admired by everyone who sees it.

The trophy will be awarded every month, and the winner will be announced in the following issue of SHORT WAVE CRAFT. The winner's name will be hand engraved on the trophy.

The purpose of this contest is to advance the art of radio by "logging" as many short-wave commercial phone stations, in a period not exceeding thirty days, as possible by any one contestant. The trophy will be awarded to that SHORT WAVE SCOUT who has logged the greatest number of short-wave stations during the month for which the award is made.



# SHORT WAVES and

## A German Amateur Station Experimenting With 5 Meters



Editor, SHORT WAVE CRAFT:

As a German radio amateur, I read your magazine regularly, which I find very interesting. At this time I have before me your November issue and I would like to express my pleasure in seeing a description of an ultra short-wave transmitter. I have a German license for the operation of an ultra short-wave transmitter and am very much interested in the progress accomplished along this line in your country.

Besides this, I read in the same issue

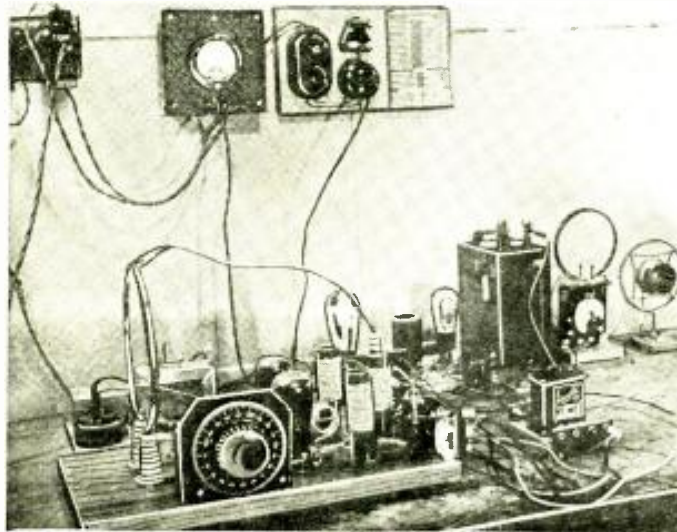

Mr. Frese's short-wave station is shown at the left; photo at the extreme left was taken during an outdoor "receiving test" on ultra short waves. The larger photo shows one of Mr. Frese's push-pull transmitters which is modulated by a buzzer-tube.

Photo directly at left shows a very interesting transmitter designed to operate on the low wavelength of 5.3 meters. We are glad to note that German "Hams" are also engaged in 5-meter work.

your request to send to you pictures of amateur stations and I am glad to satisfy it. You will find herewith a photograph of our station, which probably looks very small, according to American standards. We have a "push-pull" transmitter which is modulated by a buzzer-tube, and are operating on a wavelength of 5.3 meters. The circuit of the transmitter is of the generally accepted push-pull type. The second picture shows the writer and a friend, with whom I do all the experimental work, during an outdoor "receiving test". As our main interest is devoted to the investigation of radiation from short-wave transmitters, we made our receiver as simple as possible in order to have it light and portable. After

a long and tedious experimentation, we developed a circuit of a single-tube receiver, which according to our experience to date operates perfectly.

Frank Frese,  
Transmitter D4UAS,  
München 13,  
Türkenstr. 27/IV,  
Germany.

(We are mighty glad to hear from you, Frank, from the good "old-world" city of München, Germany, and we congratulate you on your interest in the ultra short-wave field. We hope to receive many more photos and descriptions of foreign amateur stations and we invite "hams" and "fans" as well, to send photos of their stations.—Editor.)

### HE "WORKED" JAPAN!

Editor, SHORT WAVE CRAFT:

I have been reading *Gernsback* publications since 1921, and have constructed numerous transmitters and receivers from "circuit data" gleaned from these sources. I have been a constant reader of *SHORT WAVE CRAFT* since August, 1931.

The XYL, W7CXQ, is an ardent "S.W. C." fan and delights in building the various receivers and transmitters described therein. They usually out-perform some of the OMs' concoctions.

I am enclosing a photo of the station layout at W7AUQ—W7CXQ. Perhaps you may find space for it. The lineup is as follows:

Type 47 crystal oscillator; 865 buffer stage; a push-pull '210 intermediate stage is used to excite an 852 final amplifier.

Input to the final stage is usually around 500 watts with a plate voltage of 3000. The oscillator power supply employs a type '82 tube, two 30 henry chokes, two 8 m.f. electrolytic condensers and delivers 250 volts of P.D.C. The buffer and intermediate amplifiers have a separate power supply which employs a type '83 tube and delivers 600 volts P.D.C. In other respects it is similar to that of the oscillator. A pair of type 866 rectifier tubes are used in the large power supply. Both input and output chokes are employed, with a single 1 m.f.d. condenser rated at 6000 volts.

The tank coils for the final stage are of the plug-in variety and so proportioned that operation in the three popular bands may be had without retuning the plate tank condenser. Those who have tried QSY'ing without reducing power will appreciate this.

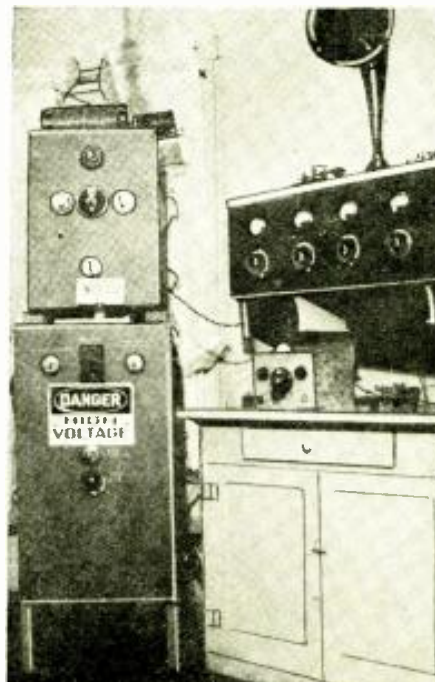

Well, Milton, this station looks mighty interesting and the editor wouldn't mind taking a twirl at the dials himself.

Obviously, the approximate setting of the antenna tuning condensers must be known.

There are two smaller transmitters, not shown in the photo, which are used occasionally. One is a TNT, employing a type '10, for operation on 7 and 14 mc. The other is a two tube crystal job, housed in an old neutrodyne cabinet, and used for 3525 and 1909 kc. work.

The receiver employs two tubes: a type '32 detector and '33 audio amplifier. A combination of capacity and resistance regeneration control is used and has been found very effective.

The transmitting antenna is the conventional half-wave, current-feed type. All 3.5 mc. "DX", however, was accomplished with an antenna and ground.

W7AUQ-W7CXQ was the first "W" station to QSO Japan on the 3.5 mc. band (J1A0). New Zealand and Australia are worked consistently on 7 m.c., and 14 ZL and VK stations were QSO'd between April 10 and April 23, on 3.5 mc.; the best report being QSA5R8; this from VK2RB.

The equipment is now located on Centreton Road, near Elmer, N. J., and operates under portable call—W7ZZAK. Milton F. Peterson  
W7AUQ—W1ZZAK  
Route No. 2  
Elmer, N. J.

(Fine business, Milton, and a very neat arrangement of apparatus in your station. Station W7CXQ looks like "real business" and we believe that many of our readers will take a tip from the arrangement shown in your photo and build their apparatus in neat dust-proof cabinets.—Editor.)



# LONG RAVES . . . OUR READERS' FORUM

## WSAZT—A "HOT" STATION

Editor, SHORT WAVE CRAFT:

Here are some photos of my amateur radio station WSAZT. The transmitter is a high-C Hartley circuit using a 210 tube with 46 watts input.

The power transformer is a Thordarson with 560 volts each side of the center tap, rectified by a 250 tube with a swinging choke input, a 4 mf. condenser, a 30 henry choke, another 4 mf. condenser, with a 25,000 ohm resistor across the output furnishing 520 volts to the 210 tube in the transmitter.

The main receiver is a National SW-3, also a home-made receiver using 224 det., 227 audio.

The monitor is self-contained in an aluminum box, using a 199 tube. I also have an "all A.C." frequency meter and monitor combined, using a 224 electron-coupled oscillator and a 227 as a detector. I usually work in the 40 and 80 meter bands. Most of the time is taken up by "rag-chewing," and once in a while working some "DX." I like to read SHORT WAVE CRAFT as I have almost every copy from the first issue two or three years ago.

Milton Seltzer, WSAZT  
102 Avenue B  
Schuylkill Haven, Pa.

(Mighty neat and well arranged, Milton S., and we note that you apparently have a cloth cover to throw over the apparatus when it is not in use—a very good idea. If there is any one thing that makes a "bum" out of a fine-looking amateur apparatus, it is dust and the best thing to do is to have a light cloth cover to throw over the apparatus when the owner and operator is not using it. More power to you, Milton, and we hope to hear further from you whenever you have new experiences or new apparatus to describe for the readers of SHORT WAVE CRAFT.—Editor.)

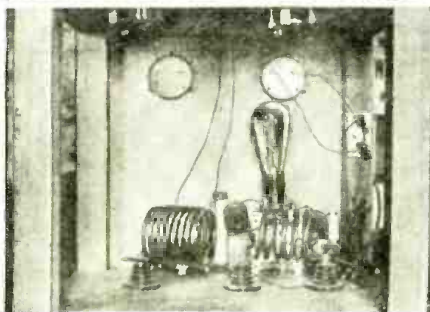
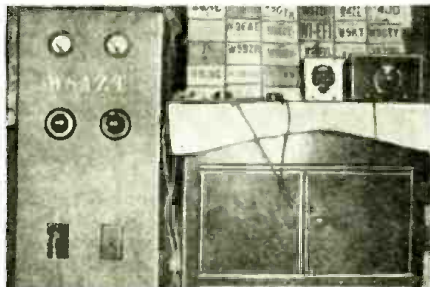

Mighty neat looking, WSAZT, and that is a nifty transmitter control panel. We'll bet it "steps out" plenty!

Give us more good photos and descriptions of your stations—Please keep the stories short and the photos clear!—The Editors.

## Hats Off to This "YL"—She Flies, Paints and CQ's

● THIS month we salute an AA-1 "YL" (meaning young lady "ham" station owner and operator)—Melba Beard of sunny Pasadena, California. Mrs. Beard numbers among her many accomplishments not only the art of transmitting and receiving on short waves, but she also has a number of other interesting hobbies. She is an apt flyer and also goes in for swimming and diving. (Note the diving helmet in the photo.) Another one of the fine arts that Mrs. Beard has cultivated is that of painting pictures. Certainly a rather extraordinary display of talent for any "YL" and we bow low to this lady who doesn't have to worry if her sigs don't get through—she can hop in her plane and deliver her "msg" in person. So, if you hear a plane a-buzzing over your roof—well—maybe . . . it might be Melba.



Mrs. Melba Beard of sunny Pasadena, Calif., beside her amateur radio transmitting and receiving set. She is also an artist, an expert swimmer and diver, and flies her own plane around the country!

## Radio City Amateur Club

Editor, SHORT WAVE CRAFT:

We have been reading your most interesting magazine for a long time and in the last few months it has been particularly interesting to read about the different amateur stations, the photos of which you have been publishing, and we were wondering if you would care to publish this photograph of our station so that many of your readers could look at it, as perhaps some of them have "worked" us in past.

There are five of us interested in amateur radio and we formed a club to experiment and have social meetings. We have our own club shack which is three miles from the city and offers an excellent place for working "dx," being free from any noises.

The station has only been "on the air" a little over a year but in that time we have "worked" every state, Alaska, Hawaii, not only once but several times each, with good reports from all over there.

The transmitter uses a 47 crystal oscillator working on 3,843 kc., 7,126 kc. with 300 volts on plate, a 47 buffer with 500 volts and 10 final amplifier with 500 volts on plate. Two antennas are used for transmitting, one a vertical 132 ft. long

for 80 meters and the other a 66 foot Hertz for 40, and with separate antennas in different directions for receiving. For receiving we use a Pilot Super Wasp, and a National FB7.

We have plenty of spare parts and tools and the keynote of the whole thing is to experiment and work "dx" only on weekends. We plan on a phone job about next winter and slightly higher power.

We trust that the above description and the photo will be of interest to others; we will gladly exchange letters and station photos with anyone. (Call W7CNW.)

Fred W. Fisher, Pres.,  
R. C. Naser, Chief Opr.,  
Radio City Amateur Club.

(Thanks for the picture and snappy description, Fred, and station, W7CNW sure looks the berries. You certainly have a fine-looking station and headquarters for meetings of your amateur radio club. You will probably be deluged with requests to exchange station photos.—Editor.)

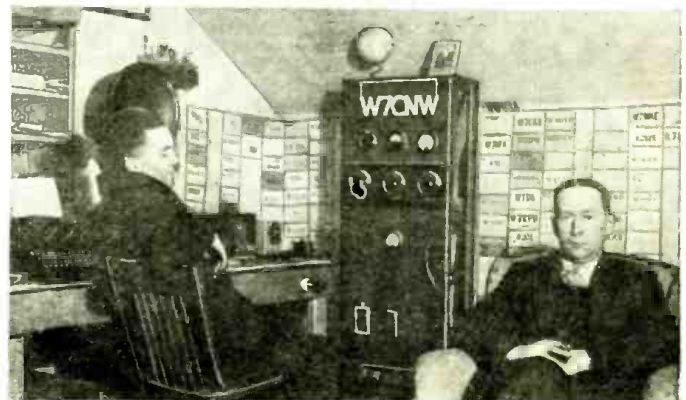

Here's a "cracker-jack" station, fellows; call W7CNW. This station has "worked" every state, including Alaska and Hawaii, with good reception reports from all points.



# WORLD-WIDE SHORT-

## THE CRYSTAL PALACE 6-METER CONVERTER

● IN SOME recent experiments conducted by *Popular Wireless*, an English magazine, considerable interest was shown by listeners and as a result several sets were designed for the home constructor.

One of these is shown in the circuit here. It consists of a single tube of the triode type that serves as both the oscillator and the first detector. While the triode does not give the same sensitivity as tetrodes or pentodes, it is easier for the amateur to handle and when used in conjunction with a good broadcast set tuned to about 1,000 kc. very fine results are possible.

As shown in the circuit, the *beat frequency* is taken off via the .002 mf. condenser and the current is localized by the choke R.F.C. which may be any good radio frequency choke designed for short-wave use. The details for constructing the coils and special choke coils in the unit are shown on the diagram.

While a battery type tube is shown, it is a simple matter to change the circuit to accommodate the A.C. type tube, so that all power for the converter can be obtained from the broadcast receiver.

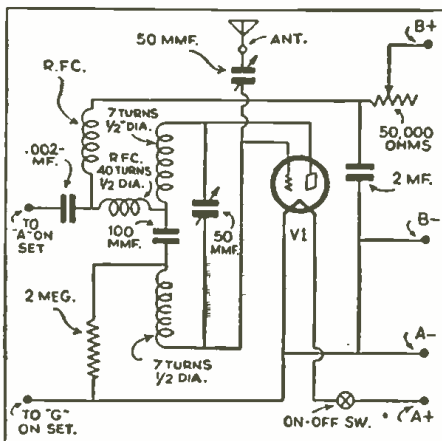

Diagram of English 6-meter short-wave converter described in detail above.

## ELECTROSTATIC SHIELD FOR TRANSPOSED S-W AERIAL

● IN ORDER to obtain the greatest signal-to-noise ratio with a short-wave aerial composed of two horizontal sections and a transposed lead-in, several precautions are necessary. These were described recently in *World-Radio*.

Firstly, the dipole should be arranged at right angles to the direction of the station it is desired to receive and, secondly, the one-turn coupling coil should be electrostatically shielded from the grid tuning coil in the manner shown in the accompanying illustration (failing this, the two coils should be very loosely coupled). It is important that the V-shaped shielding device (copper foil should be used if possible) should not be a complete turn. The coupling coil should be made of about No. 24 covered with insulating tubing and led away from the tuning coils and components toward the feeder-line terminals in such a manner that no undue *electrostatic coupling* occurs with the receivers. The center point of the coupling coil may be soldered to the shielding device (at its center) and this point on the shield should then be connected to the ground.

It must be emphasized that for this arrangement to be effective in places of high noise-level, the short-wave receiver must be contained in a completely shielded

● The editors have endeavored to review the more important foreign magazines covering short-wave developments, for the benefit of the thousands of readers of this magazine who do not have the opportunity of seeing these magazines first-hand. The circuits shown are for the most part self-explanatory to the radio student, and wherever possible the constants or values of various condensers, coils, etc., are given. Please do not write to us asking for further data, picture-diagrams or lists of parts for these foreign circuits, as we do not have any further specific information other than that given. If the reader will remember that wherever a tuned circuit is shown, for instance, he may use any short wave coil and the appropriate corresponding tuning condenser, data for which are given dozens of times in each issue of this magazine, he will have no difficulty in reconstructing these foreign circuits to try them out.

be found that this horizontal system will also give greater freedom from automobile ignition interference since the field emitted from car ignition systems is generally vertically polarized.

In the case of power operated receivers care should be taken that no disturbances are entering via the power lines. If such disturbances are found or suspected a line-filter should be used. Many of these devices are available on the market.

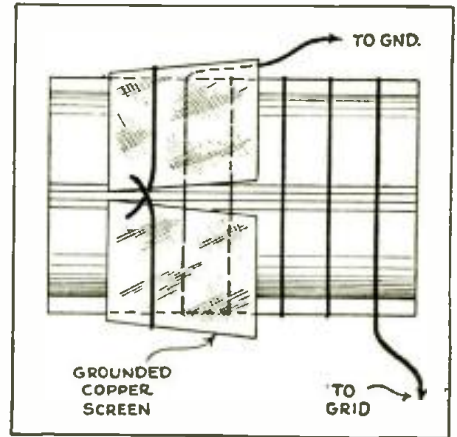

How to make a simple electrostatic shield between coupling and grid coil.

box, or, alternatively, every R.F. lead and point should be shielded in cans or similar devices mounted on a metal chassis, which is entirely enclosed. An open-bottomed metal chassis is not good enough.

The horizontal portion of the aerial should be as high as possible, and it may

## A French 4-Tube Ultra Short Wave Receiver

● THIS receiver, which has been designed for some experiments conducted by a group of French amateurs, was described in *Radio Revue*, a French radio magazine.

The circuit of the receiver is shown in the accompanying drawing. The antenna tuning circuit is connected directly to the control-grid of the R.F. screen-grid amplifier tube, V1. The tuned-plate circuit of this tube is connected to the detector tube, V2, through a fixed air condenser, C6, and a grid leak. The coupling between the coils L2 and L3, one of which is inserted in the plate circuit of the detector and the other to the tuned grid circuit is fixed. The regeneration is controlled by the variable midjet condenser, C9. The third tube V3, belongs to the resistance-coupled A.F. stage and is connected to the power tube V4, of the last stage by means of an A.F. transformer, T1. The output volume is controlled by the potentiometer across the secondary of the A.F. transformer. A

common rheostat, R4, allows adjustment of the filament voltage of the tubes. Besides that, an additional rheostat R3, enables you to adjust the voltage of the detector in order to bring this tube to the most favorable oscillating conditions.

The coils L1, L2 and L3 are all wound the same, with the exception that L1 has a tap at the center. For the 10 meter band, the coils consist of 5 turns of number 18 wire on a form 1 inch in diameter. The forms are specially made to keep the losses as low as possible. For the 7 meter band, the coils contain 3 1/2 turns, while for the 5 meter band, 2 turns are required.

To obtain the greatest amplification on the last mentioned band, it is suggested that the size of the tuning condensers be reduced and the coils increased somewhat in size. The R.F. chokes in the R.F. and detector plate circuits are very important and must be well designed.

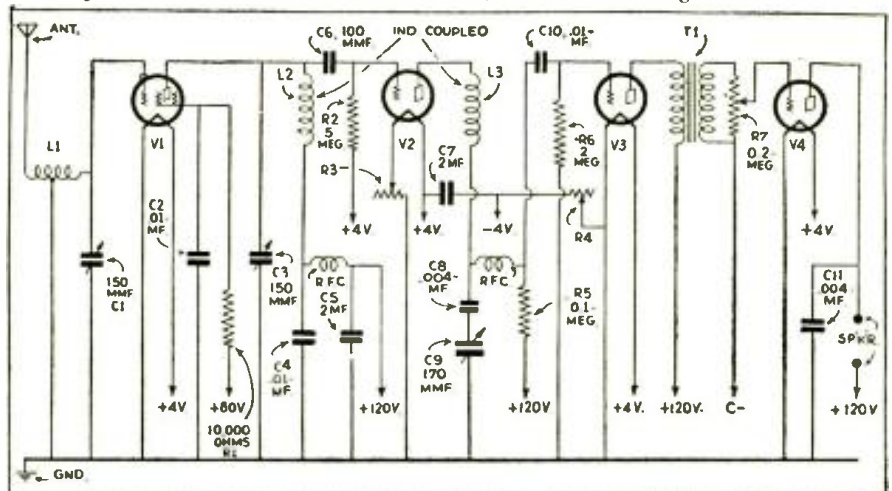

Hook-up of 4-tube ultra short-wave receiver, recently developed by a group of French experimenters.



# WAVE REVIEW

Edited by C. W. PALMER

## AN AUSTRALIAN 56 MEGACYCLE TRANSMITTER

● IN THE accompanying illustration, is shown the circuit of the 56 megacycle transmitter used by station VK2PS and VK2TS, two Australian amateurs. This circuit appeared in *Australian Radio News* recently.

As you will notice, it is a combination C.W., I.C.W., and phone circuit. For the

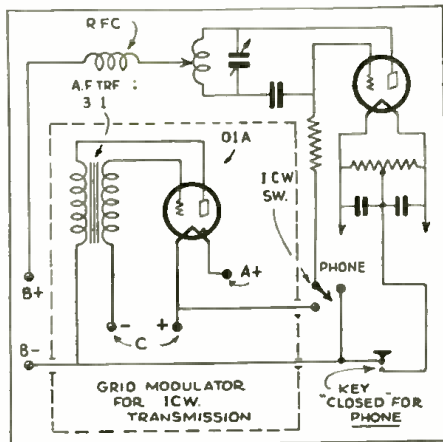

Circuit of 56 megacycle transmitter used by two Australian amateurs.

modulator, an 01A tube is employed. For the oscillator any of the small power tubes such as the 45, 2A3, 71A, 10, etc., may be employed. The transformer for modulation purposes is an audio transformer with a ratio of 3-1. This serves to modulate the unit for either I.C.W. or phone work. A shield is placed around the modulator to prevent direct coupling to the oscillator, except through the grid leak.

No details are available for the coils, but the experimenter will have little difficulty in adapting the coils of other 56 megacycle transmitters which have appeared in *SHORT WAVE CRAFT* to this purpose.

## ENGLISH COIL FORMS

● IN *Practical Mechanics* (England) recently appeared a coil-form that has many possible uses, especially for short-wave coils. The form is shown here. The form consists of two hexagonal discs of

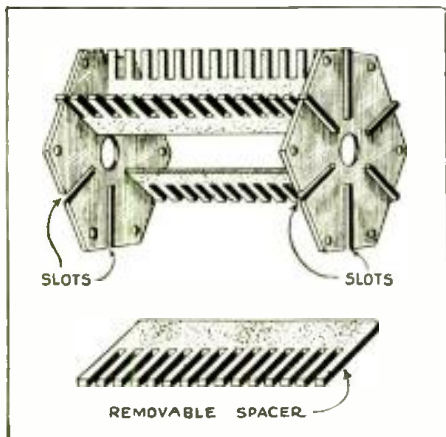

New form for short-wave coils, which consists of a series of discs and strips of bakelite, cut or punched to the shape shown.

bakelite, with six strips of similar material having one edge smooth and being cut on the other edge into a number of slots.

As shown in the examples, these slots can be used in numerous ways in coil winding. They can be used to support short-wave coil windings; chokes, long-wave coils, etc.

For those who like to experiment with circuits and coils, these forms are ideal. And they can easily be constructed by the experimenter—as they cannot be obtained in the U. S. The shape of the parts is obvious from the illustration.

## IMPROVING THE SHORT-WAVE AERIAL

● IN A recent issue of *World-Radio*, C. H. Smith tells how the aerial for the reception of short-wave signals can be greatly improved. Without going into the intricate details mentioned by Mr. Smith, the theory of the new aerial which, by the way, is called the *Bruce Aerial*, is as follows:

It is known that in a vertical aerial for short waves, that the best length for a given wavelength is  $\frac{1}{2}$  the wavelength to be received. However, if the wire is tilted instead of being vertical, the length for greatest signal strength can be much increased, with a resulting increase in the maximum amount of pick-up, but with a certain amount of directional characteristic. The dimensions of the aerial depend a good deal upon the wavelength and the greatest height possible for the supporting

## Don't Miss the Description of HEINIE JOHNSON'S "TROPHY-WINNING" RECEIVER in the June Issue!

mast, but the following suggestions are given for popular wavelengths. The illustration here shows the final form of the aerial: with its high central support, grounding resistor at the far end and direct lead-in to the set.

The efficiency of the aerial as a collector of energy is a maximum when the condition of wire length minus base-line equals one wavelength. This condition is, however, not critical and satisfactory reception will be obtained when the difference between these two quantities lies between  $\frac{1}{2}$  and  $1\frac{1}{2}$  wavelengths. The best wire length to give a good signal-to-noise ratio is also far from critical, and in practice it should be found that provided a wire not less than  $3\frac{1}{2}$  wavelengths long is used, a considerable advantage results, irrespective of wire length.

Assuming a wavelength of about 25 meters as being about the middle of the desired band, the following table of sizes can be given:

Length of base in wavelengths	Length of wire in wavelengths	Mast height in wavelengths
$\frac{1}{2}$	$1\frac{1}{2}$	0.7
$1\frac{1}{2}$	$2\frac{1}{2}$	1.0
$2\frac{1}{2}$	$3\frac{1}{2}$	1.21
$3\frac{1}{2}$	$4\frac{1}{2}$	1.41
$4\frac{1}{2}$	$5\frac{1}{2}$	1.58

This means that the mast heights for different lengths of base are 59, 84½, 102 and 129 feet. Assuming the listener is fortunate enough to be able to fasten the apex of the aerial 102 feet high (III) the length of wire is 295 feet and the total base length is 211 feet. Some aerial, eh?

For those who are still interested, after learning the dimensions (III) the resistor R should have a value of about 400 ohms and should obviously be protected from the weather. The aerial is quite directional in the direction indicated, which is advantageous in obtaining highest signal-to-noise ratio.

## ULTRA SHORT WAVES

● IN RECENT issues on this page, we have shown a number of different methods for obtaining oscillation on very short wavelengths. As we have seen, circuits vary considerably from those used on longer waves, due to the extremely small capacity allowed between various circuits so that

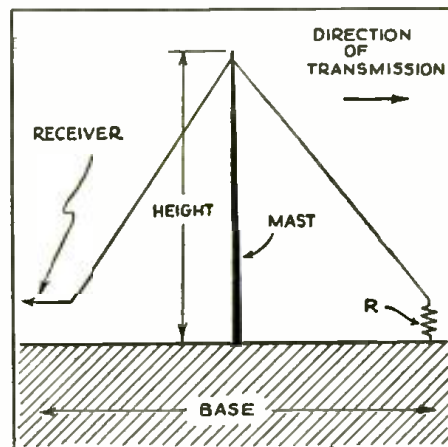

New idea in short-wave aerials—the "Bruce antenna". The one thing strongly in its favor is its extreme simplicity.

capacity effects will not disturb the oscillatory circuit or circuits.

Among the circuits shown were a number of variations of the Barkhausen-Kurz type. To increase the amount of subsequent amplification possible in the reception of decimeter waves (ordinary amplification methods being impracticable on account of the internal capacity of the tubes) two Barkhausen-Kurz circuits are coupled together as shown. The first tube A is set into oscillation by the received signals, and the amplified energy radiated from the dipole aerial A1, is picked up by a second dipole aerial B1 and fed to the amplifier B. The output from the latter is then coupled at C to further stages of amplification in the usual way.

This unique way of obtaining amplification on ultra-high frequencies was published in *The Wireless Engineer and Experimental Wireless*.

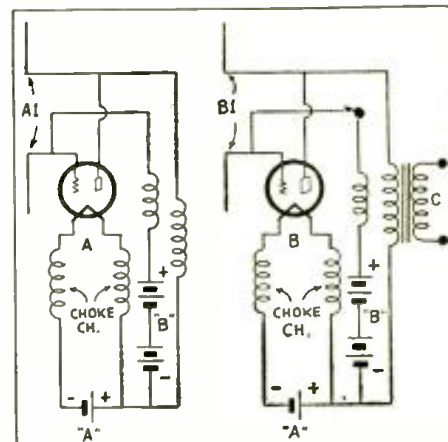

Circuit showing how to increase the amplification for ultra short-wave reception. Involving two Barkhausen-Kurz circuits coupled together.



# WHAT'S NEW

## In Short-Wave Apparatus

The short wave apparatus here shown has been carefully selected for description by the editors after a rigid investigation of its merits.

### 5 and 10 Meter Transceiver

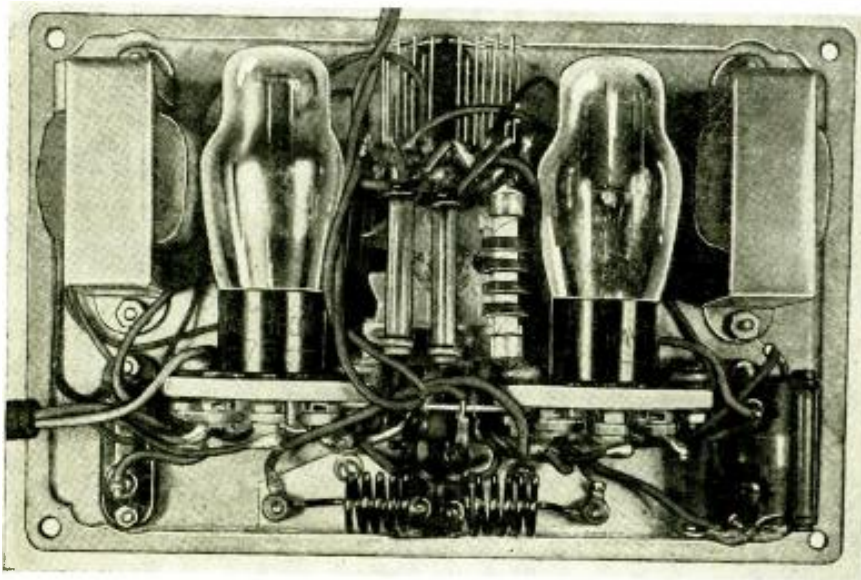

Note the extremely compact and handsome appearance of this 5 and 10-meter Transceiver. (No. 155.)

Rear view of the 5 and 10-meter Transceiver here described—set is changed from "transmit" to "receive" by a simple switch on the panel.

● THE accompanying pictures illustrate one of the latest designs of 5 and 10 meter transceivers. A transceiver is a set arranged to use the same tubes for either transmitting or receiving short waves, the change in the circuit connections being effected by means of a switch. In the set shown, this "transmit" or "receive" switch is mounted on the front panel. The compactness is but one of the outstanding features of the very fine transceiver here illustrated and it is really remarkable to note that all of the apparatus, including the tubes, are enclosed in a cast aluminum case

measuring only 6"x9"x2½". The metal box is very strong, the wall of which measures about ⅜" thick. Another feature is that all of the apparatus is mounted on the front panel, which can be removed from the cabinet by simply unscrewing four thumb nuts.

This transceiver uses one 76 tube and one 41 tube. With the 5 meter coils the wavelength range is 4.5 to 5.5 meters. The coils may be interchanged by unscrewing four nuts. Additional coils for special wave bands up to 10 meters are available from the manufacturer. The wavelength either for transmitting or receiving is changed by

means of the central knob on the panel.

The antenna is coupled through a special pie-wound coil, inductively coupled to the plate coil, the coupling being adjustable by means of a thumb-screw mounted on the front panel, accurate adjustment being ensured by means of a micrometer screw. This feature is especially valuable in receiving weak stations. The antenna connections are brought out to two binding posts on top of the case.

The accessories used for operating this 5 and 10 meter transceiver are a head-set or loud speaker, which are connected to jacks on the left-hand side of the front panel. A single-button microphone is connected to jacks on the right side of the panel. A 6 volt filament supply and a 135 to 180 volt plate current supply are required. Also an antenna outfit is needed and a special impedance-matching transformer and rods are provided by the manufacturer of this set as additional equipment. This antenna can be connected to the binding posts mounted on top of the set; feeders of any reasonable length may be employed.

(Continued on page 53)

### New "Code Practice" Oscillator



The embryo "Ham" will find this new National "code practice" oscillator a valuable aid indeed. (No. 156.)

● IT IS safe to say that 90 per cent of the short-wave "fans" who learn the code in order to become amateur radio operators use the time proven audio oscillator for code practice. Recently, the National Company of Malden, Mass., marketed a complete code practice oscillator outfit put up in a neat cracked finished box. A type 30 tube is used in conjunction with an audio transformer which produces the low frequency audio sound in the earphones. Four flash-light cells are contained in the box and the voltage to the 230 tubes controlled with a conveniently mounted rheostat. This rheostat also serves to regulate the tonal pitch in the earphones. The terminals for the telegraph key are brought out on one side of the cabinet and phone tip jacks are provided on the other side. This is a very neat piece of apparatus and should find great favor among the short-wave fans who are learning to receive the code.

The tone obtained with a special oscillator such as the one illustrated is far superior to that obtained from an ordinary buzzer.

#### \$20.00 PRIZE FOR THE BEST 1-TUBE SET

The Editors are looking for some "brand-new" Receiving Circuits using but one tube. The tube must be a standard one and any type tube can be used. The new multi-element tubes provide Short-Wave "Fans" with almost limitless opportunities. See page 37 for closing date. Send along your set—or a circuit diagram and 200 word description for opinion as to acceptability. Address your entries to:

Editor,  
SHORT WAVE CRAFT,  
98 Park Place,  
New York City.

(Names and addresses of manufacturers furnished upon receipt of stamped envelope; mention No. of article.)



## New A.C.-D.C. Short-wave Converter



Here's a nifty short-wave converter that works on 110 volts A.C. or D.C. Plug-in coils are used for tuning in the various radio frequency bands. (No. 160)

● HERE is a real pleasure-providing A.C.-D.C. short-wave converter. It makes use of a 6A7 pentagrid converter and a

25Z5 rectifier. The circuit is so arranged that it can be plugged directly into either an A.C. or D.C. 110-volt power outlet. On all A.C.-D.C. instruments of this type, it is necessary to have the polarity of the connecting plug to coincide with that of the power outlet when working from a D.C. source. If results are not obtained upon plugging it into the outlet, just reverse the attachment plug. A 15 mmf. midget variable condenser is connected directly across the main tuning condenser, as can be seen in the wiring diagram. The 15 mmf. condenser is used as a sort of vernier adjustment to permit *band-spread* tuning. This is an advantageous feature, especially on the crowded short-wave broadcast bands. In order to obtain the proper filament voltage for the 6A7, a 250 ohm resistor is connected in series with the 6A7 and 25Z5 filaments. The resistance of the 25Z5, together with the 250 ohm voltage-dropping resistor supplies the proper voltage for the 6A7. In operation it is only necessary to remove the aerial from your broadcast receiver, attach it to the converter and attach the lead marked "to antenna of broadcast set", to the broadcast receiver antenna binding-post, and set the broadcast receiver dial at the point of highest sensitivity. In other words, if your broadcast set under normal conditions provided higher gain on the high frequency end of the broadcast

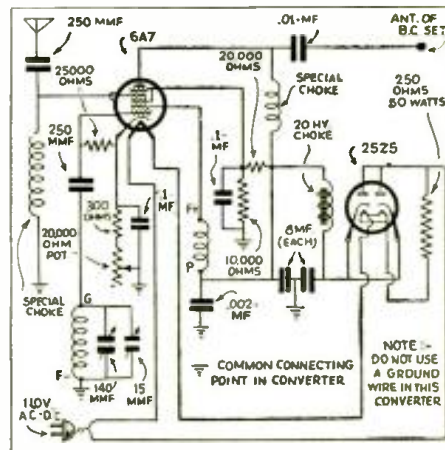

Here's how the designer of the Supertone A.C.-D.C. short-wave converter arranged the various parts of the circuit.

band, it should be set in this position or vice versa. Plug-in coils are used to cover a range of from 15 to 230 meters. All values of parts are given for the benefit of those wishing to build a converter of this type.

## The All-Wave "Air-Scout" 1-Tuber

● THE All-Wave *Air-Scout* 1-tube receiver is a nifty little set for the beginner, and as coils to cover the broadcast band are furnished with this receiver; it provides excellent entertainment from the broadcast channel, when conditions are not so favorable on the shorter waves. The diagram and photographs clearly show the various circuit connections and layout of parts for this little "one-tube wonder". The manu-

facturers of this set have worked out a rather unique scheme with the result that a person who cannot even follow a schematic or physical circuit diagram can wire up this set. All connections are color coded. For example, where wire runs from one point to another, the two points between which this wire runs are given a color. In other words, wiring up this set would be a matter of connecting all reds together, all yellows, etc. All the parts are mounted on a neat wooden baseboard only slightly larger than the average human hand.

Regeneration is controlled by the 75,000 ohm variable resistor or potentiometer, connected across the tickler coil. The rotary arm of the potentiometer is connected to the plate of the tube. The 2.5 millihenry radio frequency choke tends to keep the radio frequency energy from the earphones and eliminates bothersome capacity effects when the earphone or cord is touched. The 3 megohm grid-leak is connected directly from grid of the tube to A positive which means when the plug-in coil is removed from the socket there is not a loud squeal and the grid is maintained at relatively the same potential. The antenna trimming condenser is a low capacity affair, having a capacity of 25 mmf. with an extremely low minimum capacity. The rheostat controlling the filament of the tube is connected in the "A" negative circuit. Tuning the receiver is essentially the same as for all other short-wave regenerative detectors.

(No. 162)  
Left — The two illustrations at left show respectively wiring diagram and appearance of extremely compact and efficient All-Wave "Air-Scout" 1-tube receiver, which has made many friends among beginners especially.

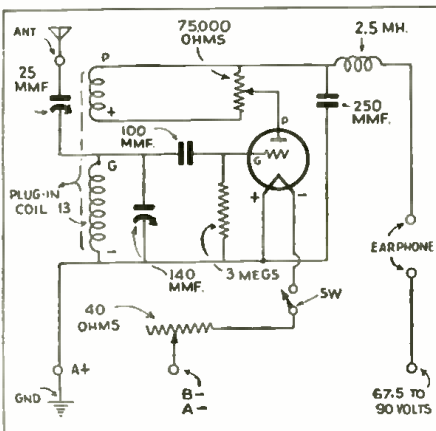

(Names and addresses of manufacturers furnished upon receipt of stamped envelope; mention No. of article.)

## World-Time Clock



A World-Time Clock is a very essential accessory to the successful short-wave "DX" listener; the clock shown, while of nominal cost, serves the purpose admirably. A small hole in the glass allows the operator to set the time dial to the proper position and thereafter time in various parts of the world may be read directly at any instant. (163)

## A Clever Aerial Spring

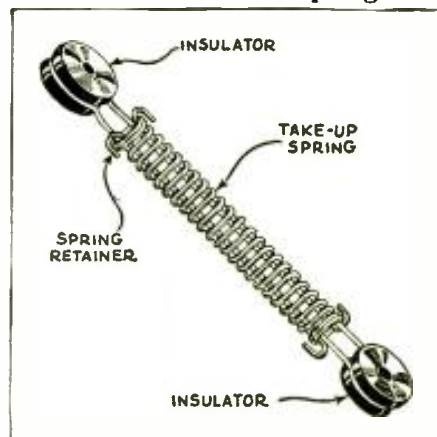

In this antenna take-up spring, the spring is actually compressed, rather than stretched; if it breaks the antenna will not fall. Breakage of the antenna wire is practically eliminated. (No. 161)



# Transformer Construction HINTS

By O. K. TIPSEL

Our readers will remember the extremely valuable article on transformer construction, with tabulated data on the various numbers of turns in the windings, core dimensions, etc., presented by Mr. Tipse in his article in the January issue. The present article contains useful transformer construction hints.

● HAVING designed an 85 watt power transformer in a previous article, entitled "Radio Power Transformer Chart and Method of Design"—see January issue—the results of that design will be used as the basis of this article. The specifications, therefore, are:

Primary, 115 Volt 60 Cycles, 346 Turns No. 22 Enamelled Wire.  
 Secondary, 360/360 Volt, 110 Ma. 2,200 Turns No. 31 Enamelled Wire.  
 5 Volt, 3 Amp. Fila. Winding, 16 Turns No. 20 Enamelled Wire.  
 2½ Volt, 3½ Amp. Fila. Winding, 8 Turns No. 19 Enamelled Wire.  
 2½ Volt, 9 Amp. Fila. Winding, 8 Turns No. 15 Enamelled Wire.  
 Core Area, 1½"x1½" = 2.25 sq. in.  
 Coil Length = 2-7/32".  
 Flux Density, 9,400. No. of Tubes = 5 to 12.  
 Size 3"x3¾"x4½". Weight, 6 pounds.

For 125 volt lines use a 360 turn primary, tapped at 346 for 115 volts. The secondary, of course, must be center-tapped for full-wave operation. The filament windings may or may not be center-tapped. If not center-tapped, the high voltage lead is taken from one side of the 5 volt winding after installing transformer and rectifier tube socket; and C.T. resistors are used across the 2½ volt filament windings.

The transformer leads may be of the thin type fixture wire, obtainable at electric supply houses, for the primary and secondary, with "push-back" wire for the filament leads; or they may be all "push-back" leads, with "spaghetti"

as extra insulation on the primary and secondary leads. The size of the leads, which should be about 12" long, is No. 18 for all except the 9 ampere winding leads, which should be No. 16 or No. 14. A color scheme follows:

115 Volts A.C. Line, No. 18 Brown Leads.  
 260/360 Volts 110 Ma. Sec., No. 18 Red Leads, Gray C.T.  
 5 Volts 3 Amp., No. 18 Blue Leads, Orange C.T.  
 2½ Volts 3½ Amp., No. 18 Black Leads, Yellow C.T.  
 2½ Volts 9 Amp., No. 16 Black Leads, Green C.T.

Colored leads not readily available may be made by running light colored leads through the desired color of Duco lacquer. Where taps are desired in the primary of which the leads are all the same color, the tap leads must be tagged with adhesive tape, and the voltages marked on the tape in ink before attaching the leads. Only the primary lead on the opposite side of the winding from the tap leads is not tagged, and this lead is always connected to one side of the power line. If two of the tap leads are connected, by mistake, across the power line, part of the primary will be burned out or a fuse blown.

If an electro-static shield is desired between the primary and secondary, use sheet copper .002 inch thick, and solder a lead to one edge for grounding. The shield is insulated by means of gummed Kraft tape. However, better results have been obtained by omitting the shield, and connecting a .1 mf. condenser from each side of the primary to ground.

Some apparatus is necessary, to turn out good coils. Fig. 3 shows an arrangement which produced very good coils. The center block of the coil form, between the two, 3/16 inch x 3¾ inch diameter hard rubber discs, is a 1½ x 1½ x 2-7/32 inch oak block, or other hard wood. It is drilled for two disc-supporting No. 4/36 x ½ inch, flat head screws on each end, and center drilled for the driving ¾ inch carriage bolt. The outside rubber disc has a square hole to fit the shank of the ¾ inch carriage bolt, which is square just below the head.

The wire guide block should be on a sliding base, so that the belt driving it can be adjusted to the right tension. The speed of the wire guide is closely adjusted by varying the driving or driven pulley diameters by means of wraps of friction tape.

When using a motor, be sure the drill chuck is tight on the carriage bolt, and it will not come loose, as the drill shaft merely rotates freely. A motor switch, close at hand, is necessary; and a starting rheostat is a helpful convenience.

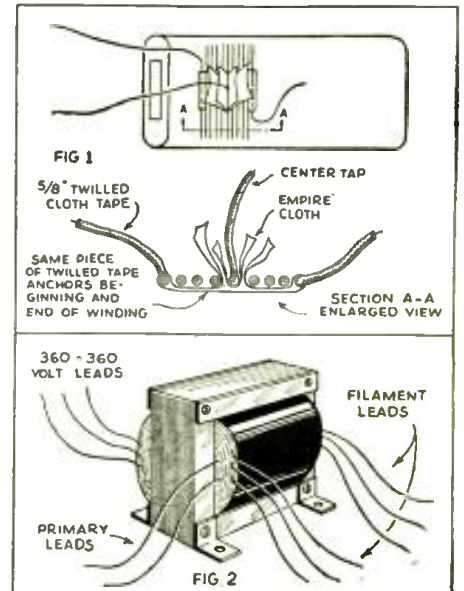

Various methods of anchoring the lead wires from the transformer coils, etc., are illustrated above.

The time saved, however, by using a motor, is not as much as might be supposed; as about half the time used in coil construction, is for placing insulation, soldering and anchoring leads, etc.

Fairly rapid and good work can be done with the breast-drill, when it is hand operated at a speed ratio of about four to one. The six inch wood pulley is also used in hand operation for fly-wheel effect, preventing jerky rotation; and as a means by which to make single turns for placing glassine paper and filament windings. When soldering center taps, the belt may be slipped on the pulley, to act as a brake against unwinding. When winding the primary and secondary, the left hand is held, lightly, against the wire spool, as a brake. The revolution counter support is springy, to allow clearing of disc screw, so that the counter may be pushed down and out of the way, when a winding is completed. The wire guide is not used for filament windings; and the counter is not needed for such few turns.

The insulating paper, for a coil, consists of .032 inch pressed board with one or two wraps of gummed Kraft tape, or simply five wraps of heavy gummed Kraft tape, for the main tube; .001 inch glassine paper (two thicknesses between winding layers of the primary and secondary); and gummed Kraft tape of heavy and light weights (two thicknesses between separate windings and varnish between thicknesses). All of these are obtainable at paper dealers. One or two wraps of glassine paper, between the block and the coil tube, facilitates removal of the block from the finished coil.

The "push-back" leads for both the primary and the secondary should come from inside the coil. The filament leads may be soldered on, subsequently, to half-inch extensions of the winding wire beyond the coil edges, and the joints taped with 1 inch Tiro tape. The leads from each winding should be brought out close together, with a coil edge for each set of winding leads, except the primary leads, which come out from inside of the coil. See Fig. 2.

(Continued on page 48)

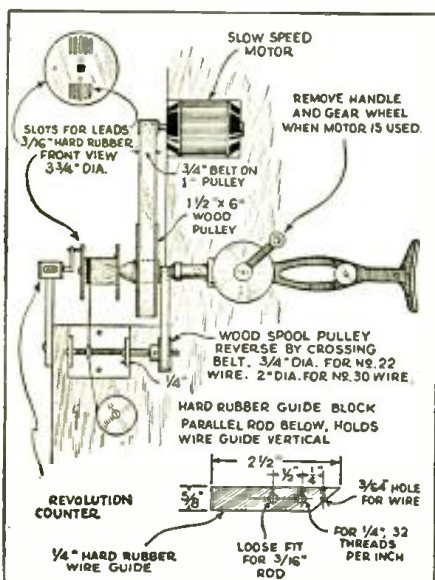

A clever coil winding "rig" for those interested in building their own transformer is shown above.



# SHORT WAVE LEAGUE



## HONORARY MEMBERS

- Dr. Lee de Forest
  - John L. Reinartz
  - D. E. Replogle
  - Hollis Baird
  - E. T. Somerset
  - Baron Manfred von Ardenne
  - Hugo Gernsback
- Executive Secretary*

## An Answer to Mr. Worcester's "No Code" Argument

Editor, SHORT WAVE CRAFT:

● MR. WORCESTER has an "F.B." (Fine Business) idea for improving the conditions on the 5-meter amateur band. Just imagine 100,000 hams operating on this band with the kind of equipment he specifies; the various manufacturers producing the various parts and equipment used in such apparatus would think that Utopia was at hand and there would be no more "depression" for them. The government would have to organize a special 5-meter Federal Radio Commission in order to keep peace in a small family of 100,000 hams.

It is all very nice and I would like to see an improvement in the 5-meter equipment, just as much as Mr. Worcester, but to invest the same amount of money in 5 meter equipment as is necessary for a good 80 meter phone outfit? Never! A communicating range of 50 miles for that amount of money would make the miles per dollar equation look kinda sick. It is safe to say that if the Government required this type of apparatus on 5-meters there would be no stations left on the band, even considering the No Code Provision. If it were not for the simple, inexpensive receivers and transmitters now available and in use, the 5-meter band would still be unpopulated.

About this "no code" argument, if a man is intelligent enough to pass a technical examination, such as Mr. Worcester advocates, and is able to build and operate equipment like this he surely should be able to accomplish a small thing such as *learning the code!* The truth of the matter is this, and in no uncertain words, the "bird" that is CQing "No Code" is too doggone lazy mentally to learn it, and would be by far too lazy to construct a multi-stage transmitter and a superheterodyne receiver, both of which would be necessary for conditions that Mr. Worcester would like to see become a reality. And I'll bet my bottom dollar that if such a law existed, together with the "No Code" Provision, that ninety per cent of those "birds" doing the shouting now would go on the 5-meter band with modulated oscillators and super-regenerative receivers! If you can't learn the code, how come you learned your A. B. C.s.  
—W2AMN.

### He's for "Code-Less" License

I have followed with interest the letters published in your magazine under the heading "Should the Code Test Be Abolished Below 6 Meters?" and would like to say a few words concerning the matter, as I see it.

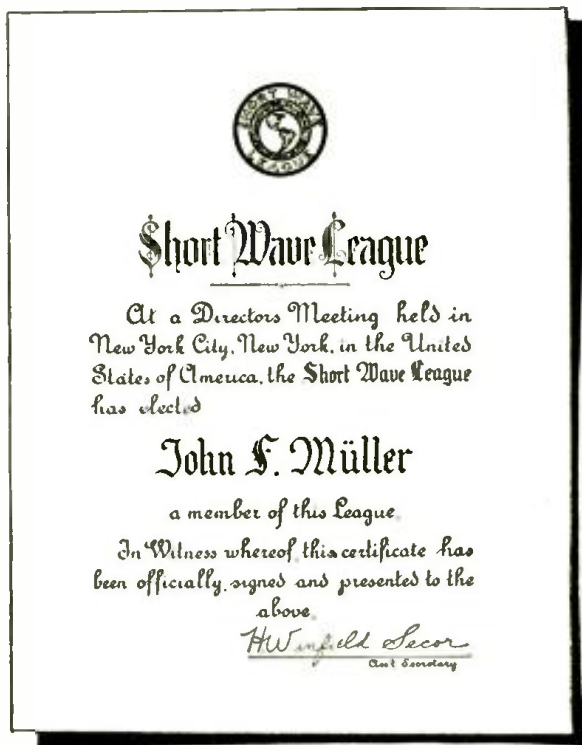

This is the handsome certificate that is presented FREE to all members of the SHORT WAVE LEAGUE. The full size is 7 1/4" x 9 1/2".

## Get Your Button

The illustration herewith shows the beautiful design of the "Official" Short Wave League button, which is available to everyone who becomes a member of the Short Wave League.

The requirements for joining the League are explained in a booklet, copies of which will be mailed upon request. The button measures 3/4 inch in diameter and is inlaid in enamel—3 colors—red, white, and blue.



Please note that you can order your button AT ONCE—SHORT WAVE LEAGUE supplies it at cost, the price, including the mailing, being 35 cents. A solid gold button is furnished for \$2.00 prepaid. Address all communications to SHORT WAVE LEAGUE, 96-98 Park Place, New York.

First, let me say that I am a graduate electrical engineer, having a Master of Science degree from Michigan State College, and have had considerable technical work in the field of communications. I built and operated, for a period of about one month, amateur station W8CPG on a Temporary Operator's ticket, but became disgusted with code work in general, the so-called "traffic handlers" and rubber-stamp "rag-chewers" in particular, and gave up the station.

Now, I am in favor of abolishing the code test on all bands, with certain restrictions. In the first place, the license issued when the code test was not taken would allow operation on phone only and only in those bands wherein the Amateur Extra First license does not apply. Secondly, in lieu of a code examination, a phone examination would be substituted, covering such theoretical and technical points as phone operation, modulators, suppression of side-band and carriers (single side-band operation) and other related phases. This, in itself, sounds as radical as anything that can be classed under the general term, "The New Deal". However, let us look at the situation more carefully.

I can easily imagine the shouts of negation, derision, etc., arising from the "dot-and-dash clan" of the amateur fraternity. "Sure thing," they say, "throw the hands wide open. Let in all the "lids" with phones a mile and a quarter wide. Spare no one." That is not

what the writer means at all. Nothing could be more disastrous than simply doing away with the code test. I am merely looking for a "square deal", equal rights if you will, and not special privileges, for the phone men. Any "lid" can throw together a mess of junk, a "pure DC" power supply, and a "sky-wire" and, by learning the code, passing the tests on why does the "junk" operate, which only the spirit of the Old-Man knows, go on the air with a code station.

Not so with the "phone" men. In the first place, the cost of the equipment necessary for a good phone station would eliminate about 90 per cent of the "lids", and about 75 per cent of the present code men. Secondly, under new regulations, the examination would be such that only those especially well versed in the operation of a phone station could obtain their tickets without passing the code test. Thirdly, the operation of the present government observing stations and the ARRL observing stations would immediately furnish the radio inspector with necessary evidence of poor

(Continued on page 55)



**\$5.00 Prize Winner**

**NOVEL ANTENNA**

Here is a type of antennae system that any radio amateur will want to have after they hear of the remarkable results it has given. I have picked up stations

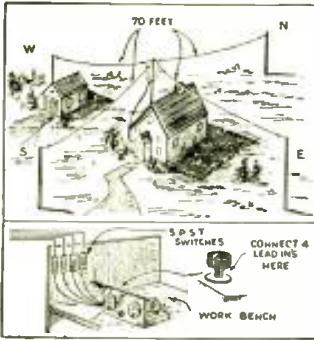

from nearly all over the world with this system. Some of the stations which I have received on my "two-tube": North—VE9GA, VAS, CGA, VHS, VE9GW, CFA, all in Canada. South—YIIRMO, Venezuela; TI4NRH, Costa Rica; LSA, FLA, both in Argentina; PRADQ, Ecuador. East—VK2ME and VK2NE, both in Australia; I2RO, Rome; OXY, Denmark; GSA, England; PIH, Holland; RNE, Moscow; CT3R2, France. West—JOCK and JOBK, Japan; XGY, China, and many others in Germany, Java, Venezuela, Morocco (CNR), Australia, etc. Capt. Horace L. Hall, one of the best known New York short-wave "fans", as a commentator and reviewer of short-wave stations: "Using this system myself, I have picked up SRI, Poznan, Poland, twice, and VQ7LO, Nairobi, Kenya Colony, South Africa, three times. Both these stations verified my reports. These two catches are considered very rare."—Joseph Gigliotti.

**AUTOMATIC "DEAD-SPOT" ELIMINATOR**

This simple device will save much trouble when changing coils, because the antenna condenser is automatically ad-

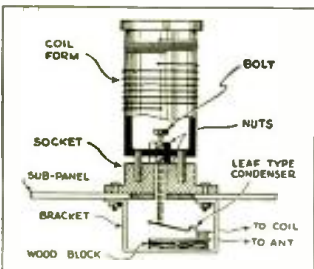

justed. First a wooden block is put under the leaf type condenser. Then make a bracket to fit your requirements. Next drill a slightly larger hole through the center of the socket than the bolt. Then drill a hole in the center of the coil form, to the size of the bolt, and place a nut on each side. The length of the bolt will have to be adjusted at first. When the coil is plugged in the bolt presses the leaf-type condenser to the required capacity to eliminate "dead spots."—Mike Kalady.

**VARIABLE CATHODE RESISTOR**

I have found that in using a transformer coupled output stage of one 27 or a 56, the volume on CW reception can be greatly increased by using a variable cathode resistor and cutting out the by-pass condenser by means of a series switch. The usual 1,500 or 2,000 ohm fixed resistor specified is often of too high a value for maximum "gain," and, especially with old tubes, this value is sufficiently critical to justify an additional control. For phone reception, the by-pass condenser is necessary, making it desirable to use a small snap switch in series to change from CW to phone.—Sheldon D. Werner.

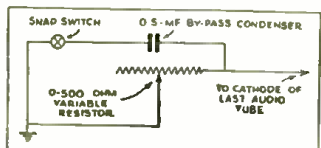

**\$5.00 FOR BEST SHORT WAVE KINK**

The Editor will award a five dollar prize each month for the best short-wave kink submitted by our readers. All other kinks accepted and published will be paid for at regular space rates. Look over these "kinks" and they will give you some idea of what the editors are looking for. Send a typewritten or ink description, with sketch, of your favorite short-wave kink to the "Kink" Editor, SHORT WAVE CRAFT.

**IMPROVED KNOBS**

I have been reading SHORT WAVE CRAFT for some time and I think it is fine. I thought I would send this kink in to you. Having no knob for a new receiver I was making, one was made from the cap of a perfume bottle and the bushing from an old cracked knob. The bushing was cut off so as not to be too long and put in the center of the bottle cap, then the hard wax from the top of an old "B" battery was melted



and poured around the bushing, until the knob was almost filled. A slit was fitted in the cap which has now become a knob, for the set-screw. The grooves in the cap will hold the sealing wax tight. There are many different styles of caps on various kinds of perfume and other bottles, which should make excellent knobs. They also look like those on some of the new electric sets.—Leonard Doughty.

**GANGING MIDGET CONDENSERS**

Here is a way to gang midget condensers, such as the Pilot. The necessary parts are two binding posts, two nuts, a

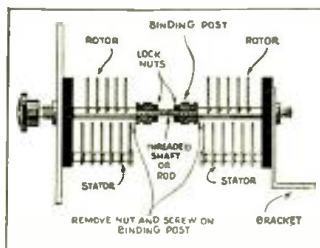

threaded rod and the condensers. Remove the nut on the end of the rotors and screw on the binding posts. Then screw in the threaded rod with the nuts on it and tighten the nuts against the binding posts. The condenser is secured to the dial at one end, while a right-angled bracket mounted on the subpanel holds the other end of the condenser. This arrangement makes a very rigid condenser when properly assembled.

**STRAIGHTENING HEAVY WIRE**

I often use the method shown here to straighten heavy wire. To straighten heavy wire or tubing merely wrap one end of the wire around a piece of pipe, or better still a pulley about 2 or 3 inches in diameter, and draw the wire around it once or twice.—William Moretan.

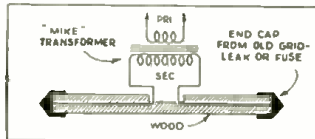
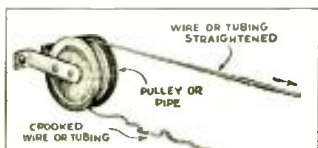

**ATTACHING "MIKE"**

Here is a kink for attaching a microphone to a receiver which uses a cartridge type grid-lead. Make a small wooden plug the size of a grid lead and put the end caps from an old grid-lead or fuse on the ends. Connect the secondary leads of the "mike" transformer to the end caps and put the plug in the grid-lead clip. This will work in most receivers using a cartridge grid-lead and many home-made as well as old-style battery receivers use this type of grid-lead. The secondary of the "mike" transformer might also be connected in place of the "C" battery in those receivers using grid-bias battery detection.—Basil Barbee.

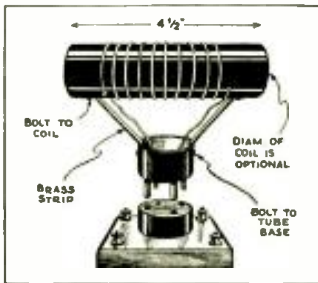

**XMITTER COIL**

This plug-in coil can be made by using a tube socket, tube base, two brass strips and some bakelite tubing. Bore holes at each end of the coil and bolt four strips to it. Bind these strips so you can bolt them on to the tube base. Bore holes in the tubing 1/2 an inch from the end. Wind your wire around the tubing and bolt at each end. Run bus wire from ends of the coil to F- and F+ prongs and solder. These coils can be wound to what is called for in the specifications of the transmitter.—Quince Brown.

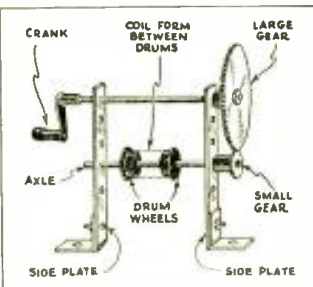

**COIL WINDER**

Meccano and Erector relics of childhood days can be successfully utilized by experimenters in the following manner. Obtain a crank, an axle, a pair of side-plates, gears and drum wheels. Hook up the crank, axle and gears in such a way as to secure a 3 to 1 ratio. With the drum wheels on the axle and supporting the coil form, coils of many turns can be easily turned out. Radio frequency choke coils are especially suited to this form of winding. The substitution of a reared-down Erector or Meccano motor for the crank makes for greater ease in winding.—B. G. Hawkes.

**CONDENSER WRINKLE**

In short-wave work there are times when one finds the need of added capacity; while there are certain types of

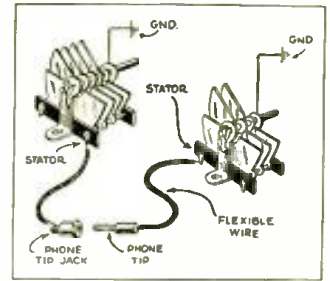

variables that include this feature there are thousands of others without such. For band-spreading the scheme permits the added capacity to be utilized, and thrown out of circuit at will. While a discarded C 4 1/2 volt battery spring clip may be used, a phone pup jack and tipped lead work best, as such requires neither fumbling or Pressure, as are involved in the former. The system fits in well with the accepted three control panel (main control at center, auxiliary capacity at left, regeneration control at right).—Dr. A. S. Hunter.

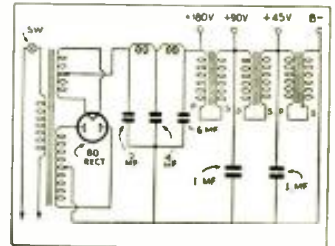

**QUIET "B" SUPPLY**

One day about six months ago I made a "B" eliminator, but I didn't have a voltage divider so I got three old unused audio transformers and connected their primaries and secondaries in series and then connected these transformers in series and put them across the output of the eliminator. A transformer with its primary and secondary in series has a D.C. resistance of about 4,000 ohms. These transformers serve as chokes and the output is filtered better than when simply using resistors. I compared this eliminator with a "B" battery on a 2-tube, battery-operated short-wave set and I could hardly tell the difference between them.—Raymond Hill.

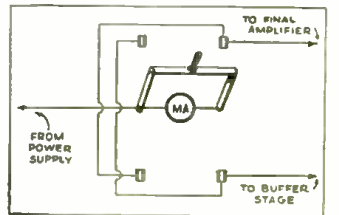

**1 METER IN 2 ROLES**

Below is a little idea which may be of interest and perhaps value to many experimenters who do not have two meters available, but find it often necessary to change a single meter around when making tests or measurements. This is especially valuable to transmitting amateurs who use master oscillator transmitters of two or three or more stages following the oscillator. All that is necessary is a double-pole, double-throw switch, and a slight change in the hook-up. The diagram I believe well illustrates how one meter may be used, for instance in measuring plate current in both a "buffer" and "final" stage.

Of course it is necessary to have a meter that will read the highest current drawn on either line. With the switch in the upper position the meter reads current in the final amplifier, at the same time shorting out the meter for the buffer. With the switch down, it reads the buffer current and shorts out the final amplifier. If constant monitoring for transmissions is used, the meter may be left to read the buffer stage, any change in note being easily discernible in the monitor when the final amplifier current may be easily read by merely throwing the switch.—E. H. Kanelmeyer, W2CJP.



# SHORT WAVE STATIONS OF THE WORLD

## New!! "Complete" Grand List Broadcast, Police, Television and Airport Stations

We present herewith a complete, revised and combined list of the short wave broadcasting, experimental and commercial radiophone stations of the world. This is arranged according to frequency, but the wavelength figures are also given for the benefit of readers who are more accustomed to working with "meters" than with "kilocycles." All the stations in this list, with one or two exceptions of the time stations, use telephone transmission of one kind or another and can therefore be identified by the average listener.

Herewith is also presented a very fine list of police, airport and television

• WE GO to considerable expense each month to revise this specially compiled list of short-wave stations, and the list is not simply repeated each time, as many readers might assume. In order to aid us in keeping this list as accurate as possible, we will appreciate hearing from short-wave listeners of any omissions or errors in the list as here published.

stations. Note: Stations marked with a star (\*) are the most active and easily heard stations and transmit at fairly regular times.

Please write to us about any new stations, changes in schedules or other important data that you learn through announcements over the air or correspondence with the stations themselves. A post card will be sufficient. We will safely return to you any verifications that you send in to us. Communications of this kind are a big help.

Stations are classified as follows: C—Commercial phone. B—Broadcast service. X—Experimental transmissions.

### Around-the-Clock Listening Guide

Although short wave reception is notorious for its irregularity and seeming inconsistency (wherein lies its greatest appeal to the sporting listener), it is a good idea to follow a general schedule as far as wavelength in relation to the time of the day is concerned. The observance of a few simple rules will save the short wave fan

a lot of otherwise wasted time. (All time given is "Eastern Standard Time"; listeners in zones having daylight saving time must make their own corrections.

From daybreak to mid-afternoon, and particularly during bright daylight, listen between 13 and 22 meters (21540 to 13000 kc.).

To the east of the listener, from about noon to 10:00 p. m., the 20-35 meter will be found very productive. To the west of the listener this same band is best from about midnight until shortly after daybreak. After dark, results above 35 meters are usually much better than during daylight. These general rules hold for any location.

## Short-Wave Broadcasting, Experimental and Commercial Radiophone Stations

<b>21540 kc. *W8XK</b> -B- 13.93 meters WESTINGHOUSE ELECTRIC SAXONBURG, PA. 7 a. m.-2 p. m.; relays KDKA programs	<b>19380 kc. WOP</b> -C- 15.48 meters OCEAN GATE, N. J.	<b>18240 kc. FRO,FRE</b> -C- 16.44 meters ST. ASSISE, FRANCE	<b>17120 kc. WOY</b> -C- 17.52 meters LAWRENCEVILLE, N. J.	<b>15250 kc. W1XAL</b> -B- 19.67 meters BOSTON, MASS.
<b>21470 kc. GSH</b> -B- 13.97 meters BRITISH BROAD. CORP. DAVENTRY, ENGLAND	<b>19355 kc. FTM</b> -C- 15.50 meters ST. ASSISE, FRANCE	<b>18200 kc. GAW</b> -C- 16.48 meters RUGBY, ENGLAND	<b>17080 kc. GBC</b> -C- 17.56 RUGBY, ENGLAND	<b>15243 kc. *FYA</b> -B- 19.68 meters "RADIO COLONIAL" PARIS, FRANCE Service de la Radiodiffusion, 103 Rue de Grenelle, Paris 8-11 a. m.
<b>21420 kc. WKK</b> -C- 14.01 meters A. T. & T. CO. LAWRENCEVILLE, N. J.	<b>19220 kc. WKF</b> -C- 15.60 meters LAWRENCEVILLE, N. J.	<b>18040 GAB</b> -C- 16.63 meters RUGBY, ENGLAND	<b>16270 kc. WLK</b> -C- 18.44 meters LAWRENCEVILLE, N. J.	<b>15210 kc. *W8XK</b> -B- 18.72 meters WESTINGHOUSE ELECTRIC & MFG. CO. SAXONBURG, PA. 1D a. m.-4:15 p. m. Relays KDKA
<b>21130 kc. LSM</b> -C- 14.15 meters BUENOS AIRES, ARGENTINA	<b>19160 kc. GAP</b> -C- 15.66 meters RUGBY, ENGLAND	<b>17810 kc. PCV</b> -C- 16.84 meters KOOTWIJK, HOLLAND	<b>16270 kc. WOG</b> -C- 18.44 meters OCEAN GATE, N. J.	<b>15200 kc. *DJB</b> -B- 19.73 meters ZEESEN, GERMANY 12:35-2 a. m., 8-11 a. m.
<b>21060 kc. WKA</b> -C- 14.25 meters LAWRENCEVILLE, N. J.	<b>18970 GAQ</b> -C- 15.81 meters RUGBY, ENGLAND	<b>17780 kc. *W3XAL</b> -B- 16.87 meters NATIONAL BROAD. CO. BOUND BROOK, N. J. 11 a. m.-5 p. m., exc. Fri. Relays WJZ	<b>16233 kc. FZR</b> -C- 18.48 meters SAIGON, INDO-CHINA	<b>15140 kc. *GSF</b> -B- 19.81 meters BRITISH BROAD. CORP. DAVENTRY, ENGLAND
<b>21020 kc. LSN</b> -C- 14.27 meters BUENOS AIRES, ARGENTINA	<b>18830 kc. PLE</b> -C- 15.93 meters BANDOENG, JAVA	<b>17770 kc. *GSG</b> -B- 16.88 meters BRITISH BROAD. CORP. DAVENTRY, ENGLAND	<b>15880 kc. FTK</b> -C- 18.90 meters ST. ASSISE, FRANCE	<b>15120 kc. *HVJ</b> -B- 19.83 meters VATICAN CITY ROME, ITALY 5:00 to 5:15 a. m., except Sunday and irregularly around 10 a. m.
<b>20730 kc. LSY</b> -C- 14.47 meters BUENOS AIRES, ARGENTINA	<b>18680 kc. GAX</b> -X- 16.06 meters RUGBY, ENGLAND	<b>17775 kc. *PHI</b> -B- 16.88 meters HUIZEN, HOLLAND Mon., Wed., Fri. 7:30-9:30 a. m. Sat. and Sun. 7:30-10 a. m.	<b>15490 kc. J1AA</b> -X- 19.36 meters Mornings and late Afternoon KEMIKAWOA-CHO-CHIBAKEN, JAPAN	<b>15055 kc. WNC</b> -C- 19.92 meters HIALEAH, FLORIDA
<b>20380 kc. GAA</b> -C- 14.72 meters RUGBY, ENGLAND	<b>18620 kc. GAU</b> -C- 16.11 meters RUGBY, ENGLAND	<b>17760 kc. IAC</b> -C- 16.89 meters PIZA, ITALY 6:30-7:30 a. m.	<b>15330 kc. *W2XAD</b> -B- 19.56 meters GENERAL ELECTRIC CO. SCHENECTADY, N. Y. Relays WGY, Mon., Wed., Fri., 2:30-3:30 p. m., Sun., 2-4 p. m.	<b>14590 kc. WMN</b> -C- 20.56 meters LAWRENCEVILLE, N. J.
<b>19900 kc. LSG</b> -C- 15.87 meters BUENOS AIRES, ARGENTINA	<b>18370 kc. PMC</b> -C- 16.33 meters BANDOENG, JAVA	<b>17310 kc. *W3XL</b> -X- 17.33 meters NATIONAL BROAD. CO. BOUND BROOK, N. J. Fri. 1 p. m.-7 p. m.	<b>15295 kc. CP5</b> -B- 19.61 meters LA PAZ, BOLIVIA 9:30-10:30 a. m.	
<b>19820 kc. WKN</b> -C- 15.14 meters LAWRENCEVILLE, N. J.	<b>18345 FZS</b> -C- 16.35 meters Saigon, INDO-CHINA	<b>17120 kc. WOO</b> -C- 17.52 meters A. T. & T. CO., OCEAN GATE, N. J.	<b>15270 kc. *W2XE</b> -B- 19.65 meters ATLANTIC BROADCASTING CORP. WAYNE, N. J. 11 a. m.-1 p. m., relays WABC	

(Time given is Eastern Standard Time)



<b>14530 kc. LSN</b> -C- 20.65 meters BUENOS AIRES, ARGENTINA	<b>11865 kc. *GSE</b> -B- 25.28 meters BRITISH BROAD. CORP. DAVENTRY, ENGLAND	<b>10330 kc. ORK</b> -C- 29.04 meters RUYSELEDE, BELGIUM From 1 p. m.	<b>9560 kc. *DJA</b> -B- 31.38 meters ZEESSEN, GERMANY 8-11 a. m.-5-7:30 p. m.	<b>7880 kc. J1AA</b> -C- 38.07 meters KEMIKAWOA-CHO-CHIBA- KEN, JAPAN
<b>14525 kc. XDA</b> -C- 20.65 meters TRANS-NEWS AGENCY MEXICO CITY	<b>11830 kc. *W2XE</b> -B- 25.36 meters ATLANTIC BROADCASTING CORP., WAYNE, N. J. 3-5 p. m. Relays WABC	<b>10300 kc. LSL</b> -C- 29.13 meters BUENOS AIRES	<b>9530 kc. *W2XAF</b> -B- 31.48 meters GENERAL ELECTRIC CO. SCHENECTADY, N. Y. Relays WGY programs 7:45-11 p. m. Also from 11 p. m.-Midnight on Saturday	<b>7830 kc. PDV</b> -C- 38.30 meters KOOTWIJK, HOLLAND After 9 a. m.
<b>14470 kc. WMF</b> -C- 20.73 meters LAWRENCEVILLE, N. J.	<b>11810 kc. *I2RO</b> -B- 25.4 meters ROME, ITALY Daily, 12 noon-1:30 p. m., 4-6:30 p. m.	<b>10220 kc. PSH</b> -C- 29.35 meters RIO DE JANIERO, BRAZIL	<b>9510 kc. *GSB</b> -B- 31.55 meters BRITISH BROAD. CORP. DAVENTRY, ENGLAND	<b>7799 kc. *HBP</b> -B- 38.47 meters LEAGUE OF NATIONS, GENEVA, SWITZERLAND 5:30-6:15 p. m., Saturday
<b>14440 kc. GBW</b> -C- 20.78 meters RUGBY, ENGLAND	<b>11790 kc. W1XAL</b> -B- 25.45 meters BOSTON, MASS. Irregularly in the morning	<b>10055 kc. ZFB</b> -C- 29.84 meters HAMILTON, BERMUDA	<b>9510 kc. *VK3ME</b> -B- 31.55 meters AMALGAMATED WIRELESS, Ltd. G. P. O. Box 1272L, MELBOURNE, AUSTRALIA Wed., 5-6:30 a. m.; Saturday, 5:00-7:00 a. m.	<b>7770 kc. PCK</b> -C- 38.60 meters KOOTWIJK, HOLLAND
<b>13990 kc. GBA</b> -C- 21.44 meters RUGBY, ENGLAND	<b>11760 kc. *DJJ</b> -B- 25.50 meters ZEESSEN, GERMANY 1-4:30 p. m.-8-11 p. m.	<b>9950 kc. GCU</b> -C- 30.15 meters RUGBY, ENGLAND	<b>9510 kc. *YV3BC</b> -B- 31.55 meters CARACAS, VENEZUELA Irregularly 10:30 a. m.-1 p. m.	<b>7480 kc. GDW</b> -C- 40.11 meters RUGBY, ENGLAND
<b>13585 kc. GBB</b> -C- 22.08 meters RUGBY, ENGLAND	<b>11750 kc. *GSD</b> -B- 25.53 meters BRITISH BROAD. CORP. DAVENTRY, ENGLAND	<b>9890 kc. LSN</b> -C- 30.30 meters BUENOS AIRES	<b>9330 kc. CGA</b> -C- 32.15 meters DRUMMONDVILLE, CANADA	<b>7444 kc. HBQ</b> -B- 40.3 meters LEAGUE OF NATIONS, GENEVA, SWITZERLAND
<b>13465 kc. GBQ</b> -C- 22.28 meters RUGBY, ENGLAND	<b>11730 kc. *PHI</b> -B- 25.57 meters HUIZEN, HOLLAND Mon., Wed., Fri., 7:30-9:30 a. m.; Sat., Sun., 7:30-10 a. m.	<b>9870 kc. WON</b> -C- 30.4 meters LAWRENCEVILLE, N. J.	<b>9300 kc. *CNR</b> -B- 32.26 meters RABAT, MOROCCO Sunday, 3-5 p. m.	<b>7150 kc. HJ4ABB</b> -B- 41.6 meters MANIZALES, COLOMBIA Various times during evening
<b>13390 kc. WMA</b> -C- 22.40 meters LAWRENCEVILLE, N. J.	<b>11720 kc. *VE9JR</b> -B- 25.6 meters WINNIPEG, CANADA Daily exp. Sun., 6-10:30 p. m.; Sun., 9-10:30 p. m.	<b>9870 kc. J1AA</b> -X- 30.4 meters KEMIKAWOA-CHO-CHIBA- KEN, JAPAN 4-7 a. m., irregularly	<b>9280 kc. GCB</b> -C- 32.33 meters RUGBY, ENGLAND	<b>6990 kc. LCL</b> -B- 42.92 meters JELBY, NORWAY Relays Oslo 11 a. m.-6 p. m.
<b>13210 kc. WOO</b> -C- 22.71 meters OCEAN GATE, N. J.	<b>11705 kc. *FYA</b> -B- 25.53 meters "RADIO COLONIAL" PARIS, FRANCE 3-6 p. m., 6:15-9 p. m., 10 p. m.-12 midnight, Daily	<b>9860 kc. *EAQ</b> -B- 30.43 meters P. O. Box 951 MAORIO, SPAIN Daily, 5:30-8:00 p. m., Sat., also 1-3 p. m.	<b>9170 kc. WNA</b> -C- 32.72 meters LAWRENCEVILLE, N. J.	<b>6977 kc. EAR110</b> -B- 43 meters MADRID, SPAIN Tues., Sat., 5:30 p. m.
<b>12840 WOO</b> -C- 23.36 meters OCEAN GATE, N. J.	<b>11680 kc. KIO</b> -C- 25.68 meters KAHUU, HAWAII	<b>9790 kc. GCW</b> -C- 30.64 meters RUGBY, ENGLAND	<b>9120 kc. CP5</b> -B- 32.88 meters LA PAZ, BOLIVIA 7:30-10:30 p. m.	<b>6905 kc. GDS</b> -C- 43.95 meters RUGBY, ENGLAND
<b>12840 WOY</b> -C- 23.36 meters LAWRENCEVILLE, N. J.	<b>11680 kc. KIO</b> -C- 25.68 meters KAHUU, HAWAII	<b>9750 kc. WOF</b> -C- 30.77 meters LAWRENCEVILLE, N. J.	<b>9020 kc. GCS</b> -C- 32.26 meters RUGBY, ENGLAND	<b>6860 kc. KEL</b> -C- 43.70 meters BOLINAS, CALIF.
<b>12840 WOO</b> -C- 23.36 meters OCEAN GATE, N. J.	<b>11680 kc. KIO</b> -C- 25.68 meters KAHUU, HAWAII	<b>9710 kc. GCA</b> -C- 30.89 meters RUGBY, ENGLAND	<b>8928 kc. TGX</b> -C- 33.50 meters GUATEMALA CITY, C. A.	<b>6840 kc. CFA</b> -C- 43.80 meters DRUMMONDVILLE, CANADA
<b>12825 kc. *CNR</b> -B, C- 23.39 meters DIRECTOR GENERAL Telegraph and Telephone Stations, Rabat, Morocco Sunday, 7:30-9:00 a. m.	<b>11680 kc. KIO</b> -C- 25.68 meters KAHUU, HAWAII	<b>9600 kc. *CT1AA</b> -B- 31.25 meters LISBON, PORTUGAL Tues. and Friday, 4:30-7:00 p. m.	<b>8920 kc. GCX</b> -X- 33.63 meters RUGBY, ENGLAND	<b>6795 kc. GDB</b> -C- 44.15 meters RUGBY, ENGLAND
<b>12800 kc. IAC</b> -C- 23.45 meters PIZA, ITALY Mornings	<b>11680 kc. KIO</b> -C- 25.68 meters KAHUU, HAWAII	<b>9600 kc. YV5BMO</b> -B- 31.25 meters MARACAIBO, VENEZUELA Tests between 5 and 10 p. m.	<b>8892 kc. GCQ</b> -C- 34.25 meters RUGBY, ENGLAND	<b>6755 kc. WOA</b> -C- 44.41 meters LAWRENCEVILLE, N. J.
<b>12780 kc. GBC</b> -B- 23.47 meters RUGBY, ENGLAND	<b>11680 kc. KIO</b> -C- 25.68 meters KAHUU, HAWAII	<b>9600 kc. XETE</b> -B- 31.25 meters MEXICO CITY, MEXICO	<b>8860 kc. GBC</b> -C- 34.56 meters RUGBY, ENGLAND	<b>6666 kc. HC2RL</b> -B- 45.00 meters Sunday, 5:45-7:45 p. m., Tues., 9:15-11:15 p. m.
<b>12290 kc. GBU</b> -C- 24.41 meters RUGBY, ENGLAND	<b>11680 kc. KIO</b> -C- 25.68 meters KAHUU, HAWAII	<b>9595 kc. *HBL</b> -B- 31.27 meters LEAGUE OF NATIONS GENEVA, SWITZERLAND Saturdays, 5:30-6:15 p. m.	<b>8860 kc. GBC</b> -C- 34.56 meters RUGBY, ENGLAND	<b>6666 kc. F8KR</b> -B- 45.00 meters CONSTANTINE, ALGERIA
<b>12780 kc. GBC</b> -B- 23.47 meters RUGBY, ENGLAND	<b>11680 kc. KIO</b> -C- 25.68 meters KAHUU, HAWAII	<b>9590 kc. *VK2ME</b> -B- 31.28 meters AMALGAMATED WIRELESS, LTD., SYDNEY, AUSTRALIA Sunday, 1-3 a. m., 5-9 a. m., 10:30 a. m.-12:30 p. m. (In May)	<b>8860 kc. GBC</b> -C- 34.56 meters RUGBY, ENGLAND	<b>6650 kc. IAC</b> -C- 45.1 meters PIZA, ITALY Evenings
<b>12290 kc. GBU</b> -C- 24.41 meters RUGBY, ENGLAND	<b>11680 kc. KIO</b> -C- 25.68 meters KAHUU, HAWAII	<b>9590 kc. *W3XAU</b> -B- 31.28 meters NEWTOWN SQUARE, PA. Relays WCAU 12 noon-6 p. m.	<b>8560 kc. WOO</b> -C- 35.05 meters OCEAN GATE, N. J.	<b>6611 kc. RW72</b> -B- 45.38 meters MOSCOW, U. S. S. R. 1-6 p. m.
<b>12260 kc. FTN</b> -C- 24.47 meters ST. ASSISE (Paris), FRANCE	<b>11680 kc. KIO</b> -C- 25.68 meters KAHUU, HAWAII	<b>9585 kc. *GSC</b> -B- 31.29 meters BRITISH BROAD. CAST. DAVENTRY, ENGLAND	<b>8560 kc. WOY</b> -C- 35.05 meters LAWRENCEVILLE, N. J.	<b>6450 kc. *HJ1ABB</b> -B- 46.51 meters BARRANQUILLA, COL., S. A. 11:30 a. m.-1 p. m. and 5-10 p. m. daily Thurs., 5-11 p. m.
<b>12150 kc. GBS</b> -C- 24.69 meters RUGBY, ENGLAND	<b>11680 kc. KIO</b> -C- 25.68 meters KAHUU, HAWAII	<b>9570 kc. *W1XAZ</b> -B- 31.35 meters WESTINGHOUSE ELECTRIC & MFG. CO. SPRINGFIELD, MASS. 7 a. m.-1 a. m. daily	<b>8380 kc. IAC</b> -C- 35.8 meters PIZA, ITALY	<b>6425 kc. *W3XL</b> -X- 46.70 meters NATIONAL BROADCASTING CO. BOUND BROOK, N. J. Fri., 5:30 p. m.-1 a. m.
<b>12000 kc. RNE</b> -B- 25 meters MOSCOW, U. S. S. R. Sat. 10-11 p. m., Sun. 6-7 a. m., 1-2 p. m.	<b>11680 kc. KIO</b> -C- 25.68 meters KAHUU, HAWAII	<b>9570 kc. *W1XAZ</b> -B- 31.35 meters WESTINGHOUSE ELECTRIC & MFG. CO. SPRINGFIELD, MASS. 7 a. m.-1 a. m. daily	<b>8185 kc. *PSK</b> -C- 36.65 meters RIO DE JANIERO, BRAZIL 6:30-7:30 p. m.	<b>6383 kc. HC1DR</b> -B- 47.00 meters QUITO, ECUADOR 8-10 p. m.
<b>11950 kc. KKQ</b> -X- 25.10 meters BOLINAS, CALIF.	<b>11680 kc. KIO</b> -C- 25.68 meters KAHUU, HAWAII	<b>9570 kc. *W1XAZ</b> -B- 31.35 meters WESTINGHOUSE ELECTRIC & MFG. CO. SPRINGFIELD, MASS. 7 a. m.-1 a. m. daily	<b>7920 kc. GCP</b> -C- 37.88 meters RUGBY, ENGLAND	
<b>11880 kc. *FYA</b> -B- 25.25 meters "RADIO COLONIAL" PARIS, FRANCE 11:15 a. m.-2:15 p. m.-3-6 p. m.	<b>11680 kc. KIO</b> -C- 25.68 meters KAHUU, HAWAII	<b>9570 kc. *W1XAZ</b> -B- 31.35 meters WESTINGHOUSE ELECTRIC & MFG. CO. SPRINGFIELD, MASS. 7 a. m.-1 a. m. daily		
<b>11870 kc. *W8XK</b> -B- 25.26 meters WESTINGHOUSE ELECTRIC CO. SAXONBURG, PA. 4:30-10:00 p. m. Relays KDKA programs	<b>11680 kc. KIO</b> -C- 25.68 meters KAHUU, HAWAII	<b>9570 kc. *W1XAZ</b> -B- 31.35 meters WESTINGHOUSE ELECTRIC & MFG. CO. SPRINGFIELD, MASS. 7 a. m.-1 a. m. daily		



<b>6335 kc. VE9AP</b> -B- 47.35 meters DRUMMONDVILLE, CANADA	<b>6110 kc. VE9HX</b> -B- 49.10 meters HALIFAX, NOVA SCOTIA 9:30 a. m.-1 p. m.; 6-12 p. m.	<b>6070 kc. YV5BMO</b> -B- 49.42 meters MARACAIBO, VENEZUELA Tests between 5 and 10 p. m.	<b>6012 kc. ZHI</b> -B- 49.9 meters RADIO SERVICE CO., 20 ORCHARD RD., SINGAPORE, MALAYA Mon., Wed., Thurs., 5:40-8:10 a. m.; Sat. 10:40 p. m.-1:10 a. m.	<b>5714 kc. HCK</b> -B- 52.5 meters QUITO, ECUADOR, S. A.
<b>6316 kc. HIZ</b> -B- 47.5 meters SANTO DOMINGO, DOMINICAN REPUBLIC Daily except Sat. and Sun. 4:40-5:40 p. m.; Sat., 9:40- 11:40 p. m.; Sun., 11:40 a. m.-1:40 p. m.	<b>6110 kc. VUC</b> -B- 49.1 meters CALCUTTA, INDIA Daily except Sat., 9:30 a. m.- noon; Sat., 11:45 a. m.-3 p. m.	<b>6070 kc. VE9CS</b> -B- 49.42 meters VANCOUVER, B. C., CANADA Fri., 12:30-1:45 a. m.; Sun., 12 noon-12 midnight	<b>6010 kc. COC</b> -B- 49.92 meters P. O. Box 98 HAVANA, CUBA 4-8 p. m., and irregularly	<b>5145 kc. OKIMPT</b> -X- 58.31 meters PRAGUE, CZECHOSLOVAKIA
<b>6276 kc. HI1A</b> -B- 47.8 meters DOMINICAN REP. Daily 12:10-2:10 p. m.; 4:10- 6:10 p. m.; Thurs., 12:10-2:10 p. m.; 7:40-9:40 p. m.	<b>6100 kc. *W3XAL</b> -B- 49.18 meters NATIONAL BROADCASTING CO. BOUND BROOK, N. J. Relays WJZ programs Saturday, 5:30 p. m.-1 a. m.	<b>6065 kc. HIX</b> -B- 49.46 meters SANTO DOMINGO, DOMINICAN REPUBLIC Tues. and Fri., 8-10 p. m.; Sun., 7:45-10:40 a. m., 3-5 p. m. Sat., 10:40-11:40 p. m.	<b>6005 kc. VE9DR</b> -B- 49.96 meters CANADIAN MARCONI CO. DRUMMONDVILLE, QUEBEC 7 a. m.-11 p. m., daily, exc. Sun.; 11 a. m.-10 p. m., Sun.	<b>5077 kc. WCN</b> -C- 59.08 meters LAWRENCEVILLE, N. J.
<b>6275 kc. HJ3ABF</b> -B- 47.81 meters BOGOTA, COLOMBIA 7-11 p. m.	<b>6100 kc. *W9XF</b> -B- 49.18 meters DOWNERS GROVE, ILL. Relays WENR, Chicago Daily except Sat., 4:30-8:00 p. m. 9:30 p. m.-2 a. m. Sun. 4:30-7 p. m.; 9 p. m.- 2 a. m.	<b>6060 kc. *W8XAL</b> -B- 49.50 meters CROSLY RADIO CORP. CINCINNATI, OHIO Relays WLW	<b>6005 kc. VE9DN</b> -B- 49.50 meters DRUMMONDVILLE, QUEBEC Sat., 11:30 p. m.	<b>5025 kc. ZFA</b> -C- 59.7 meters HAMILTON, BERMUDA
<b>6150 kc. YV3BC</b> -B- 48.78 meters CARACAS, VENEZUELA Generally 4:00-10:00 p. m.	<b>6095 kc. *VE9GW</b> -B- 49.22 meters BOWMANVILLE, ONTARIO, CANADA Mon., Thurs., 3 p. m.-midnight; Fri., Sat., 8 a. m.-midnight; Sun., 12 noon-9 p. m.	<b>6060 kc. VQ7LO</b> -B- 49.50 meters IMPERIAL AND INTERNA- TIONAL COMMUNICATIONS, Ltd. NAIROBI, KENYA, AFRICA Mon., Wed., Fri., 5:45-6:15 a. m., 11 a. m.-2 p. m. Tues., 3-4 a. m., 11 a. m.-2 p. m., Thurs., 8-9 a. m., 11 a. m.- 2 p. m., Sat., 11 a. m.-3 p. m., Sun., 10:50 a. m.-2 p. m.	<b>6000 kc. EAJ25</b> -B- 50 meters BARCELONA RADIO CLUB, BARCELONA, SPAIN 3:30-4:30 p. m., Saturday	<b>4975 kc. GBC</b> -C- 60.30 meters RUGBY, ENGLAND
<b>6140 kc. *W8XK</b> -B- 48.86 meters WESTINGHOUSE ELECTRIC & MFG. CO. SAXONBURG, PA. Relays KDKA programs, 4:30 p. m.-midnight	<b>6090 kc. VE9BJ</b> -B- 49.26 meters SAINT JOHN, N. B., CAN. 7-8:30 p. m.	<b>6060 kc. PK1WK</b> -B- 49.5 meters BANDOENG, JAVA Daily exc. Fri., 5:30-6 a. m.	<b>6000 kc. RW59</b> -B- 50 meters MOSCOW, U. S. S. R. 4-6 p. m., daily	<b>4820 kc. G6RX-GDW</b> -C- 62.24 meters RUGBY, ENGLAND Tests irregularly 8-11 p. m.
<b>6130 kc. ZGE</b> -B- 48.94 meters KUALA LUMPUR, FED. MALAY STATES Tue. and Fri., 6:40-8:40 a. m. Sun., 7-9 a. m.	<b>6085 kc. CP5</b> -B- 49.3 meters LAPAZ, BOLIVIA 6:30-7:30 p. m.; 9-11:30 p. m. Mon., Wed., Fri., 6:30-8 p. m. 9-11:30 p. m., Tues., Thurs., Sat.	<b>6060 kc. *W3XAU</b> -B- 49.50 meters NEWTOWN SQUARE, PA. Relays WCAU, Philadelphia 8 p. m.-1 a. m. irregular	<b>6000 kc. HVJ</b> -B- 50.26 meters VATICAN CITY (ROME) 2-2:15 p. m., daily. Sun., 5-5:30 a. m.	<b>4752 kc. WOO</b> -C- 63.1 meters OCEAN GATE, N. J.
<b>6122 kc. ZTJ</b> -B- 49 meters JOHANNESBURG, SOUTH AFRICA Daily except Sat. and Sun., 11:45 p. m.-12:30 a. m., 4-7 a. m., 9 a. m.-3:30 p. m. Sat., only, 4-7 a. m., 9 a. m.- 4:45 p. m. Sun., only, 11:45 p. m.-12:30 a. m., 8-10:30 a. m. and 12:30- 3 p. m.	<b>6080 kc. *W9XAA</b> -B- 49.31 meters CHICAGO FEDERATION OF LABOR CHICAGO, ILL. Relays WCFL Sunday, 11:30 a. m.-9 p. m.	<b>6050 kc. *GSA</b> -B- 49.58 meters BRITISH BROAD. CORP. DAVENTRY, ENGLAND British Empire programs	<b>5970 kc. HJ4ABE</b> -B- 50.6 meters MEDELLIN, COLOMBIA Mon., 7-11 p. m.; Tues., Thurs., Sat., 6:30-8:00 p. m.; Wed. and Fri., 7:30-11:00 p. m.	<b>4752 kc. WOY</b> -C- 63.1 meters LAWRENCEVILLE, N. J.
<b>6120 kc. *W2XE</b> -B- 49.02 meters ATLANTIC BROADCASTING CORP., WAYNE, N. J. 6:00-11:00 p. m.	<b>6075 kc. OXY</b> -B- 49.4 meters SKAMLEBOAEK, DENMARK Irregular, 1-6 p. m.	<b>6040 kc. W1XAL</b> -B- 49.67 meters BOSTON, MASS. 6:7:45 p. m. Sun., 6:30-9:30 p. m.	<b>5853 kc. WOB</b> -C- 50.25 meters LAWRENCEVILLE, N. J.	<b>4727 kc. WOO</b> -C- 70.22 meters OCEAN GATE, N. J.
<b>6120 kc. *YV1BC</b> -B- 49.02 meters CARACAS, VENEZUELA 10:30 a. m.-1 p. m.; 5:15- 10 p. m.	<b>6072 kc. OER2</b> -X- 49.41 meters VIENNA, AUSTRIA Tues. and Thurs., 8:30 a. m.- 4 p. m.	<b>6040 kc. W4XB</b> -B- 49.67 meters MIAMI, FLORIDA Relays WIOD, Sat. evenings	<b>5170 kc. PMY</b> -C- 58.00 meters BANDOENG, JAVA	<b>4727 kc. WOY</b> -C- 70.22 meters LAWRENCEVILLE, N. J.

## POLICE RADIO ALARM STATIONS

KGHG Las Vegas, Nev.	2474 kc.	KGPP Portland, Ore.	2442 kc.	KGZO Santa Barbara, Cal.	2414 kc.
KGHO Des Moines, Iowa	1682 kc.	KGPQ Honolulu, T. H.	2450 kc.	KGZP Coffeyville, Kans.	2450 kc.
KGHZ Little Rock, Ark	2406 kc.	I GPS Bakersfield, Cal.	2414 kc.	KGZQ Waco, Tex.	1712 kc.
KGJX Pasadena, Cal.	1712 kc.	KGPW Salt Lake City, Utah	2406 kc.	KGZR Salem, Ore.	2442 kc.
KGLX Albuquerque, N. M.	2414 kc.	KGPX Denver, Colo.	2442 kc.	KGZS McAlester, Okla.	2458 kc.
KGOZ Cedar Rapids, Iowa	2466 kc.	KGPY Baton Rouge, La.	1574 kc.	KGZT Santa Cruz, Cal.	1674 kc.
KGPA Seattle, Wash.	2414 kc.	KGPZ Wichita, Kans.	2450 kc.	KGZU Lincoln, Neb.	2490 kc.
KGPB Minneapolis, Minn.	2430 kc.	KGZA Fresno, Calif.	2414 kc.	KGZW Lubbock, Tex.	2458 kc.
KGPC St. Louis, Mo.	1706 kc.	KGZB Houston, Tex.	1712 kc.	KGZX Albuquerque, N. Mex.	2414 kc.
KGPD San Francisco, Cal.	1674 kc.	KGZC Topeka, Kans.	2422 kc.	KSW Berkeley, Cal.	1658 kc.
KGPE Kansas City, Mo.	2422 kc.	KGZD San Diego, Cal.	2490 kc.	KVP Dallas, Tex.	1712 kc.
KGPG Vallejo, Cal.	2422 kc.	KGZE San Antonio, Tex.	1658 kc.	UYR Montreal, Can.	1712 kc.
KGPH Oklahoma City, Okla.	2450 kc.	KGZF Chanute, Kans.	2450 kc.	WCK Belle Island, Mich.	2414 kc.
KGPI Omaha, Neb.	2466 kc.	KGZG Des Moines, Iowa	2466 kc.	WEY Boston, Mass.	1558 kc.
KGPJ Beaumont, Tex.	1712 kc.	KGZH Klamath Falls, Ore.	2382 kc.	WKDT Detroit, Mich.	1558 kc.
KGPK Sioux City, Iowa	2466 kc.	KGZI Wichita Falls, Tex.	2458 kc.	WKDU Cincinnati, Ohio	1706 kc.
KGPL Los Angeles, Cal.	1712 kc.	KGZJ Phoenix, Ariz.	2430 kc.	WMDZ Indianapolis, Ind.	2442 kc.
KGPM San Jose, Cal.	1674 kc.	KGZL Shreveport, La.	1712 kc.	WMJ Buffalo, N. Y.	2422 kc.
KGPN Davenport, Iowa	2466 kc.	KGZM El Paso, Tex.	2414 kc.	WMO Highland Park, Mich.	2414 kc.
KGPO Tulsa, Okla.	2450 kc.	KGZN Tacoma, Wash.	2414 kc.		

(Continued on page 46)



# SHORT WAVE QUESTION BOX

## GETTING STARTED

E. Howard, Indianapolis, Ind.  
 (Q) At the present I am a short-wave fan and have an all wave receiver and am very much interested in amateur work. I would like to build a suitable receiver and transmitter at a later date.

(A) For getting started in amateur radio we very highly recommend the 2-Tube Electrified Doerle which is described in this magazine and which has been remodeled to conform with amateur requirements including band spread, and a pentode audio amplifier.

(Q) How should I go about learning the code? Should I take a commercial course or do you think I could teach myself?

(A) Commercial courses in code work are to be preferred as they teach the correct principles in operating and give the student every opportunity to become a good operator. On the other hand, however, thousands of amateurs have learned the code just by merely listening and practising with a simple code test oscillator which is described on this page. However, your commercial course would enable you to become professional in a much shorter time.

## TRANSMITTER LEAD-IN

K. DeClerque, Detroit, Mich.  
 (Q) Is it necessary to have the lead-in of a short-wave antenna tapped at a certain distance from the center as it is in the "Flea Power Transmitter".

(A) It is not necessary to use an antenna of the type shown with the "Flea Power Transmitter." Various other short-wave transmitting antennas have been described from time to time in SHORT WAVE CRAFT magazine. However, the one mentioned above is known as the single feeder Hertz which is a very simple and easily constructed system and works very well in conjunction with low power transmitters.

(Q) Should regular postage stamps be used in writing for verifications from foreign stations.

(A) It is advisable in all cases to use International Postal Coupons.

## SHORT WAVE ADAPTER

Albert Hauska, Chicago, Ill.  
 (Q) I have a broadcast radio which uses a 227 detector. Would you please publish a drawing of a suitable adapter to be used with my receiver in order to receive short wave signals.

(A) We are very pleased to print your diagram. The adapter consists of a single

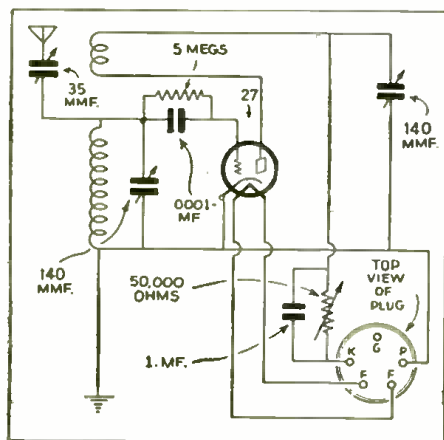

Above, is shown the diagram of a one tube adapter using the type 27 tube. To the right is the drawing of the "3-Tube Electrified Doerle" with modification for potentiometer regeneration control.

## EDITED BY

GEORGE W. SHUART, W2AMN

● Because of the amount of work involved in the drawing of diagrams and the compilation of data, we are forced to charge 25c each for letters that are answered directly through the mail. This fee includes only hand-drawn schematic drawings. We cannot furnish "picture-layouts" or "full-sized" working drawings. Letters not accompanied by 25c will be answered in turn on this page. The 25c remittance may be made in the form of stamps or coin.

Special problems involving considerable research will be quoted upon request. We cannot offer opinions as to the relative merits of commercial instruments.

Correspondents are requested to write or print their names and addresses clearly. Hundreds of letters remain unanswered because of incomplete or illegible addresses.

227 detector tube and its associated apparatus which should be plugged directly into a 27 socket of your receiver. Your 27 tube will then be plugged into the adapter.

## DETECTOR OSCILLATION

Jack Oliver, Tracy, Calif.  
 (Q) I have constructed a 3-tube receiver consisting of a 57, 56 and a 47. In fact it is the Electrified 2-Tube Doerle described in the July issue of SHORT WAVE CRAFT with a 47 added as per instructions in the Question and Answer column in the December issue. It is impossible for me to get the detector to function properly. The audio stages are working O.K.

(A) With type 57 detector it is necessary that the screen grid voltage be maintained at 22 volts or lower. We suggest that you try a potentiometer in this circuit to regulate the screen voltage. We believe your trouble lies in this part of the set.

## THE WYETH ALL WAVE SIX

G. Lindstrom, Malden, Mass.  
 (Q) I would like to construct the Wyeth All Wave Six published in the November issue and would like to use different makes of parts. Please specify the rating on all the parts.  
 (A) All the parts used in the Wyeth All Wave Receiver are specified in the article. We suggest that you choose the necessary substitutes for those you cannot duplicate.

## LEARNING THE CODE

Emile Fournier, Kankakee, Ill.  
 (Q) I am trying to learn the code and would like you to print a circuit of a simple code practice oscillator using a type 30 tube which I can operate in conjunction with my B eliminator.

(A) We are printing a diagram of a simple code practice set, which uses a single type 30 tube and an ordinary audio transformer. This should produce a pleasing signal in the earphones. If no signal can be obtained it is quite possible that the trouble lies in the connection of the primary. Try reversing these two connections.

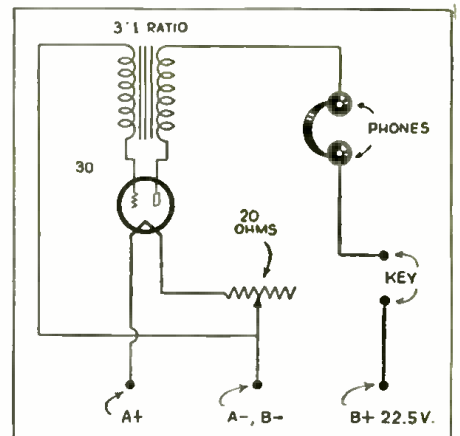

Circuit for simple "code practice" set using a single 30 type tube and an ordinary audio transformer.

## 3-TUBE DOERLE

M. Levy, Brooklyn, N. Y.  
 (Q) Will you kindly publish a circuit of the Doerle A.C. 3-Tube Receiver. I would like to use a potentiometer for regeneration control.

(A) We are reprinting a diagram of the 3-tube Electrified Doerle Signal Gripper with modifications for potentiometer control regeneration. Condenser C can still be left in the circuit as it is quite an aid in fine tuning. If you wish to use a fixed condenser, C, instead of a variable, we suggest a .0001 mf.

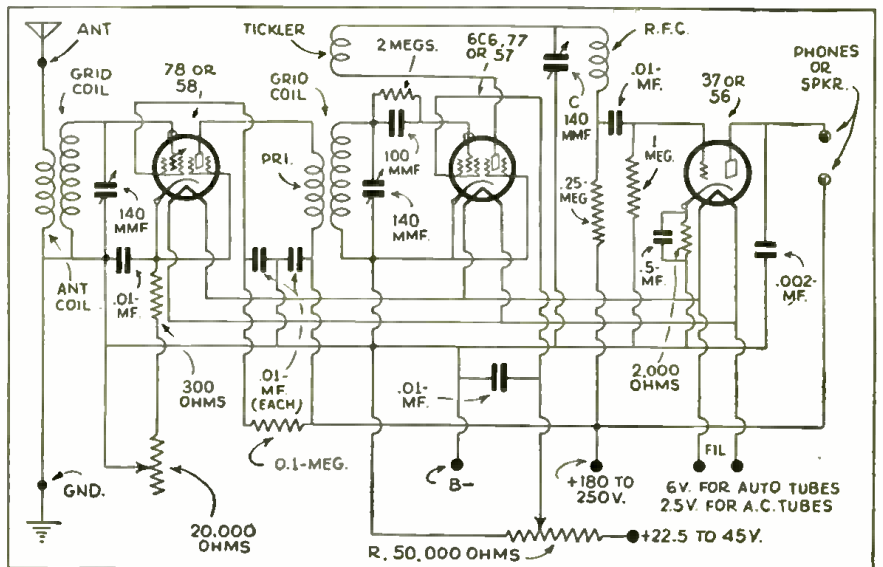

## 5-Tube T.R.F. Receiver

(Continued from page 15)

uses an *electron-coupling* scheme. The tickler coil is in the cathode circuit and not in the plate circuit. This circuit assures great stability. The tickler coil consists of very few turns (1 to 1½) on all coils up to 70 meters; the winding is reversed. This may be done by reversing the leads to the coil or by winding it in an opposite direction to the other windings on the coil. Regeneration control is had by varying the screen voltage on the detector tube through the use of a potentiometer.

The trimmer condensers for the R.F. stages are connected in a *tank circuit* to the extra windings on each coil; in the first stage the winding which is interwound with the grid coil serves this purpose. The aerial is connected to the small winding at the bottom of the coil. In the second R.F. stage the trimmer coil is the small one at the bottom of the coil form. The winding interwound with the grid coil is used to couple

### \$20.00 PRIZE MONTHLY FOR BEST SET

● THE editors offer a \$20.00 monthly prize for the best short-wave receiver submitted. If your set does not receive the monthly prize the editors will pay space rates for any articles accepted and published.

You had better write the "S-W Contest Editor," giving him a short description of the set and diagram, BEFORE SHIPPING THE ACTUAL SET, as it will save time and expense all around. A \$20.00 prize will be paid each month for an article describing the best short-wave receiver, converter, or adapter. Sets should not have more than five tubes and 1-tube sets featuring one of the new "twin-element" tubes are in great demand. Let's see "YOUR" Idea of an Ultra-Modern 1-Tube Set!

Sets must be sent PREPAID and should be CAREFULLY PACKED in a WOODEN box! The closing date for each contest is sixty days preceding date of issue (May 1 for the July issue, etc.) In the event of a "tie" an equal prize will be paid to each contestant so tying.

The judges will be the editors of SHORT WAVE CRAFT, and George Shuart and Clifford E. Denton, who will also serve on the examining board. Their findings will be final.

the plate of the preceding tube to the grid of the second tube.

In constructing the set it will be advisable to mount the tuning condenser assembly on the chassis and connect all the necessary wires to the condensers (leaving the other ends of the wires free; each wire should be about 5 inches long, to allow plenty of leeway), before mounting the shield cans as they will interfere with connecting the condensers if mounted first. The audio system should be left until the rest of the set is finished.

The set has been designed so that it can be used with batteries as well as with a "B" supply unit and filament transformer, with only slight modification. The modifications include elimination of the filament center-tap resistor and the substitution of the G.3 volt heater tubes. As there is no power triode in the G.3 volt series of tubes, it will be necessary to use a pentode in this socket; this will entail the use of another socket to take the place of the four-prong one used for the 45 tube. The voltage divider should be eliminated in the battery model as it consumes considerable current. The necessary changes are shown in the circuit diagram.

### Operation Hints

Viewing the receiver from the front, the controls are from left to right—second R.F. trimmer, regeneration control, main tuning control, antenna trimmer, and last the R.F.

They  
FOUND  
What they  
WANTED!

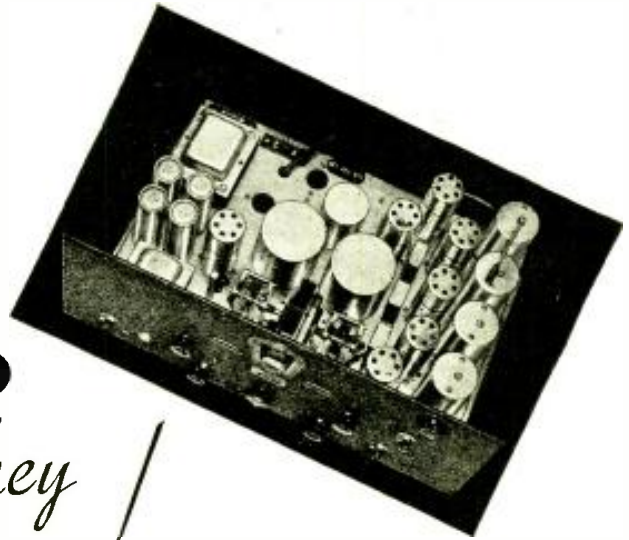

COMET "PRO" chassis with Crystal Filter and A.V.C. Supplied also in metal table cabinet and "Moderne" console.

HUNDREDS of COMET "PRO" Receivers are in daily use. Leading amateurs, professional operators, air transport and steamship lines, broadcasting networks and armies and navies all over the world chose the "PRO" after the most exhaustive tests.

There could be no finer testimonial to the extraordinary sensitivity, selectivity and dependable performance of this really great receiver.

The blindest man is not one who can't see, but one who won't see. If you have even one eye open to your best interests you will want the most efficient receiver that money can buy—and you will want it at the right price. We guarantee that the COMET "PRO" 8-to-550 meter Superheterodyne will satisfy your every requirement or money refunded.

**4 models**

STANDARD  
STANDARD + A.V.C.  
CRYSTAL  
CRYSTAL + A.V.C.

Operating on  
Battery, D.C.  
or A.C. in all  
Voltages and Cycles



### MIDGET R.F. CHOKE

Invaluable where space is at a premium and where economy is a factor. It is so small and light that its tinned copper leads provide ample support in the circuit. And it is so inexpensive that it invites generous use wherever R.F. filtering is desirable.

Five universal-wound pies on Isolantite core. Inductance 2.1 mh. D.C. resistance 35 ohms. Distributed capacity 1 mmf. Length across caps 1½". Diameter ½". Current 125 milliamperes.

### HEAVY-DUTY TRANSMITTER CHOKE

No other transmitter choke gives you more than 500,000 ohms of impedance exactly where wanted—at the 20, 40, 80 and 160-meter amateur bands.

Inductance 2.5 mh. Distributed capacity less than 1.5 mmf. D.C. resistance 8 ohms. Maximum recommended D.C. (continuous) 500 milliamperes. Six universal-wound pies on Isolantite core. Insulated mounting brackets secured by short machine screws. No metal through core. Without brackets, may be mounted with single machine screw. Choke size. 1 3/16" x 2 3/8".

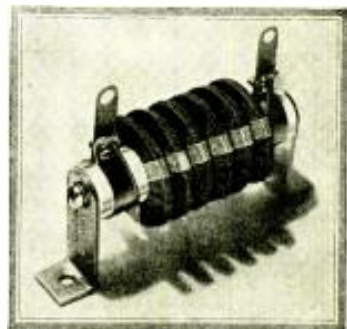

HAMMARLUND MANUFACTURING CO.  
424 W. 33rd St., New York.

—Check here for new booklet describing the COMET "PRO" Receiver.  
—Check here for General Catalog "34" of Chokes and Other Radio Parts.

Name .....

Address .....

SW-5



## NOW! The Most Complete and Up-to-Date Popular Priced Line of S.-W. Coils.

### Check these Features:

1. Most efficient Wire Spacing
2. Colored Grip Rim for Convenience
3. Each Coil Precision Wound
4. Anchored Windings for Permanence
5. Precision Molded for Rigidity
6. Silk Bank Windings on B.C. Coils
7. Plated Wire for Higher Frequencies
8. Adaptable to Selector Mountings.

### NA-ALD INSIDE FACTS

Short wave coils are not just cylinders wound with wire. The new Na-Ald Band Spread Coils are for illustration the concentrated work for a solid week by an engineer. Theory was checked by practice and the results checked with seven other engineers who are spending all of their time designing coils for manufacturers of both long and short wave receivers. This is why the serviceman's expert for one of the largest jobbers in the country tells us that our coils with the smaller wires—the wires correctly spaced for efficiency—out-perform other coils. He knows. Each week he talks with hundreds of set builders who cannot be fooled.

**Now! 705SWB Band Spread Coils** with adjustable band setting condenser mounted on top of each coil. Available for 20, 30, 40 and 50 meter Amateur Bands, and 19, 25, 34 and 49 meter B.C. bands when used with usual 140 or 150 mfd. tuning condenser. List Price \$1.00 per coil

**Now! 705SWS Regular S.W. Coils**, 10-200 meters. Most efficient space windings with plated wire for the higher frequency coils to insure lowest losses possible. Interchangeable with Band Spread coils above when used in a UX socket.

**705SWS set of Four S.W. Coils.** List Price \$2.50 per set.

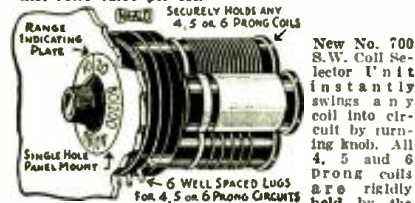
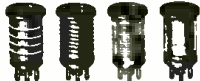

specially constructed sockets without adjustments of any kind. Knob and indicator on face of panel show what coil is in circuit. Simple - compact - rugged - electrically efficient. Don't fail to use it in sets you are building and new equipment you are designing.

**704SWS** Precision wound coils with the convenient gripping-rim for easy insertion and removal from socket. The famous set of four precision wound S-W coils as specified for dozens of receivers described in "S-W Craft," 10-200 meters, with .00014 mfd. condenser. Coils have UX bases. List Price \$3.50

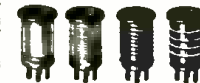

**704BCS** Set of two coils to cover 100 to 550 meters amateur, police and broadcast bands with .00014 mfd. condenser. Precision and bank wound with silk insulator for maximum efficiency. Use the 704BCS to extend the tuning range of any S-W receiver using the 704SWS coils. Coils have UX bases. List price \$2.00 set

**706SWS** Set of four six-prong coils with rel. sec. and tickler windings. Secondaries precision matched with 704SWS secs. for perfect tracking. 10-200 meters with .00014 mfd. condenser. Uses standard six-contact tube socket. List price \$3.50 set.



**706BCS** Set of two coils to cover 100 to 550 meters amateur, police and broadcast with .00014 mfd. condenser. Precision and bank wound with silk insulated wire for maximum efficiency. Use the 706BCS to extend the tuning range of any S-W receiver using the 706SWS coils. Coils have regular six prong bases. List Price \$2.00 set.



**Genuine Maklot Coil Forms** with color-coded easy-grip rings. 1 1/4 in. dia. x 2 in. winding space. Red, Yellow, Green or Blue.

704—4-pin coil form. List 25¢  
705—5-pin coil form. List 25¢  
706—6-pin coil form. List 30¢



### HERE'S THE DATA YOU WANT

Send two 3c stamps for NEW CATALOG-DATA BOOKLET showing socket diagrams of over 265 different tubes, analyzer rewiring data, new tube replacement data, sockets of all kinds, coils, forms, adapters, kits, diagrams for rewiring tube checkers, etc.

**ALDEN PRODUCTS CO.**  
Dept. SW 5 715 Center St. BROCKTON, MASS.

sensitivity control. It will be found that the three tuning condensers can be ganged together with almost equal capacity. It may be necessary to offset one of them a little. This is done by tuning the dial to about 50 and using the 20-40 meter coils, advance the gain control about half-way and then advance the regeneration control till it is just below the oscillation point. Adjust the trimmers for maximum noise level (with the aerial connected). Then loosen the set-screws holding the tuning condenser rotors and rotate each condenser separately. This must be done very slowly; a slight readjustment is all that should be necessary. Adjust for higher noise level. It may be necessary to retard the regeneration control during this process as the set may slip into regeneration as the stages are lined up. After this adjustment has been made the condensers should be locked together again and left alone. It is advisable to mark each of the 3 coils for each wave-band so that the same one will always be placed in the same socket. This is necessary because of small inequalities between the coils and also because the tickler winding of the detector coil has a different number of turns, then the same winding on the other coils.

In tuning the set, turn the gain control half on and adjust the regeneration control so that the set is just oscillating; then turn the dial until a whistle is heard. This procedure is similar to all regenerative receivers, except that sensitivity can be adjusted (and selectivity to some extent) by the R.F. sensitivity control. The trimmers should be adjusted for maximum response with each station; the antenna trimmer is quite critical.

(The editor appends a table below giving coil data for use with a 400 mfd. tuning condenser. You can also use a 100 mfd. condenser without causing any great change in the wavelength response.)

Coil data (National Co.) for use with .00009 mfd. (90 muf.) tuning condenser connected across grid coil.

P.	S.	T.	Wave Length Range in Meters.	
38 T. No. 32	63	T. No. 28	5 T. No. 32	200-115 m
22 T. No. 31	35	T. No. 24	4 T. No. 32	115-65 m
13 T. No. 34	20	T. No. 18	4 T. No. 32	70-40 m
8 T. No. 34	12	T. No. 18	3 T. No. 32	41-23 m
4 T. No. 34	6 1/2	T. No. 18	3 T. No. 32	24-14.5 m
2 T. No. 34	3	T. No. 16	3 T. No. 32	15-9 m

Dia. form 1 1/4", 6 pin.  
T= tickler; S= secondary; coil: P= primary or antenna coil.

### Parts List RESISTORS

- 2 300 ohms, 1 watt, R1. Lynch.

- 2 15,000 ohms, 1/2 watt, R2. Lynch.
- 2 50,000 ohms, 1/2 watt, R3. Lynch.
- 1 10,000 ohms, 1/2 watt, R4. Lynch.
- 2 20,000 ohms, 1/2 watt, R5. Lynch.
- 1 50,000 ohms, 2 watts, R6. Lynch.
- 1 1,500 ohms, 3 watts, R7. Lynch.
- 1 1,250 ohms, wire-wound, 25 watts, R8.
- 1 15,000 ohms, wire-wound, with slider, 25 watts, R9.
- 1 1 megohm. grid leak, 1/2 watt, R10. Lynch.
- 1 30,000 ohms, 1 watt, R11. Lynch.
- 1 75,000 ohms pot. with A.C. switch, P1. Acratist (I.C.A.).
- 1 10,000 ohms pot., tapered, P2. Acratist (I.C.A.).

### CONDENSERS (Fixed)

- 4 .02 mf., 400 v., non-inductive, C2. Polymet.
- 5 .5 mf., 100 v., non-inductive, C3. Polymet.
- 2 .2 mf., 400 v., non-inductive, C4. Polymet.
- 2 10 mf., 50 v., electrolytic, C5. Polymet.
- 1 .00005 mf., mica, C6. Polymet.
- 1 .0001 mf., mica, C7. Polymet.

### MISCELLANEOUS

- 1 Dial, type VND (National).
- 3 R.F. chokes, 2.5 millihenries, Ch. 1. National (I.C.A. Hammarlund).
- 1 R.F. choke, 60-80 millihenries, low-loss, Ch. 2. Hammarlund (I.C.A.).
- 1 3/1 ratio audio transformer, T1.
- 1 Double circuit jack, J1.
- 3 6-prong isolantite tube sockets, National.
- 3 6-prong isolantite special coil sockets, National.
- 1 5-prong tube socket, Na-Ald (I.C.A.).
- 1 4-prong tube socket, Na-Ald (I.C.A.).
- 3 100 mmf. tuning cond., C8. Hammarlund Midline midgets.
- 2 50 mmf. tuning cond. C9. Hammarlund midgets.
- 3 National coil sets. (See article for specifications.)
- 1 S-101 impedance coupler. National.
- 1 4-wire cable.
- 2 tip jacks.

### TUBES

- 2 5S's, V1; V2. R.C.A. (Arco.)
- 1 5V, V3. R.C.A. (Arco.).
- 1 5V, V4. R.C.A. (Arco.).
- 1 4V, V5. R.C.A. (Arco.).
- 1 aluminum chassis, 1 1/2 inches x 12 3/4 inches x 1 3/4 inches. Set of aluminum cans (see drawings). (Chassis and all aluminum parts obtained from Blan.)

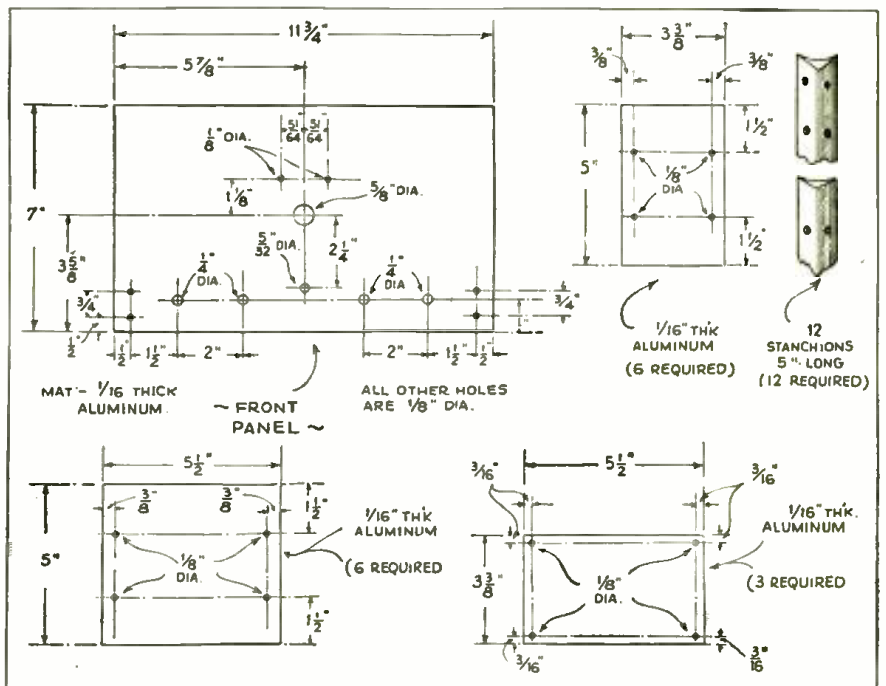

Dimensions of shields for 5-tube T.R.F. receiver.

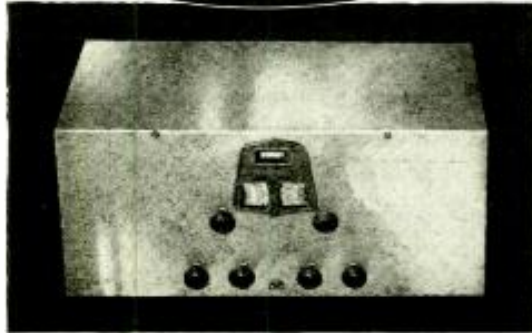
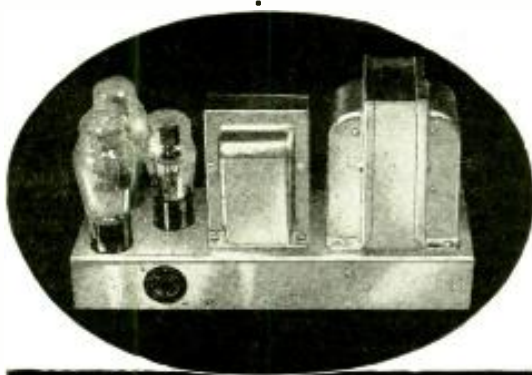

# NEW POWER TUBES

GIVE 17 WATTS UNDISTORTED OUTPUT TO

# MASTERPIECE II



**Admiral Byrd's choice now gains even more distinction thru addition of sensational new audio system.**

Masterpiece II is now equipped with two of the new 2B6 tubes in three stages of Class "A" dual push-pull. This feature, plus a totally new system of tone control even further improves Masterpiece II's already excellent signal to noise ratio...and actually yields tonal possibilities utterly unattainable with any other receiver.

cuit, eliminating all necessity for forcing tubes on even the weakest signals. But now... with the 2B6 power tubes, and the new tone control, Masterpiece II has placed an entirely new meaning upon brilliance and satisfaction in long range reception. Results are unbelievable, until you hear them yourself.

### Greatly Helps 10,000 Mile Reception

Masterpiece II has, since its inception, been noted for extreme clarity on short-wave transoceanic reception... the power resulting from absolute precision in every part and cir-

## 10 DAY TRIAL

Masterpiece II, with its new 2B6 tubes is ready to give you the thrill of a lifetime and to show you, at no risk to you, precisely why Admiral Byrd chose it for 10 to 570 work in the Antarctic. You can order Masterpiece II with the unconditional understanding that it is yours to try for 10 full days... you to be the sole judge... your money back instantly if you want it. My new book tells all about this offer and gives full technical details of the new, improved Masterpiece II.—Send coupon.

**McMurdo Silver, Inc.**  
1747 Belmont Avenue, Chicago, Illinois



McMurdo Silver, Inc., 1747 Belmont Ave., Chicago, U. S. A.

Send me full technical information on Masterpiece II.

Name.....

Street.....

Town..... State.....

## Many Frequencies on One Crystal

(Continued from page 21)

be used as the final amplifier. The "lock" circuit offers great possibilities. so go to it.

### Coil Data

No.	Coil	Turns	Size Wire	Length of winding
No. 1	80M. Xtal	30	18 enam.	2 1/4"
No. 2	80M. 2nd osc.	22	18 enam.	1 1/4"
No. 3	40M. 2nd osc.	13	18 enam.	1 1/4"
No. 4	80N. amp.	22	18 enam.	1 1/4"
No. 5	40M. amp.	19	18 enam.	1 1/4"
No. 6	20M. amp.	8	18 enam.	1 1/4"

\* With added 100 mmf. tuning cond.

### NEUTRALIZING COIL:

- No. 4—11 turns No. 24 enam. close wound
- No. 5—9 turns No. 24 enam. close wound
- No. 6—6 turns No. 24 enam. close wound

### FEED BACK COIL

- No. 2—12 turns No. 24 enam. close wound
  - No. 3—6 turns No. 24 enam. close wound
- All coils wound on standard I.C.A. or Bruno 4-prong ribbed forms. (See drawing for dimensions—page 41.)

### Parts List

- 1 set of plug-in coils—see table; wound on Bruno or I.C.A. 4-prong forms.
- 3 .00025 mf. mica condensers. Polymet.
- 2 .0001 mf. mica condensers. Polymet.
- 1 20 mmf. variable condenser, midget. Hammarlund, National.
- 2 140 mmf. variable condensers, midget. Hammarlund, National.
- 1 100 mmf. variable condenser, midget. Hammarlund, National.
- 1 50 mmf. variable condenser, midget (double-spaced). Hammarlund, National.
- 1 50,000 ohm resistor, 2 watts. Lynch.
- 1 2,000 ohm resistor, 2 watts. Lynch.

- 1 10,000 ohm resistor, 5 watts (wire-wound).
- 1 20 ohm c.t. resistor. R. T. Co. (I.C.A.).
- 5 2.5 R.F. chokes. National (Hammarlund; I.C.A.).
- 3 4-prong isolantite sockets. National (Hammarlund; I.C.A.).
- 1 7-prong isolantite socket, large. National (Hammarlund; I.C.A.).
- 1 5-prong isolantite socket. National (Hammarlund; I.C.A.).
- 1 5-prong isolantite socket, for Xtal. National (Hammarlund; I.C.A.).
- 2 single closed circuit jacks. I.C.A.
- 1 single open circuit jack. I.C.A.
- 2 "Through" stand-off insulators. Birnbach.
- 1 0-100 milliammeter.
- 1 53 tube. R.C.A. Radiotron (Arco.).
- 1 46 tube. R.C.A. Radiotron (Arco.).
- 1 special metal cabinet.
- 1 crystal and holder. Biley Co.

- 1 2 meg. grid-leak. Lynch.
- 1 1 meg. grid-leak. Lynch.
- 1 250,000 ohm resistor. Lynch.
- 1 2,000 ohm resistor. Lynch.
- 1 50,000 ohm variable potentiometer. Acra-test. (I.C.A.).
- 1 2.5 to 5 mh. R.F. choke. National (Hammarlund; I.C.A.).
- 1 5-prong wafer socket. Na-Ald. (I.C.A.).
- 2 6-prong wafer-socket. Na-Ald. (I.C.A.).
- 1 antenna-ground terminal strip. I.C.A.
- 1 phone terminal strip. I.C.A.
- 1 5-wire battery cable. I.C.A.
- 1 57 tube, R.C.A. (Arco.).
- 1 2A5 tube, R.C.A. (Arco.).

## The Doerle Goes "Band-Spread"

(Continued from page 13)

- 1 antenna trimmer (low min. cap.) 35 mmf. max.
- 1 .0001 mf. mica condenser. (Polymet.)
- 1 .01 mf. bypass condenser. I.C.A. (Polymet.)
- 1 .02 mf. bypass condenser. I.C.A. (Polymet.)
- 1 .002 mf. bypass condenser. I.C.A. (Polymet.)
- 1 20 to 25 mf. 25-volt electrolytic condenser. (Polymet.)

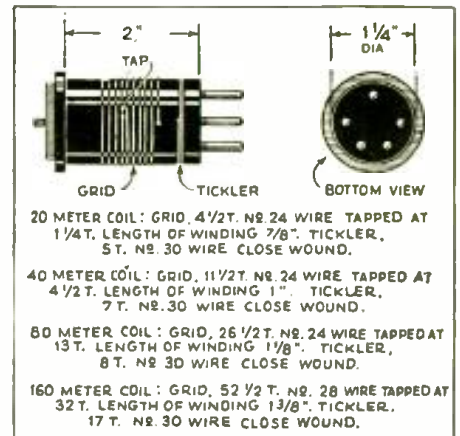

Coil winding data for band-spreading the 2-tube Doerle.





**FREE**

1934 Official Short Wave Radio Manual  
1934 Official Radio Service Manual

FREE WITH ARCO TUBE PURCHASES, you may select a 1934 OFFICIAL SHORT WAVE RADIO MANUAL which sells for \$2.50, with your order amounting to \$8.00

If you prefer you can get FREE, the 1934 OFFICIAL RADIO SERVICE MANUAL which sells for \$3.50 with orders amounting to \$10.00 or both manuals for orders of \$17.00.



**THIS OFFER IS SUBJECT TO WITHDRAWAL WITHOUT NOTICE.**

**Complete Stock Ready for Immediate Shipment**

Order from this page—Remit 20% with order, balance C. O. D. All prices are F. O. B. FACTORY, Newark. Shipments go forward express or parcel post. No order for less than \$3.00 accepted.

Type No.	Fil. Voltage	Your Cost	Type No.	Fil. Voltage	Your Cost
00A	5.0	.40	82	2.5	.85
01A	5.0	.30	83	5.0	.85
1	6.3	.85	84	6.3	.85
10	7.5	1.10	85	6.3	.60
12A	5.0	.40	89	6.5	.60
20	8.3	.40	X199	3.3	.40
22	3.3	.85	Y199	3.3	.40
22A	2.5	.40	2A3	2.5	1.10
26	1.5	.30	2A5	2.5	.85
27	2.5	.30	2A6	2.5	.85
30	2.0	.60	2A7	2.5	1.10
31	2.0	.60	2B6	2.5	1.10
32	2.0	.60	2B7	2.5	1.10
33	2.0	.85	5Z3	5.0	.85
34	2.0	.85	6A4	6.3	1.10
35	2.5	.60	6A7	6.3	1.10
36	6.3	.60	6B7	6.3	1.10
37	6.3	.60	6C6	6.3	.85
38	6.3	.60	6C7	6.3	.85
39	5.3	.60	6D6	6.3	.85
40	5.0	.40	6D7	6.3	.85
41	6.3	.60	6E7	6.3	.85
42	6.3	.60	6F7	6.3	.85
43	25.0	.85	6Y5	6.3	.85
44	6.3	.60	6Z3	6.3	.85
45	2.5	.40	6Z4	6.3	.85
46	2.5	.60	6Z5	6.3	.85
47	2.5	.60	12A5	6.3	.85
48	30.0	1.10	12Z5	6.3	.85
49	2.0	.85	25Z5	25.0	.85
50	7.5	1.10	12Z3	12.6	.85
51	2.5	.60	182B	5.0	.85
53	2.5	.85	183	5.0	.85
55	2.5	.60	401	3.0	1.50
56	2.5	.60	403	3.0	2.00
57	2.5	.60	484	3.0	.85
58	2.5	.60	485	3.0	.85
59	2.5	.60	586	7.5	2.10
71A	5.0	.30	686	3.0	.85
75	6.3	.85	866	2.5	2.75
77	6.3	.85	PZ11	2.5	.85
78	6.3	.85	WD11	1.1	.60
79	6.3	1.10	WD12	1.1	.60
80	5.0	.40	216B	7.5	.85
81	7.5	1.10	213	5.0	.60

**RECTIFIER AND CHARGER BULBS**

125 Mil. rectifier tube B.11. (Raytheon type).....	\$1.25
6-10 Amp. trickle charger Bulb (Tungar type).....	2.00
2 Amp. charger Bulb (Tungar type).....	2.00
5 and 6 Amp. charger Bulb (Tungar type).....	3.75
15 Amp. charger Bulb (Tungar type).....	7.50
UX-280M—5.0 Full Wave Mercury Vapor Rectifier.....	1.10
UX-281M—7.5 Half Wave Mercury Vapor Rectifier.....	1.90
UX-871—2.5 Half Wave Mercury Vapor Rectifier.....	1.10
UX-872—7500 Volts Half Wave Merc. Vap. Rect.....	11.00

**TELEVISION TUBES AND PHOTO ELECTRIC CELLS**

Photo Cell (Potassium), 2 1/2" Length Overall.....	\$1.75
Photo Cell (Potassium), 3 1/2" Length Overall.....	2.10
Photo Cell (Caesium Type), 3 1/2" Length Overall.....	7.90
Photo Cell (Caesium Type), Same as UX 308.....	4.90
Photo Cell (Caesium Type), Same as UX 308.....	5.90
Television Tube (Neon Electron), 1" Sq. Cathode.....	2.85
Television Tube (Neon), 1" Sq. Cathode.....	2.85
Television Tube (Neon), 1 1/2" Sq. Cathode.....	3.85

Specifications and quotations on TRANSMITTER TUBES, CRATER TUBES, GLOW LAMPS, HIGH VACUUM TYPE CATHODE RAY TUBES, suitable for television and standard oscillographic uses, SUBMITTED ON REQUEST.

**ARCO TUBE COMPANY**  
40 Park Place Newark, N. J.

**Radio Beam Guides Aircraft**

(Continued from page 9)

**Aircraft Receiver**

The receiving set used on the aircraft for receiving the landing-beam signals consists of a detector and two stages of audio-frequency amplification. The detector is not tuned, and interference from services working on lower frequencies is greatly decreased by placing a simple high-pass filter between the detector input circuit and the transmission line feeding it. To still further lessen interference from other signals, the output from the receiving set is put through a mechanical filter, tuned to the modulation frequency at the transmitter (60 cycles). Sensitivity of the set may be adjusted by use of a variable condenser which turns the input off to the detector grid.

In designing the receiving set, care was taken to provide constant sensitivity for wide variations in the supply voltages. This is necessary because the voltage of the storage battery, which is the main source of the aircraft's electrical power, may change a great deal during one flight. Quite simple means are used. The same type of receiving tubes as is used in automobiles and which are especially fitted to work on a wide range of filament voltages are used; a series resistor steps down the 12 volts from the storage battery to the necessary average value (6 volts). A dynamotor, available in the plane for use with other receiving equipment, furnishes the high voltage supply which is impressed upon a voltage divider. Correct voltages to the plate and shield-grid of the detector tube and to the plates of the amplifying tubes are provided by taps from the voltage divider. These voltages are set by trial at values giving the least change of amplification for large variances on either side of these values. Effects of variations in

the plate and shield grid voltages of the detector tube are minimized by grid detection.

**Special Lead-in and Aerial Used on Plane**

A twisted pair of insulated wires inside a shield of metal comprise the transmission line used to transfer voltage from the receiving antenna to the receiving set. The shield is grounded at both ends to the metallic part of the plane, and the transmission line is arranged so that the shield is either grounded to all metal parts or insulated from contact. A horizontal copper rod, measuring about one-half wave-length, makes up the antenna. Because the receiving antenna is so close to the plane structure, a reflector is required to reduce alteration of the space characteristics. Receiving antennae were tried at two different locations, one above the wing at the center, the other ahead of the leading edge of the wing near the wing tip. In the first arrangement, the oncoming waves when reflected from the body of the airplane cause the sharpening of the directivity of reception in the vertical plane; the direction of maximum reception was congruous to an angle above the wing surface. The effects of this were an increase in the deflection of the landing-path indicator when the plane made a dive, and a decrease when it climbed. The vertical directivity of reception was greatly reduced by use of a reflector which, placed above and a little behind the antenna, offset the effect of the plane. However, the correct length and position of the reflector had to be fixed by many flight tests. In the second arrangement, the vertical receiving characteristic proved satisfactory. But without the use

(Continued on page 47)

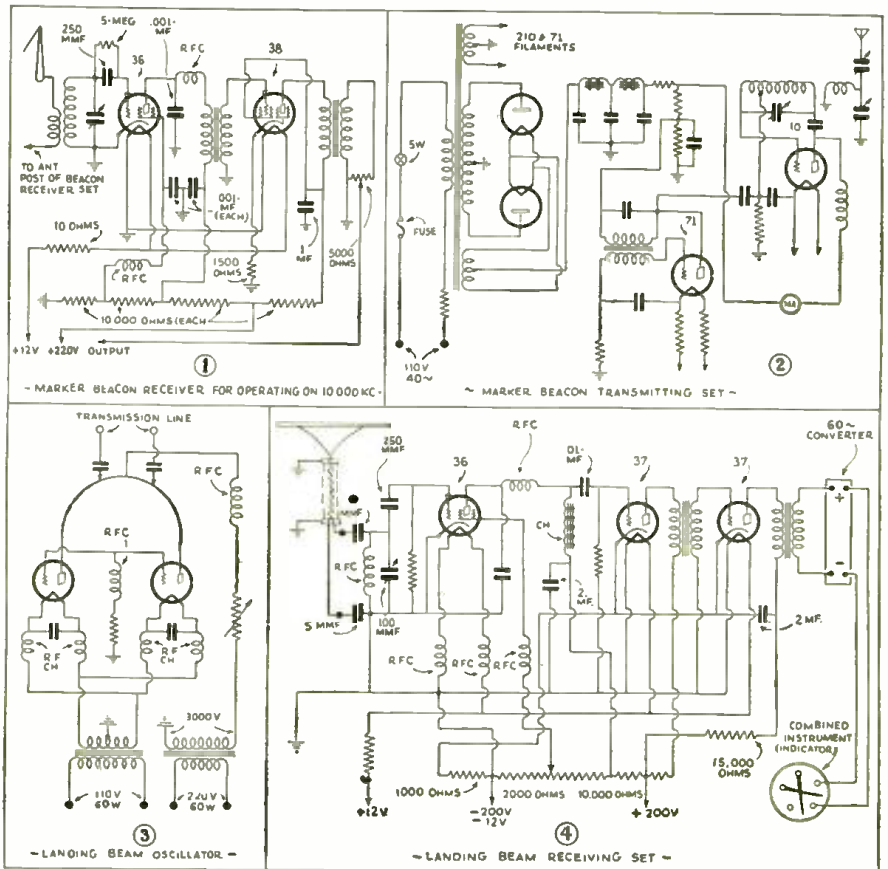

Fig. 1 shows circuit of "marker beacon" receiving set for operation on 10,000 kc. Fig. 2—Circuit of "marker beacon" transmitting set. Fig. 3, circuit arrangement of "landing beam" oscillator. Fig. 4 shows the circuit of the "landing beam" receiving set carried aboard the plane.

## A 6-Tube S-W Superhet

(Continued from page 17)

### Parts List

- 1 drilled and punched base. 3x10x14 inches. Trymo.
- 2 coil shields (for plug-in coils). Trymo.
- 2 sets of plug-in coils (15-200 meters). (Bruno).
- 3 465 kc. int. freq. Hammarlund (National; Gen.-Win.).
- 1 2-gang .00014 mf. condenser.
- 1 2A7 socket. Na-Ald (Hammarlund, National or I.C.A.).
- 2 58 sockets. Na-Ald. (Hammarlund, National or I.C.A.).
- 1 55 socket. Na-Ald. (Hammarlund, National or I.C.A.).
- 1 2A5 socket. Na-Ald. (Hammarlund, National or I.C.A.).
- 1 80 socket. Na-Ald. (Hammarlund, National or I.C.A.).
- 2 coil sockets. Na-Ald. (Hammarlund, National or I.C.A.).
- 4 tube shields. Na-Ald. (Hammarlund, National or I.C.A.).
- 1 large electrostatically shielded power transformer. Trymo.
- 1 8 inch dynamic speaker. 1,800 ohm tapped field. with output to match 2A5 tube.
- 1 500,000 ohm potentiometer and switch volume control.
- 2 8 mf. electrolytic filter condensers (500 volts). Polymet.
- 1 .01 mf. condenser. Polymet.
- 1 .005 mf. condenser. Polymet.
- 1 .0002 mf. condenser. Polymet.
- 6 .1 mf. condensers (400 volts). Polymet.
- 1 R.F. choke (2.5 to 5 M.H.). National (Hammarlund; I.C.A.).
- 1 250 ohm resistor. Lynch.
- 1 1,000 ohm resistor. Lynch.
- 1 20,000 ohm resistor. Lynch.
- 1 30,000 ohm resistor. Lynch.
- 1 100,000 ohm resistor. Lynch.
- 1 500,000 ohm resistor. Lynch.
- 1 750,000 ohm resistor. Lynch.
- 1 6,000 ohm 10 watt resistor. Lynch.
- 1 7,000 ohm, 2 watt resistor. Lynch.
- 1 full vision dial.
- 1 A.C. cable (cord and plug).

# V K 2 M E

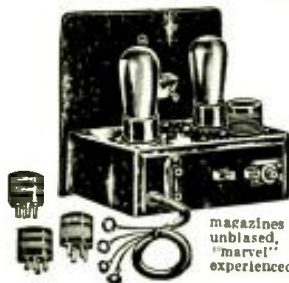

on the speaker!" writes Donald O'Sullivan of Rutherford, N. J. John F. Coleman, 158 W. 81st St., New York City, phones our office and lets us listen to GSB coming in on his set. M. Hausner in Indianapolis writes, "I wired up your excellent kit and had it working in no time. In less than a week I have 'pulled in' 112 stations, 43 of which are distant foreign stations! All were received with remarkable volume and clarity!"

These are only a few of the hundreds of unsolicited letters from delighted purchasers we constantly receive. RESULTS COUNT! That's one of the reasons why we've been actually swamped with orders for our sensational

### 12,500 MILE TWO TUBE RECEIVER

Results that make the novice tingle with delight and which thrill even the hard-boiled "old-timer"! Results that make the editors of leading magazines and newspapers write articles glowing with praise! Results that in unbiased, competitive tests put to shame all other one and two tube "wonder" and "marvel" short wave receivers. Results that seem almost unbelievable, even to experienced short wave engineers!

### The other reason is VALUE!

"How are you able to sell these neat, professional appearing receivers for only \$4.75," we are constantly asked. We answer, "By making only a small margin of profit and letting the sensational VALUE and astounding RESULTS boost our sales into tremendous quantities!"

But, wait! Don't let the low price fool you! It does not mean that we have sacrificed quality! On the contrary, these kits are composed of the finest materials available—HAMMARLUND Condensers—Polymet—large Audio Unit—CBL—Allen-Bradley, etc. All IFF insulation is of genuine Bakelite. The four coils (15 to 200 meters) are wound on polished Bakelite forms. All losses are minimized! The heavy crystal finished metal chassis has all holes drilled and this, together with the clear, plain instruction sheets and diagrams, makes construction a simple matter, even for the most inexperienced!

DRY CELL or AC MODEL— COMPLETE KIT **\$4.75**

### The Ideal Beginner's Set!

## The FULTONE II

### SCREEN GRID POWER PENTODE

A modified version of the well known 12,500 Mile Two Tube which uses a 32 screen grid detector and a 33 power pentode output tube. (Dry cell operation.) This combination results in even more sensitivity and volume! An excellent and time proven Short Wave Receiver. Complete Kit, including coils (15 to 200 meters), heavy, attractive metal chassis and cabinet with hinged cover. **\$5.75** Clear instructions. Set of Matched Tubes \$1.75



### SIMPLEX (General Electric) SOLDERING IRON

Here's a really fine electric soldering iron that will last a life time. 110 Volt AC-DC. A real bargain! Regular selling price \$4.50. **\$1.95** OUR BARGAIN PRICE! "Soldiermaster." An excellent light iron for all radio work. Good element, approved cord, unbreakable plug. Regular Value \$1.50. SPECIAL \$1.25 6 ft. Spool Rosin core solder. \$1.00 Deposit required with all orders.

### ACCESSORIES

GOOD TUBES, carefully tested and fully guaranteed!

201A—30c	230—64c	56—50c
80 —35c	227—35c	53—\$1.06

19 Twinplex—95c  
Imported Lightweight Headphones  
2000 ohm—\$1.05 4000—\$1.45 Supersensitive—\$1.90

### AC POWER PACK

Delivers 2 1/2 volts filament and 250 volts plate supply for any receiver or transmitter using up to 4 tubes. Uses 250 rectifier. Provision for dynamic speaker field. Complete kit including stamped metal chassis and full instructions **\$4.85**

2 1/2 Volt Filament Transformer. .95  
Dry Cells...\$.25 Large 45 Volt B Batteries .95

Neat crackle finished metal cabinet, with hinged lid for the 12,500 Mile kit described above. Protects tubes, coils and wiring from dust and damage. \$1.00 Set of two coils for the 12,500 mile set or Fultone II. Tune 200 to 825 meters. Enables you to hear all the regular Broadcast stations and the long wave ship and press transmissions merely by plugging in these coils. Make your set a real All-Wave Receiver! Set of two coils **\$1.25** We will completely wire and test any of the above kits, when ordered, for \$1.50.

COMPLETE STOCK OF ALL NATIONALLY ADVERTISED PARTS. VISIT OUR NEW SALESROOM!

**HARRISON RADIO CO.** Dept. C-5 New York City  
142 Liberty Street  
★ ★ THE HOME OF FOUR STAR SERVICE ★ ★

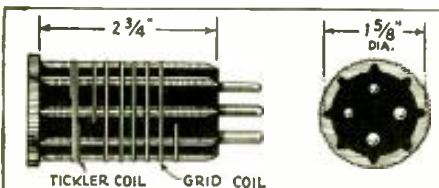

### RANGE OF COILS 15 - 220 METERS

#### -GRID COILS-

- NO.1 7 TURNS NO.18 ENAM. WIRE SPACED OVER 1 1/2"
- NO.2 13 TURNS NO.18 ENAM. WIRE SPACED OVER 1 5/8"
- NO.3 22 TURNS NO.20 ENAM. WIRE SPACED OVER 1 5/8"
- NO.4 45 TURNS NO.28 ENAM. WIRE SPACED OVER 1 1/2"

#### -TICKLER COIL-

- NO.1 6 TURNS NO.28 ENAM. WIRE CLOSE WOUND.
- NO.2 9 TURNS NO.28 ENAM. WIRE CLOSE WOUND.
- NO.3 12 TURNS NO.28 ENAM. WIRE CLOSE WOUND.
- NO.4 20 TURNS NO.28 ENAM. WIRE CLOSE WOUND.

SPACE BETWEEN GRID AND TICKLER COILS 1/8"

Bruno coil data for 6-tube superhet receiver.

See Next Issue for Description of

## "Bob" Herzog's

## 4 - TUBE

## Short-Wave Receiver

## SARGENT 9-33 ALL-WAVE RECEIVER



### Look At These Features:

- Wavelength Range 15-550 Meters
- Double Shift I.F. System
- Sargent Band Spreader, all waves
- Large Tuning Knobs
- Antenna Trimmer
- Tap Switch for changing Wave Bands
- Separate C.W. Oscillator
- Headphone Jack
- Tone Control
- Push-pull 2A5s in output stage
- Rugged, all-steel construction
- Polished aluminum panel
- Complete isolation, all I.F. circuits
- Single-Signal selectivity
- Exceptionally low noise level
- No "Frequency Creep"
- Self-contained Power Pack
- Straight Antenna or Doublet

Send Stamp for Descriptive Circular.

Tubes and Speaker extra. Requires dynamic speaker 1700 or 2500 ohm field wired for push-pull 2A5s, and the following tubes: 1—50, 1—58, 1—58, 1—2A7, 2—2A5s, 3—57s. IMMEDIATE DELIVERY—ORDER YOURS TODAY. **AMATEUR NET PRICE \$69.50**

### Sargent DX Ranger



A high grade, 2-tube regenerative receiver built for the quality buyer and the advanced amateur. For A.C. uses one 57, one 2A5, for D.C. one 77, one 41 tube. Same band spread system as on the Sargent 9-33. Smooth, "non-squawk" regeneration control. High quality, illuminated tuning dials. Humless, 15-200 meter plug-in coils included, broadcast coil 75c extra, amateur net price. Every U. S. district on 75 meter phone, and foreign broadcasts heard from San Francisco. Sold as a kit, with chassis plated, drilled and stamped, panel finished in beautiful crystal-line lacquer, complete instructions and blueprints for assembly and wiring. All screws, hardware, everything you need is furnished.

DX Ranger Kit. **\$12.50**  
Amateur Net Price.....  
DX Ranger, assembled, wired and tested. Amateur Net Price **\$15.75**  
DX Ranger Power Pack, wired, ready for use, 250 volts, 50 mls. **\$7.50**  
Amateur Net Price.....  
Immediate Delivery—Order Yours Today  
DEALERS—WRITE

## E. M. SARGENT CO.

Sold by Dealers Everywhere 2085 Broadway, Dept. S, Oakland, Cal.



# SAVE! BUY NOW!

Prices are going up

## MAYO MICROPHONES

With the prices of materials going higher every day it will soon be necessary for us to advance our prices. Mayo microphones have gone over the top in sales. The radio trade is quick to realize real value at low price, and if it were not for the volume of sales that we have had we could not afford to sell this truly \$25.00 mike for \$5.00.

At  
Your  
Distributor  
or  
Sent  
Postpaid  
on Receipt  
of  
Remittance



**\$5.00**  
NET  
TO THE  
TRADE

**THE MAYO** type "F" is a large, heavy, polished chromium plated, commercial type microphone two button, gold contacts, NEW SPECIAL HEAT TREATED DURALUMINUM DIAPHRAGM, on stretched cushion. Special process long life carbon. Frequency response 30 to 5000 cycles. Size  $2\frac{1}{2} \times 3\frac{1}{2}$ ", weight  $1\frac{1}{4}$  lbs. Furnished either 100 or 200 ohms per button.

If you cannot obtain this microphone from your distributor send us your order. **IF YOU ARE NOT THOROUGHLY SATISFIED RETURN WITHIN FIVE DAYS AND WE WILL REFUND PURCHASE PRICE.**

### MICROPHONE REPAIRS

Repairing microphones is part of our vast service. Our complete equipment and trained engineers insure accurate repairs to any make or type of microphone.

**OUR REPAIR PRICES ARE LOW**

FLOATING DIAPHRAGM FROM.....\$1.00 to \$2.50  
STRETCHED DIAPHRAGM FROM.....\$2.50 to \$4.50  
OTHER PRICES ON REQUEST  
CARBON—Special processed for repacking your own microphone, enough to repair five microphones—50c.

**DISTRIBUTORS—Write for our proposition**

### MAYO MICROPHONES

19 Park Place

New York, N. Y.

## Field Strength Measurements at 5 Meters

(Continued from page 19)

and objects of considerable size, in respect to their location relative to the receiver and transmitter during the measurements. Near buildings, on hills, and in hollows, readings were taken 50 feet apart, while on the level ground the points were more widely spaced, 200 feet separating such points. In that manner the readings were "bunched" where they were of the most value.

To find the intensity at any point the signal from the transmitter was tuned in and the output of the receiver recorded. The controls of the receiver were always adjusted to give maximum output. Then the local oscillator, tuned just a few points from the transmitter signal, was tuned in and the distance between receiver and local oscillator varied until the receiver output was the same from that source as from the transmitter. During that comparison it was absolutely necessary that the regeneration control should not be changed as the receiver sensitivity changes with the changing of that control. The distance between receiver and local oscillator was measured and the reciprocal of the distance was the relative intensity at that point. As was stated at the beginning of the article, no attempt was made to determine the field strength in microvolts per meter. Only one member of the group operated the receiver so that all errors were practically constant throughout the tests. Fig. 6 shows the apparatus set up ready for a measurement.

### Results Obtained

Now for the results of the investigation. Since the data taken would be too long and also uninteresting, the resulting "high points" will be mentioned.

In preliminary tests using a horizontal half-wave antenna, the receiver was placed in an automobile, primarily to determine the approximate range of the transmitter, and it was found that after about 50 yards from the transmitter the signal began to fade in and out at regular intervals of about 40 feet. When the final vertical antenna was erected this phenomenon had almost entirely disappeared.

### Effect of Intervening Hill

As has been found by other experimenters, hills were found to cut off the transmissions. In connection with this effect, however, something additional was found. The degree of slope of a hill seems to be a determining factor for the attenuation of signal strength about that hill. That is, if a hill has a gradual slope the signal attenuation will be slow, but if the slope is much greater, the signal strength will be attenuated more rapidly than in the first case. As examples of this fact the variation of intensities of a few hills will be cited. A hill having a 10 per cent slope caused an average decrease of only 0.075 per 100 feet, while a 15 per cent slope increased the average decrease per 100 feet to 0.31. On a 25 per cent slope the average decay of signal strength per 100 feet had increased to 0.67. On top of an almost perpendicular bank 15 feet high, a loud signal was heard, while at the foot of the bank no signal whatever could be heard.

Earlier in the article mention was made that the transmitted signal tone was not always received. Throughout the investigation it was found that whenever the receiver was taken behind a building, hill, or any fairly large obstruction, the tone of the signal changed entirely. With no intervening objects a clear 1,000-cycle note was heard. But when the conditions just mentioned existed the received note became distorted, sounding like a low frequency buzzer. This effect was found every day of the investigation, so that it could not be blamed on either receiver or transmitter. From this point alone it would

seem that the transmitter and receiver must be in direct sight of each other for "undistorted reception."

Steel structures had the very noticeable effect of absorbing the radio waves. At one place a reinforced bridge about 20 feet long crossed a creek. On the sides of the bridge toward the transmitter high intensity was found, but as soon as the receiver was located on the side of the bridge away from the transmitter no signal came through. At another point the receiver was located between a wire fence and a steel shed used for drying wood. There no signal was heard; but when the receiver was taken to a point only 50 feet from the first point, to be removed from the immediate vicinity of both fence and shed, the signal came in extremely loud. The buildings on the campus also did very well in stopping the radio waves, no signal being heard when the buildings were located between receiver and transmitter.

Other effects noticed were that at short distances from the transmitter trees had little effect on reducing signal strength, while at some distance from the transmitter the signal strength was reduced noticeably, due no doubt to the intervening trees. These effects were found in only a few places where the effect could be due primarily to the trees alone, as at the other places conditions other than trees may have accounted for the decrease in signal strength.

Wire fences at some points had a tendency to kill off the signal, while at other places they offered no hindrance to the radio waves. A wire fence made of poultry fencing seemed to have more effect on killing off the signal than did a fence of the barbed-wire type.

### Effect of Static

During the investigation an excellent opportunity was had to observe the effect of natural static at these wavelengths. A thunder storm had been brewing all morning; no reception was possible on the common short waves. With the 5-meter receiver not a sound of static was heard. Then along in the afternoon the storm arrived. Long streaks of lightning flashed across the sky, the effects of which on radio (broadcast band, 200 to 550 meters) reception are well known. But not a sound of static came through on the 5-meter receiver! From this point alone communication of 5 meters would be a pleasure.

The results of the investigation may be summed up by saying that buildings and hills cut off the propagation of ultra-radio frequency radiations; that the slope of a hill seems to be a determining factor for the attenuation of signal about that hill, the greater the slope the greater the attenuation; that the transmitter and receiver must be in direct sight of each other for undistorted reception, and that there is no interference from natural static on these ultra-short waves.

During the investigation several things were noted that would improve the quality of the measurements. The most important of these would be the using of tube modulation on both transmitter and local oscillator because of the instability of buzzers. A better method of attenuating the signal from the local oscillator would be desirable, preferably one which used a potentiometer arrangement. A different type of receiver should be used because of the regeneration control being so critical, although with great care being taken this type of receiver may be used.

And in conclusion, it is fitting that the aid of Mr. H. A. Moench and Mr. T. A. Hunter, both of the faculty of Rose Polytechnic Institute, be acknowledged, for without their timely suggestions and criticisms during the investigation, the gratifying results would not have been obtained.

**Gould Short Wave Inter-Continental TRF Receivers**

4-Tube Intercontinental T. R. F. A. C. - D. C. All-Electric Short Wave Kit. Complete with metal cabinet, 8 plug-in coils, full blueprints & constr. data, \$21.27  
Factory wired—\$4.00 extra

Parts & diagrams to construct 5 different types of S.W. sets—includes Panel, base board, tuning condenser, antenna condenser, sockets, condensers, resistors, sensitivity control, rheostat, hook-up wire, B. F. choke, knobs, hardware, headphones & one plug-in coil (specify band desired). \$3.95.

SEND FOR NEW FREE CAT. No. 17

**Gould Radio & Television Co. . . .**  
170 Washington St., New York N.Y.

**JUST OFF THE PRESS!**

**Free**

1934 RADIO AND AMPLIFIER CATALOG

HEADQUARTERS for PUBLIC ADDRESS AMPLIFIERS

Deal DIRECT with Manufacturers and SAVE BIG MONEY

**COAST TO COAST RADIO CORP.**  
131-2 WEST 17th ST., NEW YORK, N. Y.



# A Good 14-Tube Receiver

(Continued from page 22)

to the switch. This switch, especially should have the decks spaced well apart. The socket together with cathode resistor and bypass condenser are all sealed up in the copper shield; a cover with holes for ventilation is provided.

The oscillator coils are mounted on the bakelite base in inductive relation to the push-pull detector coil. The socket is secured in the base at an angle, so that the plug-in coil can be inserted from the top and be on about a 45 degree angle. These coils can be loose-coupled or close, but they must be mounted so that they stay where they are put, otherwise the oscillator dial will go off scale.

The oscillator condenser is mounted on a bracket similar to those used for the radio frequency condensers, except that it does not carry a trimmer. (Small auxiliary condenser.) The oscillator condenser is mounted at right angles with the R.F. shaft and a small pulley is attached to it. The oscillator dial is mounted in the center of the panel where a pulley on it will line up with the pulley on the oscillator condenser. I use a good grade of strong fish line for a cable and secure it to the pulley by screwing a large head 6-32 down on it after complete adjustment of the scale is made. A metal cable can make a lot of noise in rubbing against shielding.

The band-spread condenser is 20 mmf. or a midget cut down to three plates and should be about 20 to one ratio over the oscillator condenser. It is of course wired in parallel with the oscillator condenser and is mounted in exact line with the R.F. condensers with a drum dial to operate it, matching the R.F. control.

We find the drum dials work the best. I have the pointer dials on one receiver driving the R.F. gang through spiral gears, but it is not as smooth as the drum dial.

## Shielding and Base

The shielding and base are made of 32 oz. sheet copper. This has been found to be the best high frequency shield. The base is 11½ x 26½ inches with the power-pack mounted underneath, and the channel is made as wide as the core of the transformer is thick.

The I. F. tubes are sunk through the base and wired underneath, the base thus acting as a shield between these and the R.F. tubes.

The frequency conversion tank includes the detectors and is sealed up tight with a removable cover. It is seven inches square and occupies the space at the extreme right of the panel. The sides and back are all one piece and the panel forms the front of the tank.

The radio frequency tank is formed with two sides and one back, the panel also furnishing the front. It is 7 x 19 inches. Partitions may be made to fit between stages, or if you would feel more safe to remain conventional, each of the four tanks can be made separate with separate covers. I have made them this way, and also in two sections, then finally I left the partitions out altogether, and very seldom put the cover on, except to keep the dust out.

## Tuning

The receiver first should always be given about ten minutes warming up, before expecting full service. Find the band with the oscillator on the horizontal scale, bringing the radio frequency dial in resonance with it. Then twist the trimmers until the greatest response is heard in the loud speaker. Select the station with the band spread, and when it is found, twist the trimmers again until the set is in perfect resonance. Again check the band-spread

## AMERICA TURNS TO MIDWEST!



## AMAZING NEW

Super Deluxe

16-TUBE ALL-WAVE RADIO



9 TO 2,000 METERS

33 MEGACYCLES TO 150 KC

WORLD-WIDE RECEPTION

(Less Tubes)

BEFORE you buy any radio, write for big new FREE Midwest catalog . . . Printed in four colors. It has helped thousands of satisfied customers save from 1/2 to 3/4 on their radios by buying direct from the Midwest Laboratories. You, too, can make a positive saving of from 30% to 50% by buying a Midwest 16-Tube Super Deluxe ALL-WAVE radio at sensationally low direct-from-laboratory prices. They bring in broadcasts from stations 10,000 miles and more away . . . and give complete wave length coverage of 9 to 2,000 meters (33 megacycles to 150 KC). These bigger, better, more powerful, clearer toned, super-selective radios have FIVE distinct wave bands: Ultra-short, short, medium, broadcast and long . . . Putting the whole world of radio at your finger tips. Now listen in on all U. S. programs . . . Canadian, police, amateur, commercial, airplane, and ship broadcasts.

**\$59.50**  
NEW LOW PRICE  
WITH NEW DELUXE AUDITORIUM TYPE SPEAKER

Terms AS LOW AS **\$5.00** DOWN

**30 DAYS FREE TRIAL**  
Try this Midwest radio for 30 days before you decide. New four color catalog pictures a complete line of beautiful, artistic consoles and chassis. See for yourself the 40 new 1934 features that insure amazing performance. These features include Automatic Select-to-Band, Amplified Automatic Volume Control, 16 New-Type Tubes, Balanced Unit Superheterodyne Circuit, Automatic Tune Compensation, 29 Tuned Circuits, 7 KC Selectivity, etc. These and many additional features are usually found only in sets selling from \$100 to \$150! Write for FREE catalog.

**DEAL DIRECT WITH LABORATORIES**  
Increasing costs are sure to result in higher radio prices soon! Buy before the big advance. . . NOW! . . . while you can take advantage of Midwest's amazingly low prices. No middlemen's profits to pay. You save from 30% to 50% when you buy direct from Midwest Laboratories—you get 30 days FREE trial . . . as little as \$5 down puts a Midwest radio in your home. Satisfaction guaranteed or your money back. Midwest Radio Corp. (Est. 1920) Dept. 505, Cincinnati, O., U.S.A. Cable Add.: Miraco, ABC 5th Ed.

**FREE 4-COLOR CATALOG**  
**SAVE 30%**

**RUSH THIS COUPON FOR AMAZING 30-DAY FREE TRIAL OFFER AND NEW 1934 CATALOG**

**MIDWEST RADIO CORP.**  
Dept. 505  
Cincinnati, Ohio.

Without obligation on my part send me your new FREE 1934 catalog, and complete details of your liberal 30-day FREE trial offer. This is NOT an order.

Name \_\_\_\_\_  
Address \_\_\_\_\_  
City \_\_\_\_\_ State \_\_\_\_\_

**AGENTS! Make Easy Extra Money**  
Check Here for Details

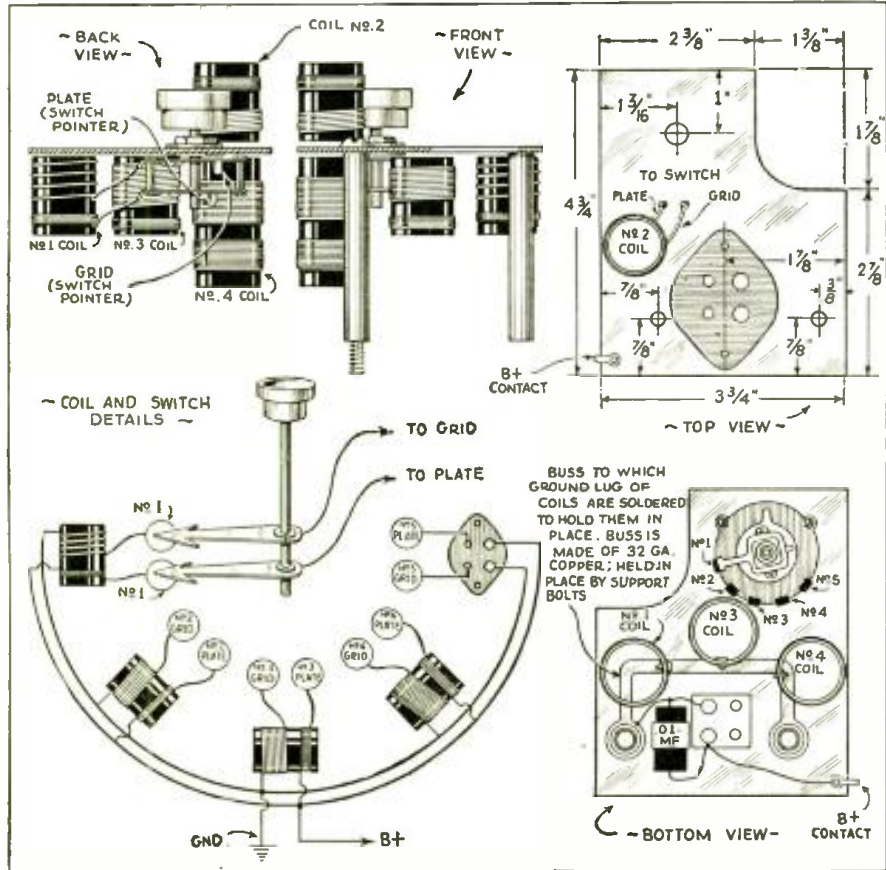

Details of coils and switches, including mounting, for Mr. Andrews' 14-tube superhet.



# RADIO for 1934

NO SERVICEMAN DEALER OR SET BUILDER CAN AFFORD TO BE WITHOUT THIS BOOK

Send for the most valuable book in Radio. Packed with quality and value. Lists the most complete line of radio replacement parts for any service requirement.



Features latest type set-building kits, test instruments, Long and Short Wave Radios, sound Systems, etc.

Write for this Catalog today!

# FREE

## ALLIED RADIO CORP.,

Dept. E, 833 W. Jackson Blvd.  
Chicago, Illinois.  
Please send me FREE your New 1934 Radio Book.

Name \_\_\_\_\_  
Address \_\_\_\_\_  
City \_\_\_\_\_ State \_\_\_\_\_

# Allied Radio

## ACTUAL TROUBLES in Commercial Radio Receivers



by BERTRAM M. FREED the author's nine years' experience, in an executive capacity in the service department of one of the largest radio chains in the country, qualifies him as an authority on all that pertains to radio service and repair. His extensive notes on unusual, but actual troubles repeatedly found in commercial radio sets, as encountered in actual field experience, are concisely described in this 200 page book (includes 45 diagrams). Space does not permit a fuller description, but we will be glad to send you the service data on any one radio free of any charge—or—examine this book at your leisure. Money back within ten days if not satisfied. We pay Postage.

**\$1** POST PAID

10 Days' Free Trial

SERVICEMEN'S PUB. CO.

136C LIBERTY ST., NEW YORK CITY



**Backed by a Good Name**

Admittedly Strong Are the claims made for the TRIMM FEATHERWEIGHT headset. Yet the phone makes good every claim—generously. Try them. Prove it to yourself.

Your favorite "Ham" store can supply you.

TRIMM RADIO MFG. CO.  
1528 Armitage Ave. Chicago, Ill.

to see that the oscillator is beating directly down the middle of the carrier to produce the intermediate frequency. A slight turn to the right or left of the *band-spread* will produce a hiss. That indicates that the side-bands of the carrier are being cut and the pointer should be allowed to rest in the center between hisses. The oscillator scale should not be moved, neither should the radio frequency dial be moved, but make sure at this point that none of the trimmers in the R.F. are cutting a side band. The ARC, or AVC, can now be turned to the right and the I.F. gain may be increased in step with it until a balance is reached and the signal is coming through quietly and smoothly. The receiver will now govern itself for hours on the frequency to which it is tuned.

### Auxiliary Controls

The six controls at the lower center of the panel are numbered in the circle at each potentiometer in the diagram. The first is the ARC or AVC. The second is the control of screen grid current to the R.F. detectors. The third is control of the bias on the R.F. amplifier tubes. The fourth is the control of screen current to the I.F. tubes, and will increase or decrease the gain of this amplifier. The fifth knob is the tone control and six controls the audio frequency output. This is a valuable control for the amateur, as the receiver can be completely shut off without cutting the pick-up operation or disturbing the tuning. Maximum volume in fine graduations to a minimum whisper, can be accomplished with this control without changing sensitivity or tuning.

The first four controls should be set with the receiver in operation, that is, the pointer of the dial to be in a vertical position when number one pointer of the potentiometer is about 20,000 ohms from the AVC supply, and when number two pointer is about 2,000 ohms from the hot side of the potentiometer, number three should be about 400 ohms from ground including the fixed cathode resistors. Number four pointer of the dial should be in a vertical position when the pointer of the potentiometer is furnishing about 10 volts to the I.F. tubes. Then before starting to tune the set, all of these pointers on the dials should be brought to the one position and not changed until the station is tuned in. In other words, the set is "wide open," and if not increase the I.F. gain until it is.

### Intermediate Amplifier Details

The intermediate frequency amplifier transformers must be tuned to perfect resonance and such material must be installed, that will remain on scale at all times. Shielding of these coupling units can be improved. Usually the manufacturers furnish these units with shielding small enough to allow their use in small sets. Here we provide necessary room to insure the greatest efficiency. Remove the coil unit from the shield it comes in and place them in one that allows the ends of the coils to be spaced at least two inches from metal, with the outside diameter of the coil at least one and a half times its radius from the side of the shield.

For this, I use 20 gauge copper tubing, 2½ inches in diameter by 5½ inches long. The top is also copper, spun to size, and removable, to allow tuning of the units after they are completely installed. The fields of the intermediates are comparatively large, and to make sure they are not cut, the unit should be suspended in such a shield.

As a whole, the intermediate amplifier is a very delicate proposition to keep on scale, and can only be held in resonance by the use of nothing but the very best materials. Crystal control of the intermediate is effective, but it will not correct the tuning of the transformers if they become jarred off scale, or if the material upon which the condensers are mounted is such that it will be altered by weather conditions. The frequency shift is either caused by the

oscillator shifting while in operation or a defective I.F. transformer, and a crystal in this part of the circuit cannot adjust either. The crystal here, I believe, acts as a good selectivity "watch-dog," but makes no corrections and gives no aid to amplification.

In lining up the I.F. stages the cathode resistors should all be matched with an ohm-meter or a Wheatstone bridge in order to maintain perfect balance. The lead feeding voltage to the screens from the manual control should be shielded cable. Each tube in this circuit should be provided with four by-pass condensers. I never use twins, preferring a good grade of paper condenser of the pig-tail type. The cathode should be *by-passed immediately at the socket, and the screen the same way.* The grid return should be by-passed immediately to ground, as close to the transformer as possible and the same with the plate return, .1 mf. condensers being used throughout this amplifier, unless otherwise indicated on the diagram.

### Oscillator

In high frequency work, a movement of a plate lead or grid lead *will change frequency*, also a slight movement of the tube shield will shift frequency. A loose condenser will jar the circuit off frequency, etc.

The oscillator plate circuit must be wired correctly to the power supply, so that any fluctuating drain caused in functioning of the other circuits will not "bounce" the oscillator.

Rise and fall in line voltage will have a tendency to change the oscillator setting, if either the power-pack or oscillator tube are forced to operate at a critical peak.

### Power-Pack

In selecting the power transformer make sure that it is designed to furnish its full rated power under a drain of at least 130 milliamperes! 150 milliamperes would be still better.

The secondary should furnish between 400 and 450 volts each side of the center tap.

The 83 mercury vapor type rectifier is used and great care must also be used in selecting the filter condensers and under no circumstances should the filter network be of the condenser input type.

A good choke of between 8 and 16 henrys with not more than 250 ohms D.C. resistance is used in the input of the filter, followed by the best filter condensers, the first being 4 MF. followed by a 1500 ohm speaker field. The output of the filter is an 8 MF. condenser.

In the power tube circuit, each plate should have in series with it a 10 to 20 millihenry choke, radio frequency type.

In the mercury vapor type tube the internal voltage drop is so low that it causes an extremely high peak current drain, and failure is bound to occur unless an input choke is used.

Each unit of the set must take its plate supply individually through its own resistor directly from the power supply. In sets with as much drain as in this one, voltage dividers and tapped resistors surge and saw the voltage up and down as many times per minute as the plate current in the audio amplifier "bounces." How could an oscillator keep steady with a "jumping-jack" like that on the line?

Check milliamperage and voltage in the circuit each side of the resistors, to see if they are large enough to carry the current.

You may use the output of this set as a "driver" for Class B amplification, but if you propose to use Class B to its full limit of efficiency, it should be built in a separate unit *with its own power supply*, and also from this power supply the Class A service in the set can draw its voltage; thus leaving the radio frequency units to function independently smooth.

A separate filament transformer is provided for the radio frequency stages and radio frequency detectors to keep electronic emission at a uniform normal value in these tubes.



**"World" Receiver  
a "Go-Getter"**

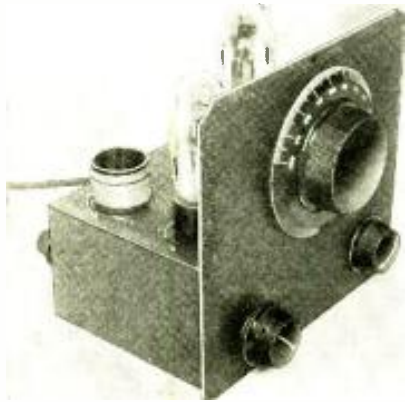

Note the neat appearance of this new 2-tube short-wave receiver. (No. 154.)

● A SIMPLE, strongly built, and fool-proof short-wave receiver of the 2-tube type which is suitable for battery operation is here illustrated. It was designed by the National Radio Distributing Co. The set is finished in black and has a very rich looking appearance. A 45-volt "B" battery is sufficient for normal reception, and in this case both the detector and amplifier B plus terminals are connected together and are fed with 45 volts from the "B" unit. To obtain greater volume, two 45-volt "B" batteries are used so that the amplifier stage can be fed 90 volts. Two ordinary dry cells are commonly used to supply the filament ground, a rheostat serving to cut down the voltage to the required amount. A well-insulated outside aerial of about 45 to 100 feet in length is recommended for use with it. Regeneration control is effected by a throttle condenser in the plate circuit. A capacity controlled regenerative detector is followed by one stage of transformer coupled audio. The coils were wound on standard four-prong tube bases.

The larger three coils have a 1/4 inch space between tickler and grid windings and are not space-wound. The shortest wave coil has a secondary winding of 3 1/2 turns spaced 1/8 inch between turns. The tickler coil is wound 1/8 inch above the secondary and is not space-wound. All coils are wound with No. 28 single cotton covered wire, except the 80-200 meter coil, which is wound with No. 32 single cotton covered wire.

**COIL DATA**

	10-20	20-40	40-80	80-200
Tickler.....	6% T	5% T	5% T	7% T
Grid Coil.....	3% T	6% T	14% T	41% T

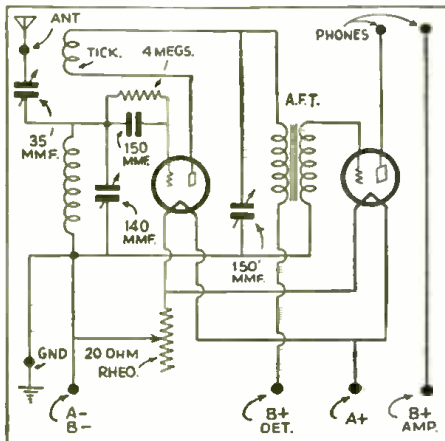

Hook-up of "World" 2-tube battery-operated receiver using two 30 tubes.

ALL RADIO PARTS ARE BACKED WITH OUR UNCONDITIONAL GUARANTEE!

**UNCLE DAVE'S**  
RADIO SHACK

WE SHIP TO ALL PARTS OF THE WORLD

SEND YOUR ORDER IN TO-DAY

356 BROADWAY, ALBANY, N.Y.

**TRANSMITTERS**

- PEERLESS RADIOPHONE TRANSMITTER, complete with microphone, tubes, milliammeter, ready to plug into 110 volt 60 cycle A.C. supply. SPECIAL..... \$36.50
- PEERLESS (CRYSTAL CONTROLLED) TRANSMITTER, with crystal ground to your frequency in 160-meter band..... 41.25
- PEERLESS JUNIOR TRANSMITTER, complete with tubes, power supply, 40-meter coils, wired and tested..... 10.95
- PEERLESS SENIOR TRANSMITTER, complete with heavy power supply, 2-245 tubes, an 83 tube milliammeter, approx. 10 watts output, wired and tested..... 16.25

**ROUND THE WORLD RECEIVERS**  
THE LATEST INNOVATIONS—WITH REMARKABLE RESULTS

	Kit Form.	Wired, Tested and Assembled.
PEERLESS 1-tube Blackhawk.....	\$3.89	\$4.89
PEERLESS 2-tube Junior receiver.....	4.75	6.15
PEERLESS 2-tube Loudspeaker receiver.....	7.95	8.95
PEERLESS 3-tube Professional receiver.....	9.50	10.95
PEERLESS 4-tube AC-DC receiver (new tubes equiv. to 8 ordinary tubes).....	21.50	24.50

Write in for detailed descriptions of above as well as other types of receivers to fit your pocketbook.

Let us also quote you on the latest National and Hammarlund Receivers!

**TUBE SPECIALS**

	Light Duty 30-day Gtd.	Heavy Duty 90-day Gtd.	Extra Heavy Duty 6-month Gtd.	PEERLESS PRECISION PLUG-IN CRYSTAL HOLDER, beautiful job.....
210.....	\$1.35	\$1.35	\$2.10	1.29
866.....	.77	1.65	3.35	PEERLESS WAVEMETER, complete with 20, 40 and 80 meter bandsread coils, special..
250.....	.69	1.35	2.10	6.25
281.....		1.20	1.75	PEERLESS CRYSTAL OVEN, complete with crystal.....
PEERLESS MONITOR, complete with tubes, batteries, etc.....		9.35		8.25
Navy 5-wattors, (G-1162 tubes, WHILE THEY LAST, PER DOZEN.....				5.50
INSULINE SHORT WAVE COILS, PER SET OF FOUR—only.....				\$1.09
CROCKET-WHEELER AEROPLANE GENERATORS, U. S. Army, 275 volts at 60 mills, and 250 volts at 110 mills. Only a few left.....				3.39
XTAL BLANKS.....	\$1.00			WESTON MILLIAMMETERS, all ranges, Model 301, SPECIAL.....
				3.69

WRITE IN FOR OUR NEW HAM CATALOG—JUST OFF THE PRESS!

Foreign Trade Solicited—Long Distance Phone 4-5746 Cable Address: "UNCLEDAVE"

**NOW**

**World-Wide Reception  
on Two Tubes with the new**

**WORLD**



**SHORT WAVE SET**



**\$4.65**

**KIT COMPLETE**  
with 4 plug-in Coils, 10 to 20 meters. Wired and laboratory tested. Read yto use. \$1.25 Extra.

This is a Professionally Designed Set shielded in beautiful crackle finish or cadmium plated metal panel and base. Spot welding is employed on chassis to reduce losses. The set is simplicity itself. A child can assemble place. Two new type "30" tubes are used delivering maximum performance and economy of operation on two dry cell "A" batteries. One 45 volt "B" battery, supplies the required plate voltage. This is the set short wave fans have waited for. Highest grade equipment is used thruout, such as Hammarlund condensers. Pilot audio transformers, etc.

**3 TUBE SHORT WAVE SET**

grams is an excellent set for the whole family. A new type "33" power pentode tube is employed in the last stage of audio amplification incorporating the latest features in circuit design.

**\$6.75**

**KIT COMPLETE**  
With 4 Plus-in Coils. Wired and Laboratory tested. Ready to use, \$1.35 Extra.

**RAYTHEON TUBES Type 30 65c.**

Get a Short Wave Set and thrill with Police Calls, Amateur and Foreign Stations.

**EAR PHONES 95c.**

**HAMMARLUND CONDENSERS 79c.**

**ADVANCE "B" BATTERIES 90c.**

**NATIONAL RADIO DISTRIBUTING CO.**

412 COMMUNIPAW AVENUE 25% Deposit with Mail Order

JERSEY CITY, N. J.



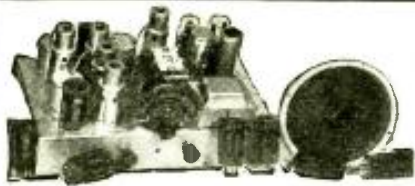

## Foreign Reception Guaranteed

### ON NEW SUPERBA

The circuit is a seven tube superheterodyne, using two plug-in coils for each band, total four bands, or eight coils.

A separate 56 tube is used as oscillator, while the modulator is the most sensitive of them all, a 57. Set uses the new 2A6 tube for high powered automatic volume control. No fading on European stations. Set uses 3 high gain intermediate transformers for extreme sensitivity.

**COMPLETE KIT OF PARTS INCLUDING SEVEN TUBES**  
Cat. SUB-K—Complete kit for the Superba Short-Wave Receiver, including the following Arcturus tubes: One

57, two 58's, one 2A6, one 2A5, one 56 and one 80. All parts absolutely furnished, including coils and speaker diagrams, except only cabinet and front panel.  
Price .....\$29.88

#### THE WIRED MODEL, WITH TUBES

For those who do not desire to wire the set themselves we will wire in our laboratory and carefully adjust and line it up, so that stations the world over will come pouring in.

Cat. SUB-W—Wired model receiver complete with coils, speaker, Arcturus tubes but less cabinet. These wired sets are tested on GSA, England;

### SHORT WAVE SUPER-HET WITH BAND-SPREAD AND A. V. C.

OGD, Germany; EHA, Spain, for good speaker reception before they are passed.

Price .....\$33.62

#### ALL IN A BEAUTIFUL CABINET, READY TO GO

We have also two models of cabinet of the mantel type into which the Superba Short-Wave Receiver can be mounted. One is the Gothic model, with rounded top, the other the Stanton model, with square top. The finish is walnut.

Cat. SUB-WC, wired receiver, complete with tubes, in cabinet (specify which style), all ready to tune in the world .....\$37.37

Cat. CBS. Stanton cabinet only, or Cat. CGTH, Gothic cabinet only .....\$3.75

#### 5 TUBE BAND SPREADER WITH DUAL REGENERATION

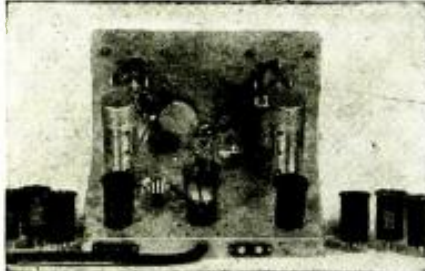

Improved plug-in coils on the new ribbon form. Hammarlund Condensers used. Vernier Dial. Delivery on these sets can be made in 4 days.

The wired and tested model consists of the kit built up at our previous laboratory by expert engineers. The price, less tubes, but including speaker; also coils. **\$23.50**

Complete kit of parts for building both the receiver and the separate power supply, contains everything except tubes and set cabinet. The speaker is included; also coils. **\$19.25**

Five tubes (one 58, one 57, one 56, one 2A5, one 80) at \$3.75 extra.

#### POWER PACK

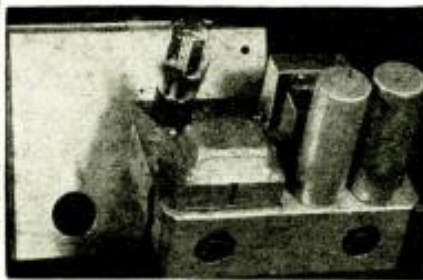

The receiver proper, less the power supply, less speaker, and less tubes. This outfit can be worked with a filament transformer and a B eliminator, and the price of the wired receiver is ..... **\$12.00**

#### SUPERBERETTE

Powerful Short Wave Converter with excellent Bandsread Converter uses 6A7 and 25Z5. With its 4 plug-in coils, covers from 15 to 200 meters. Will operate on A.C. or D.C. Has power supply built in. Merely connect to Antenna post of broadcast set and plug in cable to wall socket. This Converter pulls in police stations all over the country, aircraft reports, foreign broadcast short wave stations, England, France, Germany, Italy, Spain and South America.

#### SUPERBERETTE CONVERTER

Complete kit, including coils, cabinet; less tubes.....\$6.05  
Wired and tested model with coils and cabinet; less tubes.. 6.85  
Kit of Arcturus Tubes (one 6A7, one 25Z5)..... 1.95

35 S. Hooper St., Brooklyn, N. Y.  
Tel. EVergreen 7-0580

**SUPERTONE PRODUCTS CO.**

## FREE TO YOU

WE HAVE prepared a special list in which we have compiled all articles which have appeared in former issues of SHORT WAVE CRAFT. This list fully informs you as to all the important articles which have appeared in SHORT WAVE CRAFT since the beginning.

The greater portion of the back numbers are still available. If you are interested in getting list, send at once three cent stamp for postage and it will be sent immediately.

### SHORT WAVE CRAFT

96 PARK PLACE  
NEW YORK, N. Y.

#### BIG MONEY Assembling

### NEW BOAT IN 3 DAYS

**GIVEN!**

Make big money on each 20 lb. Mead Ki-Yak you easily assemble at home in 3 days from complete "cut-to-fit" Kit \$12.75. F. O. B. Factory (2-Senter \$18.50). Craftsmen. Beworthy! Fast! "irresistible" boat design! RUSH 10c for "irresistible" boat design, Great Money-making Plan and Free 3c Paddle Offer! **MEAD OLSEN** 12 S. Market town—HURON Sept. 7-35 CHICAGO, ILL.

#### PATENTS — TRADE MARKS

All inventions submitted held confidential and given personal attention by members of the firm.

Form "Evidence of Conception" and Instructions

"How to Establish Your Rights"—Free

LANCASTER, ALLWINE & ROMMEL

PATENT LAW OFFICES

435 Bowen Bldg.

Washington, D. C.

## S-W Stations of the World

(Continued from page 35)

WMP	Framingham, Mass.	1666 kc.
WPDA	Tulare, Cal.	2414 kc.
WPDB	Chicago, Ill.	1712 kc.
WPDC	Chicago, Ill.	1712 kc.
WPDD	Chicago, Ill.	1712 kc.
WPDE	Louisville, Ky.	2442 kc.
WPDF	Flint, Mich.	2466 kc.
WPDG	Youngstown, Ohio	2458 kc.
WPDH	Richmond, Ind.	2442 kc.
WPDI	Columbus, Ohio	2430 kc.
WPDK	Milwaukee, Wis.	2450 kc.
WPDL	Lansing, Mich.	2442 kc.
WPDN	Dayton, Ohio	2430 kc.
WPDN	Auburn, N. Y.	2382 kc.
WPDO	Akron, Ohio	2458 kc.
WPDP	Philadelphia, Pa.	2474 kc.
WPDR	Rochester, N. Y.	2382 kc.
WPDS	St. Paul, Minn.	2430 kc.
WPDT	Kokomo, Ind.	2490 kc.
WPDU	Pittsburgh, Pa.	1712 kc.
WPDV	Charlotte, N. C.	2458 kc.
WPDW	Washington, D. C.	2422 kc.
WPDX	Detroit, Mich.	2414 kc.
WPDY	Atlanta, Ga.	2414 kc.
WPDZ	Fort Wayne, Ind.	2490 kc.
WPEA	Syracuse, N. Y.	2382 kc.
WPEB	Grand Rapids, Mich.	2442 kc.
WPEC	Memphis, Tenn.	2466 kc.
WPED	Arlington, Mass.	1712 kc.
WPEE	New York, N. Y.	2450 kc.
WPEF	New York, N. Y.	2450 kc.
WPEG	New York, N. Y.	2450 kc.
WPEH	Somerville, Mass.	1712 kc.
WPEI	E. Providence, R. I.	1712 kc.
WPEK	New Orleans, La.	2430 kc.
WPEL	Middleboro, Mass.	1666 kc.
WPEM	Woonsocket, R. I.	2466 kc.
WPEP	Arlington, Mass.	1712 kc.
WPES	Saginaw, Mich.	2442 kc.
WPET	Lexington, Mass.	1706 kc.
WPEW	Northampton, Mass.	1666 kc.
WPFA	Newton, Mass.	1712 kc.
WPFC	Muskegon, Mich.	2442 kc.
WPFD	Highland Park, Ill.	2430 kc.
WPFE	Reading, Pa.	2442 kc.
WPFG	Jacksonville, Fla.	2442 kc.
WPFH	Baltimore, Md.	2414 kc.
WRFI	Columbus, Ga.	2414 kc.
WRFJ	Hammond, Ind.	1712 kc.
WRFK	Hackensack, N. J.	2430 kc.
WRFI	Gary, Ind.	2470 kc.
WRFM	Birmingham, Ala.	2382 kc.
WRFN	Fairhaven, Mass.	1712 kc.
WRFO	Knoxville, Tenn.	2474 kc.
WRFP	Clarksburgh, W. Va.	2490 kc.
WRFQ	Swathmore, Pa.	2474 kc.
WRFR	Johnson City, Tenn.	2470 kc.
WRFS	Portland, Me.	2422 kc.
WRFV	Pawtucket, R. I.	2466 kc.
WRFX	Palm Beach, Fla.	2442 kc.
WRFZ	Miami, Fla.	2442 kc.
WRGA	Bay City, Mich.	2466 kc.
WRGB	Port Huron, Mich.	2466 kc.
WRGC	S. Schenectady, N. Y.	1658 kc.
WRGD	Rockford, Ill.	2458 kc.
WRGF	Providence, R. I.	1712 kc.
WRGG	Findlay, Ohio	1682 kc.
WRGH	Albany, N. Y.	2414 kc.
WRGI	Portsmouth, Ohio	2430 kc.
WRGJ	Utica, N. Y.	2414 kc.
WRGK	Cranston, R. I.	2466 kc.
WRGL	Binghamton, N. Y.	2442 kc.
WRGN	South Bend, Ind.	2490 kc.
WRGO	Huntington, N. Y.	2490 kc.
WRGS	Mineola, N. Y.	2490 kc.
WRDH	Cleveland, Ohio	2458 kc.
WRDR	Grosse Pt. Village, Mich.	2414 kc.
WRDQ	Toledo, Ohio	2474 kc.
WRDS	E. Lansing, Mich.	1666 kc.

(Continued on page 36)

## Radio Beam Guides Aircraft

(Continued from page 40)

of the reflector, reflection of the oncoming wave from the leading edge of the wing sharpened and distorted the horizontal receiving pattern. This meant that an airplane coming down the landing path at an angle to the runway direction (which is a necessary compensation for wind drift), would receive reduced landing-indicator deflections. A reflector behind the receiving antenna lessened these effects considerably by reducing the response of the antenna to signals from behind.

### "Marker Beacon" Transmitter

The transmitting set used for the marker beacons of this radio landing system is very simple. It is composed of a low-power radio-frequency oscillator, an audio-frequency oscillator providing grid modulation of the radio-frequency oscillator, and a rectifier to permit operation from the 60-cycle supply. A small weather-proofed box encloses and protects the transmitter, and it is completely shielded to prevent direct

radiation. The transmitting antenna of this marker beacon must be suited to several things. For one thing, the radiated pattern from this antenna must be sharply directive upward to form practically a wall of radio signals through which the aircraft passes. Also control of the distance, along the line of flight of the plane over which the signal is heard, must be possible, thus obtaining any desired sharpness of definition of a given boundary line. Marker-beacon service must also be obtainable for any desired distance along the boundary to be defined. The antenna adopted, a long horizontal wire, 2 to 6 feet high and stretched crosswise along the line of flight of the aircraft, meets the above requirements. The amount of power fed to the antenna controls sharpness of definition for a given receiving set sensitivity. By increasing the length of the antenna, service may be rendered over any length of the boundary line.

## 6.5 Inch Waves Span Channel

(Continued from page 8)

hand present a character of absolute secrecy and which are almost unaffected by parasitic electrical disturbances can take place only due to the particular properties of ultra short waves, which bring to mind the properties of light waves. However, it should be remarked that this system is much superior to telegraphy and telephony by light or optical telegraphy, a system which is still used by the Navy. Not only is it possible to foresee from now on a transmission at distances of the order of 100 kms. (60 miles) but the transmissions are also independent of atmospheric conditions, and particularly from the fog.

The use of ultra short waves makes possible an enormous development of the communication network without the danger

of interference between emissions, on account of the extremely high frequency of the corresponding waves. These transmitting and receiving stations are equipped with *teletyping* machines, which enable a very rapid transmission of telegraphic messages; see photo of apparatus room. The same stations can be used also for telephone communication. In order to secure a perfectly constant frequency which is required for a practical development of this system a special study of the transmitting tubes was necessary. The fact that success was achieved, shows well the importance which doubtlessly will be taken in the near future by the systems of radio communication with ultra short waves.

## New 2-Way Police Radio

(Continued from page 7)

at police department headquarters, while the automobiles are equipped with radio-phones. A regular electric light socket supplies the power for the central control, while the mobile units are powered from ordinary automobile storage batteries.

### Station Transmitter Rated at 15 Watts

The station transmitter is a 15-watt affair and the car equipment works on a 2-watt power rating. For antennae, the police cars use a four-foot duraluminum rod fastened across the front bumper. In

preliminary, as well as in official, tests the police sets worked satisfactorily, the engineers say, from within the Posey tunnel tube, under the Oakland estuary, as well as from a sealed copper cylinder hurled into the channel.

The range of the new equipment varies with its height above ground and other factors. At sea-level it works perfectly for ranges up to 18 miles, according to tests. At a height of 40 feet it operates over a 42-mile range. At a height of 5,000 feet, such as attained in an airplane, ranges of 75 miles or more have been attained.

### Talk Exchanged 40 Miles

Working on 8 meters, officers in the cars at Mt. Diablo, 40 miles away, exchanged conversation with Chief Fred Heere at Piedmont. Perfect reception and sending has been possible over the entire area in which they operate, and communication is instantly possible at all times from any part of the City of Piedmont.

### Car Sets Use 7 Ordinary Tubes

Technically, according to Brown, well-known radio engineer and inventor, the sets use special circuits employing seven ordinary tubes of the receiving type, and a very short antenna is used for both sending and receiving. Three-way communication between sets located on a boat, a land station and an airplane have made perfect tests up to 75 miles. Brown claims for his telephone the lack of interference from other sets due to the use of the ultra short waves; the elimination of *blind-spots*, power line or electrical interference, and lack of absorption by metal buildings, small hills or trees. The sets include self-controlled power units.

# —building, testing and repairing all kinds of radio receivers!



THE three volumes of this Library cover the entire field of building, repairing and "trouble-shooting" on modern radio receivers. The Library is up-to-the-minute in every respect and is based on the very latest developments in the design and manufacture of equipment. The rapidly-growing interest in short-wave and television reception is thoroughly covered in a complete section which deals with the construction of this type of apparatus.

## Radio Construction Library

INCLUDING SHORT-WAVE AND TELEVISION RECEIVERS AND AUTO RADIO

By JAMES A. MOYER and JOHN F. WOSTREL

Faculty, University Extension, Massachusetts Department of Education

Three Volumes—1177 Pages, 6x9  
605 Illustrations

**VOLUME I:** presents the fundamental principles of radio so clearly and simply that anyone of average training will be able to read, understand and apply them. It gives actual working drawings and lists of materials for the construction of many typical sets.

**VOLUME II:** Newly revised edition, fully discusses all of the elementary principles of radio construction and repair. An explanation of the necessary steps for "trouble-shooting," repairing, servicing and constructing radio sets successfully. Practical data is also given on auto radio, midset sets, radio-noise meters, automatic volume, tone and static control, etc. This volume includes complete instructions for the construction and operation of short-wave and television receivers.

**VOLUME III:** covers the essential principles underlying the operation of vacuum tubes in a non-technical manner as is consistent with accuracy. It discusses the construction, action, reactivation, testing and use of vacuum tubes; and an interesting section is devoted to remote control of industrial processes, and precision measurements.

### EXAMINE these books for 10 days FREE

This Library is not only a thorough home-study course, but a handy means of reference for the more experienced radio experimenter, repair man, and radio shop-owner. To these men, as well as to those who desire to advance in the radio profession, this offer of a 10 days' Free Examination is made.

Simply clip, fill in, and mail this coupon

McGraw-Hill  
FREE EXAMINATION COUPON

McGraw-Hill Book Company, Inc.,  
330 W. 42nd St., New York.

Gentlemen:—Send me the new RADIO CONSTRUCTION LIBRARY, all charges prepaid, for 10 days' Free Examination. If satisfactory I will send \$1.50 in 10 days, and \$2.00 a month until \$7.50 has been paid. If not wanted I will return the books.

Name .....

Home Address .....

City and State .....

Position .....

Name of Company.....SWC-5-34

(WRITE PLAINLY AND FILL IN ALL LINES)

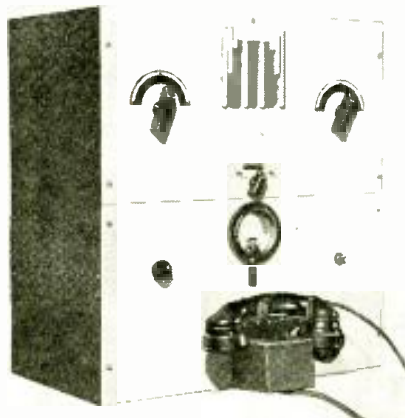

This is the transmitter now in use, which has replaced the original or experimental set.



## Leotone SHORT WAVE A.C.

This new receiver has everything you have ever looked for in a short-wave set. It is newly designed, is compact—a great distance getter—regularly brings in Italy, Spain, Germany, England and many other countries. Know the THRILL of distance—listen in on police calls, air-craft communication. Can be installed in your car or motor boat.



The LEOTONE A.C. Receiver uses the following Arcturus tubes: 58-B.F., 57 detector, 56-1st. A.F. 2A5-2nd. A.F., and 80 Rectifier. Complete Kit with 2 sets of Gen-Win coils (8 coils) and Arcturus Tubes .....\$18.95  
Completely wired and tested with matched kit of Arcturus tubes .....\$21.95

### Special Shielded S. W. Battery Set

Built in same Foundation Kit as above.

Perfect performance assured—this set has a "KICK." Uses the following tubes: 1-30, 1-32, 1-33, 1-34 low current drain tubes. Complete kit of parts with two sets of Gen-Win coils (8 coils) and Arcturus Tubes, \$11.95. Kit completely wired, including Arcturus Tubes, \$14.45.

## LEOTONE RADIO CO.

63 DEY STREET NEW YORK, N. Y.

## Transformer Construction Hints

(Continued from page 30)

With the coil tube in place, two or three wraps of 1/4 inch wide strips of 2-ply gummed Kraft tape are put around the tube ends, to keep the wire from skidding at the ends. This is also done occasionally during the winding process, when necessary. No. 22 enamelled wire is then passed through the wire guide, the enamel scraped, and a brown No. 18 "push-back" lead soldered on. The soldered joint should be small and with no sharp points. A right angle bend is made in the lead and the bend anchored by means of gummed Kraft tape, about an inch inside from the tube end. Extra Kraft tape is placed on the soldered joint; and the coil is then wound, allowing 1/8 to 1/4 inch margins at the coil ends. Quick-drying varnish is applied, sparingly, to each layer of winding.

The secondary leads and winding are handled in the same way, but using red leads with a gray center tap. The filament windings are placed last on the coil and anchored as shown in Fig. 1. As each filament winding is finished, it is covered with Kraft tape which overlaps, so that adjacent filament windings cannot come in direct contact. Varnish is applied to the cloth tape of each anchoring job, to hold permanently. The finished coil is covered with two wraps of gummed Kraft tape and removed from the form.

When the varnish is dry, a final wrap of brown gummed cloth tape is used, to cover the coil and it is ready for laminations. The "E" laminations, which should be of 26 gauge, are placed in the coil two at a time, alternately, from each side. When they are snug in the coil, a few more are added in the outer parts, by separating original pairs of laminations with a thin screw driver, and tapping in the extra laminations with a piece of wood, until no more can be added without bending. The "I" laminations are then inserted to correspond to the "E" laminations. The extra laminations, tapped in, insure against transformer hum. Four metal brackets (two straight ones for the top, and two, cut-out and bent for the bottom) hold the laminations together, and the transformer is completed, Fig. 2.

## "HAM" ADS

Advertisements in this section are inserted at 5c per word to strictly amateurs, or 10c a word (8 words to the line) to manufacturers or dealers for each insertion. Name, initial and address each count as a word. Cash should accompany "Ham" advertisements. Advertising for the June issue should reach us not later than April 5.

NOTICE! LARGE BLUEPRINTS AND COMPLETE constructional data on four different five-meter phone transmitters and transceivers can be had for 85 cents postpaid. Order from ALBERT FREEMAN, South Hanson, Mass.

203A FIFTY WATERS, \$9.75 EACH; NEW, first quality and fully guaranteed; also 211's and 845's. VTE Laboratories, Ridgefield, N. J.

FAST, RUGGED PHOTO-CELLS. LONG LIFE, only \$1.50. Speedy-Sensitive Relay, only \$3.00. Operates at one milliamper, handles one ampere at 110 volts. Suitable Remote Control, Thermal, Photo-Electric Circuits. Send for free instructions hook-ups. PESE SCIENTIFIC PRODUCTS, 4918 13th Ave., Brooklyn, N. Y.

EVER HEAR CP5 of BOLIVIA? EVER TRY Amlies Big 4 DXer? It brings in Europe daily on speaker. We publish them in society bulletin. Secretary, OLIVER AMLIE, 56th City Line Ave., Philadelphia, Pa.

TUBELESS CRYSTAL SET. SOMETHING new. Separates all stations, operates speaker. 1,800 miles verified. Blueprint, 6 others. 25c coin. MODERN RADIOLABS, 151-A Liberty, San Francisco.

QSL's! SWL's! \$50 HUNDRED UP! POSTPAID! Stationery! Free Samples! W9ECI, Clayton, Missouri!

SELL ONE TUBE TWINPLEX COMPLETE. Write DE FOREST ROMAIN, Park Ridge, N. J.

MARINE, BROADCAST, AMATEUR, RADIO-Phone, CW Transmitters. Receivers, Four to Ten Tube. Frequency Meters. Transmitting Power Units, Transformers, Condensers. Complete Stations. Also Long Wave Receivers and Coils. We construct any special apparatus to order. Quotations on request. ENSALL RADIO LABORATORY, 1527 Grandview St., S. E., Warren, Ohio.

TEN PRACTICAL AND INEXPENSIVE changes converting Dodge 12-V, Ford T.A., Chevrolet Delco 6-V generators into 100-500 watt capacity A.C. generators, or into 32-110 volt D.C. motor or generator. Dodge is 500-W. self-excited. All in one book illustrated with complete simplified instructions and drawings for only \$1. AUTOPOWER, 414 S. Hoyne Ave., Chicago.

QSL CARDS, NEAT, ATTRACTIVE. Reasonably priced, samples free. MILLER, Printer, Ambler, Pa.

BARGAINS — RADIOS, SUPPLIES, FREE Price Sheet. Stamp appreciated. GREAT LAKES RADIO, Bay City, Mich.

NEW "DRY CELL" ALL-WAVE RADIO. Coast to coast reception. Costs 10c weekly. 20TH CENTURY CO., S-3083, Kansas City, Mo.

SELL, PUSH-PULL TRANSMITTER, 110 A.C. 250 watt generator for automobile. W9JAJ. Bellevue, Iowa, Route No. 4.

PLUG-IN COILS. WOUND ON BAKELITE four prong forms. 15-210 mtrs. Set of four \$ .50. NOEL, 809 Adler, Scranton, Pa.

FOR SALE—PILOT SUPER WASP WITH Booster Unit and K111 Power pack also. Peerless Signagraph and R.C.A. Key and Peerless Dynamic Speaker. No reasonable offer refused. ARTHUR E. MILLER, Perry, N. Y.

"ATTENTION CANADIAN S.W.L.'s—TWO-tube oscilladene kits, complete coils 15-200 meters. \$10.95; Na-Ald 4 and 5 prong coil forms, 25c; 6 and 7 prong coil forms, 30c; Bud 4 and 5 prong coil forms, 32c; 6 prong, 38c; I.C.A. Midget variable isolantite insulation double bearings 35 mmfd., \$1.12; 50 mmfd., \$1.29; 75 mmfd., \$1.57; 100 mmfd., \$1.77; power transformers from \$2.78 up; 3 in. and 5 in. magnetics, wonderful tone, \$1.85; 5 in. dynamics, 38 output, \$2.25; 6 in. dynamics, 47 output, \$2.95; cased slot wound R.F. chokes, 2.5 to 85 m.h., 45c.; Kurtz Kash 4 in. dials, 65c; 6 in. dials, \$1.25. All merchandise guaranteed satisfactory or money refunded. A. & A. RADIO SERVICE SUPPLY, 101 Queen St., Toronto, Ontario.

## The Editor Talks Before New York Chapter of International S.-W. Club

• THE members of the New York Chapter of the International Short Wave Club were entertained on the evening of February 2 with a talk by Hugo Gernsback, the editor of this magazine, who spoke on the subject of "Short Waves in Europe and U. S. A." Mr. Gernsback compared short-wave activities, especially from the amateur angle, in Europe as compared with those found in America. Many interesting phases of the short-wave situation here and abroad and covering past, present, and future phases were presented to the large membership present. Among other predictions for the future utilization of short waves, Mr. Gernsback stated that special short-wave receivers in the home of tomorrow would permit the printing of a newspaper at night while we are asleep so that you would have the latest news every morning ready to serve with your breakfast.

At the close of the lecture by Mr. Gernsback, a demonstration was given with the new McMurdo Silver Masterpiece II, which created a lot of enthusiasm, short-wave stations from long distances being brought in and heard very distinctly.

In the JUNE Issue!  
A new idea in  
**SHORT-WAVE CONVERTERS**  
By  
**GEORGE W. SHUART, W2AMN**  
Don't Miss It!

## Don't Buy Crystals on Price Alone

Billey Crystals are used by all the leading manufacturers of radio transmitting and receiving equipment . . . broadcasting or amateur. They are with the Byrd Expedition . . . they have been specified on U. S. Government orders . . . they are standard equipment in the National Co.'s FBX-A and AFS-X receivers. Why? . . . because it pays to use the best crystals. And yet Billey's are sold at the lowest prices consistent with highest quality . . . power, precision and performance.

### BLILEY CRYSTALS AND HOLDERS

Type	Mc Band	Supplied	Precision	Furnished	Price
BCX	1.7, 3.5, 7.0	25 Kc*	0.05%	Unmtd.	\$3.90
BC3	1.7, 3.5, 7	25 Kc*	0.03%	Mtd.	4.95
BC3	1.7, 3.5, 7	5 Kc	0.03%	Mtd.	5.75
BC5	1.7, 3.5, 7	0.5 Kc	0.03%	Mtd.	6.85
BC5	100Kc	Exact	0.05%**	Mtd.	9.50
BC2	1.7-3.5Mc. or 7Mc holder for BCX				1.50
BC6	1.7, 3.5 or 7Mc holder-oven for FBX				7.50
SSF	465, 500 or 525Kc S.S. Qtz filter, Mtd.				5.90

\*Or your choice from distributor's stock

\*\*Adjustment by purchaser will greatly reduce this

Billey Crystals are sold at all progressive distributors of amateur equipment, and manufactured under N.R.A.

**BLILEY PIEZO-ELECTRIC CO.**  
236 Union Station Bldg. Erie, Pa.

## BRUNO

### SHORT WAVE COILS

Model "S" coils feature the heavy silvered-ribbon, secondary winding, resulting in highest efficiency and minimum losses.

Model "E" coils are used by thousands. Wound with the finest enamel wire.

Both Model "S" and Model "E" coils are wound on ribbed forms 3 3/4" high and 1 3/4" diameter.

Model "S" coils—Silver wound coils (14-200 meters) Set of 4 .....\$2.94  
Model "E" coils—Enamel wound (14-200 meters) Set of 4 .....\$1.75  
"Junior" coils (14-200 meters) Set of 4.....95c ea.

**TRY-MO RADIO CO., INC.**  
85-B Cortlandt St., New York, N. Y.

## When to Listen In

Conducted by M. HARVEY GERNSBACK

### Moscow, U. S. S. R.

The 25 meter station at Moscow, RNE, now broadcasts on Saturdays from 10:00 to 11:00 p. m. and on Sundays from 6:00 to 7:00 a. m. and 1:00 to 2:00 p. m. This station also frequently tests with American station at Rocky Point, L. I., New York, during the day. Mrs. Edith Burbank of Brattleboro, Vermont, reports hearing them on a Saturday morning from 8:45 to 9:15 a. m.

RW59 on 50 meters is now on daily from 5 to 6 p. m.

### Rio de Janeiro

There has been much argument about the call letters of the station at Rio on 8185 kc. We list it as PSK but the verifications give PRA3. The situation is this: PSK is the call of the commercial station. This station is used by the Radio Club of Brazil to broadcast its programs. These are also broadcast on the broadcast band. The broadcast call is apparently PRA3. As far as the S-W station is concerned it is a "dummy" call for PSK is the real call. The "veris" give PRA3 because they are standard veris of the Radio Club for the long and short-wave station. A somewhat similar situation exists in the U. S., when some stations announce the long wave and S-W calls together as KDKA, W8XK.

### Daventry

The Daventry stations are operating as follows: 12:15-2:15 a. m. on GSB and GSD; 7-8:45 a. m. on GSG and either GSH or GSE; 9-11 a. m. on GSE and GSG or GSF; 11 a. m.-1 p. m. on GSB and GSF or GSE; 1:15-4 on GSB and GSD; 4:00-5:45 p. m. on GSB and GSD; 6-8 p. m. on GSC or GSD; May 12, 11:30 p. m.-1:30 a. m.

### Mixed News

From John Sorensen, Bronx, N. Y. C., comes a report on COC, Havana, Cuba, on about 6010 kc. They broadcast daily from 4-8 p. m. The address is P. O. Box 98, Havana, Cuba. He also sends a report on VE9DN, Drummondville, Que., Can. This station is operated by the Canadian Marconi Co. It transmits on Saturdays at 11:30 p. m. on 6005 kc. This is the same frequency as VE9DR. \* \* \* From J. D. Samkinas of Lawrence, Mass., comes data on station using call YV5BMO now testing on 6070 and 9600 kc. between 5 and 10 p. m. They are located at Maracaibo, Venezuela, S. A.

### Singapore

There is a station at Singapore in the Malay Peninsula. The call letters are ZIII. They identify themselves as Radio Service Co., Malaya. The power is about 75 watts. They operate on 49.9 meters. Address them Radio Service Co., 2 Orchard Road, Singapore, Malaya. Schedule is: Mon., Wed., Thurs. 5:40-8:10 a. m., Sat.: 10:40 p. m.-1:10 a. m.

### W4XB, Miami, Fla.

W4XB at Miami is back on the air again after about a year of silence. It relays the programs of WIOD at Miami. The schedule is unknown but it is frequently on Saturday evening till midnight. It works on 6040 kc.

### OPM

On Thursday, February 22, OPM, at Leopoldville, Belgian Congo, Africa, was heard testing and relaying a memorial program to Brussels in memory of the late King Albert of the Belgians. The transmission was on 10,140 kc. Signal varied from r5-r7. The station was on for about 3 hours and signed off around 5 p. m.

### Station Addresses

Here are some station addresses: RW59 (6,000 kc.), Radio Centrale, Solianka, 12, Moscow, U. S. S. R. RNE (12,000 kc.), Commissariat du Peuple des Communications Postales et Electriques de l'U.S.S.R. 17 Gorki St., Moscow, U. S. S. R. CP5 (6,095 kc.), El Comité Ejecutivo pro Radio, La Paz, Bolivia, S. America. VE9BJ (6,000 kc.), C. A. Munro, Ltd., 16 Shmonds St., St. Johns, New Brunswick, Canada. YQ7LO (6,060 kc.), Imperial & Internatl. Communications, Ltd., P. O. Box 777, Nairobi, Kenya Colony, British East Africa. Sundays Only.

### Seth Parker

The schooner "Seth Parker" now en route around the world will broadcast programs every week from ship-board to the N. B. C. for rebroadcasting purposes. The station on board has been assigned the call KNRA. The power is 1 kw. Transmissions are authorized on any of the following frequencies: 6,660, 6,670, 8,820, 8,840, 13,200, 13,230, 17,600, 17,620 kc. The station has already been heard many times in this country with an R9 signal. (The ship is still in U. S. waters at this time.) It is usually heard around 9-11 p. m. on the 6,600 kc. band.

### Yearly Schedule of VK2ME

Through the kindness of P. M. Farmer of Amalgamated Wireless Ltd., Sydney, Australia, we are able to publish the entire schedule of VK2ME. Sydney, on 31.28 meters.

VK2ME (Sydney) Sundays Only (E.S.T.)		
Jan.	1st	1 a.m.-3 a.m.
	2nd & 3rd	5 a.m.-9 a.m.
	4th	9 a.m.-11 a.m.
Feb.	1st	1 a.m.-3 a.m.
	2nd & 3rd	5 a.m.-9 a.m.
	4th	9 a.m.-11 a.m.
Mar.	1st	1 a.m.-3 a.m.
	2nd & 3rd	5 a.m.-9 a.m.
	4th	9:30 a.m.-11:30 a.m.
April	1st	1 a.m.-3 a.m.
	2nd & 3rd	5 a.m.-9 a.m.
	4th	9:30 a.m.-11:30 a.m.
May	1st	1 a.m.-3 a.m.
	2nd & 3rd	5 a.m.-9 a.m.
	4th	10:30 a.m.-12:30 p.m.
June	1st	Mdt.-2 a.m.
	2nd & 3rd	5 a.m.-9 a.m.
	4th	11:30 a.m.-1:30 p.m.
July	1st	Mdt.-2 a.m.
	2nd & 3rd	4:30 a.m.-8:30 a.m.
	4th	11:30 a.m.-1:30 p.m.
Aug.	1st	Mdt.-2 a.m.
	2nd & 3rd	4:30 a.m.-8:30 a.m.
	4th	10:30 a.m.-12:30 p.m.
Sept.	1st	12:30 a.m.-2:30 a.m.
	2nd & 3rd	4:30 a.m.-6:30 a.m.
	4th	9:30 a.m.-11:30 a.m.
Oct.	1st	12:30 a.m.-2:30 a.m.
	2nd & 3rd	4:30 a.m.-8:30 a.m.
	4th	9:30 a.m.-11:30 a.m.
Nov.	1st	1 a.m.-3 a.m.
	2nd & 3rd	4:30 a.m.-8:30 a.m.
	4th	9 a.m.-11 a.m.
Dec.	1st	1 a.m.-3 a.m.
	2nd & 3rd	5 a.m.-9 a.m.
	4th	9 a.m.-11 a.m.
Wednesday		5 a.m.-6:30 a.m.
Saturday		5 a.m.-7 a.m.



In the Great Shops of

## COYNE

Pay for Your Training in Easy Payments After You Graduate

Don't spend your life slaving away in some dull, hopeless job! Don't be satisfied to work for a mere \$20 or \$30 a week. Let me show you how to make REAL MONEY in RADIO—THE FASTEST-GROWING, BIGGEST MONEY-MAKING GAME ON EARTH!

Jobs Leading to Salaries of \$50 a Week and Up

Jobs as Designer, Inspector and Tester,—as Radio Salesman and in Service and Installation—as Operator or Manager of a Broadcasting Station—as wireless Operator on a Ship or Airplane, as a Talking Picture or Sound Expert—HUNDREDS of Opportunities for fascinating Big Pay Jobs!

10 Weeks' Shop Training AT COYNE IN CHICAGO

We don't teach you from books. We teach you by ACTUAL WORK on a great outlay of Radio, Broadcasting, Television, Talking Picture and Code equipment. And because we cut out useless theory, you get a practical training in 10 weeks.

## TELEVISION Is Now Here!

And TELEVISION is already here! Soon there'll be a demand for TELEVISION EXPERTS! The man who gets in on the ground floor of Television can have dozens of opportunities in this new field! Learn Television at Coyne on the very latest Television equipment.

## Talking Pictures A Big Field

Talking Pictures, and Public Address Systems offer golden opportunities to the Trained Radio Man. Learn at COYNE on actual Talking Picture and Sound Reproduction equipment.

## Pay After Graduation

To a few honest fellows I am offering an opportunity to get a training and pay for it after they graduate in easy monthly payments. You get Free Employment Service for life. And if you need part-time work while at school to help pay expenses, we'll help you get it. Coyne is 33 years old. Coyne Training is tested—You can find out everything absolutely free. JUST MAIL the Coupon for My BIG FREE BOOK.

H. C. LEWIS, President  
Radio Division, Coyne Electrical School  
500 S. Paulina St., Dept. 54-2K Chicago, Ill.

Send me your Big Free Radio Book and all details of your Special Introductory Offer, and how I can pay for my training after I graduate.

Name.....

Address.....

City..... State.....

The  
**VICTOR**  
"Easy-Tune" 2-Tube  
**BAND-SPREADER**  
In the JUNE Issue



By Your Request!

**NORDEN-HAUCK**

"Builders of the Highest Class Radio Apparatus in the World"

— PRESENTS —

**THE NEW  
PRESIDENT  
SUPER-TEN**

Advanced Ten Tube Superheterodyne Circuit. All-Wave—15 to 550 Meters. Latest Type Tubes. Band Switching Arrangement. No Plug-In Coils. Full Vision Dial with Spot Tuning. Rich Natural Tone. Quiet Automatic Volume Control. Very Sensitive. Keenest Selectivity. Consistent Performance.

In more than a decade of supplying the world with high quality radio receivers, Norden-Hauck has never offered such an amazing value. The low price of the President Super-Ten places this receiver within the reach of all.

Complete Literature and Special Introductory Offer Sent On Request.

Our Only Location

**NORDEN-HAUCK RADIO RESEARCH**  
3233 North Stillman Street  
Philadelphia, Penna., U. S. A.

**FREE!**

108 Page RADIO

and  
SHORT WAVE  
TREATISE

Over 100  
Hook-Ups  
More Than  
1,500 Illustrations

A Veritable  
Text Book



NOT JUST ANOTHER CATALOG

This completely revised and enlarged 1934 edition contains 108 solid pages of useful radio information, diagrams, illustrations, radio kinks and real live radio merchandise. It contains more valuable radio information—more real live "meat" than many textbooks on the subject. As usual considerable space has been devoted to the beginner in radio.

**PARTIAL LIST OF CONTENTS**

Chapter Two of "Fundamental Principles of Radio for the Beginner"—The New Tubes, Their Uses, and Their Fundamental Circuits—How to Make Money with Public Address Systems. How to Install and Maintain Them—How to Revamp Six-Volt Battery Sets to Use Two-Volt Tubes—Prize Winning Kinks and Short Cuts in Radio—How to Build the "R T" Regulator's Transmitter—How to Build the Famous Twinplex Short Wave Receiver—How to Construct an Amateur Radio Transmitter—A Most Modern and Complete Tube Chart Including Socket Connections for all Tubes—Numerous Free Offers, etc., etc.

**WRITE TODAY**

Enclose 4 cents for postage. Treatise sent by return mail.

**RADIO TRADING CO.**  
100A Park Place New York City

**S-W Voice of "N.B.C."**

(Continued from page 6)

quality telephone lines. The local station announcements are made within the transmitter building.

The transmitter proper consists essentially of four units, (1) a crystal control exciter unit, (2) a class C modulated power amplifier, (3) a modulator and (4) a 150 kilowatt hot cathode main rectifier. A constant carrier frequency from this transmitter is maintained by means of especially designed piezo electric crystal controlled oscillator units which are a part of the exciter unit. Precision temperature controls of the crystals, as well as ample control of the vacuum tube voltages of these units, keep their fundamental output frequencies constant.

The crystal frequency is stepped up four times in the case of the 6,100 kilocycle transmission and twelve times in the case of the 17,780 kilocycle transmission by harmonic amplifiers. Together with a stepping up of the frequency, the power is also stepped up from a few watts output of the crystal stage to a sufficient amount to drive the modulated power amplifier unit. This exciter unit is shown in figure 1.

The main power amplifier unit, a view of which is shown in figure 2, employs four water-cooled vacuum tubes in a push-pull circuit, the output of which is delivered to the antenna system by means of transmission lines. Modulation of this power amplifier stage is accomplished by the constant current method.

The modulator unit of this transmitter employs twelve water-cooled vacuum tubes which are required to deliver sufficient audio frequency power for modulation of the power amplifier unit. Distilled water in an enclosed water system is used for cooling the water-cooled tubes. Water from an open spray pond located outside of the station building is circulated through a cooler of the enclosed system so as to permit a sufficient amount of heat transfer from the distilled water system and thus permitting a sufficiently low temperature of the distilled water to maintain proper cooling of the water-cooled tubes.

The DC power at high potential required for the modulator and modulated power amplifier is supplied from a main rectifier employing hot cathode mercury vapor rectifier tubes.

Normally the power output from the antenna system on the 17,780 kilocycle frequency is 15 kilowatts while on the 6,100 kilocycle frequency the antenna normally radiates 25 kilowatts. Half-wave radiators are used on both frequencies with a view of securing maximum coverage. These radiators are suspended more than 100 feet above earth which apparently is one of the factors involved in the tremendous world-wide coverage area which this station has.

**Silver Masterpiece II Receivers Carried on Byrd Expedition**

● FOUR of the well-known Silver Masterpiece II all-wave receivers were carried on the Byrd Antarctic Expedition, which fact has been attested to by Professor Mc-Caleb, radio adviser to the Byrd Expedition. These receivers are used by the expedition for reception of broadcast frequencies and for emergency communication service. The Masterpiece II receiver covers a range of from 13 to 570 meters and it incorporates band-spread tuning. The Masterpiece II receiver uses 12 of the newest type high-gain tubes and a special switch is used to change the coil connections for the various wave-bands, thus eliminating all plug-in coil annoyance. Those interested in this receiver will find a complete wiring diagram given on page 542 of the January issue.

**ALL-WAVE AIR SCOUT**

Only Set of Its Kind in the World

Designed by  
**H. G. CISIN,**  
Inventor of the  
Universal A.C.  
D.C. Circuit

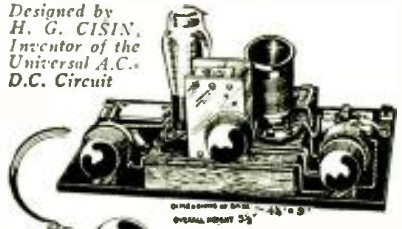

THIS powerful little set brings in all standard broadcast stations and also police calls, foreign stations, code and trans-Atlantic phone conversations. Powered by inexpensive batteries. Available in KIT form. Novel terminal color coding feature eliminates need for wiring diagram. Red is connected to red, black to black, etc., and set is ready to operate. Used by thousands of Boy Scouts. Scout John Stott of Sanford, Me., brought in England, Holland, Germany and South America on this set. Complete Kit with Tube, Earphone, Two Coils.

**NOTHING ELSE TO BUY** except inexpensive batteries..... **POSTPAID \$5.00**  
**COMPLETE KIT LESS EAR- PHONES..... POSTPAID \$4.50**  
**ASSEMBLED, WIRED AND READY TO USE, INCLUDING PHONE..... \$5.95** Postpaid  
**SPECIAL OFFER:** Valuable data on All-Wave Set sent free upon receipt of 10c to cover handling costs.

**ALLIED ENGINEERING INSTITUTE**  
98 Park Place, Dept. SWC, New York, N. Y.

**EXPLORE THE HITHERTO UNEXPLORED LONG WAVES USING YOUR OWN SHORT WAVE SET!**

The new H. B. long wave plug-in coil and its two fixed capacitors will enable you to reach from 150 meters to 1610 or 1710 or even up to 2140 meters according to the size tuning condenser you use in your set. Listen to the ships on 600 or 715 meters and Radio Compass stations on 800 meters. Airliners on 900 and Beacons on 1,000 meters.

**4 prong H. B. Long Wave Coil and 2 capacitors..... \$2.50**

Please mention make of coil and size of condenser used in your set.

**16 Gauge Aluminum Panels**

7 x 10...24c 7 x 12...28c 7 x 14...32c  
These panels are a special lot at the above prices. Longer and wider at correspondingly low prices. Add postage on 1 lb.

We have no catalog. Please do not ask for one.  
**BLAN THE RADIO MAN, INC.**  
177-H Greenwich St. Dept. SW New York, N. Y.

**GET THE NEW "KEY KLIX"**



● Thousands of amateur radio items, at the lowest prices, are contained in this FREE, 132 pages, Big Book, together with many interesting articles by people well known in amateur radio circles.

**AMERICAN SALES COMPANY**

Wholesale Radio Distributors

**S. W., 44 W. 18th St., N. Y., N. Y.**  
The Oldest Amateur Supply House, Est. 1919

**METAL-WORKING**

**LATHE**

New designs and mass production methods make this amazing bargain possible. Complete metal working lathe with compound slide-rest, improved three-jaw chucking device, 6-in. swing, 24-in. overall length, 20 lbs. steel post-card for catalog and 10 day trial offer, or save time and send \$1. balance plus Express (C.O.D.). Wood-turning lathes \$1.50. Extra bed-lengths, 50c per foot. Attachments for milling, grinding, sanding, saw table, etc., available at low prices.

**AMERICAN MACHINE & TOOL Co., New York**  
Dept. F, 200 Broadway

**Be a Television Expert**

**LEARN Radio and Television Broadcast Service, etc.**  
Leaders predict new system television requires thousands relay and broadcasting stations. Ultra-short waves permit 50,000 times as many stations in America alone. Here's opportunity! Get in NOW and "build up" with new industry in new era. Thorough training qualifies for 1st Class Radio-Phone operator license. Real experience at Television Sta. W9XAL. Write for free folder, "Pictures on the Air."  
G. P. - 4 Pres. First National Television, Inc. Dept. B-2, Power & Light Bldg. Kansas City, Mo.



### Station W8DKE Goes "Buggy Riding"

(Continued from page 8)

second 46 which doubles to 14,380, and it in turn feeds the 210 final amplifier. Two well-filtered plate supplies are used. One, employing a 2S3 rectifier, supplies the 47 with 300 volts and each of the 46's with 450 volts. The other, employing a 5Z3 tube, supplies the 210 with 850 volts. Separate filament transformers are used so that the filaments of all six tubes may be kept lighted when the primary circuits of the plate transformers are broken. The plates of the first three tubes are shunt fed. This method is believed to have advantages over series feed, in that the radio frequency plate chokes do the work instead of the grid chokes, and the excitation leads do not have to be broken by blocking condensers. Various methods of providing bias have been tried, with battery bias proving to be the most successful, especially since it is necessary to change the bias when changing bands. Three forty-five volt "B" batteries are used. Keying is done in the center tap of the final amplifier. Due to the bread-board style of layout, it is extremely easy to change from one frequency band to another.

#### S-W Receiver Employed

The receiver is a common type, employing a 58 tube as a screen-grid detector and a 56 as an impedance coupled audio amplifier. Although head phones are usually employed while operating, a speaker may be substituted if desired, and the power-pack which supplies plate and filament voltage for the 210 operating this speaker, also supplies the receiver.

A switch-key on the built-in operating table changes the phones or speaker from receiver to frequency meter, and also completes the A.C. circuit for the power supplies when transmitting.

Although a telegraph key is on the operating table, it is seldom used because it has been found that the "Go-Devil" helps the "fists" of the various operators at low as well as at high speeds.

#### Transposed Lead-in and Doublet Used

The receiving antenna is a 66-foot doublet with transposed lead-in employing the new Lynch transposition blocks and is greatly superior to any type of receiving antenna tried. For transmitting, a 132-foot single wire feed antenna is used at present and works satisfactorily on all three bands.

Although the station is portable, it can be on the air within thirty minutes after reaching a location. A hundred foot flexible cable is carried and is plugged into a convenient electric light line. The jointed antenna pole which is carried inside is easily erected and is used for one end of the transmitting antenna, the other end being fastened to a tree. The receiving doublet can be put up almost any place close to the station, since the length of the transposed lead-in does not affect its efficiency.

Station W8DKE was licensed in 1926, but Mr. Morrow had several stations before that. His first license was issued in 1914, and his 20 years experience in amateur radio has been varied. He has operated both his own and other stations in Cambridge, Mass., and Hartford, Conn., as well as in Springfield, Ohio. In 1922 he owned and operated Station WLAM in Springfield, Ohio, one of the real early "broadcasting" stations in this country. He has had four commercial operator licenses, and now holds an *amateur extra first-class* (Class A) license. Morrow's proficiency in operating is attested to by a CENTURY OF PROGRESS *silver cup* which he won in Chicago in the World's Championship Code Speed Contest.

The trailer not only contains the radio station with its spare parts, work bench and tools, but also comfortable "living quarters."

## Savings on Short Wave Sets New 1934 Performance Low 1934 Prices



ALAN ACE

110v. A.C.-D.C. S.W. (15 to 200 Meters) 3 Tubes—6F7—43—25Z5

Absolutely quiet Built-in Power Supply

Front panel plug-in coils, speaker outlet and field supply; phone jack on front panel; completely shielded in black crackle, hinged cover metal cabinet.

Complete, incl. 4 coils (15-200 m.) less tubes .....\$16.95  
Set Arcturus Tubes..... 3.95  
Complete Kit with Blueprints 13.95  
Broadcast Coll ..... 1.49

ACE and INTERNATIONAL also available for straight A.C. or D.C. 110 or 220, 2 and Gv. battery operation.



Verified World Wide Reception

ALAN PRIZEWINNER

A.C.-D.C. S.W. (15 to 200 Meters)

(Completely self powered, latest type 77-48 and 25Z5 Tubes, Provision for Head Phones and Speaker.

Complete, less tubes, in rich crackle-finish cabinet. Assembled, wired, tested, ready to plug in. Including four coils .....\$12.95

Kit of RCA or Arcturus Tubes to match ..... 3.75

Complete Kit of parts, including 4 coils ..... 10.55

Broadcast Coil for covering 200 to 500 meters ..... .90

220 V. A.C. or D.C. Adapter ..... 1.75

WRITE FOR NEW CATALOGUE



ALAN INTERNATIONAL

Tuned Radio Frequency

110v. A.C.-D.C. S.W. 15-200 meters.

4 tubes: 2-78's, 1-43 and 1-25Z5. Built-in power supply; pair of plug-in coils. Other specifications same as Alan Ace. Complete including 4 pairs of coils, 15-200 m.....\$24.95

Set Arcturus tubes..... 4.95

Complete Kit with Blueprints 21.25

Pair Broadcast Coils..... 2.75

**ALAN RADIO CORP. SPECIALISTS IN SHORT WAVE RECEIVERS**  
83 Cortlandt St. Dept. S-4 New York City



### Behind the POLYMET Trade Mark— QUALITY—SERVICE DEPENDABILITY

Alert experimenters and set-builders follow the practice of all successful manufacturers—they never guess. **THEY KNOW!** The materials used in short-wave equipment must be accurate and thoroughly dependable. Since the early days of amateur set building—and up to the present time—POLYMET Products have been synonymous with the highest standards of quality.

**POLYMET CONDENSERS**  
ELECTROLYTIC—Wet and Dry Types. PAPER—Petite Tubular, Hi-Volt in Cans, Unsealed Sections, Oil Condensers (Transmitting and Industrial uses). MICA—All Types—Midget sizes with lugs or leads. Large type for industrial uses.  
**TRANSFORMERS**  
**WIRE WOUND RESISTORS**



Polymet Petite Condenser

Write for new 1934 catalog "C"

**POLYMET MFG. CORP.**

833C East 134th St., New York, N. Y.



Polymet Electrolytic Condenser

**IT'S NEW! the ADD-A-UNIT**  
**"SHORT WAVE MASTER"**

**A POWERFUL One-Tube All-Wave Set to which you can add AF and RF Stage Units at any time. Each unit complete in itself, but attached together form a multi-tube set.**

**LISTEN** to foreign stations, police calls, amateur calls, code and trans-Atlantic conversations. M. Kramer, N. Y., reports European stations daily. J. Gigante, Brooklyn, logged 53 stations the first day—and many more since.

**THRILL** with the "S-W MASTER" (described in Radio News for April). BUILD it! It's easy. Uses but 6 wires. Unique one-piece metal chassis—all ready drilled—forms shielding panel and cabinet. All quality parts. Economical operation—uses only one 45 volt "B" and two dry cell batteries. Complete kit for one tube "S-W MASTER" with ALL 4 coils (15-200 meters)—List \$8.50; Not \$4.95 price to Experimenters and Dealers.....  
Wired and ready to use—List \$10.00—Not \$5.95  
Tube Type 30 \$ .70. Headphone \$ .75

**ADD-A-UNITS**  
Complete AF Kit—List \$4.25.....Net \$2.50  
Complete RF Kit—List \$2.50.....Net 1.50  
A.F. Tube '33.....\$1.14 R.F. Tube '34.....\$1.16

Order Direct from  
**AMPEX INSTRUMENT LABORATORIES, INC.**  
Designers of Radio Apparatus Since 1915  
240 WEST 23rd ST. Dept. C-5 NEW YORK

**FASTEST WAY TO LEARN CODE**

Easy • Fascinating  
**LEARN BY EAR**  
to Be a Good Op!

The New MASTER TELEPLEX Code Teaching Machine is exactly what thousands are looking for. Has taught code to more operators in past 10 years than all other "systems" combined. No experience needed. Ideal for beginners—steps up w.p.m. for all ops. Teleplex doesn't merely "show" you code—it IS code! You actually HEAR the dots and dashes, any speed you want. You learn code the way you'll be using it—by SOUND! Teleplex also sends back to you; impossible with any other system. Complete Code Course included; no extra charge. Used by U. S. Army, Navy, R. C. A., A. T. & T. Co., and others. Low cost, easy terms. Money-Back-Guarantee. Send now for booklet S-17; no obligation. Postcard will do.

**TELEPLEX COMPANY**  
76 Cortlandt St. New York, N. Y.

**PHOTOELECTRIC CELL**

25c WILL BUY THIS SIMPLE, EFFICIENT ELECTRIC EYE

A Photocell That Will Operate Anything, By Electricity. For Experimenters, Inventors, Electrical Men, etc. 100% of the Experimental Current 210

**GUARANTEED TO OPERATE PERFECTLY**  
Add 15c for our new, complete book on TELEVISION  
**MODERN TELEVISION CO., Dept. 10, Hartland, Wis.**



## SLIDE RULES . .

Midget 5 in 1 Circular Type:

Metal 4" Dia.  
Price \$1.50  
Case 50c extra



$1.23^2 = ? \sqrt{50.41} = ?$   
 $1.24^2 = ?$   
 $\tan 8^{\circ} 5' = ?$   
 $\cot 79 \frac{1}{2}^{\circ} = ?$   
 $4 \frac{3}{4} \times \frac{1}{2} = ?$   
 $\log 56.25 = ?$   
 $6\% \text{ of } 145.9 = ?$   
 $5.16 - \frac{1}{2} + 1.78 = ?$

Solve easily all these and dozens of other mathematical problems without pencil and paper—by means of the Midget Slide Rule. This rule solves any problem in multiplication, division, addition, subtraction, and proportion. It also gives roots and powers of numbers. The "Tri" scales give the sines, cosines, tangents and cotangents of all angles; also logs of numbers. Adds and subtracts fractions. Approved by colleges.

10" Dia., 27" Scale Special Rule. \$3.75.

**RADIO Slide Rule—Short Wave Type**  
Price 75 cents

Printed on white bristol board: Size 8 1/4" x 11". Every short wave and radio student must have this induction, capacity, and "coil-dimension" slide rule. It will answer such questions as: What is inductance of coil one inch in diameter, winding two inches long and having 30 turns per inch? What winding length of No. 24 S. C. C. wire must be put on a form two inches in diameter, to obtain an inductance of 100 microhenries? To what frequency and wavelength will 35 microhenry coil tune with a 50 mmf. condenser?



DATAPRINT CO., Box 322, Ramsey, N. J.

## Health Ray Carbon

**Lamp**  
PAYS FOR ITSELF IN A FEW TREATMENTS.



Table Model

Everyone in the family needs the health giving Violet Rays.

Send for interesting literature Free. List Price with Screen and Goggles, \$10.00.

YOUR COST—F. O. B., N. Y. \$3.38  
**Gold Shield Products Co.**  
98 PARK PLACE NEW YORK



In three to seven months we train you in secure amateur, commercial telegraph second-class, and radiotelephone first-class government licenses. We teach RCA Institutes, Inc. texts. When you secure license, you receive practical experience in studio and microphone technique in our own broadcast studios, and operating experience on a 1000-Watt W. E. Commercial Broadcast station. The lowest priced THOROUGH Radio engineering course in America.

**PORT ARTHUR COLLEGE**

Port Arthur (world-known port), Texas  
RETURN COUPON FOR DETAILS

Name .....  
Street or Box .....  
City and State .....

## W2XAF'S Directive Aerial Gives Gain of 20

(Continued from page 11)

transmission to radiating wires.

The horizontal antenna was developed following years of research along lines suggested by Dr. Alexander, consulting engineer and radio expert of the General Electric Company. The effectiveness and carrying power of horizontally polarized radiation were discovered by Dr. Alexander in 1924. When transmitting with horizontally polarized waves the so-called ground-wave is quickly absorbed, leaving only the high-angle radiation which in its carrying power appears superior to the vertically polarized wave. With the horizontally polarized system it is possible to shoot most of the energy into the air and, with the reflector, to direct the greater part of this energy in any desired direction instead of dissipating it in every direction over a comparatively small area.

W2XAF operates on a wavelength of 31.48 meters or 9,530 kilocycles. The American public is afforded an opportunity of listening in to these programs to the Byrd expedition through cooperation of the National Broadcasting Company, which broadcasts them over a chain of 51 stations associated with the WEAF or red network. The broadcasts take place every other Sunday night from 11 to 11:30 o'clock, E.S.T., the programs being arranged and sponsored by prominent newspapers all over the country.

Immediately at the close of the popular programs, or at 11:30 o'clock, the long wave station continues with its radio mail bag. This consists of the reading of letters and messages from relatives and friends of the men on the expedition. It is the only mail they receive, now that they are cut off from all civilization, and the 75 or 100 letters read to them at the conclusion of each program by short wave are eagerly awaited. These letters are read from the studios of WGY in Schenectady.

## 152 Miles on 600,000,000 Megacycles

(Continued from page 11)

structed by the beginner. The frequency is so "doggoned" high that the Federal Radio Commission could not conceive it and therefore did not make provisions for "regulation". This means that it is absolutely unnecessary to acquire a "government license" in order to operate this type of equipment. Also, it would be little use for government regulation on frequencies as high as this, because of the extreme directional effects of the wave and of the fact that there is room in the spectrum for trillions, nay quadrillions, sextillions, of transmitters of this type. The wiring diagrams are so explicit that it is unnecessary for us to go into constructional rhapsodies on them at this time. However, we might say for those wishing to operate short-wave transmitters over shorter distances on the same principle here described would do well as a starter to purchase a good powerful flashlight! APRIL FOOL! That's one on you!

(All joking aside though the U. S. Dept. referred to actually picked up a light signal from a 6 volt battery lamp over a distance of about 152 miles in the clear air of California. The light flash was seen with a telescope, the signalling and the receiving stations having been located on mountain tops, and the test was made at night.—Editor.)

## EVERY SET BUILDER MUST HAVE THIS BOOK

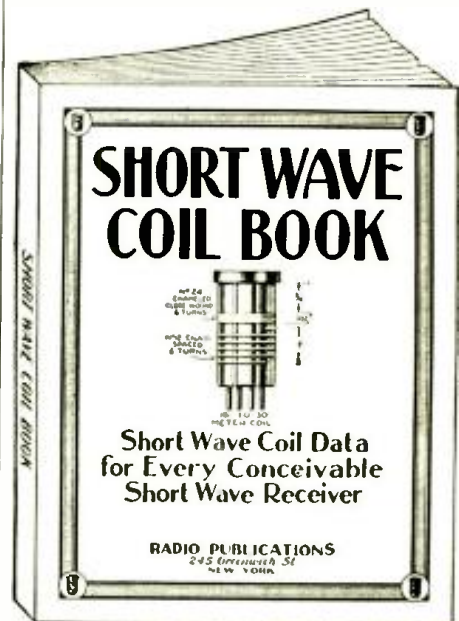

FOR the first time, it is now possible for the experimenter and short wave enthusiast to obtain the most exhaustive data on short wave coil winding information that has ever appeared in print.

As every experimenter who has ever tried to build a short wave set knows only too well by experience, the difference between a good and a poor receiver is usually found in the short wave coils. Very often you have to hunt through copies of magazines, books, etc., to find the information you require. The present data has been gotten up to obviate all these difficulties.

Between the two covers of this book you now find every possible bit of information on coil winding that has appeared in print during the past two years. Only the most modern "dope" has been published here.

No duplication. Illustrations galore, giving not only full instructions how to wind coils, but dimensions, sizes of wire, curves, how to plot them, by means of which any coil for any particular short wave set can be figured in advance, as to number of turns, size of wire, spacing, etc.

There has never been such data published in such easy accessible form as this.

Take advantage of the special offer we are making today, as due to increasing costs, there is no question that the price will increase soon.

**RADIO PUBLICATIONS**  
245 Greenwich Street  
NEW YORK, N. Y.



Radio Publications,  
245 Greenwich Street,  
New York, N. Y.

5-31

Please send immediately, your Short Wave Coil Book, for which I enclose 25c herewith (coin, U. S. stamps or money order acceptable). Book is to be sent prepaid to me.

Name.....

Address.....

City and State.....

In June Issue!  
**THE COMPLETE  
 GRAND LIST**  
 of  
**"Short-Wave Stations of the  
 World"**

Will appear with Latest  
 Corrections

**5 and 10 Meter  
 Transceiver**

(Continued from page 28)

the wires being spaced approximately 1 inch apart. The two metal antenna rods measure 46 inches in length and are made of brass, the rods measuring  $\frac{3}{8}$ " in diameter. The designers recommend the brass rod antenna used in a vertical position as being highly efficient for both 5 meter transmission and reception. For those desiring them, there are also available telescoping adjustable antenna rods.

In operating this transceiver the switch on the front panel is turned to the left to "transmit", the transmitting wavelength being varied by the central tuning knob. The switch is turned to the right for "receiving."

**VEST POCKET  
 SOLDERING IRON**



Smallest good iron now on the market. Will do the work of irons twice its size. Only 10 inches long,  $\frac{1}{2}$  inch in diameter. By using the highest grade elements, it heats up in half the time of ordinary irons. Guaranteed to give satisfaction or money back. We issue no catalog on this item.

Enclose \$1.20 and iron will be sent post-paid in U. S. 10c extra in Canada.

**GOLD SHIELD PRODUCTS CO.**  
 112 Chambers St., S.W., New York

**SEE THE NEW  
 4-TUBE  
 ALL-WAVE  
 IN THE**

**REMARKABLE  
 New CATALOG  
 OF SENSATIONAL  
 RADIO VALUES BY  
 FORDSON**

It operates on any current, anywhere—home, car, boat, farm, etc. Only in our new catalog is this set available and completely described. Try it for 30 days FREE. Get this catalog of Fordson guaranteed Radios at rock-bottom prices. Many models: AC-100; dual wave; all-wave; 6 and 32 volt; approved Air Cell battery sets; consoles. Wonderful new 6-Tube Auto Radio! Thousands of enthusiastic owners. All new—est features. Sets from.....

**ANY SET  
 30-DAY  
 FREE  
 TRIAL**

**\$9.45  
 UP**

**FREE** Send today! New catalog sent free. Shows what you want in radio at amazingly low prices. Deal Direct and save up to 50%.

**MAKE MONEY**—our agents without previous experience make real money selling Fordson guaranteed Radios. Free samples. Write.



**FORDSON RADIO, INC.,** Dept. 5-37  
 Robt. Oakman Bldg., Detroit, Mich.  
 Send me free catalog and agents proposition. (This is not an order.)

NAME .....  
 ADDRESS .....

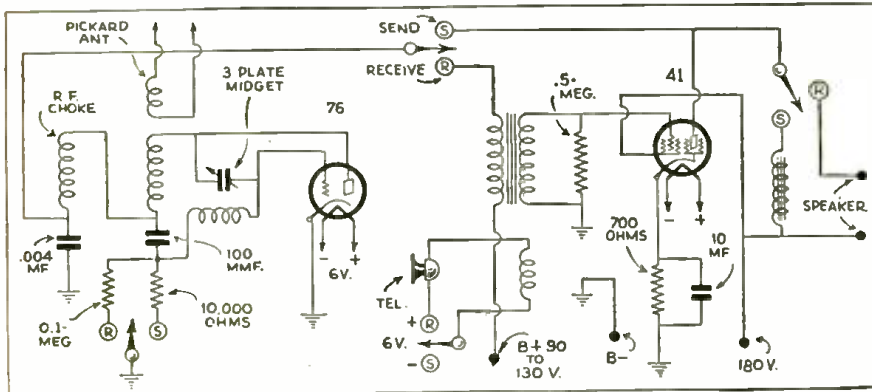

Diagram of 5 and 10 meter Transceiver.

**New "Insulex" Plug-in Coils**

• IF THERE is any one factor of paramount importance, when it comes to the plug-in coils used in the majority of short-wave sets today, it is the insulating value of the material on which the coils are wound. The accompanying illustration shows one of the very latest sets of short-wave plug-in coils, designed and built by the Insuline Corporation of America. These coils are precision wound on genuine Insulex forms, this material being a special non-hygroscopic, ceramic, compound developed especially for these coils. The Insulex material on which the new I.C.A. coils are wound has extremely low losses at ultra high frequencies. The coils are of the externally ribbed type, the ribs supporting the wire practically in air. Other styles of

coils are also supplied by the manufacturer wound on smooth bakelite forms, and also on ribbed bakelite forms. All of the coils are available as either 4 or 5 prong coils and will fit the standard 4 and 6 prong tube sockets. The 4 prong coils contain 2 windings, primary and secondary; the 6 prong coils have three windings—primary, secondary and tickler. In any of the sets of coils, the four wave bands from 16 to 200 meters are covered. The broadcast band from 200 to 550 meters is covered by a "kit" of two coils, either 4 or 6 prongs as desired. An additional ultra short-wave coil is available, which will extend the range of any short-wave set down to 9.5 meters. All of the coils are designed to operate in conjunction with a 140 mmf. (.00014 mf.) variable condenser. The bakelite forms have different colors for the various bands; for the Insulex coils the wavelength is marked on the rim of each coil.



The new "Insulex" short-wave coils are illustrated at left. They afford highest insulation and minimum high-frequency losses.

**IC A** SHORT WAVE COILS

Insist on ICA quality when in need of S.W. coils because of their greater efficiency.

**ICA BAKELITE RIBBED COILS**  
 Wave lengths 16-217 meters, 4 prongs, No. 1428, List Price... \$3.00  
 Wave lengths 16-200 meters, 6 prongs, 3 windings, No. 1428, List Price... \$3.75

Also available in **ULTRA LOW WAVE** lengths from 9-21 meters, and broadcast bands, 190-550 meters.

**OTHER ICA COILS FOR ECONOMY**  
 No. 1421, 14-225 meters, 4 prongs, Bakelite, List Price... \$2.00  
 No. 1423, 16-217 meters, 6 prongs, Bakelite, List Price... \$3.00

**ICA INSULEX with HANDLE GRIP**  
 No. 951, 4 prongs, 16-217 meters, List Price... \$4.50  
 No. 965, 6 prongs, 16-217 meters, List Price... \$5.50

Your jobber or favorite Mail Order House can supply you with any ICA product at 40% discount. If not write us direct.

**16 WIRING DIAGRAMS FREE** together with Big New **SPECIALIZED S.W. CATALOG**. All new and valuable S.W. Data LIST PRICES on converters, coils, condensers, chokes, etc.

**INSULINE CORP. OF AMERICA**  
 23-25 PARK PLACE NEW YORK, N.Y.

( ) Send me your FREE catalog together with 16 wiring diagrams and S.W. data.  
 ( ) Send me name of nearest ICA jobber.

Name .....  
 Address .....  
 City..... State.....  
 Dept. W-54.



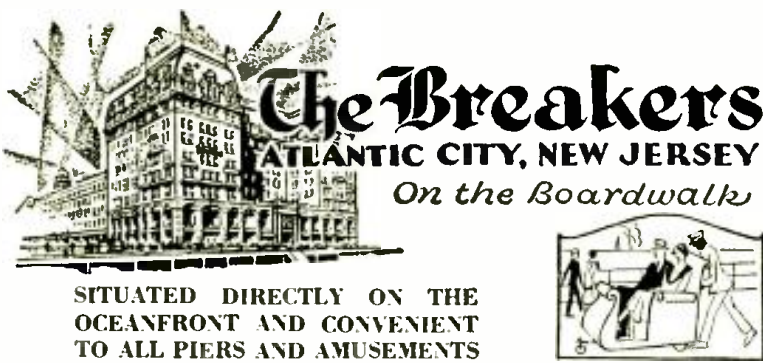

**The Breakers**  
ATLANTIC CITY, NEW JERSEY  
*On the Boardwalk*

SITUATED DIRECTLY ON THE OCEANFRONT AND CONVENIENT TO ALL PIERS AND AMUSEMENTS

**\$6** WITH MEALS *Daily* WITHOUT MEALS **\$3**  
PRIVATE BATH *Per Person* PRIVATE BATH

*Hot and Cold Sea Water in all Baths*

EXCELLENT FOOD GARAGE ATTACHED

**The Electrodyne — a  
1-Tube “Band-Spread”  
Receiver**

(Continued from page 10)

the crowded amateur bands over a large portion of the dial. A National 100 mmf. variable was cut down into two sections, five plates and two plates. On twenty and forty meters the two plate section is in parallel with the 100 mmf. band-finding condenser, and spreads the bands over most of the dial, allowing easier tuning. On eighty meters the two plate section would not be sufficient to cover the entire band, so the extra five-plate section is thrown in parallel with it. This is accomplished by connecting the five-plate section to the blank prong on the coil socket. In the eighty meter coil a wire is run from the grid prong to the blank prong, and thus when the coil is plugged in, the extra section of condenser is thrown in parallel with the two-plate condenser.

Hi-C is used on all the “ham” bands for the greatest dynamic stability. That is, the band-finding condenser is at its greatest capacity when the band is tuned in.

Resistance-controlled regeneration is used, and in the electron coupled circuit there is practically no frequency shift when this control is adjusted.

**Filament Choke Used**

Since the tube is directly heated, and it is necessary to keep the filament above ground R.F. potential, a filament choke is necessary. The .005 mf. condenser across the filament is used to provide a low-impedance path for R.F. so that both sides of the filament may be at the same potential above ground. The filament choke is wound on a piece of 3/8 inch dowel, 4 inches long. There are four pies of number 28 cotton covered wire on it. Each of these pies is wound in three layers. The bottom layer ten turns, the second layer nine turns, and the top layer eight turns. The pies are spaced 3/4ths of an inch apart. After the choke is completed it should be covered with a coat of collodion or clear Duco. With a little care this choke can be properly made, and caution should be taken, as the choke is one of the most important parts of the set.

The 32, being a screen-grid tube, has a very high plate impedance, hence we must find some means of matching this impedance to the phones. This is accomplished by using an audio transformer, reversed. The secondary of the 3 to 1 transformer is of high enough impedance to match the plate of the 32, and the primary, which is used as the secondary, works well into a pair of earphones or a loudspeaker.

**Coils Wound On Tube Bases**

The coils are wound on four-prong tube-bases, with number 30 d.c.c. wire. The following is the number of turns for the various bands:

Band	Grid to Fil.	Fil. to Ground
80m.	20 t.	1 1/2 t.
40m.	12 t.	1 1/2 t.
20m.	3 t.	1 1/4 t.

A little juggling with the tickler section of the coil, that is, moving it up and down on the tube base, may be necessary to get the set oscillating properly over the entire band with the particular antenna used. After the coils are correct, coat them with collodion or Duco, so that they will hold their characteristics.

The usual cautions about careful soldering and good wiring are in order, and especially so in a small set like this in which everything must be working perfectly. Needless to say, only the best of parts should be used. Good mica condensers and a good make of variable are requisites for



**OF COURSE**

this is not the sort of magazine that you read and then discard.

Readers keep their copies for years as a steady reference and thousands of letters attest to this.

It is now possible to save your copies and for this purpose we designed a splendid binder for you which holds twelve copies. It is made of heavy substantial material and is covered with black grain leatherette. The name of the magazine is stamped in gold on the cover.

An ingenious mechanical arrangement is provided which makes it possible to hold the copies flat when reading from the binder.

SHORT WAVE CRAFT Binder as described, \$1.25 prepaid in the United States.

Canada and foreign countries 25c extra. We accept money order, check, stamps or cash.

**SHORT WAVE CRAFT**  
98 Park Place New York, N. Y.

**Announcing Amazing  
Typewriter Bargain**

**New Remington Portable only 10c a Day**

**10-DAY FREE TRIAL OFFER**

Only 10c a day buys this latest model Remington Portable!

Not a used typewriter. Not a rebuilt machine. It's a brand new, regulation Remington typewriter. Simple to operate, yet does the finest work. Full set of keys with large and small letters.

Try this typewriter in your home or office on our 10-day FREE TRIAL OFFER. If at the end of 10 days you do not agree that this Remington is the finest portable at any price, you can return it at our expense. Don't delay. Don't put it off. Mail the coupon today. Or use postcard if you prefer.

Write for our new catalogue showing the most complete line of portable and desk models ever offered.

**FREE TOUCH  
TYPEWRITING COURSE**



**MAIL  
COUPON**  
for full facts about  
this astounding offer

REMINGTON RAND INC., Dept. SW-5  
BUFFALO, NEW YORK.

Please tell me how I can buy a new Remington Portable Typewriter for only 10c a day. Also enclose one of your new catalogues.

Name .....

Address .....

# DATAPRINTS

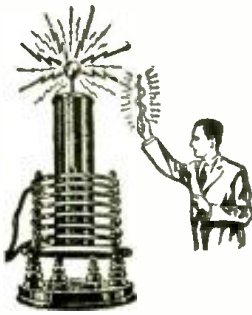

Just the  
Technical  
Information  
You Need  
To Build  
Electrical  
Apparatus

Dataprint containing data for constructing this 3 ft. spark Oudin-Tesla coil. Requires 1 K.W. 20,000 volt transformer as "excitor". See list below. Includes condenser data. . . **\$ .75**

- TESLA OR OUDIN COILS**
- 36 inch spark, data for building, including condenser data. . . . . **\$0.75**
  - 8 inch spark, data for building, including condenser data; requires 1/4 K. W. 15,000 volt transformer; see list below. . . . . **0.75**
  - Violetta type, high frequency coil data; 110 volt A.C. or D.C. type; 1" spark; used for "violet ray" treatments and "Experiments" . . . . . **0.50**
  - How to operate Oudin coil from a vacuum tube oscillator. . . . . **0.50**
  - 3 inch spark Tesla coil; operates on Ford ignition coil. . . . . **0.50**
  - 3 inch spark Oudin coil; 110 volt A.C. "Kick-Coil". . . . . **0.50**
  - 20 Tricks with Tesla and Oudin Coils. . . . . **0.50**
- TRANSFORMER DATA**
- 1 k.w. 20,000-volt transformer data, 110-volt, 60-cycle primary. Suitable for operating 3 ft. Oudin coil. . . . . **0.50**
  - 1/4 k.w. 15,000-volt transformer data, 110-volt, 60-cycle primary. Suitable for operating 8-inch Oudin coil. . . . . **0.50**
  - Electric Welding Transformer (State secondary voltage). . . . . **0.50**
  - Induction Coils—1 to 12 inch spark data. . . . . **0.50**

**TELEGRAPHONE — Records Voice or "Code" signals on steel wire by magnetism. Code can be recorded "fast" and translated "slow." Construction data (special) . . . . . \$0.50**

- NEW! RADIO AND TELEVISION. . . . . \$1.00 Each**
- The Find-All Pentagrid A.C.-D.C. "Short-Wave" Converter (3 Tubes).
  - A Five-Tube Midset with 2A5's in Push-Pull.
  - "All-Wave" Find-All Four (A.C. no plug-in coils).
  - Find All "Autotax" — Newest Five-Tube Auto Radio.
  - A.C.-D.C. Mighty Midget (43 Output, 2525 Bevt., Dynamic Speaker).
  - 3-Tube Battery Operated Personal Receiver, 2 V. tubes.
  - "Pal" Portable, Sr. (Universal A.C.-D.C., 38 Output, Magnetic Speaker).
  - The "Short Wave" Triple Pentode with 44 and 42 Tubes (A.C.).
  - The 2-volt Superheterodyne with Latest 2-volt Pentodes (8 tubes).
  - Three-Tube Reflex with 56, 58 and 47 Tubes—Reflex Revived with Modern Tubes.
  - Triple Pentode Battery Set (Fine Modern Six-Tube Battery Set).
  - The Find-All Television Receiver.
  - Nine Easy Ways to "Modernize" the Radio Set.
  - 7-Tube Television Receiver.

**MAGNET COIL DATA**

- Powerful battery electro-magnet; lifts 40 lbs. . . . . **0.50**
- 110 Volt D.C. magnet to lift 25 lbs. . . . . **0.50**
- 110 Volt D.C., 300 lb., Lift electromagnet. . . . . **0.50**
- 110 Volt D.C. solenoid; lifts 2 lb. through 1 in. . . . . **0.50**
- 110 Volt D.C. solenoid; lifts 6 lb. through 1 in. . . . . **0.50**
- 110 Volt D.C. solenoid; lifts 2 lb. through 1 in. . . . . **0.50**
- A. C. Solenoid, powerful, 110-volt, 60-cycle. . . . . **0.50**
- MOTOR**—1/16 H.P., 110 volt A.C., 60 cycle (suitable for driving 12" fan, etc.)—Data. . . . . **0.50**
- 60 or 1200 cycle Synchronous motor. . . . . **0.50**

**MISCELLANEOUS DATAPRINTS**

- Treasure Locator. . . . . **0.50**
- 2 K. W. 110 vt. to 18 vt. transformer data. . . . . **\$0.50**
- 20 motor circuits—hook-ups. . . . . **0.35**
- 20 practical telephone hook-ups. . . . . **0.35**
- 100 mechanical movements for inventors. . . . . **0.50**
- Polarized Relay—Ultra Sensitive. . . . . **0.50**
- Electro-medical coil (shocking coil). . . . . **0.50**
- Water-Wheels—How to Build and Light your house. . . . . **0.50**
- 20 Electric Bell circuits. . . . . **0.50**
- Public Address System. . . . . **0.50**
- Electric chime ringer; fits any clock. . . . . **\$0.50**

**20 "Electrical Tricks" for LODGES and PARTIES . . . . . \$0.50**

How to Fry Eggs on Cake of Ice Electrically. **\$0.50**  
"Rewinding" Small Motor Armatures. . . . . **0.50**  
**"ENGINEERING SERVICE BY MAIL"**  
Send Sketch of Your Problem for Estimate.  
(20% off on orders for \$3.00 or more. No C.O.D.)

**The DATAPRINT COMPANY**  
Lock Box 322 **RAMSEY, N. J.**

satisfactory performance. A cheap variable will get noisy and become annoying in a short time.

After the set has been wired, checked, and then double-checked, connect up the batteries. Two volts from a storage battery were used for the filament, but dry cells can be used, and will last a long time. If dry cells are used, a 20 ohm rheostat should be provided for dropping the filament voltage.

Plug in the eighty meter coil and turn the regeneration control. At some point a low rushing noise will be heard. Then tune the band-finding condenser until some station is heard. If a regular antenna is used the antenna condenser should be adjusted as tightly as possible, while still allowing the set to oscillate all over the dial.

This set has low background noise level, is extremely sensitive, and is steady in operation. We earnestly believe that it will do all that could be expected from a small set. When conditions are right, the "sky is the limit" to what can be heard. We have had excellent results with this set, and would certainly like to hear what luck those that build it have.

**Parts List for Electrodyne**

- 1 35 mmf. antenna trimmer, National (Hammarlund).
- 1 100 mmf. National 270 degrees condenser cut down, see text.
- 1 100 mmf. condenser, variable, National (Hammarlund).
- 1 .005 mf. mica condenser.
- 1 .0015 mf. mica condenser.
- 1 .001 mf. mica condenser.
- 1 .05 mf. by-pass condenser.
- 1 1 meg. half watt resistor. Lynch (I.R.C.)
- 1 100,000 ohm variable resistor. Acatest.
- 1 2.5 to 5 mh. choke, National (Hammarlund).
- 1 filament choke (special), see text.
- 1 3 to 1 audio transformer, National (or other make).
- 2 four prong Isolantite sockets, National (Hammarlund).
- 1 dial, National type B; 270 degree.
- 1 set of coils, see coil table.
- 1 232 type tube, R. C. A. Radiotron (Arco).

## Short Wave League

(Continued from page 31)

operation, rough tone, etc., with which to crack down on the offenders.

At present, the code and phone bands are fairly well differentiated. Therefore, it is only logical that the licensing of these two classes of amateur stations should also be established: Phone "exam" for phone men and code for the code men. I am sure that a class of license for the phone men, such as an "Amateur Radiophone License," would open a field for experimenters and radiophone networks which are at present discouraged. I, for one, would appreciate the opportunity to get on the air with a first-class phone station if it were possible to obtain a license without passing a code test.

Those who are so emphatic in their statements that the code can be learned should read this last paragraph. I worked at the code for about two years trying to reach a state of proficiency which would warrant my trying for an amateur extra first-class license. I have never been able to get out of the class of the "lids" and poor code operators. There are many others to my knowledge, though technically qualified in all other respects, are unable for one reason or another to learn the code. I am therefore in favor of abolishing the code test for phone men on all bands, with certain qualifications.

**J. DELMONT FLEWELLING,**  
312 Mary Street,  
Union City, Mich.

**FOR THE LOVE OF PETE, !  
COME TO BED. !**

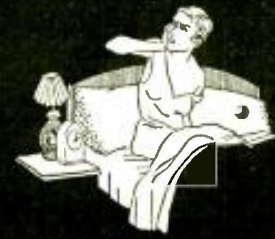

**I'll Go Nuts if You  
Don't Stop that Racket !**

**Jack** Beans! A little noise won't kill you. I paid two hundred bucks for this radio and I'm going to get London if I have to sit up all night.

**Beagle** You're a clump! For two cents I'd tell you what the trouble is.

**Jack** Okay, Mrs. "Einstein"! Here's the two. Now let's see how smart you are.

**Beagle** Right! Remember what the radio man said about using a suitable aerial? You bragged about the good one you had. He told me you'd be back. He said you need a special kind of aerial for these new receivers if you want wide-wide reception without all that noise.

**Jack** You wait! I'll be in bed in a minute.

**"No Radio Can Be Better than its Aerial"**

Lynch All-Wave Antenna System **\$6.50**  
(Complete Kit (with instructions)) List

At Radio and Department Stores or by mail, C.O.D., or postpaid upon receipt of price. Write TODAY for amazing FREE Booklet that explains how you can get out radio noise.

**LYNCH RADIO LABORATORIES, Inc.**  
51 Vesey Street **New York, N. Y.**



**Universal AC-DC  
SHORT WAVE RECEIVER**



The circuit employs all recently developed tubes. 1-78, 1-2525, and 1-43 power output tube. Full efficiency due to the special voltage rectification circuit. Uses four plus-in coils for maximum efficiency and wide band spread. They cover the short wave band from 15 to 200 meters. Write for complete details.

Kit of parts. . . . . **\$8.95**  
Set of Sylvania tubes. . . . . **3.25**

**TRY-MO RADIO CO., Inc.**

85 CORTLANDT ST., S-5 NEW YORK CITY

**NEW! THE BYRD  
2 TUBE KIT**



**NOTHING EXTRA TO BUY! 34**  
Detector, 33 Pentode Output, Micro-Vermier dial, black cracked finish hinged top cabinet. Set 4 coils, 15,200 m. Complete specifications, blueprints, hardware, wire. . . . . **\$5.75**  
Set of matched and guaranteed tubes. . . . . **\$1.95**

**SEND FOR NEW CATALOG**  
See our Regular Ad on page 51

**ALAN RADIO CORP**  
83 Cortlandt St. Dept. 44S **New York City**



# Improved RECEPTION on ANY RECEIVER

BEAT NOTE OSCILLATOR as Described in the April Issue of Radio News

no guesswork! more stations!

**WILL LOCATE ALL STATIONS. NO SKIPPING**  
It is the most sensitive and precise form of tuning indicator for use on superheterodyne receivers. May also be used to receive C.W. signals. It takes also a few minutes to install—only operation is snap switch on and off. Uses either '24A or '38 tube. These units are standard equipment on very latest all-wave and amateur receivers. Give make of receiver. \$8.95.

### LYNCH NOISELESS ANTENNA SYSTEMS

**De Luxe All-Wave Antenna Kit**—consisting of 10 cage spreaders, 20 transposition blocks, 8 Navy Type Insulators, Double Lightning Arrestor, Universal Coupler and 300 ft. 11-Mho Wire (list \$12.50)....\$7.50

For suggestion and estimate on Antenna (custom built) to meet your needs, give receiver's make, available space, maximum height and sketch of location.

**RECEIVERS WITHOUT PHONE JACK** provided for earphone listening with PHONE RECEIVER as described in April issue of Radio News. Installs without touching receiver's wiring. Inserting phone plug automatically silences speaker. Give Make of Receiver. Complete \$3.95

### AMPLIVOX LABORATORIES

Chief Engineer—801 Perlman, E.E., Consulting Engineer on Antenna Problems to Lynch Mfg. Co. 647 E. 96th St., Dept. SW-5, Brooklyn, N. Y.

**How to improve S.W. RECEPTION**

## The Postal BOOSTER

The latest short wave sensation, brings your present short or all-wave receiver years ahead of the latest on the market. It increases the sensitivity and selectivity of your receiver over 300%. It eliminates repeat spots, image frequencies and lowers the background noise considerably.

A genuine custom built laboratory instrument designed especially for the serious minded short wave fan or Amateur. Self powered, self contained, easy to install, guaranteed. Employs 2-78 and 1-2525. For A.C., D.C. or battery. Write for free circular describing the POSTAL BOOSTER and our special low price.

**POSTAL RADIO** 135 B Liberty St. New York, N. Y.

### SHORT WAVE PARTS

Alden S.W. Coll. Assembly.....	Net \$2.05
OCTOCOILS—S.W., 4-prong, set of 1.....	Net 1.45
Alden S.W. Coils—4 coils to set. 1 prong.....	Net 1.18
Alden S.W. Coils—4 coils to set. 6 prong.....	Net 2.05
Universal Model X—2 button mike.....	Net 5.88
Stancor Universal Output for single or PP.....	Net .81
Stancor Universal P. P. Input.....	Net .83
Stancor Power Transformers, horizontal mtg.:	
4 tube, 84c; 5 tube, 89c; 8 tube, \$1.30;	
7 tube, \$1.48; 8 tube.....	1.94
Continental 2 button mike, Model 10.....	4.20
Continental 2 button mike, Model 25.....	10.12
Filament Transformers—2½ V. c.t.—6 A.,	
2½ V. c.t.—9 A., 7½ V. c.t.—3 A., 6.3 V.	
c.t.—3 A., 5 V. c.t.—3 A., each.....	Net .95
Weston Photronic Cell.....	7.35
Cadmium Plated Chassis, and also black shelve	
finish metal cans in stock. Write for prices,	
20% with order, balance C. O. D. Remit by M.O.	
Postage extra. Quotations upon request.	

**MAURICE SCHWARTZ & SON**  
710-712 Broadway Schenectady, N. Y.

### THE INSTRUCTOGRAPH

(Code Teachers)

The Scientific, easy and quick way to learn the code. Send a post card today for literature. Machines, tapes and complete instructions for sale or rent. Terms as low as \$2.00 per month. Rental may be applied on purchase price if desired. Rent for a month. If the Instructograph meets every requirement, buy it. If not, send it back.

INSTRUCTOGRAPH CO. 912 LAKESIDE PLACE, CHICAGO

## S-W Stations of the World

(Continued from page 46)

### Airport Radio Stations

The airport stations do not follow any fixed schedules, and are likely to be heard any time of the day or night. The airplane transmitters are usually heard on the same wavelengths.

#### GROUP ONE

- Bakersfield, Calif.
- Bellefonte, Pa.
- Boise, Idaho
- Brookville, Pa.
- Burbank, Calif.
- Cheyenne, Wyo.
- Chicago, Ill.
- Cleveland, Ohio
- Dallas, Tex.
- Des Moines, Iowa
- Elko, Nevada
- Fort Worth, Tex.
- Fresno, Calif.
- Iowa City, Iowa
- Kansas City, Mo.
- Lincoln, Neb.
- Medford, Ore.
- Moline, Ill.
- Newark, N. J.
- North Platte, Nebr.
- Oakland, Calif.
- Oklahoma City, Okla.
- Omaha, Neb.
- Orland Twp., Ill.
- Pasco, Wash.
- Ponca City, Okla.
- Portland, Ore.
- Redding, Calif.
- Rock Springs, Wyo.
- Sacramento, Calif.
- Salt Lake City, Utah
- San Diego, Calif.
- Seattle, Wash.
- Spokane, Wash.
- Tulsa, Okla.
- Wichita, Kans.

- KQK
- WNAM
- KRA
- WNAL
- KEU
- KOE
- WUCG
- WNAK
- KNAT
- KQM
- KKO
- KGUC
- KGT
- KQQ
- KNAS
- KRF
- KGE
- WNAU
- WNAO
- KMR
- KFO
- KNAV
- KMP
- WNAT
- KRD
- KGUZ
- KVO
- KUT
- KQC
- KFM
- KQD
- KGQZ
- KZJ
- KGTZ
- KNAU
- KGTE

#### GROUP TWO

- Alameda, Calif.
- Albuquerque, N. M.
- Burbank, Calif.
- Butte, Mont.
- Camden, N. J.
- Columbus, Ohio
- Cresson, Pa.
- Harrisburg, Pa.
- Indianapolis, Ind.
- Kansas City, Mo.
- Kingman, Ariz.
- Las Vegas, Nev.
- Newark, N. J.
- Pittsburgh, Pa.
- Pocatello, Idaho
- Robertson, Mo.
- Springfield, Mo.
- Tulsa, Okla.
- Wichita, Kans.
- Winslow, Ariz.

- KGSB
- KSN
- KSI
- KGTY
- WAEW
- WHG
- WAEG
- WAED
- WHM
- KST
- KGTL
- KGTN
- WAEF
- WAEC
- KGTX
- KGTR
- KGTO
- KSY
- KGTD
- KGTA

#### GROUP THREE

- Denver, Colo.
- Las Vegas, Nev.
- Pueblo, Colo.
- Salt Lake City, Utah

- KGSP
- KGTT
- KGSR
- KGTH

#### GROUP FOUR

- Abilene, Tex.
- Beaumont, Tex.
- Birmingham, Ala.
- Boston, Mass.
- Mobile, Ala.
- Newark, N. J.
- Tucson, Ariz.

- KGUL
- KGTV
- WSDE
- WSDD
- WAEK
- WSDC
- KGUO

## Short Wave League Letter-heads

Designed for Members



This is the official letterhead

It is invaluable when it becomes necessary to deal with the radio industry, mail order houses, radio manufacturers. It can be used in many ways and gives you a professional standing. No member of the LEAGUE can afford to be without this letterhead.

This can only be used by members of the LEAGUE. No one else can purchase it.

See page 61 of this issue for order blank. Take advantage of this opportunity to handle your LEAGUE correspondence in a business-like manner.

### SHORT WAVE LEAGUE

98 Park Place New York, N. Y.

### STOPPANI COMPASS

A Precision Instrument made in Belgium. Purchased by the U. S. Government at more than \$30.00 each. Ideal for Radio Experimenters. Laboratory, also may be used as a Galvanometer for detecting electric currents in radio circuits. Ruby, jeweled. Solid bronze. 4 inches square, fitted in a hardwood case.



Our price prepaid \$4.50 each

**GOLD SHIELD PRODUCTS CO.**  
98 Park Place New York City

## SEXOLOGY

### THE MAGAZINE OF SEX SCIENCE

SEXOLOGY, foremost educational sex magazine, is written in simple language and can be read by every member of the family. It is instructive, enlightening—not a risqué book—contains no jargon. Devoted to Science of Health Hygiene.

Contains 25 important articles on Sex Science. 68 pages, with attractive two-color cover. Here are a few of the more important articles:

Editorial—"Sex Determination": The Cause of Caesarian Operations (illustrated); When and How to Have Children; Cure for Homosexuals?; Where the Sex-Cells Meet (illustrated); Mechanics of Birth Control (illustrated); Sexual Anxieties; Sex and Insomnia; The Chemicals of Sex (illustrated); Sex Impulses of the Country Child; How to Stop Masturbation; Education for Marriage; Venereal Disease Prevention (Part II); Advice to Young Unmarried Women; Scientific Sex Notes.

Get a copy of SEXOLOGY on any newsstand, or, if your dealer cannot supply you, send 25c in stamps for a copy of the current issue.

SEXOLOGY 23 West Broadway New York, N. Y.

Turn to page 48, the "Ham" Section of SHORT WAVE CRAFT. Read these advertisements. They contain offers that will interest you.

# SURPLUS RADIO PRODUCTS

ORDER DIRECT FROM THIS ADVERTISEMENT—WE DO NOT ISSUE ANY CATALOG

## G. E. Phonograph Motor

ONLY **3.95**

\$15.00 Value

Variable Speed Induction Type Self-Starting

110 volt, 60 cycle, A.C. with lever control. Speed range from 5 to 200 R.P.M. Can be installed in place of old fashioned hand winding spring motor. Also ideal for display turntable, and 100 other uses. These G. E. Electric Motors are brand new in original factory cartons. Same motor that formerly sold for \$15.00, only \$3.95. ORDER TODAY. Manufacturers and dealers write for special quantity price.

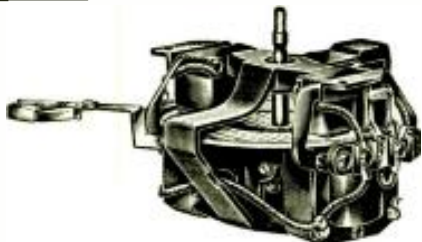

## JENSEN Auditorium Speakers

Model DA-7—D.C. Dynamic. Cone Size 13 1/2 inches

LIST PRICE \$45.00

NET TO YOU

**9.95**



Especially Suited for Theatre, Public Address, Outdoor Announcing Handling Amplifiers Delivering 20 Watts 2500 Ohm Field Push-Pull 247 Output Transformer. Ship. Wt. 20 lbs.

## WESTINGHOUSE POWER GENERATOR

Manufactured by Westinghouse for the U. S. Signal Corps, the sturdy construction of this instrument recommends it to the technician.

Built-in commutator takes off the generated D.C. Three leads extend through the casing to permit a 4 1/2 V. flashlight-type battery to be switched into circuit for starting, and to control the A.C. output of the generator. Rotated at its normal speed of 4,500 r.p.m., the output is 200 W., at 115 to 125 V. (on open circuit), 900 cycles.

The rotor turns in ball bearings. Shaft length (driving end), 2 ins.; diameter 9/16-in.; the end is threaded for a distance of 3/8-in. Case dimensions, exclusive of the shaft, 4 1/2 x 6 1/2 in. in diameter. Guaranteed new and perfect. Worth \$75.00, but while they last, only \$4.95, plus shipping charges. Shipping weight 13 lbs.

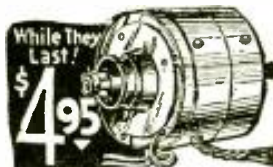

REMIT BY CHECK OR MONEY ORDER FOR FULL AMOUNT OF EACH ITEM—SHIPPED EXPRESS COLLECT. NO C. O. D. ORDER ACCEPTED—MONEY REFUNDED IF NOT SATISFIED.

Wellworth Trading Company SW-5-34  
111 West Lake Street, Chicago, Ill.

Enclosed you will find my remittance of \$..... for which please send me by express collect:  
( ) Jensen 13 1/2 Auditorium Speaker, \$9.95 each  
( ) Power Generator, \$4.95 each  
( ) G. E. Phonograph Motor, \$3.95.

Name .....  
Address .....  
City ..... State .....

### GROUP FIVE

Atlanta, Ga.  
Big Spring, Tex.  
Brownsville, Tex.  
Burbank, Calif.  
Cincinnati, Ohio  
Dallas, Tex.  
Douglas, Ariz.  
El Paso, Tex.  
Frijole, Tex.  
Indio, Calif.  
Jackson, Miss.  
Little Rock, Ark.  
Memphis, Tenn.  
Nashville, Tenn.  
New Orleans, La.  
Omaha, Nebr.  
Phoenix, Ariz.  
Robertson, Mo.  
San Antonio, Tex.  
Shreveport, La.  
Springfield, Ill.  
Waco, Tex.

WQPD  
KGUG  
KGUE  
KGUR  
KGSID  
KGUF  
KGUN  
KGUA  
KGUM  
KGUQ  
KSDB  
KQUU  
WSDK  
WSDT  
WQDQ  
KGTS  
KGUP  
KGUT  
KGUD  
KGUK  
WAEJ  
KGUH

### GROUP SIX

Chicago, Ill.  
Duluth, Minn.  
Fargo, N. D.  
Madison, Wis.  
Milwaukee, Wis.  
Pembia, N. D.  
St. Paul, Minn.

WSDS  
WSDL  
KNWB  
WSDR  
WAEH  
KNWC  
KNWA

### GROUP SEVEN

Detroit, Mich.

WAEI

### GROUP EIGHT

Blythe, Calif.  
Houston, Tex.

KGUS  
KGUB

### GROUP NINE

Baltimore, Md.  
Charleston, S. Car.  
Greensboro, N. Car.  
Jacksonville, Fla.  
Linden, N. J.  
McRae, Ga.  
Miami, Fla.  
Orlando, Fla.  
Richmond, Va.  
Spartanburg, S. Car.

WEEB  
WEEC  
WEEG  
WEEJ  
WEEN  
WEEH  
WEEM  
WEEO  
WEER  
WEEF

### GROUP TEN

Brownsville, Tex.  
Miami, Fla.  
San Juan, P. R.

KGJW  
WKDL  
WMDV

### Television Stations

1600-1700 kc.	176.5-187.5 m.
W2XR—Long Island City, N. Y.	
W8XAN—Jackson, Mich.	
2000-2100 kc.	142.9-150 m.
W9XAO—Chicago, Ill.	
W6XAH—Bakersville, Cal.	
W9XK—Iowa City, Iowa	
2100-2200 kc.	136.4-142.9 m.
W2XBS—New York, N. Y.	
W6XS—Los Angeles, Calif.	
W9XAP—Chicago, Ill.	
W9XAK—Manhattan, Kans.	
2200-2300 kc.	130.4-136.4 m.
W9XAL—Kansas City, Mo.	
2750-2850 kc.	105.3-109.1 m.
W9XG—W. Lafayette, Ind.	
43,000-46,000 kc.	6.52-5.98 m.
48,500-50,300 kc.	6.00-6.20 m.
60,000-80,000 kc.	3.75-5.00 m.
W9XD—Milwaukee, Wis.	
W9XE—Marion, Ind.	
W8XF—Pontiac, Mich.	
W3XAD—Camden, N. J.	
W2XR—Long Island City, N. Y.	
W9XAT—Portable	
W2XF—New York, N. Y.	
W6XAO—Los Angeles, Calif.	
W3XE—Philadelphia, Pa.	
W2XAK—New York, N. Y.	
W10XX—Portable and Mobile	
W8XAN—Jackson, Mich.	
W8XL—Cuyahoga, Heights, Ohio	

## QUALITY APPARATUS FOR Short Waves



### GEN-WIN SHORT WAVE COIL KIT



These coils are considered the finest made. Each coil is precision wound on a different colored bakelite form for quick identification of wave lengths. Used and highly recommended by all short wave experts. Range (16 to 225) meters, using a .00014 or .00015 mfd. condenser. Recommended for the following sets: "The Globe Trotter," "The Overseas," "The Hoerle 12,500 Mile Two Tube Receiver and Doerle Three Tube Signal Gripper," "The Megadyne."

4 Coil Enamel Wire Kit \$1.50  
4 Coil Litz Wire Kit \$2.25  
Broadcast Coil. (200 to 550 meters) \$5c

### POLICE AND SHORT WAVE ADAPTER

Convert your broadcast set into a shortwave set tuning from 80 to 200 meters.



Get exciting police alarms from thousands of miles away. Airplane comm. stations while planes are in flight. Amateur Phone and international code communications. The biggest thrill and fun for so little money. Installed in a jiffy. Plug directly into the detector tube socket. Specify the detector tube in your set or if uncertain as to detector tube, advise make and model number of set when ordering. Wiring diagram included free with coils. Separately 10c.

No. 200—for '27, '37 \$1.39 and '56 Det. tube  
No. 201—for '24, '35, and '36 Det. \$1.39 tube

### ALL-WAVE COIL KIT Range 25 to 550 Meters

Comprises a precision wound tuner and R. F. coil, both having a tapered secondary, which permits you to absorb both SHORT WAVE and BROADCAST PROGRAMS. If you own an Ambassador or any other three circuit tuner receiver, you can easily convert the set into an all wave receiver, by replacing the coils with these new GEN-WIN ALL-WAVE coils. Coils may be had for use with either .00085 or .0006 mfd. condensers or specify which when ordering. Wiring diagram included free with coils. Separately 10c.



All Wave Tuner (as illustrated) 90c  
All Wave R. F. Coil 75c

GENERAL WINDING COMPANY  
254 W. 31st St. Dept. 4-8 NEW YORK, N. Y.

## STOP Worrying About That Exam! It's EASY to Obtain Your LICENSE With CANDLER Complete Home Training

You can become a skilled Amateur or Com'op quickly and easily with CANDLER original methods of learning code, necessary radio fundamentals, building your station, passing exam., and going on the air.

FREE. BOOK OF FACTS. Contains pictures of CANDLER trained Champions, world's fastest Radio ops. and CSCG members. Describes 3 Famous CANDLER COURSES:

SCIENTIFIC CODE COURSE, for Beginners.

HIGH-SPEED TELEGRAPHING, for championship speed and copying behind.

RADIO TOUCH-TYPEWRITING. Only Specialized "Mill" Course for operators.

Save Time, Money and Worry! Send for BOOK OF FACTS today. No obligation.

CANDLER SYSTEM CO., Dept. S-5  
6343 S. Kedzie Ave., Chicago, Ill.



## SUPER TESTING KIT!

Prinol Type Handles with interchangeable Tip End. Kit complete with 2 Plug-In-Fronts, 2 Alligator Clips, 2 Needle Point Phone Tips, and 2 Spade Leads. Long, Thin Pencil-Type handles for easy testing in tight places. Ideal for testing Long and Shortwave Sets, Coils, Condensers, Etc. Complete kit. Write for free catalog.

INTRODUCTORY PRICE NOW \$1.00 PREPAID  
AMERICAN RADIO HARDWARE  
135 Grand Street New York, N. Y.





# WORLD-WIDE SHORT-WAVE STATIONS

Nearly 9,000 Short-Wave Radio  
Stations Listed in This Book

For Sale On All Principal  
Newsstands  
Look for the Yellow Cover

25c

A Copy



## Partial Contents

1. THE OFFICIAL SHORT WAVE LOG AND CALL MAGAZINE contains the largest listing of short-wave stations in the world. BECAUSE OF SPACE LIMITATIONS, NO REGULAR MAGAZINE CAN PUBLISH ALL THE WORLD STATIONS. There are so many short-wave stations which normally cannot be included in any monthly magazine; but frequently you hear these calls, and you must know where they come from. THE OFFICIAL SHORT WAVE LOG AND CALL MAGAZINE gives you this information, besides a lot of other data which you, as a short-wave enthusiast, must have.

2. Log List. The log section gives you dial settings, time, date, call letters, location, and other information. Thus, when you hear a station, you make a permanent record, which is invaluable.

3. Another large section has squared-paper pages on which you can fill in your own frequency (wavelength) curve for your particular receiver. This helps you to find stations which otherwise could never be logged by you. These tuning charts are listed in two sections; one reading 0 to 100 degrees and the other from 0 to 150 degree tuning dial.

4. World Airline Distance Chart, showing the approximate distance between principal cities of the world. Invaluable in quickly verifying distances from any country in the world.

5. A new "Meter to kilocycle" conversion chart. Quite often short-wave broadcast phone stations announce their frequency on the latter scale when signing off, and many listeners do not know the relation between them. A chart anyone can read.

6. A list of international abbreviations used in radio transmission.

7. A chart of complete Morse and Continental International Code Signals, as used in all radio work.

8. World Time Chart. This tells you instantly what the time is, anywhere in the world. Necessary for every short-wave listener.

9. Improving your Short Wave Reception. An invaluable chapter by the well-known authority on short waves, Clifford E. Denton.

10. Identification chart of stations by their call letters.

11. Map giving the standard time zones of the entire world, for quick reference.

12. New and complete list of phone stations on the ocean liners.

13. "Q" readability systems. "T" Tone system. "R" audibility system. Invaluable to amateurs.

14. New Straight-Line World Distance Chart.

15. International prefixes by which you can recognize each foreign country when you hear a call.

WE ARE happy to present to our friends, the second issue of the OFFICIAL SHORT WAVE LOG AND CALL MAGAZINE, just off press.

To the thousands of readers who bought the first issue, we express our thanks, with the hope that they liked our presentation. And those of you who bought the first issue certainly will wish to get the second one too, as it is far more complete than the first. It has been entirely revised, and brought up to date, up to the time we went to press.

There are nearly 9,000 listings of radio 'phone short-wave stations in this magazine, and, from the very nature of it, you appreciate how many changes occur from month to month.

### ONLY ONE OF ITS KIND

THE OFFICIAL SHORT WAVE LOG AND CALL MAGAZINE is the only publication in print that publishes ALL the short-wave 'phone stations of the world. Thousands of stations that the average listener hears are listed here, and you need no longer be puzzled as to whence the call emanates.

As only a limited quantity was printed for the second issue, it is possible that your newsdealer sold out his supply.

Should you not be able to secure a copy at your newsstand, use the handy coupon. This is one of the finest books that the publishers of SHORT WAVE CRAFT have ever turned out. You will be proud to possess it.

The size of this book is 9x12 inches, same size as SHORT WAVE CRAFT magazine. It is printed on a good grade of paper, and has a heavy durable cover.

**SHORT WAVE CRAFT** 96-98 PARK PLACE  
NEW YORK, N. Y.

## MAIL THIS COUPON TODAY!

SHORT WAVE CRAFT

96-98 Park Place, New York, N. Y.

Gentlemen: I enclose herewith 25c for which send to me prepaid. Immediately a copy of your new OFFICIAL SHORT WAVE LOG AND CALL MAGAZINE. (Send money order, check, cash or new U. S. Stamps. Register letter if it contains stamps of currency.)

Name \_\_\_\_\_

Address \_\_\_\_\_

City \_\_\_\_\_ State \_\_\_\_\_

SW-5-34

Mr. Hugo Gernsback,  
96-98 Park Place, New York City.  
My Dear Mr. Gernsback:  
I have just finished reading your Newest Brain Child the Official Short Wave Log and Call Book, and find it good.  
Although I am no critic, but I have followed through your radio publications your efforts for better radio, your attempts to bring the user in to the light that radio is the cleanest sport that man has found for a hobby and taught the manufacturers of radio sets that the buying public wants to also know the circuits involved, you have carried a campaign for the release of data for the service man.  
In all, Mr. Gernsback, I have grown to manhood reading your radio publications and I hope that my sons find them as interesting as I do as I have two small sized "Flams."  
So Mr. Gernsback why not say to you, you have found your work and it is well done.  
73 (s) F. B. ALLEN, 463 Fairview, Oklahoma.

• Index to Advertisers •

<b>A</b>	
Acme Specialty Company.....	44
Alan Radio Company.....	51-55
Alden Products Company.....	38
Allied Engineering Co.....	50
Allied Radio Corporation.....	44
American Machine & Tool Co.....	50
American Radio Hardware Co.....	57
American Sales Co.....	50
Amplex Inst. Tating Lab.....	51
Amplivox Laboratories.....	56
Arco Tube Company.....	40
<b>B</b>	
Birnbach Radio, Inc.....	59
Blan. The Radio Man, Inc.....	50
Bliley Piezo Electric Co.....	48
The Breakers.....	54
<b>C</b>	
Candler System Co.....	57
Coast-to-Coast Radio Corp.....	42
Coyne Electrical School.....	49
<b>D</b>	
Data Print Co.....	52-55
<b>F</b>	
First National Television, Inc.....	50
Fordson Radio Mfg. Co.....	53
<b>G</b>	
General Winding Co.....	57
Gold Shield Products Co.....	52-53-56
Gould Radio & Television Co.....	42
<b>H</b>	
"Ham" Advertisements.....	48
Hammarlund Manufacturing Co.....	37
Harrison Radio Company.....	41
Howard Radio Company.....	Back Cover
<b>I</b>	
Instructograph Co.....	56
Insuline Corp. of America.....	53
<b>L</b>	
Lancaster, Allwine & Rommel.....	46
Leotone Radio Co.....	48
Lynch Manufacturing Co.....	55
<b>M</b>	
Mayo Microphones.....	42
McGraw-Hill Book Co., Inc.....	47
Mead Gliders.....	46
Midwest Radio Corp.....	43
Modern Television Co.....	51
<b>N</b>	
National Co., Inc.....	Inside Back Cover
National Radio Institute.....	1
Norden-Hauck Radio Research.....	50
<b>P</b>	
Polymet Mfg. Company.....	51
Port Arthur College.....	52
Postal Radio Co.....	56
<b>R</b>	
Radio Publications.....	4
Radio Trading Co.....	50-62-63
RCA Institutes, Inc.....	59
Radio Control Engineering Co.....	45
Remington-Rand, Inc.....	54
<b>S</b>	
E. M. Sargent Company.....	41
Maurice Schwartz & Son.....	56
Servicemen's Pub. Co.....	56
Sexology Magazine.....	56
McMurdo Silver, Inc.....	39
Supertone Products Co.....	46
Short Wave Coil Book.....	52
Short Wave Log & Call Magazine.....	58
Short Wave Radio Manual.....	64
<b>T</b>	
Teleplex Company.....	
Trimm Radio Mfg. Co.....	44
Try-Mo Radio Co., Inc.....	Inside Front Cover, 48-55-59-60
<b>U</b>	
Uncle Dave's Radio Shack.....	45
<b>W</b>	
Wellworth Trading Company.....	57

(While every precaution is taken to insure accuracy, we cannot guarantee against the possibility of an occasional change or omission in the preparation of this index.)

### Short Wave Scouts

(Continued from page 23)

- CNR—Rabat, Morocco; 37.3 meters; Sundays only; 3 p.m. to 5 p.m.  
 I.C.L.—Oslo, Norway; 42.9 meters; Daily, 11 a.m. to 6 p.m.; relays long wave station in Oslo.  
 CEC—Santiago, Chile; 15.2 meters; works HJY and LSR, 11 a.m. to 4 p.m.  
 VE9HX—Halifax, N. S., Canada; 49.1 meters; 8:30 to 11:30 a.m., 5 p.m. to 10 p.m.  
 HJ3ABP—Bogota, Colombia; 48 meters; Daily, 7:00 p.m. to 11 p.m.  
 W9XAA—Chicago, Ill., U. S. A.; 49.3 meters; Sundays, 2 p.m. to 5 p.m.  
 VE9DN—Drummondville, Canada; 49.9 meters; Saturday after., 11:30 p.m.  
 YV1BC—Caracas, Venezuela; 49 meters; 5:15 p.m. to 10 p.m.  
 KKP—Kauhuku, Hawaii; 18.7 meters; works KWO, 2 p.m. to 7 p.m.  
 FTM—St. Assise, France; 17.5 meters; Phones LSG, 10 a.m. to 2 p.m.  
 GBB—Rugby, England; 22 meters; day-time, phones Canada.  
 VPX—Nassau, Bahama Isl.; 66.5 meters; Phones WND, 2 p.m. to 10 p.m.  
 WTDW—St. Thomas, Virgin Isl.; 69.6 meters; weather reports, 2 p.m. to 3 p.m.  
 W8XAL—Cincinnati, Ohio; 49.5 meters; relays WLW irregular.  
 KWI—Dixon, California; 19.5 meters; phones KKP, 2-7 p.m.
- The undersigned declares under oath that the stations listed in this list and submitted in the Short-Wave Scout Contest were received by me during the past 30 days (Dec. 27th to Jan. 25th), that the reception was bona fide and was obtained by me without assistance from any outsider, and that I personally listened to the station announcements as given in this list.

CHARLES GUADAGNINO.

#### Trophy Contest Entry Rules

NOTE that we have amended our rules, and you will find that the rules now read:

#### Fifty Per Cent Verified and 50 Per Cent Unverified

In other words, if you send in a list of 100 stations, and at the same time you send in 50 verification cards, you will get credit for 100 stations, beginning immediately. This, we believe, should take care of all SHORT WAVE SCOUTS handsomely and give them the benefit of the doubt.

In order to protect everyone, the rules have been amended that a sworn statement before a Notary Public, which only costs a few cents to get, must be sent in at the same time.

It is to be hoped that the amended rules now make it much easier for the would-be entrants.

For the complete article of the Purpose of the SHORT WAVE SCOUTS, we refer to page 393 of the November, 1933, issue.

Here are the rules amended:

You wish to know how you can win this valuable trophy, and here are the simple rules. Be sure to read them carefully. Do not jump at conclusions.

- 1.—A monthly trophy will be awarded to one SHORT WAVE SCOUT only.
- 2.—The purpose of this contest is to advance the art of radio by "logging" as many short-wave commercial phone stations, in a period not exceeding thirty days, as possible by any one contestant.
- 3.—The trophy will be awarded to that SHORT WAVE SCOUT who has logged the greatest number of short-wave stations during one month.
- 4.—In the event of a tie between two or more contestants, each logging the same number of stations, the judges will award a similar trophy to each contestant so tying.

## BIRNBACH All Wave ANTENNA

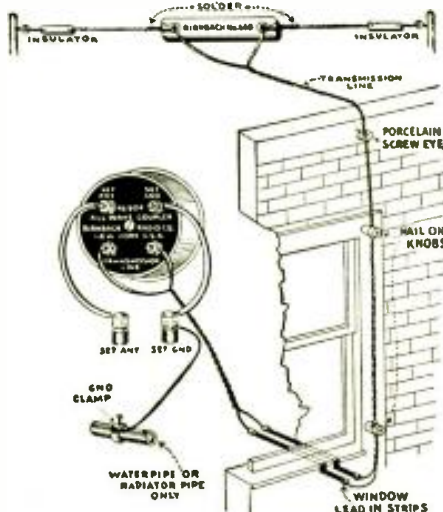

ALL-WAVE receivers need this dual antenna system for best results. Increases signal strength and clarity—reduces noises.

Kit includes doublet antenna with transmission line to an all-wave coupler. Ideal system for the reception of both broadcast and short wave.

Easily erected. List price \$3.75, complete with all parts and instructions. Write Dept. SW-5 for Complete Data on Birnbach Products.

**BIRNBACH RADIO CO., Inc.**  
 145 Hudson St. New York City

**Special**

**For SHORT WAVE LISTENERS**



TRY-MO offers a World Globe and a Servicemen's Guide and Short Wave Manual for only \$1.00 for both. The globe measures 10" high and states the time and seasons of every part of the world. An ideal station tracer for the short wave listener. The globe is all metal, lithographed in many colors.

BOTH FOR \$1.00





Manual contains 128 pages of important servicing hints and short wave data and hookups. Hard, durable cover. Regular value of both items \$1.60.

Send for 1934 Catalog

**TRY-MO RADIO CO., INC.**  
 85 CORTLAND ST. Dept. S. NEW YORK, N. Y.

## Practical Radio Engineering

An opportunity for RADIO MEN to enlarge their scope of training

Whether elementary radio principles or advanced subjects, sound applications or practical radio engineering, RCA Institutes is prepared to give you the instruction you need.

Resident schools New York and Chicago with modern standard equipment

Extension Courses for Home Study under convenient "no obligation" plan. Illustrated Catalog on Request

**R. C. A. INSTITUTES, Inc., Dept. SW-5**  
 75 Varick St., New York—1154 Merchandise Mart, Chicago



# EVERY FAN NEEDS A GLOBE



## A Man's Sized Globe for Short-Wave Fans

This remarkable globe, which measures 12" in diameter—total height with pedestal 16", and printed in fourteen different colors, is waterproof and easily washed by using a damp cloth.

There is a graduated "Meridian" scale of black enameled metal. An additional feature is the movable hour scale found at the north pole—this facilitates determining the hour in any part of the world.

Only on a globe of this size is it possible to get an accurate picture of countries and their relative positions to each other. You will actually be amazed when you compare distances—from New York to Moscow; from Cape Town to Tokio; from Los Angeles to Rio de Janeiro, etc. A flat map is deceptive for measuring, but take a small string and stretch it across the globe, from city to city, and you have the correct distances.

Here is the globe that adds dignity to home, office, studio or laboratory—it's a globe that everyone would be proud to possess. The World Short-Wave Globe, printed early in 1931, contains over 7,500 names and cities. All spellings conform to standard rulings of U. S. Department of Commerce and Royal Geographic Society of London, England.

All globes are packed in cartons assuring safe delivery. Send money order or check for \$3.25, plus sufficient postage for delivery by parcel post. Register letter if it contains cash or stamps. If preferred specify that shipment be sent express collect. Shipping weight, 8 lbs.

**NOW \$3.25**

Gentlemen:  
I have received the World Globe and wish to state that I am certainly well pleased with its completeness, appearance and its usefulness.  
Short wave listening has become a hobby with me in the last two years, and this World Globe is a necessary accessory to any short wave listener or, for that matter, to any home, especially where there are children.  
P. C. ELLIS, Supt.,  
Laboratory—19th and  
Campbell Streets,  
Kansas City, Mo.

**SHORT WAVE CRAFT**  
98 PARK PLACE NEW YORK, N. Y.

# SCOUT One Tube Short Wave

BATTERY OPERATED S.W. RECEIVER

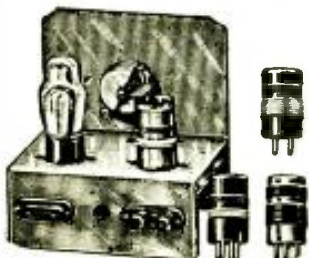

A set for the beginner! Will cover the entire short wave and broadcast bands. It is remarkable how the "Scout" intercepts short wave signals. Police signals, ship to shore, airplane, amateurs, etc., tuned with ease.

Parts in the kit are of the highest quality. Smooth regeneration control. Exceedingly simple to build. Uses 1-230 tube, 2-1½ volt dry cells, and 1-45 volt "B" battery.

Model SC-1-K—Complete kit of parts...\$3.95  
Model SC-1-W—Wired and tested...Extra 1.00  
Sylvania 230 tube..... .70

Set of batteries.....\$1.60  
Set of Matched headphones..... .95  
Broadcast coil—200-550 meters..... .39

**TRY-MO RADIO CO., Inc.,**

**85 Cortlandt Street, New York**

5.—Verifications are necessary; these must be sent in with each entry. All cards or verification letters must be sent in at the same time, with a statement by the SHORT WAVE SCOUT, giving the list of stations in typed or written form, with the station calls, wave-lengths, and other valuable information. (See below.) The verification letters and cards will be returned to the SHORT WAVE SCOUT at the end of each monthly contest. (See Jan., 1933, editorial how to obtain verifications.)

6.—Inasmuch as not all stations send out verification letters or verification cards, each contestant is entitled to report not more than 50% of station calls for which no proper verification is submitted. For example, if you should mail a list of 100 stations, and submit 50 verification cards or letters with this list, the Judges would allow the 100 stations, providing such data is given for the 50 unverified stations as to enable an intelligent check to be made by the Judges. In the interest of all SHORT WAVE SCOUTS, however, contestants should try to send in as many verifications as possible. Each list submitted must be sworn to before a Notary Public, as follows:

The undersigned declares under oath that the stations listed in this list and submitted in the SHORT WAVE SCOUT Contest were received by me during the past thirty days, that the reception was bona fide and was obtained by me without assistance from any outsider, and that I personally listened to the station announcements as given in this list.

7.—This is an international contest in which any reader, no matter where located, can join. It is allowable for SHORT WAVE SCOUTS to list stations in their own countries, if they desire to do so.

8.—SHORT WAVE SCOUTS are allowed the use of any receiving set, from a one-tube up to one of sixteen tubes, or upwards, if they so desire.

9.—When sending in entries, note the following few simple instructions: Type your list, or write in ink, *pencilled matter is not allowed*. Send verification cards, letters and the list all in one package, either by mail or by express prepaid; do not split up the package. Verification cards and letters will be returned, at the end of the contest, to their owners; the expense to be borne by SHORT WAVE CRAFT magazine.

10.—In order to have uniformity of the entries, when writing or typing your list observe the following routine: USE A SINGLE LINE FOR EACH STATION; type or write the entries IN THE FOLLOWING ORDER: Station call letters; frequency station transmits at; schedule of transmissions, if known (all time should be reduced to Eastern Standard which is five hours behind Greenwich Meridian Time); name of station, city, country; identification signal if any. Sign your name at the bottom of the list and furthermore state the type of set used by you to receive these stations.

11.—Don't list amateur transmitters in this contest. *only commercial phone stations*, no CW and no "code" stations.

12.—This contest will close every month for the next twelve months on the first day of the month, by which time all entries must have been received in New York. Entries received after this date will be held over for the next months contest.

13.—The next contest will close in New York, May 1st.

14.—The judges of the contest will be the editors of SHORT WAVE CRAFT, and their findings will be final.

15.—Trophy awards will be made every month at which time the trophy will be sent to the winner. Names of the contesting SCOUTS not winning a trophy will be listed in Honorable Mention each month.

16.—From this contest are excluded all employees and their families of SHORT WAVE CRAFT magazine.

17.—Address all entries to SHORT WAVE SCOUT AWARD, 98 Park Place, New York City.



# ... SHORT WAVE ESSENTIALS FOR MEMBERS OF THE SHORT WAVE LEAGUE ...

**T**HE following list of short wave essentials has been prepared from the suggestions to the LEAGUE by its members. A number of months were consumed in creating these short wave essentials for members of the SHORT WAVE LEAGUE. All essentials listed are approved by headquarters of the LEAGUE.

### A FEW WORDS AS TO THE PURPOSE OF THE LEAGUE

The SHORT WAVE LEAGUE was founded in 1930. Honorary Directors are as follows:

**Dr. Lee de Forest, John L. Reinartz, D. E. Replogle, Hollis Baird, E. T. Somerset, Baron Manfred von Ardenne, Hugo Gernsback, Executive Secretary.**

The SHORT WAVE LEAGUE is a scientific membership organization for the promotion of the short wave art. There are no dues, no fees, no initiations, in connection with the LEAGUE. No one makes any money from it; no one derives any salary. The only income which the LEAGUE has is from its short wave essentials. A pamphlet setting forth the LEAGUE'S numerous aspirations and purposes will be sent to anyone on receipt of a 3c stamp to cover postage.

One of the aspirations of the SHORT WAVE LEAGUE is to enhance the standing of those engaged in short waves. To this end, the SHORT WAVE LEAGUE supplies members with membership letterheads and other essentials. As soon as you are enrolled as a member, a beautiful certificate with the LEAGUE'S seal will be sent to you, providing 10c in stamps or coin is sent for mailing and handling charges.

Another consideration which greatly benefits members is that they are entitled to preferential discounts when buying radio merchandise from numerous firms who have agreed to allow lower prices to all SHORT WAVE LEAGUE members. The radio industry realizes that the more earnest workers there are who boost short waves, the more radio business will result therefrom; and a goodly portion of the radio industry is willing, for this reason, to assist SHORT WAVE LEAGUE members by placing them on a professional basis.

### SHORT WAVE ESSENTIALS LISTED HERE SOLD ONLY TO SHORT WAVE LEAGUE MEMBERS

All the essentials listed on this page are never sold to outsiders. They cannot be bought by anyone unless he has already enrolled as one of the members of the SHORT WAVE LEAGUE or signs the blank on this page (which automatically enrolls him as a member, always provided that he is a short wave experimenter, a short wave fan, radio engineer, radio student, etc.).

If, therefore, you order any of the short wave essentials without filling out the blank (unless you already enrolled as a LEAGUE member), your money will be returned to you.

Inasmuch as the LEAGUE is international, it makes no difference whether you are a citizen of the United States or any other country. The LEAGUE is open to all.

### Application for Membership SHORT WAVE LEAGUE

SHORT WAVE LEAGUE (5-34)  
98 Park Place, New York, N. Y.

I, the undersigned, herewith desire to apply for membership in the SHORT WAVE LEAGUE. In joining the LEAGUE, I understand that I am not assessed for membership and that there are no dues and no fees of any kind. I pledge myself to abide by all the rules and regulations of the SHORT WAVE LEAGUE, which rules you are to send to me on receipt of this application.

I consider myself belonging to the following class (put an X in correct space): Short Wave Experimenter  Short Wave Fan  Radio Engineer  Student

I own the following radio equipment:

Transmitting \_\_\_\_\_

Call Letters \_\_\_\_\_

Receiving \_\_\_\_\_

Name \_\_\_\_\_

Address \_\_\_\_\_

City and State \_\_\_\_\_

Country \_\_\_\_\_

I enclose 10c for postage and handling for my Membership Certificate.

### SHORT WAVE LEAGUE LETTERHEADS

A beautiful letterhead has been designed for members' correspondence. It is the official letterhead for all members. The letterhead is invaluable when it becomes necessary to deal with the radio industry, mail order houses, radio manufacturers, and the like; as many houses have offered to give members who write on the LEAGUE'S letterhead a preferential discount. The letterhead is also absolutely essential when writing for verification to radio stations either here or abroad. It automatically gives you a professional standing. **50c**

### A—SHORT WAVE LEAGUE letterheads, per 100.....

**50c**

### OFFICIAL SHORT WAVE LEAGUE LOG AND CALL MAGAZINE

Here is the finest book of its kind ever published. It contains the largest listing of short wave stations in the world, much larger in fact than the list published in SHORT WAVE CRAFT and other magazines. All experimental stations, no matter where located, are listed. A large section is provided where calls can be listed in a proper manner. This log section gives dial settings, time, date, call letters, location, and other information. Another section has squared-paper pages on which you can fill in your own frequency curve for your particular receiver. It helps you to find stations which otherwise you could never log. It is the only book of its kind published. **25c**

### B—Official Log and Call Magazine.....

**Prepaid 25c**

### RADIO MAP OF THE WORLD AND STATION FINDER

The finest device of its kind published. The world's map on heavy board is divided into 23 sections, while the rotary disc shows you immediately the exact time in any foreign country. Invaluable in logging foreign stations. Also gives call letters assigned to all nations. Size 11"x22". **25c**

### C—Radio Map of the World and Station Finder.....

**Prepaid 25c**

### GLOBE OF THE WORLD AND MAGNETIC COMPASS

This highly important essential is an ornament for every den or study. It is a globe, 6 in. in diameter, printed in fifteen colors, glazed in such a way that it can be washed. This globe helps you to intelligently log your foreign stations. Frame is of metal. Entire device substantially made, and will give an attractive appearance to every station, emphasizing the long-distance work of the operator. **\$1.25**

### D—Globe of the World.....

**Prepaid \$1.25**

### SHORT WAVE LEAGUE LAPEL BUTTON

This beautiful button is made in hard enamel in four colors, red, white, blue and gold. It measures three quarters of an inch in diameter. By wearing this button, other members will recognize you and it will give you a professional air. Made in bronze, gold filled, not plated. Must be seen to be appreciated. **35c**

### E—SHORT WAVE LEAGUE lapel button.....

**Prepaid 35c**

### EE—SHORT WAVE LEAGUE lapel button, like the one described above but in solid gold.....

**Prepaid \$2.00**

### SHORT WAVE LEAGUE SEALS

These seals or stickers are executed in three colors and measure 1 1/4 in. in diameter, and are gummed on one side. They are used by members to affix to stationery, letterheads, envelopes, postal cards and the like. The seal signifies that you are a member of the SHORT WAVE LEAGUE. Sold in 25 lots or multiples only. **15c**

### G—SHORT WAVE LEAGUE seals.....

**per 25, Prepaid 15c**

### SHORT WAVE MAP OF THE WORLD

This beautiful map, measuring 18x26 in. and printed in 18 colors is indispensable when hung in sight or placed "under the glass" on the table or wall of the short wave enthusiast. It contains a wealth of information such as distances to all parts of the world, political nature of the country in which a broadcast station is located, etc., and from the manner in which the map is blocked off gives the time in different parts of the world at a glance. **25c**

### F—SHORT WAVE Map of the World.....

**Prepaid 25c**

### PLEASE NOTE THAT ABOVE ESSENTIALS ARE SOLD ONLY TO MEMBERS OF THE LEAGUE—NOT TO NON-MEMBERS.

Send all orders for short wave essentials to SHORT WAVE LEAGUE, 98 Park Place, New York City.

If you do not wish to mutilate the magazine, you may copy either or both coupons on a sheet of paper.

**SHORT WAVE LEAGUE, 98 Park Place, New York, N. Y.**



G—15c for 25

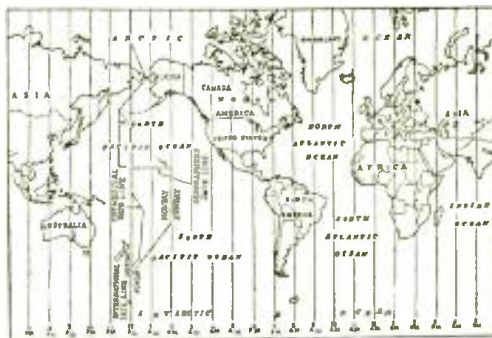

F—25c each



WE DO OUR PART

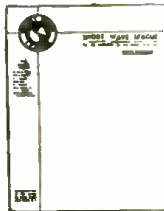

A—50c per 100



B—25c per copy



C—25c each



D—\$1.25 each



E—35c each

SHORT WAVE LEAGUE, 98 Park Place, New York, N. Y.  
Gentlemen:  
I am already an enrolled member in the SHORT WAVE LEAGUE   
I am a new member and attach my application to this coupon   
Please send me the following short wave essentials as listed in this advertisement:  
.....  
.....  
.....  
for which I enclose \$..... herewith  
(The LEAGUE accepts money order, cash or new U. S. Stamps in any denomination. Register cash and stamps.)  
Name.....  
Address.....  
City and State.....  
Country.....  
(5-34)



# Come On! LET'S FRATERNIZE Fellows! MR. SHORT WAVE AMATEUR—Meet

**"R. T."  
AMATEUR C. W. PUSH-  
PULL TRANSMITTER  
15 to 30 WATTS  
ALL AMATEUR BANDS**

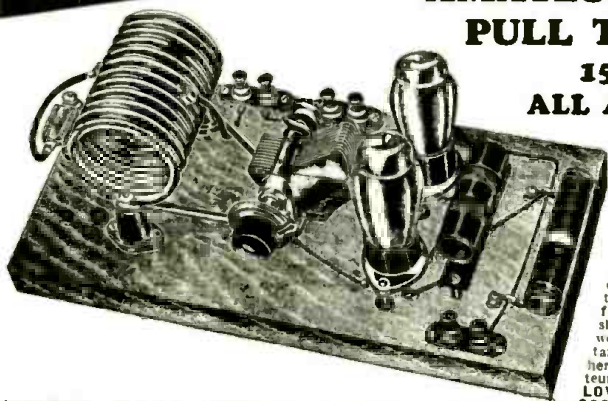

**It's Fool Proof—Be-  
cause It's Simple**

This transmitter with a power output of anywhere from 10 to 30 watts (depending on the type of tubes employed) is a real globe traveler. Some people have the impression that a transmitter with a power output of, let's say, 10 watts, will transmit only several miles and no further. This is not the case. In short wave transmission, location and weather conditions constitute important factors. The transmitter described herewith has actually "worked" amateurs in the far corners of the earth. A **LOW POWER TRANSMITTER IN A GOOD LOCATION IS, PRACTICALLY A GOOD TRANSMITTER IN A POOR LOCATION.**

**SPEAKING, MORE "POWERFUL" THAN A HIGH POWER TRANSMITTER IN A GOOD LOCATION.**

The transmitter illustrated, is essentially a low powered, low cost, outfit for the beginner. It is not, however, confined to the beginner. Many dyed-in-the-wool amateurs have one or more of these transmitters handy as auxiliaries. Two type 45 tubes are used as oscillators. These tubes are used because of their low cost and because, in actual operation, they have practically the same output as the type 210 tubes, at one-third their cost. The circuit is of the type using fixed-tuned grid, tuned plate.

All grid coils are wound on one inch bakelite tubing with fine wire so that their natural frequency response is near the center of each amateur band. The frequency peaks of these coils are rather broad which means that **THE ENTIRE BAND OF ANY GIVEN COIL CAN BE COVERED WITH THE PLATE CIRCUIT, WITHOUT THE TWO CIRCUITS GETTING OUT OF RESONANCE.** These grid coils are of the 3-prong plug-in type. The plate coils are of copper tubing and are mounted on stand-off insulators. They are easily interchangeable for the various bands.

The construction of this transmitter is the simplest ever devised. From the diagram printed in the editorial section of this catalog it can be seen that no grid or filament by-pass condensers are used and that the usual R.F. choke has been omitted from the plate circuit. No benefit was derived from their employment and hence they were not used. The method of coupling the antenna to the output circuit is unique, and is a desirable feature. The antenna suggested for use with this transmitter is the single-wire-feed Hertz. **THE TRANSMITTER IS SUPPLIED WITH A SET OF 160 METER COILS.** Coil sets to cover the other amateur bands had at the addition prices shown below.



## POWER SUPPLY

The power supply to operate this transmitter delivers 400 volts at 150 milliamperes for the plates of the tubes and 2.5 volts for the filaments. A type 83 mercury vapor rectifier is used because of its low voltage drop which permits excellent regulation. The filter consists of a 30 Henry iron-core choke with two 2 mf. 1000 volts condensers on either side. A suitable size bleeder resistor is connected across the output filter to further aid in regulation by suppressing the high voltage peaks when there is no load on the power pack as is the case when the key is in the "off" position. Ship. wt., 8 lbs., for transmitter and 18 lbs. for power pack.

- No. 2121 "R.T." Push-Pull Transmitter, complete with 160 meter coils, but less tubes. **YOUR PRICE \$5.93**
- No. 2122 Power Pack for R.T. Transmitter, less tube, **YOUR PRICE 7.97**
- No. 2123-A Plug-In Coils for 20 Meter Band, **YOUR PRICE 1.77**
- No. 2123-B Plug-In Coils for 40 Meter Band, **YOUR PRICE 1.77**
- No. 2123-C Plug-In Coils for 80 Meter Band, **YOUR PRICE 1.77**

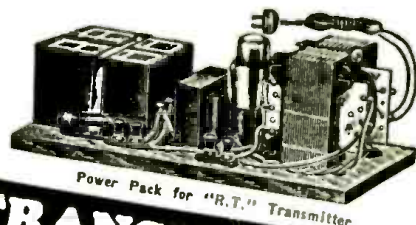

# Popular 1-TUBE "PUSH-PULL" TRANSMITTER

for  
**10 METERS**

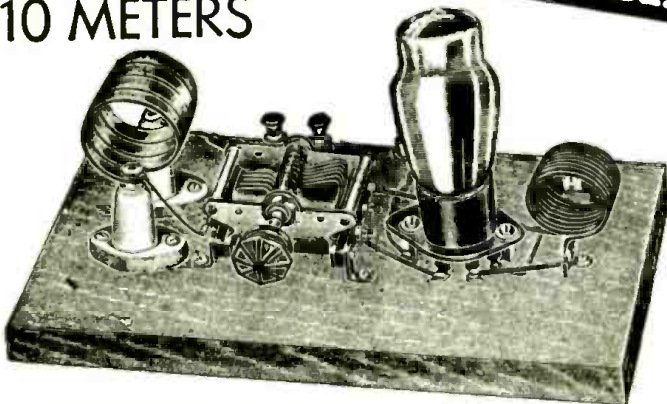

**EXCELLENT FOR PHONE WORK**

A single button microphone can be inserted in series with the grid return lead (using no transformer,) thereby obtaining from 50 to 75% modulation.

### Order From These Pages

Send money order or certified check. C. O. D. only, if 20% remittance accompanies all orders. Order NOW—TODAY.

**FREE** 108 Page Radio and Short Wave Treatise, 1934 Edition. Send 4c postage. Treatise by Return Mail.

Paradoxical as it may sound, this ten meter transmitter **EMPLOYS A SINGLE TUBE IN PUSH-PULL ARRANGEMENT.** Heretofore the word "push-pull" automatically implied the use of two tubes, yet here we are with a one tube push-pull transmitter.

It is the advent of the new type 53 tube, which makes this feat possible. This tube is actually "TWO" tubes, in one glass envelope. It was designed primarily as a class "B" twin amplifier.

This transmitter is not a high power job, for high power is not necessary on ultra short wave work. When properly coupled to a suitable antenna system such as a single-wire-feed Hertz or the familiar "Zeppelin" antenna, it will, under favorable conditions, go a long way. The circuit is of the fixed-tuned grid, tuned plate type and utilizes a solenoid of solid copper ribbon as the plate coil. All component parts are of the highest possible quality, since R.F. losses in ultra short wave work are fatal.

There are any number of uses to which a compact unit of this type may be placed. For instance it can be used as a master oscillator for multi-stage high frequency transmitters OR two such units may be connected together to produce a complete master oscillator—R.F. amplifier transmitter. Neutralizing condenser must be added when used as an R.F. amplifier. The transmitter requires 2 1/2 volts either A.C. or D.C. for the filament of the 53 tube and anywhere from 180 to 350 volts "B" supply. A key measures 11" long x 6 1/4" wide x 6" high overall. Furnished complete with a set of 10 meter coils. Shipping weight 6 mitter less Tube. **YOUR PRICE \$4.47**

# Special A. C. Short-Wave Power Pack

Everyone knows that an A. C. short-wave set is no better than the power pack which supplies its power than the supply for short-wave use must be constructed with extreme care. It must be absolutely free from hum or other disturbances caused by inefficient filtering, poor wiring, or faulty equipment. This unit has a two-section filter circuit, employing two heavy-duty 30 Henry chokes and a tremendous amount of capacity. This assures PURE D. C. with practically no ripple at all. This power pack supplies 250 volts at 50 mills for the plates of the tubes, 22 1/2 volts for the screens, and 2 1/2 volts at 5 amperes, for the filaments. All the component parts of this pack are built into a sturdy metal base. The pack employs a type 280 full-wave rectifier which is inserted in a socket on top of the base. A convenient switch is mounted on the side. The pack is sold complete with four feet of connecting cord, terminating in a standard male plug. Measures 7 1/2" long x 4" wide x 4 1/4" high overall. **Sold complete with #80 tube. Ship. wt. 10 lbs. No. 2149 Short-Wave Power Pack, including \$7.23** 280 tube. **YOUR PRICE**

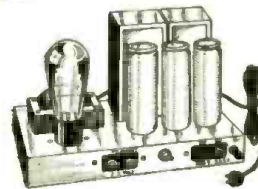

Note the heavy Filtering Section

**RADIO TRADING COMPANY, 100A Park Place, New York City**



# GET ACQUAINTED via Short Waves

## MR. SHORT WAVE LISTENER



### The OSCILLODYNE 1-Tube Wonder Set ABSOLUTELY FOOL-PROOF

Simple directions and blueprints show you how to build and operate the set for best results. It may be used either on A.C. or with batteries. If A.C. is employed, a type 227 tube is used in conjunction with a suitable A.C. power pack (such as the one listed on the opposite page. If batteries are employed, a 237 tube should be used in conjunction with either a storage battery or four No. 6 dry cells and two 45 volt B batteries.

If you have never operated a short-wave set, this is the one with which to start! It is a set which will convince you that foreign stations CAN be tuned in whenever they are on the air.

Its circuit which is of the regenerative variety, acts like a super-regenerative set although it does not belong in that class. Its sensitivity is tremendous.

Here, then, is a set which brings in stations thousands of miles away; a set which frequently brings in Australia, loud enough to rattle your phones, and with power to spare; a set which, if you do not wish extreme distance, will bring in stations several thousand miles away without aerial or ground.

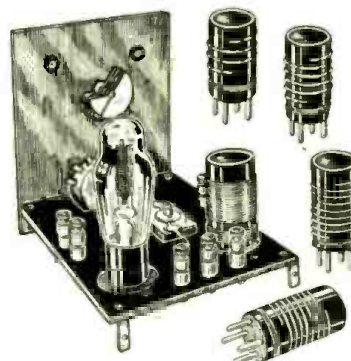

#### SPECIFICATIONS

The set is exactly as illustrated here, size of aluminum panel is 6" high by 4 1/2" wide, base 5 1/2" long by 4 1/4" wide. List of materials used: No. 2116. Official One-Tube Wonder Set, completely wired and tested as per above specifications. **YOUR PRICE \$7.21**

No. 2147. Official One-Tube Wonder Set, but not wired, with blueprint connections and instructions for operation, complete shipping weight 3 lbs. **YOUR PRICE \$6.34**

No. 2148. COMPLETE ACCESSORIES, including the following: one 6 month guaranteed Neontron No. 237 tube; one set No. 1678 Brandes matched headphones; four No. 6 Standard dry cells; two standard 45-volt "B" batteries, complete shipping weight 22 lbs. **YOUR PRICE \$5.51**

### The Twinplex One Tube "Double-Action" Receiver



#### Real Two Tube Performance

It may seem paradoxical when we say that this 1 tube receiver is a 2 tube set, but actually that is so. The type 53 tube employed is the latest to be placed on the market. It contains in one glass envelope, TWO ENTIRELY INDEPENDENT RADIO TUBES which have only their cathodes in common. Hence this receiver is a REAL 2 tube set.

This "2 tube" Twinplex can now be constructed for the same money required to build a 3 tube receiver.

In operation this set is exactly the same as 2 tube regenerative receivers. The results obtained during a week of testing have been exceedingly good. Some of the foreign stations received during this period include EAQ, GIS, GSA, DIC, HKD and ONY. FOR A MAN WHO IS FIRST STARTING IN SHORT WAVES, THIS TWINPLEX RECEIVER IS THE "BEST BET."

The receiver is UNIVERSAL in operation, that is it may be operated either with batteries or an A.C. 110-volt power pack. A plate potential of 180 volts is required. The heater requires 2 1/2 volts either A.C. or D.C. Only high grade parts such as Hammarlund Condensers, etc., are used in the constructions of this set. All component parts are mounted on a cadmium-plated metal chassis, measuring 6" x 9" x 6 1/4"

No. 2115. Twinplex 1 Tube Short Wave Receiver Wired, but less tubes and accessories. Ship. wt. 9 lbs. **YOUR PRICE \$7.50**

No. 2117. ACCESSORIES ONLY—FOR A.C. OPERATION—Including 1 special Hum-Free A.C. Power pack, 1 230 Rectifier tube, 1 53 Tube and one set of matched head-phones. **YOUR PRICE \$10.33**

No. 2118. ACCESSORIES ONLY—FOR BATTERY OPERATION—Including 1 53 Tube, 3 45 volt B Batteries, 4 No. 6 Dry Cells (arranged in series—parallel) and 1 set of matched head-phones. Ship. wt. 15 lbs. **YOUR PRICE \$6.09**

## THE WORLD FAMOUS DOERLE RECEIVERS

### Both A. C. and 2-Volt Battery Sets

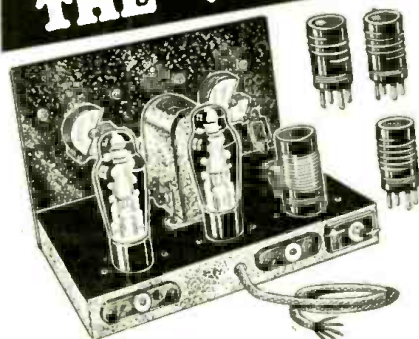

Rear View of Battery 2-Tube Set  
**Battery Doerle Sets**

If you are a constant reader of this magazine, you have probably noticed our consistent advertisements of these famous Doerle receivers. It is no longer necessary to describe them in minute detail. The tremendous sale of these receivers is in itself a fine tribute to their quality and performance.

Two different styles are available, each style having two models. The A. C. TYPE is designed for metropolitan areas where electric service is available. It is obtainable in 2 and 3-tube models, each requiring a power pack such as the one illustrated on the opposite page. The 2 VOLT BATTERY TYPES were designed particularly for rural districts. They, too, are available in 2 and 3-tube models.

There is no question but what these receivers are comparable to, and in many instances even surpass many of the more expensive short wave receivers. Thousands of testimonials in our files laud these sets to the skies. Only the finest parts go into their construction. Stations which you have never heard before will come in clearly and regularly. Yet withal they are extremely simple and therefore absolutely foolproof. All 2-tube models measure 9"x6"x6 1/4"; 3-tube models measure 10 1/2"x7"x8".

## FREE! BOOKS

YOUR CHOICE

of either one of books illustrated here—FREE OF CHARGE—with the purchase of any of the short-wave receivers listed on these pages.

Book No. 866 explains the ways and means of obtaining an amateur transmitting license. Book 830 is a comprehensive compilation of the most prominent short-wave receiver circuits published during a period of two years.



No. 830

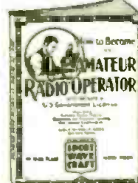

No. 866

- No. 2140. TWO TUBE 12,500 MILE 2-VOLT DOERLE SHORT WAVE RECEIVER, completely wired and tested. Shipping wt. 5 lbs. **\$9.87**
- YOUR PRICE
- No. 2141. Same as above in kit form, with blueprint connections and instructions. Shipping wt. 5 lbs. **\$8.67**
- YOUR PRICE
- No. 2142. COMPLETE ACCESSORIES, including 2 No. 230 tubes; one set of headphones; 2 No. 6 dry cells; 2 standard 45-volt "B" batteries complete. Shipping wt. 22 lbs. **\$5.37**
- YOUR PRICE
- No. 2143. THREE TUBE 2-VOLT DOERLE SET, completely wired, ready for use. **\$12.83**
- YOUR PRICE
- No. 2144. THREE TUBE 2-VOLT DOERLE SET IN KIT FORM, with blueprint connections and instructions. Shipping wt. 7 lbs. **\$11.47**
- YOUR PRICE
- No. 2145. COMPLETE ACCESSORIES, including 2 No. 230 tubes; and one type 34, one set of headphones; 2 No. 6 dry cells; 3 standard 45-volt "B" batteries; 1 B. B. L. 9 inch Magnetic Loudspeaker. Shipping weight, 32 lbs. **\$11.47**
- YOUR PRICE

#### Electrified Doerle Sets

- No. 2174. Electrified 2 Tube 12,500 Mile Doerle Receiver, completely wired and tested, less tubes. Ship. wt. 5 lbs. **\$10.43**
- YOUR PRICE
- No. 2175. Same as above in kit form, less tubes, but including blueprints and instructions. Ship. wt. 5 lbs. **\$9.23**
- YOUR PRICE
- No. 2176. Complete set of tubes for above: either one—57 and one—56 for A. C. operation, or one—77 and one—37 for battery operation. **\$1.58**
- YOUR PRICE
- No. 2177. Electrified 3 Tube Doerle Signal Gripper, completely wired and tested; less tubes. Shipping wt. **\$15.28**
- YOUR PRICE
- No. 2178. Same as above in kit form, including blueprints and instructions; less tubes. Ship. wt. 7 lbs. **\$13.73**
- YOUR PRICE
- No. 2179. Complete set of tubes: either one—58 one—57 and one—56 for A. C. operation or one—78 one—77 and one—37 for battery operation. **\$2.48**
- YOUR PRICE

#### New Crackle Finished Chassis



Front View of all 3-Tube Doerle Receivers

**RADIO TRADING COMPANY, 100A Park Place, New York City**



# NOW READY

The First and Only

New York City.

Gentlemen:  
I received my "Short Wave Radio Manual" and it is a real joy to read and study the book. I waited long for it, but it was worth waiting for. I am introducing it around to all of my friends, and I am glad to own one of these books.  
Yours respectfully,  
(s) Vincent Krainak,  
100 West 119th Street.

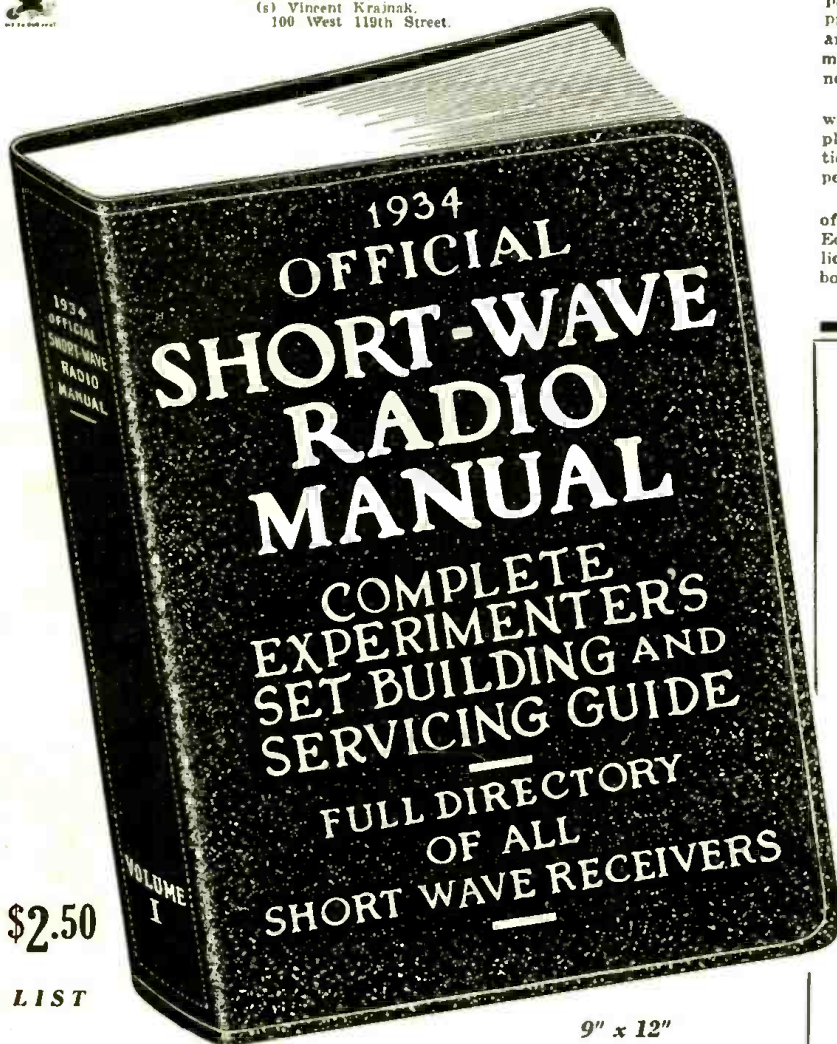

\$2.50

LIST

9" x 12"

Over 240 Big Pages  
Over 1,000 Illustrations  
Flexible, Looseleaf Leatherette Binder

**CLIP — MAIL THIS COUPON TODAY!**

SHORT WAVE CRAFT,  
96-98 Park Place, New York, N. Y. Dept. SWC-5-34

Gentlemen: I enclose herewith my remittance of \$2.50 for which you are to send me, POSTAGE PREPAID, One Copy of the 1934 OFFICIAL SHORT-WAVE RADIO MANUAL. (Send remittance in check or money order. Register letter if it contains cash, stamps or currency.)

Name .....

Address .....

City..... State.....

## Short Wave Manual

WORLD'S GREATEST SHORT WAVE BOOK!

We are proud to present the first modern and complete book on Short Waves which has appeared in the field.

There has been a big boom in short waves during the past two years in spite of the depression. Tremendous progress has been made, but up to now there has not been an adequate book depicting all the progress that has been made. The 1934 OFFICIAL SHORT WAVE RADIO MANUAL now fills this need completely.

It is a big book in which you will find everything on short waves, regardless of what it might be. It is not only a complete manual, but a veritable encyclopedia of facts, information, hookups and illustrations. Lack of space does not permit a complete description of this comprehensive volume.

The Manual has been edited by Hugo Gernsback, Editor of SHORT WAVE CRAFT, and H. W. Secor, Managing Editor. If you are a reader of Mr. Gernsback's other publications, you know just about what to expect from this book—his greatest effort in the short-wave field.

### 15 VALUABLE FEATURES

- 1. A large section featuring the most important Short-Wave Receivers and how to construct them.
- 2. Short-Wave Transmitters in all their phases.
- 3. A complete Ultra Short-Wave Section featuring construction of 1, 3, 5 and 10 meter receivers.
- 4. A complete Short-Wave Beginner's section.
- 5. A section devoted exclusively to coil winding with all information about it.
- 6. A section on Commercial Short-Wave Receivers. Every important commercial receiver, including all-wave sets, is represented. Full servicing data is included which makes it invaluable for Service Men.
- 7. A section devoted to A.C. Short-Wave Power Packs and how to build them. These vary for 1 to 7 tube receivers.
- 8. A section for the Short-Wave Experimenter on short-wave kinks—hundreds of them.
- 9. A section on the important new art of Short-Wave Therapy (treatment of diseases by short waves).
- 10. A section devoted to Short-Wave Converters and their construction. Full servicing data on all commercial models is included.
- 11. A special section on Short-Wave Antennae and noise eliminating procedures.
- 12. A section on Short-Wave Superheterodynes. This section tells how to build them, including many commercial models of receivers. The latter with complete service data.
- 13. A section on Amateur 'Phone Transmitters and how to build them.
- 14. A Short-Wave Physics section on theoretical short-wave data for the advanced experimenter and radio student.
- 15. A most interesting section on Super-Regeneration in Short-Wave Receivers.

# ATWATER KENT RADIO

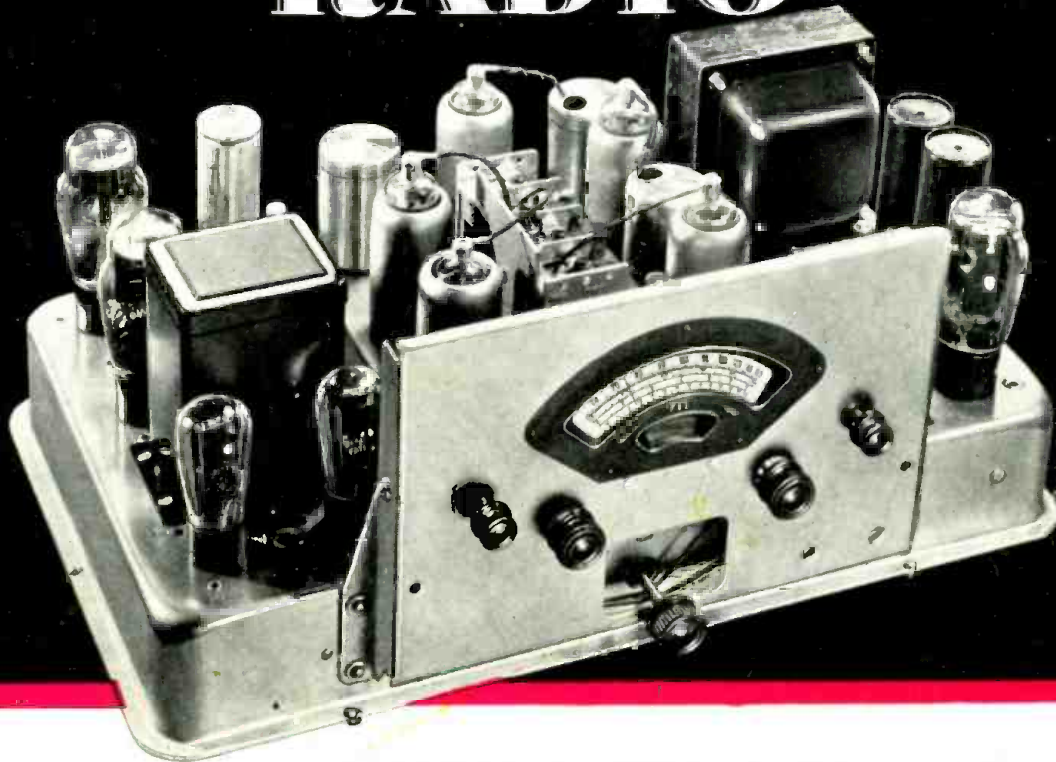

## Announcing THE WORLD'S FINEST ALL-WAVE RADIO

**F**OR distant reception you need the finest precision workmanship to give TRUTHFUL reproduction of a broadcast. The slightest deviation—an eighth of a turn on a R. F. coil, or one loosely soldered wire—might not be noticed if you were tuned in on a local station, but it might easily ruin a broadcast from Germany.

The weakness of a signal from half way around the globe makes it imperative that "losses" in the set be held to a minimum, which is one of the chief reasons why

Atwater Kent Radios are so favored by short wavers.

The painstaking care with which every Atwater Kent Radio is built reaps its full reward when you tune in Siam or the Argentine and hear all the sparkle and color of their native music reproduced with lifelike realism.

Add to the dependable satisfaction of an Atwater Kent for regular programs, the exciting luxury of truthful short wave reception—and you have everything that radio has to offer.

ATWATER KENT MANUFACTURING CO.

A. Atwater Kent, Pres.

4700 Wissahickon Ave., Philadelphia, Pa.

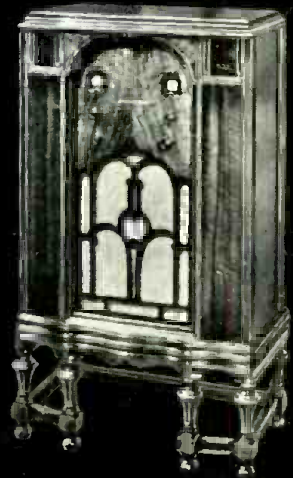
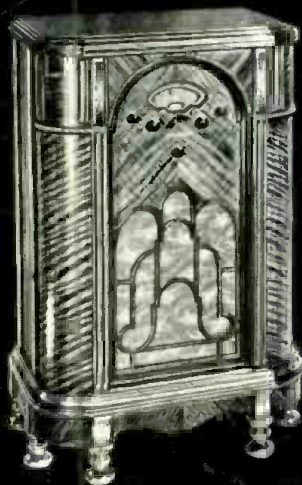

● *At left* MODEL 711-J (11 tubes) tuning range from 540 to 23,000 kilocycles, 4-point switch for wave lengths, visual shadow tuning, auditorium type speaker, 15 watts undistorted output, 4-gang condenser, 10 tuned circuits. For truthful reproduction of broadcast throughout entire range of sound, it is the finest radio ever sold commercially! **\$135**

● *Above* MODEL 708 (8 tubes). Contains same set as model 808, entire, 8½-inch electro-dynamic speaker has full acoustical area. Cabinet is 15¾ inches wide. **\$68.50**

● *At right* MODEL 808 (8 tubes) range from 540 to 20,000 kilocycles, 4-point switch for wave lengths, 11-inch speaker, 3 watts output, 4-gang condenser, 8 tuned circuits on broadcasting band, 9 on short wave band. All 8 tubes function at full power throughout the tuning range. **\$88**

All prices F.O.B. Philadelphia—subject to change without notice



I saved 1/2 by buying direct from the Midwest Laboratories

Yes, and it gives you WORLD-WIDE Reception!

Amazing New SUPER Deluxe

16-TUBE ALL-WAVE Radio 9 TO 2,000 METERS

30 DAYS FREE TRIAL



WRITE FOR NEW FREE CATALOG



**B**EFORE you buy any radio, write for this big new FREE Midwest catalog... printed in four colors. It has helped thousands of satisfied customers save from 1/3 to 1/2 on their radios... by buying direct from the Midwest Laboratories. You, too, can make a positive saving of 30% to 50% by buying a Midwest 16-tube deluxe ALL-WAVE radio at sensationally low direct-from-laboratory prices. You'll be amazed and delighted with its super performance! Broadcasts from stations 10,000 miles and more away are brought in... "clear as locals". You get complete wave length coverage of 9 to 2,000 meters (33 megacycles to 150 KC). Now, you can enjoy the new DX-ing hobby... and secure verifications from world's most distant stations.

These bigger, better, more powerful, clearer-toned, super-selective radios have FIVE distinct wave bands: ultra-short, short, medium, broadcast and long... putting the whole world of radio at your finger tips. Now listen in on all U. S. programs... Canadian, police, amateur, commercial, airplane and ship broadcasts... and programs from the four corners of the earth. Thrill to the chimes of Big Ben from GSB, at Daventry, England—tune in on the "Marseillaise" from FYA, Pointoise, France—hear sparkling music from EAQ, Madrid, Spain—listen to the call of the Kookburra bird from VK2ME, Sydney, Australia—etc. Never before so much radio for so little money! Write for FREE catalog.

WORLD'S GREATEST RADIO VALUE  
\$49.50 with New Deluxe Auditorium Type SPEAKER

... 40 NEW 1934 FEATURES ...

Try this Midwest radio... in your own home... for thirty days before you decide. See for yourself the 40 new 1934 features that insure amazing performance. Other features include: Automatic Select-O-Band, Amplified Automatic Volume Control, 16 New Type Tubes, Balanced Unit Superheterodyne Circuit, Velvety Action Tuning, Super-Power Class "A" Amplifier, 29 Tuned Circuits, New Duplex-Diode-High Mu Pentode Tubes, No-Image Heterodynes, Full Rubber Floated Chassis, Variable Tone Blender, Centralized Tuning, 7 KC Selectivity, New Thermionic Rectifier, Automatic Tone Compensation, Auditorium Type Speaker, etc. These features are usually found only in sets selling from \$100 to \$150.

**AMAZING FOREIGN RECEPTION**

AKRON, OHIO—My Midwest 16 is a real getter for distance. Received 205 stations on regular wave band... including U.S., Canadian, Mexican, Cuban and Hawaiian stations. Also many police, airport and "ham" stations from all over the country. Have logged England, France, Germany, Madrid, Rome, on 15-30 meter band. South American stations include Venezuela, Colombia, Brazil, Yucatan.—L.H. MOELLER, 793 N. South St.

**DEAL DIRECT WITH LABORATORIES**  
Increasing costs are sure to result in higher radio prices soon. Buy before the big advance... NOW, while you can take advantage of Midwest's amazingly low prices. No middlemen's profits to pay! You save from 30% to 50% when you buy direct from Midwest Laboratories... you get 30 days FREE trial—as little as \$5.00 down puts a Midwest radio in your home. Satisfaction guaranteed or your money back! FREE catalog shows sensational radio values. Write TODAY!

**SAVE UP TO 50%**

**TERMS AS LOW AS \$5.00 DOWN**

**NEW STYLE CONSOLES**

Write quickly for your FREE copy of the new Midwest catalog. It pictures a complete line of beautiful, artistic de luxe consoles and chassis... in four colors! Sensational low prices save you 30% to 50%. Also shows performance curves that prove Midwest radios out-perform most of the \$150 sets. You can order your Midwest radio from this catalog with as much certainty of satisfaction as if you were to select it personally at our great radio laboratories. Write TODAY!

**MAIL COUPON TODAY! FOR AMAZING 30-DAY FREE TRIAL OFFER AND NEW 1934 CATALOG**

MIDWEST RADIO CORP., Dept. 381 Cincinnati, Ohio.

Without obligation on my part send me your new FREE 1934 catalog, and complete details of your liberal 30-day FREE trial offer. This is NOT an order.

AGENTS Make Easy Extra Money Check Here for Details

Name.....  
Address.....  
City..... State.....

**MIDWEST RADIO CORP.**  
DEPT. 381 — CINCINNATI, OHIO, U. S. A.  
Est. 1920 Cable Address: MIRA ABC 1th Edition