

THE RADIO EXPERIMENTER'S MAGAZINE

SHORT WAVE CRAFT

Edited by
HUGO GERNSBACK

1933

*Best Short Wave
Station List
of the World*

**When to hear
the
Foreign Stations**

*ALL IN THIS
ISSUE*

NOW
25¢
IN CANADA
30¢

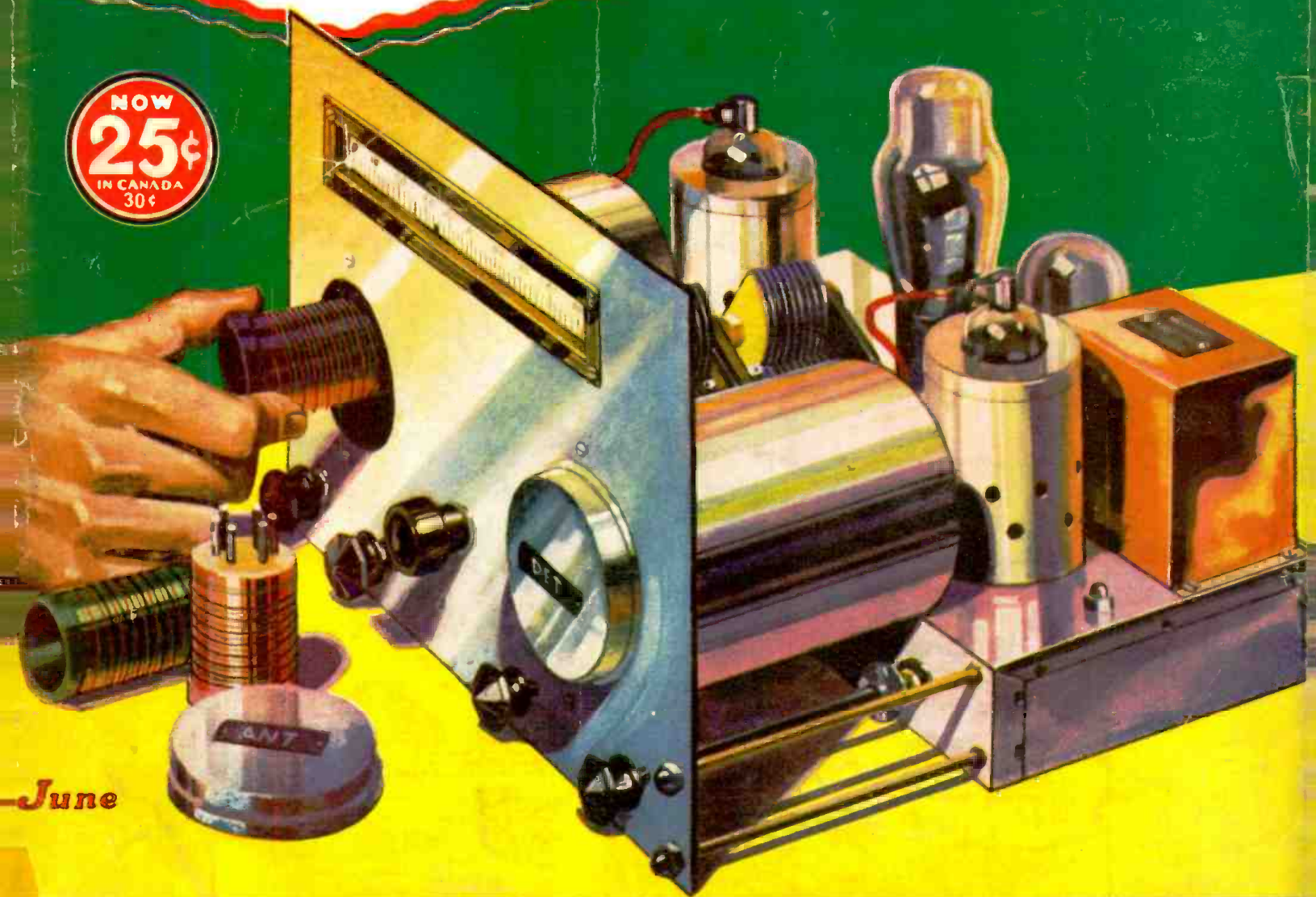

June

The 4-Tube "MASTER COMPOSITE" Set YOU Voted For - See Page 80

ORDER DIRECT FROM THIS PAGE

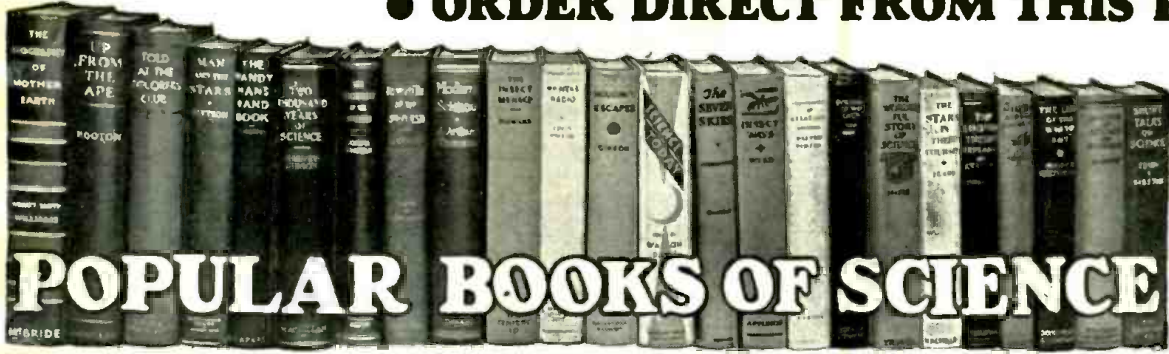

We herewith present the most complete collection of really important popular science books. We have, after some exhaustive study, selected these volumes because they represent the foremost books of their kind in print today. There is such a great variety that we are sure you will find any topic as well as any requirement of the student of science.

We publish an catalogue and ask you to be kind enough to order from the publishers. Prompt shipments will be made to you direct from the publishers. We merely act as a clearing house for a number of publishers and OUR PRICES ARE AS LOW AS POSSIBLE. FIND ANYWHERE Remitt by money order or certified check.

POPULAR BOOKS OF SCIENCE

THIS LIST CHANGED MONTHLY. NOTE NEW LOW PRICES

ASTRONOMY
MAN AND THE STARS, by Harlan T. Station. Cloth covers, size 5 1/2 x 8 1/4, 221 pages illus- \$2.50
 The story of the adventure of astronomy, from the days when primitive man began wondering about the meaning of the heavens, through the work of the great pioneers of the science to the present day. Profoundly exciting.

THE UNIVERSE AROUND US, by Sir James Jeans. Cloth covers, size 5 1/2 x 8 1/4, 351 pages. \$4.50
 24 illustrations. Price. A non-technical book which reveals through the mysteries of modern physics and astronomy, opening up new vistas for the imagination. The very latest word in physical science. A marvelous work.

THE STARS IN THEIR COURSES, by Sir James Jeans. Cloth covers, size 5 1/2 x 8 1/4, 172 pages, 50 illustrations and maps. \$2.50
 Price. Modern astronomy and the wonders of the universe as seen through the giant telescopes of today. An informal conversational style, and simple language has been retained.

POPULAR ASTRONOMY, by Camille Fleming. Cloth covers, size 5 1/2 x 8 1/4, 696 pages. \$6.00
 291 illustrations. Price. A general description of the heavens written in an interesting and lucid manner for those who wish to acquire a knowledge of astronomy without technicalities.

AVIATION
WINGS OF TOMORROW, by de la Cierva. Cloth covers, size 8 1/2 x 5 1/4, 284 pages, 31 illustrations. \$2.50
 Price. When the inventor of the most revolutionary aircraft—the autogyro—speaks, we listen with respect. This book is a notable contribution to air transport set forth interestingly and convincingly.

CHEMISTRY
THE AMATEUR CHEMIST, by A. Frederick Collins. Cloth covers, size 5 1/2 x 8 1/4, 210 pages. 77 \$1.50
 illustrations. Price. An extremely simple but thoroughly practical chemistry book. A vast amount of practical information is given, also how to make and do things which will save time and money.

EXPERIMENTAL CHEMISTRY, by A. Fred Collins. Cloth covers, size 5 1/2 x 8 1/4, 108 \$2.00
 illustrations. Price. Here is a book that approaches the fascinations of chemistry in a new way. Contains a vast store of interesting and unusual material. THE book for experimenters.

HOW TO UNDERSTAND CHEMISTRY, by A. Frederick Collins. Cloth covers, size 5 1/2 x 8 1/4, 322 pages, numerous illustrations. \$2.00
 Price. A clear, simple but entertaining book on the wonders of modern chemistry. It explains matter and its make-up, discusses common elements, shows what the symbols of chemistry are and how they are used and gives countless other interesting information.

POPULAR CHEMISTRY EXPERIMENTS, by John H. Winn. Cloth covers, size 10 x 8 1/4, 80 pages, 323 experiments, 100 ill- \$1.50
 illustrations. Price. Absolutely for Junior Chemists. Contains over 300 experiments, all explained clearly and simply. How to make safe fire-

works, inks and paints, glass blowing, food analyses and electroplating are but a few of the experiments. The clearest and newest book on the subject

ELECTRICITY
THE BOOK OF ELECTRICITY, by A. Frederick Collins. Cloth covers, size 5 1/2 x 8 1/4, 185 \$1.50
 pages. Price. With the aid of this book, anyone may enjoy the fascination of conducting electrical experiments and learn the fundamental principles of electricity. Contains an abundance of useful information.

PRACTICAL ELECTRICS, Cloth covers, size 7 1/2 x 5, 135 pages, 126 illustrations. \$0.75
 Price. A universal handy book on every-day electrical subjects. Covers among its subjects: alarms, batteries, bells, induction, intensity and resistance coils, microphones, motors, photophones, dynamo electric machines, telephones and storage batteries, all written in a clear and simple manner. Just the book for the young electrician.

THE WIMSHURST MACHINE, by A. W. Marshall. Cloth covers, size 5 1/2 x 11 1/2, 112 pages, 30 illustrations and drawings. \$0.75
 Price. A Practical Handbook on the Construction and Working of the Wimshurst (Static) Machine, including Radiography, Wireless Telegraphy, and many Static Electrical Apparatus. Written in simple language for the experimenter. Only book of this kind.

INDUCTION COILS, by H. S. Norris. Cloth covers, size 7 1/2 x 5 1/4, 259 pages, 79 illustrations. \$1.50
 Price. Practical handbook on the construction and use of medical and spark coils. Also includes construction data on Ruhmkorff, Tesla coils, etc., Roentgen radiography, wireless telegraphy, and practical information on primary and secondary batteries. An excellent experimenter's volume.

HOW TO INSTALL ELECTRIC BELLS, ANNUNCIATORS AND ALARMS, by N. H. Schneider. Cloth covers, size 7 1/2 x 5, 83 pages, 10 illustrations. \$0.75
 Price. This book was written to explain in practical language how an electric bell operates and how they are installed. Includes such subjects as batteries, wires and wiring, burglar alarms, fire alarms, interphone house sets, etc. Worth its weight in gold.

GENERAL SCIENCE
TWO THOUSAND YEARS OF SCIENCE, by R. J. Harvey-Gibson. Cloth covers, size 5 1/2 x 8 1/4, 522 pages, fully illustrated. \$3.50
 Price. This authoritative work is meeting one of the greatest Science needs of the general reader. Fascinating histories of the great inventors and discoveries with lucid explanations of their work.

EXPERIMENTAL SCIENCE, by A. Frederick Collins. Cloth covers, size 5 1/2 x 8 1/4, 280 pages, 152 \$2.00
 illustrations. Price. A wealth of outstanding and surprising experiments are to be found in this book. Not only vastly entertaining, but also highly instructive. The book for amateurs.

SCIENCE TODAY, by Watson Davis. Cloth covers, size 5 1/2 x 8 1/4, 310 pages. \$2.50
 Price. 48 brief talks about the latest things

Science has found out—about the sun, moon, stars, the earth, light, electricity, the weather, germs, the past of man, and dozens of other absorbing topics.

INVENTION
THE PSYCHOLOGY OF THE INVENTOR, by Joseph Roseman. Pb. D. Cloth covers, size 5 1/2 x 8 1/4, 252 pages, 13 illustrations. \$3.00
 Price. A comprehensive picture of the inside of the inventor's mind. Observations from 710 prominent inventors are quoted. Many absorbing topics discussed, also facts never before in print. No inventor should miss it.

PATENTS, INVENTIONS, by F. B. Wright. Paper covers, size 7 1/2 x 5, 108 pages, 1 plate. \$0.35
 Price. A practical and up-to-date guide for inventors and patentees. How to protect, sell and buy inventions is also thoroughly discussed. Discusses all patent questions and shows you the pitfalls of most inventors.

MECHANICS
EXPERIMENTAL MECHANICS, by A. Frederick Collins. Cloth covers, size 5 1/2 x 8 1/4, 302 pages, 167 illustrations. \$2.00
 Price. The most fascinating book on mechanics. Chuck full with experiments you can make; all mechanical lock and clock movements, as well as perpetual motion in profusion.

THE HANDY MAN'S BOOK, by C. T. Schneider, M. E. Cloth covers, size 6 1/2 x 5, 341 pages, 14 \$4.00
 illustrations and diagrams. Price. A complete manual covering every phase of repair and maintenance work in the home, factory, office and farm, readily understood and applied by the non-professional worker. A fine book.

THE HOME HANDY BOOK, by A. Frederick Collins. Cloth covers, size 5 1/2 x 8 1/4, 165 pages, ill- \$1.50
 illustrations. Price. This book tells with many illustrative diagrams, how to do the thousand and one odd jobs around the house which need to be done.

MISCELLANEOUS
HOUDINI'S ESCAPES, by Walter Gibson. Cloth covers, size 5 1/2 x 8 1/4, 315 pages, illustrated. \$3.00
 Price. The first and only authentic record of the actual methods devised and used by Houdini. Explains his modern miracles in non-technical language. Learn how this master accomplished the impossible!

NEW AND ORIGINAL MAGIC by Edward M. Massey. Cloth covers, size 8 1/2 x 5 1/4, 205 pages, 29 illustrations. \$3.00
 Price. A fund of information for the professional artist and his younger brother, the amateur. It comprises numerous novel and entertaining magic aids. A permanent text and guide for the worker in magic and mystery. Don't miss this.

How to order
 We cannot ship C.O.D. Our prices are net, as shown. Please include sufficient postage, for Parcel Post, otherwise books must be shipped by express collect.

MICROSCOPY AND PHOTOGRAPHY
SCIENCE AND PRACTICE OF PHOTOGRAPHY, by John R. Roebuck. Cloth covers, size 5 1/2 x 8 1/4, 298 pages, 52 illustrations. \$2.50
 Price. A practical book for the professional and amateur. Covers thoroughly and logically the entire elementary ground of photography. Invaluable information and suggestions.

SEXOLOGY
THE SEXUAL SIDE OF MARRIAGE, by M. J. Essex, M. D. Cloth covers, size 5 1/2 x 8 1/4, 252 pages, illustrated. \$2.50
 Price. An understandable book free from sentiment or hypocrisy, for those who seek marriage at its best. Deals frankly with intimate marriage relationships, especially at crucial points where ignorance and misinformation are often disastrous.

SEXUAL IMPOTENCE, by Dr. Wm. J. Robinson. Cloth covers, size 5 1/2 x 8 1/4, 502 pages, 18 \$3.00
 illustrations. Price. The most complete book obtainable on this important subject. Explains symptoms and causes of impotence, sterility, and frigidity. Gives practical advice for treatment and sure; with other valuable sex knowledge.

COMPLETE BOOK OF SEX KNOWLEDGE, by Dr. Bernard Bernard. Cloth covers, size 7 1/2 x 5, 331 pages. \$2.75
 Price. At last here is the book which dispenses with conventionalism in the discussion of sex. It is a book which solves the problem. Not a single side of the sex question that has not been fully treated.

SEX CONDUCT IN MARRIAGE, by Dr. Bernard Bernard. Cloth covers, size 7 1/2 x 5 1/4, 218 \$1.75
 pages. Price. Answers simply and directly intimate questions which the author has been called upon innumerable times to answer. A sound understanding of sex conduct in marriage by simple, straight-forward explanations. A most valuable book.

WOMEN, HER SEX AND LOVE LIFE, by Dr. William J. Robinson. Cloth covers, size 5 1/2 x 8 1/4, 411 pages, numerous anatomical illustrations. \$3.00
 Price. A real book dealing with intimate relations of woman's sex and love life. Full of practical information of vital importance to every woman, and through her to every man.

SANE SEX LIFE AND SANE SEX LIVING, by Dr. H. W. Long. Cloth covers, size 5 1/2 x 7 1/4, 151 pages. \$2.00
 Price. Absolutely the plainest book ever written on the sexual intimacies of marriage. Ignores no details, goes into every subject frankly and gives the most complete and practical information ever contained between two covers. Endorsed by such men as Havelock Ellis, Geo. S. Wilson and Dr. W. F. Robie.

MARRIED LOVE, by Dr. Marie C. Stoppes. Cloth covers, size 5 1/2 x 7 1/4, 190 pages. \$1.00
 Price. Over 800,000 copies of this famous book have been sold already. It is one of the most lucid, most delicate and most helpful books ever written on the vital subject of the intimate contacts of love in marriage. In lifting the ban on this book Judas Wolsey has given the people a great work.

THE BOOK OF THE MICROSCOPE, by A. Frederick Collins. Cloth covers, size 5 1/2 x 8 1/4, 245 pages, 71 illustrations. \$1.50
 Price. Simple but vivid descriptions of all the wonderful fascinating uses of the microscope. Plant and animal life, curious hygiene facts, the microscope in criminal investigation are but a few of the subjects discussed. Splendid for experimenters. The only book of its kind in print.

LOVE, A TREATISE ON THE SCIENCE OF SEX ATTRACTION, by Dr. Bernard B. Talmy. Cloth covers, size 5 1/2 x 8 1/4, 438 pages, 131 illustrations. \$3.00
 Price. Because of the thoroughness and completeness of its contents the sale of this volume was restricted to physicians. It is now available to men and women who desire the real truth and the intimate details about sex and love.

SEXUAL TRUTHS, by Dr. William J. Robinson. Cloth covers, size 5 1/2 x 8 1/4, 400 pages. \$3.00
 Price. One of the most unique books ever printed. It is an answer to the requests from sane, sensible people for the honest, straight forward information they cannot find elsewhere. Don't be without a copy of this fascinating and daring book.

BIRTH CONTROL, OR THE LIMITATION OF OFFSPRING, by Dr. William J. Robinson. Cloth covers, size 5 1/2 x 8 1/4, 262 pages. \$2.00
 Price. This book on the burning question of the day has been written by a pioneer in Birth Control. It is he who advocated the movement to permit husbands and wives to decide for themselves how large their families should be.

SEX KNOWLEDGE FOR MEN AND BOYS, by Dr. William J. Robinson. Cloth covers, size 5 1/2 x 7, 262 pages. \$2.50
 Price. This is the one book that every man and youth, conscious of his responsibilities and health should read. An excellent program for the sex education of the boy makes it a doubly valuable book to parents.

SEX, LOVE AND MORALITY, by Dr. William J. Robinson. Cloth covers, size 5 1/2 x 7, 157 \$3.00
 pages. Price. Here is the book which dare to be different. After a quarter of a century of daily experience, this author concludes that the present-day conception of love, sex and morality is wrong. In this pioneer book he outlines a rational code of sexual ethics which liberal and intelligent people will be eager to accept.

MARRIED LIFE AND HAPPINESS, by Dr. William J. Robinson. Cloth covers, size 5 1/2 x 8, 250 \$3.00
 pages. Price. Here is a book that every husband should read and see that his wife reads it too. For genuine lasting usefulness, a better book for women has never been written than this fascinating volume. Every page is crowded with advice and information.

AMERICA'S SEX AND MARRIAGE PROBLEMS, by Dr. William J. Robinson. Cloth covers, size 5 1/2 x 8, 500 pages. \$3.00
 Price. Never before have you read any book so daring and so outspoken. Facts proved by over 200 cases taken from actual experience.

SCIENCE PUBLICATIONS 94SW Park Place New York, N.Y.

We can get ANY book in Science or Mechanics, Radio, etc. Just furnish us with Title and Author or tell us in which topic you are interested.

I Will Show You Too

How to Start a Spare Time or Full Time Radio Service Business



J. E. SMITH, President National Radio Institute

The man who has directed the Home-Study Training of more men for the Radio industry than any other man in America.

Here are a few examples of the kind of money I train "my boys" to make

\$50 to \$75 a Week



"The National Radio Institute put me in a position to make more money than I ever made in good times. I am in the Radio service business for myself, where it is possible for me to make from \$50 to \$75 a week. Service work has increased because people, who in normal times would buy a new Radio, now are contented to have the old one 'pepped up'."—BERNARD COSTA, Box 83, Station "G," Brooklyn, N. Y.

\$500 a Year Extra in Spare Time



"Although only doing spare-time Radio work, I averaged about \$500 extra a year in addition to my regular income. Full-time Radio work would net me many times that amount. My example and that of hundreds of other N. R. I. graduates should convince any skeptical person of the superiority of N. R. I. training."—EDWARD H. FAWCETT, Slough Road, Ladner, B. C., Canada.

Averages \$80 per month in Spare Time



"I am getting along well in my Radio work, always being kept very busy. Since enrolling I have averaged around \$80 a month working on Radios just part time, since I am still holding down my regular job in a shoe factory."—JOHN R. MORISSETTE, 733 Somerville St., Manchester, N. H.

My Free book gives you many more letters of N. R. I. men who have made good in spare time or full time businesses of their own

SPECIAL Radio Equipment for Broad Practical Experience Given Without Extra Charge

My course is not all theory. I'll show you how to use my special Radio equipment for conducting experiments and building circuits which illustrate important principles used in such well-known sets as Westinghouse, General Electric, Philco, R. C. A., Victor, Majestic and others. You work out with your own hands many of the things you read in our lesson books. This 50-50 method of training makes learning at home easy, interesting, fascinating, intensely practical. You learn how sets work, why they work, and how to make them work when they are out of order.

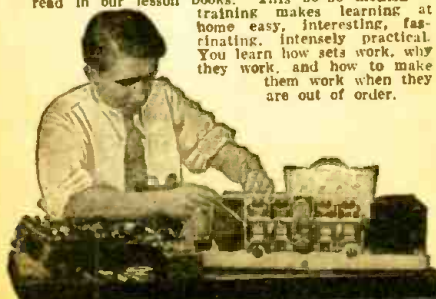

Without Capital

The world-wide use of Radio sets for home entertainment has made many opportunities for you to have a spare-time or full-time Radio business of your own. I give you instructions early in your course for doing 28 Radio jobs common in every neighborhood. Many N. R. I. men make \$5, \$10, \$15 a week extra in spare time almost at once. I show you how to install and service all types of receiving sets. I give you Radio equipment and instructions for conducting experiments, for building circuits and testing equipment, and for making tests that will give you broad, practical Radio experience. Clip the coupon below and get my free 64-page book, "Rich Rewards in Radio"—it gives you a full story of the success of N. R. I. students and graduates, and tells how to start a spare-time or full-time Radio business of your own without capital.

Many N. R. I. Men Make \$5, \$10, \$15 a week Extra Servicing Sets in Spare Time

Many of the more than sixteen million sets now in use are only 25 per cent to 40 per cent efficient. I will show you how to cash in on this condition. I will show you the plans and ideas that have enabled many others to make \$5, \$10, \$15 a week in spare time while learning. Ford R. Leary, 1633 Davison Road, Flint, Mich., wrote: "My part-time earnings while taking the N. R. I. course were \$651."

Get Ready Now for a Radio Business of Your Own and for Jobs Like These

Broadcasting stations use engineers, operators, station managers, and pay up to \$5,000 a year. Radio manufacturers use testers, inspectors, foremen, engineers, service men and buyers, and pay up to \$6,000 a year. Radio dealers and jobbers employ hundreds of service men, salesmen, managers, and pay up to \$100 a week. Radio operators on ships enjoy life, see the world, with board and lodging free, and get good pay besides. Talking Movies pay as much as \$75 to \$200 a week to

the right men. My book tells you of the opportunities in Radio, Talking Movies, Set Servicing, Aircraft Radio, Television, Police Radio, Short Wave and other fields. Get it.

I Will Train You at Home in Your Spare Time

Hold your job until you're ready for another. Give me only part of your spare time. You do not need a high school or college education. Hundreds with only a common school education have won bigger pay through N. R. I. J. A. Vaughn jumped from \$35 to \$100 a week. J. E. McLaurine increased his earnings 100 per cent. The National Radio Institute is the Pioneer and World's Largest Organization devoted exclusively to training men and young men by Home Study for good jobs in the Radio industry.

You Must Be Satisfied

I will give you an agreement to refund every penny of your money if you are not satisfied with my Lessons and Instruction Service when you complete my course. And I'll not only give you thorough training in Radio principles, practical experience in building and servicing sets, but also Advanced Training in any one of five leading branches of Radio opportunities.

Free Book of Facts

Mail the Coupon for "Rich Rewards in Radio." It's free to residents of the U. S. and Canada over 15 years old. It tells of the special training I give you that has made hundreds of men successful; and explains the many fine jobs for which my course trains you. Mail coupon in envelope or paste on post card.

J. E. SMITH, Pres., Dept. 3FB3 National Radio Institute, Washington, D. C.

Get my new book It points out what Radio Offers You



Special Free Offer

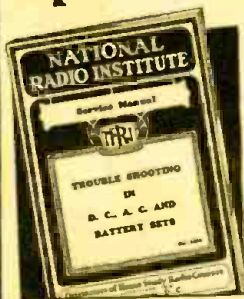

Act now and receive in addition to my big free book, "Rich Rewards in Radio," this Service Manual on D.C., A.C., and Battery operated sets. Only my students could have this book in the past. Now readers of this magazine who mail the coupon will receive it free. Overcoming hum, noises of all kinds, fading signals, broad tuning, howls and oscillations, poor distance reception, distorted or muffled signals, poor Audio and Radio Frequency amplification and other vital information is contained in it. Get a free copy by mailing the coupon.

THIS COUPON IS GOOD FOR ONE FREE COPY OF MY NEW BOOK

mail it TODAY

J. E. SMITH, President, National Radio Institute, Dept. 3FB3, Washington, D. C.

Dear Mr. Smith: I want to take advantage of your Special Free Offer. Send me your two books, "Trouble Shooting in D.C., A.C. and Battery Sets" and "Rich Rewards in Radio." I understand this request does not obligate me. (Please Print Plainly)

Name _____ Age _____

Address _____

City _____ State _____

"M"

The Famous Course That Pays For Itself

IN THIS ISSUE: PROMINENT SHORT-WAVE AUTHORS
Worcester • Shuart • Denton • Hunter • Vette • Palmer



HUGO GERNSBACK
 Editor

H. WINFIELD SECOR
 Managing Editor

CONTENTS FOR JUNE, 1933

FEATURES:

Editorial—Patience in Short Wave Tuning, by Hugo Gernsback	69
Short Waves Valuable Aid to Vienna Police.....	70
League of Nations Station at Geneva, by Miss Constance Drexel.....	71
“Java” and other stations hot from the “Percolator” Receiver, by Percy T. Booth.....	72
A Simple 5-Tube S-W Superhet, by A. H. Matthews.....	73
A 5-Tube deLuxe Oscillodyne A.C. Receiver, by J. A. Worcester, Jr.....	74
A 3-Tube Band Spread, Loud Speaker Set, by George W. Shuart, W2AMN-W2CBC.....	76
A “Dual Regeneration” Control Set, by H. Winfield Secor	78
The 4-Tube “Master Composite”—The Set YOU Voted For, by Clifford E. Denton.....	80
A 4-Tuber That “Brings Home The Bacon,” by Dr. A. S. Hunter.....	84
\$500.00 Prize Contest—List of Prizes and Rules.....	85
The “Voyager” 2-Tube Receiver, by C. E. Denton.....	86
The “Super-Wasp” Becomes A “Superhet,” by William Vette.....	88
New 2-Tube Short-Wave Converter.....	90
S-W Receiver Works on 110 Volts A.C. or D.C.....	90
This Power Supply Unit Uses New 25-Z-5 Tube, By C. E. Denton.....	91
Mr. Ingram Adds A “Power Unit” To His de Luxe Receiver	92
A Multi-Wave 7 Tube Receiver with Band-Selector Switch	94
A “T.N.T.” Transmitter for 160 Meters, by Hal Sullivan, W1AAD.....	95
A “Humless” Power Supply.....	95
“Ham” Radio Foils Ransom Plot, by A. D. Middleton, W8UC-W4CA	96
The Short-Wave Beginner, by C. W. Palmer.....	98
\$5.00 For Best Short Wave Kink, Monthly.....	99
SHORT WAVE STATIONS OF THE WORLD—“Grand List”.....	100
Letters From S-W Fans.....	104
Short Wave League, by Robert Hertzberg.....	105
Short-Wave Question Box, edited by R. William Tanner	106

FEATURES IN NEXT ISSUE

The “Ace High” Band-Spread 3, by Howard McEntee.
 The Electrified A.C. “Doerle” 3-Tuber.
 A “Band-Spread” S-W Converter, by George Shuart, W2AMN-W2CBC.
 3 New English S-W Circuits.
 An Efficient “Tapped-Coil” S-W Receiver, by C. E. Denton.
 Ultra Short Waves Guide Planes in “Blind Landing.”
 Plenty of 2- and 3-tube sets for the beginner.
 New Digest of European S-W Circuits, by C. W. Palmer.



Certified Circuits

● **SHORT WAVE CRAFT** goes to a large expense in verifying new circuits published in this magazine. Whenever you see the seal shown here in connection with any of the sets published in this and future issues of **SHORT WAVE CRAFT**, this will be your guarantee that this set has been tested in our laboratories, as well as privately, in different parts of the country to make sure that the circuit and selected parts are right. Only “Constructional-Experimental” circuits are certified by us.

When you see our certificate seal on any set described you need not hesitate in spending money for parts, because you are assured in advance that the set and circuit are bona fide and that this magazine stands behind it.

SHORT WAVE CRAFT is the only magazine that thus certifies circuits and sets.

OUR COVER

This month’s cover shows the handsome appearing and fine working “Master Composite” Receiver which represents the majority of the features recently voted upon by our readers. Full illustrated description appears on page.....80.

COPYRIGHT, 1933, BY H. GERNSBACK

Published by **POPULAR BOOK CORPORATION**

HUGO GERNSBACK, President - - **H. W. SECOR**, Vice-President
EMIL GROSSMAN - - - - - Director of Advertising
 Chicago Adv. Office - - - **L. F. McCLURE**, 737 No. Michigan Blvd.
 Publication Office - - - 404 N. Wesley Avenue, Mount Morris, Ill.
 Editorial and General Offices - - 96-98 Park Place, New York, N. Y.
 London Agent: **HACHETTE & CIE.**, 16-17 King William St., Charing Cross, W.C.2

Paris Agent: **HACHETTE & CIE.**, 111 Rue Reaumur
 Australian Agents: **McGILL'S AGENCY**, 179 Elizabeth St., Melbourne

SHORT-WAVE CRAFT—Monthly. Entered as second class matter May 7, 1930, at the post office at Mount Morris, Illinois, under the act of March 3, 1879. Trademarks and copyrights by permission of H. Gernsback, 98 Park Place, N. Y. C. Text and illustrations of this magazine are copyrighted and must not be reproduced without permission. **SHORT WAVE CRAFT** is published on the 15th of every month. Twelve numbers per year. Subscription price is \$2.50 a year in the United States and possessions. Canada and foreign countries, \$3.00 a year. Single copies 25c. Address all contributions for publication to Editor, **SHORT WAVE CRAFT**, 96-98 Park Place, New York, N. Y. Publishers are not responsible for lost manuscripts. Contributions cannot be returned unless authors remit full postage. **SHORT WAVE CRAFT** is for sale at all principal newsstands in the United States and Canada. European agents: Brentano's, London and Paris. Printed in U. S. A. Make all subscription checks payable to Popular Book Corporation.

LEARN RADIO IN 10 WEEKS!

PAY FOR YOUR TRAINING AFTER YOU GRADUATE

I am making an offer that no other school has dared to do. I'll take you here in my shops and give you this training and you pay your tuition after you have graduated. Two months after you complete my course you make your first payment, and then you have ten months to complete your payments. There are no strings to this offer. I know a lot of honest fellows haven't got a lot of money these days, but still want to prepare themselves for a real job so they won't have to worry about hard times or lay offs.

I've got enough confidence in these fellows and in my training to give them the training they need and pay me back after they have their training.

If you who read this advertisement are really interested in your future here is the chance of a life time. Mail the coupon today and I'll give you all the facts.

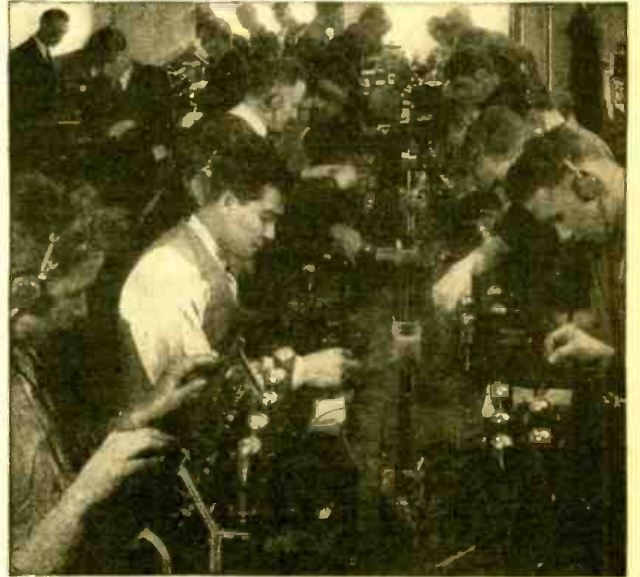

A scene in the big, busy Radio Shops at Coyne. Here you see fellows working on real Radios—not reading about them from books or lessons. This is THE way to prepare for the big-money field of Radio!

TELEVISION *and* TALKING PICTURES

Television is already here! Soon there'll be a demand for THOUSANDS of TELEVISION EXPERTS! The man who learns Television now can have a great future in this great new field. Get in on the ground-floor of this amazing new Radio development! Come to COYNE and learn Television on the very latest, newest Television equipment. Talking Picture and Public Address Systems offer opportunities to the Trained Radio Man. Here is a great new Radio field just beginning to grow! Prepare NOW for these wonderful opportunities! Learn Radio Sound Work at Coyne on actual Talking Picture and Sound Reproduction equipment.

PREPARE NOW and be ready for Radio's many opportunities

Forget pay-cuts—lay-offs—unemployment! Don't be tied down to an untrained man's future. You NEED TRAINING IN A FAST-GROWING MONEY-MAKING TRADE. Here's your chance of a lifetime to get it! Hundreds of opportunities now open in Radio. My sensational offer, explained below, makes it possible for you to START AT ONCE!

The right way to learn Radio is the Coyne way—not by books, but by actual, practical work on actual Radio, Television and Sound equipment. Here at Coyne you'll service and operate scores of modern Radio receivers, huge Broadcasting equipment, late type Television apparatus, Talking Picture machines, Code transmitters and receivers, etc. In 10 weeks you can step into a REAL JOB, leading to a salary of \$50 a week and UP!

ALL PRACTICAL WORK At COYNE in Chicago

ALL ACTUAL, PRACTICAL WORK. You build radio sets, install and service them. You actually operate great Broadcasting equipment. You construct Television Receiving Sets and actually transmit your own Television programs over our modern Television equipment. You work on real Talking Picture

machines and Sound equipment. You learn Wireless Operating on actual Code Practice apparatus. We don't waste time on useless theory. We give you the practical training you'll need—in 10 short, pleasant weeks.

MANY EARN WHILE LEARNING

You get Free Employment Service for Life. And don't let lack of money stop you. Many of our students make all or a good part of their living expenses while going to school and if you should need this help just write to me. Coyne is 33 years old. Coyne Training is tested—proven beyond all doubt. You can find out everything absolutely free. Just mail coupon for my big free book!

H. C. LEWIS, Pres. RADIO DIVISION Founded 1899
COYNE ELECTRICAL SCHOOL
500 S. Paulina St., Dept. 53-6K, Chicago, Ill.

Mail Coupon Today for All the Facts

H. C. LEWIS, President
Radio Division, Coyne Electrical School
500 S. Paulina St., Dept. 53-6K, Chicago, Ill.

Dear Mr. Lewis: Send me your big FREE Book; details of your FREE Employment Service; and tell me all about your special offer of allowing me to pay for training on easy monthly terms after graduation.

Name.....
Address.....
City..... State.....

..... SHORT WAVE ESSENTIALS FOR MEMBERS OF THE SHORT WAVE LEAGUE

THE following list of short wave essentials has been prepared from the suggestions to the LEAGUE by its members. A number of months were consumed in creating these short wave essentials for members of the SHORT WAVE LEAGUE. All essentials listed are approved by headquarters of the LEAGUE.

A FEW WORDS AS TO THE PURPOSE OF THE LEAGUE

The SHORT WAVE LEAGUE was founded in 1930. Honorary Directors are as follows:

Dr. Lee de Forest, John L. Reinartz, D. E. Replogle, Hollis Baird, E. T. Somerset, Baron Manfred von Ardenne, Hugo Gernsback, Executive Secretary.

The SHORT WAVE LEAGUE is a scientific membership organization for the promotion of the short wave art. There are no dues, no fees, no initiations, in connection with the LEAGUE. No one makes any money from it; no one derives any salary. The only income which the LEAGUE has is from its short wave essentials. A pamphlet setting forth the LEAGUE'S numerous aspirations and purposes will be sent to anyone on receipt of a 3c stamp to cover postage.

One of the aspirations of the SHORT WAVE LEAGUE is to enhance the standing of those engaged in short waves. To this end, the SHORT WAVE LEAGUE supplies members with membership letterheads and other essentials. As soon as you are enrolled as a member, a beautiful certificate with the LEAGUE'S seal will be sent to you, providing 10c in stamps or coin is sent for mailing and handling charges.

Another consideration which greatly benefits members is that they are entitled to preferential discounts when buying radio merchandise from numerous firms who have agreed to allow lower prices to all SHORT WAVE LEAGUE members. The radio industry realizes that, the more earnest workers there are who boost short waves, the more radio business will result therefrom; and a goodly portion of the radio industry is willing, for this reason, to assist SHORT WAVE LEAGUE members by placing them on a professional basis.

SHORT WAVE ESSENTIALS LISTED HERE SOLD ONLY TO SHORT WAVE LEAGUE MEMBERS

All the essentials listed on this page are never sold to outsiders. They cannot be bought by anyone unless he has already enrolled as one of the members of the SHORT WAVE LEAGUE or signs the blank on this page (which automatically enrolls him as a member, always provided that he is a short wave experimenter, a short wave fan, radio engineer, radio student, etc.).

If, therefore, you order any of the short wave essentials without filling out the blank (unless you already enrolled as a LEAGUE member), your money will be returned to you.

Inasmuch as the LEAGUE is international, it makes no difference whether you are a citizen of the United States or any other country. The LEAGUE is open to all.

Application for Membership SHORT WAVE LEAGUE

SHORT WAVE LEAGUE (6-33)
98 Park Place, New York, N. Y.

I, the undersigned, herewith desire to apply for membership in the SHORT WAVE LEAGUE. In joining the LEAGUE I understand that I am not assessed for membership and that there are no dues and no fees of any kind. I pledge myself to abide by all the rules and regulations of the SHORT WAVE LEAGUE, which rules you are to send to me on receipt of this application.

I consider myself belonging to the following class (put an X in correct space): Short Wave Experimenter Short Wave Fan Radio Engineer Student

I own the following radio equipment:

Transmitting

Call Letters.....

Receiving

Name

Address

City and State.....

Country

I enclose 10c for postage and handling for my Membership Certificate.

SHORT WAVE LEAGUE LETTERHEADS

A beautiful letterhead has been designed for members' correspondence. It is the official letterhead for all members. The letterhead is invaluable when it becomes necessary to deal with the radio industry, mail order houses, radio manufacturers, and the like; as many houses have offered to give members who write on the LEAGUE'S letterhead a preferential discount. The letterhead is also absolutely essential when writing for verification to radio stations either here or abroad. It automatically gives you a professional standing.

A—SHORT WAVE LEAGUE letterheads, per 100..... **50c**

OFFICIAL SHORT WAVE LEAGUE LOG AND CALL BOOK

Here is the finest book of its kind ever published. It contains the largest listing of short wave stations in the world, much larger in fact than the list published in SHORT WAVE CRAFT and other magazines. All experimental stations, no matter where located, are listed. A large section is provided where calls can be listed in a proper manner. This log section gives dial settings, time, date, call letters, location, and other information. Another section has squared-paper pages on which you can fill in your own frequency curve for your particular receiver. It helps you to find stations which otherwise you could never log. It is the only book of its kind published.

B—Official Log and Call Book..... Prepaid **25c**

RADIO MAP OF THE WORLD AND STATION FINDER

The finest device of its kind published. The world's map on heavy board is divided into 23 sections, while the rotary disc shows you immediately the exact time in any foreign country. Invaluable in logging foreign stations. Also gives call letters assigned to all nations. Size 11"x22".

C—Radio Map of the World and Station Finder..... Prepaid **25c**

GLOBE OF THE WORLD AND MAGNETIC COMPASS

This highly important essential is an ornament for every den or study. It is a globe, 6 in. in diameter, printed in fifteen colors, glazed in such a way that it can be washed. This globe helps you to intelligently log your foreign stations. Frame is of metal. Entire device substantially made, and will give an attractive appearance to every station, emphasizing the long-distance work of the operator.

D—Globe of the World..... Prepaid **\$1.25**

SHORT WAVE LEAGUE LAPEL BUTTON

This beautiful button is made in hard enamel in four colors, red, white, blue and gold. It measures three quarters of an inch in diameter. By wearing this button, other members will recognize you and it will give you a professional air. Made in bronze, gold filled, *not plated*. Must be seen to be appreciated.

E—SHORT WAVE LEAGUE lapel button..... Prepaid **35c**

EE—SHORT WAVE LEAGUE lapel button, like the one described above but in solid gold..... Prepaid **\$2.00**

SHORT WAVE LEAGUE SEALS

These seals or stickers are executed in three colors and measure 1 1/4 in. in diameter, and are gummed on one side. They are used by members to affix to stationery, letterheads, envelopes, postal cards and the like. The seal signifies that you are a member of the SHORT WAVE LEAGUE. Sold in 25 lots or multiples only.

G—SHORT WAVE LEAGUE seals..... per 25, Prepaid **15c**

SHORT WAVE MAP OF THE WORLD

This beautiful map, measuring 18x26 in. and printed in 18 colors is indispensable when hung in sight or placed "under the glass" on the table or wall of the short wave enthusiast. It contains a wealth of information such as distances to all parts of the world, political nature of the country in which a broadcast station is located, etc., and from the manner in which the map is blocked off gives the time in different parts of the world at a glance.

F—SHORT WAVE Map of the World..... Prepaid **25c**

PLEASE NOTE THAT ABOVE ESSENTIALS ARE SOLD ONLY TO MEMBERS OF THE LEAGUE—NOT TO NON-MEMBERS.

Send all orders for short wave essentials to SHORT WAVE LEAGUE, 98 Park Place, New York City.

If you do not wish to mutilate the magazine, you may copy either or both coupons on a sheet of paper.

SHORT WAVE LEAGUE, 98 Park Place, New York, N. Y.



G—15c for 25

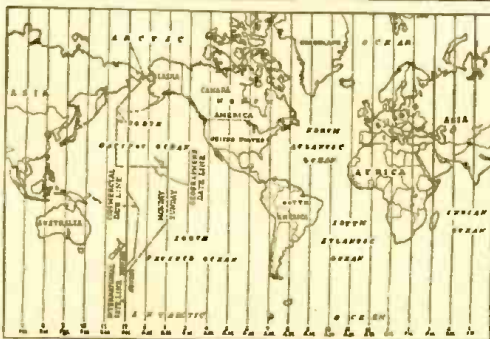

F—25c each



A—50c per 100



B—25c per copy

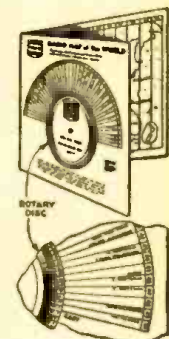

C—25c each



D—\$1.25 each



E—35c each

SHORT WAVE LEAGUE, 98 Park Place, New York, N. Y.

Gentlemen:

I am already an enrolled member in the SHORT WAVE LEAGUE

I am a new member and attach my application to this coupon

Please send me the following short wave essentials as listed in this advertisement:

.....
.....
.....
.....

for which I enclose \$..... herewith.

(The LEAGUE accepts money order, cash or new U. S. Stamps in any denomination. Register cash and stamps.)

Name.....

Address.....

City and State.....

Country.....

(6-33)



Patience In Short-Wave Tuning

An Editorial by HUGO GERNSBACK

● A MAN who has never driven a car cannot expect, by any stretch of the imagination, to jump into one and drive off immediately without having mastered the intricacies of the different levers and pedals, to say nothing of watching the various gauges, and other instruments before him.

He knows that, before he attempts to drive a car, he must master its control details; and, after he has done all this, he must then become used to the road, traffic conditions, and many other things.

Yet, when the average individual buys a high-priced, short-wave receiver he immediately expects to pull in stations from the four corners of the earth. You can no more do this immediately than you can drive a car without any previous training or experience.

The difference between a short-wave set and an ordinary broadcast set is enormous. The broadcast set can be tuned with little difficulty, and particularly fine tuning is not necessary unless you are quite distant from transmitting stations. In short-wave work we have an entirely different situation. To begin with, tuning is *exceedingly sharp*. By that is meant that there may be as many as twenty stations, all comprised in a single division of the dial; in other words, *crowded into the space of less than one-tenth of an inch*. It is then the operator's job to "fish" these stations out of this cramped space. This requires not only a firm hand and careful and accurate tuning, but above all, *PATIENCE!* The difference between the short-wave listener who "logs" all continents regularly and the man who gets a distant station only now and then is represented in the single word, *patience*. If your temperament is impatient, then the short waves are not for you. You will never successfully "log" hundreds of foreign stations unless you have that one important requisite.

Of course, there is nothing new about all this, and it has been said many times before; but the point is that thousands of new short-wave enthusiasts come along every month and many of them become disappointed,—particularly the owners of expensive sets,—when they do not immediately, the very first night, tune in every station in Europe and Asia.

Frequently, the owner of an expensive set is dismayed because some young boy with a simple one- or two-tube set "pulls in" almost everything in creation, whereas he himself cannot do so with his expensive outfit. On the other hand, if the youngster is given a chance to play with the "big set" he will not only duplicate his own former success, but will pull in many additional foreign stations besides.

Even the experimenter who has been in short waves for some time has many surprises in store for him. It is the easiest thing in the world to pass right over dozens, and even hundreds, of stations, *simply by turning the dial too fast!* Good sets usually have a high-ratio transmission attached to the dial; so the control advances any point of the dial exceedingly slowly. Even that is not slow enough; because a faint whistle may be passed over if there are other noises in the room, and that station, therefore, is

lost for the time being. Even experienced short-wave listeners sometimes pay little attention to such exceedingly faint signals, only to find that, if they try again, that the signal can be built up into a powerful sound. The reason, of course, is simple. It frequently happens that short-wave stations *fade* in and out. You may pass over a faint whistle while the carrier is at its *minimum* and is hardly audible. Three minutes later, it may be very loud, because the signal will be at its maximum. "Old-timers" know from experience that the faintest whistle may be built up into a loud signal if the controls are handled right. This is particularly true with sets of the regenerative variety, where the regeneration can be increased to full maximum. All this, requires patience with a big "P." It can't be done if you wish to get results in a hurry.

In addition to this, most disappointments by beginners are traceable directly to the old bugaboo, "time difference." The newcomer to short waves simply cannot realize that when it is 10 o'clock in the evening, let us say, in the Middle West, it is 4:00 a. m. the next morning in London, 6:00 a. m. in Moscow, and 2:00 p. m. in Sydney, Australia. For that reason, the seasoned short-wave listener will never attempt to listen haphazardly, but keeps his Time-Conversion chart in front of him, so that he will know exactly at what time to listen.

Then, too, the wavelength or frequency is of the greatest importance. The short-wave beginner will foolishly start to listen in for a station in the 20-meter band at, say, 11 p. m. This, as a rule, cannot be done because from daybreak until mid-afternoon; and, usually, during bright daylight, only stations between 13 and 22 meters, 23,070 to 13,630 kilocycles, should be listened for.

Then, to the east of the listener, from about noon to 10 p. m., stations between 20 and 35 meters are the ones that come in best. To the west of the listener, this same band is as a rule best from about midnight until shortly after daybreak. After dark, it is the rule among many listeners to try only for stations above 35 meters; anything below this band will not, as a rule, come in satisfactorily.

These simple rules hold good, no matter where you live on this globe. Naturally, there are exceptions. Short waves are often tricky and frequently have surprises in store for you. Thus, for instance, it happens once in a while that stations below 20 meters can be picked up from distant points in the late evening; but such results are the result of freak conditions and are not usual.

Then too, there are other circumstances which often will mar reception; atmospheric conditions, meteorological conditions, magnetic storms, sun spot activity—all have a great deal to do with reception. Even veterans in short-wave reception do not find it possible to pull in certain stations day after day, all year round. Electrical storms between the transmitter and receiver frequently play havoc with signals, giving rise to static which often ruins good programs. Of course, these conditions are exceptional, but they should be known, because eventually they will be met by every listener.

SHORT-WAVE CRAFT IS PUBLISHED ON THE 15th OF EVERY MONTH

This is the June, 1933, Issue - Vol. IV, No. 2. The next Issue Comes out June 15th

Editorial and Advertising Offices - 96-98 Park Place, New York City

Short Waves Valuable AID TO POLICE OF VIENNA

European Police Systems are up to the minute when it comes to "short-wave" communication between the "men on the beat" and headquarters—yes they even have "pocket" transmitters.



The Vienna policeman we see at right is sending reports to headquarters by means of the portable short-wave transmitter hung on his chest. Left—sending and receiving antennae at Vienna Police Headquarters.

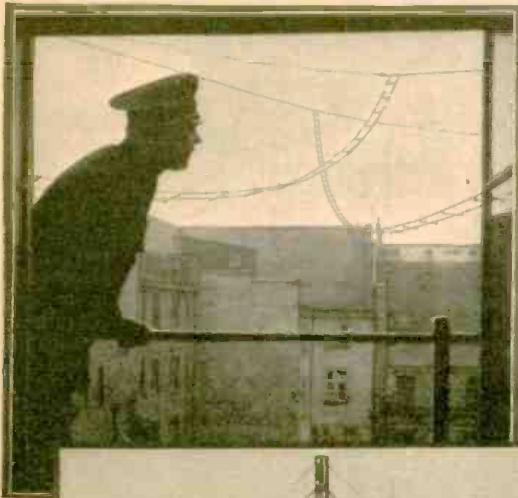

● THE accompanying photos show some of the quite unusual short-wave and receiving equipment now being used by the Police Department of Vienna. Not only is Austria hooked up with the International Police Radio-Net but she has a very elaborate intercity radio "safety service." Some of the patrol cars are fitted with complete short-wave



Headquarters in Vienna where messages are received and transmitted.



Left—Special giant, loop-type, short-wave receiver in use by Vienna police expert for listening in on "unlawful" radio transmissions. Above—portable short-wave, loop receiver used for listening in on unlawful transmitters. Right—radio truck of the Vienna police fitted with radio cabin and aerial on the roof.

One of the principal pieces of short-wave apparatus frequently used by the Vienna Police, is a portable "loop" receiver used for listening in and locating "unauthorized" transmitters.

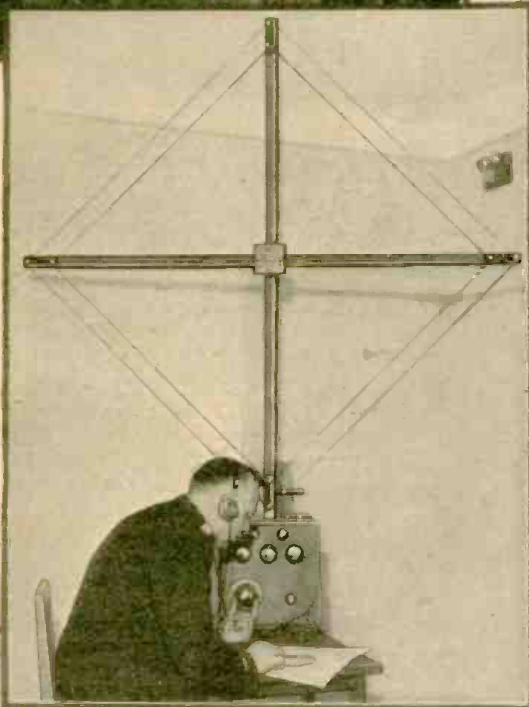

transmitters and receivers, as one of the photos shows, and also there has been perfected a short-wave "transmitter" which can be carried by the policeman and operated "while on beat"!



What the up-to-date Vienna police "radio-car" looks like. The radio operator in the photo above has just received a dispatch from headquarters and he is handing it to the officer. In the portable transmitter carried by some policemen, the batteries are put in the pocket; the transmitter, with special tube, is worn on the breast; weight two pounds. Signals have been transmitted up to 1.25 miles.



League of Nations Station at GENEVA

By **CONSTANCE DREXEL**

Officially Accredited Correspondent, League of Nations, Geneva.
(Specially written for SHORT WAVE CRAFT)

One of the world's most important and powerful short and long wave broadcast stations is that located at Geneva

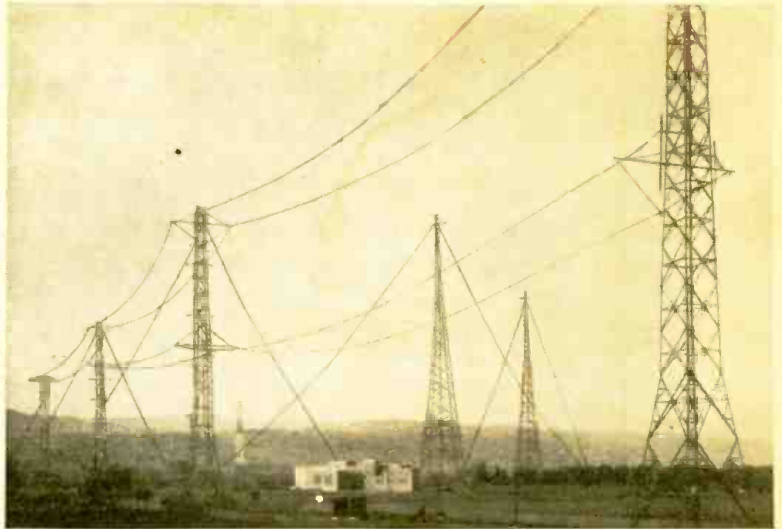

Above—A view of the antenna masts at the powerful League-of-Nations station at Geneva, Switzerland. It was from this station that the League-of-Nations report on Manchuria was transmitted, the signals having been picked up in practically every important country of the world. See page 8, May issue.

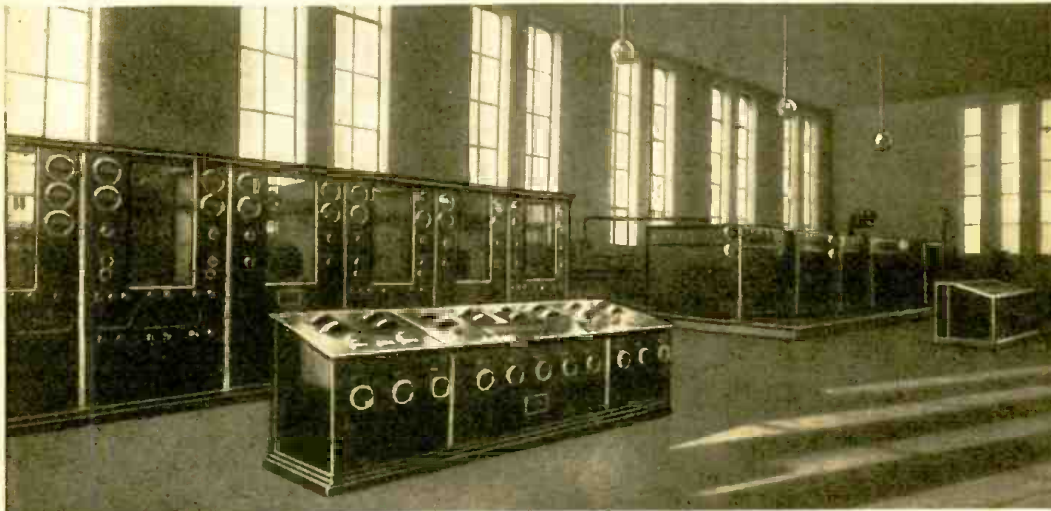

Photo at left shows interior of main radio apparatus room at the League-of-Nations high-power station at Geneva. The aerial system includes three groups of beam aeri-als and three omni-directional aeri-als.

● WITH the completion of the League of Nations' wireless station at Geneva, Switzerland, one of the world's most comprehensive experiments in short wave transmission is ready to add its contribution to human knowledge and human understanding. It is being used for many purposes in wireless telegraphy and telephony, among them a regular broadcasting program to which you can listen on Sunday evenings for three quarters of an hour, beginning at 10 p. m. (Greenwich Mean Time) which is 5 p. m. Eastern Standard time. Preceding the regular program one hears signals and tests for about 15 minutes; then a fifteen minute talk, first in English, then in French and for the last quarter of an hour in a third language, usually Spanish, for the benefit of Central and South America.

The various wavelengths used by Radio-Nations, depending upon time of day or night and direction desired, are: 15.83, 16.25, 20.64, 20.74, 31.3, 38.74 and 40.3 meters. The wave lengths 20.74 and 38.74 are good for the U. S. A.

Technical Description

For those interested in the technical side, let us state that Radio-Nation's transmitting station at Prangins (near Geneva) comprises two short wave transmitters belonging to the League of Nations, and a medium wave trans-

mitter provided by the Radio-Suisse. One of the short wave transmitters was supplied by the Société Française Radio-Electrique of Paris, and the other by Marconi's Wireless Telegraph Co., Ltd., of London, which firm likewise erected the medium wave transmitter.

The French short wave transmitter has a waverange from 14 to 40 meters and is quartz crystal controlled. This transmitter is at present working on three waves, the change from one wavelength to the other being effected in a few minutes. The Marconi transmitter has a waverange of 14 to 100 metres and is driven by a master oscillator. This transmitter is at present working on four wavelengths, and the change from one to the other can be made in a couple of minutes.

Both transmitters can be used for telegraphy as well as for telephony.

SHORT WAVE CRAFT would be pleased to hear from you in regard to these programs, both as to how well they reach you and what you would like to hear from Geneva, and your letters will be forwarded to the proper officials at the League of Nations.

The two short wave transmitters are situated in a large room on the ground-floor, and the machines and cables in a room directly underneath the transmitters. The two shortwave transmitters can be connected to any of the aeri-als through an aerial switch.

The aerial system consists of three groups of beam aeri-als, and the station possesses three omni-directional aeri-als. They are divided into day and night array. These six aeri-als are directed to Japan, Java, North America, Mexico, Australia and South America. The two short wave transmitters have an aerial power of 20 k.w. This is sufficient for reaching the most distant countries.

The medium wave transmitter of 50 k.w., belonging to the Radio-Suisse, is installed in a special room. This transmitter can work on waves between 3000 and 5000 metres, and it is possible to establish by means of it communications with any point in Europe.

Radio-Nations' receiving station at Colovrex (near Geneva) is equipped with three groups of receivers, i.e., one group of three short wave high speed receivers (of which two are of the Telefunken System and one of the Bell Telephone Company); another group of seven Telefunken receivers for waves between 10 and 30,000 metres, and a third group of Marconi receivers for medium waves.

(Continued on page 124)

"JAVA" and Other Stations Hot from the PERCOLATOR

By PERCY T. BOOTH

Many novel short-wave receivers have been submitted to the editors, but one of the neatest and most attractive 2-tube sets we've seen is that built in a coffee percolator; it operates with battery tubes and has brought in stations from all over the world, including VK2ME, Australia. Plug-in coils are used, covering all bands.



Left—The young lady is pouring out some hot jazz from Java. The tuning and regeneration control of the set built within the percolator are adjusted by means of the external knobs shown. Battery current for the tubes is taken in to the set through the wires passing through the spout.

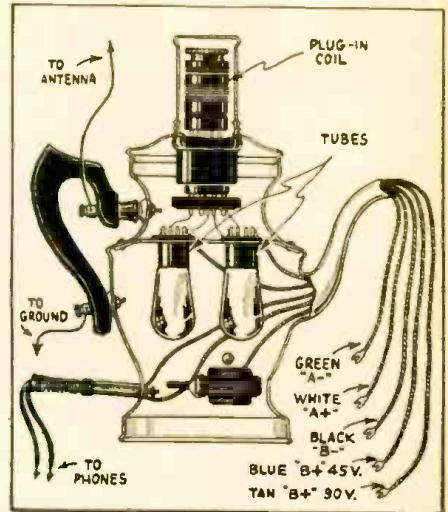

This diagram shows interior arrangement of the short-wave receiver parts.

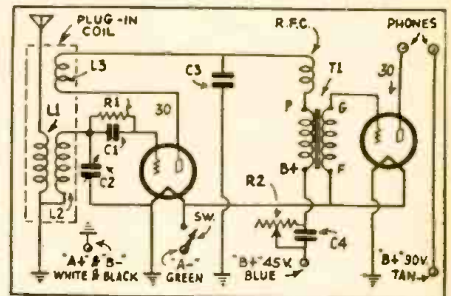

Schematic wiring diagram.

● HOW'S your morning "Java," fans? Does it come ready mixed with South American coffee, Hawaiian sugar and New Jersey cream? If it doesn't, it's time to renovate that old electric percolator of yours and make it ultra-modern. My old aluminum coffee pot having come from a very good A. C. line, it seemed a shame that its usefulness should end just because of a burned out element, so with a new mixture of tubes, condensers, coils, etc., she was made to "perk" again stronger than ever.

The primary consideration throughout in constructing this novel two tube short wave set has been low-first cost and efficiency, coupled with valuable expense-saving "kinks," practical for use to beginners and set builders with limited funds and tools. There is a great deal of satisfaction to be had

in enjoying the thrills of short wave reception from a set built with the least possible outlay.

First the burned out element and heating plates were removed, thus making the interior accessible from top or bottom. Next came the problem of finding room enough to assemble the various parts in the limited space. A midget condenser for tuning? No. They cost money, so I made one. The junk box supplied an old type 23 plate broadcast tuning condenser which was altered as follows. It was torn down completely and the original pins supporting the stator plates removed. Brass bolts of the same diameter and 1 1/4 inches long put in their place. Three stator plates were put back and spaced as before except for one extra spacing washer being added between

(Continued on page 119)



Here we have a close-up view of the "coffee-percolator" 2-tube receiver, which has brought in world-wide S-W stations from many foreign climes.

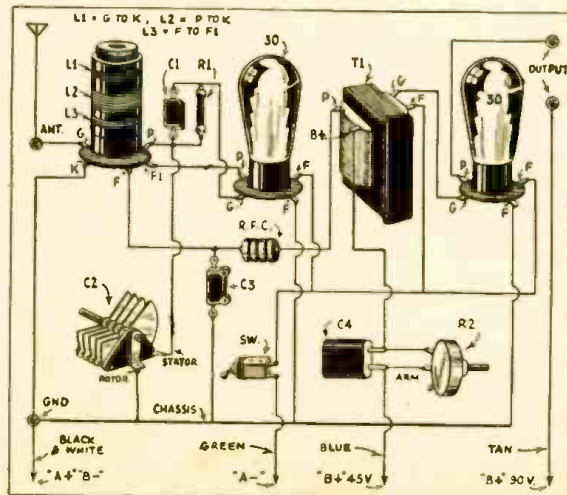

The center diagram, above, will make it clear to the uninitiated just how the various parts comprising the "coffee pot" 2-tube short wave receiver are connected or wired. The photo at the extreme right shows the "coffee pot" receiver open and the ingenious plug-in coil arrangement.

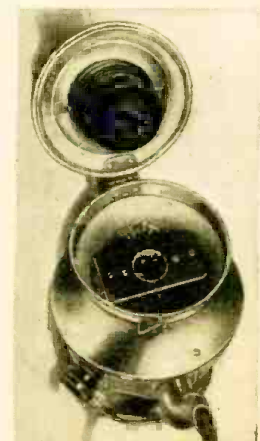

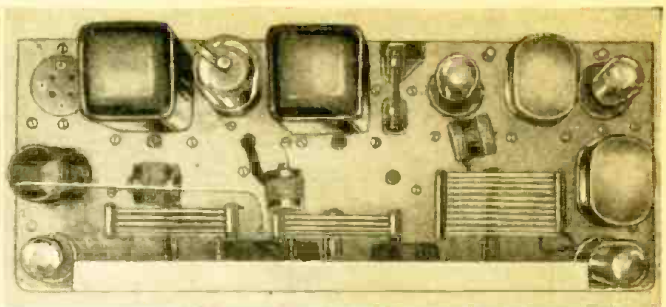
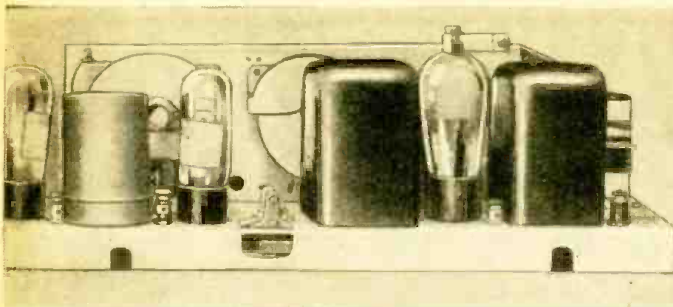

A SIMPLE 5-TUBE S-W SUPERHET

By A. H. MATTHEWS

A 2-volt, battery-operated superheterodyne short-wave receiver, built from an old Crosley 6-Tube Bandbox "B.C." receiver.

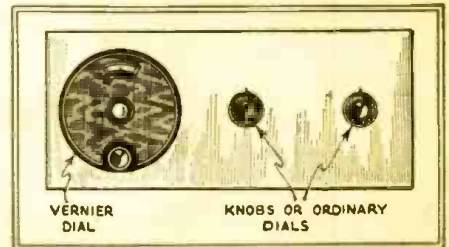

Photos above show rear and top views of the 5-Tube S-W Superhet built by Mr. Matthews from an old Crosley "Bandbox" B.C. Receiver. Drawing above—front panel of converted set.

● THE following is a description of a dependable short-wave battery-operated super-heterodyne which any beginner can build at very little expense; most beginners seem to think a super-het is very difficult to make—really a super is just as easy to build as a straight set. In this super I have purposely avoided trick tubes, except in the I.F. stage, which uses a 32 or 22; the results obtained from the set using the battery tubes are well worth the trouble of making it. I made a very good set out of an old Crosley 6-tube "Band-Box" broadcast (200-550 meter) receiver. This is an all-shielded set with copper cans over the R.F. coils and with very slight changes it becomes a first-rate super-het. L4 and L5 old "B. C." coils.

The choke coils are 300 turns No. 30 D.C.C. wound on 1/4 inch dia. hard rubber tube (jumble wound; i. e., haphazardly—not in even layers). The old tuning condensers

are made use of, by cutting off all but four of the rotor plates. Remove all the old hook-up wire and test the audio transformers and wire up the filament for whatever tubes you intend to use. The hook-up works well with 12; 01A, or the new 30 tubes. I made my set to cover the 40 meter band only, but of course plug-in coils can be used to cover the other bands, simply by putting in an extra socket, as shown in the sketch. The tickler coil for the second detector is made by winding 60 turns No. 36 on cardboard tubes same diameter to fit inside of I.F. coil as shown. In tuning the set the oscillator control is set about half-way in and the regeneration control set so that a smooth wave is heard; in this position stations can be heard all over the dial, without resetting the oscillator dial. The regeneration should be moved to bring the station in at its best point; I have received a number

of European stations on this set with crystal-sharp clearness and good volume.

- L1—2 turns No. 24 D.S.C.
- L2—12 turns No. 24 D.S.C.
- L3—Wound on small tube inside L2 18 turns No. 30 D.C.C.
- R1—2 meg. grid leak
- R2—2 meg. grid leak
- R3—German silver resistance choke (about 8,000 ohms, No. 40, wound on 1/4" dia. wood rod)
- C1, C2, C3—Tuning condensers
- C4, C5, C6, C7—.00025 fixed condensers
- C8, C9—1 mfd.
- TC—Trimmers (.0005 mf.)
- R.F. Ch.—Choke coils, 300 turns No. 30 D.C.C. on 1/4" dia.
- L4, L5, R.F. coil; L6, 60 turns No. 36 D.C.C. wound on small tube inside L5;
- T1, T2, audio transformers

At left—Plan view of the converted Crosley "Bandbox" broadcast receiver, after re-arrangement as a "super-het" for short-wave reception.

Below—diagram of the 5-tube super-het as evolved by Mr. Matthews from a Crosley "Bandbox" broadcast receiver. The values of the various components are given in the text.

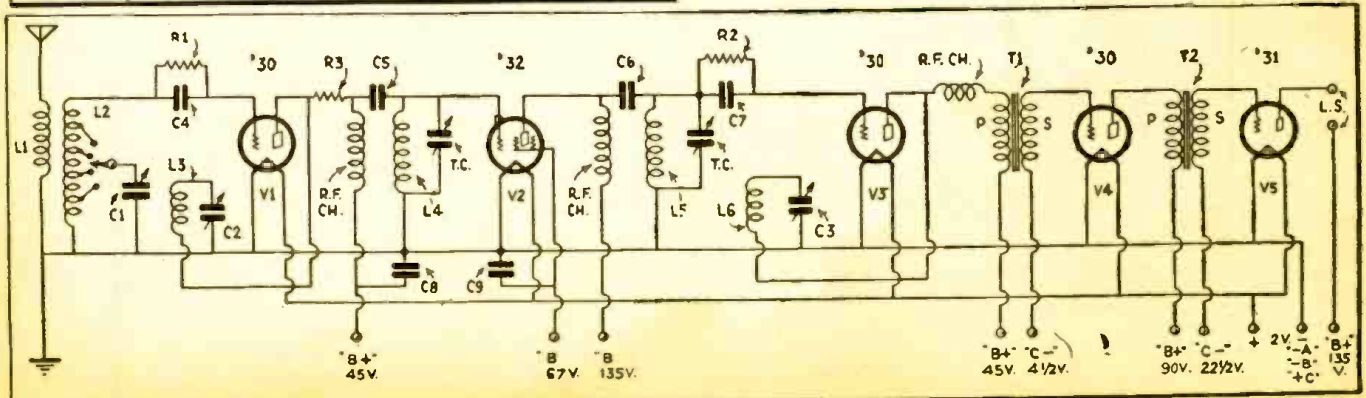
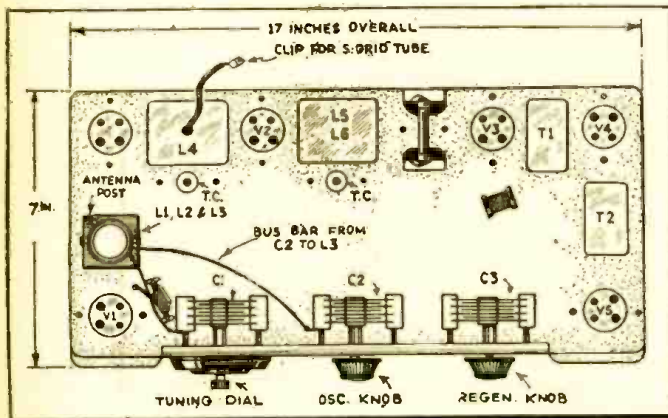

A 5-Tube de Luxe OSCILLODYNE

By J. A. Worcester, Jr.

The Oscillodyne circuit, representing a new idea in regenerative receivers, was invented by Mr. Worcester, who described a "baby" model, using but 1 tube, in the April issue of this magazine. In the May issue he described a peach of a 2-tube "Oscillodyne" receiver on which the editors heard stations 12,500 miles distant. The present powerful 5-tube model A. C. "Oscillodyne" combines improved selectivity and great volume of signal, thanks to the use of the proper tubes, plus the high gain afforded by the special properties of the "Oscillodyne" circuit.

detector stages is essential for two reasons. In the first place, as mentioned above, it is necessary to prevent feedback of the detector impulses into the antenna circuit which would tend to nullify any beneficial results from the additional stage. Secondly, complete shielding of the detector circuit is necessary in order to eliminate direct pickup by the detector inductance and associated wiring which would, of course, render useless any selectivity in the antenna circuit.

The schematic diagram of the receiver connections is shown in Fig. 1.

THE third article of a series describing the Oscillodyne circuit is here presented. The set to be described differs from the two previous models in that a stage of radio frequency amplification has been added. An additional stage of audio frequency amplification has also been added to give more volume on the loudspeaker and a built-in power supply has been included for complete A.C. operation.

The stage of radio frequency amplification has been added from the standpoint of selectivity rather than sensitivity. As users of the previous models are doubtless aware, the detector alone is capable of amplifying any signal that is not hopelessly lost in the noise level.

Due to the nature of the impulses flowing in the detector circuit, however, the selectivity is not all it might be. These highly damped impulses, whose production was described in the first article, are not unlike in nature to

signals emitted from an old-fashioned spark transmitter and have a similar effect on the selectivity. These signals are capable of setting up currents in a detuned circuit by a process known as "shock excitation," the detailed treatment of which would be out of place in an article of this nature.

It is obvious, however, that any attempt to improve the selectivity by merely adding additional tuned circuits would be to no avail, since being coupled to the detector circuit they would be "shock excited" by induction.

How Selectivity Was Improved

By inserting a screen grid tube between the two tuned circuits, however, it is possible, by taking suitable precautions in regard to shielding, to practically eliminate all feedback from the detector circuit into the input circuit. This enables a degree of selectivity to meet the demands of the average short-wave listener.

Complete shielding of the R.F. and

General Layout

The general layout of the parts will be noted from the photograph. All the parts are mounted on a special *Blan* chassis which can be procured already drilled and "folded."

Plug-in coils are used to eliminate losses that would necessarily be introduced in the antenna circuit if a tapped coil construction were employed. The use of such a construction in the detector circuit, such as was employed in the last receiver, would, of course, be entirely feasible. However, in order to make the two circuits as nearly identical as possible for ganging purposes, plug-in coils were used in this position also.

These coils plug into Hammarlund *isolantite* sockets mounted above the panel by means of 1" fibre bushings. To facilitate coil changing, holes are

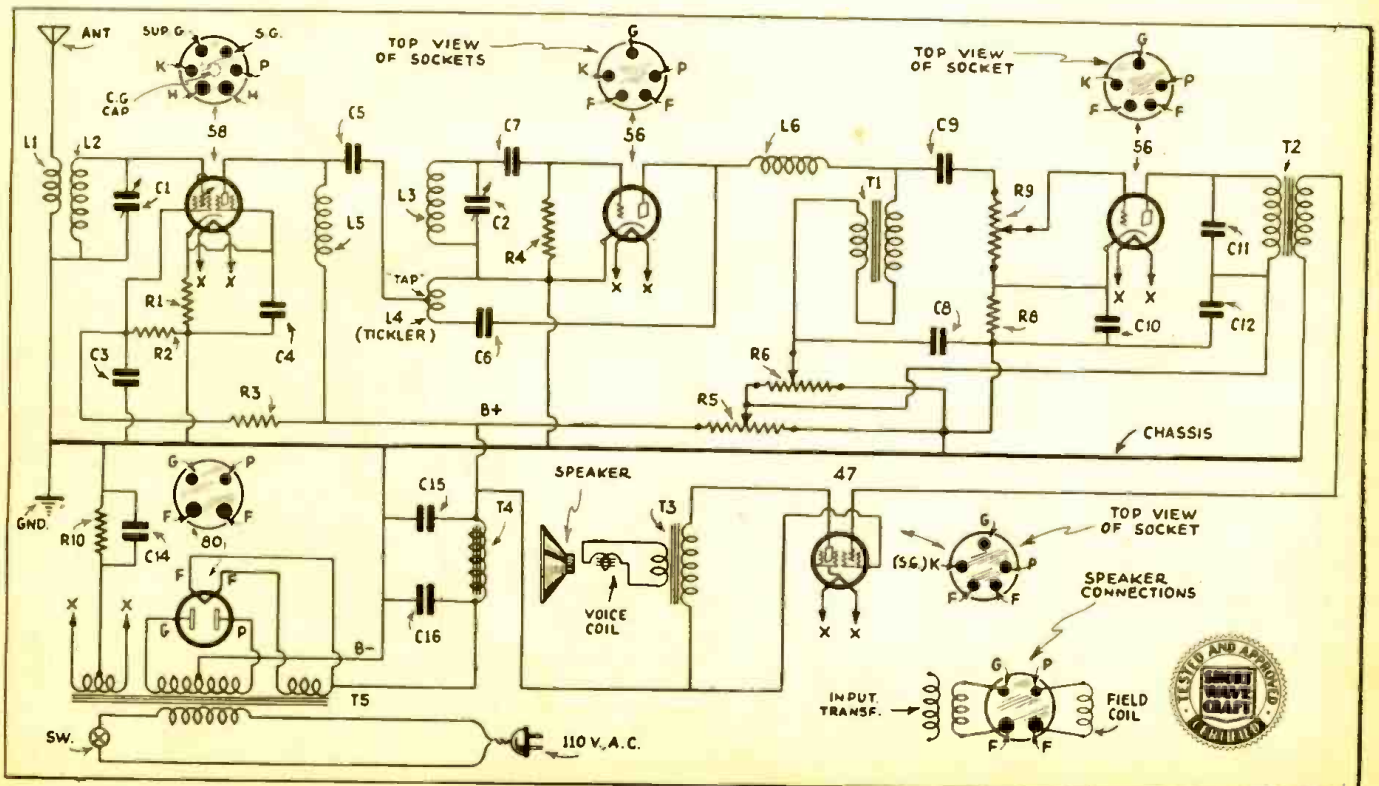

Hook-up of Apparatus used in building Mr. Worcester's 5-tube "Oscillodyne" Receiver.

A. C. RECEIVER



cut in the shield box directly above the coil sockets. These holes are normally covered by caps, as shown in the photographs.

A type 58 tube is used as the R.F. amplifier and a type 56 as the detector. The output of the detector is coupled to another 56 by means of a Thordarson T-5736 transformer employed in a "choke" style connection. The output of this tube couples to a type 47 pentode through a second T-5736 transformer used in regulation manner.

The audio amplifier equipment,

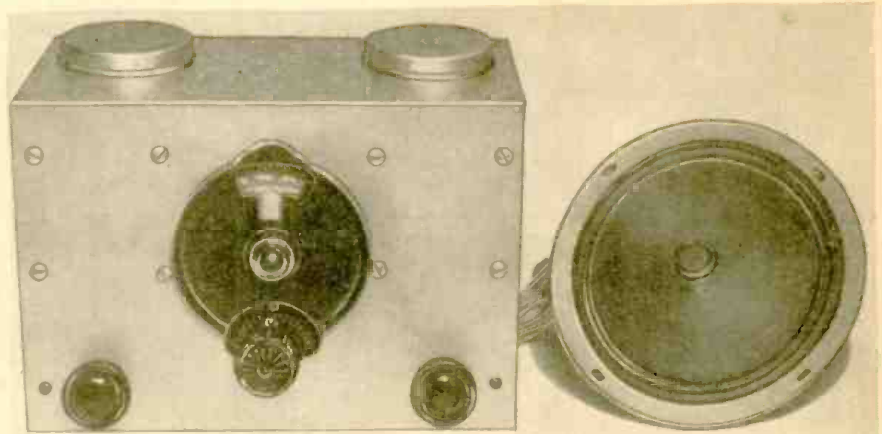

The Oscillodyne a Wow!

Editor SHORT WAVE CRAFT:

This is the first time I have bought the SHORT WAVE CRAFT magazine and I believe it is the best magazine I have come across. From this issue I have constructed the *S. W. Oscillodyne receiver* and boy! how it works! The first day without any trouble I received Spain, England, France, and other foreign countries. Amateurs! why I never knew there were that many until now. With the *one-tube Oscillodyne* I bring in more stations on one plug-in-coil, than with a set of coils on different short-wave sets. If any one is trying his luck on short-wave sets it will be worth while to construct the *one-tube Oscillodyne*.

I have tried some of the things that Don C. Wallace tells about in his article "*Some Things You Don't Know About S. W. Aerials*," which improved my reception greatly. I believe amateurs, fans, and experimenters depend on your magazine for their advancement in the short-wave field. Before I say 73, I repeat once more the *Oscillodyne* can't be beat and I would like to hear from anyone who tries his luck at it.

73
PAUL KORNEKE, Jr.,
2032 Lautner St.,
N. S. Pittsburgh, Pa.

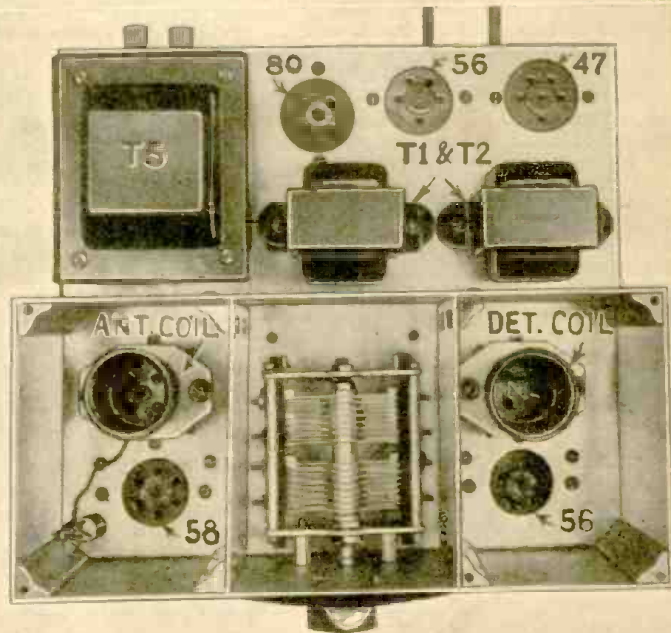

along with the power supply, is mounted on the back portion of the chassis, as shown. The power transformer is a Thordarson Type T-4900.

Loud Speaker Details

The loud speaker used in connection with this set is a Jensen type 3007A having a built-in transformer designed to couple to a single type 47 output. The field of this speaker has a resistance of 1800 ohms and is used as the choke in the power-supply filter. Connections to the loudspeaker are made with an Alden four prong Connectorald which inserts into a four-prong wafer socket mounted on the back of the subpanel. The proper method of making connections to this socket is shown in the diagram.

(Continued on page 113)

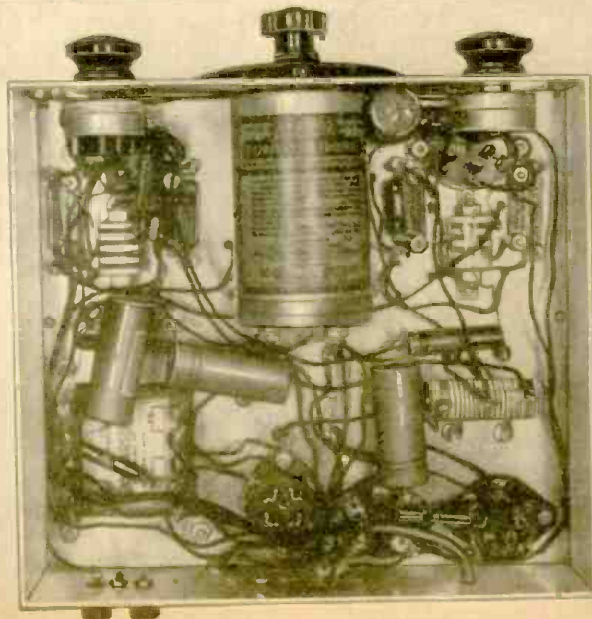

Photos at right show, from top to bottom — front view, top view and bottom view of the 5-tube "Oscillodyne" Receiver.

A 3-Tube BAND SPREAD

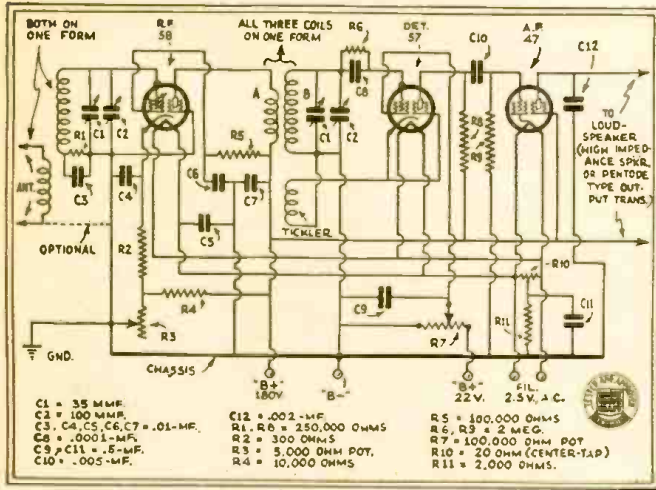

Schematic wiring diagram of the 3-tube band spread receiver here described. The two condensers C1 and C1 are ganged.

● The receiver described in this article is one of the "sweetest" little short-wave jobs we have ever had the pleasure of describing for the benefit of the "home constructor." The aluminum shields are easily bent at home, and the completed set presents a truly professional appearance.

As far as operation is concerned, nothing more could be desired in the way of smoothness of control and over-all sensitivity of response. This "high gain" 3-tube circuit, employing pentodes of the latest type, makes the use of earphones unnecessary, as practically all received signals are strong enough to operate a "loud speaker" directly! Although designed primarily for the popular 20, 40, and 80 meter "amateur bands," Mr. Shuart's instrument is also a superlative receiver for "general" short-wave reception.

● IN designing the receiver here described, a number of items were taken into consideration. Among these was that the receiver complete, including coils and tubes but less power-supply unit, should not cost more than twenty dollars. In order to maintain this low cost the set had to be of such design that the chassis or foundation could be made at home with the usual tools found in the experimenter's workshop. The saving on this part of the set allowed the incorporation of many refinements that otherwise would have been impossible at this low cost.

The aluminum used for the base of the receiver is of 1/32nd inch stock. Material this thin would be far too weak if it were not for the particular design used in forming the base and the mounting of the two shields which form the compartments for the tuned R.F. and detector stages.

Metal Base and Shields

When bending the base and shields the only tools needed were two pieces of wood and two "C" clamps together

with a small vise. The "C" clamps can be purchased in any hardware store for about ten cents. It is advisable to have the aluminum cut to size when buying it rather than trying to cut it at home with a pair of tin snips. The cost of the aluminum cut to size as indicated in the drawing was only \$1.25, not including the front panel. If care is taken in measuring and bending the material a very neat and sturdy chassis can be turned out.

Kind of Tubes Used

As can be seen, this set uses a type 58 as the tuned R.F. amplifier and a type 57 as detector, with a 47 as audio amplifier, a 56 can be used instead of the 47 if ear phones are to be used.

When using a stage of tuned R.F. ahead of an autodyne detector it is absolutely necessary to have some sort of R.F. gain control if overloading of the detector is to be eliminated. Therefore a type 58 is used in order to obtain control of volume by the cathode method. This type of control is very quiet in operation and has very little

effect on the tuned circuit. As can be seen in the diagram, the grid circuit of the R.F. stage is decoupled by a 250,000 ohm resistor and a .01 mf. condenser. This helps to prevent the R.F. stage from detuning the detector and allows the full benefit of the shielding. Screen grid voltage is obtained with a 100,000 ohm resistor which adds to decoupling and eliminates one wire in the cable. Isolantite coil forms and sockets and tube sockets are used because of their low loss.

Coupling R.F. to Detector

A separate winding on the detector coil form provides the R.F. coupling between the R.F. stage and the detector. This is the most efficient means of coupling and should be used when ever high gain and stability are required. Bypass condensers are used freely but no R.F. chokes are shown because no benefit was derived from them.

The type 57 was chosen as the detector because it oscillated much better at the higher frequencies than any other type. The detector circuit is of

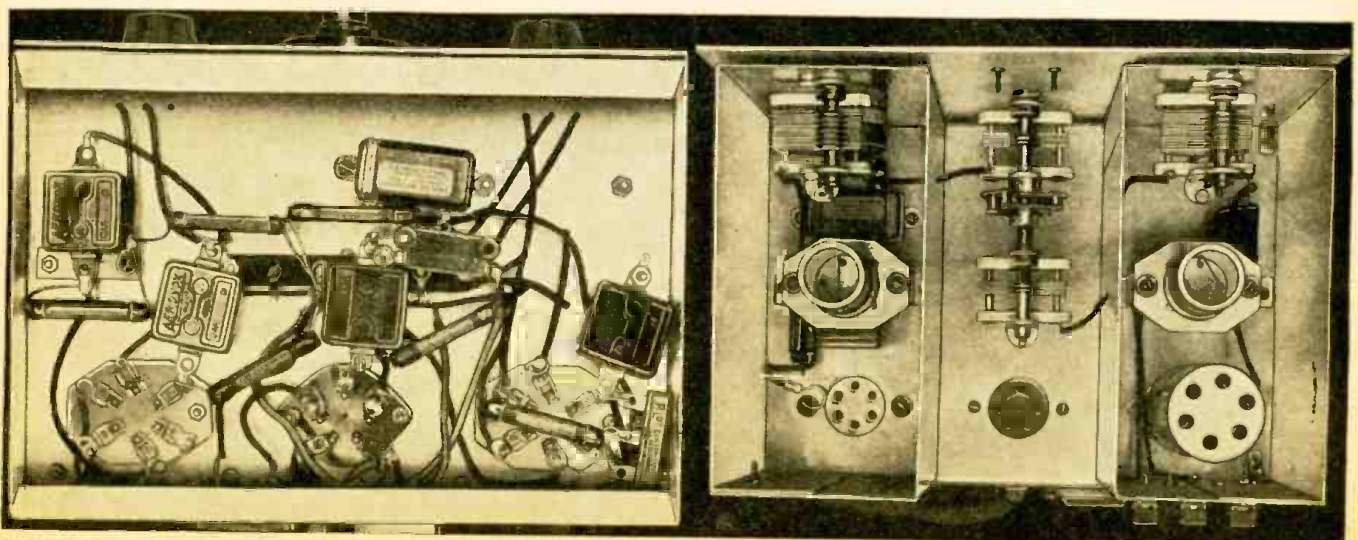

Bottom view of Mr. Shuart's 3-Tube Band Spread receiver is shown at the left, while we have an excellent top view of the receiver at the right.

Loud Speaker Set

Rome, Paris, and London on the loud speaker! Yes Sir, and with only 3 tubes! Thanks to the ingenious circuit here presented by Mr. Shuart, plus the utilization of three of the latest style tubes, this set provides unusually high amplification. This is one of the finest receivers we have ever had the pleasure of describing to our readers; moreover, it provides "band - spread" on any band. The receiver can be built for less than \$20.00.

By **GEORGE W. SHUART**
W2AMN-W2CBC



the electron-coupled type. This allows the use of five prong coil forms and it is also more stable when oscillating. The feed-back coil is wound separate from the grid coil and is spaced about 1/4 inch from it. This method is preferred rather than tapping the grid coil because it is not as critical and allows better control of regeneration.

There is no spacing between turns because distributed capacity was not an important item; in fact the opposite was desired. The total capacity across the grid coils is 135 mmf. when the condensers are tuned to maximum. The coils are wound so as to have high "C" (capacity) on any of the amateur bands. High "C" tends to make the circuit more selective and this is needed

in the amateur bands more so than for general short-wave reception.

The R.F. plate coil is threaded right along with the grid coil of the detector, beginning at the ground end. The wire for the R.F. plate coil, the tickler and the antenna coil is No. 34 silk covered. The grid coils are wound with No. 24 silk covered wire. The coil forms are Hammarlunds, intended for ultra short waves. These coils are small but provide ample room for the windings for all bands.

Regeneration Control Feature

Regeneration control is one of the most important items in any short wave receiver, and deserves careful consideration. To obtain smooth and noise-

less control of regeneration one must bear in mind that when regeneration is controlled by varying the screen grid voltage with a potentiometer, the voltage across the potentiometer should be only slightly higher than that required to make the tube oscillate and that the resistance of the potentiometer should be large enough to allow a very fine adjustment of this voltage. With the number of tickler turns designated in the coil table and 22 volts across the potentiometer, which is of 100,000 ohms resistance, it is possible to swing the regeneration control all over the scale without affecting the tuning of the detector circuit. It takes a swing of about one-half inch to bring the tube

(Continued on page 117)

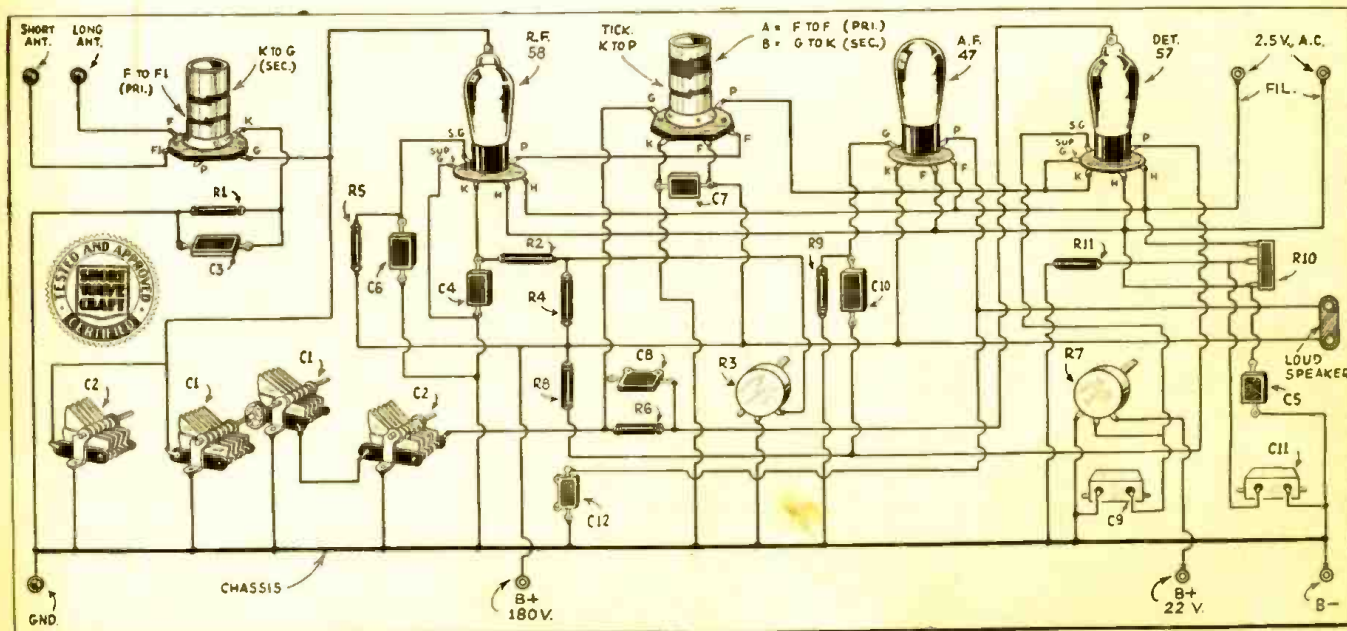

Picture wiring diagram drawn especially for the benefit of the uninitiated reader, who may find the schematic wiring diagram shown on the opposite page too difficult to understand. You should have no difficulty in following the wires connecting the various pieces of apparatus in this diagram.



Dual

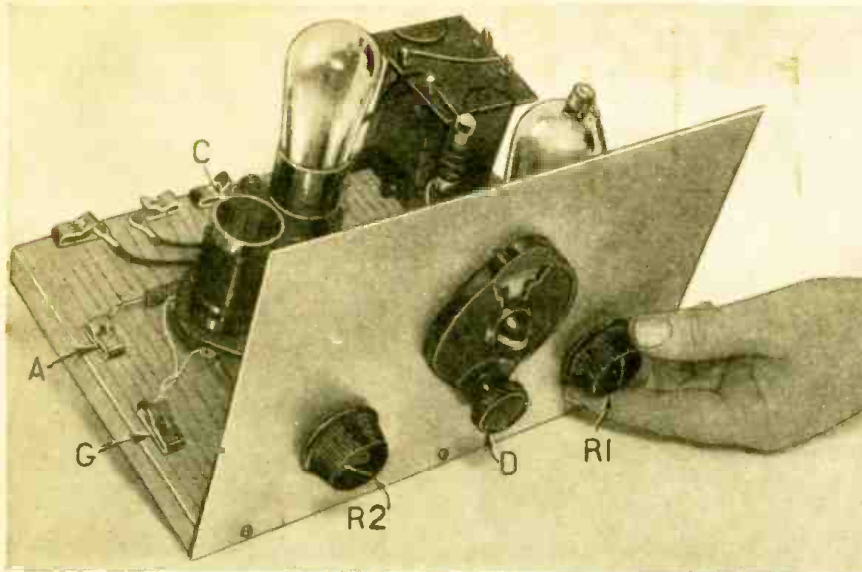

Above—Front panel appearance of the "Dual Regeneration Control" Short Wave Receiver, which worked very smoothly in the Editors' tests.

worked out very nicely indeed. The plug-in coils, incorporating the grid and tickler windings, may be of the Gen-Win, Na-Ald, or other type suitable for operation with a .00014 mf. tuning condenser. The first control element of the regeneration is a .0001 mf. variable condenser of the midget type, while the second control element in the set here illustrated, and successfully tested by the editors, is a 50,000 ohm potentiometer. Mr. Bucher suggested a 500,000 ohm potentiometer, which would probably work as well, particularly if the voltage applied to the potentiometer was in the neighborhood of 90 volts or more, but the standard practice in practically all of the short-wave receivers at present is to use a 50,000 ohm potentiometer, so that was the one chosen. Many short-wave fans find that the value of the grid-leak is important and that with certain tubes and circuits greater sensitivity is sometimes obtained by using a grid leak of more than two megohms resistance; it is a good idea to use either an adjustable grid-leak or else to obtain several grid-leaks of various values from 1/2 megohm to say 7 megohms. Mr. Bucher states that he tried leaks as low as 1/10 megohm successfully; also that when using this circuit with A. C. tubes (a 24 tube detector stage and a 27 tube in the audio stage) most of the short wave stations came in on the loud speaker; in fact, he received a Spanish station on the loud speaker.

One of the smoothest-working, 2-tube, short-wave receivers we have yet seen is the one here illustrated and described—it embodies dual control of regeneration. There are two schools when it comes to regeneration control; one favors the throttle condenser method and the other the potentiometer method of controlling the potential supplied to the screen-grid of the detector tube. The present set utilizes both methods, which have their advantages under different operating conditions.

● IF there is any one problem that bothers the short-wave "beginner" more than any other, it is probably that of smooth and reliable control of regeneration. The set illustrated and described herewith was suggested and

tried out by Mr. J. F. Bucher, Jr. There is nothing particularly new, but Mr. Bucher, as well as the editors in their test of the set, found that this combination of condenser and resistance control of the regeneration

Cost of Set Reasonable

The cost of building the dual regeneration control receiver here illustrated is very low, considering the very fine results and strong signals obtained with the two very economical tubes

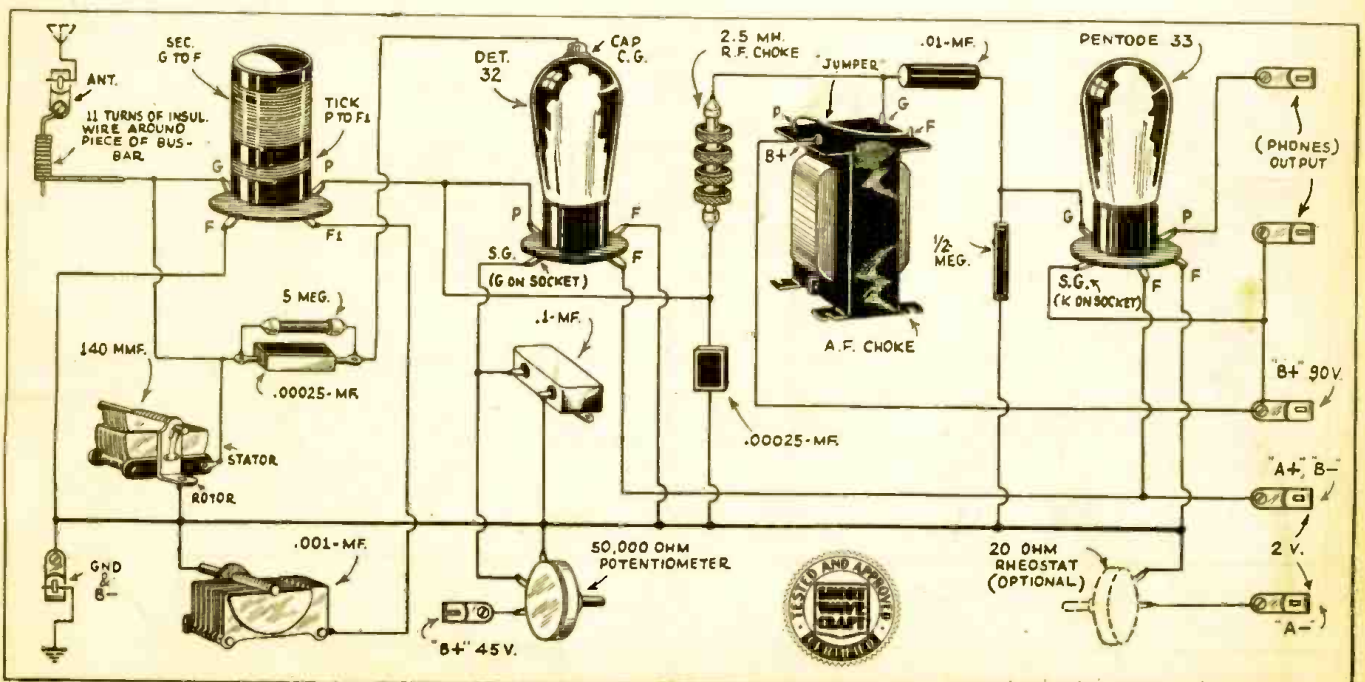

Picture wiring diagram which even the uninitiated can readily follow in building this smooth-working "Dual Regeneration Control" short-wave receiver.

Regeneration Control Set

By H. WINFIELD SECOR

used, viz., a 32 screen-grid detector and a 33 pentode in the audio stage. These tubes can be operated from ordinary dry cells or from a 2-volt Air-cell battery (or from a 2-volt storage battery, a new model of which has just been placed on the market and one type of which resembles a No. 6 dry cell in size and appearance).

The type 32 tube draws but .06 ampere at 2 volts, while the 33 pentode draws .26 ampere at 2 volts. The screen-grid and plate potentials can be supplied either from "B" batteries or from any good "B" eliminator, and we mean by "good" one using a well-filtered plate system. If you have trouble from hum when using a "B" eliminator with any short-wave receiver, you can usually eliminate a great part of the hum by adding an additional filter section to the "B" eliminator. As will be seen from the diagram, the screen-grid detector tube is impedance-capacity-resistance coupled to the 33 pentode, which will be found to give very good quality, and a minimum of trouble from howling and other transient disturbances to which many short-wave receivers are subject.

Note that the R. F. choke used in the detector plate circuit is of the new National 2½ millihenry type, while the main A. F. coupling choke (iron core) may be either the National type S101, or an A. F. transformer such as the Silver-Marshall type used in the set here illustrated, the primary and secondary windings of which are connected in series to give a high impedance. In passing, the short-wave fraternity will undoubtedly be pleased to know that the transformer and radio manufacturers have recently developed special high impedance A. F. chokes for the particular purpose of coupling screen-grid tubes to A. F.

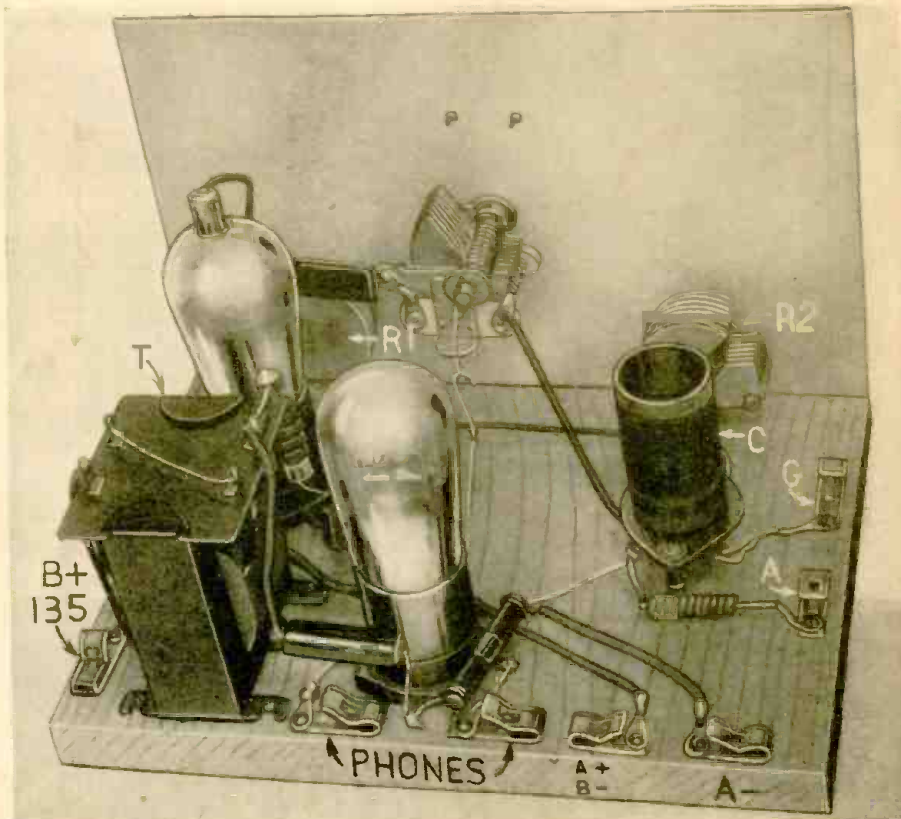

Rear view of the Dual Regeneration Control receiver which you will find to have a good "wallop"—thanks to the excellent audio stage incorporated.

stages; one of these is the National S-101 type mentioned; another is the new Acratest 800 henry A. F. choke. Many requests have been received for receivers of the type here illustrated and designed to operate with

2 volt tubes—so here's your meat! It is an easy matter, of course, to also employ the 6.3 volt auto type tubes with but slight change in the circuit and the same principle holds true in
(Continued on page 113)

PARTS LIST—DUAL CONTROL SET

- 1 antenna series condenser (about 10 to 25 mmf.) or Hammarlund equalizer, type E.C. 35.
- 1 tuning condenser Hammarlund MC 140 m. (cap. .00014 mf.).
- 1 set S-W plug-in coils, Na-ald; (Gen-Win; Kresge; I.C.A. etc.) or other coils suited to match .00014 mf. condenser.
- 1 regen. control cond. Hammarlund MC-100M (Cap. .0001 mf.) (or National).
- 1 4 prong socket Na-ald (or Eby)
- 1 5 prong socket Na-ald (or Eby)
- 1 4 prong wafer socket for coil Na-ald (or Eby)
- 1 50,000 ohm potentiometer, Frost.
- 1 by-pass cond. (for potent.) .1 mf., Flechtheim.
- 2 .00025 mf. condensers, Aerovox.
- 1 grid-leak, 5 meg., Lynch.
- 1 ½ meg. resistor (couples grid of pentode to ground).
- 1 20 ohm rheostat, Frost.
- 1 R.F. choke, National, 2½ m.h. (millihenry).
- 1 .01 mf. condenser, Aerovox.
- 1 A.F. Choke; National type S101; or Silver-Marshall A.F. transformer with sec. and prim. con. in series.
- 1 32 type 2 vt. S.G. detector tube, Triad (R.C.A. or Arcturus).
- 1 33 pentode, 2 Vt. output tube, Triad (R.C.A. or Arcturus).
- Binding posts (Eby).
- 1 panel, Blan, (or Insuline Corp. of America).
- 1 pair 4000 ohm, high impedance phones, to suit pentode; Trimm "feather-weight."

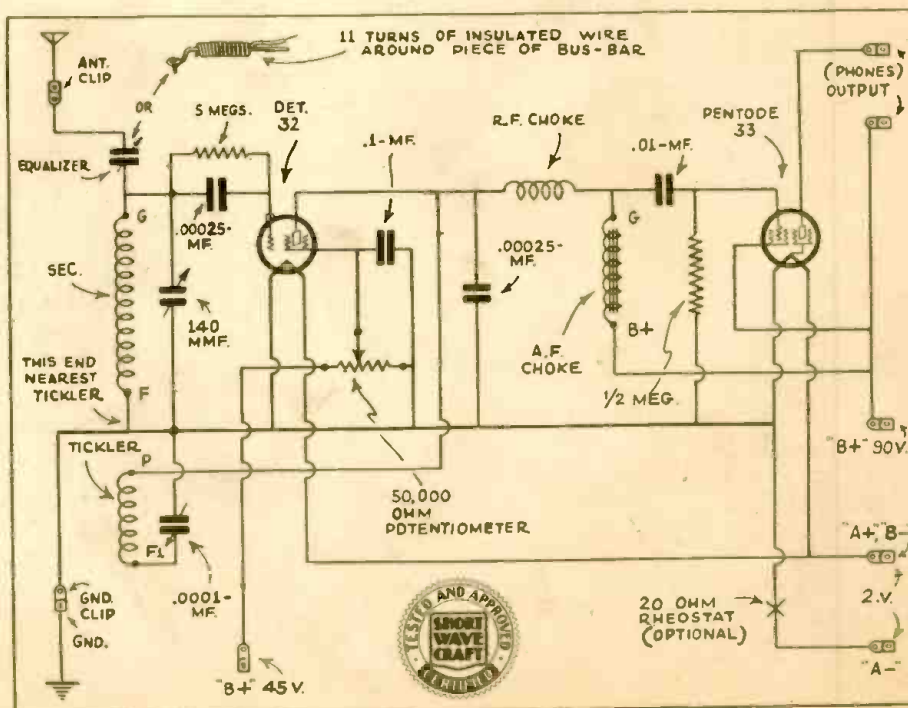

Schematic hook-up, showing the simple arrangement of the relatively few and inexpensive parts required for building the 2-tube set here described.

Here we see the "Master Composite" 4-Tube Receiver, which embodies all of the desirable features you readers voted for, undergoing its test. This set is designed to operate a "loud speaker"; at the right a complete set of National plug-in coils are observed in a new handy dust-proof coil cabinet.

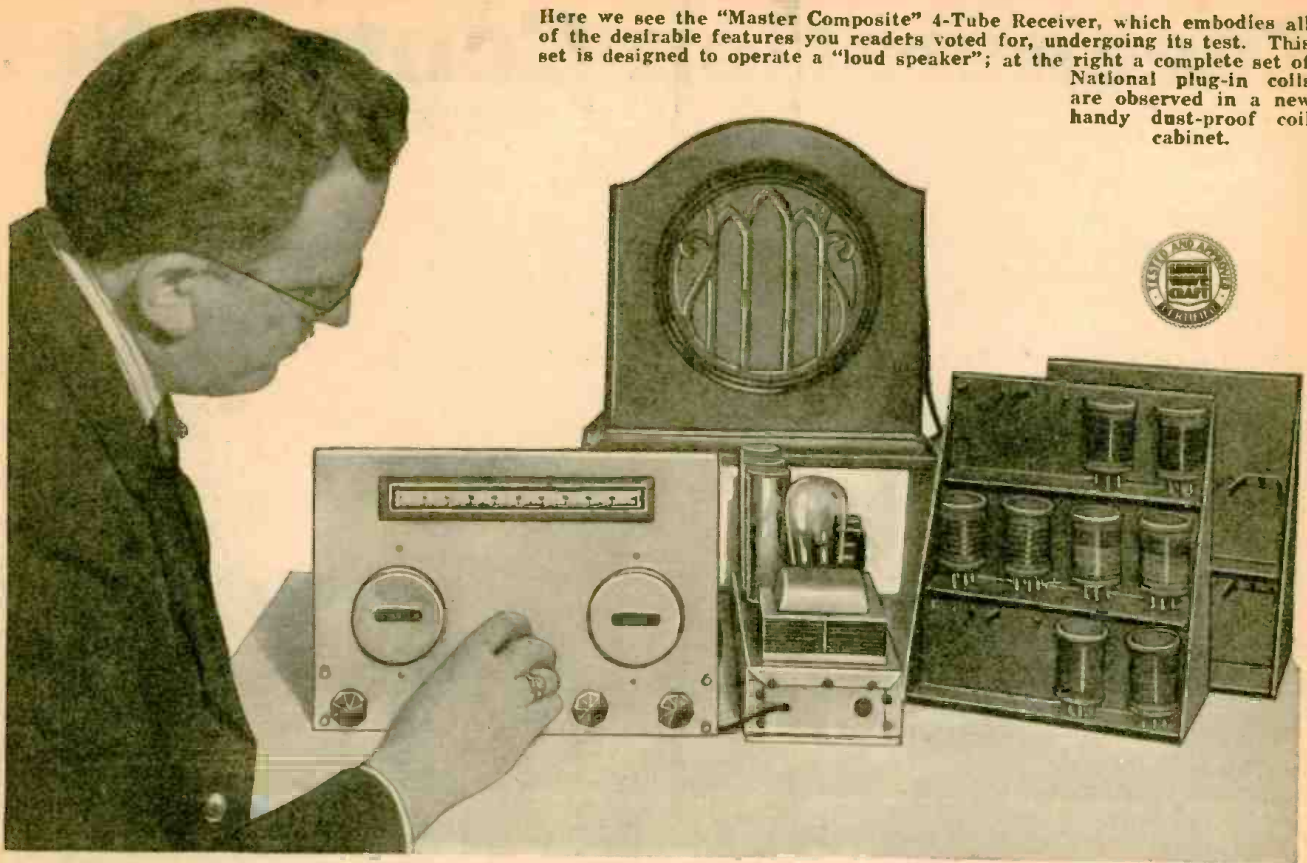

4-Tube "MASTER COMPOSITE"

By Clifford E. Denton

● THREE thousand S. W. fans cannot be wrong. Results prove it, because tests on the receiver which was voted ideal by so many sure does the job 100 per cent. Stations all over the world at loud speaker volume, low back-ground noise, plus a very satisfactory degree of selectivity, are the result.

Permit the author to express his

thanks to the manufacturers of the components used. They have presented material for use in this set that will give maximum efficiency, highest gain and sturdy, long-life construction. There are other manufacturers making similar equipment that will give equal results but the manufacturers listed in the parts list are to be commended for

their vision and aid in developing equipment that will permit "real" short-wave reception.

Description of Receiver

Looking at the set from the front one will note the new National 7 inch straight line tuning scale. This is of great assistance in logging stations and makes for easy tuning.

Note that the coils are plugged in from the front—a real convenience for the fellow who wants to change from band to band quickly. It is possible to place the set in a metal case for further shielding and still be able to change coils without fuss or bother.

The tuning dial control is located at the center of the panel between the two coil hand-hole covers.

Starting from the left-hand side of the front panel and looking at the bottom row of knobs, we find that the first knob is the antenna potentiometer. This is used as a volume control when the set is used with a conventional antenna. When a doublet antenna or a Lynch transposed lead-in system is used, then the leads from the potentiometer are disconnected so that the primary winding of the antenna coil is not grounded. This permits balanced input conditions.

The second knob from the left controls the antenna compensating condenser and it "works like a charm."

The third knob controls the switching of the phones into and out of the circuit. When the phones are in use no signal will come from the speaker and when the speaker is in use, no signal will come from the phones. The

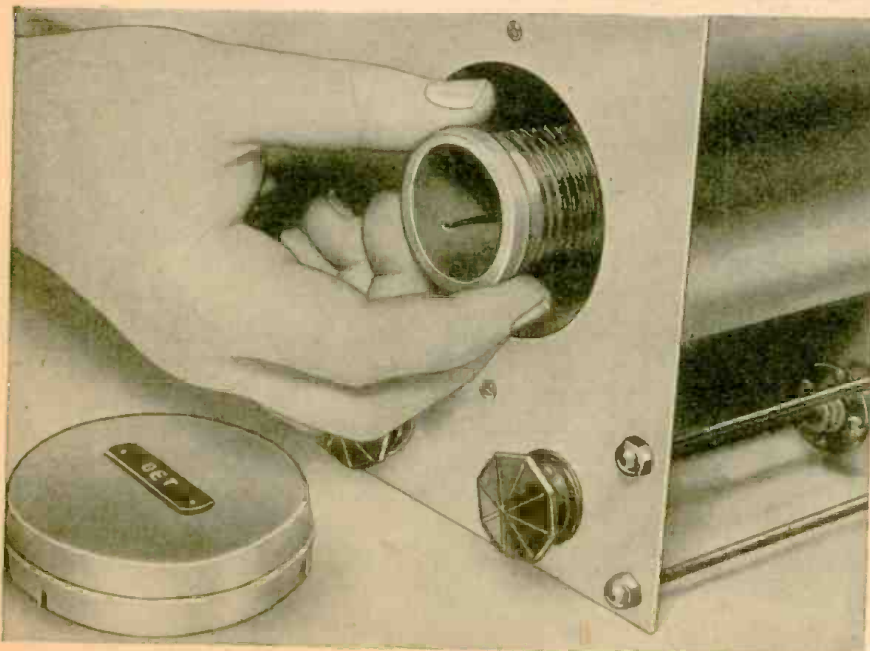

At two a. m. in the morn'—and your arm is tired perhaps, from lifting the lid of a receiver cabinet to change plug-in coils, you will give thanks for this method of changing plug-in coils, incorporated in the "Master Composite" receiver here described.

Several months ago the editors asked the readers of SHORT WAVE CRAFT to vote on a ballot, which was printed in the magazine, and to indicate the features they would like to have in this "ideal" short-wave receiver. The "Master Composite" short-wave receiver, incorporating all the major features for which you readers voted is here described and illustrated. The set was designed and constructed under the supervision of Clifford E. Denton, well-known short-wave engineer, who has described so many good S-W receivers in past issues. Features of the present set are—only 4 tubes and therefore economical operation; together with the latest method of changing plug-in coils from the front of the set; a non-detuning regeneration control, and a powerful A.F. output stage, using the new 59 tube.

Photo at right shows rear view of the 4-tube "Master Composite" S-W Receiver, showing the shield cans, inside of which are the plug-in coils. National 6-pin coils with the R-39 low-loss forms are used.

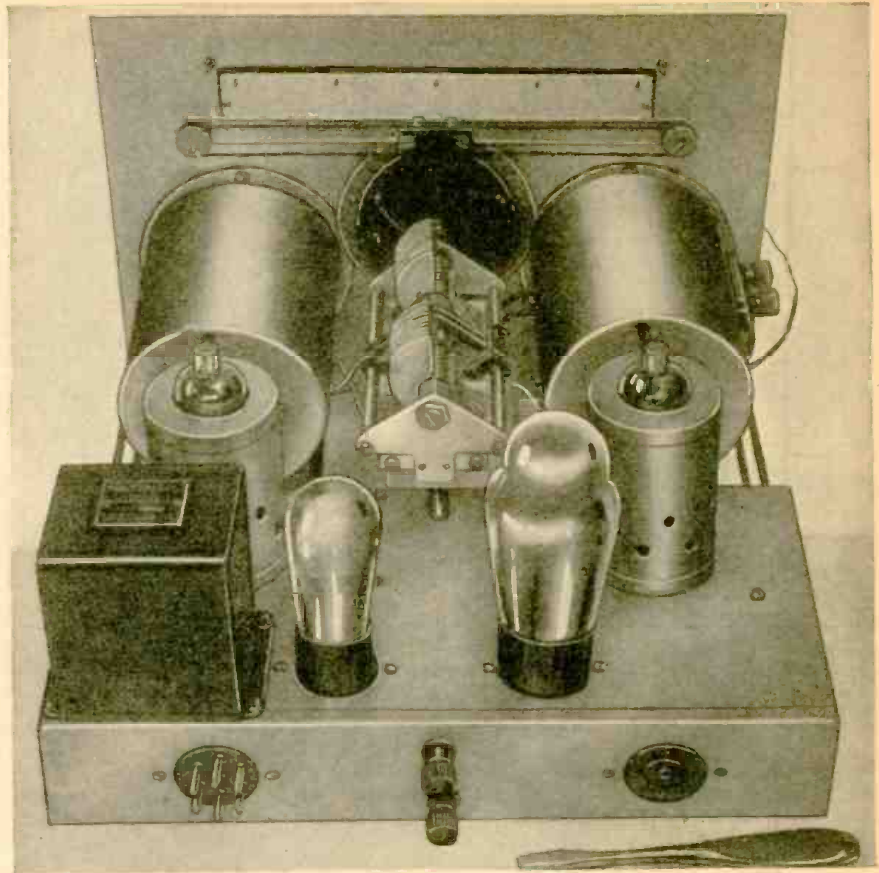

The Set YOU Voted For . . .

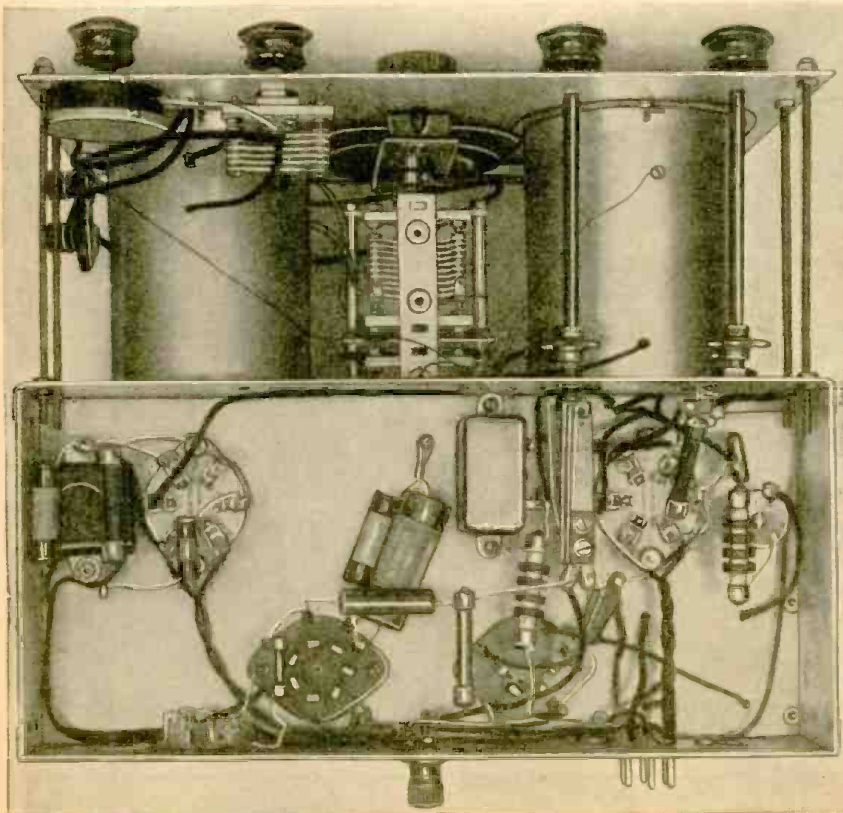

Bottom view of the "Master Composite" receiver, showing the neat arrangement of the various resistors, R.F. chokes and by-pass condensers.

phones are permanently connected to the two binding posts provided on the rear of the chassis.

Regeneration in the detector stage is controlled by the remaining or fourth knob and is very smooth in action. The potentiometer of 50,000 ohms gives a *noiseless* variation of the voltage applied to the screen of the 58 type tube used as the detector. The action of the 58 type tube, as far as regeneration is concerned, is superior to the results obtained with a 57 type tube.

Of course, the two aluminum covers marked ANT and DET mark the placing of the openings through which the coils are inserted in their respective coil sockets. It is well to note at this time that the two coils used for any particular band are *identical in construction*.

When looking down on the top of the receiver it will be seen that the actual chassis is small in size.

The tuning condensers are mounted on the center line and are flanked by the two coil shields. Directly back of the coil shields are the two shields and tube sockets for the 58 type tubes. The shield to the left holds the R.F. amplifier tube and the shield to the right holds the detector tube.

The special detector coupling impedance is mounted to the rear of the detector tube and has the high inductance choke, coupling condenser and the grid coupling resistor mounted in the can. This method of coupling is more satisfactory than the standard resistance plate coupling so often used with screen-grid detectors. The main advantages are higher gain and smoother regeneration control.

On the right of the audio coupling

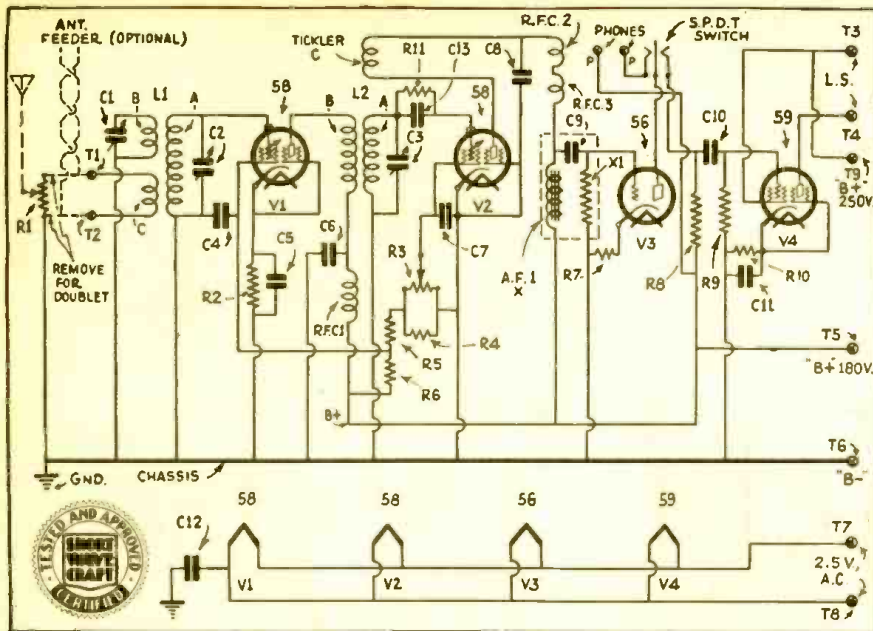

Schematic diagram of the "Master Composite" 4-Tube Short-Wave Receiver which embodies the major features which thousands of readers of SHORT WAVE CRAFT voted for.

unit is the first audio stage; a 56 type tube is used here. The output of this tube is resistance-coupled to the power tube, which is a 59. This tube is more satisfactory than a 47 for one important reason—less hum. The 59 is a cathode type (heater) tube—which explains the hum reduction.

Space is provided on the rear of the chassis to the left for an output transformer if it is desired. The plate current of the 59 should not be allowed to flow through a pair of phones or a magnetic loud speaker as it will destroy their efficiency.

On the rear of the chassis, the

phone binding posts are located in the center and they are flanked to the right (under the 59 output tube) by the plug and socket for the loud speaker connections. The remaining plug connection is for the power cable; five wires are all that are necessary for these connections even though the designer used a six-connector unit.

Note that the front panel is fastened to the chassis mechanically in five places, four by means of the threaded brass rods and the fifth by the brass collar used under the end-section of the tuning condenser.

The antenna volume control and the antenna compensating condenser are mounted on the front panel and the phone-speaker switch and the regeneration control are mounted on the chassis and are controlled from the front panel by means of the flexible couplings and the 5-inch long, 1/4-inch diameter bakelite rods. This layout permits of easy wiring and much shorter leads, which improves the stability of the receiver and its general operation.

Examination of the receiver from underneath shows the layout of the various by-pass condensers and resistors.

Three .01 mf. mica condensers used as by-passes in the R.F. stage are mounted by a single through bolt near the R.F. tube socket. The two .25 mf. paper type condensers by-passing the plate of the detector and the screen of the detector are mounted one above the other, by means of small brass collars.

The small resistors, radio frequency

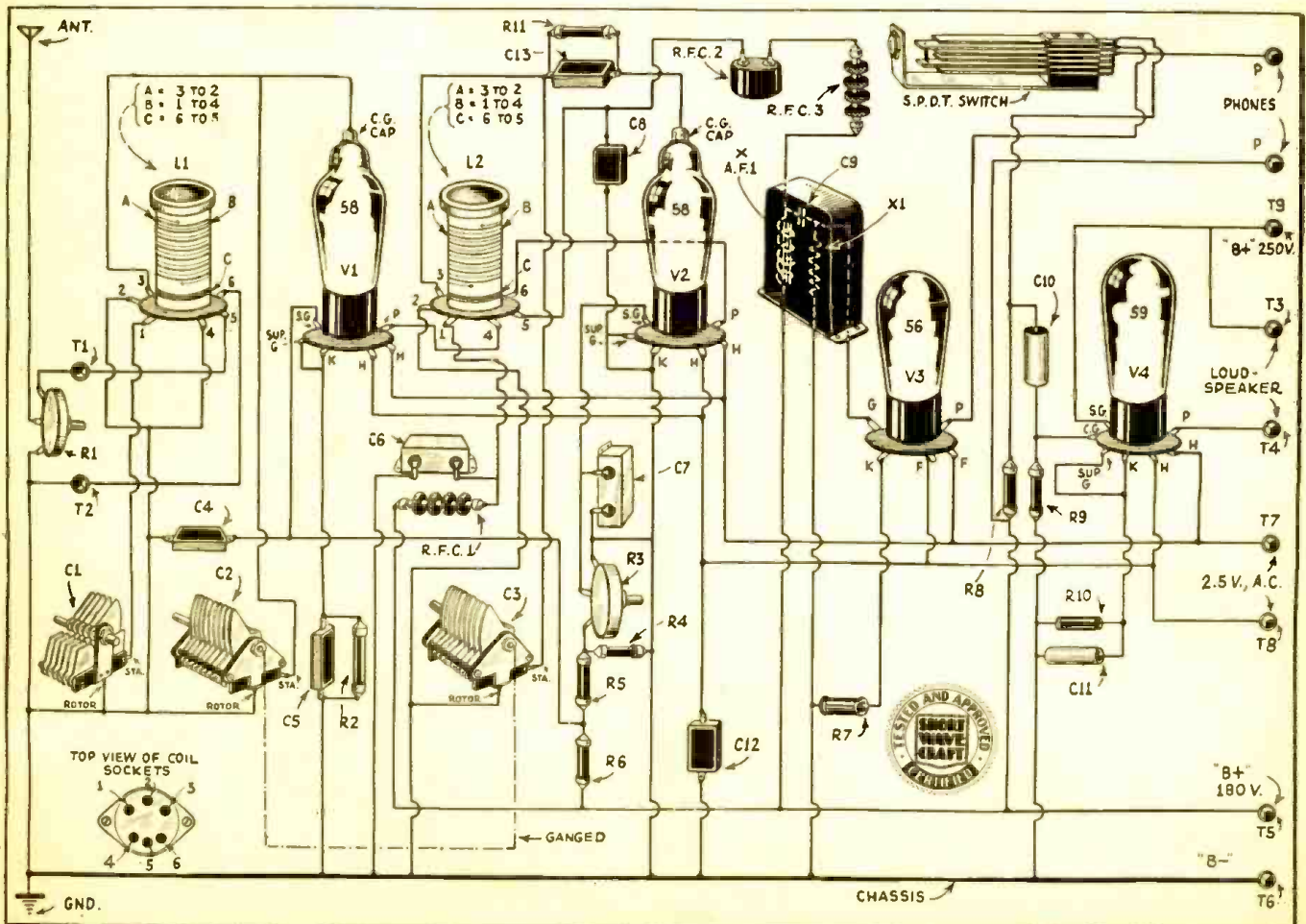

Picture wiring diagram, showing in A-B-C style just how to build the "Master Composite" short-wave receiver. You will find this set easy to build and also easy to tune—and speaking of a "hot" signal—wait till you hear it!

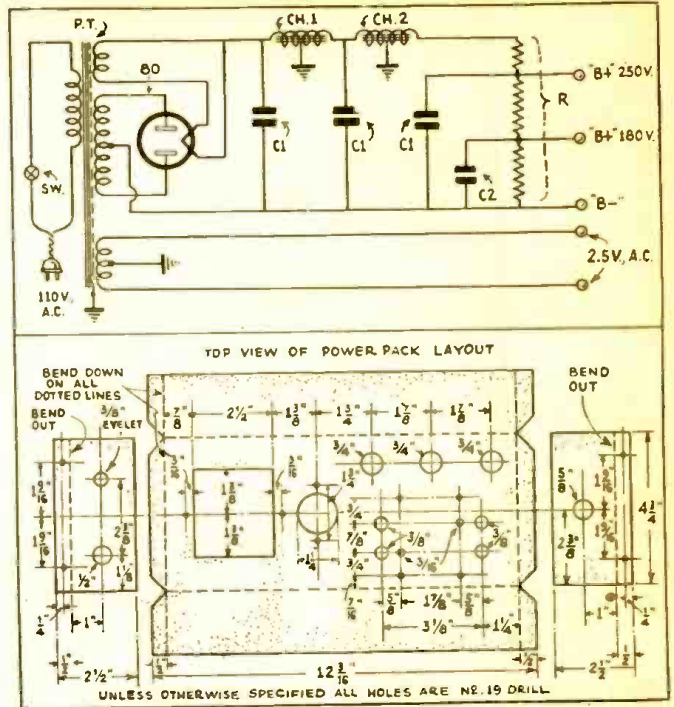
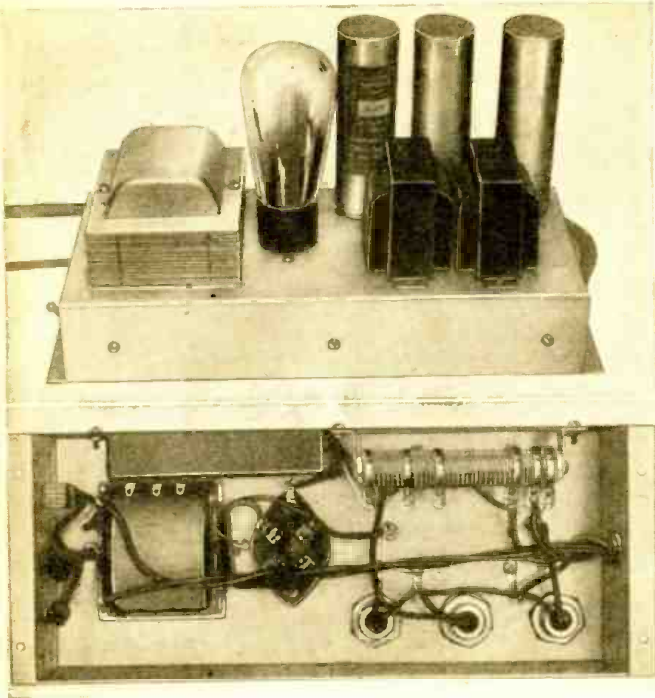

The two photos at left show the plate supply unit from the side and from the bottom. The diagrams at right show wiring diagram for the plate supply unit and lay-out of the metal subpanel.

chokes and mica condensers are held in position by the wiring. Therefore be sure to test every soldered connection for mechanical strength.

The detector grid condenser and the 5 megohm grid-leak are soldered into place before the coil socket of the detector tube is fastened into its shield.

Coil sockets are held away from the ends of the coil shields by means of 1-inch long collars drilled and tapped for a 6-32 thread.

Power Supply Unit

The power supply unit is simplicity itself and should offer no problems to the constructor, but a few words of

description, together with the photographs, may prove helpful.

Many set-builders are not equipped to build the chassis. For that reason two possible sources of supply have been mentioned in the parts list. One of the chassis makers builds his chassis out of steel and the other uses aluminum.

If the chassis is obtained *ready-drilled*, then the job of assembly and wiring can be finished in "jig time."

Mount the power transformer, chokes, and electrolytic condensers on the chassis and the voltage divider (R), with the 180 volt by-pass condenser, under the chassis, as shown in

the photographs here reproduced. Place the rubber grommet in the hole on the side of the chassis; this will serve to prevent chafing of the power cable.

The power switch is mounted on the side of the chassis near the power transformer.

Wiring can be done in less than 20 minutes after the soldering iron is heated. Follow the pictorial wiring diagram, if you are not familiar with the regular wiring diagrams.

Solder all connections carefully and be sure that there are no cold rosin-core connections if you want the best (Continued on page 125)

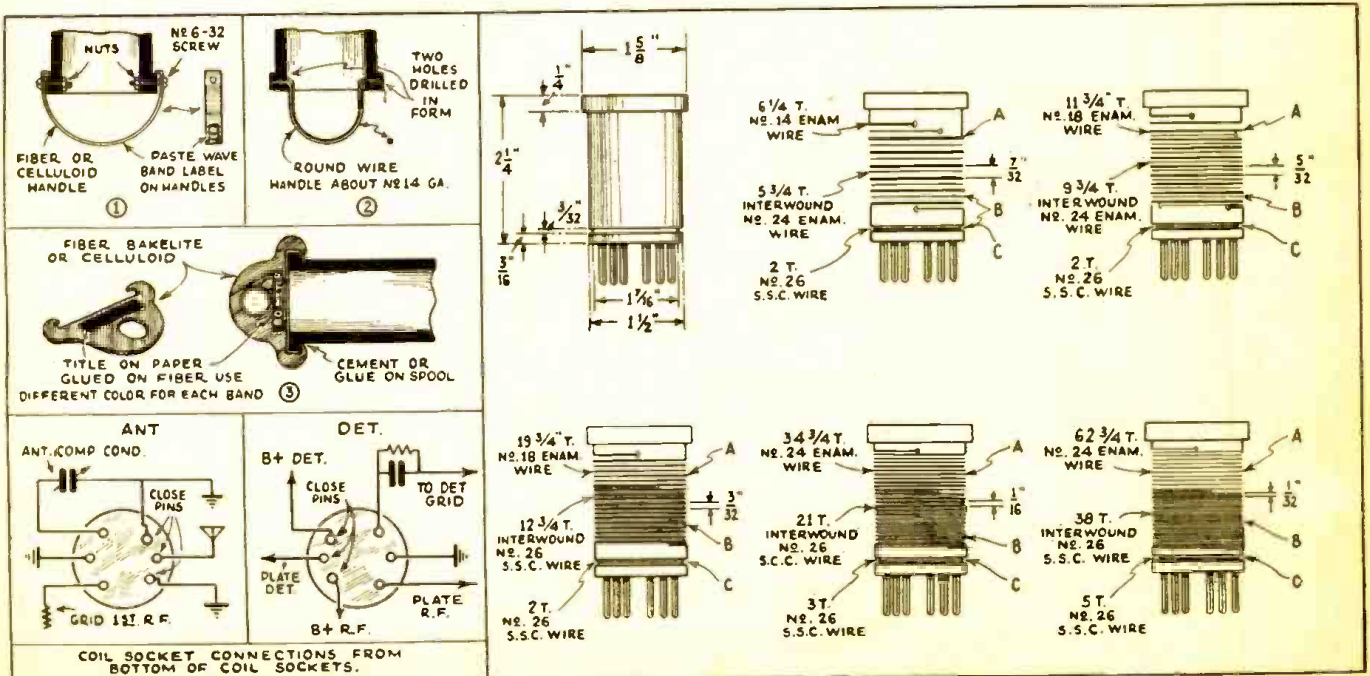

The two drawings at left show respectively how to make plug-in coil handles and also how to wire up the "coil" sockets. The data for winding the National type plug-in coils for the "Master Composite" 4-tube receiver are shown at right.

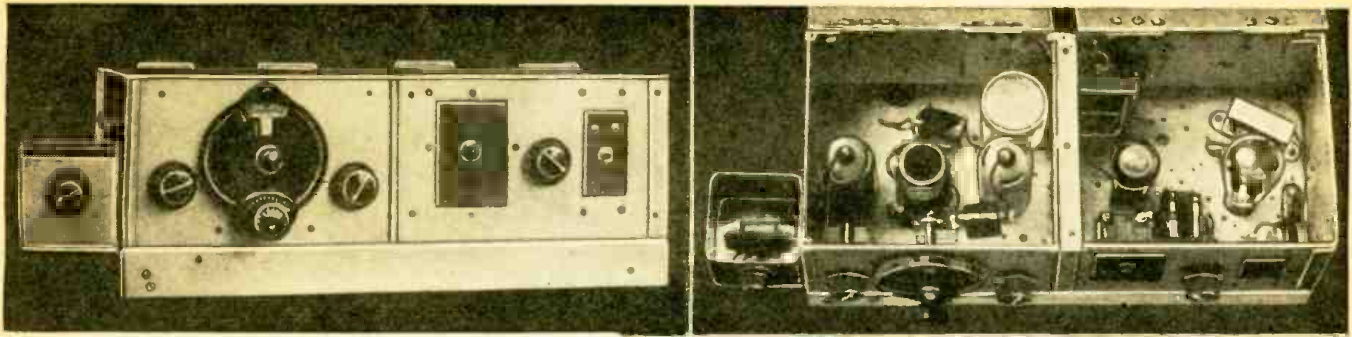

A 4-TUBER THAT "BRINGS HOME THE BACON"!

By DR. A. S. HUNTER

\$20.00 March Prize Winner

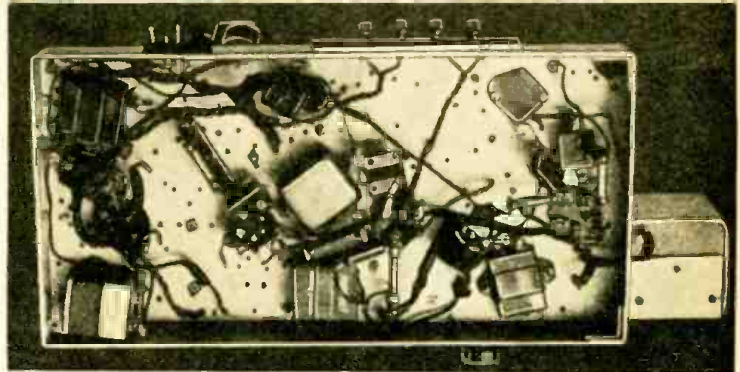

The three photos above show the "business-like" appearance of Dr. Hunter's final evolution of an efficient-working "4-tube" short-wave receiver. The upper left-hand view shows the front; top photo, above —inside view and lower picture, a bottom view.

● AS a charter member on your subscribers "log," having sailed with you in the good old craft over both many lands and seas, we wish to thank you for the many thrills, benefits, and happy landings.

You promised a publication of interest for the short-wave "gang," you have not only done this but you have exceeded the most exacting expectation.

AN EVOLUTION OF MR. INGRAMS DE LUXE PRIZE WINNER (Sept. SHORT WAVE CRAFT) DRESSED UP IN FULL MAN SIZE CLOTHES.

With the converter craze abating in

its intensity, men have begun to look for real dependability from a smaller number of tubes. After many experiments we used for over a year a very efficient 4-tube, self-powered converter, working into a well-built ten-tube broadcast A.V. control "super."

We were able to make the magic circle bringing in both trans-Atlantic and Pacific reception—but with fourteen tubes, and with every tube contributing to the raise of noise level with every increase of signal, much was generated and received that we did not want.

I went back to using an old reliable 4-tube A.C. job for short wave recep-

tion. When I opened my September number, the De Luxe presented such a clean cut business like appearance, I found myself plundering in the old junk box. On the check up I found that I had all the needed parts with the exception of six prong coil forms and socket.

My first impulse was to build the job in a discarded Knapp "A" eliminator cabinet, but finally roughed it in on the left end of a metal chassis 9 x 18 x 1½ inches, placing the detector and R.F. in a shield covering half the length, reserving the other for audio.

With the first experiment the results were such that I found it would merit doing anything for improvement. We found that no single choke used as an input would function equally as well over the entire band coverage.

Read article by R. Wm. Tanner, May (Continued on page 112)

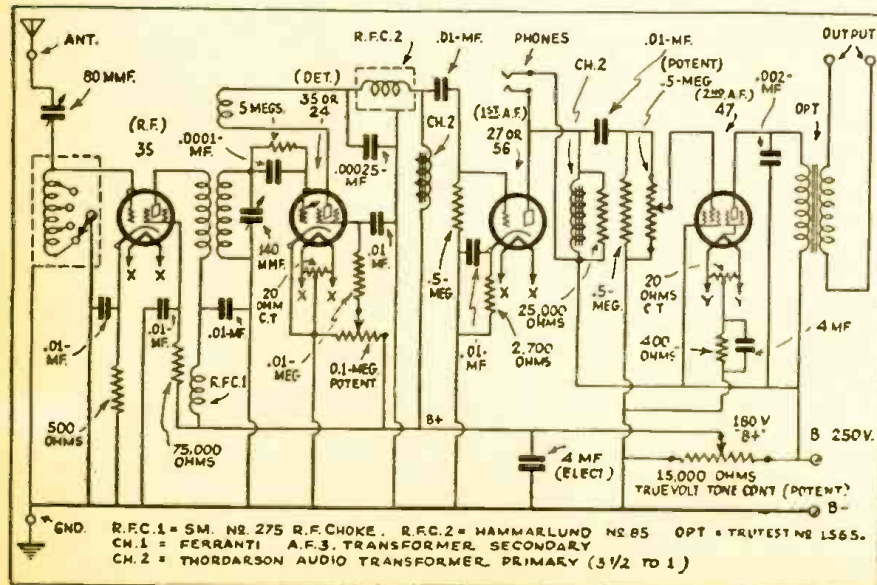

Schematic wiring diagram of the 4-tube receiver as finally evolved by Dr. Hunter after many experiments.

Dr. Hunter is a dyed-in-the-wool short-wave experimenter and some of the valuable discoveries he made while trying out dozens of different combinations of coils, condensers, and tubes are set forth in this valuable article. An improved antenna coupling choke was devised and this is described in detail, as well as a stable audio amplifier with a "hot" output.

\$500.00 PRIZE CONTEST

Grand List of Prizes Offered to Contestants

● IN our May issue we announced a \$500.00 Prize Contest which concerned itself with the front cover of that issue.

For those readers who did not see that issue, the following information will give them the details:

The cover depicted a scene at two a. m. in the morning. Pa and a young hopeful son are in the midst of assembling a "short-wave" set. Blue-prints, soldering iron, tubes, and plug-in coils are strewn about the table. Suddenly, the "disturber" in the guise of Mother, dressed in her night shirt and holding a candle (it must be the rural district) makes a dramatic appearance. Wrathfully she points to the clock. Pa looks on sheepishly and the young experimenter is "scared stiff." Here then is a situation familiar to every radio ham. The editor could not think of a good title for the cover, so he washed his hands of the whole affair and asked the readers to supply the missing title. \$500.00 in prizes were to be awarded for the best title.

These prizes, as also was stated in the May issue, were not cash prizes but merchandise donated to the contest by a number of radio manufacturers, also advertisers of SHORT WAVE CRAFT, and to whom the editors are indebted for their liberality and fine spirit in making this a successful contest. The editors here wish to thank the radio manufacturers in the name of our readers for having made this contest possible, and we know that the lucky prize winners will be happy also to thank the manufacturers for helping along the good cause.

The entire contest has been arranged in such a manner that practically every contestant will get a prize. Anyone who can think up a fair title has an excellent chance to win one of the prizes. There are so many radio items that the judges will not have much trouble in assigning a prize to almost all, always providing that the editors don't become "snowed under" with too many thousands of really good titles, but this, as a rule, is unlikely.

What then, is wanted in this contest is a good title explaining the cover illustration of this issue.

READ CAREFULLY AND DON'T JUMP AT ANY CONCLUSIONS. IN A CONTEST OF THIS KIND READERS USUALLY DO NOT READ INSTRUCTIONS AND CONDITIONS CAREFULLY AND AFTERWARDS ARE DISAPPOINTED WHEN THEY WIN NO PRIZE. READ THE SIM-

The PRIZES and their DONORS

- 1st PRIZE—One "Royal Star" 2-Tube Short-Wave Receiver, donated by HARRISON RADIO CO., New York City. Value \$25.00.
- 2nd PRIZE—One "Powertone" 2-Tube Battery Operated Short-Wave Receiver, donated by TRYMO RADIO CO., Inc., New York City. Value \$20.00.
- 3rd PRIZE—One "Midwest" Model C-4 Short-Wave Converter, donated by MIDWEST RADIO CORP., Cincinnati, Ohio. Value \$16.75.
- 4th PRIZE—One 2-Tube "Doerle" Receiver, completely wired, donated by RADIO TRADING CO., New York City. Value \$8.90.
- 5th, 6th, 7th, 8th, 9th, 10th PRIZES—A 1-Tube Short-Wave Receiver, donated by CHARLES HOODWIN CO., Chicago, Ill.
- 11th, 12th, 13th PRIZES—One transmitting type T-10 S Tube, donated by TRIAD MFG. CO., INC., Pawtucket, R. I.
- 14th, 15th, 16th, 17th, 18th, 19th and 20th PRIZES—Various radio parts to be selected by winner from Hammarlund catalogue, donated by HAMMARLUND MFG. CO., New York City.
- 21st and 22nd PRIZES—One complete "Lynch" Short-Wave Antenna Kit, donated by LYNCH MFG. CO., New York City.
- 23rd and 24th PRIZES—One Short-Wave Tuning Condenser, donated by NATIONAL COMPANY, Malden, Mass.
- 25th and 26th PRIZES—One "Majestic" Output Transformer, Model 70 or 90, donated by MAURICE SCHWARTZ & SON, Schenectady, New York.
- 27th, 28th and 29th PRIZES—Four each No. 27 type radio tube, donated by MAURICE SCHWARTZ & SON, Schenectady, New York.
- 30th and 31st PRIZES—One "Stromberg & Carlson" High-Power Transformer and Prize 31—one "Dubilier" 11¼ mf. high voltage filter condenser block, both donated by AMERICAN SALES COMPANY, New York City.
- 32nd, 33rd, 34th, 35th, 36th and 37th PRIZES—One year's subscription to SHORT WAVE CRAFT, donated by SHORT WAVE CRAFT Magazine, 98 Park Place, New York City.

A good title should have some allusion to radio or short waves, and the higher prizes will go to those who have the best titles. To give you an idea what is meant, a few titles are given at random:

- "Mom Rules the Waves"
- "Wavering Between Sleep and Science"
- "Short Waves vs. Shorter Hours"

These are just a few titles that we thought up in a hurry. We are sure that you will be able to think up a better title than any of these.

Prizes will be awarded for the best titles submitted.

Rules pertaining to this contest:

- 1.—A suitable title is wanted for the front cover of this month's issue.
- 2.—The title should be self-explanatory and should have in it some reference to radio, short-waves, or both. It should be humorous, if possible.
- 3.—You may submit as many titles as you wish. There is no limit.
- 4.—Titles must be submitted on slips of paper size of a postal card, 3¼x5½ inches, or you can send your title on a one-cent postal card, if you prefer to do so. Only one title must go on one sheet of paper. Use only one side of paper. If the paper or postal card is larger than that size the entry will be thrown out automatically.
- 5.—Write in ink or type-write the title; no pencilled matter considered.
- 6.—Name and address must be given on each title, no matter how many you send in.

7.—This contest is open to everyone, whether you are a newsstand reader or subscriber.

8.—From the contest are excluded employees of SHORT WAVE CRAFT magazine and their families.

9.—This contest closes on May 30, at which time all entries must have been received.

10.—The editors of SHORT WAVE CRAFT will be the judges of this contest, and their findings will be final.

11.—No correspondence can be engaged in on this contest, nor letters answered, nor the entries returned.

12.—In the event of "ties" the prizes tied for will be awarded to the contestants so tying.

The prizes will be sent from the radio manufacturers and radio firms to the winners at the end of the contest, and the results giving the winners' names will be published in our August issue.

Address all entries to Title Contest Editor, SHORT WAVE CRAFT, 98 Park Place, New York City.

PLEASE INSTRUCTIONS CAREFULLY TO MAKE SURE THAT YOU FULLY UNDERSTAND WHAT THIS CONTEST IS ALL ABOUT.

Understand that this is not a "cash" contest. The \$500.00 is the actual worth of the radio apparatus which has been donated by radio manufacturers and other radio firms toward this contest.

In Next Issue!

INSIDE STORY

of

THE WORLD-FAMOUS

"TI4NRH"

The World's Smallest

Short Wave

Broadcasting Station

As Told by

Its Owner and Operator

Amando Cespedes Marin

The "Voyager"

2-Tube Receiver

By CLIFFORD E. DENTON*

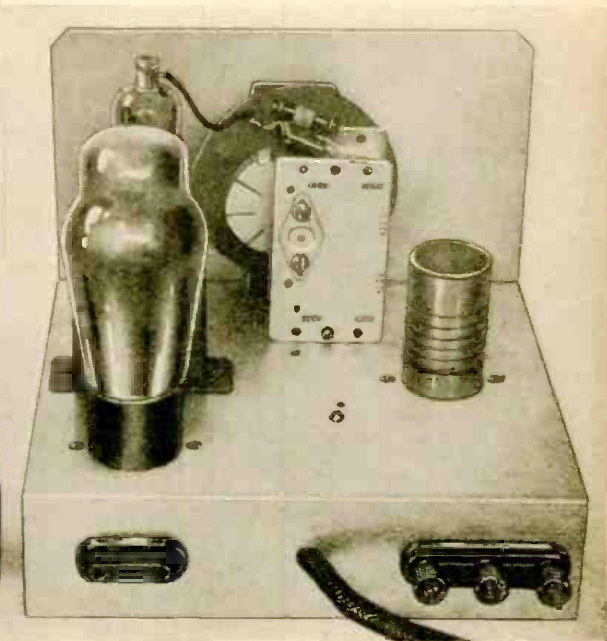
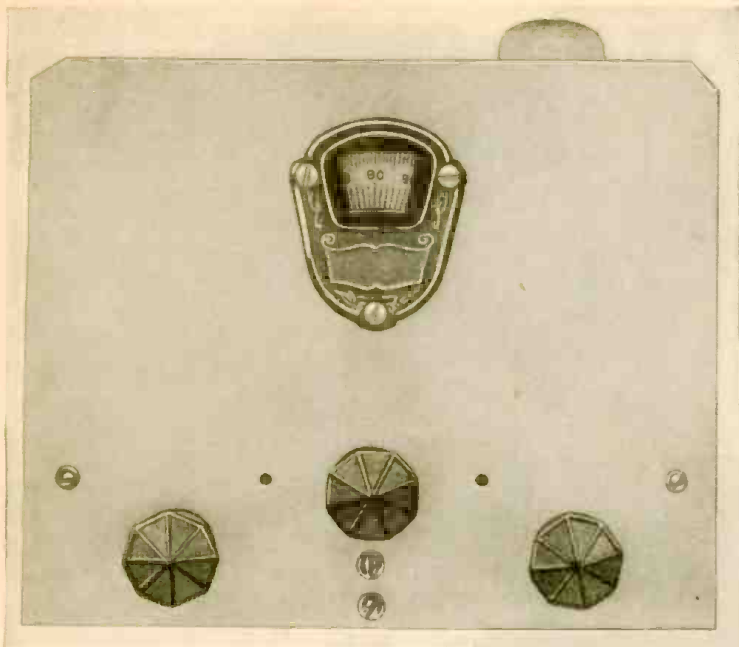

The two photos above and at right show the very latest "red-hot," 2-tube receiver designed by the well-known short-wave expert, Clifford E. Denton, whose many excellent articles on short-wave receivers you have enjoyed in the past. This set employs two of the latest tubes, a 57 and a 59. It is A. C. operated with battery or rectified A. C. supply for the plates

● ONE of the most popular receivers described some time ago in *SHORT WAVE CRAFT* was the two tube "All-Wave" job. Hundreds of set-builders wrote in to the editor telling of the excellent results which had been obtained.

The "Voyager" is an adaptation of the original circuit, improved in many respects by the addition of more modern parts and newer types of tubes. Being A.C. operated, it is necessary to have a power-supply of some kind. Later on in the article an interesting wrinkle will be disclosed, showing how this receiver can be operated from any of the standard midget receivers, or any other standard receiver, using pentode tubes in the output stage.

Among the improvements in design over the original two tube All Wave receiver that will be found in the new Voyager will be noted the use of the 59 type tube in the output stage. This tube has rather similar characteristics to that of the 47, except that it is equipped with a cathode. This materially reduces the hum to such an extent as to make the set really very quiet in operation. This point is appreciated best when phones are used instead of the loud speaker. The 57 type tube is used in the detector circuit. The main feature differentiating this receiver from the older one is the use of an impedance load in the plate circuit. This is a special 800 henry iron core choke.

Smooth control of regeneration in the screen circuit, results in a very smoothly operating detector stage.

The series antenna condenser is variable and is mounted on the front panel, so that the best coupling between the antenna and tuned circuit can be obtained very readily for all wavelength bands.

Several interesting changes, as above described, coupled with the inherent "high-gain" and distance-getting ability of the original receiver tend to make this receiver ideal for real DX reception. Most of the readers of *SHORT WAVE CRAFT* are familiar with the original 2-tube All-Wave Receiver, and will note the marked similarity to the Voyager.

The necessary power supply for this set can be built up of material already available, or the receiver can be used with a standard broadcast receiver using 47 type tubes in the output, as will be shown later.

The "B" supply can be any voltage from 180 volts to 250 volts. The maximum power can be obtained with 250 volts and the most sensitive condition for detecting in the 57 type tube will be obtained when the voltage is 180 volts, or a little higher.

The filament supply is A.C., of course, and should be capable of delivering 2½ volts at 3 amperes. Most every experimenter has a small 2½ volt transformer, which will safely carry the load of 3 amperes, so the filament supply should offer little difficulty to the constructor.

No batteries are necessary in the operation of this receiver, as the bias for the power tube is automatically taken up by a bias resistor under the chassis.

Under normal operating conditions a pair of phones will be uncomfortable as far as volume is concerned. In fact, most stations, especially the high-powered ones, can be received and tuned in directly on the loud speaker. When using the phones it is well to use a coupling transformer so that the direct current is kept out of the phone windings.

The circuit of the Voyager is very simple and essentially follows the older 2-tube All-Waver. The small antenna coupling condenser, which is mounted on the front panel, gives the maximum values of coupling between the antenna used and the tuned circuit, which consists of the plug-in coil and the .00015 mf. tuning condenser.

Grid-leak and grid-condenser detection is used and the grid return of the tuned circuit goes directly to the cathode, which is connected to the ground. The standard feed-back plate coil is in the conventional place, and the radio frequency energy is prevented from getting into the audio amplifier by means of the radio frequency choke and the .0001 mf. mica by-pass condenser. Regeneration is controlled by means of the 75,000 ohm potentiometer connected between the chassis and the 150,000 ohm resistor. This series resistor drops the maximum voltage of this circuit to the point that will permit smooth regeneration con-

*Chief Engineer, Federated Purchaser, Inc.

control and provide the maximum sensitivity.

The screen circuit is by-passed to the chassis and ground by means of the 1/2 mf. metal-cased by-pass condenser, connected between the middle arm of the potentiometer and the ground. Smooth control of regeneration is obtained by means of this method and has the added advantage of minimizing the detuning effects. The critical point and maintenance of smooth regeneration control can best be obtained by variation of the grid-leak, which in most cases seems to be most satisfactory when a 2 meg. leak is used with this receiver. Variation of the capacity of the antenna series condenser will also effect the smoothness of this control and experience in operation will enable the set builder to obtain the maximum and smoothest results.

Very satisfactory loud speaker results can be obtained with this receiver, making it, under good conditions, unnecessary to use ear-phones. The maximum output is obtained from the 57 type detector by means of the specially wound 800 henry inductance, which makes up the plate load for this tube. A .01 mf. coupling condenser and a 1 meg. ohm grid resistor complete the coupling arrangement between the detector and the type 59 Pentode tube used in the output circuit. An additional post is furnished on the antenna-ground strip so that changes can be made in the antenna connections and various types of inputs employed for

the maximum signal strength and minimum background noise. The chassis cannot be grounded when used with a doublet type antenna and a transposed lead-in.

When the circuit is operating under conditions for the highest gain, it is necessary to have a tuning dial with a control ratio of such a value as to permit satisfactory tuning. The tuning condenser for this receiver is controlled by means of a very ingenious tuning dial, giving a very satisfactory ratio of condenser plate displacement to knob movement. It has the distinct added advantage of being very quiet in operation. Most dials used on short wave receivers become noisy at the higher frequencies, especially when the gain due to regeneration is pushed up to receive very weak signals.

The chassis for the receiver comes already drilled with the sockets mounted in place. These sockets are held in place with rivets so that there will be no danger of loosening it or causing noisy moving parts. The tuning condenser is equipped with stay bolts so that they can be slipped into the holes provided for them in the chassis and fastened securely. Before mounting the panel onto the chassis it is important that the small drive unit of the tuning dial be inserted into place, as it will be impossible to put this on after the panel is bolted to the chassis. After fastening the small tuning drive unit into place, mount the panel to the chassis by means of the two small 6/32 round head screws

which are furnished with the kit; then mount the 75,000 ohm regeneration control on the right-hand side of the front panel. Mount the antenna series condenser on the left-hand side, being sure that the rotor plate of this condenser is isolated from the chassis by means of insulating washers.

Mount the output speaker terminal on the rear, as well as the antenna ground terminal strip. You will note that there are holes supplied in the chassis for this purpose, so that all of these parts will fit together readily and accurately. Put the edge of the tuning dial into the wedge drive of the tuning control shaft, and slide the tuning condenser into place, after two 5" lengths of wire have been connected to the soldering terminal of the stator plate and the rotor soldering lug terminal. Do not depend on the chassis as a return circuit for the tuning circuit. Run wires to all points in the high frequency circuit. This is necessary if maximum results are to be obtained.

One of the simplest ways to place the Voyager Short Wave Receiver in operation is to use the power pack and the dynamic loud speaker of any of the radio receivers now on the market which use the 47 type power tube in the output. Examination of Fig. 3 shows how a five prong plug can be connected to the end of the cable so that the filament supply, the B voltage and the speaker connection can be taken up simply without changing any of the wiring in the standard broadcast

(Continued on page 122)

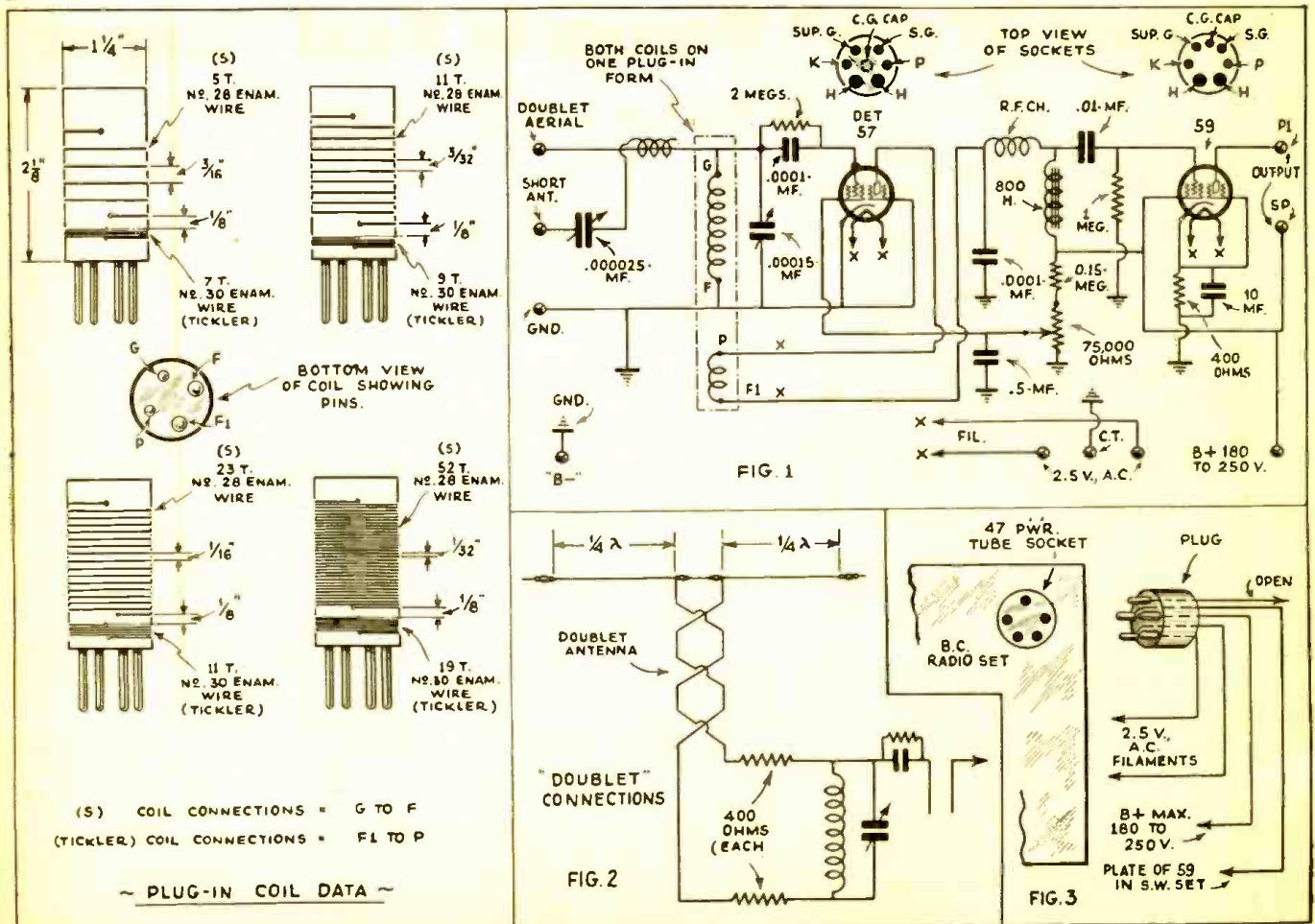

Above, to the left of the diagram, we have details of the plug-in coils used with the "Voyager" 2-tube receiver. The schematic wiring diagram is shown at the top of the drawing at right. One of the smaller drawings below shows connection of the doublet antenna with transposed lead-in and Fig. 3, lower right, shows how SW set can be plugged into output socket of your "broadcast" receiver.

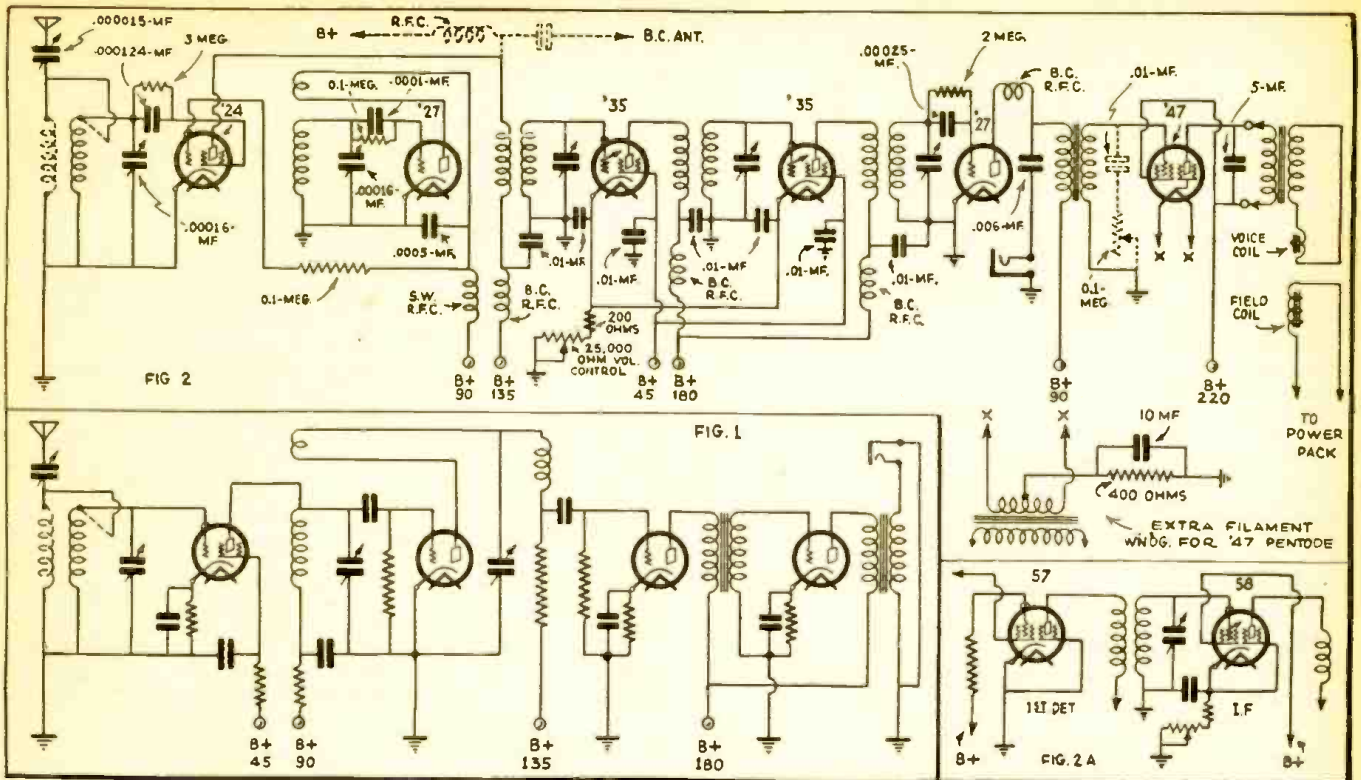

Fig. 1, above, shows general schematic of the Super-Wasp S-W Receiver "before modification" and Fig 2 shows how it is rewired for use as a "superhet."

"Super-Wasp" Becomes Real "Super"

● HERE'S real news for the Super-Wasp owner. Now that the Super-Heterodyne is coming into such prominence among short-wave amateurs and enthusiasts, those possessing the older R.F. receivers feel somewhat behind the times if they are unable to build a real, punch-packing, globe-trotting short-wave set. So this article is dedicated to those owners of Pilot Super-Wasps who desire the ultimate in short-wave reception. It will be possible, as well, perhaps, to apply the same changes to other receivers.

Some while ago a friend of mine who owns a Super-Wasp asked me to use the set for some time, and give him my opinion as to what changes might be made that would be beneficial. I had not used the set more than a few hours when I decided that it would be possible to make an honest-to-goodness Super-het out of it, with only a slight change in the R.F. end of the set. Examination of the wiring diagram further convinced me that the plan was a good one. Further use of the set showed that one of its faults would prove an advantage. While the same might not be true in all cases, most Super-Wasps I have had occasion to use do not tune the same on R.F. and detector dials; i.e., the two dials do not "track." In most instances the R.F. dial, when the two circuits are in resonance, shows a much lower reading; and were the two dials set at the same reading the detector would be tuned to a higher frequency than the R.F. stage. Now, I doubt if any of the readers of this article do not know that a Super-Heterodyne depends upon such a difference in frequency between the oscillator and first detector. So, if we change the circuit somewhat, so as to

By William J. Vette

Thousands of short-wave fans own Super-Wasp S-W Receivers and Mr. Vette here explains in clear style how to make a "superhet" out of the old set, with very few changes

use the detector ('27) for the oscillator, and the present R.F. stage ('24) for a first detector, it will be seen that we have a Super-Heterodyne converter arrangement, which, when the dials are tracking, gives us the necessary frequency difference between the two circuits, without altering the coils or condensers. The addition of a few intermediate stages with a second detector and possibly an audio stage, gives us a very satisfactory super-heterodyne. So much for the theoretical side of it. Now, on to how it is actually done.

We have decided to discard everything except the R.F. and detector stages for the time being, so the first thing to do is remove all of the audio stages and their auxiliary equipment. Remove, also, the regeneration condenser. This will not be used in the superhet assembly. After all other apparatus has been removed except that relating to the R.F. and detector stages, the back halves of the two shield cans should be taken off, giving access to the wiring contained within them. Reference now to Fig. 2 and comparison with the diagram in Fig. 1 of the Super-Wasp before any changes have been

made, will show that very few changes are made in the wiring of these two units. It will be noted that the R.F. stage is converted to act as the first detector, with the tube used as a space-charge Detector, coupling to the Oscillator being obtained through the control (cap) grid, which is connected through a 100,000-ohm fixed resistor to the oscillator tickler coil. This form of coupling is very satisfactory, and in this case quite convenient. The grid-leak and condenser are removed from the detector stage and inserted in the screen-grid lead of the '24, and except for this insertion and the reversal of grid connections permitting of space-charge operation, no other changes are made in the circuit. The plate terminal on the socket is left open for the time being. Since the tube will operate as a grid-leak detector, the cathode is grounded, and the by-pass condenser and bias resistor laid aside for later use.

We will turn now to the re-wiring of the detector so that it may be used as an oscillator. First, the coupling condenser (.2 mf.) in the coil-condenser ground is removed, and the resistor in the coil lead also taken out. This resistor, as well as one of the sides of the .2mf. condenser, are connected to the F₂ prong of the coil socket. This prong is then grounded. A grid-leak and condenser are necessary in this circuit, and are connected as shown in the diagram (Fig. 2). The regeneration condenser has already been removed, so the next thing to do is to remove the R.F. choke coil from its present circuit position and insert it in the position shown in the diagram (Fig. 2). The regeneration condenser is replaced by a fixed

condenser of about .0005 mf. value. The plate lead is brought to the B+90 post through the R.F. choke just taken from the detector plate lead. After all of the above wiring has been completed the shields may be replaced. At this stage it is perhaps advisable to test the set by applying the voltages necessary, and using it as a converter, in connection with a broadcast set. The plate voltage to the detector may be applied through the resistor removed from the R.F. screen or plate, and coupling to the antenna post on the B.C. set through a small .00025 mf. fixed condenser. These connections are shown in the dotted lines in Fig. 2. Using it as a converter will make possible the selecting of the correct intermediate frequency, as in this case the intermediate frequency is easily variable. The frequency at which the set operates best should be noted for future reference.

Assuming that the foregoing units have been put in working order, we are ready to add the intermediate frequency stages. There is room on the subpanel, in the space taken up by the audio stages, for two intermediate frequency stages and *second detector*, which will suffice for most "ham" work. It will be necessary to buy or procure three intermediate frequency transformers. Winding data for these will be found at the end of this article if you care to wind your own. If the constructor desires to wind his own the secondaries may be tuned by small spring-type equalizing condensers. Little more need be said about the intermediate frequency stages except that if one so desires he may add regeneration to the *second detector* for reception of CW signals. About 15 turns on the second detector coil with an .00025 mf. fixed condenser, should suffice. Regeneration may be controlled by means of a resistor in the

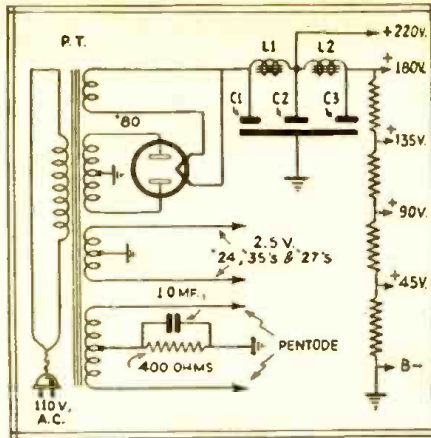

How the few but important parts used in building a plate power-supply unit are wired up in accordance with Mr. Vette's instructions.

plate lead. If the constructor desires an audio stage he may add a *pentode*, as shown in the diagram. This may be placed between the two shields, up near the front.

It might be well to mention here that this circuit does not have to be used with a Super-Wasp. The constructor who is wanting a simple, easy-to-build Superhet may use this circuit as well. For this reason all values are given at the end of the article. Any inquiries addressed to the writer concerning this set will be answered promptly if postage is included to cover the reply.

PARTS LIST

- 1 Pilot AC Super-Wasp short-wave receiver—or,
- 2 Sets Pilot short-wave coils (RF & Det.)

- 1 Pilot J-5 antenna condenser (Capacity, .000015 mf.)
- 2 .00016 mf. tuning condensers (Pilot)
- 2 .0001 mf. grid condensers (Aerovox Type 1460)
- 1 .00025 mf. grid condenser (Aerovox Type 1460)
- 6 5-prong sockets (Pilot Universal; Eby)
- 1 .0005 mf. fixed condenser (Aerovox Type 1460)
- 8 .01 mf. by-pass condensers (7 if tone control not used) (Sprague)
- 1 .5 mf. by-pass condenser (Aerovox Cartridge)
- 1 10 mf. pentode bias condenser, 50 Volt. (Trutest)
- 1 400-ohm pentode bias resistor (Trutest)
- 2 100,000-ohm resistors (Trutest)
- 1 3 meg. grid-leak (Trutest)
- 1 2 meg. grid-leak (Trutest)
- 1 SW. RF Choke (Trutest, or one in set)
- 4 BC. RF Chokes (Trutest)
- 1 200-ohm resistor (Yaxley Grid)
- 1 25,000 Var. resistor, volume control (Clarostat)
- 1 100,000 Var. resistor tone-control (optional—Clarostat)
- 3 Dejur-Amsco Varitors, for IF. tuning
- 3 Trutest shielded RF Coils, (or wind as per instructions.)
- 2 Lafayette type '27 Tubes, or 2 Lafayette '56's
- 1 Lafayette type '24 Tube, or 1 Lafayette '57
- 2 Lafayette type '35 Tubes, or 2 Lafayette '58's
- 1 Lafayette type 247 Tube
- 1 Lafayette Model "MB" Dynamic Speaker

(Trutest and Lafayette parts are marketed by Wholesale Radio Service Company, 100 6th Ave., New York City)
(Continued on page 124)

2 and 6 Volt Tube "Oscillodyne" Hook-Ups

MANY readers who became interested in experimenting with the novel new high-gain circuit of the *Oscillodyne* of the 1 and 2-tube types, which appeared in the April and May issues of *SHORT WAVE CRAFT* respectively, have asked for more data on how to use battery type tubes with these models of the *Oscillodyne*.

We show herewith a circuit for the one tube *Oscillodyne* rearranged for use with a 2 volt, 30 type tube. For those interested in trying a 6.3 volt tube the socket does not have to have its connections changed in the 1-tube model of *Oscillodyne* as described by Mr. Worcester in the April, 1933 issue of *SHORT WAVE CRAFT*. The 37 type, 6 volt tube is interchangeable with the 27 type tube, as there shown.

Referring to the 2-tube *Oscillodyne* described by Mr. Worcester in the May number of *SHORT WAVE CRAFT* no numbers of interchangeable battery tubes were given. For those interested in trying the 6.3 volt battery tubes in the 2-tube *Oscillodyne* a revised circuit is given herewith and has been brought up-to-date, so as to use the very newest output pentode tube, the type 89. With 180 volts plus on the plate, 18 volts minus C bias from a C battery, or a small B battery unit, is applied as indicated in the diagram. The detector tube may be the number 37. Those who have not read the original article on the 1 and 2-tube *Oscillodynes* described in the April and May

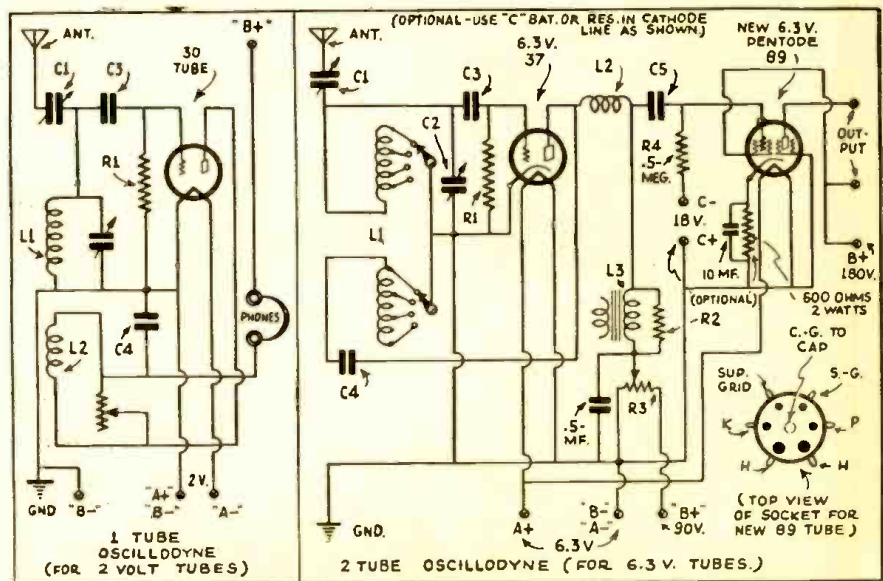

Diagram at left shows how to rewire the 1-tube *Oscillodyne* for use with a 2-volt, 30 type tube. Diagram at right shows 2-tube *Oscillodyne* wired for use with 6.3 volt tubes of the 37 and 89 types, respectively.

issues, respectively, may refer to those issues for the values of the various condensers, resistors, coils, etc.

As shown in the diagram the builder may use a grid-bias resistor in the cathode lead, so as to provide the bias

voltage automatically. The advantage of this method over the "C" battery is that the bias voltage will then drop in proportion to the fall in "B" or plate potential as the B-batteries age and lose potential.

New 2-Tube Short-Wave Converter

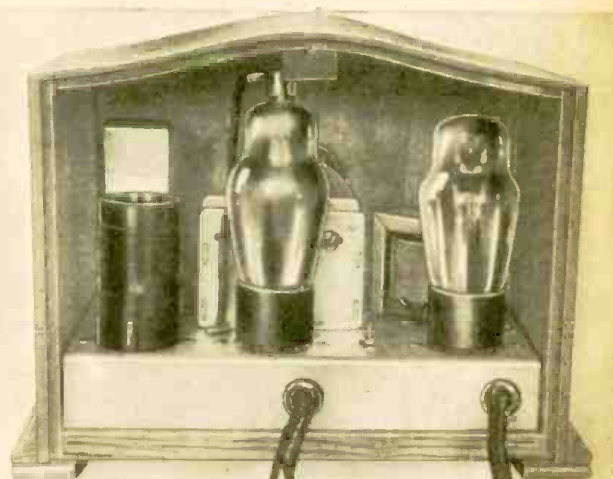

A new converter, which enables you to receive short-wave stations by simply connecting it to your "broadcast" receiver, is illustrated above.

● A NEW short-wave converter known as the ICA Short Wave Scout is here illustrated; one of its features is that it utilizes but two tubes and it can be instantly switched into circuit by means of a switch mounted on the front of the converter. The same switch, when thrown in the opposite direction, connects your broadcast re-

ceiver for regular 200 to 550 meter reception. This converter, which is mounted in a very neat and small walnut cabinet, may be connected to any broadcast receiver and complete instructions and wiring diagram come with each converter.

It is a very simple matter for the purchaser to quickly connect the con-

verter to his broadcast receiver. The antenna wire is disconnected from the regular broadcast receiver and is connected to a post on the converter. A marked wire from the converter is connected to the antenna post of the "BC" receiver. The ground connection is left on the "BC" receiver and after that

(Continued on page 121)

"Prize-Winner" Short-Wave Receiver

This Set Works on 110 Vts., A. C. or D. C.

By M. K. Baker

● FOR the short-wave enthusiast with a modest pocketbook who desires sensitivity and volume together with a quiet, built-in power supply, the Alan "Prize Winner" will be of interest.

Herewith is presented constructional data on this set, which is a self-powered AC-DC outfit.

Though primarily intended for head-phone operation, this set will operate a magnetic or small dynamic speaker on many local signals. The circuit utilizes a sensitive type 78 grid-leak detector, a 43 power amplifier, and a 25Z5 rectifier, a combination of tubes which adapts itself readily to both A.C. and D.C. operation with practically identical performance.

Aside from the use of the 78 tube, the detector circuit is a conventional

Left—neat professional appearance of the front panel of the "Alan" 110 Volt A.C.-D.C. Short-Wave Receiver; it uses but 2 tubes, a 78 and a 43, with one of the new 25-Z-5 rectifiers.

regenerative grid-leak arrangement. The grid-leak found most satisfactory was 5 megohms, and the grid condenser .0001 mf. Regeneration is smoothly controlled by means of a 50,000 ohm potentiometer of the carbon element type in the 78 screen lead, by-passed with a .5 mf. condenser. The tuning condenser has a maximum capacity of 165 mmf. or .000165 mf. and about 9 mmf. (.000009 mf.) minimum capacity. This, coupled to a 10:1 tuning dial, makes for fairly easy tuning.

In the antenna circuit, a small "trimmer" of 40 mmf. maximum has been included for the elimination of dead-spots.

(Continued on page 121)

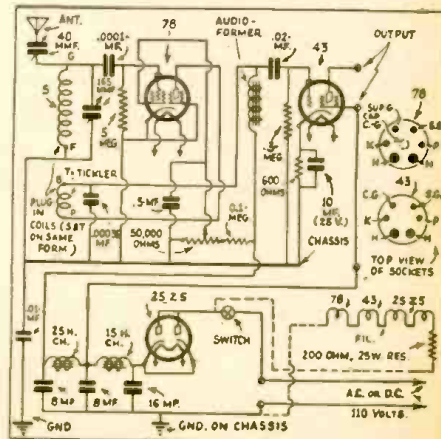
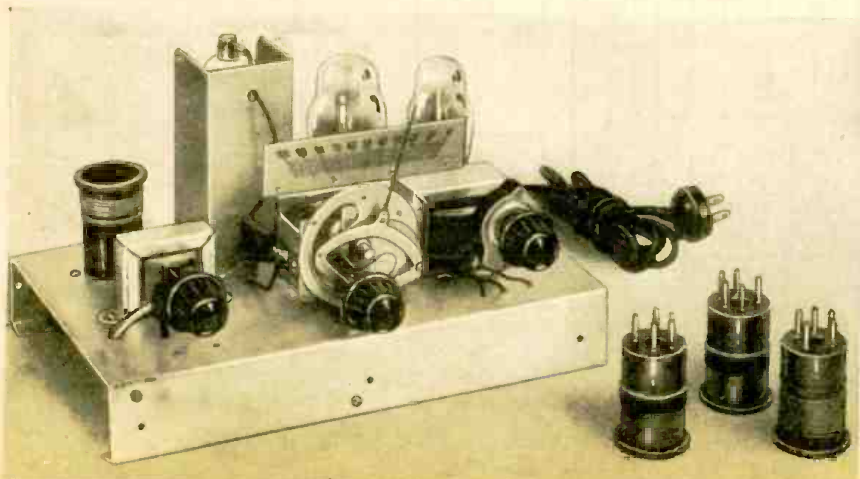

Wiring diagram of the new "Alan" Short-Wave Receiver—it employs plug-in coils to change the wave bands. The tubes are operated in series with a small resistance across the line.

This Power Supply Unit USES NEW 25-Z-5 TUBE

By CLIFFORD E. DENTON



At left we have top view of the 25-Z-5 power supply unit as designed and built by Mr. Denton. No power transformer is required and among other features, voltage doubling can be obtained. Close-up view of the new 25-Z-5 rectifier tube is shown at right.

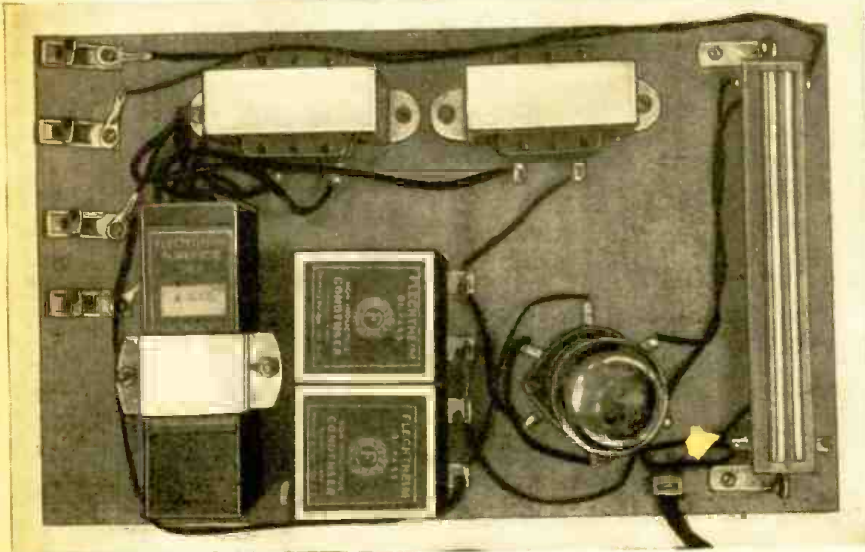

This very latest type S-W power supply unit designed by Mr. Denton utilizes the new "25-Z-5" tube, and does away with the cost of a power transformer. Voltage doubling is effected when the proper size condensers are used.

● EVERY day tube manufacturers are bringing forth new tubes that permit radical changes in the design of radio sets, audio amplifiers and power-supply units.

One of the many tubes announced is the 25-Z-5, which offers several inducements for the short-wave fan. It does away with the cost of a power transformer when used as the rectifier for small and medium size short-wave sets. It has satisfactory regulation and is not noisy, being of the high vacuum type. Gas-filled tubes have no place in the short-wave receiver power-pack.

The following characteristics covering this tube are given for reference, as every one is interested in having as much tube data on hand as possible.

25-Z-5 Tube

Heater Rating: Voltage, 25 volts; current, 0.3 ampere.

Operating Conditions and Characteristics: A.C. Voltage per Anode, 135 maximum RMS volts; D.C. Output Current, 100 maximum ma.; Voltage between cathode and heater, 300 maximum peak volts; Peak Plate Current, 300 maximum ma.

With the circuit as shown in Fig. 1, voltage doubling can be obtained, dependent on the values of condensers connected at C1. These condensers should be selected for their efficiency; low power losses and high internal resistance per microfarad will permit the best results.

When building the power supply unit study the chart in Fig. 2, which tells just what values of C1 must be used for a given result. For example, if 200 volts is required at 100 ma., then condensers C1 should have a value of 16 mf. each. Select the smallest value of capacity that will provide the required current at the proper operating voltage and that will be the only change from the specifications given.

The rest of the power supply unit should follow specifications as shown.

A radio frequency choke can be con-

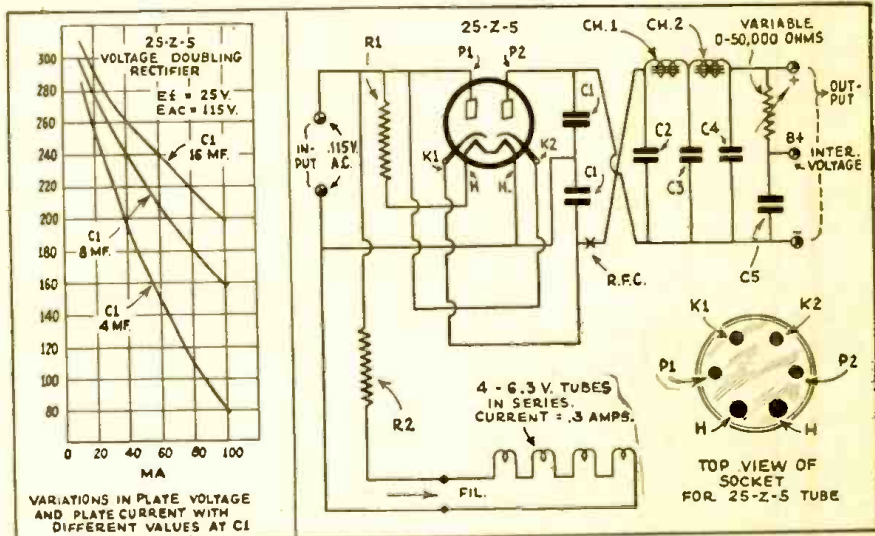

The graphs shown above, at left, tell the story of the variation in size of condensers used in conjunction with the 25-Z-5 rectifier. Wiring diagram for the complete rectifier is shown at the right. 0-50,000 ohm resistor is R3.

nected in the filter circuit as indicated at X. This will help to reduce noise from the power line in many cases. If additional voltages other than the high voltage are to be obtained from the power supply unit, use a series feed circuit with a paper by-pass condenser at C5. The value of R3 will depend on the voltage required and the current drain in the circuit. In general this circuit will supply screen voltages for screen grid tubes, so the current through R2 will never be great.

The filament supply circuit as shown is for use with four 6.3 volt tubes in series with a total current drain of .3 ampere. If more tubes are used in this circuit it will be necessary to change the value of resistance at R2.

For those interested in using the filaments of the tubes in the radio set in parallel, it will be more economical to use a small separate filament supply transformer. As a great number of the short-wave sets in use today have four tubes, the resistor recommendations

given will be satisfactory. Remember this value of R2 is for use with the 6.3 volt tubes consuming .3 ampere; any other tubes will require different resistor specifications.

Parts List

- Two Flechthelm By-pass Condensers, 4 mf., 250 volts (C1)—(Wego; Aerovox)
- One Flechthelm Electrolytic Condenser 4 mf. Cardboard type (C2)—(Wego; Aerovox)
- Two Flechthelm Electrolytic Condensers 8mf. Cardboard type (C3, C4)—(Wego; Aerovox)
- One Eby six-prong socket
- Two Federated Purchaser, No. 2505 Power Chokes (Ch1, Ch2)
- Two Acratest Shielded Resistors, 310 ohms, 300 ma. (R1, R2)
- One 25-Z-5 Rectifier (Sylvania)
- One power cord and plug
- One wooden baseboard, 7 by 11½ by ¾ inches
- Wire, wood screws, etc.

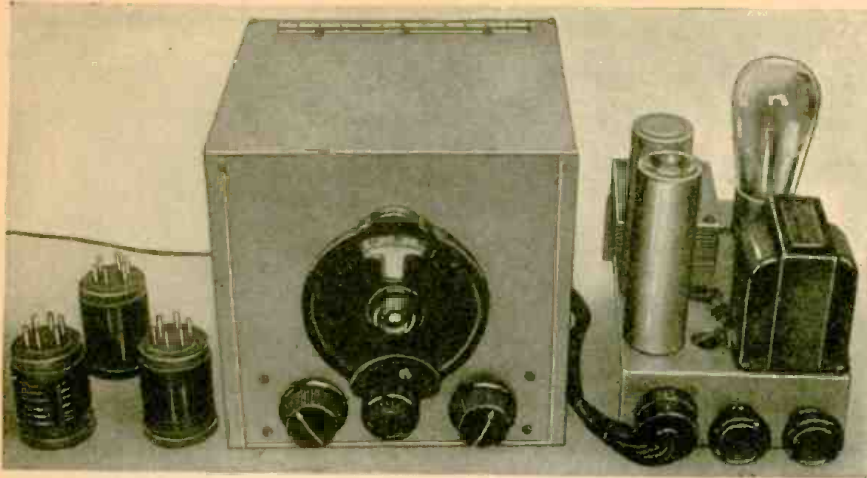

The extreme compactness and neat design of Mr. Ingram's 3-tube prize receiver and "humless" power unit, can be seen from this photo.

Mr. Ingram Provides A POWER-PACK for His De Luxe Set

Besides a number of worthy refinements in the 3-tube receiver itself, the "prize winner" described in the September issue of this magazine

By **EDWARD G. INGRAM**

● **NUMEROUS** requests have been received by the writer for information on the design and construction of a small power-pack suitable for operating the three-tube De Luxe prize-winning receiver described in the September issue of *SHORT WAVE CRAFT*. Such a power pack has been built and the writer is pleased to disclose its features in *SHORT WAVE CRAFT* in conjunction with some further refinements in the receiver, made in part to keep pace with recent developments in the field of vacuum tubes.

Type 58 pentode tubes in the R.F. and detector stages which, owing to their high A.C. plate resistance, call for the latest type of National coils, combined with a 56 tube in the audio stage, markedly improve the performance of a receiver that has already given a very good account of itself.

Advantage has been taken of the recently introduced National 2½ milli-henry R.F. choke, wound on an isolantite form and having an extremely low distributed capacity, further to increase the efficiency. Two of these chokes are used, one in series with the larger choke in the plate circuit of the detector and the other in the plate circuit of the R.F. stage.

Tuning is facilitated by the provision of a 270 degree National condenser, having an insulated rotor bearing and isolantite mounted stator, used in conjunction with a type C dial of the same make.

Consistent with the design of the receiver, compactness was aimed at in the development of the power supply unit, which is built on an aluminum chassis measuring but 5 by 7½ inches with a height of 2 inches, and which will fit into a suitable aluminum box having a height of 7 inches.

The small size of the receiver and power unit makes it convenient to carry the combined outfit about; all that is required to put it in operation being an electric outlet and an aerial. A ground connection is not really necessary in most locations.

The power pack is also suitable for operating many other small short-wave receivers such as the "Two-Tube Reliable" described in the August, 1932, issue.

To arrive at the best final results a number of preliminary experiments were conducted, the power-pack first being set up on an inverted cigar box for a chassis.

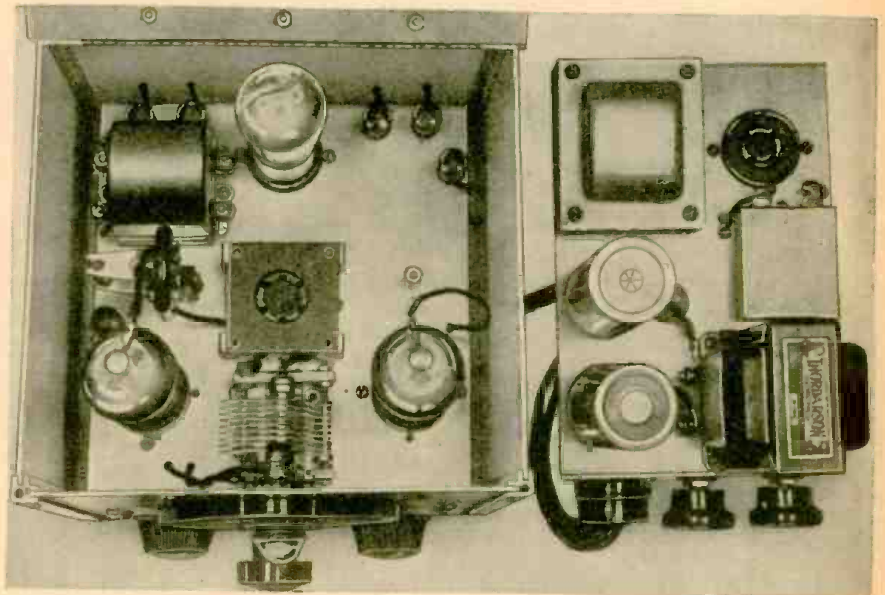

Interior view of Mr. Ingram's receiver, also the power supply unit, which required much research to remove the hum.

Compactness being a requirement, it was felt the employment of only one filter stage would be desirable if adequate. With this point in view, two by-pass condensers of 8mf. each and a large 30 henry choke were used. An R.F. choke was placed in the positive side of the line before the filter.

How "Hum" Was Removed

Filtration proved adequate except for a *residual hum* which appeared when receiving below 20 meters. As an experimental check, an additional filter stage was added, but provided no improvement in performance and so it was removed. Buffer condensers were tried between the plate leads to the rectifier tube and ground, but gave no help. A 1 mf. by-pass condenser placed before the R.F. choke somewhat reduced the hum. This choke and condenser then were removed entirely and the hum almost disappeared. Returning the 1 mf. by-pass condenser, which merely augments the 8 mf. electrolytic condenser before the filter choke, proved the final solution to the difficulty.

An innovation that tends to make the power unit more satisfactory for

high-frequency receiver operation is the provision of by-pass condensers from each side of the A.C. line to ground, which tends to eliminate line noises of radio frequency.

With the space limitations imposed it was necessary to search for a small power transformer and the one found meets the requirements nicely, having a width of only 2½ in. and a length of 3 in. It is manufactured primarily for small short-wave converters and has a 200-200 volt secondary with a current output of 25 milliamperes. The current consumption of the receiver is less than this and voltage must be regulated by the incorporation of suitable resistance. As a voltage divider, a 50,000-ohm potentiometer is used across the output. The movable arm of the potentiometer provides an adjustable screen-grid supply. With the set in its present form current for the screen-grid of the R. F. tube is taken from the plate supply (in the set) through a 100,000 ohm fixed resistor, which provides a voltage of about 100 with a 58 tube. The voltage for the detector screen-grid may then be reduced from 100 to about 50 at the set terminal.

Parts For Receiver

- 1—Pilot variable condenser, .0001 mf.
- 2—Aero R.F. choke No. 65 (choke of from 30 to 60 m.h. can be used)
- 3, 6, 9, 15, 17, 22—Fixed condensers .01 mf., Aerovox and Pilot
- 4, 14—Eby sockets taking either 5 or 6-prong tubes
- 5—350-ohm, 1 watt resistor, Lynch
- 7—100,000 ohm, 1 watt resistor, Lynch
- 8—National S.W. transformer coils, Nos. 61, 62, 63, 64
- 10, 19—National No. 100 R.F. chokes, 2½ m.h.
- 11—Grid leak, 5 meg. Lynch
- 12—Fixed condenser, .0001 mf. Sangamo
- 13—National Tuning Condenser SE 90, .00009 mf.
- 16—Frost roller type potentiometer, 50,000 ohms
- 18—Fixed condenser, .00025 mf. Micamold
- 20—Aero R.F. choke No. 60 (about 85 M.H.)
- 21—Pacent No. 26 Audioformer (secondary used as choke)
- 23—¼ meg. resistor, Lynch
- 24—Fixed condenser, 0.5 mf. Aerovox
- 25—2000 ohm, 1 watt resistor, Lynch
- 26—Pilot 5 prong tube socket
- 27—Carter midjet jack
- 28—Two-pole, single-throw switch (optional)

Other Parts Required

National type C dial (200 to 0, with light. Six Eby binding posts with bakelite bushings and washers, Aluminum Chassis and box (see SHORT WAVE CRAFT, Sept., 1932).

Parts For Power-Pack

- 1, 2—Fixed condensers, .003 Sangamo
 - 3—Trutest power transformer No. 4C 1500 (400 v. center tapped, 25 m.a.)*
 - 4—Eby socket for '80 tube
 - 5, 10—Fixed condensers, 1. mf.
 - 6, 8—Trutest dry electrolytic condensers, 8 mf.
 - 7—Thordarson 30 henry choke, R 196
 - 9—Electrad potentiometer 50,000 ohms, 7.5 m.a.
 - 11—Pilot Resistograd 200 ohms to 1 meg.
 - 12—Eby tube socket, 5 prong (for terminals)
- Aluminum Chassis (and aluminum box if desired)
*Trutest parts obtainable at Wholesale Radio Service Co., New York.

Data on National Coils

SW5 (For '35 Tubes)

	Secondary	Wire	Primary	Wire	Tickler	Wire
No. 11	14 to 25M.	6½	16 En.	3½	34 En.	3 32 D.S.
No. 12	23 to 41M.	11	18 En.	7	34 En.	3 32 D.S.
No. 13	40 to 70M.	19½	18 En.	12	34 D.S.	4 32 D.S.
No. 14	65 to 115M.	34½	24 En.	21	34 D.C.	4 32 D.S.

New Type Coils for '58 Tubes

(Approximate changes from above)

- No. 61, 13½ to 25 M. Primary 5½ turns; Tickler, 2 turns.
No. 62, 23 to 41 M. Primary 9½ turns; Tickler, 2 turns.
No. 63, 40 to 70 M. Tickler, 4 turns.
No. 64, 65 to 115 M. Tickler, 2 turns.

(Coils No. 61 and 62 have slightly heavier gauge wire for primaries.)

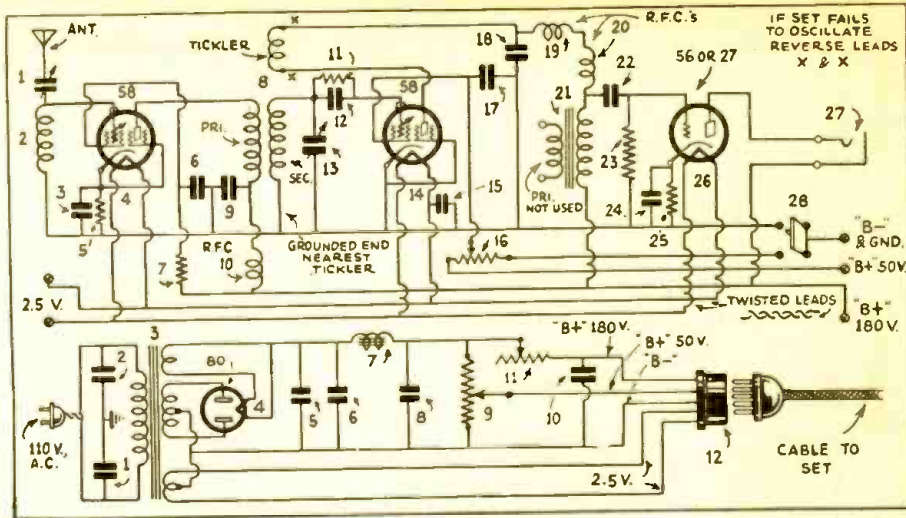

Wiring diagram for the De Luxe 3-Tube Receiver as designed and built by Mr. Ingram. Many readers have built this set from the original description in the September issue and report excellent results with it.

Control of Plate Supply

Control of the plate supply is provided by a 200 to 1,000,000-ohm variable resistor which permits the voltage to be adjusted to 180. Owing to the low current consumption of the set it is possible to run the voltage up to about 240 if desired.

Partial Log of Stations Received

Call	Country	Dial	Meters
Coil 61			
LSN	Argentina	31½	14.27
PHI	Holland	77½	16.88
W2XAD	U. S. A.	109	19.56
Pontoise	France	111	19.68
GSF	England	112	19.81
Coil 62			
Pontoise	France	46	25.20
W8XK	U. S. A.	46½	25.28
GSE	England	46	25.40
2RO	Italy	48	25.53
GSD	England	49½	25.53
DJD	Germany	49½	25.53
VE9JR	Canada	51	30.40
EAQ	Spain	94	31.30
GSC	England	99½	31.30
W1XAZ	U. S. A.	100½	31.48
GSB	England	101½+	31.48
YVQ	Venezuela	109	31.48
Coil 63			
WOO	Columbia	49	46.50
W8XK	U. S. A.	69½	48.86
W2XE	U. S. A.	92+	48.86
VE9DW	U. S. A.	92½	48.86
GSA	Canada	93	49.59
DJC	England	95-	49.83
VE9DR	Germany	96	49.83
	Canada	96	49.96

An ordinary tube socket is used for the terminals so that the leads from the set may be plugged into it easily. A six-prong socket is provided, but only five prongs are used with the present arrangement.

The 2½-volt secondary winding of the power transformer for supplying current to the tube heaters is center-tapped. If the heater wires to and in the set are of equal length the center tap may be grounded. In case there is an inequality in the length of the leads it may be necessary to place a 30 ohm resistor with an adjustable center tap across the secondary, which can be regulated for minimum hum.

The latter arrangement has the objection of putting an additional drain on the heater transformer of about .8 ampere. Since the leads to the set are about 3 feet long and the voltage is low, there will be quite a voltage drop in them, so it is desirable to hold the drain on the transformer to a minimum. Heavy leads are electrically advantageous, but are clumsy. The writer uses two No. 16 gauge wires for each lead. The actual voltage at the tubes is slightly over 2, which is about the minimum for satisfactory cathode emission.

If there is any reason to believe that a hum is coming from the heater circuit disconnect one side of the circuit from the set. Because of the heat stored in the elements the receiver will continue to function for a few seconds, but the hum will disappear if it is coming from this source.

If there is a persistent tendency to hum at some or all dial settings, a faulty tube may be the cause. Good tubes are essential to the operation of an A.C. short-wave receiver. This is especially true in the case of the detector. If several tubes are available

(Continued on page 123)

\$20.00 Prize Monthly For Best Set

THE editors offer a \$20.00 monthly prize for the best short-wave receiver submitted. If your set does not receive the monthly prize you still have a chance to win cash money, as the editors will be glad to pay space rates for any articles accepted and published in SHORT WAVE CRAFT. You had better write the "S-W Contest Editor," giving him a short description of the set and a diagram, BEFORE SHIPPING THE ACTUAL SET, as it will save time and expense all around. A \$20.00 prize will be paid each month for an article describing the best short-wave receiver, converter, or adapter. Sets should not have more than five tubes and those adapted to the wants of the average beginner are much in demand. Sets must be sent PREPAID and should be

CAREFULLY PACKED in a WOODEN box! The closing date for each contest is sixty days preceding date of issue (June 1 for the August issue, etc.).

The judges will be the editors of SHORT WAVE CRAFT, and Robert Hertzberg and Clifford E. Denton, who will also serve on the examining board. Their findings will be final.

Articles with complete coil, resistor and condenser values, together with diagram, must accompany each entry. All sets will be returned prepaid after publication.

REQUIREMENTS: Good workmanship always commands prize-winning attention on the part of the judges; neat wiring is practically imperative. Other important features

the judges will note are: COMPACTNESS, NEW CIRCUIT FEATURES, and PORTABILITY. The sets may be A.C. or battery-operated. Straight Short-Wave Receivers, Short-Wave Converters, or Short-Wave Adapters. No manufactured sets will be considered; EVERY SET MUST BE BUILT BY THE ENTRANT. Tubes, batteries, etc., may be submitted with the set if desired, but this is not essential. NO THEORETICAL DESIGNS WILL BE CONSIDERED! The set must be actually built and in working order. Employees and their families of SHORT WAVE CRAFT are excluded. Address letters and packages to the SHORT WAVE CONTEST EDITOR, care of SHORT WAVE CRAFT Magazine, 96-98 Park Place, New York, N. Y.

A MULTI-WAVE 7-Tube Receiver with Band-Selector Switch

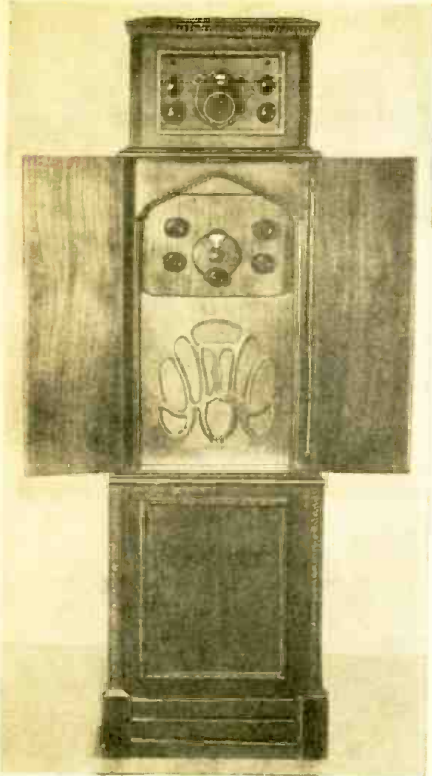

Front view of the Whisk "short" and "broadcast" wave receiver, including loud speaker grille. The short wave control panel is at the top.

This receiver employs "band-pass" tuning and has a 3-gang switch for changing the coils in the R.F. and detector stages to tune in the various frequency bands. It has a push-pull A.F. output stage using two 45's.

constructor will probably have a cabinet of some other shape in which he will desire to install such a set, with panel arrangements to suit himself.

Therefore, we will confine ourselves to a general consideration of the circuit and its component parts as supplied by Mr. Whisk. The antenna is connected to a two-point switch as shown, so that it can be connected to either the band-pass tuner for broadcast reception, or to the lower point, when it is connected to the blade of the first five-point switch and the grid of the second R.F. tube, only one R.F. stage being used for short-wave reception. After the signal leaves the plate of the 24 detector tube, it passes into the grid of the first A.F. tube, which is of the 27 type, the detector and first A.F. stages being resistance-capacity coupled as the diagram indicates. After the signal current leaves the plate of the first A.F. stage, it passes through the A.F. transformer, of the push-pull type, into the grids of the two 45 amplifier tubes, the amplified signal passing through the primary and secondary of the push-pull output transformer, T1, to the loud speaker, which may be of the dynamic or magnetic type, the windings of the proper impedance to match the output transformer.

(Continued on Page 119)

● THE interesting 7-tube multi-wave receiver here illustrated was built by Samuel Whisk, well-known to radio experimenters. A glance at the diagram shows that instead of plug-in coils, the various frequency bands are selected by the three-gang, five-point switch. The photos show the short and broadcast band receivers arranged on two different panels, with the power amplifier on the lower shelf just behind the loud speaker. This is only one of the many possible arrangements and the average



Rear view of Mr. Whisk's receiver, which contains "short" as well as "broadcast" range units.

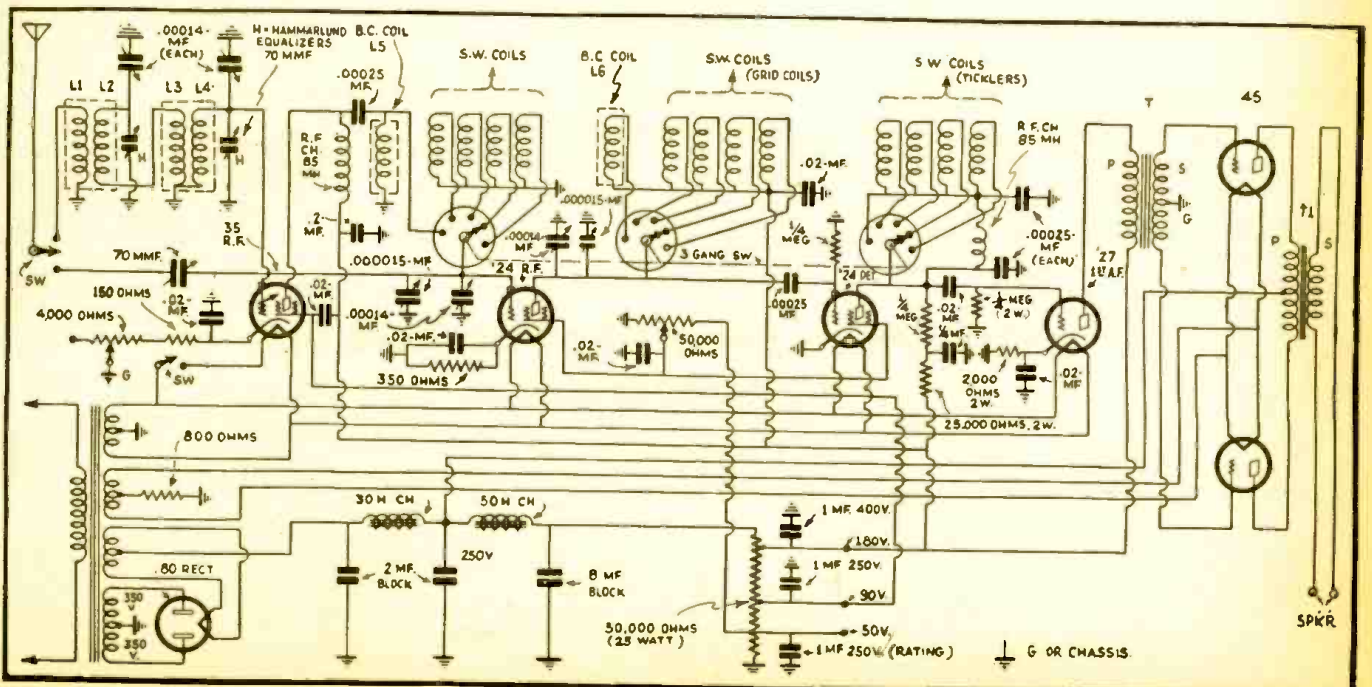

How Mr. Whisk wired his 7-tube Multi-Wave Receiver, which employs a 3-gang 5-point switch to change the coils for the various frequency bands.

A "TNT" Transmitter for 160 Meters

By HAL SULLIVAN, WIAAD

The author describes how to convert a regular high frequency TNT transmitter to operate on a wavelength of 160 meters. The values of the various components are given.

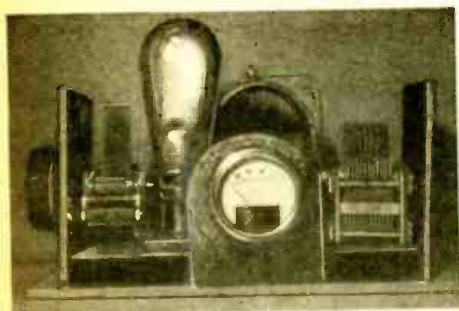

Front view (above) of Mr. Sullivan's 160 meter TNT transmitter. Top view (below).



Top view of the 160 meter transmitter as built by Mr. Sullivan. Compactness is but one of its many virtues. Coil and other values are given in the article.

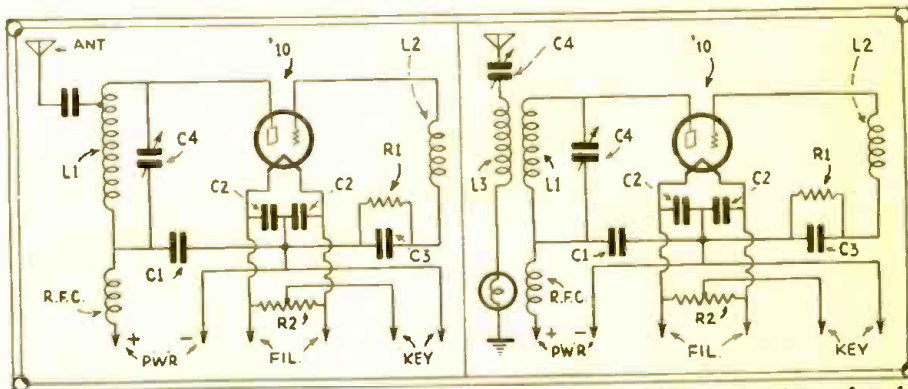

Regular TNT circuit at left; at right, the converted TNT transmitter for 160 meter operation. Inductances remain unchanged and are the same for either set. Constant: C1—.005 mf.; C2—.002 mf.; C3—.00025 mf.; C4—.0005 mf. variable; L1—16 turns No 12 enameled copper wire; L2—60 turns No. 32 D.C.C. magnet wire; L3—12 turns No. 12 enameled copper wire.

As the much discussed (and "cussed") sun spots seem to be working a sort of reversed depression effect on the normal amateur transmitting bands of 20-40-80 meters, the amateur fraternity is moving back to the long deserted 160 meter band for "local" and medium distance transmitting work. Due to the fact that most of the present-day amateurs were not in the game when the waves in the neighborhood of 200 meters were the regular amateur channels, there is some confusion as to just how to make the higher frequency transmitters work on this band and what to do about the antenna situation. Probably the most popular of the amateur transmitting circuits is the TNT version of the tuned-plate, tuned-grid arrangement, using a type '10 tube, and so this article will describe the changes neces-

sary in such a set to convert it for 160 meter operation.

The essential changes in the set itself are, of course, larger plate and grid coils. For operation on the higher frequencies the tank coil is usually a self-supporting affair of copper tubing. Using the regular tuning condenser, a tank coil of this type for operation in the 160 meter band would be impractical, so a coil consisting of 16 turns of number 12 enameled aerial wire, wound on a 3-inch diameter tube, with approximately 1/8 inch spacing between turns, should be constructed. This will permit the circuit to be reasonably "high C," using the ordinary tuning condenser. Next in order is the grid coil, which is, we'll assume, of the usual plug-in type, wound on a tube base. This coil should be wound with 60 turns of number 32 D.C.C. wire and

no spacing between turns is required. All other parts of the outfit remain "as is." Now let's consider the radiating system.

The popular antenna for the TNT seems to be a stretch of wire measuring from 127 to 134 feet, measured from the extreme end to the connection at the set. This length is admirably suited for 160 meter work in conjunction with a counterpoise or ground. A true counterpoise necessitates considerable "back yard" space and is, therefore, impractical for the majority of amateurs.

On the other hand a ground is apt to be conveniently located and can be made to serve quite successfully. As a good ground is very important to the working of the set, considerable care

(Continued on page 115)

A "Hum-less" Power Supply

SHORT-WAVE receivers require a power supply quite superior to those for ordinary broadcast reception. The extreme sensitivity of a good short-wave receiver, together with the low

signal strength on distant stations, necessitates the use of a power supply that is unusually free from residual and tunable hum.

Connecting up a power-supply that

had previously given good service for broadcast work, I encountered a most exasperating condition. The receiver was fairly quiet while oscillating but when out of oscillation, the hum effectively drowned out the weak stations I was trying to get. Changing tubes, coils, and voltages helped but slightly. Eventually I decided to get at the root of the trouble and overhaul the entire "B" eliminator.

The resulting hook-up is shown in Fig. 1. The chokes T-1, T-2, and T-3 are the primaries of audio-frequency transformers. The resistors in series with the chokes were found to be quite necessary to get the exact voltage on the tubes for humless operation. Using head-phones, with volume control full on, and listening to a weak station, I found this power supply had eliminated every trace of hum.—By Jess M. Reed.

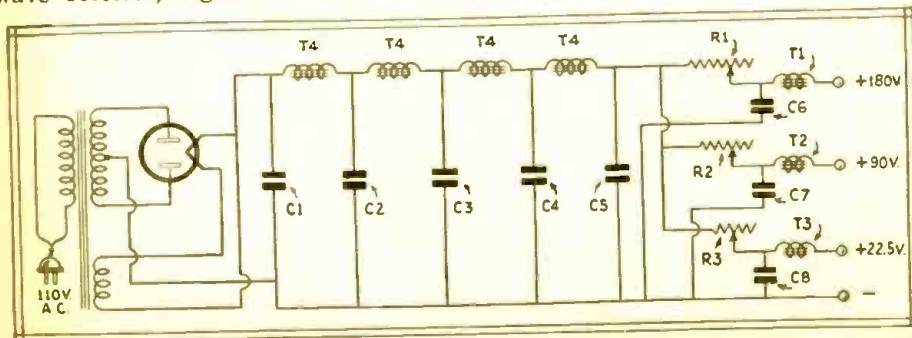

Fig. 1—Diagram above shows Mr. Reed's conception of a "hum-less" power supply circuit. T1, T2, T3—Audio Transformer primary; T4—30 Henry iron core chokes; C1, C2, C4, C5—2 mf. filter condensers; C3—8 mf. filter condenser; C6, C7, C8—1 mf. filter condenser; R1, R2, R3—0-50,000 ohm variable resistance.

"Ham" Radio Foils Ransom Plot

By A. D. Middleton,
W8UC, W4CA



"... Now for the test!" cried Billy, pressing the key down. The bulb in the wavemeter glowed faintly. That got it! Now for tuning up! ... Then he switched the transmitter on and slowly tuned it up to the proper point as shown on the wavemeter ... "Here we go! ... Let's try to raise some land station!"

● "LOOKS like the storm is lifting some, Billy," cried the elder Cameron as he shifted his position to the least uncomfortable spot.

"Sure does, Dad!" yelled Billy, giving the tiller a jerk to swing the tossing catboat back into the wind. Sails tied down, decks awash, the boat had all appearances of an egg shell tossed about on the rough water.

"Seems as tho' I showed poor judgment this morning, when I said we'd go for a sail."

"That's all right, son, you couldn't tell it was going to storm."

It had not looked stormy that morning when the Camerons had taken the catboat out for a few hours sail up the coast and back. But a storm had come up and blown them out to sea. They did not know how far the mad rush had carried them or what their next port-of-call would be, for they were out of the regular lane of coastwise traffic.

The wind died little by little until at last it was safe to lift a bit of sail. It was four o'clock and if they were to avoid a night on the water they would have to find a harbor soon. Turning the boat in the apparent direction of the mainland, Billy and his father set the sails and settled back for a cold, wet ride.

Darkness came on all too soon, leaving them still forging ahead towards what they hoped was land and safety. The darkened sky was growing black

and the water was rapidly turning to ink when suddenly Billy shouted, "Look! Dad, a light over there to port!"

Mr. Cameron stood up and peered through the darkness. Sure enough there was a light of some kind—far away and very dim but there—just the same. They headed the boat straight for the welcome light.

The light grew brighter as the boat plunged forward. They could soon see that it was not from another boat. It was far too steady. It must be an island! A few more minutes and Mr. Cameron sighted the faint outline of a low building on top of a slight rise from the water. The light took shape—it was coming from a window of the house on the island.

As the Camerons drew closer they could see a small dock extending into a cove. Billy slipped the boat in towards the dock and they hailed the island. After several minutes of "high pressure" yelling, a voice answered from the dock.

"Who are you and what do you want?"

"This is the catboat DEE EX of Point Flame, and we want shelter for the night!" shouted Billy.

You Can't Land Here

"You can't land here!" came the angry cry from the land, "this is a private dock."

"Why, man, you can't refuse us a

landing on a night like this," returned the exasperated elder Cameron, "we might go down in the night—besides the wind is rising strong."

"What do I care about that? Shove off! Land's off the starboard about forty miles. Get going!"

By this time the sailboat had coasted almost up to the dock. When the boat rubbed the side of the dock, a man rushed to the edge and stood, as if on guard, above them.

"I said don't come on land here. Turn the boat out to sea and keep moving!"

"But man!" pleaded Mr. Cameron, "what is the meaning of this? Common decency would permit us the use of your dock until daylight."

"Nothing doing—this is a special dock and we don't want nobody hanging around."

Billy had been looking the place over in the meantime and nudging his father he whispered, "Look over there!"

At the far end of the dock lay a cabin cruiser. Black, with rakish lines, and a sense of mystery increased by the hooded device on the bow—there were few doubts as to the identity of their unfriendly hosts. Rum runners!

"Hey you! Get away from that boat," shouted the man on the dock as Billy began to edge the catboat nearer the cruiser. "Shove off or I'll put a slug into ya."

"What's the noise about, Tony?" questioned another voice, obviously one in authority.

"Aw, Chief, it's only a couple guys in a sailboat, say they want to land for the night, but I tells them to keep moving as we don't want nobody around here when we take that load—"

"That'll be enough, Tony, I'll take care of this."

"What is the meaning of this outrageous treatment?" asked Mr. Cameron, still trying to tie up the tossing boat.

"Come ashore at your own risk. This is a private island and we do not welcome strangers here."

"Give us a hand with the rope," snorted Billy. "Let's argue this out on land. I'm tired of this wet seat."

The man on the dock reached down and grasping the rope Billy handed up, snubbed it on a post. The Camerons jumped out onto the dock.

"Doggone glad to be out of that." Billy heaved a sigh of relief. "Hey! What you doing with that rock—HEY!"

A Mysterious Move

Billy and his father turned and stood frozen in amazement. The man had dropped a large rock into the cockpit of their boat. The rock crashed thru the thin planking and the boat filled rapidly as the water gushed thru the jagged hole.

"We don't care for squealers, especially tonight," angrily returned the man called "Chief." "You'll stay on this island until we take you ashore—and that'll be a long time—"

Billy and his father exchanged

You will be fascinated by this exciting tale of the experiences of "Billy" Cameron and his father, who are captured by a band of bootleggers and held for ransom. Billy Cameron, like many other young Americans, has mastered the art of handling a "ham" station and his expert radio knowledge comes in mighty handy. You will find yourself quite amazed at the method used by Billy in building an "emergency" transmitter from a broadcast receiver, and how he managed to "tune up" the transmitter and broadcast a distress call for help—And it worked!

glances of bewilderment and then Mr. Cameron spoke up— "Well, at least we're not going to drown—" "Not tonight," cut in the Chief.

Billy spun around and retorted "Or anytime I guess—"

"Shut up, you two and follow me— watch your step."

Gingerly the Camerons trailed after the man towards the building where the light showed thru the window. The door opened and the Camerons entered a large room, hazy with tobacco smoke. A jumble of conversation ceased as the Chief entered. "Here they are, boys." "What'll we do with 'em?" queried a burly red-headed tough. "Let's drop 'em over the dock or tie 'em on behind tonight!"

"No rough stuff—yet," the Chief seemed definite. "They can't get away. I sunk their boat and they can't swim forty miles."

The Chief left the Camerons and went over to the group of men sitting around the plank table. There were low mumbled words as the men apparently discussed the unexpected arrival of Billy and his father.

Presently the conference ended and the Chief and his right-hand-man, Tony, came back to the Camerons and questioned them as to their connec-

tions on the mainland. Eager to do anything to insure the safety of his son, Mr. Cameron was a little too enthusiastic with his promises of reward for their return to land.

"What do you say to five grand?" asked the Chief.

"What do you mean five grand—for what?"

Five Thousand Dollars or—

"Don't be a fool. You know what I mean. We want five thousand in our hands before we set you ashore and we're going to get it or else—" He drew his finger across his throat in an only too convincing manner.

"Man," angrily snorted Mr. Cameron, "that's impossible. I haven't even that much in cash at the bank."

"We'll settle that later. Get into that room there and keep quiet. If you're good boys we'll bring you some grub." The Chief pushed them into a small room off the main part of the shack and locked the door behind them.

Billy lit a few matches and they peered around. They were in a store room filled with bales of straw and burlap sacks. Each sack was stamped with figures and symbols which brought a smile of recognition from the elder Cameron, but only added to

Billy's increasing bewilderment.

"These men are repacking the liquor into sacks and straw, Billy. They probably cut it plenty too."

"Anyway it gives us a swell bed for tonight," answered Billy as he burst open a bale of straw. His labor was interrupted by the red-headed man they had seen. He had a couple of sandwiches and a can of coffee in one hand and a lantern in the other. "Pitch in, you two! Ya oughta be glad to get it."

Red stood guarding the door while the Camerons ate their food with much gusto. Escape was not in their minds now, not in the face of so many odds. The food tasted good, as they had gone hungry all day and the thick meat-filled sandwiches and hot coffee warmed them up. They felt better now that they had fed the inner man. More like tackling the problem at hand.

"Did you get what they meant about the five thousand? These rascals mean to hold us for ransom."

"Gosh, where will we get that much cash?"

"Don't know, Billy, but I think your Uncle Charley might let us have it. It's terrible to think about it—these men would just as soon kill us as not and no one would be the wiser. It will be better to get the money some way and save our necks."

"Let's forget it for tonight. A good night's sleep will put a different light on the whole business. Besides—as long as they think there is a chance of getting some money, they won't harm us."

The Camerons, tired out and warmed by the food soon dozed off on their makeshift beds of straw. They slept fitfully for hours. Light was slowly breaking over the ocean when

(Continued on Page 108)

Map Showing How Daventry Radio Beams Cover World

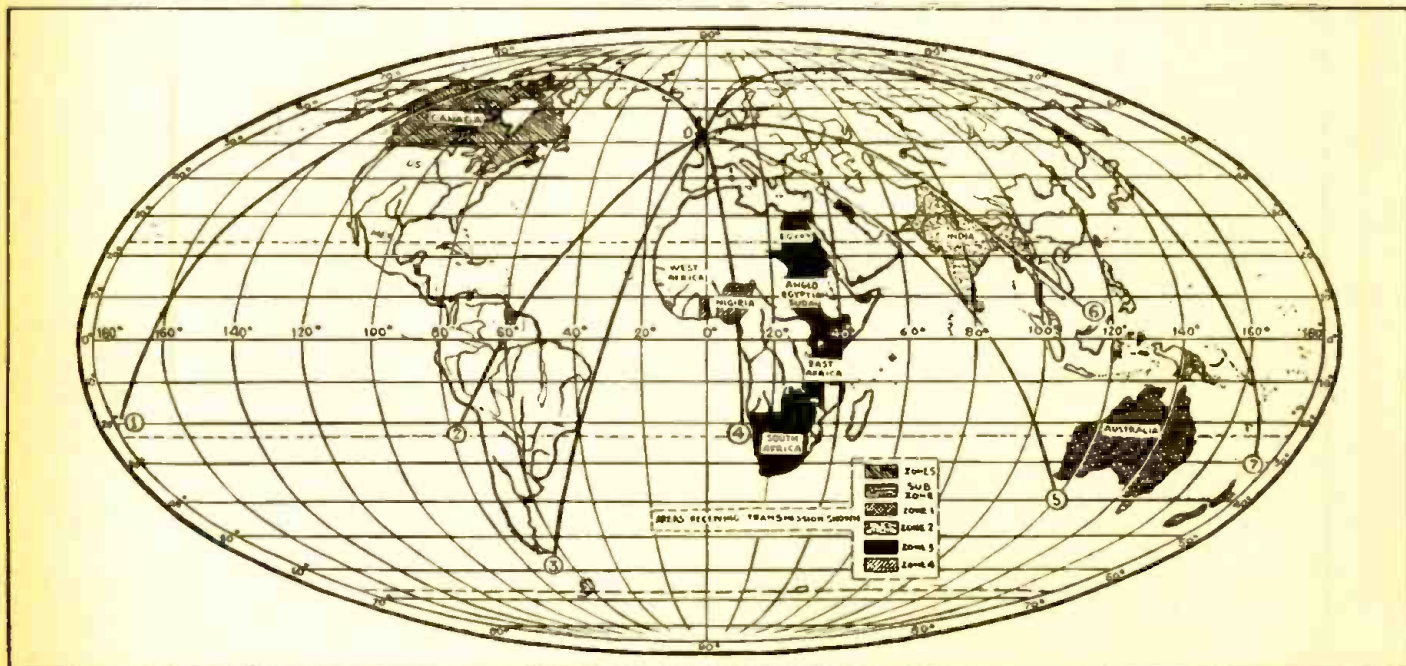

This special zone map of the world (reproduced by courtesy of Standard Telephones and Cables, Ltd., who supplied the transmitting apparatus to the British Broadcasting Company) shows how the Empire transmitters at Daventry cover the whole globe. Zone

1 (bounded by curves 5 and 7) covers Australasia; Zone 2 (between curves 5 and 6) covers India; Zone 3 (between curves 4 and 5) covers South Africa; Zone 4 (between curves 3 and 4) covers West Africa; and Zone 5 (between

curves 1 and 2) covers Canada. The wavelengths to be used for the Empire transmissions range from 16.9 to 49.6 meters. Already satisfactory reception of these Empire transmissions has been reported from all corners of the globe.

SHORT-WAVE BEGINNER

By C. W. PALMER

No. 12 of a Series

“Doc” Palmer gives some mighty valuable remedies for the general run of ailments which the short-wave “beginner” is liable to bump into, including lack of oscillation; dead spots; improper plate feed; R. F. chokes that do not choke, et cetera.

● THERE is nothing more provoking than to make a neat short-wave receiver and then find that it refuses to work on certain parts of the tuning dial. There are numerous causes for lack of oscillation in short-wave regenerative receivers and a discussion of these will probably be of more assistance to the beginner in short-wave receiver construction than a dozen articles on the theory of operation.

In the first place, the causes for lack of oscillation can be divided into two classes—those produced by mechanical faults and those effected by electrical faults.

Mechanical Defects

The mechanical faults are usually more obvious than electrical ones. For example, if the moving plates of the tuning condenser touch the fixed plates at certain points of the dial, the set will obviously refuse to work at these points. The condenser short-circuits the coil it is supposed to tune, when this occurs.

If you were impatient to hear your set operating you may have been careless about some of the wiring; perhaps one of the wires is touching the metal chassis or the metal parts of one of the components of the set. This contact may only be made at certain times, producing erratic operation of the receiver. Or you may have dropped

some solder into a place where it causes a short-circuit.

It is well to avoid the use of tuning condensers with bare metal “pigtailed” for contact purposes. These pigtailed have a bad habit of catching and producing crackling noises when the dial is turned. They have even been known to make a receiver inoperative on a part of the scale. Condensers with covered pigtailed are satisfactory, of course.

Resistors of the carbon-strip type should also be avoided in short-wave receivers whenever possible, as they often become noisy after being in use for some time. Other mechanical defects, such as defective contacts in tube sockets, poorly soldered or unsoldered “high-resistance” connections, etc., are usually easy to locate if a little patience is used.

Electrical Defects

There are many electrical causes for “dead-spots” in short-wave receivers. As these defects are not easily eliminated by an inexperienced constructor, we will consider them in detail.

Perhaps the worst offender is the aerial. If the “natural wavelength” of the antenna system is at a value within the band covered by one of the coils, the aerial absorbs current from the set when it is tuned to this wavelength and prevents it from oscillating. Also, if the set is tuned to some multiple such as twice, three times, four times, etc., the fundamental frequency of the aerial, the same effect is produced.

The most common method of overcoming this difficulty is to place a small condenser in the aerial wire. By adjusting the capacity of this condenser the fundamental frequency of the aerial may be shifted sufficiently to overcome the difficulty. Figure 1 shows how this condenser is connected. Many methods of construction for aerial condensers have been shown in past issues of SHORT WAVE CRAFT—any of these is satisfactory.

Perhaps a better way to remove dead-spots caused by the aerial is to use a method employed extensively in Europe. This consists of connecting a coil and a variable condenser in the aerial lead as shown in Fig 2. The coil may be wound on a form one inch in diameter and contains 10 turns of No. 24 cotton covered wire. The condenser is a standard .00035 mf. variable unit such as those used for broadcast receivers.

This condenser is then adjusted until the resonance point of the aerial is moved off the scale. The procedure is simple: first, tune the receiver to the dead-spot with the aerial connected in the usual manner; then connect in the coil and condenser and turn the .00035 mf. condenser until the set starts to oscillate. If the dead-spot is caused by aerial resonance, this method will work and a point can usually be found on the scale of the condenser that will remove the dead-spots from all the coils.

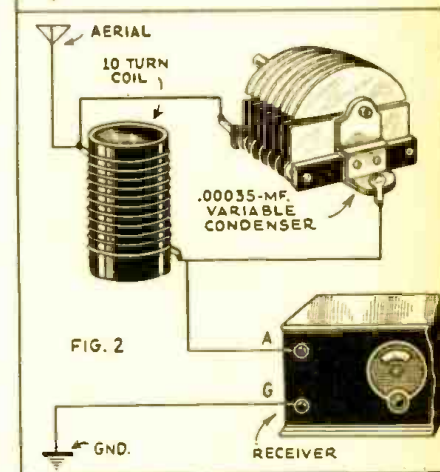
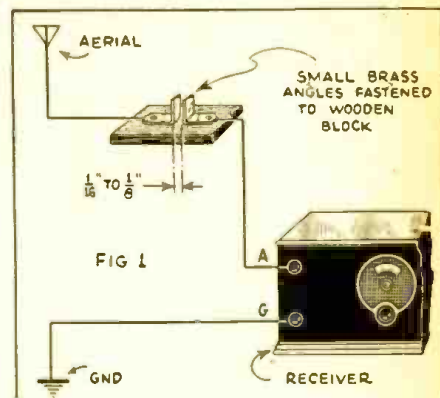

Top diagram shows method of eliminating “dead-spots” in short-wave receivers by connecting a small capacity condenser in series with the antenna; a midget variable condenser of 25 to 50 mmf. is preferable. The lower diagram shows a better method for eliminating “dead-spots,” comprising a small coil connected in shunt with a variable condenser as explained in the text.

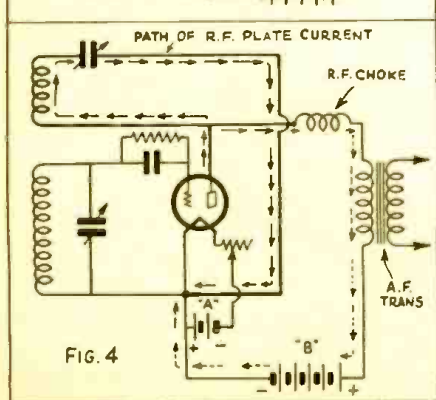
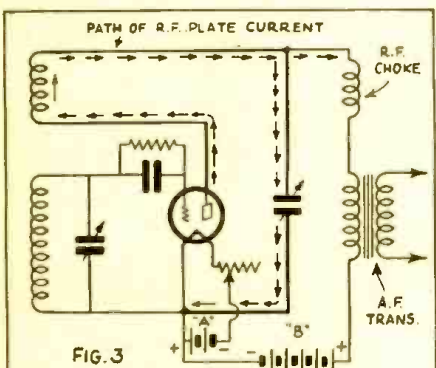

Two different methods of feeding the plate current into the detector tube are shown above, the method shown in the lower diagram, Fig. 4, being preferred.

Next in importance in the line of dead-spot producers is the use of a tickler coil of incorrect size. If the tickler or plate coil is too small, the set will not oscillate all the way up to the maximum setting of the tuning condenser. If the coil is too large, dead-spots will be encountered at different points of the scale.

Another important point is to see that the “ground” end of the grid coil is that nearest the tickler. In many cases the lead wires connecting to the tickler socket terminals have to be reversed before proper regeneration is obtained.

The ideal size of tickler coil is one that will just allow the set to oscillate at the maximum reading of the dial. In order to achieve this condition, the following procedure is recommended.

First try several tubes in the detector socket, so that you are sure that the tube you are using is not an exceptionally poor or exceptionally good oscillator. Sometimes you will find a great difference caused by changing the B+ voltage applied to the plate of the detector. Try voltages all the way from 16 to 90. Then, try different grid-leaks in the set, varying the value from about

(Continued on page 121)

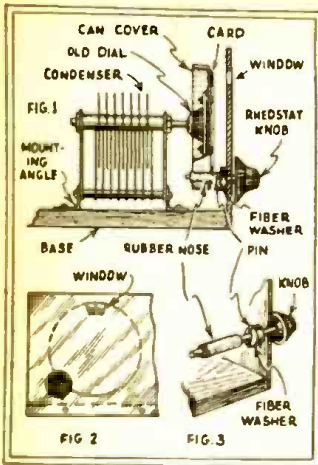

**\$5.00 Prize
SIMPLE VERNIER DIAL**

As most everyone has been hit by the depression, these ideas ought to come in handy. A cover from a tin coffee can, an old flat type dial and a few odds and ends from the junk box will make a serviceable vernier dial, as shown in FIG. 1. The tuning control is mounted in a single 1/4 inch hole drilled in the panel. A hole for the condenser shaft is drilled through the knob of the dial so that the latter may be held to the shaft by the usual set-screw. The can cover is then fastened to the dial by two short machine screws as indicated. A circular card is fastened to the can cover at front where it may be seen through a hole cut in the panel. The usual dial markings are filled in or the various call letters printed on the card. The small window may be covered by a celluloid cover and illuminated from near by a small flash-light bulb. The panel arrangement is shown in Fig. 2 and the drive shaft in Fig. 3.—Arthur Buentenhirsch.



NOVEL TUNING SYSTEM

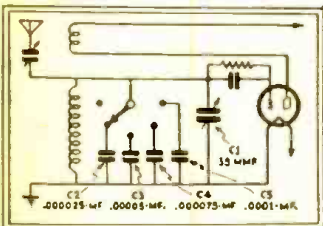

Here is a band-spread system I use, and find much superior over many types. When using a vernier dial on the small tuning condenser you can log stations and find them again at the same dial setting. With the system using a lumped capacity for band-centering, logging is impossible due to the fine tuning necessary on the lumped capacity to bring it to correct setting to match the vernier. A tapped switch is used in conjunction with fixed condensers for the lumped capacity. This switch is mounted behind the panel, while the condensers are mounted directly on the switch. A bakelite rod and a coupling are used to extend it through the panel. Marks can be made on the panel to correspond with the condenser switch points. The variable condenser should be of a good make, with a low "minimum" capacity to give a little "lap" on each setting. Not being able to get a .000025 mf. condenser two .00005 mf. were used in series to give the right capacity.—Marlon Henley.



ANTI-BODY CAPACITY KINK

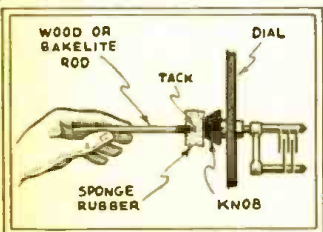

For those who have constructed any of the very compact short-wave sets as described in Short Wave Craft and are still bothered by "body capacity," I offer the following solution. In most cases, where space is at a premium, there is not sufficient room to mount permanent bakelite rods as exten-

**\$5.00 For Best
Short Wave Kink**

The Editor will award a five dollar prize each month for the best short-wave kink submitted by our readers. All other kinks accepted and published will be paid for at regular space rates. Look over these "kinks" and they will give you some idea of what the editors are looking for. Send a typewritten or ink description, with sketch, of your favorite short-wave kink to the "Kink" Editor, SHORT WAVE CRAFT.

sions of the condenser shafts. By mounting a small block of sponge rubber on the end of a wooden dowl or bakelite rod and applying it to the dial of the condenser, the set may be tuned just as easily. The rubber block gives a very good grip on the dial and will not slip in the tuning.—A. F. Kennard.

WIRE HOLDER

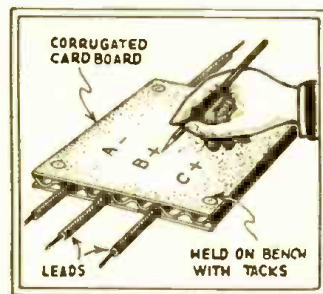

The usual experimenter's table is littered with unsightly tangles of wires; often he cannot tell where the wires lead to. This can be remedied by this kink which I have used myself. Take an ordinary piece of corrugated cardboard and run your wires through the corrugations. Then tack the cardboard on your table and you will have a handy way of keeping track of the wires. You can write in "identification" numbers or words on the cardboard to indicate where each wire leads to or comes from.—Y. H. Mori.



**"STEPPING OUT" ON 160
METER PHONE**

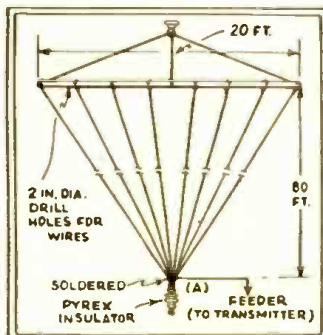

With the new amateur regulations restricting the use of 85 meters (3500 kc) for phone use, many hams are facing the problem of getting out with low power on the 160 meter phone band (1875 kc). The antenna system for use on 160 meters is really more critical than the average operator figures it is. My idea for the aerial described here is based on the broadcast type antenna, a large multi-wire flat-top to radiate all of the power produced by the oscillator. Broadcast transmitters either low or high power step out with the multi-wired system. Why shouldn't the ham fone do the same thing? The flat-top consisting of eight, eighty foot wires made up in "kite shape" No. 16 gauge is best, but seven strand No. 26 will work just as well. The point end, A, to which the feeder connects should be toward the transmitter so as to make the feeder as short and direct to the tank as possible, and not over 25 feet long if possible. Good Pyrex or Glass insulators should be used to reduce the leakage of the system. The counterpoise is constructed on the same layout except it is thirty feet wide and approximately 7 feet high, while the flat-top should be placed as high as pos-

sible. It is not necessary to have the counterpoise directly under the flat-top but it is best to place it there if possible. I have designed this antenna for my transmitter which is a Hartley circuit, one UX 210 as Oscillator, 1-250 modulator and two 227's as speech amplifiers. 95% of the stations "worked" with this aerial report steady signals and perfect modulation. By ordering the antenna wire from some salvage house you can obtain the wire very cheaply. Be sure that all splices are soldered when making up the antenna, as this reduces the total resistance of the system. Approximately 1300 feet of antenna wire is used in the entire system.—W. T. Golson, W4AV; W4ZZA.



IMPROVED DIAL KNOB

This idea is particularly applicable to the National RMD Velvet-Vernier dial but it can be adapted to other makes. Desiring to increase the size of the knob, to give a better grip and take some of the "cramp" out of "cranking" from one end of the band to the other, and being unable to secure a larger knob to fit this shaft, I used the following method to accomplish the desired result.

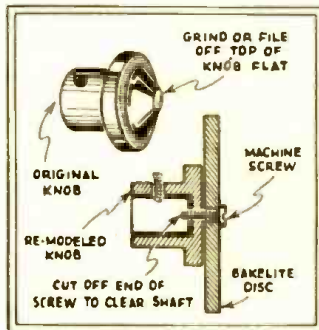

Grind or file the top of the knob flat. Drill a hole in the center and tap it for a 8/32 or 8/32 machine screw. Procure a disc about one-quarter of an inch thick and of the desired diameter (I cut mine from an old bakelite panel). Drill a hole in the center and tap it also. This disc is then fastened to the top of the knob with a machine screw just long enough to go through the end of the brass bushing and still clear the end of the shaft. This arrangement makes a "dial-twisting" a pleasure.—R. E. Lauth.



**BATTERY CASING FOR
COILS**

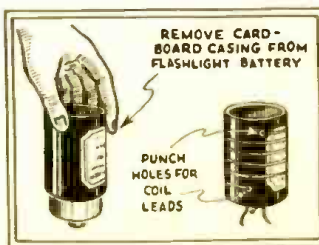

When tube bases are not handy and you want to wind some coils for an experimental hook-up, a cardboard casing off of an old flashlight battery is the answer. Wrap your wires around the casing just as on any coil form. Punch holes in the casing to bring in the wires. This is not meant for use on a set but to experiment with.—Y. H. Mori.

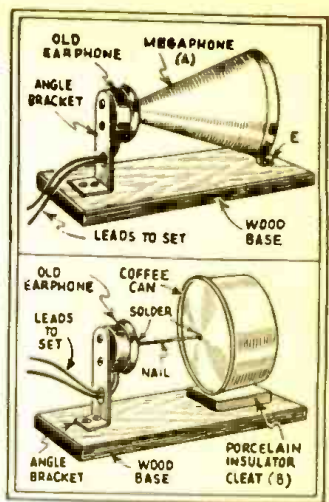

CHEAP "CODE" SPEAKERS

The megaphone A can be made of thin tin or other metal or cardboard and is cemented with good strong glue on the earphone and is mounted at point E with glue. The angle bracket is bolted on the phone through holes that are to be drilled through the case. At B, an old coffee can is used with a nail or metal rod three inches long soldered in the middle of the can on one end, and the other end to the earphone diaphragm. The can should be bolted on the base separated by a porcelain cleat. With a 2-tube set these give fair volume, considering their simplicity.—M. Hermes.



SOLDERING TINSEL

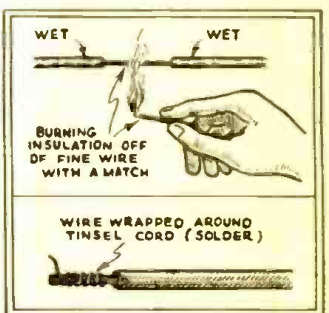

The fine tinsel should first be wrapped with a single strand of small copper wire for a distance of half an inch, then tin the wrapping. If tips are to be soldered on they should be half filled with solder. Heat the tip and then the protected end is deftly plunged into the tip's opening. Broken connections can be repaired the same way. Removing Insulation From Fine Wire: After determining the length of insulation it is desired to remove, wet the wire several inches back from the place where the wire is to be burned off. The insulation is then burned off by the flame of a match and the wire is rubbed lightly with fine emery paper.—Joe Kosorak.



**LENGTHENING TUBE
BASES**

Many times an experimenter will find that he cannot wind all the turns of a certain coil onto a tube base. This can be remedied by this useful kink. Wrap a strip of celluloid around the tube base so that the edges just overlap. Now, cement the celluloid to the base with some good glue. Also cement the edges of the celluloid together with some acetone. Holes can be bored in the celluloid form to bring the wires to the different prongs on the tube base.—Y. H. Mori.

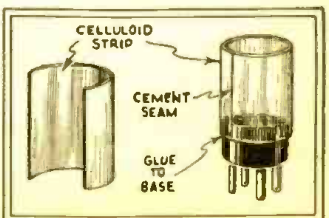

SHORT WAVE STATIONS OF THE WORLD

SECTION ONE

As promised in the last issue, we are presenting herewith a complete, revised and combined list of the short wave broadcasting, experimental and commercial radiophone stations of the world. This is arranged according to frequency, but the wavelength figures are also given for the benefit of readers who are more accustomed to working with "meters" than with "kilocycles." All the stations in this list, with one or two exceptions of the time stations, use telephone transmission of one kind or another and can there-

fore be identified by the average listener. The May, 1933, issue (copies mailed for 25c) contained a very fine list of police, airport and television stations, which was marked "Section Two." This will reappear in the July issue with the latest corrections and additions. Section One (this month's list) will be published again in the August issue, also with last minute changes. Note: Stations marked with a star (*) are the most active and easily heard stations and transmit at fairly regular times.

Around-the-Clock Listening Guide

Although short wave reception is notorious for its irregularity and seeming inconsistency (wherein lies its greatest appeal to the sporting listener), it is a good idea to follow a general schedule as far as wavelength in relation to the time of the day is concerned. The observance of a few simple rules will save the short wave fan a lot of otherwise wasted time.

From daybreak to mid-afternoon, and partic-

ularly during bright daylight, listen between 13 and 22 meters (21540 to 13000 kc.).

To the east of the listener, from about noon to 10:00 p. m., the 20-35 meter will be found very productive. To the west of the listener this same band is best from about midnight until shortly after daybreak. After dark, results above 35 meters are usually much better than during daylight. These general rules hold good whether you live in the United States or in China.

31000 kc. W8XI 9.68 meters Westinghouse Electric SAXONBURG, PA.	21020 kc. LSN 14.27 meters (Hurlingham), Buenos Aires, Argentina Commercial radiophone; occasional broadcasting.	19906 kc. LSG 15.07 meters MONTE GRANDE, ARGENTINA 8-10 a. m., commercial radiophone	18350 kc. WND 16.35 meters DEAL BEACH, N. J.	17780 kc. W3XAL 16.87 meters NATIONAL BROAD. CO. Bound Brook, N. J. Experimental; relays WJZ programs
27800 kc. W6XD 10.79 meters Mackay Radio PALO ALTO, CALIF.	21000 kc. OKI 14.28 meters PODEBRADY, CZECHOSLOVAKIA	19850 kc. WMI 15.10 meters A. T. & T. CO., DEAL, N. J.	18310 kc. GBS 16.38 meters General Post Office RUGBY, ENGLAND Telephony with New York	17780 kc. W9XF 16.87 meters DOWNERS GROVE, ILL. Irregular; relays NBC programs
25960 kc. G5SW 11.55 meters British Broad. Corp. CHELMSFORD, ENGLAND Experimental, relay broadcasting	20730 kc. LSY 14.47 meters MONTE GRANDE, ARGENTINA Commercial radiophone; occasional broadcasting.	19830 kc. FTD 15.12 meters ST. ASSISE, FRANCE	18310 kc. FZS 16.38 meters SAIGON, INDO-CHINA 1 to 3 p. m. Sundays	17770 kc. GSG 16.88 meters, British Broad. Corp. DAVENTRY, ENGLAND British Empire programs
25700 kc. W2XBC 11.67 meters Radio Corp. of America NEW BRUNSWICK, N. J.	20680 kc. LSN 14.50 meters MONTE GRANDE, ARGENTINA after 10:30 p. m. Telephony with Europe	19400 kc. FRO, FRE 15.45 meters ST. ASSISE, FRANCE	18240 kc. FRO, FRE 16.44 meters ST. ASSISE, FRANCE	17770 kc. PHI 16.88 metes HUIZEN, HOLLAND Experimental
24000 kc. W6XQ 12.48 meters SAN MATEO, CALIF.	20680 kc. LSX 14.50 meters BUENOS AIRES Telephony with U. S., also occasional broadcasting	19300 kc. FTM 15.55 meters ST. ASSISE, FRANCE 10 a. m. to noon	18170 kc. CGA 16.50 meters DRUMMONDVILLE, QUEBEC CANADA Telephony to England	17640 kc. Ship. 17.00 meters SHIP Phones to Shore WSBN, "Leviathan" GFWY, "Majestic" GLSQ, "Olympic" GDLJ, "Homeric" GMJQ, "Belgenland" Work on this and higher channels
21540 kc. W8XK 13.93 meters WESTINGHOUSE ELECTRIC SAXONBURG, PA. 7:30 a. m.-noon; relays KDKA programs	20680 kc. FSR 14.50 meters PARIS-SAIGON PHONE	19240 kc. DFA 15.58 meters NAUEN, GERMANY	18100 kc. GBK 16.57 meters General Post Office BODMIN, ENGLAND	17380 kc. JIAA 17.25 meters TOKIO, JAPAN
21470 kc. GSH 13.97 meters BRITISH BROAD. CORP. Daventry, England British Empire programs	20620 kc. PMB 14.54 meters Bandoeng, Java After 4 a. m.; radiophone to Holland	19220 kc. WNC 15.60 meters A. T. & T. CO., DEAL, N. J. Transoceanic radiophone	18050 kc. KQJ 16.61 meters BOLINAS, CALIF. Transpacific radiophone	17300 kc. W8XL 17.34 meters DAYTON, OHIO
21420 kc. W2XDJ 14.00 meters A. T. & T. CO., DEAL, N. J. Experimental radiophone	20140 kc. DWG 14.89 meters NAUEN, GERMANY Tests 10 a.m.-3 p. m.	18820 kc. PLE 15.94 meters BANDOENG, JAVA. 8:40-10:40 a. m. Phone service to Holland	17850 kc. PLF 16.80 meters BANDOENG, JAVA ("Radio Malabar")	17300 kc. W6XAJ 17.34 meters OAKLAND, CALIF.
21400 kc. WLO 14.01 meters A. T. & T. CO. Lawrence, N. J. Transoceanic phone	19950 kc. LSG 15.03 meters MONTE GRANDE, ARGENTINA From 7 a. m. to 1 p. m. Telephony to Paris and Berlin	18620 kc. GBJ 16.10 meters General Post Office BODMIN, ENGLAND Telephony with Montreal	17850 kc. W2XAO 16.80 meters Radio Corp. of America NEW BRUNSWICK, N. J.	17300 kc. W9XL 17.34 meters ANOKA, MINN.
21130 kc. LSM 14.15 meters MONTE GRANDE, ARGENTINA Commercial radiophone; occasional broadcasting.	19500 kc. LSG 15.03 meters MONTE GRANDE, ARGENTINA Commercial radiophone; occasional broadcasting.	18620 kc. GBU 16.11 meters General Post Office RUGBY, ENGLAND	17830 kc. PCV 16.82 meters KOOTWIJK, HOLLAND 9:40 a. m. Sat.	
	19950 kc. DIH 15.03 meters NAUEN, GERMANY	18370 kc. PMC 16.33 meters BANDOENG, JAVA.	17780 kc. W8XK 16.87 meters WESTINGHOUSE ELECTRIC AND MFG. CO. Saxonburg, Pa. Relays KDKA programs	

Short Wave Stations of the World

17110 kc. WOO 17.52 meters A. T. & T. CO., DEAL, N. J. Transoceanic radiophone	15120 kc. JIAA 19.83 meters TOKIO, JAPAN Irregular, early morning.	12150 kc. GBS 24.68 meters RUGBY, ENGLAND Transatlantic phone to Deal, N. J. (New York)	11760 kc. XDA 25.50 meters TRENDS-NEWS AGENCY Mexico City 3-4 p. m.	10390 kc. GBX 28.86 meters RUGBY, ENGLAND
17110 kc. W2XD0 17.52 meters A. T. & T. Co. OCEAN GATE, N. J.	15075 ★TI4NRH 19.9 meters HEREDIA, COSTA RICA, C. A.	12150 kc. FQ0, FQE 24.68 meters STE. ASSISE, FRANCE	11760 kc. ★DJJ 25.50 meters ZEESEN, GERMANY	10350 kc. LSX 28.98 meters BUENOS AIRES, ARGENTINA Commercial radiophone
17080 kc. GBC 17.55 meters RUGBY, ENGLAND	15000 kc. CM6XJ 19.99 meters CENTRAL TUINUCU, CUBA Irregular	12045 kc. ★NAA 24.89 meters ARLINGTON, VA. Time signals, 11:57 to noon.	11750 kc. ★GSD 25.53 meters BRITISH BROAD. CORP. Daventry, England British Empire programs	10250 kc. ★TI4NRH 29.30 meters AMONDO CESPEDES MARIN Heredia, Costa Rica Mon. and Wed., 7:30 to 8:30 p. m.; Thurs. and Sat., 9:00 to 10 p. m.
16300 kc. PCL 18.40 meters KOOTWIJK, HOLLAND Works with Bandoeng from 7 a. m.	14620 kc. XDA 20.50 meters TRENDS-NEWS AGENCY Mexico City 2:30-3 p. m.	12045 kc. ★NSS 24.89 meters ANNAPOLIS, MD. Time signals, 9:57-10 p. m.	11750 kc. ★VE9JR 25.53 meters WINNIPEG, CANADA Weekdays, 5:30-7:30 p. m.	10150 kc. DIS 29.54 meters NAUEN, GERMANY Press (code) daily; 6 p. m., Spanish; 7 p. m., English; 7:50 p. m., German; 2:30 p. m., English; 5 p. m., German. Sundays: 6 p. m., Spanish; 7:50 p. m., German; 9:30 p. m., Spanish
16300 kc. WLO 18.40 meters A. T. & T. CO., LAWRENCE, N. J.	14530 kc. LSA 20.65 meters BUENOS AIRES, ARGENTINA	12000 kc. FZG 24.98 meters SAIGON, INDO-CHINA Time signals, 2-2:05 p. m.	11730 kc. PHI 25.57 meters HUIZEN, HOLLAND	10000 kc. 30 meters BELGRADE, JUGO-SLAVIA
16200 kc. FZR 18.50 meters SAIGON, INDO-CHINA Radiophone to Paris	14480 kc. GBW 20.70 meters RADIO SECTION General Post Office, London E. C. 1. Rugby, England	11945 kc. KKQ 25.10 meters BOLINAS, CALIF.	11705 kc. ★FYA 25.6 meters "RADIO COLONIAL" Pontoise (Paris) Daily, 3:00-6:00 p. m.	9950 kc. GBU 30.15 meters RUGBY, ENGLAND
16150 kc. GBX 18.56 meters RUGBY, ENGLAND	14480 kc. WNC 20.70 meters A. T. & T. CO., DEAL, N. J. Transoceanic radiophone	11905 kc. ★FYA 25.16 meters "RADIO COLONIAL" Pontoise, Paris Daily 10:30 a. m.-2:00 p. m.	11690 kc. ★YVQ 25.65 meters MARACAY, VENEZUELA (Also broadcasts occasionally)	9890 kc. LSN 30.30 meters BUENOS AIRES Phone to Europe
16060 kc. ★NAA 18.68 meters U. S. NAVY, ARLINGTON, VA. Time signals, 11:57 to noon	14420 kc. VPD 20.80 meters SUVA, FIJI ISLANDS	11880 kc. ★W9XF 25.24 meters NATIONAL BROADCASTING CO. Downers Grove (Chicago), Ill. 9-10 p. m. daily; relays NBC programs	11670 kc. KIO 25.68 meters KAHUHU, HAWAII	9890 kc. LSA 30.30 meters BUENOS AIRES
15950 kc. PLG 18.80 meters BANDOENG, JAVA Afternoons.	14150 kc. KKZ 21.17 meters BOLINAS, CALIF.	11870 kc. VUC 25.26 meters CALCUTTA, INDIA 9:45-10:45 p. m.; 8-9 a. m.	11670 kc. CGA 26.00 meters DRUMMONDVILLE, CANADA	9860 kc. ★EAQ 30.4 meters TRANSRADIO ESPANOLA Alcala 43-Madrid, Spain (P. O. Box 951) 5:30-7:00 p. m. daily
15860 kc. FTK 18.90 meters ST. ASSISE, FRANCE Commercial radiophone	13400 kc. WND 22.38 meters A. T. & T. CO., DEAL BEACH, N. J. Transoceanic telephony	11870 kc. ★W8XK 25.26 meters WESTINGHOUSE ELECTRIC East Pittsburgh, Pa. 4-10 p. m., relays KDKA programs	11670 kc. GBK 26.10 meters BODMIN, ENGLAND	9790 kc. GBW 30.64 meters RUGBY, ENGLAND
15490 kc. JIAA 19.36 meters TOKIO, JAPAN 5:00-7:00 a. m.	12880 kc. CNR 23.38 meters RABAT, MOROCCO, AFRICA	11865 kc. ★GSE 25.28 meters British Broad. Corp. DAVENTRY, ENGLAND British Empire programs	11670 kc. IBDK 26.15 meters S.S. "ELETTRA" Marconi's yacht	9750 kc. WNC 30.75 meters DEAL, N. J.
15330 kc. ★W2XAD 19.56 meters GENERAL ELECTRIC CO. Schenectady, N. Y. Relays NBC and WGY programs	12850 kc. W2XO 23.35 meters GENERAL ELECTRIC CO. Schenectady, N. Y. Experimental radiophone and relay broadcasting	11840 kc. W9XAO 25.34 meters CHICAGO FEDERATION OF LABOR Chicago, Ill. Relays WCFL programs	11645 kc. DHC 26.22 meters NAUEN, GERMANY	9700 kc. WMI 30.90 meters DEAL, N. J.
15300 kc. OXY 19.60 meters LYNGBY, DENMARK Experimental & relay broadcasting	12850 kc. W2XCU 23.35 meters AMPERE, N. J.	11840 kc. W9XAL 25.34 meters CHICAGO FEDERATION OF LABOR Chicago, Ill. Relays WCFL programs	11630 kc. DAN 26.44 meters NORDEICH, GERMANY Time signals, 7 a. m., 7 p. m. Deutsche Seewarte, Hamburg	9675 kc. ★T14NRH 31 meters HEREDIA, COSTA RICA, C. A.
15270 kc. ★W2XE 19.65 meters COLUMBIA BROAD. SYS. Wayne, N. J. 11:00 a. m.-1:00 p. m.	12820 kc. ★CNR 23.38 meters DIRECTOR GENERAL Telegraph and Telephone Stations, Rabat, Morocco Sun., 7:30-9 a. m. Daily, 5-7 a. m. Telephony	11830 kc. ★W2XE 25.36 meters COLUMBIA BROADCASTING SYS., Wayne, N. J. 3:00-5:00 p. m.	11630 kc. PLR 28.20 meters BANDOENG, JAVA Works with Holland and France weekdays from 7 a. m.; some- times after 9:30	9640 kc. HSP2 31.10 meters BROADCASTING SERVICE Post and Telegraph Department Bangkok, Siam 9-11 a. m., daily
15240 kc. ★FYA 19.68 meters "RADIO COLONIAL" Pontoise (Paris), France Service de la Radiodiffusion, 103 Rue de Grenelle, Paris Daily 7:00-10:00 a. m. Also during late afternoon	12780 kc. GBC 23.46 meters RUGBY, ENGLAND	11810 kc. ★I2R0 25.4 meters "RADIO ROMA NAPOLI" Rome, Italy Daily, 11:30 a. m. to 12:15 p. m. and 2:00-6:00 p. m. Sunday, 11:00 a. m.-12:15 p. m. Woman announcer	11618 kc. ★CT3AQ 26.83 meters FUNCHAL, MADEIRA Tues., Thurs., 5:00-6:30 p. m. Sunday, 10:30 a. m.-1:00 p. m.	9600 kc. ★CTIAA 31.25 meters LISBON, PORTUGAL Tues. and Friday, 4:30-7:00 p. m.
15210 kc. ★W8XK 19.72 meters WESTINGHOUSE ELECTRIC & MFG. CO. Saxonburg, Pa. 7:30 a. m. to 5 p. m. Relays KDKA programs	12290 kc. GBU 24.41 meters RUGBY, ENGLAND	11800 kc. ★VE9GW 25.42 meters W. A. SHANE CHIEF ENGINEER Bowmanville, Canada Daily, 1-4 p. m.	11610 kc. WLO 28.44 meters A. T. & T. CO., LAWRENCE, N. J. Transoceanic radiophone	9600 kc. LQA 31.25 meters BUENOS AIRES
15200 kc. DJB 19.73 meters ZEESEN, GERMANY	12250 kc. FTN 24.46 meters STE. ASSISE (PARIS), FRANCE Works Buenos Aires, Indo- China and Java. On 9 a. m., to 1 p. m. and other hours	11790 kc. WIXAL 25.45 meters BOSTON, MASS.	11610 kc. VLK 28.44 meters SYDNEY, AUSTRALIA Commercial radiophone	9600 kc. LGN 31.23 meters BERGEN, NORWAY
15140 kc. ★GSF 19.81 meters BRITISH BROAD. CORP. Daventry, England British Empire programs	12250 kc. GBS 24.46 meters RUGBY, ENGLAND	11780 kc. ★VE9DR 25.47 meters DRUMMONDVILLE, QUEBEC Canada Irregular	11610 kc. PDK 28.80 meters KOOTWIJK, HOLLAND	9595 kc. ★HBL 31.27 meters League of Nations GENEVA, SWITZERLAND
15120 kc. ★HVJ 19.83 meters VATICAN CITY Rome, Italy Daily 5:00 to 5:15 a. m.	12250 kc. PLM 24.46 meters BANDOENG, JAVA Radiophone to Holland		11610 kc. KEZ 28.80 meters BOLINAS, CALIF.	9590 kc. ★VK2ME 31.28 meters AMALGAMATED WIRELESS, Ltd., Sydney, Australia Sun., 1-3 a. m., 5-9 a. m., 9:30- 11:30 a. m.

Short Wave Stations of the World

<p>9585 kc. ★GSC 31.29 meters BRITISH BROAD. CORP. Daventry, England British Empire programs</p>	<p>9200 kc. GBS 32.61 meters RUGBY, ENGLAND Transatlantic phone</p>	<p>8120 kc. PLW 36.92 meters BANDOENG, JAVA</p>	<p>7220 kc. HB9D 41.50 meters ZURICH, SWITZERLAND 1st and 3rd Sundays at 7 a. m., 2 p. m.</p>	<p>6425 kc. ★W3XL 46.70 meters NATIONAL BROADCASTING CO. Bound Brook, N. J. Relays WJZ programs</p>
<p>9580 kc. ★W3XAU 31.32 meters BYBERRY (Philadelphia), PA. relays WCAU daily</p>	<p>9010 kc. GBS 33.30 meters RUGBY, ENGLAND</p>	<p>8100 kc. EATH 37.02 meters VIENNA, AUSTRIA Mon. and Thurs., 5:30 to 7 p. m.</p>	<p>7195 kc. VSIAB 41.67 meters SINGAPORE, S. S. Mon., Wed. and Fri., 9:30-11 a. m.</p>	<p>6425 kc. VE9BY 46.7 meters LONDON, ONTARIO, CANADA</p>
<p>9570 kc. ★WIXAZ 31.35 meters WESTINGHOUSE ELECTRIC & MFG. CO. Springfield, Mass. 6 a. m.-10 p. m., daily</p>	<p>8928 kc. TGX 33.50 meters GUATEMALA CITY, C. A.</p>	<p>7390 kc. DOA 37.80 meters DOEBERITZ, GERMANY 1 to 3 p. m. Reichpostzentramt, Berlin</p>	<p>7140 kc. HKX 42.00 meters BOGOTA, COLOMBIA Irregular</p>	<p>6420 kc. RV62 46.72 meters MINSK, U. S. S. R. Irregular</p>
<p>9570 kc. SRI 31.35 meters POZNAN, POLAND Tues., 2:00-5:00 p. m., Wed., 7:00-8:00 a. m., Thurs., 2:00- 3:30 p. m.</p>	<p>8872 kc. NPO 33.81 meters CAVITE (MANILA) Philippine Islands Time signals 9:55-10 p. m.</p>	<p>7890 kc. VPD 38.00 meters SUVA, FIJI ISLANDS</p>	<p>7020 kc. EAR125 42.70 meters MADRID, SPAIN Irregular</p>	<p>6382 kc. HC1DR 47.00 meters QUITO, ECUADOR 8-11 p. m.</p>
<p>9560 kc. ★DJA 31.38 meters REICHSPOSTZENTRALAMT 11-15 Schoenberge Strasse (Berlin) Konigswusterhausen, Germany</p>	<p>8872 kc. ★NAA 33.81 meters ARLINGTON, VA. Time signals 9:57-10 p. m., 2:57-3 p. m.</p>	<p>7880 kc. JIAA 38.07 meters TOKIO, JAPAN Broadcasting 5:00-7:00 a. m.</p>	<p>6990 kc. ★CTIAA 42.90 meters LISBON, PORTUGAL Fridays, 5-7 p. m.</p>	<p>6335 kc. VE9AP 47.35 meters DRUMMONDVILLE, CANADA</p>
<p>9530 kc. ★W2XAF 31.48 meters GENERAL ELECTRIC CO. Schenectady, N. Y. Relays NBC and WGY programs</p>	<p>8810 kc. WSNB 34.05 meters S.S. "LEVIATHAN"</p>	<p>7830 kc. PDV 38.30 meters KOOTWIJK, HOLLAND After 9 a. m.</p>	<p>6976 kc. EAR110 43 meters MADRID, SPAIN Tues., Sat., 5:30 p. m.</p>	<p>6270 kc. HKC 47.81 meters BOGOTA, COLOMBIA 8:30-11:30 p. m.</p>
<p>9520 kc. ★OXY 31.51 meters SKAMLEBOEK, DENMARK Daily from 1:00 p. m.</p>	<p>8690 kc. W2XAC 34.50 meters SCHENECTADY, NEW YORK</p>	<p>7799 kc. ★HBP 38.47 meters LEAGUE OF NATIONS, GENEVA, SWITZERLAND</p>	<p>6875 kc. F8MC 43.60 meters CASABLANCA, MOROCCO Sun., Tues., Wed., Sat.</p>	<p>6243 kc. HKD 48.05 meters BARRANQUILLA, COLOMBIA</p>
<p>9510 kc. ★GSB 31.55 meters BRITISH BROAD. CORP. Daventry, England British Empire programs</p>	<p>8650 kc. W2XCU 34.68 meters AMPERE, N. J.</p>	<p>7770 kc. FTF 38.60 meters STE. ASSISE, FRANCE</p>	<p>6860 kc. KEL 43.70 meters BOLINAS, CALIF. Transpacific Radiophone</p>	<p>6220 kc. ★I2RO 48.2 meters ROME, ITALY</p>
<p>9510 kc. ★VK3ME 31.55 meters AMALGAMATED WIRELESS, Ltd. 167-169 Queen St., Melbourne, Australia Wed., 5:00-6:30 a. m., Sunday, 5:00-7:00 a. m.</p>	<p>8650 kc. W3XE 34.68 meters BALTIMORE, MD. 12:15-1:15 p. m., 10:15-11:15 p. m.</p>	<p>7770 kc. PCK 38.60 meters KOOTWIJK, HOLLAND 9 a. m. to 7 p. m.</p>	<p>6860 kc. Radio Vitus 43.70 meters PARIS, FRANCE 4-11 a. m. 3 p. m.</p>	<p>6167 kc. XIF 48.65 meters MEXICO CITY, MEXICO</p>
<p>9375 kc. EH9OC 32.00 meters BERNE, SWITZERLAND 3:5-30 p. m.</p>	<p>8650 kc. W2XV 34.68 meters RADIO ENGINEERING LAB. Long Island City, N. Y.</p>	<p>7660 kc. FTL 39.15 meters STE. ASSISE, FRANCE</p>	<p>6840 kc. CFA 43.80 meters DRUMMONDVILLE, CANADA</p>	<p>6147 kc. ★VE9CL 48.8 meters WINNIPEG, CANADA 7:00-9:30 p. m.</p>
<p>9330 kc. CGA 32.15 meters 5:00-7:00 a. m. DRUMMONDVILLE, CANADA</p>	<p>8650 kc. W8XAG 34.68 meters DAYTON, OHIO</p>	<p>7612 kc. HKF 39.40 meters BOGOTA, COLOMBIA 8-10 p. m.</p>	<p>6753 kc. WND 44.40 meters DEAL, N. J.</p>	<p>6140 kc. ★W8XK 48.86 meters WESTINGHOUSE ELECTRIC & MFG. CO. Saxonburg, Pa. Relays KDKA programs, 5 p. m.-midnight</p>
<p>9310 kc. GBC 32.22 meters RUGBY, ENGLAND Sundays, 2:30-5 p. m.</p>	<p>8650 kc. VE9BY 34.68 meters LONDON, ONTARIO, CANADA</p>	<p>7612 kc. X26A 39.4 meters NUEVO LAREDO, MEXICO</p>	<p>6660 kc. F8KR 45 meters CONSTANTINE, ALGERIA Mon., Fri., 5 p. m.</p>	<p>6125 kc. VE9HX 48.98 meters HALIFAX, NOVA SCOTIA</p>
<p>9300 kc. CNR 32.26 meters RABAT, MOROCCO Sunday 2:00-4:00 p. m.</p>	<p>8650 kc. W4XG 34.68 meters MIAMI, FLA.</p>	<p>7530 kc. EI Prado 39.80 meters Riobamba, Ecuador Thurs., 9-11 p. m.</p>	<p>6660 kc. HKM 45 meters BOGOTA, COLOMBIA 9-11 p. m.</p>	<p>6122 kc. ZTJ 49 meters JOHANNESBURG, SOUTH AFRICA 10:30 a. m.-3:30 p. m.</p>
<p>9250 kc. GBK 32.40 meters BODMIN, ENGLAND</p>	<p>8630 kc. W3XX 34.68 meters WASHINGTON, D. C.</p>	<p>7520 kc. CGE 39.74 meters CALGARY, CANADA Testing, Tues., Thurs.</p>	<p>6660 kc. YR 40.20 meters LYONS, FRANCE Daily except Sun., 10:30 to 1:30 a. m.</p>	<p>6120 kc. ★W2XE 49.02 meters COLUMBIA BROADCASTING SYS. Wayne, N. J., 6:00-11:00 p. m.</p>
<p>9230 kc. FLJ 32.50 meters PARIS, FRANCE (Eiffel Tower). Time signals 2:56 a. m. and 2:56 p. m.</p>	<p>8630 kc. WOO 34.74 meters DEAL, N. J.</p>	<p>7460 kc. HBQ 40.3 meters LEAGUE OF NATIONS, GENEVA, SWITZERLAND</p>	<p>6660 kc. TGW 45 meters GUATEMALA CITY, C. A.</p>	<p>6120 kc. ★W2XE 49.02 meters EIFFEL TOWER, PARIS 5:30-5:45 a. m., 5:45-12:30, 4:15- 4:45 p. m.</p>
<p>9230 kc. FLJ 32.50 meters PARIS, FRANCE (Eiffel Tower). Time signals 2:56 a. m. and 2:56 p. m.</p>	<p>8630 kc. W2XDO 34.74 meters OCEAN GATE, N. J.</p>	<p>7444 kc. HBQ 40.3 meters LEAGUE OF NATIONS, GENEVA, SWITZERLAND</p>	<p>6660 kc. WOO 46.05 meters DEAL, N. J.</p>	<p>6120 kc. ★W2XE 49.02 meters EIFFEL TOWER, PARIS 5:30-5:45 a. m., 5:45-12:30, 4:15- 4:45 p. m.</p>
<p>9230 kc. FLJ 32.50 meters PARIS, FRANCE (Eiffel Tower). Time signals 2:56 a. m. and 2:56 p. m.</p>	<p>8570 kc. ★RV15 35.00 meters FAR EAST RADIO STATION Khabarovsk, Siberia 5-7:30 a. m.</p>	<p>7444 kc. HBQ 40.3 meters LEAGUE OF NATIONS, GENEVA, SWITZERLAND</p>	<p>6660 kc. WOO 46.05 meters DEAL, N. J.</p>	<p>6120 kc. ★W2XE 49.02 meters EIFFEL TOWER, PARIS 5:30-5:45 a. m., 5:45-12:30, 4:15- 4:45 p. m.</p>
<p>9230 kc. FLJ 32.50 meters PARIS, FRANCE (Eiffel Tower). Time signals 2:56 a. m. and 2:56 p. m.</p>	<p>8550 kc. WOO 35.09 meters OCEAN GATE, N. J.</p>	<p>7320 kc. ZTJ 40.90 meters JOHANNESBURG, SO. AFRICA 9:30 a. m.-2:30 p. m.</p>	<p>6660 kc. REN 46.6 meters MOSCOW, U. S. S. R.</p>	<p>6120 kc. FL 49.02 meters EIFFEL TOWER, PARIS 5:30-5:45 a. m., 5:45-12:30, 4:15- 4:45 p. m.</p>
<p>9230 kc. FLJ 32.50 meters PARIS, FRANCE (Eiffel Tower). Time signals 2:56 a. m. and 2:56 p. m.</p>	<p>8450 kc. PRAG 35.50 meters PORTO ALEGRE, BRAZIL 8:30-9:00 a. m.</p>	<p>7230 kc. DOA 41.46 meters DOEBERITZ, GERMANY Irregular</p>	<p>6660 kc. W9XL 46.70 meters ANOKA, MINN.</p>	<p>6120 kc. FL 49.02 meters EIFFEL TOWER, PARIS 5:30-5:45 a. m., 5:45-12:30, 4:15- 4:45 p. m.</p>

Short Wave Stations of the World

<p>6120 kc. ★YV1BC 49.02 meters CARACAS, VENEZUELA 8:00-10:00 p. m. nightly</p>	<p>6060 kc. ★W8XAL 49.50 meters CROSLY RADIO CORP. Cincinnati, O. Relays WLW program</p>	<p>6023 kc. XEW 49.8 meters MEXICO CITY, MEXICO</p>	<p>5550 kc. W8XJ 54.02 meters COLUMBUS, OHIO</p>	<p>4430 kc. DOA 67.65 meters DOEBERITZ, GERMANY 6-7 p. m., 2-3 p. m., Mon., Wed., Fri.</p>
<p>6110 kc. VE9CG 49.10 meters CALGARY, ALTA., CANADA</p>	<p>6060 kc. ZL2ZX 49.5 meters WELLINGTON, N. Z. Mon., Wed., Thurs., Sat., 10:15 a. m.-1:15 p. m.</p>	<p>6020 kc. DJC 49.83 meters ZEESEN, GERMANY</p>	<p>5170 kc. OK1MPT 58.00 meters PRAGUE, CZECHOSLOVAKIA 1-3:30 p. m., Tues. and Fri.</p>	<p>4273 kc. ★RV15 70.20 meters FAR EAST RADIO STATION Khabarovsk, Siberia Daily, 3-9 a. m.</p>
<p>6110 kc. VUC 49.1 meters CALCUTTA, INDIA</p>	<p>6060 kc. ★VQ7LO 49.50 meters IMPERIAL AND INTERNA- TIONAL COMMUNICATIONS, Ltd. Nairobi, Kenya, Africa Monday, Wednesday, Friday, 11 a. m.-2:30 p. m.; Tuesday, Thursday, 11:30 a. m.-2:30 p. m. Saturday, 11:30 a. m.-3:30 p. m.; Sunday, 11 a. m.-1:30 p. m.; Tuesday, 3 a. m.-4 a. m.; Thursday, 8 a. m.-9 a. m.</p>	<p>6005 kc. VE9DR 49.96 meters CANADIAN MARCONI CO. Drummondville, Quebec 6-10 p. m. daily.</p>	<p>5170 kc. PMY 58.00 meters BANDOENG, JAVA</p>	<p>4116 kc. WOO 72.87 meters DEAL, N. J.</p>
<p>6100 kc. ★W3XAL 49.15 meters NATIONAL BROADCASTING CO. Bound Brook, N. J. Relays WJZ programs</p>	<p>6060 kc. CMCI 49.5 meters HAVANA, CUBA 9:00-11:00 p. m.</p>	<p>6005 kc. VE9CU CALGARY, CANADA Irregular</p>	<p>5170 kc. PMB 58.00 meters SOURABAYA, JAVA</p>	<p>4105 kc. ★NAA 74.72 meters ARLINGTON, VA. Time signals, 9:57-10 p. m., 11:57 a. m. to noon</p>
<p>6100 kc. VE9CF 49.15 meters HALIFAX, N. S., CANADA 6-10 p. m., Tues., Thurs., Fri.</p>	<p>6060 kc. ★W3XAU 49.50 meters BYBERRY, PA. Relays WCAU, Philadelphia</p>	<p>6000 kc. ZGE 50 meters KUALA LUMPUR, MALAY STATES</p>	<p>5714 kc. HCJB 52.5 meters QUITO, ECUADOR, S. A.</p>	<p>3750 kc. F8KR 80.00 meters CONSTANTINE, TUNIS, AFRICA Mon. and Fri.</p>
<p>6100 kc. ★W9XF 49.18 meters DOWNERS GROVE, ILL. Relays WENR, Chicago</p>	<p>6060 kc. ★GSA 49.58 meters BRITISH BROAD. CORP. Daventry, England British Empire programs</p>	<p>6000 kc. EAJ25 50 meters BARCELONA RADIO CLUB, BARCELONA, SPAIN</p>	<p>5145 kc. OK1MPT 58.31 meters PRAGUE, CZECHOSLOVAKIA</p>	<p>3750 kc. I3RO PRATO EMERALDO, Rome, Italy Daily, 3-5 p. m.</p>
<p>6095 kc. ★VE9GW 49.17 meters BOWMANVILLE, ONTARIO, CANADA 5:00 p. m. to midnight</p>	<p>6050 kc. ★W9XAA 49.31 meters CHICAGO FEDERATION OF LABOR Chicago, Ill. Relays WCFL programs</p>	<p>6000 kc. FIQA 49.97 meters ADMINISTRATION DES P. T. T. Tananarive, Madagascar Tues., Wed., Thurs., Fri., 9:30- 11:30 a. m. Sat. and Sun., 1-3 p. m.</p>	<p>4975 kc. W2XV 60.30 meters RADIO ENGINEERING LAB- ORATORIES, Inc. Long Island City, N. Y.</p>	<p>3620 kc. DOA 82.90 meters DOEBERITZ, GERMANY</p>
<p>6080 kc. ★W9XAA 49.31 meters CHICAGO FEDERATION OF LABOR Chicago, Ill. Relays WCFL programs</p>	<p>6050 kc. VE9CF 49.59 meters HALIFAX, N. S., CANADA 11 a. m.-noon, 5-6 p. m. On Wed., 8-9; Sun., 6:30-8:15 p. m.</p>	<p>6000 kc. ★RV59 50 meters RADIO MOSCOW, U. S. S. R. 2:00-5:00 p. m. daily</p>	<p>4795 kc. W3XZ 62.56 meters WASHINGTON, D. C.</p>	<p>3560 kc. OZ7RL 84.24 meters COPENHAGEN, DENMARK Tues. and Fri. after 6 p. m.</p>
<p>6075 kc. ★OXY 49.4 meters SKAMLEBOAEK, DENMARK</p>	<p>6040 kc. PK3AN 49.67 meters SOURABAYA, JAVA 6-9 a. m.</p>	<p>5970 kc. ★HVJ 50.26 meters VATICAN CITY (ROME) 2-2:15 p. m., daily. Sun., 5-5:30 a. m.</p>	<p>4795 kc. W9XL 62.56 meters CHICAGO, ILL. Irregular</p>	<p>3256 kc. W9XL 92.50 meters CHICAGO, ILL.</p>
<p>6072 kc. UOR2 49.41 meters VIENNA, AUSTRIA</p>	<p>6040 kc. ★W4XB 49.67 meters LAWRENCE E. DUTTON care Isle of Dreams Broadcast Corp., Miami Beach, Fla. until 10:00 p. m.</p>	<p>5900 kc. HKO 50.80 meters MEDELLIN, COLOMBIA 8-11 p. m., except Sunday</p>	<p>4795 kc. VE9BY 62.56 meters LONDON, ONTARIO, CANADA</p>	<p>3156 kc. PK2AG 95.00 meters SAMARANG, JAVA</p>
<p>6069 kc. VE9CS 49.43 meters VANCOUVER, B. C., CANADA</p>	<p>6040 kc. WIXAL 49.67 meters BOSTON, MASS.</p>	<p>5857 kc. XDA 51.22 meters MEXICO CITY, MEXICO</p>	<p>4770 kc. ZL2XX 62.80 meters WELLINGTON, NEW ZEALAND</p>	<p>3124 kc. WOO 96.03 meters DEAL, N. J.</p>
<p>6069 kc. JB 49.43 meters JOHANNESBURG, SOUTH AFRICA 10:30 a. m.-3:30 p. m.</p>	<p>6030 kc. VE9CA 49.75 meters CALGARY, ALTA., CANADA</p>	<p>5835 kc. HKD 51.40 meters BARRANQUILLA, COLOMBIA 7:45-10:30 p. m., Mon.; Wed., 8-10:30 p. m.; Sunday, 7:45- 8:30 p. m. Elias J. Pellet.</p>	<p>4760 kc. Radio LL 63.00 meters PARIS, FRANCE</p>	<p>3076 kc. W9XL 97.53 meters CHICAGO, ILL.</p>
<p>6065 kc. SAJ 49.46 meters MOTALA, SWEDEN 6:30-7 a. m., 11 a. m. to 4:30 p. m.</p>		<p>5710 kc. VE9CL 52.50 meters WINNIPEG, CANADA</p>	<p>4750 kc. WOO 63.13 meters OCEAN GATE, N. J.</p>	<p>2342 kc. W7XAW 128.09 meters FISHER'S BLEND, INC., Fourth Ave. and University St. Seattle, Washington</p>
			<p>4700 kc. WIXAB 63.79 meters PORTLAND, ME.</p>	<p>1560 kc. WIXAU 199.35 meters BOSTON, MASS.</p>

A Word of Explanation About S. W. Schedules

This list is compiled from many sources, all of which are not in agreement. In fact, conflicting data are received sometimes from the stations themselves. We are constantly writing to stations all over the world and reading reports from hundreds of correspondents. We invite individual listeners to inform us of any stations not listed herewith, or operating on frequencies of hours different from those indicated. All times given are Eastern Standard.

Listeners living in zones operating on daylight saving time must make their own corrections.

Special note: please do not ask us to identify unknown stations from snatches of voice or music. This is utterly impossible. Make a notation of the dial setting and try for the station again until you get an understandable announcement. This list will appear again with last minute corrections, in the August issue.

LETTERS FROM S-W FANS

SUPER-REGENERATION

Editor, SHORT WAVE CRAFT:

I have SHORT WAVE CRAFT magazine from No. 1. Its contents have recently given us some "super-regeneration" but I note most of the prize sets usually keep to straight regeneration.

If the regeneration is controlled by rheostat and variable resistance in the "B" plus lead it is possible by the use of a D.T.S.P. switch and a good fixed .006 mf. condenser to "try out" modified super-regeneration at will by means of this simple addition.

Herewith diagram—the tube selected may be any tube ordinarily used as a detector. The circuit is adaptable to and for duolateral (or honeycomb coils) three circuit tuner and any short wave plug-in type coil.

I advise isolating the tuning condenser behind the front panel by means of an insulating rod, or flexible fibre coupling device.

I have used this circuit for over ten years and find it "satisfactory"; need I say more? You once printed my letter regarding super-regeneration and I think I sent you ten or twelve letters from many parts of the United States and I still get them!

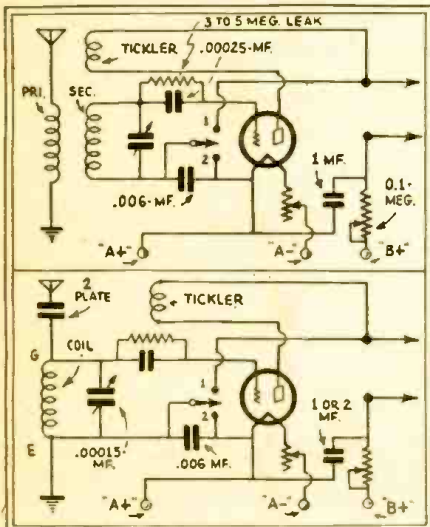

Top circuit for short-wave receiver; lower for long-wave set using honey-comb coils. Switch lever on point 1 super-regenerative; on point 2, regenerative.

I note that SHORT WAVE CRAFT occasionally publishes "long wave" circuits. I am sending you a few stations that the "weary" short wave hunter may care to go "hunting for," due East to Europe.

There's more good hunting from 550 to 2000 meters than one may imagine—a few stations are given below; use the old two or three honeycomb modified super-regenerative set and its two audio stages—high, long aerial and the set hook-up uses good sized bare copper bus bar, well burnished!

The adjustment of the aerial coil is part of the fun and one can use a 43 plate (.001) or .0005 mf. S.L.F. condenser.

M	KW	Station
1935	7	Kovno, Lithuania
1875	8.5	Huizen, Holland
1724	75	Radio, Paris, CFR, France
1487	100	Moscow, RVI, Russia
1412	120	Warsaw 1, Poland
1554	30	Daventry, England

Yours truly,
RICARD WEST,
4048 Baltimore Ave.,
Philadelphia, Pa.

(A dandy super-regeneration idea, Ricard, and we are sure that the boys will be duly thankful for the suggestion. In fact, the switching scheme for changing from "regenerative" to "super-regenerative" reception is at once so simple and intriguing that the editors are adding this switch to

all their regenerative "Stand-by" sets, so as to try out this new wrinkle.—Editor.)

A BOOSTER FROM ENGLAND

Editor, SHORT WAVE CRAFT:

No doubt you are surprised at the address but I am a short-wave enthusiast, and, while wandering through our local stores of F. W. Woolworth & Co., Ltd., my eyes alighted on SHORT WAVE CRAFT. I immediately purchased it and have since absorbed the knowledge contained in its contents. We have no magazine of this special nature in England and I am certainly going to obtain SHORT WAVE CRAFT whenever I see it for sale. It certainly is the goods.

My chief object in writing is to ask if you would be good enough to publish my name and address in SHORT WAVE CRAFT, asking your readers if they could spare a little time to write to me with a view to the exchange of ideas existing in our respective countries on the short-wave conditions. My experience unfortunately is limited to reception, because we have very stringent regulations with regards to obtaining a transmitting license. Would you therefore be good enough to include my name in the "Swappers" column or any other suitable position?

If I receive any replies it will be my earnest endeavor to give each one my personal attention.

If you would like periodical reports of European short-wave broadcasting, I shall be glad to forward same on receipt of your request.

I have received one or two of your American stations but on the whole, conditions are not good. Our best year was 1928, when I was receiving your stations, 2XAF, 2XAD, and 8XK very well—practically every night!

Yours faithfully,
GEORGE WOOD,

4 Elmfield Road,
Davenport, Stockport, Cheshire, England.
(Fine, let's have some reports on short waves in Europe.—Editor.)

OUR "DOPE" VERY GOOD

Editor, SHORT WAVE CRAFT:

I have been buying SHORT WAVE CRAFT for a long time, and I'm very much afraid I'm going to have to subscribe, because I sometimes have a hard time finding one in town. They don't last very long here!

I've built probably a dozen of your sets and variations of them and find that the "dope" you publish is very good! There is something about the construction details in SHORT WAVE CRAFT that makes it really a pleasure to experiment. So far, I have not found any circuit given that would not work satisfactorily if rightly built. So far I've been able to keep off the five-meter stuff, but I'm afraid all your splendid articles are going to tempt me to "go down there," and there's no telling then what will happen.

There is only one suggestion that I have in mind at present, and that is for details of a power supply of, say, 350 volts and less, so constructed that it could be used on any short wave set. I find one indispensable in experimenting with numerous sets. Variable voltages are made possible and every possible need is provided for. When building a set, then, much of the work is already done, and much time is saved.

CARL A. KNOWLES,
132 E. 5th Street,
Eugene, Oregon.

(Well, well, Carl, we're sure glad to hear from you, particularly since you have successfully built a dozen of the sets we have described from time to time. We're afraid, Carl, that if you do not watch your step, you will surely get bitten by the 5-meter "bug," as the 5 meter field is growing rapidly. We will endeavor to publish an article as soon as possible on a power supply unit delivering up to 350 volts. On the aver-

age, 250 to 300 volts will take care of any ordinary short wave receiving set requirements and you will find an excellent article on such a 300 volt power-supply unit on page 662, March issue.—Editor.)

HATS OFF TO "BINNEWEG 2-TUBER"

Editor, SHORT WAVE CRAFT:

Just completed my first short-wave set: it's the Binneweg 2-Tube set described in your December issue. Hold your hat—here is my DX results for three days of tuning, (all code): eleven different European countries, South America 6, Central America 3, Japan 2, New Hebrides 2.

And this is not including U. S. code and broadcast stations, which are too numerous to mention.

I wish to congratulate Mr. Binneweg for
(Continued on Page 123)

WELCOME CRITICISM

Editor, SHORT WAVE CRAFT:

I have been wanting for a long time to tell the editors of SHORT WAVE CRAFT, also the authors and staff, just what I think of your magazine. To begin with, it is "fine business" and I wouldn't miss the monthly issue for anything. The short-wave Question Box and the page of radio kinks and wrinkles sure contain some excellent suggestions, especially the Question Box, as it is always very interesting to know the problems and answers of others.

But, (and what a but) where did you get the idea that the average SW fan and amateur is interested in the "All-Wave" receiver or any other radio equipment that some manufacturer is putting on the market at a fancy price? I am not referring to parts of reputable make, but the ten-tube super "something-or-other" you so often describe in detail, to the tune of two or three pages.

It is probably very hard, if not impossible, for you and your engineers to understand that about 99% of your subscribers have to refrain from building this or that, simply because they have not got a variable resistor, or other parts that cost about seventy-one cents wholesale. I realize that you can never hope to please all of your readers, but I know the majority of your readers are looking for the "dope" on how to build something for a total cost of nine cents, rather than in the nine-tube "superhot" of Mr. Harry Georges' article in March. (With respects and compliments to Mr. Steve Erdel.)

Your articles in March—Keying With Audio Oscillator; Condenser Mike, for 10 cents; Fly Power Transmitter; Two-Tube Reliable, and other dope sure was "great stuff," and more power to yuh! As to the "no code" argument, I've been a Morse telegrapher for eleven years and have had a blue ticket for over a year, so naturally I don't like the "no code" idea. And now, Gentlemen, having run out of "squawks," I am going to wish SHORT WAVE CRAFT plenty of luck n' every thing and shall continue to be a "booster."

R. G. HUNT,
Blodgett Mills, N. Y.

(Right you are, Brother Hunt, and we're hopping to it post instanter. We shall endeavor to put plenty of low-cost sets in the coming issues. Watch for them. On the other hand, believe it or not, SHORT WAVE CRAFT advertisers tell us that our readers buy more expensive sets than those of any other radio magazine in America. Proof? More advertisers of expensive sets advertise in SHORT WAVE CRAFT continuously, than in any other magazine.—Editor.)

SHORT WAVE LEAGUE



HONORARY MEMBERS

- Dr. Lee de Forest
- John L. Reinartz
- D. E. Replogle
- Hollis Baird
- E. T. Somerset
- Baron Manfred von Ardenne
- Hugo Gernsback
- Executive Secretary*

Meet Capt. Hall—He Heard All Continents

By ROBERT HERZBERG

● We recently spent a very interesting afternoon with Captain H. L. Hall, the only member of the "Heard-All-Continents" Chapter of the International Short Wave Club in the city of New York. Captain Hall is a retired sea captain who has been enjoying truly phenomenal results. He makes ship models for a living, and as he usually works during the night, he is able to make occasional excursions to his short-wave receiver at hours when most other people are asleep. The result is that he has located Asiatic stations that very few other people in the East even know about. *He has not merely heard these stations, but he has also received confirmations from them.* His stack of "verification" cards and letters would make other short-wave "fans" turn green with envy!

To give some idea of what Captain Hall can accomplish in the heart of New York on just a Sunday alone we give below a copy of a typical weekend "log." The mileage figures indicated are calculated very closely, as Captain Hall has been a sea-faring man all his life and he knows how to measure distances over the face of the earth.

5:30 a. m. Sydney. 31.23 m. VK2ME	Australia 8850 miles
6:00 a. m. Daventry. 31.30 m. GBC	England 3470 miles
7:00 a. m. Pontoise. 19.68 m.	France 3290 miles
7:30 a. m. Rabat. 23.38 m.	Morocco 3310 miles
8:00 a. m. Zeesen. 19.73 m. DJD	Germany 3830 miles
Take a nap until:	
12:00 n. Rome. 25.40 m. I2RO	Italy 3945 miles
3:00 p. m. Zeesen. 25.51 m. DJD	Germany 3830 miles
4:00 p. m. Pontoise. 25.60 m.	France 3290 miles
5:00 p. m. Geneva. 31.27 m. HBL	Switzerland 3400 miles



Capt. Hall "Heard All Continents!"

Captain H. L. Hall pointing to a verification he received from station F31CD, Saigon, French Indo-China. The rest of the verifications on the wall are by no means his entire "crop," but represent merely his star stations. The following transmitters are represented by letters or cards: OXY, Denmark; VE9JR, Winnipeg, Canada; KGU, Hawaii; CNR, Morocco; EAQ, Madrid, Spain; X1Q, Mexico City; VK3ME, Melbourne; YV1BC, Caracas, Venezuela; PBBA, Rio de Janeiro; T14NRH, Costa Rica, C. A.; LR4, Argentina; VK2ME, Sydney; CT1AA, Lisbon, Portugal; VLK, Australia; GBC, Rugby, England; HVJ, Vatican City; SR1, Poland; GSA, Daventry; FTE, France; G5SW, Daventry; I2RO, Rome; DJA, Germany; XEW, Mexico; RV59, Moscow; HBL & HBP, Geneva, Switzerland; HKD, Colombia, S. A.; El Prado, Ecuador.

Get Your Button!

The illustration here-with shows the beautiful design of the "Official" Short Wave League button, which is available to everyone who becomes a member of the Short Wave League.



The requirements for joining the League are explained in a booklet, copies of which will be mailed upon request. The button measures 3/4 inch in diameter and is inlaid in enamel—3 colors—red, white, and blue.

Please note that you can order your button AT ONCE—SHORT WAVE LEAGUE supplies it at cost, the price, including the mailing, being 35 cents. A solid gold button is furnished for \$2.00 prepaid. Address all communications to SHORT WAVE LEAGUE, 96-98 Park Place, New York.

5:30 p. m. Madrid. 30.40 m. EAQ	Spain 3240 miles
5:45 p. m. Heredia. 31.00 m. NRH	C. Rica 1935 miles
Eat your dinner:	
7:00 p. m. Caracas. 49.10 m. YV1BC	Venez. 1860 miles

Innumerable South American stations on the 45 and 50 meter band until 11 p. m.

With fair regularity Captain Hall has received PKP, Medan, Sumatra, on phone, talking to Holland on 28.8 meters, between 6:00 and 8:00 a.m. E.S.T.; J1AA, Tokyo, Japan, irregularly on 30.40 meters at about 5:00 a.m. E.S.T.; VWY, Poona, India, 17.10 meters testing and calling England early in the morning. Just as a suggestion, we might remark that J1AA uses exactly the same wavelength as EAQ, Madrid, so if you get up early some morning, set your dials for EAQ and see what luck you have with Japan.

In order to save Captain Hall an avalanche of mail, we will not give his exact address here. If any readers are interested in communicating with Captain Hall, they may address their letters to him in care of SHORT WAVE CRAFT. They are also requested to enclose postage for a reply, as the expense of answering numerous letters mounts up quite startlingly!

Captain Hall's receiving equipment is surprisingly modest and comprises an old National SW5, battery-operated set, using a storage "A" battery and dry "B" batteries, an old RCA magnetic speaker and a 70 foot aerial with a Lynch transposition type lead-in. This lead-in is particularly valuable in eliminating very bad ignition interference from busses which pass the house.

SHORT WAVE QUESTION BOX

Edited by R. WILLIAM TANNER

CHOICE OF COILS

Carl Zimmerman, Dover, N. J.

(Q) Can I substitute manufactured S-W plug-in coils for the hand-wound ones described in SHORT WAVE CRAFT set articles and still get good results?

(A) Yes, of course. Results would probably be superior.

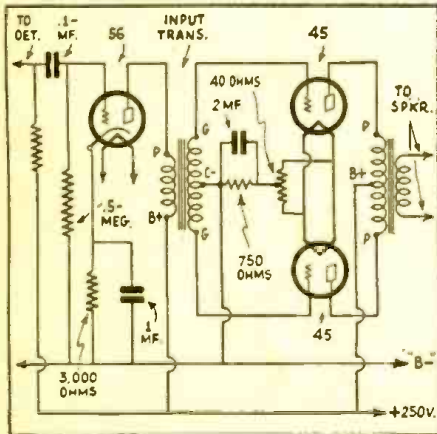

Hook-up for 1 stage "56" A.F. and "Push-pull" output stage of 2-45's.

A.F. AMPLIFIER

H. U. Green, Brooklyn, N. Y.

(Q) Will you print a circuit of an audio amplifier using All-American transformers and a 56 first stage feeding into push-pull 45's?

(A) The circuit is given in these columns. Resistance coupling from detector to amplifier input is preferable. The plate resistor should be 250,000 ohms for a 57 or 58 detector, 100,000 for a 24 or 35 detector and 50,000 ohms for a 27 or 56 detector.

A.F. TRANSFORMER RATIO

Robert Cooper, Bronx, N. Y.

(Q) Referring to the receiver on page 80, June, 1932, issue, the audio transformer is specified as 3 to 1. At another point in the description, the ratio is mentioned as being 3.5 to 1. Which is correct?

(A) Either can be used. The difference in tone quality due to 3.5 to 1 over that from a 3 to 1 would be very slight.

NOISE FROM PASSING AUTOS

Gail McWilliams, Pittsburgh, Pa.

(Q) Cars passing the house cause much noise in my short-wave set, especially down around 20 meters. What can I do to eliminate this trouble?

(A) Noise reducing antennas have little or no effect upon such interference unless the antenna can be located well above the street. Therefore, you should advise the state law-making house to pass a law compelling all motorists to equip their cars with filters (hi!). (Or it might be easier for you to move!—Ed.)

CIRCUIT CORRECTION

W. G. Jones, Dorchester, Mass.

(Q) In the article on page 268, September, 1932, issue, a grid leak and condenser is mentioned but the values are not given. Neither are they shown in the circuit. Can you clear up this matter?

(A) The grid condenser would connect between the detector grid and the high side of coil L4 with the grid-leak in parallel. The condenser may be .0001 mf. with a leak varying from 2 to 5 megohms.

Questions, ordinary ones, will only be answered by mail when a fee of 25 cents accompanies them. Special queries involving considerable research will be quoted upon by the editor of this department.

BEST DETECTOR TUBE

David Middleman, New York, N. Y.

(Q) Which is better as a regenerative detector, a 57 or a 58 tube?

(A) The 57 seems a little more sensitive but a 58, with a suitable grid-leak, offers smoother regenerative control. Authorities differ on this, however.

500 HENRY CHOKE

Loyed Jones, Galt, Ont., Canada.

(Q) I have an old burned out A. F. transformer. Can I wind a 500 henry choke on the core?

(A) You could if you have suitable winding machinery, but not by hand.

(Q) Can an 82 rectifier be substituted for an 80 without any changes?

(A) No. The 82 tube requires a 2.5 volt filament winding. Besides, for short wave work, a high vacuum rectifier is preferable.

(Q) On page 543, January, 1933, issue, what is the value of the grid resistor R1?

(A) A safe value would be 250,000 ohms.

VALUE OF CENTER-TAP RESISTOR

L. D. Field, Altoona, Pa.

(Q) What should be the value of a center-tapped resistor for use across a 2.5 volt filament winding?

(A) 20 to 60 ohms.

(Q) Can the power supply shown on page 487 of the December, 1932, issue be used for the band-spread circuit on page 592, February, 1933, issue?

(A) Yes by setting the power pack voltage divider taps at correct points.

1 A.F. STAGE TOO WEAK

Jason Whitaker, Utica, N. Y.

(Q) I notice that many short wave and broadcast circuits employ a 57 tube (detector) feeding directly into a 47 pentode audio stage. In my short wave and broadcast set, the volume is far too weak with this arrangement. I use one tuned R.F. stage and a regenerative detector. Would it be advisable to add another A.F. stage?

(A) It is seldom possible to load a 47 A.F. stage to anywhere near full capacity with a 57 detector, even with two stages of tuned R.F. I would advise a 56 tube in an additional A.F. stage, as shown in the circuit given in these columns.

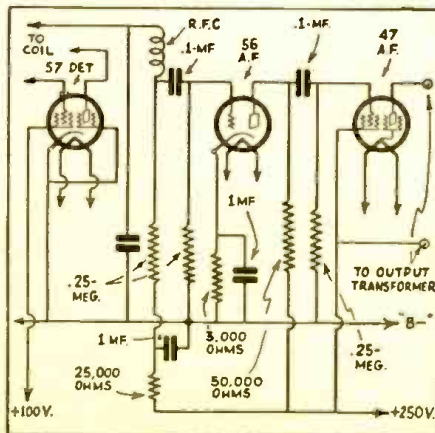

Mr. Tanner advises use of "56" A.F. stage ahead of "47" output stage.

B.C. CONDENSERS FOR SHORT WAVES

R. F. Neilson, Milwaukee, Wisc.

(Q) I have a broadcast type two-gang condenser with an oscillator tracking section. Could I use this for a short-wave superhet by cutting out plates?

(A) No. Such condensers are designed to tune from 1500 to 550 kc. with an intermediate frequency of 175 kc.

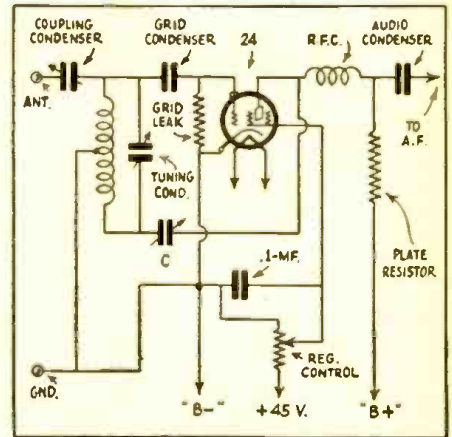

In this circuit the regeneration is set once by "C" and regulated thereafter by the variable resistor in the 45+ lead.

(Q) Would Litz wire be suitable for short-wave plug-in coils?

(A) It would probably be suitable but of no advantage over solid wire. Besides, Litz is expensive and is difficult to solder properly.

(Q) How can I obtain better selectivity with a regenerative 24 detector?

(A) A circuit is given herewith which, some experimenters claim, gives better selectivity. The rotor of the tuning condenser cannot be grounded and the shaft must be coupled to the tuning dial through an insulated coupling. The condenser C is a trimmer type, having a capacity of 35 mmf. This is set once so that the tube oscillates strongly at the high end of the tuning scale and then regeneration is controlled by the variable resistor. The setting of C generally holds good for all bands if the center tap on all of the coils is exact.

"SCRAMBLE WINDING" COILS

C. Williams, Jackson, Mich.

(Q) In reference to the long wave receiver shown on page 535, January, 1933 issue, what is meant by "scramble winding" coils?

(A) This is merely winding the turns without any attempt at even layers or spacing.

(Q) When a 5 to 1 ratio audio transformer is specified, would it be permissible to use one of a different ratio?

(A) Any ratio can be used. It is only necessary to remember that the higher the ratio, the poorer will be the audio quality, as a general rule.

MORSE VERSUS CONTINENTAL CODES

J. J. Fisher, Tampa, Fla.

(Q) Asks several questions on Morse and Continental Codes.

(A) American Morse, consisting of dots, spaces, dashes, is used exclusively for wire communications in the United States and Canada, states Mr. Walter H. Candler, director of the well-known Candler system of teaching telegraphy.

(Continued on page 125)

Only THE SCOTT 15-550 METER ALL-WAVE Deluxe RADIO delivers such Clear, Consistent Year 'Round WORLD-WIDE RECEPTION



This receiver is the crowning achievement of my eight years experience building world's record-breaking superheterodyne receivers. I have no hesitancy in backing it with the strongest guarantee ever placed on a radio.

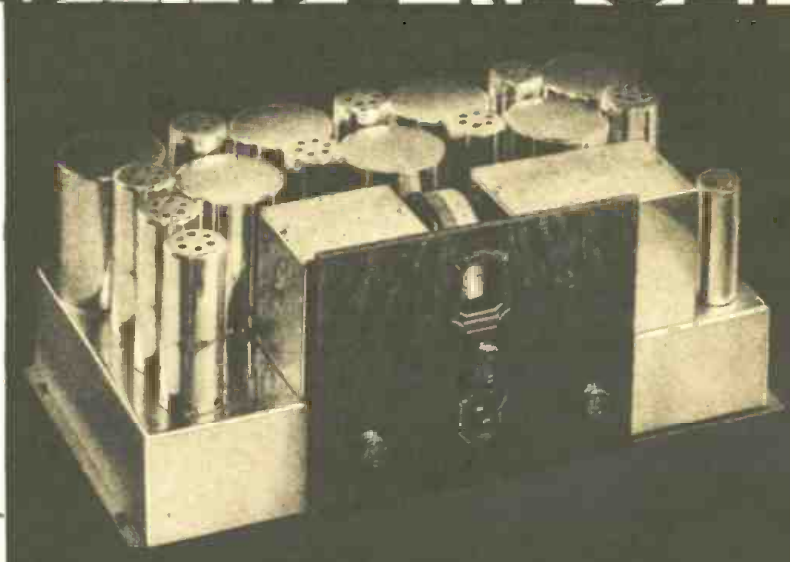

BEAUTIFUL in its chromium-plated finish, the SCOTT ALL-WAVE DeLuxe is as capable as it looks. Embodying every worthy scientific improvement, such as automatic volume control, visual tuning, static suppressor, etc., it is a marvel of careful custom building to most-exacting laboratory standards of perfection.

ITALY

Each day come new letters of enthusiastic praise from owners of SCOTT ALL-WAVE DeLuxe RADIOS. Here are excerpts from a few late ones—on file at

*They Said It Couldn't Be Done
..but I GUARANTEE It!*

FOREIGN STATIONS LIKE LOCALS

SPAIN

SCOTT ALL-WAVE DeLuxe owners are more enthusiastic over their receivers than most radio listeners—why not?—they have more to be pleased

FRANCE

the Scott Laboratories for inspection by any one. "Rome, England, Germany and Spain come in very good—more than pleased with set—tone is superb," RPH,

The thrill of tuning in foreign short wave stations, as far as 10,000 miles distant, clearly with full loudspeaker volume, consistently the year 'round... plus perfect reception of literally everything on the regular broadcast band on the North American continent! For years a dream... scoffed at as "impossible" by many so-called "experts" even today... yet the SCOTT ALL-WAVE DeLuxe RADIO actually does it—not only in occasional test cases, but regularly—for every owner—under the broadest, soundest guarantee ever placed on a radio set. If you would like to know more about such a sensationally performing record-breaking radio... send for complete details, including PROOFS.

ENGLAND

over! "Never owned or heard a better, clearer or purer-toned receiver, and this is my 13th all-electric set," RCS, Texas... "France, Italy, Russia and China with very

GERMANY

Conn. "Best radio I have ever owned—price very reasonable for what it is and will do—have logged Rome, England, France, Spain, Brazil, Germany, Australia," OSJ, Conn. "VK3ME,

ECUADOR

powerful loudspeaker volume," EB, Indo-China... "Get as far afield as England," GAH, Australia... "Moscow, South America and Pittsburgh fine," EAC, Alaska... "U.S.A.,

INDO-CHINA

Australia, every time they are on the air—clarity of tone and volume like local," CGB, Conn. "European stations as much 'at my finger tips' as locals," TPB, D. C. "England so that it can be heard all over house—

ARGENTINE

Canada, Australia, Japan, Indo-China, Siberia, Mexico, France whenever they are on the air," JTM, Hawaii. These and hundreds of other like letters may be seen in our files at any time upon request.

AUSTRALIA

also Paris and Rome—on grounded 25-foot aerial," WCD, N. J. "Congratulations on a receiver of such extreme sensitivity. Marvelous tone quality." JES, Ill.—commercial manager of a great broadcasting station—Reception and recording on phonograph records of every program from VK2ME and VK3ME for an entire year accomplished by Mr. Scott under home reception conditions in Chicago.

If you plan to visit Chicago's
A CENTURY OF PROGRESS
be sure to come and inspect our Laboratories,
to see and to hear these marvelous receivers.

**E. H. SCOTT
RADIO
LABORATORIES, INC.**
4450 RAVENSWOOD AVENUE
Dept. SWC 63
CHICAGO, ILLINOIS

Mail Coupon NOW

E. H. SCOTT RADIO LABORATORIES, INC.
4450 Ravenswood Ave., Dept. SWC 63, Chicago, Ill.

Send me complete details regarding the SCOTT ALL-WAVE DeLuxe RADIO, including technical data, performance PROOFS, and price quotations.

Name _____
Address _____
Town _____ State _____

"Ham" Radio Foils Ransom Plot

(Continued from page 97)

USE These PARTS When You Build Short-Wave

AIR DIELECTRIC-TUNED I. F. TRANSFORMERS

Same as used in National commercial communication receivers. Standard mounting. Litz wound inductances. 450-550 k.c. range. Self-locking velvet Vernier control of double-bearing precision air dielectric peaking condensers located at top of transformer. No necessity to remove chassis from cabinet to make adjustments.

NEW FRONT-OF-PANEL COIL FORMS

With grounded and shielded cast-metal end-handle. Form made of R-39 low-loss coil form material, especially developed for National, and containing internally mounted Isolantite-base-adjustable padding condenser. Made to fit any National front-of-panel-chance coil shields;—also available complete with shielded sockets.

SEU CONDENSER

For short-wave work only. Heavy double-spaced, rounded edge 270° plates, constant low impedance pigtail, Isolantite insulation, for single hole panel- or base-mounting. Any capacity up to 25 mmf. For ultra short-wave tuning or neutralizing in low power transmitters.

NATIONAL ISOLANTITE SOCKET

Isolantite tube and coil sockets, glazed upper surface, give maximum efficiency in ultra high frequency circuits, suitable for sub-panel or base-board mounting, in standard 4, 5 and 6-prong types—now also available in 7-prong type.

TYPE 100 RADIO FREQUENCY CHOKE

Extremely low distributed capacity, four narrow sections universal wound, spaced on Isolantite form. Has stiff leads for mounting but fits in grid leak clips. 50 ohms DC res.; dist. cap. 1 mmf.; induct. 2½ mh.; rated at 125 MA.

NEW TYPE BX VELVET VERNIER DIAL, WITH VERNIER INDEX

Equipped with well-known National B-Dial Velvet-Vernier drive and variable ratio, 6-1 to 20-1, and with new vernier index, reads accurately to 1/10th division. Permits accurate locking so necessary in short wave work.

NATIONAL PRECISION SHORT-WAVE PARTS & RECEIVERS SEND IN COUPON TODAY

NATIONAL COMPANY, Inc.,
61 Sherman Street, Malden, Mass.
Gentlemen:

Please send me your new catalogue sheets giving full description and prices of NATIONAL Short-Wave Sets and Parts.

Name

Address

SC-6-33

Billy was aroused by voices discussing something of apparent vital importance. He woke his father and they crept quietly to the door and listened. It was the Chief and his gang planning a trip to the coast with a load of liquor. Carefully the Chief pointed out each move to be made. They would start at noon, proceed slowly to the Coast Guard blockade and cruise around there out of sight until dark. The plans called for disposal of the Guard by a very dastardly move. They would lure the Coast Guard cutter within throwing distance—then place the cutter in absolute confusion by the exploding of hand grenades dropped on their deck by the Chief, who had a good arm for such work, having proved it in Chicago.

The chaos aboard the cutter would permit the rum runners to speed towards the shore unmolested and unseen in the cover of darkness. Boats inside the patrolling limits of the Coast Guard were seldom hailed or investigated. Once through the line, they would transfer their cargo at a secluded dock and make their getaway. The Chief was to deliver a letter which Cameron would be compelled to write. This letter would be the means used by the gang to obtain the ransom money. Following the receipt of the cash, the Chief would return to the island and transport the Camerons to the mainland. "Don't let on, Billy, that we know anything about their plans. Just 'play possum'."

"That's what we'll do Dad. Let's have some of those snores of yours when Red comes in," whispered Billy as he drew the sacks over his shoulder.

Breakfast

It was fairly light when the Camerons heard the lock snap back and in came Red with some food. The elder man was snoring quite convincingly and Billy seemed "dead to the world."

"Snap out of it," shouted Red, "this is no hotel and this is our busy day. There's no time to waste feeding you two blokes."

Billy roused up and after much shaking, his father also seemed almost awake. They ate the bread, bacon and coffee and felt much better.

Red brought them out of the storage room and thrust them before the Chief.

"What do you say this morning? Do you think that you can swim forty miles?"

"No, I don't think that we can. Nor do we intend to try—yet," cut in Billy.

"I don't think you would want to, so your old man had better write a letter to Santa Claus so he will give you some passage money—to the tune of five grand."

"But man! I haven't that much in cash. Neither have my friends," spoke up Mr. Cameron.

"Never mind lying. You spouted last night about 'rewards and compensations'—now produce! Think up some one who can and will pay some good jack to see your ugly mug again—or else!"

Mr. Cameron thought for a few minutes. There was no use trying to dicker with this class of men. They were too lawless. Better sacrifice money than their lives! Besides—there might be some way to foil them in their attempt to get the money.

The "Chief" Dictates

"I'll do it," he said reluctantly, seating himself in a chair beside a table. He reached for pen and paper.

"Now write what I tell you," dictated the Chief. "Put down the name and address and start out like it was a regular letter."

The Chief dictated a letter which would cause Billy's Uncle Charley to turn over five thousand dollars to a stranger, without question.

"Now, sign it," demanded the Chief.

"You are certainly clever," remarked Billy as he looked the letter over and handed it to the Chief.

"None of your blarney. Take these birds back into their cage and lock 'em up until we're ready to start."

Back they went and through the small, dirty window they watched the men carry bag after bag of liquor down the hill to the dock.

Minutes dragged into hours. Finally the boat was loaded. The Chief came back to the shack. He talked to Red giving strict orders. It seemed that Red was to stay behind and guard the Camerons.

"They can't get away, Red, but they might signal to some passing ship. It's not likely that anyone would pass close enough but we'll take no chances."

"OK, Chief, I'll watch them plenty close, but they can come out of the store room, can't they?"

"Sure, I guess they can do no harm on the loose. You have your gat and we're taking all the other guns on our visit to land—we'll need 'em!"

With this parting instruction the Chief went down to the dock and after casting off, the slim, low-hulled cruiser slid silently out of the cove on the first leg of it's law-breaking journey.

Billy and his father watched the boat move out of sight over the rolling waves.

What was to be their fate, if the money was not forthcoming? They both knew that the Chief would not be foolish enough to be caught red-handed in the attempted blackmail. If anything was to be done to save the money and the lives of the Coast Guardsmen, it had to be done before dark. In not more than eight hours! Even though they could signal a passing freight boat it might be hours before they could reach the mainland, as many of the ships did not carry radio. If they were lucky enough to signal one with an outfit, they could get word in to land in time—but first—there was Red, who apparently was not going to take his eyes off them for a second!

When the fast-moving runner slipped out of the cove, Red returned to the shack. His attitude and manner had changed. The Camerons sensed this as soon as he let them out of the store room. Judging from what they had seen and heard, discipline on the island was pretty stiff when the Chief was in command. Now, with all hands ashore, Red was going to have a holiday. This fact he proclaimed to the "dad-blinked world," knocking the cork out of a squat bottle.

With a pretext of desiring sleep, the Camerons went back to their store room. With careful whispers they discussed their plight. There were several things to be done. First—Red must be overpowered. Second—the mainland must be notified so that the Coast Guardsmen would not be killed or injured; also—in the event of a slip-up, the ransom money must not be paid. Last, but by no means least—they must escape from the island before the possible return of any of the band—"or else—" as the Chief had so aptly put it.

Billy and his father went carefully over each point. Mr. Cameron had an idea as to the overpowering of Red. It might work, but what then?

A Radio Receiver—And an Idea!

Their whisperings were suddenly drowned out by a blare of music from the outer room. Billy slipped the door open and peered out. There was Red, feet on the table, sitting in front of an old horn type radio speaker. Blatant, rasping music was pouring forth from the speaker as the program from a shore station came roaring in. Billy gave a cheer and returned to his father, his eyes sparkling with anticipation.

"We're practically rescued, Dad. All we have to do is to get Red off our hands. I can do the rest."

"Are you crazy? What has that so-called music got to do with signalling land?"

"Just wait and see. I've got a grand idea."

The Camerons strolled out into the other room and Billy complained that food was desired. Red followed the plan by saying "Well, ya ain't crippled are ya?"

"That's OK, Red. I'll fry up a few eggs. Do you want some too?"

"Never mind me, Kid. This old bottle has eggs beat a mile." Red patted the fast emptying bottle affectionately.

Billy stepped into the lean-to that served as a kitchen and began busying himself at the stove. Red settled back in his chair and took another drink. The elder Cameron sneaked into the store room and came back with a rolled up bundle behind his back. At that moment Billy returned from the kitchen with a long tube-like affair.

Red had his back turned at an angle to Billy and did not hear him slip up to his side.

Billy suddenly raised the tube up to his mouth and blew with all his might. WHOOF! Straight at Red's eyes poured a stream of pepper. Red jumped to his feet—the cloud of pepper engulfed his head—he was blinded by it! Choking, sneezing, cursing, Red stampeded around the room, dashing into chairs and tables in his mad frenzied attempt to get the pepper out of his eyes. Mr. Cameron rushed after Red and opening his bundle, he dropped a burlap sack over Red's head and arms.

"Quick, Billy, that rope."

Billy grabbed a piece of rope from the floor and wound it round and round Red's body, pinning his arms tightly to his sides. Reaching in, he took the automatic pistol from Red's pocket.

Red continued to rave and kick as the Camerons dragged him to a cot and with a few turns of the rope trussed him up.

Taking a knife from the table, Billy slashed open the sack, freeing Red's head. Red greeted him with a fresh volley of curses and threats about their future—"when he got loose."

"Listen, you big rough-neck! I'll put some cream on your eyes if you tell me where we can find tools, screwdrivers, pliers and the like," said Billy.

"Anything to get this blankety-blank pepper outa my eyes!" cried Red. "There's plenty tools in a box in the locker at the dock. Now, where's that cream?"

"Don't put it on yet, Dad. Wait till I get back with the tools."

"All right, I'll just put a few more hitches into this rope to make sure that Red doesn't walk away."

Billy soon returned from the dock carrying an armload of tools. "Great luck, Dad, all we need—even to a torch and an iron."

"Gimme that cream, you blokes, my eyes are killing me," wept Red.

Mr. Cameron applied the thick layers of the soothing cream and when he turned to look for Billy, the boy was already at work at the radio.

Billy inspected the set. Yes, there were the batteries, luckily three of them. There were six tubes, plenty of condensers and other parts necessary in an old type three-dial set.

"We're sure in luck, Dad. Now to see if it can be done."

Billy sent his father on a search for a "couple hundred feet of wire—any kind of wire." He pitched into the set. Screws fell out. Nuts and bolts came loose under the skilled fingers of Billy.

"What'll I do with this wire, Billy?"

An Emergency Aerial Takes Form!

"Measure off approximately 133 feet and attach another piece about 19 feet from the center—" and Billy told his father how to erect an aerial, which while not exactly accurate, would serve the purpose.

(Continued on page 110)

The Improved 12,500 Mile Two Tube Short Wave Receiver



The sensationally popular 12,500 MILE receiver—improved—refined—and available in complete kits that are so easy to assemble.

\$4.75

Our Engineering Department incorporated new features such as velvet regeneration control with no detuning effect, ultra low loss condensers of advanced design, friction drive (no backlash) vernier dial for easy tuning, metal chassis and panel for efficient shielding (eliminating hand capacity) and other carefully selected and tested refinements, resulting in a receiver that by far outperforms the original.

These kits contain every necessary part of highest quality. All high frequency insulation is genuine Bakelite. The four coils, which tune from 15 to 200 meters are wound on polished Bakelite forms. (Prices include wound coils.) The sockets are Bakelite. All losses are minimized! The attractive crystal finished chassis and panel has all holes needed to mount the apparatus and this, together with our complete, detailed instruction sheets, simplifies construction.

Only by purchasing in large quantities are we enabled to offer these neat, professional appearing sets at such an amazingly low price! And the parts are all first grade, too! This is the ORIGINAL 12,500 Mile Kit. (See our ad in the March Short Wave Craft.)

BATTERY MODEL

Uses two 230 tubes. Batteries required are two dry cells (or a 2-volt storage cell) and two 45 volt B Batteries. If you have a 6-volt storage battery you may use 201-A's. **\$4.75 COMPLETE KIT . . .**

AC MODEL

Uses two of the new type 56 or 27 tubes. Power is obtained from the AC Power Pack listed below (or any GOOD pack), or it may be run on a 2 1/2 volt filament transformer and two 45 volt batteries. **\$4.95 COMPLETE KIT . . .**

From Our Customers

"I want to thank you for the Royal receiver you sent me. It performs beyond my fondest expectations. I get Australia, Spain, Italy, etc. consistently and with more than enough volume. I don't see how such an excellent set can be put out for so little."
"Received my Improved 12,500 Mile kit in good shape and thanks to your remarkably clear and simple diagrams and instructions I had it wired and working in no time. Received three continents in the first two days. Not bad for my first attempt at short waves, eh."
"Your prompt service and the excellent value of the tubes you sent me insure that all my future orders will be sent to Harrison."
(Excerpts from the many letters of praise in our files)

AC POWER PACK

A compact power unit measuring only 3 1/2 x 7 x 4 1/2 high. Delivers A, B, and C voltage for up to a four tube receiver. Even one using a power tube! Can also be used for low-power transmitter. Provision for dynamic field supply. Uses one 280. Output: 250 Volts DC at 50 MA and 2 1/2 Volts AC at 5 Amps. Complete KIT including stamped metal chassis and full instructions **\$4.85**
Wired and Tested...\$5.75

SPECIALS

The New "STAR" Condensers Made by HAMMARLUND! 15. 25 mmf.—50c; 50 mmf.—55c; 100 mmf. (0001 mid.)—60c.

GENUINE DE FOREST TUBES

At the lowest prices in tube history! Every tube brand new and fully tested. Limited quantities. ORDER NOW! 410 US-210—\$1.85; 450—\$1.55; 481—\$1.50; 401-A—37c; 430—68c; 433—88c; 433—98c; X90—65c.

HARRISON'S SPECIAL 35 WATT TRANSMITTING TUBE \$3.45

Just what the Hams have been waiting for! Increase your output at one fourth the cost of a 50 watt. FB oscillator and RF amplifier. Rated at 850 volts (will stand more) and 7 1/2 volt filament. Grid bias 85 volts. Big plate with lead at top of tube. No danger of breakdown! A real rugged tube that can be safely overloaded up to 50 watts output! Every one transmitter tested.
Sub-panel wafer sockets, 60c doz.
No-Add large Coil Forms, 14c.
Set of 4 plug-in coils, 15 to 200 meters, \$1.15. Tube base type.
80c. New Bakelite tube bases, 4 or 5 prong. Six for 25c.
EC-80 Equalizers (Postage stamp), 15c.
Cornell Aze-metal Vernier Dial—35c.
GRENE Transmitting RF Chokes, 1 1/2". Will pass 300 MA. 23c. 5 for \$1.00.
Ereps light-weight phones, \$1.45.

ROYAL

SHORT WAVE RECEIVERS

Reliable Performance—Reasonably Priced
When you buy a SW receiver, BUY THE BEST! We recommend Hammarlund, National, and Royal. See previous ads or send for literature and our wholesale prices.

Preston DC meters 25, 100, 150, 200 MA. 58c

SPECIALS

Aerme Phones, 2000 ohm \$1.15, 4000 \$1.35. Midget Power transformer, 350-0-350 high voltage, 5 V. and 2 1/2 at 5 Amps. Special 93c. Special 200—220—240 volt primary power transformer. Delivers 350-0-350, 5, and 2 1/2 volts. \$1.95. PILOT uncase power transformer. Heavy Duty (Jumbo block), 325-0-325, 5, 2 1/2 at 4 amp, and 2 1/2 at 6 amp, 5 lbs. Excellent for 235 or 247 Amplifier or transmitter. Special 98c. Itrunswick 30 Henry, 80 MA chokes, 45c. Thordarson 20 Henry 125 MA chokes, 80c.

RCA Licensed TUBES

Every tube tested and carefully packed, insuring its safe delivery to you! Fully guaranteed for THREE MONTHS.
201-A 39c 233 85c 56 55c
210 \$1.40 236 95c 58 70c
227 45c 237 95c 280 45c
230 70c 238 95c 281 \$1.35
232 80c 47 69c 86A 1.85

All other types at Lowest Prices

COLUMBIA "GEM"

Three Tube Screen Grid Receiver

An efficient battery operated S W Receiver using three screen-grid 232 tubes. RF stage, regenerative detector, and high-gain amplifier. In art metal cabinet 11"x12"x7" with hinged cover. (Batteries fit inside.) Full vision vernier dial. Tunes from 14 to 200 meters. This is the receiver sold by the Columbia Specialty Co. In August Short Wave Craft for \$13.75. Our special price for the original and complete KIT including stamped metal chassis, panel, and cabinet with full instructions is only **\$7.95**
Chassis, panel, and cabinet \$2.50
alone \$2.50

We are NATIONAL DISTRIBUTORS of every advertised line and can supply your entire wants at the lowest prices. Just order everything you need. We will make immediate shipment of your order and guarantee our prices to be lowest! A trial will convince you!

SEND YOUR ORDER NOW! SATISFACTION GUARANTEED! Prices F. O. B. New York. Deposit Required. VISIT OUR SALES ROOMS Second Floor

HARRISON RADIO CO. THE HOME OF FOUR STAR SERVICE

Dept. C-20 New York City 142 Liberty Street

Interference Eliminator

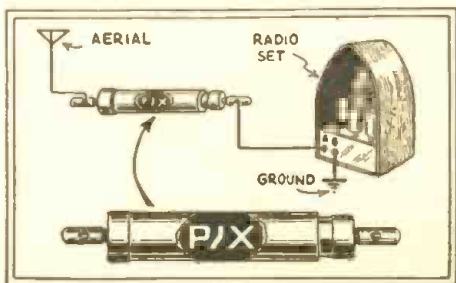

abling him to tune out a powerful local station and bring in a distant one, which had been impossible previously owing to the close proximity of the frequency channels. The distributors of "Pix" state that it may be used to sharpen the tuning and consequently cut out interference of all side bands of overlapping stations. Furthermore, they claim that this device has a lower minimum capacity than any pre-set aerial condenser, or .000004 mf., certified in a test made by Faraday House of London. This auxiliary tuning device also has a greater range than others or a 40 to 1 ratio between maximum and minimum capacity.

● ONE of the latest interference eliminators on the market is known as "Pix" and is a new importation from England. A member of the editorial staff tried out this device and it did improve operation by en-

The apparatus is out of action when closed; when the local interfering station is not broadcasting the eliminator is closed or pushed together so as to get maximum volume. The "gadget" is easily installed by anyone by following the simple instructions given with it.

DATAPRINTS

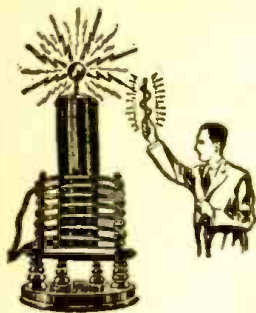

Give
Technical
Information
on the
Building
of
Worthwhile
Apparatus

Dataprint containing data for
constructing this 3 ft. spark
Oudin-Teala coil.

\$.75

Includes condenser data.

OTHER "DATAPRINTS"

TESLA OR OUDIN COILS

36 inch spark, data for building, including condenser data	\$0.75
8 inch spark, data for building, including condenser data	0.75
Violetta type, high frequency coil data; 110 volt A.C. or D.C. type; 1" spark; used for giving "violet ray" treatments	0.75
How to operate Oudin coil from a vacuum tube oscillator	0.75

TRANSFORMER DATA

Any size, 200 to 5000 watts. (1 Primary and 1 secondary voltage data supplied—specify watts and voltage desired)	\$1.00
1 k.w. 20,000-volt transformer data, 110-volt, 60-cycle primary. Suitable for operating 3 ft. Oudin coil	0.50
1/2 k.w. 15,000-volt transformer data, 110-volt, 60-cycle primary. Suitable for operating 8-inch Oudin coil	0.50
Induction Coils—1 to 12 inch spark data	0.75

MAGNET COIL DATA

Powerful battery electro-magnet; lifts 40 lbs.	\$0.50
110 Volt D.C. magnet to lift 25 lbs.	0.50
110 Volt D.C. solenoid; lifts 2 lb. through 1 inch	0.50
110 Volt D.C. solenoid, lifts 6 lb. through 1 inch	0.50
12 Volt D.C. solenoid, lifts 2 lb. through 1 inch	0.50
A. C. Solenoid, powerful, 110-volt, 60-cycle.	0.50
MOTOR—1/16 H.P., 110 volt A.C. 60 cycle (suitable for driving 12" fan or light apparatus), constructional data	0.50
1200 cycle Synchronous motor	0.50
60 cycle Synchronous motor	0.50

TELEGRAPHONE—Records Voice or "Code" signals on steel wire by magnetism. Code can be recorded "fast" and translated "slow". Construction data (special) \$0.50

CLOCKS—Electric chime ringer. How to make one to fit on any ordinary clock 0.50

MISCELLANEOUS DATAPRINTS—

Electric Ice Skates—How to make	0.50
How to Thaw Pipes by Electricity	0.75
20 motor circuits—hook-ups	0.75
20 practical telephone hook-ups	0.50
Treasure Locator	0.50
100 mechanical movements for inventors	0.50
Polarized Relay—Ultra Sensitive	0.50
Electro-medical coil (shocking coil)	0.50
REFRIGERATION MACHINE—Dataprint—How to Make Data	1.00

SLIDE RULES—Specially Selected

Students' 10-inch wood slide rule, accurately engraved (prepaid)	\$1.10
ELECTRICAL Slide Rule, 10 inch size, with special electrical law ratios and indexes, wood with white Ivorine scales, prepaid	5.75
5" "Pocket" slide rule	4.00
"Circular Pocket" slide rule. Fits vest pocket, 2 1/2" diameter, leather case	4.00
Student's circular slide rule	1.50

(Postage 10 cents extra on last three slide rules.)

The DATAPRINT COMPANY
Lock Box 322 RAMSEY, N. J.

Meanwhile, Billy was assembling the parts of the former music set, but in a vastly different arrangement. The set took shape! There was the tuning condenser with its dial. Back of it was the coil, which with the condenser would tune to the "eighty-meter band." Here was a place where Billy's years of "monkeying with radio" counted. It took skill and vast experience to assemble those makeshift parts, correctly, the first time! There would be no time to re-check the set to correct any errors.

"There we are, Dad, hand me that loud speaker cord." Billy hooked the speaker in the set and clipped on the storage battery. Boosting the regeneration control he turned the dial—"CQ CQ de W4CMK—"

"It works! Now for some more stations." Tuning the set brought more signals out through the old speaker. "If the transmitter only works as good as this—" "I've got that aerial up, Billy,—what next?"

"Bring that feeder wire in through the window there." Billy pointed out the desired lead-in arrangement.

Taking a piece of board Billy hurriedly built a crude transmitter. His coil was made from a piece of heavy wire wound on a form from the old set. His tubes were in parallel to give more power. For a grid-leak he used two wires stuck in a glass of salt water. At least the set was finished. Making a crude switching arrangement from some wires and screws he fixed the "B" batteries so that they could be switched from the receiver to the transmitter.

An Improvised "Key"

"How about this hack-saw blade for a key?" queried Mr. Cameron.

"That's great, fix it up please," Billy wired in the key and switching on the batteries he heaved a sigh of regret. "Gosh, if I only had my monitor now. Is there a flashlight around, Dad?"

There was a flashlight and the elder Cameron soon had it apart and the bulb went into a crude but efficient wave-meter made from a variable condenser and a coil.

Tuning Up the Transmitter

"Now's the test!" cried Billy pressing the key down. The bulb in the wave-meter glowed faintly. "That's got it. Now for tuning up!" He switched the batteries and "clicked the meter" to determine the part of the band to tune the transmitter. Then he switched the transmitter on and slowly tuned it up to the proper point as shown on the wavemeter. Attaching the aerial to the set, Billy carefully, but rapidly brought the set into tune. Once more his many hours of practice served him in good stead. In his home town Billy was noted for his painstaking adjustment—that determination to get the last bit of efficiency from the set. His efforts were well placed for it takes skill to properly "Tune up" such a low powered rig as he had constructed from the parts of the old receiver.

"Here we go! Let's try to raise some land station!"

"What'll we do, Billy? Call a CQ?"

"No, this is a real emergency and QRR should do the trick, that's the amateur's SOS. Now—hold your breath!"

Billy pounded out the letters over and over. Then he signed "de X4." Almost like a machine his steady fingers formed the letters into the dots and dashes that were to mean salvation for the Coast Guardsmen and themselves.

"What did you sign, Billy?"

"I put it 'X4.' That is an illegal call, but we must attract attention. My regular portable call would not do it as well as some fluke call."

Then he switched the batteries and listened. Slowly his hand turned the dials. There were a few signals coming through but none in answer to his. Again the pleading call went out over the roaring sea. Surely someone would hear that time! He tuned the receiver more carefully than

before—listening to each signal, trying to find someone calling him.

Mr. Cameron had turned away. He had not shared his son's belief that they could radio ashore. It hurt him to see Billy's efforts so fruitless.

Minutes dragged by—Billy's fingers ached from the countless calls he had pounded out on the makeshift key. He called CQ—he called stations that he heard and he called the distress signal. No one answered! But his faith in the set was limitless. Never had he failed to "raise somebody" and this indomitable spirit kept his fingers turning the dials and ticking away at the key. His father brought him food—it went untouched. Repeated urgings to stop failed to check his relentless search for contact with land.

Billy "Raises" a Station At Last!

"—X4 X4 de W3DBT k." "I've landed a three, Dad," Billy shouted as he shifted the batteries. His fingers were quivering as he answered the faint signals. Slowly he told the far off station of their plight. Bare details only, this time. He would give him the full story on his next transmission.

The chap at the distant point answered — "—vy sorry but did not get you thru heavy static." Billy groaned as he repeated his message, this time each word twice. When the land station stated that he could still hear him but was unable to copy him Billy noticed that the sending was jerky and erratic. A beginner! Just his luck to get hold of some "lid" who couldn't read code. This was a blow! Better turn off the set. No use trying to give the lengthy details to that "punk." Better save the batteries. What was the time? Six-forty! It would soon be dark. The runners would be about ready to attack the coast guard!

The unsuccessful contact with the poor operator almost took the spirit out of Billy. There was one factor on which he had not counted! To hook up with an operator on land who would not have ability and brain to act on the startling information that Billy would pass to him from the island prison.

"It's growing darker now. Signals should be better, Dad. Maybe there's a chance yet."

"That's the proper spirit, son, don't ever give up." The elder Cameron felt ashamed for his lack of faith in Billy as he saw him desperately attempt to signal for help.

Billy tuned the receiver slowly. Then a clean-cut signal whistled into Billy's ears—"CQ CQ CQ de W4BMT ar."

Billy desperately called the station. "Here is an operator," said Billy half to himself, "if he'll only answer me." He switched to the receiver—a lengthy pause—nothing came thru. "Must be still listening—I'll call again. Now for the last chance—"X4 X4 de W4BMT your signs weak but steady QSA3 R5 pdc Why QRR X4? ar k."

"I've got him! A real guy this time," Billy cried with relief. Billy's practiced fingers never pounded out such important information as he now sent slowly but surely to the distant station. The elder Cameron sat by the set and compiled brief cut-to-the-line instructions for the operator at W4BMT. The far-off operator sensed the imperativeness of the situation and had already, he reported, phoned the telegraph office and was putting Billy's words into a message for the Coast Guard. "The batteries are getting weaker,—don't know if they'll last out. Only five more minutes will finish our job."

Help Assured

Billy listened. "Coast Guard says message OK will prepare for runners. Sending cutter for men on island at once. Light beacon fire one hour. Any more there? Your signs weak now ar W4BMT." "Send this, Billy," said his father. "It's a message to Charley about that letter. Even tho' the runners escape the Coast Guard, they can be caught when they try to get the money."

THREE NEW DENTON KITS

THE AIR ROVER Model 10A

The two tube set with a wallop!

A highly sensitive battery operated receiver with an abundance of power. This set uses 1-232 and 1-233. A regenerative detector and a pentode power stage. Regeneration controlled by a smooth working potentiometer. And a new feature—a high impedance audio choke for matching the plate of the 232 for stability and maximum gain. Easy to assemble.

KIT INCLUDING DRILLED PANEL AND CHASSIS AND ALL PARTS

\$5.95 less tubes and coils. SET OF COILS for 15 to 200 meters \$1.29 extra.

THE VOYAGER Model 45A

An A.C. operated powerful two tuber!

A highly sensitive receiver using the new tubes. Will operate a speaker on even foreign stations. Uses a 57 as a regenerative detector and a 59 as a pentode power amplifier. Smooth tuning and perfect regeneration control. Uses a special high impedance audio choke in the plate circuit of the 57 for stability and maximum gain. Easily assembled.

KIT INCLUDING DRILLED PANEL AND CHASSIS AND ALL PARTS

\$5.95 less tubes and coils. SET OF COILS for 15 to 200 meter \$1.29 extra.

A. C. POWER SUPPLY \$7.95

Designed by
Clifford E. Denton

THE ARGONAUT Model 15A

A beginner's two tube set!

Battery operated. The ideal kit for the newcomer to short waves. Good power and easy operation. For phones or speaker. Uses a 2 - 230 tubes. Regenerative detector followed by audio stage. Smooth regeneration control. Easily assembled within 30 minutes.

KIT INCLUDING DRILLED PANEL AND CHASSIS AND ALL PARTS

\$5.65 less tubes and coils. SET OF COILS for 15 to 200 meters \$1.29 extra

Complete instructions with each kit—20% With Order, Balance C. O. D.

Federated Purchaser Inc.

25 Park Place, Dept. S

New York City, N. Y.

This time it took several "repeats" to get the message thru. Finally Billy got an "OK." Then he heard the words he had been fighting against—"QSZ you too weak now 73 W4BMT gn."

"We're finished. The batteries have gone down too much." Billy turned off the set and eased back into his chair.

"That's all right, son. I think you did the job up brown."

"Let's eat! I'm hungry as a bear." Billy grabbed a plate of meat and bread.

Remembering the instructions, the Camerons prepared a beacon fire. Promptly as the time came, Billy lit the fire. Flames soon roared high into the air, forming a beacon which could be seen for miles.

Rescued!

Finally the sound of a roaring motor came drifting over the water. Was it the runners returning—or the Coast Guard? Soon they could see the running lights. Then a searching beam from a powerful light fingered its way into the cove. It was the Coast Guard cutter!

Billy and his father raced for the dock where they welcomed the guardsmen with wild enthusiasm. "Let's get going!" cried the skipper of the cutter.

"We've got a prisoner to take ashore," said Mr. Cameron. "Can you send a couple of men to get our 'good friend'?"

"Sure. Hop up there, Miller and Tubby, and drag the bird out."

Red was brought to the cutter handcuffed and the men went aboard. The boat slipped out of the cove, heading towards land.

The Skipper could offer no information as to the thwarting of the vicious plans of the runners. All he knew was that he had been ordered to proceed as fast as possible to pick two men marooned by run runners on an island off the coast. Billy and his father sketched the happenings of

the past twenty-four hours for the interested Skipper and his crew of guardsmen. Their eyes fairly popped as they listened to the almost unbelievable story of the makeshift radio.

The Camerons were mighty glad to be saved but their anxiety over the capture of the runners spoiled some of their joy. After what seemed like days, the cutter eased into port alongside a craft that was very familiar to Billy and his father. It was the runner's speed boat!

"How did you do it?" asked the Camerons almost in one breath as they approached the Skipper of the other Coast Guard cutter.

"Easy, we just beat 'em to the throw and tossed some tear gas onto their deck. That took all the wind outa their sails—"

"Great work," cried Mr. Cameron. "I'd like to charge these men with kidnapping."

"That's OK with us," said the commander of the guards, "after they get through serving the time Uncle Sam will give them for their notorious running they can start in on about seven to ten for you."

"That sure will be great," grinned Billy, "—and how about our boat? You know these birds sank my cat boat."

"Never mind that. There's enough rewards for the capture of these men to buy a dozen cat boats. You'll get a new boat all right."

"And that course at Radio Tech., too, son!" cut in Billy's father.

"Gosh, Dad, all that for just a little work and a few minutes operating."

"Sure, Billy. But you fitted yourself for just such an emergency. I've thought all along you were wasting your time. But, son, I'm proud of you."

"Aw, heck, Dad. Forget it!"

(The End)

BOOK REVIEW

Radio Operating Questions And Answers, by J. L. Hornung and R. Nilson. Cloth covers; size, 5¼"x8¼"; 356 pages; 96 illustrations; published by McGraw-Hill Book Company, New York, N. Y. Price \$2.50.

Over 500 practical questions on the operation of radio apparatus in all its branches, including storage batteries, dynamos, tubes, receivers, and transmitters are given together with correct answers, thoroughly illustrated where necessary. Both of the authors have had lengthy practical experience in the radio field and this book is a very valuable one to any student of radio. Among the subjects illustrated with new and valuable diagrams we find tube transmitters and their power supply; what is a "tank circuit?" If a transmitting tube fails to oscillate, how do you find the trouble? Why is a radio frequency choke coil used in a V. T. transmitter? How would you transmit signals if your entire transmitter became inoperative? How would you use the grid-bias method of keying? Give diagram of an A. C. W. tube transmitter complete with receiver, automatic starter and emergency equipment. Other chapters treat on "arc" transmitters; "spark" transmitters; receiving apparatus and radio-compass; storage batteries; motors and generators; a goodly section of questions and answers on the radio laws and the traffic regulations; general radio circuit theory; amateur station operation; amateur radio laws and regulations; aeronautical and police radio; radio beacons; information concerning license examinations and a complete table of the famous "Q" signals, also a table of code abbreviations with a chart of radio symbols. The book has a good index.

Don't Go West Go Western

EVERY SPORT THAT THE HEART CAN DESIRE

- • • Surf and Fresh Water Swimming
- • • Lake and Deep Sea Fishing
- • • Shooting
- • • Tennis
- • • Golf

The Golden West 55 Minutes
from Broadway

Rodeo Champions will instruct you in
HORSEBACK RIDING—

Dancing—Modern and Old Fashioned
and a good glass of beer in a
real old time WESTERN MUSIC HALL

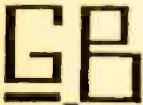

For a complete rest or strenuous holiday and rates attune with the times

G. BAR B. RANCH

For Descriptive Booklet Write Three Lakes, Stamford, Conn., Tel. Sta. 4-6694

FREE 104 page RADIO and SHORT WAVE TREATISE



Avail yourself now of the opportunity to receive the free 1933 winter edition of our Radio and Short Wave Treatise. No. 26. 104 solid pages of useful information, radio items, diagrams, illustrations, etc.

Over 100 New Hook-Ups, Etc. 1000 Illustrations. Considerably larger and more instructive than our treatise No. 25 and incidentally all our previous issues, you are familiar with the type of book we publish; but the new No. 26—what a book! The entire editorial section is new from beginning to end—not an old word remains. Considerable space has been devoted to articles for the radio beginner. This alone is worth its weight in gold. The Superheterodyne principle is thoroughly explained in this issue in clear, simple language. No. 26 is not just another catalog. It contains more valuable and up-to-date information than can be found in any radio text book on the subject.

PARTIAL LIST OF CONTENTS

Fundamental Principles of Radio—Ohm's Law—Discussion of New Tubes—Constructing a Triple Tuning Amplifier—Constructing a Tiny A.C.-D.C. Portable Receiver—All About Superheterodynes—Eliminating Man-made Static—Constructing a Two-tube Short Wave "Globetrotter" Receiver—Completely revised and Up-to-date Radio Tube Chart—\$3.00 Price Suggestions—Radio Kinks, Etc., Etc.

WRITE TODAY. Enclose 4 cents for postage. Treatise sent by return mail.

RADIO TRADING CO.

100A Park Place New York City

PATENTS—TRADE MARKS

All cases submitted given personal attention by members of the firm.

Information and booklet free

LANCASTER, ALLWINE & ROMMEL
PATENT LAW OFFICES

Suite 434 815-15th St. N. W., Washington, D. C.

A 4-Tube that "Brings Home the Bacon"

(Continued from page 84)

SHORT WAVE CRAFT 1932 page 34.

Read article by R. M. Tanner, August SHORT WAVE CRAFT, 1932, page 214.

We carefully wrecked a National No. 90 R. F. choke and began experiment for a well-functioning tapped choke. In order that an accurate check could be made on the amount of wire used, we wound a definite number of turns of fine enameled wire on a long one inch form (broom handle).

This particular choke form has only three slots; thus if there are to be four coils, two windings must be placed in one slot. I found by trial, using the same wire removed from choke, that 20 turns taken from the broom handle made peaked efficiency for the first coil. The choke was finished, tap leads brought out through the waterproof shell and end terminals re-assembled, turns as follows—20-20-20-40, the last two windings being placed in the third slot. Feeding this wire checked from a one inch form made it easy to determine the amount of wire used.

Shielding the choke (input) brought about results that showed over a fifty percent improvement, and fell but little under the peak efficiency of a tuned input. The tap switch and coil assembly with choke were housed in a neat tin can 3x3x4 with tight fitting lid (a coil mailing can) and bolted to front input end of chassis. Oh, yes! this possibly throws the panel effect off balance somewhat, however I am primarily more interested in hearing "London calling" and "This is Amalgamated Wireless, Australia," than I am in "symmetry."

We experimented with the choke in the detector circuit, under chassis, and inside of shield compartment but when we shielded the choke (Rumford baking powder can with height cut down), there was real functioning.

As shown I am using a well-filtered (power) pack with only the high line reduced to 250 volts going to set. With a 15,000 ohm Truvalt type-C resistor, mounted on the back of audio shield with a slider, the high voltage is dropped to 180 volts.

The resistor was so placed to permit better air cooling and easy access. An angle iron prevents short-circuiting from open cabinet lid.

The seventy-five thousand ohms resistor permits tapping the 180 volt line for R.F. screen voltage, and there is a .01 meg. resistor in the detector screen line between slider (potentiometer) and socket. These resistors not only afford voltage drop, but they decouple.

In order to vary the audio "gain," a potentiometer was used in the grid circuit of pentode.

tentiometer was used in the grid circuit of pentode.

The first shield was built from sheet aluminum with four grooved corner posts. The audio shield was built from an old aluminum (walnut-finished) panel (finish removed with paint remover from 5 and 10 cent store).

For the use of phones following first audio, an output transformer is plugged into the jack; hum and noise-level exceptionally quiet.

Was pleased to note in December edition page 476 that Mr. Slack's experiment had paralleled my own. Some time ago I picked up a scrap length of BX electric cable and readily saw its adaptability to radio. I make use of the cable with the inclosed ready twisted heavy gauge leads for carrying filament from pack to set.

Results—voice transmission—domestic stations from the lakes to the gulf, from east to west coast, Canada, Mexico, Cuba, South America, Australia, England, Spain, Germany and Italy all on "real" loud-speaker volume.

The Daventry (England) station has a signal that seems like a local on 49.59 meters. The selectivity as well as tone quality is rather a surprise, and the detector goes into and out of oscillation with both ease and grace.

For coils refer to page 387, April SHORT WAVE CRAFT, 1932. Coil sizes can only be approximated, and one soon finds that the lay of leads, their length, together with the tuning condenser, are the determining factors that control the number of turns and the ratio one coil bears to another.

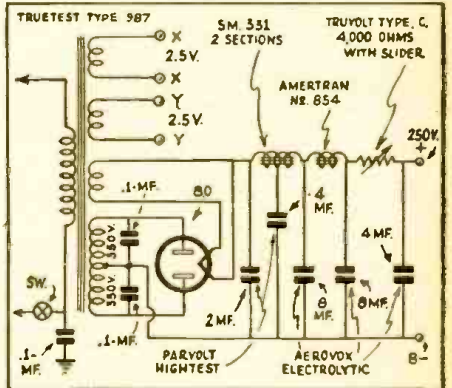

Power-Pack Hook-up

WHAT DO YOU WANT?

● The editors are anxious to give you the sort of articles you wish. It has always been our policy to publish only such material which you demand.

Please tear out this voting blank, paste it on a postal card and mail it to us properly filled in. You need not sign your name if you do not wish to do so.

This will give us an exact idea of the sort of articles in which you are most interested. Naturally, the majority will decide.

In case you do not wish to mutilate the magazine, you may copy the blank.

Check the subjects you are interested in.

Wanted	Not-Wanted		
<input type="checkbox"/> 1, 2, 3, 4, 5 Tube Battery operated receivers (check which)	<input type="checkbox"/> or A.C.	<input type="checkbox"/>	<input type="checkbox"/> Short Wave Question Box
<input type="checkbox"/> Short-Wave Transmitters	<input type="checkbox"/>	<input type="checkbox"/>	<input type="checkbox"/> "Amateurs Who Made Good"
<input type="checkbox"/> Frequency Meters—How to Construct and Use Them	<input type="checkbox"/>	<input type="checkbox"/>	<input type="checkbox"/> Short-Wave Stations of the World, List
<input type="checkbox"/> Short-Wave Aerials	<input type="checkbox"/>	<input type="checkbox"/>	<input type="checkbox"/> Descriptions of New Factory Built S-W Receivers
<input type="checkbox"/> Learning the Code	<input type="checkbox"/>	<input type="checkbox"/>	<input type="checkbox"/> General News Section
<input type="checkbox"/> Super-Regenerative Receivers	<input type="checkbox"/>	<input type="checkbox"/>	<input type="checkbox"/> Editorial
<input type="checkbox"/> Superheterodyne S-W Receivers	<input type="checkbox"/>	<input type="checkbox"/>	<input type="checkbox"/> Suggestions
<input type="checkbox"/> "Portable" S-W Receivers	<input type="checkbox"/>	<input type="checkbox"/>	
<input type="checkbox"/> "Single Signal" Receivers	<input type="checkbox"/>	<input type="checkbox"/>	
<input type="checkbox"/> Plug-In Coils or Switch Type band-selector	<input type="checkbox"/>	Name	
<input type="checkbox"/> "Power Amplifier" for S-W Receivers	<input type="checkbox"/>	Address	
<input type="checkbox"/> Letters From S-W Fans Department	<input type="checkbox"/>	City and State	

A 5-Tube de Luxe Oscillodyne

(Continued from page 75)

After the set has been completely wired it is necessary to make alterations to the Alden coils used in the detector circuit before the set can be put in operation. The ticker winding is removed and re-wound according to the specifications given in the following table. The details of the other windings are also given for the benefit of those wishing to wind their own coils from blank forms.

Coil No.	Wdgs. L1		Wdgs. L2 and L3		Wdg. L4	
	Turns	Length	Turns	Pitch	Turns	Tap
No. 31 DSC					No. 35 DSC	
1	4 1/4	4 3/4	3 1/4	6	6	3
2	6 1/4	10 3/4	1	12	8	4
3	7 1/4	22 3/4	1 1/4	16	12	6
4	15 1/4	51 3/4	1 1/4	40	20	10

It will be noted that the re-wound winding L4 is tapped at the center. In order to do this and at the same time employ a four-prong coil form it is necessary to solder the grounded lead of this winding into the prong occupied by the grounded terminal of L3. The tapped lead then occupies the prong vacated by this procedure, while the outside terminal retains its former position. As previously, the windings L3 and L4 should be wound in the same direction or the tube will not oscillate.

Parts List

- C1, C2—Cardwell Midway Double Section "C" Type Variable Condenser—140 mmf. per section. Type 405-c.
- C3, C4, C5, C6, C11—Aerovox Type 1460 Mica Condenser .004 mf.
- C7—Aerovox Type 1460 Mica Condenser—.00015 mf.
- C8, C10, C12—Aerovox Type 281 Tubular Cartridge Condensers, .5 mf., 200 D.C.W.V.
- C9—Aerovox Type 281 Tubular Cartridge Condenser, .01 mf., 200 D.C.W.V.
- C14—Aerovox Type PR25 Dry Electrolytic Tubular Condenser, 25 mf., 25 V.D.C.
- C15, C16—Aerovox Type E5 Dry Electrolytic Filter Condenser, 8-.8. mf., 450 D.C.W.V.
- R1—Electrad Truvolt Wire Wound Pigtail Resistor, Type PG, 400 ohm.
- R2, R3—Aerovox Type 1094 Resistors, 50,000 ohm, 1 watt.
- R4—Aerovox Type 1095 Resistor, 1 megohm, 1/2 watt.
- R5—Electrad Truvolt Adjustable Resistor, Type B 150, 15,000 ohm, 25 watts, with one extra slide.
- R6—Electrad Potentiometer, Type R1-279, 25,000 ohms.
- R8—Electrad Truvolt Wire Wound Pigtail Resistor, Type PG, 2000 ohm.
- R9—Electrad Potentiometer, Type R1-281P, 200,000 ohm, with A.C. Switch.
- R10—Electrad Truvolt Wire Wound Pigtail Resistor, Type PG, 500 ohm.
- L1, L2, L3, L4—2 sets Alden Short Wave Coils. Type 704SWS. L4 re-wound, see text for details.
- L5, L6—Hammarlund Isolantite R.F. Chokes Type CH-8. (Inductance 8 M. H.)
- T1, T2—Thordarson Audio Frequency Transformers, Type T-5736.
- T3, T4—Jensen Dynamic Loud Speaker Type 3007A, 1800 ohm field.
- T5—Thordarson Pentran Power Transformer, Type T-4900.
- 2 Hammarlund 4 prong isolantite sockets, S-4.
- 1 Alden* 4 prong laminated socket, 280 marking; 2 5 prong, 56 mark; 1 5 prong, 47 mark; 1 6 prong, 58 mark; 1 4 prong, plain; 1 4 prong connectoral socket, type 94. *(Na-ald)
- 1 Ehy Twin Binding Post Assembly
- 1 Special "Blan" chassis
- Five tubes—R.C.A., one-58, two-56, one-47, one-80 (Arcturus; Sylvania or R. C. A.)

A Dual Regeneration Control Set

(Continued from page 79)

the event that 2 1/2 volt A.C. tubes are used. The antenna coupling is effected by winding about eleven turns of insulated wire around a piece of copper bus-bar or 3/8" diameter copper wire, the capacity of this home-made condenser being varied by sliding the 11 turn coil of insulated wire back and forth slowly on the piece of bus-bar. You may use a 20 to 50 mmf. capacity variable condenser instead. The type 33 power amplifier pentode, designed especially for use in the output stage of battery-operated receivers, requires 2 volts filament potential and a cur-
(Continued on page 115)

I. C. A. SHORT-WAVE SCOUT

An A.C.-D.C. Converter that operates with any radio—even the Ultra-Tiny Universal Midgets



Enjoy the big thrill of radio—short-wave reception. Hear calls from police headquarters—amateurs throughout the country—aviation reports—news from ships at sea. The Scout brings all this to you. It contains its own power supply

using the 237 and new 6A7 Pentagrid Converter Tube. Complete coverage from 60 to 200 meters. And, if you want to experiment in the European zone, an extra 20 to 60 meter coil can be had at slight additional cost.

Attractive burl walnut cabinet 6 3/4" high, 7 3/4" wide, 4 1/4" deep. Vernier tuning control, on and off switch, switch for changing from Short Wave to Regular Broadcasting.

Ask your dealer to demonstrate! If he hasn't the Scout on hand, write to us, mentioning the dealer's name.

\$16.50
With RCA TUBES

INSULINE CORP. of AMERICA 23-25 PARK PLACE NEW YORK CITY

For BETTER RESULTS

THERE was never a time in radio history when Hammarlund quality meant more to serious amateurs, professionals and experimenters.

The performance of the COMET "PRO" Short-Wave Superheterodyne—custom-built by Hammarlund—has won world-wide acclaim. If you don't know the details, mail the coupon.

Likewise, Hammarlund parts are backed by more than thirty years of engineering prestige. Mail coupon for catalog.

- Use
- Hammarlund
- Precision
- Products

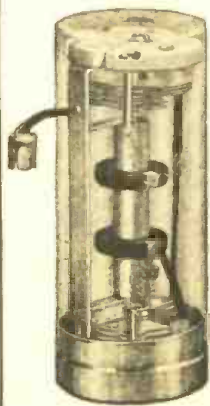

These I. F. Transformers, tuned by AIR-dielectric condensers, are used exclusively in the COMET "PRO" Receiver. They are equally well adapted for use in other superheterodynes, and will increase selectivity and sensitivity amazingly. Available in 525 kc., 465 kc. and 175 kc. types.



Special low-loss R. F. Choke for short-wave receivers and transmitters. Equally efficient on broadcast band.

Hammarlund's reputation was first won with condensers, back at the beginning of radio. Today, that reputation still stands for perfection in condenser design and watch-like workmanship. All types for all purposes—transmitting and receiving.



HAMMARLUND MANUFACTURING CO., 424-438 33rd Street, New York, N. Y.

.....Check here for folder on Air-tuned I. F. Transformers.

.....Check here for General Catalog "33."

Name

Address

SW-6

For Better Radio
Hammarlund
PRECISION
PRODUCTS

New! New!! New!!!

TWO NEW 25c SHORT WAVE BOOKS

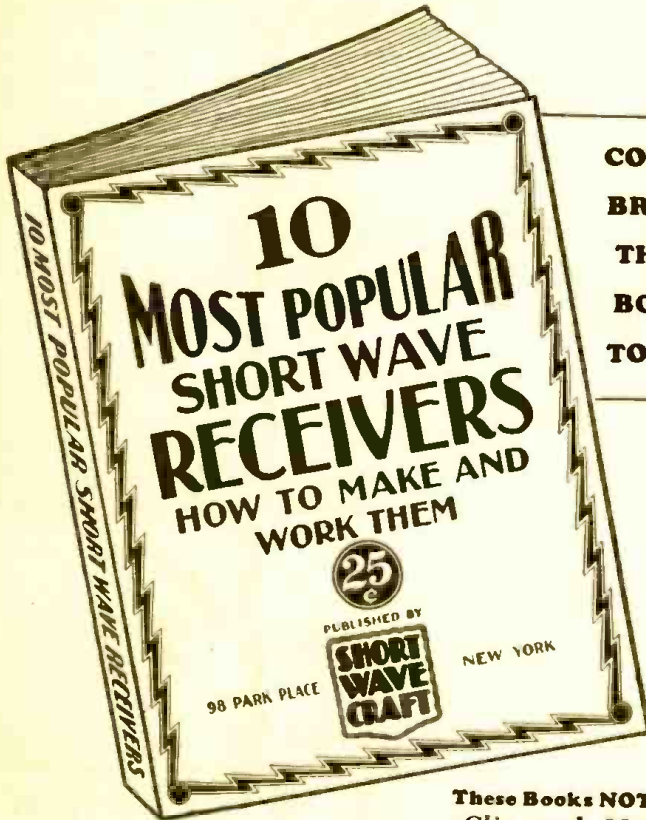

COUPON BRINGS THESE BOOKS TO YOU

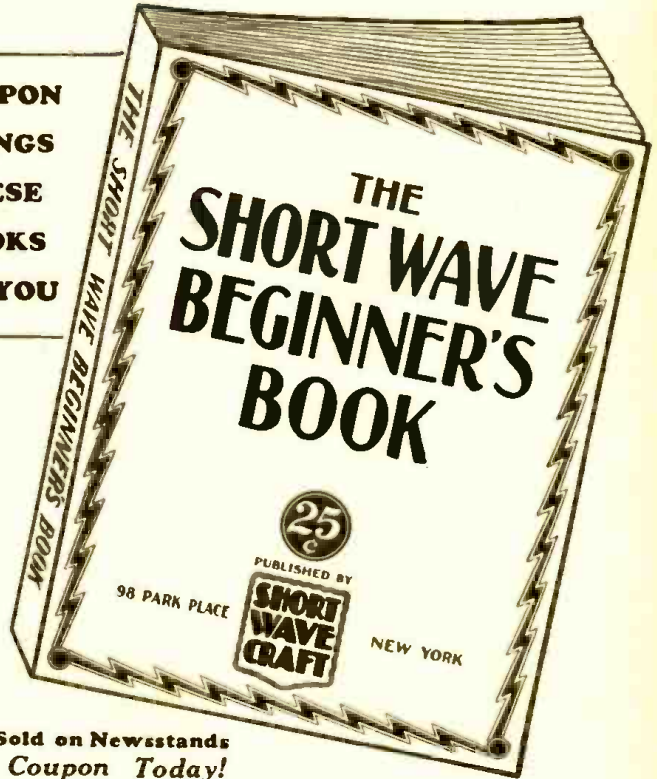

**These Books NOT Sold on Newsstands
 Clip and Mail Coupon Today!**

HERE IS GREAT NEWS

PURSUANT to many requests from our readers, we have decided to publish two new popular short wave books, for which there is a persistent demand at this time. These new books contain everything on the subjects worth knowing and both books will be welcomed by all short wave experimenters, short wave fans and short wave enthusiasts, the same as our former two books HOW TO BUILD AND OPERATE SHORT WAVE RECEIVERS, and HOW TO BECOME AN AMATEUR RADIO OPERATOR were welcomed by thousands of our short wave friends.

instead of 50c, which is the price of our other books. Yet the two new 25c volumes that we are offering now contain a tremendous amount of information and the type and illustrations have been chosen in such a manner as to give you almost as much for your 25c as you received for your 50c before. Only by increasing the press run enormously and making other printing economies has it been possible to price these books at such a low, popular price. You will make no mistake in getting either or both of these new and popular books and we know in advance from our many years of experience with short wave enthusiasts that you will thank us for having made these books possible.

**Ten Most Popular Short Wave Receivers.
 How to Make and Work Them**

This new volume will be a revelation to all those who wish to build their own short wave receivers. The editors of SHORT WAVE CRAFT for a period of years have learned to know exactly what short wave experimenters and short wave builders want to get. For that reason they have selected ten outstanding short wave receivers and these are described in the new volume. Everything worthwhile about every one of the ten receivers is described in the text. Each receiver is fully illustrated and each receiver has a complete layout, pictorial representation, photographs of the set complete, hookup and all worthwhile specifications, so there is nothing left to your imagination when it comes to building any one of these ten popular receivers. Everything from the simplest one tube set to a six tube superheterodyne is presented. Complete lists of parts are given to make each set as complete as it is humanly possible to do. You can select any or all receivers and know beforehand that you will be able to successfully build and operate such a receiver and not waste your money in building some theorist's dream-child. You will also be shown how to operate the receiver to its maximum efficiency.

IMPORTANT

THERE IS NO DUPLICATION WHATSOEVER BETWEEN THIS BOOK AND OUR OTHER VOLUME "HOW TO BUILD AND OPERATE SHORT WAVE RECEIVERS." ALL THE MATERIAL PUBLISHED IN THE NEW BOOK HAS NEVER APPEARED IN ANY BOOK BEFORE.

This book has been edited by the editors of SHORT WAVE CRAFT, which alone is a guarantee that you will get satisfaction and that nothing has been left undone to give you between two covers the greatest selection of short wave receivers ever published.

**PRICE 25c PREPAID 40 PAGES
 OVER 75 ILLUSTRATIONS**

A Short Wave Beginner's Book

Here is a book that will solve your problems if you are new to the short wave game. It contains positively everything that you would wish to know in connection with short waves, leading you in easy stages from the simplest fundamentals to the present state of the art in short waves as it is known today. It is the only low-priced reference book on short waves for the beginner, whether he be a short wave enthusiast, short wave listener or short wave amateur.

The book is profusely illustrated with all sorts of illustrations, explanations and everything worthwhile knowing about short waves in this interesting and growing field. Yet without, the book is not "technical." It has no mathematics, no "high-faluting" language and no technical jargon which would only serve to frighten you away. The entire book is kept in popular language throughout. Wherever technical words are used, explanations are given, leaving nothing to the imagination. You are shown how to interpret a diagram and a few simple sets are also given to show you how to go about it in making them. Yet everything has been done to make it possible to give you a complete understanding of short waves from the ground up.

After reading this book, you will never be at a loss for short wave terms and you will not have to consult other text-books or dictionaries. The editors of SHORT WAVE CRAFT who have edited this book have seen to it that everything has been done to make this volume an important one that will be used as reference for years to come by all those who wish to break into the short wave art. The book covers everything, "from soup to nuts" and will be of tremendous importance to everyone.

It abounds with many illustrations, photographs, simple charts, hook-ups, etc., all in simple language. It also gives you a tremendous amount of very important information which you usually do not find in other books, such as time conversion tables, all about aerials, noise elimination, data on coil winding and cores of other subjects. The book is just chock full of information and you will never regret having gotten this important volume. You will keep referring to it every day in your work.

**PRICE 25c PREPAID 40 PAGES
 OVER 75 ILLUSTRATIONS**

SHORT WAVE CRAFT
 98-98 Park Place, New York City. SW-6-33

Gentlemen:

I enclose herewith 25c, for which please send me as soon as published, prepaid, a copy of your new book "Ten Most Popular Short Wave Receivers, How to Make and Work Them." The book to be sent to me immediately upon publication.

I enclose herewith 25c for which please send me as soon as published, prepaid, a copy of your new book "The Short Wave Beginner's Book." The book to be sent to me immediately upon publication.

I enclose 50c for which please send me, prepaid, as soon as published, your two books, "Ten Most Popular Short Wave Receivers, How to Make and Work Them," and "The Short Wave Beginner's Book." The books to be sent to me immediately upon publication.

(Send money order, check, cash or new U. S. stamps. Register letter if it contains currency or stamps).

Name _____
 Address _____
 City _____ State _____

A Dual Regeneration Control Set

(Continued from page 113)

rent of .26 ampere. The plate and screen voltages are 135, grid bias voltage minus 13.5 volts; the plate current is 14.5 ma., the screen current 3 ma., the plate resistance 50,000 ohms; amplification factor, 70; load resistance, 7,000 ohms. Power output 700 milliwatts. This tube requires a medium 5-pin socket.

If you are using an A. F. transformer as an impedance choke, you may have to experiment a little when connecting the "jumper" wire which joins the primary and secondary in series; you can tell whether the two windings are bucking or aiding each other, as they should, by connecting the primary and secondary terminals first one way and then the other and listening to the signal to see whether it is stronger or weaker. When the coils are properly connected the signal will be at maximum strength.

Coil Winding Data

Band Meters	Grid Coil Turns	Tickler Coil Turns	Space between Coils
10-20	4 1/4 T. No. 22 Wound 6 T. per inch	4 T. No. 31 Close wound	3/32"
20-40	10 1/4 T. No. 22 Wound 12 T. per inch	6 T. No. 31 Close wound	1/8"
40-80	22 1/4 T. No. 22 Wound 16 T. per inch	7 T. No. 31 Close wound	3/32"
80-200	51 1/4 T. No. 22 Wound 40 T. per inch	15 T. No. 31 Close wound	1/8"
200-350	68 1/4 T. No. 28 Close wound	28 T. No. 36 Close wound	1/8"
350-500	131 1/4 T. No. 32 Bank wound in 2 layers*	32 T. No. 36 Close wound	1/8"

Data for Na-Ald coils form 1 1/4 inches dia. by 2 1/2 inches long (4 pin).
*See drawing page 55, May issue.

A "TNT" Transmitter for 160 Meters

(Continued from page 95)

should be taken to obtain the best possible. A length of pipe driven into the earth at some damp spot is probably best, although a water-pipe connection works very well at the writer's station. Some amateurs have used the ground side of the electric light system with good results. However, this system is not recommended for general use and the water-pipe ground appears to be the best compromise. The antenna and ground are inductively coupled to the tank circuit by means of a coil similar to the plate inductance. This coil should consist of 12 turns of the aerial wire wound around a 3 inch diameter tube and should be coupled to the plate end of the tank inductance. The antenna is series-tuned and connects to the end of the antenna coil nearest the plate tank. The ground connects to the other end of the coil and a flashlight bulb is wired in series to indicate resonance.

This type of transmitter is in use at W1AAD and, although using only 250 volts on a '10 tube, its performance has amply repaid the small expenditure of time used to construct it. Give it a try, OM or YL, and I'll CUL.

CORRECTION NOTICE

The photo which appeared on page 719 of the April, 1933 issue and bearing the caption, "One of the code classrooms in the Candler School, etc.," as a matter of fact shows the code room of the Department of Communications, The Air Corps Technical School, Chanute Field, Rantoul, Illinois.



As described in the May issue of SHORT WAVE CRAFT.

The New 1933 Beginner's Twin

Battery Operated Short Wave Receiver USING HAMMARLUND PARTS

Economical—Uses two, two volt 230 tubes
Sensitive—Consistent long distance reception under all conditions
Selective—Logs the station you want, excluding all others
A well designed short-wave receiver which covers all useful short-wave police broadcasts, ship-to-shore, commercial communications, television and amateur and experimental frequencies. Do not confuse this with many short-wave kits and sets on the market which cover only part of the range, and require the purchase of additional coils. This receiver is constructed of the finest parts available.

Here are some examples of the apparatus used:
Hammarlund tuning condenser.
Hammarlund Drum Dial, assures precision and knife edge tuning.
Kit of parts with drilled panel and base all necessary parts down to the last nut and bolt, scaled blueprint, a set of MATCHED SYLVANIA TUBES, and coils. **\$7.59**
Power test meter calibrated coils (15-200 meters)
Hammarlund regeneration control condenser.
High Quality audio transformer.
Wired with SYLVANIA TUBES, and coils. **\$8.95**
Set of batteries. **\$2.50**

ALUMINUM PANELS AT REDUCED PRICES	
7 x 10—32c	7 x 18—69c
7 x 12—35c	7 x 21—75c
7 x 14—51c	7 x 24—89c
7 x 16—61c	Best grade obtainable
Amateur Handbook (New Issue)	\$1.00
Standoff Insulators (2 1/2 inches)	per doz. .50
Special Short Wave Blueprints for any set	10c each

TRY-MO RADIO CO., Inc. Dept. S-6
Mall orders to 85 Cortlandt St., N.Y.C.
Branch Stores: 178 Greenwich St. and 179 Greenwich St., N.Y.C.
Write For Free Catalog

Here It Is!

The finest and most ingenious STATION FINDER and RADIO MAP of the World

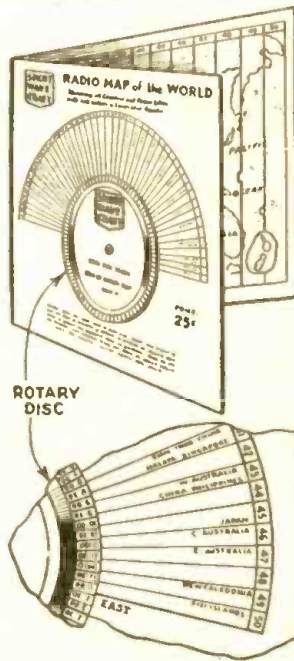

Here is a device that no radio man should do without. It lends that professional dignity to your den. It instantly shows you the exact time in any foreign country.
Professional short wave listeners are never without this station finder because they do not twiddle the dial needlessly in trying to fish for stations which may not be on the air due to time difference.

This handy device is printed on heavy yellow board; on the front there is the automatic time converter, which rotates; you can set it for any time of the day in fifty different zones in the world. On the inside are illustrated the fifty zones showing the principal countries of the world. All the important cities are shown, and inasmuch as they are all zoned, the exact time can be converted within a few seconds.
The size of the station finder and radio map of the world is 11x22.
The price of this handy device is 25c prepaid.
However, it is sold only to members of the Short Wave League. Outsiders cannot buy it.

We refer you to page 68 for order blank. Take advantage of this opportunity at once, and get rid of your present annoyance in calculating the time for the different countries.

SHORT WAVE LEAGUE

98 Park Place New York, N. Y.



This Big 152 Page Bargain Book should be before you—if you are thinking of SHORT WAVE Equipment. It lists every latest development in sets, coils and equipment. NATIONAL and HAMMARLUND sets and equipment are not only listed in this catalog but are on demonstration in our great show rooms.

MORE THAN 10,000 BARGAINS
Besides Short Wave there are more than 10,000 phenomenal values in sets, tubes, speakers, replacement parts, kits, amplifiers, public address systems. Anything and everything in Radio at Lowest Wholesale Prices!

WHOLESALE RADIO SERVICE CO.,
100 SIXTH AVE., NEW YORK, N.Y.

GENTLEMEN: DEPT. SW-43
PLEASE RUSH YOUR NEW, FREE CATALOG No. 54.
Name: _____
Address: _____
Town: _____ State: _____

DO IT NOW
PATENT Z.H. POLACHEK
YOUR IDEAS REGISTER YOUR TRADE-MARK BY 1234 BROADWAY 31st. NEW YORK
REG. PATENT ATTORNEY PROF. ENGINEER
WHAT IS YOUR INVENTION?
Send me a simple sketch or model for CONFIDENTIAL ADVICE

ALUMINUM PANELS Genuine 1/16 "ALCOA" /16
7x10—40c, 7x12—49c, 7x14—58c, 7x18—75c. Any size to order—postage extra. SOMETHING NEW! MARKINGS FOR YOUR PANELS. ON BLACK ALUMINUM Ribbon. LOOKS LIKE ENGRAVING. 5c each. Sample 8c. We do not issue catalogues. Exact Size—
W2FZ
BLAN, The Radio Man, Inc., 177 Greenwich St., N. Y. C.

A 3-Tube Band-Spread Loud Speaker Set

(Continued from page 77)

completely in and out of oscillation. From this it can be seen that it is possible to get right on the edge of oscillation without a hair-splitting adjustment and receive phone signal with the same ease that C.W. signals are received. Then again, it takes a large change in line voltage to have any effect on reception, which means that one does not have to have one hand on the regeneration control all the while phone signals are being received.

47 Tube Used for Output

A type 47 tube is used in the audio stage because loudspeaker operation was desired. Of course, if one expects to use headphones it is suggested that a type 56 be used if the ears are valued at all. Resistance coupling is used in the audio stage because of its economy and the minimum of space it requires.

All necessary data are contained in the diagram for drilling and placing the parts, together with the plans for the construction of the chassis and the shields.

The two 35 mmf. midget tuning condensers are ganged with a flexible coupling. These condensers have to be mounted on posts in order to obtain height enough for the mounting of the dial. These posts can be made of 1/4 inch copper tubing with machine screws run through them to hold the condensers in place.

The R.F. stage is mounted in the left-hand shield. The 100 mmf. tuning condenser and the R.F. volume control of this stage are mounted directly on the front of the shield itself. This layout is also used in the detector stage. The R.F. decoupling resistor and condenser are mounted on the bracket that supports the R.F. coil socket. The grid leak and condenser are mounted in the same fashion in the detector compartment.

The audio tube is mounted between the two shields and directly behind the two ganged 35 mmf. condensers. All parts are mounted on the chassis before the panel is attached, it only being necessary to drill five holes in the panel and mount it over the lock nuts holding the parts to the chassis. This allows a space the thickness of the nuts between the panel and the shields which is a form of double shielding and has been carried out extensively in this receiver.

It is necessary to have very nearly the same amount of capacity in the two tuned circuits of the receiver, if the controls are expected to track with any workable degree and be able to utilize the full tuning range of the two 100 mmf. tank condensers. This would be impossible, of course, if one of the tank condensers were set at a much higher degree of capacity than the other. Therefore, the number of turns stated in the table must be used if the two stages are expected to tune through the band without getting "out of resonance."

How to Tune Receiver

In tuning the receiver the two tank condensers are set at the approximate section of the band on which one desires to receive and the tuning done with the two smaller condensers which are controlled by the main tuning dial. This method allows band spreading at any frequency and still keeps the number of coils necessary to cover the usual short wave bands down to the ordinary amount. For ease in retuning to a previously recorded station, it is suggested that the two tank condensers be calibrated as to their frequency response.

In the receiver described it is usually impossible to use the full gain of the R.F. stage without overloading the detector so it is recommended that the volume control be set at about half way on in

(Continued on page 118)

→THOR'S← ANNIVERSARY SPECIAL!

AUDIOLA <<< SHORT-WAVE CONVERTER

COMPLETE WITH (1)-224, 1-227 R. C. A. TUBES

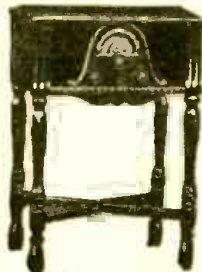

Table Size
27 1/2 x 18 1/2 x 12 deep

Our Special Price,
complete with beautiful table and tubes,

\$8 75

CHASSIS ONLY
WITH TUBES

\$6 75

The Audiola Short-Wave Unit, combined with any Set makes it the latest type Short and Long Wave Set.

The table is big enough to hold any midget set on top.

20 to 200 meters. No plug-in coils. Switch Band Control. A Special LOW RATIO VERNIER DIAL.

Built by the Audiola Co. Designed by Engineers who for 10 years have maintained a reputation for quality merchandise.

Only 300 Units
to be Sold
at These Prices



Mail Orders Promptly
and Carefully Filled.
Include 10 per cent.
Balance C.O.D.

THOR'S BARGAIN BASEMENT 167 Greenwich Street New York

FREE CATALOG

on one of the largest international connector lines for all short wave, broadcast, experimental and servicemen.

Write to
BANK'S INTER-AIR PRODUCTS
41-06 50th Street (SWC)
Woodside, L. I., New York City

Coil-plugs shown. Ideal for 5-meter work. 55 post takes all the plugs, plain Battery markings for short wave sets. 7 colors.

D.X. SPECIAL

CUT OUT INTERFERING STATIONS AND ENJOY FOREIGN PROGRAMS

Just Fix a Pix In the aerial terminal and increase the range and selectivity—permits knife-edge tuning—two million European users. Once "Pix'd" you're fixed to bring in Distant concerts.

Approved by Faraday House Testing Laboratories. Takes the place of complicated wave traps and noise eliminators. Nothing like it before. Money-Back Guarantee. \$1.00 Post-Paid. Send Cash or Money-Order.

FIXAPIX IN YOUR AERIAL

POSTAL RADIO
133-35 Liberty St., Dept. SW, N. Y. City

Read Page 116—Every Book Described You Will Find of Interest

Short Wave and Amateur Specialties

- Hammarlund new type Air-Tuned I. F. Transf. shielded each..... \$2.64
- National latest type Air-Dielectric Tuned I. F. Transf. shielded, each..... 2.94
- Hammarlund New Comet "Pro" and National PB-7 Short Wave Receivers in stock—write for prices.
- EBY Low-Loss Isolantite sockets: 4 or 5 prong—25c each, 6 prong—27c. 7 prong—30c.
- EBY Bakelite Sockets—either for above or below sub-panel mounting—4 or 5 prong—each 14c. 6 prong—19c. 7 prong—22c.
- 4 prong wafer, square shape sockets..... 4c
- 5 prong Majestic Wafer sockets..... 5c
- 6 prong oval type wafer sockets..... 6c, 7 prong—7c
- Full Vision Dials with Escutecheons..... 89c
- G. R. Plugs..... 6c. Jacks, 5c
- Write for very special prices on CARTER Power Transformers.
- Plug-in Coil Forms—bakelite—ribbed surface—4 or 5 prong..... 22c each. 6 prong, 29c
- Biley X-cut Crystals..... \$4.50
- Biley New Type Crystal Holder..... \$1.50
- Pyrex insulators and stand-offs in stock.
- Duovac Transmitting tubes in stock—write for special discount.
- Readrite D.C. Meters 0-5 to 0-400 m.a..... each 59c
- 806 M. V. Rectifiers—guaranteed..... \$1.39
- 210 type tubes—guaranteed..... \$1.20
- Filament trans.
- Crystal Blanks 1" square—very special..... 85c
- Magnet Wire, Shielded Cable and aerial wire stocked. Dry Cells 4"x1 1/4" for Monitors, etc., where space is limited each..... 15c

Filament Transformers—Receiving and Transmitting Types:

- 2 1/2 volts at 12 A.C.T.; 5 Volts at 2 A.C.T.—(semi-cased) \$1.10
 - 2 1/2 volts at 12 A.C.T.; 2 1/2 V. at 3 A.C.T.: 5 V. at 2A.—(semi-cased)..... 1.25
 - Sec.—7 1/2 V.C.T. at 3 A.; 7 1/2 V.C.T. at 3 A.—(cased)..... 3.75
 - Sec.—10 volts C.T. at 7 A.—(cased)..... 3.75
 - Sec.—12 Volts C.T. at 7 A.—(cased)..... 3.75
 - Sec.—2 1/2 Volts C.T. at 12 A.—(cased)..... 3.75
 - Sec.—5 Volts, C.T. at 20 A.—(cased)..... 5.50
 - Sec.—2 1/2 Volts, 3 amps. (semi-cased)..... 1.45
 - Crystal Blanks—X-Cut..... 79c
- 20% with each order, balance C. O. D. Cash, postal or express money orders accepted. Write for NEW bulletin.

MAURICE SCHWARTZ & SON 710-712 Broadway Schenectady, N. Y.

FLECHTHEIM SUPERIOR DRY Electrolytic Condensers

Made in U. S. A.
A. M. Flechtheim & Co.
136 Liberty Street
New York City

Please write for Catalog No. 25 and 25A

SOLEX CALIBRATED LIGHT SOURCE FOR TELEVISION



TYPE 15

IDEAL FOR

TELEVISION ENGINEERS
AND EXPERIMENTERS
INDIVIDUALLY CALIBRATED
AND EACH LAMP FURNISHED WITH
COMPLETE DATA AND
CHARACTERISTIC.

COLD CATHODE
ANY DIAMETER
APERTURE

RED—GOLD—WHITE

SOLEX LIGHTS

5064 Broadway, New York City

"HAM" ADS

Advertisements in this section are inserted at 5c per word to strictly amateurs, or 10c a word (8 words to the line) to manufacturers or dealers for each insertion. Name, initial and address each count as one word. Cash should accompany all "Ham" advertisements. Not less than 10 words are accepted. Advertising for the July Issue should reach us not later than May 18.

SHORT WAVE CONSTRUCTION KITS, SETS, Supplies. Wholesale Catalog 5c. Federal Radio & Telegraph Co., 4224 Clifford Road, Cincinnati, Ohio.

PLUG-IN COILS, SET OF 4, 50c. AMATEUR band spreading or 14-200 meters. Guaranteed. State choice. Gordon, 28 Clinton St., Santa Cruz, Calif.

SOCKET HOLE DIE PUNCH 1 1/4" CLEAN hole in 1/8" sheet iron, 3/4" aluminum 75c. C. O. D. Stoughton Mfg. Co., 84 Oak Street, Portland, Maine.

TRANSFORMERS, CHOKES BUILT OR REWOUND to order. New low prices. Boston Transformer Co., 886 Main Street, Cambridge, Mass.

FEEDER SPREADERS \$0.4, TRANSPOSITION blocks .05. Doublet antennas for any band. If it's Short Wave, we do it. J. W. Cherryhomes Radio Service, Jacksboro, Texas.

DX FANS—NEW TYPE AERIAL WIRE JUST out. Has all other aerial wires beaten. Marvelous for reception and transmitting. Free sample. J. F. Barry, Box 335, White Plains, N. Y.

TRANSFORMERS AND COILS REWOUND or made to order. Transformer laminations for the experimenter. Inclose 3c for prices and data sheets. Pemberton Laboratories, 921 Parkview, Fort Wayne, Indiana.

PLUG-IN COILS, SET OF FOUR WOUND on Bakelite four prong forms. 15-210 meters with .0001 condenser .75. Tube bases .05 each. Coils wound to order. NOEL, 809 Alder, Scranton, Penna.

U. S. NAVY DYNAMOTORS—IDEAL HIGH voltage supply operating from storage batteries. General Electric 24/1500 volt, 350 watt \$37.50; 24/750 volt, 150 watt \$25. On 12 volt deliver 375. Westinghouse 27 1/2/350 80 mills \$10. Mounted twins \$15. 500 cycle 500 watt \$7.50. All ball bearings. Harry Kienzle, 501 East 84th Street, New York.

IMPROVED 12,500 MILE RECEIVERS, PEN- tode output giving three times the volume, quality parts such as Hammarlund and pilot condensers, aluminum panel, Vernier dial, coils, when wired tested on foreign reception. Kit \$3.95. Wired \$4.45. W2EUN, 619 Leland Ave., Bronx, New York City.

TELEPLEXES, OMNIGRAPHS RENTED complete 75c a week; \$10 deposit. Lowest prices on Comet Pros, National receivers, all short wave apparatus. Henry's Radio Shop, Butler, Mo.

RADIOS, PARTS, LIST FOR STAMP. Plavetchi, 1597 East 47th, Cleveland, Ohio.

JUST OUT: HOTTEST DX 2-TUBE SW CIR- cuit. Blue print 25c coin. 4 special 11-280 Coils \$1.25. Modern Radiolabs, 1508-23rd Avenue, Oakland, Calif.

CRYSTAL DETECTOR, SHORT WAVE PIC- torial blueprint. Something new in DX reception, 25c (coin). Four Na-Ald coils (15-200 Meters) to match Hammarlund .00014 mfg. midjet condenser, both \$2.50. Super Engineering, 1313-40th St., Brooklyn, N. Y.

SHORT WAVE LISTENERS CARDS: JUST what you need for reporting the stations you hear. Write for free samples today. WIBEF, 16 Stockbridge Ave., Lowell, Mass.

SHORT WAVE RADIOS, CUSTOM-BUILT. Low prices. Amateurs, beginners write to Armstrongs, Webster City, Iowa.

CODE MACHINES, TAPES AND COMPLETE instruction for beginners or advanced students—both codes—for rent—\$2.00 per month. Rental to apply on purchase price. Extra tapes for all machines. Instructograph, 912 Lakeside Place, Chicago.

WIBTE PLUG-IN COILS, NA-ALD FORMS, wound for your receiver, four for \$1.00. Hall, Brockton, Mass.

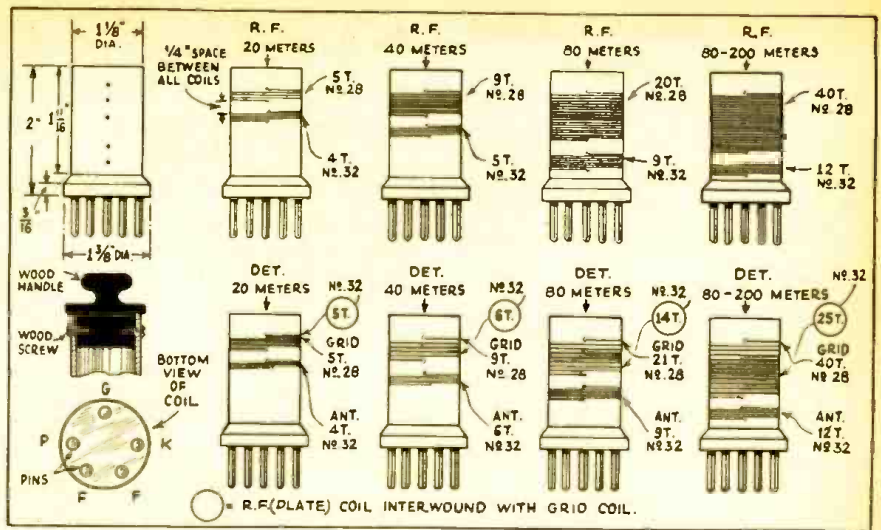

Coil Winding Data for Shuart 3-Tube Band-Spread Set.

tuning in a station and then bringing the "volume level" up as desired. With the volume control set in this position the selectivity of the set is as good as the average short wave "super" and as to volume, well, any foreign short wave station that is received in this country can be brought in on the loudspeaker, with ease.

List of Parts

- 1—7"x10"x1/8" aluminum panel
- 2—5 1/2"x21 1/2"x1/8" sheet aluminum for shields
- 1—12"x10" aluminum for base
- 1—Type 58 tube Sylvania (R.C.A.)
- 1—Type 57 tube Sylvania (R.C.A.)
- 1—Type 47 tube Sylvania (R.C.A.)
- 6—Hammarlund coil forms (five prong) "small" Isolantite
- 2—Hammarlund five-prong sockets Isolantite
- 2—Hammarlund six-prong sockets Isolantite
- 2—Hammarlund 100 mmf. tuning condensers
- 2—Hammarlund 35 mmf. tuning condensers
- 1—Hammarlund flexible coupling
- 1—National type "B" dial
- 1—100,000 ohm Electrad potentiometer (Claro-stat)
- 1—5,000 ohm Electrad potentiometer (Claro-stat)
- 2—Aerovox .5 mf. bypass cond. (Polymet)
- 5—Aerovox .01 mf. fixed cond. (Polymet)

- 1—Aerovox .005 mf. fixed cond. (Polymet)
- 1—Aerovox .0001 mf. fixed cond. (Polymet)
- 1—Aerovox .00025 fixed cond. (Polymet)
- 2—Aerovox 250,000 ohm resistors (Lynch)
- 1—Aerovox 100,000 ohm resistor (Lynch)
- 1—Aerovox 15,000 ohm resistor (Lynch)
- 1—Aerovox 2,000 ohm resistor (Lynch)
- 1—Aerovox 300 ohm resistor (Lynch)
- 2—Aerovox 2 megohm resistors (Lynch)
- 1—Aerovox 20 ohm C.T. resistor (Claro-stat)
- 1—Eby five-prong socket
- 1—Hammarlund "Triple-grid" tube shield
- 1—Five-wire cable
- 1—Antenna binding post assembly
- 1—Speaker cord tip assembly.

PLUG-IN-COILS, FOR NEW '57, '58 D.X. Circuit (tunes 14 to 200 M with .0001 M.F.D.) \$1.00. Amateur band-spread coils Ea. 30c. Circuit free. M. Carney, 2041 So. Kennison Dr., Toledo, Ohio.

SWL AND QSL CARDS, FREE SAMPLES. Radio Press, Springdale, Pa.

ONE TUBE SHORTWAVE "MARVEL" Blueprint dime. Blanchard, 438 N. 9, Reading, Pa.

NEW EXPLORER, LOW-PRICED SHORT wave kits and receivers. One tube kit—\$4.25; two tube—\$5.50; three tube—\$7.50. Free catalogue. Rim Radio Mfg. Co., 691 Grand Street, Brooklyn, N. Y.

1—\$18.00 **CROSSMAN AIR GUN, \$7.50.** \$75.00 Victoreen B.C. Superheterodyne, 5 volt D. C. model, 8 tubes, for \$15.00, includes Weston meter. 1—National B.C. Screen Grid Tuner (110 v. A.C.) and Thordarson Power pack, 8 tubes, make offer. 1—6 foot R.A.C. Victor Exponential Horn with electric pick-up, make offer. Satisfaction guaranteed. Dataprint Company, Ramsey, N. J.

DIZZY CARTOON FOR QSL OR SHACK. Send \$2 with your rough idea for large original pen drawing. W1AFQ, Harwich, Mass.

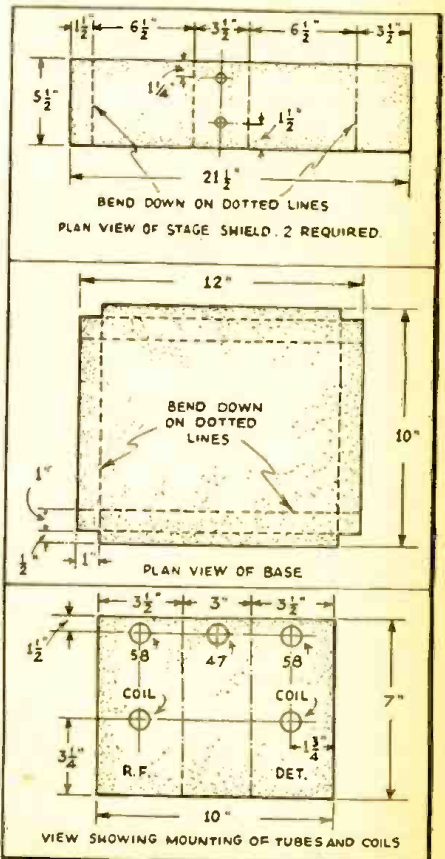

Details of aluminum chassis used by Mr. Shuart in building his 3-Tube Band-Spread Receiver.

A Multi-Wave 7 Tube Receiver

(Continued from page 94.)

The rectifier tube used in the plate supply section is of the 80 type. Two good sized iron core chokes, of thirty and fifty henries respectively, coupled with healthy sized filter condensers, serve to deliver a quiet plate supply current.

Referring to the interesting coil components of Mr. Whisk's Multi-Wave Receiver, we have the following data supplied by the constructor of this set.

Referring to the band-pass tuner, the four coils, L1 to L4 inclusive, have the following turns: L1, 10 turns, No. 30 enameled magnet wire, wound on a bakelite or other tube 3" long by 1 1/4" in diameter; alongside of L1 is wound L2, comprising 150 turns of No. 30 enameled wire. On another similar tube are wound coils L3 and L4; L3 has 6 turns of No. 30 enameled wire, and L4 has 150 turns of No. 30 enameled wire. 3/8" space is left between the windings comprising L1-L2 and L3-L4.

The broadcast coils, L5 and L6, each have 150 turns of No. 30 enameled wire and wound on 1 1/4" diameter tubes.

The short-wave coil data are as follows: The first group of S.W. coils connected to the first or left-hand five-point switch are the tuned grid inductances for the 24 R.F. tube, as can be seen from the diagram; the first two coils are wound on 1 1/4" outside diameter tubes, the 80 to 200 meter coil comprising 33 turns, No. 26 enameled spaced to a length of 1 1/16"; the 40 to 80 meter coil having 14 turns, No. 20, enameled wire spaced to a length of 7/8". The third coil, covering the 20 to 40 meter band, has 10 turns of No. 16 enameled wound to a length of 7/8" on a tube 7/8" O.D. (outside diameter), and the fourth coil, covering the 10 to 20 meter band, is wound on a similar sized tube and comprises four turns of No. 16 enameled spaced 3/32" between turns.

The second group of S.W. coils, connected to the second five-point switch of the gang, follows the same winding data as that just given.

The four short wave tickler coils, which are separated by a 3/16" space from the plate coils (the second group of S.W. coils), are wound on the same tube with them and contain the following turns:

Tickler Coil Data

80 to 200 meter band, 22 turns, No. 28 D.S.C. close wound; 40 to 80 meter band tickler, 11 turns, No. 28 D.S.C. close wound, these two ticklers being wound on the 1 1/4" O.D. tubes with the plate coils as previously explained.

Tickler coil for 20 to 40 meter band, 8 turns, No. 28 D.S.C. close wound; 10 to 20

ALAN PRIZE WINNER

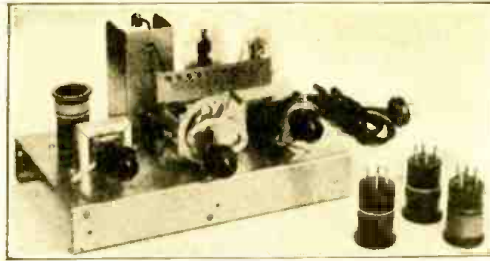

Remarkable sensitivity, the new 78 heater type RF pentode is used in the detector stage

Efficient power conversion, the new heater type rectifier tube, the 25Z5, is used. For greater output and complete elimination of hum the new 43 heater type pentode is used in the output stage.

Complete kit of PRIZEWINNER parts identical in every respect with those used in built-up models, complete in every detail including hardware, hookup wire, solder, coils, etc. \$8.95 and also the cabinet and dial. Price..... \$3.75

Set of RCA tubes for above..... \$3.75

Assembled, wired, tested and enclosed in beautiful crackle finish metal cabinet, ready to plug into your power line. Complete with \$10.95 four coils..... \$10.95

NEW UNIVERSAL AC-DC AMPLIFIERS for all PORTABLE PUBLIC ADDRESS purposes, using the latest type tubes. (43, 25Z5, 37) complete with R. C. A. \$14.95

EXTRA SPECIAL on: Samson Audio Components interstage push pull \$2.95, INPUT Push Pull \$1.99. Special outputs \$2.95 up.

The house of dependable service. Mail orders promptly filled.

ALAN RADIO CORP.
835 Cortlandt St. N. Y. C.

meter tickler, 5 turns, No. 28, D.S.C. close wound, the last two ticklers being wound on the 7/8" O.D. tubes with the remaining two plate coils.

In arranging the various S.W. coils in each group these may be spaced about two to two and one-half inches on centers, in the same manner as shown in Mr. Palmer's article, page 32 of the May, 1932, issue, or in a manner similar to that used in the Best and other similar S.W. coil assemblies.

To anyone interested in building a set of this type, there is very simple solution of the coil problem, if you intend to buy the coils already made; the second and third groups of S.W. coils, in view of the fact that they are tuned by .00014 mf. condensers, shunted by a trimmer of .000015 mf., may be commercial S.W. coils such as the Gen-Win, Na-Ald, I. C. A., or any other coils designed to operate with .00014 mf. tuning condensers. The first group of S.W. coils would necessitate buying another set of the usual four pin plug-in coils, suited for use with a .00014 mf. tuning condenser, and removing the tickler windings.

A word of caution in regard to mounting the S.W. coils: the first group of four S.W. coils at left of the diagram had best be mounted in a shielded compartment, away from the second assembly group, comprising four plate coils and their corresponding tickler windings. Grounded aluminum or other shield material should be spaced away from the coils at least 1 1/2" to avoid undue broadening of the

AC-DC Short Wave Receiver

Completely Self-Powered
Latest Type Tubes
15 to 200 Meters

THE PRIZEWINNER is complete. No extras, such as power supply coils, etc., to buy. Power supply is built-in and will operate on EITHER AC OR DC! Four coils, (included) cover all bands, 20,000 KC to 1,500 KC.

Short Wave Specials

RESCO 3 RECEIVER

Using 1-34 Screen Grid and 2-30 tubes, constructed of quality parts throughout aluminum chassis and panel, Vernier dial, range 15-200 M.

Assembled, Wired and Tested

\$9.75 less tubes

Resco 5. W. 5 Tube A. C. Receiver

using (2) 57's—(2) 56's and (1) 280 rectifier. Aluminum chassis and panel with Vernier dial. Special

\$17.95 less tubes

SHORT WAVE BARGAINS

2 1/2 V. 8 amp. fil. trans. cased.....	\$1.69
Set of 4 short wave plug-in coils.....	1.79
Billy Crystals 40-60—160 meter.....	3.50
Class B Transformers Type 40, per pair.....	4.95
Class B Transformers Type 203 A's, per pair.....	9.95
American Double Button Mike.....	5.95
3" Bakelite Vernier dial.....	.60
Bakelite coil forms ribbed.....	.19
Water Socket 4, 5 or 8 prong.....	.08
Telegraph Keys.....	.80

All Merchandise Guaranteed

Radio Electric Service Co., Inc.
N.E. Cor. 7th & Arch Sts. Phila., Pa.

tuning and also inductive losses. Regeneration control in the detector stage is taken care of by the 50,000 ohm potentiometer, by-passed by .02 mf. condenser to ground. Mr. Whisk reports very excellent success with this circuit.

"Java" Hot from the Percolator

(Continued from page 72)

plates. Next the rotor was treated likewise, leaving 2 plates. This particular condenser had no shoulder on the rotor shaft, so the extra length of shaft was allowed to come through the front bakelite mounting end. A hole was cut in the side of the coffee pot and the shaft measured and cut off with a hack-saw. The shaft was held snugly on center through the panel by a bushing made from a brass nut and mounting ring or panel fitting of an old earphone jack. An extra bakelite condenser end of the same size and shape as the one used was slipped over the shaft, so that the brass nuts on the bolts supporting the stator plates would not ground to the panel. Finished, I had a 1 1/4 inch semi-midgert condenser made from one formerly measuring 2 1/2 inches. (C-2)

Because of limited space a potentiometer (R-2) mounted opposite, on the right, with the by-pass condenser (C-4), was used to

control regeneration, which it does very nicely. The shaft is insulated from the chassis by fiber washers.

Directly behind these two controls, on an aluminum strip wide enough to accommodate a socket, are mounted the two tubes, upside down, in two wafer sockets. Mounting in this manner made very short leads to the grid condenser and grid-leak and coil terminals, and also provided access to the socket terminals for soldering and inspection. Rubber washers were placed under the bolts holding the tube mounting strip, to help eliminate microphonic noises. The grid condenser (C-1) and grid-leak (R-1) are mounted on a brass leg, which is in turn screwed into one of the projecting bolts holding a tube socket.

Again to the "junk box," which supplies me with a small size audio transformer (T-1) and materials for the R. F. C. (radio frequency choke) which, with by-pass con-

denser (C-3) and battery switch, are located in the lower portion of the percolator.

The R. F. C. is an old sewing thread spool cut in 4 sections 1/4 of an inch thick each. Next a 1/4 inch fiber shaft was pushed through the hole in the center of all four and each section spaced 1/16 of an inch apart, then wound full of enameled magnet wire taken from an old Ford spark coil. (About No. 36 B. & S. gauge.) Finished, it will have approximately 300 turns in each of its 3 sections. Stiffer mounting wire is soldered to the small choke wire and then twisted once around the fiber shaft. Then 1/4 inch fiber washers are pushed snugly over each end of the shaft, tight against the choke form. It can be mounted the same as a pigtail resistor.

Another expense was eliminated by using the regular A. C. input posts as output jack, for the phones. A regular elec-

tric iron appliance plug was substituted for a phone plug.

No resistance is needed in the "A" battery lead as only 2 volts is supplied the tubes, this eliminating a third control.

The original bolts holding the handle were removed and brass ones put in their place and the heads cut off. The top one is antenna, and extends through the aluminum chassis to the set and is insulated by fibre washers. Both were fitted with binding posts which serve to hold the handle as well as to connect antenna and ground. The lower one, the ground, merely grounds to the chassis. Color-coded battery wires lead out of the spout.

The problem of how to construct the top in such a manner that the lid might be lifted without soldering and unsoldering was next.

Another trip to the "junk box" supplied an old bakelite earphone case. The screw cap and unit were removed. The perforated cap was cut out enough to allow a 5 prong wafer socket to be mounted under the hole just cut. The cap was drilled and the socket bolted under the hole in the cap. Next five small holes were drilled in the back of the earphone case, and a 5-prong tube base cut off, leaving only the prongs and bottom of the base. This was bolted on the back of the case over the five holes. Wires from the socket terminals go through the case and solder to the tube base prongs. The cap is screwed on and the unit is finished. The entire case is then bolted to the lid under the hole left by the glass percolator top.

Directly below the unit just described, mounted on a bakelite strip bolted to the chassis by aluminum angles, is a second 5-prong wafer socket, into which the cut tube base on the earphone case plugs as the lid is closed. By this plugging system the lid may be raised and lowered without soldering and still provides good contacts. An aluminum clamp holds the lid from

raising as the coils are plugged in and out. To complete the neat appearance of the set, a coil shield was designed from a large aluminum salt shaker. The screw top or perforated part was cut out, leaving space for the bolts which hold the earphone case and also the shaker top. The shield is turned upside down and screwed into its own top. The color code is pasted in the top of the coil shield. The proximity of the shield effects the coils characteristics but little. It may be left off in tuning below 25 meters, if desired.

The coils L-1, L-2 and L-3 are all wound on one form; namely old 5-prong tube bases. Two bases may be joined together by a good grade of cement to afford additional winding space for coils of higher wave-length. With no antenna compensating condenser it may be necessary to experiment in spacings between windings to eliminate "dead-spots." The set works equally well with or without a ground up to 100 meters. Because of the complete enclosure of all parts in grounded aluminum much wiring was eliminated.

Use a single cell of a storage battery as an "A" battery. Often batteries having one good cell can be bought for junk in garages and battery shops for as little as fifteen or twenty-five cents. They will last two or three months under normal drain.

Forty-five volt "B" batteries may be used instead of ninety with but little drop in signal strength.

Blown fuse plugs of the visible mica type can be removed from their brass fittings and waxed into tube bases to form no-cost low-loss coil handles. A slip of paper showing the coils number or wave-length can be put in the handle and will be readable through the mica top.

Volume on the phones is great enough to be really uncomfortable on many broadcast, police, airport, and amateur stations. I have received all nine amateur districts

with "hams" in twenty-five states and more coming in, as well as many airport and police stations. Also the following—with loud speaker volume!

Springfield, Ill.	W1XAZ	31.33 Meters
Schenectady, N. Y.	W2XAF	31.48 "
Chicago, Ill.	W9XAA	49.31 "
Sydney, Australia	VK2ME	31.28 "
Mexico City, Mex.	X1Q	40. "
Caracas, Venezuela	YV1BC	6,112 Kilo.
Pittsburgh, Penn.	W8XK	19.72 Meters
Bound Brook, N. J.	W3XAL	16.87 "
Melbourne, Australia	VK3ME	31.55 "
Vancouver, B. C.	VE9CS	49.40 "
Honolulu, Hawaii	KKP	"
Boston, Mass.	W1XAL	25.45 "
Bandoeng, Java	PLE	15.94 "
Chicago, Ill.	W9XF	49.18 "
Khabarovsk, Siberia	RV15	70.20 "
Philadelphia, Penn.	W3XAU	"

Coil No.	Wavelength Approx.	Coil Winding Directions		Tick
		L-1	L-2	
1-	14-20	4 3/4 T.	2 3/4 T.	L-3 3 3/4 T.
2-	20-29	5	3 3/4	8 3/4
3-	30-40	9	7 3/4	8 3/4
4-	40-50	11	14 3/4	10 3/4
5-	49-85	14	38	12
6-	80-125	10	60	14.

T-No. of turns.
All coils wound with No. 28 D.C.C. wire.
Approximate Spacings:
Coil No. 1-2—1/16 in. between L-2 L-3
Coil No. 3-4-5—1/4 in. between L-1 L-2 L-3
Coil No. 6—1/4 in. between L-1 L-2 L-3
Coil No. 6—wound on 1 1/2 in. form slipped over tube base.

- List of "Ingredients"
- L-1 L-2 L-3 (see coil winding directions).
 - C-1 .00025 m.f. grid condenser with clips
 - C-2 tuning condenser (see text)
 - C-3 .001 m.f. by-pass condenser
 - C-4 1/4 m.f. by-pass condenser
 - R. F. C. see text
 - T-1 Crosley audio transformer
 - R-1 5 megohm grid-leak
 - R-2 50,000 ohm Frost potentiometer
 - 2-4 prong EBY wafer sockets
 - 2-5 prong EBY wafer sockets
 - 2-30 type tubes
 - 1-toggle switch
 - 1-electric iron plug
 - 1-aluminum salt shaker
 - 1-bakelite earphone case
 - Misc. angles, nuts, bolts, washers, etc.

And NOW The Oscillodyne 1 TUBE Wonder Set

And here are letters from those who have actually tried this wonder set:

HOW IT WORKS!

I have constructed the OSCILLODYNE RECEIVER and boy! how it works!
The first day without any trouble I received Spain, England, France, and other foreign countries. Amateurs why I never knew there were that many until now. With the one tube Oscillodyne, I bring in more stations on one plug-in coil than with a set of coils on different shortwave sets.
IF ANY ONE IS TRYING HIS LUCK ON SHORT WAVE SETS, IT WILL BE WORTH WHILE TO CONSTRUCT THE ONE TUBE OSCILLODYNE.
PAUL KORNEKE, JR.,
N. S. Pittsburgh, Pa.

A PEACH!

The oscillodyne receiver, believe me is a "peach". I set short-wave stations from Germany, France, Spain and Italy—not to mention the American stations, including amateurs all over the United States.
I heartily recommend this set to any Short-wave fan.
HENRY TOWNSEND,
Rainey, N. J.

A NEW SHORT-WAVE DEVELOPMENT!

WE take great pleasure in announcing that we have acquired the sole rights to manufacture exclusively the Official Oscillodyne One Tube Set as designed by Mr. J. A. Worcester, Jr. This novel set was first described in the April, 1933 issue of SHORT WAVE CRAFT, and since that time hundreds of builders who have built the set themselves have declared that it is the most efficient and greatest wonder in short waves created so far.

Here is what the editor of SHORT WAVE CRAFT says in the April issue: A REALLY NEW CIRCUIT

We are pleased to present to our readers an entirely new development in radio circuits. Under the name of "The Oscillodyne," Mr. J. A. Worcester, Jr. has developed a fundamentally new circuit. This circuit, which is of the regenerative variety, acts like a super-regenerative set although it does not belong in this class. Its sensitivity is tremendous. The editor, in his home on Riverside Drive, New York, in a steel apartment building, was able to listen to amateurs in the Midwest on this simple one tube set, without aerial and no ground!
With a ground alone, a number of Canadian stations were brought in, and with a short aerial of 40 feet length, many foreign stations were pulled in easily.

This circuit is certainly an epoch-making one which should find immediate acceptance by the entire radio fraternity. The circuit has the advantage that it is not tricky if good material and common sense are used. The set was tested in different parts of the East, and it has been found that the results are satisfactory in practically every location. In our own estimation, the Oscillodyne is one of the greatest recent developments in radio circuits, and the editors recommend it warmly to all readers.

Here then, is a set that brings in stations thousands of miles away, a set that frequently brings in Australia loud enough to rattle your phones with surplus power to spare; a set that if you do not wish extreme distance will bring in stations several thousand miles away without aerial or ground.
The set as we now sell it either completely wired or in kit form, is absolutely foolproof. Simple directions show you how to work the set for full satisfaction.

This is the Ideal Beginner's Set
If you have never used a short wave set, this is the one to get—If, on the other hand you are a hard-boiled short wave fan and know the difficulties of the usual short wave set, the Oscillodyne is the set that will convince you that foreign stations CAN be tuned in whenever you want them, providing they are on the air.

Only First Class Parts Used
We admit it is possible for you to buy parts for the Oscillodyne for less than we sell the kit, but after having tried a low-priced kit, we refused to put it upon the market because the results were not satisfactory. In short waves only the best material will work. Cheap material brings you nothing but grief. For that reason we are using the latest type Hammarlund condenser, Kura-Kasch vernier dial, Centralab potentiometer, and space-wound coils with the best insulation obtainable.

The panel is of aluminum, and the sub-base for higher insulation purposes is of Bakelite. That is why this set prices right. No guesswork—no disappointments.

Absolutely Fool-proof
There is absolutely nothing to go wrong with the Oscillodyne. It is to be used in connection with a 237 type tube, which uses very little current, and, therefore, your "B" batteries will last a long time. Four ordinary dry cells are all you require. 90-volt "B" battery is sufficient.

If you do not wish to use "A" batteries, a type 27 tube will work exactly in the same manner and then all you require is a 2 1/2 filament transformer connecting it to your A.C. line. No filters are required with this tube.

Laboratory Tested
All assembled sets are actually tried out on the aerial and must work right before they pass the inspector's hands. Our own tests have convinced us that the Oscillodyne is an entirely new circuit, the first one to come along in years.
It would be simple for us to list several hundred stations in foreign countries which we have listened right along and are still logging, but we always prefer to have our customers about whom results, and that is why, difficult as we find it to do, we must suppress our enthusiasm.

Guarantee
Our usual guarantee (see our full page ad elsewhere) also pertains, of course, to the Oscillodyne. Read this guarantee.
Official Oscillodyne Wonder Set
The set is exactly as illustrated here. Size of aluminum panel is 8" high by 4 1/2" wide, base 5 1/2" long by 4 3/4" wide. List of materials used:
No. 2146. Official One-Tube Wonder Set, completely wired and tested, as per above specifications. \$6.20
YOUR PRICE \$5.35
No. 2147. Official One-Tube Wonder Set, but not wired with blueprint connections and instructions for operation, complete shipping weight 3 lbs. YOUR PRICE \$5.35
No. 2148. COMPLETE ACCESSORIES, including the following: one 6 month guaranteed Neontron No. 237 tube; one set No. 1078 Brandes matched headphones; four No. 6 Standard dry cells; two standard 45-volt "B" batteries, complete shipping weight 22 lbs. YOUR PRICE \$5.10

FREE 104-page Radio and Short Wave Treatise; 100 hook-ups, 1,000 illustrations. Enclose 4c for postage. Treatise sent by return mail.

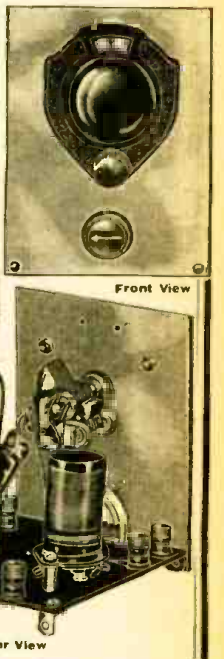

ORDER DIRECT FROM THIS AD

Send money order or certified check. C.O.D. only if 20% remittance accompanies all orders. Return NOW—TODAY.

RADIO TRADING COMPANY, 100A Park Place, New York City

New 2-Tube S-W Converter

(Continued from page 90)

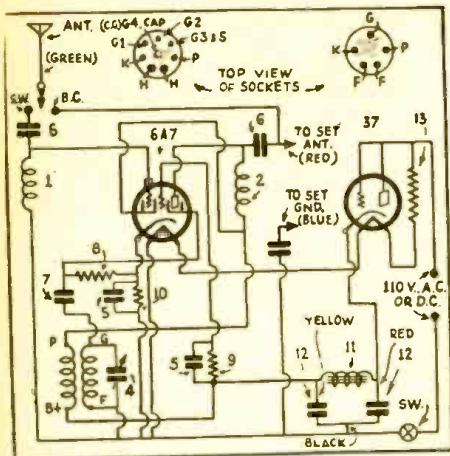

Hook-up of S-W Converter

one has simply to plug the cord from the converter into a convenient 110 volt AC or DC lamp socket. The dial on the BC receiver is set to approximately 650 KC or 460 meters, or as close to this point as freedom from BC interference will permit; for tuning the short waves the center dial on the converter is used, the dial on the BC receiver being left set at 650 KC.

The range of this ICA Scout S-W Converter is from 200 meters down to 60 meters and by means of an additional plug-in coil supplied at slight extra cost, the short-wave range can be extended down to 20 meters.

"Prize-Winner" Short Wave Receiver

(Continued from page 90)

Coil Data For Use With 165 Mmf.

Coil Forms: 1 1/4 inch diameter, five prong type.
 "G" terminal of grid winding at top of form.
 "P" terminal of tickler winding at bottom of form.
 All windings close wound except "A."
 Spacing on "A" equal to diameter of wire.
 All windings wound in same direction.
 Grid terminal of form not used.

Wavelength (meters)	Grid		Tickler		Separation
	Type of wire	Turns	Type of wire	Turns	
'A'-14 to 35	No. 20 enam.	5	No. 28 SCC	3	5/32"
'B'-34 to 63	No. 20 enam.	11	No. 28 SCC	4	5/32"
'C'-62 to 112	No. 24 SCC	19	No. 28 SCC	5	1/8"
'D'-110 to 195	No. 26 SCC	48	No. 28 SCC	7	3/32"

List of Parts

- COILS**
 1 set four "Prize Winner" coils to cover 14 to 200 meters or as described in table.
 1 AUDIOFORMER (National, etc.)
 1 15 h., 100 ohm filter choke
 1 25 h., 350 ohm filter choke
- CONDENSERS**
 1 .00004 mf. Ant. Trimmer (Hammarlund)
 1 .01 mf. bypass, Aerovox
 1 .02 mf. bypass Aerovox
 1 Prizewinner 165 mmf. short-wave condenser
 1 .0001 mf. mica bypass condenser (Elmenco)
 1 .00035 mf. mica bypass condenser (Elmenco)
 1 10 mf. 25 volt electrolytic bypass (Dubilier)
 1 Filter block consisting of two 8 mf. and one 16 mf. 200 v. electrolytic condensers (Aerovox, Wego)
- RESISTORS**
 1 5 meg. resistor
 1 600 ohm one watt resistor (Elmenco)
 1 100,000 ohm 1/2 watt resistor (Elmenco)
 1 50,000 ohm potentiometer (Centralab)

S-W Beginner

(Continued from page 98)

2 megohms to 10 megohms and find the value that will permit the set to oscillate over the widest range (assuming that the set does not oscillate up to the maximum dial reading). Then splice a wire to the end of the tickler coil and wind on a few extra turns. You will notice that the oscillation is much further up the scale. Repeat this procedure until the set just oscillates at the top end of the scale when the regeneration condenser or resistor is at the maximum position. Finally, remove the entire tickler coil, count the number of turns and rewind it with a new length of wire.

If the set has points over the length of the scale at which oscillation cannot be obtained and the aerial adjustment does not help or if the set drops into oscillation with a loud "plop," the tickler coil is probably too large. The procedure in this case is to set the regeneration condenser or resistor to the maximum setting and turn the tuning dial to the maximum position. Then, very cautiously remove one turn at a time, until the set just oscillates.

Another trouble met with when using a 50,000 ohm potentiometer to regulate the voltage applied to the screen grid of an S-G detector, is "sudden oscillation"; remedy—reduce the voltage fed to the B+ end of the potentiometer, or place a 10,000 to 20,000 ohm resistor in series with it; also use a .01 mf. bypass condenser from potentiometer arm to ground.

Two methods of connecting the tickler coil and regeneration control are shown in Figs. 3 and 4. There is some question among short-wave experimenters as to which of these two methods is preferable. In order to show the difference between the two, we have placed small arrows to indicate the instantaneous path of the radio frequency current flowing in the plate circuits of the two circuits.

You will notice that in Fig. 3 the current must pass through the tickler coil before it reaches the R.F. choke and the audio frequency transformer. In this way, the plate coil will feed current back into the secondary coil, even if the R.F. choke coil has a resonance point in the band. In the other method, there are two paths for the R.F. current that flows from the plate of the detector tube. One of these is through the tickler coil and the other is through the R.F. choke and the audio frequency transformer primary to the filament circuit. If the choke is not successful in retarding the flow of R.F. currents, they will pass through the low impedance of the audio transformer winding and will not be useful in feeding current back into the secondary coil. As regeneration and oscillation depend on sending some of the current in the plate of the detector back into the grid or secondary circuit, in order to build up the strength of the current which carries the signals, this leakage in the R.F. choke will obviously prevent the detector from oscillating.

For this reason, the circuit in Fig. 3 is to be preferred to that shown in Fig. 4.

OTHER REQUIREMENTS

- 1 Ant. and Gnd. terminal strip
- 1 Strip for phones
- 1 6 prong wafer socket marked 78
- 1 6 prong wafer socket marked 25Z5
- 1 6 prong wafer socket marked 43
- 1 5 prong wafer socket marked coil
- 1 Prizewinner stamped chassis (all necessary holes punched out)
- 1 Metal Cabinet, crackle finished
- 1 10 to 1 vernier dial
- 1 Escutcheon plate for dial
- 1 Tube shield
- 1 Rotary "off" & "on" line switch
- 3 One-inch bakelite knobs
- 1 Line cord
- 1 Pair head phones (or magnetic speaker)
- 1 Type 78 tube
- 1 Type 43 tube
- 1 Type 25Z5 tube

QUALITY APPARATUS FOR Short Waves

GEN-WIN SHORT WAVE COIL KIT



These coils are considered the finest made. Each coil is precision wound on a different colored bakelite form for quick identification of wave lengths. Used and highly recommended by all short wave experim. Ranges (15 to 225) meters, using a .00014 or .00015 mfd. condenser. Recommended for the following sets: "The Globe Trotter," "The Overseas," "The Doerle 12,500 Mile Two Tube Receiver and Doerle Three Tube Signal Gripper," "The Megadyne."
 4 Coil Enamel Wire \$1.50
 4 Coil Litz Wire \$2.25
 Broadcast Coil. (200 to 550 meters) \$5e

POLICE AND SHORT WAVE ADAPTER

Convert your broadcast set into a shortwave set tuning from 80 to 200 meters.



Get exciting police alarms from thousands of miles away. Airplane communications while planes are in flight. A message or photo and international code communications. The biggest thrill and fun for a little money. Installed in a jiffy. Plug directly into the detector tube socket. Specify the detector tube in your set or if uncertain as to detector tube, advise make and model number of set when ordering.
 No. 200—for '27, '37 \$1.39
 and '56 Det. Tube
 No. 201—for '24, '35, and '36 Det. \$1.39
 tube

ALL-WAVE COIL KIT

Range 25 to 500 Meters



Comprises a precision wound tuner and R.F. coil, both having tapered sections on either end, which permits you to enjoy both SHORT WAVE and BROADCAST CAST PROGRAMS. If you own an Ambrosian or any other three circuit tuner receiver, you can easily convert the set into an all wave receiver, by replacing the coils with these new GEN-WIN ALL-WAVE coils. Coils may be had for use with either .00035 or .0005 mfd. condenser. Specify which when ordering. Wiring diagram included free with coils. Separately 10c.
 All Wave Tuner (as illustrated) 90c
 All Wave R. F. Coil 75c

GENERAL WINDING COMPANY

214 FULTON ST. NEW YORK, N. Y.

100 PAGE

RADIO

ACCESSORY CATALOG AND PUBLIC ADDRESS AMPLIFIER SYSTEMS TREATISE

COAST-TO-COAST RADIO CORP.

123-125 WEST 17th ST. N. Y. U.S.A.

WHOLESALE PRICES!

COAST TO COAST RADIO CORP.

123-S WEST 17th ST. NEW YORK, N.Y. U.S.A.

YOU-CANNOT POSSIBLY AFFORD TO BE WITHOUT THIS VALUABLE BOOK...

It is an Up to Date ENCYCLOPEDIA of the RADIO INDUSTRY

CONTAINS THOUSANDS OF LISTINGS FROM A LUG OR SCREW TO A 100 WATT DUAL-CHANNEL-RACK AND PANEL PUBLIC ADDRESS AMPLIFIER

We are Manufacturers of CLASS-A and B PUBLIC ADDRESS AMPLIFIERS

Producing Undistorted Outputs Ranging from 4 to 100 Watts

Get our Quotations on Complete Single and Dual Channel Sound Truck and Semi-Stationary P.A. Installations...

BUY DIRECT FROM THE MANUFACTURER AND SAVE BIG MONEY!

Electric Telegraph Set 15c

BOYS!

A private Electric Telegraph Set of your own for 15c. Lots of fun sending messages to your friends. Better still get two sets, hook them up as shown in the directions, for TWO-WAY MESSAGES (sending and receiving.) No trouble at all to operate with the simple instructions that accompany each set. Operates on any standard dry battery obtainable everywhere. With this outfit you can learn to transmit and receive messages by the Morse International Code, and in a very short time become an expert operator. Mounted on a wooden base measuring 4 x 8 in., first class construction throughout, complete with key, magnet, miniature Western Union blank, pack, cell, neat box with full illustrated instructions.

DOT 'N' DASH

MORSE CODE

ALL FOR 15c (without battery pack) (Canadian and Foreign 20c.)

Add 10c for 64 page book "HOW TO MAKE ELECTRICIAN" Tells how to make batteries, dynamos, motors, radios, bells, sirens, etc. \$10 TO PAGE CATALOG 10c. Amazing catalog of novelties, tricks, puzzles, jokes, books, etc. (no postpaid.)

Johnson Smith & Co., Dept. 568, Racine, Wis.

Members
SHORT WAVE LEAGUE
 Read Page 68

ALDEN S.W. COILS

Precision wound coils with the convenient gripping-ring for easy insertion and removal from socket. Set of four precision wound short-wave coils—20 to 200 meters with .00014 mfd. condenser. 704SWS List Price \$2.00 set. Set of two coils to cover 100 to 540 meters with .00014 mfd. condenser. 704SWW and 704SWO. List Price \$1.50



Genuine Makalot Coil Forms with color-coded easy-grip rings. 1 1/4 in. dia. x 2 in. winding space. Red, Yellow, Green or Blue. 704—4-pin coil form. List... 25c 705—5-pin coil form. List... 25c 706—6-pin coil form. List... 30c

The Neatest Coil for Front-of-Panel Mounting
Brilliantly colored ring in plain view indicates coil in use—easy to insert and remove—does not protrude unduly from panel. Moulded of genuine Makalot and supplied wound or unwound as listed above. Just the coil for your new short wave receiver.

Send 10c for 40-page Adapter Data Booklet—over 300 diagrams with directions, tube connections, analyzer rewiring instructions, etc. See page 124.

ALDEN PRODUCTS CO.
Dept. SW6 715 Center St. BROCKTON, MASS.

RADIO OPERATING— RADIO SERVICING



Prepare for the new Government Radio Operating license examinations: Radio Operator, Marine and Broadcasting. Also Radio Amateur Telegraph and Telephone. Resident courses. Write for booklet
"Opportunities In Radio"

West Side Y M C A Trade & Technical Schools
18 West 63rd Street New York City

FREE 13th ANNIVERSARY RADIO CATALOG



132 pages containing the most complete listing of radio items for the amateur and experimenter at real bargain prices.
Send for your copy now!

AMERICAN SALES COMPANY
Wholesale Radio Distributors
SW-44 W. 18th St., N. Y. C.
The Oldest Amateur Supply House, Est. 1919

INFRA RED HEALTH LAMP

(Floor Model with flexible shaft)

Recommended by all health institutions and physicians all over the world.

Save doctors' bills

Save your health

Save your family the trip to the doctor who charges \$5.00 per treatment.

List Price \$25.00
Your Cost . . . **\$9.75**

One sale in a neighborhood sells 5 more
Send for circular with full details.

Gold Shield Products Co.
112 Chambers St. (S. W.) New York

Short Wave Sensation

Science has perfected a powerful Super-Adapter that will bring in Short Wave Stations with loud speaker volume. Easily attached to any radio. Packed with "thrills." C. H. Smith, 9884 Candler Bldg., Kansas City, Mo., wants local agents and will send a no-cost sample. So write him today.

The "Voyager" 2-Tube Receiver

(Continued from page 87)

receiver. This method, of course, can only be used with sets using tubes such as the 47 or the 59, where the maximum voltage can be obtained from the screen grid socket connection; as a study of the diagram will show it would be impossible to use the speaker with a tube such as the 45, due to the fact that there is no position in the tube socket for the high plate voltage, other than that which is supplied to the plate circuit. Another reason why sets using the 45 tube in the output stage will not work satisfactorily is the fact of the improper matching of the voice coil transformer.

If an external power-pack is to be used, it will be necessary to have a source of direct current capable of supplying 180-250 volts at 40 milliamperes, and a small filament transformer capable of giving 2 1/2 volts A.C. at 3 amperes. If the set builder has an ordinary "B" eliminator of the old Majestic type, this is quite satisfactory for the B supply and it will simply be necessary to obtain a small filament transformer giving the 2 1/2 volts. This transformer can be mounted under the chassis of the receiver if necessary.

Insert the phones or loud speaker into terminals 4 and 5, if the power supply is not taken up from a radio set; connect the antenna to either 1 or 2 and the ground to 3, as indicated in Fig. 1 or 2. Place the tubes in the socket and turn on the power supply.

Advance the regeneration control to the right, until the tube goes into oscillation. If the receiver goes into oscillation too quickly, it may be necessary to increase the coupling between the antenna and the tuned circuit by the antenna series condenser.

After the power supply has been connected to the set and tubes placed in the sockets, insert the plug-in coil with the greatest number of turns in the winding. This coil tunes from 200 meters down to about 80 meters. The coil, of course, will be placed in the coil socket on the left-hand side of the chassis. Slowly turn the tuning dial and advance the regeneration control towards the right. Stop turning the regeneration control when the set goes

into oscillation. Keep turning the tuning condenser until a station is heard. If it is a phone station the speech will be indistinct and accompanied by a whistle. Turn the regeneration control back until the signal clears up and voice or music is heard clearly. Try and work the set always below the point of oscillation, so as not to cause annoyance to your neighbor, who may also have a short-wave receiver tuned to approximately the same frequency for which your receiver is tuned.

After testing all the "bands" to see if the set is operating and oscillating, adjust the antenna series condenser to eliminate "dead-spots," and at the same time give the smoothest regeneration control over the entire wave-bands which are to be covered.

Coils are available which will permit this receiver to tune from 200 meters down to 15. Additional coils may be obtained to use with this tuning condenser which will permit tuning in any of the stations in the broadcast band from 200 to 550 meters. If the receiver does not oscillate reverse the terminals XX in the diagram shown in Fig. 1. In general, all these plug-in coils have their sockets and terminal connections made as shown in Fig. 1, i. e., BA goes to radio frequency choke, B the grid condenser and F to ground. Coils made by the Alden Mfg. Company must have the B connection to the plate of the detector tube and P connection of the coil socket to the R.F. choke in order that they can be made to oscillate properly. All the connections on these coils are for radio frequency amplification and unless this point is understood, the connections as indicated will not give the regenerative effect which is so desired. Care should be taken at this point to see that the proper connections are made to the feed-back coil so that the set will go into oscillation and give the best results.

Model 45a Voyager

2 TUBE SHORT WAVE RECEIVER USING 1-57 and 1-59 TUBE

- 1 Chassis and front panel, Acratest—
- 1 Tuning Condenser .00015 mf., Acratest—6854
- 1 Screen Grid Choke AF (800 henries), Acratest—7776
- 1 7 prong socket marked 59, Acratest—7524
- 1 6 prong socket marked 57, Acratest—6934
- 1 4 prong socket plain, Acratest—4062
- 1 Phone Jack, Acratest—4069
- 1 Antenna Ground Post, Acratest—4106
- 1 2 meg. 1/2 watt resistor, Acratest—5860
- 1 75,000 ohm Potentiometer, Frost—6187
- 1 R.F. Choke (8 mh. inductance), Acratest—6755
- 1 Tuning Dial, Acratest—7779
- 1 Escutcheon Plate, Acratest—4043
- 1 .5 mf. 300 volt condenser, Acratest—2774
- 1 Antenna Series Condenser and insulating washer, Acratest—5256
- 2 .0001 mf. Mica Condensers, Acratest—6630
- 1 .1 meg. 1 watt resistor, Acratest—5860
- 1 10 mf. 30 volt, Electrolytic type, Acratest—6645
- 1 400 ohm, 1 watt Resistor, Acratest—3500
- 1 .02 mf. 400 volt Tubular, Acratest—5641
- 1 Special hardware and wire kit
- 1 tube shield, Acratest—7173
- 1 screen grid clip, Acratest—4173
- Source of A supply and B supply 2.5 volts at 3 for filaments 180 to 250 volts at 40 MA.
- 1 59 type tube (R.C.A.)
- 1 57 type tube (R.C.A.)
- 1 Pentode type speaker

Correction Notice

Through an oversight, credit for the article entitled, "Ultra Short Waves In Medicine," by Dr. E. Schliephake on page 646 of the March issue was omitted and credit should have been given to its German source—DIE UMSCHAU.

SLIDE RULES

Midget 5 in 1 Circular Type:

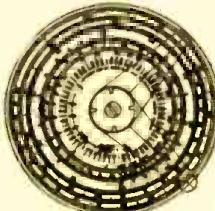

Metal 4" Dia.
Price \$1.50
Case 50c extra

- 1.23³ = ? √50.41 = ?
- 1.24⁴ = ?
- Tan 8°5' = ?
- Cot 79 1/2° = ?
- 4 3/4 × 4 = ?
- Log 58.25 = ?
- 6% of 145.9 = ?
- 5.16 - 11 + 1.78 = ?

Solve easily all these and dozens of other mathematical problems without pencil and paper—by means of the Midget Slide Rule. This rule solves any problem in multiplication, division, addition, subtraction, and proportion. It also gives roots and powers of numbers. The "TRIG" scales give the sines, cosines, tangents and cotangents of all angles; also logs of numbers. Add and subtract fractions. Approved by colleges.

RADIO
Slide Rule
Short Wave
Type

Price 50 cts.

Printed on white bristol board: Size 7 1/2". Every short wave and radio student must have this inductance, capacity, and coil-dimension slide rule. It will answer such questions as: "What is inductance of coil one inch in diameter, winding two inches long and having 30 turns per inch? What winding length of No. 24 S. C. wire must be put on a form two inches in diameter, to obtain an inductance of 100 microhenries? To what frequency and wavelength will 35 microhenry coil tune with a 50 mfd. condenser?"

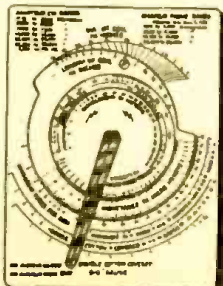

Dataprint Co., Box 322, Ramsey, N. J.

S-W Question Box

(Continued from page 106)

Continental Morse, known sometimes as Universal or International Morse, consists only of dots and dashes. Previous to the advent of Wireless it was used exclusively for wire communications in all foreign countries and for trans-Atlantic communications with the United States and Canada.

It was found, in the early days, that Continental Morse, because spaces were not used, was more adaptable to wireless because of so much static which interfered with space signals causing confusion. Therefore at the first International Convention it was unanimously agreed to use Continental code in all wireless communications, otherwise, all American wireless operators would be compelled to use both codes.

In all commercial broadcasting stations telegraph operators know and use both codes, as the fancy strikes them. They use, more for the novelty of it, American Morse on the air and Continental Morse on the wire. One of the requirements for extra first-class commercial license is that operators use "both" codes. All international communications, however, are conducted in Continental Morse as practically no foreigners are familiar with American Morse. Mr. Candler estimates American Morse to be from 20% to 25% faster than Continental Morse. There is a likelihood that the use of American Morse will spread in domestic communications, but Continental Morse will continue to be used for international communications, Mr. Candler believes.

Letters from S-W Fans

(Continued from page 104)

this marvelous hook-up. It was the best and most detailed article for the beginner appearing in your SHORT WAVE CRAFT to date.

73's
J. I. JEFFERS, JR.,
1308 Tarbutt St.,
Fort William, Ont., Canada.

(Yes, we've had quite an avalanche of letters from enthusiastic readers who built the Binneweg "2-tuber," and got fine results with it. Mr. Binneweg "knows his onions"—and when he designs a short-wave set, it works! Let's hear from some more Binneweg set builders.—Editor.)

LETTER WE PRINTED BRINGS 30 NEW MEMBERS

Our Short-wave Club finds that it would be useless to go to the trouble of publishing a club magazine, when we have SHORT WAVE CRAFT to help us out. We have had several letters published in SHORT WAVE CRAFT and one of the letters by Mr. Stanley J. Yurek brought in thirty new members! So thanks to SHORT WAVE CRAFT, and I hope that you will publish other letters from time to time in benefit of our club.

OLIVER AMLIE,
566 City Line Ave.,
Overbrook, Philadelphia, Pa.

(Glad we were able to help you, Oliver, and that your worthy club gained thirty new members. We shall be glad to hear from the officers of other short wave clubs.—Editor.)

Mr. Ingram Provides a Power-Pack

(Continued from page 93)

each should be tried in turn and the one selected which provides most satisfactory results.

An innovation incorporated in the receiver is the provision of Eby tube sockets in the R.F. and detector stages which will take either five or six-prong tubes. This permits comparison between the 35 and 58 types of tubes, and also makes possible the use of the 6.3 volt automobile type tubes when "all-battery" operation is desired. In this socket there are two screen-grid prongs which must be tied together and the suppressor grid prong must be connected to the cathode.

With the changes outlined the performance of the little receiver has exceeded all expectations! Given reasonably good reception conditions, GSA, Daventry, on 49.58 meters, will operate a cone speaker so that it can be heard all over the house and it is impossible to stand the ear phones on without reducing the volume!

Many who have heard this station in the evening report they cannot get GSC on 31.29 meters, which operates simultaneously with GSA.

This is not surprising, for the 30 meter band is unfavorable for evening reception during winter. Nevertheless the receiver has frequently brought in GSC loud enough to be heard with phones.

On Inauguration Day the President's address was received through a German short-wave station with perfect clarity!

Some claim there is practically no gain obtained from an untuned R.F. stage. Definite proof of the fallacy of this idea can be obtained by shifting from the 35 to the 58 R.F. tube. With the latter tube—used, of course, in conjunction with the proper coil—the gain in volume is startling, even at the higher frequencies. The type of tube used would make no difference if there was no gain in the R.F. stage. So far as the writer is aware this

is the first receiver to be described having an untuned R.F. stage with a 58 tube.

While the old type coils can be used with the new type tubes with some increase in sensitivity, much better performance will be obtained with the coils designed for the 58 tube.

Many have requested coil-winding data. As was stated in my original article, this information was published in the April, 1932, issue of SHORT WAVE CRAFT. It should be pointed out, however, that the experimenter will find these coils difficult to construct. The primary turns are wound between the secondary, heavier gauge wire being used for the latter. The wire gauge and spacing is different for each coil. Grooves for both windings are provided in the special bakelite forms so they will not slip and change the inductance. The tickler coil is wound in a special groove at the bottom of the form.

Fairly good results may be obtained with less complicated design, but it is important to wind the primary between the secondary turns. Variations in the wire gauge and spacing will affect the band coverage. He who makes such changes must experiment until satisfactory results are obtained.

Changing to a tuned R.F. stage requires complete shielding of stages and more space than is available in the receiver as laid out.

Where extreme loud speaker volume on loud signals is required, the new 59 power pentode, which unlike the 47 pentode, is of the heater type, offers interesting possibilities. With proper changes it might be used in place of the present audio tube so that the number of tubes in the set would not be increased. It has a high amplification factor and undistorted output, but requires more plate current than a small power-pack could supply and additional filtering in the latter unit to control residual hum.

FREE!
AN IMPORTANT NEW
IRC SERVICE HELP

If your name isn't on the IRC mailing list, better get it there—quick! Beginning this month the makers of the famous IRC Metallized and Power Wire Wound Resistors and Motor Radio Suppressors will issue one of the finest, most useful helps ever prepared for the radio service man—a monthly publication known as the "IRC SERVICER." Far from being a mere "puff sheet" this little magazine will contain more interesting, more helpful information than you'd imagine could be packed between two covers. You'll not only read it and enjoy it BUT YOU'LL PROFIT FROM EVERY ISSUE.



Available to bona fide service men only. Don't miss it!

INTERNATIONAL RESISTANCE CO.

2006 Chestnut St., Philadelphia, Pa.
In Canada, 74 Wellington St., W., Toronto, Ont.

USE THIS COUPON

International Resistance Co.,
2006 Chestnut St., Philadelphia, Pa.
Certainly I'm a radio service man and will be glad to receive the "IRC SERVICER" every month—FREE—without cost or obligation on my part.

Name.....
Street.....
City..... State.....

LEARN AT HOME TO BE A

Good Radio Operator



It's Easy

with
The NEW MASTER

Teleplex
Code Teaching Machine

Pleasant, interesting work. No experience necessary. We guide you step by step—furnish you Complete Code Course and lend you The New Master Teleplex. Teleplex has instructed more students in the code in the past ten years than all other systems combined. It is the only instrument ever produced that will record your own sending in visible dots and dashes, and then repeat it to you audibly on headphones. Used by U. S. Army and Navy, R. C. A., A. T. & T. Co. and others. Get started NOW. Low cost, easy terms. Write for folder SW6 giving full details.

TELEPLEX COMPANY
76 Cortlandt St. New York, N. Y.

New Short Wave D-X Sensational Converter

A simple amazing D-X device is being offered on trial to users by J. H. Miller, 513 Kirkwood Building, Kansas City, Mo., with which any radio set can be converted into short wave frequency, bringing in police, amateur and air plane stations at full loud speaker volume. Enjoy thrills of short wave reception. Easily attached without charge by anyone. Mr. Miller wants local agents and is willing to send you a no-cost sample. Write him today.

SUPER TESTING KIT!



WITH PENCIL TYPE HANDLES and interchangeable Tip End. Kit complete with 2 Plug-In-Prongs, 2 Alligator Clips, 2 Needle Point Phone Tips, and 2 Blade Lugs, Long. Thin Pencil-Type handles for easy testing in tight places. Ideal for testing Long and Short-wave Sets, Coils, Condensers, Etc. Complete Kit. Introductory Price Now \$1.00 Prepaid.

AMERICAN RADIO HARDWARE CO.
137 Grand Street New York, N. Y.
Agents Write for Exclusive Territory

AERO INTERNATIONAL ALL WAVE 11-TUBE SUPER-HETERODYNE DE LUXE



Completely Assembled With 2 Matched Full Dynamic Speakers **\$29.75**

At last! World wide reception at a sane price. 15 to 550 meters. Besides the regular broadcast band, it brings in foreign programs, amateurs, police calls, ships at sea and aeroplanes. One dial control. No plug in coils. Latest super-phonous tubes.

AERO 4-TUBE MIDGET



\$10.95 less tubes \$2.95 kit of tubes

The lowest priced quality Midget Receiver on the market today. Very selective, brings in long distance like local stations.

AERO 5-TUBE MIDGET... \$11.90
AERO 6-TUBE MIDGET... 18.50

AERO WORLD WIDE

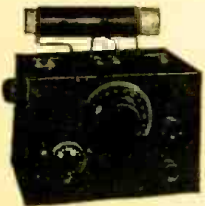

1-Tube SHORT WAVE SET for Head-Phone Operation **\$5.95**

Listen in DIRECT to London, Paris, Berlin, Buenos Aires and other broadcasting stations throughout the world via short waves. Your ordinary receiver cannot tune in these low wave stations. **WORLD-WIDE RECEIVER** sets 15 to 500 meters. Aero 2-Tube Short Wave Set \$8.75. The same as above set but it has 1 stage of Audio Frequency added to it.

Write for Complete Catalogue
CHARLES HOODWIN CO.
4240 Lincoln Ave., Dept. D-17 Chicago

New Genuine MAKALOT S. W. Sockets "IT'S THE CONTACT THAT COUNTS" For ABOVE or BELOW PANEL MOUNTING

- 424 For UY 4-prong tubes... List price 25c
- 425 For UY 5-prong tubes... List price 25c
- 436 For 6-prong tubes... List price 25c
- 437 For 7-prong tubes like the 59... List price 35c
- 450 Composite Socket for 4, 5 and 6 prong tubes—filament circuit common—all others isolated—has nine contacts... List price 50c
- 457 Composite Socket for 5 and 7 prong tubes—Pentode screen grid isolated—other circuits common—has eight contacts... List price 50c
- 477 Composite Socket for ALL 7 prong tubes—takes type 59 large diameter and type 2A7 small diameter seven prong tubes—has seven contacts... List price 50c
- 567A Composite socket for 4, 5 and small lined 7-prong tubes—has seven contacts—These sockets are fine for building new checkers and analyzers... List price 50c

Genuine MAKALOT S. W. Lab. Sockets FOR BASEBOARD MOUNTINGS

- 481X 4-contact socket. List price... 25c
 - 481Y 5-contact socket... 25c
 - 485 6-contact socket... 25c
 - 487 7-contact socket (59 type)... 35c
 - 487A 7-contact socket (2A7 type)... 35c
- High quality laboratory type sockets. Fine for breadboard mounting in R.W. receivers, transmitters, experimental set-ups, etc. Send for catalog sheets. See our offer on page 122.

ALDEN PRODUCTS CO.
Dept. 5W6, 715 Center St.
BROCKTON, MASS.

IN 1936

You will be interested in tracing the early developments of Short Waves. Your best source of information will be **SHORT WAVE CRAFT**. Back numbers may be had at 25c per copy. Address: **SHORT WAVE CRAFT, 96 Park Pl., New York.**

League of Nations Station

(Continued from page 71)

The receivers of the first and second groups are connected to an aerial change-over switch, enabling any receiver to be coupled to any aerial. The receivers of the third group are connected to two radiogoniometric aeriels (Bellini-Tosi system).

On the ground outside the building there are four aerial groups, of which three with beam aeriels (i.e., one group) are directed towards South America and the Far East, a second group towards the West Indies and Central America, and a third group towards North America and British India.

A fourth group comprises several simple omni-directional aeriels, enabling reception of waves between 10 and 30,000 metres to be carried out from all directions.

Radio-Nations was erected at a cost of nearly four million gold francs, of which about 2,500,000 was borne by the League and about 1,500,000 by Radio-Suisse, owned and operated by the Swiss government. In normal times, it is Radio-Suisse, in collaboration with the League's Transit and Communication Section, which operates the station, while in times of emergency, such as during the Shanghai crisis, the League has complete control.

In normal times, the station is in constant use for the exchange of telegraphic messages between the League Secretariat and delegations at various conferences at Geneva, and the greatest possible number of extra-European governments, either direct or by means of re-transmission. Apart from this, the plant can be employed for transmitting circular messages from the League Secretariat to member States, and for rapid conveyance of important documents to distant points, thereby insuring a nearer connection between the League and extra-European countries. An example of such functioning was the transmission in Morse code of the League's 15,000 word report on the Manchurian question in February which was picked up by official government stations all over the world. (See May, 1933, issue of **SHORT WAVE CRAFT**.)

Super-Wasp Becomes Real "Super"

(Continued from page 89)

COIL DATA

The IF. Coils are wound on bakelite forms $\frac{7}{8}$ " in diameter by 2" high. The primaries have 61 turns No. 30 Enamel, the secondaries 130 turns No. 30 Enamel. If one desires to wind the Detector and Oscillator Coils he may do so. The "dope" on these coils follows:

DETECTOR COILS (RF)

- Meters
- 14.5- 27.0—4½ turns No. 24 DSC
 - 26.0- 50.0—9½ turns No. 24 DSC
 - 48.0-100 —20½ turns No. 24 DSC
 - 100.0-200 —46½ turns No. 24 DSC

OSCILLATOR COILS (Det.)

- | | |
|----------------|---------------|
| Grid | Plate |
| 3½ No. 24 DSC | 4 No. 24 DSC |
| 7½ No. 24 DSC | 6 No. 24 DSC |
| 17½ No. 24 DSC | 7 No. 24 DSC |
| 45½ No. 24 DSC | 15 No. 24 DSC |
- Coil Form 1½" diameter

Antenna winding, shown in dotted lines, not used.

POWER-PACK

- L₁—Field coil on Lafayette "MB" Dynamic Speaker
- L₂—Trutest center-tapped 30 H. choke; CT not used
- C_{1, 2, 3}—Trutest triple-anode 8 mf. dry detector condenser
- T₁—Trutest power transformer for 7-8 tube receivers (4C1507)
- 1—4-prong socket
- 1—Lafayette 280 type rectifier tube
- R₁—Trutest Vitreous 20 Watt. 10,000-ohm Resistor
- R₂—Trutest Vitreous 20 Watt. 800-ohm Resistor
- R₃—Trutest Vitreous 20 Watt. 10,000-ohm Resistor
- R₄—Trutest Vitreous 20 Watt. 750-ohm Resistor

FREE CONDENSER

for You!

Here is the famous Pilot 23-plate short wave condenser .001 mf. (100 mm.) This most unusual condenser is the only one made the capacity of which can be changed by eliminating plates as shown in the illustration. It is, therefore, one of the most flexible short wave condensers made. One hole mounting, mounted on Bakelite panel, as shown. Friction type, beautiful brown imitation wood mahogany knob, 1¼" in diameter with white spot in rim for easy turning. This condenser is no doubt the finest short wave condenser on the market. It usually sells for \$1.25 upwards.

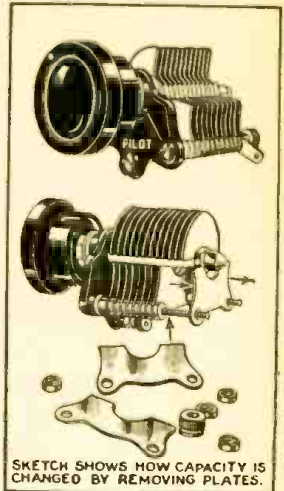

SKETCH SHOWS HOW CAPACITY IS CHANGED BY REMOVING PLATES.

Now, for the first time, you can get it absolutely free by subscribing to **SHORT WAVE CRAFT** for one year. You can get two condensers absolutely free with a two year subscription. Not more than two condensers given free in connection with subscriptions to any one reader.

This is an opportunity which does not often come, and inasmuch as we have only a limited supply of these condensers ACT NOW. This condenser has two binding posts, as well as two solder lugs, making it possible for either screw connection or solder connections. Plates are of solid brass. Precision construction throughout. Condensers sent prepaid to you.

Send today only \$2.50 for one year's subscription to **Short Wave Craft** (\$2.75 Canada & foreign) and free condenser will be sent at once.

Two free condensers with a 2 years' subscription \$4.25 (\$5.25 Canada & foreign).

SHORT WAVE CRAFT

98 Park Place, N. Y. City

St. Charles

An Entire Block On the Boardwalk

ATLANTIC CITY

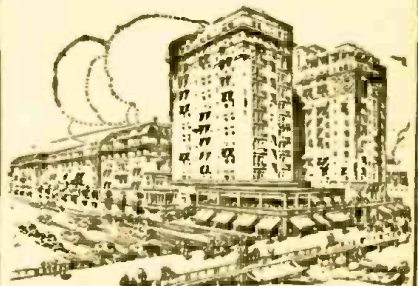

A Smart Hotel in America's Smartest Resort

Atlantic City—Healthful—Restful—Affording complete relaxation so welcome after intensive work—Where the St. Charles offers the maximum in hotel comfort and service—Spacious Sun-Deck occupying one entire block overlooking Boardwalk and Sea—Ocean view Lounge—High standard of French and German Cuisine. Garage.

European or American Plan Rates Greatly Reduced

THE KING'S ENGLISH

By Arthur J. Green

President, International Short Wave Club

● IF an American radio experimenter who is not acquainted with British radio terms and a British experimenter who is not acquainted with American terms were to meet, a conversation on their favorite subject would probably be hard to carry on because the terms are so different. Let us suppose that two do meet and start talking things over. The American experimenter might say,

"Boy, I am working on a real outfit now. It has five tubes with two stages of radio frequency, a regenerative detector and two stages of audio frequency amplification. It uses AC electric on the filament and a 'B' battery for the plate supply."

The British fan would probably say to himself, "What sort of talk is this?" and then out loud say,

"I am working on a new wireless myself. It has five valves, with two in the high frequency, a reactive detector and two low frequency stages. It uses mains for filament and HT battery for the plate."

And while the two of them would walk away muttering to themselves about the mysteries of radio and people, they would both have been talking about the same thing.

4-Tube "Master Composite"

(Continued from page 83)

results. Make sure that the solder flows through the joint thoroughly. The iron must be kept clean, well tinned and hot!

Tuning Frequency Range

Coils can be obtained ready wound to cover the wavelengths from 9 to 850 meters very efficiently. The following coils and the ranges covered were tested in SHORT WAVE CRAFT'S Composite Receiver and give the maximum of efficiency for their respective bands.

Range	Coil Number (National)
9 to 15 meters	No. 60
13.5 to 25 meters	No. 61
23 to 41 meters	No. 62
40 to 70 meters	No. 63
65 to 115 meters	No. 64
115 to 200 meters	No. 65

Those interested in band spread coils have a choice of the following coils:

Band	Coil Number
20 meter	No. 61A
40 meter	No. 63A
80 meter	No. 64A
160 meter	No. 65A

In the photographs showing the S-W-C "Composite" receiver the extra coils not in use are placed in a neat metal coil cabinet. This offers a convenient way of keeping the coils from being misplaced and preventing damage when not in use. The cabinet will hold 20 coils.

Antenna Recommendations

World-wide reception can be obtained under half-way decent conditions with an ordinary broadcast antenna at loud speaker volume. Nevertheless, it is recommended that one of the newer transposition lead-in types of antenna be employed, such as the system recommended by Arthur H. Lynch in the article "Reducing Noise on Short Wave Aerials," (See SHORT WAVE CRAFT for August, 1932, and "Good Antenna Design" in SHORT WAVE CRAFT for September, 1932).

Tests with this receiver in a suburban location shows marked improvement in the noise level and signal strength when the transposed lead-in was used with a 75 foot flat-top.

Speaker Considerations

Most every set builder has a dynamic speaker on hand and for that reason the choice of the loud speaker was left to the individual. Be sure that the loud speaker has a voice coil transformer with a primary that will match the tube; this is 7,000 ohms when used as it is in this set. The tube is used as a pentode for greater

In England radio is known as "wireless." A tube as called a "valve." Radio frequency is known as "high frequency" and audio frequency is "low frequency." An all-electric set is known as an "all-mains" receiver. An antenna is called an "aerial" which is oftentimes used in America, but they never speak of a ground. It is always "earth." A ground connection is an "earth connection." A tube base is a "valve holder" and a binding post is a "terminal."

An A battery is known as an "LT battery" and a C battery as a "GB battery." A B battery is an "HT Battery." A tickler coil is a "reaction" coil and a regeneration condenser is always a "reaction" condenser. Of course, regeneration is always spoken of as "reaction" and a regenerative detector is known as a "reactive" detector. A dynamic speaker is called a "moving coil" speaker.

And so it goes. There are many other technical terms used by the British that may sound very odd to us, although we are both using the English language. And there are other things besides radio terms that make the British laugh at us. Don't ever say that "Big Ben gonged midnight" unless you want to be laughed at. I did once and as Walter Winchel says, "Is my face red?" Don't say "broadcasting" but "radiating" and don't write the word "meter" but "metre."

power sensitivity. Do not connect a magnetic type speaker to the output terminals of the set, without using an output transformer. Generally the magnetic speaker will not match the tube impedance and it may be damaged by the strong plate current flowing through the speaker windings.

Construction and Wiring Hints

So much has been written about the construction of radio receivers that little need be said at this time; study the photographs and the electrical circuit—then go ahead and build. Use care in the construction and see that everything is fastened firmly in place. Loose parts result in noise and noise is especially to be avoided in a short-wave receiver.

Make all connections in a direct manner. Do not have loops in the wiring and be sure that every lead from the tuned circuits of the radio frequency and detector are wired by connecting wires. Do not depend on the chassis for common connections! This will increase the stability of the receiver and result in smoother operation.

Conclusion

This receiver was designed in accord with the votes of readers of SHORT WAVE CRAFT and represents the majority opinion of the readers. Some of you may have wished that the set were a super-het and many may not like the method of regeneration control (for example) but the majority wins. So, here is YOUR set.

Parts List

- One National Co. Type 2-SE 100 tuning condenser (Cap. 100mmf. each section). (C2, C3.)
- Two National Co. Short Wave Chokes, Type 100, (RFC1, RFC2) (2.5 M. H.)
- One National Co. Radio Frequency Choke, Type 90 (RFC3) (90 M.H.)
- One National Co. Screen Grid Coupling Impedance Type S101 (AF1)
- Two National Screen Grid Clips (V1, V2) type 24.
- Two National Coils Sockets, Isolantite 6 prongs for National Coils (L1, L2)
- Two National Isolantite Tube Sockets for 58 type tubes (V1, V2)
- One National Co. Antenna Compensating Condenser, Type ST-50 (C1) (Cap. 59 mmf.)
- One National Coil Cabinet (optional)
- Two National Co. Tube Shields Type T58 (V1, V2)
- One pair of the following National S.W. Coils, Nos. 61, 62, 63, 64, 65 (L1, L2).
- One National "Full Vision" Tuning Dial, Type VKE
- Three Micamold .01 mf. mica condensers (C4, C5, C12)

RCA INSTITUTES

Recognized Standard in Radio Instruction Since 1909

Technical Training Courses in Radio and Associated Electronic Arts

Practical Radio Engineering
Sound Engineering
Broadcast Transmission
Radio Servicing
Commercial Radio Operating

Resident Schools at New York and Chicago

EXTENSION COURSES for HOME STUDY under new "no obligation" plan, with privilege upon graduation of 2 weeks' intensive practical training without charge at either Resident School.

Mail Coupon for Illustrated Catalog



RCA INSTITUTES, INC.,
Dept. SW6
75 Varick Street, New York, N. Y.
1154 Merchandise Mart, Chicago, Ill.

Please send with no obligation to me:

Illustrated catalog and information about resident school courses.

Information about extension courses for study at home, together with illustrated catalog.

Name..... Age.....

Address.....

City..... State.....

FREE—C. S. Code Guild Sked. Daily C. S. practice programmes on amateur bands.

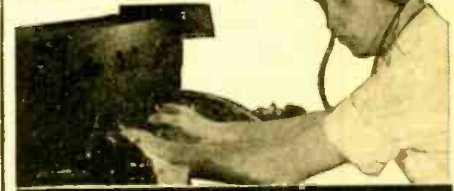

You Can Become a Fast, Capable RADIO OPERATOR at Home

With the Famous CANDLER Scientific System

FREE short wave press schedules. Learn to copy px from Candler trained ops, sending out of principal px stations. Amazing results in short time. FREE ADVICE IF "STUCK." Write Candler. No obligation. Junior Course for beginners. Advanced Course for ops with speed of 10 wpm or over who want to get in 30 to 45 wpm class and copy behind. Also Radio Typing Course. Save time and money by sending for FREE BOOK today. CANDLER SYSTEM CO., Dept. A-2 6343 S. Kedzie Ave., Chicago

"Candler training enabled me to copy 56 1/2 wpm for the all-time record."—T. R. McElroy, Official Champion Radio Operator of the World, 46 Everdean St., Boston, Mass.



World's Only Code Specialist

BRING IN NEW and DISTANT



Stations with this AMERICAN ALL DIRECTION ANTENNA

Coast to coast reception is possible. Gives clearer and louder reception. Gets greater distance and volume. Made of copper. Neat and durable. Easily and quickly installed. Guaranteed. PRICE NOW \$1.00 PREPAID AMERICAN RADIO HARDWARE CO. 137 Grand Street, New York, N. Y. Agents write for exclusive territory

an old timer says—

Gentlemen:

Allow me to congratulate you on Myron F. Eddy's "How to Become an Amateur Radio Operator." I have been a "ham" since 1909 and have worked up from the open crashing sparks of "Old Betsy's" and took sullenly to these new fangled gadgets and had to park "Betsy" in the junk heap under the eaves to go in for tubes. I'm too old now to dabble in the game very much but in my teaching a bunch of ether disturbing young squirts here—all Boy Scouts, I still get a certain "kick" out of it. I purchased nine copies for my gang and I suppose five or six others got them because they saw ours—had to send to Oakland for three additional copies. They're GREAT!

San Francisco, Calif.

One of the "Old Men" of Radio
 Ex. Lieut. Al. A. Weber (Retired)
 1153 Capp St., San Francisco, Calif.



50c
 EACH



THERE is not a radio man in the field, experimenter, service man or dealer who will not want to read these two books. Right up to the minute with outstanding developments in short-wave radio—new methods and apparatus for quickly learning how to become a practical radio operator. Each book is authoritative, completely illustrated and not too highly technical. The text is easily and quickly grasped.

How to Become an Amateur Radio Operator

We chose Lieut. Myron F. Eddy to write this book because his long years of experience in the amateur field have made him pre-eminent in this line. For many years he was instructor of radio telegraphy at the R.C.A. Institute. He is a member of the I.R.E. (Institute of Radio Engineers), also the Veteran Wireless Operators' Association.

If you intend to become a licensed code operator, if you wish to take up phone work eventually, if you wish to prepare yourself for this important subject—this is the book you must get.

Partial List of Contents

Ways of learning the code. A system of sending and receiving with necessary drill words is supplied so that you may work with approved methods. Concise, authoritative definitions of radio terms, units and laws, brief descriptions of commonly used pieces of radio equipment. This chapter gives the working terminology of the radio operator. Graphic symbols are used to indicate the various parts of radio circuits. General radio theory particularly as it applies to the beginner. The electron theory is briefly given, then waves—their creation, propagation and reception. Fundamental laws of electric circuits, particularly those used in radio are explained next and typical basic circuits are analyzed. Descriptions of modern receivers that are being used with success by amateurs. You are told how to build and operate these sets. Amateur transmitters. Diagrams with specifications are furnished so construction is made easy. Power equipment that may be used with transmitters and receivers, rectifiers, filters, batteries, etc. Regulations that apply to amateur operators. Appendix, which contains the International "Q" signals, conversion tables for reference purposes, etc.

How to Build and Operate Short Wave Receivers

is the best and most up-to-date book on the subject. It is edited and prepared by the editors of SHORT WAVE CRAFT, and contains a wealth of material on the building and operation, not only of typical short-wave receivers, but short-wave converters as well. Dozens of short-wave sets are found in this book, which contains hundreds of illustrations; actual photographs of sets built, hook-ups and diagrams galore. The book comes with a heavy colored cover, and is printed throughout on first-class paper. No expense has been spared to make this the outstanding volume of its kind. The book measures 7½x10 inches. This book is sold only at such a ridiculously low price because it is our aim to put this valuable work into the hands of every short-wave enthusiast.

We know that if you are at all interested in short waves you will not wish to do without this book. It is a most important and timely new radio publication.

**Over 150 Illustrations
 in Each Book**

**72 Pages 7x10 Inches
 Heavy Colored Covers**

Not Sold on Newsstands

SHORT WAVE CRAFT

96-98 Park Place, New York, N. Y.

- One Micamold .0001 mf. Mica condenser (C15)
 - One Micamold .00025 mf. mica condenser (C8)
 - One Flechtheim Tubular Condenser .01 mf. (C10)
 - One Flechtheim Electrolytic Condenser Type LT1000 (C11) 10 mf. 30 Vts.
 - Two Flechtheim .25 mf. Bypass condensers (C6, C7) Type GF25
 - One Acratest Wire Wound Resistor, 5 Watt, 7000 ohms Cat. No. 5900 (R6)
 - One Acratest Wire Wound Resistor, 5 Watt, 400 ohms Cat. No. 5900 (R10)
 - One Acratest Carbon Resistor, .5 Watt, 300 ohms Cat., No. 5860 (R2)
 - One Acratest Carbon Resistor, .5 Watt, 2000 ohms Cat. No. 3500 (R7)
 - One Lynch Mfg. Co. .5 Watt resistor .5 meg. (R9)
 - One Lynch Mfg. Co. .5 Watt resistor .1 meg. (R8)
 - One Lynch Mfg. Co. .5 Watt resistor 5. meg. (R11)
 - One Lynch Mfg. Co. 1. Watt resistor 2000 ohms. (R5)
 - One Lynch Mfg. Co. 1 Watt resistor 3000 ohms (R4)
 - One Frost 40 series potentiometer Cat. No. 6182 (R1) 3000 ohms.
 - One Frost 40 Series Potentiometer Cat. No. 6186 (R3) 50,000 ohms.
 - One Wafer Socket Type 59, 7 prong (V4)
 - One Wafer Socket 5 prong Type 56 (V3)
 - One Yaxley S.P.D.T. rotary jack switch (S)
 - One Wafer socket and male plug for speaker
 - One Eby Ant. Ground terminal strip (T1, T2)
 - One four-prong chassis mt'g plug and socket cable connector Type 7A-11 and 11A (T5, T6, T7, T8)
 - Two Eby Insulated Binding Posts (for phone) (P)
 - One Steel Chassis drilled and folded to specifications—Korrol Mfg. Co. or
 - One Aluminum Chassis drilled and folded to specifications Blan-the-Radio-Man
 - NOTE—The builder has a choice of chassis material
 - One Drilled panel. Aluminum panel is dipped and the steel panel is cadmium plated.
 - Two Blan—The-Radio-Man, special aluminum shields for the coils
 - Two Blan—The-Radio-Man "Hand-Hole" Covers for the coil openings
 - Two Blan—The-Radio-Man flexible couplings
 - Two 6 inch lengths of bakelite ¼ inch in diameter
 - Four small brown knobs
 - Four 5 inch lengths of 6/32 threaded brass rod
 - Two Raytheon 58 type tubes (R.C.A.)
 - One Raytheon 59 type tube (R.C.A.)
 - One Raytheon 56 type tube (R.C.A.)
 - Wire, soldering lugs, machine screws, etc.
- Parts List of the Power Supply**
- One Jefferson Power transformer. Type 463-934. (P.T.)
 - Federated Purchaser Cat. No. 2532
 - Two Jefferson Filter Chokes, Type SA2071
 - Federated Purchaser No. 2503 (CH1, CH2)
 - Three Flechtheim Electrolytic Condensers. 8 mf., 500 volts peak. Type JW800 (C1)
 - One Flechtheim Dry Electrolytic Condenser 8 mf., 500 peak volts Type KL800 (C2)
 - One Korrol Mfg. Co. Steel, cadmium plated chassis drilled and welded as drawings
 - Aluminum chassis by Blan, The-Radio-Man
 - One Federated Purchaser power switch No. 4112 (S)
 - One Federated Voltage Divider Cat. No. 3915. 25,000 ohms with taps (R)
 - One Five Wire Cable (Use No. 16 wire in cable if possible)
 - One Rubber Grommet
 - One Four prong wafer socket. Marked 280 (80)
 - One Raytheon 80 rectifier tube (R.C.A.)

SHORT WAVE CRAFT
 96-98 SWC Park Place,
 New York, N. Y.

Gentlemen: I enclose herewith \$.....
 for which please send me, prepaid a copy
 of the book checked.

() HOW TO BUILD AND OPERATE
 SHORT WAVE RECEIVERS—50c
 () HOW TO BECOME AN AMATEUR
 RADIO OPERATOR—50c.

Send money order, check, cash or new
 U. S. stamps. Register letter if it con-
 tains stamps or currency.

Name

Address

City..... State.....

Details of Parts for "Master Composite"

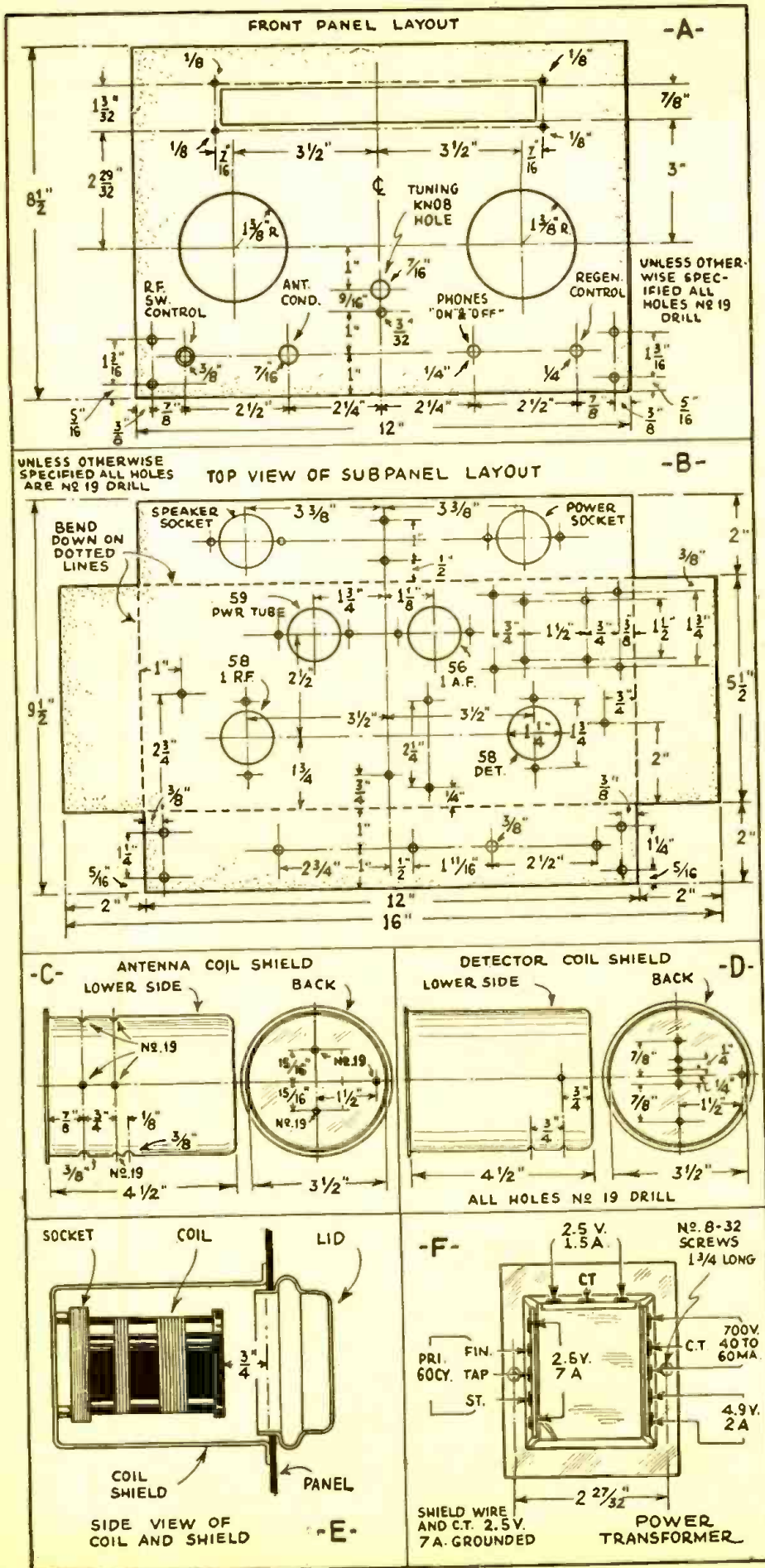

STOPPANI BELGIAN COMPASS

Being a Precision Instrument, the Stoppani Compass lends itself admirably for use in the Radio Experimenter's test laboratory. It affords an ideal means of determining the polarity of magnets, electro-magnets and solenoids carrying current. Since the compass needle is itself a magnet having a North-seeking pole (which is actually the South pole) and South-seeking pole (which is actually the North pole); and since, as we all know, like poles repel each other and unlike poles attract each other, it is merely necessary to bring the compass in the vicinity of the magnet under test. The North pole of the compass needle will then point to the North pole of the magnet under test or the South pole of the needle will point to the South pole of the magnet depending, of course, upon their relative positions.

May Be Used As a Galvanometer

Because of its uniform magnetic properties, high sensitivity, and delicate frictionless bearings, the Stoppani compass may be utilized to advantage as a highly precise galvanometer for detecting electric currents in experimental or conventional radio circuits. The Compass is easily and readily converted into said galvanometer by merely winding several turns of ordinary radio wire completely around the face and lower case of the compass; leaving small spaces between turns to observe the movement of the needle. The ends of the wire are brought out as test leads to be inserted in series in circuits under test. A deflection of the compass needle in either direction indicates the presence of an electric current. Incidentally the intensity of the current may be closely approximated since the force with which the needle gravitates is proportional to the intensity of the current flowing through the wire.

Stoppani Compass is an ideal SURVEYORS instrument with elevated sights. It is made of Solid Bronze. Parkered, non-rusting, graduated in 1/10. Ruby Jewelled. 4 inches square. Fitted in a hardwood case, with set screw in corner to hold needle rigid when not in use. The United States Government paid more than \$30.00 for this precision instrument.

OUR PRICE \$4.50

Gold Shield Products Company
112 Chambers Street SWC New York, N. Y.

Be a TELEVISION EXPERT



During the next few years, thousands will become rich in Television, the amazing new major industry. Will you be one of these? There is only one way for you to get into Television and that is with specialized training. Television experts are needed right now and this marvelous new business has hardly started. If you are over 17 years of age, send your name and address for full information about our plan whereby you may step out of the world's greatest Television School—occupying the three top floors of Missouri's tallest skyscraper—into a high pay position. Write Today.

Sid Noel, President
FIRST NATIONAL TELEVISION
2911 Power & Light Bldg.
Kansas City, Missouri

ENJOY A CLEAN, SMOOTH SHAVE AND SAVE VALUABLE TIME

Order a trial package of 10

RUBY EXTRA SHARP BLADES

for 25c postage prepaid

We GUARANTEE FULL SATISFACTION or money will be cheerfully refunded.

Package of 100 for \$2.00 prepaid.

You can sell a package to EVERY FRIEND and KEEP HIM AS A FRIEND.

GOLD SHIELD PRODUCTS CO.

112 Chambers St., New York City

FREE RADIO CATALOG

WORLD'S FAIR ISSUE JUST OUT

Write for FREE catalog today. Most complete line of radio sets, service men's supplies, replacement parts, test equipment, at lowest wholesale prices.

ALLIED RADIO CORP.

833 W. Jackson Blvd.

CHICAGO

Details of chassis and other parts used in building the "Master Composite" Receiver.

DOERLE WORLD-WIDE Receivers

Improved Doerle Receivers—Absolutely Fool Proof 15 TO 200 METERS

THERE have never been produced short-wave receivers which have taken the whole country by storm as much as the now famous DOERLE Receivers. Mr. Doerle described his first receiver, the now famous TWO TUBE 12,500 MILE RECEIVER in the December-January issue of SHORT WAVE CRAFT. You have seen the many letters published in SHORT WAVE CRAFT lauding this receiver to the skies, and for a good reason. It is a low-priced receiver, yet, pulls in short-wave stations from all over the world, REGULARLY, in practically any location, not only in this country, but anywhere. Thousands of experimenters have built their own, and have obtained miraculous results, as hundreds of glowing testimonial letters from radio fans testify.

Recently, Mr. Doerle brought out another receiver, the THREE TUBE SIGNAL GRIPPER, which already has started to make history. There is no question that the three tube job will also make its triumphant tour all over the world.

Despite the remarkable performance of these two receivers, our technical staff felt that they could obtain even better results with slight modifications of the circuit. This is especially true of the Three-Tube Signal Gripper. The first type 30 R. F. tube was replaced with a type 34 which is a high gain Screen-grid R. F. amplifier. This has increased the sensitivity and selectivity of these receivers considerably. Yet despite these changes, we have not raised the prices of these instruments to you.

In the course of the year, we have received many requests for these receivers, and we have sold a great many parts for both receivers, but not until recently we concluded our tests which now places us in a position to supply the two complete receivers so that you can either buy them completely wired or in kit form.

By special arrangement with the publishers of SHORT WAVE CRAFT, we are now in a position to sell you these official receivers so that all short wave enthusiasts who ever wished to own either of these fine sets can now be sure to buy them without a question in their minds that they will perform 100%.

It took a lot of labor, and much ingenuity to collect the correct parts to make sure that each receiver would work under all circumstances. This means that all the usual "bugs" have been ironed out by us in such a way that you may order every receiver with full confidence, that in practically every location, anywhere, "they will do their stuff."

ONLY FIRST CLASS PARTS USED

It may be possible to buy the parts of the completed sets at a lower price. We admit this at once. But if you will look over our parts list, you will find that only first class material is used. We have done away with all losses. There is no "hand capacity." IN THESE TWO SETS ONLY THE BEST CONDENSERS—AND THAT MEANS HAMMILLUND—ARE USED. The sets could be produced for a considerable less amount if we used cheaper condensers. We have refrained from doing so because we wanted a first class product. And this goes for everything else in the sets. They are low in price, yet the quality is excellent considering the low price. Thus, for instance, we are using Kurta-Kaach dials because we found them excellent for their purpose, and as everyone knows, they are really first class verniers. The aluminum chassis is completely drilled, ready for mounting parts.

Panels are polished aluminum, on which the condensers and other parts are mounted. These panels do away with hand capacity. The plug-in coils are of Bakelite, wound with enamel wire for low losses. In short, despite the exceedingly low price of these sets, we give you quality. Bakelite sockets only are used. Even the aerial condensers are of the Micamold Equalizing type. We have even included pin-tip jacks, rheostats with "off" positions and binding post strips of Bakelite to keep down losses.

In short, you will be pleased not only with the business-like appearance, but with the performance as well.

Only by making these sets in quantities can we afford to sell them at the extremely low prices quoted.

Note the testimonials printed on this page. They will give you an idea what can be expected from these great sets.

HOW DO THE TWO SETS DIFFER?

The TWO TUBE 12,500 MILE SHORT-WAVE SET is intended to be used with headphones, although it is bringing in right along, stations on the loudspeaker. We, however, do not make such a claim. For instance, stations 5,000 and 10,000 miles away come in only on headphones. This set uses two 230 two-volt battery type tubes.

The Improved THREE TUBE SIGNAL GRIPPER, as its name indicates, is a three tube set. It uses a type 34 screen grid R. F. amplifier followed by a Type 30 regenerative detector and finally a type 30 A. F. Amplifier. It is a great deal more powerful than the smaller set and will bring in stations from great distances on the loudspeaker. A good magnetic loudspeaker should be used. Thus, for instance, stations from all over the country come in on the loudspeaker, but, of course, stations 12,000 miles distant require the use of earphones.

The Price of the two sets includes a set of Plug-in coils. Both sets are operated from ordinary dry cells. The "B" battery supply can be either 90 volts or 135 volts for the THREE TUBE SIGNAL GRIPPER. For the TWO TUBE SET, 90 volts is sufficient.

Both sets tune exceedingly easy, and the oscillation control is always under full control of the operator. The vernier dials are accurate so that stations can be locked and found in their allotted positions every time you use the set.

Both sets have been tested by us, and we found that they do all and more claimed by Mr. Doerle, and other enthusiasts who built the sets, especially since they have been improved. We refrain from giving you the astonishing list of stations which we ourselves have locked because we do not wish to let our enthusiasm run away with us, and because you might not believe the actual results accomplished with this set. We much rather have others talk about the results.

Incidentally, we have, as yet, to receive a single complaint on these sets, although we sold a large quantity of parts for both of them.

WHAT THEY SAY!

"Does All You Say"
I have built the Doerle short wave receiver and I want to say it does all you say it will.
J. Joseph Whalley, 401 Springdale Street, Cumberland, Md.

Some List
Have just completed your Doerle two-tube. I received the following on the loudspeaker: XDA, LOA, GMB, VEYDI, VEHW, KKO, WJAZ, WJAP, WJAL, WJAU, WJAB, WSK, WJAL, WJAF, WJAA, Bermuda, Honolulu, Budapest, Hungary, and "hams" in 25 states
Maurice Kraay, R. F. D. 1, Hammond, Ind.

This is Going Somel
Today is my third day for working the Doerle set, and to date I have received over fifty stations. Some of the more distant ones I shall list. From my home in Maplewood, N. J. I received the following: WVR, Atlanta, Ga.; WOK, Ohio; WOBHM, Ft. Wayne, Ind.; WJAZ, Elm. Ill.; WSEH, Grand, Ohio; and, best of all, XDA, Mexico; PZA, Surinam, South America; TH, Caracas, Costa Rica; GZM, Leicester, England. I have also received stations WDC and PIQ, which I have not found listed in the call book.
That's not a bad record for three days on a two-tube job, is it? I will answer any questions concerning the Doerle set.
Jack Prior, 9 Mosswood Terrace, Maplewood, N. J.

A Good Word for the Doerle
I would like to put a word in for the Doerle 12,500 mile receiver. I recommend this set to all "set wreckers" in a big way! Hoping that this set "perks" for all "hams" in a big way.
H. J. Keilholz, 1508 Belt Street, Baltimore, Md.

A Doerle Enthusiast
I have just completed my two-tube Doerle, and it surely is a great receiver! It works fine on all the wavebands. Nobody could wish for any better job than this one. I can get WSK and WJAA to work on the loudspeaker at night, and the code stations come in with a wallop behind them.
Nanuel E. Smith, Lock Box 241, Graylin, Mich.

Two Tube 12,500 Mile Doerle Receiver



\$8.90

This receiver is exactly as illustrated in our photographs. Size of aluminum panel is 9 1/2 x 6 inches; base 9 1/2 x 8 inches. List of material used: 2 Hammillund .00014 Condensers; 1 Carter 20 ohm Rheostat and Switch; 1 Peerless Audio Transformer; 2 Kurta-Kaach Vernier Dials; 3 Bakelite Low Loss Sockets; 1 Micamold Equalizer Antenna Condenser; 1-0001 Aerovox Fixed Condenser; 1-5 meohm Carbonum Grid Leak; 2 Telephone Pin Jacks; 1 Aluminum Panel; 1 Aluminum Base; 1 Bakelite Rheostat Knob; 1 Bakelite Binding Post Strip; 1 set of 6 Bakelite Short Wave Plug-in Coils; Instructions for Operation; 1 Set of Hardware. Wire, etc. Complete shipping weight 5 lbs.

No. 2140. TWO TUBE 12,500 MILE DOERLE SHORT WAVE RECEIVER, completely wired and tested as per above specifications. **YOUR PRICE \$8.90**

No. 2141. TWO TUBE 12,500 MILE DOERLE SHORT WAVE RECEIVER KIT, with all parts as specified above, but not wired, with blueprint connections and instructions for operation. Complete shipping weight 5 lbs. **YOUR PRICE \$7.70**

No. 2142. COMPLETE ACCESSORIES, including the following: 2 six months guaranteed Neontron type No. 230 tubes; one set of No. 1078 Brandes Matched Headphones; 2 No. 6 standard dry cells; 2 standard 45-volt "E" batteries, complete, shipping weight 22 lbs. **YOUR PRICE \$5.40**

Improved 3-Tube Doerle Signal Gripper



\$11.85

This receiver also, is exactly as shown in our photographs. The aluminum panel measures 10 1/2 x 8 inches. It comprises the following parts: 3 Hammillund .00014 Tuning Condensers; 1 Carter 20 ohm Rheostat; 2 Sets of Short Wave Coils; 1-5 Medium Carbonum Grid Leak; 3 Aerial Condensers; 1 Bakelite Low Loss Sockets; 2 Micamold Equalizer Jacks; 2 Bakelite Knob; 1 Aluminum Panel; 1 Aluminum Base; One Set of Directions and Instructions for Operation; 1 Set of Hardware. Wire, etc. Shipping weight 7 lbs.

No. 2143. Improved THREE TUBE DOERLE SET, completely wired, ready to use. **YOUR PRICE \$11.85**

No. 2144. Improved THREE TUBE DOERLE SET IN KIT FORM with all parts as specified above, but not wired with blue-print connections and instructions for operation, complete. Shipping weight 7 lbs. **YOUR PRICE \$10.50**

No. 2145. COMPLETE ACCESSORIES, including the following: 2 six months guaranteed Neontron type No. 230 tubes; and one type 34 one set of Brandes Matched Headphones; 2 No. 6 standard dry cells; 3 standard 45-volt "E" batteries; 1 H.B.L. 9 inch Coils Magneto Loudspeaker, complete. Shipping weight 32 lbs. **\$11.00**

GUARANTEE

We guarantee and warrant that all material furnished in the two sets described in this advertisement, whether in the completed set or in the kit form, is first class, in every respect; that the complete sets have been tested before shipping, and that we will stand back of these sets and kits in every way. We will replace any parts, with the exception of accidentally blown out vacuum tubes within three months, if parts are returned to us within that time.

PLEASE NOTE

We are short wave specialists. Please understand that the two sets here described are not the only ones which we produce. We can furnish parts in kit form of practically any short wave receiver described in SHORT WAVE CRAFT or other radio magazines. Get our prices first. We will save you money.

ORDER FROM THIS PAGE Send money order or certified check. C.O.D. only if 20% remittance accompanies all orders. Order NOW—TODAY

FREE 104-page Radio and Short Wave Treatise; 100 hook-ups, 1,000 illustrations. Enclose 4c for postage. Treatise sent by return mail.

RADIO TRADING COMPANY, 100A Park Place, New York City

Look!

INSPECT, COMPARE

We are confident of your approval

This new 7-tube short-wave super-heterodyne, designed originally for amateur phone reception, with professional design details, offers the short-wave broadcast listener and the experimenter exceptional distance, selectivity, stability and tone quality in the reception of short-wave broadcasts. From such a receiver, National-built, one expects remarkable performance, and gets it. With its strictly single control tuning, front-of-panel coil changing, full vision dial and single-hand control of tuning and volume, the National FB-7 gives you a simplicity and convenience of operation heretofore not available at such a reasonable price.

FB-7 SPECIFICATIONS

THE CIRCUIT . . . 7 tubes: one 57, two 24's, two 58's, one 56, and one 59 . . . Electron Coupled Oscillators . . . Separate Oscillator for CW beat frequency giving "semi-single signal" or "offset" tuning . . . High efficiency Litz wound IF Transformers . . . Class A Power Pentode Output . . . R-39 Coil Forms with grounded metal shield handles . . . Band Spread Coils available for 20, 40, 80 and 160 meter amateur bands, each covering 100 full dial divisions . . . Standard coils for continuous coverage from 20 MC to 1500 KC . . . No frequency drift . . . Double Shielding . . . May be used with either conventional antenna or "doublet" with transposed transmission-line lead-in.

THE CHASSIS . . . Single Control Tuning. (No trimmers) . . . Full Vision Dial with SFL 270° condenser . . . Front-of-panel coil changing, without disturbing shielding . . . CW Beat Oscillator Switch on panel . . . Front-of-Panel Switch for "cutting" B voltages during transmission . . . Phone Jack, connecting ahead of final audio stage . . . Calibrated Volume control located under tuning knob, for one-hand operation—gain control calibrated in R units . . . All fixed adjustments, such as I.F. peaking, accessible from top without removal of chassis from cabinet.



SINGLE SIGNAL OPERATION

Both the circuit and the chassis layout have been designed for ready addition of mechanical filter (quartz crystal) when desired for full "single signal" operation.

MADE FOR AC POWER-SUPPLY

The FB-7 is designed to be operated by filament transformer and B-batteries, or the National 5887 or 5880 Short-Wave Power Units. Where the maximum undistorted power output is desired for short-wave broadcast reception, the National 5897 is recommended, which furnishes voltages sufficient to drive the type 59 power output pentode at full rating. R. C. A. Licensed.

AIR TUNED I. F.

The new National air-dielectric-tuned intermediate frequency transformers are also now available for use in the FB-7 receiver.

NEW NATIONAL FB-7 SHORT-WAVE RECEIVER



NATIONAL COMPANY, INC.
61 Sherman Street, Malden, Mass.

Gentlemen:—
Please send me your new catalogue sheets giving full description of the new FB-7 Short-Wave Super and your new Short-Wave Parts. I enclose 6c in stamps to cover mailing costs.

Name _____

Address _____

SWC-6-33

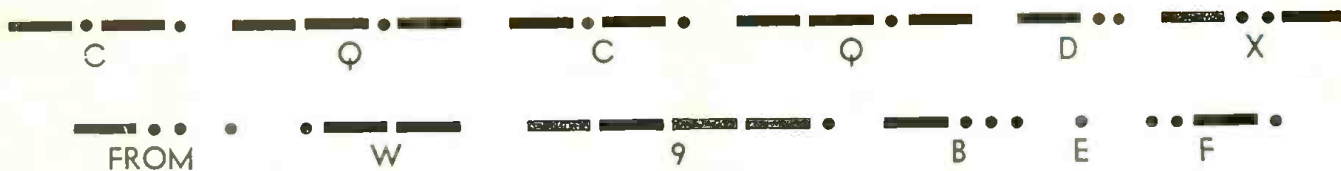

LINCOLN R-9

9-200 METERS

The Lincoln Super Powered R-9 strictly short wave receiver is tested on the air; not simply by tuning in to distant stations but by actual two-way communication where every word is absolutely necessary; no waiting over long periods for call letter identification, it must be positive and clear the first time, and all of the time.

Tests of this kind in actual work with a powerful short-wave transmitter guarantee to you the ultimate in world wide reception. Just remember! Commercial radio must have consistent dependable performance. Lincoln's dependable performance was proved on the last MacMillan Arctic Expedition when two-way communication was held between W9ABD Chicago and WDDE—Bowdoin Schooner, without missing a day; 348 messages were handled with Lincoln receivers at both ends of the transmission.

SHORT WAVE CONSULTANT ENTHUSIASTIC OVER R-9

The short wave consultant for the International DX'ers Alliance of Bloomington, Ill., writes: "I have never in all my years of radio seen anything to compare with it in operation. The quietness of operation, the marvelous tone quality, and the simple tuning. I am sure sold on the idea of band spread. To the eye it presents a wonderful piece of workmanship. Yesterday morning I received DJB, 12RO, Pointoise, DJA, Hilversum, LSG, Rabat, RXA, HJB, FTM and K6BAZ (20 meter amateur in Honolulu). Believe you me the oscillator sure handles the weak signals. The more I tune it the more I am convinced what it sure will do with the amateurs. I have spent more time on the 75 meter phone band than I

have heretofore, in order to just see how the stations are spread on the dial, and I have heard many operators complain of the QRM on the stations which they were working, while at the same time I could get both stations without any QRM whatever. I have never experienced an automatic volume control as effective as the system in the R-9. It is a great pleasure to tune a program without the customary fading on high frequencies."

FOREIGN RECEPTION WITH A "BANG" THROUGH HEAVY INTERFERENCE

"I was remarkably surprised with the operation of the receiver. It was a real pleasure to hear the carrier wave push to one side the background noise generated by trucks and busses. I live at the foot of the George Washington Bridge and the stream of busses and trucks with heavy ignition is constant. Foreign reception comes in with a 'bang' even though the location where the set is installed is anything but favorable for international short wave reception. I picked up with good signal strength, England, Spain, France, Switzerland, Germany, Venezuela, the first afternoon the set was installed.

"C. Lea, N. Y. City."

Why not put one of these receivers in your den where you can enjoy this kind of performance, and let friend wife tune the broadcast receiver to her heart's content? The price is very moderate in comparison; and full information "why" Lincoln receivers give dependable performance is yours for the asking.

Amateur station operators and servicemen write for information on how you can represent Lincoln in your city.

LINCOLN RADIO CORPORATION, Dept. J, 333 S. Wood St., Chicago

LINCOLN RADIO CORPORATION
 Dept. J, 333 S. Wood St., Chicago
 Send free information and prices on R-9 SW-33
 Name
 Street
 City State
 Amateur Call Letters.....

LINCOLN
De Luxe Receivers