

★ SHORT WAVE CRAFT

Edited by
HUGO GERNSBACK

SPECIAL
BEGINNER'S
Number

NOW
25¢
IN CANADA
30¢

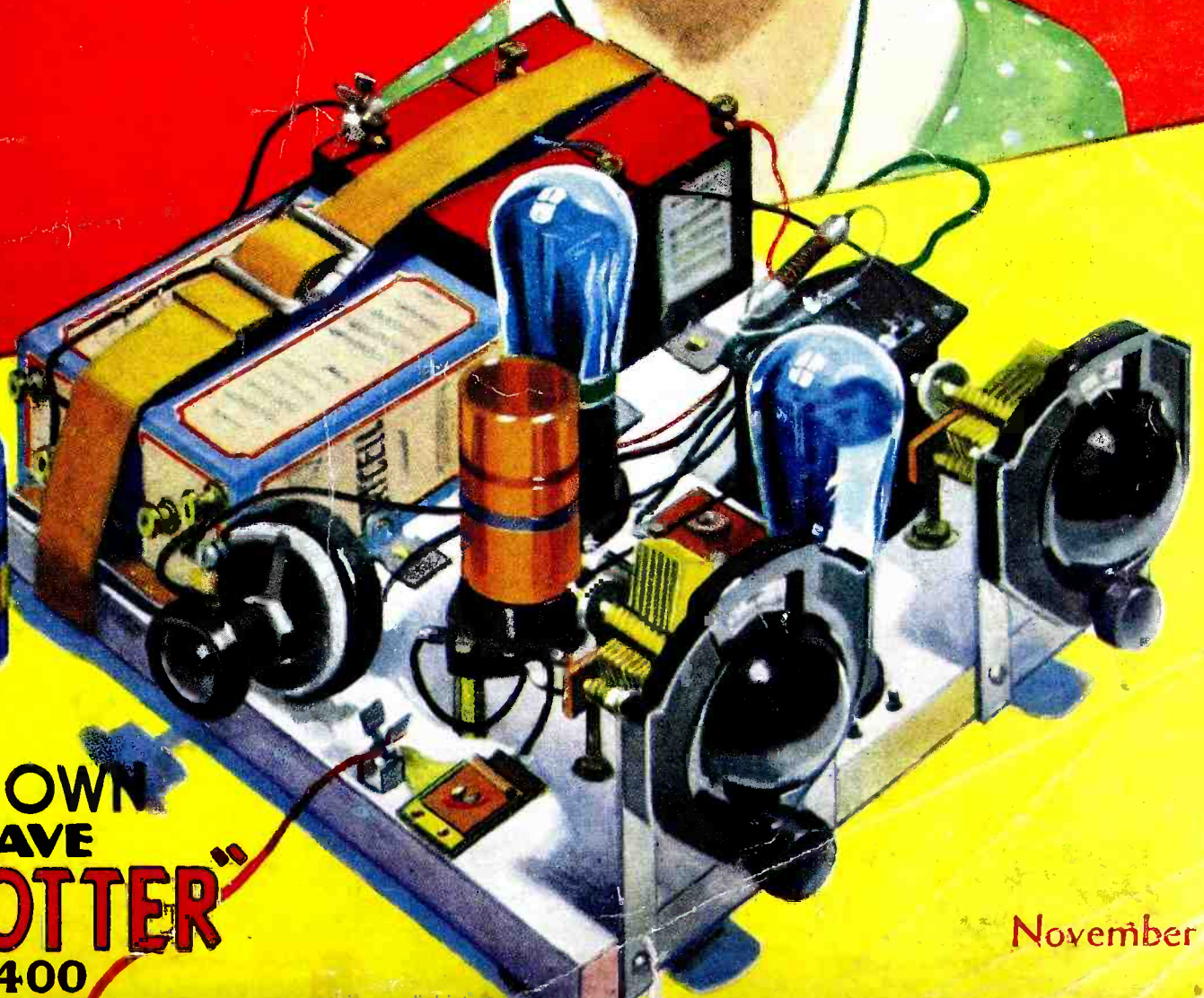

BUILD YOUR OWN
SHORT WAVE
GLOBE-TROTTER
See Page 400

November

WORLD WIDE RECEPTION

ALL WAVE WITH THE NEW LAFAYETTE

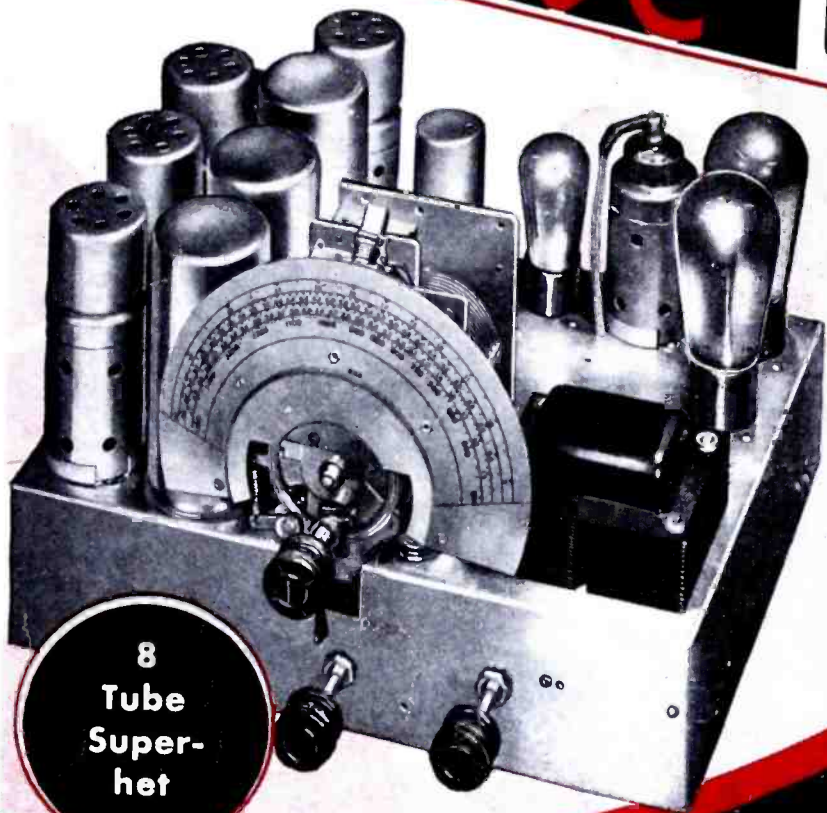

8 Tube Superhet

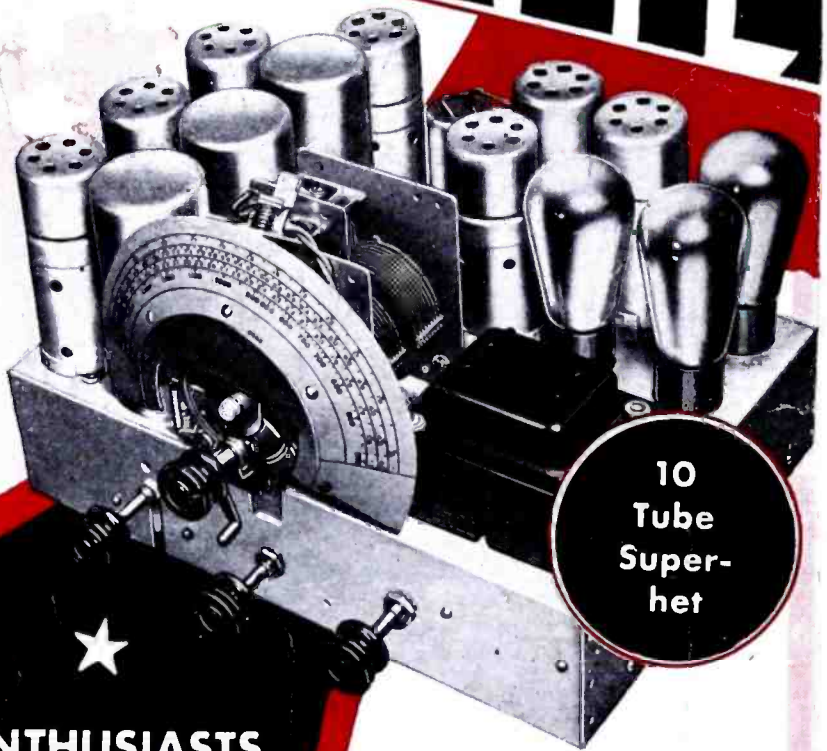

10 Tube Superhet

SHORT WAVE ENTHUSIASTS

This remarkable new ALL WAVE 8-tube Superhet uses the new HIGH GAIN TUBES, assuring extraordinary power and amplification. Performance standards are of the finest—a true LAFAYETTE! Features include AUTOMATIC VOLUME CONTROL, TONE CONTROL, CALIBRATED TWO-SPEED DIAL, and an IMPROVED SUPERHETERODYNE CIRCUIT (NO PLUG-IN COILS). An important innovation is the band selector switching arrangement, a rotary type with which enough combinations may be had at a single turn to afford individual peaking and padding of the oscillator. A portion of the voltage generated in the radio frequency AUTOMATIC VOLUME CONTROL is used to govern the audio amplification, preventing overloading and reducing distortion. Available with dual Dynamic Speakers. Span the world of radio with this ALL WAVE LAFAYETTE. Priced sensationally low. For full details and prices mail the coupon below—no obligation.

Short wave fans and enthusiasts are especially invited to write for a copy of the new 1933 WHOLESALE RADIO SERVICE COMPANY catalog, featuring the latest developments and improvements in short wave craft. Full details of the great new 8 and 10 tube ALL WAVE CHASSIS will be found, together with a complete selection of RADIO RECEIVERS, PARTS, KITS, etc. EVERYTHING IN RADIO AT THE LOWEST WHOLESALE PRICES.

Write for a free copy of this catalog TODAY. The coupon below will place you on our mailing list and keep you in touch with the newest inventions and discoveries in radio.

TUNES 12 to 550 METERS Model Available for 12 to 2,000 Meters The finest ALL WAVE receiver ever developed. This great new 10-Tube Lafayette Superhet features radio's newest discovery, AUTOMATIC NOISE SUPPRESSOR. When no signal is being received the AUTOMATIC NOISE SUPPRESSOR prevents any audio signal from passing to the first stage, eliminating the "between station noises." Electrical interference from vacuum cleaners, refrigerators, etc., is rejected. New heights of performance are made possible by AUTOMATIC VOLUME CONTROL, HIGH GAIN TUBES, PUSH-PULL OUTPUT, A PERFECTED SUPERHETERODYNE CIRCUIT DEVELOPED TO UTILIZE THE NEW TYPE TUBES TO THEIR GREATEST MAXIMUM, CALIBRATED DIAL, TUNING CONTROL, AND PHONO ATTACHMENT. Special new type two-speed dial, calibrated in the four bands covered. Single station selector tunes all wave bands. Try this great new LAFAYETTE in your own home on our 30 days free trial offer. Judge for yourself. Listen to the world at play. We'll be glad to send you complete description and prices, plus details of our 30 days free trial plan.



This Lafayette Cabinet Model may be obtained with either the 8-tube or 10-tube All Wave Superhet Chassis. The cabinet is modern in design, built to grace the finest homes. Scientifically constructed with adequate baffle areas for finer sound reproduction. Priced amazingly low—sold direct to you at the LOWEST WHOLESALE PRICES. Select the chassis you prefer to go with this cabinet, try it in your own home under our 30 days free trial plan, and convince yourself that these ALL WAVE LAFAYETTES will give you superfine radio performance and satisfaction.

WHOLESALE RADIO SERVICE COMPANY,
100 Sixth Avenue, New York Dept. SW 53

Please rush new 1933 catalog, absolutely free, with complete information and prices on the new Lafayette 8 and 10 Tubes ALL WAVE SUPERHETS.

NAME

ADDRESS

TOWN..... STATE.....

394 400 404 408 412 415 421
 398 402 406 410 414 417

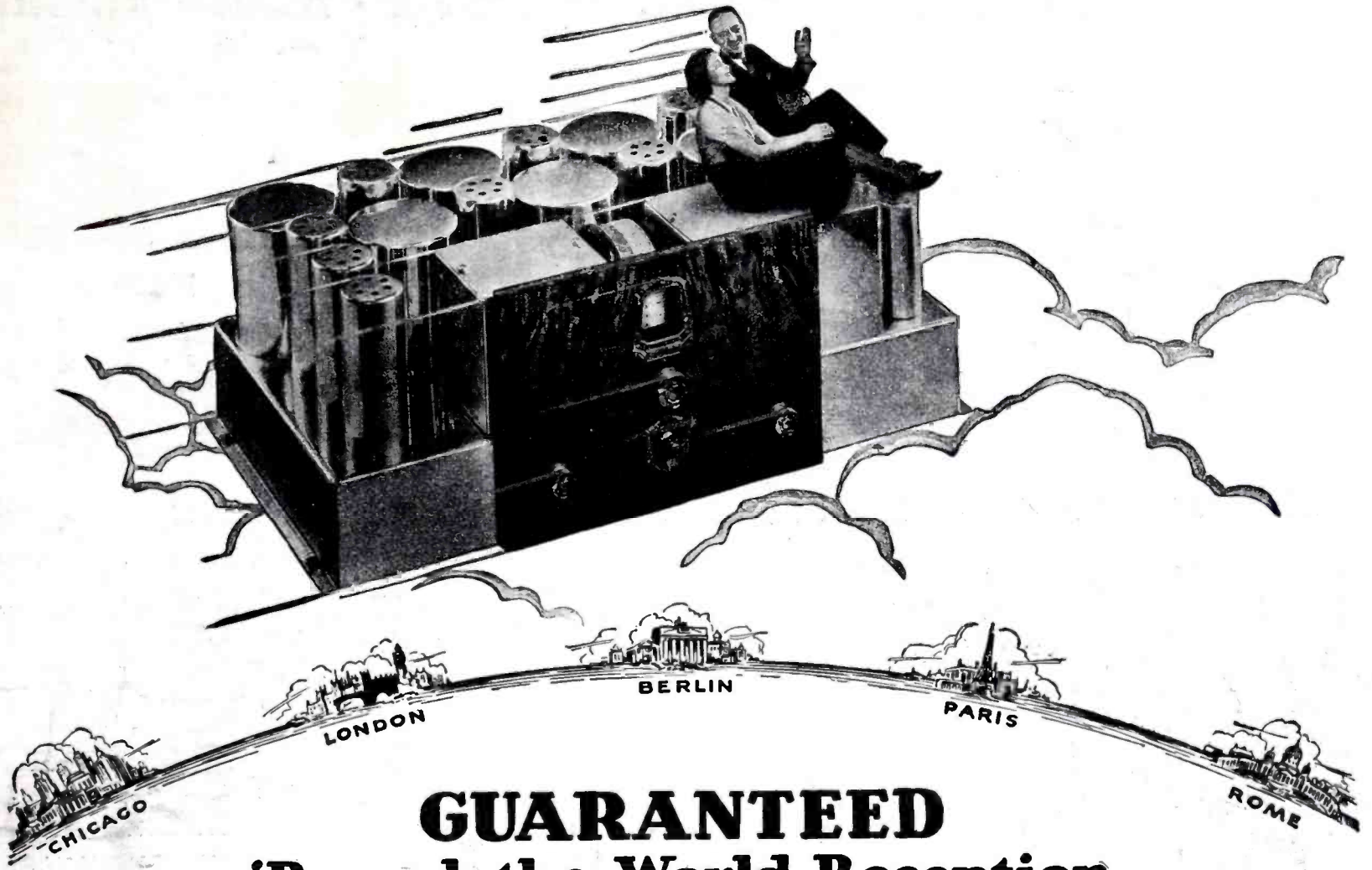

GUARANTEED 'Round-the-World Reception For the First Time in Radio History

JUST turn a switch and—z-i-p! we're off on a world tour via radio. Because it's a new SCOTT ALLWAVE DELUXE there'll be no fussing and fumbling about—only one dial to tune, no coils to plug in, no trimmers to adjust carefully. Just use the convenient log furnished with the set and the foreign station you want—maybe 10,000 miles or more away—comes in on the dot.

Let's Start to Merrie England!

Let's try G5SW, Chelmsford, England. Get it any day between 3:00 and 6:00 P.M. Hear peppy dance music from the Hotel Mayfair in London (Yes, those Britishers furnish music that's as "hot" as any orchestra in the States!). Then, too, there are world news broadcasts that tell listeners all over the far-flung British Empire the news of the day in the homeland. At 6:00 P.M. (Midnight London time) it's thrilling to hear "Big Ben," in the House of Parliament, strike the hour of midnight in a sonorous voice.

Foreign Reception Every Day in the Year

Tired of the English program, eh? Like something French? That's easy—let's go to gay Páree.

Here's Radio Colonial, Paris, France, and it is on the air for the SCOTT ALLWAVE DELUXE any day between 3:00 and 6:00 P.M. Hear those dulcet tones of a spirited Mademoiselle? What, you can't understand French? Never mind, here's an orchestra and a song. Music is a universal language. This is Monday—that's lucky, for there'll be an hour's talk in English today about the encampment of the Veterans of Foreign Wars to be held in Paris in 1935.

10,000-Mile Distant Stations Guaranteed

Unusual to get such reception? Not at all for this receiver. This new SCOTT ALLWAVE DELUXE is guaranteed to bring it in like that—yes, absolutely guaranteed to bring in foreign stations 10,000 miles or more away, every day of every week in the year, with loud speaker volume.

How can they make such a guarantee? Well, chiefly because the SCOTT ALLWAVE DELUXE is a custom-made receiver. It is built with as much care and

precision as a fine watch. There's skilled designing and engineering behind it too—as well as parts good enough to carry a five-year guarantee against failure.

Most Perfect Tone Quality in Radio

Want to hear some more? Sure! Where do you want to go? Germany? All right. Here's Zeesen. It can be SCOTT-ed any morning between 9:30 and 11:00. From it you will hear about the grandest symphony concerts put on the air any place. You'll be glad your SCOTT ALLWAVE DELUXE has such exquisite tone. And it is exquisite tone! So perfect that, in a studio test, observers were unable to distinguish between the actual playing of a pianist and the SCOTT reproduction of a piano solo from a broadcasting station when the set and the pianist were concealed behind a curtain.



Tired of Germany? Then let's jump to Spain on our "Magic Carpet." Here's EAQ, Madrid. Hear the castanets and guitars? Always typically Spanish music from this station between 7:00 and 9:00 P.M. You'll enjoy EAQ doubly because they thoughtfully make their announcements in both English and their native tongue.

Opera Direct from the Eternal City

Want a quick trip farther south? Here's Rome—12RO. The lady announcer's voice is saying, "Radio Roma, Napoli." From here, between 3:00 and 6:00 P.M. daily, you'll hear grand opera with its most gorgeous voices and with the finest accompaniments.

So you want to hear what's doing on the other side of the world now? That's easy, let's get up early and pick up VK2ME, from Sydney, Australia, any Sunday morning between 5:00 and 8:30 A.M., or VK3ME, Melbourne, any Wednesday or Saturday morning, between 4:00 and 6:30 A.M. Hear the call of the famous bird of the Antipodes—the Kookaburra. There'll be

an interesting and varied program, music, and always a talk on the scenic or industrial attraction of the country.

Australian Stations Sound Close as Home

Can I get Australia easily? Why, of course you can! In a test didn't one SCOTT ALLWAVE pick up every regular program from VK2ME in Chicago, 9,500 miles away, over a whole year's time? Quite a record! You bet! And what's more, the programs received were recorded on phonograph records, and one was even played back to Australia over long distance telephone, and they heard it clear as a bell! That's performance!

These are but a few of the more than 200 foreign stations that may be heard by SCOTT owners.

Tired of foreign travel? Well, let's jog about the STATES—or Canada or Mexico—on the regular broadcast frequencies. Wonderful? You bet! There was never finer reception. Or you can eavesdrop on police calls, international phone transmission, gabbing amateur wireless telephony fans. Your fun with a SCOTT ALLWAVE DELUXE is unlimited.

New Values! Prices Lowest Ever!

Too expensive for you? Not at all! A SCOTT ALLWAVE DELUXE won't cost you more than any good model of an ordinary receiver. And it gives so much more in pleasure and satisfaction!

You'd like to know more about it—the technical details, and proofs of those wonderful performances? Easy! Just tear out the coupon below, fill in your name and address, and mail it TODAY.

THE E. H. SCOTT RADIO LABORATORIES, INC.,
 4450 Ravenswood Ave., Dept. SWC112, Chicago, Ill.

Tell me how I can have a SCOTT ALLWAVE DELUXE for a "Magic Carpet" of my own, and send me complete technical details, proofs of performance, and complete information.

Name _____
 Address _____
 City _____ State _____



HUGO GERNSBACK
Editor

H. WINFIELD SECOR
Managing Editor

CONTENTS FOR NOVEMBER, 1932

FEATURES IN NEXT ISSUE

FEATURES:

Editorial—Short Wave Beginners, by Hugo Gernsback 393
 Eclipse Affects Short Waves, by Dr. E. F. W. Alexanderson, Radio Consulting Engineer, General Electric Company 394
 Radio from the Dark World, by Dr. Robert A. Marks. 396
 Boy! Do They Roll In On This 1-Tuber! by Clifford E. Denton 398
 Building the 2-Tube "Globe-Trotter" Receiver, by Robert Hertzberg, W2DJJ..... 400
 A 3-Tube "Signal Gripper," by Walter C. Doerle.... 402
 Prize Winners in the Fourth Set-Builders' Contest... 404
 Learning the Code, by John L. Reinartz, No. 5 of a series, "How To Become A Radio Amateur"..... 407
THE SHORT WAVE BEGINNER, No. 4, Adding An Amplifier to the Beginners' Receiver, by C. W. Palmer 408
 Audio Amplifiers—How to build a good one, by Louis Martin 410
DOUBLET ANTENNAS Eliminate Man-Made Interference, by Everett L. Dillard..... 412
 A "Free-Wheeling" Receiver for Beginners, by R. W. Vosburgh 414

A 1-Tube Super-Regenerative Receiver, by R. William Tanner, including photos, diagram and complete coil data.
 A 3-Tube Short-Wave Receiver of Quality, by H. W. Secor.
 A 2-Tube S-W Receiver of Proven Excellence and "DX"-Getting Ability, by Nelson G. Haas.
 A De Luxe 5 T.R.F. Receiver, by Barton Currie, W6CHJ.
 Short-Wave Thrills on Two Tubes! by M. Harvey Gernsback.
 Smoothing Up the Regeneration Control, by Robert J. Slack.
 W9ZG Saves A Life, by A. D. Middleton, W8UC—Short Wave Fiction!
 A 20-Meter Transmitter, by A. Binneweg, Jr.

SHORT WAVE RECEIVERS:

A 1-Tube Receiver of Low Cost and High Efficiency, By C. E. Denton..... 398
 The 2-Tube "Globe-Trotter" Receiver, by "Bob" Hertzberg 400
 A 3-Tube "Signal Gripper," by W. C. Doerle..... 402
 \$500.00 Contest Prize-Winning Receivers..... 404
 How to Add Audio Amplifier to the Beginners' Receiving Set 408
 What Is a Good AF Amplifier?..... 410
 A "Free-Wheeling" Receiver for Beginners..... 414
 A 9-Tube "Plug-less" Superhet Receiver, by William J. Vette 417
SHORT WAVE CRAFT Will Build YOUR Ideal Receiver 422

CONTENTS FOR NOVEMBER—Continued

TELEVISION Stations 420
 POLICE Short Wave Stations..... 420
 Short Wave QUESTION BOX..... 421
SHORT WAVE CRAFT will Build YOUR Ideal Receiver 422
SHORT WAVE LEAGUE 424
 Amateurs Who Made Good..... 429
 When to Listen In, by "Bob" Hertzberg..... 429
 Short Wave Events of the Month..... 434

SHORT WAVE TRANSMITTERS:

Learning the Code, by John L. Reinartz..... 407
 Short Wave Transmitting Antenna Data..... 422
 Uncle Sam's Regulations Governing Radio Operators' Licenses—Part II 424

OUR COVER

How to Build the 2-Tube Short-Wave "Globe-Trotter" Receiver is fully described for the layman, by Robert Hertzberg, on page..... 400

MISCELLANEOUS:

Eclipse Affects Short Waves, by Dr. E. F. W. Alexanderson 394
 How Short Waves Entertain the Blind..... 396
 Prize Winners in Fourth Contest for S-W Set-Builders 404
 Novel Plug-In Coil Construction..... 406
 \$20.00 New Monthly "Set" Contest..... 406
 THE SHORT WAVE BEGINNER, No. 5 of a series.. 408
 DOUBLET ANTENNAS and Transposition Lead-Ins —How to Install Them..... 412
 \$5.00 for Best Short Wave Kink..... 415
 Letters from S-W Fans..... 416
 Short Wave Stations of the World—Complete List.. 418

SHORT WAVE CRAFT—Monthly. Entered as second class matter May 7, 1930, at the post office at Mount Morris, Illinois, under the act of March 3, 1879. Trademarks and copyrights by permission of H. Gernsback, 98 Park Place, N. Y. C. Text and illustrations of this magazine are copyrighted and must not be reproduced without permission. SHORT WAVE CRAFT is published on the 15th of every month. Twelve numbers per year. Subscription price is \$2.50 a year in the United States and possessions. Canada and foreign countries, \$3.00 a year. Single copies 25c. Address all contributions for publication to Editor, SHORT WAVE CRAFT, 96-98 Park Place, New York, N. Y. Publishers are not responsible for lost manuscripts. Contributions cannot be returned unless authors remit full postage. SHORT WAVE CRAFT is for sale at all principal newsstands in the United States and Canada. European agents: Brentano's, London and Paris. Printed in U. S. A. Make all subscription checks payable to Popular Book Corporation.

COPYRIGHT, 1932, BY H. GERNSBACK

Published by POPULAR BOOK CORPORATION

HUGO GERNSBACK, President - H. W. SECOR, Vice-President
 EMIL GROSSMAN - - - - - Director of Advertising
 Chicago Adv. Office - - - L. F. McCLURE, 737 No. Michigan Blvd.
 Publication Office - - - 404 N. Wesley Avenue, Mount Morris, Ill.
 Editorial and General Offices - 96-98 Park Place, New York, N. Y.
 London Agent: HACHETTE & CIE., 16-17 King William St., Charing Cross, W.C.2

Paris Agent: HACHETTE & CIE., 111 Rue Reaumur
 Australian Agents: MCGILL'S AGENCY, 179 Elizabeth St., Melbourne

OPPORTUNITIES *are many* for the Radio Trained Man



Don't spend your life slaving away in some dull, hopeless job! Don't be satisfied to work for a mere \$20 or \$30 a week. Let me show you how to get your start in Radio—the fastest-growing, biggest money-making game on earth.

Jobs Leading to Salaries of \$50 a Week and Up

Prepare for jobs as Designer, Inspector and Tester—as Radio Salesman and in Service and Installation Work—as Operator or Manager of a Broadcasting Station—as Wireless Operator on a Ship or Airplane, or in Talking Picture or Sound Work—HUNDREDS of OPPORTUNITIES for a real future in Radio!

Ten Weeks of Shop Training

We don't teach by book study. We train you on a great outlay of Radio, Television and Sound equipment—on scores of modern Radio Receivers, huge Broadcasting equipment, the very latest and newest Television apparatus, Talking Picture and Sound Reproduction equipment, Code Practice equipment, etc. You don't need advanced education or previous experience. We give you—RIGHT HERE IN THE COYNE SHOPS—the actual practice and experience you'll need for your start in this great field. And because we cut out all useless theory and only give that which is necessary you get a practical training in 10 weeks.

TELEVISION *and* TALKING PICTURES

And Television is already here! Soon there'll be a demand for THOUSANDS of TELEVISION EXPERTS! The man who learns Television now can have a great future in this great new field. Get in on the ground-floor of this amazing new Radio development! Come to COYNE and learn Television on the very latest, new-

est Television equipment. Talking Picture and Public Address Systems offer opportunities to the Trained Radio Man. Here is a great new Radio field just beginning to grow! Prepare NOW for these wonderful opportunities! Learn Radio Sound Work at COYNE on actual Talking Picture and Sound Reproduction equipment.



All Practical Work At COYNE In Chicago

ALL ACTUAL, PRACTICAL WORK. You build radio sets, install and service them. You actually operate great Broadcasting equipment. You construct Television Receiving Sets and actually transmit your own Television programs over our modern Television equipment. You work on real Talking Picture machines and Sound equipment. You learn Wireless Operating on actual Code Practice apparatus. We don't waste time on use!ess theory. We give you the practical training you'll need—in 10 short, pleasant weeks.

Many Earn While Learning

You get Free Employment Service for Life. And don't let lack of money stop you. Many of our students make all or a good part of their living expenses while going to school and if you should need this help just write to me. Coyne is 32 years old! Coyne Training is tested—proven beyond all doubt. You can find out everything absolutely free. Just mail coupon for my big free book!

H. C. Lewis, Pres. RADIO DIVISION Founded 1899
COYNE Electrical School
500 S. Paulina St., Dept. 82-2K Chicago, Ill.

Mail Coupon Today for All the Facts

H. C. LEWIS, President
Radio Division, Coyne Electrical School
500 S. Paulina St., Dept. 82-2K Chicago, Ill.

Dear Mr. Lewis:— Send me your Big Free Radio Book, and all details of your Special Offer.

Name.....
Address.....
City.....State.....

More Money



I show beginners how experienced service men

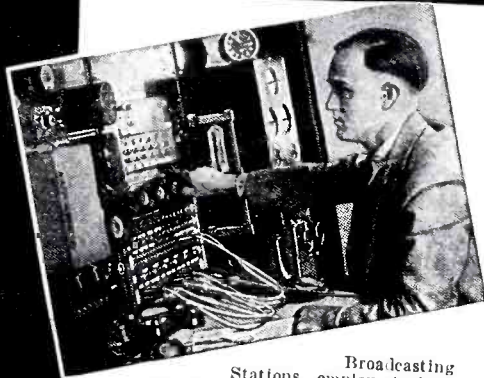

Broadcasting Stations employ trained men for jobs paying up to \$5,000 a year.

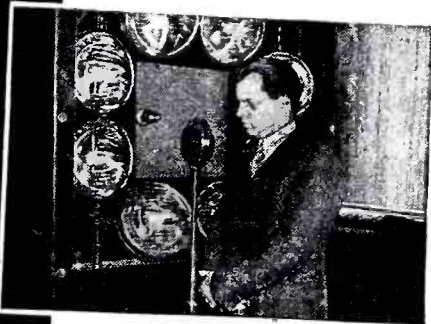

Television—the coming field of many great opportunities—is covered by my course.

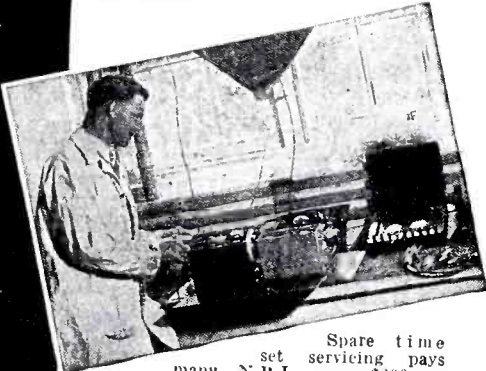

Spare time set servicing pays many N.R.I. men \$200 to \$1,000 a year. Full time men make as much as \$50, \$65, and \$75 a week.



Talking Movies—an invention made possible by Radio—employs many well trained Radio men for jobs paying as much as \$75 to \$200 a week.

My book, "Rich Rewards in Radio," gives you full information on the opportunities in Radio and explains how I train beginners at home to become Radio Experts and experienced service men for better Radio jobs—better pay. It's free. Clip and mail the coupon NOW. Radio's amazing growth has made hundreds of fine jobs which pay \$50, \$60, \$75, and as much as \$100 a week. Many of these jobs lead to salaries as high as \$125 and \$150 a week.

Radio—the Field with a Future

Once or twice in a man's lifetime a new business is started in this country. You have seen how the men and young men who got into the automobile, motion picture, and other industries when they were started had the first chance at the big jobs—the \$5,000, \$10,000, and \$15,000 a year jobs. Radio offers the same chance that made men rich in those businesses. It has already made many men independent and will make many more wealthy in the future. You will be kicking yourself if you pass up this once-in-a-lifetime opportunity for financial independence.

Many Radio Experts make \$50 to \$100 a week

In the short space of a few years, 300,000 Radio jobs have been created, and thousands more will be made by its future development. Men with the right training—the kind of training I will give you in the N.R.I. Course—have stepped into Radio at 2 and 3 times their former salaries. Experienced service men as well as beginners praise N.R.I. training for what it has done for them.

Many make \$5, \$10, \$15 a week extra in spare time almost at once

My Course is world-famous as the one "that pays for itself." The day you enroll I send you material, which you should master quickly, for doing 28 Radio jobs common in most every neighborhood. Throughout your Course I will show you how to do other repair and service jobs on the side for extra money. I will not only show you how to do the jobs, but how to get them. I'll give you the plans and ideas that have made \$200 to \$1,000 a year for N.R.I. men in their spare time. G. W. Page, 110 Raleigh Apts., Nashville, Tenn., wrote me: "I made \$935 in my spare time while taking your Course." My book, "Rich Rewards in Radio," gives many letters from students who earned four, five, and six times their tuition fee before they graduated.

Get ready for jobs like these

Broadcasting stations use engineers, operators, station managers and pay up to \$5,000 a year. Radio manufacturers

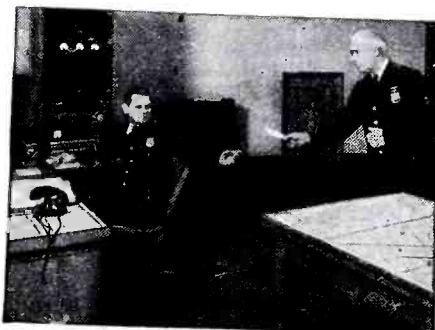

Police Departments are finding Radio a great aid in their work. Many good jobs have been made in this new field.

SPECIAL FREE OFFER

Mail the coupon today, and in addition to my big free book, "Rich Rewards in Radio," I'll send you my text, "Short Wave Receivers and Transmitters." Only my students could get this book in the past. Here's up-to-date information on the latest phase of Radio. 30 pages packed with fascinating details of this important new development. Learn about the new Detector Circuit, Short Wave Coils and Condensers, Audio Amplifier, Short Wave Superheterodyne, etc. Also complete construction details for practical circuits. Mail the coupon at once. Act now—and receive the latest technical information on this subject.



Some of the Jobs N. R. I. Trains Men For

- Broadcast Engineer
- Maintenance Man in Broadcasting Station
- Installation Engineer of Broadcast Apparatus
- Operator in Broadcast Station
- Aircraft Radio Operator
- Operator of Airway Beacons
- Service Man on Sound Picture Apparatus
- Operator of Sound Picture Apparatus
- Ship Operator
- Service Man on Public Address Systems
- Installation Engineer on Public Address Systems
- Sales Manager for Retail Stores
- Service Manager for Retail Stores
- Auto Radio Installation and Service Man
- Television Broadcast Operator
- Set Servicing Expert

Act! MAIL COUPON Today - - - Get The Facts About

for You in Radio

to get into Radio quickly how to get better jobs-better pay

Here's Proof



\$400 Each Month

"I spent fifteen years as travelling salesman and was making good money, but could see the opportunities in Radio. Believe me, I am not sorry, for I have made more money than ever before. I have made more than \$400 each month and it really was your course that brought me to this. I can't say too much for your school." J. G. Dahlstead, Radio Station KYA, San Francisco, Cal.



Radio Service Man Doubles Salary

"I spent 15 years building and repairing Radios, but felt I could refresh my memory and learn about developments I had overlooked. Upon completion, I was appointed Service Manager of Parks & Hull, and was immediately repaid for the cost and time spent in study. I give the N.R.I. full credit for my success in the Radio field—it immediately increased my earnings 100%." J. E. McLaurine, 1511 Guilford Ave., Baltimore, Md.



From \$10 to \$50 a week in spare time

"Besides being employed by the Power & Light Company to locate Radio interference in this district, which is a very good position, I have a service business of my own that nets me from \$10 to \$50 a week in spare time. I owe all my success to the National Radio Institute, as I was only a common factory worker before taking the course." H. L. Penie, 812 W. High Street Piqua, Ohio.

employ testers, inspectors, foremen, engineers, service men, buyers, and managers for jobs paying up to \$6,000 a year. Radio dealers and jobbers (there are over 35,000) employ service men, salesmen, buyers, managers and pay up to \$100 a week. Radio operators on ships enjoy life, see the world, with board and lodging free, and get good pay besides. Talking pictures pay as much as \$75 to \$200 a week to men with Radio training. There are hundreds of opportunities for you to have a spare time or full time Radio business of your own—to be your own boss. I'll show you how to start your own business with practically no capital—how to do it on money made in spare time while learning. My book tells you of other opportunities. Be sure to get it at once. Just clip and mail the coupon.

You can learn at home in your spare time to be a Radio Expert

Hold your job. There is no need for you to leave home. I will train you quickly and inexpensively during your spare time. You don't have to be a high school or college graduate. My Course is written in a clear, interesting style that most anyone can grasp. I give you practical experience under my 50-50 method of training—one-half from lesson books and one-half from practical experiments with equipment given without extra charge. This unique and unequalled method has been called one of the greatest developments in correspondence Radio training. N.R.I. pioneered and developed it. It makes learning at home easy, fascinating, practical.

Learn the secrets of Short Wave, Television, Talking Pictures, Set Servicing, Broadcasting

I'll give you more training than you need simply to get a job—I'll give you your choice, and not charge you extra either, of my Advanced Courses so that you may SPECIALIZE in these subjects—(1) Television, (2) Set Servicing and Merchandising, (3) Sound Pictures and Public Address Systems, (4) Broadcasting, Commercial and Ship Radio Stations, (5) Aircraft Radio. Advanced specialized training like this gives you a decided advantage.

Your Money Back if you are Not Satisfied

I will give you an agreement in writing, legal and binding upon this Institute, to refund every penny of your money upon completing my Course if you are not satisfied with my Lessons and Instruction Service. The resources of the National Radio Institute, Pioneer and World's Largest Home-Study Radio School, stands behind this agreement.

Find out what Radio offers you. Get my book AT ONCE

One copy of my valuable 64-page book, "Rich Rewards in Radio," is free to any resident of the U. S. and Canada over 15 years old. It has started hundreds of men and young men on the road to better jobs and a bright future. It has shown hundreds of men who were in blind alley jobs, how to get into easier, more fascinating, better paying work. It tells you what my graduates are doing and making, where the good jobs are in Radio, what they pay, how you can quickly and easily fit yourself to be a Radio Expert. The Coupon will bring you a copy free. Send it at once. Your request does not obligate you in any way. ACT NOW.

J. E. SMITH, President
Dept. 2MB3 National Radio Institute
Washington, D. C.

SPECIAL Radio Equipment for Broad Practical Experience Given Without Extra Charge

My course is not all theory. I'll show you how to use my special Radio Equipment for conducting experiments and building circuits which illustrate important principles used in such well-known sets as Westinghouse, General Electric, Philco, R.C.A., Victor, Majestic, and others. You work out with your own hands many of the things you read in our lesson books. This 50-50 method of training makes learning at home easy, interesting, fascinating, intensely practical. You learn how sets work, why they work, how to make them work when they are out of order. Training like this shows up in your pay envelope—when you graduate you have had training and experience—you're not simply looking for a job where you can get experience.



With N.R.I. equipment you learn to build and thoroughly understand set testing equipment—you can use N.R.I. equipment in your spare time service work for extra money.

I have doubled and tripled the salaries of many. Find out about this tested way to **BIGGER PAY**



FILL OUT AND MAIL THIS COUPON TODAY

Mr. J. E. SMITH, President
National Radio Institute, Dept. 2MB3
Washington, D. C.

Dear Mr. Smith: Send me your book, "Rich Rewards in Radio," which points out the opportunities for spare time and full time jobs in Radio and your famous 50-50 method of training men to become Radio experts through home study. This request does not obligate me.

Name

Address

City State

"32FR"

The Famous Course That Pays For Itself

The house of a million radio items. We carry the largest stock of Short Wave material in this country. Mail orders filled the same day. On this page you will find listed the greatest radio bargains of brand new merchandise ever offered by any radio house. 10% cash must accompany all C.O.D. orders. 2% cash discount if full amount accompanies order.



WE HAVE NO CATALOG. Order direct from this page. All orders shipped the same day. Our prices are the lowest in America. All merchandise guaranteed. Your money refunded instantly if you are not fully satisfied. Watch this page every month for new bargains. We are Short Wave headquarters. All prices include Government tax.

IMPROVED 5-METER SUPER-REG. RECEIVER



Accepted and enthusiastically endorsed by many prominent experimenters, following its introduction last month. Setting as it does new standards of excellent performance and low price. Completely described in our July adv.

It's cheaper to buy this AIR TESTED 3 tube receiver than it is to assemble a kit that may not function properly. Using 2 type 37—one type 38 tube. Unconditionally guaranteed (at less tubes)..... **\$12.45**

GENUINE NATHANIEL BALDWIN MATCHED HEADSET



An accurately matched set of headphones, each unit consisting of a high-flux magnet surrounded by a field winding of 2000 ohms resistance. Ruggedly constructed of light weight highly polished Bakelite shells and ear caps. Can be worn for hours at a time without fatigue. Internal construction same as that on magnetic speakers; i.e., diaphragm (mica) directly connected to driving motor thru connecting rod. Many experimenters construct TWO magnetic speakers from each headset. Excellently suited for DX work. Complete with 6 ft. cord. Shipping weight, 2 pounds. **\$3.95**

"PARA" FEATHERWEIGHT HEADPHONES—4000 OHMS



Total Weight—6 Oz. The lightest headphones ever manufactured! No more pressing pains around the ears. Each unit is of 2000 ohm resistance and measures 2 3/8" diameter x 1" thick. Compactly built into a light, non-magnetic aluminum case finished in dark-brown crackle. Magnets are of "chrome" steel and will last indefinitely. Head-band made of 1/2" wide spring metal. Earcaps of molded bakelite. No grief with these phones. Complete with 3 1/4 ft cord and phone tips. Shipping weight, 1 lb..... **\$1.35**

DUO-LATERAL HONEYCOMB COILS

Unmounted honeycomb coils that can be used for broadcast or long wave reception. Widen the scope of your receiver by employing these coils. Ship. wt., 1 lb.



Size (Turns)	Price Each
25	.20
35	.30
50	.45
75	.55
100	.60
150	.70
200	.75
250	.85
300	.95
400	1.00
500	1.10
600	1.25
750	1.35
1000	
1250	
1500	

TRANSCONTINENTAL T.R.F. COILS



These are the same make of Diamond-weave T.R.F. coils which made the Freshman name famous. Designed for use in tuned radio frequency receivers with .00035 condensers. Excellent for replacements in Freshman Master-piece receivers or in construction work. Sold only in sets of three—attractively boxed. FREE PLANS for constructing a complete T.R.F. receiver furnished with each set. Each coil is provided with a convenient fiber mounting for attaching directly to tuning condenser. Shipping weight, 1 lb. Overall size, 3 1/4 x 3 1/4". SET OF 3 COILS..... **25c**

SOLID BRASS TELEGRAPH KEY



This key has four adjustments and may be used for either amateur or professional work. The arm, base and supporting positions are constructed of heavy cast lacquered brass. Contacts points are of coin silver and will not arc. Provided with double-finger rest knob of the Navy type to eliminate fatigue. List \$3.60. The price is down temporarily. Get yours **\$1.25** now. Ship. wt., 2 lbs.....

LOW LOSS S.W. CONDENSER

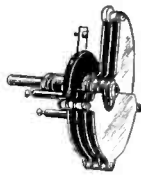

7 Plate Variable Condenser for use in short wave receivers. Heavy aluminum plates with SIL rotors. Excellent for DX work. Sturdily constructed for indefinite use. Rotors will not short to stator when "wide open." A very popular condenser with amateurs. Shipping weight, 1 lb..... **25c**

6 MF.—600 VOLT FILTER BLOCK



This neat unit contains 1—4 mf. and 1—2 mf. filter section, both at 600 volts D.C. working voltage. Put up in a neat metal shield can, provided with mounting flanges and convenient soldering lugs. Excellent for replacement and constructional work. May also be had with wire leads for Sub-panel Mounting. Measures 5" high x 2 3/4" wide x 3 1/4" deep **\$1.10**

KURZ-KASCH VERNIER DIAL



Attaches to shaft of tuning condenser by means of famous Kurz-Kasch split-bushing method. Heavy spring compensates for wear. Vernier ratio 14 to 1. Excellent for short wave tuning. Translucent dial permits lighting from the rear. Ship. weight 8 oz. **45c**

3" Dial **55c**
4" Dial

MEDIUM FREQUENCY TRANSFORMER General Radio No. 371



A thoroughly shielded, medium frequency transformer designed for the amplification of wave lengths in the order of 30 KC (10,000 meters.) Employed universally in superheterodyne circuits as well as in transoceanic communication. Instructions for hooking up these units included. Put up in shielded metal case provided with suitable mounting flanges and convenient soldering lugs. Overall dimensions 2 1/2" x 1 3/4" x 2 1/2". Ship. weight, 1 lb. **49c**

DUBILIER DRY ELECTROLYTIC CONDENSERS Guaranteed Surge Proof



These guaranteed units will perform miracles in eliminating objectionable A.C. hum from A.F. and filter circuits. Their self-heating and surge-proof characteristics prevent damage to the condenser from high voltage surges and increase their life. Available in 3 sizes. Complete with mounting brackets. Ship. weights, 1 to 3 lbs. Single 8 mf. section..... \$0.69 Two 8 mf. sections..... 1.00 Three 8 mf. sections..... 1.60

AMATEUR TELEGRAPH KEY

A three-adjustment key for all amateur and experimental uses. Arm is of nickel-plated steel, base of cast metal. Coin silver contacts, will not arc. Key is mounted on black enameled wooden base and is provided with 2 convenient terminals. Equipped with 4 rubber feet to prevent scratching. Shipping weight, 1 1/2 lbs. **55c**

HAMMARLUND 4 GANG TUNING CONDENSER WITH TRIMMERS



A .00035 mf. (per section) condenser of the "bath-tub" type. Each section is equipped with a trimmer condenser in order to perfectly align the entire unit. Impossible to get out of alignment. Measures 8 3/4" long less 1/4" shaft x 3 3/4" wide x 2 1/4" deep. Ship. wt., 6 lbs..... **95c**

1 MF. 600 VOLT FILTER CONDENSER



Just the thing for noise filters—for shunting light lines or electrical apparatus. One such condenser will eliminate quite a bit of noise. Three or four such units will eliminate every trace of line noise. Complete elimination is assured by a series-parallel arrangement of six condensers with center taps grounded. Excellent for filter replacement and constructional work. Measures 2 1/4" high x 2 1/2" wide x 2" deep. Shipping weight, 1 lb..... **45c**

STAND-OFF INSULATORS



Made of high-grade porcelain composition, black enamel coated. Recommended for low power transmission work and S.W. reception. Particularly suited to the mounting of extremely high frequency (quasi-optical) B.F. coils. Used universally for 5 meter work. Shipping weight, 4 ounces. Each **10c**

THORDARSON 30 HENRY CHOKE—Type 3653T



A neat, compact 30 Henry Choke which will easily pass 75 mils without heating. Recommended for constructional, repair and experimental work. Put up in neat, completely shielded metal can with suitable mounting flanges. Convenient soldering lugs protrude through the bottom for concealed, sub-panel wiring. Shipping weight, 3 lbs. **69c**

LEEDS 2 1/2 VOLT FILAMENT TRANSFORMER



Here is an ideal transformer to have around the laboratory or repair shop. Practically every commercial A.C. set uses 2 1/2 volt filament tubes. This transformer has one center tapped 2 1/2 volt winding, capable of supplying 10 amperes without heating. For use on 110-20 volts 60 cycles, A.C. Completely shielded in attractive metal case with mounting flanges. Heavy insulation between windings—will stand test of 1,000 volts. Shipping weight, 5 lbs... **\$1.15**

Headquarters for Short Wave Transmitting and Receiving Apparatus. When in town, visit our store.

DeFOREST TUBES

Look at these prices—all perfect

400-A	\$2.00	428	\$1.38
401-A	.38	439	1.38
412-A	.75	445	.55
422	1.50	446	.75
424-A	.80	447	.80
426	.40	451	.88
427	.50	456	.63
430	.80	457	.80
431	.80	458	.80
432	1.15	471-A	.45
433	1.38	480	.50
435	.80	482	.53
436	1.38	566 1/2 rec.	3.95
437	.88	510 15w.	3.95
410-50-81	1.95	503-A-11-45	14.45

GREBE POWER TRANSFORMER

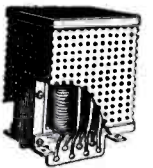

Just the power transformer for constructing a high-grade P. A. amplifier, using a screen grid A.F. amplifier to boost the output of a mike or phono-pickup; following this with 2 stages of push pull amplification consisting of 2—27's in the first stage and 2—45's in the second. Sold complete with perforated metal case to assure cool operation under heavy loads. Equipped with electro-static shield to prevent transformer noises. Supplied with 2 insulated terminal strips arranged for concealed sub-panel wiring. Case measurements: 5 1/2" high x 4" deep x 3 1/2" wide. Diagram included. Ship. wt., 14 lbs **\$2.25**

KENYON REPLACEMENT POWER TRANSFORMERS

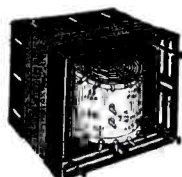

Provided with universal mounting brackets and convenient soldering lugs, properly identified. 3 types available:
Type KR-1. High voltage, 700 volts ct, 125 MA; 5 volts, 2 amp; 2 1/2 volts ct, 3 amp; 2 1/2 volts, ct, 10 1/2 amp..... **\$2.95**
Type KR-2. High voltage, 580 volts, ct, 85 MA; 5 volts, 2 amp; 1 1/2 volts, 4.2 amp; 2.5 ct, 1.75 amp; 5 volts, ct, 1.5 amp. **\$1.95**
Type KR-3. High voltage, 650 volts, ct, 60 MA; 5 volts, 2 amp.; 2.5 volts, ct, 1.5 amp.; 2.5 volts, ct, 8.5 amp..... **\$1.95**

THORDARSON PLATE TRANSFORMER Type B.H.

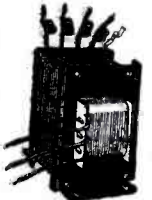

This transformer may be used as a replacement in receivers where the high voltage winding has become shorted or burnt-up. Merely leave the old transformer there, mount the new one, and you're all set to operate once more. Comprises center tapped high-voltage winding of 285 volts either side of CT, and tapped primary to accommodate line voltages from 95 to 115 volts. Excellent replacement transformer for Majestic Super B and other B Eliminators using Rathanon tube. Semi-shielded with heavy iron brackets and provided with suitable mounting flanges. Ideal for low power transmitters as well as for experimental and constructional work. Electrostatically shielded to prevent extraneous noises. Ship. wt., 4 lbs List Price, \$8.00..... **\$1.25**

R.C.A. 30 HENRY CHOKE

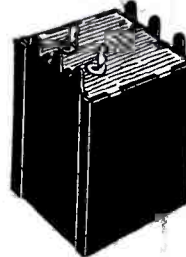

Genuine RCA 30 Henry Choke, capable of passing 125 mils without heating. D.C. resistance 200 ohms. Provided with convenient soldering lugs for concealed sub-panel wiring. For replacements in all RCA-Victor receivers as well as for constructional and experimental work. May be used in all types of filter circuits, for P.A. systems, amplifiers, radio receivers, etc. Measures 8 1/2" high x 3" wide x 2 1/4" deep. Sold in original factory containers. Ship. wt., 4 lbs.... **79c**

New

[15 to 550 Meters]

IMPROVED SUPER-HETERODYNE CIRCUIT

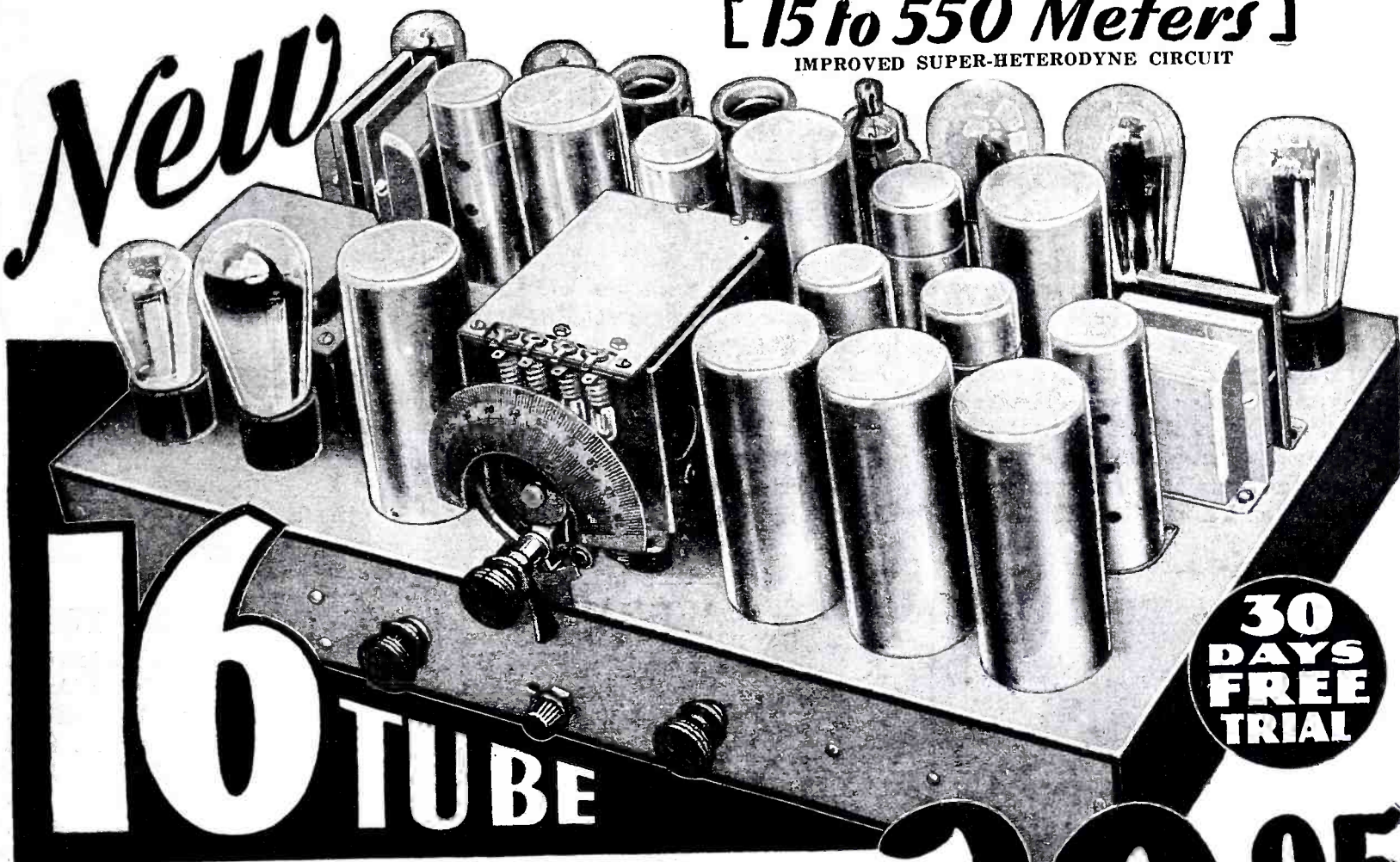

30 DAYS FREE TRIAL

16 TUBE

ALL-WAVE RADIO Only

\$39.95

Completely Assembled with Large Dual Speakers

World Wide Reception may be yours when you own this sensational new Midwest 16-tube ALL-WAVE set with a tuning range of 15 to 550 meters. Hear standard U. S. broadcasts from coast to coast, listen to amateurs, police calls, airplane conversations, and, when conditions are favorable, short-wave broadcasts from England, Germany, France, Italy, South America, Australia, and other stations all over the world. You get the **WHOLE WORLD OF RADIO** when you get this new 16-tube Midwest—and you buy it at an amazingly low price direct from the big Midwest factory, on easy payments if you wish. No middlemen's profits to pay when you buy the Midwest way.

Don't be satisfied with less than a 16-tube Midwest ALL-WAVE set. A receiver covering only the regular broadcast waves is only half a set. Improvements in short-wave programs and receivers have made ordinary broadcast sets obsolete. The Midwest All-Wave gives you everything that's good in radio, both at home and from abroad—and all in one single dial set with perfect tone and volume control and the marvelous new color-lite tuning and STAT-OMIT.

Don't buy any radio until you get the big new Midwest catalog. Just sign and mail the coupon or send your name and address on a postal—NOW!

ALL THE NEW 1933 FEATURES

- Stat-Omit Tuning Silencer
- Class "B" Amplification
- Color-Lite Wave Band Selector
- Acoustically Matched Dual Speakers . .
- Full Band Automatic Volume Control
- Dual Power, Two separate transformers
- Dual Ratio Dial
- One Complete Chassis
- Complete Scientific Shielding
- 18 Tuned Circuits, 9 in cascade
- 15 to 550 Meter Tuning Range
- Image Frequency Suppressor
- Fractional Microvolt Sensitivity
- Full-Floating Variable Condenser . . .
- Absolutely Faithful Tone Reproduction
- Positive Tone Control
- Thermal Safety Fuse
- Duplex Duo-Diode Detection
- New Type Tubes
- Low Operating Cost

TERMS AS LOW AS \$5 DOWN

Read this letter!

"During the past week I logged the following: FYA Pontoise, France; GBK Bugby, England; HVJ Vatican City, Italy; XDA Mexico City; VK2ME Sydney, Australia; VE9GW Bowmanville, Canada; 12Ro, Rome, Italy; G5SW Chelmsford, England; CGA and VE9DR Drummondville, Canada. Also picked up many amateur and airport stations from all over United States. Numerous ship, shore and transatlantic phones from both sides and an Hawaiian Test Station came in clear and sharp. Several Spanish and German speaking stations have also been received but not yet identified. Have received every broadcast from FYA, morning and afternoon, for over a week with wonderful tone and volume. The Midwest set is certainly one to be proud of."
—Wm. S. Teter, Winterpark, Florida.



COMPLETE LINE OF CONSOLES
The big new Midwest catalog shows gorgeous line of artistic consoles in the new six-leg designs. Mail the coupon now. Get all the facts.

Deal Direct with Factory! SAVE UP TO 50%

Midwest sweeps aside the costly old-fashioned way of selling through distributors and dealers. You buy direct from the Midwest factory with just one small profit added. You save all of the middlemen's profits.

Investigate! Mail the coupon. Get the Midwest catalog. Learn the facts about Midwest 9, 12 and 16-tube ALL-WAVE sets—also Battery sets and amazing new Radio Phonograph. Learn about our sensationally low factory prices, easy payment plan and positive guarantee of satisfaction or money back. Get a bigger, better, more powerful, better toned radio—at a positive saving of 30% to 50%!

MIDWEST RADIO CORP.
Dept. 115 (Est. 1920) CINCINNATI, OHIO

RUSH THIS COUPON FOR AMAZING FREE TRIAL OFFER AND BIG BEAUTIFUL CATALOG

Midwest Radio Corp., Dept. 115, Ohio Cincinnati, Ohio
Without obligation on my part send me your new 1933 catalog, and complete details of your liberal 30-day free trial offer. This is NOT an order.

NAME.....
ADDRESS.....
TOWN.....
STATE.....

User Agents
Easy EXTRA MONEY! Check here for details.

Aero International All Wave 11 Tube Super-Heterodyne DeLuxe

15 to 550 METERS **\$29.75**

The greatest radio value ever offered. Explore the world with the Aero International. At last! World Wide Loud Speaker Reception at a Sane Price. One-dial control. No plug-in coils. Designed so any novice can get maximum results on both short and broadcast bands. This is not a converter and broadcast chassis. It is one receiver covering all wave lengths. 2 Sets in 1. Besides your regular broadcast band, also receives Foreign Programs, Amateurs, Police, Ships at Sea and Aeroplanes. Employs the latest type Super-Phonic Tubes. Completely assembled with 2 matched full Dynamic Speakers (less tubes) . . \$29.75

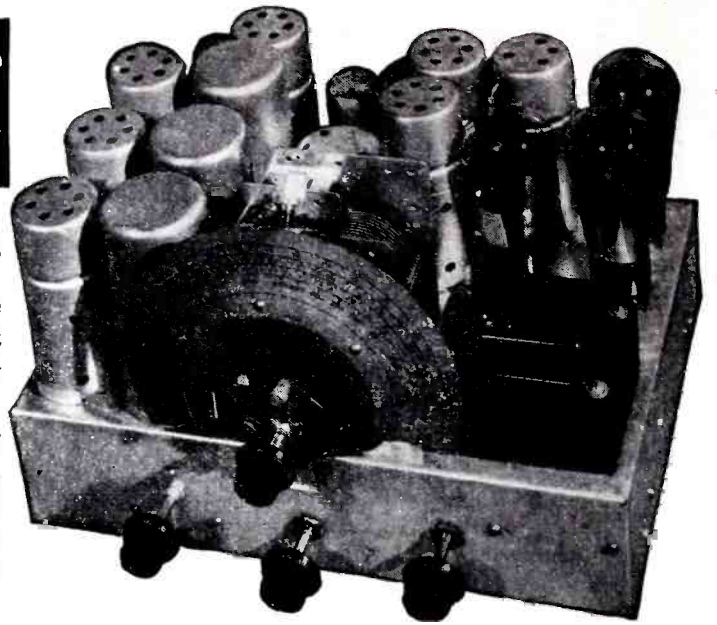

AERO 4 TUBE

The lowest priced quality Midget Receiver on the market today.

PRICE \$10.95

(Less tubes)

Complete set of the New Super-Phonic Tubes **\$2.95**

This wonderful distance getter is equal in performance to last season's 5 Tube Pentode Sets.



AERO 6 TUBE

Super - Heterodyne Automatic Volume Control

Price of Set \$18.50

(Less tubes)

Complete set of Tubes \$4.50

Split Hair Selectivity, Phono Jack, Guaranteed Coast-to-Coast Reception. Seven Tuned Circuits. Composite First Detector and Oscillator followed by 2 stages of 175 D.C. Intermediate.



AERO 5 TUBE

Employs the latest type Super - Phonic Tubes. Guaranteed Coast-to-Coast Reception. Split Hair Selectivity Phonograph Pick-up connection. Single illuminated Full Vision Traveling Spot Light Dial. Mellow Toned Full Dynamic Speaker.

Price \$11.90
Tubes . . . \$3.75

Mellow Toned Full Dynamic Speaker.

AERO PENTODE AUTO RADIO SUPER-HETERODYNE



6 TUBE SET New 1933 Model. Automatic Volume Control. Employs

the latest Super-Phonic tubes. At last! The perfect Auto Radio. Take your favorite stations with you while you travel along.

Price of set with Matched Dynamic Speaker and Remote Control (less tubes) \$19.75

Price Complete with all accessories, ready to install. \$31.90

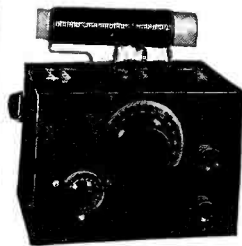

AERO World - Wide 1-Tube Short Wave Set

For Headphone Operation

PRICE \$5.95

Listen in DIRECT to London, Paris, Berlin, Buenos Aires and other broadcasting stations throughout the world via short waves. Your ordinary receiver cannot tune in these low wave stations. WORLD-WIDE RECEIVER gets 14 to 550 meters. AERO 2 Tube Short Wave Set \$8.75. The same as above set but has 1 stage of Audio Frequency added to it.



AERO SHORT WAVE SUPER- HETERODYNE CONVERTER

Convert your A.C. Radio Set into a Short Wave Super-Heterodyne. 15 to 550 Meters.

PRICE \$12.50

AERO PENTODE POWER AMPLIFIER

PRICE \$9.85



Employing the New Super-Phonic tubes. Designed to supply the need for a reasonable priced amplifier for sound trucks and public address systems.

Employing the New Super-Phonic tubes. Designed to supply the need for a reasonable priced amplifier for sound trucks and public address systems.

AERO BATTERY SUPER-HETERODYNE 6 TUBE SET

Employing Latest Air Cell Tubes. Price in Midget Cabinet with Electro Magnetic Speaker \$14.50

Send for Catalog of Sets and Parts

AERO A.B.C. AC POWER PACKS

For Sets Using Up to 12 Tubes

Type No. 10—Supplies filament and B power to six 227 or six 224 tubes. Also six 235 tubes and two 247 or 245 tubes.

PRICE \$9.75

Type No. 12—For sets using up to 9 tubes, using 226, 227, 271 and 280 tubes.

PRICE \$8.75

CHAS. HOODWIN CO.

4240 LINCOLN AVE.

Dept. W-15

CHICAGO, ILLINOIS



THE SHORT WAVE BEGINNER

An Editorial by HUGO GERNSBACK

● EVERY year at this time a new crop of short-wave enthusiasts embark upon the exciting adventure of listening to the entire world by means of the short waves. Conservative estimates, collected from various sources during the past few years, show conclusively that between 30,000 and 40,000 new members join the short-wave fraternity annually, and it is a proven fact that most of them start in the fall months, when the nights become longer and the weather cooler. That is the time when the *home experimenter* becomes interested and when his enthusiasm is at the highest pitch.

Every Broadcast Listener a Short-Wave Prospect

When the broadcast craze first hit the public, between 1922 and 1923, millions developed the itch for "distance" and, believe it or not, there are still several hundred thousand broadcast listeners in this country alone who nightly sit up with their sets and fish for distant stations. Sooner or later a good percentage of these will take to the short waves and many will build their own receivers.

I have no fault to find with those short-wave beginners who start out with a manufactured set which they have bought complete, ready to operate. There are, of course, any number of excellent sets of this description on the market, and they are becoming increasingly popular with the public. These enthusiasts cannot of course be termed beginners, in the strictest sense of the word; neither can they be called experimenters, although they experience exactly the same thrills as that large body of short-wave experimenters who "make their own."

Home-Made Short-Wave Sets Cost Little

Not everyone can afford to buy a manufactured set these days, and we find therefore a high percentage of radio-mechanically inclined people who wish to have the indescribable thrill of building a set themselves, thereby gaining an insight into the mysterious workings which they might not otherwise get. In due time they will, of course, buy factory-made sets, but the present discussion concerns those who wish to start from *scratch* and work their way up by easy stages.

At present-day prices anyone with a lean pocketbook can afford to buy the few parts with which a one- or two-tube short-wave set can be built. A one-tube set can be assembled for as little as \$5.00, including batteries and phones, while a good two-tube set can be built at a cost of \$8.00 and up. If you have spare radio parts lying about, the cost will be even less.

While a good two-tube set such as the one pictured on the cover of this magazine will, under fair circumstances, pull in stations from all over the world, it is well for the beginner to realize that there are certain requirements which must be met in the operation of short-wave sets in general.

In the first place, a set that may work good in your friend's house may not perform nearly as well when transported to your own. The reason for this is bad "location." Conditions in the open country or in the suburbs are generally better than in crowded cities, although there are notable exceptions to this rule. Ground and aerial conditions have a lot to do with good reception, particularly when it comes to receiving *over-seas* stations. As a rule, the man in an apartment house should have a much longer aerial than his country cousin; so if your set does not "perk" immediately, try and change the aerial. Sometimes changing the aerial in either direction, that is from east-west to north-south, will also make a surprising difference.

Nullifying the Effect of Man-Made Static

Of course, the apartment house experimenter—and this holds true of those living in the suburbs also—is bedeviled by a good deal of local "man-made" static. This can be better gotten around by using a "transposition" type lead-in from the aerial binding post of the set to the aerial flat-top, leaving only the horizontal aerial exposed to the radio waves. The flat-top should be at least 20 to 30 feet above roofs, trees, etc.

The Greatest Asset of the Beginner—Patience

You have to get used to the idiosyncracies of your set. Every short-wave receiver has its own little "bugs" to which you must become accustomed, and you must know them to get the best results. It is unusual to pull in every country on the globe the first night after you have finished your receiver. It may take you some time, even if your set is operating at its best. In the first place, the station you may be fishing for may be *out of the air*. Second, you may not have the right time, because it takes a while to figure out and translate foreign time to your own, due to time differences.

The beginner must become acquainted with the different faint whistles in the earphones, because some of the faintest whistle sounds can be built up into good signals, *if you learn how to do it!* The broadcast listener, of course, is the greatest sinner when it comes to tuning a short-wave set. It takes in some time before he understands that moving the condenser a thousandth of an inch will tune in or tune out a station. In short-wave tuning, your hand must become accustomed to exceedingly fine and careful motions.

Of course, you will not expect to obtain the same results from a *junk* set that can be gotten from one that is carefully built, with all connections carefully soldered and with the insulation of the entire set of the best. Always remember that the energy which comes in over your aerial is less than the *mouth part of a fly-power*, and you cannot afford to waste much of this power due to insulation losses.

SHORT WAVE CRAFT IS PUBLISHED ON THE 15th OF EVERY MONTH

This is the November, 1932, Issue - Vol. III, No. 7. The Next Issue Comes Out November 15th

Editorial and Advertising Offices - 90 West 4th Place, New York City

ECLIPSE Affects SHORT

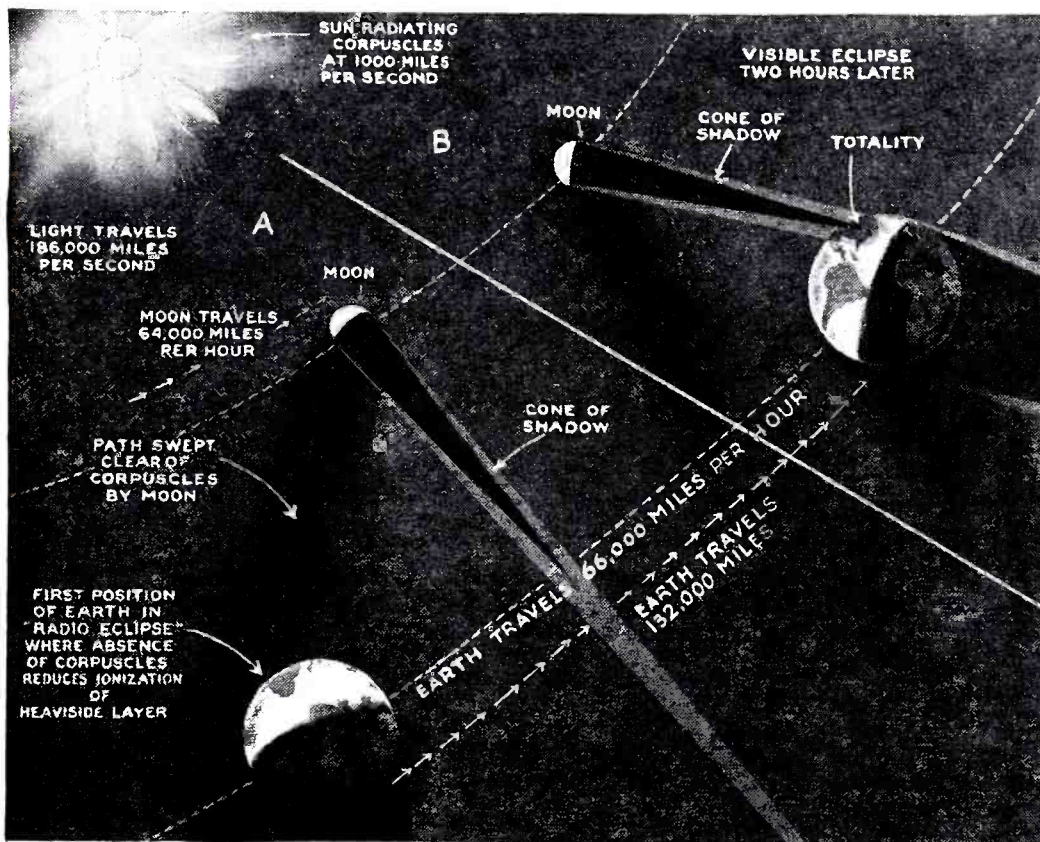

Dr. Alexanderson had some very interesting radio experiences during the recent solar eclipse; to determine just what effect the eclipse had on short waves, he arranged for a predetermined signal to be continuously transmitted from Schenectady to a point within the path of the total eclipse. By means of a special recording device the effects of the Sun's eclipse on the signal strength were thus preserved for future study by scientists. Dr. Alexanderson gives us an interesting analysis of the Kennelly-Heaviside and Appleton layer phenomena.

The illustration at the left shows graphically the relative positions of the moon, earth and sun just before and during the recent solar eclipse. Note how the "radio eclipse" (due to the path being swept clear of corpuscles by the moon) precedes the solar eclipse, visible to the inhabitants of the earth.

● WHEN we try to interpret something about which we really know so little, as the effect of the sun's eclipse on the propagation of radio waves, the best we can do is to start with such theories as we may have and try to carry these theories somewhat further by establishing new facts. In equipping an expedition to make radio observations on this eclipse, we had in mind particularly to follow out a suggestion made by Dr. Irving Langmuir, who desired to obtain some more data regarding the theory that from the sun there is a corpuscular or electronic emission traveling at a rate of 1,000 miles a second.

For the test we selected a radio frequency of 8,655 kilocycles (about 34.4 meters) because we thought that this wave would have a *skip distance* not much beyond the distance at which observations were made and that the *fringe effects of fading* at the edge of the skipping distance would be strongly pronounced. These phenomena are especially apparent in television under certain unfavorable conditions where the multiple reflections cause several images, both positive and negative, which rapidly appear and disappear, suggesting a "dance of ghosts." We concluded, however, that television would not be the best medium for these observations because what we desired most of all was a permanent record so that the results could be accurately compared with other results at a later date.

Special Signal Used in Tests

In our test of facsimile transmission between San Francisco and Schenectady some years ago, we had found that the *ghost images* of television can also be observed on the facsimile record. Instead of attempting to transmit facsimile of writing or pictures, we selected a type of signal with continuous wave radiation interrupted sixty times per second, each interruption being one five-hundredth of a second. A facsimile record of this signal gave parallel black lines on a white background if the record was perfect. The signal from Schenectady which we recorded at Conway, N. H., during normal conditions in the afternoon previous to the eclipse proved, as we expected, that we had to deal with multiple reflections. Though the signal was strong it was of a type with rapid fadings that gives distortion of speech and music. On the record it appears like an irregular mixture of black marks on white background and white marks on black background, alternating with totally black and totally white streaks. This is the kind of signal that is particularly useless for facsimile and television; and was just what we wanted.

Strange Disappearance of Signal

The outstanding result of our observations was that this normally strong signal almost totally disappeared during the two hours preceding the optical eclipse of the sun, which in accordance with the calculations of the astronomers would be the time during which the corpuscular or electronic eclipse would take place.

The nearly complete disappearance of the signal was so striking we were worried that something might have gone wrong with our receiver, but, when shortly before the optical eclipse began the signal came back first in a scattered way and then strongly and continuously, we felt that we had a complete proof of the correctness of the theory of the electronic eclipse. This record, which was taken during the whole afternoon and evening, will be preserved for those to whom it is of scientific interest.

German Signal Heard

During this same period observations by earphones were made on other signals. We were particularly interested in a telegraph signal from Germany with approximately the same wavelength as the signal from Schenectady. This signal was heard during the whole afternoon, but during the period when the Schenectady signal was at a *minimum*, the signal from Germany was at its *maximum* with a very substantial increase.

One fact which is important to keep in mind in attempting to interpret these observations is the calculations of the astronomers that the electronic shadow falls entirely east of the path of the total eclipse where the observations were made. The electronic shadow as shown on published graphs covered a large area, nearly bridging the Atlantic Ocean. It is thus easy to see why the signal from Germany came in stronger during the eclipse, since the electronic shadow produced the effect of night over the Atlantic Ocean and a 30-meter signal is known to be stronger over such a distance at night. It is not so easy, however, to see why the presence or absence of electronic bombardment to the east of the point of observation should have such an effect on a signal from the west.

Test Signals "Reflected"

A clue to this apparent contradiction may be found in the observations of A. Hoyt Taylor, who has made elaborate measurements of the speed of wave propagation. These measurements by Taylor indicate that a short-wave sig-

WAVES

By Dr. E. F. W. Alexanderson

Radio Consulting Engineer
General Electric Company

nal received a moderately short distance is delayed in arrival, so that it appears as if the signal had traveled something like 2,000 miles further than the direct distance from the transmitting to the receiving station, thus indicating that it does not arrive by the *direct* path but is *reflected* from some point 1,000 miles away.

On this basis our observations during the eclipse may be explained. We can assume that the only signal we were able to receive at our point of observation 200 miles from Schenectady arrived at that point, not after a direct travel of 200 miles, but through one of these Taylor reflections from some point 1,000 miles east. The disappearance of the signal during the electronic eclipse can then be explained if we assume that the reflecting medium had something to do with an electronic bombardment which was absent at that time.

At Least "Two" Wave Reflections!

With this assumption we can go further in attempting to explain what has taken place. In examining our graphic record we find that such a record could not have been made by one single ray. If the signal arrives at the receiving station after reflection, we must conclude that there are at least *two such reflections, i.e., two rays arrive simultaneously, one having traveled a distance of several hundred miles more than the other.* This would explain the double image on the record,

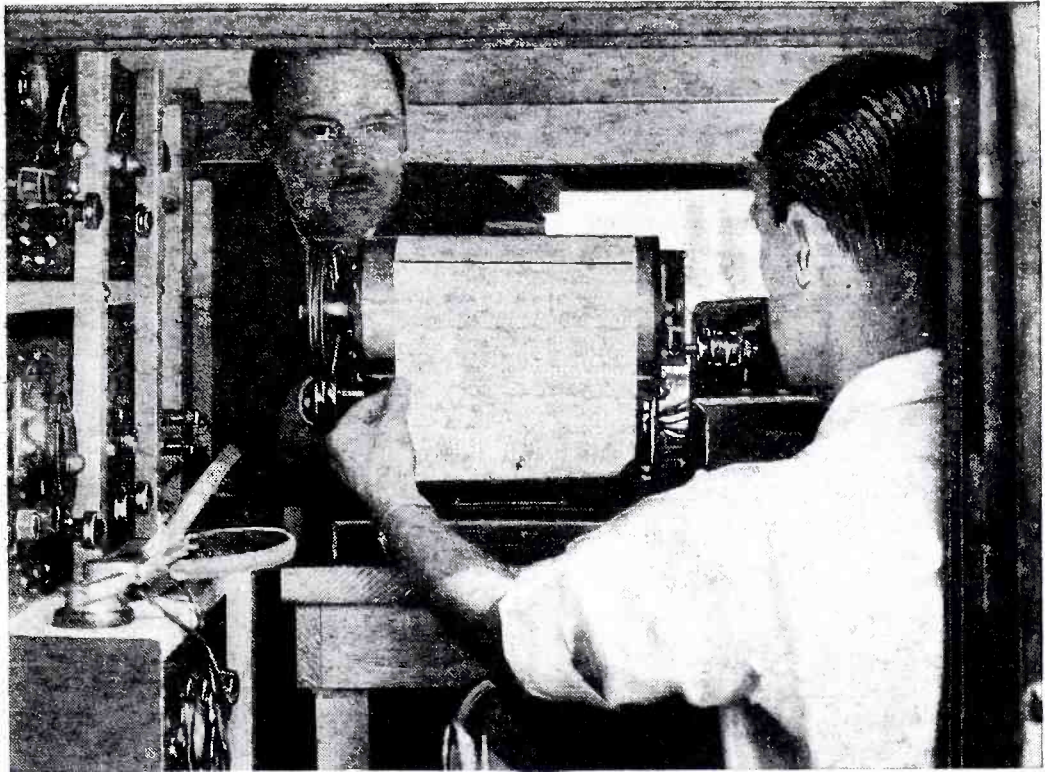

The author, Dr. E. F. W. Alexanderson of the General Electric Company (at left), and one of his assistants, together with the special apparatus used for recording the short-wave signal transmitted from Schenectady.

which occasionally gives the appearance of white lines on black background, instead of black lines on white background. This theory of reflection may also explain the recent findings of Marconi that even ultra-short waves may at times reach points far beyond the horizon.

If this theory is correct, there remains to be explained the nature of the reflecting medium which is produced by the electronic bombardment. Possibly it is one of those phenomena which has become known as the *Appleton layer*

(Continued on page 439)

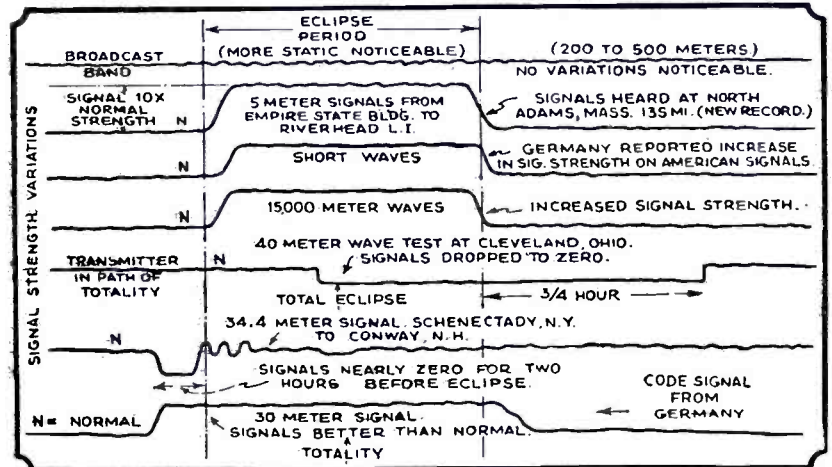
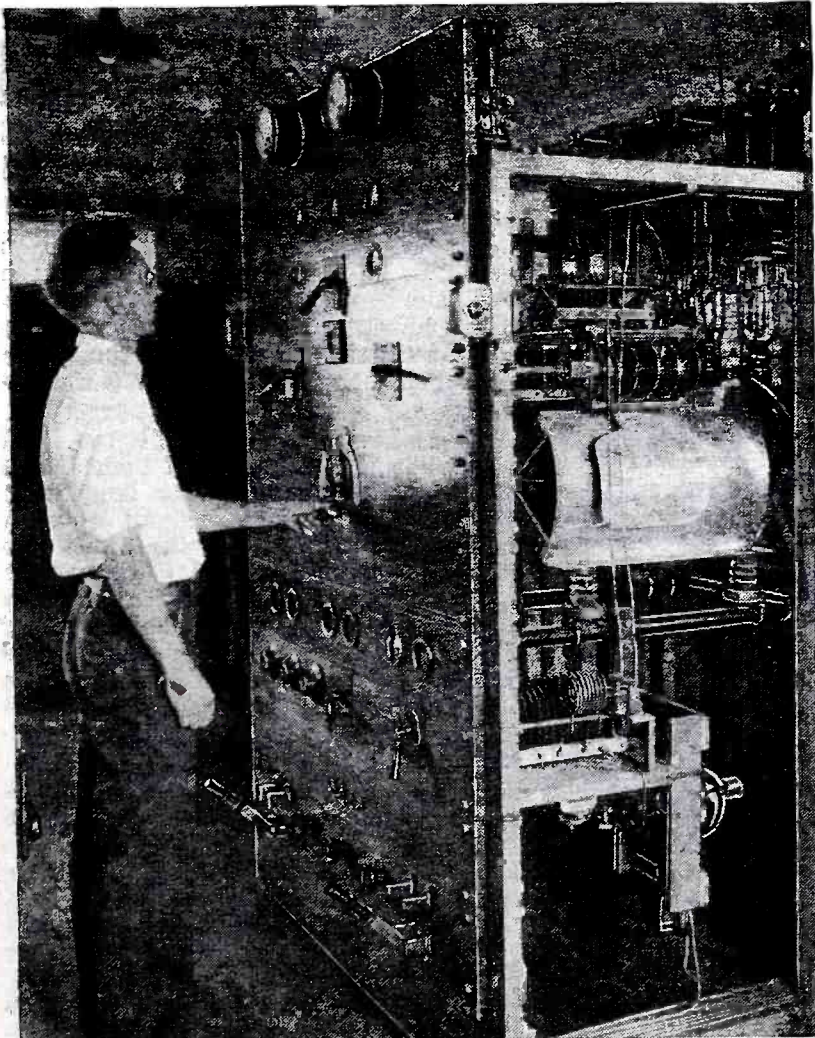

Above — Effects on radio waves of different lengths caused by solar eclipse, as reported by various observers.

Left—The General Electric Company short-wave transmitter located at Schenectady, N. Y., which transmitted continuously the "check" signal to Conway, New Hampshire, where its variations were recorded. Right — Typical record of radio signals received at Conway, N. H., from Schenectady showing variations in signal strength.



Aero International All Wave 11 Tube Super-Hetrodyne Deluxe

15 to 550 METERS \$29.75

The greatest radio value ever offered. Explore the world with the Aero International. At last! World Wide Loud Speaker Reception at a Sane Price. One-dial control. No plug-in coils. Designed so any novice can get maximum results on both short and broadcast bands. This is not a converter and broadcast chassis. It is one receiver covering all wave lengths. 2 Sets in 1. Besides your regular broadcast band, also receives Foreign Programs, Amateurs, Police, Ships at Sea and Aeroplanes. Employs the latest type Super-Phonic Tubes. Completely assembled with 2 matched full Dynamic Speakers (less tubes)..\$29.75

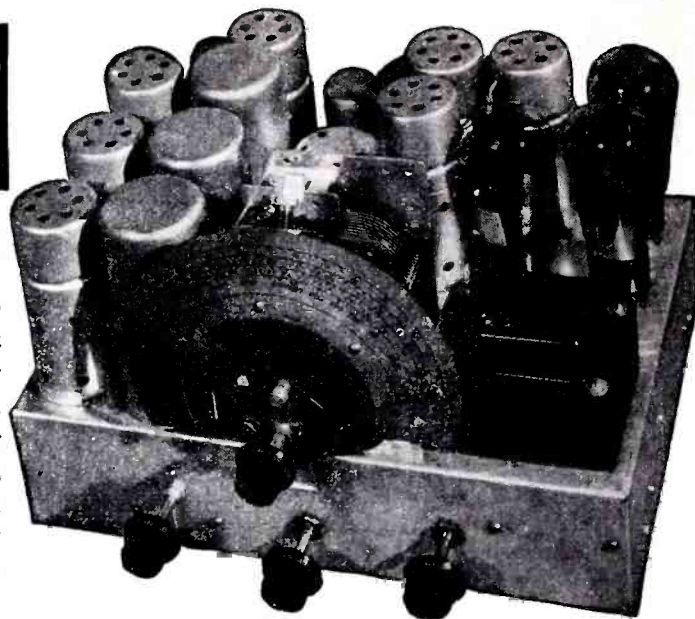

AERO 4 TUBE

The lowest priced quality Midget Receiver on the market today.

PRICE \$10.95
(Less tubes)

Complete set of the New Super-Phonic Tubes \$2.95

This wonderful distance getter is equal in performance to last season's 5 Tube Pentode Sets.



AERO 6 TUBE

Super - Heterodyne Automatic Volume Control

Price of Set \$18.50
(Less tubes)

Complete set of Tubes \$4.50

Split Hair Selectivity, Phono Jack, Guaranteed Coast-to-Coast Reception. Seven Tuned Circuits. Composite First Detector and Oscillator followed by 2 stages of 175 D.C. Intermediate.



AERO 5 TUBE

Employs the latest type Super - Phonic Tubes. Guaranteed Coast-to-Coast Reception. Split Hair Selectivity Phonograph Pick-up connection. Single illuminated Full Vision Traveling Spot Light Dial. Mellow Toned Full Dynamic Speaker.

Price \$11.90
Tubes...\$3.75

Mellow Toned Full Dynamic Speaker.

AERO PENTODE AUTO RADIO SUPER-HETERODYNE



6 TUBE SET New 1933 Model. Automatic Volume Control. Employs

the latest Super-Phonic tubes. At last! The perfect Auto Radio. Take your favorite stations with you while you travel along.

Price of set with Matched Dynamic Speaker and Remote Control (less tubes)\$19.75

Price Complete with all accessories, ready to install.....\$31.90

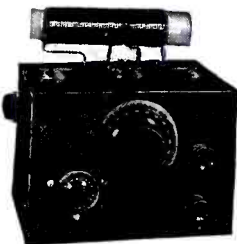

AERO World - Wide 1-Tube Short Wave Set

For Headphone Operation

PRICE \$5.95

Listen in DIRECT to London, Paris, Berlin, Buenos Aires and other broadcasting stations throughout the world via short waves. Your ordinary receiver cannot tune in these low wave stations. WORLD-WIDE RECEIVER gets 14 to 550 meters. AERO 2 Tube Short Wave Set \$8.75. The same as above set but has 1 stage of Audio Frequency added to it.

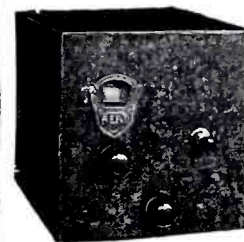

AERO SHORT WAVE SUPER-HETERODYNE CONVERTER

Convert your A.C. Radio Set into a Short Wave Super-Heterodyne. 15 to 550 Meters.

PRICE \$12.50

AERO PENTODE POWER AMPLIFIER PRICE \$9.85



Employing the New Super-Phonic tubes. Designed to supply the need for a reasonable priced amplifier for sound trucks and public address systems.

reasonable priced amplifier for sound trucks and public address systems.

AERO BATTERY SUPER-HETERODYNE 6 TUBE SET

Employing Latest Air Cell Tubes. Price in Midget Cabinet with Electro Magnetic Speaker\$14.50

Send for Catalog of Sets and Parts

AERO B ELIMINATOR

180-volt Bone dry. Supplies B current for sets using up to 9 tubes.

PRICE including 280 tube \$6.75

AERO A.B.C. AC POWER PACKS

For Sets Using Up to 12 Tubes

Type No. 10—Supplies filament and B power to six 227 or six 224 tubes. Also six 235 tubes and two 247 or 245 tubes.

PRICE \$9.75

Type No. 12—For sets using up to 9 tubes, using 226, 227, 271 and 280 tubes.

PRICE \$8.75

CHAS. HOODWIN CO.

4240 LINCOLN AVE.

Dept. W-15

CHICAGO, ILLINOIS



THE SHORT WAVE BEGINNER

An Editorial by HUGO GERNSBACK

● EVERY year at this time a new crop of short-wave enthusiasts embark upon the exciting adventure of listening to the entire world by means of the short waves. Conservative estimates, collected from various sources during the past few years, show conclusively that between 30,000 and 40,000 new members join the short-wave fraternity annually, and it is a proven fact that most of them start in the fall months, when the nights become longer and the weather cooler. That is the time when the *home experimenter* becomes interested and when his enthusiasm is at the highest pitch.

Every Broadcast Listener a Short-Wave Prospect

When the broadcast craze first hit the public, between 1922 and 1923, millions developed the itch for "distance" and, believe it or not, there are still several hundred thousand broadcast listeners in this country alone who nightly sit up with their sets and fish for distant stations. Sooner or later a good percentage of these will take to the short waves and many will build their own receivers.

I have no fault to find with those short-wave beginners who start out with a manufactured set which they have bought complete, ready to operate. There are, of course, any number of excellent sets of this description on the market, and they are becoming increasingly popular with the public. These enthusiasts cannot of course be termed beginners, in the strictest sense of the word; neither can they be called experimenters, although they experience exactly the same thrills as that large body of short-wave experimenters who "make their own."

Home-Made Short-Wave Sets Cost Little

Not everyone can afford to buy a manufactured set these days, and we find therefore a high percentage of radio-mechanically inclined people who wish to have the indescribable thrill of building a set themselves, thereby gaining an insight into the mysterious workings which they might not otherwise get. In due time they will, of course, buy factory-made sets, but the present discussion concerns those who wish to start from *scratch* and work their way up by easy stages.

At present-day prices anyone with a lean pocketbook can afford to buy the few parts with which a one- or two-tube short-wave set can be built. A one-tube set can be assembled for as little as \$5.00, including batteries and phones, while a good two-tube set can be built at a cost of \$8.00 and up. If you have spare radio parts lying about, the cost will be even less.

While a good two-tube set such as the one pictured on the cover of this magazine will, under fair circumstances, pull in stations from all over the world, it is well for the beginner to realize that there are certain requirements which must be met in the operation of short-wave sets in general.

In the first place, a set that may work good in your friend's house may not perform nearly as well when transported to your own. The reason for this is bad "location." Conditions in the open country or in the suburbs are generally better than in crowded cities, although there are notable exceptions to this rule. Ground and aerial conditions have a lot to do with good reception, particularly when it comes to receiving *over-seas* stations. As a rule, the man in an apartment house should have a much longer aerial than his country cousin; so if your set does not "perk" immediately, try and change the aerial. Sometimes changing the aerial in either direction, that is, from east-west to north-south, will also make a surprising difference.

Nullifying the Effect of Man-Made Static

Of course, the apartment house experimenter—and this holds true of those living in the suburbs also—is bedeviled by a good deal of local "man-made" static. This can be better gotten around by using a "transposition" type lead-in from the aerial binding post of the set to the aerial flat-top, leaving only the horizontal aerial exposed to the radio waves. The flat-top should be at least 20 to 30 feet above roofs, trees, etc.

The Greatest Asset of the Beginner—Patience

You have to get used to the idiosyncracies of your set. Every short-wave receiver has its own little "bugs" to which you must become accustomed, and you must know them to get the best results. It is unusual to pull in every country on the globe the first night after you have finished your receiver. It would take you some time, even if your set is operating at its best. In the first place, the station you may be fishing for *may be off the air*. Second, you may not have the right time, because it takes a while to figure out and translate foreign time into your own, due to time differences.

The beginner must become acquainted with the different faint whistles in the earphones, because some of the faintest whistle-like sounds can be built up into good signals, *if you learn how to do it!* The broadcast listener, of course, is the greatest sinner when it comes to tuning a short-wave set. It takes him some time before he understands that moving the condenser a thousandth of an inch will tune in or tune out a station. In short-wave tuning, your hand must become accustomed to exceedingly fine and careful motions.

Of course, you will not expect to obtain the same results from a *junk* set that can be gotten from one that is carefully built, with all connections carefully soldered and with the insulation of the entire set of the best. Always remember that the energy which comes in over your aerial is less than the *millionth part of a fly-power*, and you cannot afford to waste much of this power due to insulation losses.

SHORT WAVE CRAFT IS PUBLISHED ON THE 15th OF EVERY MONTH

This is the November, 1932, Issue - Vol. III, No. 7. The Next Issue Comes Out November 15th

Editorial and Advertising Offices - 96-98 Park Place, New York City

RADIO

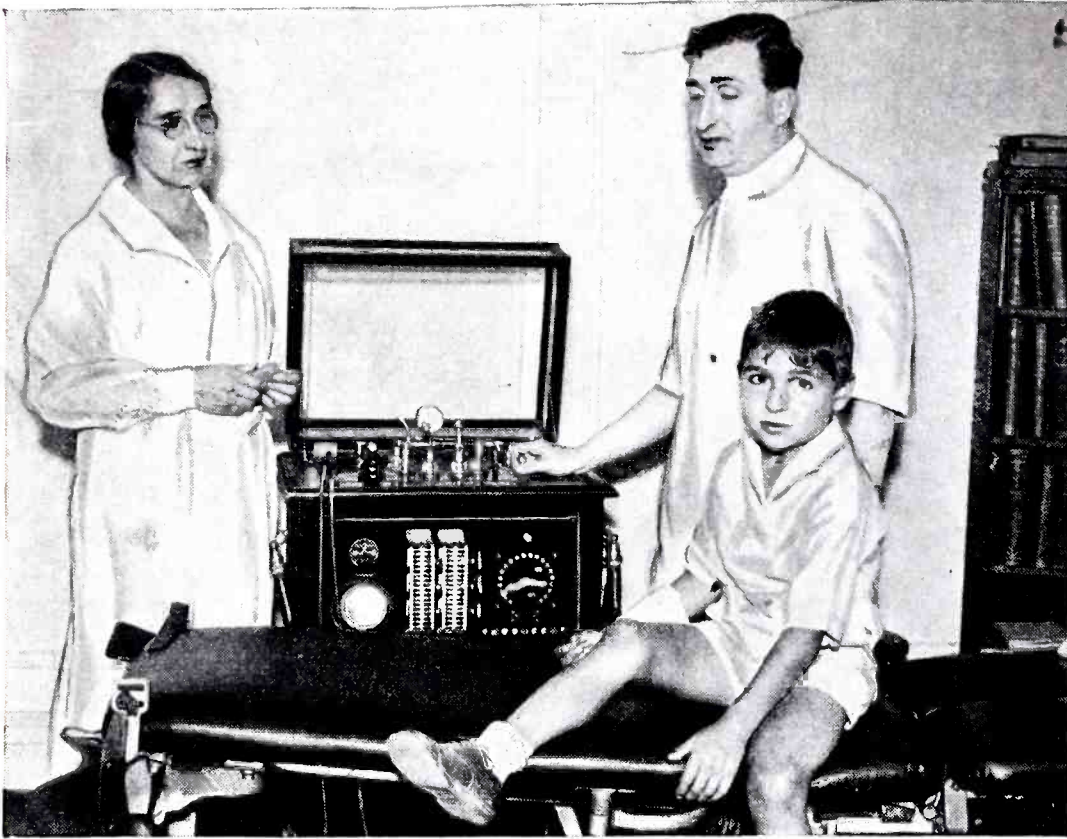

Dr. Marks, together with his wife and son, showing one of the elaborate electrical apparatus used in treating his patients. Dr. Marks, who is handicapped by loss of sight, actually builds his own short-wave transmitters and receivers, besides operating them.

● A BLIND MAN I once knew sold cigars and stationery in a store half of which was occupied by a barber. Customers used to amuse themselves by giving him bills to change when they bought tobacco or a newspaper just to see him exhibit what they thought was his ability to tell, by means of his sense of touch, the denominations of these bills. Of course I must admit at the outset that no blind person can tell the value of paper money when he feels it for the first time. Once he has been told its denomination, however, he can then employ some system whereby he can pull from his pocket or from a roll previously assorted any bill called for. But the man I am writing about was expected to tell the denomination of a bill unaided and he seemed to be able to do this. All his customers thought he could; but none other than the barber with his mirrors on the opposite wall and the different objects that gave forth different sounds when struck and which represented one, two, five, ten and twenty, knew how the trick was accomplished.

My story illustrates that where there is a will there is a way, that there are tricks to every trade, and in this case trade resulted from tricks, for this blind man encouraged customers to spend their money just to see him do something which to them seemed phenomenal.

So it was with me. People used to see me working at radios in the evening when I had finished with my patients; they used to see my sets assembled and hear them in operation; but they never knew how much help my wife had given me.

I Get the Radio Fever

In a recent article published in "The Saturday Evening Post," I pointed out that on becoming blind at the age of twelve I was persuaded by another blind boy to continue my education. I never

heard a radio signal of any kind until almost ten years ago, when I was visiting a blind man in Orange, N. J. He owned a Westinghouse crystal set for which he had paid twenty-five dollars. So thrilled was I over what I heard that were it not for the fact that I had just returned to my practice in New York after teaching at the Philadelphia College of Osteopathy for two years and my finances were low, I would have rushed right out to purchase one of these small sets.

Several days later, however, a young friend told me how I could make an outfit which would work quite satisfactorily and I followed his instructions. The net result was one of those then familiar oatmeal box coils with two sets of switches and taps. I did not solder the leads but instead made large loops where leads were necessary and twisted them into strands over which were slipped spaghetti tubing. The free ends were fastened under the nuts which secured the taps. The switches themselves I made by drawing circles on cardboard with a sharp compass and cutting them out. The discs were about the size of a half dollar and were fastened to a square piece of hard rubber by screws passing through their centres. With the compass properly spaced I marked the places along the circumferences of the discs where I would drill for the taps and stops.

My First "Tube" Set

This crystal set worked so well that when the WD-11 made its appearance on the market I felt sufficiently competent to purchase the parts for a small battery-operated receiver and assembled them like the one which I had examined at the radio store. Soldering was unnecessary because it was a simple matter to twist the bus bar into loops, which were fastened together with small screws

and nuts. So remarkable did this one-tube set seem to some of my patients that I could have sold it any number of times, but I clung to it until one day someone offered to pay me enough for it to enable me to purchase the parts for a *Sleeper* outfit, which employed two variometers and a fixed coupler and had a range of from 150 meters to 1,000 meters. I even added two stages of audio-frequency to this circuit and would have nothing simpler than filament control jacks. It was thus that I discovered that I could hear the amateurs on phone and code and for the first time heard the voice of Fred Neuhardt, W2LD. He was one of many to whom I often listened when he used phone and whose conversations were frequently very instructive. Several weeks later I had the good fortune to meet Fred when a perplexing problem was in my mind. I wanted to know whether it would be better to use a three-megohm grid leak instead of the one I was then using. Fred suggested that I try a variable leak with a range as high as ten megohms and recommended the product of a particular manufacturer. I shopped about for this bit of equipment and well do I remember the reply of the salesman in one of the stores I visited. When I asked for the article I wanted he replied:

"I haven't a ten-megohm grid leak, but if you will take this one I have to offer you will find that five megohms of this make are as good as ten of any other manufacturer."

The salesman must have recognized my unsophistication but I did not realize it until later. Then I felt like my friend who visited Paris for the first time.

"Ou est la salle a manger?" he asked the clerk at the desk in the hotel where he was staying.

"Come right this way," was the answer he received.

Superdynes and Reflexes

Next I built a "Superdyne" and it seemed to be a marvel in spite of the knobs, thirteen in all, which hid the expensive bakelite panel. After the Superdyne, I built several models of the Harkness reflex, using two tubes and a crystal.

This is how I used to drill panels: I had a piece of hard rubber 7 inches wide and 24 inches long. Running lengthwise were three rows of very small holes $\frac{1}{2}$ inch apart which divided the panel into quarters. One-quarter inch from each long edge was a row of holes 3 inches apart for locating the panel-mounting holes. These latter were bored and countersunk first and the guide panel was then secured to the back of the panel to be drilled. It was then a simple matter for me to proceed.

While all this experience in set building was being gained by me, my wife was improving her own accomplishments. In addition to taking care of three children, supervising the household work, assisting me with patients and reading my medical literature, she read me three radio papers every Saturday evening, as well as all the worth-while weeklies and monthlies. She could describe circuits as

from the DARK WORLD

By Dr. ROBERT A. MARKS

well as anyone. Then she took up the art of soldering and while I have been given all the credit for the looks of the insides of my sets, she really deserves most of that credit.

The Author's Electrical Background

Nor must it be supposed that without some earlier knowledge of electricity would I have been able to get this far in my work with radio, even though to some who may read this article the work I did may appear very elementary. As a youngster I used to take electric bells apart and put them together again. I used to devise all sorts of circuits with switches, buttons, buzzers and batteries. Even before I studied physics in high school, I had discovered for myself that a bell is an electro magnet, although I knew nothing at the time about fields, poles, direction of current or armatures. In high school, of course, I added to my knowledge, and my teachers, observing my keen interest in everything and recognizing my manual skill, did all they could to encourage me. In college I further added to my store of knowledge of electricity, and took motors apart, tested windings, studied transformers and enjoyed myself generally.

When I first began my practice I possessed very little equipment but it wasn't long before I purchased a high frequency machine with a spark gap that no one enjoys coming in contact with, but which I have had the good fortune to know only when the current was off. Nor have I ever burned or shocked a patient. In addition I have a low voltage generator for giving electrical treatments and which delivers alternating, pulsating-direct and galvanic or smooth direct cur-

rents. I have motors for operating pressure and suction pumps and ultra-violet and infra-red generators, all of which equipment I operate and keep in repair myself.

Three-Circuit Tuners and Roberts Reflex

But I am getting away from the radio end of my interests. I built many "three-circuit" tuner sets for blind friends, who wanted nothing better, and then became fascinated by the performance of the Roberts reflex. I think I built this circuit with every kind of coil offered to the public.

About the time I began with the Roberts circuit I had the good fortune to procure a Western Electric power amplifier, which consisted of an output stage of audio-frequency amplification and operated a WE2050 power tube. A similar tube was used for rectifying the house current. This was really before A.C. tubes were on the market, so I considered myself extremely fortunate. It was easy for me, therefore, to experiment with sets and tone quality, because I did not have to consider the output stage in a set built by myself, and everybody envied my radios. What I paid for that amplifier and speaker would buy four very good radios today and amounts to three times what I paid for the superheterodyne and dynamic speaker built into a Duncan Fyfe table like the one I use in my home.

"The set that took Boston by storm" was my next success, and then I built several versions of the *B. T. synchrophase* and the *Every Man Four and Five*. There was hardly a circuit with which I was not familiar and whose efficiency I had not tested.

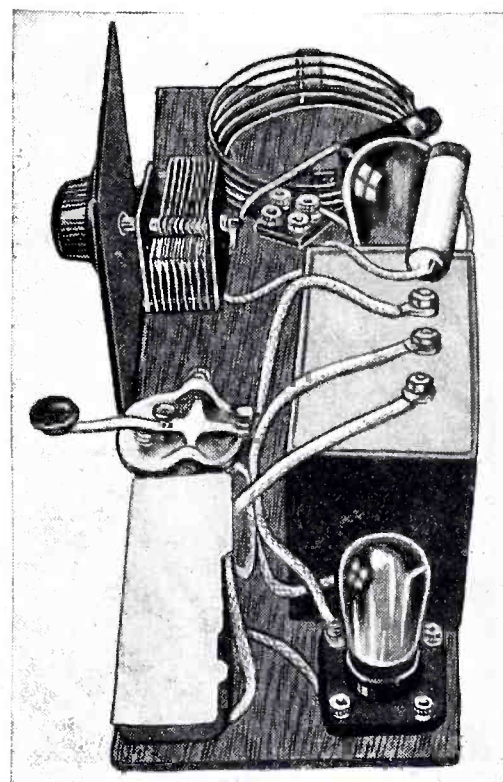

Built without benefit of eyesight—one of Dr. Marks' short wave transmitters. The author also builds his own receiving sets and operates a licensed "ham" station. He is widely known to the radio amateur fraternity.

My "Proudest" Set

But the set which has served me more than any other and of which I am proudest is the one with a range from 15 to 550 meters, capable of bringing in broadcast as well as amateur signals. It employs Aero interchangeable coils. The secondary is tuned with a seven-plate condenser and feed-back is controlled by means of an eleven-plate condenser. There is one stage of audio-frequency amplification and the entire unit is housed in a handsome cabinet, and my family can readily find the broadcasting stations with the aid of an illuminated dial. When loud speaker volume is desired a wire from the power amplifier is plugged into the jack on the front panel. A relay switch with two outlets, one for a "B" eliminator and the other for a trickle charger, is in constant use. The cord from the power amplifier is connected to the "B" eliminator socket and the power transformer of my sending set is connected to the trickle charger outlet. When my transmitter is working my receiver is off, and vice versa. There is a switch which disconnects the transmitter when not in use.

I Learn the Code

Ever since I built the *Sleeper* set and could hear the amateurs I wanted to be sure of them. I knew it would be simple enough to learn the meaning of the dots and dashes from paper, but it was not simple to recognize them when heard. I soon discovered why this was so. Blind people always convert into mental images all stimuli which reach them, no matter through which organ they are perceived. I knew that an A was a dot and a dash; but when I converted the sounds I heard into mental images, these images were never registered in my mind as a dot and a dash on the same line. By listening to the rhythm of many a CQ I soon discovered that what I actu-

(Continued on page 440)

• TO those of us fortunate enough to be able to see or to have our eyesight, radio and radio experimenting is taken for granted. We see an article about the latest short-wave set, and in no time at all we have built it.

But what about our brethren not as fortunate as we—those who dwell perpetually in darkness. What, in other words, does the world appear like to those who have no eyesight; to those who cannot read articles, study diagrams and see at a glance what is going on in their set?

Suppose you were totally blind and still had a hankering for radio and wanted to build your set just the same? How, then, would you go about it.

Off hand, you probably would say it can't be done—you must SEE in order to build a radio set.

Nature, however, is far more wonderful than this, as is pointed out in this article. Dr. Robert A. Marks, a well-known New York doctor, is totally blind. He has been blind ever since he was a youngster. This has not prevented him from being an excellent doctor in New York City, and from handling his electrical instruments as well, if not better, than the practitioner endowed with eyesight.

And, incidentally, Dr. Marks is a well-known radio amateur. He holds a radio license, builds his own sets, and gets as much "kick" from short wave radio and radio in general as the next fellow.

We were fortunate to secure Dr. Marks' story, and believe it makes an important human document that every radio amateur and radio experimenter will be more than interested in.

Boy! Do They ROLL IN on this 1-TUBER

By CLIFFORD E. DENTON

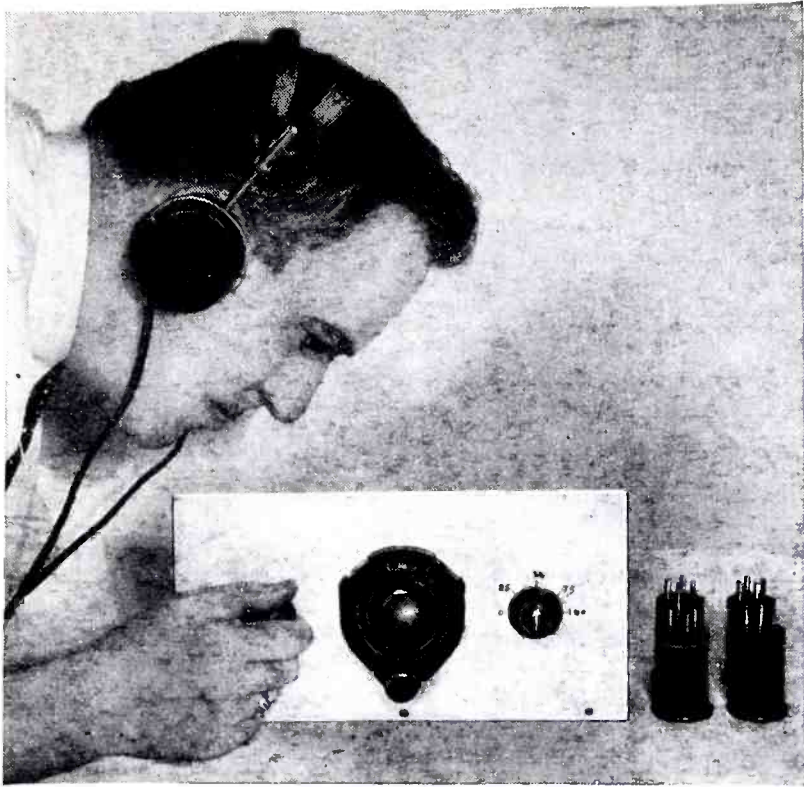

Under favorable conditions the receiving range of this 1-Tuber is unlimited.

• THIS article is not dedicated to the person who can build a short wave receiver but to the person who would like to but thinks that he would never get it together and if he did finish the construction that "it wouldn't work" anyway.

Let's start with a simple one tube receiver; because, if we make a mistake, one tube may burn out and not four or five, and besides a minimum number of parts will be necessary for the construction of the receiver.

Any mechanically minded person can construct this set in about three hours and be ready to connect the batteries for the initial test. If you obtain the set of coils as specified in the parts list, plug in the one with the yellow ring around the top, set the condenser mounted on the right hand side of the front panel to 25 and the condenser tuned by the vernier dial to 46 and you should hear KDKA's short wave transmitter, W8XK, loud enough to hold your phones away from your head. In tests at the author's laboratory the phones were laid on a chair and the signals could be heard several feet away in a quiet room. Remember, if the station mentioned is not broadcasting at the particular time that you are trying to hear it—don't blame the set—try later in the day. Canada comes in a few points further down and below that the N. B. C. transmitter at Bound Brook, N. J., "rolls in."

By what manner and means does the set work? Simple. Light your pipe and listen.

Look at the picture diagram and see that little gadget marked 2; well, this unit has the effect of increasing and decreasing the length of wire that is called the aerial. The idea is to bring the electrical length of the aerial down to such a value that it will give the best results. How does it do it? Don't worry about that now. When an electrical current flows down the antenna to the set it is following the first law of electricity and follows the path of least resistance and continues through the coil marked 3.

The Short-Wave BEGINNER is the one we instructed Mr. Denton, well-known radio set designer, to keep actively in mind in designing this special, ultra-simple, short-wave 1-tube receiver. You will find the cost of this 1-tube receiver very low, even though the best parts are used, as they should be, to realize the greatest range and signal strength. If you have never listened to the short wave stations, you will find this set extremely easy to build and tune.

Passing through coil 3 as though it were running from a bill collector, it rushes to the ground and then back to the transmitter. Well, that is one way to tell it.

Now, as the energy flows through the coil of wire 3, it is held back by the magnetic force generated by the flow of energy. In other words, the coil says "let's talk this over." This halting or blocking action causes the energy to build up to appreciable amounts, if the units called a condenser, 6 and 7, are so adjusted that their electrical length is the same as that of the transmitter. In fact, one would have perpetual motion right here if the coil and condenser were

perfect. You see, the energy would chase around and around like a dog chasing its tail. See Fig. 1. When the dog gets tired he stops and the electrical losses soon stop the energy from going around and that is a good thing too, as it permits more energy to flow into the circuit to merry-go-round awhile.

This energy causes a surprisingly large electrical force to appear between the control member of the vacuum tube called the *grid* and the heating element, called the *filament*. This force is greater in value than the original energy derived from the aerial.

Unit 8 stores this force as though it

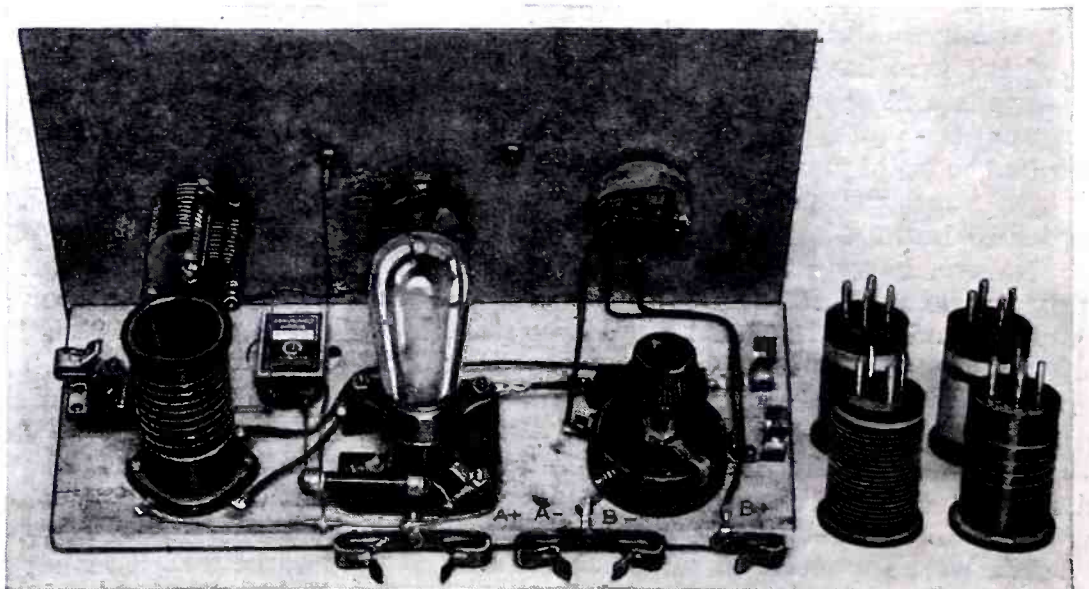

"Simplicity" is the keynote in this 1-Tube S-W Receiver, especially designed by Mr. Denton for this number of SHORT WAVE CRAFT. "Thrills by the carload" are yours at an insignificant cost.

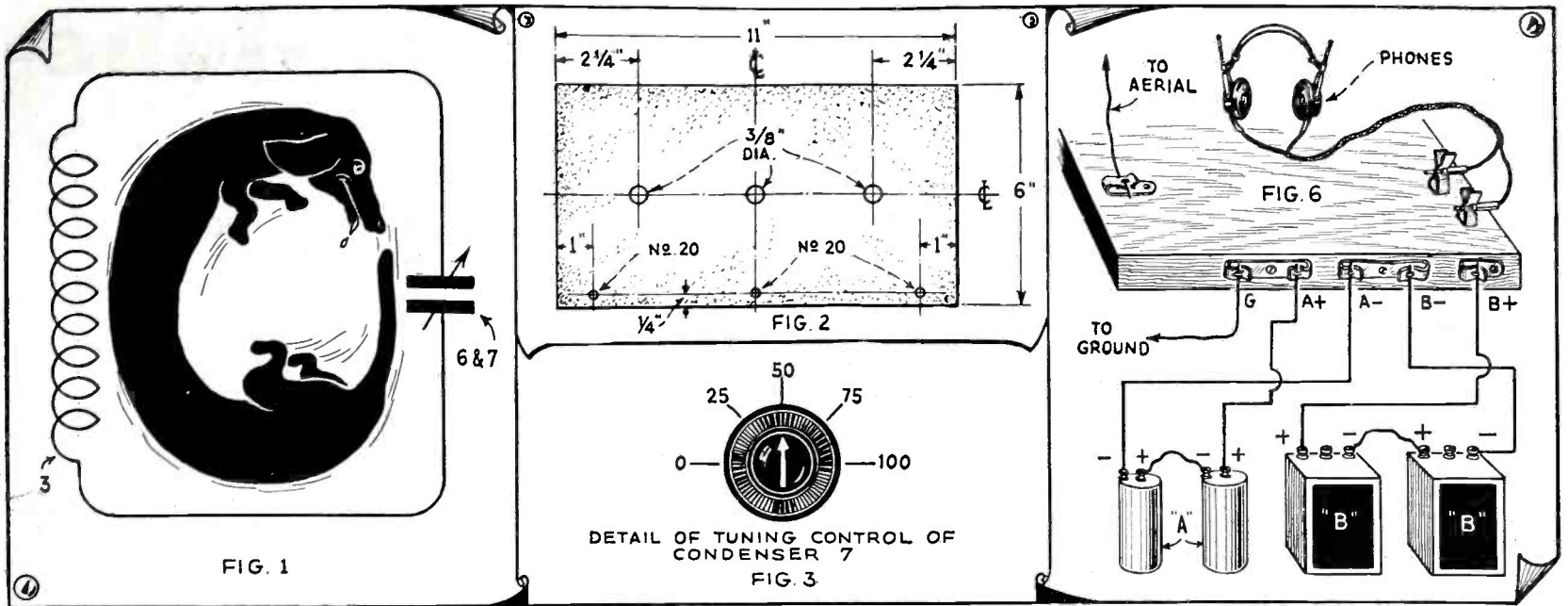

Fig. 1—Oscillations flow around a tuned circuit like a dog chasing its tail. Details for drilling panel, calibrating the band-spreader condenser dial and battery connections are shown above.

were a storage tank and delivers it to the control unit at regular intervals of time. The poor electrical path of unit 9, called a *grid-leak*, permits surplus energy to flow off to the ground.

This rise and fall in the value of force applied to the grid causes a symmetrical rise and fall in the energy drawn from the battery connected to the remaining element in the tube called the *plate*. This change in the amount of energy flowing in the phones causes the small diaphragm to vibrate, emitting speech, music, code signals, or "what have you."

Construction Remarks

The detailed drawing covering the drilling specifications of the front panel is shown at Fig. 2 with a special template for laying out the tuning control for the condenser 6. Condenser 6 is

known as a *tank condenser* and serves as a master control for the *band-spreading* tuning condenser 7. Units 6, 7, 12 and 20 are mounted on the panel. Each tuning dial has a template to aid in the drilling of the three holes necessary for mounting the dial.

The rest of the parts are mounted as shown in the pictures and the detailed picture drawing, Fig. 4.

Run the wires exactly as shown in Fig. 4, carefully soldering each lead as the work progresses. For those desiring to construct this set and who can follow a schematic diagram, Fig. 5 can be consulted. **SOLDER EVERYTHING CAREFULLY AND CHECK OVER ALL CONNECTIONS!**

Testing Your Receiver

After all of the connections are made the set can be tested. Connect the bat-

teries as shown in Fig. 6 and insert a type 30 tube in the socket 10. Turn the control knob on the left hand side of the front panel to the right and adjust the knob on the rheostat until the filament inside of the tube glows with a dim cherry light. If a voltmeter is available then adjust 11 until the meter reads two volts. This is the correct operating point for this type of tube.

Plug in the coil with the yellow band around the top and set the knob controlling condenser 6 to 25 on the scale. Turn the knob on the left hand side of the front panel full on. Turning the main tuning control under these conditions should bring forth a series of whistles and chirps and if there is any speech or music being broadcast at that time it will be badly distorted. After a signal has been picked up turn the
(Continued on page 437)

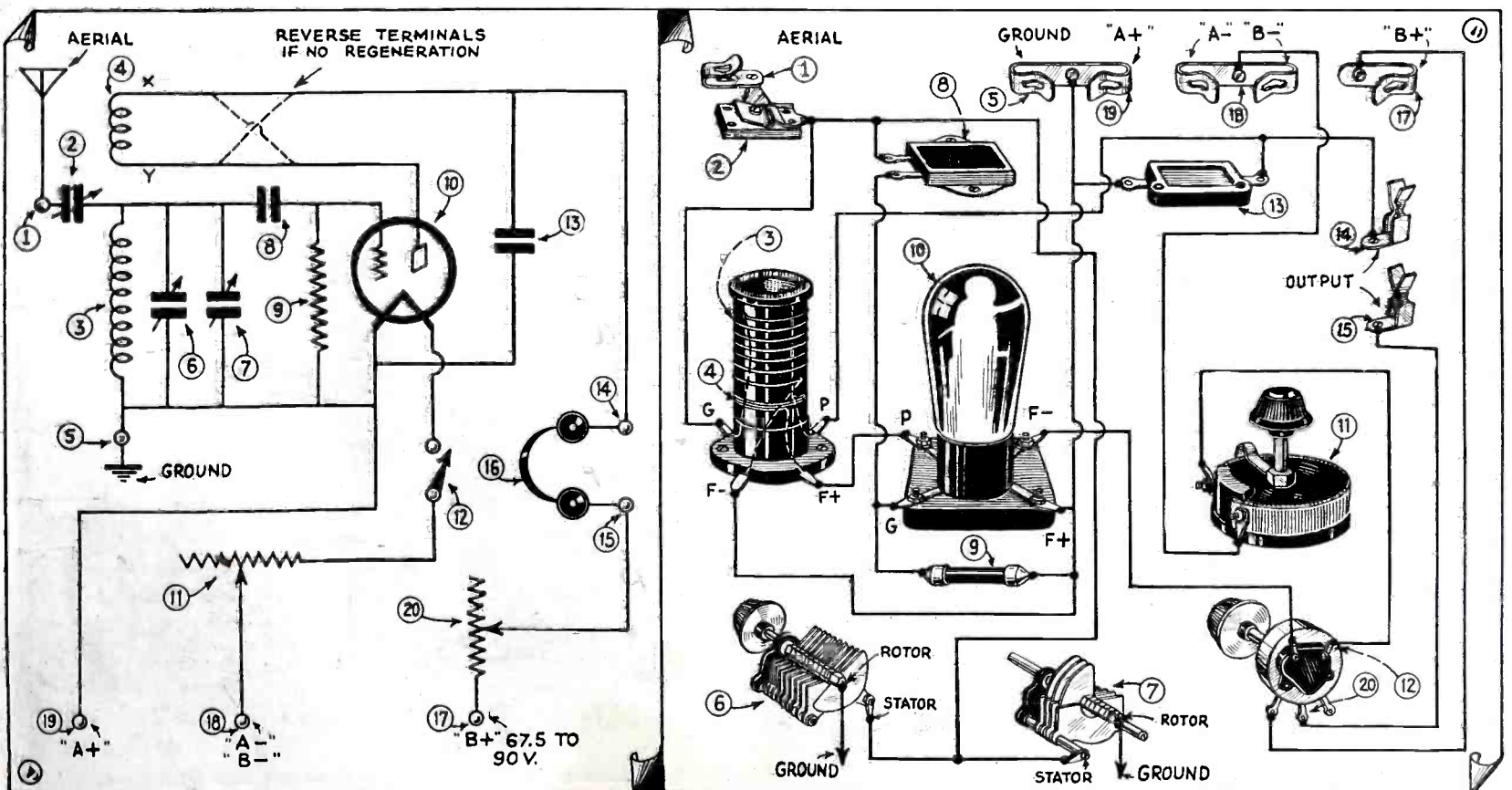

Regular schematic wiring diagram (Fig. 5) for the Denton 1-Tube is shown above at left; popular picture diagram (Fig. 4) which anyone can follow, is shown at right.

Building the 2-Tube "Globe-

We commissioned "Bob" Hertzberg to build a "beginner's" short-wave receiver which would bring 'em in—a set that you could build without previous experience in set-building—and the cost had to be low. Here's the set—and we're sure you'll like it. The 2-tube "Globe-Trotter," as described in detail, is complete with batteries, and on test it brought in G5SW (England) and other distant short-wave stations.

By **ROBERT HERTZBERG, W2DJJ**

● THE instrument illustrated on these pages is probably the simplest *complete* short-wave receiver that the beginner can build. The word *complete* is italicized because the set includes all the necessary "A" and "B" batteries right on the baseboard, along with the parts of the receiving circuit proper. A great many so-called "beginner" sets look simple and cheap because the batteries or other sources of power are kept separate from the receiver unit, yet these batteries may cost as much as and take up more room than the latter itself. The

writer recalls one such receiver which could be built for about four dollars and occupied as much space as an ordinary cigar box, but which required a fifteen-pound storage battery and four 45-volt "B" batteries.

Uses But Two Tubes

Using two tubes of the '30 type in a straightforward, "sure fire" regenerative hook-up, this little outfit is an *honest-to-goodness* receiver, and not a mere toy. It employs the minimum number of parts to make the circuit operative, with all fancy embellishments eliminated. The first tube is a regenerative detector, the second an audio frequency amplifier with transformer coupling. This combination is quite adequate for comfortable earphone reception. As a matter of fact, if it is adjusted carefully it will bring in most everything on the short waves worth hearing.

Since the two '30 tubes draw a total of only .12-ampere at two volts, the use of dry cells for filament supply is altogether practicable. Two No. 4 dry cells connected in series will last for several weeks of frequent listening. These batteries are only 2 inches square by 4 inches high—an extremely convenient size for radio purposes. They are much less bulky than ordinary No. 6 cells and much more satisfactory for continuous service than small "C" or flashlight batteries, which drop in voltage very quickly if more than a microscopic current is drawn from them. The chain stores sell the No. 4 batteries for ten cents—another feature in their favor.

Plate current is furnished by two 22½-volt "B" batteries of the smallest standard size, which measure 3⅞ x 2 x 2½ inches high. Along with the "A" batteries, these fit very nicely along the back of a wood baseboard 9 inches wide and 9½

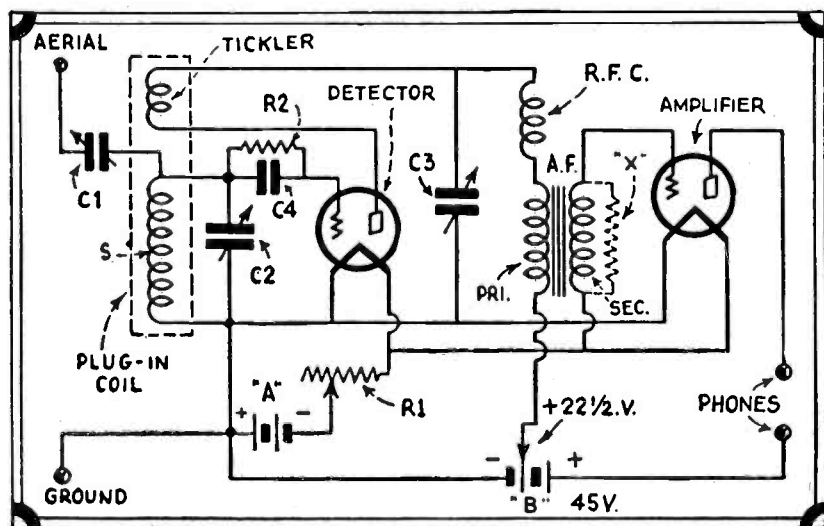

Wiring diagram for the 2-Tube "Globe-Trotter"—a receiver that you will enjoy.

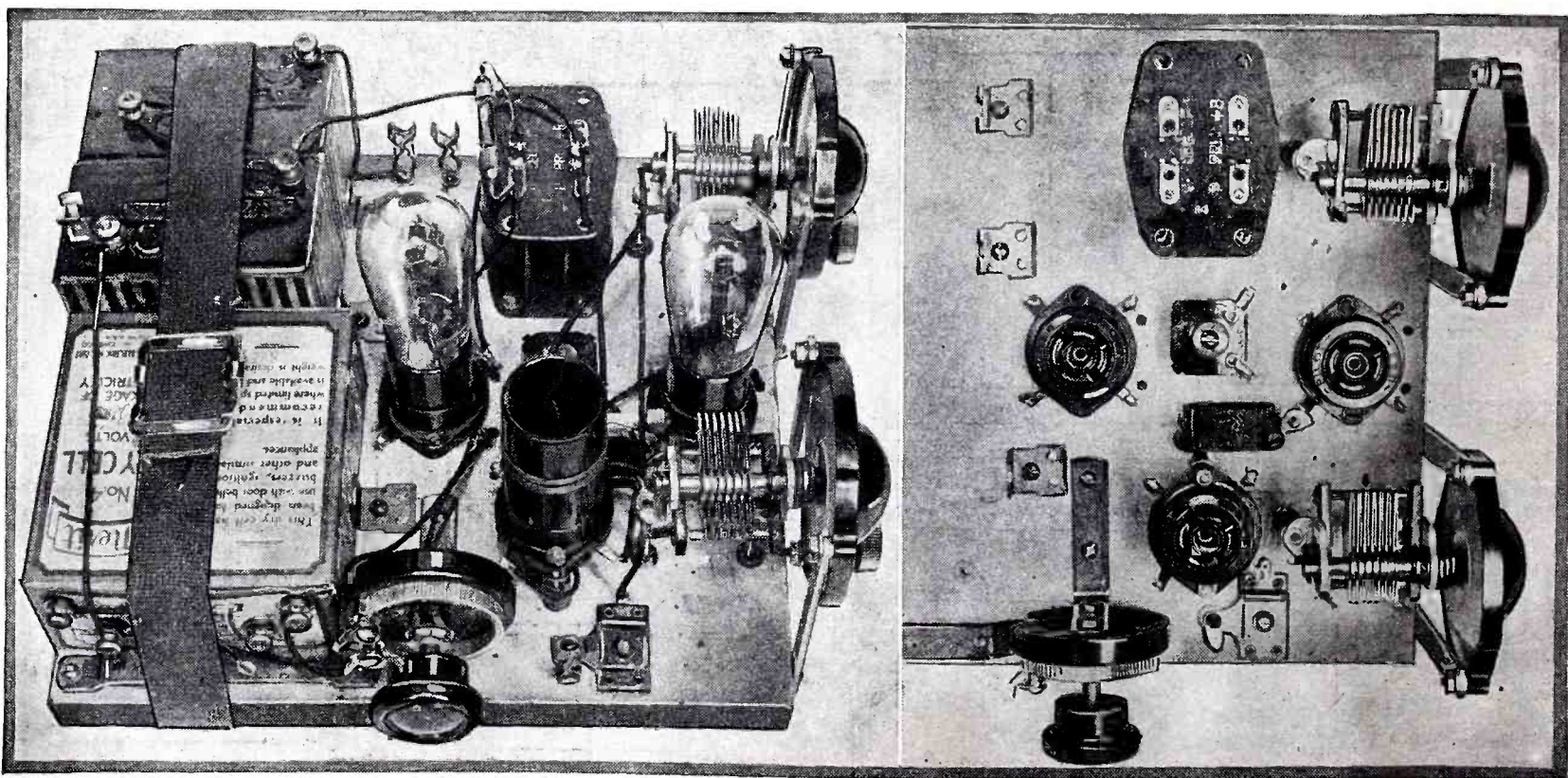

Left—Two views of the 2-Tube Short-Wave "Globe-Trotter" Receiver, designed and built by "Bob" Hertzberg. Photo at right shows set minus batteries and wiring.

Trotter"

inches deep, being held in place by a ten-cent web strap one inch wide.

Economical "B" Battery Used

No apology is offered for the use of three-element tubes instead of screen-grid tubes in this receiver, or for the use of a plate voltage as low as 45. The point is that screen-grid tubes require at least 135 volts of "B," which means a flock of expensive batteries, while three-element tubes work very sweetly on 45 volts and even less. Surely, screen-grid tubes would work better, but the cost and size of the set would be tripled! Such things are all purely relative.

Coil Data

There are numerous coils on the market that are designed to cover the 15 to 200 meter range with .0001-mf. tuning and regeneration condensers. A set sold by the Radio Trading Company, No. 1616, was used in the model receiver. These use four-prong form 2 1/8 inches long and 1 1/4 inches in diameter, and are all wound with No. 24 double cotton covered wire. The grid winding in each case connects to the plate and right filament prongs in the base, the tickler to the grid and left filament. Grid and tickler coils are wound in the same direction and are separated about 1/8 inch. If you want to "wind your own," follow this dope:

Approximate Wavelength Range	Number of Turns	
	Grid Coil	Tickler Coil
15- 25 meters	6	7
25- 50 meters	12	8
50-100 meters	24	13
100-200 meters	54	20

Start the assembly work by mounting the two midget condensers in the vernier dials. Tighten the shafts of the condensers in the studs of the dials, and then fasten the latter upright in the position shown by means of brass angles 4 inches long and 5/16 inch wide. The K-K dials are fitted with convenient screws that make this construction possible. Now drill holes in the baseboard just under the threaded mounting feet of the condensers, so that when long 6-32 machine screws are passed through these holes they will go into the feet and prevent the condensers from turning when the dials are turned. Put two 6-32 nuts on each screw before turning them into the mounting feet; tighten one against the top of the baseboard and the other under the condenser foot. In this manner the condenser and dial assembly will be made quite rigid.

(Continued on page 438)



The "Globe-Trotter" in actual operation, with extra plug-in coils at the left.

LIST OF ESSENTIAL PARTS

- In addition to the batteries and baseboard specified, the set uses the following parts:
- 2 Midget variable condensers, .0001-mf. (Hammarlund used in original model because they mount very easily.)
 - 2 Self-supporting 3-inch vernier dials (Kurz-Kasch).
 - 3 Four-prong tube sockets (Pilot).
 - 1 Audio transformer, not less than 3:1 ratio, not more than 6:1. (An old Stromberg-Carlson was used because it was advisable; any other good make will do.)
 - 1 .0001-mf. mica grid condenser (Aerovox).
 - 1 3-megohm grid leak (Lynch).
 - 1 Special (Blan) short-wave radio-frequency choke coil.
 - 1 "Postage stamp" antenna condenser, about .0001-mf. (Hammarlund).
 - 1 10-ohm filament rheostat. (This can be any make that has holes through the base or has other means for vertical mounting on the baseboard).
 - 4 Fahnestock spring binding posts for baseboard mounting.
 - 1 Set of four plug-in coils, 15 to 200 meters.

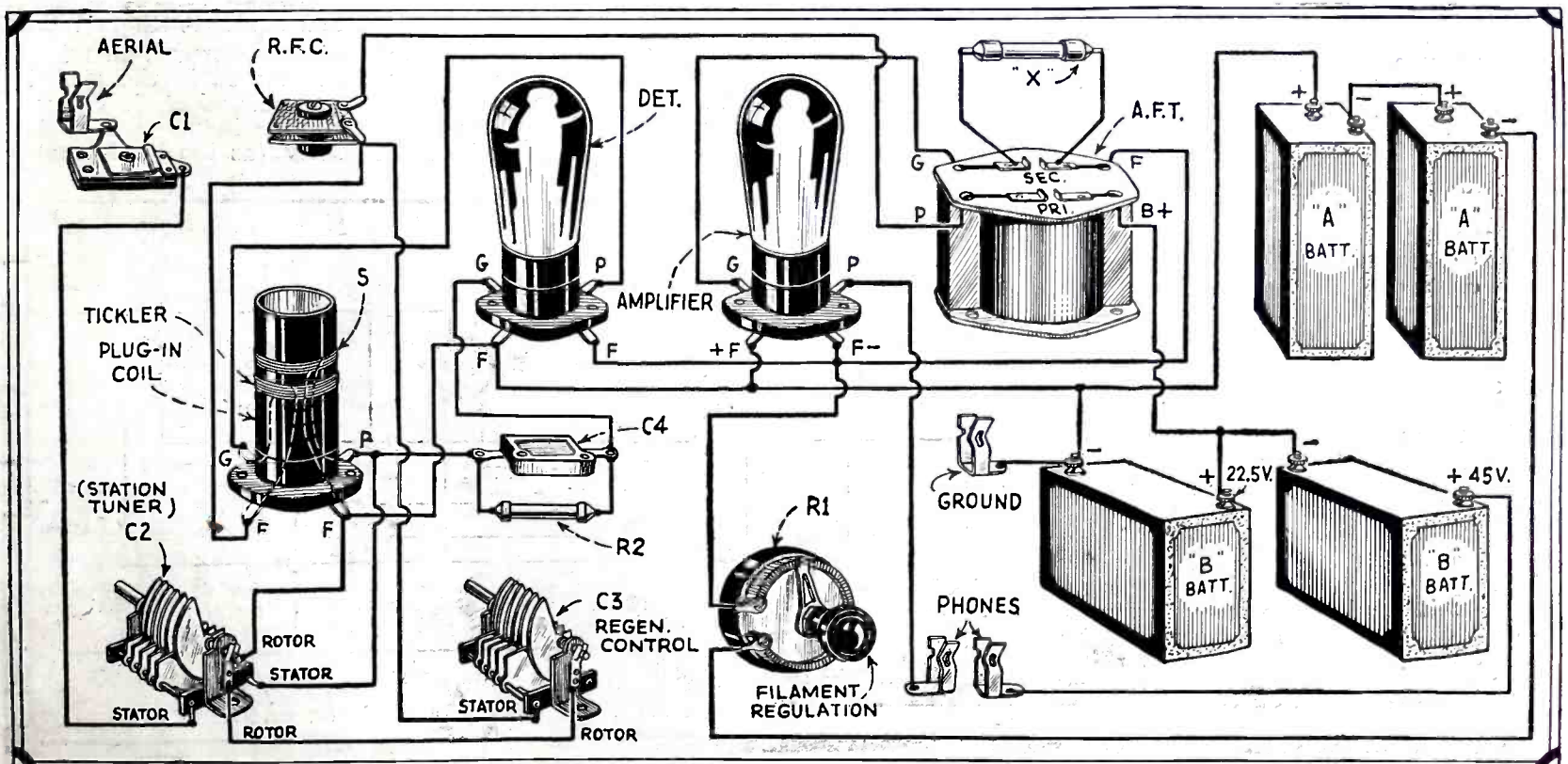

Even though you have never built a radio set, you can't help but go right with this 2-Tube "Globe-Trotter," as the "picture diagram" above shows you just how to wire it.

Yep! Mr. Doerle in person, whose original design of a 2-tube receiver created such a stir among thousands of short-wave fans the world over. Here Mr. Doerle presents his latest—a 3-tube "DX" receiver capable of operating a loud speaker.

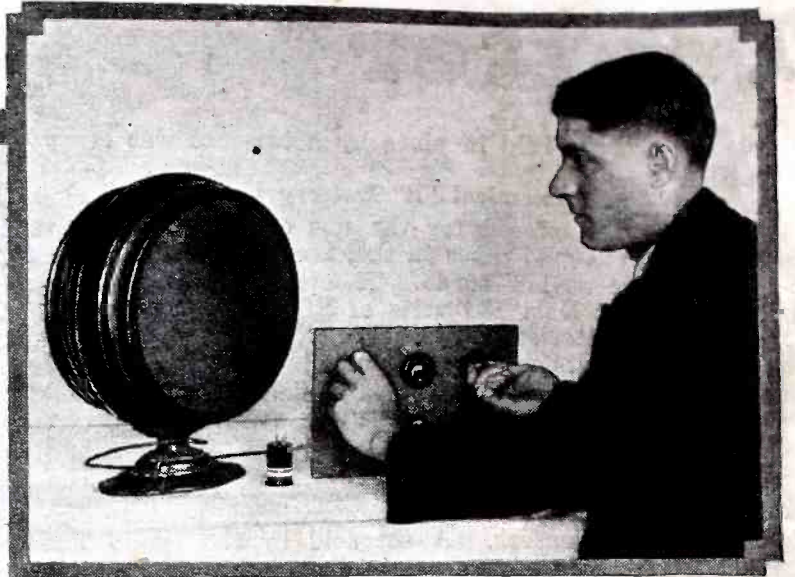
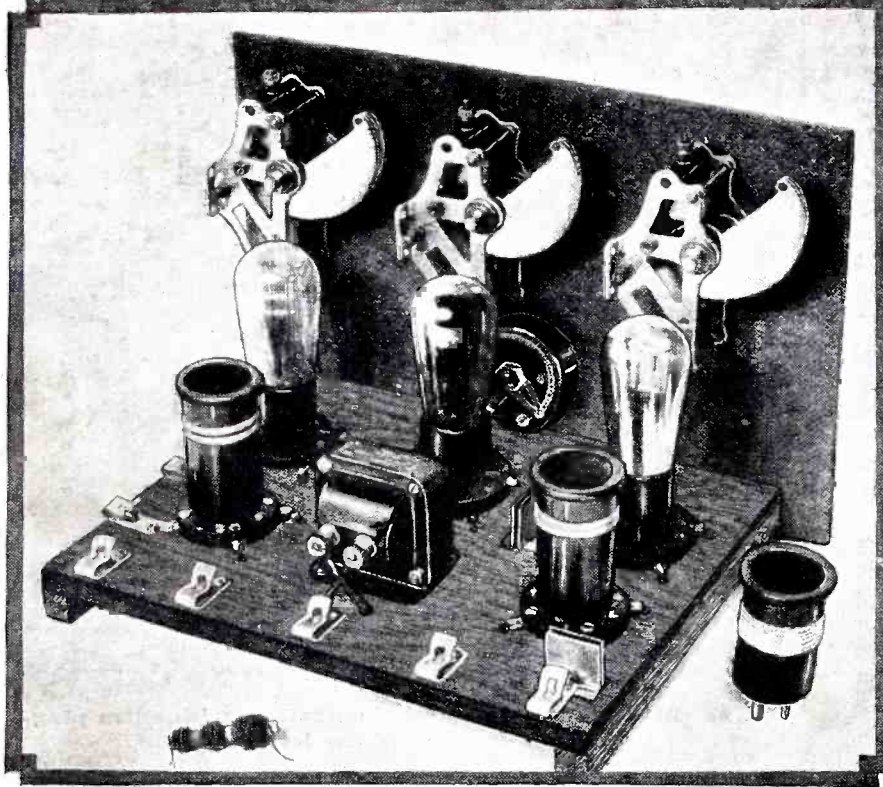

Another Doerle receiver! Thousands of our readers have written to us acclaiming the worldwide reception that they had enjoyed with the 2-tube receiver described by Mr. Doerle some months ago in SHORT WAVE CRAFT. We never published a simple receiver which created such popular acclaim and so we know that our readers will be tickled pink to have another design from Mr. Doerle. Three tubes and the world is yours! Let's go!

A 3-Tube "Signal Gripper"

● FOR a long time no single article has occurred in print which gives the "babe" the outstanding principles of operation and description of a short-wave set, though as has been stated many newcomers have joined the short-wave ranks. Not only do the following paragraphs remedy the ill, but supply the "food" for the two classes of will-be short-wave enthusiasts.

30 Minutes of Short-Wave Education

For the facts that are of outstanding importance, and that will soon be elaborated, assume that the neophyte has listened to a friend's short-wave receiver bring in distant signals and that from such an "audition" he has received his inspiration to construct a receiver that will afford him pleasure in his home. No doubt he also has searched through short-wave magazines to find out which materials and radio parts are necessary for the construction of a set—one that fits the leanness or fatness of his purse—but is at a great loss to get a panoramic view of the whole situation. If the "beginner" goes too blindly at the construction of a short-wave set, he will be addressing many letters to radio editors, set manufacturers, and companies selling radio parts, asking for help with his difficulties; whereas if he knew the facts about short-wave receiver operation and construction, he would be amazed at his technique and "trouble-shooting" for the "needle in the haystack."

Since the story is getting somewhat lengthy already, it is necessary at this point to give a hook-up of a short-wave set that involves all the principles which will be explained in the text. This diagram for a set would be called a three-tube hook-up, embodying a stage of R.F. (radio frequency) amplification, a regen-

By WALTER C. DOERLE

erative detector (DET.) and a stage of A.F. (audio frequency) amplification. As a battery set has such a versatility of use (portable, can be operated in an automobile, affords much pleasure while rolling along with the breeze, can be operated in wooded lands, and in short is independent of all external circumstances), the diagram and photographs show the use of the '30 two-volt tubes, which require two dry cells in series for filament-supply current.

The important items which come up for consideration can be grouped around five elements—antenna, radio frequency

amplifier, detector, audio frequency amplifier and output device. It cannot be too strongly emphasized that the neophyte should make a study of these elements, for by so doing his radio education will become rounded out. (Be it made known here that all facts are not brought to light, but only those which are of the utmost value to the beginner—if all were included, there would be volumes instead of a few pages.)

How Antenna and R.F. Stage Work

For the antenna element, this is not "just a wire insulated in the air," but an oscillating circuit which is composed of the wire (as the inductance) and its inherent capacity (as the condenser) to

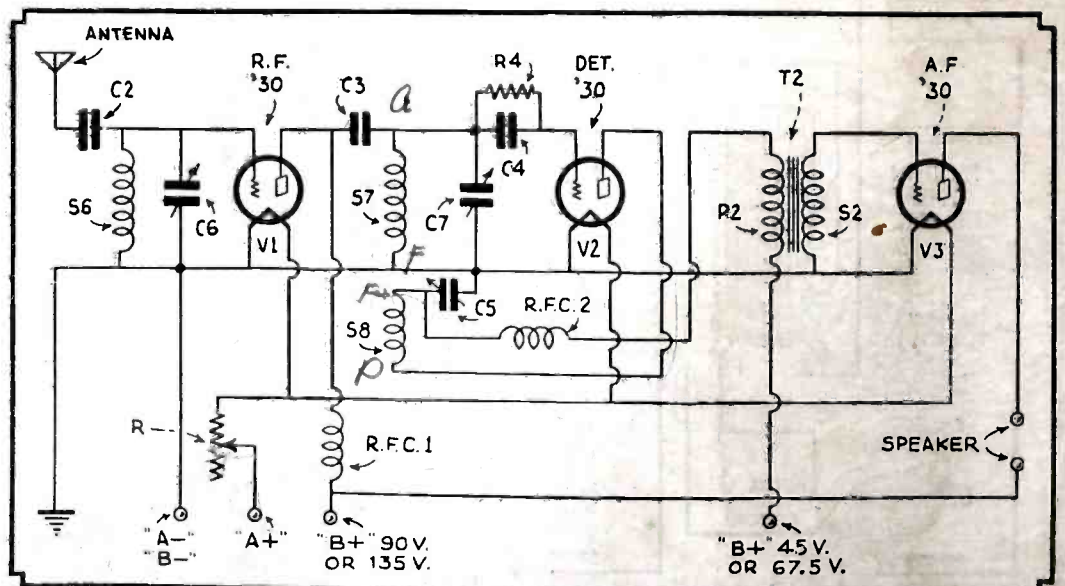

Walter Doerle's new 3-tube receiver, comprising a stage of "high gain" tuned R.F. ahead of a regenerative detector and one stage of A.F. Sweet Patootie! Does this set pull 'em in!

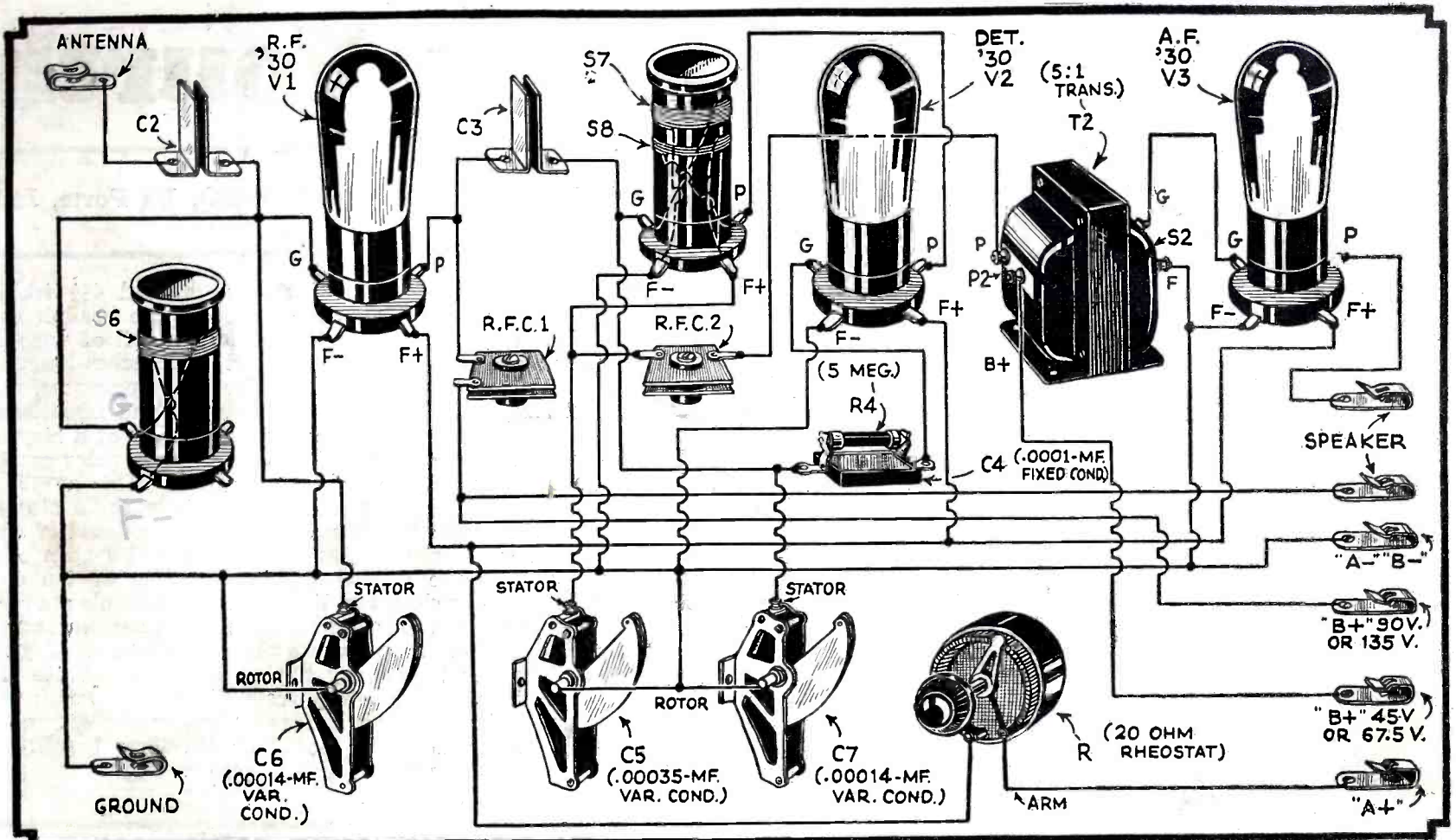

To make sure that you may enjoy all the fun of listening to short-wave programs from "foreign" as well as American short-wave stations, the editors had this special picture diagram drawn. The parts are not shown mounted in any particular layout, as you may have your own ideas as to mounting the apparatus. A very good layout of the parts is shown in one of the photos of the set actually built and tested by Mr. Doerle.

its image below the ground surface and to nearby objects above the surface. Its function is to intercept the radio waves and by the use of condenser C2 electrostatically couple this R.F. energy to that oscillating circuit made up of of coil S6 and condenser C6.

This leads to a consideration of the stage of radio frequency. If S6-C6 be tuned to the wavelength of the transmitted signal, then a very high value of oscillating current is set up in S6-C6, which in turn establishes a large value of R.F. voltage between the grid and filament negative connection of tube V1. As this stage is called an R.F. amplifier, its function is to enlarge the amplitude of the R.F. voltage that will act on the grid of the detector (DET.). This amplified voltage is due to the inherent characteristic of any three-element radio tube. (If the beginner will consult an up-to-date book on principles of radio communication, he will see very readily why such a tube acts as an amplifier—the curve of grid voltage versus plate current should be convincing proof.) But the discussion of the R.F. stage does not end here—the RFC1 (radio frequency choke coil) still must be considered. It acts as the plate "load" (for without a load, the tube will not amplify), and while one end, nearest the plate, is "alive," the other end should be practically at zero potential or "dead" if properly constructed. (One was placed in the photograph to save the beginner much grief, since a small picture at times conveys more than volumes of words.) This choke coil was a three-section winding of No. 36 D.C.C. copper wire wound on a 1/4-inch wood dowel stick, with "section" turns of 40-80-120, the 40 turns being connected nearest to the plate.

Thus, succinctly stated, a stage of R.F.

is used to get large enough values of grid voltage "swing" in the detector oscillating circuit S7-C7, so that the plate current of tube V2 will cause a reasonable amount of magnetization of the iron in the primary winding P2 of the audio transformer T2. But before proceeding too far, it is well to state here that coils S6, S7, and condensers C6, C7, have the same number of turns and capacities respectively.

Since the plate end of RFC1 is "alive" with R.F. voltage and if the oscillating circuit S7-C7 of the detector stage be tuned to the same frequency as that in S6-C6, then it acts as a wavemeter, and coupling of the R.F. and detector stage takes place through condenser C3. As listed in the circuit constants (C2 equals C3), these condensers are made of thin copper sheet cut to 1 x 1 1/4 inches and spaced 1/16 inch apart on the baseboard with their longest dimension folded 1/4 inch, thus making effective areas of 1 x 1 inch. (If these are made too large, broadcast harmonics will "peep in" and also may cause blocking of the detector; if made too small, C3 will have such a high reactance in the region of 150-200 meters that these signals will not be detected. In other words, not enough coupling will exist between the R.F. and detector stage in this region of wavelengths.)

The Detector Stage

Passing so closely to the brink of the stream, it is time to take a drink of that which pertains to the detector stage. This is made up of the coils S7 and C8, condensers C5 and C7, and tube V2 with its grid-leak R4 and grid condenser C4. The tickler coil serves as the "power" source for regeneration, while the condenser C5 has the purpose of throttling this feed-back energy. If the oscillating

circuits S6-C6 and S7-C7 are tuned exactly to the same wavelength (the condition for clear short-wave phone reception), no audible sound comes from the speaker. However, for code reception C7 is detuned somewhat so that an audible beat-note suitable to the listener's ear can be heard. Thus the detector stage is in fashion a converter stage—high frequency current in S7-C7 is changed to audio frequency or zero-beat frequency, respectively, for code and phone reception in the plate circuit of V2.

Now three other items command interest of a deep nature, but briefly theorized can be thus stated—condenser C4 holds the electric charge on the grid, while R4 permits this charge to leak off slowly, thereby creating an automatic grid bias. RFC2 is a coil identical with RFC1, for its purpose here is not to "load" the plate of V2, but to keep the creeping R.F. energy out of the audio transformer primary, and confining "serious trouble" to a limited space. (If allowed to "wander," the speaker might squeal if the cord is squeezed.)

It has been implicitly stated that due to the changes in grid voltage in the R.F. and detector stages, an identical change occurs in the plate current of coil P2 of the audio transformer T2. It is this variation in the plate current through P2 that is heard from the speaker. The audio frequency transformer T2 greatly increases the voltage which exists across coil P2. If a 5:1 transformer, S2 voltage will be five times that of P2. With this S2 voltage applied to the grid-filament of tube V3, here again amplification of the detected (rectified) signal occurs, for V3 acts as an audio amplifier.

And lastly in theory is mentioned the speaker, which in fashion, too, is a

(Continued on page 434)

Winners in the Fourth

FIRST PRIZE—\$50.00

Won by ALTUS SALZWEDEL, W9FZQ, La Porte, Ind.

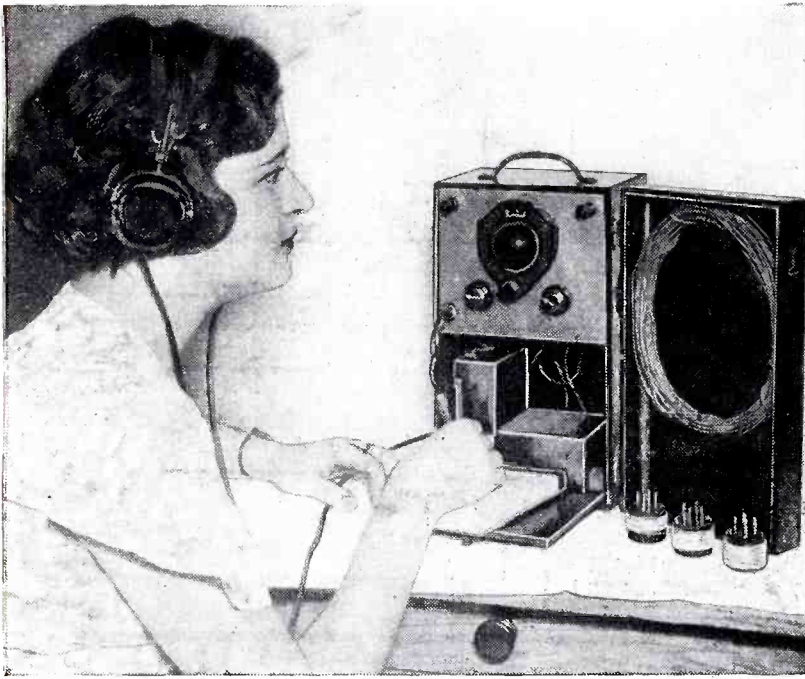

One of the fair sex finds Mr. Salzwedel's portable short-wave receiver intriguing.

measures 6½ inches wide, 5½ inches high, and 4½ inches deep. The lower part contains the batteries, the headphones, and the coils. On the inside of the cover is a coil of wire 35 feet long for an aerial, and a ground rod 11½ inches long.

This portable receiver can be used for many purposes, due to its small size, light weight, great volume, and sensitivity. This receiver was mounted on the luggage carrier of a bicycle, about 15 feet of wire was stretched between two poles of the bicycle, acting as aerial; no ground was used. This arrangement was used in connection with an amateur radio station to find out if the transmitter's antenna was directional or not. The set was tuned to the station's frequency and I then rode the bicycle around the station within a radius of ten city blocks. When the bicycle got in line with the station's antenna the signals were noticed to fade way down. This same arrangement can be used to find out where the skip distance of your amateur transmitter begins, by having someone operate the transmitter while you ride away from the station, with the receiver tuned to its frequency. This system works very good for transmitters operating in the 20 or 40 meter bands. A

(Continued on page 430)

SECOND PRIZE—\$25.00

Won by George V. Dubuc, Mount Vernon, N. Y.

● MOST portable receivers that are described or advertised are usually found to be very bulky or heavy and so are not as portable as the public desires them to be. The receiver here described will be found very satisfactory as a portable, for it weighs only 11 pounds, including everything all packed in a cabinet measuring 12 inches high, 7 inches wide, and 6½ inches deep. The light weight and small size of this outfit is made possible by using two of the new type 30 tubes, and using the new size portable batteries, which have just been placed on the market. The "B" supply is furnished by one 45-volt battery measuring 3½ x 2¼ x 3½ inches in size, and the "A" supply is furnished by a 3-volt battery measuring 3½ x 1¼ x 4½ inches in size. This receiver is designed for short-wave use, but with a broadcast coil the set will bring in the broadcast stations nicely.

The cabinet is made of three-ply wood. The upper part contains the receiver, which

● FIRST the bottom of the knock-down aluminum cabinet (5 x 9 x 6 inches) is laid out. At extreme left front is mounted the audio transformer (a replacement type; approximate size, 2¼ x 2¼ x 2¼ inches; ratio, about 3½ to 1). Next to this, towards the rear, is mounted an 85 mh. choke. Directly to the right the two 4-prong base mounting sockets. On grid of detector socket is mounted the .0001-mf. grid condenser and 10-megohm leak. To the right of transformer, mount the .5-mf. by-pass condenser, and to the right of this the other 85 mh. choke. Care should be taken to leave enough space for the batteries to fit in on the right side, and also for the corner posts of the cabinet. So much for the base.

On the left panel of
(Cont'd on page 430)

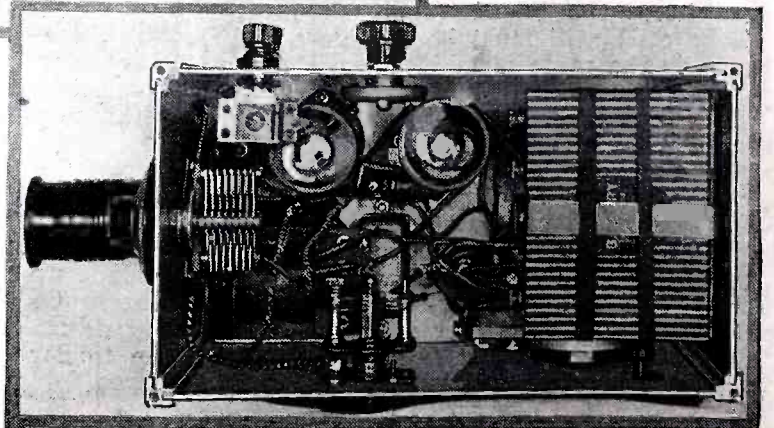
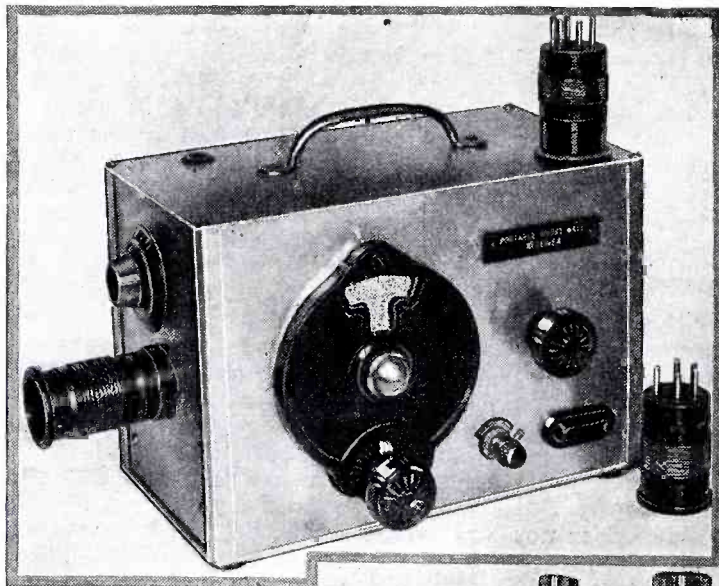

George Dubuc, second prize winner in the August contest, did a very fine job on the aluminum shield box receiver illustrated above and at the right. This receiver is complete with battery and the coils are plugged into the receptacle mounted on the left side of the cabinet.

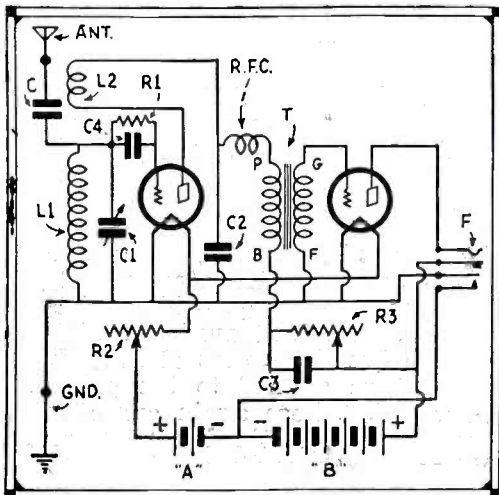

Wiring diagram for Mr. Salzwedel's first prize winner.

Set Builders' Contest

THIRD PRIZE—\$12.50

Won by Alfred H. Rowe, Jr., W2BSJ, New York, N. Y.

● IT WAS in the writer's mind at the time of building this short-wave receiver to have it compact, selective, and of low cost, besides having sufficient volume to be able to receive low-power stations. The parts are enclosed in an aluminum box, 9 x 6 x 5 inches, which has grooved corners. The top is hinged so that it will be easy to change coils or to shift the General Radio plug arrangement for sharp or broad tuning. The circuit is of the well known two-circuit type with regeneration controlled by a variable condenser. The grid of the type '30 detector tube is voltage fed through a small Hammarlund equalizing condenser which is in series with the aerial. The main advantage of the circuit is the way the stations are spread over the tuning dial as will be seen from the diagram. The plug at (3) is a General Radio plug, and when it is plugged into jack (1), the .00005-mf. variable tuning condenser is shunted across the secondary of the plug-in coils, and when plug (3) is plugged into jack (2), the .00005-mf. condenser is across only part of the secondary coil. The secondaries have a tap on them which is located about two-thirds the way from the filament end. With this scheme there is used an equalizing condenser inside the coil forms, which is wired across all the secondary coils.

(Continued on page 431)

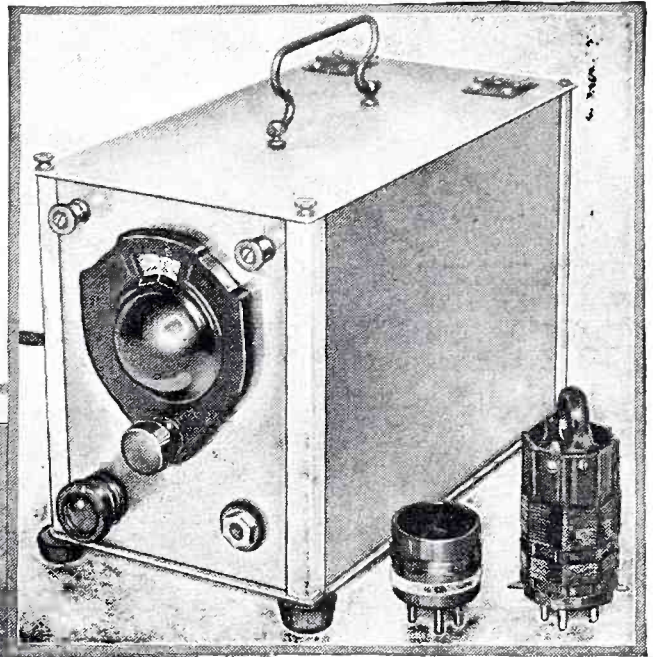
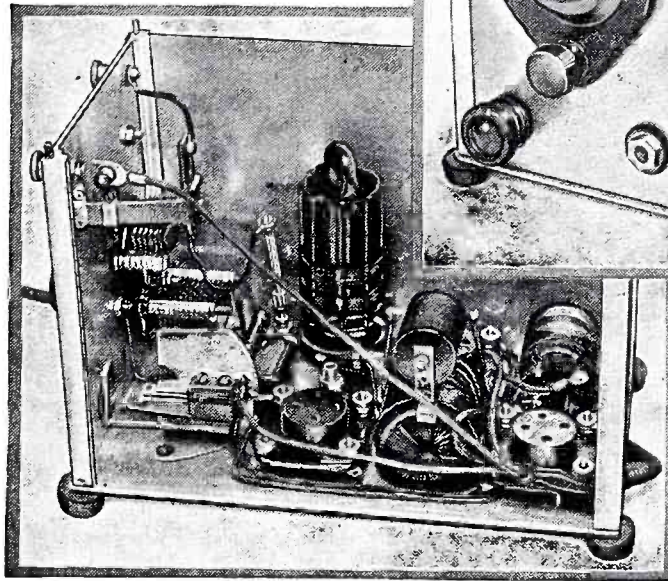

Third prize in the August contest was awarded to Alfred H. Rowe, Jr., for this fine short-wave receiving set. Mr. Rowe mounted a regenerative detector and two complete stages of audio in this small space, thanks to the extremely small Hedgehog A.F. transformers. The complete receiver uses three tubes.

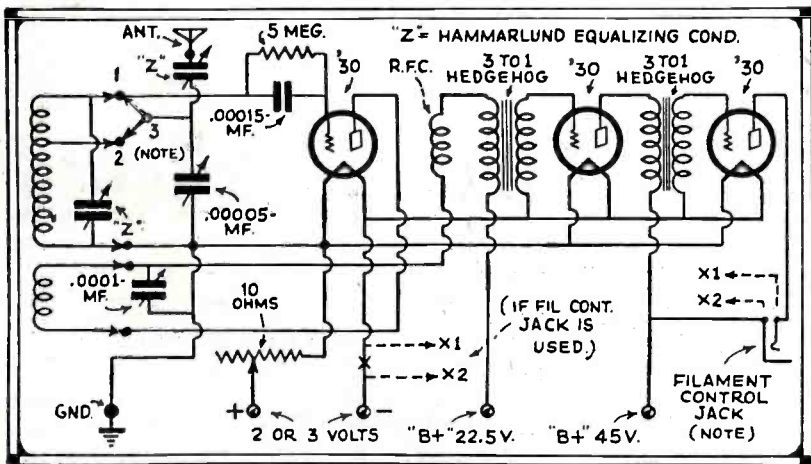

Wiring diagram of third prize winning short-wave receiver.

FOURTH PRIZE—\$7.50

Won by Angus G. Neaves, Long Branch, N. J.

● AFTER six months of experimenting with different battery circuits, I have found this one to give best all-around satisfaction. This set is not what one would call a compact short-wave receiver, but the space is occupied by giving the proper spacing for all parts.

The size of the aluminum panel used is 7 x 18 inches, with a 6 x 16 inch baseboard. Beginning on the left side of the chassis we find the gang condenser (C1), radio frequency tube (T34), and the antenna coil (L1) are in one compartment. In the second compartment the detector stage is contained. Separating

(Continued on page 432)

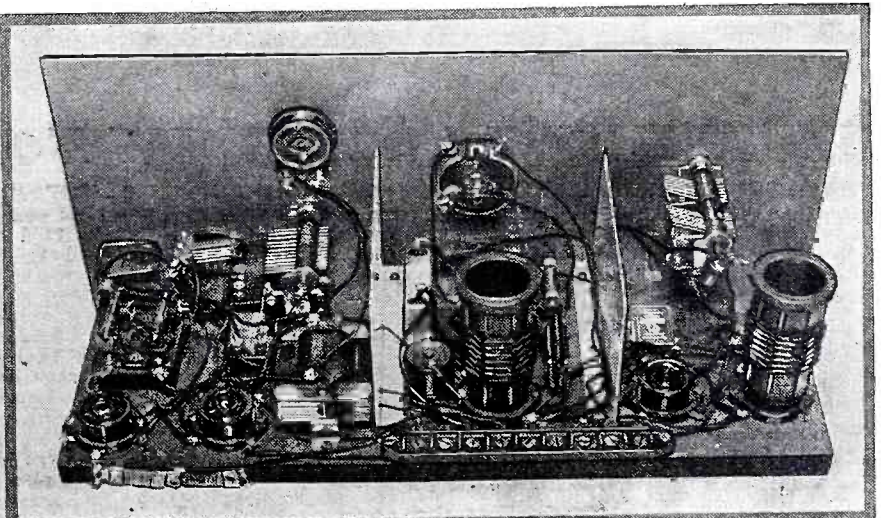
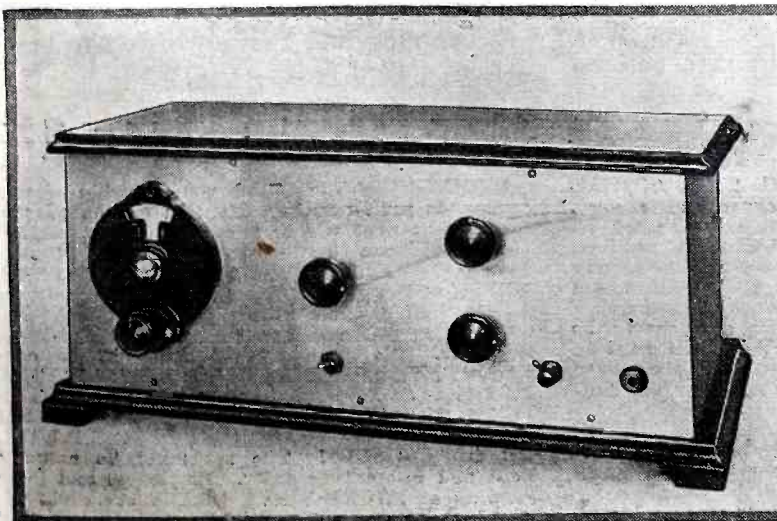

Front and rear views of fourth prize winner; a very neatly constructed short-wave receiver of the semi-shielded type.

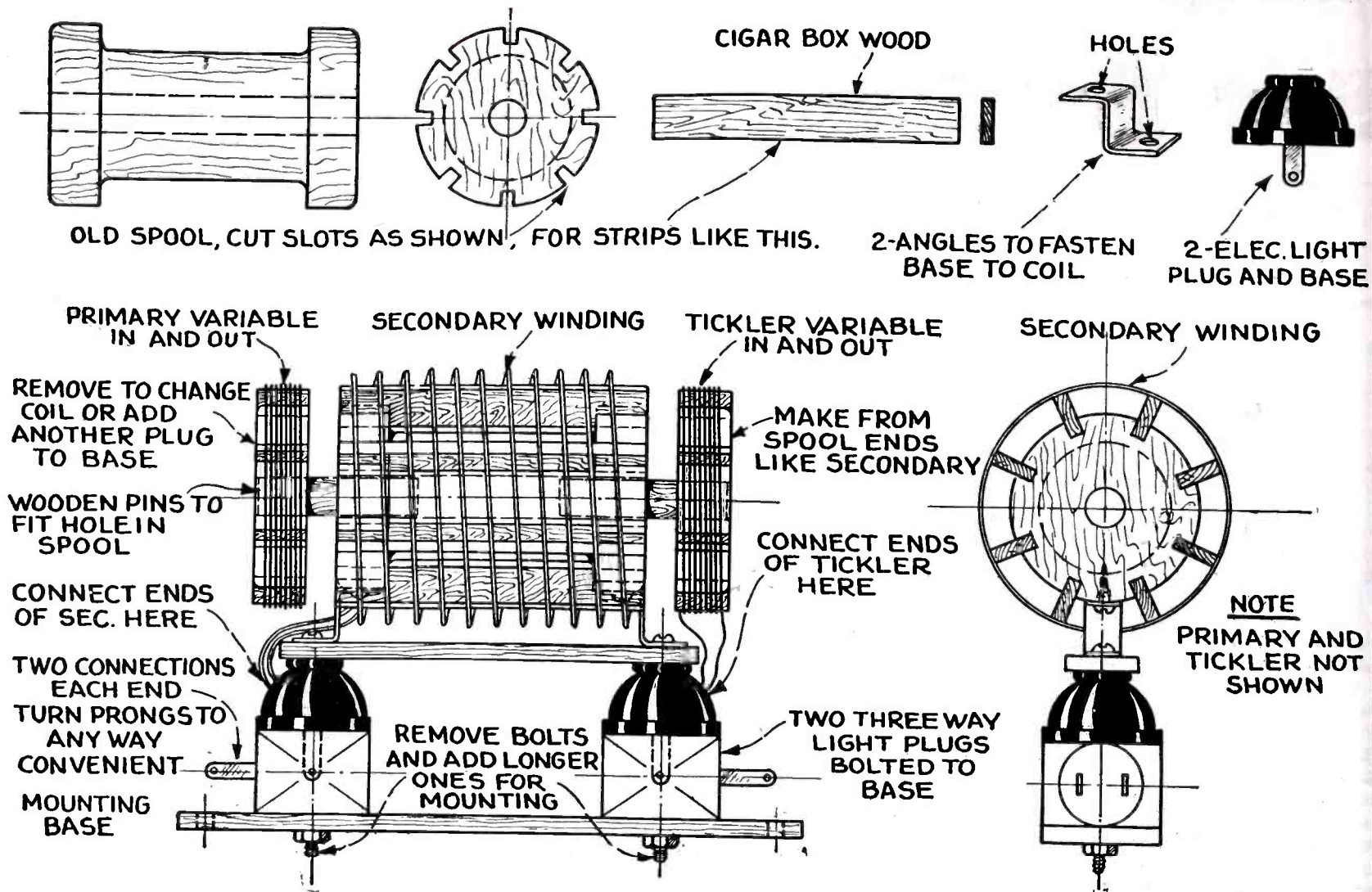

Simple and effective means for establishing contact with plug-in coils; particularly useful for transmitting coils used in S-W transmitters, where good heavy electrical contacts are desirable and necessary. The variable induction between primary or tickler and the secondary is a very good feature. The position of the primary or tickler can be varied from the front panel by a knob and lever action, or by cams, a cord and pulley arrangement, et cetera.

Novel Plug-In Coil Construction

● I THINK that the drawing is self-explanatory. Of course the constructor can make the top part of the coil from tubing if he desires, instead of the old wire spool, or use his own idea of what to use; but I find that using the electric light plugs and the three-way plugs, makes a very solid and substantial coil, easy to plug in and out.

There is no necessity, of course, to use three-way plugs, but that is the way

they come, and they make a neat job. I reamed out the small holes in the prongs to take a $\frac{1}{8}$ " bolt and they make four good connections, and they can be turned any way it is the most convenient.

I removed the bolt holding the three-way plug together and substituted a longer one to fasten the plugs to the base; to fasten the electric light plug to the coil base, I simply run a bolt up

through it with a washer on that would fit in it.

The angles that I used I bought in the radio department of a chain store. Any of the fans who uses their heads, can devise different connections to the coil.

Any one who wants to make a separate primary for each coil, to save himself the trouble of removing the primary each time he changes coils, can just add another plug and receptacle to the base. —Contributed by P. F. Barrett.

\$20.00 Prize Monthly For Best Set Submitted

● THE \$500.00 Short-Wave Set-Builders' Contest closed on September 30; at least, that was the final date for the receipt of entries in the fifth and last monthly "set-builders" contest. SHORT WAVE CRAFT readers showed so much interest in the contest, especially as it drew to a close, that the editors have decided to offer a \$20.00 monthly prize for the best short-wave receiver submitted.

If your set does not receive the monthly prize you still have a chance to win cash money, as the editors will be glad to pay space rates for any articles accepted and published in SHORT WAVE CRAFT. So if your set does not become a prize winner, it still may win space as an editorial article for which you will receive a check.

You had better write the "S-W Contest Editor," giving him a short description of the set and a

diagram, BEFORE SHIPPING THE ACTUAL SET, as it will save time and expense all around. A \$20.00 prize will be paid each month for an article describing the best short-wave receiver, converter, or adapter. Sets should not have more than five tubes and those adapted to the wants of the average beginner are much in demand. Sets must be sent PREPAID and should be CAREFULLY PACKED in a WOODEN box!

The closing date for each contest is sixty days preceding date of issue (November 1 for the January issue, etc.).

The judges will be the editors of SHORT WAVE CRAFT, and Robert Hertzberg and Clifford E. Denton, who will also serve on the examining board. Their findings will be final.

Articles with complete coil, resistor and condenser values, together with diagram, must accompany each entry. All sets will be returned prepaid after publication.

REQUIREMENTS: Good workmanship always commands prize-winning attention on the part of the judges; neat wiring is practically imperative. Other important features the judges will note are: COMPACTNESS, NEW CIRCUIT FEATURES, and PORTABILITY. The sets may be A.C. or battery-operated, Straight Short-Wave Receivers, Short-Wave Converters, or Short-Wave Adapters. No manufactured sets will be considered; EVERY SET MUST BE BUILT BY THE ENTRANT. Tubes, batteries, etc., may be submitted with the set if desired, but this is not essential. NO THEORETICAL DESIGNS WILL BE CONSIDERED! The set must be actually built and in working order. Employees and their families of SHORT WAVE CRAFT are excluded. Address letters and packages to the SHORT WAVE CONTEST EDITOR, care of SHORT WAVE CRAFT Magazine, 96-98 Park Place, New York, N. Y.

LEARNING the CODE

By JOHN L. REINARTZ

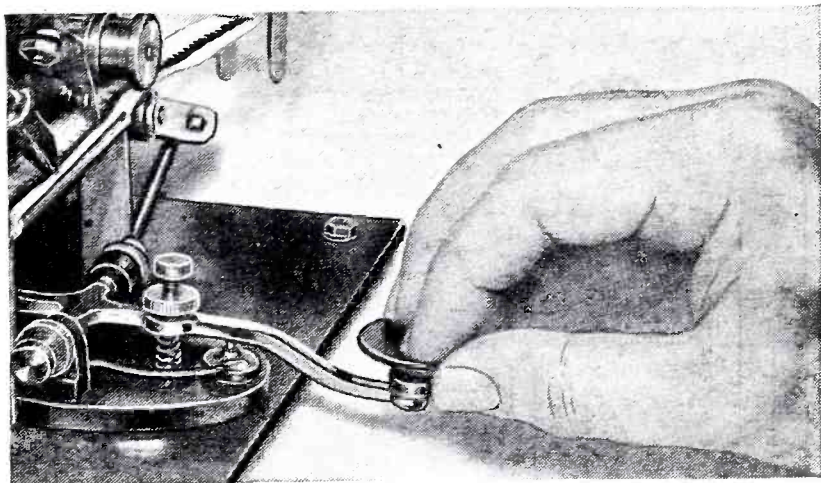

Illustrating correct position for gripping the key.

No. 5 of a Series

● ONE of the greatest mysteries to the uninitiated is how an amateur can make head or tail out of the jumble of dots and dashes that he hears in the ear phones. When one has learned how to read these dots and dashes it is quite an accomplishment; to read them at great speed is an art. Sometimes one meets an operator who can read the code, read a book and carry on a conversation at the same time. Edison was also one of these. All of us cannot be Edisons, so we won't be able to do all this at the same time, but we can learn how to read the code so that we may be able to obtain an operator's license and also be able to sit in and take our turn at the key and converse through the ether.

During the great war it fell to my lot to teach the code to several classes of future radio men for Uncle Sam. This was a splendid experience and indicated to me why some of us have such a hard time trying to get the hang of it. Time after time some student would be able to get as far as 5 words per minute and then be stuck, at times getting to the point of giving it up. At first it was a case of individual instruction to get by this 5 word per minute point, only in some cases to have the thing repeat itself at 7 or 8 words per minute. Always in a case of this kind the student would be one who had a hard time trying to remember which letter in the alphabet fol-

lowed the preceding one or which letter preceded the one to follow. It was so bothersome that I finally hit upon the stunt of starting a new student in to learn the alphabet both forward and backward before he was allowed to sit in and listen to a transmission.

This is what I want you to do if you really wish to learn the code. Go right after it; learn to say Z Y X W V U as well as A B C D E, even to be able to go on both forward and backward from any letter that may come to your mind, like M, say M L K J I or M N O P Q R and so on to the beginning or the end of the alphabet. When you are able to do that, it will be time enough to see what a key is like.

When the times comes when you think you are ready to read the code, get some one to do the sending for you. It is all too easy to learn how to send the characters that go to make up the letters of the alphabet, much easier than it is to copy them down when they are being sent by some one else. It is much too early in the game to try to do the sending, anyhow. You won't be able to make the characters so they will sound like what they are supposed to. Get some one, even if it has to be your sister.

While you are looking for some one to send to you, look over the International code and get an idea what the letters become. You will see that A be-

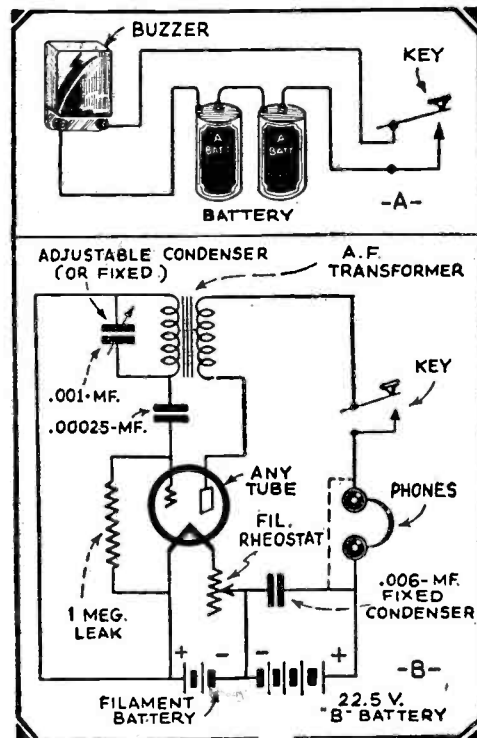

Diagrams above show simplest buzzer code practice set; lower diagram, more elaborate practice set. Dotted line shows optional condenser hook-up.

comes — and B becomes — . . . C — . . . D — . . . E . . . F . . . G — . . . and so on, dots and dashes being used to indicate (Continued on page 436)

INTERNATIONAL MORSE CODE AND CONVENTIONAL SIGNALS

A	• —	R	• • •	9	— — — — •	PERIOD	• • • • •	FROM (DE)	• • • •
B	— • • •	S	• • •	0	— — — — —	SEMICOLON	— • • • • •	INVITATION TO TRANSMIT	• • • •
C	— • — •	T	—	'A'	• • • • —	COMMA	• • • • •	(GO AHEAD)	• • • •
D	— • •	U	• • —	(GERMAN)	— — — — •	COLON	— • • • • •	WARNING-HIGH POWER	— • • • • •
E	•	V	• • • —	A or A	• • • • •	INTERROGATION	• • • • •	QUESTION (PLEASE REPEAT AFTER...)	• • • • •
F	• • • •	W	• — — —	(SPANISH-SCANDINAVIAN)	— — — — •	EXCLAMATION POINT	— • • • • •	INTERRUPTING LONG MESSAGES	• • • • •
G	— • — •	X	— • • • —	CH	— — — — •	APOSTROPHE	• • • • •	WAIT	• • • • •
H	• • • •	Y	— • — —	(GERMAN-SPANISH)	• • • • •	HYPHEN	• • • • •	BREAK (BK) (DOUBLE DASH)	— • • • • •
I	• •	Z	— — — •	E	• • • • •	BAR INDICATING FRACTION	• • • • •	UNDERSTAND	• • • • •
J	• — — —	1	• — — — —	(FRENCH)	— • • • • •	PARENTHESIS	• • • • •	ERROR	• • • • •
K	— • —	2	• • — — —	N	— • • • • •	INVERTED COMMAS	• • • • •	RECEIVED (O.K.)	• • • •
L	• — • •	3	• • • — —	(SPANISH)	— • • • • •	UNDERLINE	• • • • •	POSITION REPORT (TO PRECEDE	• • • •
M	— —	4	• • • • —	O	• • • • •	DOUBLE DASH	• • • • •	ALL POSITION MESSAGES.)	• • • •
N	• —	5	• • • • •	(GERMAN)	— • • • • •	DISTRESS CALL	• • • • •	END OF EACH MESSAGE (CROSS)	• • • • •
O	— — —	6	— • • • •	U	• • • • •	ATTENTION CALL TO PRECEDE	• • • • •	TRANSMISSION FINISHED	• • • • •
P	• — • •	7	— — • • •	(GERMAN)	• • • • •	EVERY TRANSMISSION.	• • • • •	(END OF WORK) CONCLUSION	• • • • •
Q	• — — •	8	— — • • •	(GERMAN)	• • • • •	GENERAL INQUIRY CALL	• • • • •	OF CORRESPONDENCE	• • • • •

[TO BE USED FOR ALL GENERAL PUBLIC-SERVICE RADIO COMMUNICATION. (1) A DASH IS EQUAL TO THREE DOTS; (2) THE SPACE BETWEEN PARTS OF THE SAME LETTER IS EQUAL TO ONE DOT. (3) THE SPACE BETWEEN TWO LETTERS IS EQUAL TO THREE DOTS; (4) THE SPACE BETWEEN TWO WORDS IS EQUAL TO FIVE DOTS]

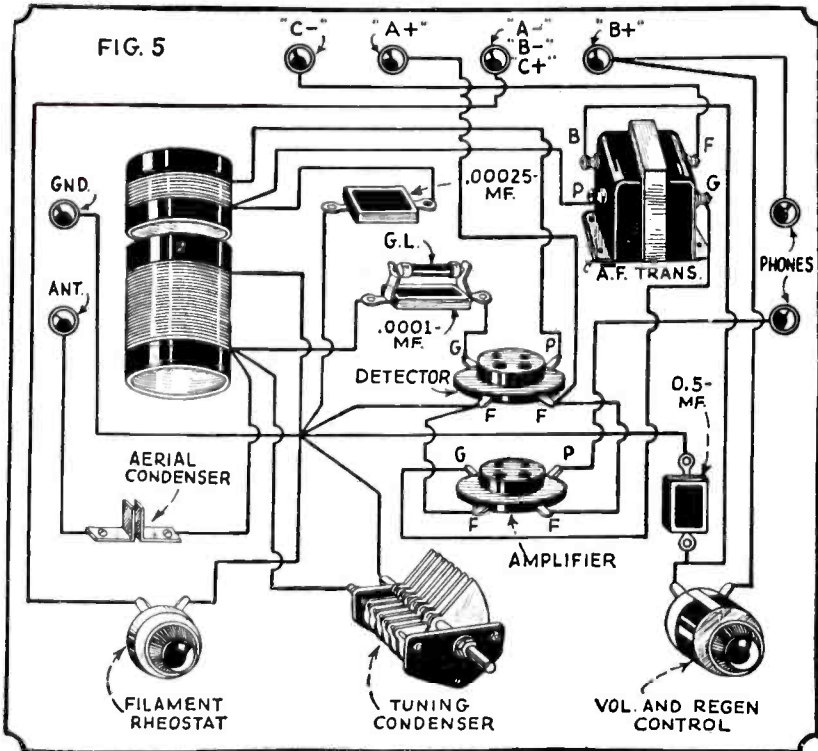

Picture wiring diagram of the expanded beginner's short-wave receiver, including one stage of audio amplification and detector.

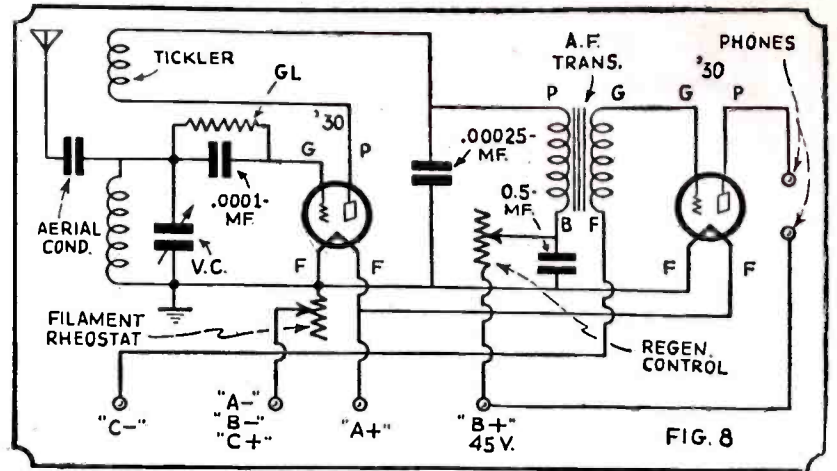

Schematic wiring diagram of the beginner's short-wave receiver with A.F. amplifier added.

SHORT WAVE

The Beginner's Set Gets an Amplifier

An audio amplifier to increase the volume of the one-tube set described in the August issue.

● IN the article which appeared in the August issue, describing the Beginner's one-tube set, we learned how the vacuum tube can be used to change the extremely high frequency currents (radio waves) to low frequency currents that are needed to operate a loud speaker or head-phones. There is another important use for the vacuum tube. This is to increase the volume of the sounds received, so that a loud-speaker can be used, and so that the far distant stations can be heard with sufficient volume to be understood.

To utilize the vacuum tube as an amplifier, we must connect it in a certain manner and use several other parts, as we shall see. The ordinary type of receiving tube contains three elements—the filament, the grid and the plate. The filament, when heated, throws off electrons. These electrons hit the plate and as we will remember from the first article, the flow of electrons is also a flow of current. By placing the correct voltages on the plate and the grid by the use of batteries, the grid can be made to control the number of electrons flowing to the plate.

Then if the output of the detector is

connected to the grid of the amplifier tube, the signal received can be used to control the current flowing in the plate of the amplifier tube. In this way, the current in the latter tube changes with each change in the detector and as the current in the amplifier is larger than that in the detector, greater volume can be obtained.

Several amplifiers can be connected after the detector to further increase the volume; at this time, though, we will content ourselves with adding a single tube. Later, we will add another tube and a device that will do away with the batteries.

To couple the detector tube to the amplifier, some device must be used to permit the tube to be used efficiently and to separate the battery leads in the two circuits. There are three common systems of accomplishing this separation. The first and most universal is known as the transformer method. The second is called the resistance coupled method and the third is the impedance system.

Transformer Coupling Method

We will recall that if two coils are coupled together and a current is flowing

in the first, a current will also flow in the second whenever a change takes place in the applied current. This action is known as *induction* and is used in radio tuners and in transformers. The transformer consists of two coils (a primary and a secondary) with an iron core between them. The iron core increases the inductive action and makes the device more efficient for low frequency currents. This is shown in Fig. 1.

Now if we look at Fig. 2, we will see how the transformer is employed to couple the detector tube to the amplifier tube. It will be noticed that the primary of the transformer is used in place of the phones that were formerly in the detector plate lead. The secondary is then wired to the grid of the amplifier and finally the phones are connected in the plate wire of the amplifier tube.

The advantage of the transformer system over the two other circuits to be explained is that the voltage of the signals in the detector is increased or stepped-up, as it is commonly called. This is a well known property of the transformer which is used extensively in radio and electrical work. One everyday application of the voltage step-up or

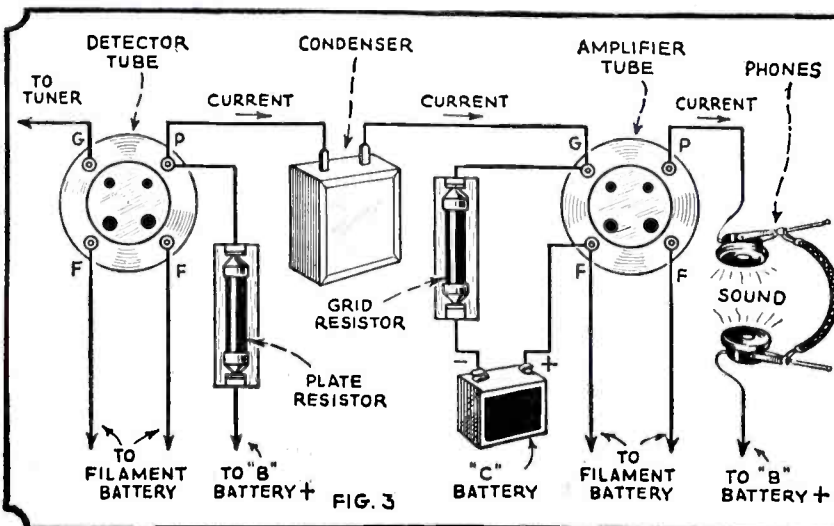

Wiring diagram of resistance-coupled audio amplifier stage and detector.

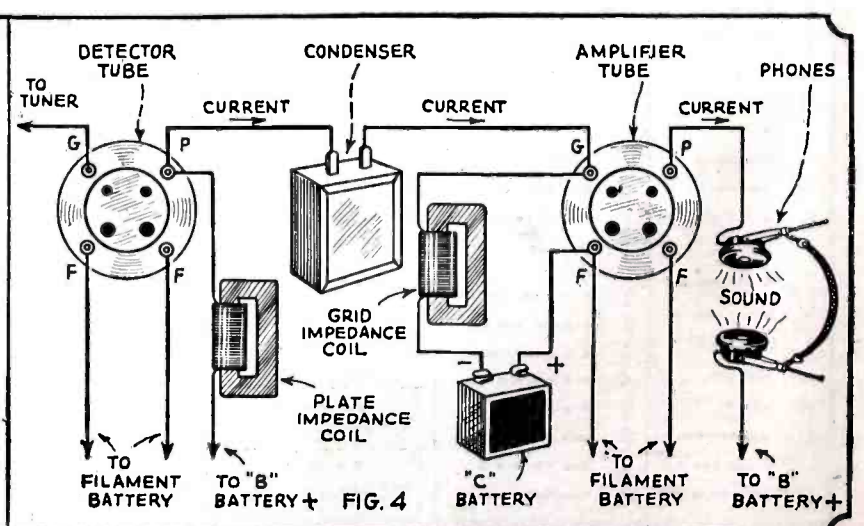

Above—Impedance-coupled detector and amplifier stages.

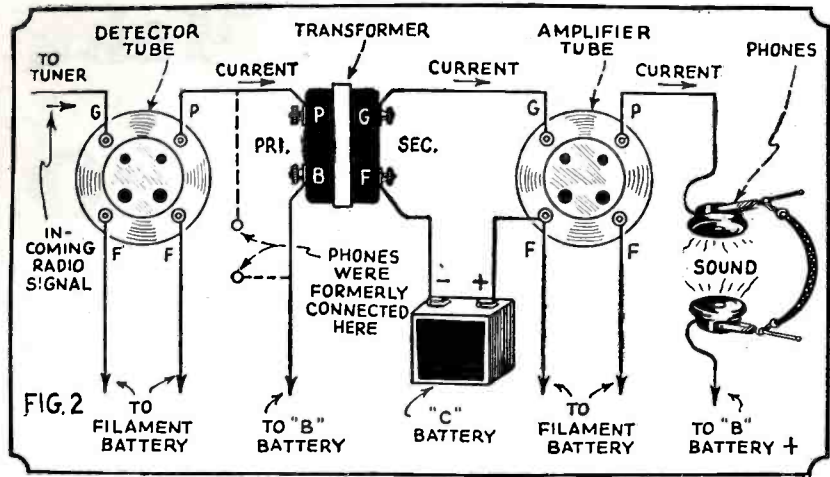

Picture diagram showing typical transformer-coupled A.F. amplifier.

BEGINNER

No. 5 of a Series

By C. W. PALMER

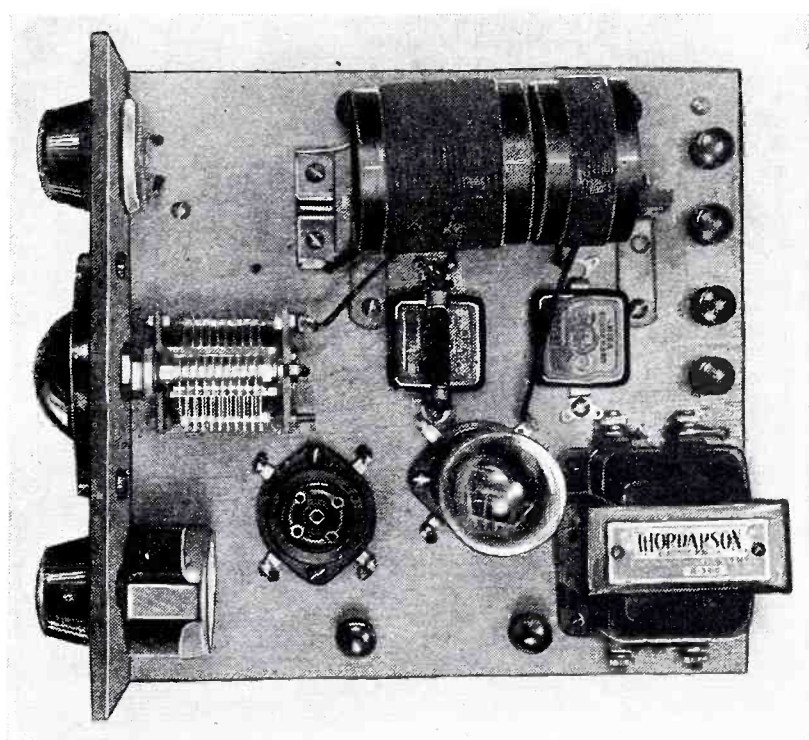

Appearance of the actual beginner's receiver with one stage of A.F. amplification.

step-down principle is in the electric light lines, where the current is carried at 550 volts or more and is stepped-down in transformers to the commonly used 110 volts.

In the amplifier that we will build for our *Beginner's Receiver*, transformer coupling will be employed. However, in order to understand how the other systems work, we will discuss them briefly.

Resistance Coupling

If the transformer in Fig 2 is replaced with a condenser and two resistances of the correct values, a suitable coupling will result that is known as the *resistance method*. We found some time ago that a condenser stores current and that it will pass an *alternating* current but not a *direct* current. This is the property that is utilized in the resistance coupled amplifier. The condenser is connected between the detector plate and the amplifier grid. The resistances prevent the signal from being short-circuited through the batteries. These resistances must be of such a value that the current from the "B" and "C" batteries can be impressed on the plate and grid respectively, but still be high enough

so that the signals are carried from the plate to the grid. Figure 3 shows the circuit for the resistance amplifier. The plate resistor is similar in appearance to the grid-leak that we used in the detector, but it has a value of about 100,000 ohms. The grid resistor is also of the grid-leak type and has a resistance of about 250,000 ohms.

Impedance Coupling

The *impedance-coupled amplifier* is similar to the resistance amplifier in that a condenser is used to couple the two tubes together. The difference lies in the fact that instead of using plate and grid resistors, coils with a large number of turns and iron cores are used. This is not the same as transformer coupling, as the two coils are not coupled inductively, but are entirely separate.

The operation of the impedance amplifier is also similar to the resistance amplifier, in that all the amplifying is done in the tubes. It has advantages over the former amplifier, though, in certain respects. The coils are made with a sufficient number of turns so that the audio frequency currents that make up the signals cannot pass. However, the

resistance of the coils to the passage of the battery current is much less than that for the resistance coupled method. This permits the use of fewer batteries, for the same amplification. There are other advantages in a well-designed impedance amplifier in the quality when very loud signals are required. However, as the reasons for these actions are rather complicated, we will not attempt to explain them. The resistance coupled amplifier has one good point in its favor, and that is that both the low and high notes that make up good music are amplified with the same intensity for medium volume. Unless the transformers or the impedance coils are very well designed, the quality will not be as good in the latter amplifier.

The circuit of an impedance amplifier is shown in Fig. 4. The similarity to the resistance amplifier is quite evident.

The "Beginner's" Amplifier

Now that we know in a general way how radio signals are amplified and the methods of accomplishing this amplification, we will consider the problem of adding an amplifier to our one-tube set.

(Continued on page 442)

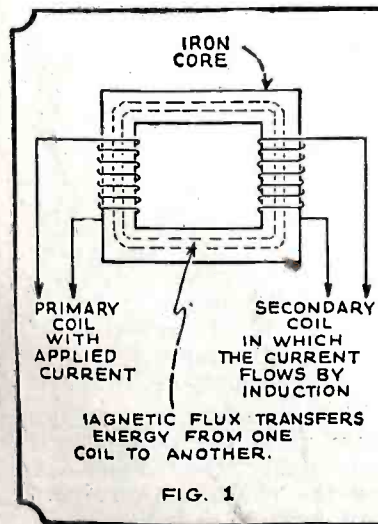

FIG. 1

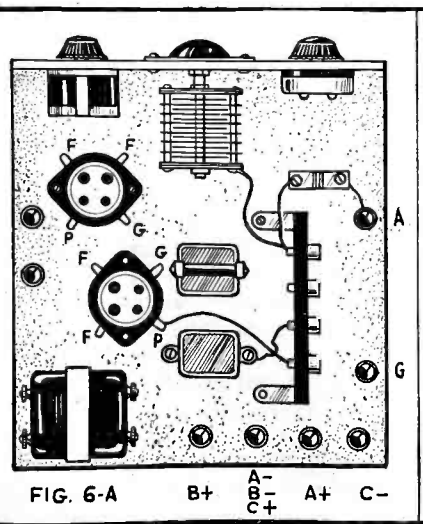

FIG. 6-A

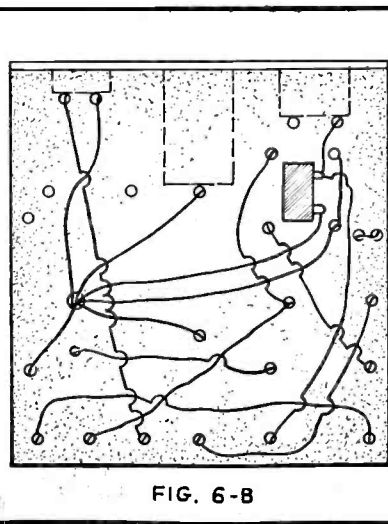

FIG. 6-B

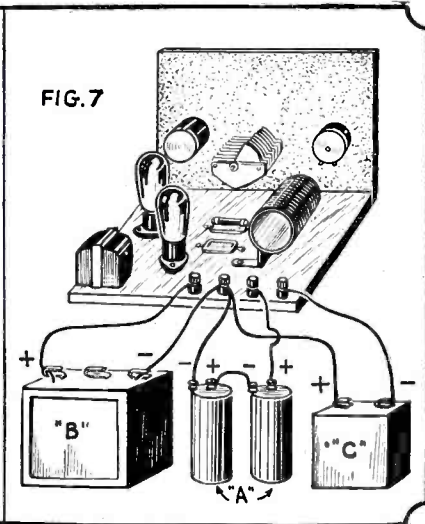
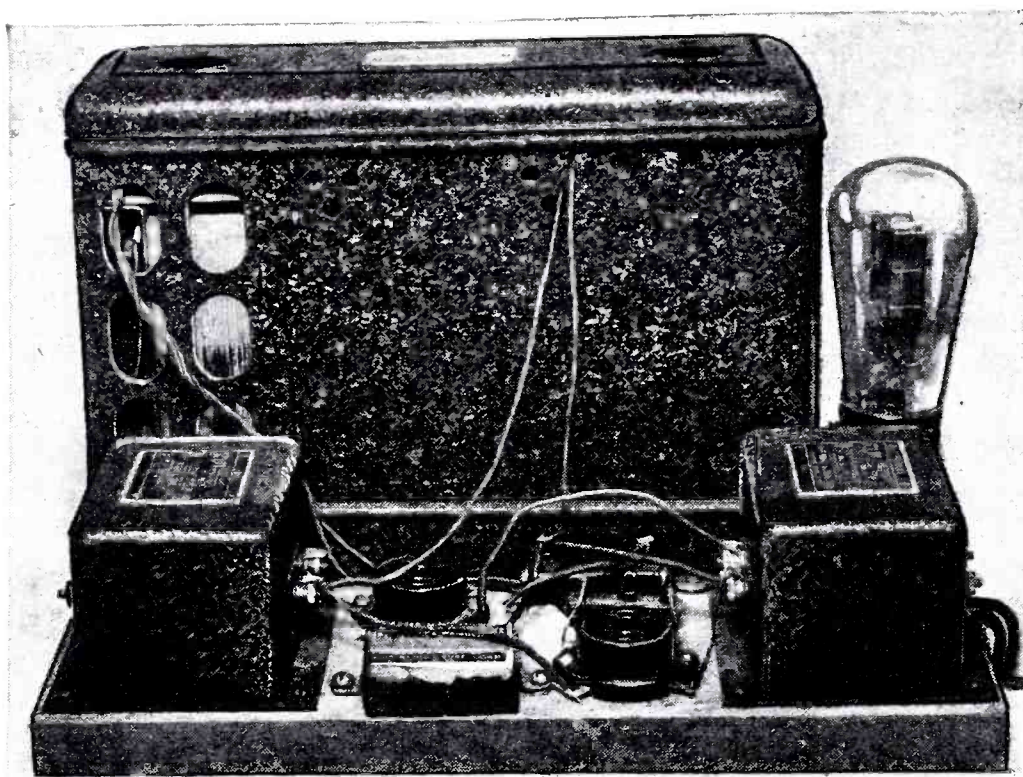

FIG. 7

Fig. 1 shows action in A.F. transformer; 6A shows layout of A.F. and detector stage apparatus on subpanel.

6B—Wiring on under surface of the one stage A.F. and detector receiving set; Fig. 7—Battery connections.



Appearance of finished impedance-coupled audio amplifier, employing '47 tubes and an '80 rectifier. You must have plenty of power in your A.F. amplifier in order to hear distant short-wave stations on the loud speaker.

How to Make AUDIO

By LOUIS MARTIN

After all—just what kind of audio amplifier shall we build for our short-wave receiver? Shall it be of the resistance, impedance, or transformer coupled type? Should we utilize the new 56 and '47 tubes? Is one A.F. power-stage better than two ordinary amplifier stages, and why? What is one objection to the screen grid tube in this type amplifier? These and many other "hot" questions are answered by Mr. Martin.

● RECENTLY the writer visited the home of a radio writer who was conducting a comparison between five well-known short wave receivers. Some of the sets were equipped with audio amplifiers and therefore gave good loud speaker response on foreign stations; however, there were two that had very sensitive R.F. amplifiers but were not equipped with sufficient audio gain to permit decent loud speaker reception.

In order to place the receivers on a more equitable basis, the amplifier pictured in Fig. 1 was built "on the spot." It consists of an input push-pull transformer feeding two '47's in push-pull—nothing more, nothing less; but it sure made reception interesting.

Since then, it has occurred to the writer that every S.W. station should have at least one audio amplifier on hand to operate or test any R.F. chassis on hand. In the discussion to follow, the advantages and disadvantages of several types of audio systems will be analyzed.

The Resistance-Coupled Amplifier

The simplest of amplifier systems is the straight resistance-coupled unit depicted in Fig. 2. As may be seen by reference to the figure, coupling between stages is effected by resistances and condensers, no transformers of any sort being used, with the exception, of course, of the output transformer.

While this class of amplifier cannot boast of high gain, nevertheless it has many desirable features upon which its popularity has been founded. In the first place, it is the most economical class of amplifier one can build; secondly, the quality of reproduction cannot be equalled by any other type of amplifier unless the very highest grade of parts obtainable are used; thirdly, the space occupied is very small and the unit can fit almost anywhere.

All values are given in the diagram of Fig. 2. The coupling resistors should be of the 1 (one) watt size, not so much because of the actual heat they generate, but because they may be heated by other parts of the set such as the rectifier, etc., and therefore be called upon to dissipate safely .75-watt although they are only generating .2-watt of heat. The .01-mf. coupling condensers should be tested for leakage with 300 volts D.C. before using them. The rating of a reliable manufacturer may sometimes be relied upon.

The gain of this amplifier should be sufficient to operate a loud speaker from the usual S.W. receiver output. If, however, the gain of the amplifier is to be varied, then the grid resistor of the '47 may be in the form of a potentiometer as shown in the diagram. All filter and bypass condensers are of the dry electrolytic type because of their low cost, small size, and high capacity.

If a magnetic speaker is used, then a 30-henry choke must

be used in the filter circuit; if a dynamic speaker is used, then the choke may be removed and the speaker field used in its stead. No attempt has been made to give a layout, as most men have the equipment in the "junk box" and will probably use it.

While this amplifier is designed to operate from a screen-grid detector, it may, by changing the size of the 100,000-ohm input resistor to 50,000 ohms, be used with the usual R.F. tuner having a '27 (or the more recent 56 which is the same as the '27, except for the filament current, in the detector stage.

The Impedance-Coupled Amplifier

The diagram of the impedance-coupled amplifier is exactly the same as the resistance-coupled unit of Fig. 2 with the exception that the coupling resistors are replaced by audio chokes; 200 henry chokes being substituted for R1 and R2, and, for real good reception, 500 henry units for R3 and R4. The primary of any good audio transformer has an inductance of about 200 henries, but the 500 henry "brutes" may be a little difficult (or costly) to obtain. However, if one is not worried so much about quality, primaries of old audio transformers (with the secondaries burnt out) may be used for R1, R2, R3 and R4.

The "fly in the ointment" may be that four primaries are not in the "box," so that to make the amplifier as practical as possible, the resistors R3 and R4 may be left as shown in Fig. 2, but the chokes substituted for R1 and R2. This diagram is shown in Fig. 3. The construction of the power unit is the same as that of Fig. 2, therefore repetition is not made.

This amplifier, properly called an impedance-resistance coupled amplifier, has most of the advantages of the amplifier of Fig. 2 but not some of its disadvantages. First, due to the use of relatively low-resistance chokes in the plate circuit, a higher voltage may be applied to the plate of the 56 than in the resistance-coupled amplifier; second, due to the use of chokes in the plate circuit, the actual gain per stage is greater than if resistors were used; third, the quality of response is about as good as a resistance-coupled amplifier, especially if low resistance, high impedance chokes are used. Another advantage of the amplifier of Fig. 3 over that of Fig. 2 is the fact that impedance-coupled amplifiers have less tendency to *motorboat* than resistance-coupled amplifiers.

One thing that may prove to be a disadvantage is the ability of the chokes to pick up hum from the power unit. This may be obviated by shielding either the choke, the power unit or both; or by rotating the choke with respect to the power unit; or, again, by separating both.

This amplifier is well worth while building for the man with high ideals and a small purse.

Worth-while AMPLIFIERS for Short Wave Receivers

The Transformer-Coupled Amplifier

The author was never an advocate of high-gain audio amplifiers for radio receivers. By this is meant that more than two stages should *never* be used, but the maximum gain per stage should, of course, always be realized. For high gain per stage and good (but not excellent) quality the transformer-coupled amplifier should always be used.

For the average short-wave receiver two stages of transformer-coupled tubes is too much because of the following reasons:

Most receivers of modern design use a detector that amplifies in itself (unlike those of five years ago) so that an additional stage should give excellent volume on most stations. For stations too weak to be heard on the speaker with only one stage of audio the headphones should be used, for an additional audio stage would only tend to make matters worse.

As the number of audio stages is increased, the noise level increases—and at a greater rate than the number of stages. Anyone who has ever constructed three or four stage audio amplifiers for radio work will bear this out.

Additional instability such as microphonic noise, oscillation and poor quality increase tremendously as the number of stages is increased above two.

Every piece of equipment that is added to an amplifier distorts the quality. The more apparatus added, the worse the quality becomes. This is one of the main reasons why present-day tubes have a high gain—so that the number of stages may be reduced to one, as will become evident by an inspection of any modern broadcast receiver.

For an amplifier suitable for use with a short wave receiver, any of the preceding types are excellent, and for those who prefer the transformer-coupled type, a single, push-pull stage is recommended as being the simplest and most efficient of its type for the purpose. Figure 4 is a schematic of such a circuit.

It is not unlike the standard units used for radio work, and may easily be built in a few hours. Shielded cabinets and neat wiring are not requisites for good reception; good apparatus and careful wiring are far more important. As before, the power unit of Fig. 2 is used, the only change being in the size of the grid-bias resistor—now 225 ohms instead of 450 ohms as shown. Also, the 25 mf. bypass condenser across this resistor may be omitted.

That the gain obtained from this single stage is sufficient for all ordinary purposes was borne out in tests conducted by the writer—for it is the schematic of the circuit used in the amplifier shown in Fig. 1.

The input circuit of the amplifier under discussion may only be used when the output tube of the receiver is of the '27 type. If the amplifier is to be used with a set whose output tube is of the high impedance or screen-grid type, then the input circuit must be revised slightly as shown in the insert of the figure.

Conclusion

It will be noticed that in all of the diagrams given, tubes of the '24 type were not used. The reason for this is not difficult to see. For one, the gain of the amplifier would be too great for the purpose for which it is intended; second, the input to such tubes must be small because (1) the grid bias is small and (2) a large signal would overload the second stage.

Since the use of a larger power tube than the '47 is certainly not justified, then a tube of the 56 type must be used when good all-around reception is desired.

The above, however, is a matter of opinion. For cases where a high-gain, two-stage amplifier is desirable, as, for instance, in conjunction with a single-tube tuner, the circuit of Fig. 5 is suggested. As before, the power unit is the same as that of Fig. 2, the only change being in the first stage.

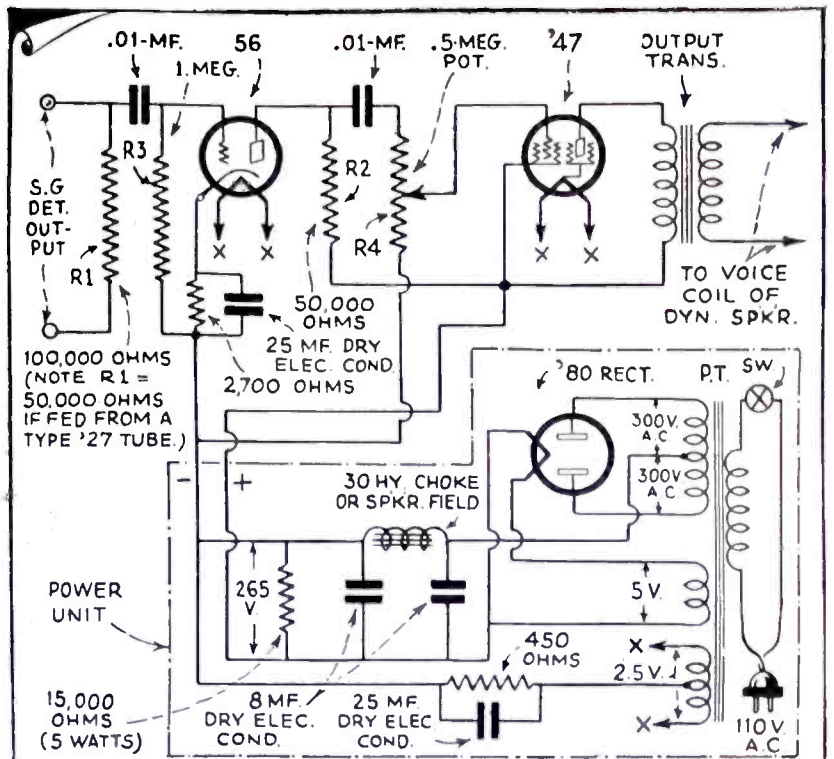

FIG. 2 RESISTANCE COUPLED AMPLIFIER

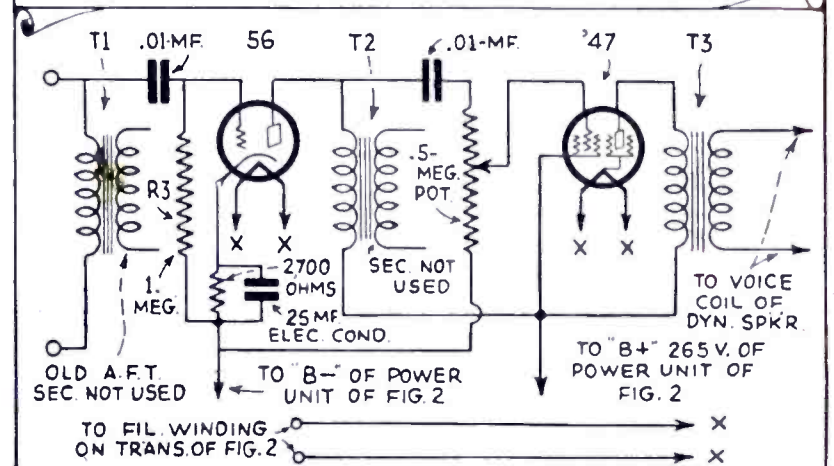

FIG. 3 IMPEDANCE COUPLED AMPLIFIER

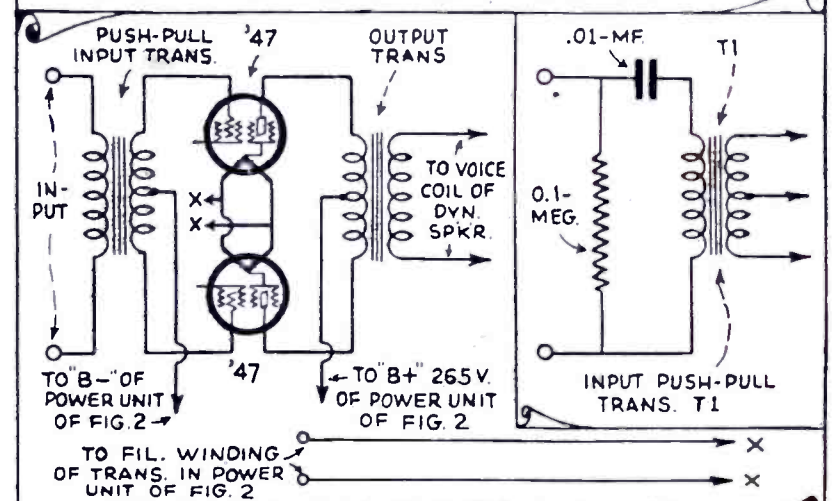

FIG. 4 PUSH-PULL PENTODE AMPLIFIER

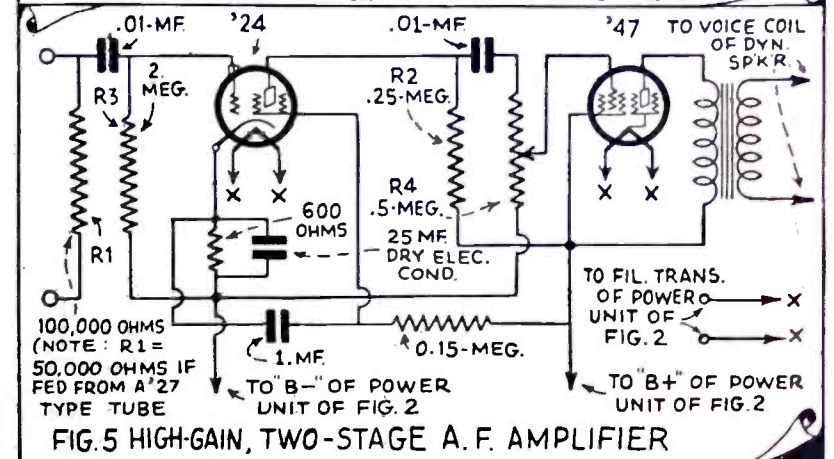

FIG. 5 HIGH-GAIN, TWO-STAGE A.F. AMPLIFIER

Eliminating Man-DOUBLET and Transposition

Short wave listeners are just beginning to realize that a lot of the noise and interference caused by electrical devices operating in the vicinity of their antenna lead-ins, may be eliminated by the use of carefully designed doublet antennas with transposition lead-ins.

● THERE is much general knowledge on the design and construction of good high frequency receivers. It is now possible to buy several makes of excellent short wave sets at reasonable prices, all A.C. operated and complete and ready to work—except for the necessity of attaching an antenna. For those experimenters who care to build their own sets many good circuits of practical receivers are fully described in every issue of every good radio magazine. It is easy to find complete constructional details on any type of short wave receiver one might care to construct—whether it ranges from the portable “junk box” variety to the most advanced superheterodyne.

Yet, with all of this knowledge of receiver design, together with the abundance of good receivers obtainable, the average short-wave enthusiast considers that a good receiving antenna for high frequencies is just “any old kind” of a single wire thrown up in a haphazard manner. It seems strange that there is so much general knowledge of good receivers and so little general knowledge of how to design high frequency receiving antennas. They go hand in hand, yet on the average it is safe to say that the majority of short wave listeners are using antenna systems of the same general design that have been used for the past several years. Why are we content to put up a single wire affair for use with the best receiver that we can buy—and then blame the receiver and the manufacturer for all of the static, background noises, and all other sources of interference coming from the loud-speaker?

stormy weather. Most of the crackling and frying sounds we hear are not true atmospherics generated by Nature, but are, instead, originated by many man-made sources of interference. Street car lines, transmission wires, electric refrigerators, washing machines, irons, flashing signs and at least several thousand other electrical devices are grinding away merrily every hour of the day and night, creating undesirable radio interference without the least regard for the patience of the short wave listener, the rules of the Federal Radio Commission, or a consideration of anybody else. Generally, the interference area of such interfering sources is limited to the immediate neighborhood in which they are located. Yet, for any given locality a few of these devices, creating their limited interference areas and picked up by the antenna and its lead-in attached to a short wave set, are the cause of most of the crackling and sizzling sounds we attribute so often to true static.

Country vs. City Reception

If you have listened to short waves in the country or any other location free from man-made electrical sources of interference, you will be amazed at the remarkably clear reception that is possible even during the summertime. Signals that you cannot even begin to hear in your city flat or apartment, will boom in on the loud speaker. Yet the same receiver in the city location will be unable to receive these signals because of the higher background noise level. If we will face the facts we shall find that we are blaming Mother Nature too much for our troubles and doing too little work ourselves to eliminate these undesirable noises. Until we take the necessary steps to minimize this objectionable interference, we are not getting the full benefits of really good short wave reception.

Enter—the “Doublet Antenna”

Radio engineers, for the past several years, have been using a type of antenna called the “doublet antenna” that is suited for high frequency reception. It is an antenna that reduces background noise levels to a minimum and yet does not weaken or diminish the signal from the station that is being received. Its design is simple and the doublet is extremely easy to construct. The doublet antenna can be built within the confines of the average city yard or apartment roof. It seems hard to believe that an antenna so admirably suited to short wave reception has to this day not been more universally adopted. The purpose

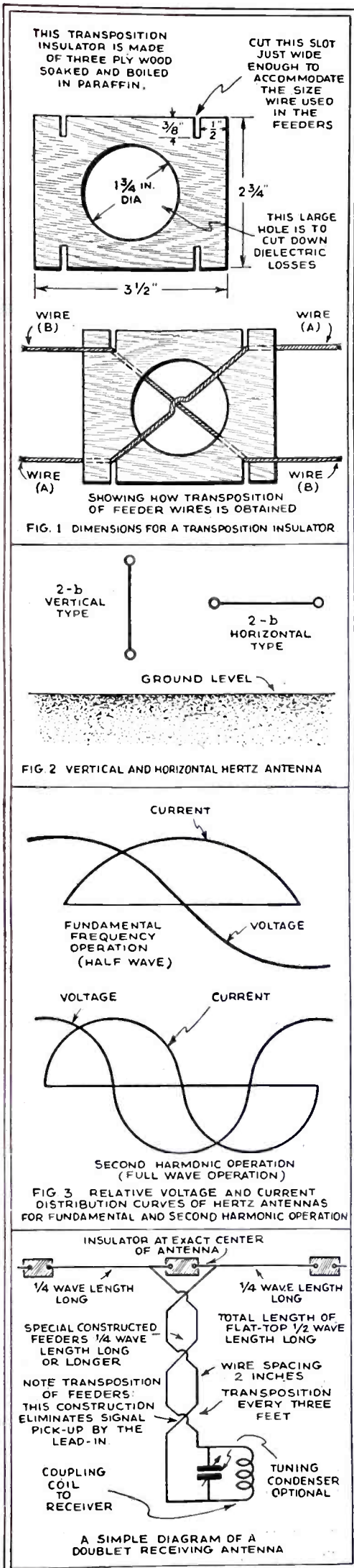

Illustrations above show the design of transposition insulators, together with diagrams showing action and also construction of complete doublet antennas.

Made Interference by ANTENNAS

Lead-in Systems

Mr. Everett L. Dillard, a well-known radio engineer, here explains the theory and construction of an ideal doublet antenna system for short-wave as well as broadcast reception, together with data on "transposition feeder" systems.

of this article is to promote a more general use and understanding of the doublet for receiving purposes among short wave fans. Due to its superiority in high frequency work it is entitled to become the standard antenna design for short wave reception.

The doublet antenna is the simplest form of high frequency antenna to build that will improve reception over that of the ordinary single wire aerial. The secret of its success in high frequency work is the fact that a great deal of our background noise is eliminated with no sacrifice in the strength of the original signal. With our background level reduced it is possible to hear stations that it was previously impossible to hear. The doublet is truly the antenna to be used in the city or industrial districts, being simple to erect and doing its work effectively.

Mr. "Lead-in," the Villain

Most of us know that for best results we must place our antenna as high in the air as practical and as free from all obstructions as possible. This is to give us the best pick-up of radio signals. Yet, it is not the part of the antenna high in the air that receives most of our man-made static—instead, it is the *lead-in* portion running close to the house or garage, building or wiring that adds this type of interference to our signals, which is picked up by the antenna high in the air. Motors and most of the other sources of man-made interference do not radiate their interfering waves over any considerable distance, but the lead-in, running close to these sources of trouble, cannot help but pick up these interfering sounds because of its proximity to them, even though they are radiated over limited areas. It is safe to say, that, if the antenna itself were placed a considerable distance away from these sources of interference, our reception would remain unspoiled by them; i.e., if the interference picked up by the lead-in could by some means be eliminated from reception.

This is exactly what the doublet antenna does. Using the doublet it is possible to place the antenna high in the air where it, itself, will only pick up the desired signals. Then by means of a special type of lead-in construction there is absolutely no signal pick-up by the lead-in part of the antenna system—the lead-in merely furnishing a path for the radio signal received in the antenna proper to reach the receiving set. It plays no part other than this and does not act as a part of the antenna

proper in the sense of picking up any signals.

New Antenna Eliminates Interference

Thus, by placing our antenna away from man-made interference, even though our specially constructed lead-in must pass close to these sources of interference to reach the receiving set, we will pick up only the signal energizing the antenna. What an ideal aerial for crowded apartment hotels and factory districts where it is possible to get an antenna high enough for good reception, yet where the signal pick-up of the lead-in, by itself, of man-made static is too great to allow comfortable reception! With the doublet it is possible to use a short wave receiver in the next room to the family refrigerator, electric fan or curling iron without excessive interference from them. The only possible means whereby this interference might get into the receiver, other than from the antenna lead-in, would be through the power supply lines, and generally this can be effectively eliminated by adequate filtering.

Transposed Feeders the Secret

The doublet antenna, which we will explain in this article, is known as the "current-fed" doublet antenna. In reality it is nothing more than a half-wave, current-fed Hertz antenna, using *transposed feeders*. The transposed feeders are the secret of our successful elimination of those undesired signals that would ordinarily be picked up by the usual type of lead-in. Transposed feeders are feeders that are transposed at equal distances. Thus, each succeeding reversal along the entire feeder length of the feeder position of the wires cancels out any voltage induced in the preceding feeder section. Our fields in each section are 180 degrees out of phase with each other, a condition which results in cancellation of any induced signal voltages in any one feeder section. By a feeder section we mean the length of the feeder between any two consecutive transposing insulators. To assure fields exactly 180 degrees out of phase, all feeder sections must be of equal length. This is important.

Feeders transposed every three feet with the wires separated two inches will work nicely where the feeders are more or less in the open and not too close to the sources of interference. When it becomes necessary to run the feeder within a few feet of potential sources of interference pick-up, it becomes necessary to transpose more often and to

(Continued on page 426)

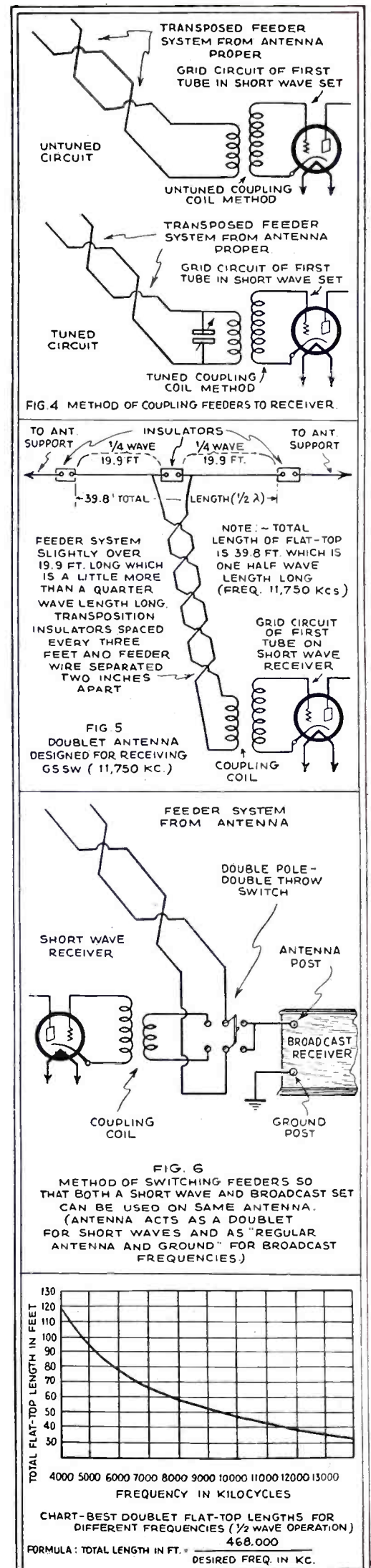

Fig. 4, above, shows how feeders are coupled to receiving set; doublet design for 11.750 kc. signal and connection of doublet for S.W., B.C. reception.

A "Free-Wheeling" Receiver For Beginners

By R. W. VOSBURGH

• THE writer has spent much effort in evolving a short-wave receiver which would compare with a broadcast receiver for power and ease of control. The following is the result, being a receiver which has fulfilled his every hope. With proper care, it is believed that condenser ganging could be accomplished, so flexible is the assembly. However, in order to insure constructional simplicity it was decided that this feature could be dispensed with. Briefly, the merits of the receiver are as follows:

- Transformer audio-frequency amplification (good volume).
- Absence of "fringe howl."
- Exceptional radio-frequency amplification (no station too weak to come in, if above noise level).
- Improved selectivity.
- Perfect regeneration control. (No detuning even on shortest waves; no "popping," gradual approach.)
- Real detection (comparable to 200-A detection in sensitivity).

Many "beginner" articles present circuits which, while simple to construct, are lacking in power on waves around 15 to 45 meters. Naturally this disappoints one who is led to expect volume and sensitivity equal to that of a long-wave receiver. Those having had this experience are urged to try this circuit and to retract any thoughts of short waves as being "alotta baloney." True, amplification is not as great on these

The author claims for this receiver plenty of volume on the low waves, from 15 to 45 meters; also "smooth" regeneration control. Dead-end losses in the tapped coils are minimized by using the idle coil turns as "chokes"—thus aiding the decoupling resistors. The proper type of "B" eliminator is suggested by the author.

waves, but signals have plenty of "pep" for most purposes; even at 15 meters.

Smooth Regeneration Feature

To the analyst it will be obvious that this is a new combination of old principles. First, there is a resistance-coupled screen-grid stage, which, in addition to adding stability and preventing radiation, amplifies with a high μ , due to a high plate reactance. From the T.R.F. stage signals are detected, R.F. from the detector being passed to be reamplified by the T.R.F. stage. Regeneration is under complete control at all times, since by decreasing the resistor, the detector plate is gradually shielded from the grid. Dead-end losses are reduced by utilizing

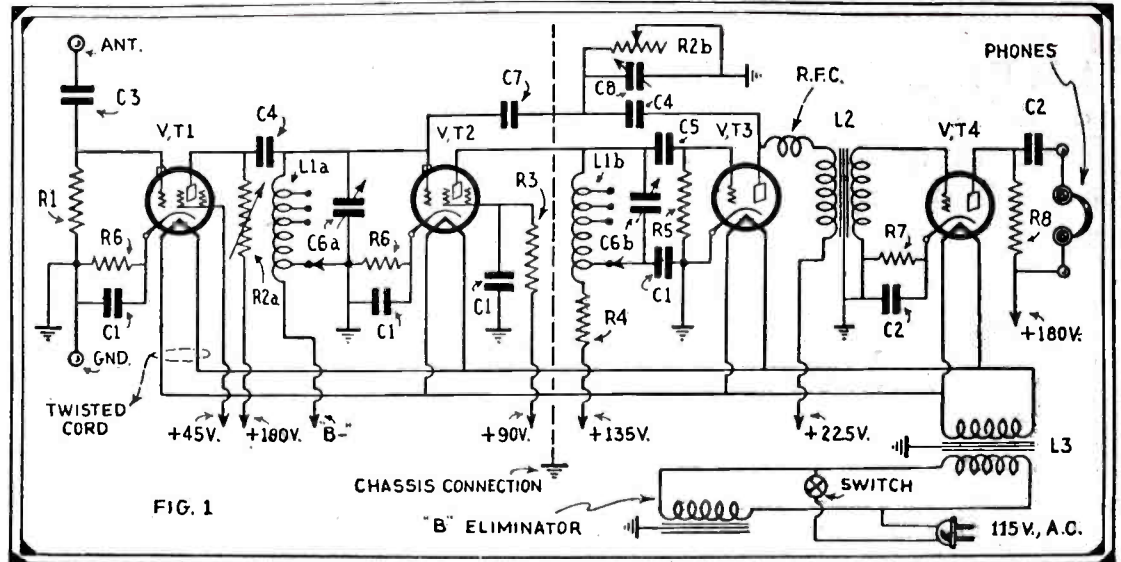

A very interesting short-wave receiver which the beginner will find easy to construct. To try it out, any type of tubes at hand may be employed. Tapped coils are used to cover the wave bands from 15 to 200 meters; a smooth regeneration control is one of the special features of this receiver.

the discarded ends of the coils as choke coils, thus aiding the decoupling resistors. It is interesting to note that when regeneration occurs in the R.F. stage, "fringe howl" becomes zero in the audio stage. However, this trouble manifests itself in the coupling between the two R.F. stages through the high resistance, R2a, which responds to A.F. unless a sufficiently small-size resistor is used. This resistor is also critical in allowing good regeneration at the shortest waves. Perhaps the most important feature is the good "old-fashioned" detector designed for utmost sensitivity to weak signals. Why use a rectifier of powerful signals which are not usually sought and which scarcely passes weak signals at all?

Constructional Details

Now to the details: In general, the layout of the hook-up can be followed out, placing the parts in the order shown. Coils, condensers, and tubes must be an inch or more from each other, roughly. The parallel leads from the grid and plate of VT3 should be very short. All grid and plate leads should be as short as possible under the conditions. Be sure to insulate C6b from shielding; also the switch lever of L1b. The B-minus connect as shown; do not ground it except through the coil. Both terminals marked +180 connect together and connect to a good "B" eliminator. The eliminator used must be hum-free and preferably operate with a Raytheon tube. All shielding is grounded; tubes do not require individual shields, and complete shielding is not absolutely necessary, but should be used for better selectivity on locals. Contrary to ordinary practice, complete freedom from stray currents is secured solely by separating VT2 and VT3 stages by use of a shield and by shielding the panel. Ordinary switch points and levers may be used for band switching and may be mounted behind the metal panel. A

semi-shielded bakelite panel could be used to advantage, thus simplifying construction.

Coil Data

Coil Spacing	(End)	Wire	Range (Meters)	Length of
				Winding
}	5 turns	#10 dec	15-31.48	7/8"
	9 turns	#18 dec	31.3-54	5/8"
	21 turns	#24 dec	53-127	5/8"
	43 turns	#32 dec	126-250	1 1/8"
	(End)			

All four coils are wound on a single form 1 1/2 inches in diameter and 4 1/2 inches long. Note that the sum of the number of turns covers the band specified; thus 5 turns plus 9 turns equals 14 turns, which is the total inductance used for 31.3 to 54 meters.

Regeneration should be fairly constant over all wavelengths down to approximately 15 meters. If none is secured below this, do not be alarmed, since all receivers such as this behave in the same manner. Condenser C8 gives vernier adjustment for regeneration.

How to Adjust the Set

To adjust the set, tune to about 32 meters. This is done by tuning the first condenser, which leads the tuning, keeping the detector condenser "in step" with it. Be sure oscillation or "hissing" is present when doing this, by adjusting R2b. The set is tuned to resonance when R2b is adjusted so that, when either dial is turned either way, no "hissing" occurs. The tuning becomes really very simple after a little practice. It is advisable to practice on the 31.3 to 54 meter band before attempting to receive lower waves.

Suggested parts are as follows:

(Continued on page 428)

SUPER-RATIO VERNIER DIAL

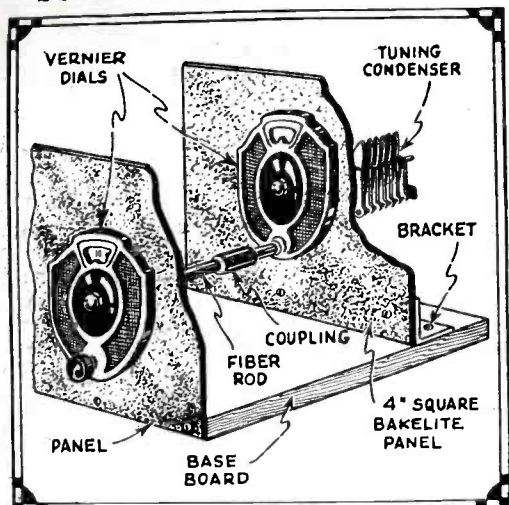

A super-vernier dial is easily made in the manner shown.

\$5.00 PRIZE

● FOR short-wave operators who are having trouble separating stations on their present vernier dials, and for those who find the 20 and 40 meter bands too sharp for their receiver, I present the following kink:

Take an ordinary vernier dial and remove the control or operating knob. Mount your tuning condenser on a second metal panel about 3 inches to the rear of your regular cabinet panel. Next mount one vernier dial with the knob removed on the condenser shaft and run a fiber, bakelite or other insulating rod through the front panel of the cabinet and join this with a flexible coupling, such as the Hammarlund, to the condenser shaft. Place your second master-control vernier dial on the front panel of your cabinet and your super-vernier is complete.—Harold R. Smith.

A CODE PRACTICE SET

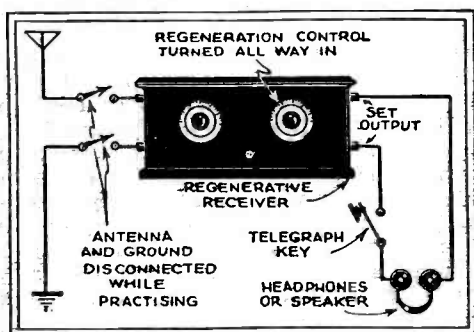

Simple code practice set—simply connect a key in series with the phones as shown.

● AN excellent code practice set can be made by using any receiver of the regenerative type (the majority of short-wave receivers are of this type). The wiring of the receiver need not be changed in any way. The accompanying sketch shows how this is accomplished. A telegraph key is connected in series with the headphones and the output posts of the receiver. The receiver is made to oscillate violently by turning the regeneration control all the way in. If no squeal is heard in the headphones when the key is depressed, then the receiver is not oscillating in the "spill over" condition. In this case connect a fixed condenser of small capacity (.00025-mf should be sufficient) between the side of the tickler coil that connects to the audio amplifier and the A-minus, or increase the detector plate voltage 22½ or 45 volts. The tone

**\$5
FOR BEST
SHORT
WAVE
KINK**

The Editor will award a five dollar prize each month for the best short-wave kink submitted by our readers. All other kinks accepted and published will be paid for at regular space rates. Look over these "kinks" and they will give you some idea of what the editors are looking for. Send a typewritten or ink description, with sketch, of your favorite short-wave kink to the "Kink" Editor, SHORT WAVE CRAFT.

of the signals can be regulated to sound exactly like that of a code station by changing the position of the regeneration control. The antenna and ground should be disconnected while practising, as a regenerative receiver in an oscillating state acts as a transmitter. This would cause interference to neighboring receivers if the antenna and ground were not disconnected. A loud speaker can be used instead of headphones for reproducing the code if desired.—Alvin Gregory.

SUBSTITUTE FOR METAL PANEL

● ANYONE who has tried operating a short-wave set having a bakelite or composition panel has had the "fun" of tuning by a wave of the hand. An aluminum panel makes tuning more comfortable but costs money, so get a piece of heavy tin or copper foil and shellac it to the rear side of your panel so as to cover all the surface. Remove small sections of the tin foil around binding posts, condenser mountings, etc., so as to insulate them. Connect the tin foil to ground and you have a shielded panel at little expense.—Erwin C. Thompson.

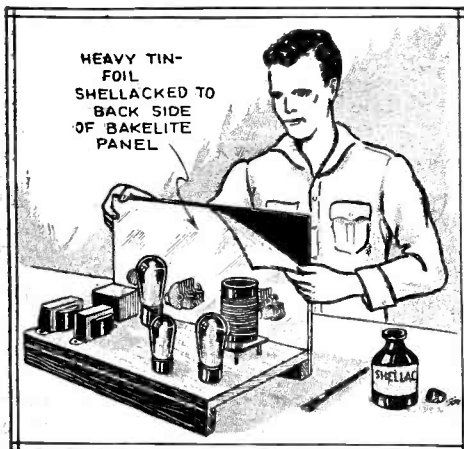

A substitute for metal panels is made by shellacking metal foil on the rear of a bakelite panel.

HOWL SILENCER

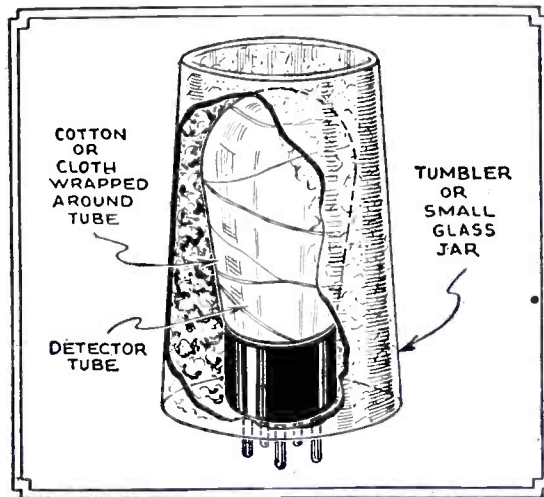

Simple "howl eliminator" made from a tumbler and cotton placed over the offending tube.

● MICROPHONIC tubes are a great nuisance. The howl is caused by the vibration of the tube elements. When the elements are started vibrating, the jar is reproduced by the loud speaker. The air waves from the speaker react upon the microphonic tube and a continuous howl is the result. The detector tube is usually one that is responsible for the microphonic howl. If the tube is insulated from jars and sound waves from the speaker, there will not be any howl. A simple method to prevent the howl is to wrap the detector tube in cotton or loose cloth and invert a tumbler or small glass jar over the wrapped tube.—Alvin Gregory.

S-W REGENERATION HINT

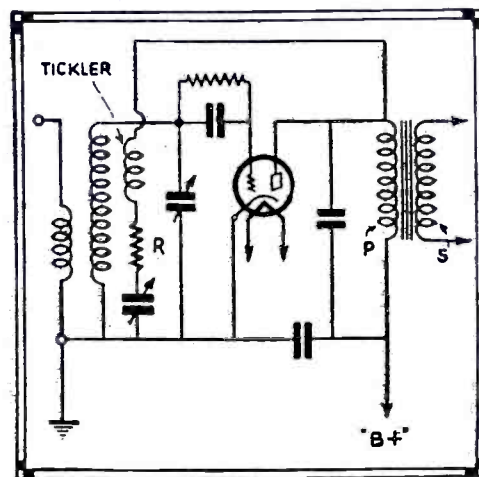

Spurious oscillations in regenerative receivers are eliminated by the resistance in series with the plate coil.

● WHERE the regeneration is controlled by capacitance variation, the feedback coil and the regeneration control condenser have such characteristics as to permit the growth of oscillations at their resonant frequency, rather than at the frequency of the normal tuned circuit. This is evidenced by the fact that although the tube distinctly "plops" into oscillation, there is no rise in the signal intensity as the regeneration point is reached, nor is there any heterodyne action while the tube is oscillating. In existing circuits this condition may be cured by the use of resistance of 100 ohms or so in series with the plate coil. This is indicated at R in the diagram. When constructing new receivers wind the feedback coil with No. 38 to No. 44 B. & S. gauge resistance wire.—C. H. W. Nason.

SHORT WAVE STATIONS OF THE WORLD

ALL SCHEDULES EASTERN STANDARD TIME: ADD 5 HOURS FOR GREENWICH MEAN TIME

Wavelength (Meters)	Frequency (Kilocycles)	Call Letters	Address and Schedule	Wavelength (Meters)	Frequency (Kilocycles)	Call Letters	Address and Schedule	Wavelength (Meters)	Frequency (Kilocycles)	Call Letters	Address and Schedule
13.93	21,540	W8XK	Westinghouse Electric, East Pittsburgh, Pa. 7:30 a.m.-noon.	31.49	9,520	OXY	Skamleboek, Denmark. 2-7 p.m. daily.	48.99	6,120	W2XE	Columbia Broadcasting System, 485 Madison Avenue, New York, N. Y. 7:00 a.m. to midnight.
16.87	17,780	W3XAL	National Broadcasting Co., Bound Brook, N. J.	31.55	9,510	VK3ME	Amalgamated Wireless, Ltd., 47 York St., Melbourne, Australia. Wed. and Sat., 5-6:30 a.m.			FL	Eiffel Tower, Paris. 5:30-5:45 a.m., 5:45-12:30, 4:15-4:45 p. m.
19.56	15,330	W9XF W2XAD	Downers Grove, Ill. General Electric Co., Schenectady, N. Y. Broadcasts 3-6 p.m. daily; 1-6 p.m. Sat. and Sunday.	31.70	9,460	Radio Club of Buenos Aires, Argentina.			Toulouse, France. Sunday, 2:30-4 p. m.
19.65	15,270	W2XE	Wayne, N. J.	32.00	9,375	EH90C	Berne, Switzerland. 3-5:30 p.m.	49.10	6,110	VE9CG	Calgary, Alta., Canada.
19.68	15,240		Pontoise (Paris), France. 9:30-12:30 a.m. Service de la Radiodiffusion, 103 Rue de Grenelle, Paris.	32.26	9,290	Rabat, Morocco. 3-5 p.m. Sunday, and irregularly weekdays.	49.15	6,100	W3XAL	National Broadcasting Company, Bound Brook, N.J., Irregular.
19.72	15,210	W8XK	Westinghouse Electric & Mfg. Co., East Pittsburgh, Pa. 7:30 a.m. to 5 p.m.	35.00	8,570	RV15	Far East Radio Station, Khabarovsk, Siberia. 5-7:30 a.m.	49.17	6,095	VE9CF	Halifax, N. S., Canada. 6-10 p.m. Tu., Thu., Fri.
		DJB	For address, see listing for D.J.A. Mondays, 10-11 p.m.	38.6	7,790	HBP	League of Nations, Geneva, Switzerland. 3-8 p.m., irregular.	49.18	6,100	VE9GW	Bowmanville, Ontario, Canada. 4-10 p.m.
19.83	15,120	HVJ	Vatican City (Rome, Italy) Daily, 5:00 to 5:15 a.m.	39.80	7,530	"El Prado," Riobamba, Ecuador. Thurs., 9-11 p.m.	49.31	6,080	W9XF W9XAA	Chicago Federation of Labor, Chicago, Ill. 6-7 a. m., 7-8 p.m., 9:30-10:15, 11-12 p.m. Int. S.W. Club programs. From 10 p.m. Saturday to 6 a.m. Sunday.
19.99	15,000	JIAA CM6XJ	Tokio, Japan. Irregular. Central Tuinucu, Cuba. Irregular.	40.00	7,500	"Radio-Touraine," France. Lyons, France. Daily except Sun., 10:30 to 1:30 a.m.			VE9CS	Vancouver, B. C., Canada. Fridays before 1:30 a.m. Sundays, 2 and 10:30 p.m.
20.50	14,620	XDA	Trens-News Agency, Mexico City. 2:30-3 p.m.	40.20	7,460	YR	Eberswalde, Germany. Mon., Thurs., 1-2 p.m. Tests after midnight. I.S.W.C. programs 11 p.m. Wed. A.P. 31.	49.40	6,070	Johannesburg, South Africa. 10:30 a.m.-3:30 p.m.
20.95	14,310	G2NM	Gerald Marcuse, Sonningon-Thames, England. Sundays, 1:30 p.m.	40.50	7,410	Johannesburg, So. Africa. 9:30 a.m.-2:30 p.m.	49.46	6,065	SAJ	Motala, Sweden. 6:30-7 a. m., 11 a.m. to 4:30 p.m.
21.50	13,940	University of Bucharest, Bucharest, Roumania. 2-5 p.m. Wed., Sat.	40.70	7,370	X26A	Doberitz, Germany. Zurich, Switzerland. 1st and 3rd Sundays at 7 a.m., 2 p.m.	49.50	6,060	W8XAL	Crosley Radio Corp., Cincinnati, O. Relays 6:30-10 a.m., 1-3 p.m., 6 p.m. to 2 a.m. daily. Sunday after 1 p.m.
23.35	12,850	W2XO	General Electric Co., Schenectady, N. Y. Antipodal program 9 p.m. Mon. to 3 a.m. Tues. Noon to 5 p.m. on Tues, Thurs. and Sat.	40.90	7,320	ZTJ	Budapest, Hungary 2:30-3:10 a.m., Tu., Thurs., Sat. Budapest Technical School, M.R.C., Budapest. Muegyetem.	49.50	6,060	VQ7LO	Imperial and International Communications, Ltd., Nairobi, Kenya, Africa. Monday, Wednesday, Friday, 11 a.m.-2:30 p.m.; Tuesday, Thursday, 11:30 a.m.-2:30 p.m.; Saturday, 11:30 a.m.-3:30 p.m.; Sunday, 11 a.m.-1:30 p.m.; Tuesday, 3 a.m.-4 a.m.; Thursday, 8 a.m.-9 a.m.
		W2XCU W9XL	Ampere, N. J. Anoka, Minn., and other experimental relay broadcasters.	41.46	7,230	DOA	Singapore, S. S. Mon., Wed. and Fri., 9:30-11 a.m.			W3XAU VE9CF	Halifax, N. S., Canada. 11 a.m.-noon, 5-6 p.m. On Wed., 8-9; Sun., 6:30-8:15 p.m.
23.38	12,820	Director General, Telegraph and Telephone Stations, Rabat, Morocco. Sun., 7:30-9 a.m. Daily 5-7 a.m. Telephony.	41.50	7,220	HB9D	Wed. and Fri., 9:30-11 a.m.	49.59	6,050	HKD PK3AN W4XB	Barranquilla, Columbia. Sourabaya, Java. 6-9 a.m. Lawrence E. Dutton, care Isle of Dreams Broadcasting Corp., Miami Beach, Fla.
25.63	11,920	FYA	Pontoise, France. 1-3 p.m. daily.	42.00	7,140	HKX	Bogota, Colombia.			VE9CA VE9DR	Calgary, Alta., Canada. Canadian Marconi Co., Drummondville, Quebec. 6-10 p.m. daily.
25.24	11,880	W9XF	National Broadcasting Co., Downers Grove (Chicago), Ill. 9-10 p.m. daily.	42.70	7,020	EAR125	Madrid, Spain. 6-7 p.m.			YV2BC	Caracas, Venezuela. 7:45-11 p.m. daily ex. Mon. Testing, 6:30 to 6:45 a.m.; 1:15 to 1:30, 5:15 to 5:45 p.m., around this wave.
25.26	11,870	VUC	Calcutta, India. 9:45-10:45 p.m.; 8-9 a.m.	42.90	6,990	CTIAA	Lisbon, Portugal. Fridays, 5-7 p.m.	49.97	6,000	Eiffel Tower, Paris, France. 6:30 to 6:45 a.m.; 1:15 to 1:30, 5:15 to 5:45 p.m., around this wave.
25.34	11,840	W8XK	Westinghouse Electric, East Pittsburgh, Pa. 4-10 p.m.	43.00	6,980	EAR110	Madrid, Spain. Tues. and Sat., 5:30 to 7 p. m.; Fri., 7 to 8 p.m.			VE9CU	Calgary, Canada. Administration des P. T. T., Tananarive, Madagascar. Tues., Wed., Thurs., Fri., 9:30-11:30 a.m. Sat. and Sun., 1-3 p.m.
25.34	11,840	W9XAO	Chicago Federation of Labor, Chicago, Ill. 7-8 a.m., 1-2, 4-5:30, 6-7:30 p.m.					50.26	5,970	HVJ	Vatican City (Rome). 2-2:15 p.m., daily. Sun., 5-5:30 a.m.
25.36	11,830	W2XE	Wayne, N. J.					50.80	5,900	HKO	Medellin, Colombia. 8-11 p.m., except Sunday.
25.42	11,800	VE9GW	W. A. Shane, Chief Engineer, Bowmanville, Canada. Daily, 1-4 p.m.					51.40	5,835	HKD	Barranquilla, Columbia. 7:45-10:30 p.m. Mon., Wed. 8-10:30 p.m.; Sunday 7:45-8:30 p.m. Elias J. Pellet.
25.45	11,790	WIXAL	Boston, Mass.	43.60	6,875	F8MC	Casablanca, Morocco. Sun., Tues., Wed., Sat. 8-10 p.m.	52.50	5,710	VE9CL	Winnipeg, Canada.
25.47	11,780	VE9DR	Drummondville, Quebec, Canada. Irregular.	46.40	6,480	TGW	Guatemala City, Guat. 8-10 p.m.	54.02	5,550	W8XJ	Columbus, Ohio.
25.50	11,760	XDA	Trens-News Agency, Mexico City. 3-4 p.m.	46.70	6,425	W9XL W3XL	Anoka, Minn. National Broadcasting Co. Bound Brook, N. J. Belays WJZ, irregular.	58.00	5,170	OK1MPT	Prague, Czechoslovakia. 1-3:30 p.m., Tues. and Fri.
25.53	11,750	G5SW	British Broadcasting Corporation, Chelmsford, England. Mon. to Sat., 1:45-7:15 p.m.	46.72	6,420	RV62	Minsk, U.S.S.R. Irregular.			PMY	Bandaeng, Java.
		VE9JR	Winnipeg, Canada. Weekdays, 5:30-7:30 p.m.	47.00	6,380	HCIDR	Quito, Ecuador. 8-11 p.m.	60.30	4,975	W2XV	Sourabaya, Java. Radio Engineering Laboratories, Inc., Long Island City, N. Y. Irregular.
29.30	10,250	T14	Amondo Cespedes Marin, Heredia, Costa Rica. Mon. and Wed., 7:30 to 8:30 p.m.; Thurs. and Sat., 9:00 to 10 p.m.	47.35	6,335	VE9AF CN8MC	Drummondville, Canada. Casablanca, Morocco. Mon. 3-4 p.m., Tues. 7-8 a.m., 3-4 p.m. Relays Rabat.	62.56	4,795	W9XAM W3XZ W9XL DOA	Elgin, Ill. (Time signals.) Washington, D. C. Chicago, Ill. Doberitz, Germany. 6-7 p.m., 2-3 p.m., Mon., Wed., Fri.
30.3	9,890	EAQ	Transradio Espanola, Alcalá, 43-Madrid, P.O. Box 951, Spain. 11:30 p.m.-1 a.m.; 6-8 p.m., daily; 1-3 p.m. Saturday.	47.81	6,270	HKC	Bogota, Colombia. 8:30-11:30 p.m.	67.65	4,430		Vienna, Austria. Sun., first 15 minutes of hour from 1 to 7 p.m.
31.10	9,640	HSP2	Broadcasting Service, Post and Telegraph Department, Bangkok, Siam. 9-11 a.m. daily.	48.00	6,250	HKA	Barranquilla, Colombia. 8-10 p.m. ex. Mo., Wed., Fri.	70.00	4,280	OHK2	Tegucigalpa, Honduras. Monday, Wednesday, Friday, Saturday 5-6 p.m. and 9-12 p.m.
31.28	9,590	VK2ME	Amalgamated Wireless, Ltd., 47 York St., Sydney, Australia. Sun., 1-3 a.m. 5-9 a.m., 9:30-11:30 a.m.	48.62	6,170	HRB	Tequigalpa, Honduras. Monday, Wednesday, Friday, Saturday 5-6 p.m. and 9-12 p.m.	70.20	4,273	RV15	Westinghouse Electric and Mfg. Co., East Pittsburgh, Pa. 5 p.m.-midnight
31.30	9,580	W3XAU	Byberry, Pa., relays WCAU daily.	48.86	6,140	W8XK	Westinghouse Electric and Mfg. Co., East Pittsburgh, Pa. 5 p.m.-midnight	7.05	42,530	Motala, Sweden, "Rundradio," 6:30-7 a.m., 11-4:30 p.m. Holidays, 5 a.m. to 5 p.m.
31.33	9,570	WIXAZ	Westinghouse Electric & Mfg. Co., Springfield, Mass. 6 a.m.-10 p.m. daily.	48.99	6,120					Berlin, Germany. Tues. and Thurs., 11:30-1:30 p.m. Telefunken Co.
		SRI	Poznan, Poland. Tues. 1:45-4:45 p.m., Thurs. 1:30-8 p.m.								
31.38	9,560	DJA	Reichspostzentramt, 11-15 Schoenherge Strasse (Berlin), Konigswusterhausen, Germany. Daily, 8 a.m.-7:30 p.m.								
31.48	9,530	W2XAF	General Electric Co., Schenectady, N. Y., 5-11 p.m. daily.								

(NOTE: This list is compiled from many sources, all of which are not in agreement, and which show greater or less discrepancies; in view of the fact that most schedules and many wavelengths are still in an experimental stage; and that wavelengths are calculated differently in many schedules. In addition to this, one experimental station may operate on any of several wavelengths which are assigned to a group of stations in common. We shall be glad to receive later and more accurate information from broadcasters and other transmitting organizations, and from listeners who have authentic information as to calls, exact wavelengths and schedules. We cannot undertake to answer readers who inquire as to the identity of unknown stations heard, as that is a matter of guesswork; in addition to this, the harmonics of many local long-wave stations can be heard in a short-wave receiver.—EDITOR.)

(Continued on opposite page)

SHORT WAVE STATIONS OF THE WORLD

(Continued from opposite page)

Short Wave Broadcasting Stations

80.00	3,750	F8KR	Constantine, Tunis, Africa. Mon. and Fri.	82.90	3,620	DOA	Doerberitz, Germany.	128.09	2,342	W7XAW	Fisher's Blend, Inc., Fourth Ave. and University St., Seattle, Washington.
		I3RO	Prato Smeraldo, Rome, Italy. Daily, 3-5 p.m.	84.24	3,560	OZ7RL	Copenhagen, Denmark, Tues. and Fri. after 6 p.m.				

Experimental and Commercial Radio-Telephone Stations

Wavelength (Meters)	Frequency (Kilocycles)	Call Letters	Address and Schedule	Wavelength (Meters)	Frequency (Kilocycles)	Call Letters	Address and Schedule	Wavelength (Meters)	Frequency (Kilocycles)	Call Letters	Address and Schedule
9.68	31,000	W8XI	Pittsburgh, Pa.	17.34	17,300	W8XL	Dayton, Ohio.	29.54	10,150	DIS	Nauen, Germany. Press (code) daily: 6 p.m., Spanish; 7 p.m., English; 7:50 p.m., German; 2:30 p.m., English; 5 p.m., German. Sundays: 6 p.m., Spanish; 7:50 p.m., German; 9:30 p.m., Spanish.
10.79	27,800	W6XD	Palo Alto, Calif. M. R. T. Co.			W6XAJ	Oakland, Calif.				
11.55	25,960	G5SW	Chelmsford, England. Experimental.			W9XL	Anoka, Minn., and other experimental stations.				
11.67	25,700	W2XBC	New Brunswick, N. J.	17.52	17,110	W00	Deal, N. J. Transatlantic phone.				
12.48	24,000	W6XQ	San Mateo, Calif.			W2XD0	Ocean Gate, N. J. A. T. & T. Co.				
			Vienna, Austria. Mon., Wed., Sat.	17.55	17,080	GBC	Rugby, England.				
14.00	21,420	W2XDJ	Deal, N. J. And other experimental stations.	18.40	16,300	PCL	Kootwijk, Holland. Works with Bandoeng from 7 a.m.	30.15	9,950	GBU	Rugby, England.
								30.30	9,890	LSN	Buenos Aires. phone to Europe.
14.01	21,400	WLO	American Telephone & Telegraph Co., Lawrence, N. J., transatlantic phone.	18.50	16,200	WLO	Lawrence, N. J.	30.64	9,790	LSA	Buenos Aires.
				18.56	16,150	FZR	Saigon, Indo-China.	30.75	9,750	GBW	Rugby, England.
14.15	21,130	LSM	Monte Grande, Argentina.	18.68	16,060	GBX	Rugby, England.				
14.27	21,020	LSN	(Hurlingham), Buenos Aires, Argentina.			NAA	U. S. Navy, Arlington, Va. Time signals, 11:57 to noon.				
14.28	21,000	OKI	Podebrady, Czechoslovakia.	18.80	15,950	PLG	Bandoeng, Java. Afternoons.	30.90	9,700	WNC	Deal, N. J.
14.47	20,710	LSY	Monte Grande, Argentina. Telephony.	18.90	15,860	FTK	St. Assise, France. Telephony.	30.93	9,600	WMI	Deal, N. J.
								31.23	9,600	LQA	Buenos Aires.
14.50	20,680	LSN	Monte Grande, Argentina, after 10:30 p.m. Telephony with Europe.	18.93	15,760	JIAA	Tokio, Japan. Up to 10 a.m. Beam transmitter.	32.13	9,330	CGA	Bergen, Norway.
		LSX	Buenos Aires. Telephony with U. S.	19.60	15,300	OXY	Lynby, Denmark. Experimental.	32.21	9,310	GBC	Drummondville, Canada.
		FSR	Paris-Saigon phone.	20.65	14,530	LSA	Buenos Aires, Argentina.	32.40	9,250	GBK	Rugby, England. Sundays 2:30-5 p.m.
		PMB	Bandoeng, Java. After 4 a.m.	20.70	14,480	GGBW	Radio Section, General Post Office, London, E. C. 1.	32.50	9,230	FL	Bodmin, England.
14.89	20,140	DWG	Nauen, Germany. Tests 10 a.m.-3 p.m.			WNC	Deal, N. J.	32.59	9,200	GBS	Paris, France (Eiffel Tower). Time signals 4:56 a.m. and 4:56 p.m.
		LSG	Monte Grande, Argentina. From 7 a.m. to 1 p.m. Telephony to Paris and Nauen (Berlin).	20.80	14,420	VPD	Suva, Fiji Islands.				
15.03	19,950	DIH	Nauen, Germany.	21.17	14,150	KKZ	Bolinas, Calif.	33.26	9,010	GBS	Rugby, England.
		LSG	Monte Grande, Argentina. 8-10 a.m.	22.38	13,400	WND	Deal Bench, N. J. Transatlantic telephony.	33.81	8,872	NPO	Cavite (Manila), Philippine Islands. Time signals 9:55-10 p.m.
15.07	19,906	WMI	Deal, N. J.								
		FTD	St. Assise, France.	23.46	12,780	GBC	Rugby, England.	33.98	8,810	WSBN	S.S. "Leviathan."
		FRO, FRE	St. Assise, France.	24.41	12,290	GBU	Rugby, England.	34.50	8,690	W2XAC	Schenectady, New York.
		FTM	St. Assise, France. 10 a.m. to noon.	24.46	12,250	FTN	Ste. Assise (Paris), France. Works Buenos Aires, Indo-China and Java. On 9 a.m. to 1 p.m. and other hours.	34.68	8,650	W2XCU	Ampere, N. J.
15.58	19,240	DFA	Nauen, Germany.			GBS	Rugby, England.	34.68	8,650	W3XE	Baltimore, Md. 12:15-1:15 p.m., 10:15-11:15 p.m.
15.60	19,220	WNC	Deal, N. J.	24.68	12,150	PLM	Bandoeng, Java. 7:45 a.m.				
15.94	18,820	PLE	Bandoeng, Java. 8:40-10:40 a.m. Phone service to Holland.			GBS	Rugby, England. Transatlantic phone to deal, N. J. (New York).				
		GBJ	Bodmin, England. Telephony with Montreal.	24.80	12,090	FQO, FQE	Ste. Assise, France.	34.74	8,630	W00	Deal, N. J.
16.10	18,620	GBU	Rugby, England.	24.89	12,045	NAA	Tokio, Japan. 5-8 a.m. Arlington, Va. Time signals, 11:57 to noon.				
16.33	18,370	PMC	Bandoeng, Java.					35.02	8,550	W00	Ocean Gate, N. J.
16.35	18,350	WND	Deal Beach, N. J. Transatlantic telephony.	24.98	12,000	FZG	Annapolis, Md. Time signals, 9:57-10 p.m.	35.50	8,450	PRAG	Ocean Gate, N. J.
16.38	18,310	GBS	Rugby, England. Telephony with New York. General Postoffice, London.	25.10	11,945	KKQ	Saigon, Indo-China. Time signals, 2-2:05 p.m.	36.92	8,120	PLW	Porto Alegre, Brazil. 8:30-9:00 a.m.
		FZS	Saigon, Indo-China, 1 to 3 p.m. Sundays.	25.65	11,680	YVQ	Bolinas, Calif.	37.02	8,100	EATH	Bandoeng, Java.
16.44	18,240	FRO, FRE	Ste. Assise, France.	25.68	11,670	K10	Maracay, Venezuela. (Also broadcasts occasionally.)				
16.50	18,170	CGA	Drummondville, Quebec, Canada. Telephony to England.	26.00	11,530	CGA	Kahuhu, Hawaii.				
		GBK	Bodmin, England.	26.10	11,490	GBK	Drummondville, Canada.				
		KQJ	Bolinas, Calif.	26.15	11,470	IBDK	Bedmin, England.				
		PLF	Bandoeng, Java ("Radio Malabar").	26.22	11,435	DHC	S.S. "Elettra," Marconi's yacht.				
		W2XAO	New Brunswick, N. J.	26.44	11,340	DAN	Nauen, Germany.				
		PCV	Kootwijk, Holland. 9:40 a.m. Sat.				Nordeich, Germany. Time signals, 7 a.m., 7 p.m. Deutsche Seewarte, Hamburg.				
16.87	17,780	W8XK	Westinghouse Electric and Mfg. Co., Saxenburg, Pa.	27.30	10,980	ZLW	Wellington, N. Z. Tests 3-8 a.m.				
				28.20	10,630	PLR	Bandoeng, Java. Works with Holland and France weekdays from 7 a.m.; sometimes after 9:30.				
17.00	17,640		Ship, Phones to Shore: W8XB, "Leviathan"; GFVW, "Majestic"; GLSQ, "Olympic"; GDLJ, "Homeric"; GMJQ, "Belgenland"; work on this and higher channels.	28.44	10,540	WLO	Lawrence, N. J.				
		JIAA	Tokio, Japan.	28.80	10,410	VLK	Sydney, Australia. 1-7 a.m.				
						PDK	Kootwijk, Holland.				
						KEZ	Bolinas, Calif.				
						LSY	Buenos Aires, Argentina.				
						GBX	Rugby, England.				

(Continued on next page)

"STAR" SHORT WAVE BROADCASTING STATIONS

The following stations are reported regularly by many listeners, and are known to be on the air during the hours stated. Conditions permitting, you should be able to hear them on your own short-wave receiver. All times E.S.T.

G5SW, Chelmsford, England. 25.53 meters. Monday to Saturday, 1:45 p.m. to 7:15 p.m. Broadcasts the midnight chimes of Big Ben in London at 7 p.m.

HVJ, Vatican City. Daily 5 to 5:15 a.m. on 19.83 meters; 2 to 2:15 p.m. on 50.26 meters; Sunday 5 to 5:30 a.m. on 50.26 meters.

VK2ME, Sydney, Australia. 31.28 meters. Sunday morning from 1 to 3 a.m.; 5 to 9 a.m.; and 9:30 to 11:30 a.m.

VK3ME, Melbourne, Australia. 31.55 meters. Wednesday and Saturday, 5 to 6:30 a.m.

Pointoise, France. On 19.68 meters, 9:30 a.m. to 12:30 p.m.; on 25.16 meters, from 1 to 3 p.m.; and on 25.63 meters from 4 to 6 p.m.

Konigs-Wusterhausen, Germany. On 31.38 meters daily from 8 a.m. to 7:30 p.m.

HKD, Barranquilla, Colombia. On 51.4 meters, Monday, Wednesday and Friday, 8 to 10:30 p.m.; Sunday, 7:45 to 8:30 p.m.

VE9GW, Bowmanville, Ontario, Canada. 25.42 meters, from 1 to 10 p.m.

HRB, Tegucigalpa, Honduras. 48.62 meters. Monday, Wednesday, Friday and Saturday, 5 to 6 and 9 to 12 p.m.

T14, Heredia, Costa Rica, Central America. 29.3 meters. Monday and Wednesday, 7:30 to 8:30 p.m.; Thursday and Saturday, 9 to 10 p.m.

EAQ, Madrid, Spain. 30.3 meters. 11:30 p.m. to 1 a.m.; 6 to 8 p.m. daily; 1 to 3 p.m. Saturday.

RV15, Khavarovsk, Siberia. 70.2 meters. Daily from 4 to 9 a.m.

SHORT WAVE QUESTION BOX

Edited by R. WILLIAM TANNER

A.F. STAGE FOR 1-TUBE SET

Ted Gray, Detroit, Mich., inquires:

Q. Can you publish a circuit of a 27 A.F. stage to use with the one-tube circuit shown in the "Question Box" of the June-July, 1931, issue?

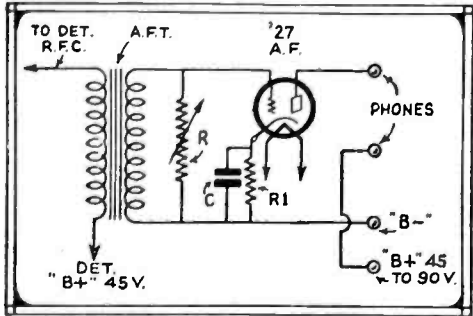

One-stage A.F. amplifier using a '27 tube.

A. The circuit is given in these columns. The A.F. transformer may be of any ratio from 2 to 1 up to 6 to 1. R is a variable 250,000 ohm resistor and is adjusted to eliminate fringe howl. R1 is 2,000 ohms shunted by a 1 mf. condenser C.

Q. What is the comparison in regard to gain between the 51 and the new 58 pentode?

A. On the broadcast band, with the 35 or 51 tubes it is possible to obtain a gain per stage of 50; at the very short waves not over 4 to 6. With the 58, on the B.C. band, a gain of 200 is possible and at very short waves, around 10 to 20.

AUTOMATIC VOLUME CONTROL

J. Hitchmann, Baton Rouge, La., wants to know:

Q. How to add automatic volume control to a Pilot Super-Wasp?

A. This cannot be done since the R.F. gain for automatic volume control must be quite high. The Super-Wasp has low R.F. gain.

SUPER-REGENERATOR "MUSHY"

Max Kirschner, Philadelphia, Pa., writes:

Q. I have built a one-tube super-regenerative set. Signals are strong but always accompanied with a loud "mushing" noise. Is there any cure for this?

A. A variable grid leak and variable grid condenser will be helpful in reducing this noise to a minimum. An increase in the variation frequency will also help.

S-W SUPER-HET.

Geo. Chartier, Albany, Ind., would like to have:

Q. A block drawing of a circuit using the smallest possible number of tubes for a short wave superhet.

A. This is shown in these columns. Number 1 is a two-section band-pass filter to prevent image interference. 2 is 58 first detector and combined 2nd harmonic oscillator. 3 and 4 are 58 I.F. stages, the I.F. transformers being of the band-pass type. 5 is a good stable crystal detector. 6 is a 57 audio stage. 7 is a pentode power stage, feeding into a dynamic speaker 8. The tube 9 is the rectifier. This makes a total of 9 tubes and can result in very good sensitivity and selectivity with a minimum of noise.

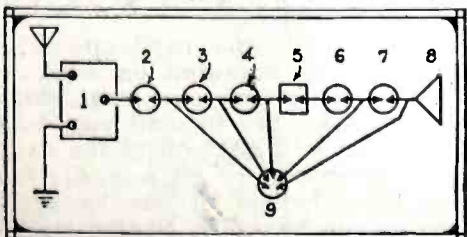

Desirable line-up of tubes in a short-wave super-het.

I.F. TRANSFORMER INDUCTANCE

Jerome Harter, Battle Creek, Mich., asks:

Q. What value inductance is necessary for I.F. superhet transformers when used with Hammarlund .0007 to .00014 mf. peaking condensers for 450 kc. and 175 kc.?

A. For 450 kc. the inductance would be approximately 1.2 mh. and 8 mh. for 175 kc.

Q. Would it be possible to employ 175 kc. regular broadcast I.F. transformers in short-wave superhet without the harmonic squeals and image interference?

A. 175 kc. transformers could be used, providing you use two or more tuned circuits ahead of first detector.

Q. Would a regenerative first detector be of any great advantage?

A. Both sensitivity and selectivity would be considerably increased but it would be far preferable to employ a separate regeneration tube in place of a regenerative first detector.

SUPER-HET TRANSFORMERS

Jerry Bowman, Louisville, Ky., writes as follows:

Q. I wound a set of superhet transformers of the band filter type. These together with trimmer condensers are mounted in copper shields. The diameter of the forms is 1 1/2 inches and both sections are placed end for end. My trouble is oscillation unless I adjust the sections far apart and then the selectivity is too great for television reception. Could this be due to defective tubes?

A. Your trouble can probably be eliminated by installing small discs slightly larger than the coils between the sections. The discs should be made of copper screen and grounded. The installation of a disc in each stage will allow closer coupling without oscillation. This device is termed an electro-static shield and prevents capacity coupling.

Q. What is the simplest type of home-made tube shield?

A. Merely a sheet of lead foil wrapped around the tube from the prongs up to the screen grid cap. This should, of course, be grounded.

GRID-LEAK CONNECTION

A. G. Grener, Baltimore, Md., inquires:

Q. Which is the correct way to connect a grid leak, across the grid condenser or from grid to filament?

A. Either way will give equal sensitivity and stability. Some circuits, however, require connection from grid to filament, because of the presence of high voltage on one side of the grid condenser.

Q. Does it make any difference to which side of the filament the grid return is made?

A. With any D.C. tube having a direct heater filament, the grid return should be connected to the POSITIVE side of the filament. The only exception is a soft detector tube such as a 200A, which generally works best with a negative grid return.

DIRECTIONAL ANTENNA

H. C. Crosby, Butte, Mont., asks:

Q. Would grounding the far end of a 125-foot single wire antenna through a 10,000-ohm resistor, as was done in the old Beverage antenna, cause it to be directional?

A. It is doubtful if the directional effect would be sufficient with such a short length. If you could increase the length to 400 or 500 feet and place it not more than 8 feet above ground, with the far end in the direction of desired station, the directional effect would be worth while.

USING 55 TUBE IN SUPER-HET.

C. D. Brecklin, Portland, Ore., writes:

Q. I want to use one of the new RCA-55 tubes in a superhet I am building. This will be the 2nd detector. I prefer a push-pull hook-up.

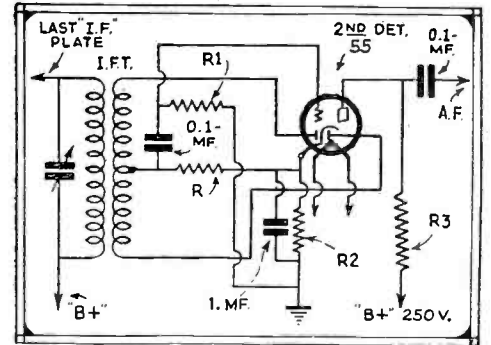

Circuit for using a type 55 tube as a second detector in a super-het.

A. The circuit is given in these columns. The secondary of the last I.F. transformer must be center-tapped. The resistor R has a value of 500,000; R1 may be 250,000 ohms and R3 100,000 ohms. The bias resistor R2 is 2,500 ohms. No by-pass condenser across the output of the full wave diode (resistor R3) is required, but one may be used if desired; 250 mmf. will do. It should be remembered that the triode elements in conjunction with R, R1 and the coupling condenser substitute an audio stage of amplification. The bias resistor R2 supplies a negative voltage to the grid of the triode and not to the diode.

NEON TUBE AND OSCILLATOR

Ed. Lambert, Columbus, Ohio, asks:

Q. For a circuit showing how to use a neon lamp with an R.F. oscillator for television reception.

A. The circuit appears in these columns. The power audio stage in the receiver should employ two 45 tubes connected in parallel. The oscillator tube should be a 71A. This oscillator is modulated by the constant current system. The "B" supply is fed to both audio (modulator) and oscillator plates through 30 and 4 henry iron core chokes. The oscillator coil L should be tuned in conjunction with the condenser C of .0005 mf. capacity, to the frequency you have determined upon. The coil L1 will depend upon the resistance of the neon lamp. It may be necessary to vary the grid leak from the value given in order to hold the plate current to 15 to 20 ma.

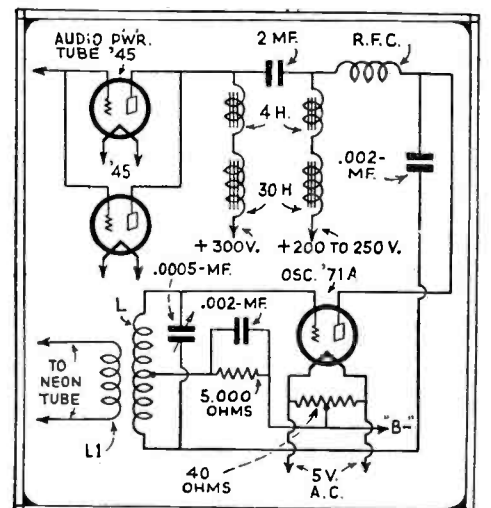

How to connect an oscillator to a neon tube for television reception.

Amateur Transmitting Antenna Data

TABLE OF PRINCIPAL TYPES OF ANTENNAS FOR AMATEUR TRANSMISSION
STUDIED FOR WAVE LENGTH $\lambda = 42$ METERS ($F = 7140$ KILOCYCLES.)

TYPE	HOOK - UP	GEOMETRICAL DIMENSIONS		ELECTRICAL CHARACTERISTICS	FUNCTIONING ON 21 METERS	FUNCTIONING ON 84 METERS.	
		METERS	CM.				
ZEPPELIN		20	10	SWELL OF INTENSITY IN L WEAK SELF-INDUCTANCE OF COUPLING. LOOSE COUPLING		PSEUDO-ZEPPELIN NO MODIFICATIONS, BUT TIGHTER COUPLING.	
		40	10			1-CORRECT; m= INCORRECT; CARRY IT TO 20 METERS OR ARRANGE BY CONDENSER.	
		20	30			PSEUDO-ZEPPELIN, NO MODIFICATIONS BUT TIGHTER COUPLING.	
		40	30			1-CORRECT; m= INCORRECT; CARRY IT TO 20 METERS OR ARRANGE BY CONDENSER.	
		20	20	SWELL OF TENSION IN L CIRCUIT L C ARRANGED FOR 42 METERS. LOOSE COUPLING	NO MODIFICATIONS, SAME FUNCTIONING, EXCEPT L C ARRANGED FOR 21 METERS.	NIL.	
		40	20			PSEUDO-ZEPPELIN SUPPRESSION OF C. COUPLING BY SIMPLE SELF-INDUCTANCE, RELATIVELY TIGHT.	
LEVY		30	VARIABLE GENERALLY 10-30 CM. (d = DIAM. OF WIRE IN CM.)	SWELL OF INTENSITY IN L WEAK SELF-INDUCTANCE OF COUPLING. LOOSE COUPLING		REDUCE m TO 10 METERS COUPLING IN INTENSITY	
		50				LENGTHEN m BY 10 METERS. COUPLING IN TENSION, OR ARRANGE BY CONDENSER.	
FUCHS		20	X	SWELL OF TENSION IN L CIRCUIT L C ARRANGED FOR 42 METERS. LOOSE COUPLING	SAME FUNCTIONING CIRCUIT L C ARRANGED FOR 21 METERS.	NIL	
		40				SAME FUNCTIONING, CIRCUIT L C ARRANGED FOR 80 METERS.	
A.O.G.		20	X	C NEAR b EXCITATION IN TENSION. C WEAK	SAME FUNCTIONING. SAME REGULATIONS.	COUPLING IN INTENSITY. C NEAR a. C STRONG.	
		40				COUPLING IN TENSION. C NEAR b. C WEAK.	
		10				INTERMEDIATE POSITION OF c. INTERMEDIATE VALUES OF C.	
		30				INTERMEDIATE VALUES	
MARCONI ANTENNA NOT ADVISABLE EXCEPT FOR BANDS ABOVE 80 METERS		10	X	SWELL OF INTENSITY IN L WEAK SELF-INDUCTANCE OF COUPLING. LOOSE COUPLING		LENGTHEN l 10 METERS. COUPLING IN INTENSITY.	
		30				LENGTHEN l 10 METERS. SWELL OF TENSION IN L TENSION COUPLING.	
		20	X	SWELL OF TENSION IN L CIRCUIT L C ARRANGED FOR 42 METERS.	SWELL OF TENSION IN L. CIRCUIT L C ARRANGED FOR 20 METERS.	COUPLING IN INTENSITY. SUPPRESS C.	
		40				COUPLING IN TENSION. L C ARRANGED FOR 80 METERS	
PROGRESSIVE WAVE ANT WITH 2 FEEDERS		20	10	e = 98 d d = DIA OF WIRE FOR FEEDER	NO STATIONARY WAVES ON THE FEEDERS. COUPLING BY MEANS OF S. ANY LENGTH	NIL	NIL
PROGRESSIVE WAVE ANT. WITH 1 FEEDER		20	5.65	X	NO STATIONARY WAVES ON THE FEEDER ANYLENGTH. COUPLING BY MEANS OF TERMINALS ON SELF-INDUCTANCE PLATE.	SAME FUNCTIONING ACCORDING TO U.S.A. HANDBOOK. FUNCTIONING INCORRECT ACCORDING TO FUCHS.	NIL

NOTE - THIS TABLE GIVES THE PRINCIPAL CHARACTERISTICS OF THE ORDINARY ANTENNAS ESPECIALLY INTENDED FOR USE ON THE WAVE LENGTH 42 METERS, AS WELL AS THEIR ADAPTION TO WAVE LENGTHS EITHER HALF OR TWICE AS GREAT. TO DETERMINE ACCORDING TO THIS TABLE AN ANTENNA FOR FUNCTIONING ESPECIALLY ON A WAVE LENGTH λ' (LAMBDA PRIME), MULTIPLY ALL THE DIMENSIONS BY THE RATIO $\frac{\lambda'}{\lambda}$, EXCEPT THE DIMENSION e (NOT COUNTING THE TWO FEEDERS FOR THE LEVY AND ZEPPELIN ANTENNAS AND OF THE PROGRESSIVE WAVE ANTENNA WITH TWO FEEDERS.)

Short Wave Craft Will Build YOUR Ideal Set!

● IF you are a real short-wave fan, doubtless you have often dreamed of your IDEAL short-wave receiver. Perhaps it would have one or two stages of radio-frequency amplification placed ahead of a regenerative detector, followed by two or more stages of audio-frequency amplification, in order to reproduce the signals on a loud speaker.

Then again, your "dream" short-wave receiver might have only two tubes, or possibly three tubes. Possibly you have a strong penchant for "battery-operated" sets, and then again perhaps you think the best short-wave receiver is an A.C. operated superheterodyne or a super-regenerative set.

At any event, the editors are going to give you a real treat and are offering all readers of SHORT WAVE CRAFT *carte blanche* and you are to do the ordering. Imagine yourself seated at a banquet table and all you have to do is to tell the waiter what you want. Herewith we present a voting ballot. After we have had a chance to receive a sufficient number of these ballots to provide a good cross-section of the opinion of SHORT WAVE CRAFT readers as to what they

think is the ideal short-wave receiver, we will commission Mr. Clifford E. Denton, the well-known radio set designer and constructor, to build the "composite" receiver, which will embody all the worthwhile features voted on. For example, if 5,000 ballots are returned within the next thirty days and 3,000 readers vote for a four-tube receiver, battery operated, with one stage of R.F., regenerative detector and two impedance coupled A.F. stages—that's what we will build!

You will note from the various features to be voted on in the ballot that you have a fine chance to see your Ideal receiver, which will be published in as early an issue as possible, probably the January or February number, and so you might as well treat yourself to a "real feast." Do not overlook the convenience of A.C. operation, automatic volume control (AVC), latest high mu tubes, multiple R.F. stages (TRF) ahead of the detector, improved regeneration control by meter, use of duo-diode detector, band-pass tuning, and most important among other salient features, be sure to give us any special data on requirements you have found desirable,

such as a specially arranged power audio amplifier, size of tubes you think should be used, the number of stages, etc. The audio amplifier, we realize, requires special attention, especially where weak signals are concerned.

Readers who live in remote places in various parts of the country, and who have heard stations from overseas and other distant points, should tell us what they find lacking in their present audio amplifiers. Tell us what you think you would need to give good loud-speaker strength on an all-around *de luxe* type short-wave receiver. We will endeavor to incorporate your ideas, plus Mr. Denton's valuable technical experience gained in designing dozens of short and long wave receivers.

Put your "thinking cap" on and do some real hard planning on what you would like to see in your IDEAL SHORT-WAVE RECEIVER. Try to mail your ballot to the editors within the next ten days—because the sooner we get a goodly number of these ballots in our hands, the earlier we can have Mr. Denton start on the construction of the "perfect composite receiver. (Continued on page 433)

NATIONAL SW-58 THRILL-BOX
'ROUND THE WORLD --- FIRST CLASS!
RANGE 9-850 METERS
NEW 58 TUBES INCREASE R.F. GAIN AND SELECTIVITY
NEW ISOLATED FULL VISION ROTOR GANG CONDENSER
CONTROLLED SELECTIVITY
USED BY POLICE, U.S. GOVT., SHIPS, AIRWAYS, EXPEDITIONS, AIRWAYS, PERFORMANCE
COMPLETE ISOLATION BETWEEN CIRCUITS
LOUD SPEAKER EVERYWHERE, PHONE JACK
STANDARD SET OF COILS NOW COVERS RANGE 1.5 TO 900 METERS, ADDITIONAL COILS AVAILABLE FOR HIGHER AND LOWER FREQUENCIES
VERNIER DIAL
OPERATES ON A.C.

4 YEARS NEW!

NATIONAL SW-58 Thrill Box is four years NEW. Four years ago short-wave broadcast listeners heard around the world with NATIONAL Thrill Boxes. Each year, with new and better tubes and new and better research, the Thrill Box has been improved . . . now the SW-58 Thrill Box offers features to the users not dreamed of in September 1928. "Controlled Selectivity," an entirely new order of isolation between circuits, tremendous RF gain with the new 58 tubes . . . and during four years, a constant stream of unsolicited, unpaid for, enthusiastic testimonials from users who PAID for their NATIONAL Receivers, have flowed in praising the performance of the Thrill Box.



"In two months I have logged nearly 1000 stations which includes about forty foreign countries."
 Centralia, Washington.

"I would like to tell you that the Thrill Box is absolutely the best short-wave set I have heard, regardless of price. I have received stations in Australia, Holland, England, Germany, South America, Central America, all on the loud speaker . . ."
 San Antonio, Tex.

"I am tuning in stations from all over the world . . ."
 Malvern, Pa.

"I have had the receiver in operation for about a month and wouldn't trade it for any six others I have ever heard . . ."
 Fairport Harbor, Ohio.

Takes a Whiskey and Soda in Sweden

"Apart from listening clearly every night to 2XAF on 31, 48 meters and other American stations on 79 meters, I have had both F.2k Saigon, and VK2ME Australia on the speaker with volume enough to fill the house. No distance is too great for my 'box'. I am proud of my NATIONAL and take a real whiskey and soda in honor of the best short-wave set in the world."
 Trilhattan, Sweden.

Names on Request

When You Buy the NATIONAL SW-58 Thrill Box You Get

Utmost Sensitivity, Extremely Low Background Noise (highest signal-to-noise ratio), Unequaled Flexibility and Ease of Control.

"Controlled Selectivity." An entirely new feature, found only in the SW-58, which allows the set always to be operated at the best selectivity consistent with signal strength and reception conditions.

Loud Speaker Performance. A Push Pull Stage with 245 tubes for best tone-quality gives fine loud-speaker volume. There is also a jack for headphones.

Full AC or DC. The AC set operates with the NATIONAL 5880 Special SW Power Supply with extra shielding and filter sections for humless operation. RCA Licensed. Battery model also available for use where there is no AC current.

New 16-Page Catalogue and Full Particulars Without Obligation. Mail the coupon below today for your copy of our new 16-page catalogue and full details of the new NATIONAL SW-58 THRILL BOX.

REGULAR USERS of NATIONAL Short-Wave Equipment

NATIONAL Short-Wave Equipment and Short-Wave Receivers are used by thousands of Short-Wave listeners and amateurs all over the world, and by every large commercial company in the communications field, including:

- | | |
|-------------------------------------|--|
| General Electric Co. | Signal Corps, U. S. Army |
| Westinghouse Electric & Mfg. Co. | U. S. Dept. of Commerce (Lighthouse Service) |
| R.C.A. Communications | Pan American Airways |
| Tropical Radio (United Fruit Co.) | Boeing Air Lines |
| Federal Tel. & Tel. Co. | Western Air Express |
| Western Electric Co. Press-Wireless | Transcontinental and Western Air Express |
| Mackay Radio (Postal) | Radio-Marine |
| American Airways | United Air Lines |
| American Tel. & Tel. Co. | Eastern Air Transport |
| Canadian Marconi | Canadian Airways, Ltd. |
| U. S. Naval Research Laboratories | Southern Air Transport |
| U. S. Navy | |

NATIONAL A. C. SW-58 THRILL-BOX



NATIONAL CO., INC.
 61 Sherman Street, Malden, Mass.

Please send me your new 16-page catalogue and full information on the NATIONAL AC SW-58 THRILL BOX.

Name.....

Address.....

SW-11-32.

SHORT WAVE LEAGUE



HONORARY MEMBERS

Dr. Lee de Forest
 John L. Reinartz
 D. E. Replogle
 Hollis Baird
 E. T. Somerset
 Baron Manfred von Ardenne
 Hugo Gernsback
Executive Secretary

Regulations Governing the Issuance of Radio Operators' Licenses

• ON page 346 of the October number of SHORT WAVE CRAFT we published the regulations covering the issuance of amateur operators' licenses. Every would-be "ham" is advised to look up this important "dope" and to read it over carefully, so that he will be fully prepared when he takes the license examination. This month, as promised, we are running the regulations governing the various kinds of commercial licenses.

Commercial extra first class.—To be eligible for examination, an applicant for this class of license must hold a radiotelegraph operator first-class license and must have been actually engaged as an operator at stations open to public correspondence for at least 18 months during the two years previous to his application and must not have been penalized for violation of any radio act, treaty, or regulation binding on the United States. Applicants must pass code tests in transmission and reception at a speed of not less than 30 words per minute in continental Morse code and 25 words per minute in American Morse code, five characters to the word. The questions in this examination will cover the same subjects required for radiotelegraph and radiotelephone class of operator license, but considerably wider in scope.

Holders of license of this class are authorized to act as chief operator at any licensed radiotelegraph or radiotelephone station except amateur.

Radiotelegraph operator first class.—To be eligible for examination, an applicant for this class of license must have been actually engaged as an operator at ship or coastal stations open to public correspondence for at least 12 months. Applicants for this class of license must pass code tests in transmission and reception at a speed of at least 20 words per minute in continental Morse code, code groups, and 25 words per minute in Continental Morse code, plain language (5 characters to the word).

The practical and theoretical examination shall consist of comprehensive questions under the following headings:

(a) Diagram of radio installation: Applicants are required to draw a complete wiring diagram of a modern marine radio installation as used aboard American vessels. The applicant may be required to draw either a spark, arc, or vacuum-tube transmitter (with radiotelephone attachment).

(b) Theory, adjustment, operation, and care of modern radiotelegraph and radiotelephone transmitting apparatus.

- (c) Receiving apparatus.
- (d) General principles of electricity.
- (e) Operation and care of storage batteries.
- (f) Power-supply apparatus.
- (g) International regulations governing radio communication and the United States Radio Laws and Regulations.

Holders of this class of license are authorized to act as operator at any licensed radiotelegraph station except amateur, or to act as chief operator on a vessel in the first class engaged in international service.

Radiotelegraph operator second class.—Applicants for this class of license must pass code tests in transmission and reception at a speed of not less than 16 words per minute in continental Morse code, code groups, and 20 words per minute in continental Morse code, plain language (5 characters to the word). The practical and theoretical examination will cover the same subjects as radiotelegraph operator first-class license.

Holders of this class of license are authorized to act as operator at any licensed radiotelegraph station except amateur or as chief operator on a vessel in the first class engaged in international service. They will be authorized to act as chief operator on a vessel in the second class after license is indorsed certifying to six months' or more satisfactory service as an operator at radiotelegraph stations open to public correspondence.

Radiotelegraph operator third class.—Applicants for this class of license must pass a code test in transmission and reception at a speed of not less than 15 words per minute in continental Morse code, plain language (5 characters to the word), and a practical and theoretical examination consisting of comprehensive questions on the care and operation of vacuum-tube apparatus and radio communication laws and regulations.

Holders of this class of license will be authorized to operate any radiotelegraph station, except amateur, and stations open to international mobile public correspondence.

Holders of radiotelegraph operator licenses of the first, second, and third classes may qualify to operate radiotelephone stations by passing the regular radiotelephone operator examination of the class desired and having their licenses so indorsed.

Radiotelegraph operator first, second, and third class license examinations will include questions relative to the theory and operation of radiotelephone apparatus in order that the holders of these classes of licenses may operate radiotelephone apparatus employed in mobile and point-to-point service.

Radiotelephone Operator Licenses

No code test is required for these classes of licenses.

Radiotelephone first class.—Applicants for this class of license must pass a theoretical examination covering the following:

- (a) Diagram of modern broadcast installation.
- (b) Theory, adjustment, operation and care of modern radiotelephone transmitters.
- (c) Receivers.
- (d) General principles of electricity.
- (e) Operation and care of storage batteries.
- (f) Power-supply apparatus.
- (g) Radio communication laws and regulations.

Holders of this class of license are authorized to act as operator at any licensed radio station except stations licensed for radiotelegraph service.

Radiotelephone operator second class.—Applicants for this class of license must pass an examination similar to that required for radiotelephone operator first class, but not so comprehensive in scope.

Holders of this class of license are authorized to act as operator at any licensed radio station except broadcast and sta-

(Continued on page 436)

Get Your Button!

The illustration here-with shows the beautiful design of the "Official" Short Wave League button, which is available to everyone who becomes a member of the Short Wave League.

The requirements for joining the League were explained in the May issue; copies of rules will be mailed upon request. The button measures 3/4 inch in diameter and is inlaid in enamel—3 colors—red, white, and blue.



Please note that you can order your button AT ONCE — SHORT WAVE LEAGUE supplies it at cost, the price, including the mailing, being 35 cents. A solid gold button is furnished for \$2.00 prepaid. Address all communications to SHORT WAVE LEAGUE, 96-98 Park Place, New York.

SM

For the first time in history a receiver is guaranteed to outperform, on every count, any other radio right in your own home—or your money back!

McMurdo Silver
McMurdo Silver

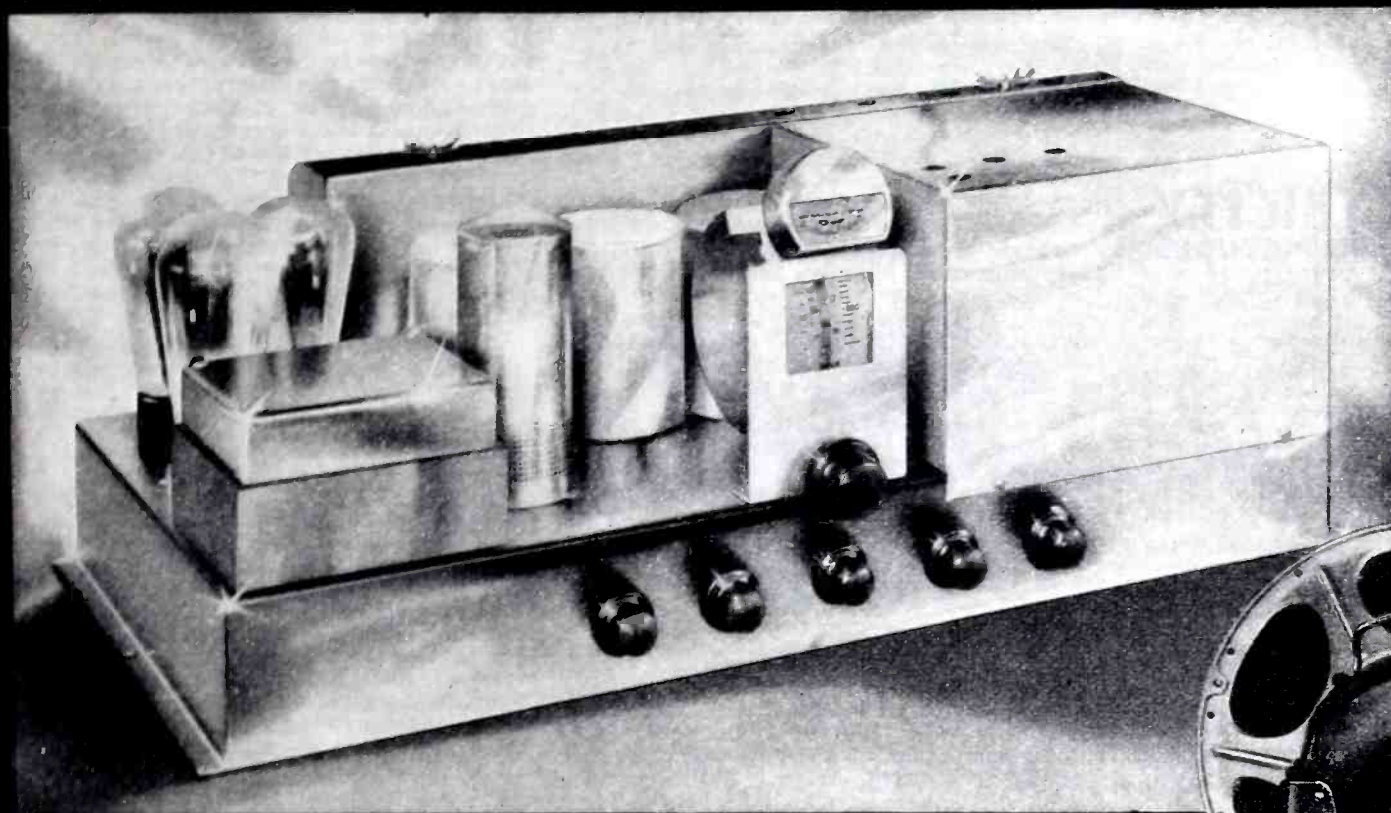

The NEW CB-1

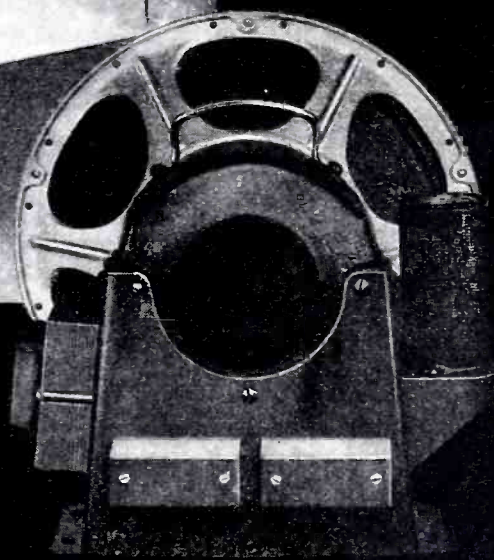

If the finest of anything can have a price—that should be the price of the CB1. It is Silver-Marshall's *Custom-Built* sister radio to the 728SW. It has 13 tubes with "bong" enough to fill a cathedral. Its speaker is an exclusive new auditorium model that, alone, weighs 42 pounds, with a voice coil $2\frac{1}{2}$ inches in diameter—equivalent to 4 ordinary speakers and an extra stage of audio. That speaker is rated at 15 watts, giving the receiver an all-wave sensitivity almost impossible to measure.

Into the CB1 has been built every feature known to the S-M Laboratories. And they have produced 39 major radio developments in the last eight years!

We could go on for pages listing its technical perfections. No wonder it is brass plated, brushed, buffed and lacquered like the finest laboratory instrument. It is a laboratory instrument. And each one personally tested and approved by McMurdo Silver.

Available both as a matched assembly installed in a beautiful acoustically selected cabinet and as a chassis.

And remember—guaranteed to outperform anything at any price—or your money back.

Why is Silver-Marshall Custom Built equipment used by the United States Navy on the Akron, the largest dirigible in the world?

Why is it used as official equipment by important airports in all parts of the country?

Why do you find it on famous sea-going private yachts?

Why is it selected by the Chief Engineers of almost every important broadcasting station?

Write for technical description, logs of world-wide reception and prices.

SILVER-MARSHALL, Inc.

6457 WEST 65th STREET « « » » CHICAGO, U. S. A.

Come to Los Angeles!

4 full courses at price of single course

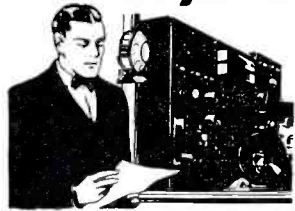

LEARN RADIO-ELECTRICITY TELEVISION-TALKING PICTURES and BROADCASTING

NO longer is it necessary to pay several tuitions. Now, for the first time in history, National offers complete training in Radio, Electricity, Television, Talking Pictures and Broadcasting all at a single tuition fee.

Come to Los Angeles, the center of radio and electricity—and where the great American television laboratories are located—where hundreds of trained sound engineers and mechanics are employed in talking picture studios.

Largest and Oldest Trade School in West— Est. 1905

For 27 years National has successfully trained men by practical shop methods. Previous education unnecessary. More than 25,000 graduates.

Railroad Fare Allowed to Los Angeles

For a limited time we will allow coach railroad fare to Los Angeles from any point in the United States. This is deducted from tuition, so the trip costs you nothing. FREE EMPLOYMENT SERVICE. Spare time jobs while at school.

Send for Big Free Training Book Our big radio, electrical, television, talking picture and broadcasting book, brimful of interesting pictures, will be forwarded free, without obligation.

NATIONAL RADIO & ELECTRICAL SCHOOL including Television, Talking Pictures and Broadcasting 4006 So. Figueroa St.

Dept. 1198E Los Angeles, California A Million Dollar Institution of Practical Training MAIL THIS COUPON TODAY

Information regarding National's four-for-one course. We reserve privilege to withdraw this bargain offer at any time. Mail coupon immediately.

Form with fields for Name, Address, City, State and a box for National Radio & Electrical School details.

Save money by enrolling in National NOW. For single tuition fee, we now offer the four complete radio, electrical, television, talking picture and broadcasting courses. Four courses for price of one.

Commercial operating taught on regular standard equipment.



ELECTRICITY Become an electrical expert. Complete electrical machinery and equipment for you to work on at National.

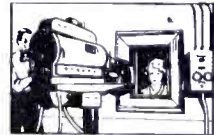

TELEVISION The newest trade with a tremendous future. Latest scanning disc equipment. National pioneers in this interesting work.



TALKING PICTURES 10,000 theatres equipped for sound. Good pay. National-trained men preferred in studios and theatres.

Doublet Antennas

(Continued from page 413)

decrease the distance between the two wires constituting the feeder. This affords more effective feeder cancellation of such interfering signals. Transposition every twelve inches with a wire spacing of one inch is correct under these conditions.

Transposition Insulators Needed

The construction of the transposing insulators is quite simple. Insulators made of ordinary three-ply wood boiled in paraffin are excellent and will withstand many months of our-door use without too much deterioration or breakdown in dielectric resistance.

The drawing shown in Fig. 1 is fully explanatory and shows the construction of a transposition insulator, which will keep the wires separated two inches. The large hole in the center is to eliminate as much of the dielectric loss as possible.

We have explained in what manner the doublet antenna for receiving is different from the so-called Hertz antenna. In reality it is nothing more than the Hertz, except for the specially constructed lead-in.

In the Hertz antenna the ground and its capacity to ground have little to do with its performance. The true Hertz antenna is suspended sufficiently high above the ground so that its capacity to ground is extremely small.

There are two types of Hertz antennas. They are both shown in Fig. 2; 2-a is the vertical type and 2-b is the horizontal type.

Operating at its fundamental frequency the true Hertz is a half wave antenna. Under these conditions the voltage and current curves are as shown in Fig. 3-a. Its lowest resistance, of course, is at the fundamental frequency.

The doublet we are discussing is a current-fed doublet on its fundamental frequency and immediate frequencies adjacent to it, and will be considered as such in this discussion, except as brought out later.

Fundamentals

Here is a thought that, while entirely obvious, is not clear to many short wave listeners. Whether the same Hertz antenna is energized by a transmitter or by the extremely minute voltages of the radio signal in space,

* Insulators of this type are now available on the market.

its relative voltage and current distribution is the same for a given exciting frequency. If we attach our feeders to the center of our antenna with an insulator separating each side at the exact center and each half-section a quarter wavelength long, we are feeding at a point of maximum current and our feeder system is then known as a current-fed one.

The doublet that we are designing is built to operate primarily as a current-fed system and accordingly we will confine most of our discussion to this mode of operation.

Feeders in receiving antennas do not have to be cut to the exactness required in transmitting circuits. Thus, we can say that for best results the length of each wire in the feeder should be at least a quarter-wave long. This insures the best distribution of voltage and current on the antenna for maximum efficiency at received signals on the fundamental frequency of the antenna.

The secret of the success does not lie in antenna and feeder lengths cut exactly to within fractions of an inch, but in the cancellation effect of the transposed feeders.

Fig. 4 shows two methods of coupling the feeder system to the receiver. The first method is an untuned coil arrangement, which is entirely satisfactory. The second method, though, if an extra tuning operation is permissible, will give superior results. It consists merely of a tuned circuit. This added control is not a great deal of bother and, after once being set for a given band of frequencies, it does not need to be retuned, except for extreme changes in frequency.

We have been more or less delving into general theory and before closing this article a few practical working figures will be given.

The proper length of a pure Hertz antenna operating at its fundamental frequency (half-wave) is easily found by the following formula:

The Length in Feet = 463,000 / Frequency in Kilocycles

This gives the total length of the Hertz portion. We have stated that our feeder should be somewhat more than one-quarter wave long, i.e., for the ideal condition of current-feed. Since the above formula gives us the proper length of a half wave antenna, the feeder must be at least half the length of that given in the formula in order to be at least a quarter wavelength long.

Design of a 11-750 kc. Doublet

Let us illustrate by designing a doublet for, say, best operation at 11,750 kilocycles, which is the frequency of G5SW. We assume that this is the station we would like to hear most. Using the formula just given, we are able to compute the length of a Hertz antenna resonant to 11,750 kilocycles. The solution is this:

$$\text{The Length in Feet} = \frac{468,000}{11,750} = 39.82 \text{ feet.}$$

Then 39.82 feet is the total length necessary for the Hertz part of our antenna system. Since formulas are at the best only very good approximations, we will not cut our antenna to the hundredth of an inch as figured above, but will, instead, cut it to 39.8 feet, which is fully satisfactory for our purposes. We must break our antenna with an insulator at its exact center, making each section one quarter wavelength long. The figure of 39.8 feet is the total length of the Hertz part, which is, of course, one-half wavelength long at the frequency of 11,750 kilocycles. Since our feeders must be at least one quarter wave long, our feeders must then be equal in length to one-half of 39.8 feet, which is 19.9 feet. Thus, each wire in our feeder must be cut at least 19.9 feet long. They may be longer but the value of 19.9 feet should be the minimum length. The antenna shown in Fig. 5 is then best suited for picking up G5SW on his 11,750 kilocycle frequency.

The antenna of Fig. 5 would also give good reception on all stations whose frequencies are between 7,000 and 15,000 kilocycles. Reception equal to that on the average antenna could easily be had over the entire short wave spectrum now generally used, even though the voltage current distribution curves would be extremely complex and far from ideal.

Another Design Problem

Let us consider another location and assume that again the station we want to hear most is G5SW. The conditions this time are considerably different. The short wave set is located in an apartment building on the third floor from the roof of the building. We have poles twenty feet high to which the antenna can be attached; on the floor below the roof are the elevator motors; on the floor below this several electric ice machines and electric fans. We find that the only path that our lead-in can take to reach our window is within a few feet of these sources of potential interference. Here is a condition where the antenna can be placed high enough for excellent reception, yet there is going to be an almost certain amount of man-made interference picked up by the lead-in, due to its closeness to the electric motors. This is where the doublet antenna really proves its worth. Let us design our antenna to the surroundings.

Since we want an antenna again resonant to 11,750 kilocycles, the length of the flat top remains the same as above, i.e., 39.8 feet. We again place an insulator in the exact center, making each half of the Hertz 19.9 feet or one quarter wave long. So far our case is similar to the previous instance. However, we find that the shortest length of feeder we can use is around eighty-three feet. This is much longer than a quarter wave long, in fact several times longer. We will not let this worry us, however, and cut our feeders the necessary length to stretch down to the set, three stories below. Being considerably over a quarter of a wavelength long, we can couple to our receiver with the tuned coil coupling circuit. By tuning this coil we can then tune the feeder for best operation.

We know there will be little man-made interference picked up by that portion of the lead-in stretching from the antenna to the roof of the building, so for this length we will transpose our feeders only every three feet, and leave the feeder wires separated about two inches. We know, though, that the elevator motors will create interference, especially on starting. To successfully eliminate this we must transpose our feeders more often and keep the wires closer together on that part of the feeder running from the roof past the motors and ice-boxes, right down through the window and up to the set.



**SHORT WAVE RECEIVERS
NOW USE "TRANS-X" COUPLING**

Time tried and proven OK! Accepted by amateurs and fans everywhere as the **OUTSTANDING VALUE** today.

Consistent reception of radiophone stations in all parts of the world. Full spread with amateur band coils. Simple to operate — quiet — economical — powerful — and inexpensive! Higher priced receivers? They can give you no more! Cheaper sets? They simply can't be compared to the ROYAL!

The "TRANS-X" Unit (patent pending) is the result of much costly research and experimentation! This new method of trans-conductance insures maximum transference of signal energy and gives three times the amplification possible with ordinary methods of coupling. An exclusive ROYAL development—it is found only in ROYAL receivers

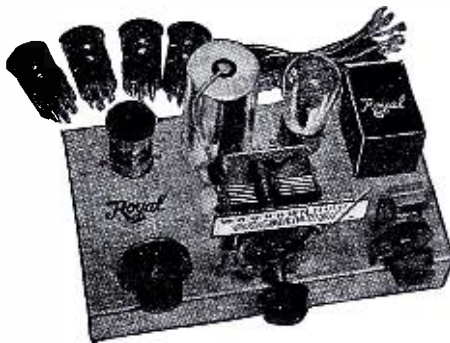

**HERE IS WHY
THEY'RE BETTER:
ROYAL "TRANS-X"**

and is striking evidence of their superiority of design. Many other ultra-modern features stamp ROYAL as the best "buy" in the history of short waves! Dual-ratio dial with ratios of 12:1 or 60:1 at will (the fine ratio gives five times the tuning spread of ordinary receivers) — smooth regeneration control with no effect on tuning — Royal special coil forms — amateur band spread coils — single broadcast coil with full range — heavy metal chassis — dustproof art metal

cabinet with heavy hinged cover — battery or A.C. operated models — highest quality parts — and many other points that make ROYAL receivers more efficient and more economical than any other short-wave set!

The use of a screen grid detector (43 to 166 times the gain of the ordinary triode!) and a power pentode audio amplifier with "Trans-X" coupling give a sensitivity and volume that is practically unbelievable!

We guarantee these ROYAL Short Wave Receivers to outperform any other set! Order your ROYAL today and if you are not entirely satisfied we will promptly refund your money! What could be more convincing!!

ROYAL STAR

(The famous Model RP)

A two-tube with a sterling pedigree. This remarkable receiver is not to be confused with poorly designed sets cheaply thrown together to sell at "bargain" prices! Uses one type 232 super-sensitive detector and a type 233 power pentode.

List Price, \$25.00. **\$14.70**
SPECIAL.....
Complete Kit\$11.76
Set of ROYAL Short Wave
Tested Tubes\$2.55

AC STAR

Uses one of the new type 58 super-control screen grid pentodes, a 247 pentode audio amplifier, and a 280 rectifier. Especially designed for humless, quiet operation on Short Waves. Ready to plug into AC line.

List Price, \$40.00. **\$23.52**
SPECIAL.....
Complete Kit\$20.58
ROYAL Tested Tubes... 2.15

ROYAL CHIEF

A knock-out three-tube set embodying all the well known features of the STAR, plus a stage of high gain type 232 screen grid radio frequency amplification.

List Price, \$30.00. **\$17.64**
SPECIAL.....
ROYAL Tested Tubes... \$3.75
Full Set of Batteries for any
ROYAL\$3.95

AC CHIEF

The AC STAR with an additional type 58 used as screen grid radio frequency amplifier.

List Price, \$45.00. **\$26.46**
SPECIAL.....
Complete Kit\$23.52
ROYAL Tested Tubes... 2.95

**ENORMOUS STOCK OF
RADIO SUPPLIES**

If we haven't got it, we will get it for you **AND SAVE YOU MONEY!**

ROYAL OLYMPIC

A four-tube receiver that shatters all records for performance, quality, and price! Utilizing the basic structure of the ROYAL STAR, it incorporates a high gain screen grid R.F. amplifier stage and an additional booster Class A audio amplifier tube for super dynamic power. A separate control to modulate the signal down to any desired level is another feature. Uses two 232, one 230, and one 233 tubes.

List Price, \$35.00. **\$20.58**
SPECIAL.....
Complete Kit\$17.64
ROYAL Tested Tubes... 4.50

AC OLYMPIC

A De Luxe AC operated receiver employing two 58, a 56, a 47, and a 280.

List Price, \$50.00. **\$29.40**
SPECIAL.....
Complete Kit\$26.46
ROYAL Tested Tubes... 3.60

**HERE'S WHAT
ROYAL USERS SAY:**

"Can lay the phones on the table, walk around the room, and still hear FYA in Pontoise, France."
"Received Spain, and several VK's and ZL's through strong interference."
"Received the ROYAL a week ago in fine condition—received many stations in all parts of the world and have heard all continents (all broadcast stations, no code)."
"I certainly congratulate you for putting the best little DX hound on the market, within reach of any ham."
(Names on request.)

"It's the sweetest little receiver I have ever used, harring none!"
"I have different makes of SW sets, but the Royal Model RP gets more stations than any other set, and with more pep."

**REMEMBER! Royal APPEARANCE can be copied — but Royal PERFORMANCE cannot!
ROYAL Performance is REAL Performance!**

SPECIALS

- BRUNSWICK Two-Tube Short Wave Tuners. (See Sept. Short Wave Craft).....\$6.95
- BRUNSWICK Super-het Converters. (Sept. Short Wave Craft).....\$10.95
- GENERAL ELECTRIC Panel Mount Milliameters, 3 inch diameter. 100, 200, 300 mills. Brand new!.....SPECIAL \$2.95

- We are National Distributors for
- ROYAL
 - NATIONAL
 - HAMMARLUND
 - UNIVERSAL MICROPHONE
 - MAYO
 - CARDWELL
 - JEWELL
 - WESTON
 - BURGESS
 - EBY
 - READRITE
 - ETC., ETC.

Write for Our Low Wholesale Prices
• QUICK SERVICE •

SEND FOR CATALOG

Harrison Radio Co. 142 LIBERTY ST., Dept. C-13
NEW YORK CITY

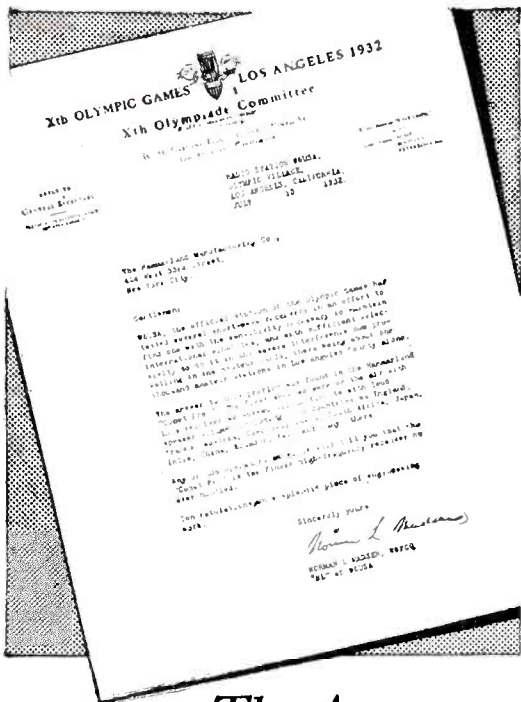

The Answer: "COMET 'PRO'"

"We tested several short-wave receivers to find one with the sensitivity to maintain international schedules, and sufficient selectivity for the severe interference now prevailing, there being about 1,000 amateur stations in Los Angeles County alone. The answer was the 'Comet Pro.' We work all continents with loudspeaker volume, including England, France, Austria, Czechoslovakia, South Africa, Japan, India, China, Ecuador, Peru and many others. Any operator at W6USA will tell you that the 'Comet Pro' is the finest high-frequency receiver he ever handled. Congratulations on a splendid piece of engineering."

NORMAN L. MADSEN,
Operator, W6USA,
Official Station of the Olympic Games

Due to recent tube developments, the new model "PRO" is even *more* selective. Delivers *full loudspeaker volume*. Increased intermediate amplification, with greater stability. Smoother operation on 10 to 20 megacycle band. More effective shielding. New metal cabinet removes all stray influences. Wood cabinet optional. *A really GREAT receiver!*

Mail
Coupon
for
16-page
Folder

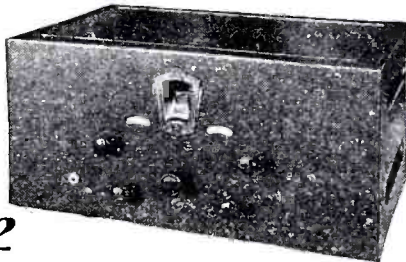

The

COMET

Custom-Built "PRO"

by
HAMMARLUND

HAMMARLUND-ROBERTS, INC.,
424 W. 33rd St., New York

Please send me 16-page illustrated folder, describing the COMET "PRO" Short-Wave Superheterodyne.

Name

.....

.....

SW-11

It is true that we have been rather inaccurate in putting up a feeder system the exact figured length for best results, but it is safe to say that results on the doublet will be better in every way and the noises less than on the customary single-wire antenna, even though we have missed exact feeder dimensions somewhat in its erection.

Where the antenna is indoors or where the lead-in is protected from the rain, a simple form of transposed lead-in can be made by the use of ordinary twisted lamp cord used for the feeder. This is quite effective, and there is very little feeder signal pick-up. Lamp cord for feeders is not practical for use out-of-doors, because the rain will eventually break down the insulation and tear down dielectric resistance of the cloth and rubber covering on the wires. It may be successfully used for a short period of time in the open for experimental work or upon temporary installations, because it takes some time before the elements can affect its dielectric losses. Of course, when

soaked with water after a severe rainstorm it is useless.

The occasion arises sometimes where a broadcast receiver is used on the same antenna as that used on the short wave set. If this condition exists the switching arrangement shown in Fig. 6 will solve the problem. While the short wave set is worked with the antenna as a doublet, the feeders after being tied together and switched to the antenna post of the broadcast receiver, will allow the entire antenna system including the lead-in to work against ground as a regular type antenna.

The doublet antenna offers a possibility of better reception in all congested districts where man-made interference exists. It is not needed on the farm and in the rural and isolated sections of the country, where background noises are already at a minimum. However, to the short wave listener in the city who wants the best reception possible with the least amount of background we suggest its use, knowing that when once tried it will stay up until the insulators break of old age.

New Code Teacher and Recorder

● TO record your own sending has been the goal of many a short wave amateur, not to mention the code teacher, who has often thought what a fine thing it would be to have a means of recording some of the awful sending beginners hand out and be able to show them by graphic record charts how and where they "sliced" their dots, dashes and spaces. This new Teleplex code teaching machine is about the cleverest device of its kind the editors have yet seen. The student receives a number of standard code, paper tape records, which he can run through the machine and thus learn the proper spacing of the various code characters, the signals being heard in a pair of headphones. A vacuum tube oscillator circuit is used to generate the signals, which sound just like those from a regular commercial radio station. The student can place a roll of blank paper tape in the machine and record his own sending; the recorded signals are afterwards run through the machine so that he can hear just how good or

bad his transmitting "fist" is. Also the record of the beginner's signals can be visually com-



Latest code teaching machine also records your "sending" for comparison.

pared with those on the standard tapes supplied with the machine. A rheostat on the front panel permits changing the tone of the signal.

A "Free-Wheeling" Receiver

(Continued from page 414)

Symbol	Quantity	Article	RFC	1 Pilot No. 130 80-mh. choke.
VT1, VT2	2	'27 type tubes.	A.C. switch.	
VT3, VT4	2	'24 type tubes.	R2b and C8 (oscillation).	
	4	Y-base sockets.	C6a and b (tuning).	
	4	Binding posts (2 for 'phone tips).	C1	4 .2 mf. condensers.
	1	Baseboard or chassis 9 1/2"x18".	C2	2 1 mf. condensers.
L1	2	Special coils.	C3	1 .00001 mf. (10 mmf.) condenser.
L2	1	A.F. transformer, 6:1 ratio or less.	C4	2 .001 mf. condensers.
L3	1	Filament transformer, 2.5 volts, 8 amps.	C5	1 .00025 mf. condenser.
	1	"B" eliminator.	C6	2 .00015 mf. variable condensers.
R1	1	25,000 ohm resistor, Pilot #954.	C7	1 .00002 mf. (20 mmf.) condenser.
R2	2	50,000 ohm variable resistors.	S	1 Toggle switch.
R3	1	1,000 ohm resistor, 5 watt.		2 Switch levers.
R4	1	5,000 ohm resistor, 10 watt.		8 Switch points.
R5	1	2 megohm grid leak.		4 Switch stops.
R6	2	450 ohm resistor, 10 watt.		8 ft. Acme push-back wire.
R7	1	2,000 ohm resistor, 10 watt.		4 ft. No. 16 twisted hook-up wire.
R8	1	100,000 ohm resistor, 140 volts, 7 M.A.	CS	1 Midget condenser, .000065 mf. (Hammarlund).

Amateurs who made good

RALPH B. AUSTRIAN

● MR. AUSTRIAN, who now holds the important position of sales manager of Kolster Radio, Inc., located at Newark, New Jersey, was the proud possessor of one of the early amateur radio stations back in 1914.

Mr. Austrian tells us that he entered the amateur radio game in 1914, when he operated a "ham" station with the call 2NY, the station having been located in New York City. Next we find Mr. Austrian holding the position of radio instructor during the World War, at the U. S. Army Signal Corps School, located at City College, New York, under the direction of Dr. Alfred N. Goldsmith, now vice-president of R. C. A.

The war drew to a close and in 1921 Mr. Austrian became vice-president of the Union Radio Corporation, then located at Newark, New Jersey. In 1923 and 1924 he was radio buyer for the large Gimbel Brothers store in New York. Later we find Mr. Austrian still climbing the ladder of radio fame and during the years 1925 to 1928, inclusive, he was vice-president of the R. B. Rose Company, an organization operating a number of leased radio departments in the country's leading department stores.

Now we jump to the year 1929 and we then find Mr. Austrian acting as recording engineer at the Paramount-Famous Players-Lasky studios at Astoria, Long Island. The famous Westinghouse Electric & Manufacturing Company next enjoyed the services of Ralph B. Austrian, where he served as assistant merchandise manager in the radio department in 1930. During 1931 he served as manager of the retail distribution department of the Westinghouse Company. At present the well-known Kolster Radio line of receivers are making their bow to the public under the able sales directorship of Mr. Austrian.



Ralph B. Austrian, sales manager of Kolster Radio, Inc., Newark, N. J., one of America's prominent radio men, who once delighted in "pounding brass" in his ham station, 2NY, back in 1914.

KEEP YOUR EYES OPEN!

For the Next Issue

which will contain valuable articles of A-1 interest to

BOTH BEGINNERS AND ADVANCED AMATEURS!

The Editors of SHORT WAVE CRAFT are looking for "good" articles, illustrated with "clear" photos and diagrams, at all times. Subjects: SHORT-WAVE RECEIVERS, NEW CIRCUITS, CONVERTERS, ADAPTERS and TRANSMITTERS. All articles accepted and published will be paid for. Address the Editor, SHORT WAVE CRAFT, 96-98 Park Place, New York, N. Y.

When to Listen in

By BOB HERTZBERG

Address of VK3ME

Mr. P. A. Jordan, Box 1037, Wichita Falls, Texas, writes that the address of Station VK3ME is Amalgamated Wireless, Ltd., Broadcasting Department, 167/169 Queen Street, Melbourne, C1. The address of 47 York Street, as given in the SHORT WAVE Station List, was taken right off a VK3ME letterhead, but perhaps listeners' mail is handled at the address given by Mr. Jordan.

Latest "Dope" of the British Stations

We are indebted to a British reader, who wishes to be known only by his initials, T. F. H., London, for a revised list of the more important short-wave transmitters in Great Britain. This list is worth saving for future reference.

BROADCAST

G5SW—11,750 kc., Chelmsford, 12 kilowatts. Programs: 11:30-12:30 and 17:45-23:00. News: 11:30 (11:45 on Saturdays) and 17:15-23:00 (G. M. T.). Transmits every day except Sunday.

COMMERCIALS

TELEPHONE TRANSMITTERS AT RUGBY

Call	Frequency	Works To
GAS	18,310	New York
GBS	12,150	New York
GCS	9,020	New York
GDS	6,905	New York
GAW	18,200	New York
GBW	14,440	New York
GCW	9,790	New York
GAU	18,620	New York
GBU	12,290	New York
GCU	9,950	New York
GBB	13,585	Egypt and Canada
GCB	9,280	Egypt and Canada
GBC	4,975	Ships at Sea
GBC	8,680	Ships at Sea
GBC	12,780	Ships at Sea
GBC	17,080	Ships at Sea
GBP	10,770	Australia
GAA	20,380	Buenos Aires, Monte Grande
GCA	9,710	Buenos Aires, Monte Grande
GAG	18,970	South Africa

TELEGRAPH TRANSMITTERS AT OXFORD

Call	Frequency	Works To
GIA	19,640	Europe: sends press at 12, 14, 17 GMT
GIC	8,640	Europe: sends press at 19, 20, 23:30 GMT
GID	13,555	Europe
GIF	9,220	Europe
GIH	10,650	Europe
GIK	5,325	Europe

BEAM SYSTEM TELEGRAPH TRANSMITTERS

Call	Frequency	Location	Works To
GMI	18,500	Grimsby	India
GOI	8,780	Grimsby	India
GNH	11,585	Grimsby	Australia
GMJ	18,580	Bodmin	South Africa
GOJ	8,820	Bodmin	South Africa
GMK	18,100	Bodmin	Canada
GOK	9,260	Bodmin	Canada

SHIPS EQUIPPED WITH TELEPHONE TRANSMITTERS THAT WORK WITH BGC

GDLQ	S.S. Homeric
GFVV	S.S. Majestic
GLSQ	S.S. Olympic
GMBJ	S.S. Empress of Britain
GMJQ	S.S. Belgenland

FREQUENCIES COMMON TO ALL THE SHIPS

4430	12,380	16,440
8,860	13,320	17,550

(Continued on page 443)

RADIO+

A Host of Other Interesting
Scientific Subjects—

TELEVISION
ELECTRICITY
PHOTOGRAPHY
AVIATION
WOODWORKING
AUTOMOBILES
PATENTS AND
INVENTIONS
NEW DEVICES

CONSTRUCTION
METAL WORKING
PHYSICS
ENGINEERING
METALLURGY
PUBLIC ADDRESS AND
SOUND EQUIPMENT
HOUSEHOLD AND
SHOP HINTS
AND OTHERS

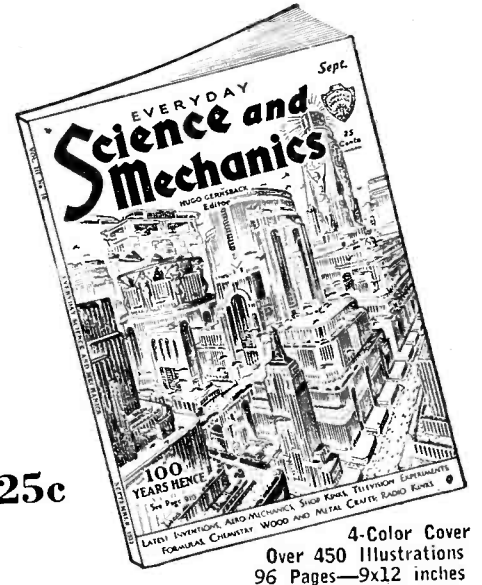

MR. HUGO GERNSBACK'S latest magazine contains the most important and recent developments in Science, Mechanics, Radio, Television, Aviation and Chemistry. For everyone, regardless of age, EVERYDAY SCIENCE AND MECHANICS will be found to be useful and instructive. Thoroughly illustrated with scientific events from all parts of the world, and helpful to thousands of high school, university students and instructors who wish to advance their scientific knowledge.

Many excellent pages for the home workshop man who finds pleasure in building things; experiments in electricity, chemistry and formulas of all kinds.

SPECIAL OFFER!

8 Months for \$1.00

Clip Coupon Now and Mail!

EVERYDAY SCIENCE MECHANICS
100 Park Place, New York, N. Y. SW-3-7

I enclose herewith One Dollar for which you are to enter my subscription to EVERYDAY SCIENCE AND MECHANICS for the next Eight Months.

Name

Address

City..... State.....

Canadian and Foreign Subscriptions Not Accepted

Over 600 questions and answers covering all radio operator license examinations

This new edition of Nilson and Hornung's well-known book will help you pass examinations and to know your stuff better in any field of practical radio. Brought completely up to date. Enlarged to cover more amateur work; also police, aeronautical and other radio.

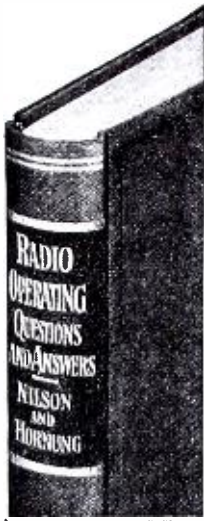

Just published

Nilson and Hornung's

RADIO OPERATING QUESTIONS AND ANSWERS

350 pages, 5½ x 8, 96 illustrations, \$2.50

New 4th Edition

including:

- information on broadcasting, marine, aeronautical, police and amateur operating
- many new questions and answers on latest types of transmitters and other equipment
- more information on amateur operation, including unlimited amateur telephone operator's license
- new radio laws
- new questions and answers on important technical, general and theoretical topics
- regulations governing issuance of all classes of radio operator's license examinations

Every question is typical of those you meet on examinations; answers are complete, illustrated, and give the information essential to meet every situation. For amateurs, short wave fans, men who are preparing for operator examinations or technical positions. Radio companies give preference to licensed operators for all positions. This book gives quick, direct preparation for all examinations. Examine it free.

Companion Book
Nilson and Hornung's
PRACTICAL RADIO TELEGRAPHY

Covers all types of transmitters and receiving sets, based on actual information demanded in the theoretical part of government examinations. 380 pages, 5½ x 8, illustrated, \$3.00.

See these books 10 days FREE
Send this coupon

FREE EXAMINATION COUPON

McGraw-Hill Book Co., Inc.,
330 W. 42nd St., New York City.

Send me the books checked below postpaid for 10 days' Free Examination. I will pay for the books or return them within 10 days of receipt.

() Nilson and Hornung—Radio Questions and Answers, \$2.50
() Nilson and Hornung—Practical Radio Telegraphy, \$3.00

Name

Address

City and State

Position

Name of Company.....SWC-11-32

(Books sent for free examination to retail purchasers in U. S. and Canada only.)

First Prize Winner—Altus Salzwedel

(Continued from page 404)

piece of copper screen can be tacked to the back of this receiver and connected to the antenna post to act as an aerial, and with this system the set makes a very good outfit to locate interference. This receiver works very good in a boat, with a few feet of wire stretched up for aerial, or in a car using a regular automobile antenna. A portable of this type comes in very handy when you are going on a camping trip. These are just a few of the many uses this receiver can be put to. Due to the fact that the receiver will work with an aerial from 5 to 125 feet long, and no ground is necessary for the 20 or 40 meter coils, it can be installed most any place.

In building this set, an aluminum panel 5½ x 6½ inches and a baseboard 6¼ x 4¼ inches are used to mount the receiver parts on. All the coils are made from tube bases, and are tuned with a Pilot 23-plate midget condenser. The regeneration is controlled by the knob on the right side of the receiver, which is connected to a variable 100,000-ohm resistance in the plate circuit of the detector tube, thereby varying the detector plate voltage. A ½-mf. condenser is connected across this resistance and very smooth regeneration control is obtained. The coupling between the detector tube and the audio tube is obtained by a Hedgehog transformer, which was the smallest transformer I could find on the market. A radio frequency choke, 80 mh., and a by-pass condenser, .001-mf., are used to keep the R.F. where it belongs. The knob on the left side of the set operates a 20-ohm rheostat which cuts the 3 volts of the "A" battery down to 2 volts for the two type 30 tubes. On the extreme left side of the set is a filament control jack which automatically cuts off the negative side of the "A" supply when the phone plug is pulled out; thus the set cannot be left running when the set is packed up. The antenna condenser "C" is made out of two strips of aluminum 2 x ¾ inches, bent at right angles and separated by the thickness of a piece of paper. The receiver is held firmly in the cabinet by two screws which go through the baseboard into the cabinet. The batteries are held in place by a small block of wood slipped between the batteries and the cabinet.

The results with this set are quite astonishing, for I have tuned in many Australian "ham" stations in the 40-meter band and all kinds of South Americans and Europeans in the 20-

meter band. Of course, commercial stations all over the world have been received with good volume. Short-wave broadcasting from W3XAL, VE9GW, W2XAL, and W8XK have been received loud enough at times to be heard comfortably on a loud speaker. For short-wave reception an aerial about 35 feet long works best.

The cabinet which I mentioned is made out of three-ply wood and is made up of the following sizes:

- 2 pieces 4½ inches wide by 12 inches high for the sides.
- 2 pieces 6½ inches wide by 4½ inches deep for top and bottom.
- 2 pieces 7 inches wide by 12 inches high for front and back.
- 2 pieces 1¼ inches wide by 12 inches high for sides on cover.
- 2 pieces 1¼ inches wide by 6½ inches long for top and bottom of cover.
- 1 piece 6½ inches wide by 6 inches high for door that covers batteries.

The coils are wound as follows:

- 20-meter coil (No. 24 wire)—9 turns for tickler and 4 turns for grid coil.
- 40-meter coil (No. 24 wire)—10 turns for tickler and 9 turns for grid coil.
- 80-meter coil (No. 28 wire)—13 turns for tickler and 24 turns for grid coil.

The parts used in the set are as follows:

- 1 Antenna condenser, home-made (C).
- 1 Pilot 23-plate midget condenser (C1).
- 1 .001-mf. by-pass condenser (C2).
- 1 ½-mf. condenser (C3).
- 1 .0001-mf. grid condenser (C4).
- 1 1-megohm grid leak (R1).
- 1 20-ohm rheostat (R2).
- 1 100,000-ohm variable resistance (R3).
- 1 Hedgehog transformer, ratio 4 to 1 (T).
- 1 Filament control jack (F).
- 1 Aluminum panel, 5½ x 6½ inches.
- 3 UX sockets.
- 1 "General" "B" battery, type V 30 AA.
- 1 "General" "A" battery, type P 2 KX
- 1 Kurz-Kasch 3-inch dial.
- 2 Type 30 tubes.
- 2 Eby binding posts (aerial, ground).
- 4 Feet push-back wire.
- 1 Ground rod 11½ inches long.
- 35 Feet of wire for aerial.
- 1 Pair headphones.
- 3 Tube bases.

Second Prize Winner—George V. Dubuc

(Continued from page 404)

the cabinet, 2¼ inches up from the bottom, and in the center, drill a hole for an Eby 5-prong socket. One and one-half inches down from the top, also in the center, drill a hole for the .0001-mf. variable condenser (this is used to spread the wave band).

The last panel is the right side. On this is mounted the three batteries, 4½-volt large "C" type for filament supply, small 22½-volt for plate current, and small 4½-volt "C" for "C" bias. The batteries are mounted by means of a brass strip ¼-inch wide, which is bent to the shape of the batteries and screwed down over them to the panel. In this way the side slides in and out, and the batteries may be changed very easily.

The coils are wound on 5-prong molded forms 2 inches long and 1¼ inches wide. The wire used is No. 30 enamel for tickler and primary coils, No. 24 double silk covered for the secondary. The primary and tickler coils are spaced ½ inch from secondary, and the coils are all wound in the same direction. The number of turns for the 20-meter, 40-meter, 80-meter and 160-meter coils is listed below:

Wavelength	Primary Turns	Secondary Turns	Tickler Turns
20 meters	9	11, spaced	15
40 meters	10	16, close wound	15
80 meters	13	25, close wound	20
160 meters	12	38, close wound	27

Primary is wound on bottom of coil form, secondary in center, tickler on top. Grid end of secondary is wound nearest tickler. Connections to coil form prongs may be brought out to any prong as long as the coil socket is wired to correspond.

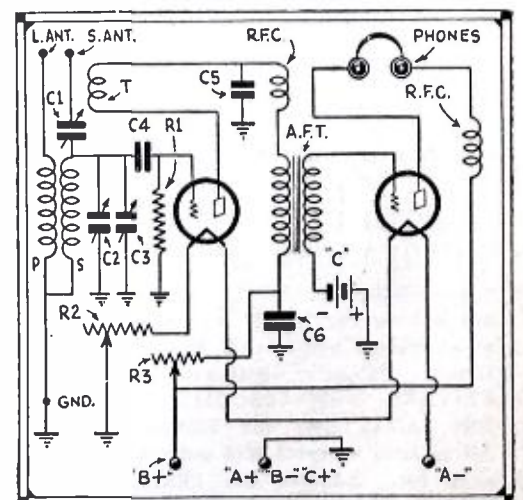

Mr. Dubuc used this hook-up in his 2nd prize winning set.

Third Prize \$12.50

Alfred H. Rowe, Jr.

(Continued from page 405)

A wire is soldered to the tap on secondary coil and then soldered to the post (C) or (K) on coil form. After the coils are wound and the equalizing condensers are bolted in place and the set is wired OK, pick up a station that is in about the middle of the band and then with a bakelite screwdriver turn the small screw on the equalizing condenser so that the station will be heard at about 50 degrees on the tuning dial. It will be noted that the rest of the stations will be spread over the tuning dial and they will be easy to tune in.

The set uses three of the type '30 2-volt tubes and they consume very little current. A set of two No. 6 dry-cells and one 45-volt "B" battery will last six to eight months with about four hours' use a day.

Western Electric phones are used most of the time, although a magnetic speaker will work on most of the strong broadcast and commercial stations. The .0001-mf. regeneration condenser, filament control jack and aerial binding post are mounted and insulated so that they will not touch the aluminum panel, while the .00005-mf. tuning condenser and ground binding post are mounted on it. The 10-ohm resistor is fastened to the inside of the ground post near the top right-hand side, so the filament voltage can easily be changed at will when the voltage of the "A" battery decreases.

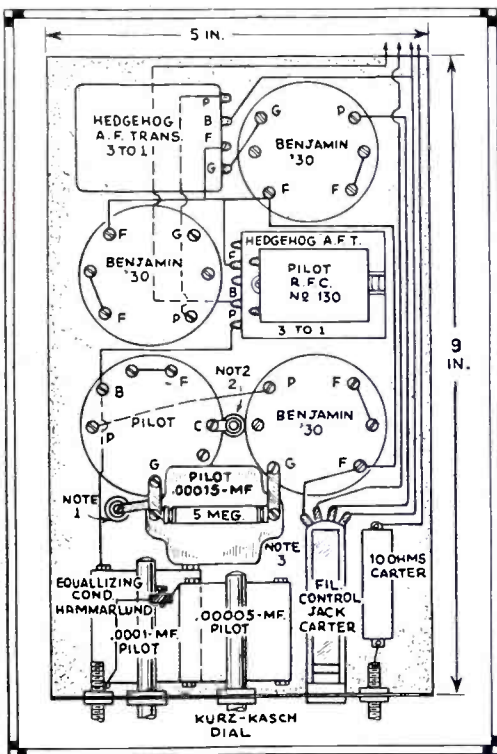

Placement of parts in Mr. Rowe's third-prize set.

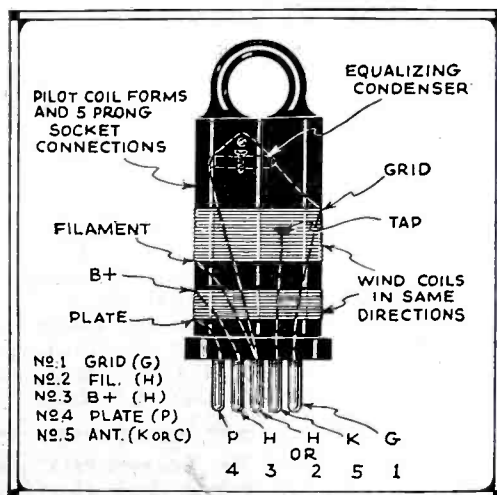

How Mr. Rowe winds his short-wave plug-in coils.

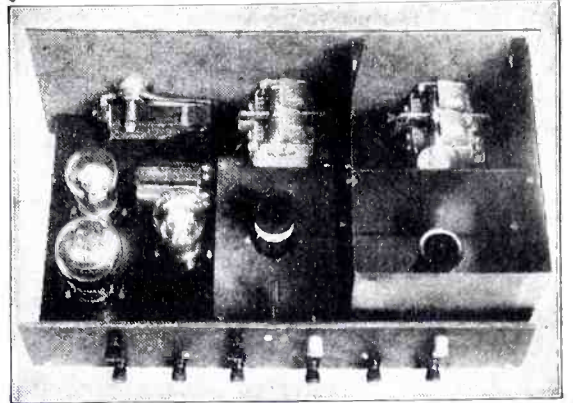
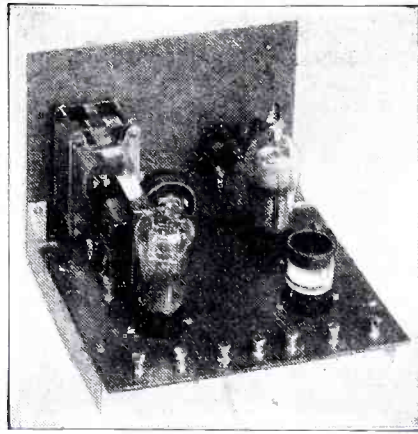

NEW LONG DISTANCE ELECTRIC SETS!!

We guarantee international reception on our popular Sets! Here's what our 3-Tube sets get on headphones (same stations on loudspeaker!) Packs of U. S. Stations, Canada, Indo-China, Siberia, Java, Australia, Mexico, Madrid, Spain, Argentina, etc. Complete Pentode two-tube set, \$12.00 less tubes. Complete Pentode 3-Tube set, \$13.00, less tubes. Lowest prices on accessories. See detailed description below. Its the modern tubes we use that does it! Our sets get anything on short waves, as well as ordinary broadcast reception! Get a modern set for less! (For unusual low prices, read every word in this ad; you may be surprised!) Here we go! . . . One Tube Set Complete (DC) \$7.95. Can be used as is, as a one-tube separate S.W. set, or as a converter for either an A.C. or D.C. broadcast set.

Build a simple oscillator to it, and make it a super-het. converter of the latest design. Kit of Parts, \$6.45. One-Tube AC Kit, \$7.45. TWO TUBE KIT (PENTODE IN AUDIO), DC, \$6.95. AC \$7.95. THREE TUBE KIT (PENTODE IN AUDIO); DC \$8.95; AC \$9.95. Above AC sets or kits need a \$3.45 filament transformer; also a B-Eliminator or power pack to complete them. AC sets, however, can be operated temporarily on B Batteries; buy the power pack later. The DC sets are very economical with 2-volt tubes which use only 2 dry cells and 2 B-battery blocks, which are very cheap now. Ordinary headphones, loudspeakers B-eliminators, aerial and ground connections can be used. We believe in showing you what you need; don't be deceived by prices that merely LOOK higher. All Kits are complete to the last washer, and come complete with a set of plug-in coils. Also a good set of instructions; show where to put each wire so you don't even have to know how to read hookups to build one. Of course, they are as good as any and much better than most!

SPECIAL HIGH GAIN QUALITY KITS: Give the greatest volume per tube of any existing sets. Pentode detector and pentode audio! TWO TUBE KIT, AC or DC, \$8.95. THREE TUBE HIGH GAIN KITS: Like 2-Tube Kit but with an extra stage of audio. AC or DC Kit, \$10.95. State kind of tubes to be used in your set, or current supply to be used. Better order short-wave tested tubes with your set! NOTE: The assembly charge on any of our 2- or 3-tube sets is \$5.00, for building and testing.

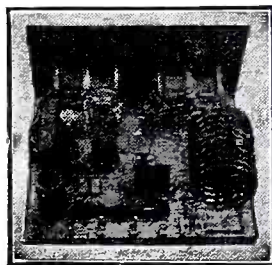

TRANSMITTERS! We

haven't much room to tell about them, but... Our Modern Kits furnish all necessary parts and hardware to build the transmitters as in photo. Full Instructions. Will operate AC or DC. Any tube or batteries or eliminators. Any power, from zero to 50 watts! All parts will stand up on high power. Range: 500 to 1000 miles on a receiving tube. MODEL A

TRANSMITTER: \$12.00; Kit, \$6.00. Hartley circuit. Easy to adjust and operate. MODEL B TRANSMITTER: \$13.00. Kit, \$6.95. Works in any two Ham Bands without changing coils! TP-TG Circuit. Can be used in new Band at 160 meters. Phone attachments \$1 extra. Helms Modulator Kit for either of above transmitters, \$9.95. Fil. Transformer, \$3.45. Transmitting tubes 95c. Keys, \$2.25. Nicked "Mike", \$5.95. MODEL C TRANSMITTER: Push-Pull. Can be used at high power. Great stability. Efficiency high. Kit, \$8.95. Complete \$14.95. ULTRA SHORT WAVES: Super-regenerative 4-7 meter receiver. Kit, \$12.00 Push-Pull 5-Meter Transmitter Kit, \$12.00. Developed by A. Binneweg. Push-Pull Crystal Oscillator Kit, \$8.95. Xtal holder, \$1. (80 and 160-Meter crystals, \$3.95. 40-Meter Crystal, \$4.95.)

Complete set of slightly used parts to build a 2-Tube Short-Wave set, panel, tuning condenser, set of plug-in coils etc., \$3.95. Parts for 3-Tube set, \$4.95. Instructions furnished. Good used parts are better than cheap new ones! No taxes on used parts! Parts for 4-tube, \$8.95. For Hartley transmitter, \$4.95; for TP-TG Transmitter, \$5.95. NEW PARTS: 2-Gang, 00015 condensers, \$2.00. 3-Gang, \$3.00; 4-Gang \$4.00. Four position coil-changing switch, \$2.60. Complete Short-Wave Superhet Assembly (includes above switch), \$5.50. 50,000-ohm regeneration controls, \$1.00. 25, 35 and 50 mmfd., midjet condensers, 80c ea. 100 mmfd. 90c. Include sufficient postage on small orders.

NEW PENTODE SETS!!

Here is the most powerful receiver on the market offered at a reasonable price!! Available in both AC and DC Models. With Four Modern Tubes, a Tuned Pentode Input, and Pentode Output, it is a greater Distance Getter than any other Type of receiver or Converter in its price class! Four Times as much Distance as on a Converter! Economical in Operation. If other sets get distance, this set gets MORE DISTANCE and Greater Volume. Gives FULL BROADCAST BAND COVERAGE with a single coil (No other set does this!). Tunes from 14 to 550 meters (and also up to 2000 meters with extra coils). Note the special two-gang condensers. Special connections eliminate hand capacity. Gives full dial spread on short-wave stations; easy to tune. Uses latest, long, low-loss coil forms. Heavy, shielded R.F. compartment (photo shows cover removed). All Modern Features. An entirely new design! Neat, colored, metal chassis. We manufacture them. Kits come Complete with all necessary hardware and a set of coils. (Broadcast Coil, 85c extra). Kits come set up as shown in photo but not wired. DC Kit (uses any desired style of DC Tubes), \$19.95. AC Kit, \$23.95 (includes filament transformer). You can't buy the parts for that! Magnavox Dynamic Speaker \$1.00 extra. AC Kit uses any standard power pack, or your own B-eliminator. Full, simplified Instructions (several pages) furnished with Kits, so that anybody with little or no experience can build and tune one of these remarkable sets. Order tubes with your set; lowest prices; can be sent safely; you can't always get the new tubes locally. . . . Dealers! Write for quantity prices. We charge \$8.00 to wire the above kits.

SPECIAL!! Plug-In Coils for 15 to 125 meter range, for 4-prong plug-in, set of 3, for Detector use, \$1.10 postpaid with hookup diagram. For R.F. Amplifier use, 15-125 meters, set of 3, \$1.05 postpaid.

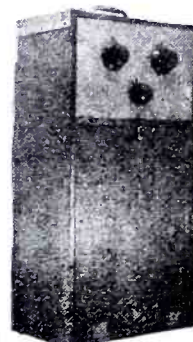

Here's your PORTABLE SET!!

Takes up minimum space, easy to move around. All complete as shown. GIVES FINE LOUD HEADSET VOLUME ON ANY SHORT WAVE. Will also get ordinary broadcasts. Light in weight; very popular for airplane, auto and yacht use. 1000 miles on small aerial. Extras slip inside case. Uses 2, 2-volt tubes and PENTODE (works like 3-tube set!)

Size: 9"x18"x7" deep. The small set itself at the top of the case is completely enclosed and can be slipped out like a drawer for separate table use with any kind of tubes and batteries. Complete Kit, including case and tubes, \$18.00. Completely assembled Set, \$25.00.

Although sufficient information is given above about our various products to order intelligently, you may desire to see our complete line; Send few stamps for our wholesale catalogue before ordering anything not described here; the prices will surprise you. There are receivers and Kits, transmitters and kits, coils and coil-winding sets, wavemeters, radio frequency amplifiers and kits, code practice sets, and complete lines of inexpensive sets, parts and set-building instructions. 2% off for cash in full. If C.O.D., send about 15% deposit in \$1.00 Bills or stamps, pay rest to postman when delivered.

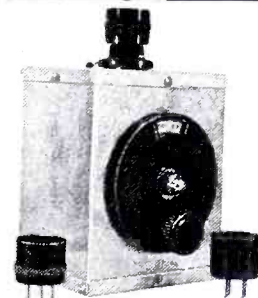

(List Price, \$15.) (We have a special wavemeter for Superheterodynes and S. H. Converters. Ask for leaflet.) HAM-BAND WAVEMETER. Looks like above meter. 1/4 of 1% extreme accuracy. With calibrated coil for any one Ham Band, \$7.95. For each extra Ham Band, Add \$2.

DELFT

DELFT RADIO MFG. CO.

524 Fairbanks Avenue

Phone: Higate 0748

OAKLAND :: CALIFORNIA

Devoted Entirely to

Short Waves and

Ultra-Short Waves



If you want to SAVE trade at JERRY'S

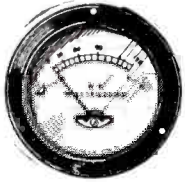

HOYT ANTENNA METERS!!!
Hot wire antenna meters 1 1/2 and 3 ampere ranges. Why do without antenna meters when you can buy them at Jerry's, who knows what the "Ham" wants? Special low price...\$2.95 each Hoyt perfectly damped meters at a price. These are not to be confused with the usual meter "bargains." 2" mounting hole, flange 2 3/4" diameter, supplied in the following sizes: 10 m.a., 50 m.a., 100 m.a., 150 m.a., 250 m.a., 300 m.a., 4 vol. A.C., 10 volt A.C., 15 volt A.C., 10 volt D.C. Price each...\$1.60 Three for...\$4.50

G. E. 1/4, 1/2, 1 watt Neons	\$.55	Filament transformers, 2 1/2 V.—2 1/2 V. and 7 1/2	\$1.50
866 Heavy duty tubes	2.50	30-henry 80 m.a. chokes	.60
281-M	1.75	Ebonite panels, beveled edges, 3/8" thick (easily drilled)	1.10
281	1.00	8 1/4" x 25"	.95
210	1.40	8 1/4" x 20"	.70
217	.60	8 1/4" x 15"	.60
230	.70	8 1/4" x 10"	1.10
Enamel solid copper wire, any length, No. 14, per 100 ft.	.30	10" x 16 1/4"	1.10
Enamel solid copper wire, any length, No. 12, per 100 ft.	.45	Hammarlund band spread condenser, 20 and 100 mmf.	2.10
Enamel solid copper wire, any length, No. 10, per 100 ft.	.80	Transformers for 866 tubes, 2 1/2 V. 10 amp.	2.65
Enamel solid copper wire, any length, No. 8, per 100 ft.	1.20	Aerovox Dry 8 mfd. Electrolytics	.85
13 1/4" sure fire porcelain insulators	.80	Erpee lightweight phones	1.35
6" stand-off insulator, wood screw in base.	.25	Baldwin Type C mica diaphragm phones	3.75
Egg strain insulators, 6 for	.35	Thordarson double chokes, 36-henry, 250 m.a.	7.00
10 Volt filament transformer, 7 1/2 amps.	1.25	Special 30-henry, 250 m.a. chokes	2.75
Mike transformer for single-button hand mike	.85	4" Kurz-Kasch dials	.50
Stand-off insulators (beehive)	.07	2 3/4"	.40
Midget stand-off insulators	.10	Aluminum, cut to any size specified:	
R. C. A. single-button hand mikes	1.75	1/16" thick per sq. in. 7/10c	
Filament transformers, 2 1/2 and 5-V.	1.25	3/32" thick per sq. in. 3/4c	
Filament transformers, 2 1/2-2 1/2 and 5-V.	1.35	1/8" thick per sq. in. 1c	
Filament transformers, 7 1/2-7 1/2 and 2 1/2-V.	1.50	Aluminum cans:	
Franklin transmitting key	.75	6 x 5 x 9	1.45
Eby Isolantite sockets	.17	7 x 6 x 10	2.10
Eby Bakelite UX and UY sockets	.15	7 x 7 x 12	2.50
Tube Shields	.12	7 x 8 x 14	3.40
Isolantite Zepp spreader 2 or 3-inch	.40	Kester solder, per lb.	.40
5-meter receiver oscillator coil	.75	Bakelite tubing, 2" dia. 2 3/4" long	.10
The new type 83 full-wave 5-volt filament mercury rectifier tube	.90	D. C. Wire:	
Midget 2.5 V. C.T. filament transformers, 7 amps.	.90	1/2 lb. spool No. 22	.35
Midget 7.5 V. C.T. filament transformers, 3 amps.	.90	1/2 lb. spool No. 24	.45
Power transformers for use with the new 46 tubes, 415 V. each side of C.T. at 200 m.a., three 2 1/2-volt C.T. windings	4.75	1/2 lb. spool No. 26	.55
Midget power transformers, 350 V.—350 V. C.T. 2 1/2 V. and 5 1/2 V. filament	1.35	Bakelite coil forms, UX Hammarlund Isolantite forms, 4, 5 and 6 prong	.57
Keying Relays! Will operate on one dry cell, can be used as a single-pole single-throw, double-pole single-throw, also has an extra back contact which is very convenient for many purposes.	.95c	Signal buzzers	.70
		Mica condensers, .002	.06
		Condenser microphone kit	3.00
		5-wire cables	.15
		Crowe full vision dials	.90
		Lynch transposition insulators, use in lead-in for quiet reception	.15
		G. R. 25-ohm rheostats	.25
		3" aluminum coil shields	.05
		Fahnestock single clips, per doz.	.15
		Fahnestock double clips, per doz.	.25
		Screen grid clips, 4 for Pilot 20, 50 or 75-ohm resistors	.10
		Aluminum brackets:	
		1 x 8 1/2"	.23
		2 x 9"	.35
		5-ft. 2-wire cord and plug	.10
		UX & UY wafer sockets	.05

The rest of the parts are mounted on the inside of the aluminum base. The coil socket is raised off the base by two 1 1/2-inch pillars, while the wiring of the set is raised 1/4 inch from the base.

The grid condenser and General Radio jack is soldered direct to the post G on coil socket, while the other end of the condenser goes direct to post G on detector socket. The other General Radio jack is soldered to post C on coil socket. The General Radio plug is attached to a flexible wire which is connected to the stator plates of the .00005-mf. tuning condenser and the equalizer condenser that is in series with the aerial binding post.

The A.F. transformers used are of the Hedgehog 3-to-1 type, which occupy a space of only 2 x 1 1/2 inches.

Regular Pilot wound coils will work in this receiver if the General Radio plug is plugged into the jack marked (1) in diagram, or the following coils may be made up for the 80, 40 and 20 meter bands:

Wave Meters	Secondary Turns	Tap on Sec. Coil Turns	Tickler Turns
80	30	20 from fil. end	15
80	12	8 from fil. end	11
20	8	5 from fil. end	7

No. 24 enameled wire is used for all coils. Tickler is spaced 1/4 inch from secondary. Wind all coils in one direction.

The following is a list of the parts:

- Aluminum box, 9 x 6 x 5 inches (Blan, the Radio Man).
- Benjamin 4-prong sockets.
- Pilot 5-prong socket.
- Pilot 5-prong coil forms.
- Hedgehog 3-to-1 A.F. transformers.
- Pilot R.F.C. No. 130.
- Pilot .00005-mf. midget condenser.
- Pilot .0001-mf. midget condenser.
- Carter open circuit filament control jack.
- Pilot .00015-mf. grid condenser.
- Pilot 5-megohm grid leak.
- Carter 10-ohm resistor.
- General Radio jacks and plugs.
- Hammarlund equalizing condensers.
- Kurz-Kasch 3-inch dial.
- 4-foot, 4-wire cable.
- Pair hinges, nuts and bolts, lock washers, and two binding posts and fiber washers for jack, antenna binding post and regeneration condenser.

Fourth Prize \$7.50

Angus G. Neaves

(Continued from page 405)

The two compartments is an aluminum shield 4 inches high and 6 inches deep. In the detector compartment is placed the detector tube (T32), second coil (L2), rheostat (R6), battery switch, radio frequency choke (RC2), grid leak and condenser and blocking condenser (C6). Condensers C3, C4 and C5 are placed in the radio frequency compartment. The third compartment contains the regeneration condenser (C2) and the two stages of audio amplification. The detector and amplifying stages are separated by the same type shield used between the radio frequency and the detector circuits. After a great amount of experimenting I have

found by using a good 5-to-1 ratio audio frequency transformer between the detector and first stage gives the finest reception for ear-phone work. Between the first and second stages resistance coupling gives the finest tone with the least distortion, I have found. In the diagram you will notice that a double-pole, double-throw switch is employed to change the phones or loud speaker from one stage to another without changing the plug.

The rheostat (R6), phone jack, both switches and variable resistance (R1) should be insulated from the panel with bakelite bushings.

The first evening the perfected receiver was put into operation the following stations were received within a short period: FYA, Pontoise, France; G5SW, Chemsford, England; I2RO, Rome, Italy; VE9GW, Bowmanville, Canada. All this distance was obtained using a V-shaped aerial containing 45 feet of No. 12 enamel covered copper wire, 30 feet high.

The battery tubes used are of the 2-volt type, consuming very little current, and under normal use of the receiver one should get from five to six months on one set of dry cells. The tube chosen for the radio frequency circuit is a type 34 radio frequency pentode, which has very high amplification factor. The detector tube, being the 32 type, acts as a high grade detector with easy control of the regeneration, even with 90 volts on the plate. The type 30 tube used in the first stage serves as an excellent amplifier, having only 90 volts on the plate. In the last stage a type 33 pentode is preferably employed. The loud speaker used was the R.C.A. 100-B magnetic speaker.

The parts used are as follows:
L1, L2—2 sets of Octocoils. (See April issue for turns data.)

- C1—140-mmf. Hammarlund 2-gang condenser.
- C2—250-mmf. Hammarlund condenser.
- C3, C4, C5—.01-mf. Flechtheim blocking condensers.
- C6—.25-mf. Dubilier blocking condenser.
- C7—.00025-mf. grid condenser.
- C8—.01-mf. condenser.
- R1—500,000-ohm variable resistance.
- R2—1-megohm resistance.
- R3—.25-megohm resistance.
- R4—4-ohm filament resistance.
- R5—8-ohm filament resistance.
- R6—30-ohm filament resistance.
- R7—5-megohm grid leak.
- RC1, RC2, RC3—85 millihenries choke.
- T34—R.C.A. 34 tube.
- T32—R.C.A. 32 tube.
- T30—R.C.A. 30 tube.
- T33—R.C.A. 33 tube.
- 5 Pilot 4-prong sockets.
- 1 Pilot 5-prong socket.
- 1 Dejur binding post strip.
- 1 7 x 18 inch aluminum panel.
- 1 6 x 16 inch baseboard.
- 1 5-to-1 ratio audio transformer.
- 1 Battery switch.
- 1 Yaxley phone jack.
- 1 Yaxley panel mounting D.P.D.T. Sw.
- 1 Grid leak mounting.
- 2 Aluminum shields, 6 x 4 inches.
- 1 National type C vernier dial.

5TH PRIZE WINNER

The fifth prize winner (\$5.00) in the August contest was Mr. R. B. Kingsbury of Wilmington, North Carolina, and his excellently designed set

will be described in the next number of SHORT WAVE CRAFT. Honorable mention for a very attractive little short-wave receiver, complete with batteries, all built into a cigar box, goes to George W. Buncie, of Olmstead Falls, Ohio; picture and diagram of his set will also appear in the next issue, due to lack of space.

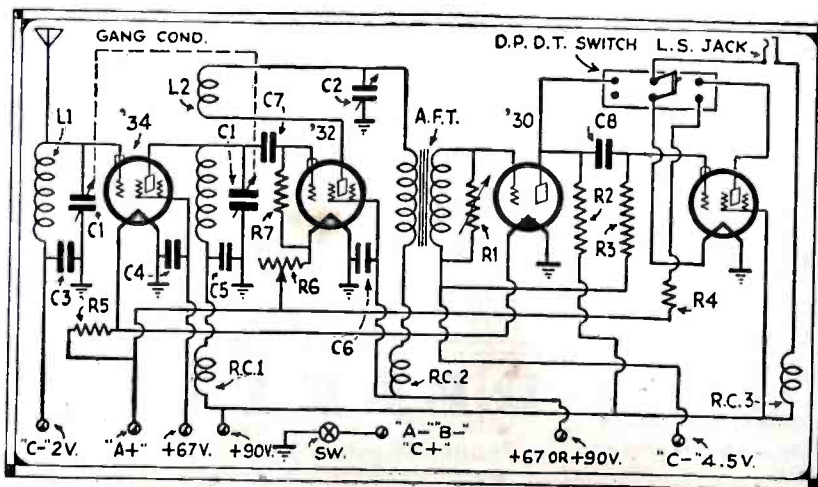

Mr. Neave's "DX" receiver has the four tubes connected per this diagram.

Complete Line of Standard Parts
JERRY'S PLACE
23 WARREN ST. (Dept. C) NEW YORK

VOTING CHART
 For Short Wave Craft's
 "COMPOSITE" RECEIVER
 (Continued from page 422)

List may be copied so
 as to preserve magazine.

Vote "yes," "no,"
 or "number"

Number of tubes	
Types of tubes	
A.C. Operation	
Battery Operated, 2 or 6 volts	
Regenerative Detector	
Tuned Radio Frequency	
Superheterodyne	
Super-Regenerative	
Number of Controls	
Portable	
Shielded or Non-shielded	
Band Spread Tuning—What Type?	
Tuning Meter	
Automatic Volume Control (AVC)	
Plug-in Coils or Coil Switching	
Resistance, Impedance or Transformer Coupled A.F.	
Power Output in Watts	
Push-Pull or Push-Push A.F.	
Provision for Phones	
Filament Control on Panel	
Tone Control	
Line Voltage Control	
Band-Pass Tuning	
Push-Pull R.F. (Radio Frequency)	
Duo-Diode Detector	
Type of Regeneration Control	
Regeneration Control by Meter	
Sets for Entertainment Purposes	
Professional Purposes	
Amateur Purposes	
Headphone Operation	
Loud Speaker Operation	
Voice Reception	
Code (C.W.) Reception	
Foreign Reception	
Local Reception	
Selectivity	
Sensitivity	
I now have a short-wave receiver of the following make or design	

ANNOUNCING

a new method of Mastering the Code
 a complete scientific course in Radio Code

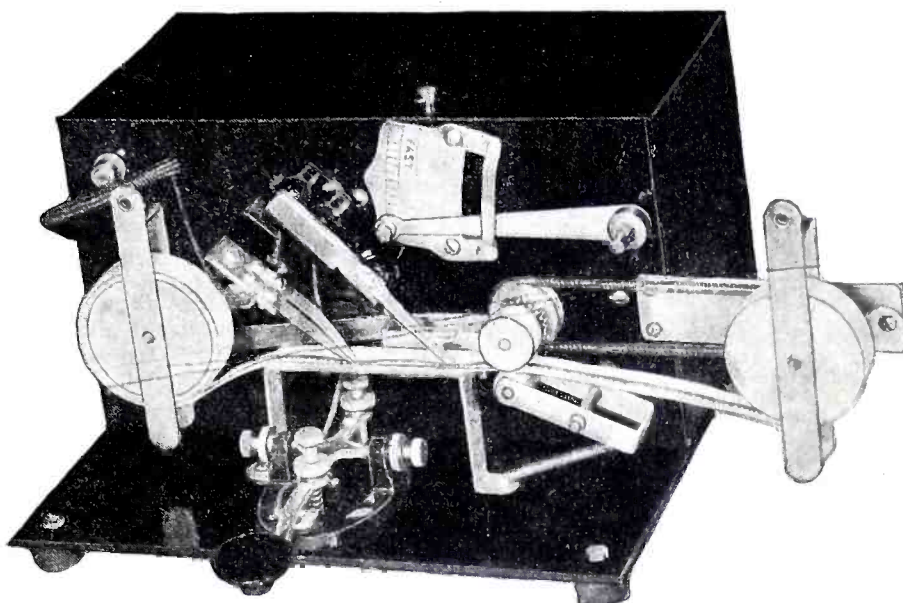

The Master TELEPEX records your own sending in visible dots and dashes and then repeats them to you audibly on the headphones.

5000 words on each tape and the number of tapes available unlimited.

The only instrument of its kind ever made that will record your own sending and repeat it back to you.

Originally this machine was not intended for individual instruction, because it is too expensive. It was developed for the United States Signal Corps to be used for class room instruc-

tion. However, we have formulated a plan that makes this instrument available to any and all individuals.

This machine will give you a complete course in radio telegraphy that will qualify you to pass the Government Examination.

Professional radio operators will find this instrument of inestimable value to increase their speed and accuracy in sending and receiving and also in mastering the American Morse code and qualifying you for an extra class license. Test your own ability by receiving your own signals.

This machine cannot be purchased through dealers.
 It is obtainable only from us.

Teleplex

TELEPLEX COMPANY,
 76 S Cortlandt Street,
 New York City.

Please send me your plan how I can get the full use of this machine without buying it.

Name

Address

City..... State.....

FREE CATALOG

on one of the largest international connector lines for all short wave, broadcast, experimental and servicemen. Write to

BANK'S INTER-AIR PRODUCTS

Woodside, L. I., New York City

42
Coil-plugs shown, ideal for 5-meter work. 55 post takes all the plugs, plain Battery markings for short wave sets. 7 colors.

46

111

113

RADIO'S REWARDS

are rich for those who are prepared. Study all branches of practical radio at RCA Institutes, America's oldest radio school. Resident schools in New York and Chicago. Also extension courses for home study on new "no obligation" enrollment plan. Catalog upon request.

RCA INSTITUTES, Inc.
 Home Office, Dept. SW-111
 75 Varick St. New York

IN 1936

You will be interested in tracing the early developments of Short Waves. Your best source of information will be **SHORT WAVE CRAFT**. Back numbers may be had at 25c per copy. Address: **SHORT WAVE CRAFT**, 96 Park Pl., New York.

A 3-Tube "Signal Gripper"

(Continued from page 403)

converter device—the electrical changes which occur in the plate current of V3, by actuating electro-magnets and diaphragm, produce energy in the form of sound waves. Be it noted that the "steady" plate current creates no sound, but only the variable component.

The panel size is 7x12 inches and wood baseboard, 8 x 11 inches, the latter being mounted on 1/2 x 1/2 x 8 inch wood cleats.

Mounting Condensers

Though the three variable condensers on the panel make the set appear Babylonian, the beginner need not fear their price, for the Pilot and other companies now have on the market a very compact 23-plate midget size which has practically the same capacity as those shown in the photograph for the R.F. and detector stages. It might be supposed that vernier dials would be necessary for tuning these stages, but the ease of tuning-in stations with common 2-inch dials on the condenser shafts (C, C7) can hardly be appreciated until the set is actually built and is doing its duty. For the position of the condensers, all are on the same level (2 1/4 inches from top of panel) with the end ones 2 1/4 inches and the center one at the middle. This permits clearance for the end condenser rotor plates if the set is to be mounted later in a cabinet. The condensers (C6 and C7) have four rotor plates and the throttle control condenser C5, to the extreme left, has a total number of 17.

The three UX tube sockets for the '30 type tube are mounted on the baseboard directly behind the panel variable condensers with about 1/2 inch clearance (this will be sufficient also if 01A's are used) and in line with these are the plug-in coil sockets, with each 4 inches from the center of the transformer, thus making the R.F. and detector stage coils 8 inches apart. A good reason exists for this distance. If coils S6 and S7 are too close, the coupling will be too "tight" and the set will give the R.F. "plop" or "howl." Thus the coupling between these two stages should be through condenser C3 and not between the coils.

Coil Details

Through an elaboration of constructional facts, the details for the coils have now appeared for consideration. These may be wound on the regular size *tube bases* and elsewhere in this article appears the necessary data for those who wish to "roll their own." Those shown in the photograph were purchased from the Delft Radio Co. and seem to be superior to those made on tube bases.

Several reasons may be mentioned why they are better—the forms are genuine bakelite, while a flock of tube bases today are more or less porous composition material; if metal subpanels are used and the coils are too close to it (as would occur with tube bases) a great deal of the R.F. energy "shoots" to ground because of the *condenser action* between coil windings and subpanel, and the coils, as seen from the appreciative side, make a set appear more majestic.

Memorized Knowledge Proves Valuable

After constructing this set and trying to get it to work in a decent manner, "old man trouble" was not far away. There existed right at the point of maximum sensitivity that "plop" or "howl." At first it was thought to be due to the closeness of the R.F. and detector stage coils, but recalling that mistakes are made in the process of manufacture, the idea of correction was followed out to make things right. It is a well-known fact that when an audio transformer coil has reverse connections made to it, that coil will act as a "tickler" and due to its large value of inductance and capacitance, there results the audible (audio) "howl." Sure enough, that proved to be the "bugaboo," for the connections from the transformer coil had been run to the wrong binding posts on the shell. Instead of the "P" terminal of V2 going to "P" on the transformer and "B" bat-

tery connection to B-plus on the same, connections were reversed with "B" battery going to "P" on the transformer and B-plus to "P" on the tube socket of V2. And "old man trouble" flew to another job, for the stations that poured in with their melody indicated that his services were no longer required.

List of Parts for "Signal Gripper"

- 1 Panel, 7 x 12 inches.
- 1 Baseboard, 8 x 11 inches.
- 2 Wood cleats, 1/2 x 1/2 x 8 inches.
- 2 .00014-mf. variable condensers (C6, C7) and 2-inch dials.
- 1 .00035-mf variable condenser (C5) and 2-inch dials.
- 4 Pieces of sheet copper, 1 x 1 1/4 inches (C2, C3).
- 5 UX sockets.
- 1 5:1 transformer (T2).
- 7 Fahnestock clips.
- 2 R.F. chokes.
- 1 .0001-mf. grid condenser (C4).
- 1 5-megohm grid-leak (R4).
- 1 20-ohm rheostat (R).
- Hook-up wire, screws, etc.

Coil Data

Range	Coil Turns		
	R.F. S6	S7	DET. S8
15- 25 meters	4	4	4
24- 45 meters	8	8	5
40-110 meters	20	20	6

All coils wound with No. 24 D.C.C. copper wire. Note also the feature that the coils give ample tuning range for the 20, 40, 80 meter short-wave code and phone amateur bands.

Short Wave Events of the month

- Aug. 21—Arrival of Mollison, 4:35 1/2 to 5:09 p.m. (N. B. C.)—W2XAD, 15,530 kc., WGY.
- Aug. 24—Promenade Concert from London, England, 3:58 to 4:30 p.m. (C. B. S.)
- Aug. 26—Talk by Mollison to Australia, actually 7:16 to 7:26 and again 7:27 to 7:35 a.m. (N. B. C.)—W2XAF, 9,530 kc., WGY.
- Aug. 27—Stanley Baldwin, former Prime Minister of England from London, speaking on "The Imperial Conference," 5 to 5:15 p.m. (C. B. S.)
- Aug. 28—High Goal Polo Match from Sands Point, Long Island, 5 to * p.m. (C. B. S.)
- Aug. 28—Talk by Outstanding Speakers, Honorable Bruce, 7:45 to 8 p.m., E.D.S.T. (N. B. C.)—W2XAF, 9,530 kc., WGY.
- Aug. 31—Talk, Hon. Bruce to Australia. (N. B. C.)—W2XAF, 9,530 kc., WGY.
- Sept. 1—National Air Races from Cleveland, 9 to 9:15 p.m. (C. B. S.)
- Sept. 3 and 5—Harmsworth Trophy Races, 7:15 to 8 a.m. (N. B. C.)—W8XK, 11,870 kc., KDKA.
- Sept. 4—High Goal Polo Match from Sands Point, Long Island, 5 to 6 p.m. (C. B. S.)
- Sept. 10—High Goal Polo Match from Meadowbrook, 4:30 to 5:30 p.m. and 5:45 to 6 p.m. (C. B. S.)
- Sept. 11—High Goal Polo Match from Sands Point, 5 to 6 p.m. (C. B. S.)
- Sept. 12—Pan American Concert, 10:30 to 11 p.m., E.D.S.T. (N. B. C.)—W2XAF, 9,530 kc., WGY, and W8XK, 11,870 and 6,140 kc., KDKA.
- Sept. 12—Colonel Stoopnagle and Budd broadcasting with the mighty gas-pipe organ from two airplanes of the American Airwaves flying over New York City, 10:15 to 10:30 p.m. (C. B. S.)

KEEP UP WITH RADIO

An opportunity for RADIO MEN to enlarge their scope of training

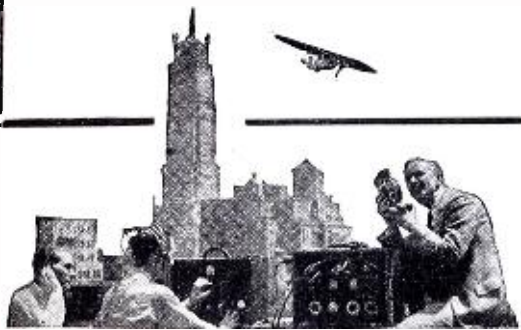

NEW GENERAL COURSE IN RADIO combines Broadcasting . . . Sound Motion Pictures . . . Aircraft Radio . . . Marine Radio . . . Radio Servicing . . . Home and Studio Recording . . . Television Fundamentals . . . Electronic Tube Applications . . . Radio Code . . . Public Address Systems . . . and other radio and allied subjects.

In a 52-week GENERAL COURSE

At the New York School

At a moderate cost which may be paid \$10 weekly until tuition fee is completed. A graduate of this course is well fitted to handle practical radio engineering problems.

No matter how much or how little knowledge of radio you have, there is a distinct advantage in taking this course. Further details will prove it.

If you wish to specialize in a particular phase of radio or associated arts, send for a copy of our illustrated catalog which contains all particulars about RCA Institutes' various Resident School Courses.

Visit our RCA institutes School in New York or Chicago. You will find them modern, fully-equipped, and ample in scope for the ever-growing field of radio. We shall be glad to see you at any time of day—morning, afternoon or evening—from Mondays to Fridays inclusive.

Whether you plan a visit to us, wish to enroll for a resident school class, or merely wish a free copy of the new RCA Institutes catalog, fill in and mail the coupon below.

RCA RCA Institutes, Inc., Dept. SW-11.
New York School and Head Office:
75 Varick Street, New York, N. Y.
INSTITUTES
Chicago School:
1154 Merchandise Mart,
Chicago, Ill.

Please send with no obligation to me:

- () Full information on the New General Course in Radio. (At New York Resident School only.)
- () Illustrated catalog and information about specialized resident school courses in radio and allied arts.
- () Information about extension courses for study at home, together with illustrated catalog.

Name..... Age.....
Address

FREE Amateur and Servicemen's Wholesale Guide

Hot off the press! Chock full of the latest of everything for the Radio Serviceman, Amateur, Experimenter. Detailed illustrations; vital and interesting facts. Valuable tips that mean money in your pocket.

Astonishing Low Wholesale Prices—Hundreds of "Hot Shot" bargains at deep cut prices that challenge all America.

WRITE TODAY—A free copy of this record smashing book is ready for you. Write for it today!

BURSTEIN-APPLEBEE COMPANY
1408-A McGee Street, Kansas City, Missouri



9-Tube Plugless Super

(Continued from page 417)

Parts List

- C and C1—National "Equitone" condensers, 100 mf., variable (2).
- C2—Hammarlund midget condenser, 80 mmf. (1).
- C3—Aerovox type 1450 mica, .0001-mf. grid condenser (1).
- C4—Aerovox type 1450 mica, .001-mf. (1).
- C5—Single DeJur-Amsco Varitor, 10 to 70 mmf. variable (1).
- C6, C8—Aerovox type 1450 mica, .006-mf. (3).
- C7—Trutest by-pass .25-mf., 3 double units (6 condensers) and 4 single units.
- C9—Aerovox type 1450 mica, .00025-mf. (1)
- C10—DeJur-Amsco Varitors, 3 double units, furnished with I.F. transformers, item L6).
- CH—Trutest 3-section 24 mf. dry electrolytic condenser.
- L1, L2, L3—Trutest short-wave superhet coil and switch assembly.
- L4—Trutest 8-millihenry chokes (4).
- L5—Trutest 5.5-millihenry choke (1).
- L6—DeJur-Amsco short-wave intermediate transformers, 465 kc. type.
- L7—Trutest heavy duty chokes, 30-henry (2).
- R—Trutest resistor, 10,000-ohm, 1-watt (1).
- R1—Trutest resistor, 2,000,000-ohm, 1-watt (2).
- R2—Clarostat, 50,000-ohm (1).
- R3—Yaxley variable center tap, 200-ohm (1).
- R4—Trutest, 800-ohm, 3-watt (1).
- R5—Trutest 10,000-ohm, 2-watt (1).
- R6—Trutest 250,000-ohm, 2-watt (1).
- R7—Trutest, 2,000,000-ohm, 1-watt (1).
- R8—Trutest, 2,250-ohm, 1-watt (1).
- R9—Clarostat 25,000-ohm tone control resistor (1).
- R10—Universal voltage divider, 1,300 ohms, 4 taps; 2 used (1).
- R11—Trutest, 300-ohm, 3-watt (1).
- R12—Truvolt, 1,250-ohm, 25-watt.
- R13—Trutest, 700-ohm, 2-watt (1).
- T1—Trutest push-pull input transformer (1).
- T2—Output transformer on Temple dynamic speaker.
- T3—Trutest type 987 power transformer (1).
- SW—Cutler-Hammer toggle switch (1).
- Full vision high ratio dial, 1 or 2, depending on whether you wish single or double control.
- Eby Isolantite UY (5-prong) sockets (6).
- Eby UX (4-prong) sockets (3).
- Trutest tube shields (6).
- Trutest-Lafayette 7 x 12 inch aluminum shielded panel (1).
- Screen grid clips with shielded leads (4).
- Trutest male speaker plug, 5-prong (1).
- Cartons Corvico braidite hook-up wire, assorted colors (2).
- Temple A.C. speaker (1).
- 2 Lafayette 227 tubes (oscill. and first A.F.).
- 2 Lafayette 224A tubes (2 detector tubes).
- 2 Lafayette 235 (or '51) tubes (I.F. stages).
- 2 Lafayette 245 tubes (P.P. output amplifier).
- 1 Lafayette 280 tube (rectifier).

UNCLE DAVE

356 Broadway, Albany New York

We buy, sell and trade Ham stuff!

24 HOUR SERVICE SHIP ANY PLACE

If we have not got it we will get it for you!

8AD10 = 73 Uncle Dave W2APF

SETS

- Pilot Universal Wasp, 6 tube electric set, tunes 15 to 650 meters, no plug-in coils, less tubes, completely wired and assembled, NEW.....\$32.50
- Extra Special—Arceo 2-Tube Short Wave Set—Breadboard Style with coils for 20, 40 and 80 meter bands, with two 230-tubes..... 8.75
- National D.C. 4-tube Thrill Boxes..... 17.50
- New model Hammarlund Comet "Pro" in stock at lowest prices. Uses new "50" series of tubes.

MICROPHONES

- Extra Special—American Double Button Microphone. This Month Only, Type EL, net..... 5.00
- Universal watch case model, single button mikes. Universal Chromium plated single button "Baby-Mike" each..... 4.20
- Kodak microphone cases, each..... 1.49
- Universal "BB" bullet microphone, list \$50.00, our price is the lowest in the country at..... 28.00

METERS

- Readrite Milliammeters: 0-15, 25, 50, 100, 150, 200, 300 or 400, each..... .59
- 0-5 mills, each..... \$1.15; 0-10 mills, each..... 1.00
- A.C. Voltmeters: 0-6, 0-10, 0-15 volts, each..... 1.48
- Readrite No. 710 Set Tester, tests four, five, six and seven prong tubes, list \$25.00; our big special..... 14.00
- G.E. 0-500 milliammeters, new \$2.75; used..... 1.50
- ONE MONTH ONLY: Weston Model 301, 0-50 mills meter, each..... 3.39
- Learn the code: Teleplexes with 3 tapes, only..... 10.00

Bleeder Resistances

- 20,000 or 25,000 ohm 100 watt, each..... .79
- Ward-Leonard 10,000 ohm 60 watt, each 60c; 5000 ohm 25 watt, each..... .35
- W.E. polarized relays 1000 ohm D.C.—relays 3 mills at 3 volts, adj. shielded—will follow 40 WPM..... 1.95
- Mfg's. relay, follows 40 WPM, has two 1/2" contacts, unmounted..... .59

TUBES at lowest prices ever sold

- Arceo 15-watt 210 transmitting tubes, all first and guaranteed..... \$1.20
- 866 Heavy duty, each..... \$1.59 866 extra heavy duty 3.35
- 281M, new type, each 1.75 871 or 888, each..... 1.50
- 280M, each..... .90 UX250s, extra special..... .65
- 82M, each..... .65 Speed triple twin, ea. 1.83
- 56-57-58 tubes, each..... .75 23G-237-238 tubes, ea. .85
- Class "B" type 46 tubes..... .83 DeForest 510 tubes, ea. 3.85
- Rectobulbs R-3, each, 5.90 Rectobulbs R-81, ea. 3.40
- Heavy duty Soldering Irons, each..... .95
- Extra heavy duty soldering irons, each..... 1.65
- STANDOFF INSULATORS, beehive type, dozen..... .59
- Pyrex lead-in bowls, complete..... 1.45
- CRYSTALS: 80 or 160 meter xtals, ground to your frequency, with free adj. dustproof holder..... 4.50

CONDENSERS—SPECIAL!

- Arceo xmitting condensers (1 yr. unconditional guarantee)
- 1500 volt 2000 volt 3000 volt 3500 volt
- 1 mfd. \$1.75 1 mfd. \$3.50 1 mfd. \$7.25 1 mfd. \$8.00
- 2 mfd. 3.00 2 mfd. 6.00 2 mfd. 10.50 2 mfd. 12.00
- 4 mfd. 4.50 4 mfd. 10.00 4 mfd. 18.75 4 mfd. 22.00
- Very sturdily built, finest material, all cont. working D.C. voltage.
- Arceo unmounted condensers but sealed in paraffin, guaranteed 90 days.
- 600 volt 800 volt 1000 volt
- 1 mfd. \$1.20 1 mfd. \$1.30 1 mfd. \$1.45
- 2 mfd. .25 2 mfd. .40 2 mfd. .70
- 3.5 mfd. .35 3.5 mfd. .50 3.5 mfd. .90
- 4 mfd. .40 4 mfd. .60 4 mfd. 1.00

- WIRE: Genuine Acme, solid enameled aerial wire 100 ft. No. 10 ga. 95c; No. 12 ga. 65c; No. 14 ga. 50c 200 ft. No. 10 ga. 1.65; No. 12 ga. 1.25; No. 14 ga. 90c
- Arceo individually calibrated monitor, complete with tube, batteries, 20, 40, 80 meter coils, special..... \$ 9.35
- Arceo wavemeter with individual chart and coils for 20, 40, 80 meter bands, special..... 6.23

ARSCO XMITTERS AND RECEIVERS

- A new 5-meter xmitter \$8.95; in kit form..... 5.00
- A new 5-meter receiver \$17.95; in kit form..... 12.00
- Arceo Junior single 245 TNT transmitter, complete with power pack, tubes and mercury rectifier tube 13.95
- Arceo Senior push pull TPTG 245 xmitter, complete with tubes and mercury rectifier..... 18.95

OPEN
EVENINGS

Include Postage With All Orders and 20% Deposit Against C.O.D. Shipments

Visit Uncle Dave's New Radio Shack When in Town. Good Time Assured. 1st Four Story Building with over 35,000 square feet of space, devoted to nothing but parts. For Goodness' sake, what do you need? We sure got "it."—What have you for sale or trade?

Write for FREE
HAM Sheet

We Carry Everything for the Ham in Stock

More Foreign Trade Solicited

We also carry a tremendous stock of used parts, etc. Write in on special requirements and we shall be pleased to take care of you.

UNCLE DAVE'S RADIO SHACK

356 BROADWAY

Long Distance Phone 4-5746

ALBANY, NEW YORK

In the Next Issue!

Don't Miss

**"THE I-TUBE
SUPER-REGENERATOR
RECEIVER"**

By R. William Tanner

One tube does the work of
Three!

Get Started in
RADIO



Write for free booklet telling about this growing and most promising industry. The radio operator is an officer aboard ship. His work is light, pleasant and interesting. He has many opportunities

to travel to all parts of the world. A new course in TELEVISION now under way. Full information on request.

EDUCATIONAL DEPARTMENT
WEST YMCA 18 W. 63rd St.
SIDE YMCA New York

1933 Edition
**UNIVERSAL
CATALOG**

Keep posted on the new Universal products. Get your copy from your dealer.

New items include the superfine line of Bullet Type Microphones; the new compact Torpedo Microphones; the Watch Model "W"; the super-sensitive Mid-et Model "Y"; the sensational two-button, popular priced "X" and an ultra-modern line of Transformers that will set the pace for years to come.

Universal makes Tomorrow's New Developments Available Today!

UNIVERSAL MICROPHONE CO., Ltd.
424 Warren Lane Inglewood, Calif., U.S.A.

Turn to Page 442 and learn how to keep your copies of SHORT WAVE CRAFT intact for future reference.



**ADAPTER
No. 950XYL
CHECKS 40
DIFFERENT
NEW TUBES**

The new 950XYL adapter for use with all standard tube checkers tests the 36, 37, 38, 39, 44, 64, 65, 80, 293, 295, 55, 57, 58, 59 (7 prong), 41, 42, 82, 83, 85, 89, Wunderlich-A, Wunderlich-B, G-2S, G-4S, GA, LA, PA, PZ, PZH, 29, 33, 46, 47, 49, 52, 68, 69, 70, 985 and 986. All of these 30 new tubes are checked in any standard tube checker with this one adapter. Simple to operate. Has only one toggle switch which is used for the double plate tubes: 82, 83, G-2S, G-4S, 985 and 986. Attractive molded Makalot case—high grade construction and correctly designed to protect the sensitive diode tubes from ionization under test. The resistance network in this adapter protects the most sensitive checker instruments from harm while testing the mercury vapor and other high current tubes. Complete instructions on adapter. No lead, plugs or jacks to fuss with. Simple and dependable in operation.

No. 950XYL Universal Tube Checking Adapter. List Price.....\$6.00

ADAPTER DATA SHEETS

SEND 10c FOR NA-ALD ADAPTER DATA SHEETS giving 300 diagrams of adapters, directions and their use. Adapter charts included show instantly which adapter to use for checking all of the new tubes and analyzing their circuits. All tubes are included, from the early UV-200 and WD-11 to the latest 59, seven-prong tube.

Send for catalog of adapters and sockets of every conceivable type, speaker plugs, multi-wire connectors, microphone connectors and cables, coil forms, wound and unwound, short-wave broadcast, practice code-sets, dials, Fade-Outs, self-indicating fuses, etc.

SHORT WAVE PLUG-IN WOUND COILS



With a 150 mmfd. condenser these coils cover the following bands:
Blue ring coil... 12.5 - 25.5 meters
Red ring coil... 25 - 52 meters
Yellow ring coil... 50 - 100 meters
Green ring coil... 100 - 200 meters

NA-ALD set of Four Wound Short Wave Coils. List Price.....\$2.00

NA-ALD set of Four Unwound Coil Forms (Blue, Red, Yellow and Green Code Ring)..... 1.00

Wound Forms have standard UX bases. Unwound Forms may be ordered in either 4, 5, or 6-prong bases.

PRACTICE CODE SET

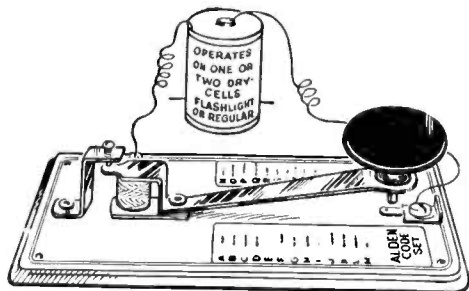

Adjustable pitch buzzer, nickel plated metal parts mounted on beautifully black molded Makalot base. Continental Code relief molded each side of key. Clips can be put in binding post to hold fountain pen flashlight battery. Great for practice—signals with wire up to 1000 feet—or grounded and connected to antenna sets as wireless transmitter for short distances—signal being received on any kind of set—connected to amplifier produces loud signal for group practice. Alden Code Set. Price, 75c

Alden Products Co., Dept. W.
715 CENTER ST.,
BROCKTON, MASS.

Learning the Code

(Continued from page 407)

cate a letter, these dots and dashes are usually spoken of as dit and dah, so you send A as dit dah, and B as dah dit dit dit, and C as dah dit dah dit and D as dah dit dit. The reason for this is that it really sounds that way when you listen to someone's transmission, the dots being very short and sounding like dit, while the dashes are longer and sound like dah, depending somewhat on the tone of the signal.

Now that you are acquainted with character A, go through the entire alphabet and memorize the rest of them. When someone says C you should be able to say—dah dit dah dit and not have to stop and think for a minute or more. You won't be ready to listen to any transmission until you are able to associate these dit dah things with the letter that they represent. You are now able to do two things: say the alphabet over both forward and backward and to transform the letters into dit and dah. Until you have mastered this part of the job of learning the code do not attempt to copy a transmission.

Unless you live way out somewhere you will find an amateur in your town or city. If you have not already made his acquaintance do so at once; you will find him a regular fellow whether he is fourteen or forty. Tell him that you are in need of someone to send the code so that you may have practice at receiving, ten to one he will arrange that you will receive this instruction. Be sure that who ever will do this for you will start off nice and slow. Two to three words per minute is fast. At first it will be necessary to have letters only sent with lots of time in between each letter. Get the hang of associating the dit dah with the letter it represents. Write it down as the letter and not as the character or dit dah. Do it the right way while you are at it, otherwise you will have to undo it at a later date.

About the time you are able to receive at the rate of 5 words of 5 letters each per minute, you will have spent several weeks' at two hours a day, so if you are not getting on any faster than that do not feel bad, as it is the average rate of learning. In a month you will do ten words per minute. About that time it will be safe for you to try your hand at the key. You will then know how a character should sound. Do not slur the dots and dashes. Make them distinct: allow the proper space between the dots and dashes. None of us uses the same time interval; that becomes part of the individual. Make the dash much longer than the dot, three to four times. It makes it sound lots nicer and it will also be easier to read.

Do not make the mistake of running the words together. Remember that some one else has to read what you send. As a rule the shorter the space between the characters themselves, the better the whole sounds. Have the dot or dash follow quickly. Make the dot as short as you can, follow with a short space and then make the dot if one follows nice and short; if a dash follows make it plenty long at first. When you have attained speed you will automatically cut down on its length.

In case you are so located that you are not able to get in touch with an amateur and you have no one who is able to send dots and dashes for you, there is still a way out. Look through the radio magazines and find a device called the Telepex, which consists of a clock work which drives a tape containing the dots and dashes. This can be run at any speed within reason, both fast and slow. One or more tapes can be purchased with the device. When connected with a battery it will teach you the code. As the short or long characters come under a finger it makes contact with the metal over which the paper runs. This closes a circuit of battery and tube and we have another sending device which does not get tired.

When I was teaching the class I made use of a set of records that had the code and complete sentences recorded on them. The advantage of these records was that they could be run off on any phonograph; no batteries were necessary.

Short Wave League

(Continued from page 424)

tions licensed for radiotelegraph service.

Radiotelephone operator third class.—Applicants for this class of license will be required to pass an examination covering the laws and regulations governing radio communication and the general procedure of handling radiotelephone traffic between mobile and fixed points in aeronautical or marine harbor service.

This class of license will be valid for the operation of mobile radiotelephone stations equipped for operation on a single frequency and with apparatus so constructed as to prohibit any change in adjustment by operators.

Passing Mark for All Examinations

The percentage that must be obtained as a passing mark in each examination is 75 out of a possible 100. No credit will be given for experience in the examination for any class of license.

Execution of Oath of Secrecy

Licenses are not valid until the oath of secrecy has been executed and the signature of the issuing officer affixed thereto.

All examinations, including the code test, must be written in longhand by the applicant.

Renewals

Renewals—(a) Commercial operator extra first class.—These licenses may be renewed without examination provided the record shows 12 months' satisfactory service at stations which the applicant is authorized to operate, at least 6 months of which have been during the last 12 months of the license period.

Provided further, That the holders of these licenses employed as radio inspectors, radio instructors, or in similar occupations requiring exceptional qualifications, where the duties require the testing, or demonstrating, or otherwise using commercial radio apparatus and the telegraph codes, may be issued renewals of their licenses without examination, provided such employment has covered a period of 18 months out of the 2-year license period. Where the applicant has not regularly used the telegraph codes, he will be given the code examination as for an original license, and if he has used only one code he will be examined in the code not used.

Other renewals.—Renewal licenses may be issued to holders of other classes (except amateur) without examination, provided the operator has had three months' satisfactory service during the last six months of the license term. One year's satisfactory service out of two years of the license term may be accepted for renewal at the discretion of the examining officer.

No credit will be allowed for service unless it appears that such service was obtained under conditions that required the employment of a licensed operator.

Renewals or new licenses may be issued a reasonable length of time prior to the expiration of existing licenses, but must bear the exact date of issue, which must correspond with the date on Form 756 forwarded to the radio division. Operators who fail to apply for renewal of their licenses on or prior to the date of expiration must be re-examined.

If, because of circumstances over which the applicant has no control, an operator is unable to apply for renewal of license on or prior to the date of expiration, an affidavit may be submitted to the radio division through the supervisor of radio or examining officer, attesting to the facts. After consideration by the radio division, advice will be forwarded to the supervisor of radio or examining officer in regard to the issuance of a renewal of the license.

Service records must be completed and signed only by masters, employers, or the duly authorized agents of either.

Any improper alteration of the service record or the forgery of the master's or employer's

(Continued on page 441)

Boy! Do They Roll in on This 1-Tuber!

(Continued from page 399)

knob of unit 20 slowly back until the signal clears up. Then readjust the master tuning control 7 for maximum volume.

Aerial and Ground

The aerial can be any length; use the same aerial that is connected to the receiver used for broadcast reception. Make sure that the connection to the ground is well made. Solder this connection if possible. Loose connections increase the noise that tends to swamp out the signal; the better the connections the less the noise and the more satisfactory the reception.

Troubles and Where to Find Them

Every radio set, no matter how simple, can refuse to work. The following information may be helpful:

If the Set Doesn't Work

- "B" battery connections reversed.
- Dry cells defective or worn out. ("A" battery.)
- Wires left off in the construction.
- Tube defective. (Have it tested.)
- Antenna touching the side of the house and "grounded."
- One of the windings of the coils "opened."

Tube Lights But Set Will Not Oscillate (Squeal)

- "B" battery run down. Voltage too low.
- Tube defective. (Tube can light and still be no good.)
- Feed-back connections wrong. Reverse connections x and y , Figs. 4 and 5.
- Open connection due to poor soldering or careless handling.
- Improper adjustment of condenser 2.

Set Works but Signals are Weak

- "B" voltage too low; increase the voltage by adding a new "B" battery in series.
- Tube old or defective.
- Adjust the small condenser 2 for maximum results.
- Increase size of aerial.
- Use "sensitive" phones. Phones may be defective.
- Poorly soldered connections. Resolder all connections, using a clean, hot iron.

These suggestions should help the fellow building his first short-wave receiver. If you have trouble, read these notes over again and see if you can be your own "trouble shooter."

Short-wave receivers of the more simple type have been described before but they have lacked several features that have been incorporated in this design.

Beginners have a habit of passing over any number of stations because they are used to tuning a broadcast receiver. A short-wave set should be tuned VERY closely, because if you don't you will miss them. Note that the main tuning condenser has but a few plates and is equipped with a vernier dial for critical setting. The effect of tuning this small condenser is that of spreading the 100-degree tuning range over a small portion of the total range, which could be tuned by means of condenser 7, which is very large. Thus with a very simple set of coils the "tuner-in" can pick out that portion of the various tuning ranges that will give the maximum tuning control for accurate tuning. This feature alone will be of assistance to the beginner trying to find out about these short waves.

As experience crawls upon us, short-wave reception will lose some of its mystery and the builder of this simple receiver can look for bigger and better sets to build, but in the meantime let's try and build this one first.

in hoc signo vinces

PATENT YOUR IDEAS

Small Ideas May Have Large Commercial Possibilities

This FREE Book shows how

If you hope to realize profits from your invention, you must protect it with a U. S. Government Patent. Otherwise you may find that all your time and labor have been lost, because it often happens that other inventors are working on the same idea. IF YOU HAVE AN IDEA, TAKE STEPS TO GET A PATENT AT ONCE! Your first step is to get my FREE BOOK. It tells you in simple, plain language just what you must do, how you must proceed in order to secure Patent protection.

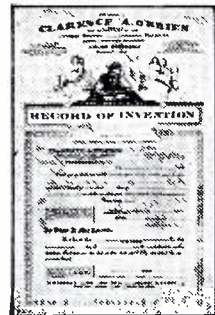

I Serve You in Secrecy

You can communicate with me in perfect confidence. Any drawings, sketches or letters you send me will be kept in strong, steel, fireproof files, that are accessible only to authorized members of my staff. I have served inventors located in every state in the Union. My service is prompt, careful, efficient. Your first step—the move you should make today—is to SEND THE COUPON FOR MY FREE BOOK.

"Record of Invention"

FREE If you act promptly I will send you this valuable Record of Invention blank absolutely FREE. It may help you to prove your right to your invention later on.

Clarence A. O'Brien

Registered Patent Attorney
WASHINGTON, D. C.

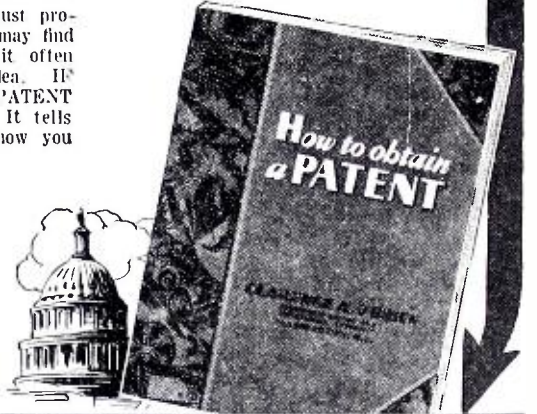

Mail to Washington!

Clarence A. O'Brien, Registered Patent Attorney, 23C Adams Building, Washington, D. C.

Please send me your free book, "How to Obtain a Patent," and your "Record of Invention" form without any cost or obligation on my part.

Name

Address

(Important—Write or print plainly)



You Can Become a Fast, Capable RADIO OPERATOR at Home

WITH THE FAMOUS CANDLER Scientific System

Fine opportunities for trained operators! Copy px easily from CANDLER trained operators sending out of WNU, KUP, WPN, KAA, WGG, WHD, NAA, NSS and others. FREE Px Schedule and other valuable information. Make reputation in Amateur field. results in short time. If "stuck," write Candler. No obligation. Learn about Junior Course for beginners, Advanced Course for operators with speed of 10 wpm or over who want to get in 45 wpm class and copy behind, also Radio Mill Course. Save Time and Money by sending for FREE BOOK today.

CANDLER SYSTEM CO., Dept. 28
6343 S. Kedzie Ave., Chicago

"Passed amateur exam, with 3rd lesson." — E. Miller, Toledo, Ill. "Studied 11 hours, can copy 8 wpm." — E. J. Yarris, Chicago. T. R. McElroy, Boston, Retired World's Champion Radio Operator, is Candler trained.

Amazing



World's Only Code Specialist

F. & H. CAPACITY AERIAL



Price \$1.00 Complete postpaid

Every Instrument Tested on Actual 1127 Mile Reception A LARGE NUMBER ARE IN USE BY GOVERNMENT, IN NAVY HOSPITAL

The F. & H. Capacity Aerial Eliminator has the capacity of the average 75-foot aerial, 50 feet high. It increases selectivity and full reception on both local and long distance stations is absolutely guaranteed. It eliminates the outdoor aerial along with the unsightly poles, guy wires, mutilation of woodwork, lightning hazards, etc. It does not connect to the light socket and requires no current for operation. Installed by anyone in a minute's time and is fully concealed within the set. Enables the radio to be moved into different rooms, or houses, as easily as a piece of furniture.

Dealers! Order sample. Write for information. Notice! For sale at all S. S. Kresge Dollar-stores, Gamble Stores, Neisner Bros., stores.

SEND COUPON, IT PROTECTS YOU

Name

Address

City State

Send one F. & H. Capacity Aerial with privilege of returning after 3-day trial if not satisfactory, for which enclosed find check M. O. or dollar bill, or send C. O. D. Send Literature, Dealer's proposition.

F. & H. RADIO LABORATORIES
 Fargo, N. Dak. Dept. SW

PATENT YOUR IDEAS REGISTER YOUR TRADE-MARK BY **Z. H. POLACHEK** 1234 BROADWAY 31st FLOOR NEW YORK

REG. PATENT ATTORNEY PROF. ENGINEER

WHAT IS YOUR INVENTION?
Send me a simple sketch or model for CONFIDENTIAL ADVICE

Train Now for New RADIO Opportunities

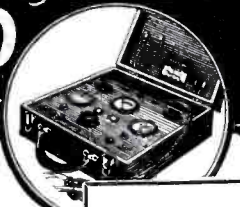

Get Into a Line Where There's Action — Every Day — And a Payday Every Week—You Be the Boss!

Right now while hundreds are looking for work where there isn't any, the radio service field can use trained men. With the proper training and the necessary equipment, you can enter this field and make a comfortable living. We include with our course this modern set analyzer and trouble shooter without any extra charge. This piece of equipment has proved to be a valuable help to our members. After a brief period of training, you can take the set analyzer out on service calls and really compete with "old timers." We show you how to wire rooms for radio—install auto sets—build and install short-wave receivers—analyze and repair all types of radio sets—and many other profitable jobs can be yours.

YOURS Without Extra Cost

This excellent set analyzer and trouble shooter included with our course of training.

Teaching you this interesting work is our business and we have provided ourselves with every facility to help you learn quickly yet thoroughly. If you possess average intelligence and the desire to make real progress on your own merits, you will be interested.

ACT NOW — MAIL COUPON

Start this very minute! Send for full details of our plan and free booklet that explains how easily you can now cash in on radio quickly. Don't put it off! Write today! **Send Now!**

RADIO TRAINING ASSN. OF AMERICA.
 Dept. SWC-11, 4513 Ravenswood Ave., Chicago, Ill.
 Gentlemen: Send me details of your Enrollment Plan and information on how to learn to make real money in radio quick.

Name

Address

City..... State.....

Two Great MAGAZINES for One Price

Until the 15th of November, this opportunity is yours—this chance to read radio's two great magazines, **SHORT WAVE CRAFT** and **RADIO-CRAFT**, at a saving of \$2.00. Regularly the rate for eight months of **RADIO-CRAFT** and **SHORT WAVE CRAFT** is \$4.00. For a brief period only, our readers can enter their subscription to receive both magazines for \$2.00. This is a reduction of 30 per cent and represents a saving of \$2.00.

SHORT WAVE CRAFT you have read, and it is needless for us to say that you are well pleased and want to read every issue. It is the "Town Crier" of new developments in the short wave field.

And **RADIO-CRAFT**, also edited by Hugo Gernsback, is the radio magazine selected by the greatest number of service men, dealers and radiotricians. Of course, thousands of amateurs read **RADIO-CRAFT**, too. Each month, men of outstanding prominence in the radio field contribute articles of real interest to all.

Mail Coupon TODAY!

SHORT WAVE CRAFT, SWC 3-7
 100 Park Place, New York, N. Y.

As per your special offer, I enclose \$2.00, for which you are to enter my subscription to **SHORT WAVE CRAFT** and **RADIO-CRAFT** for the next eight months.

Name

Address

City..... State.....

- Parts List**
- 6 Fahnestock clips (1, 5, 14, 15, 17, 18, 19).
 - 1 Pilot 4-prong socket for the plug-in coils.
 - 1 Air-gap 4-prong socket for the type 30 detector tube (10).
 - 1 Pilot 23-plate midget condenser (6).
 - 1 Pilot 7-plate midget condenser (7).
 - 1 Flechtheim midget condenser, .00025-mf. (8).
 - 1 International Resistance Co. 3-megohm resistor (9).
 - 1 Pacent 10-ohm rheostat (11).
 - 1 Hammarlund equalizing condenser ECS0 (2).

- 1 Alden Mfg. Co. set of short-wave coils (3, 4). 3 is the large winding and 4 is the small winding on all four coils.
- 1 Frost 100,000-ohm potentiometer with power switch (20, 12).
- 1 Aerovox mica condenser, .441-mf. (13).
- 1 Pair of good phones (16).
- 1 Wooden baseboard, 11 x 4 1/2 x 1/2 inch thick.
- 1 Aluminum front panel, 6 x 11 x 1/16 inch thick.
- Wood screws, solder, soldering lugs, wire, etc.

DATA ON ALDEN PLUG-IN COILS

Number of turns		
(1)	4 3/4	6 Pitch No. 22 D.S.C. Primary 4 turns No. 31 D.S.C.
(2)	10 3/4	12 Pitch No. 22 D.S.C. Primary 6 turns No. 31 D.S.C.
(3)	22 3/4	16 Pitch No. 22 D.S.C. Primary 7 turns No. 31 D.S.C.
(4)	51 3/4	40 Pitch No. 22 D.S.C. Primary 15 turns No. 31 D.S.C.
(5)	68 3/4	Close wound No. 28 D.S.C. Primary 28 turns No. 36 D.S.C.
(6)	131 3/4	Bank wound, 2 layers, No. 32 (Optional Litz) Primary 32 turns No. 36 D.S.C.

WAVE BANDS:

- (1) Blue—10 to 20; (2) Red—20 to 40; (3) Yellow—40 to 80; (4) Green—80 to 200;
- (5) White—200 to 350; (6) Orange—350 to 550.

D.S.C.—double silk covered. Pitch—turns per inch.

Building the 2-Tube "Globe-Trotter"

(Continued from page 401)

Coil Plugs Into Standard Socket

One of the four-prong sockets accommodates the plug-in coils. Mount this one inch above the baseboard, directly behind the left hand condenser, using brass studs or piles of washers for the spacers. Elevating the socket in this manner makes for short connecting leads and keeps the coil away from the metal body of the condenser. To the left of the coil socket mount the "postage stamp" antenna condenser C1 and the filament rheostat R1. The latter is supported by a simple L-shaped brass bracket. The rheostat knob sticks out to the left, where it is easily adjusted. It doesn't belong out front, as it is touched only occasionally. Incidentally, this rheostat also serves as the "on-off" switch for the receiver. When the batteries are new, it is advanced only a few turns, to cut the three volts down to the required two. As the batteries age, it is advanced further and further.

Screw the grid condenser C4 down to the baseboard just to the right of the coil socket. Next in line to the right is the R.F. choke and then the audio transformer. The sockets for the tubes fit along the center line of the baseboard. The detector goes in the socket nearest the front edge, the amplifier in the rear socket.

Put one binding post under the screw that holds condenser C1. Fasten the other two posts at the extreme right hand edge, in back of the audio transformer.

Use short wood screws for all of this fastening. Make starting holes in the wood with an awl or a sharp nail, and you will have no trouble making the screws "bite".

Lateral movement of the batteries can be prevented by little L shaped brackets screwed to the baseboard around them. The ends of the fastening strap are simply held by wood screws on the under side of the board. It is a good idea to put soft rubber feet in the four under corners of the latter.

Wiring Set Very Simple

With the exception of two filament wires, all connections are made on the top of the baseboard, in plain sight. The wiring is very simple and can be followed from the accompanying schematic and picture diagrams. Note that the ground connection is made to the common junction of the "B" minus and "A" plus; simply tighten the last Fahnestock post under the battery binding post.

The aerial for use with this receiver should be about 50 feet long overall. The most convenient ground is the nearest cold water pipe.

Connect the cord tips of the earphones to the two posts on the right. The earphones may be any respectable units of the usual 2,000-ohm size.

Loosen the antenna condenser C1 about half way, turn on the filament rheostat a few notches, plug in the 25-50 meters coils if you do your initial testing at night, and get to work on the condenser dials. With the left hand—the tuning—condenser at any one setting, turn in the other condenser SLOWLY. If the set has been wired correctly, you will hear the characteristic rushing sound of a regenerative detector, and immediately squeals and whistles indicative of stations will fill your ears. *From then on, you don't go to sleep nights any more.*

Operating Hints to the Novice

If the set regenerates, but tends to let out a loud squawk just on the point of oscillation, connect a 250,000 grid-leak directly across the secondary of the audio transformer, as indicated by X in the diagrams. This annoying "fringe howl" does not occur in all sets, but you might as well be warned about it in advance.

If the set "flops" into oscillation too violently with the wire from "B" plus on the transformer connected to 45 volts, swing this lead to 22 1/2 volts. Different tubes will require different adjustments in this regard.

If the set does not oscillate at all, the trouble is almost certain to be in a reversed tickler connection. Simply unsolder the leads to the G and left filament posts of the coil socket, switch them around, and the set will immediately come to life. Except for a defective R.F. choke or a plain "bum" tube, there is no other reason for lack of regenerative action.

It may happen that the set will regenerate perfectly over some portions of the tuning condenser dial, but not on others. This is invariably due to absorption effects by the antenna, and the cure is a readjustment of the antenna condenser C1. In some locations one adjustment of C1 will suffice for all coils; in other places you may have to give it a turn or two for different coils. For adjusting this condenser use an insulated screwdriver made by pointing a lollypop stick or any similar short piece of wood.

One of the things you will have to put up with for a while is hand capacity effects. In tuning in stations you will find that the proximity of your hands to the dials will change the apparent dial settings. If this trouble is particularly severe, mount a sheet of aluminum

DATAPRINTS

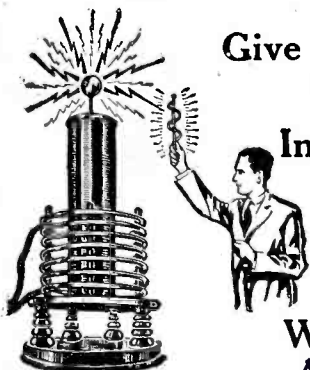

Give
Technical Information
on the
Building of
Worthwhile
Apparatus

Dataprint containing data for constructing this 3 ft. spark Oudin-Tesla coil.

\$.75

Includes condenser data.

OTHER "DATAPRINTS"

TESLA OR OUDIN COILS

- 36 inch spark, data for building, including condenser data\$0.75
- 8 inch spark, data for building, including condenser data 0.75
- Violetta type, high frequency coil data; 110 volt A.C. or D.C. type; 1" spark; used for giving "violet ray" treatments..... 0.75
- How to operate oudin coil from a vacuum tube oscillator 0.75

MAGNET COIL DATA

- Powerful battery electro-magnet; lifts 40 lbs. \$0.50
- 110 volt D.C. magnet to lift 25 lbs. 0.50
- 110 Volt D.C. solenoid; lifts 2 lb. through 1 inch. 0.50
- 110 Volt D.C. solenoid, lifts 6 lb. through 1 inch. 0.50
- 12 Volt D.C. solenoid, lifts 2 lb. through 1 inch. 0.50
- A.C. Solenoid, powerful. 110-volt, 60-cycle... 0.50
- MOTOR—1/16 H.P., 110 volt A.C. 60 cycle (suitable for driving 12" fan or light apparatus), constructional data..... 0.50
- 1200 cycle synchronous motor..... 0.50
- 60 cycle synchronous motor..... 0.50

TRANSFORMER DATA

- Any size, 200 to 5000 watts. (1 primary and 1 secondary voltage data supplied—specify watts and voltage desired).....\$1.00
- 1 k.w. 20,000-volt transformer data, 110-volt, 60-cycle primary. Suitable for operating 3 ft. Oudin coil 0.50
- 1/4 k.w. 15,000-volt transformer data, 110-volt, 60-cycle primary. Suitable for operating 8-inch Oudin coil 0.50
- Induction Coils—1 to 12 inch spark data..... 0.75

TELEGRAPHONE — Records Voice or "Code" signals on steel wire by magnetism. Code can be recorded "fast" and translated "slow". Constructional data (special).....\$0.50

CLOCKS—Electric chime ringer. How to make one to fit on any ordinary clock..... 0.50

MISCELLANEOUS DATAPRINTS—

- Electric Ice Skates—How to make..... 0.50
- How to Thaw Pipes by Electricity..... 0.75
- 20 motor circuits—hook-ups 0.75
- 20 practical telephone hook-ups..... 0.50
- Treasure Locator 0.50
- 100 mechanical movements for inventors..... 0.50
- Polarized Relay—Ultra-Sensitive 0.50
- Electro-medical coil (shocking coil)..... 0.50

REFRIGERATION MACHINE — Dataprint — How to Make Data.....\$1.00

SLIDE RULES—Specially Selected

- Students' 10-inch wood slide rule, accurately engraved (prepaid)\$1.10
- ELECTRICAL** Slide Rule, 10 inch size, with special electrical law ratios and indexes, wood with white ivory scales, prepaid..... 5.75
- 5" "Pocket" slide rule..... 4.00
- "Circular Pocket" slide rule. Fits vest pocket, 2 1/2" diameter, leather case..... 4.00
- Student's circular slide rule 1.50

(Postage 10 cents extra on last three slide rules.)

The DATAPRINT COMPANY
Lock Box 322 RAMSEY, N. J.

(cut from a 10-cent pie dish) behind the dials, and "ground" this to "A" plus.

Foreign Stations Easily Heard

With a good pair of phones the volume of this little "two-lunger" is really surprising. American stations in the 49-meter channel can sometimes be heard five or six feet from the phones if the room is quiet, while no difficulty is experienced in pulling in the more powerful European broadcasters like G5SW, Chelmsford, England, I2RO, Rome, and EAQ, Madrid. Of course it takes some fishing around for results like these, but this fishing in the sea of short waves is three-quarters of the fun!

What does this outfit cost? Well, if you buy the parts new, it will cost about \$10 for everything including tubes, batteries and phones. It will cost much less if you can "chisel" odd parts out of the junk boxes of more advanced amateur friends. The main consideration is to get good tubes and fresh batteries.

You can build the whole receiver in two evenings: one for assembly and another for wiring. If you are adept with tools, particularly the soldering iron, and your evenings start early and end late, you can probably do the job at one sitting.

Two Air Layers Return Radio Waves

Radio waves, which travel skyward, are turned back to earth by two reflecting layers or regions rather than one, scientists now believe.

This theory is based on a series of tests conducted by J. P. Schafer and W. M. Goodall of Deal, N. J., who described the outcome recently before the annual convention of the Institute of Radio Engineers.

The reflecting region, named the Kennelly-Heaviside layer after its discoverers, consists of ionized particles which are believed to reflect or bend radio waves. One layer, Mr. Schafer and Mr. Goodall explained, is found at a height of about sixty-two miles and the other at a height of between 125 and 186 miles. In addition, they said, there may be an absorbing region below the lower layer.

Heretofore, scientists have held that the height of the Heaviside layer varied from 60 to 200 miles, being in one section. Mr. Schafer and Mr. Goodall go a step further and define the layer as in two sections, although they say that when the layers are greatly disturbed during magnetic storms there doesn't seem to be any distinct separation between them.

The tests were made with the use of a cathode ray oscillograph tube which gave a visual indication of the action in reflected signals.

New International List of Call Signals Ready

The International Bureau of the Telegraph Union, Radio Telegraph Service, Berne, Switzerland, now has available for distribution to the public the third edition of the Alphabetical List of Call Signals of Fixed, Land and Mobile Radio Stations, at \$1.41 for the edition on ordinary paper, paper cover, without index (type A), and at \$1.93 for the edition on heavy paper, cardboard cover, with index. These prices include the monthly supplements up to the time the next edition is issued. All remittances should be forwarded direct to the Berne bureau by international postal money order.

Eclipse Affects Short Waves

(Continued from page 395)

and which must be recognized in addition to the Kennelly-Heaviside layer to explain the phenomena of radio.

Fortunately we do not need to wait for the next eclipse in order to investigate this subject further, because the signals that have this peculiar character may be studied any day. The important fact that we have established is that a signal of a particular wavelength and a particular distance is almost completely suppressed by the electronic eclipse if this eclipse area lies immediately beyond the point of observation as seen from the transmitting station.

Your Copy is Ready



Service Men—
Write for your
FREE Copy
of our 1933
Radio Catalog

LOWEST WHOLESALE PRICES

80 Pages of everything you need in Radio. Complete stocks of the highest quality replacement parts, tubes, test equipment, and accessories at the lowest wholesale prices.

UP-TO-THE-MINUTE SERVICE

Our tremendous stocks and efficient organization are waiting to serve you promptly, courteously, and efficiently.

Write today for your FREE COPY of our 1933 Service Men's Radio Catalog.

ALLIED RADIO CORPORATION
837 W. JACKSON BLVD. CHICAGO

BAD Times Are GOOD Times to Plan!

You know enough about **RADIO** to know the value of specialized training today!

Plan now for your future! Here is an advanced Radio Engineering Course for you men who know enough to realize you don't know it all—for men who know that the better jobs are held by "trained" minds — men who have advanced their education, and are now ready to enter the technical field of Radio and Television Engineering. Specialized training is the only short cut to success!

SEND FOR FREE BOOKLET

Our booklet, "Practical Radio Engineering," gives you complete information regarding our courses... send for it today... no obligation.

CAPITOL RADIO ENGINEERING INSTITUTE
14th & Park Rd. N.W. Dept. SW-11 Wash., D.C.

BE "IN THE KNOW" ON RADIO

New things are happening in radio! Developments! Improvements! Keep up to date! RCA Institutes Resident Schools in New York and Chicago offer the opportunity. Illustrated book free.

RCA INSTITUTES, Inc.
Dept. SW-112
75 Varick Street New York



This is the "SPECIAL BEGINNERS' NUMBER" and we want every beginner in short waves to keep this issue and refer to it from time to time as his knowledge in the field increases.

**Be Wise ---
shop Federated
and Save half.**

Send for our Catalogue

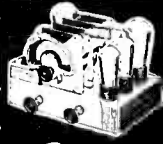

KITS
Nook Midget
9 tube Superhet
8 tube Battery
Dual Wave

Complete Instructions and
Diagrams mailed for 25¢ set

100 pages of Bargains

**Acratone
Receivers**

A complete range
of 5, 6, 7, 10 and 12
tube sets - short &
long wave and
combinations - 985 up

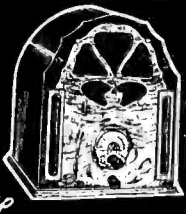

You shouldn't be without it



Amplifiers

The largest array
of Loftin-White and
Acratone Amplifiers
3 to 6 tubes; Single 45 up to
push-pull 250. From 85¢ up

Over 3000 items

**Replacement
Parts. Federated**



is headquarters for
replacement parts. Over
3000 items in stock for all
Standard Receivers.
Prices Always Lowest

at Wholesale prices



Speakers

A complete line of
Dynamics and
Magnetics, R.C.A.
Magnavox, Utah, Rola and
Operadio

Sent FREE on Request

Microphones

We carry a complete
line of "Universal"
microphones, including
the new "Bullet" and
"Torpedo" types. Discount 40-2%



**The Name is
Radio Bargain News**

Dealers' and Servicemen's
Buying Guide... issued by

Federated Purchaser Inc.

25 PARK PLACE Dept. W N.Y.C.

**Radio From the
Dark World**

(Continued from page 397)

ally saw were dots and dashes all right, but they were made on different levels, the dots occupying the upper of the two. I therefore punched my letters on paper according to this observation, memorized their new appearances and had no further difficulty in learning to recognize words. The "Q" signals and "ham" abbreviations next occupied my attention but I soon became familiar with these.

My First Transmitter—and It Perked!

My first transmitter consisted of a coil made by sewing seven turns of ordinary aerial wire to a 4-inch form made out of the side of a suit box. The tube I used was a UX-112 and the power supply was a "B" eliminator. A voltage fed antenna was used and after obtaining a license to operate and being assigned the call letters 2AZP, I decided to try out the transmitter one rainy Sunday morning. I sent a long CQ and then listened. Imagine my surprise and excitement when a Canadian answered me. In fact, my excitement was so great that I found myself unable to read his "stuff." He must have been disgusted with me. Then the UV-210 made its appearance and I changed the home-made coil for one made by R. E. L. and used a transformer designed to operate a 50-watt tube for my power supply, reducing the voltage in order not to ruin my tube.

Next I experimented with a ¼-kilowatt tube, whose filament I lighted by connecting the filament secondaries of the last mentioned transformer together and adding another filament transformer to the series to give me the necessary voltage. An Acme transformer provided the plate supply, which was raw A.C. I did not cling to this outfit for very long, because I found it a little too dangerous for me to handle alone. I had never shocked myself; but why should I wait until I had actually done some damage before giving it up?

The transmitter which has been my pride is the simple one now in my possession. It consists of a .00035-mf. variable condenser mounted on a piece of bakelite, the lower edge of which is screwed to the edge of a small board. On the back of the condenser is mounted a coil made from ¼-inch tubing, having five turns of wire nearly 3 inches in diameter. Porcelain insulators separate the coil from the condenser. Each end of this inductance is connected to a .002-mf. fixed condenser, one side of which is then connected to the plate of the tube and the other, which has a 5,000-ohm resistance across it, is connected to the grid. The power supply is derived from a Thordarson 210 power-pack transformer which has terminals for the filament of the power tube and for the plates of the rectifier tube. A 100-turn choke coil separates the high voltage terminal of the transformer from the plate of the power tube. The key is mounted on the wooden board in such a way that the button projects beyond the edge. One side of the key is connected to the center tap of the filament secondary and the other is connected to the center of the tank coil.

My antenna system is of the Zeppelin type. Two leads approximately 60 feet long are connected to the ends of a 6-turn inductance made of the same copper tubing as the tuning inductance. Another .00035-mf. variable condenser supports this coil and the entire unit is fastened by means of brackets to the base-board. The 60-foot leads are separated by dowels 12 inches long at regular intervals, one terminating at a porcelain insulator and the other being fastened to the end of a 66-foot "flat-top."

Determining Radiation by "Feel"

I used no meters at all, but determine maximum radiation by feeling the temperature of a Christmas tree bulb connected in series with



**Stoppani
Belgian Compass**

Being a precision instrument, the Stoppani Compass lends itself admirably for use in the Radio Experimenter's test laboratory. It affords an ideal means of determining the polarity of magnets, electro-magnets and solenoids carrying current. Since the compass needle is itself a magnet, having a North-seeking pole (which is actually the South pole) and South-seeking pole (which is actually the North pole); and since, as we all know, like poles repel each other and unlike poles attract each other, it is merely necessary to bring the compass in the vicinity of the magnet under test. The North pole of the compass needle will then point to the North pole of the magnet under test or the South pole of the needle will point to the South pole of the magnet depending, of course, upon their relative positions.

May Be Used As a Galvanometer

Because of its uniform magnetic properties, high sensitivity, and delicate frictionless bearings, the Stoppani compass may be utilized to advantage as a highly precise galvanometer for detecting electric currents in experimental or conventional radio circuits. The Compass is easily and readily converted into said galvanometer by merely winding several turns of ordinary radio wire completely around the face and lower case of the compass; leaving small spaces between turns to observe the movements of the needle. The ends of the wire are brought out as test leads to be inserted in series in circuits under test. A deflection of the compass needle in either direction indicates the presence of an electric current. Incidentally the intensity of the current may be closely approximated since the force with which the needle gyrates is proportional to the intensity of the current flowing through the wire.

Stoppani Compass is an ideal SURVEYORS instrument with elevated sights. It is made of Solid Bronze, Parkersized, non-rusting, graduated in 1/10, Ruby Jewelled, 4 inches square. Fitted in a hardwood case, with set screw in corner to hold needle rigid when not in use. The United States Government paid more than \$30.00 for this precision instrument.

Our Price \$4.50

Gold Shield Products Company

102 Chambers Street SWC New York, N. Y.

LYNCH

Noise-Reducing Antenna Products Solve the Interference Problem!

Practically noise-free results on all waves, long and short alike. For the broadcast listener, the short wave and television experimenter and the "amateur." No serviceman should be without these LYNCH Antenna Products which have proved their ability, by test, to eliminate background racket. Ideal for suburbs as well as the most congested city areas. Very simple to "hook-up" to any receiver. Better performance assured.

- LYNCH Transposition Blocks**
Extremely durable. Made of "Lynchite," a new material, recognized for its great resistance and natural freedom from electrical losses.
- LYNCH Handy Complete Kit of 10 Blocks...\$2.50**
- LYNCH Cage-Aerial Spreaders**
Great pick-up qualities and freedom from directional effect. Also made of "Lynchite."
- LYNCH Handy Complete Kit of 10...\$2.50**
- LYNCH "U. S. Navy Standard" Antenna Insulators**
antenna insulators. Kit of 8.....\$3.00
- LYNCH Commercial Antenna Insulators**
Patterned after the "U. S." but for use where the tensile strength of the "U. S." is not required. Kit of 8.....\$1.50
- LYNCH "All-wave" Antenna Coupler**
Secures best possible results with any of the noise reducing antenna systems recommended by us.....\$1.50

Servicemen—Discount of 40% from above List Prices

Send order TODAY or write for new, illustrated and descriptive folder.

LYNCH MFG. CO., Inc., 1775SW Broadway, N. Y.

the lead supplying the flat-top. This bulb is disconnected when the set is in operation.

The only change I am contemplating in my present equipment is to dispose of the batteries which now operate my receiver, and employ some heater type tubes which can be operated from a small transformer and "B" eliminator.

While at present I am not using the air waves for sending, because in the rush of other affairs I neglected to renew my licenses, my application for reinstatement is now in the hands of the proper authorities and I am waiting for permission to renew my acquaintance with many kind friends.

There are amateurs within a radius of 2,000 miles who are wondering why they have never received QSL cards from me. Of course, when I communicate with another "ham" I do not tell him I am blind; I often intend remembering his call letters and expect to write to him, but often matters of a different sort occupy my attention and I forget the letters. I hope in the future to be more determined to reciprocate the courtesies which I have enjoyed and to communicate with all those who "work me."

Since my special interest as far as my daily work is concerned is in the field of psychology. I ought to say a word about what the radio has meant to me. Of course, broadcast reception brings the blind in contact with the outer world in a manner which it must be admitted they could get in no other way. But the establishment of two-way communication, letting the other fellow know that you have a common interest with him, telling the world that you are alive, is even more fascinating.

"What do you amateurs talk about?" I am often asked.

"What difference does that make?" is as good an answer as any. It's like shaking hands with strangers who are glad to see you, and every amateur is glad to say "gld to QSO" to every other.

"Best 73's and C U agn."

S-W League

(Continued from page 436)

signatures, or any attempt to obtain a license by fraudulent means, or by attempting to impersonate another, or copying or divulging questions used in examinations, will constitute a violation of the regulations, for which the operator may suffer suspension of license or debarment from further examination for a period not exceeding two years at the discretion of the Secretary of Commerce.

Duplicate licenses.—Any operator applying for a duplicate license to replace an original which has been lost, mutilated, or destroyed will be required to submit an affidavit to the radio division through a supervisor of radio or examining officer, attesting to the facts regarding the manner in which the original was lost. The director of radio will consider the facts in the case and advise the supervisor of radio or examining officer in regard to the issuance of a duplicate license. Duplicates will be issued under the same serial number and date as the original, and will be marked "Duplicate" in red on the face of the license.

Re-examination.—No applicant who fails to qualify will be re-examined within three months from date of the previous examination. However, when an applicant for the radiotelegraph operator first-class or second-class license fails in the code examination, he may be re-examined the same day for any other class of license desired.

License Endorsements

Radiotelegraph class licenses to be valid for the operation of radiotelephone stations will be indorsed as follows: The holder of this license has qualified by examination for additional authority to operate any radiotelephone station. (If radiophone examination taken by applicant is for second-class radiotelephone operator's license, indorsement should be followed by "except broadcast.")
Date..... Examining Officer.....

EXPLORE the New Radio Wonderland!

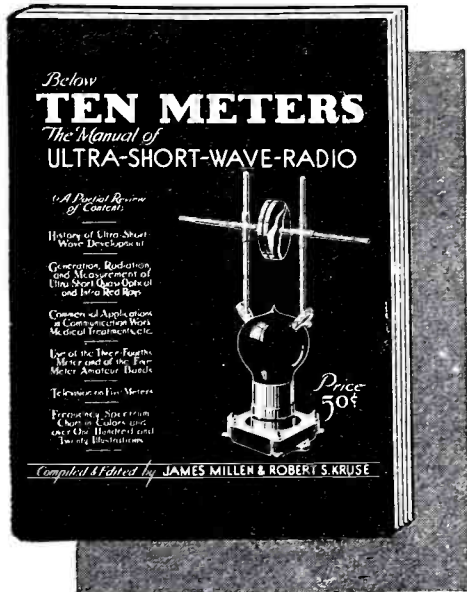

"BELOW 10 METERS"

A new, big 68-page book, full of invaluable information for Experimenters and Amateurs. Contains history of Ultra Short-Wave development, articles about the Generation, Radiation and Measurement of Ultra Short-Wave Quasi-Optical and Infra-Red Rays, the Commercial Application of Short Waves in Communication Work, the use of Ultra Short Waves in Medical Treatment, the use of 3/4-Meter and 5-Meter Amateur Band, Uses of Ultra Short Waves for Television. Attractive green and silver cover. Contains more than 200 illustrations.

Price 50 cents

Send for your copy today, using coupon below

New!
NATIONAL
MANUAL OF
ULTRA - SHORT - WAVE
RADIO
"A Whole Lot of Book for half a dollar"

NATIONAL Co., Inc.,
61 Sherman Street, Malden, Mass.

Please send me postpaid your new Manual of Ultra Short-Wave Radio, "Below 10 Meters". I enclose 50c (stamps, coin, money order).

Name

Address

SWC-11-32

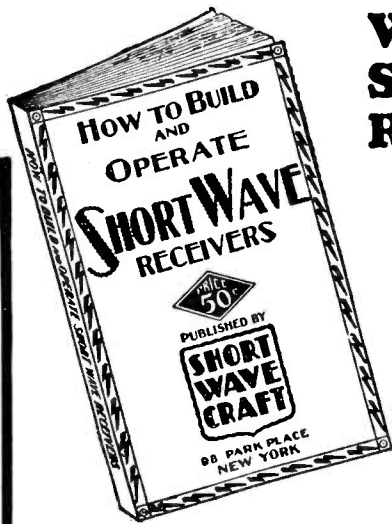

WHAT THE WELL VERSED SHORT WAVE FAN IS READING THESE DAYS

- Partial List of Contents**
- The "S. W. C." Two Tube Portable Works "Speaker"—Clyde Fitch.
 - How to Operate a Short Wave Receiver
 - A Two-Volt Tube Receiver
 - A "Plug-less" S. W. Receiver—John M. Avery
 - "My Favorite" Short Wave Receiver—F. H. Schnell
 - The HY-7B Super-Het for A. C. Operation—L. W. Hatry
 - The "Egert" SWS-9 Super-Het—How to Make It—Joseph I. Heller
 - A Super Sensitive Short Wave Receiver—Thomas A. Marshall
 - A S. W. Power Amplifier—H. Winfield Secor

72 Pages
100 Illustrations

Mail Coupon Now!

SHORT WAVE CRAFT SW-3-7
96-98 Park Place, New York City.

Gentlemen:—
I enclose herewith fifty (50c) cents for which please send me a copy of your new book, HOW TO BUILD AND OPERATE SHORT WAVE RECEIVERS. (Send money order, check, cash, or new U. S. Stamps. Register letter if it contains currency or stamps.)

Name

Address

City and State.....

If you have a library of Short Wave books, your collection is incomplete without this instructive text. If you haven't a library as yet, let HOW TO BUILD AND OPERATE SHORT WAVE RECEIVERS be the forerunner of a group of ready references. Our "Partial List of Contents" is just an idea of the topics that this book covers, and of the experts that have written for it. You should own a copy if you want to be well versed in the art of Short Waves.

SHORT WAVE Headquarters

SPECIAL OFFER

DETROLA 3-TUBE SHORT WAVE
CONVERTER KIT WITH TUBES

Easy
to
Assemble

\$7.50

Works
with
Any Set

LIMITED QUANTITY

DISTRIBUTORS

All Nationally Known Lines
Short Wave Receiving and
Transmitting Apparatus.

Radio Electric Service Co., Inc.

N. E. Cor. 7th & Arch Sts. Philadelphia, Pa.
Send for Complete Catalog

"HAM" ADS

Advertisements in this section are inserted at 4c per word to strictly amateurs, or 8c a word (8 words to the line) to manufacturers or dealers for each insertion. Name, initial and address each count as one word. Cash should accompany all "Ham" advertisements. No less than 10 words are accepted. Advertising for the December issue should reach us not later than October 20.

JOIN THE RADIO EXPERIMENTERS CLUB of Canada—Free Circuits—Advice, etc. American members welcomed. Write Secretary, 6 Gould St., Toronto, Ontario.

1—\$18.00 CROSSMAN AIR GUN, \$7.50. 1—\$36.50 Workrite S-W Converter, \$8.00. 1—250 power microscope, \$6.00. \$25.00 3-tube S-W Converters, \$8.00 each. \$75.00 Victoreen B.C. Superheterodyne, 5 volt D.C. model, 8 tubes, for \$15.00, includes Weston meter. 1 National B.C. Screen Grid Tuner (110 v. A.C.) and Thordarson Power pack, 8 tubes, make offer. 1—6 foot R.C.A.-Victor Exponential Horn with electric pick-up, \$25.00. Write before sending money. Dataprint Company, Ramsey, N. J.

WESTINGHOUSE Oil Tank Static Condensers. Maximum Operating Voltage 2500. 60 cycle. \$4.75 each. Maynard Miller, 938 North Homan Avenue, Chicago, Illinois.

SEND 6c STAMPS for Wholesale Catalog. Short Wave Sets, Kits, Supplies. Federal Radio & Telegraph Co., 4224 Clifford Road, Cincinnati, Ohio.

FIVE SHORT WAVE BLUEPRINTS, consisting of 1, 2, 3, 4 tube D.C. and one five tube A.C. all wave midget. 25c (coin). Build these circuits and receive read DX results. Gordon, 1313 49th St., Brooklyn, N. Y.

PLUG-IN COILS, set of four wound on bakelite forms, 15-210 meters. 75c. Condensers, .0001, 50c. Noel, 419 Mulberry, Scranton, Pa.

SHORT WAVE LISTENERS CARDS: We print just the type of cards you need for reporting the stations you hear. Write for free samples today. WIBEF, 16 Stockbridge Avenue, Lowell, Mass.

SPECIAL POWER PACKS—D.C. for Phone, handles up to 5 UX 210s, 500 volts PURE D.C. to plates and 7½ A.C. to filaments. 170 mills. uses 2 UX 281s as rectifiers. SPECIAL PRICE, \$15.00. We also manufacture D.C. Power Packs to 1 kw. for broadcast work. Filter Chokes, highest quality, 170 mill 44 henries, \$2.00. Variable transmitting condensers, 5000 volt, \$10.00; also filter condensers and a full line of transmitting supplies, we guarantee everything. We manufacture only the highest quality in merchandise, write for bulletin. The General Engineering Corp., Charlotte, Mich.

GUARANTEED MICROPHONE REPAIRS — Any make model—24 hour service. Stretched diaphragm double button repairs, \$7.50. Others, \$3.00. Single button repairs, \$1.50. Write for 1933 Catalog with diagrams. Universal Microphone Co., Ltd., Inglewood, Calif.

S-W Beginner

(Continued from page 409)

First, we will need a few more parts than we used in the first set. These are as follows, or other parts may be substituted:

- 1 Audio transformer, Thordarson R260.
- 1 4-prong tube socket, Pilot type 216.
- 1 Type '30 tube, Triad.
- 1 4½-volt "C" battery, Burgess Battery Co. type 2370.
- 1 Binding post, Eby Junior.

When the parts are all procured the changes can be made. The transformer is mounted at the right-hand side at the back. To place this unit, one of the binding posts must be moved, as we used as wide spacing as possible between these terminals in the original set. Half way between the two left-hand binding posts, drill another hole for the one that we removed and the same distance to the left of the extreme left-hand one, drill another hole for the additional terminal. This latter post is needed for the "C" battery that we mentioned before in discussing amplifiers.

Next, mount the transformer at the point indicated in the photographs, with the terminals marked P and B to the left. Then drill four holes for the wires from the transformer terminals through the baseboard, as close to the terminals as convenient. Then mount the new tube socket between the detector tube and the tuning condenser, slightly to the right as shown. The socket terminals should be placed so that the G and P binding posts are to the back. Then drill four holes through the baseboard for the wires from the socket.

Now that the parts are all in place, the wiring can be changed. First remove the wires that must be changed. These consist of the following: The wire from the plate coil to the phone binding post is removed. The wire from the other phone terminal that was connected to the .5-mf. condenser and the regeneration control is removed. The wires on the two remaining battery binding posts of the original set are taken off, as they must be shifted around.

Wiring the Amplifier

The wiring of the amplifier can now be started. Connect a wire from the plate coil and .00025-mf. condenser to the P terminal on the transformer. Now connect a wire from the B terminal of the transformer to the oscillation control and .5-mf. condenser. Next connect a wire from the G binding post on the transformer to the G post on the amplifier tube socket, and one from the F post of the transformer to the binding post at the extreme left at the back (looking from the front of the set). This is for the negative terminal (—4½) on the "C" battery. Connect a wire from the P terminal on the amplifier tube socket to the front phone binding post, and one from the back phone post to the battery binding post at the extreme right. Another wire from the volume right-hand binding post also connects to this right-hand post. This is the connection made to the positive "B" battery terminal (+45). The second battery post from the right, looking back from the point of the set, is the negative "A," negative "B" and positive "C" (—A, —B, and +C). This terminal is connected to the left terminal on the filament rheostat, and was formerly the center of the three battery binding posts.

The third battery post from the right is the "A" positive (+A) and it is connected to the rear filament terminal on the detector socket. An additional wire is now run from this socket terminal to the left-hand filament terminal of the amplifier socket. The right-hand filament terminal of the amplifier is connected to the front filament terminal of the detector socket. This completes the wiring of the set.

The complete wiring of the two-tube set is shown in Fig. 5, and Fig. 6 shows the top and bottom views of the receiver with all the wiring in place. The batteries are connected in the manner shown in Fig. 7.

Save Your Copies

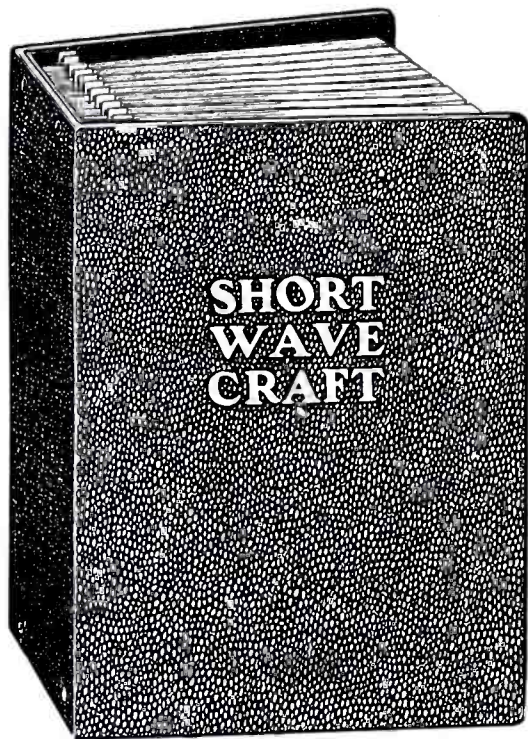

- SHORT WAVE CRAFT is not the sort of magazine that you read and then discard.

SHORT WAVE CRAFT readers keep their copies for years as a steady reference, and thousands of letters from them attribute to this fact.

We now have made it possible to save your copies in a way they should be saved, and for this purpose we have originated a splendid binder for you which holds twelve copies. The binder is made of heavy, substantial material, and is covered with black grained leatherette. The name of the magazine is stamped in gold on the cover.

In addition to this, an ingenious mechanical arrangement is provided which makes it possible to hold the copies in such a way that they are not clamped tight, so that when reading the magazines from the binder no hardship is had. Binder opens flat on any part.

Through a fortunate circumstance, we are enabled to offer this binder at a much lower cost than a binder of this type is usually sold for. We want every reader of SHORT WAVE CRAFT to own this binder, and we urge you to place your order at once.

SHORT WAVE CRAFT Binder as described, prepaid in the United States..... **\$1.25**

Canada and foreign countries, 25c extra.

We accept money order, check, stamps or cash.

SHORT WAVE CRAFT

98 PARK PLACE

NEW YORK, N. Y.

210 XMITTER, power supply, receiver, \$32. Wilson, 2515 Colonial Ave., Waco, Texas.

SINGLE BUTTON Microphone, \$5.00; Input transformers for single button microphone, \$4.00; for double button microphone, \$7.00; Microphone button for experimental work, \$1.25; Clar-a-tone to reduce static and tune out interfering stations, simple to connect, \$2.50. Charles English, Prospect, Pa.

When to Listen in

(Continued from page 429)

- THE effectiveness of police short-wave radio systems is becoming more and more widely appreciated, if the increasing number of licenses for this class of service is any indication. Following are some notes taken from the bulletins of the Federal Radio Commission:
 - City of Newton, Police Department, Newton, Mass. Granted construction permit (Emergency Police), 1712 kc., 50 watts. Call letters not yet assigned.
 - City of Chanute, Chanute, Kansas. Granted license to cover construction permit (Emergency Police), 2450 kc., 5 watts. Call, KGZF.
 - City of Dayton, Police Department, Dayton, Ohio. Granted license to cover construction permit (Emergency Municipal Police), 2430 kc., 150 watts. Call, WPDM.
 - Commonwealth of Mass., Department of Police, Framingham, Mass. Granted special authority to operate on 1574 kc., 10 watts, subject to filing formal appeal. Call, WMPI.
 - City of San Diego, Police Department, San Diego, Cal. Granted license for police service, 2430 kc., 100 watts. Call, KGZD.
 - City of Wichita Falls, Texas. Granted license for police service, 1712 kc., 50 watts. Call, KGZI.
 - City of Richmond, Richmond, Indiana. Granted license for police service, 2442 kc., 50 watts. Call, WPDH.

Latest Schedule of Australian Stations

The following letter should settle—for a while at least—the continual controversy that seems to center around the schedules of the Australian short-wave broadcasting stations: AMALGAMATED WIRELESS (AUSTRALASIA) LTD. "Wireless House, 167/169 Queen Street Melbourne, C1. (Australia)

The Editor, SHORT WAVE CRAFT, 96 Park Place, New York City, U.S.A.

Dear Sir:

From time to time we receive letters from American wireless enthusiasts commenting on the misapprehension that seems to exist in certain quarters regarding the transmission times of our two Australian short-wave broadcasting stations, VK2ME, Sydney, and VK3ME, Melbourne, and it has been represented to us that the publication of our official transmission schedules in your very widely read magazine would clear up any doubts regarding the times we are on the air.

With this object in view we are enclosing herewith the transmitting schedules of our two stations, in the hope that you will publish them for the benefit of American listeners. Many thanks.

Yours faithfully,

Amalgamated Wireless (A/Asia) Ltd.
H. Johnston, Engineer.

Here is the schedule reduced to Eastern Standard Time:

- VK3ME, Melbourne, wavelength 31.54 meters. Transmitting hours: Wednesday, 5:00 to 6:30 a.m. Saturday, 5:00 to 7:00 a.m.
- VK2ME, Sydney, wavelength 31.28 meters. Transmitting hours: Sunday, 1:00 to 3:00 a.m., 5:00 to 9:00 a.m., 9:30 to 11:30 a.m.

New Universal "Mike" Catalog

● THE 1933 catalog of the Universal Microphone Co., Ltd., 424 Warren Lane, Inglewood, Cal., has come from the press in the form of a 29-page booklet, fully illustrated and containing descriptive data on the various lines of the Universal laboratories.

This will be the fifth year of the pioneer organization, which is said to be the largest firm in the world devoting its entire activity to microphone manufacture.

Microphone stands—desk stands, banquet types, floor models, amateur stands—will all be equipped with call letter name-plate unless ordered to the contrary. Letters may then be painted or cemented on the plate. The inclusion of the name-plate will make the stands mechanically perfect and will present a striking appearance.

HERE IS YOUR OPPORTUNITY TO LEARN . . . How to become an Amateur Radio Operator



● This book covers literally everything from "soup to nuts" on the subject, in such a clear and lucid manner that it will be of great value to every student.

● If you intend to become a licensed code operator, if you wish to take up phone work eventually, if you wish to prepare yourself for this important subject—this is the book you must get.

● We commissioned Lieut. Myron F. Eddy, U. S. Navy, Retired, to write a book on this subject that would answer EVERY possible question in such a way as has never been done before. We chose Lieut. Eddy because his long years of experience in the amateur field have made him pre-eminent in this line. For many years he was instructor of radio telegraphy at the R.C.A. Institutes, and in this capacity he obtained a vast knowledge and insight on the subject. He is a member of the I.R.E. (Institute of Radio Engineers), also the Veteran Wireless Operators' Association.

PARTIAL LIST OF CONTENTS

- Chapter 1. Ways and means of learning the code. A system of sending and receiving with necessary drill words is supplied so that you may go right to work on approved methods.
- Chapter 2. Concise, authoritative definitions of radio terms, units and laws, brief descriptions of commonly used pieces of radio equipment. This chapter gives the working terminology of the radio operator. All graphic symbols used to indicate the various parts of radio circuits are shown so that they may be readily recognized when studied in the following chapters.
- Chapter 3. General radio theory, particularly as it applies to the beginner. The electron theory is briefly given, then waves—their creation, propagation and reception. Fundamental laws of electric circuits, particu-

larly those used in radio, are explained next and typical basic circuits are analyzed.

Chapter 4. Descriptions of modern receivers that are being used with success by amateurs. You are told how to build and operate these sets, and how they work.

Chapter 5. Amateur transmitters. Diagrams with specifications are furnished so construction is made easy.

Chapter 6. Power equipment that may be used with transmitters and receivers, rectifiers, filters, batteries, etc.

Chapter 7. Regulations that apply to amateur operators.

Chapter 8. Appendix, which contains the international "Q" signals, conversion tables for reference purposes, etc.

Other Important Data

The Amateur Self-Examiner.—Something radically new—every amateur has been looking for it. Over 300 Questions and Answers on radio subjects of interest to amateurs.

Latest Changes in Radio Law.—Rules and regulations, including the new license requirements issued July, 1932.

All information contained in this book which you need to become a licensed radio amateur—and more! It tells you how to build and operate an amateur radio station.

Written for the Amateur
72 Pages—Over 150 Illustrations

THIS BOOK IS NOT SOLD ON NEWSSTANDS

CLIP AND MAIL COUPON TODAY!

SHORT WAVE CRAFT,
98SW Park Place, New York City. SW-3-7

Gentlemen:

I enclose herewith 50c, for which please send me, prepaid, a copy of your new book, "How to Become a Radio Amateur and Secure a U. S. Government License," the book to be sent to me immediately upon publication. (Send Money Order, Check, Cash, or new U. S. Stamps. Register letter if it contains currency or stamps.)

Name

Address

City..... State.....

Round the World Reception With Polo Products

ROME ... ITALY ... PARIS ...
FRANCE...CHELMSFORD...ENG-
LAND ... HONOLULU ... HAWAII

The Polo Converter can be used with your present radio for shortwave, without disturbing the hookup of the Broadcast receiver.

\$26.50



SH-5 — Superheterodyne, Volume Control, On - Off Switch as one unit, Dynamic Speaker. Complete with two 57's, one 58, one 47, one 280.

ONLY \$18.50

TRF-4—Junior four-tube high gain T.R.F. circuit. Illuminated Dial, Walnut Cabinet, Pentode Output, Dynamic Speaker. Special Overload Power Transformer. Cadmium plated chassis. Range 200 to 500 meters. Complete with one 57, one 58, one 47, one 280.

ONLY \$12.00

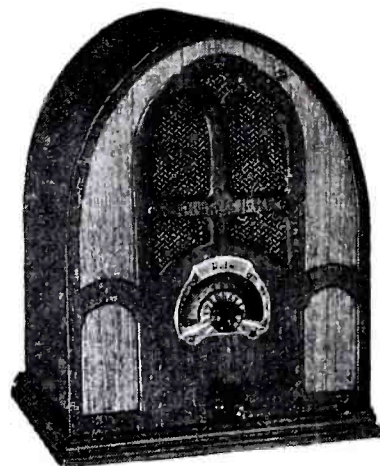

OTHER POLO PRODUCTS: AEROPLANE SETS, SUPERHETERODYNE AUTO RADIO, ALL TYPES OF RECEIVING SETS

Our two Superheterodyne AC home receivers are the SH-7 and SH-5, and they represent the best value for such fine construction and performance. The selectivity of both is most excellent, the distance penetration is of a very high order, while the tone is unequalled.

• • • read what **SATISFIED USERS** say:

Dear Sir:

I received the Polo Super set in good condition, and to say I am pleased with it would be putting it mild; it's the best bargain I have ever had, and away ahead of a set at \$49.00 from my point of view.

I brought KFI very easy last night, and I am not able to get it on a snappy night in winter with another make of set I have, costing much more. I also got XER like a local, and received a very pleasant surprise when I found it would bring in the police stations and 160 meter phones; think you should let others know this, as most people are anxious to hear them; that would have sold it to me right away.

Yours truly,

(Signed) C. H. Wells, Sr., Spencer, Mass.

Kindly forward to me another Polo Midget, cat. P.M.T. No. 23. I wrote to you regarding the great results I am getting from my first set. Chicago in the daytime and KFI and KOA at nights and only 60 miles from the ATLANTIC COAST. I am very much pleased.—Chas. M. Potter, 216 George Street, Norristown, Pa.

SH-7—Superheterodyne. Volume Control, Tone Control, On-Off Switch, Dynamic Speaker. Complete with two 58's, two 57's, two 47's, one 280.

ONLY \$28.00

Remember, the Polo stands for reliability, that our products are recognized for their superior performance, are guaranteed and represent the best values obtainable.

POLO ENGINEERING LABORATORIES

125 WEST 45th STREET — SW4

NEW YORK, N. Y.

Phone BRyant 9-6516

WHAT ARE YOU DOING IN RADIO IN THESE DAYS OF KEEN COMPETITION AND SCARCITY OF JOBS?

● IT IS always the well-trained man who wins out over the horde of thousands of superficially trained and incompetent men. You are reading this magazine because you are interested in radio. Sooner or later, the time will come when you will wish to cash in on your knowledge. Your chance may come over night, and then the big and vital question will be, "How well equipped am I to fill the job?" You are in radio because you like it. You also realize that, at the present time, there are many branches of the radio art which you do not know as thoroughly as you should. Knowledge, these days, can be gotten cheaper than ever before. It isn't necessary for you to go to college to become proficient in radio. Start today, to build a REAL radio library and become acquainted with all branches of this great and growing art. In this page are listed the world's best radio books. We have combed the market for the really important books in radio; so that, no matter what branch you are interested in, you can pick out the best books that are now printed. Start, today, to build a complete radio library. You do not have to get all the books at once, but make up your mind to get one book a month; so that, when your chance comes, you will be fully equipped to win out over the others not so well equipped.

ORDER FROM THIS PAGE

IMPORTANT.—This list is changed every month to include the latest books. Note also new low prices.

THE RADIO HANDBOOK, by James A. Moyer and John F. Wostrel. Flexible covers, size 5½x8", 886 pages, 650 illustrations. Price **\$5.00**

Comprehensive data on short-wave apparatus, vacuum tubes, modern radio receivers and transmitters, photoelectric cells, television, sound motion pictures, tables, graphs, diagrams, etc. No radio man should miss it.

RADIO FREQUENCY ELECTRICAL REQUIREMENTS, by Hugh A. Brown. Cloth covers, size 6x9", 386 pages, 235 illustrations. Price **\$4.00**

One of the few great books on this important subject. Everything from thermionic-tube coefficients to piezoelectric measurements.

PRACTICAL TELEVISION, by E. T. Lerner. Cloth covers, size 5½x8", 223 pages, 127 illustrations. Price **\$3.75**

This book explains television in full, including elementary principles, photo-electric cells, and all important types of television sets as well as basic principles of optics, images, mirrors, lenses, etc.

TELEVISION, Its Methods and Uses, by Edgar H. Felix. Cloth covers, size 5½x8", 272 pages, 73 illustrations. Price **\$2.50**

A practical complete cross-section of television today. One of the very best books on this important art in print.

MAGNETIC PHENOMENA, by Samuel Robinson Williams. Cloth covers, size 6x9", 230 pages, 150 illustrations, and numerous tables. Price **\$3.00**

All electric motors, coupling coils, magnetic and dynamic loud-speakers, transformers, choke coils, etc., are dependent on magnetic phenomena. This fine book is complete on the subject.

HOW TO BUILD AND OPERATE SHORT-WAVE RECEIVERS, by the Editors of SHORT WAVE CRAFT. Stiff Paper covers, size 7½x9½", 76 pages, 250 illustrations. Price prepaid **40c**

The greatest book on building and operating short wave sets and converters in print today. No better book printed.

CINEMATOGRAPHY, by James R. Cameron. Stiff covers, size 7½x5", 240 pages, 150 illustrations. Price **\$4.00**

Everything on the subject from "silent" and "talkie" 16 mm. film to its manufacture and to the final projection is in this marvelous volume.

HOW TO ORDER We cannot ship C.O.D. Our prices are net, as shown. Some of the books include postage (In U. S. only). Those that do not will be shipped by express collect if sufficient postage is not included by you.

EXPERIMENTAL RADIO, by R. Ramsey, Prof. of Physics, Indiana University. Cloth covers, size 7½x5½", 256 pages, 168 illustrations. Price, postpaid **\$2.75**

A marvelous book for the experimenter. Experiments galore in easy comprehensible language.

AUDEL'S RADIOMAN'S GUIDE, by Frank D. Graham. Cloth covers (flexible), size 5x8½", 220 pages, 300 illustrations. Price **\$1.00**

A practical, concise book presenting the theoretical and practical information for the proper operation, maintenance and service as applied to modern radio practice.

THE RADIO AMATEUR'S HANDBOOK, (New Revised Edition), by A. Frederick Collins. Cloth covers, size 5¾x7¾", 394 pages, 116 illustrations. Price... **\$2.00**

If you wish to become a radio amateur (radio ham) this book tells you how. Everything in receiving and transmitter sets and how to build them.

RADIO SET ANALYZERS AND HOW TO USE THEM, by L. Van der Mel. Stiff Paper covers, size 6x9", 68 pages, 45 illustrations. Price prepaid **40c**

The first book giving the fundamentals of radio servicing design in a manner which is clear even to the tyro. No service man can be without it.

RADIO AND ELECTRONIC DICTIONARY, by Harold P. Manley. Cloth covers, size 6x9", 300 pages, 550 illustrations. Price prepaid **\$2.50**

A fully indexed volume, which places at your finger-tips definitions of 3,800 radio words and phrases; of inestimable value.

FOUNDATIONS OF RADIO, by Rudolph L. Duncan. Cloth covers, size 5½x8", 246 pages, 145 illustrations. Numerous tables. Price **\$2.50**

This textbook gives you the fundamentals of electricity as applied to radio. It equips you for further study in the field of radio.

EXPERIMENTAL RADIO ENGINEERING, by John H. Morecroft. Cloth covers, size 6x9", 346 pages, 250 illustrations. Price **\$3.50**

A student's book; devoted to the principles of radio apparatus; intended to accompany a course in electricity. The best of its kind.

TALKING PICTURES, by Bernard Brown. Cloth covers, size 5½x8½", 327 pages, 161 illustrations. Price **\$3.00**

The non-technical man reading this book feels that he has been transported to a wonderland; technicians refer to it time after time.

RADIO THEORY AND OPERATING, by M. T. Loomis. 5th revised Edition. Cloth-bound; size 5½"x8" x1½" thick; 1,000 pages; over 800 illus.; 450 review questions and answers. Price **\$4.50**

Written in textbook style, a tremendous amount of useful information has been crammed into this thin-paper, compact reference work. Radio transmission and reception have been covered, "from soup to nuts." A truly great book.

THE RADIO MANUAL, by George E. Sterling and Rob't S. Kruse, E.E. 2nd enlarged edition. Flexible fabrikoid covers. Size 5½x3", 805 pages, 348 illustrations. Price **\$6.00**

A complete Radio Course for the operator, the technician, the amateur, the student and experimenter. Everything imaginable in the whole radio art is covered in this great book—the "radio bible" of the amateur. DON'T MISS THIS.

MODERN VACUUM TUBES and How They Work, by "Bob" Hertzberg. Stiff Paper covers, size 6x9", 68 pages, 150 illustrations. Price, prepaid **40c**

Just published, this important book covers the art as does no other book. Describes all the latest tubes, including the "Triple Twin".

SHORT WAVES, by C. R. Leutz and R. B. Gable. Stiff Covers. Size 6x9", 384 pages, 258 illustrations. Price, prepaid... **\$3.00**

The biggest and most complete book on short waves. Covers every imaginable phase, including S.W. Superheterodynes. The authors are famous S.W. authorities.

FUNDAMENTAL PRINCIPLES OF RADIO, by Louis Martin, B.S. Stiff Paper covers, size 6x9", 68 pages, 85 illustrations. Price, prepaid **40c**

Just what the title says, but it gives you the HOW and WHY of radio in plain English. THE book for beginners.

We herewith present the most complete collection of recent important radio books. We have, after an exhaustive study, selected these volumes because they represent the foremost radio books of their kind in print today. There is such a great variety that we are sure it will satisfy any taste as well as any requirement that the student of radio might have.

We publish no catalog and ask you to be kind enough to order direct from this page. Prompt shipments will be made to you direct from the publishers. We merely act as a clearing house for a number of radio publishers and OUR PRICES ARE AS LOW OR LOWER THAN WILL BE FOUND ANYWHERE. Remit by money order or certified check. If you send cash, be sure to register it.

RADIO MOVIES AND TELEVISION, by C. Francis Jenkins. Cloth covers, size 9½x6", 144 pages, profusely illustrated. Price **\$1.00**

A complete volume by the master of television, giving everything in television, including constructional details for building your own television sets.

RADIO VISION, by C. Francis Jenkins. Cloth covers, size 9½x6", 144 pages, profusely illustrated. Price prepaid **90c**

An excellent book. The Jenkins television system, as well as many other modern television systems fully described.

A POPULAR GUIDE TO RADIO, by B. Francis Dashiell. Cloth covers, size 5½x8½", 286 pages, profusely illustrated. Price prepaid **\$3.50**

The fundamental principles of radio. From crystal rectifiers to the latest electron tube amplification, etc.

PRINCIPLES OF RADIO COMMUNICATION, by J. H. Morecroft, Prof. of Electrical Engineering, Columbia University. Cloth covers, size 9½x6", 398 pages, profusely illustrated. Price... **\$7.50**

THE radio classic, by the dean of radio. Covers entire radio art as does no other book.

SOUND PICTURES AND TROUBLE SHOOTERS MANUAL, by Cameron and Rider. Cloth cover, size 8x5½", 120 pages, profusely illustrated. Price **\$7.50**

The standby of every operator. It is the most thorough book on the subject.

TELEVISION TODAY AND TOMORROW, by S. A. Moseley and H. J. B. Chapple. Cloth covers, size 8x5½", 130 pages, profusely illustrated. Price prepaid... **\$2.50**

A most up-to-date work on television describing in detail the apparatus used by Baird.

S. GERNSBACK'S RADIO ENCYCLOPEDIA (Second Edition). Red Morocco Flexible Binder, 352 pages, 2201 radio definitions, 1253 illustrations, 34 tables. Price **\$3.25**

The most comprehensive encyclopedia of its kind in print. Remarkably up-to-date in every way, with marvelous illustrations.

DRAKE'S CYCLOPEDIA OF RADIO AND ELECTRONICS, by H. P. Manly. Cloth covers, size 6x9", 1050 pages, 1080 illustrations. New 1932 Edition. Price **\$5.00**

The largest work of its kind ever put between two covers. New and up-to-date; a standby for every radio man.

RADIO TROUBLE SHOOTING, by Ennor R. Haan, E.E. Flexible covers, size 6x9", 323 pages, 257 illustrations. Price... **\$3.00**

An intensely practical handbook for all radio service men and operators. Up-to-date in every respect.

PRINCIPLES OF RADIO, by Keith Henney, M.A. Cloth covers, size 8x5½", 478 pages, 306 illustrations. Price **\$3.50**

A marvelously written textbook with the latest radio principles, including screen grid and pentode, amplifiers, etc.

PRACTICAL RADIO CONSTRUCTION AND REPAIRING, by J. A. Moyer, S.B., A.M. and J. F. Wostrel. Cloth covers, size 8x5", 354 pages, 163 illustrations. Price **\$2.50**

A handbook that every radio set tester and general student must have. The diagrams alone are worth the price of the book.

PRACTICAL RADIO—INCLUDING THE TESTING OF RADIO RECEIVING SETS, by James A. Moyer, S.B., A.M. and John F. Wostrel. Cloth covers, size 8x5", 378 pages, 223 illustrations. Price **\$2.50**

The title gives the story. Everything from crystal sets to the latest multi-tube receiver, and how they work.

FUNDAMENTALS OF RADIO, by R. R. Ramsey, Professor of Physics, Indiana University. Cloth covers, size 9½x6", 372 pages, illustrated. Price, prepaid... **\$3.50**

The backbone of the radio art. This book gives you the foundation on radio from A to Z.

OFFICIAL RADIO SERVICE MANUAL, Volume I, by Hugo Gernsback and Clyde Fitch. Flexible loose-leaf binder, size 9x12", over 2,000 illustrations, 650 pages. COMPLETE WITH SIX SUPPLEMENTS. Price prepaid **\$4.50**

The Service Man's Bible. Greatest book ever published on the subject. Contains all old circuits of every imaginable commercial radio set up to 1931.

OFFICIAL RADIO SERVICE MANUAL, Volume II, by Hugo Gernsback, C. E. Denton and C. H. W. Nason, with 1932 Free Supplements, 1000 pages, 2000 illustrations. Flexible Loose-leaf Binder, size 9x12". Price, prepaid... **\$4.00**

The talk of the radio industry. This marvelous volume contains everything in radio, circuits, and radio developments, for 1932. Not a line of duplication between 1931 and 1932 volumes. (Vol. I and Vol. 2.)

ELEMENTS OF RADIO COMMUNICATION, by Professor John H. Morecroft. Cloth covers, size 9x6", 270 pages, 170 illustrations. Price **\$3.00**

An authoritative volume embracing every imaginable phase in radio communication.

RADIO SERVICE MAN'S HANDY-BOOK WITH ADDENDA DATA SHEETS. Flexible covers, size 9x12", 200 pages, 400 illustrations. Price prepaid... **\$1.49**

The Service Man's standby. Contains the latest practical information on radio servicing.

RADIO RECEIVING TUBES, by Moyer and Wostrel. Cloth covers, size 7½x5½", 298 pages, 181 illustrations. Price... **\$2.50**

One of the finest books on vacuum tubes. Everything worthwhile on the subject treated in a masterful manner.

HOW TO PASS U. S. GOVERNMENT RADIO LICENSE EXAMINATIONS, by R. L. Duncan and C. E. Drew. Flexible covers, size 9½x7", 170 pages, 92 illustrations, appendix. Price... **\$2.00**

The most important book on the subject ever published. Gives every conceivable angle which will help you to pass a radio license examination successfully.

RADIO TELEGRAPHY AND TELEPHONY, by R. L. Duncan and C. E. Drew. (New Edition.) Cloth covers, size 9½x6", 950 pages, 468 illustrations. Price **\$7.50**

Everything from Ohms Law to vacuum tubes and detectors, to oscillographs and radio compasses thoroughly treated in this great book.

PHOTOELECTRIC PHENOMENA, by Arthur Llewelyn Hughes and Lee Alvin Duhridge. Cloth covers, size 6"x9¼", 531 pages, 202 illus. Price **\$5.00**

A critical survey of the whole field of photoelectric phenomena, intended as a reference book for research workers, students and teachers. The most complete work in print.

RADIO TRAFFIC MANUAL AND OPERATING REGULATIONS, by R. L. Duncan and C. E. Drew. Flexible covers, size 9x6", 186 pages. Price..... **\$2.00**

A live wire book for all radio amateurs, including how to learn code, abbreviations, International Radiograph Convention, Radio Act of 1927, etc.

RADIO PUBLICATIONS
245-S GREENWICH STREET
NEW YORK, N. Y.

BLUEPRINTS of RADIO WORLD'S Star Circuits

80-550-METER T-R-F RECEIVER



BLUEPRINT No. 627, full-scale, with schematic diagram also included, as well as a list of parts, is our most popular star circuit, since it is a-c operated and covers from 80 to 550 meters. Thus you can tune in television, police calls, some relay stations and the broadcast band. It uses five tubes: two vari-mu, either —35 or —51, one —24, one —47 and one —80. The chassis is 14½x7¾ inches, so may be fitted into a midget cabinet as illustrated.

The reason for the great popularity of this circuit is that it represents the highest achievement so far in a five-tube tuned radio frequency design, with high sensitivity all over the dial, including the high wavelengths, on which most t-r-f sets drop off considerably. For instance, patients at a sanitarium at Liberty, N. Y., were most eager to receive WEAf, 660 kc, about 150 miles distant, and all sets tried, including supers, failed to produce sufficient volume. But the 627 circuit not only brought in WEAf loudly but met all other several such receivers now will

requirements, arousing such enthusiasm that be found in that sanitarium.

As to selectivity, strong local stations can be cut out within a very few degrees of the dial, to bring in distant stations, and it is nothing unusual of an evening, in Winter or Summer, to tune in fifty or sixty different stations without interference. From various points in the United States many users receive Cuban and Mexican stations with plenty of volume.

Special precautions have been taken to make the tone the very best. This includes complete filtration in the B supply, since hum is ruinous to tone quality. The circuit is as free from hum as any a-c receiver can be, which means you can scarcely hear the hum with no station tuned in, and your ear against the grille.

The 627 circuit was carefully engineered in Radio World's Laboratories, and represents the selection of fourteen different circuits, all of the five-tube t-r-f variety. So not only has the trouble been taken out by experts, but the virtues have been built in with great engineering skill.

Order BP-627 @25c

6-TUBE AUTO SET

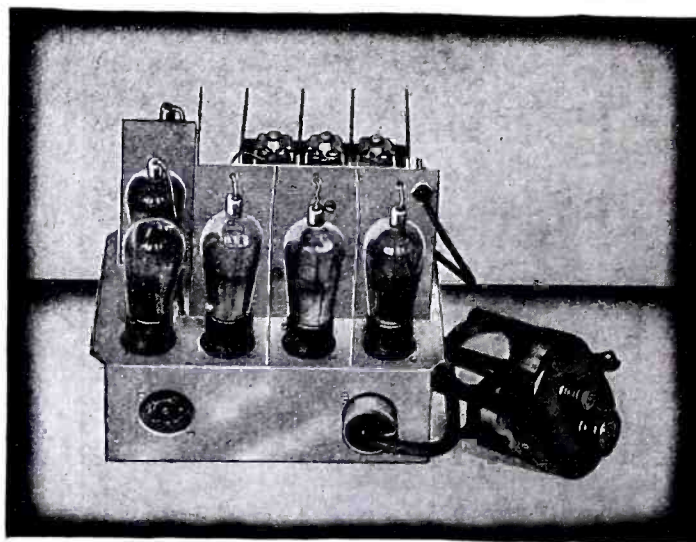

A SIX-TUBE automobile receiver, using remote control tuning, with tuning-switch-volume control assembly on the steering post, is covered by our Blueprint No. 629. The size of the chassis is only 7x9 inches, and the chassis, enclosed in a steel cover, may be placed at rear of the fireboard, just under the instrument board, to the driver's right. Since there will be little aerial pickup the receiver has been made extremely sensitive. It is of the t-r-f type, using the new —39 variable mu r-f pentode tubes, and two pentode output tubes, —38's, in push-pull. All the tubes are of the 6-volt automotive series, to work from the car's storage battery, and requiring 135 volts of B battery.

Steel partition walls serve to shield the r-f and detector tubes, while two outlets are for plugging in the remote control unit and the speaker, which should be an automobile dynamic, as set forth in the blueprint. A schematic diagram and list of parts are included on the full-scale print.

Order BP-629 @25c

WE have just completed an 8-tube pentode push-pull automobile super-heterodyne, designed by J. E. Anderson, technical editor of Radio World. This is Blueprint No. 631, full-scale, including schematic diagram and list of parts.

Order BP-631 @50c

SHORT WAVES

A TOTALLY a-c operated short-wave converter that can be built for \$7.60, comprising three tubes, and affording excellent results when worked with any broadcast receiver, including a superheterodyne, is covered by Blueprint No. 630. No plug-in coils are used, there are two tuning controls for maximum sensitivity, both oscillator and modulator tuned, and the construction is so simple that any novice can make a great success of this circuit.

Order BP-630 @25c

OUR blueprints also include two short-wave receivers for battery operation, one for earphone use, the other to work a speaker. These models use plug-in coils, with UX sockets as coil receptacles. The 2-volt tubes are used in both instances.

The earphone model, Blueprint No. 633, consists of an efficient and specially sensitized detector, with one stage of transformer coupled audio. With this circuit many foreign stations have been tuned in by hundreds of users. In fact, all our short-wave blueprints call for designs that yield foreign reception not as a rarity but as a fairly steady record. Two —32 tubes used.

The four-tube model, Blueprint 634, uses a stage of tuned r-f, a tuned detector specially sensitized, and two stages of transformer-coupled audio frequency amplification, the r-f tube being the —34 vari-mu r-f pentode, and the output being a —33 pentode. Schematic diagram and list of parts included on blueprint.

These two blueprints, Nos. 632 and 633, are full-scale, on one large sheet, the complete data for one on one side, and for the other on the other side.

Order BP-633-634 @30c

OSCILLATOR

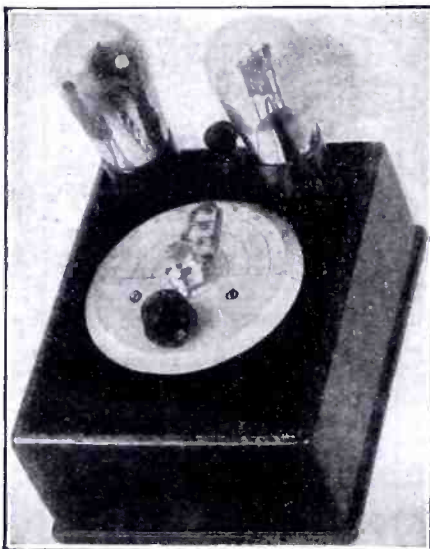

A MODULATED battery-operated oscillator, 540 to 1,500 kc. and 150 to 250 kc. by switching. One tube is the oscillator, the other is the modulator. Modulated-unmodulated service by switching.

Order BP-635 @25c

GUARANTEE

WE guarantee that the circuits embodied in the blueprints listed on this page have been carefully engineered.

Radio World takes great pains with its circuits and renders them as free from trouble and as abundant in satisfactory results as is possible. This record for authenticity has helped to make Radio World one of the most outstanding publications in its field.

Now in its eleventh year, Radio World has been catering to the home experimenter and service man with a faithfulness that has won it a wide following. Published every week, dated Saturday, Radio World is obtainable at newsstands at 15c per copy, or by subscription at \$6 per year (52 issues), \$3 per six months (26 issues), or trial subscription, \$1 per 8 weeks.

Radio World, the first and only national radio weekly, technical accuracy second to none, invites you to familiarize yourself with the exceptional service it is rendering to radioists the world over, and to profit by the expert engineering reflected by the circuits featured in its columns.

The circuits listed on this page were engineered by our laboratories with great pains, but no greater pains than attach to all the circuits featured in our columns from week to week.

Parts for all our circuits are readily obtainable.

RADIO WORLD, 145-G West 45th Street,

New York, N. Y.

NOVEMBER SPECIALS!!

EVERY month we list on this page certain **STAR** ★ items, which are NOT LISTED IN OUR CATALOG. These are all specials of which the quantities on hand are not sufficient to catalog them. *Once sold out, no more can be had.* First come, first served. **ORDER NOW, TODAY.**

STOP SHOPPING. The lowest prices are right on this page. *No one undersells us.* We meet any price on ANY NEW Merchandise. Order direct from this page and save money. 100% satisfaction on every transaction. Take advantage of these special offers. **ORDER NOW, TODAY.**

G-M PHOTO-RELAY SWITCH For 110-20 Volts 60 Cycle A.C.

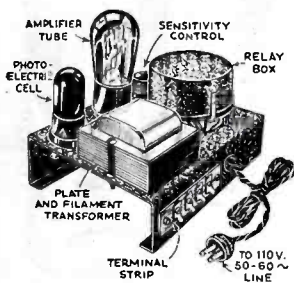

This new unit is an actual Photoelectric Relay containing all the principal parts used in the more costly industrial units. It comes fully equipped with a VISITRON Type B Caesium Cell, Magnetic Relay with special winding and silver contacts.

Transformer of large capacity, Amplifier Tube, Wire-Wound Potentiometer, Condensers, Terminal Strip, Sockets, Chassis, etc. This unit can be made the foundation of such photoelectric applications as burglar alarms, door-opening equipment, illumination control, race timing, counting, control of window displays and illumination, and myriad other installations. The Photo-Switch

No. 1222A—Photo-Switch. **Your Price \$15.00**

"MEGADYNE" ONE-TUBE PENTODE LOUDSPEAKER RECEIVER KIT

In the front part of our catalog—get your FREE copy now—there is presented a thoroughly illustrated discussion on the construction and operation of the

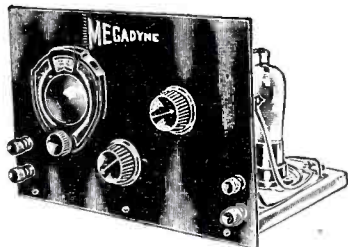

MEGADYNE Receiver by Hugo Gernsback, editor. This ingenious circuit was originally described in the July issue of the RADIO CRAFT Magazine, FREE copy of which will be given with each purchase.

This receiver is indeed one of the most outstanding developments in the radio industry. It is the first real one-tube receiver which will actually operate a loudspeaker. Thousands of experimenters and radio fans will want to build this remarkable receiver. For their convenience, we have compiled a complete list of parts required for its construction. These parts are of the highest quality and are exactly as specified by the author. The following parts comprise the complete kit.

1 B.M.S. Fixed Crystal Detector; 1 6-ohm Filament Rheostat; 1 3-circuit tuner for use with a .0005 mf. tuning condenser; 1 Na-ald type 481 UY 5-prong socket; 1 Hammarlund type ML-23 Variable Condenser; 2 sets of Cinch double binding posts; 1 Polymet .00025 mf. fixed condenser; 1 X-L Variodens; 1 Polymet .00025 mf. fixed condenser, or 1 Polymet .0005 mf. fixed condenser. (NOTE: Only one of the latter two condensers is actually employed in the circuit); 5 Fahnestock binding posts; 1 25-ft. roll of hook-up wire; 2 black Bakelite 1½" knobs; 1 Kurz-Kasch vernier dial with 0 to 100 scale reading clockwise; 1 type 38 pentode tube, "Triad" or "Speed"; 1 Bakelite Panel already drilled with all holes, size 7 x 10 x 3/16 inch; 1 hardware assortment. The wooden base is not included.

No. 2545—Megadyne Receiver Kit. **Your Price \$10.25**

ELIMINATES NOISE AND CROSS-TALK

Service men throughout the world are beginning to realize the importance as well as the advantages obtained through the use of a shielded lead-in wire from antenna to radio receiver. More than 75 per cent of the complaints of "noisy" and "inselective" receivers may be eliminated by merely replacing the old, unshielded wire which leads from the aerial on the roof to the radio set with this new type of wire. Not only does it help to clear radio noises but to a certain extent, it makes the receiver more selective due to the capacity effect between the wire core and the metal shield. Easily installed. The wire core is connected between aerial on the roof and antenna post on receiver. The outer shield is connected to ground. Every service man should carry at least one spare roll of shielded wire in his service kit.



No. 1665, 50 Ft. Roll **\$.85**
Shielded Lead-in Wire...
No. 1668, 100 Ft. Roll **1.60**
Shielded Lead-in Wire...

★ PORTABLE PUBLIC ADDRESS SYSTEM

Comprises Microphone, Loftin-White Amplifier and Dynamic Speaker. A recently completed all-electric A.C. development incorporating all the features and advantages of the direct-coupled



Loftin-White Amplifier principle. The amplifier is a high quality two stage job, having some **RADICALLY NEW IDEAS IN AUDIO FREQUENCY AMPLIFICATION** and employing 1-27, 1-45 power tube and 1-80 full-wave rectifier. It is remarkably free from A.C. hum.

The design is adaptable to all purposes, i.e., microphone, radio and phonograph. Has an undistorted power output of approximately 3.5 watts; **SUFFICIENT TO OPERATE FROM 2 TO 3 ADDITIONAL DYNAMIC SPEAKERS.**

The portable address system is sold **COMPLETE WITH THE NEW R.C.A.-VICTOR HAND MICROPHONE.**

Put up in a single compact and perfectly balanced carrying case, the front of which is utilized as a baffle for the self-contained dynamic speaker. Complete with microphone and accessories the weight is only 30 pounds. For 50-60 cycles, 110-120 volts A.C. operation. Shipping weight, 38 pounds.

List Price, \$75.00
No. SP-5011—Versatile Portable Address System Your Price, complete with microphone... **\$24.95**

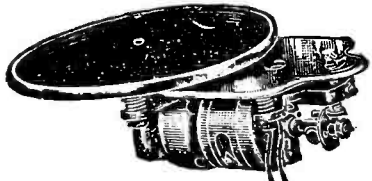

★ PRIME "GREEN GIANT" Electric Phonograph Motor

Induction type model with newly improved, humless motor. Equipped with speed regulator, also "on and off" switch. Completely equipped with large turn-table—takes records up to 12" in diameter. An ideal motor for electrifying the old phonograph. When used in conjunction with any amplifier on this page superb electrical reproduction is obtained.

No. 100—Your Price... **\$7.50**

★ "PEERLESS" DIRECT COUPLED AMPLIFIERS

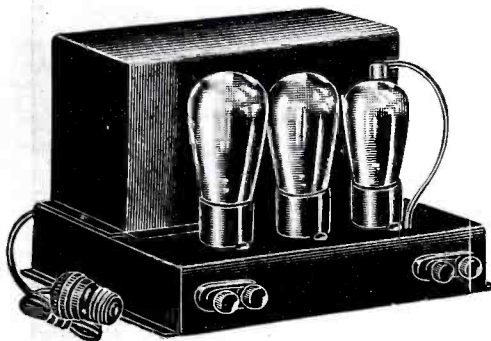

All the latest features in amplifier design have been incorporated in this direct coupled amplifier. Input terminals for permitting phonograph attachment, and in addition, by attaching the proper microphone transformer, also dry cell batteries, a microphone may be used for public address work. Any type of receiver can be connected to the input terminals without fear of loss of energy. These amplifiers are for use with dynamic speakers.

Amplifiers supply field current of 2500 ohms to dynamic speakers. Resistors are furnished when A.C. speakers are used. Amplifiers operate on 110 volts, A. C., 60 cycles.

Model SP-5003 uses 1-224, 1-245 and 1-280. Output is rated at 3 watts.

No. SP-5003—Your Price... **\$10.95** (less tubes)
Exactly the same amplifier, but employs a power pentode in place of the 245 tube. Output 3.5 watts.

No. SP-5004—Your Price... **\$12.95** (less tubes)
Model SP-5005 uses 1-224, 1-250 and 1-281. Consumption is 85 watts; maximum undistorted output, 6 watts. Gain rated at 1000 cycles, 55db; gain at 10,000 cycles, 51.5. Input direct to 224 control grid; output direct from 250 plate.

No. SP-5005—Your Price... **\$15.25** (less tubes)

★ SYNCHROMATIC ELECTRIC CLOCK

Never was such a first class electric clock sold at such a ridiculously low price. An electric clock using the famous synchromatic movement. Naval observatory time right from your light socket! No spring to wind, no batteries. Never out of order. Lubricated for a life-time at the factory. Enclosed in a dust-proof and shock-proof genuine molded Bakelite case. The case is of walnut wood finish with simple but catching design. For 110 volts, 60 cycle A.C. operation only. Complete with cord and attachment plug. Size 3¾" x 4¼" x 1½". Weight 1 lb. Service men now sell these fine clocks by the hundreds. Be the first in your locality to handle them.



List Price \$3.00

No. 1689—Synchromatic Electric Clock. **Your Price \$1.00**

FREE RADIO AND SHORT WAVE TREATISE



The new and enlarged Summer edition of our Radio and Short Wave Treatise, No. 25, has just come off the press—100 solid pages of useful information, radio items, diagrams and illustrations. Positively the greatest book in print—NOT JUST ANOTHER CATALOG. Contains a large editorial section with valuable information not found anywhere else. Considerable space is devoted to a **TREATISE ON SHORT WAVES** for both beginners and regular "hams." Among the new technical information listed are the following: Modernizing old radio sets—repairing speakers and headsets—making superhets out of old sets—data on constructing two-volt battery and automobile receivers—circuit of the famous Gernsback Megadyne One-Tube Loudspeaker Set—short wave coil winding data—discussion on S.W. adapters, converters and receivers, etc., etc.

WRITE TODAY. Enclose 4 cents for postage. Treatise sent by return mail.

100 New Hook-Ups, Etc.
1000 Illustrations.

★ SILVER-MARSHALL AUDITORIUM AMPLIFIER

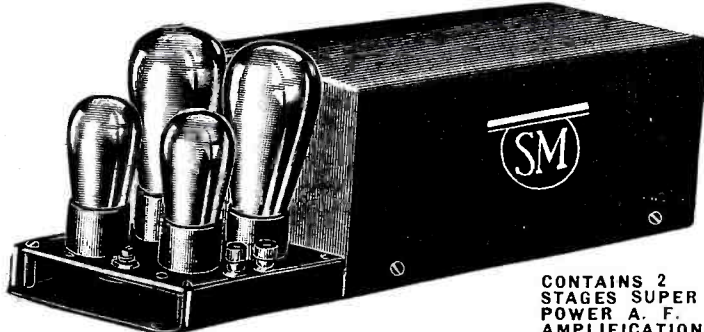

CONTAINS 2 STAGES SUPER POWER A. F. AMPLIFICATION

Ideal for theatres seating approximately 3,000 people, dance halls, schools, lectures, hospitals, auditoriums, outdoor gatherings, etc., etc. The gigantic power is at all times within control—for that matter it can be used in any home, as the volume can be regulated down to a whisper!

Supplies all necessary A, B and C. power to its own tubes. Operation requires one type X250 power tube, one X226 A.C. tube and two type X281 rectifier tubes. Attractive crystalline finish metal cabinet. 21x5¾x5½ in. Shipping weight, 38 lbs.

No. SP-5006—Your Price... **\$12.75**

★ METALLIZED PIGTAIL RESISTORS AT ROCK BOTTOM PRICES

A very fortunate purchase enables us to offer these fine resistors at prices which surprise even ourselves—prices more than three times lower than in our own catalog. Resistors are guaranteed to maintain their ohmage under even adverse operating conditions. The resistance element is based on the famous metallized principle which has proven its superiority wherever accuracy and uniformity are paramount requisites. The special ceramic casing of these re-



Values Clearly Marked on Each Unit

No. SP2226. Metallized Resistors. NOW YOUR PRICE... **6c**
12 for 60c. EACH

sistors is of sturdy construction and affords maximum heat dissipation. A feature of these resistors is their molded end-caps, tapered so they can be mounted in all standard resistor mounts. By means of their pigtails, they may also be soldered in any convenient position. Available in the following sizes—all rated at one watt: 300, 450, 600, 8,000, 10,000, 12,000, 350,000. Act fast to take advantage of this offer, as the supply is limited. Sold only in lots of six or more.

WE ARE A WHOLESALE HOUSE AND CANNOT ACCEPT ORDERS FOR LESS THAN \$3.00. If C. O. D. shipment is desired, please remit 20% remittance, which must accompany all orders. If full cash accompanies order, deduct 2% discount. Send money order—certified check—U. S. stamps.

Radio Trading Co.
25A West Broadway
New York, N. Y.

ORDER FROM THIS PAGE. You will find special prices from time to time in this magazine. Get our big FREE catalog for the greatest Radio Bargains. Should you wish goods shipped by parcel post, be sure to include sufficient extra remittance for same. Any excess will be refunded.



● This is no time for sleeping, man! Things are happening —the world is making new demands, offering more opportunities than ever before. But you've got to be wide awake if you expect to benefit by them! You can't stand still in a world that's going ahead. You can't climb upward if your ambition is merely to hold on. Face the facts—it's training that counts today! Many of your associates and competitors, realizing these facts, have enrolled for International Correspondence Schools Courses and are devoting their spare time to study of them. Your own welfare, your future says—"Mark and mail the coupon today!"



INTERNATIONAL CORRESPONDENCE SCHOOLS

"The Universal University"

BOX 2882, SCRANTON, PENNA.

★ Without cost or obligation, please send me a copy of your booklet, "Who Wins and Why," and full particulars about the subject *before* which I have marked X: ★

TECHNICAL AND INDUSTRIAL COURSES

- Architect
- Architectural Draftsman
- Building Estimating
- Wood Millworking
- Contractor and Builder
- Structural Draftsman
- Structural Engineer
- Electric Wiring
- Electrical Engineer
- Electric Lighting
- Welding, Electric and Gas
- Reading Shop Blueprints

- Telegraph Engineer
- Telephone Work
- Mechanical Engineer
- Mechanical Draftsman
- Machinist
- Toolmaker
- Patternmaker
- Pipefitter Tinsmith
- Bridge Engineer
- Bridge and Building Foreman
- Gas Engines
- Diesel Engines

- Aviation Engines
- Automobile Mechanic
- Plumbing Steam Fitting
- Heating Ventilation
- Sheet Metal Worker
- Steam Engineer
- Steam Electric Engineer
- Civil Engineer
- Surveying and Mapping
- Refrigeration
- R. R. Locomotives
- R. R. Section Foreman

- R. R. Bridge and Building Foreman
- Air Brakes Train Operation
- Highway Engineering
- Chemistry Pharmacy
- Coal Mining Engineer
- Navigation Boilermaker
- Textile Overseer or Supt.
- Cotton Manufacturing
- Woolen Manufacturing
- Agriculture Fruit Growing
- Poultry Farming Radio
- Marine Engineer

BUSINESS TRAINING COURSES

- Business Management
- Office Management
- Industrial Management
- Personnel Management
- Traffic Management
- Accountancy

- Cost Accountant
- C. P. Accountant
- Bookkeeping
- Secretarial Work
- Spanish French
- Salesmanship Advertising

- Business Correspondence
- Lettering Show Cards Signs
- Stenography and Typing
- Complete Commercial
- Civil Service Mail Carrier
- Railway Mail Clerk

- Grade School Subjects
- High School Subjects
- College Preparatory
- Illustrating
- Cartooning
- Lumber Dealer

Name.....Age.....Address.....

City.....State.....Occupation.....

If you reside in Canada, send this coupon to the International Correspondence Schools Canadian, Limited, Montreal, Canada

A BETTER TUBE GUARANTEE IF:

YOU want the best possible radio performance;

YOU expect to get the distance;

YOU want to have tubes that are double-tested;

YOU want tubes which are better than are required to meet standard specifications;

YOU want to be sure that your serviceman or dealer will replace defectives, without charge, for longer periods and without question;

YOU want the tubes backed by years of success and experience and made by skillful operators in a truly modern factory;

YOU want the tubes accompanied by a certificate which shows the *characteristics of that particular tube—not general characteristics* which it is supposed to have;

YOU want the best — at the cost of the ordinary;

Certified Triad Guarantee

After distributing many thousands of CERTIFIED TRIAD TUBES we are proud to say *not a single tube has been returned for any reason.* Therefore;

We guarantee each CERTIFIED TRIAD to possess the exact characteristics shown on the certificate which accompanies it—also to replace it, free of any cost, if it should become defective within *six months* after shipment from our factory.

**YOU WILL DEMAND
CERTIFIED**

TRIAD TUBES

SERVICEMEN—DEALERS

Write for our special sales plan today which gives you all kinds of selling helps, premiums, liberal discounts and satisfied customers.

TRIAD MANUFACTURING CO. INC.. PAWTUCKET, R. I.

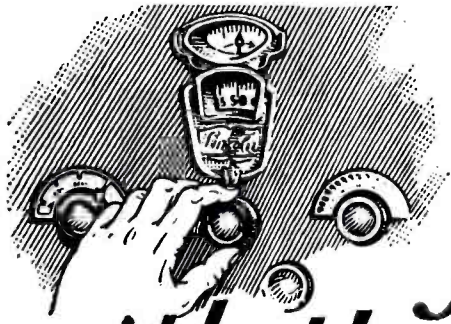

Tune the **NEW** way for World-Wide Reception with the **LINCOLN DE-LUXE-SW-33**

FOR 10 DAYS
RIGHT IN YOUR OWN HOME
AND
YOU WILL UNDERSTAND

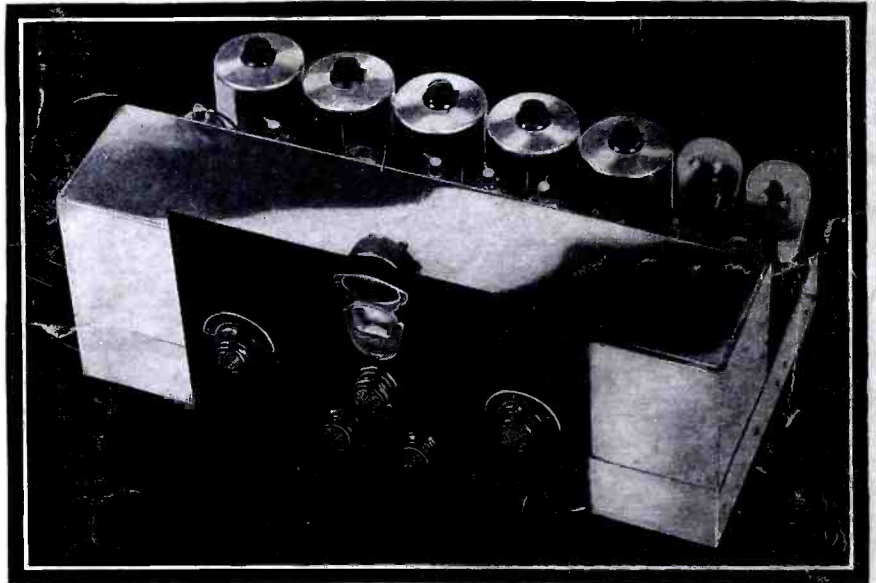

WHY —

*We Have Not Had
One Single Request for Refund on the
Lincoln DeLuxe SW-33*

- WHY** — Only eight requests for refund were made in the whole previous year; which were promptly made.
- WHY** — The MacMillan Expedition, Professional Experts, and super-critical fans are so enthusiastic about Lincoln performance.
- WHY** — Automatic volume control, silent tuning, dual control allowing full sensitivity with low speaker volume, undistorted high amplification and a range of 15-550 meters, is giving Lincoln owners 100% satisfaction.

*You Can Buy the Lincoln DeLuxe SW-33 on a Ten Day Trial With
Money Back Guarantee*

LINCOLN
DeLuxe Receivers

LINCOLN RADIO CORPORATION
Dept. SWC-13, 329 S. Wood St., Chicago, Ill.
Please send information on A.C. D.C. receivers.

Name

Address

City State

Print name and address plainly