

Feb.—Mar.

SHORT WAVE CRAFT

Edited by
HUGO GERNSBACK

ARTICLES BY

Dr. Fritz Noack
E. T. Somerset, G 2 D T
R. W. Tanner, W 8 A D
Arthur J. Green
Joseph Noden, G 6 T W
A. Binneweg Jr.
Maynard Marquardt
S. R. Winters

IN THIS ISSUE

NEWEST RESULTS WITH ULTRA-SHORT
WAVES

A ONE METER SHORT WAVE
TRANSMITTER

THE COAST GUARD'S BEST SHORT
WAVE RECEIVER

A PHONE TRANSMITTER FOR THE
BEGINNER

HOW TO OPERATE A SHORT WAVE
RECEIVER

TELEVISION SHORT WAVE RECEIVER
CONSTRUCTION

A "ONE-COIL" SUPER-HET CONVERTER

PRACTICAL SHORT WAVE HINTS AND
HOOK-UPS

HOW TO LEARN THE CODE

AMONG THE HAMS

150 ILLUSTRATIONS

75 HOOK-UPS

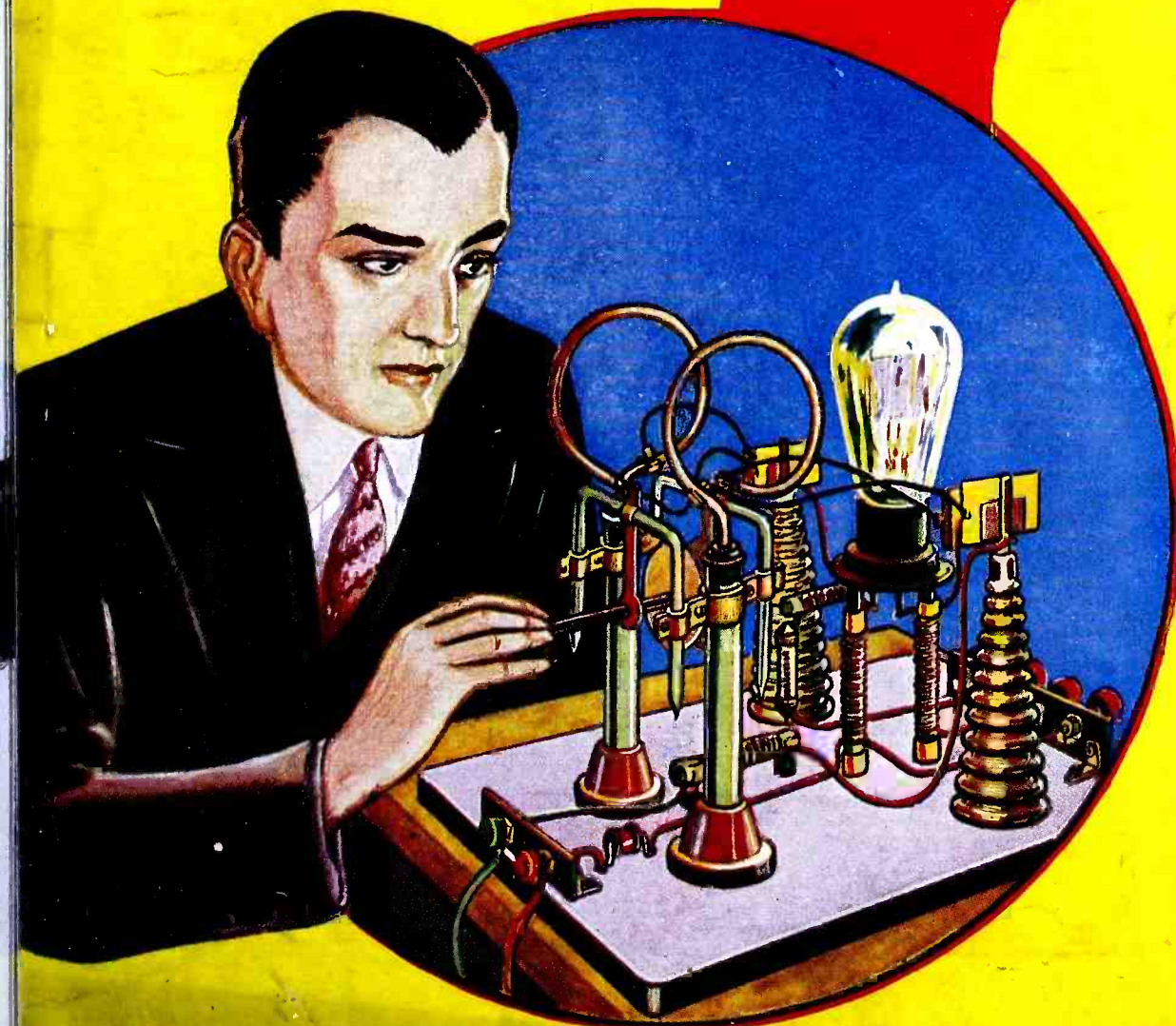

50c

\$75,000.00 worth of standard merchandise at 75% off!

SEND FOR BIG FREE CATALOG

Going Big!

You are not fully equipped without our 40 page Catalog.

THE NEW MELORAD

Cathedral Tone

MANTLE SET

TRIPLE SCREEN-GRID

tone CONTROL

MATCHED DYNAMIC

SPEAKER

Dealers and Servicemen!



Housed in this gorgeous walnut Gothic Cabinet 16 1/2" high, 14 1/2" wide and 10 1/4" deep. Only

\$26⁹⁵ | \$24⁵⁰

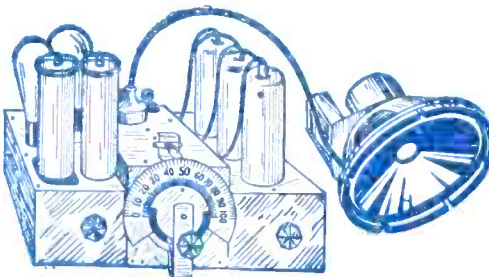

Chassis uses 3-224, 1-245 and 1-280 tubes and is equipped with matched dynamic speaker. For chassis and speaker. Tubes, \$2.50 extra.

REPLACEMENT Condenser Blocks

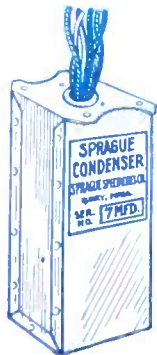

- Peerless Courier, as illustrated, ea. \$1.75
- A K 37 4.80
- Majestic B 2.95
- Victor R32 3.25
- RCA 18, 33 and 51 1.50
- RCA 17 4.95
- RCA 41 4.25
- RCA 60, 62 5.95
- Zenith 11E 3.25
- Brandes B15 2.95
- Kolster 611 2.95
- Kolster K21 2.50
- Kolster K43 3.25
- Kolster K22, 20, 42 3.25

Voltage Dividers, Fixed Resistances and GRID Suppressors



Ward-Leonard, Aerovox, Ohmite and Hy-watt wire wound resistances from 33 to 250,000 Ohms for all standard sets at 20 to 50c each. Full description in our catalog.

Centralab, Frost, Yaxley, Clarostat, Bradley-ohm, Carter and Electrad Variable Volume Controls and Potentiometers

All sizes from 2 to 500,000 ohms carried in stock for replacements in all standard sets. Prices from 20 to 45c each. ALSO Wire Wound and Carbon pigtail resistances from 10 ohms to 5 megohms at \$1.50 per dozen.

FOR PRICES GET OUR CATALOG
MAIL YOUR ORDER TO



We Carry a Complete Line of Microphones, Turntables, Pick-ups and Amplifiers for Public Address Systems and Theatres.

Universal Baby Mike. A real microphone, single button, with covers and 25 ft. of cable. List, \$7.50. Our Price, \$4.50.

Carryola Synchronous Motor

Complete with turn-table. Silent, sturdy and compact, only 1 1/4" thick. No brushes. Only \$4.25.

Bosch Power Amplifier

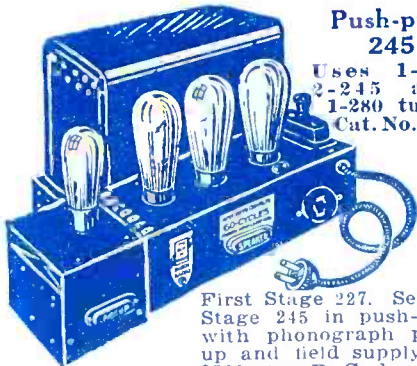

Push-pull 245

Uses 1-227, 2-245 and 1-280 tubes. Cat. No. 7031

First Stage 227. Second Stage 245 in push-pull, with phonograph pick-up and field supply for 2500 ohm D. C. dynamic speaker with or without input transformer (specify which). Also furnishes filament and plate voltage for 224, 227 tubes. Can be used to convert any battery set into an up-to-date A. C. receiver with 245 push-pull audio.

OUR NET PRICE, \$19.50

Power Transformers For all Standard Sets Carried in Stock

VARIABLE LINE VOLTAGE → 105V. 115 120V.

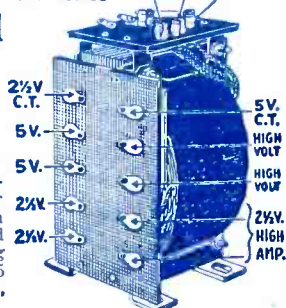

Model illustrated is for A C Dayton Navigator and other sets using 224, 227, 245 and 280 tubes, \$3.85.

- Freshman Q \$ 6.75
- Freshman QD 7.85
- Philco sets 3.75
- Zenith 33, 35 3.25
- Radiola 44, 46 4.95
- RCA Double Choke95
- AK40-42 Power Pack 11.50
- AK46 Power Pack 15.00
- Sonora B33 4.75
- RCA Audio55
- Earl 21, 22 2.25
- Radiola 60, 62 5.95
- Kolster K20 2.25
- Stromberg-Carlson 642 3.95
- Step down 220 to 110V 3.95
- Kolster 6H 7.50

Dynamic Speakers

Peerless Giant Auditorium, 12" Diaphragm, 110 V., A. C. \$14.50

D. C. with 1000 and 2500 ohm fields ... \$10.00

Peerless Courier, 7", D. C. \$7.50

Baldwin, 9", A. C. \$7.50

Temple A. C., Model 2, in Walnut Cabinet \$9.75

Peerless 17A, in cabinet.....\$11.50

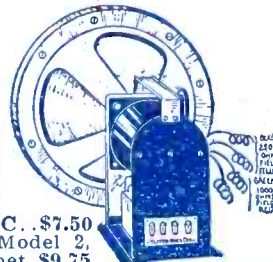

TERMS:—20% with order, balance C.O.D. 2% discount allowed for full remittance with order only.

Federated Purchaser

20-D Hudson Street

New York, N. Y.



Broadcasting stations need trained men continually for jobs paying \$1,800 to \$5,000 a year.



Operators on ships see the world and get good pay plus expenses.



Aviation is needing more and more trained Radio men. Operators employed through the Civil Service Commission earn \$2,000 to \$2,800 a year.



Television—the coming field of many great opportunities—is covered by my course.



Talking Movies—an invention made possible only by Radio—offers many fine jobs to well trained Radio men.

You'll Get Thrills-Adventure BIG PAY in RADIO



J. E. Smith, Pres.

I will Train You at Home to Fill a Fascinating Job in Radio

Radio's Amazing Growth is Opening Hundreds of Big Jobs Every Year

You like action, romance, thrills! You'll get them in Radio—plenty of them! Big pay, too. That is why I urge you to mail the coupon below for my free book of startling facts on the variety of fascinating, money-making opportunities in this great, uncrowded field. It also explains how you can quickly learn Radio through my amazingly simple 50-50 method of home-study training, even though you may not now know the difference between a "Screen Grid and a Gridiron". Thousands of men who knew absolutely nothing about Radio before taking my course are today making real money in this growing industry.

Thrilling Jobs That Pay \$50 to \$100 a Week

Why go along with \$25, \$30 or \$45 a week in dull, no-future work when there are plenty of good jobs in Radio that pay \$50, \$75 and up to \$250 a week? For instance, by taking my training, you can see the world in grand style as a Radio operator on shipboard. There are many splendid openings in this line with good pay plus your expenses. You'll also find thrills and real pay in Aviation Radio work. Broadcasting is another field that offers big pay and fascinating opportunities to men who know Radio. And think of the great, thrilling future

for men with Radio training in Television and Talking Movies. My free book tells all about these and many other branches of Radio that bring you in contact with interesting people, pay big money and make life pleasant for you. Without doubt, Radio training is the key that opens the way to success. And my training, in particular, is the only training that makes you a "Certified RADIO-TRICIAN"—the magic words that mean valuable recognition for you in whatever type of Radio work you take up after graduation. You'll see why, when you receive my interesting book.

Earn While You Learn

You don't have to quit your present job to take my course! You stay right at home, hold your job, and learn in your spare time. (Lack of high school education or Radio experience are no drawbacks.) I teach you to begin making money shortly after you enroll. My new practical method makes this possible. I give you eight big laboratory outfits that teach you to build and service practically every type of receiving set made. Many of my students earn \$15, \$20, \$30 weekly while learning. Earle Cummings, 18 Webster St., Haverhill, Mass., writes: "I made \$375 in one month in my spare time, installing, servicing, selling Radio sets." And let me emphasize right

here that a Radio business of your own is one of the money-making opportunities my training prepares you for in case you wish to settle down at home.

Get My Free Book

Send the coupon below for my 64-page book of opportunities in Radio and information on my home-study training. It has put hundreds of fellows on the road to bigger pay and success. It will tell you exactly what Radio offers you, and how my Employment Department helps you get into Radio after you graduate. I back my training with a signed agreement to refund every penny of your money if, after completion, you are not satisfied with the Lesson and Instruction Service I give you. Fill in and mail the coupon NOW!

J. E. SMITH, Pres., Dept. 1BB3
National Radio Institute,
Washington, D. C.

Act Now



Mail Coupon Today

J. E. SMITH, President
National Radio Institute, Dept. 1BB3
Washington, D. C.

Dear Mr. Smith: Send me your book "Rich Rewards in Radio" giving information on the big-money opportunities in Radio and your famous 50-50 method of home-study training. I understand this places me under no obligation and that no salesman will call.

Name.....

Address.....

City..... State.....

Occupation.....

Travelled 75,000 Miles

"Dear Mr. Smith: I have worked as Junior Operator on board S. S. Dorchester and Chief Operator of the Chester Sun. I have travelled from 75,000 to 100,000 miles, visited ports in various countries, fished and motored with millionaires, been on airplane flights, etc. I am now with Broadcasting Station WREN." (Signed) Robin D. Compton, 1213 Vermont St., Lawrence, Kansas.



\$400 a Month

"The Radio field is getting bigger and better every year. I have made more than \$400 each month and it really was your course that brought me to this." J. G. Dahlstead, 1484 So. 15th St., Salt Lake City, Utah.

Employment Service to all Graduates

HUGO GERNSBACK, Editor

H. WINFIELD SECOR, Managing Editor

CONTENTS

FEBRUARY-MARCH, 1931 ISSUE

*In This Issue: Prominent Short Wave Authors***Dr. Noack – Tanner – Somerset – Green – Noden – Binneweg – Hertzberg****FEATURES:**

- W2XAF Can Send Code, Voice and Photos Simultaneously, by Guy Bartlett..... 344
- W9XAA—The Short Wave "Voice of Labor," by Maynard Marquardt 346
(Chief Engineer WCFL-W9XAA)
- How to Operate a Short Wave Receiver, by Arthur J. Green 349
(President of International Short Wave Club)
- Combination Long and Short Waver, by E. T. Somerset 350
- The New Pilot "Universal Super Wasp"..... 352
- A One-Coil Super-Het Converter..... 353
- How to Add Two Radio Frequency Stages to the Hammarlund Receiver, by H. W. Secor..... 354
- A One Meter Transmitter—Operating at a Frequency of 300,000,000 Cycles Per Second, by Joseph Noden, G6TW (England)..... 356
- When to "Listen In," by Robert Hertzberg 360
- Ultra All-Wave Receiver, by H. G. Cisin, M.E. 362
- "Among the Hams"—Station Photos and Letters. 364
- Transmitting on Ten Meters, by A. Binneweg, Jr. 366
- The Influence of the Earth's Atmosphere on the Propagation of Radio Waves, by Dr. J. Fuchs 368
- A Low-Power Phone Transmitter for the Beginner, by R. Wm. Tanner, W8AD..... 372
- Newest Work in Germany on Ultra Short Waves, by Dr. Fritz Noack..... 374
- Practical Experiments in Ultra Short Waves, by C. C. Whitehead..... 376
- How to Build a Good "Television" Receiver, by R. Wm. Tanner, W8AD..... 381

SHORT WAVES FOR THE BROADCAST LISTENER:

- A Combination Long and Short Waver..... 350
- The New Pilot "Universal Super Wasp"—Plugless Reception From 15 to 650 Meters..... 352
- A One-Coil Superhet Converter..... 353
- An Ultra All-Wave Receiver—Receives Waves From 16 to 550 Meters..... 362

SHORT WAVE RECEIVERS:

- How to Operate a Short Wave Receiver..... 349
- Combination Long and Short Waver..... 350
- The New Pilot "Universal Super Wasp"—15 to 650 Meter Range..... 352
- The Hammarlund Short Wave Receiver..... 354
- When to "Listen In"..... 360
- Ultra All-Wave Receiver—16 to 550 Meter Range. 362
- Ultra Short Wave Receiver..... 376
- A Good "Television" Receiver..... 381
- The Coast Guard's Best Short Wave Receiver.... 384
- The A.C. "Conqueror"—Picks Up Both Short and Broadcast Waves, by Joseph Heller..... 389

SHORT WAVE TRANSMITTERS:

- W2XAF's New Multiple Short Wave Transmitter. 344
- The New Short Wave Transmitter at W9XAA.... 346
- A One Meter Transmitter..... 356
- Transmitting On Ten Meters..... 366
- A Low-Power Phone Transmitter for the Beginner 372
- An Ultra Short Wave Transmitter..... 374
- Practical Experiments With Ultra Short Waves.. 376

TELEVISION AND AIRCRAFT SHORT WAVES:

- How Short and Long Waves Link Planes With Ground, by Robert Speaker..... 369
- A Good "Television" Receiver—How to Build It.. 381

MISCELLANEOUS

- Short Wave Snapshots..... 342
- Short Waves Play Novel Roles..... 343
- Short Waves for the Broadcast Listener..... 350
- Falkland Islands Hear W2XAF and G5SW, by William T. Meenam..... 351
- To Our Readers..... 352
- Adding Untuned Radio Frequency Stage to Walker Flexi-Unit 355
- The Short Wave Beginner..... 359
- When to "Listen In"..... 360
- Among the Hams..... 364
- Short Wave Stations of the World—Directory.... 371
- \$2,000.00 Radio Amateur Prize Contest..... 385
- Short Wave Question Box..... 386
- You Can Learn the Code Easily..... 388
- SWAPPERS 399
- Book Reviews 404

SHORT WAVE CRAFT—Bi-monthly. Entered as second class matter May 7, 1930, at the post office at Mount Morris, Illinois, under the act of March 3, 1879. Trademarks and copyrights by permission of H. Gernsback, 98 Park Place, N. Y. C. Text and illustrations of this magazine are copyright and must not be reproduced without permission. SHORT WAVE CRAFT is published on the 15th of every other month. Six numbers per year. Subscription price is \$3.00 a year in the United States and possessions. Canada and foreign countries, \$3.50

a year. Single copies 50c. Address all contributions for publication to Editor, SHORT WAVE CRAFT, 96-98 Park Place, New York, N. Y. Publishers are not responsible for lost manuscripts. Contributions cannot be returned unless authors remit full postage. SHORT WAVE CRAFT is for sale at all principal newsstands in the United States and Canada. European agents: Brentano's, London and Paris. Printed in U. S. A. Make all subscription checks payable to Popular Book Corporation.

COPYRIGHT, 1931, BY H. GERNSBACK

Published by **POPULAR BOOK CORPORATION**

H. GERNSBACK, President - H. W. SECOR, Vice-President

Publication Office, 404 N. Wesley Avenue, Mount Morris, Ill.
Editorial and General Offices, 96-98 Park Place, New York, N. Y.

a Big Job Open for Every Radio Trained Man

5000

Service Men Needed



ACTUAL PHOTOGRAPH OF STUDENTS WORKING IN SERVICE DEPT. OF COYNE RADIO SHOPS

LEARN RADIO ~ TELEVISION TALKING PICTURES in 8 WEEKS By Actual Work ~ ~ ~ In the Great Shops of Coyne

Don't spend your life slaving away in some dull, hopeless job! Don't be satisfied to work for a mere \$20 or \$30 a week. Let me show you how to make REAL MONEY in RADIO—THE FASTEST-GROWING, BIGGEST MONEY-MAKING GAME ON EARTH!

THOUSANDS OF JOBS OPEN
Paying \$60, \$70 to \$200 a Week

Jobs as Designer, Inspector and Tester, paying \$3,000 to \$10,000 a year—as Radio Salesman and in Service and Installation Work, at \$45 to \$100 a week—as Operator or Manager of a Broadcasting Station, at \$1,800 to \$5,000 a year—as Wireless Operator on a Ship or Airplane, as a Talking Picture or Sound Expert—THOUSANDS OF JOBS PAYING \$60, \$70 and on UP TO \$200 A WEEK.

No Books - No Lessons
All Practical Work

Coyne is NOT a Correspondence School. We don't attempt to teach you from books or lessons. We train you on the finest outlay of Radio, Television and Sound equipment in any school—on scores of modern Radio Receivers, huge Broadcasting equipment, the very latest Television apparatus, Talking Picture and Sound Reproduction equipment, Code Practice equipment, etc. You don't need advanced education or previous experience. We give

H. C. Lewis, Pres. **Radio Division** **Founded 1899**
COYNE ELECTRICAL SCHOOL
500 S. Paulina Street Dept. 31-5H Chicago, Illinois

you—right here in the Coyne Shops—all the actual practice and experience you'll need. And because we cut out all useless theory, you graduate as a Practical Radio Expert in 8 weeks' time.

TELEVISION Is on the Way!

And now Television is on the way! Soon there'll be a demand for THOUSANDS of TELEVISION EXPERTS! The man who learns Television NOW can make a FORTUNE in this great new field. Get in on the ground-floor of this amazing new Radio development! Come to COYNE and learn Television on the very latest, newest Television equipment.

Talking Pictures A Great Field

Talking Pictures and Public Address Systems offer thousands of golden opportunities to the Trained Radio Man. Here is a great new field of Radio work that has just started to grow! Prepare NOW for these mar-

velous opportunities! Learn Radio Sound work at Coyne on actual Talking Picture and Sound Reproduction equipment.

EARN AS YOU LEARN

Don't worry about a job! Coyne Training settles the job question for life. We often have more calls for Coyne graduates than we can supply. YOU GET FREE EMPLOYMENT SERVICE FOR LIFE. And don't let lack of money stop you. If you need part-time work while at school to help pay living expenses, we will gladly help you get it. Many of our students pay nearly all of their expenses that way.

COYNE IS 31 YEARS OLD

Coyne Training is tested, proven beyond all doubt. You can find out everything absolutely free. How you can get a good Radio job or how you can go into business for yourself and earn from \$3,000 to \$15,000 a year. It costs NOTHING to investigate! Just MAIL THE COUPON for YOUR COPY OF MY BIG FREE BOOK!

H. C. LEWIS, President
Radio Division, Coyne Electrical School
500 S. Paulina St., Dept. 31-5H Chicago, Ill.
Send me your Big Free Radio Book and all details of your Special Introductory Offer. This does not obligate me in any way.

Name.....

Address.....

City.....State.....

WORLD'S BEST RADIO BOOKS

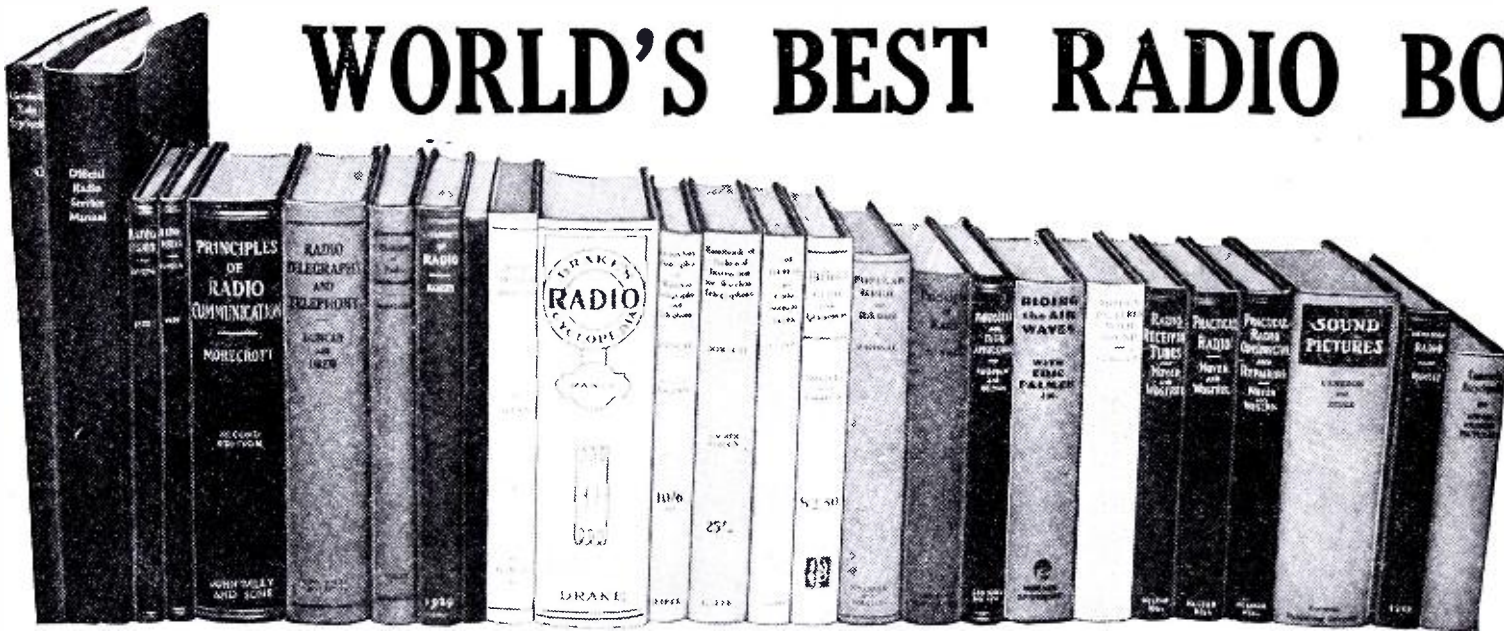

ORDER DIRECT FROM THIS PAGE

WE herewith present to the readers of **SHORT WAVE CRAFT** the most complete collection of recent important radio books. We have, after an exhaustive study, selected these volumes because they represent the foremost radio books of their kind in print today. There is such a great variety that we are sure it will satisfy any taste as well as any requirement that the student of radio might have.

We publish no catalogue and ask you to be kind enough to order direct from this page. Prompt shipments will be made to you direct from the publishers. We merely act as a clearing house for a number of radio book publishers and **OUR PRICES ARE AS LOW OR LOWER THAN WILL BE FOUND ANYWHERE.** Prompt shipments will be made.

Remit by money order or certified check. If you send cash, be sure to register it. If you wish to get any other radio book, please write us.

EXPERIMENTAL RADIO, by R. R. Ramsey, Professor of Physics, Indiana University. Cloth covers, size 7½x5½", 256 pages, 168 illustrations. Price, postpaid **\$2.75**

This book by Professor Ramsey is written in the nature of an experimental radio course and contains 128 experiments, illustrated and described in a clear and interesting style. The experiments cover such valuable subjects as: A test on a loud speaker; the impedance of coils; construction of a filter, screen grid tube; beat note audio oscillator; etc.

PRINCIPLES OF RADIO COMMUNICATION, by J. H. Morecroft, Prof. of Electrical Engineering, Columbia University. Cloth covers, size 9½x6", 988 pages. Profusely illustrated. Price **\$7.50**

A radio classic, indeed, is Professor Morecroft's very complete text-book which covers such important radio phenomena as: the action in condensers; self and mutual induction in a circuit; phase and phase difference; effect of condensers and coils on wave shape; resonance frequency of coupled circuits; skin effect in coils; antenna resistance; transformers; vacuum tubes; radio frequency alternators; modulation and circuits; amplifiers and filters.

RADIO TRAFFIC MANUAL AND OPERATING REGULATIONS, by R. L. Duncan and C. E. Drew. Flexible covers, size 9x6", 186 pages. Price **\$2.00**

This valuable handbook starts off with instructions on how to learn the code in considerable detail, with a list of abbreviations. Then comes operating rules and regulations of the Radiomarine Corporation of America with operators' report forms; followed by the rules of the International Radiograph Convention; the United States Radio Act of 1927; the Ship Act of 1912; etc.

PHOTOCELLS AND THEIR APPLICATION, by V. K. Zworykin, E.E., Ph.D., and E. D. Wilson, Ph.D. Cloth covers, size 5½x8", 210 pages, 97 illustrations. Price **\$2.50**

Photo-cells today occupy a very important place in radio and talking pictures, as well as other branches of applied science, and these two experts have provided the very latest information as to the action taking place in various types of photo-cells. The theory on which these different cells operate, including color sensitivity, together with amplifier and scanning discs used in picture as well as television transmission, etc.

PRINCIPLES OF RADIO, by Keith Henney, M.A. Cloth covers, size 8x5½", 478 pages, 306 illustrations. Price **\$3.50**

The author is well known in radio and he has here provided a very complete and clearly written discussion of radio circuits and apparatus, including such important topics as: condensers; transformers; determination of inductance;

vacuum tube action, including Screen Grid and Pentode; wave meters, their calibration and use; modulation; amplifiers; long wave receivers; and different types of rectifiers.

HOW TO PASS U. S. GOVERNMENT RADIO LICENSE EXAMINATIONS, by R. L. Duncan and C. E. Drew. Flexible covers, size 9½x7", 170 pages, 92 illustrations, appendix. Price **\$2.00**

The authors are thoroughly conversant with their subject and all of the most important information including hook-ups; types of antennae and receivers with wiring diagrams of both small and large receivers and transmitters of commercial type, including ship sets are given.

RADIO RECEIVING TUBES, by Moyer and Wostrel. Cloth covers, size 7½x5½", 298 pages, 181 illustrations. Price **\$2.50**

No radio student or operator can do without this authoritative book on the radio vacuum tube. The various chapters include construction of vacuum tubes; electrical fundamentals; elementary action taking place in the vacuum tube, with graphs; reactivation of tubes; testing of tubes including determination of amplification factor; plate resistance; grid resistance, etc.

PRACTICAL RADIO—INCLUDING THE TESTING OF RADIO RECEIVING SETS, by James A. Moyer, S.B., A.M., and John F. Wostrel. Cloth covers, size 8x5", 378 pages, 223 illustrations. Price **\$2.50**

Everyone will find this volume of the utmost practical value as the authors have explained in text and diagrams, for the practically-minded student, such interesting subjects as telephone receivers and crystal sets; various types of aerials; current sources for vacuum tubes; audio and radio frequency amplification with hookups; loud speakers and how they work; various radio receiving sets with diagrams and just how they work.

PRACTICAL RADIO CONSTRUCTION AND REPAIRING, by J. A. Moyer, S.B., A.M., and J. F. Wostrel. Cloth covers, size 8x5", 354 pages, 163 illustrations. Price... **\$2.50**

This handbook is one that every radio set tester and general student will want to read carefully. These experts have given a very complete description of instruments used to test and repair modern radio sets, together with complete diagrams of many modern receiving sets, with explanations on how to test the radio and audio frequency stages for faults.

ELEMENTS OF RADIO COMMUNICATION, by Professor John H. Morecroft. Cloth covers, size 9x6", 270 pages, 170 illustrations. Price... **\$3.00**

Professor Morecroft explains in an authoritative and clear manner such important radio phenomena as current flow in circuits containing capacity and inductance; propagation of radio waves; vacuum tubes as detectors and amplifiers; fading of radio waves and its causes; neutralization; superheterodynes for short waves, etc.; audio frequency amplifiers; how filters work, etc.

RADIO TELEGRAPHY AND TELEPHONY, by R. L. Duncan and C. E. Drew. Cloth covers, size 9½x6", 950 pages, 468 illustrations. Price **\$7.50**

This 950 page book forms indeed a most complete treatise on radio facts. The authors treat thoroughly the magnetic circuit; Ohm's law; transformers and induction; motor generators and starters; storage batteries; alternating currents; capacity and inductance formulae. Vacuum tubes as detectors and amplifiers; oscillographs; radio compass; wavelength measurements and short wave receivers.

RADIO SERVICE MAN'S HANDBOOK WITH A DDENDA DATA SHEETS. Flexible covers, size 9x12", 200 pages, 200 illustrations. Price, prepaid **\$1.75**

This remarkable book contains several hundred illustrations with wiring diagrams and charts covering every conceivable subject, including radio sets, tubes, etc. The book is strictly up-to-date and contains the newest practical information which every radio man absolutely must have.

OFFICIAL RADIO SERVICE MANUAL, by Hugo Gernsback and Clyde Fitch. Flexible covers, size 9x12", over 1,000 illustrations, 352 pages. Price, prepaid **\$2.98**

Commercial wiring diagrams for all the regularly manufactured receiving sets are included in this manual and no radio service man or student who builds and repairs radio sets can be without this tremendously useful compilation of circuits and their descriptions. This book is worth \$100.00 to anyone who has a use for it. The Manual is indexed so that any commercial receiving circuit can be found instantly. One of the most valuable radio books ever published.

FUNDAMENTALS OF RADIO, by R. R. Ramsey, Professor of Physics, Indiana University. Cloth covers, size 9½x6", 372 pages, illustrated. Price, prepaid **\$3.50**

Dr. Ramsey gives us a very refreshing treatment of the fundamentals of radio, including battery and dynamo action; alternating currents; inductance; vacuum tube constants; aerials of different kinds and how they operate; radio frequency instruments and apparatus; audio amplification and receivers in general.

RADIO TROUBLE SHOOTING, by Eunor R. Haan, E.E. Flexible covers, size 6x9", 323 pages, 257 illustrations. Price **\$3.00**

This is a well illustrated and intensely practical handbook for all radio service men and operators, as well as set builders and testers. Some of the practical problems illustrated and discussed are: interference and noise problems—how to locate and remedy them; antenna circuit troubles and their effect on radio; batteries, chargers and eliminators.

DRAKE'S RADIO CYCLOPEDIA, by H. P. Manly. Cloth covers, size 6x9", 1035 pages, profusely illustrated. Price **\$6.00**

This massive cyclopedia covers radio apparatus—its operation and maintenance, the various subjects being alphabetically arranged. There are 1735 subjects in alphabetical order ranging from A-battery to zero-beat. This volume contains 1110 illustrations, diagrams, etc. There are 414 illustrations and articles on the building and designing of radio sets, alone; 110 articles with 383 illustrations on the methods of repair, service and adjustment of radio sets.

S. GERNSBACK'S RADIO ENCYCLOPEDIA, by S. Gernsback. Stiff leatherette covers, size 9x12", 168 pages, profusely illustrated. Price **\$1.45**

Radio apparatus, inventors and terms are all illustrated and described in this remarkable book which required the efforts of several engineers in its compilation. The subjects are alphabetically arranged and the illustrations are especially fine and clear.

TELEVISION TO-DAY AND TOMORROW, by S. A. Moseley and H. J. B. Chapple. Cloth covers, size 8x5½", 130 pages, profusely illustrated. Price, prepaid **\$2.50**

This up-in-the-minute work on television describes in detail the apparatus used by Baird. The student will learn all about scanning discs; the best type of motor; reverse defects and how to overcome them; isochronism and synchronism; various ways of synchronizing the receiving discs; photocells and neon tubes; radio receivers for television signals; noctovision.

SOUND PICTURES AND TROUBLE SHOOTER'S MANUAL, by Cameron and Rider. Cloth covers, size 8x5½", 1120 pages, profusely illustrated. Price **\$7.50**

This useful volume will appeal to all radio as well as "talkie" trouble-shooters. The first chapters deal with fundamentals of electrical circuits, including Ohm's law, A.C. and D.C. circuits, rectifiers, amplifiers, mixers and faders; various types of loud speakers and how to arrange them; photocells; electric motors; various types of talkie projectors; also commercial amplifiers with diagrams are given.

RIDING THE AIR WAVES, WITH ERIC PALMER, JR., by himself. Cloth covers, size 7½x5½", 328 pages. Price **\$2.00**

Short wave fans cannot miss reading this highly entertaining and informative book which tells the story of youthful Mr. Palmer and his remarkable achievements in amateur radio. "Around the World with 5 Watts" and many other interesting subjects appear between the covers of this book.

A POPULAR GUIDE TO RADIO by B. Francis Dashiell. Cloth covers, size 5½x8½", 286 pages, profusely illustrated. Price, prepaid **\$3.50**

The author starts off with an excellent section on electricity and magnetism; the use of radio aerials and grounds; the fundamental principles of radio; the electron tube and crystal rectifiers—how they work; the principle of radio amplification; radio inductance coils and condensers; fundamental radio receiving circuits; electrical reproduction of sound; the atmosphere and radio phenomena, etc.

RADIO VISION, by C. Francis Jenkins. Cloth covers, size 9½x6", 144 pages, profusely illustrated. Price, prepaid **\$1.25**

A beautifully printed and interesting illustrated history of transmission of images by radio; particularly covering the apparatus and successful demonstrations of the Jenkins system. Other apparatus illustrated and discussed are the Braun tube receiver; the R. C.A. Photo-radio apparatus; the A. T. & T. Company system; and the Bellini machine.

RADIO MOVIES, by C. Francis Jenkins. Cloth covers, size 9½x6", 144 pages, profusely illustrated. Price, prepaid **\$1.25**

An absorbing history, handsomely illustrated, of the Jenkins system of transmitting and receiving movies "via radio." One of the chapters gives constructional details and drawings for building your own Radiovisor or machine for making the radio movies visible in your home. Diagrams of amplifiers are given, with some other very valuable information.

Howtoorder

We cannot make C.O.D. shipments. Our prices are net, as shown on this page. You will note that some of the books include postage. Those that do not will be shipped by express collect if you do not wish to include a sufficient amount of postage.

HUGO GERNSBACK

EDITOR

FEB.-MAR.

1931



H. WINFIELD SECOR

MANAGING EDITOR

VOLUME 1

NUMBER 5

The Short Wave Experimenter

By HUGO GERNSBACK

NOT so many years ago, it was generally thought that the only reason for the existence of the radio amateur was to send and receive code messages; and that in rendering this service to other amateurs (as well as to his community in time of disaster, such as floods, etc.), the amateur was performing his whole duty; and his place in the scheme of things was thereby permanently settled.

More recently, this view has been changed entirely; and the research and the experimental amateurs have come to the fore.

It is one thing to send and receive messages, which may or may not be of use to the public; and it is quite another matter to use one's facilities for scientific purposes. And the latter is what we are rapidly coming to, particularly in short-wave experimenting.

Of course, ever since radio amateurs first started, there has been a small band of amateurs who have distinguished themselves in experimental research work; but only lately have many of the "ham" fraternity become enthusiastic amateur scientists.

There is indeed a tremendous amount of work to be done, and not the most gifted amateur can do it all alone. Such excitingly interesting things as skip-distance effects, fading, radio echoes, and many other radio phenomena and effects are being studied today as they never have been before.

Of course, the serious amateur keeps notes and a "log" of all his observations and, not infrequently, radio science becomes enriched by these experiments.

While the longer waves, used for general broadcast purposes, are fairly well understood in a way, the highest frequencies are still a book closed with seven seals; to open them will necessitate a tremendous amount of research. And here is where the amateurs can do a really creditable amount of work during the years to come.

With television on the threshold, an entirely new radio paradise has been opened to the experimenter;

because television will, no doubt, be transmitted on the shorter wave lengths for a long time to come. The up-to-date experimenter is, of course, thinking about this and is following the new art in all its different branches; so that, when television finally "breaks", he will be equipped to work with it as thoroughly as he has been familiarized with transmission and reception, 'phone as well as code.

Then, of course, we have the ultra-high frequencies, which are a distinct field in themselves, and of which next to nothing is known nowadays. Most of the effects that these frequencies are apt to create in us are not even known; and intensive study in this field alone may bring a rich harvest.

A number of experimenters have voiced the opinion to us that transmitting with the ultra-high frequencies is apt to prove a dangerous game, because the effects on the human body might be fatal.

This is not necessarily true, as Dr. Erwin Schliephake, M.D., one of the greatest investigators of ultra high frequency wave effects on the human body, recently pointed out. We refer to Dr. Schliephake's learned article "Ultra Short Waves in Medicine", which appeared in the Aug.-Sept. issue of this journal. This savant has some more to say in this direction in a most interesting article, scheduled for our next issue, in which he tells us what happens physiologically to the human body, when it is subjected to the ultra short waves.

Dr. Schliephake has done a tremendous amount of investigating into this realm of short waves; and his findings are reassuring, as far as the dangerous aspect of these waves is concerned. He states that, unless you are using a good deal of power, and unless your body is directly in the electric field, there is hardly any danger worth mentioning to the experimenter.

This is indeed good news to every experimenter who has heretofore held off from investigating the ultra-high frequencies.

SHORT WAVE CRAFT IS PUBLISHED ON THE 15th OF EVERY OTHER MONTH

THE NEXT ISSUE COMES OUT MARCH 15TH

SHORT WAVE SNAPSHOTS



© by Underwood & Underwood

Above — Pretty Miss Barbara Russell Sprague, 17-year-old Washington, D. C., girl, who recently received her second-class commercial radio operator's license. Miss Sprague is said to be the youngest woman ever to receive such a license. She is shown adjusting her short wave transmitter.

"Aussie", at right, W2XAF's mascot, is shown talking via short waves to VK2ME, Sydney, Australia, 9,930 miles away. "Aussie" is shown before the microphone in Schenectady—her "meouw" was transmitted early on a cold October morning and received on a spring evening in Australia.

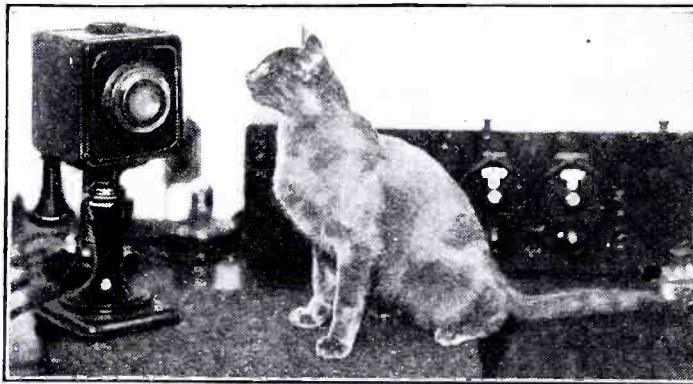

200 kilowatt short wave tube. This remarkable high-power, high-frequency tube is of the type used at KDKA's short wave transmitter, at Saxonburg, Pa. Approximately five tons of cooling water must be passed through the water jacket of the tube each hour. The power used by one of these tubes would operate simultaneously 400 electric toasters or flat-irons.

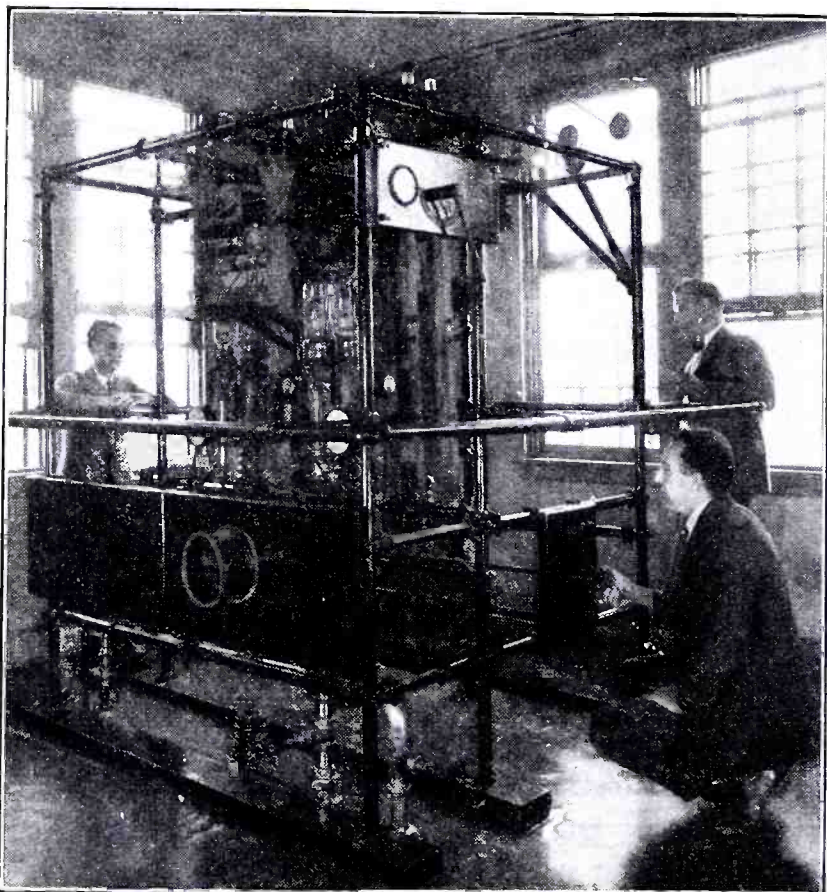

This is the transmitter at short wave station W3XAL operated by the National Broadcasting Company, at Bound Brook, N. J.



Robert Brown at the "mike" of the 150 watt short wave broadcasting station KHILO in the Crosley-Brock airplane.

Short Waves Play Novel Roles

Bootleggers Use "Undamped" Waves

THE photo at right shows one of the Short Wave Transmitters seized by the U. S. Dept. of Justice agents, and which formed an important connecting link between rum-runners ashore and afloat. Clever these rum-runners—they not only steal waves but they even impersonate stations and use calls allotted to duly licensed stations. Photo shows two short-wave transmitters on the floor, while a dynamic speaker rests on one of the transmitters; above the speaker we see an elaborate receiver. The detective is holding a microphone and just in front of him is seen a short wave receiver.

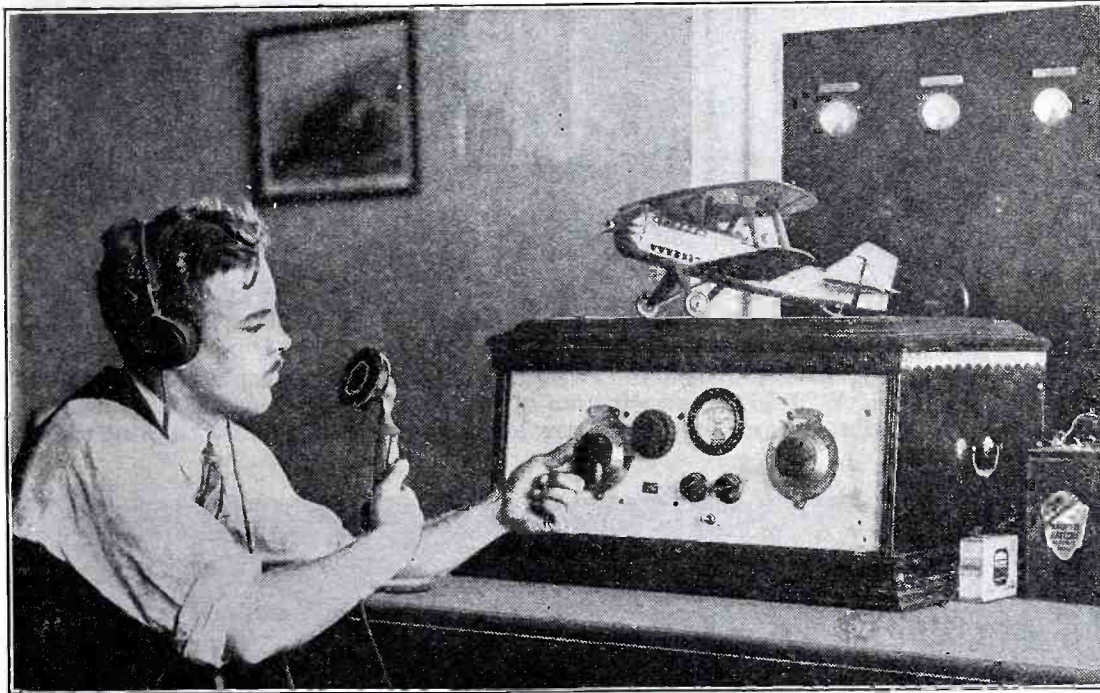
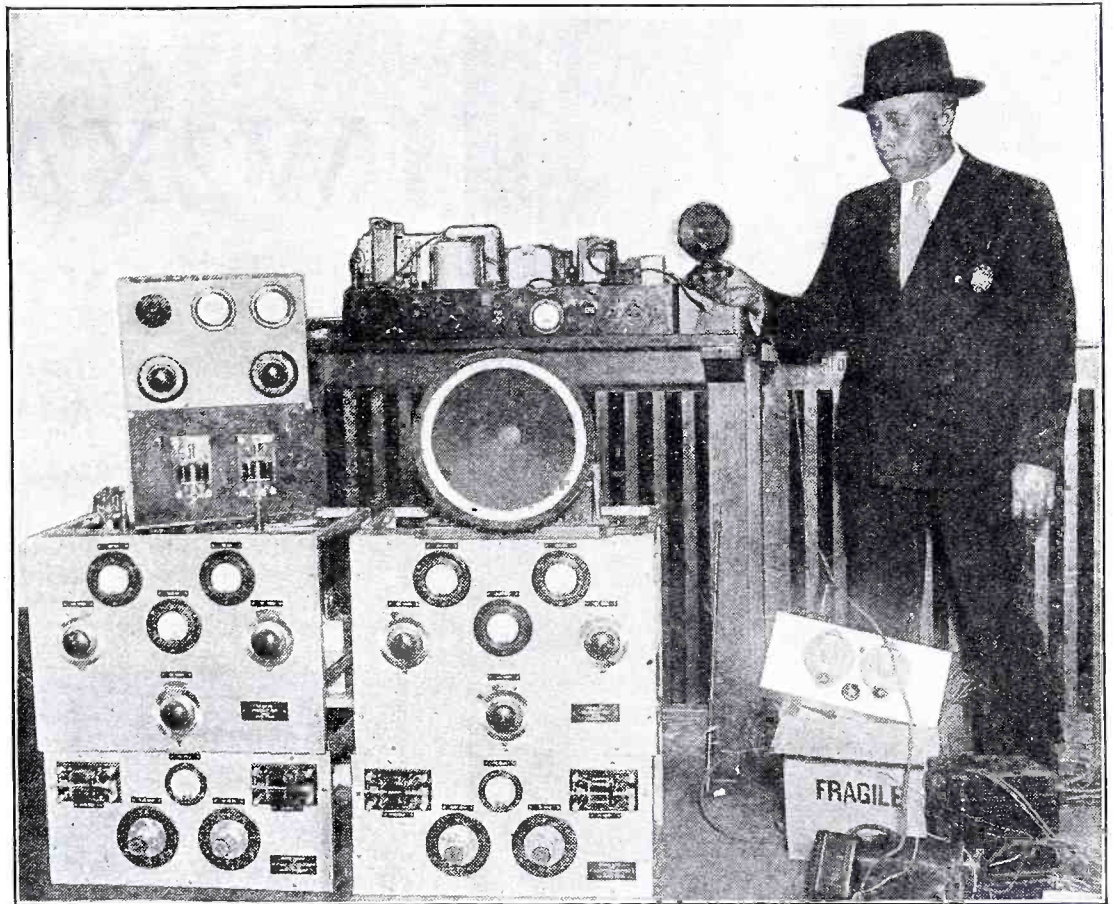

Plane-to-Ground Radio

AT the left we see the new ground-to-air and vice versa radio communication equipment installed at Boston by the Colonial Air Transport, by means of which radio-phone messages may be transmitted from the ground station to airplanes in flight and also from the planes to the ground stations. John H. Gould of the Boston division of the Colonial Air Transport is shown tuning a short wave receiver at the Boston air station. The transmitter panel may be observed in the background with the usual indicating meters. One of the newest reports is to the effect that a ten-pound radio direction finder has been perfected and tried out on one of the airlines, a plane having followed a 400-mile course to its home airport by training the radio direction finder on a broadcast station.

Short Waves on Reception Boat

PHOTO at right shows a short-wave receiver and transmitter on the New York City reception boat "Macom" which maintained constant communication with Mayor Walker's office in New York City. The photo at right shows the Macom's radio operator, Robert W. Dickens, who is tuning the short-wave set (operating at 178 meters in this instance) to the New York City Hall station, while the gentleman shown on the left of the picture is the radio announcer, Thomas Cowan. Mr. Cowan is shown talking into the microphone connected with the Macom's short-wave transmitter. Part of the transmitting equipment is seen on the extreme right of the operator's desk and the conversation carried on between the Macom and the city's land station, was broadcast throughout the country.

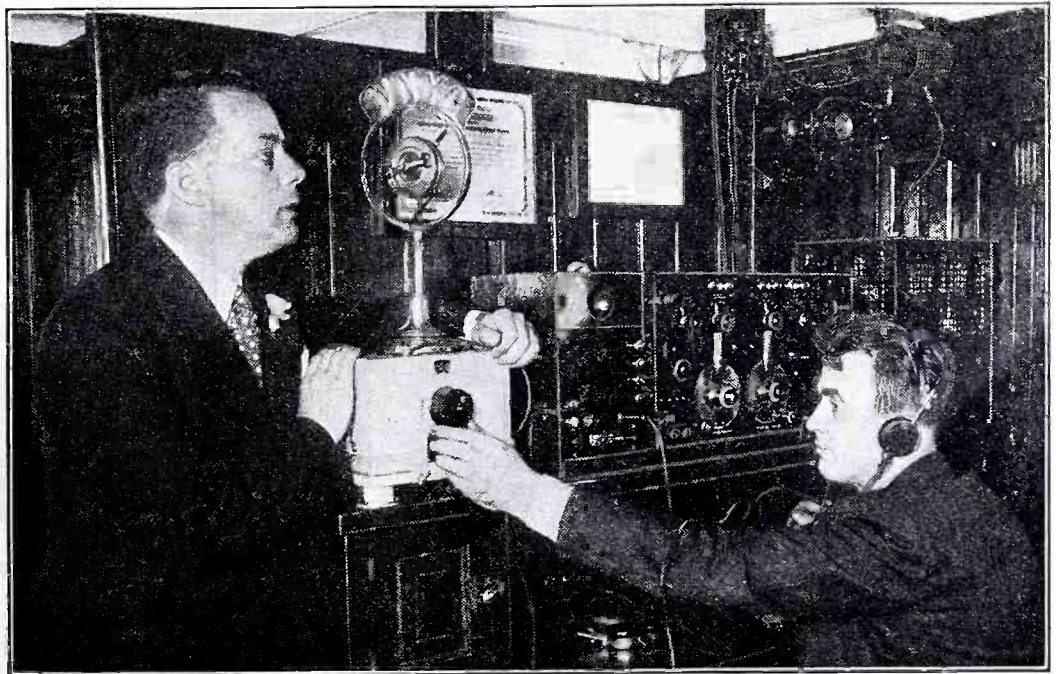

W2XAF CAN

One of the world's most powerful short-wave transmitting stations is that located at South Schenectady, N. Y. The new equipment here shown can handle six different messages simultaneously; code, voice and pictures can be sent out at the same time.

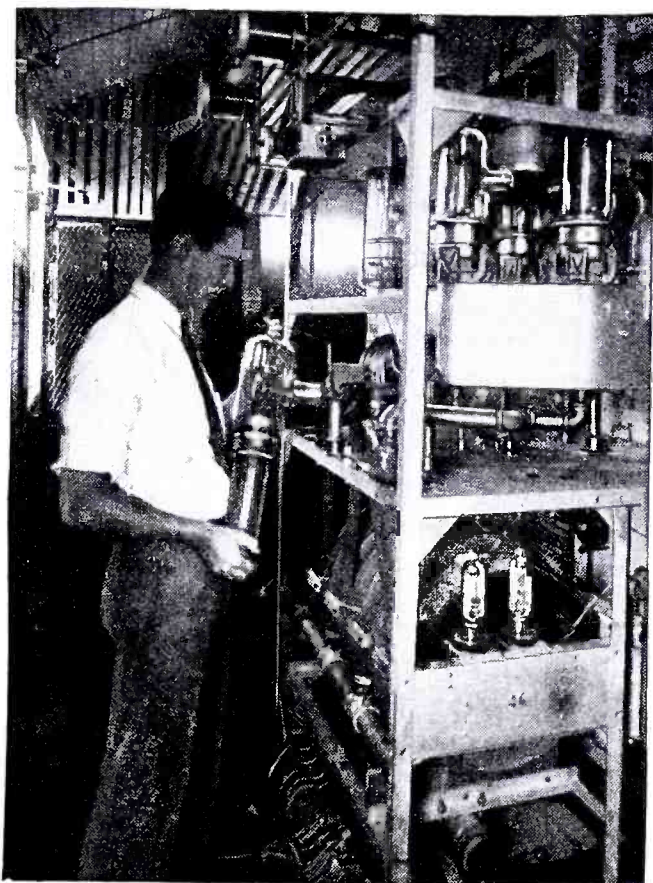

Above—Operator seen holding one of the large water-cooled tubes used in one of the power amplifiers at W2XAF, the new General Electric Company's powerful short-wave station at South Schenectady, N. Y.

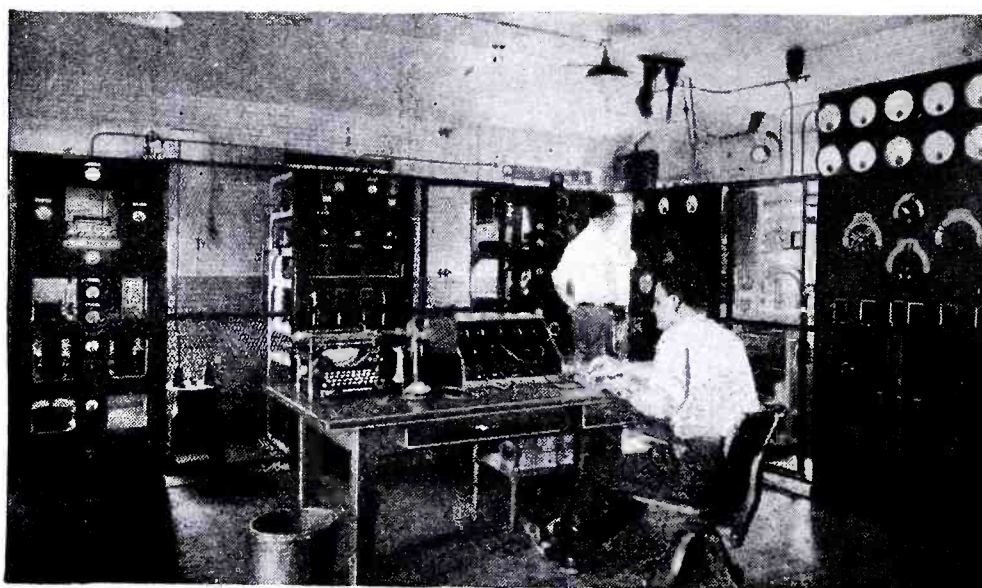

Below—One of the short-wave experts at W2XAF's new, ultra-powerful short-wave transmitting station at South Schenectady, examining a one kilowatt short-wave unit, consisting of a crystal oscillator and vacuum tube multiplier.

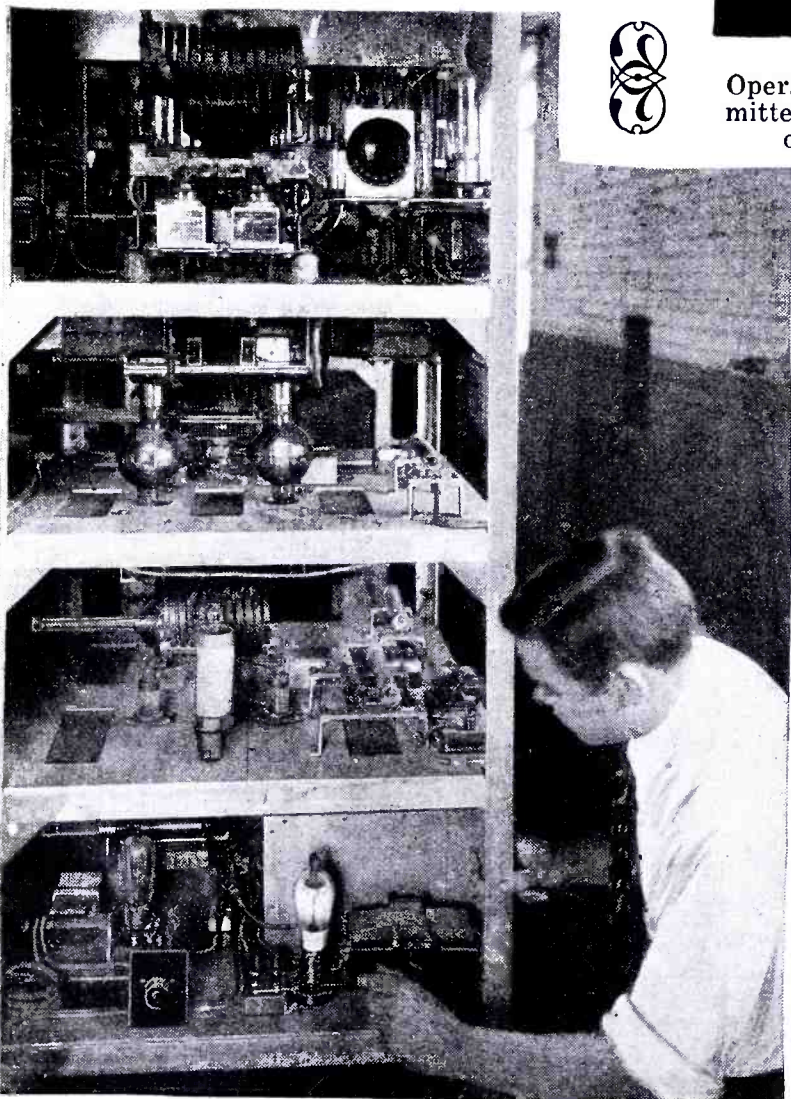

Operating desk and control switchboard panels of the short-wave transmitter at W2XAF's new station. The high power vacuum tubes used as oscillators and amplifiers are located behind these switch panels.

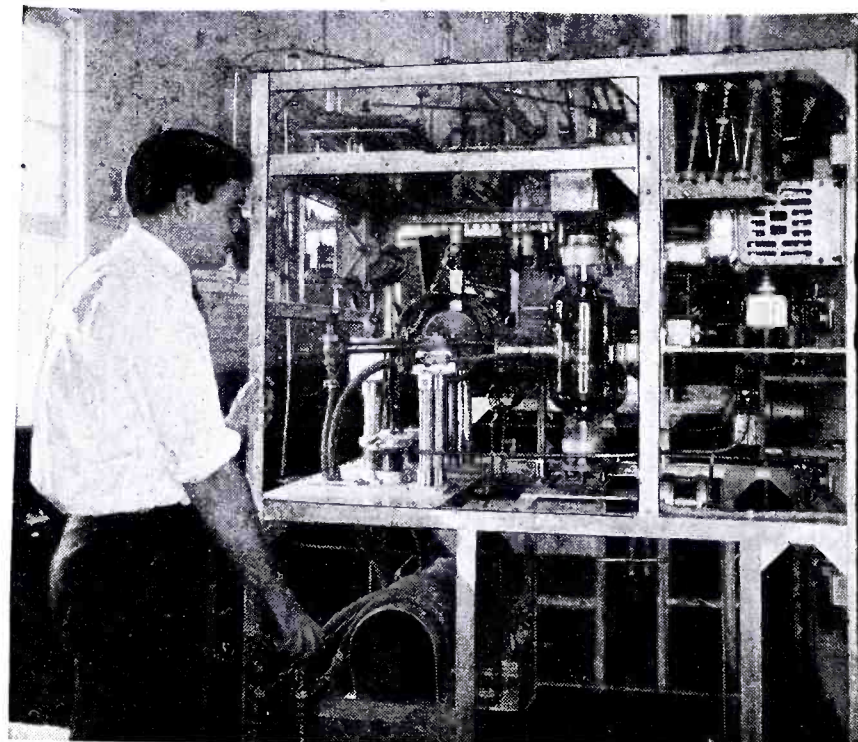

Above we have a close-up view of one of the intermediate linear amplifiers at W2XAF. The powerful vacuum tubes used are water-cooled and the expert seen in the picture has his hand on one of the valves controlling the cooling water. This water line is connected to the tube by means of rubber hose.

SEND CODE, VOICE and PHOTOS *Simultaneously*

By GUY BARTLETT*

OUT of years of research and experimentation by General Electric radio engineers at Schenectady, N. Y., has grown a transmitter which is probably without parallel in the radio art. Today it is used by W2XAF, one of the group of "short-wave" stations of WGY, to sustain that station's standing as the unofficial ambassador of the United States to the nations of the world.

Here is a single transmitter so built that three musical programs can be simultaneously broadcast without interference.

Six Independent Voice Channels Available

Six separate, independent and non-interfering voice channels are available. In other words, should occasion demand, and the federal license permit, addresses by six different people could be transmitted by the same equipment, on six different wavelengths without interference.

The same transmitter may be used for television signals up to sixty-line scanning, at twenty pictures per second. It may be used for television and voice transmission at the same time; that is, one channel may be used for picture and another for voice.

When the demand for service is created, W2XAF's new transmitter may be used for the simultaneous transmission of eight still pictures (facsimile) each in its own channel or independent wavelength.

All that is needed for multi-service is the addition of crystal-control, low-power intermediate amplifiers, and low-power modulators of standard design, for each additional program.

* Of the General Electric Company.

Equivalent Power 240 Kilowatts

W2XAF is equipped with three independent antenna systems for broadcast purposes; a single doublet of special construction to avoid "corona discharge" on high powers; a horizontal checkerboard antenna directive toward South America; a similar directional antenna for transmission to the Far East. The directional antenna increases the power radiated in one direction from 35 kilowatts (the maximum power of the transmitter) to an equivalent power of 240 kilowatts if radiated non-directionally. When used for telegraph purpose this outfit, combined with a directive antenna, will give a signal equal in strength to that picked up from a 1000-kilowatt transmitter using a simple antenna.

W2XAF, located at the South Schenectady transmitter laboratory of the General Electric Company, five miles south of Schenectady, is licensed by the Federal Radio Commission for experimental relay broadcasting on 40 kilowatts.

Quartz Crystal an Important Factor

The carrier frequency of 9530 kilocycles is generated by a quartz crystal, oscillating at one-fourth the carrier frequency, or 2382.5 kilocycles. Effective operation of the crystal is possible only when the temperature surrounding it is constant. To gain this uniformity of temperature, an ingenious automatic temperature-controlled oven has been devised. The oven consists of a number of compartments arranged one within the other, each acting as an insulating chamber to protect the crystal from the temperature variations of the transmitter room. The crystal is housed in the final compartment, in a metal box, where the temperature deviation is so slight as to have no effect on its efficiency.

Modulation Equipment

The output of the crystal oscillator is amplified and multiplied in frequency, until a power of one kilowatt is available at 9530 kilocycles. At this point modulation takes place. The modulating equipment is unique, in that frequencies from 25 to 50,000 cycles may be used and the maximum variation throughout the band is less than 10%—an amount so small as to be negligible; the result is incomparable fidelity over an exceptional range of frequencies. It is so arranged as to make possible the 100% modulation of the one-kilowatt radio-frequency amplifier without distortion. The unit is then coupled to an intermediate amplifier, whose output voltage varies rectilinearly with the input voltage. The output of this stage is about four kilowatts.

This stage, in turn, is used to excite the large power amplifier, which is connected to the antenna system. The power amplifier utilizes six 30-kilowatt (a total of 180 kilowatts) vacuum tubes, arranged in a push-pull circuit, with three tubes on each side. The last amplifier has been tested up as far as 134 kilowatts continuous antenna output, such as might be used in continuous-wave telegraphic communication.

Twenty Gallons of Water Per Minute to Cool Tubes

W2XAF's new transmitter employs thirteen different types of tubes, or twenty-seven tubes in all. Twenty gallons of water per minute are pumped through the set to cool the plates of the tubes.

W2XAF, using 20 kilowatts of power on its old set, was capable of reaching Europe, Australia and South America, with exceptional reliability and generally with a fair signal. When directional an-

(Continued on page 393)

An Amateur Short Wave Phone Transmitter. By C. H. W. Nason. Snags in S-W Receivers and How to Overcome Them.

What Short Wave Receiver Should I Build? A discussion of the various types of circuits, including tone-filters and autodynes. By Rolf Wigand.

A 5-Meter Transmitter and Receiver. Constructional details, drawings and photos of the set as built and successfully tested. By E. T. Somerset, G2DT.

In Our Next Issue:

How Directive Aerials Work. Elaborately illustrated.

Audio Amplifiers for Short Wave Receivers, including constructional details for building special "tuned" units for code reception.

The Human Being as an Antenna. What happens physiologically to a person subjected to high frequency waves. An important and most interesting description of results ac-

tually observed. By Dr. Erwin Schliephake, M.D. of the Jena University Medical Clinic.

The Proper Use of R.F. Chokes in Short Wave Circuits. By R. William Tanner, W8AD.

What Vacuum Tube to Use in Short Wave Circuits. By Robert Hertzberg.

The New Pilot A.C. "Universal Super-Wasp." Diagrams, photos and complete description of the latest "plugless" receiver with a range of 15 to 650 meters.

W9XAA-

The SHORT WAVE VOICE of Labor

By MAYNARD MARQUARDT

Chief Engineer WCFL-W9XAA

The author of the present article provides a lot of interesting data on a commercial "up and going" S-W transmitter. The amateur operator often wonders how the "big boys" really do it. Well—here's how—with diagrams n' everything for good measure.

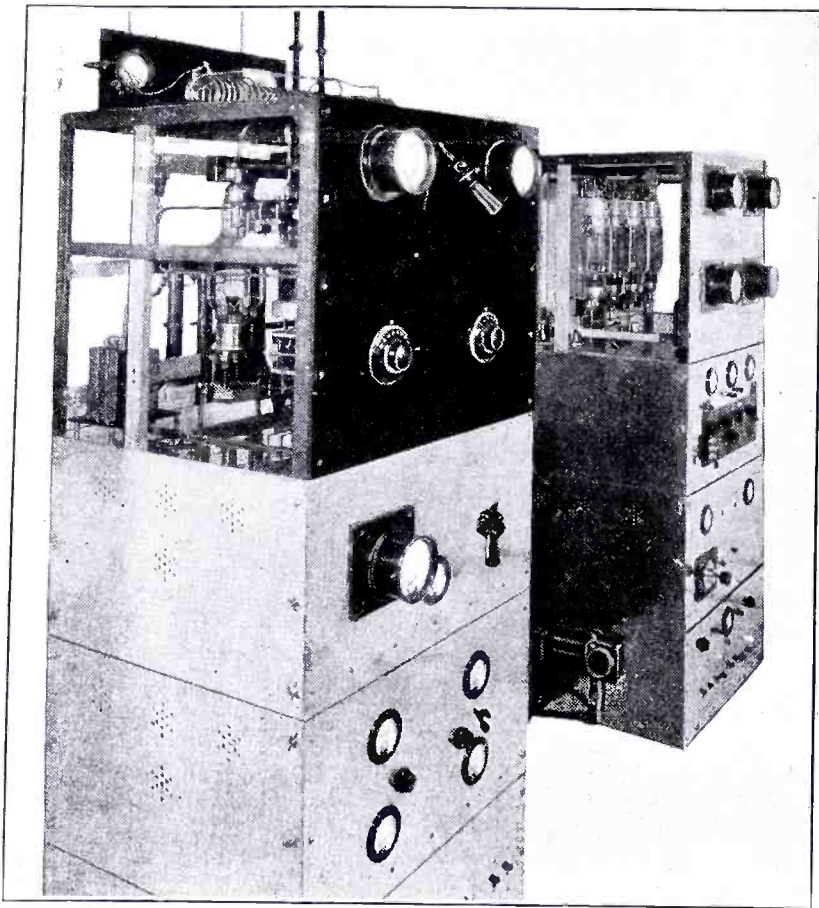

View of the short-wave transmitter at W9XAA, Chicago, Ill.

BEFORE going into a description of W9XAA's transmitter, I believe it fitting to explain the reason and ideas behind its inception and existence. The station has its founder in E. N. Nockels, general manager of WCFL-W9XAA and secretary of the Chicago Federation of Labor, whose aim it was to tie together laboring men and labor unions the world over, promote international broadcast exchanges, and to bring the nations of the world to closer understanding.

The transmitter of W9XAA is located in the northeast tower of Navy Pier, Chicago, Illinois, together with its sister transmitter WCFL. It transmits on 6080 kilocycles, or 49.34 meters, with a power of five hundred watts.

In building the transmitter the engineering staff of WCFL-W9XAA (which did all of the design, construction and installation work), decided that there were four major requirements which the transmitter must fill: (1) stable frequency; (2) good audio quality; (3) high percentage of modulation; (4) a good radiating system. With these ideas in mind the transmitter was built.

In the case of the first requirement, stable frequency, the use of crystal control was the only system considered. Master oscillator-power amplifier circuits, no matter how well adjusted, are more prone to dynamic frequency instability, i.e., frequency swing or "wobulation" upon modulation. Crystal control has become such a common byword that it is usually considered synonymous with stable frequency. However, even a crystal does not insure stability of frequency, unless accompanied by proper transmitter design. The frequency of the crystal is dependent upon its thickness. It fol-

lows that temperature changes, by causing expansion and contraction, will vary the working frequency of the crystal.

Methods of Insuring Constant Frequency

The crystal at W9XAA is kept in a thermo-regulated cabinet, in which the temperature varies less than one-tenth of one degree centigrade. This constancy is obtained by a mercury column, acting

on a vacuum-tube relay which, in turn, energizes the armature of a mechanical relay. This relay tips a glass tube with enclosed mercury contacts, thus causing a mercury pool to roll into place and close the circuit to the cabinet's heater elements. The crystal must be ground to oscillate at the desired frequency at a specific temperature (usually 50° C.) which is sufficiently above room temperature so that cooling is never necessary.

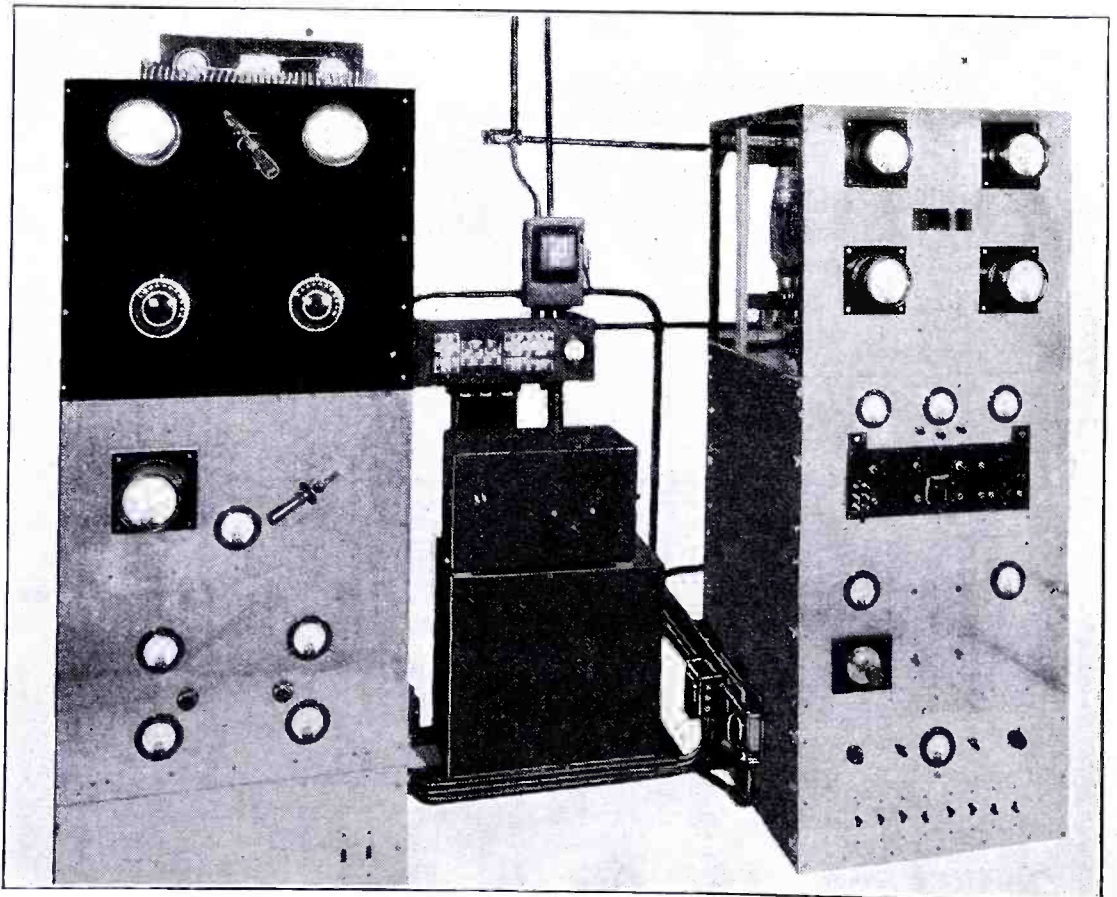

Front view of 500-watt S-W transmitter at W9XAA; it operates on 6,080 kilocycles or 49.34 meters.

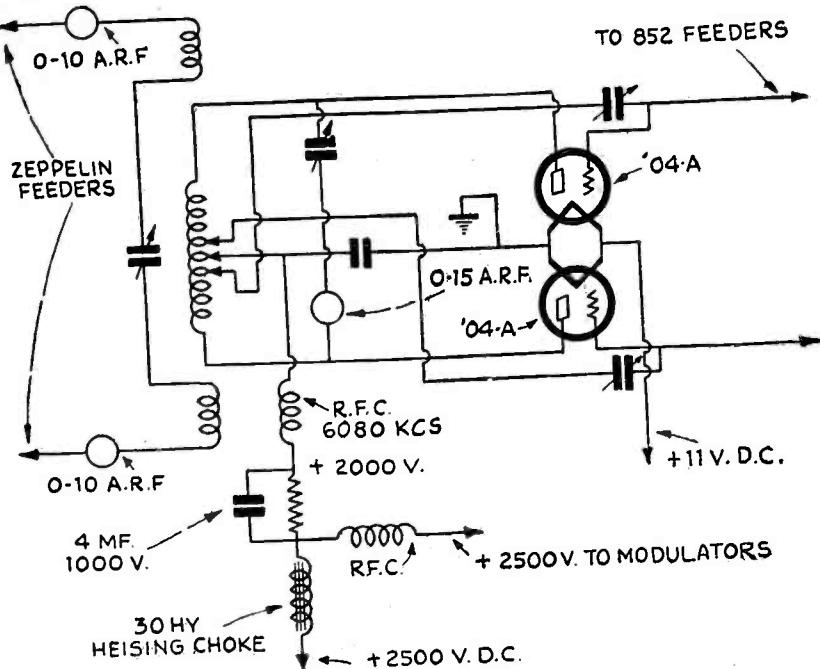

Two 204 'A's in push-pull, last R.F. stage feeding antenna at W9XAA.

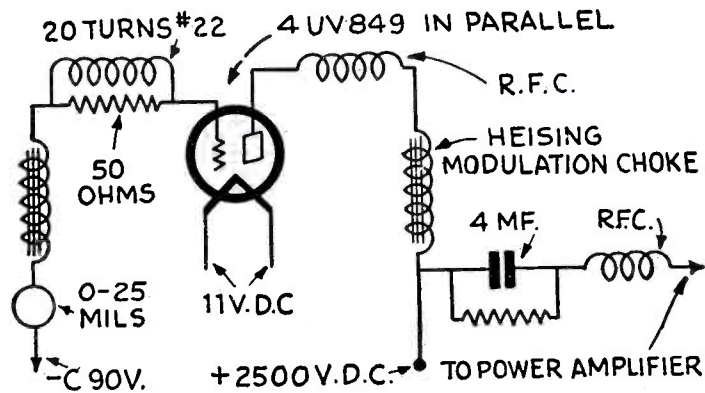

Modulator tubes (four) are used in parallel at W9XAA.

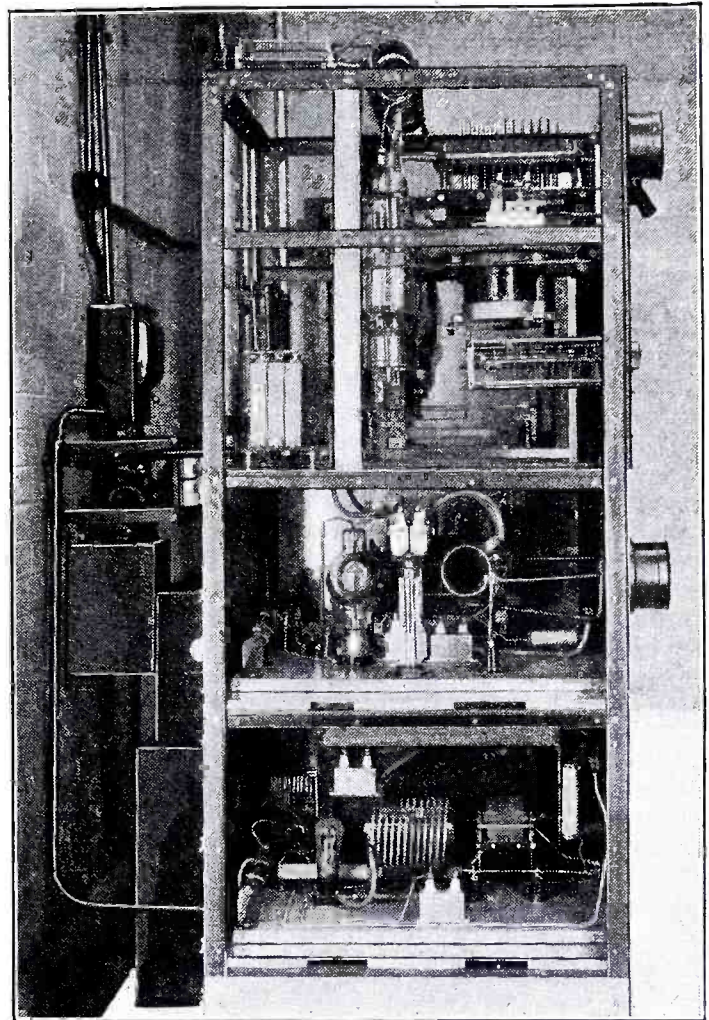

End view of 500-watt S-W transmitter at W9XAA, showing tuning condensers with specially spaced plates, inductances, tubes, etc.

A great factor, in constant temperature cabinet work, is proper cabinet heat-insulation. The inside of the cabinet at W9XAA is lined with aluminum plates, to give rapid heat diffusion inside the cabinet. Outside this are a layer of celotex; then an air space, another layer of celotex, a wooden boxing and finally a metal covering for protection and good appearance. The heaters are three 15-watt bulbs, it being important to use small heaters over a long period rather than large heaters over a short period. The constancy of temperature and attendant stability of frequency is very important when it is realized that a station's license would be imperilled by a frequency variation of more than five one-hundredths of one per cent., or 3040 cycles at the operating frequency of 6080 kilocycles. Then too, the use of frequency-doubling stages, which will be explained later, multiplies any deviation of the oscillator frequency.

The frequency of W9XAA is 6080 kilocycles. The problem of grinding a crystal to that frequency is difficult, and its operation meets with even more difficulty. Such a crystal is extremely thin and liable to be fractured by careless handling, overloading or bad tuning conditions. It is much more practical to use a 1520-kilo-

cycle crystal and two frequency-doubling amplifiers to reach 6080 kilocycles. The crystal in use oscillates at 1520 kilocycles at 53.1° C., which is 127.58° Fahrenheit.

Arrangement of Amplifiers and Modulators

The crystal oscillator circuit uses a 210 tube; in order to obtain a high percentage of output at the second harmonic, the plate circuit contains a high capacity with reference to the inductance. The second radio-frequency stage of the transmitter also uses a 210 tube; it is interesting to note that, in this stage, the grid is excited at 1520 kilocycles but the plate is tuned to 3040 kilocycles, thus doubling the oscillator frequency.

The third radio-frequency amplifier, which is also a frequency doubler, is a UX-852; a seventy-five watt tube specially designed for high-frequency operation. In this stage, the tube's grid is excited from the 3040-kilocycle "tank" of the preceding stage; its plate, however, amplifies the second harmonic of the 210's output and works at 6080 kilocycles.

Two UV-204As in push-pull constitute the fourth and final radio-frequency amplifier. Up to this point in the transmitter the necessity of neutralization has been avoided by the use of frequency-

doubling stages. The last two stages operate on the same frequency, and neutralization is necessary. W9XAA uses a cross system of neutralization, from each grid to the opposite plate. The ease of adjusting the neutralization in this circuit is a very desirable feature and a very welcome one.

From the photographs of the transmitter, it will be seen that very complete shielding is employed. The frame of the transmitter is of angle iron; the front is of 1/8-inch aluminum and the side is 1/16-inch. Each unit of the transmitter slides in and out from the front on a shelf of 1/16-inch aluminum. In this manner each section is well isolated from the others. In the course of much experimentation at W9XAA, the importance of meticulous and thorough shielding was made quite evident. Circuits which were often unstable without shielding became very reliable after being put inside the frame and shielding.

In addition to crystal control, the transmitter operator at W9XAA has the added assurance of crystal check of his frequency. The checking circuit oscillates at the desired frequency through the use of a crystal ground to 6080 kilocycles, in connection with a 199 tube having forty-five volts on the plate and two

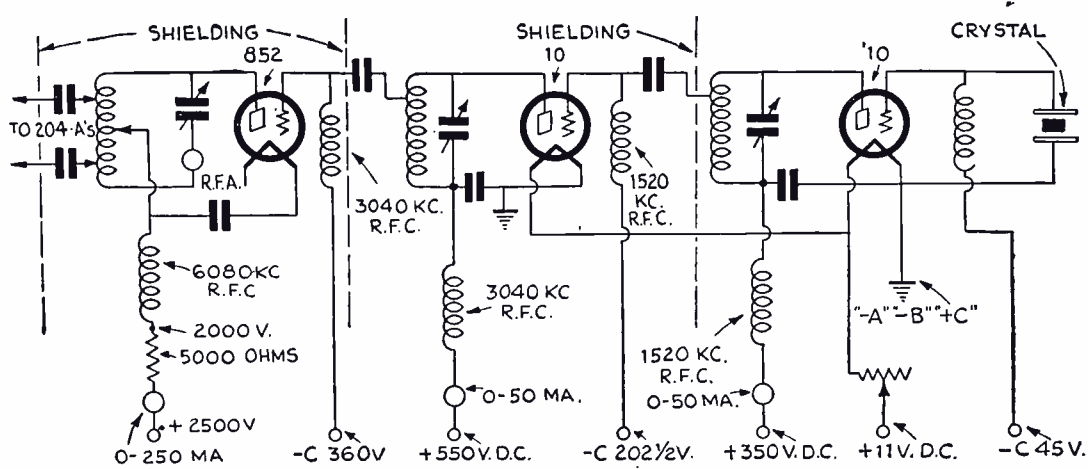

Hook-up of crystal oscillator and two frequency doublers at W9XAA.

steps of amplification. This checking unit, or "check," is kept in its own thermo-regulated cabinet. The beat between the carrier of W9XAA and the oscillating frequency of the crystal check is amplified to a point where it can be heard on a loud speaker; and the transmitter's operator can thus tell how far off frequency he is.

Details of the Power Supply

The preceding paragraphs have outlined the system by which W9XAA obtains and checks a constant frequency of 6080 kilocycles. The second requisite of the transmitter is that it must have good audio quality. The amplifier uses three steps of impedance-coupled amplification. The speech-amplifier tube is a W.E. 211D. The line amplifier has its own filament battery supply, and gets its plate current from a separate well-filtered rectifier. Jacks are provided for reading the plate current of each tube; by a switching arrangement, one voltmeter reads all filament potentials, the aim of this being to cut fewer holes in the aluminum panels and thereby preserve the effectiveness of shielding.

One hundred per cent. modulation is obtained through the use of four UV-849 modulator tubes, which are operated at a plate potential of 2,500 volts. The lead to the modulated power amplifier contains resistors to cut this down to 2,000 volts for the two 204As; for good audio quality, these are bypassed by a four-microfarad condenser. The system of using a higher voltage on the modulators makes possible a high percentage of mod-

ulation with a minimum of distortion.

The power supply, to the plates of the oscillator and first doubler, is obtained from two separate rectifiers using 280s. The plates of the 849s, 204As, 852 and 211D are fed from a common source, a plate generator. Filament supply for the

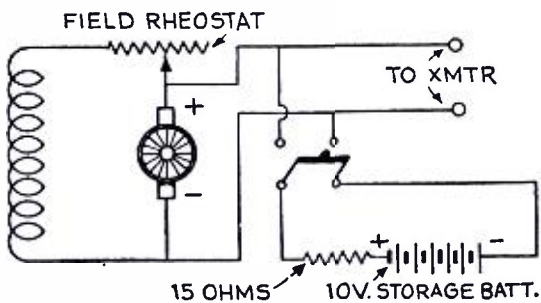

How a battery is used to absorb commutator ripple on filament generator.

entire transmitter, except the audio amplifier, is furnished by a generator capable of delivering seventy-five amperes at fifteen volts. A ten-volt storage battery is floated across the output of the fila-

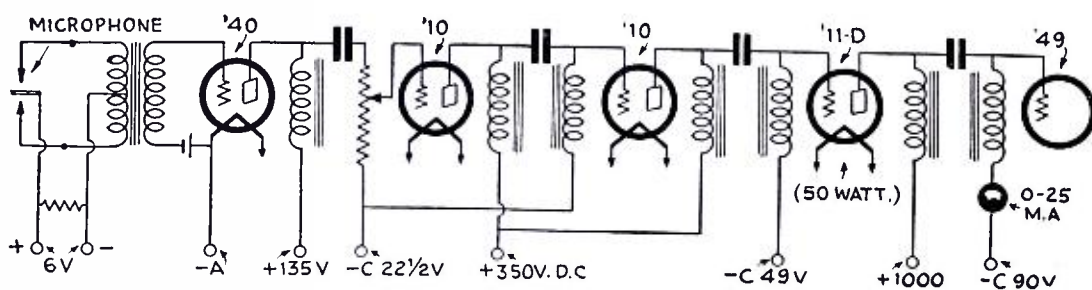

Connection of microphone to audio amplifier at W9XAA.

Short Wave Oscillations

brate in the same manner as the keys of a xylophone. The plate was provided with two pairs of electrodes connected to a generator, and the frequency at which the plate vibrated was somewhat over 7,000 cycles per second. The plate vibrated so vigorously that particles of sand scattered on the surface were seen to dance violently.

International Ultra Short Wave Tests

THE Radio Society of Great Britain has organized a series of tests on the ultra-high frequencies, and will have special (code) transmissions made on the dates given below. Since little is known

of the path of such waves, after the disappearance of the signal beyond the horizon of the transmitter, careful reports of the results will be appreciated by the Society; they may be addressed to Mr. H. J. Powditch (G5VL), Porth, St. Columb Minor, Cornwall, England.

The Antenna System Gives Exceptional Distance

The antenna problem confronting W9XAA was a serious one. One entire side of the premises has beneath it a huge copper roof which covers a municipal auditorium; the antenna was placed as far from this as possible. It is of the Zeppelin type, having two horizontal feeders, one-quarter wave in length, and a vertical fundamental or half-wave antenna. The feeders are 39 feet in length, and the radiator is seventy-eight feet long. This antenna system was chosen because of its known excellence for low-angle radiation which is desirable for maximum skip distance and DX reception.

Not without considerable trouble, W9XAA went on the air. A fire extinguisher proved a very handy thing at the beginning; as some very startling pyrotechnics occurred at points of weak insulation.

Inside of forty-five days after W9XAA was put on the air, every state in the United States, four Canadian provinces, Mexico, Brazil, and New Zealand had been heard from. Many of the letters were so complimentary that they were regarded as being more friendly than accurate. But, as evidence in the form of consistent reports by mail continued to come in, it became plain that W9XAA on only five hundred watts is "covering the world."

In closing, I want to give credit to the men who run W9XAA, who kept on through months of stamina-testing experimentation and put W9XAA on the air—Harold Eby, Eugene Krusel, R. B. Pappin and William Pracht.

From 11:30 to 11:40, 14:10 to 14:20, and 14:30 to 15:00, G.M.T., transmissions will be made on the frequency of 58 megacycles (5.169 meters) on Sundays, Feb. 1, 8, 15 and 22. Stations participating are G2DT, G6TW, G6LK, G6XN, G2OL, G2BY, G5WK, G5VL.

(Continued on page 396)

HOW to OPERATE a SHORT WAVE Receiver

TUNING a short-wave radio receiver is fast becoming a world favorite indoor sport. It opens a new field of entertainment for those who have an experimental turn of mind and a desire for adventure, but who must curb their desire to what adventure may be found in their own homes. As in most other sports, the results obtained by the short-wave listener depends much on his skill; and, when he has once attained a certain degree of efficiency, he is prone to call in his friends and proudly entertain them with music coming from many miles' distance.

Short-wave work is also instructive. Circumstances surrounding reception on short waves are entirely different than those found in operating a broadcast receiver. Our short-wave sets are not calibrated; stations are continually changing waves and schedules; new stations are going on the air at intervals; reception is world-wide and many different languages are heard; confusing harmonics of local stations are heard; time differences between the station and the listener must be taken into consideration; and, added to all this, short waves are peculiarly affected by light and dark—some being increased in their carrying power by light and others by darkness.

It may be said that there are three different classes interested in short waves. The first, and oldest, is the amateur. This group of experimenters in transmission and reception, distributed over the entire globe, comprises two types, the code and the phone man. Code is known to have a far greater carrying power than voice, and it is not in the least uncommon for an amateur on 20 or 40 meters to "work" several continents in a day's time. The phone man is confined to bands on 85 and 150 meters, but may be heard at all hours.

The commercial class, connected with stations transmitting and receiving news reports, business communications, weather and time signals, etc., also comprises two groups, the code and phone classes. For several years the ability of short waves to carry a signal over a long distance has been known, and recently many commercial companies have supplanted high-powered long-wave stations with medium-powered ones on short waves and find them more satisfactory. The phone class includes ships at sea conversing with shore stations and each other, airplanes and airport stations, and commercial telephone service between all parts of the world.

By **ARTHUR J. GREEN**
(President of the International Short Wave Club)

Mr. Green knows most of the foreign S-W stations by their "first name" and in this article he tells you how and when to listen in for them. In one month Mr. Green's club members reported hearing 72 "foreign" short-wave stations! In one month 22 new American S-W stations were heard. Are S-W's on the up-and-up? We'll say so!

The third and most numerous class is that of the short-wave broadcaster and the short-wave broadcast listener. The quite frequent re-broadcast of overseas stations by our American stations have awakened thousands to the fact that they can receive these and other stations direct. In the tropical and sub-tropical countries, where a high static level is found on long waves, and regular broadcast entertainment has been limited to approximately two months out of a year, listeners have turned to short waves with tremendous interest. Short-wave broadcast stations have been installed in at least fifty of the countries of the world, and short-wave receivers are to be found everywhere.

Times Have Changed—And Sets Improved

The first short-wave receivers were, for the most part, haphazard affairs of poor quality. During this period thousands of listeners, failing in attempts to receive overseas stations, threw up their hands in disgust; and they have ever since been prejudiced against short waves as a medium of entertainment. If these same persons were now to operate modern receivers, with proper instructions, they would be greatly surprised. Short-wave receiver design has advanced rapidly during the past fifteen months, and the new sets are in every way more efficient and easy to tune.

It is also absolutely true that, even with this great advancement, many set owners are not enjoying success in tuning in foreign stations. In many cases, a listener with an old-style receiver is reaching out for stations that his better-equipped neighbor may not be able to hear. The difference lies in the skill of

the operator and his knowledge of when and where to tune.

Several writers have attempted to draw up a list of so-called "dependable" short wave stations; they take into consideration the power the station uses and its distance from the U. S. A. Such a list is impractical and useless.

Many times a low-powered station will cover far greater distance than a high-powered one, because the the former has certain characteristics of short waves helping the signal along (viz.: light or darkness effects, atmospheric conditions, less interference, and the waves used being more adapted for distance). Some listeners wonder why reception of certain stations is not to be had all the year round and at any time they happen to be on the air. Such a condition is caused mostly by the effects of light and darkness. In winter, when nights are long and the days are shorter, many stations up above 33 meters may be picked up, though they cannot be heard during the summer months. To the contrary, stations below 25 meters are helped by daylight. A very helpful rule to follow when searching for stations is as follows:

When to Listen on Short Waves

From 14 to 20 meters, tune for stations from any direction from daybreak until about 4 p. m. After that, darkness effects take away the carrying power of these waves.

From 20 to 33 meters, stations in Europe can be heard from noon till about 10 p. m., reaching a peak of efficiency about three and keeping it until eight p. m. Stations to the west in this band are heard best from 10 p. m. until approximately two hours after daybreak.

From 33 to 70 meters, darkness is needed to give carrying power from any direction. This statement applies to distant stations only, for many "locals" and amateurs may be picked up at all hours. Above 70 meters there is little or nothing to be heard in the way of distant stations.

With stations so erratic and conditions changing so rapidly, it is quite necessary for listeners to depend on each other to a great extent for obtaining information that will enable them to tune in stations that can be heard at certain periods and certain times of the year. Such an organization, The International Short-Wave Club, has been in existence for the past year. The membership of this organization covers thirty-seven coun-

(Continued on page 390)

Short Waves for the Broadcast Listener

Every Broadcast Listener Will Be Interested in This COMBINATION LONG and SHORT WAVE

By E. T. SOMERSET
Associate Member, Institute Radio Engineers.

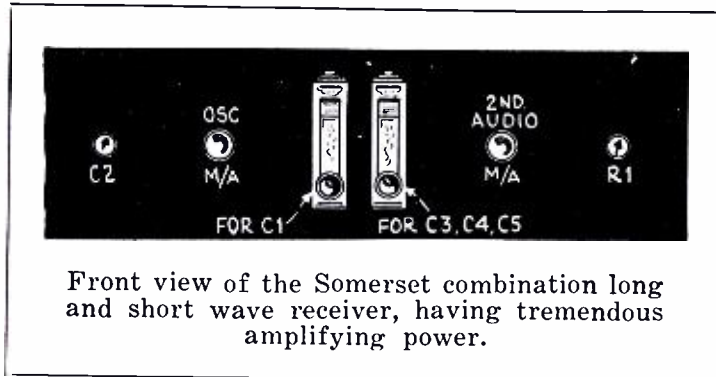

Front view of the Somerset combination long and short wave receiver, having tremendous amplifying power.

This combination long and short wave receiving set possesses many excellent points. It operates as a regular tuned radio frequency set for receiving the broadcast band, while for short wave reception a frequency changer is utilized, which causes the T.R.F. stages to act as the intermediate-frequency amplifier of a superheterodyne. Data is given for winding the coils as well as operating the set.

IN spite of the perfected commercial receivers there are many who still get a real kick out of making their own receivers, be they for the short waves or normal broadcasting. It is to these enthusiasts that this receiver is dedicated. Take a look at the schematic diagram, and it will be seen that all to the right of C6 is a quite straightforward, normal T.R.F. broadcast receiver; while to the left of C6 is a frequency changer. Now, with everything made up and connected as shown, we have a superlative short-wave telephony receiver; but, by breaking the connection just to the right of C6 and attaching the antenna here, we immediately have a receiver that will bring in the longer-wave broadcast stations in an extremely satisfactory manner.

Some may say "But why not AC operation?": the answer is that many set owners may not have power in their homes or, again, there may be some who would like to use a transportable receiver, which this certainly is. To those who are on A.C. power lines, it is per-

fectly in order to wire up this receiver for such operation.

From the panel layout, it will be observed that two National dials are shown close together; the left-hand control is the detector tuner for short-wave work, and, that at the right is for broadcast work. For the ham, who wishes to spread the amateur frequency bands, the tuning into the band will be accomplished with the left dial, and the spreading by using the right dial; the latter varying the intermediate frequency in this case, (for it must be remembered that, when the whole receiver is working for short-wave use, the T.R.F. broadcast portion becomes the intermediate-frequency amplifier of a Superheterodyne). The three-gang condenser fitted to the right hand dial is of such maximum capacity as to suit the R.F. Transformers (L3, L4, L5) which the constructor decides to use. To the left-hand dial is fitted a National 100-mmf. short-wave condenser; and any suitable 200 or 250-mmf. instrument may be used for C2. An ordinary arrow-head knob can control this regeneration con-

denser, as it is not critical in its setting, but requires only alteration occasionally to keep the T1 oscillating. This will be shown up by the milliammeter, which will show about two milliamperes more with the oscillator functioning than it does when this tube is not oscillating.

Control of volume, whichever way the receiver may be used, is effected by R1 which varies the potential on the screen-grids of T3, T4 and T5. The various resistors shown in the "B+" leads may be looked upon as both voltage-dropping resistors and decoupling resistors and, in this latter sense, they play no mean part in keeping the receiver stable. Should it be found, however, that R.F. currents are getting into the audio amplifier, it will then be necessary to decouple the grids of the audio tubes by inserting, in series with their grid leads, quarter-megohm resistors.

Operation as a Short-Wave Receiver

First test out the broadcast portion, and line up the trimmers on the three-gang condenser unit. When quite satis-

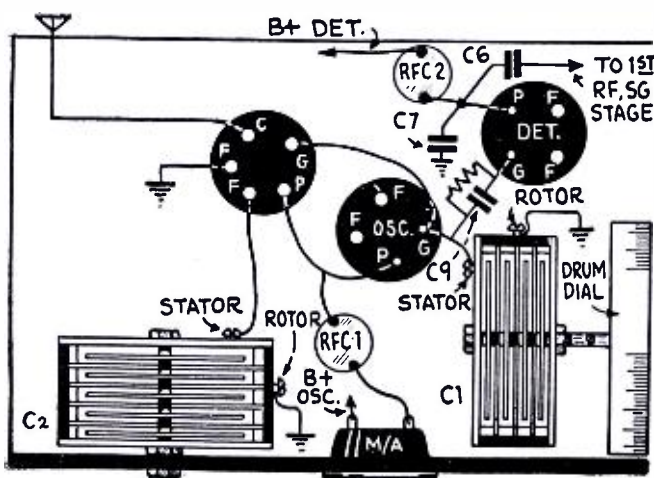

Baseboard layout of the frequency changer which enables the operator to hear short waves on a T.R.F. broadcast set.

Data on the plug-in coils used in the Somerset converter are given in the chart at the right.

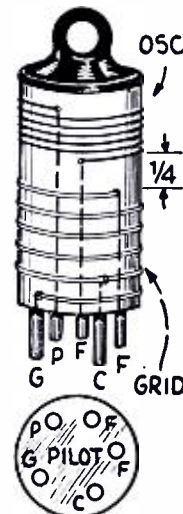

COIL WINDING DATA FOR PILOT FORMS (BOTH WINDINGS ON SAME FORM.)

	15/23 M	22/32 M	30/48 METERS
L1	5 TURNS	5 TURNS	4 TURNS
L2	4 TURNS	8 TURNS	12 TURNS

L1 WOUND WITH 30 DSC SPACING 1/16"
L2 WOUND WITH 20 DSC SPACING 3/16"

ANTENNA TAPPING TO BE 1/4-TURN FROM LOW-POTENTIAL END OF GRID WINDING.

Complete hook-up of the Somerset "Long and Short Wave" receiver. To listen in on long wave stations, the tubes T1 and T2 are switched off and the antenna connected to point X at condenser C6.

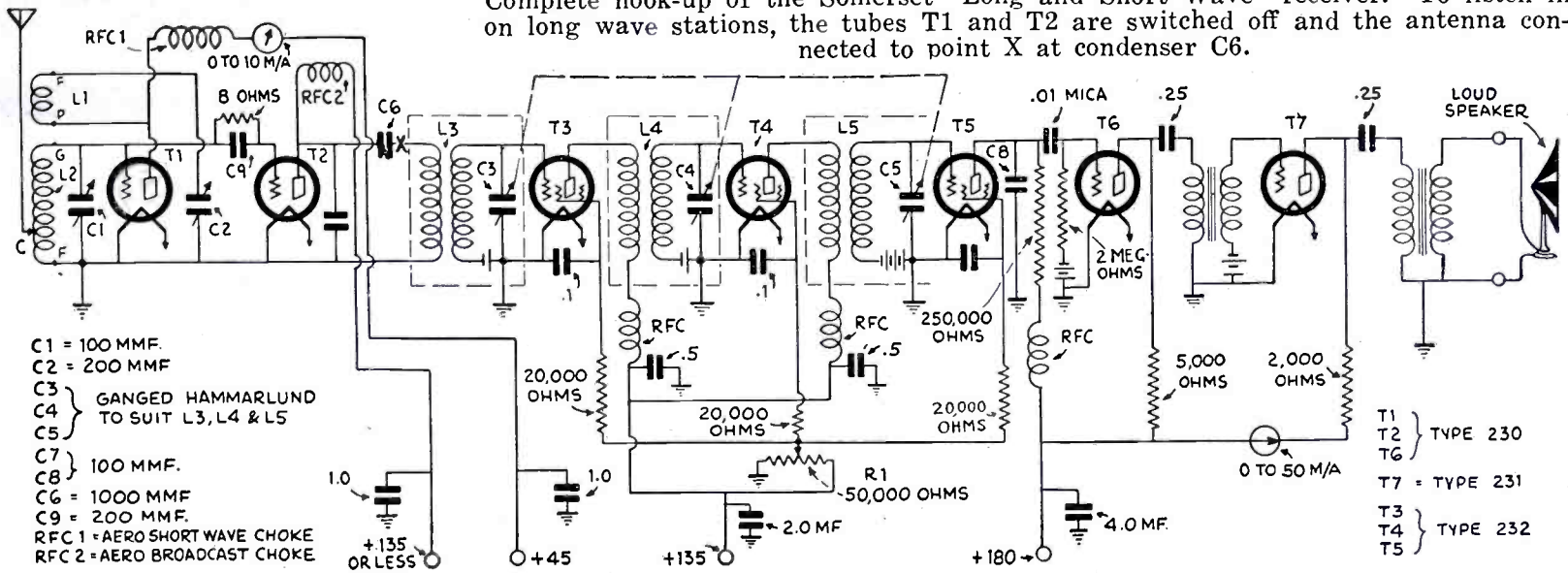

fied with the performance of this part of the receiver, the constructor can, with confidence, connect up the frequency-changer portion at the left of C6 and plug in the 8-turn Pilot coil (which will have been made up according to the sketch and winding data given.) With the rotors of C1 and C2 opened right out, take a note of the oscillator milliammeter's reading. Now gradually enmesh the rotors of C2 until the meter's needle kicks up. When this occurs it is a sign that all is well; and the constructor can proceed to tune in G5SW (or any strong short-wave station) on C1. If the milliammeter does not kick upwards, make

sure that L1 and L2 are correctly wound. To continue—having discovered G5SW or any other station—it is merely necessary to tune him in accurately by means of the right-hand dial, where tuning will be broad, instead of the left-hand dial where tuning will be very sharp.

Generally speaking, it will be found that best results are to be obtained with the right-hand dial tuned to about 350 meters and clear of any powerful local broadcast station operating close to this wavelength.

When it is desired to listen to long-wave stations, all that is necessary is to switch off the filaments of T1 and T2;

disconnect the frequency changer by means of a switch on the right side of C6; and attach here the antenna which had previously been connected to the binding post making connection at C on the Pilot form. Note that RFC1 MUST be a short-wave choke, and RFC2 a normal broadcast choke. If desired, a three-element tube may be used as second detector, and this followed by two audio transformers (instead of the plate-bend screen-grid detector T5 with resistance coupling and one transformer stage, as shown); but the quality of reproduction will suffer by this change although volume of output will, of course, be increased.

Falkland Islands Hear W2XAF and G5SW

By WILLIAM T. MEENAM*

THE British Empire, frequently referred to as "far flung," hasn't been scattered so far or widely that any part cannot be reached by W2XAF, one of the "short wave" stations of WGY, the General Electric broadcasting station at Schenectady.

From the most southerly output of that great Empire W2XAF recently received a letter written on behalf of His Excellency, the Governor, by the Colonial Secretary. The letter was from the Falkland Islands, which, for those who may be a little rusty on their geography, are directly opposite and east of the Strait of Magellan, off the southerly tip of South America.

With the letter was a copy of the Stanley newspaper which sells for two shillings per month or one pound per year. The newspaper consists of a four-page printed section. With the exception of the cover page which bears a central drawing of a group of saucy penguins on an icy barrier, bordered by gulls, whales and seals, the printed section contains the advertisements of a Liverpool mail-order house. The news section was made up of four mimeographed pages which dealt with social affairs at Stanley, a dance, the rifle club, whist club, the Badminton club, a birth,

a death, affairs in India and Egypt, and Carnera, the Italian fighting giant. The main story, the story which won first page position, was headed, "New Epoch in the Falkland Islands," with a sub-head "Big Ben and President Hoover."

This story related that on Friday, June 20, a new six valve short wave wireless receiving set had been used for the first time. The set was first tuned for G5SW, Chelmsford, England, but atmospheric were bad and reception was distorted. They then tuned to W2XAF, at Schenectady and they heard a rebroadcast from England, (Contd on p. 401)

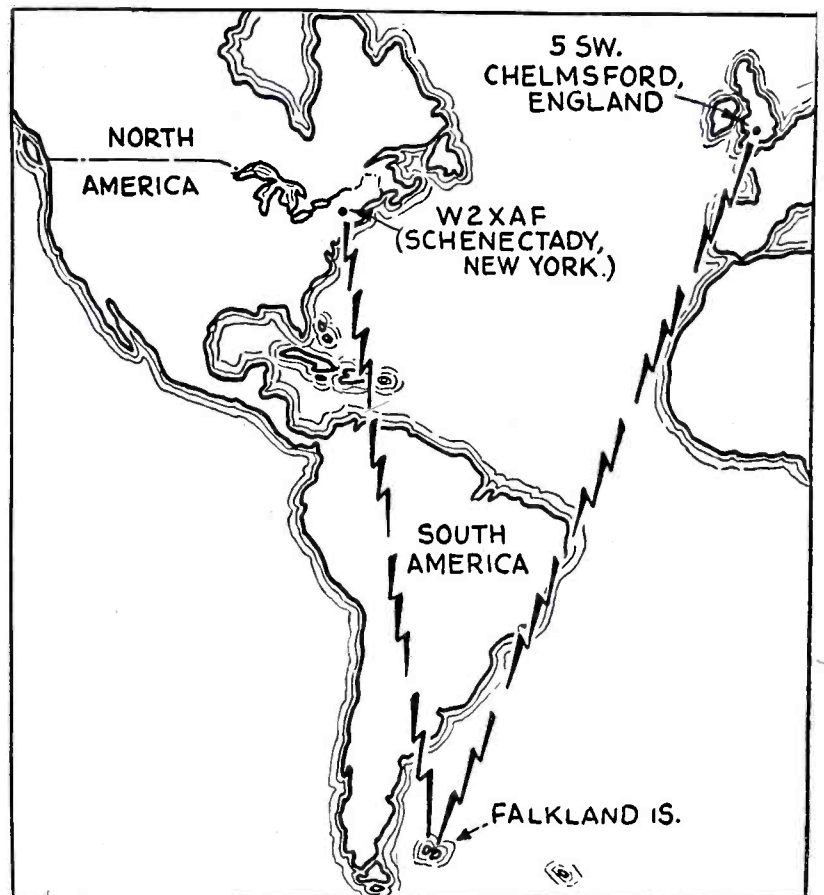

Short Waves help to make life worth while for those who live on the far distant Falkland Islands. The Islanders hear such stations as W2XAF and G5SW.

* Of the General Electric Company.

The New Pilot "Universal Super-Wasp"

Switch Eliminates Plug-in Coils; A. C. Operation; Range from 15 to 650 Meters.

By ROBERT HERTZBERG*

SHORT-WAVE receivers have been undergoing a steady process of development, passing from simple to advanced stages. Three years ago practically all short-wave sets were straightforward, regenerative tuners with two stages of audio amplification, and used battery tubes, insulated panels, and plug-in coils. Also, they were terribly critical in adjustment and suffered from several hand-capacity effects. With the advent of the screen-grid tube, untuned R.F. amplification was added, with shielded cabinets to eliminate the hand-capacity trouble. With improving short-wave technique, the untuned R.F. became tuned R.F. and the sets became more sensitive and more selective. Then the battery nuisance was obviated with the perfection of a tuned R.F. circuit that used 224 and 227 tubes and worked entirely on alternating current. However, the power-pack had to be kept a respectable

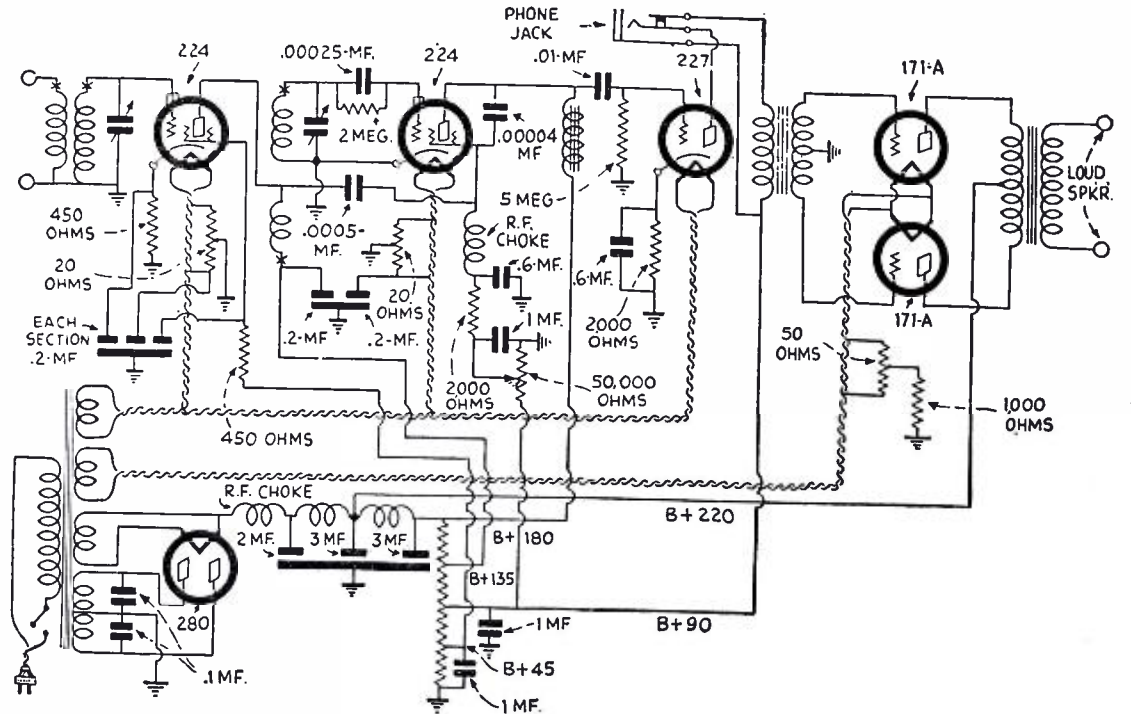

Circuit of newest Pilot Universal Super-Wasp receiver. Switch changes coils at point marked X, for ranges of 15 to 650 meters.

*Short Wave Engineer, Pilot Radio and Tube Corp.

(Continued on page 411)

TO OUR READERS

WITH this issue—the fifth—it may be said that SHORT WAVE CRAFT is now firmly established, and no longer in the formative and experimental stage.

I have been convinced, by the many letters of praise which are received daily from our readers, that SHORT WAVE CRAFT is meeting satisfactorily the increasing needs of a growing army of Short-Wave Fans—in other words, that it is just the magazine you want. I am sure, therefore, that you are sufficiently interested in SHORT WAVE CRAFT so that we can have a short heart-to-heart talk.

Publishing a magazine of the size and scope of SHORT WAVE CRAFT is an undertaking which makes tremendous demands, not only on the publisher's time and energy, but for money as well.

While the magazine has shown steady progress, and forged ahead with every issue, notwithstanding the world-wide economic depression, you will not be surprised to learn that nearly every issue published so far has shown a financial loss.

No magazine can go on losing money, month after month, as may be easily understood; therefore, this frank statement to you.

The backbone of every publication is its advertising patronage; SHORT WAVE CRAFT has enjoyed the confidence of a number of advertisers but, unfortunately, a number of them have acquired an impression that either our readers are not of the "buying class" or that, while they see the advertisements, they do not act upon them. Be that as it may, any advertiser feels that he has a legitimate complaint if other magazines appear to "pull" better, while readers of SHORT WAVE CRAFT seem to lag behind in their response.

I sincerely trust that you who read this will, from now on, pay more attention to the advertisements in SHORT WAVE CRAFT; because each and every one of our

advertisers has something to offer you which, I know, is not only of interest to you, but will save you money in the end.

It is an easy matter, whenever you are writing to an advertiser, to say: "I saw your advertisement in SHORT WAVE CRAFT." In this way, he will learn that you are "with us," and that you wish to help make SHORT WAVE CRAFT the success it deserves to be.

Remember always that, in many respects, the advertising section is just as important as the text. Very often, a tremendous amount of information can be obtained from our advertising pages; and, if you do find such information of value, I am sure you will be willing to tell the advertiser so.

It costs money to advertise (\$147.50 a page in SHORT WAVE CRAFT) and, unless he gets returns in dollars and cents, no advertiser can afford to go on patronizing a publication.

Please understand, also, that if you do not find in SHORT WAVE CRAFT the advertisements you want, or that you think this magazine should carry, we will sincerely appreciate your writing us a letter to that effect; so that we can induce the advertisers, who are not as yet represented in this magazine, to come in with us.

And, finally, remember that this magazine can be only as good as YOU PERSONALLY are willing to make it, by taking an active interest in all its contents, both text and advertising.

Publisher.

The Short Wave Experimenter

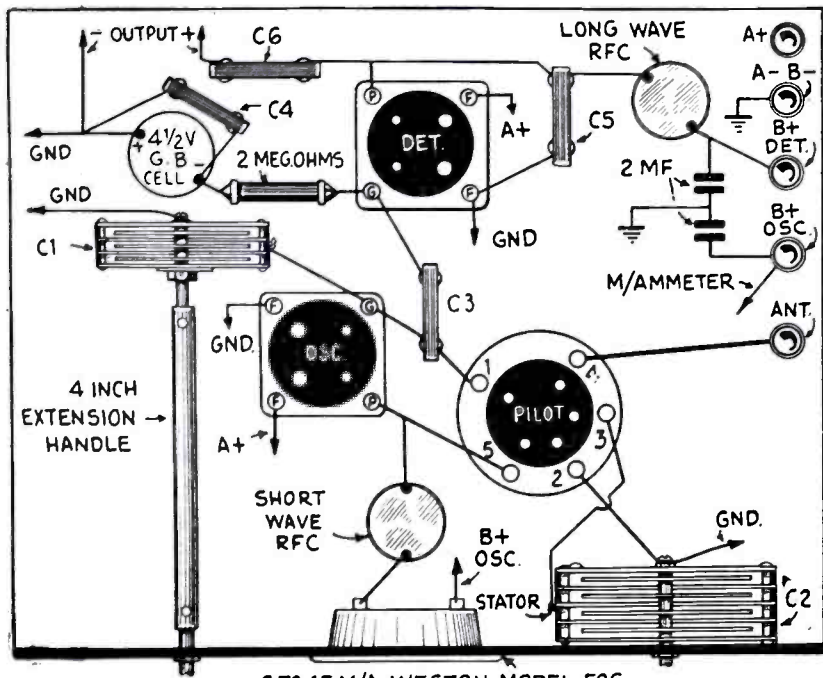

0 TO 15 M/A WESTON MODEL 506

Top view of One-Coil Super-Het S-W Converter.

A ONE-COIL SUPER-HET CONVERTER

THE converter about to be described is essentially for those who still believe that the triode (3 electrode tube), when properly used, makes the best detector; in that careful regulation of screen-grid voltage for maximum efficiency does not enter into the question, and a lot of experimenting is saved. It will be seen from the theoretical diagram that two tubes are used. In a previous issue of SHORT WAVE CRAFT was described a Tropadyne in which only one tube was used. The writer has no wish to belittle this idea; but experiments have shown that, at the high frequencies dealt with here, considerable difficulty is likely to be experienced in obtaining uniformity of operation, owing to small differences in characteristics between one tube and another—and it is presumed that not everyone has a stack of tubes with which to experiment!

The oscillator is quite straightforward, and best results are to be obtained with a tube whose impedance is of the order of 10,000 ohms (an '01A, '27 or '30). Capacity feed is utilized, and a radio-frequency choke used to deflect the oscillations through the regeneration circuit.

One set of plug-in coils is all that you have to change when using this Super-Het Converter, which has been specially designed by a famous short wave specialist and is here presented for the first time to our readers. This converter makes a short wave super-het of your broadcast receiver.

The detector receives radio-frequency as usual but, unlike a broadcast receiver's detector, passes on R.F. oscillations also; thus demanding in its plate circuit a component that will put up a high impedance at radio frequency. To achieve this, the R.F. choke has been introduced as if we had decided upon a tuned circuit; but in that case an extra tuning control would have been required. A standard broadcast choke will do, since long-wave signals are being dealt with.

For the detector tube, it is recommended that a tube whose impedance is of the order 20,000 to 30,000 ohms to be used. (This corresponds to the '00A; but ordinary American single-grid tubes have lower impedances. —Editor.)

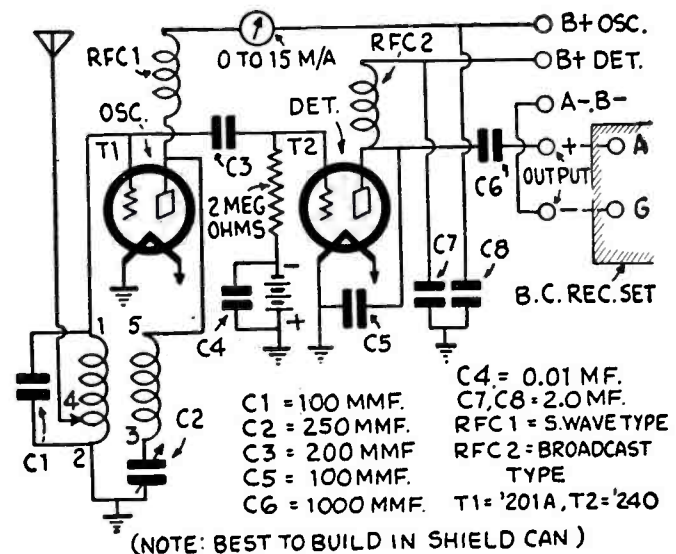

Wiring diagram of One-Coil Converter. Windings 3 and 4 are wound on one tube.

Referring to the diagram it will be seen that a condenser C5 is connected between the detector plate and "A—"; this is to combat an anti-regenerative effect that sometimes occurs and so damps the circuit that the oscillator ceases to function. From the plan layout, it will be observed that the tuning condenser C1 is set well back; and this is really worth while to completely avoid hand-capacity effects. Grid-bias detection is used, because it is more economical, should "B" batteries be used; and nothing is to be gained by the "leaky-grid" method, since small inputs are not being dealt with.

The reader is very strongly urged not to consider beauty of layout too much, but rather to aim at efficiency; and, if this is decided upon, then only low-voltage wiring will go below the sub-panel. The inductances are wound on "Pilot" (Continued on page 394)

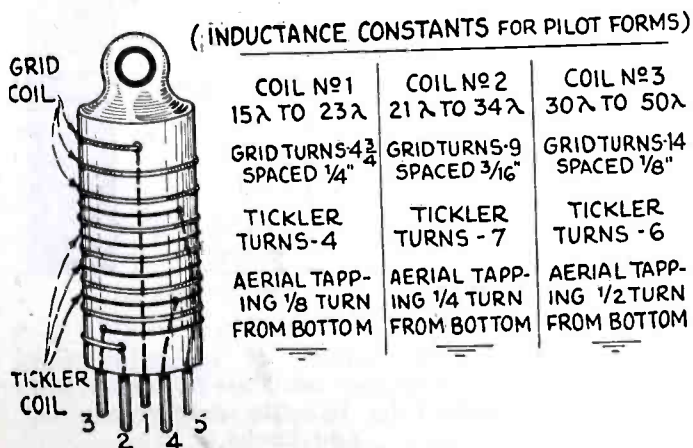

How to Add Two Radio Frequency Stages to The Hammarlund S-W Receiver

By H. W. SECOR

IN an effort to improve the sensitivity or pick-up range on my short wave receiver, the author, after reading all of the articles published in past issues of SHORT WAVE CRAFT, finally worked out the circuit herewith illustrated. There is nothing radically new or startling about this arrangement but considerable increase in signal strength results from this hook-up. It will be re-

The suggestions given in the accompanying article are the result of actual construction and tests. Excellent results were obtained in the reception of both code and phone short wave stations. The object in designing this circuit was to maintain simplified tuning control, but still have the advantage of two stages of R.F. ahead of the detector.

nect the aerial and ground to the variable coupling primary P1 of the tuned radio frequency stage. The main tuning controls are condensers C and C1, and the regeneration control condenser C2.

This circuit was tried out with '22 screen grid tubes in the radio frequency circuits and a '99 in the detector circuit. The author generally uses a Benjamin shock-proof socket and a great many noises and howls that operators complain of, especially when using '22 tubes, are entirely eliminated in this simple way. In the author's opinion no tube should be mounted on a solid socket as microphonic howls are liable to be built up when non-resilient sockets are used. By following some of the diagrams published in various previous issues of SHORT WAVE CRAFT, it is a simple matter to wire this circuit so that '24 A.C. screen grid tubes can be used and a '27 detector tube used in the detector stage. Very strong signals were received with this circuit in the phones without any audio amplification; the signals were then amplified and placed on the loud speaker by connecting the detector out-put to a two stage audio amplifier, comprising an impedance-coupled stage and transformer-coupled stage. The plug-in-coils used in this circuit were the regular set of Hammarlund coils, the plug-in-base in the tuned radio frequency stage being fitted with the Hammarlund variable coupling or pivoted primary. The tickler winding can be cut off the coils used in this stage, but this is not necessary when you are first trying out the circuit.

This circuit was tried out at first with A and B batteries and later tests were made with B eliminator (All-American, which has extra large choke coils in the filter. These were the standard coils furnished originally in the eliminator and not built special), while the A supply was furnished by an A eliminator similar to the Balkite or electrolytic rectifier type. In accordance with the

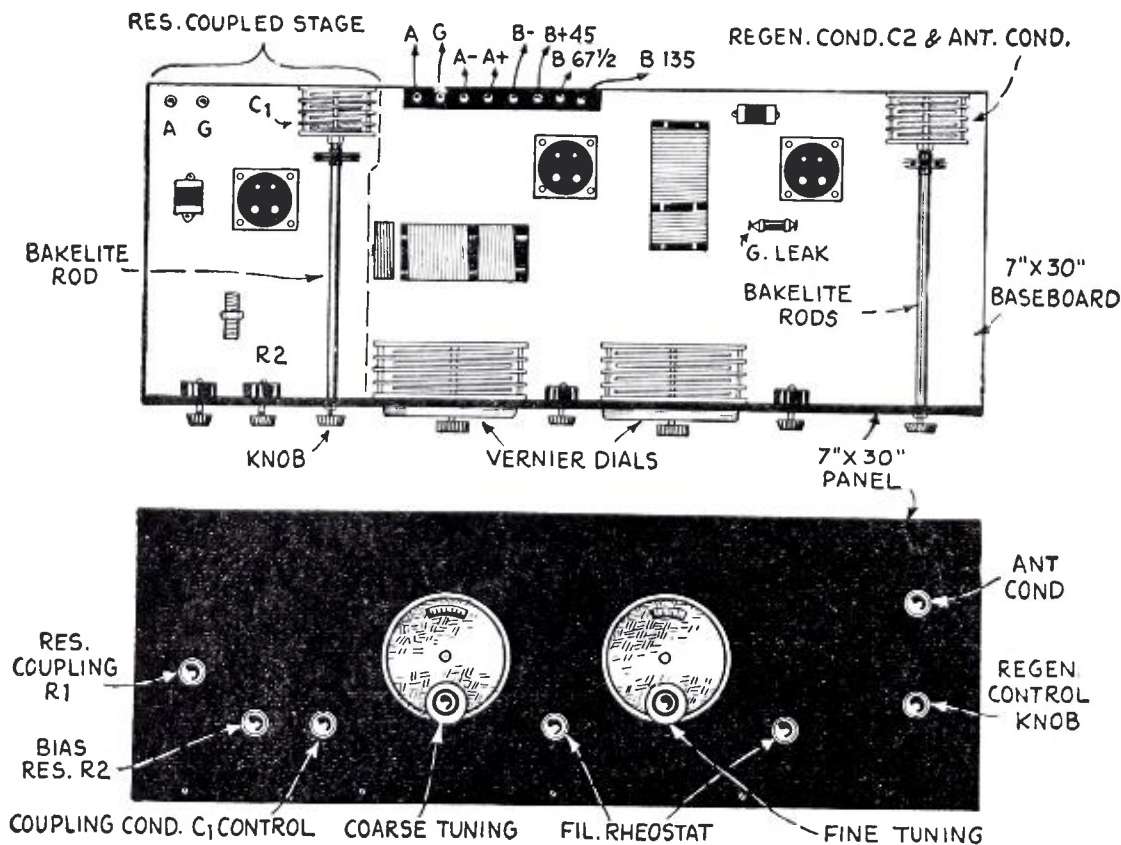

Top and front views of the modified Hammarlund short wave receiver, having one untuned and one tuned stage of R.F. ahead of the detector. Once the set is adjusted, all the tuning is done with the two large vernier dials.

membered that the ordinary Hammarlund short wave receiver circuit calls for one stage of shield-grid amplification ahead of the detector, this stage being an untuned stage. As is well known a tuned stage of radio frequency is always preferable to an untuned one, for when such a stage is tuned to the exact wave being received in a given instance, the circuit is then operating at full or maximum efficiency, in accordance with the well-known laws of electrical resonance. Of course the designer of a short wave circuit is always bothered in his conscience by two salient problems: One, the simplicity of tuning and two, the greatest sensitivity and selectivity possible at a nominal expense for apparatus.

This circuit seems to supply both of these qualifications as there is practically one additional tuning control added, that of the variable condenser at C1, connected across the inductance S1.

To eliminate a third tuning condenser the first stage is either resistance or choke coil coupled to antenna and ground. From experiences of others as well as the author's the choice of a resistance or choke coil coupling to antenna and ground seems to be about even, a lot depending of course upon the form of resistance used and also upon the design of the choke coil you may select. The writer tried an 85 M.H., Hammarlund radio frequency choke for antenna coupling at R1 and the results seemed to be about the same as when using a Bradley-ohm of from 10,000 to 100,000 ohms rating (variable). A Clarostat was used with equally good results.

The untuned antenna stage of radio frequency is coupled through a 50 mmf. condenser C1, to the tuned radio frequency stage S1-C1. For those who do not care to bother with the untuned booster stage here shown, they may con-

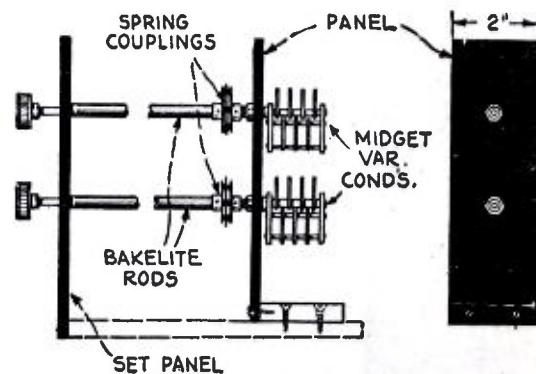

Preferred manner of mounting the midget variable condensers, which are controlled by bakelite extension rods and knobs.

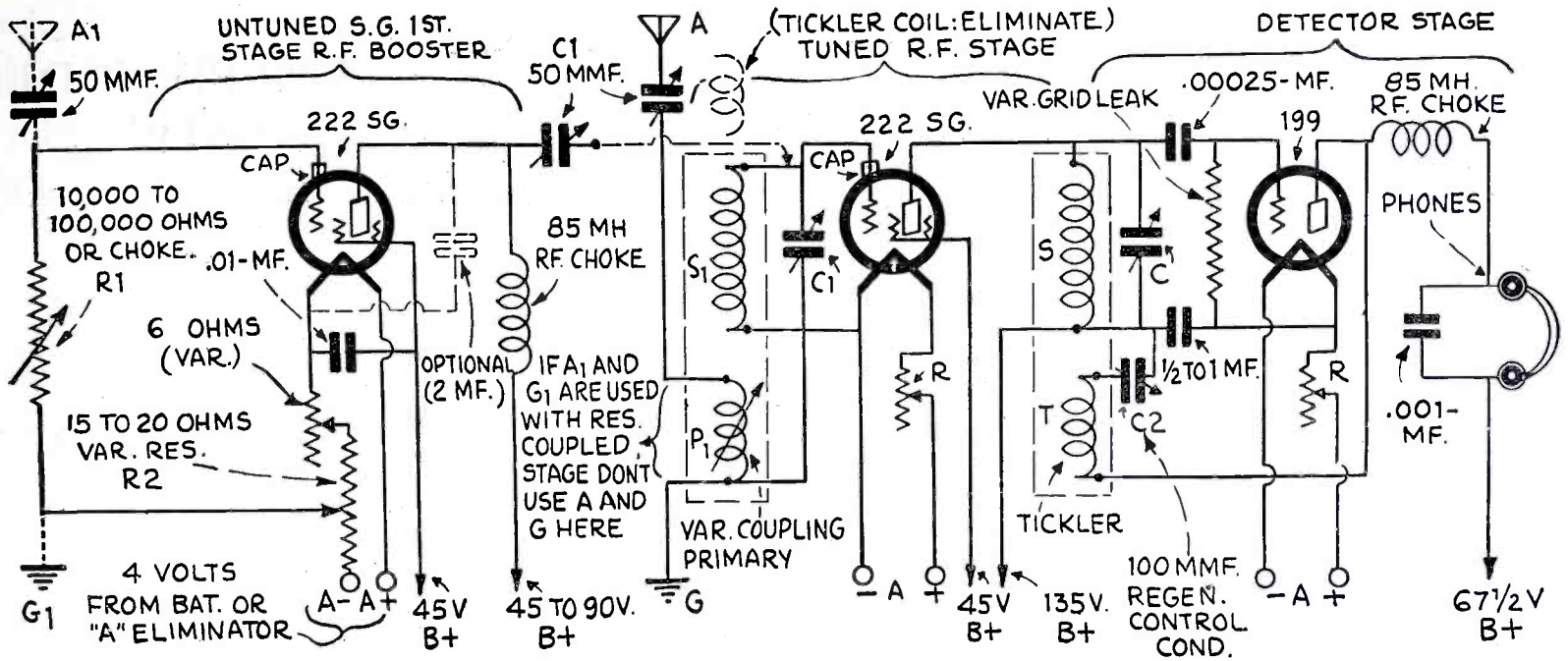

Wiring diagram showing connections for one untuned, shield grid stage and one tuned, shield grid R.F. stage ahead of the detector, in a Hammarlund short wave receiver. Greater selectivity and sensitivity are produced, so that good readable signals are heard in the phones without an audio amplifier stage, the signals may also be passed on to an audio amplifier of any suitable type.

modern practice in commercial short wave receiver design, the tubes may be of the '24 shield-grid and '27 type with their heater current supplied from a filament transformer.

If a shield-grid tube such as the '24 is used in the detector stage a very fine and even control of the regeneration is then obtainable by utilizing a 50,000 ohm potentiometer to regulate the voltage supplied to the screen-grid of the detector tube, as is done very effectively in the new National A.C. short wave receiver circuit.

The drawings given herewith indicate the general arrangement of the apparatus as tried out by the author and

while shielding may be used and experimented with, no shielding was employed in the experiment mentioned. It will be found very desirable to mount the midget condensers C1 and C2 at the rear of the sub-base and to connect these by means of bakelite rods with the knobs on the front of the panel. It is best to mount the plug-in-coil bases so that the coils will be at right angles to one another; metal shields may be placed over the tubes, or else the new Hyvac "self-shielding" tubes may be employed.

The following list of parts will be found valuable and practical for the circuit here described:

- 1—Variable resistor, 10,000 to 100,000 ohms R1; Bradleyohm, Clarostat, etc.

- 2—50 MMF midget variable condensers; Hammarlund
- 1—6 to 10 ohm variable filament resistor; Electrad
- 1—Filament rheostat R2; Bradleystat or other make
- 1—.01 MF condenser; Sangamo
- 1—2 MF by-pass condenser, 250 volt rating; Aerovox
- 2—85 MH radio frequency chokes; Hammarlund
- 2—.22 screen grid tubes; any standard make
- 2—sets of short wave plug-in-coils; one set being preferably fitted with variable coupling primary; Hammarlund used by author.
- 2—125 MMF short wave type variable condensers; Hammarlund
- 2—Filament rheostats for tuned radio frequency and detector stages
- 1—100 MMF regeneration control condenser; Hammarlund midget
- 1—Grid condenser .00025; any well-known make
- 1—Variable grid leak; use Bradleyleak or else experiment with different metallized grid leaks such as Durham, from 2 to 5 megohms
- 1—Phone by-pass condenser .001; Sangamo
- 1—Condenser C3, of 1/2 to 1 MF; Aerovox

Adding Untuned Radio Frequency Stage to Walker Flexi-Unit

HAVING experimented for some time with one of the new Walker Flexi-units, a compact, combination short wave receiver and adapter, which was designed to permit the owner of a broadcast set to receive short waves or even to use the unit as a complete short wave receiver itself, the scheme here shown in the diagram was concocted and tried out with marked success. No additional tuning control is added, generally speaking, and the increased strength of signal that is obtained when this stage of resistance-coupled, shield-grid amplification is added ahead of the Walker Flexi-unit, (or any other one tube short wave receiver for that matter) is very surprising and gratifying. The connections of the new untuned stage with shield-grid tube are very simple to follow and the writer also found it advisable to add a Bradleystat (extra filament control resistance) in series with the A battery connected to the Walker Flexi-unit. A capacity of about .002 M.F. shunted across the 2,000-ohm head-phones helps to make regeneration smoother and it is also advisable to

insert a 0 to 1,000-ohm Bradleyohm or Clarostat variable resistance in series with the phone circuit.

The writer tried this circuit out very

successfully and it greatly increased the signal strength, utilizing A and B batteries at first with a '22 screen-grid tube (Continued on page 395)

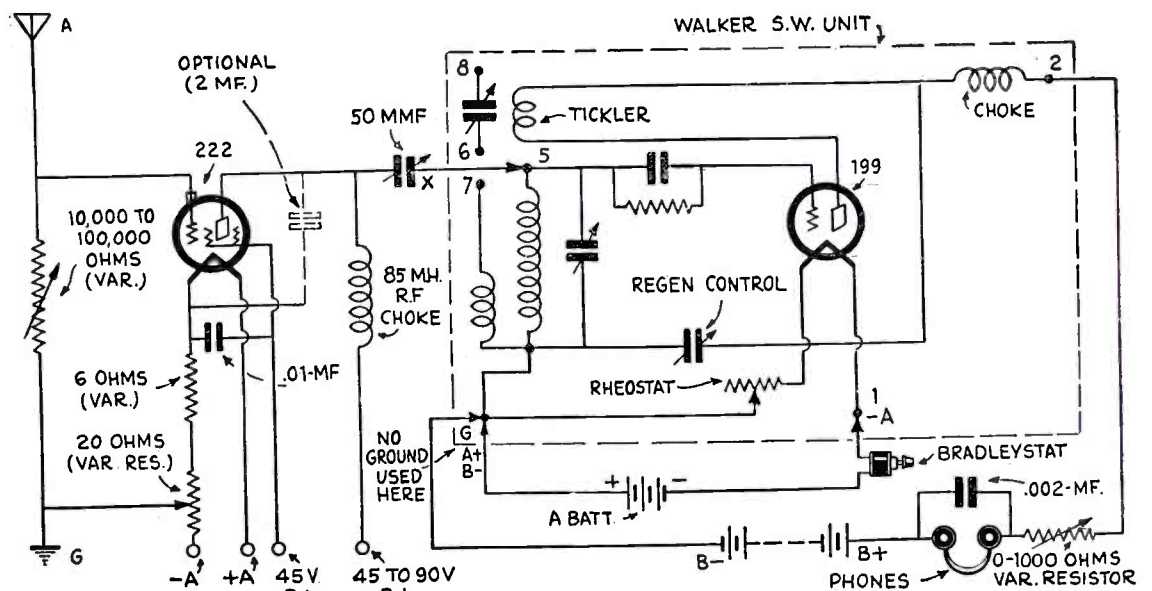

Diagram above shows how to add an untuned, screen grid, radio frequency stage to the "Walker Flexi-Unit", resulting in much stronger signals and pick-up range. This circuit was tried out with gratifying success.

"Yes, Ladies and Gentlemen of the Short Wave Audience"—this is a real job—a vacuum tube transmitter that actually oscillates on a wave length of 1 meter or a frequency of 300,000,000 cycles per second. Mr. Noden is England's outstanding ultra-short wave champion and the transmitter he tells you about here is a prize-winner. Mr. Noden explains how you can tell when the 1 meter transmitter is oscillating. Also he gives you full construction details and dimensions of parts. Important research work awaits the experimenter in this realm of ultra-short waves.
—Editor.

By JOSEPH NODEN
G6TW

Associate Member, Institute of Radio
Engineers

A One Meter

Operating at a Frequency

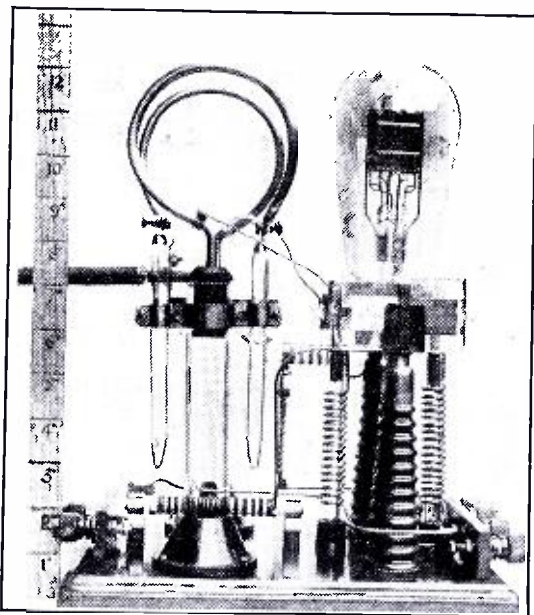

Side view of 1 to 1½ meter transmitter—the scale is in inches. The tube should be "de-based".

The General Circuit Used

With these remarks, we may now proceed to our circuit. (Fig. A.) You will notice that it is well-balanced, and that all capacities and inductances are in series with one another; by this means, we are able to reduce the inductive capacity, thus lowering the wave and increasing the frequency. I will be candid with you: it is not an easy matter to hold a one-meter wave in oscillation, although this transmitter has done so for a considerable period of time. At two to two-and-a-half meters, however, it will become very easy, and any ordinary make of tube will submit to the electron bombardment and keep quite stable during oscillation. Later on, I will explain how to make this transmitter suitable for a two-meter wave.

Assembly of the Transmitter a Work Demanding Ingenuity

We can now start to build the set. First, here is a list of materials required:

- A suitable baseboard, 9½x6½ inches;
- Two glass tubes, 6 inches long and one inch in diameter, and two sockets to secure them to the baseboard;
- Two stand-off insulators, 4½ inches high;
- Four ⅜-inch glass tubes; two 4½-inch; one 4-inch; one 2½-inch;
- Two glass tubes or rods, 7½ inches long;

- Two feet of ¼-inch copper tubing;
- One Electrad grid leak;
- A piece of No. 22 copper or brass sheet;

Two terminal strips, six binding posts, wire, foil, sheet glass, etc.

And now your ingenuity is called upon; I am giving you the diagrams, sketches and photographs, but omitting such details as "bend this" and "fasten that."

Mark off your baseboard according to the layout (Fig. B).

P1 and G1 are the pillars, 6x1 inch, supporting the inductances and variable condensers; these are mounted in their sockets. Fasten the terminal strips and binding posts to the base; four at the filament voltage end, and two for the plate-voltage connections.

Fasten to the base P2 and G2, the standoff insulators supporting the tube; then mount the two filament choke-coil supports, made of 4½x⅜-inch tubes. These are held in position by two fiber sockets, and are further straightened by the heavy wire chokes which will be described later. The only other item for the base is to secure two clips for the plate input choke RFC1.

Construction Details

Now for the construction of parts. We start with Figs. 1 and 2. For this variable capacity, the pitch of the thread on the movable spindle does not matter,

but see that it is a perfect fit and that no rocking takes place. For the extension handle, six inches is plenty. The method of securing it to the spindle is left to the reader; for the holding-bracket nut you must refer to Fig. 1a. The fixed part

SINCE the editor of SHORT-WAVE CRAFT has asked me to write an article on a one- to one-and-a-half meter transmitter, that oscillates on the unimaginable frequency of 200,000,000 to 300,000,000 cycles per second, I can only do so, hoping that the constructor will closely follow the various points which I tend to raise and pay special attention to eliminating leakage losses (such as dielectrics and supports). At the same time, make your layout compact, and avoid mutual resonance between the various parts of the circuit.

The transmitter described was perfected only after a great deal of research since, for the past eighteen months, I have been working on the five-meter band. If I had not had the previous experience on this band that I have obtained, I could not be writing this article.

In the construction and operation, you have three important requirements to provide, as follows: a certain amount of ingenuity; a little practical ability; and a determined perseverance—for you cannot run to the store for the parts, though you may replace them where possible with a commercial product for trial.

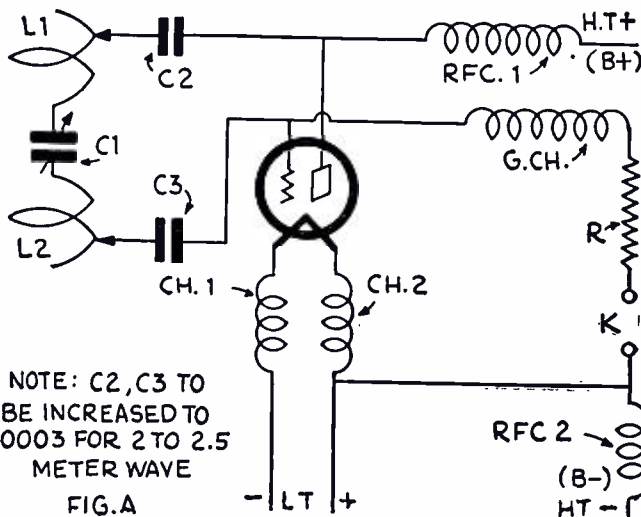

Fig. A—Wiring diagram of Mr. Noden's 1 to 1½ meter transmitter.

The Editors consider themselves fortunate indeed in being able to present this valuable and epoch-marking article by Mr. Noden, who here explains just how he built his one-meter transmitter and how to make a wavemeter to measure the radiated wave.

TRANSMITTER

of 300,000,000 Cycles Per Second

of this is cut from sheet brass or copper, as per Fig. 2, and is then bent as in Fig. 2a.

We now want our supports for this variable capacity; take the two lengths of 7 1/2 x 3/8-inch glass tube or rod (those shown in the photos were glass stirring rods and are a little longer); bend these two tubes over a Bunsen burner, as per Fig. 5. Take your time; it's not a difficult job.

For the clips securing these tubes, cut four strips of brass or copper 4 x 1/2-inch; drill and bend them as in Fig. 6. These are secured to P1 and G1 by eight small screws and nuts, thus supporting your bent glass tubes.

Now you can put your variable condenser into position (yes, things are shaping a bit) and make your inductances, L1 and L2. A single turn, 3 inches in diameter, of 1/4-inch copper tubing, is required for each. The correct angle of bending is taken from the photos. One end is flattened, and a hole is drilled to enable you to secure it to the clip screws of our variable capacity; the other end of each is fitted into an ebonite or fiber plug which fits into the top of P1 and G1.

You will be very satisfied with the set at this stage of completion, and will see how you have avoided all possible means of leakage.

Now for the chokes: we start with RFC1. This is wound on the 4 x 3/8-inch glass tube and has 180 turns of No. 36 D.S.C. copper wire, wound in 15 sections; each end is secured to a very small brass clip. The filament chokes 1 and 2 are wound with 1/8-inch spacing between each turn; altogether, 16 turns of No. 14 copper wire are required for each.

These ehokes must have a short length of wire left free on each end, so that they can be connected to the "A" binding posts; the opposite leads run to the tube sockets (or corresponding means for holding tube), which are fitted over the glass tubes.

Next, you have the grid choke. This is wound on the 2 1/4 x 3/8-inch glass tube, and contains 60 turns of No. 36 D.S.C. copper wire in six sections; clips of the same type as on RFC1 secure the ends. The best American grid leak I can recommend is an Electrad, between 5,000 and 10,000 ohms; but try and match the value to the impedance of the tube you will probably use.

The By-pass Condensers

You now come to the most difficult piece of work (in my estimation) and remember you may try a commercial

Above, at right, details of variable tuning condenser C1; the capacity is varied by turning the rotary plate.

Left: Clip to hold by-pass condensers.

Right: Further details of by-pass condensers.

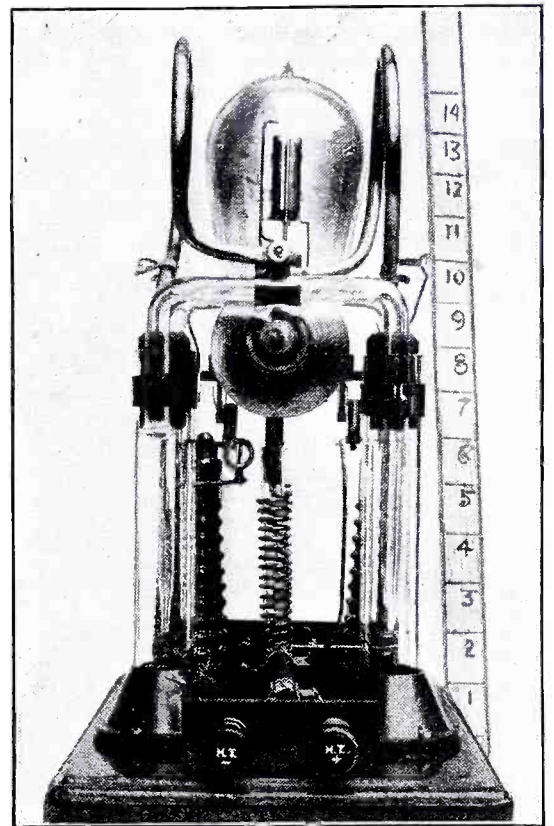

Front view of Mr. Noden's ultra-short wave transmitter. Scale is in inches.

product for this. I mean, for the by-pass H.F. condensers C2 and C3; but, if you will only go to the trouble, it is well worth while to make them. See Figs. 3, 3a, 4 and 4a. The slots in the glass can be ground with ease: Fig. 3 gives you the size and shape of each, four being required. The dotted line is the mica dielectric extension, the thickness of which governs the capacity; try 10 mils (1/100-inch). Only two pieces of copper foil (as in Fig. 4) are required for each.

When these condensers are assembled, and secured by a clip round the center as in Fig. 4a, they are very strong and sound and extra low-loss. If you make this type up, you will require clips to hold them on the standoff insulators;

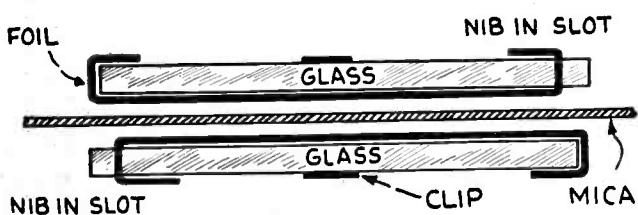

FIG: 3a & 4a

Above: Details of by-pass condensers which are made of glass and copper foil, as shown.

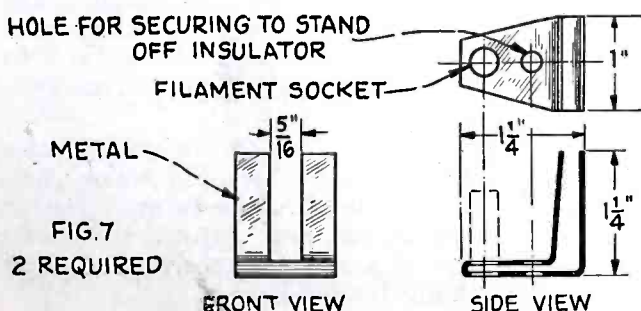
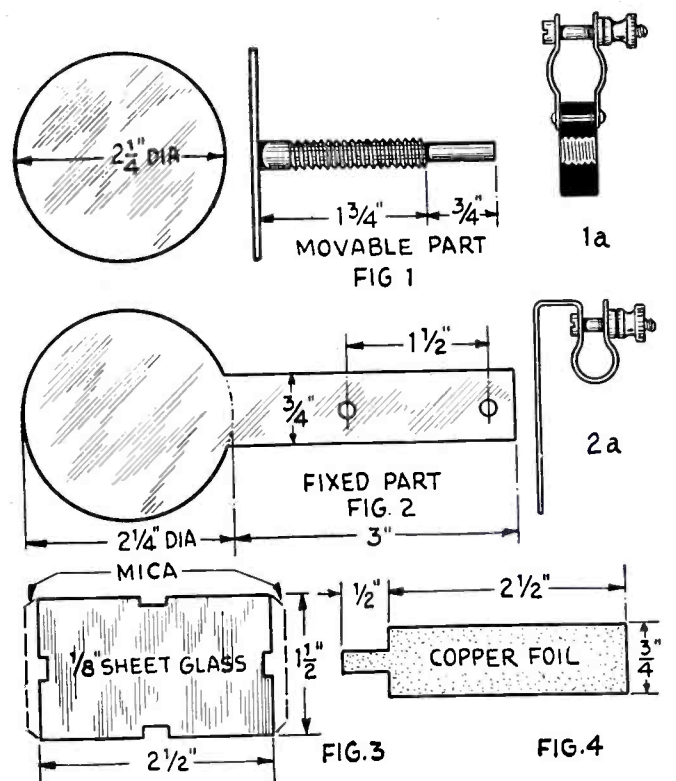

FIG. 7
2 REQUIRED



these are detailed in Fig. 7. Notice there is a $\frac{1}{8}$ -inch slot down these clips, for the purpose of holding the condensers in a perfect upright position. One end of the foil makes contact with the clip, and the other has a 4-inch length of copper braid attached to it, and terminating with a clip for connecting to the inductance.

Your only other component is the "B—" choke RFC2; this is lump-wound on a small hard-rubber bobbin. You ask, why lump-wound? It is for the purpose of reducing mutual resonance with the input choke. Then you complete the wiring of your circuit, and your trans-

How to Tell When Set Is Oscillating

As a temporary means of proving whether the set is in oscillation, you must have a makeshift wavemeter; this will be an absorption circuit. A single rotor-plate condenser, with a single 3-inch turn across it, is all that is required.

If you want to make a graph of this wavemeter, then you have an afternoon's job; and this will be done best by the Lecher-

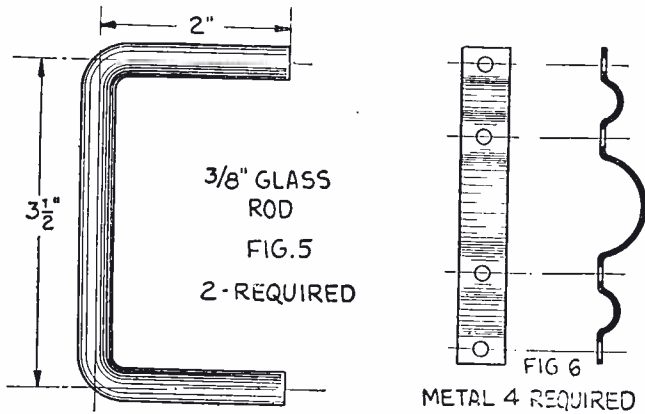
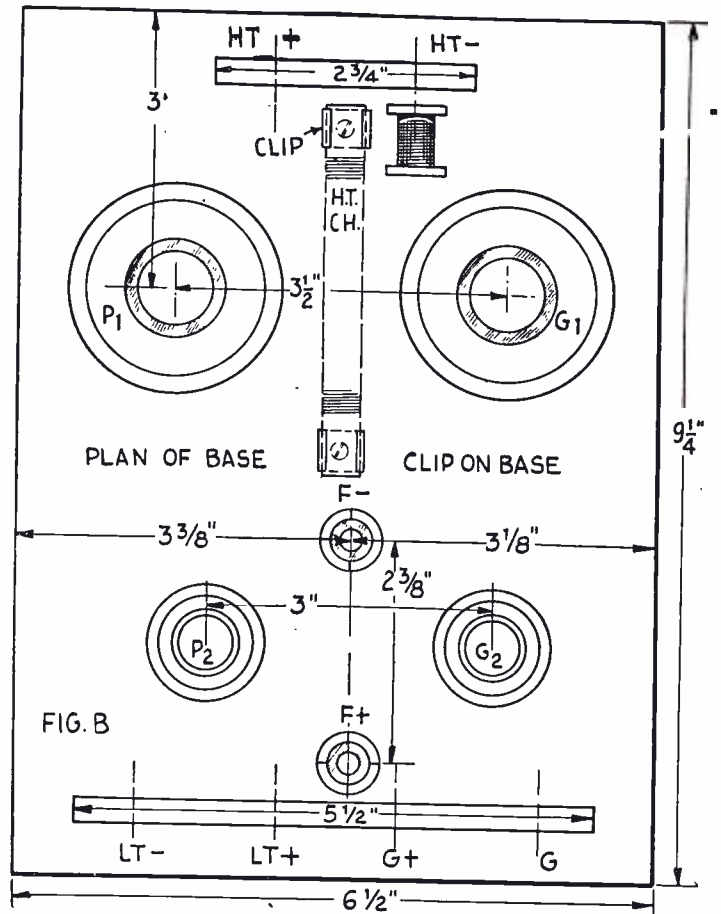

Fig. B, at right, shows top view of baseboard for 1 to 1 1/2 meter transmitter.

Left — Details of glass rod inductance supports and clamps.



mitter is built. I do not know what type of tube or fitting you are going to employ, but let it be as low-loss as possible. The matter is left to your choice.

Operation at Ultra-Short Waves Requires Perseverance

I take it you are now fitted up and ready for trial. You have taken note of my previous remarks that ingenuity and practicability are required; now you are called to display a determined perseverance. If you are all fixed up with suitable batteries for the type of tube employed, connect a short length of wire (marked K in diagram) across the grid terminals, put on the power, and do not be afraid to load your tube to maximum; for somehow they seem to stand high frequencies very well indeed with this circuit. I take it that this is due to the circuits being well balanced.

When using this transmitter with 1,000 volts input, there is no chance of its breaking down or shorting; for you have three condensers and a leak in series before we can come to a breakdown point.

First, start with your variable capacity C1 about one-fourth open. Do not be surprised if the set does not start to oscillate until the plates are less than one-sixteenth of an inch apart. You will find that you are rather low in wave then—somewhere between 1.5 and 2 meters. Of course this depends upon the internal capacity of the tube; but here is a point worth considering, and debating. The higher the frequency put into a valve, the lower its internal capacity becomes. I know that this sounds ridiculous; but I have definite means of demonstration to prove my statement.

wire system. You cannot beat it, for the harmonic method is hopelessly out of consideration.

You will be so interested in this calibration that it will be as if you were starting radio all over again.

As soon as you know whereabouts you are in wavelength, a means of direction will be required; but I cannot give, at present, a receiver for one meter. If you have an "Ultra-Audion" set that is made low-loss, and the grid and plate leads are short, it will be able to get down to 1 1/2 to 2 meters, providing a single grid turn of two-inch diameter is employed.

SNAGS
In S-W Receivers
and How to Overcome Them!
In our next Issue.

It is necessary to project these waves from the earth's surface and, also, the transmitter must be away from the earth's surface as much as possible; preferably at a distance from the earth greater than the wavelength one is trying to radiate. Although this is not always possible for the average experimenter, when working on 20 meters and above, it becomes a possibility for 5 meters and below.

Best Form of Radiator

The best radiating system is at present a current-fed Hertzian. Use a 2.5-meter radiator on each side of the feeder, and space the feeders 3 to 4 inches apart. If you are situated in the open, then by all means try a reflector system. Feed two radiators of one meter length, ver-

tically for preference, and place the reflector wires at one meter's distance behind radiators.

Many ideas will come to you when experimenting; and do not forget, if you do come across anything special or advantageous to our small band of enthusiastic workers, to let the technical press know of it. Information is required that will further the possibilities of providing this band, and enable it to take its place beside the lower frequencies for practical purposes.

Among the peculiarities and possibilities of the waves, I may point out that near-by grounded objects attract the waves more easily to the earth than do the lower frequencies. For instance, if we have even a 5-meter receiver in oscillation, you will find that interference can take place at a distance of 60 feet during the movement of metal objects; especially when two metal bodies are moved in proximity to each other. Hence, they must create a static charge, which interferes with the field of radiation. A case in point is offered by the metal pendulum of a chain-driven "grandfather's clock." As it passes the chain, the resonant beat will be heard in the phones; that is, if the aerial lead to the set is in the same plane and parallel to the pendulum.

The ultra short waves have most valuable possibilities for the future, for within the compass of one meter many thousands of stations could work with freedom. Then we will have true television.

Such is my article on the building of a transmitter to produce the waves that will be most used in the future. I hope to have, in the near future, the specifications of a suitable receiver for these ultra-high frequencies.

The Short Wave Beginner

Practical Short Wave Hints

Home-made Aerial Condenser

In experimenting with short wave sets I had need of an adjustable aerial condenser. Not having one on hand, I made one entirely from old discarded parts from my "junk box." I had tried several other types of home-made condensers before, but this one works far better than any other I have tried. It is nothing more than an old 199 tube base, with the prongs cut off; two copper disks, two battery bolts, mica, Fahnestock clip and sealing wax, arranged as shown in the drawing, which is self-explanatory.—**RAPHAEL RASLER.**

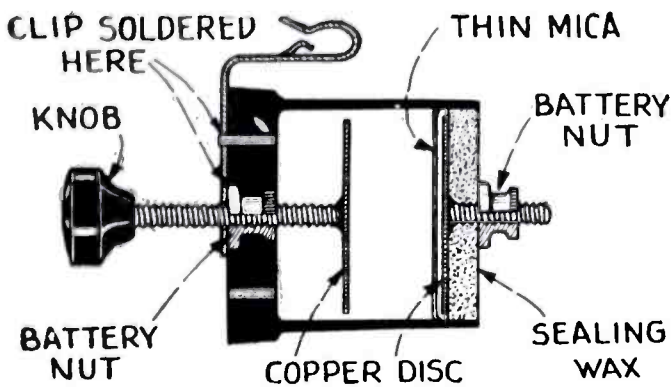

Home-made antenna condenser from an old tube base.

Here's how to make a "cage" aerial with the aid of embroidery hoops.

A Simple Cage Aerial

Have you ever longed to have a fine cage antenna on top of your shack, but had to be satisfied with a single wire, on account of the high price for the loops for the cage. Well, stop in a 5 and 10 cent store and purchase some 7 and 4 inch embroidery hoops.

The hoops should be given at least two coats of shellac, or better still, soaked in hot paraffine.

A set of these hoops has been used for over five years on a boat, for a BCL receiving antenna; they are still in perfect condition.

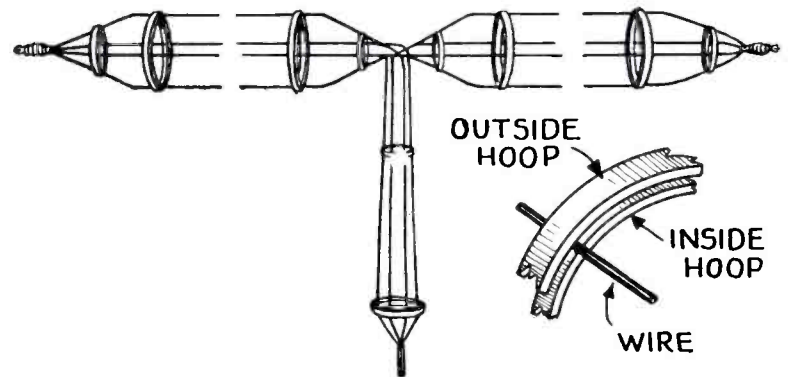

Plug-in Short-wave Chokes

The efficient working of a short-wave set depends, to some extent, on the use of a suitable R.F. choke. A range of interchangeable short-wave chokes of varying sizes, which enable one to experiment in order to find the best value for any particular circuit and wave-band can be made quite easily on the lines suggested in the accompanying sketch.

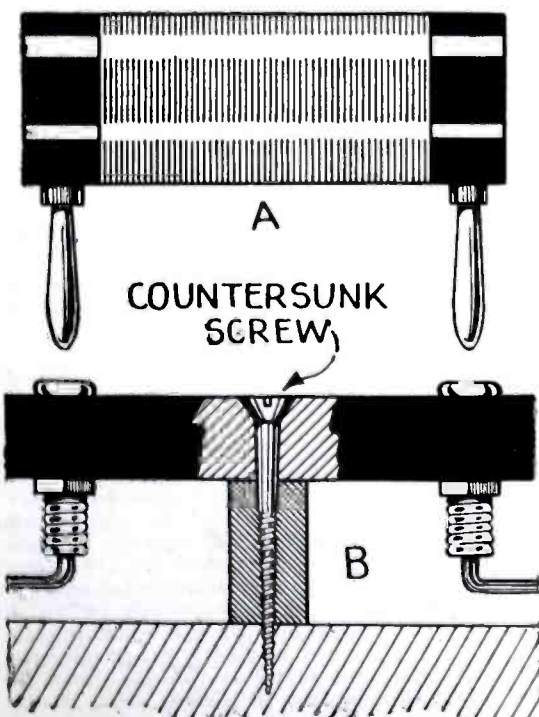

How to make plug-in type R.F. chokes.

can be made by mounting a pair of sockets on a strip of hard rubber, supported on a short piece of hard rubber tubing and secured by means of a wood-screw of suitable length passed through the strip (in which its head should be counter-sunk) and the tube into the base-board of the set, as shown at B in the sketch.

Experiments can be carried out with chokes having a number of turns varying from 50 to 100 or more, and the effect of sectionalized or astatic winding can be tried.—*English Mechanics.*

USE OF COUNTERPOISE

IT sometimes happens that the set owner finds it impossible to obtain a good ground connection of low resistance and free from noise pick-up. If an efficient installation is to be made, it will be best to use the device, familiar to transmitting amateurs and experimenters, known as a counterpoise; this is a second (and preferably larger) aerial placed beneath the regular one, and connected to the ground binding post of the set. In places where the soil is sandy and dry, or is composed largely of rock, a counterpoise will give much better results than any ground.

Excellent results can be obtained from a single-wire horizontal counterpoise, stretched beneath the single-wire horizontal aerial. An installation made in a large rooming house eliminated outside pick-up. For maximum efficiency and

These embroidery hoops consist of two hoops, one fitting inside the other; No. 12 or No. 14 wire will fit in between these hoops very securely.

The writer has used this antenna with fine results.—**JOSEPH A. STAUHS.**

where space permits, a more elaborate counterpoise system can be adopted as illustrated.—*Courtesy Radiocraft.*

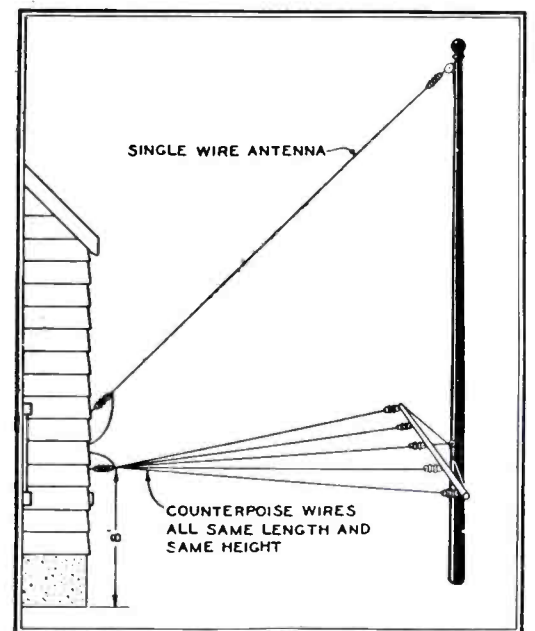

One form of the counterpoise. For those who have an ample yard or area-way, this will be found better than a "ground".

WHEN to "LISTEN IN"

By ROBERT HERTZBERG

THE owner and builder of a short-wave receiving set wishes to know, as most important of all, "when to listen in." The following data represent the fruits of seven months' research conducted by Robert Hertzberg, short-wave engineer of the Pilot Radio & Tube Corporation. Mr. Hertzberg, one of the designers of the famous "Super-Wasp" short-wave receiver, is also the editor of *Radio Design*. Since the advent of Short Wave Craft, a year ago, interest in short-wave reception has become widespread; to give some idea of just how great the public's interest in short waves really is, it may be stated that one radio concern alone has manufactured and sold over a hundred thousand short-wave receivers in the past eighteen months.

Short Wave Craft, as many of our readers undoubtedly know, publishes the most up-to-date and complete directory of short-wave stations, with their wavelengths and call letters, that has appeared anywhere. As a plain matter of fact, our readers will probably be interested to know that, when one of the members of the editorial staff visited several of the most famous high-power short-wave transmitting and receiving stations in this country, he found that Short Wave Craft's List of Short-Wave Stations of the World is in use as the official schedule. We feel we may be pardoned for blowing our own horn now and then, especially when we have found such first-class evidence of the esteem in which our roster of S.W. stations has been held by professional short-



Robert Hertzberg, Short Wave Engineer, who compiled the data here presented.

wave operators. The editors have checked up many short-wave station lists, as published in magazines from all parts of the world; and most of the foreign lists are very short, while some of the American

lists (especially those published in newspapers) have been copied (often inaccurately) from Short Wave Craft's schedule of stations, in many instances without giving any credit. Mr. Hertzberg, in collecting all of the valuable data given in the following paragraphs, exchanged letters with short-wave stations in Siam and Russia, Holland and New Zealand, Canada and the Argentine; studied every radio magazine published in foreign countries; and finally sifted hundreds of reports from individual listeners.

The author reports that the majority of the stations have been identified very definitely; but some have chosen to ignore the letters of inquiry addressed to them, so that the statements about their activities are duly qualified. This list of stations does not include dozens of stations shown on other lists; because we know that many of them are not on the air regularly, or in some cases they have probably never existed, except on their "license blanks."

Mr. Hertzberg wishes to extend his sincere thanks to those who have helped him to collect this valuable information on short-wave stations and he wishes to give particular honors to: John Clark, 360 Moncada Way, San Francisco, Cal.; J. Gratien Bordeleau, P. O. Box 228, Grand Mere, Province of Quebec, Canada; Stannard Smith, 1823 Crenshaw Blvd., Los Angeles, Cal.; J. J. Montgomery, West End Irma Street, Tavares, Fla.; and Fred Easter, 3353 Southside Ave., Cincinnati, Ohio.

You Must Know "When" as Well as "How" to Listen in Here's the Very Latest "On the Air" Short Wave Station News

UNITED STATES

Schenectady, N. Y.—The General Electric Company operates an assortment of short-wave stations; the two best known outfits being W2XAF, on 31.48 meters or 9,530 kilocycles, and W2XAD, on 19.56 meters or 15,340 kilocycles. These usually relay the regular programs of WGY, which is part of the National Broadcasting Company's network, and on occasions broadcast special features for the benefit of Europe, South America or Australia. W2XAF operates daily from 5.30 to 11.00 p. m., and W2XAD daily except Saturday from 1.00 to 3.00 p. m., Eastern Standard time.

The following stations are also licensed for transmission, but do not operate on a regular schedule. They are likely to be heard at any time of the day or night, participating in casual conversation with the Antipodes or broadcasting messages of cheer to Arctic explorers: WXO, W2XAK, W2XAH, W2XAZ, W2XH, W2XK, and W2XAC. They may use any of these frequencies: 1604, 2398, 3256, 4795, 6425, 8650, 12,850 and 17,300 kilocycles.

New York, N. Y.—The Columbia Broadcasting System, 485 Madison Avenue, New York, operates W2XE in conjunction with WABC, the key station of its network. The actual transmitter is located at Cross Haddock Bay (on the road leading into the Rockaways) and works on 49.02 meters or 6,120 kilocycles. It relays the regular programs of WABC, and is on the air continuously from about 7.30 a. m. to 1.00 a. m. the next morning. A good station to test on because of its consistent operation.

New York, N. Y.—Aviation Radio Station, Inc., 27 West 57th Street, New York, operates W2XAL in conjunction with

WRNY, which is on the regular broadcast band. The main short-wave transmitter is on 49.9 meters or 6,040 kilocycles; occasionally 11,800, 15,250, and 21,460 kilocycles are used. All the actual apparatus is at Coytesville, N. J., on the Palisades across the Hudson River from New York. The full schedule is as follows: Sunday, 4.30 to 7.30 p. m.; Monday, 9.30 a. m. to 1.30 p. m. and 5.30 to 9.00 p. m.; Tuesday, 9.30 a. m. to 1.30 p. m. and 5.30 to 11.30 p. m.; Wednesday, 12.30 noon to 4.00 p. m.; Thursday, 9.30 a. m. to 1.30 p. m. and 9.30 p. m. to 12.30 midnight; Friday, 1.00 to 1.30 p. m. and 3.30 to 9.30 p. m.; Saturday, 9.30 a. m. to 1.30 p. m. and 8.00 p. m. to 12.00 midnight. All times Eastern Standard.

New York, N. Y.—The National Broadcasting Company, 711 Fifth Avenue, is using a powerful short-wave transmitter experimentally in conjunction with WJZ, at Bound Brook, N. J. This is station W3XAL, on 49.1 meters or 6,100 kilocycles. It has no definite schedule, but is usually heard during the early afternoon and at about midnight, E. S. T. The regular WJZ programs are relayed, the short-wave transmissions being identified by frequent announcements. This station evidently is making a big noise in the ether, judging from listeners' letters.

Springfield, Mass.—The Westinghouse Electric & Mfg. Company operates W1XAZ (not W1XAD, as many people seem to think) on 31.35 meters or 9,570 kilocycles. It relays all the programs of WBZ, Springfield, and WBZA, Boston, and is on the air morning, afternoon and evening.

Long Island City, N. Y.—The Radio Engineering Laboratories, 100 Wilbur Avenue, operate experimental station W2XV

on 34.68 meters or 8,650 kilocycles, on Wednesday and Friday evenings from 8.00 to 10.00 p. m., E. S. T. Occasional tests are made during the daytime on 17.34 meters or 17,300 kilocycles, and on 60.3 meters or 4,975 kilocycles.

Philadelphia, Pennsylvania—WCAU, the Philadelphia key station of the **Columbia Broadcasting System**, has W3XAU on the short waves associated with it. Two waves are used: 31.28 meters or 9,590 kilocycles, and 49.5 meters or 6,060 kilocycles. These stations take their programs from New York and their operating schedule is the same as W2XE's.

Pittsburgh, Pa.—The Westinghouse Electric & Mfg. Company operates the world-famous W8XK (relaying the programs of KDKA) on a sliding schedule of three wavelengths, on Sunday, Tuesday, Thursday and Saturday, as follows: 8.00 a. m. to noon, 19.72 meters or 15,210 kilocycles; noon to 5.00 p. m., 25.25 meters or 11,880 kilocycles; 5.00 p. m. to midnight, 48.86 meters or 6,140 kilocycles. Many special programs are put on at other times.

Chicago, Illinois—The Great Lakes Broadcasting Company, 310 South Michigan Avenue, operates W9XF in connection with WENR, whose programs it relays. The station itself is located at Downers Grove, Ill., about twenty-three miles southwest of Chicago. A wavelength of 49.83 meters or a frequency of 6,020 kilocycles is used. We do not have its exact operating schedule, but it is on the air most of the day and evening. Chicago time is six hours slower than Greenwich (England) time.

Chicago, Ill.—The Chicago Federation of Labor is taking quite an interest in the short waves, its short-wave transmitter W9XAA being very active. This works with WCFL, the Federation's regular broadcasting station, from which it takes its programs. The wavelength is 49.31 meters, or 6,080 kilocycles. The schedule in E. S. T. is as follows: 6.00 to 7.00 a. m. daily, except Sunday; 7.00 to 8.00 p. m. daily; 9.30 to 10.15 p. m., daily; and 11.00 p. m. to midnight, daily. Reports of reception may be addressed to 623 South Wabash Avenue, Chicago.

Cincinnati, Ohio.—The Crosley Radio Corporation is supposed to have a short-wave station, W8XAL, working with its regular transmitter WLW; but there seems to be some misunderstanding about the license and we have not been able to obtain any authentic information about it. To the best of our knowledge the wavelength is 49.5 meters, 6,060 kilocycles.

Bolinas, Cal.—Station KEL, on a number of waves, seems to be quite active, occasionally using radio telephony to Hawaii; 43.7 meters is one reported wavelength. There is also KEZ, on 28.85 meters.

TIME SIGNALS

Short-wave set owners can check their watches much more accurately with the "time signals" sent out by stations NAA and W9XAM than they can by attempting to follow the so-called "correct time" announced by most of the regular broadcasting stations. NAA, the famous U. S. Navy Station at Arlington, Virginia, transmits Naval Observatory Time on 74.72, 37.36 and 24.9 meters every day beginning at 11.55 a. m. and 9.55 p. m., E. S. T., and at 2.55 p. m. on 37.36 meters alone. No announcements are made in voice, but the signals are easily recognized. They consist of a series of high-tone dots, each impulse representing a second. At the end of the five-minute period a single dash (a noticeably longer signal), indicates the exact hour. The NAA time signals are absolutely accurate; ships in all parts of the world depending on them for the correction of their chronometers and for the charting of their positions. It is interesting to compare this Naval Observatory time with the time given by some broadcast stations, and to note the difference.

W9XAM, owned by the Elgin National Watch Company and located at Elgin, Illinois, operates on 62.56 meters or 4,795 kilocycles on the following schedule (hours indicated are Central Standard Time, one hour slower than Eastern Standard): 7.55 to 8.00 a. m., daily except Sunday; 9.55 to 10.00 a. m., daily except Sunday; 11.55 to 12.00 noon, daily except Sunday; 1.55 to 2.00 p. m., daily except Saturday and Sunday; 3.55 to 4.00 p. m., daily except Saturday and Sunday; 5.55 to 6.00 p. m., daily except Saturday and Sunday; and 9.55 to 10.00 p. m., daily except Sunday.

These transmissions are also in code, no voice being used. During the five-minute period, impulses are sent every second except the 29th, 55th, 56th, 58th and 59th second of each minute, which are omitted for reference purposes. The last signal is a long dash, the beginning of which indicates the exact hour.

AUSTRALIA

VK3UZ, Nilsen's Broadcasting Service, Bourke St., Melbourne, 34 meters, music Monday and Wednesday, 3.00 to 5.00 a. m., E. S. T.

The Amalgamated Wireless Ltd., Wireless House, 47 York Street, Sydney, operates a string of important stations, as follows: In Sydney, VLK, 28.5 meters, Anglo-Australian telephone service; VK2ME, 18.3 meters, alternate channel. VK2ME, 31.28 meters, relay broadcasting channel, taking programs from various Australian stations. VK2ME, 37.69 meters, Australia-New Zealand phone. Melbourne: VK3ME, 31.55 meters, relaying the Melbourne stations. Suva, Fiji Islands, VP1A,

20.8 meters, telephone to Australia. VK2ME on one of the other of its various waves has been heard quite frequently in the United States during the early morning hours.

ARGENTINA

While there do not appear to be any regular short-wave broadcasting stations in the Argentine, there are a number of radio-telephone stations that operate frequently and are heard by many American listeners. LSX, on 28.99 meters or 10,350 kilocycles, is the most consistent performer. It transmits test programs of music usually between 8.00 and 10.00 p. m., E. S. T., all programs ending with the "San Lorenzo" march.

General Hints on Reception of S.W. Stations

FIRST of all, Mr. Hertzberg suggests that every owner of a short-wave set should send one American dime (not stamps!) with a request for a copy of Miscellaneous Publication No. 84, entitled "Standard Time Conversion Chart," to the Superintendent of Documents, U. S. Government Printing Office, Washington, D. C. A copy of this chart, which will enable the reader to make tracings on Bristol board, will appear in the next issue. The time-conversion chart enables the operator to determine just what time it is in any foreign country, which is a very important factor; since there is not much use in listening for G5SW (Chelmsford, England) during the evening in New York City, when the "time table" shows us that the English operator has concluded his daily labors at 12.00 P.M. London time, or 7.00 P.M. New York time.

An ordinary flat map of the world is almost useless for the purpose of determining straight-line distances between American and foreign countries. Obtain a small globe and stick colored-head pins in it to represent the short-wave stations you have heard; and you will have a real interesting and worth-while exhibit.

As Mr. Hertzberg pointed out in a recent interview, many short-wave listeners, who were formerly able to hear the various transatlantic radiophone stations very clearly, now complain that many of the transmissions sound like "Greek". This is explained by the fact that the radiophone messages are probably "scrambled", so that they become unintelligible on ordinary S.W. receivers. These short-wave commercial transatlantic stations utilize this secret method of transmission because the telephone company's patrons are naturally entitled to privacy when carrying on business or social conversations with Europe. These transatlantic phone stations usually give their call letters when working in the "clear" which will more than satisfy most of the short-wave "hams".

Some of the American stations (particularly WGY) put on special Spanish programs for the benefit of South American countries and, until you hear the announcer say W2XAF or W2XAD in clear unadulterated American, you may be fooled into believing you are actually tuned in on one of the short-wave transmitters of dear old sunny Spain.

Other stations are LSH, on 28 and 30 meters; LSN, on 30.3 meters; and LSG, on 15.2 meters. All of these stations are located at Monte Grande, just outside of Buenos Aires, and are operated by the Trans-Radio Internacional.

AUSTRIA

Station UOR2, in Vienna, broadcasts on 49.4 meters or 6,072 kilocycles Tuesday and Thursday, between 7.00 and 8.00 a. m., E. S. T., and on 25.42 meters or 11,800 kilocycles on Wednesday and Saturday beginning at about 6.00 a. m. Vienna, by the way, is pronounced "Wee-en" in German.

BRAZIL

According to letter received, there is a station MTH on 48 meters in Rio de Janeiro, operated by the Radio Club of Brazil. The call letters belong to Great Britain; and we cannot explain how or why they are used in Brazil.

BRITISH EAST AFRICA

VQ7LO, Nairobi—Has been using a number of waves, but is most likely to be heard on 31.2 meters.

BRITISH GUIANA

VRY, in Georgetown, is another standby. It is on 44.6 meters, and broadcasts on Wednesday between 7.00 and 9.00 and Sunday between 5.45 and 9.00 p. m., E. S. T.

CANADA

Winnipeg—Station VE9CL (formerly CJRX) relays the programs of CJRW during the early evening hours. The waves of 52.5 and 48.5 meters are used. Owned by J. Richardson & Son.

Bowmanville, Ontario—Station VE9GW, on 49.2 meters or 6,095 kilocycles, relays the programs of CKGW. Week days schedule: 6.45 to 8.00 a. m., 3.00 p. m. to midnight; Sunday, 12.30 p. m. to midnight, E. S. T. Reported by Gooderham and Worts, Ltd. Address reports of reception to Mr. W. A. Shane, Station Engineer, R. R. 4, Bowmanville, Ont., Canada.

CZECHOSLOVAKIA

Station OKI, at Podebrady, is on 14.28 and several higher waves. Telephony is used now and then, the main purpose of the station being to contact direct with the United States for the handling of Telegraphic traffic.

DUTCH EAST INDIES

Java has become known as the Island of Short Waves, because of the number of stations on it. PLE, in Bandoeng, on 15.93 meters, broadcasts programs on Tuesdays from 8.40 to 10.40 a. m., E. S. T. There are at least six other phone stations, which frequently transmit phonograph records while the apparatus is being adjusted. These are PMB on 14.55 meters, PLF on 16.8, PLG on 18.8, PLR on 28.2, PLW on 36.92 and PMC on 16.52. They are usually heard in the early morning working with Holland.

The Sourabaya Radio Society operates an amateur station, PK3AN, on 49.7 meters. This is being heard in the United States between 6.00 and 9.00 a. m., E. S. T.

ENGLAND

Chelmsford, G5SW—This is the short-wave relay link of the British Broadcasting Corporation, transmitting the regular BBC programs for the benefit of the British Colonies. Operates on 25.53 meters or 11,751 kilocycles. Hours: 7.30 to 8.30 a. m., and 2.00 to 7.00 p. m., E. S. T. Signs off with the midnight chimes of "Big Ben" in London.

G2NM, Gerald Marcuse, "The Ranch," Sonning-on-Thames, Berkshire, England. An amateur station with an international reputation. It was Mr. Marcuse who demonstrated to the British that short-wave broadcasting to the colonies was really possible. He is now on the air on 20.90 meters, Sundays from 1.30 to 3.00 p. m., E. S. T., for the benefit of American listeners.

FRANCE

While there are few real short-wave broadcast stations in France, there is a nest of radiophones (mostly at Saint Assise) which conduct a regular service between France and Buenos Aires, Rio de Janeiro, and Saigon, French Indo-China. Their calls all begin with F, and they are distributed between 14 and 38 meters to the extent of about ten different transmitters. A knowledge of French is useful with these.

(Continued on page 392)

Full Simplified Details for Constructing the ULTRA ALL-WAVE RECEIVER

From Standard Parts Available on the Market

As its name indicates, the "Ultra All-Wave" receiver functions perfectly, not only for "short-wave" reception, but also for the reception of broadcasting on the present broadcast band. This receiver is equally satisfactory, either for phone or for code reception. Many powerful stations are broadcasting entertainment regularly on short waves. Distant reception, with a properly designed short-wave receiver, is the rule rather than the exception and, in such a set, static is greatly reduced.

By H. G. CISIN, M.E.

This "All-Wave" receiver has a wavelength range of 16 to 550 meters, plug-in coils being used for short wave reception. All of the standard parts specified are of the highest quality and make a very satisfactory all-around job.

transformers bring in the much-desired bass notes and, in fact, their amplification "curve" over the entire audible range is a straight line; showing uniform amplification at each frequency.

The Ultra "All-Wave" receiver is built in two units. The R.F. section is designed in the form of a conventional receiver to be placed in a standard 7 x 21-inch cabinet or console. The audio portion of the circuit, together with the "B" and "C" eliminator, is separate and may be located at any convenient point; a cable is used to interconnect the two sections. The receiver may be turned "on" or "off" from the R.F. section; using a Yaxley, full-automatic power control, to switch the eliminator "on" as required.

The Racon air-column speaker is ideal for use with the Ultra "All-Wave" receiver. The true exponential air column of this reproducer offers maximum response to all frequencies in the most realistic fashion, and it can handle the maximum output of the receiver with ease.

Building the Ultra "All-Wave" Receiver

The R.F. portion is constructed first. Cut the sub-panel to 20 inches. The brackets should be 1 inch high and 8½ inches long. Fasten the four brackets to the sub-panel, one at each end and one 2 inches on either side of the center. The end of each bracket should be flush with the rear edge of the sub-panel. Since the sub-panel is 7 inches wide, the bracket will overlap by a distance of 1½ inches. Fasten the shield bottoms to the sub-panel. The 8½-inch edge is flush with the panel edge of the brackets; the 8-inch edges are flush with the sides of the sub-panel. The larger compartment of each shield must be nearest the panel.

Drilling Panel

Drill holes in the panel, 4½ inches from each side of the vertical center line and on the horizontal center line for the variable condenser shafts. Drill two

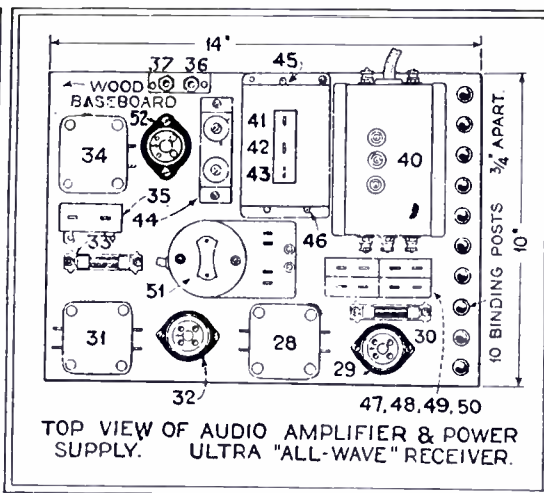
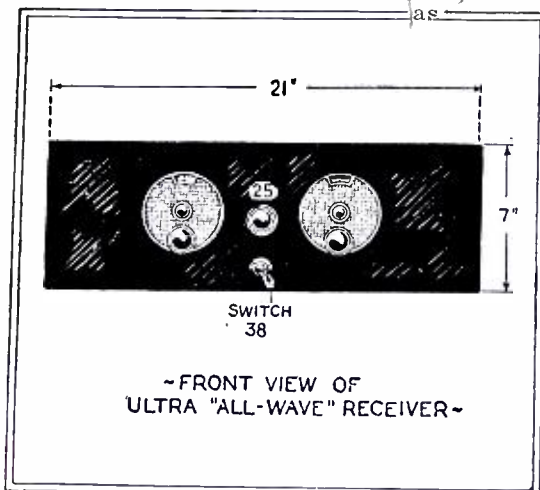

Top view of audio amplifier and power supply which any one after reading this article can easily construct with standard parts, all of which are carefully specified in detail.

Those who care to learn the "Continental" code, find another fascinating field for experiment or amusement, and there is little wonder that fans everywhere are showing such great interest in short-wave sets.

With its interchangeable Aero coils, the range of the Ultra All-Wave receiver can be altered at will. The coils overlap in range, so that it is possible to cover not only the short waves, but the entire broadcast band, and even higher if desired.

Set Is Easily Tuned

Cardwell .00014-mfd. tuning condensers are used as indicated at (4) and (13). The receiver is easily controlled, and tuning is as simple an operation as in the ordinary broadcast receiver.

Two Hyvac self-shielded screen-grid tubes are used in this circuit, one as an R.F. (radio frequency) amplifier and the other as a space-charge detector. The R.F. screen-grid tube adds to the sensitivity of the receiver and limits radiation, because of its very low grid-to-plate capacity. Both screen-grid tubes add greatly to the amplification and make this an unusually powerful receiver; adequate shielding permits fuller use of amplification factors of the tubes. The

tuned antenna circuit gives the receiver the requisite selectivity, even on the broadcast band.

Good Audio Quality a Feature

In order to make the Ultra "All-Wave" receiver adaptable to the reception either of broadcast programs or of code, especial care has been given to the design of the audio amplifier. Instead of low-grade transformers (ordinarily used in short wave sets for the reception of C.W. high-pitched [continuous wave] signals) special high-quality Thordarson audio transformers have been used. These

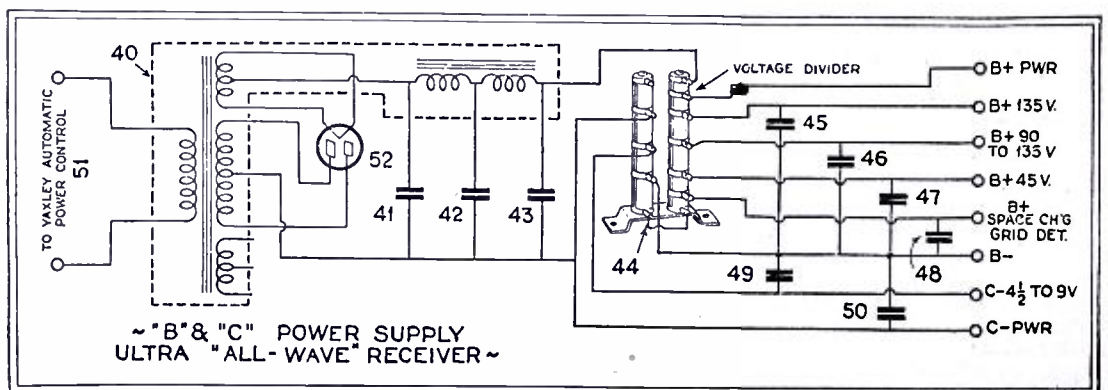

This diagram shows the connections for the various condensers, voltage divider and power transformer, from which are drawn the B and C supply.

smaller mounting holes, using template furnished with condensers. Drill holes on the vertical center line for mounting the Tonatrol and filament switch. Mount these parts. Locate, drill and counter-sink holes for fastening panel to brackets.

After fastening panel to brackets, locate and drill condenser mounting holes in the shield fronts; mount variable condensers. Drill holes in the shield bottoms for mounting the various parts. To avoid short-circuiting their terminals, raise the sockets on washers or drill extra large holes for terminals in shield bottoms. Mount all parts on shield bottoms and drill holes for bringing wiring from beneath sub-panel. Mount all other apparatus.

The R.F. portion of the receiver is now ready for wiring. Corwire "Braidite" wire is used throughout. Perform as much of the wiring as possible beneath the sub-panel. Rosin-core solder is recommended for soldering the various joints. Wire the filament circuit first, then R.F. grid and plate circuits and, finally, the detector grid and plate circuits. Wire in the by-pass condensers. Wire to the cable mounting.

Screen-Grid Tube Connections

Note especially that the lead from the stator of condenser (4) goes to the "cap" of the shield-grid tube (7); make this wire as short as possible and isolate it from the other leads. Use a piece of armored flexible Braidite for this purpose and solder a No. 45 "Peewee" clip to the end of the lead for making connection to the cap of the screen-grid tube. Be sure to have the lead from "B" plus

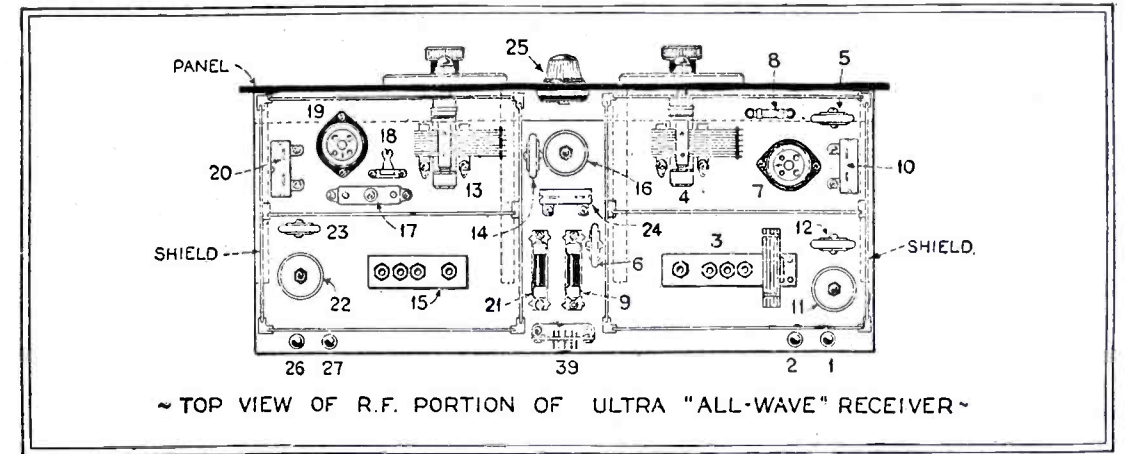

This top view of the radio frequency portion of the "All-Wave" receiver shows preferred position of plug-in coil bases and tuning condensers in shield boxes.

ience of the builder. The wiring is conventional and offers no trouble.

It may be found desirable to increase the voltage on the plate of the detector above 45; in this case, break the circuit at the point marked "X," and use an extra conductor in the cable. If the receiver is to be used to cover a range between 235 and 550 meters, Aero coils "No. INT-5" are used at (3) and (15). To increase the range to 725 meters, fasten an extra G-5 Variodenser within the shield near each variable condenser. Solder one terminal of each Variodenser to its respective shield, and a flexible lead with a clip at the end to each of the other terminals. When the set is to be used for the extra high wavelengths, plug in the INT-5 coils and clip the free terminals of the two variodensers to the stators of the variable condensers. This will

- 2—Aero Coils, No. INT-5, Range 235 to 550 meters (3, 15)
- 3—Silver-Marshall R.F. Chokes, No. 277 (11, 16, 22)
- 2—.00014-mfd. Variable Condensers, type 168-C (4, 13) Cardwell
- 2—UX-type Eby Sockets (7, 19)
- 1—X-L Variodenser, type G-5 (17)
- 1—2-10 meg. Durham Metallized Resistor Grid Lead, with Durham Single Vertical Mounting (18)
- 4—.01-mfd. Flechtheim Midget Condensers, type M-K (5, 6, 12, 14)
- 1—.0005-mfd. Flechtheim Midget Condenser, type M-D (23)
- 2—.05-mfd. Flechtheim By-Pass Condensers, type B 50 (10, 20)
- 1—1-mfd. Flechtheim By-Pass Condenser, type B 100 (24)
- 1—Electrad Tonatrol, type "S" (25)
- 1—Electrad 10-ohm. Fixed Resistor (8)
- 2—Amperites, No. 622, with M't'gs (9, 21)
- 4—Binding Posts (1, 2, 26, 27)
- 1—Yaxley No. 660 Cable, complete with Connector Plug and M't'g Plate (39)
- 1—Roll Corwico Braidite Hook-up Wire, Stranded Core
- 1—Can Kester Radio Solder (Rosin Core)
- 1—Electrad Filament Switch (38)
- 2—Vernier Dials
- 1—Panel, 7" x 21" x 1/8", Composition
- 1—Sub-Panel, 7" x 20" x 1/8", Composition
- 4—Brackets, low type
- 2—Hammarlund Aluminum Shields, type "HQS"
- 2—Hyvac VX 222 "Self-Shielded" Screen Grid Tubes (7, 19)
- 1—Racon Exponential Horn with Racon "Baby" Dynamic Unit

LIST OF PARTS REQUIRED FOR THE AMPLIFIER AND "B" AND "C" POWER SUPPLY FOR THE ULTRA "ALL-WAVE" RECEIVER

- 1—Electrad Voltage Divider, type C-245 B2 or type C-130 S (44)
- 2—Thordarson Audio Transformers, type R-400 (28, 31)
- 1—Thordarson Output Impedance, type R-196 (34)
- 3—UX-type Eby Sockets (29, 32, 52)
- 1—Hyvac VX201-A Tube (29)
- 1—Hyvac VX171-A or 112-A Tube (32)
- 1—Hyvac VX280 Rectifier Tube (52)
- 1—Wooden Base, 10" x 14" x 3/4"

(Note: Numbers in parentheses after each part, refer to corresponding numbers used to mark parts on diagrams.)

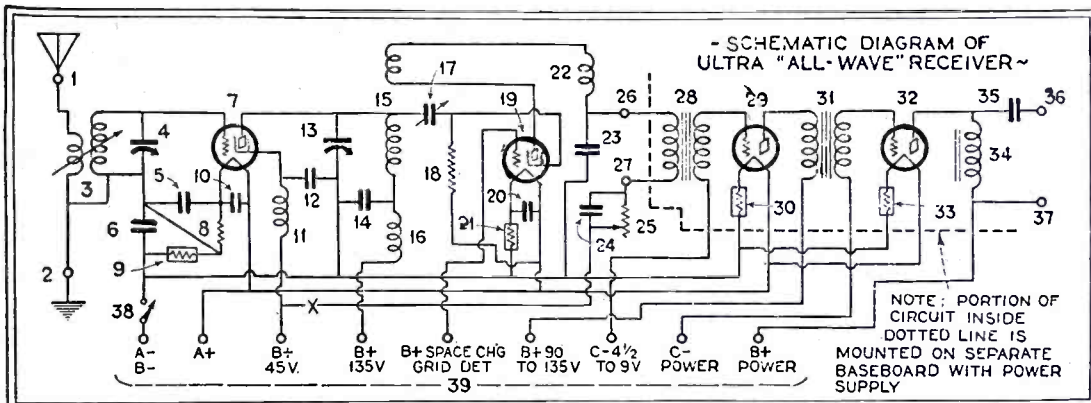

Wiring diagram of the ultra "All-Wave" receiver which comprises one stage of shield grid R.F. amplification ahead of regenerative detector with two stages of audio. This is a battery operated set.

go to the cap of tube (19). The double grid connection from the grid-leak and condenser goes to the socket terminal marked "G".

The parts for the audio amplifier and "B" and "C" eliminator are mounted on a wooden baseboard. The layout shown may be followed, or the position of the parts may be varied to suit the conven-

permit covering airplane and ship-to-shore bands.

LIST OF PARTS REQUIRED FOR THE R.F. PORTION OF THE ULTRA "ALL-WAVE" RECEIVER

- 1—Aero Coil Kit, No. LWT-12, Range 16.5 to 89.5 meters (3)
- 1—Aero Coil Kit, No. LWT-11, Range 16.5 to 89.5 meters (15)
- 2—Aero Coils, No. INT-4, Range 125 to 250 meters (3, 15)

Record Speed in Short-Wave Telegraphy

IN sending by hand, 130 characters of the International code (letters, figures, etc.), is excellent speed in commercial operation. The world's record of 225 a minute in reading code is held by an American ship's operator.

The machine can naturally exceed the limitations of the human operator. On Sept. 27, 1930, the Nauen station, working North America on 15 meters, maintained a speed of 1500 characters a minute (about 300 words a minute) on the

automatic transmitters and recorders. This is another record for high-speed operation, to which the use of short waves is more conducive than the long waves (which are very little above audio frequency).—Adapted from Radiowelt.

AMONG THE "HAMS"

Mr. Mesher (W6ERK) Wants Traffic for the Orient

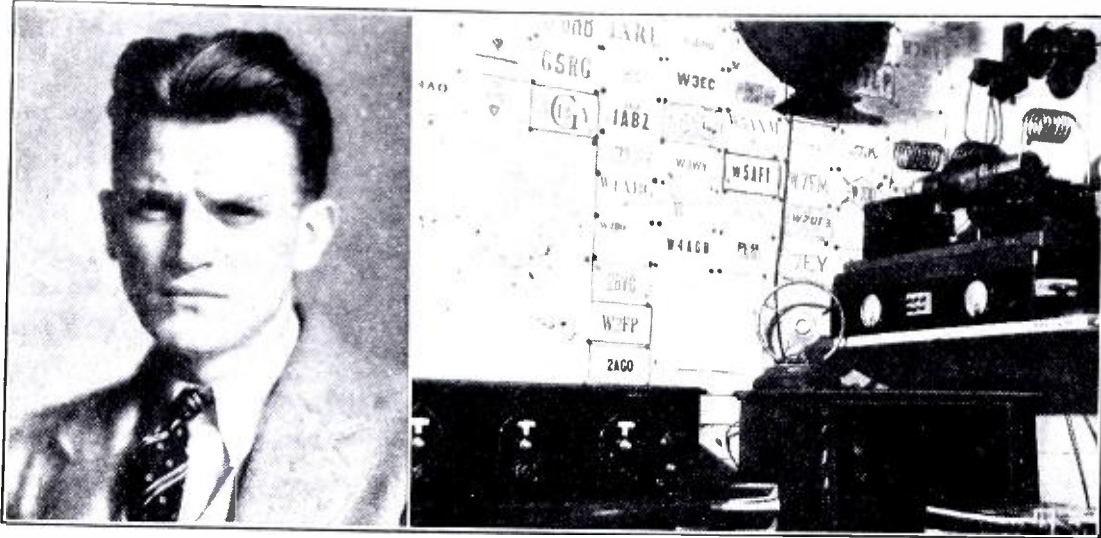

Editor SHORT WAVE CRAFT:

I am enclosing pictures of myself and my

radio station, W6ERK. A description follows:
250-watt tuned-plate, tuned-grid transmitter,

operating in 20, 40 and 80 meter bands. Power supply is from a Thordarson 3,000 volt transformer, this is rectified through Rectobulbs and filtered with chokes and condensers. The receiver is home-made and has tuned R.F. stage (UX232) Detector (UX226) and two stages of transformer-coupled audio. Traffic is the main interest and this station wants traffic for the Orient. This station has been in operation since December, 1928, and has handled thousands of messages. Thirty-three countries in all continents have been worked. Regular schedules are kept with the Philippine Islands. This station has handled messages direct with WFA, the Byrd Antarctic Expedition.

It would please me very much to have this published on the "Ham" page.

Sincerely yours,

GEORGE W. MESHER,
Owner and Operator.

(Inasmuch as we have quite a circulation in the Orient, we know, George, that you will have to sit up until all hours of the night to catch up with the traffic. You sure started something, Old Man. Serves you right!—Editor.)

BOYS, GET YOUR PICTURE HERE

Editor SHORT WAVE CRAFT:

I purchased my late copy of SHORT WAVE CRAFT and noticed my article on page 236 and thank you for your kindness. Since my last letter to you I have heard quite a number of active stations. Some of them are HRB, VRY, HKC, HKF, XDA, PCV, PCL, GBK, VE9CL, Bangkok, Siam; Bandoeng, Java, 3RO.

There are many active stations on the air at present that I hear but can't find out as yet who they are. Buenos Aires is active in the evening. The ships *Majestic* and *Leviathan* are active. I have at present two short wave sets. One of them a National AC5 and the other a Silver-Marshall "Round-the-World" 4 Receiver which is D.C. I use no elaborate aerial or ground system for I've found out that if a signal is being heard anywhere near my vicinity, it can be picked up even with an inside aerial, if the signal is a well modulated one and is coming through with any volume at all. My aerial is 100 feet long and points in a N.E.-S.W. direction and the lead-in being taken off the S.W. end.

I have heard with nice loud speaker volume, the following stations: HRB-HKC-VRY-XDA, Zeesen, Germany—LSN-P111, RCV, PCL-Y5SW-PCJ-2ME-2TC-3RO-Bangkok, Siam—Bandoeng, Java, GBK, GBU, G.B.S.

I am having some pictures taken of my receiver and of myself and will gladly send one to you folks. Your short wave list cannot be beat and I rely on it to check my waver.

GEORGE C. STARRY,
P. O. Box 262,
Derry, Pa.

(That's the spirit, George—now you are talking! That is a great idea about your picture and I know you will receive many requests from the boys to get yours. When you send them out do not be too easy, and make them give you one of their's in exchange! Otherwise we predict you'll be broke soon.—Editor.)

A Real S. W. P. H.

Editor SHORT WAVE CRAFT:

Dear Sir:

Being a S. W. P. H. (Short-Wave Phone Hound) I thought it would be just as well if I pestered you with a few inquiries, and also a few facts of reception in this neck of the woods, from which I have never seen a report.

First I want to congratulate you on your splendid new magazine, SHORT WAVE CRAFT;

it is just the thing I, and, I am sure, thousands of others, have been waiting for.

Friday, the 13th, I received my verification from K1XR in Manila; this is evidently a very good zone of reception for the P. I. and Australia, but a very rotten one for Europe, and my neighbors haven't been klicking about being disturbed by Java waking them up in the morning.

VK2ME is coming in good this time of the year; yesterday morning, 17th of June, I pulled myself out of bed about four A. M. for a listen to Russia, but they have never favored me by using enough power or being close enough or something. Any way I got to listening to

to write and tell you how it hits the right spots, that's just what it does, it is a real ham's magazine, or a tinkerer's magazine, or a professional's magazine, even the fellows who have no short wave sets begin, after looking through SHORT WAVE CRAFT, to look just like a short wave hound, they begin sniffing around, until they find a three tube set and the set begins squealing and the hound begins bragging, funny game, but once you start there's no quittin'. (Well! Well! Ain't that sum-pin!)

Mine is a Super Wasp and I think I get just about as many foreigners as most any one, considering the time I have to spend at the radio.

Just had a card from LSX yesterday, also have verifications from VK2ME, NR11, HRB, HKC, PCJ, ZIESEN, G5SW and several others and am looking for answers from VRY, K1O and KES.

I get lots of fun hearing the Aircraft Stations; they will call the man in the plane by name and the plane number, and many times I have heard the pilot answer and tell them his position; the station in turn calls the information to other land stations along the route. These stations are on about 53 meters, and are very easy to tune in, are loud enough to come in without any regeneration to locate them, of course the transmitters on the planes are not very loud and require very careful and quick tuning, because they are just on for a few seconds usually.

I have a Silver-Marshall 440 Time Signal Amplifier and it seems that I saw where someone built a short wave Superheterodyne using one, and have forgotten where I saw it, if you can publish a diagram of a circuit of this kind, or if someone else will give me some information concerning same it will surely be appreciated.

With best wishes to the Editor and all the hams.

I am, yours faithfully,

ROY E. GOAD,
Filbert, W. Va.

(Have no information on the Silver-Marshall 440 set and would suggest that you write direct to the manufacturers, Silver-Marshall, Inc., 6409 West 65th Street, Chicago, Ill. They might be able to give you the correct information.—Editor.)

WE WANT
Photos of Your Station
and Brief Description
Address the Editor

VK2ME testing with 2XAF, 2ME was running circles all around 2XAF.

I use a three bottle outfit, straight regenerative, one det., two audio. I use two sockets that are alike, none of the other parts are of same make, but the results are very gratifying, considering the money put into the outfit.

I would like to communicate with any one in Arizona about the way Europe is or is not, the latter in my case, coming in.

I am,

PAUL SANMAN,
3616 N. 12th St.,
Phoenix, Arizona.

(Congratulations Paul. One congratulation deserves another. You are certainly a real Short Wave Phone Hound and our illustrious secretary, Pips, was more than pleased to receive your letter. Keep up the good work.—Editor.)

SORRY, OLD MAN

Editor SHORT WAVE CRAFT:

SHORT WAVE CRAFT is such a wonderful magazine, it would be a downright shame not

Some Phone Hound

Editor SHORT WAVE CRAFT:

I am another one of those so-called short wave "DX" hounds.

I've had a fair DX record for SW. Using only two tubes and sometimes only one. How's this—

- 1925 3 Short Wave Stations
- 1926 1 Short Wave Station
- 1927 None
- 1928 25 SW Stations. All in U.S.A.
- 1929 25 SW Stations. All in U.S.A.

To Date 1930 72 SW Stations

- 1—Lyons, Radio Lyon, France, 39.6 M.
- 1—G2BR, Chelmsford, Eng.
- 1—FLE, Paris, France
- 1—Honolulu, Hawaii
- 1—G2AA, Rugby, Eng.
- 1—S.S. Leviathan, 35.48 M.
- HICYB, Ecuador, South America
- VE9GW, Bowmanville, Canada.

It may be interesting to note that all the stations I have listed above are "phone" stations.

Quite a record, "what say?"

My antenna is about 15 feet long with a 15 foot lead in. Inverted L type. Top or antenna proper runs in the S.W.W. by N.E.E. direction. Lead-in on western end. Highest point on antenna about 18 feet from ground. Lowest point about 17 feet. Antenna is a single wire. 7 strands of No. 24. Use 4-inch Pyrex glass insulators. Antenna and lead-in one wire.

My ground is the city water pipe in the house.

Now to my set.

One of the photos shows my short wave receiver. This one happens to be one of my 1 tube affairs using a 227 tube. Picture No. 2 is the back view of same set with a few other things I have in my collection of radio apparatus.

I have nearly all the parts variable. Hard to tune for a beginner, but to me it's as simple as a single dial set; and I am not fooling either.

I may add to my information, that with this set and one of my secret attachments I have been able to see pictures broadcast from W3XK, the Jenkins Laboratories at 1519 Connecticut Ave., Washington, D. C. The fact is a one tube receiver furnishing power enough to see pictures with a television kit.

Very truly yours,

RAYMOND STEPHENS,
203 East 18th Street,
Davenport, Iowa.

Mr. Raymond Stephens and his short wave apparatus are observed in photos at right. Mr. Stephens has a special attachment of his own design which enables him to "see" radio pictures on a 1 tube set!

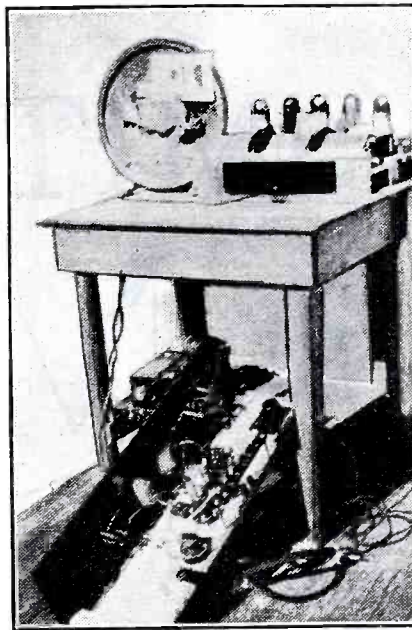

Raymond Stephens and his S-W layout

(Congratulations Raymond, on your accomplishments. We sure have to hand it to you and we hope that all of our other readers will soon become "phone hounds" like yourself. Glad to publish your photo. It is now up to the other readers to send us some too.—Editor.)

FINE CRITICISM

Editor SHORT WAVE CRAFT:

I wish to say, without any reservations, that SHORT WAVE CRAFT is the finest radio magazine (outside of "Radio Craft") that I have ever seen. It gives us real live "dope" and doesn't soar away into the realms of higher mathematics, and leave us in a haze, wondering what it's all about.

The Oct.-Nov. number came out late up here, but the high quality of the issue completely made up for it.

The editorials are splendid as all Mr. Gernsback's editorials are. I have every one of his editorials since 1927, bound in book form, and I consider the book a mine of priceless information.

The covers are beautiful in every manner.

I am glad to see, that you have imported articles from Germany, where a great deal of amazing short-wave work is being done.

I have only two criticisms to make, and they are:

(1) Use the same point type throughout. It is very irritating to read one article in small type, followed by one in large type. What is the idea of that?

(2) Issue SHORT WAVE CRAFT monthly.

I'll sign off, hoping to see the letter in the "Among the Hams" department.

Yours truly,

E. ANDERSON,
1765 Southern Boulevard,
New York City, N. Y.

(Thanks for the criticism Old Man and as you will probably have noticed from this issue we are using practically all one type and in the future all articles will be in the one type.

As to the issuing of SHORT WAVE CRAFT monthly, we have thought about this for a long time but right now that idea is not yet practical. In the end we probably will do it but just now, particularly due to the advertisement situation, where advertisers would have to advertise every month, it will not work out economically. However, remember that although the magazine costs 50 cents a copy—and our readers say it is well worth it—yet this is only "25 cents per month," as you no doubt have figured out for yourself.—Editor.)

Announcement

THE publishers of SHORT WAVE CRAFT are pleased to announce that they are launching a new magazine,—a sister publication to SHORT WAVE CRAFT,—which will be known as



The first issue will be out on the newsstands on February 15th.

In makeup, contents, typography and general interest, it will be similar to SHORT WAVE CRAFT. It will be published every other month and will alternate with SHORT WAVE CRAFT.

The subscription price is \$3.00 a year, but for a limited time, readers of SHORT WAVE CRAFT may avail themselves the right of subscribing at a special reduced rate of \$2.00 a year (foreign countries \$2.25).

The first issue contains important articles on television by a galaxy of radio stars, such as Dr. A. N. Goldsmith, Dr. E. F. W. Alexanderson, Dr. Herbert E. Ives, Dr. Fritz Noack, C. Francis Jenkins, Laurence M. Cockaday, D. E. Replogle, Philo T. Farnsworth, Clyde Fitch, and many others.

Address all communications, checks, etc., to TELEVISION NEWS, 98 Park Place, New York, N. Y.

TRANSMITTING ON TEN METERS

By A. BINNEWEG, JR.

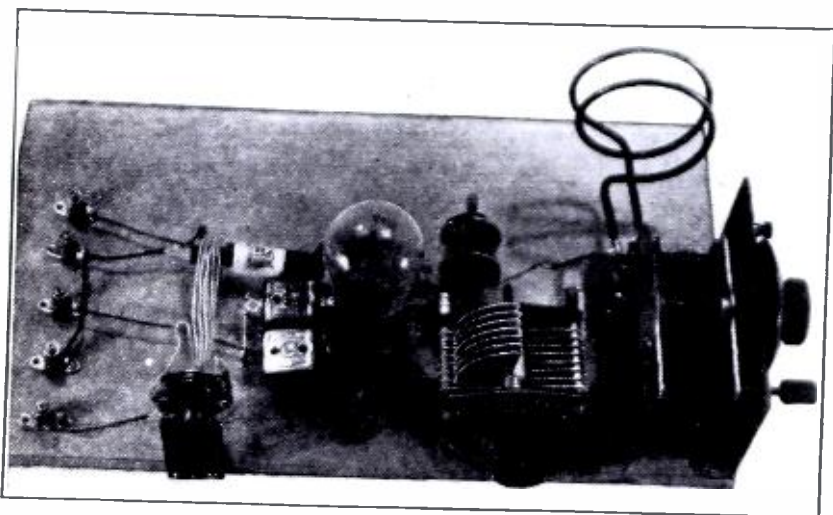

Interest in short waves down in the 10-meter part of the spectrum is becoming greater every day. Mr. Binneweg presents his subject in an elementary style so that those who are unfamiliar with the generation of waves as low as 10 meters, can easily understand each step in the process. The author is a well-known Short Wave writer.

The author's experimental "bread-board" model of 10 meter transmitter.

through the filament-clip lead; there is usually quite a drop in the filament-clip lead employed. Therefore the clip was adjusted carefully along the turns of the coil with a shorter lead. Each change in the position of the clip changes circuit conditions and often shifts appreciably the correct setting, especially at higher frequencies. This is undesirable, since it hinders greatly any proper adjustment.

ASTONISHING distances are covered in daylight at ten meters! With the proper use of reflecting systems, one can obtain very unusual results with but a fraction of the power necessary at longer wave-lengths. The transmitters and receivers are not difficult to construct and are, often, less expensive than similar apparatus for lower frequencies. The ten-meter amateur band is being explored by more and more experimenters and some very interesting phenomena are being investigated. It is an exceptionally interesting band to the amateur and experimenter but it is not all easy sailing—unless you know how. That gives us an excuse for the following story, about conditions in general, and how to construct ten-meter sets cheapest and best.

The popular Hartley oscillating circuit, without change, does not function well at a wave-length of ten meters. This was discovered early at W6BX; therefore, experiments were undertaken to improve the circuit for efficient operation at these frequencies.

Fig. 2 shows the general arrangement of the test oscillator circuit. The filament-clip was disconnected, with an immediate gain in efficiency and stability of oscillation. This suggested immediately the possibility that the clip had not been placed at the true voltage node on the oscillating circuit's inductance. This would cause voltage-feed to the filament

Experimenting With Oscillators

A small S.P.D.T. switch was arranged in the filament-clip lead, as shown in Fig. 2; this was to provide for connecting, in series with the clip-lead, either a small choke coil or a variable condenser of moderate value for testing purposes. It was discovered, when using this interesting combination, that results were greatly improved when either a small 60-turn choke or a 25-mmf. condenser was connected in series with the

Transmitting Circuits

The popular Hartley oscillator circuit of Fig. 1, is a favorite among transmitting amateurs, because of its simplicity and flexibility. The condenser can be connected across the entire coil in the oscillating circuit, or else across only a small part of the coil (as suggested by the dotted lines). The latter arrangement allows better adjustment of the circuit constants and the grid excitation, which is important for a good "note." By some minor changes, this circuit can be used at ten meters; the same is true of others, but the Hartley is perhaps more familiar to short-wave amateurs and experimenters.

Fig. 1 — Hartley circuit as used at longer wave-lengths. Often the condenser is connected as shown by the dotted lines, instead of across the entire coil.

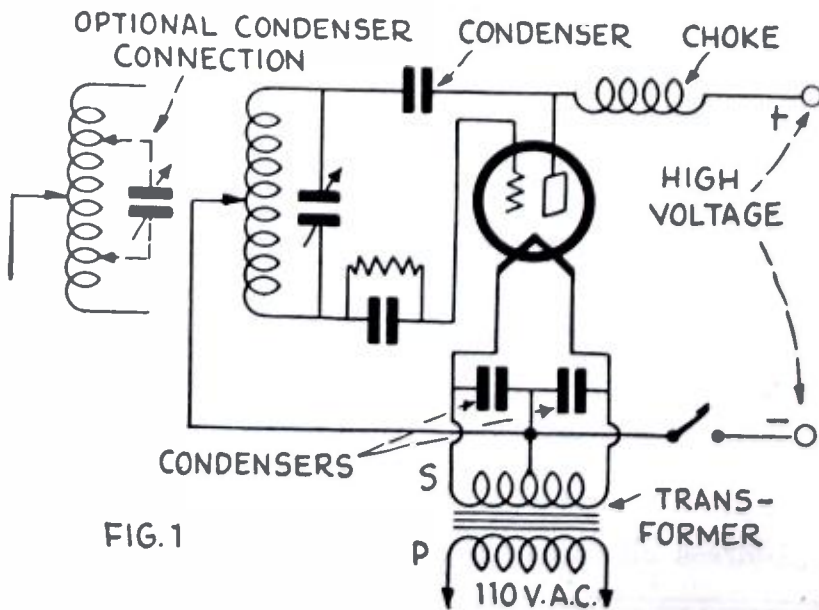

FIG. 1

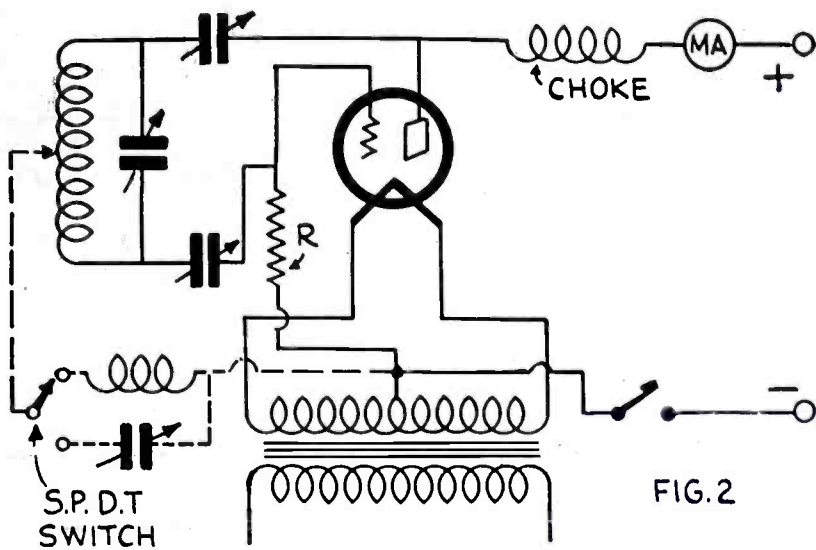

Fig. 2 (Above)—Experimental ten-meter transmitter circuit which gave interesting results.

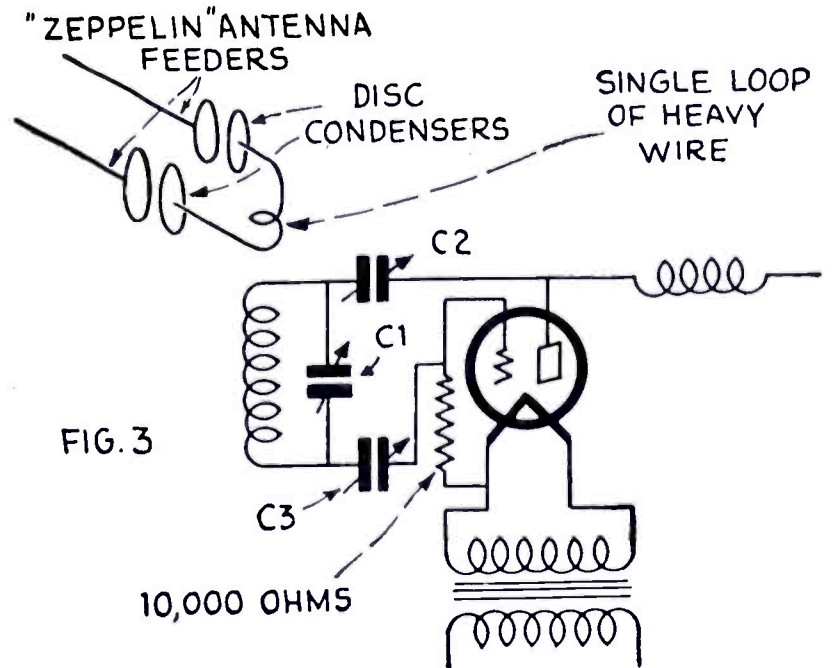

FIG. 3

Fig. 3 (At Right)—Ten-meter transmitter circuit showing method for coupling to Zeppelin antenna.

filament-clip lead, at a wavelength of ten meters.

The test oscillator was then modified to the circuit of Fig. 3, in which no filament-clip whatsoever is employed. This circuit gives strong oscillations and is somewhat more efficient for ten-meter transmitters; although the tuned plate-tuned grid circuit is also good.

The circuit of Fig. 3 is adjusted for optimum results for ten-meter operation in the following manner (the coil and condenser in the oscillating circuit should be of reasonably low-loss construction). With the blocking condensers C2 and C3 set at about 25 mmf. each, tune C1 until a wavemeter check shows the frequency within the ten-meter band. Although a large capacity at C1 will give a somewhat steadier wave, C1 should not be too large, for reasons described later, for the efficiency falls off rapidly as C1 is increased beyond a certain best value.

Choosing Condenser Values

Therefore, if it is necessary to use too much capacity in C1, for given size of inductance, results will not be entirely satisfactory. With a coil consisting of about two spaced turns of copper tubing, 2½ inches in diameter, are used (as shown in the photograph of a ten-meter transmitter used by the writer), they will be quite so. The settings of C2 and C3 will also influence the wavelength to some extent. C2, the plate-blocking condenser, should ordinarily be an instrument with double plate spacing; for it must withstand higher voltages. C3, the grid condenser, may be an ordinary midget variable condenser. When ordinary tubes are employed, it is best to use a comparatively small value of capacity in condensers C2 and C3. These two, together with the grid-plate capacity of the tube, constitute a series combination which allows oscillating currents of comparatively large values to pass through the tube; with small values in C2 and C3, this effect is reduced. It is not possible, however, to make these condensers exceedingly small, for the tube will not then oscillate.

One can easily determine when the

correct values for ordinary use are obtained, by a simple test, which consists of reducing the capacity values until the tube no longer oscillates. A sudden change in plate current will show this. As the capacities are decreased, C1 is increased to compensate for the falling wavelength value, keeping it constant. The values of capacity, corresponding to a condition which does not allow oscillation, are extremes; for best results, the capacities in C2 and C3 are then increased somewhat until proper oscillation is restored. Experiment will then show any further necessary refinements in adjustment.

Harmonizing Inductance with Capacity

Amateurs possessing tubes of higher power than the type '10 transmitting tube ordinarily employed, can perform some very interesting tests with oscillating circuits at ten meters. For these, a fifty-watt tube or larger should be used. In Fig. 4, two extremes for oscillating circuits (tuning to the same frequency) are indicated: at A, a low inductance is used with a large capacity; at B the inductance is large and the capacity comparatively small. In a transmitter, neither of these two ex-

tremes is satisfactory; one chooses values between them for best results. A is not satisfactory, because the oscillating currents in the tuned circuit become large, and the resulting efficiency is very poor. B is not satisfactory, because the tube capacities change slightly in value as the tube's elements become warm and expand; since the capacity in the oscillating circuit itself is small, any small change in tube capacity (connected across the oscillating circuit condenser) influences greatly the frequency transmitted; this is the cause of "climbing" signals. A small change in tube capacity has relatively little effect on an oscillating circuit like that shown at A, because the total capacity is so large. Somewhere between these two extremes lies a ratio between inductance and capacity which will give best all-around results for a given set.

Generating High Voltages

In the oscillating circuit of Fig. 4A, the radio-frequency voltage will be found very small, while an oscillating circuit like Fig. 4B will give some husky, long sparks because of the high voltages developed. It is an extremely interesting

(Continued on page 398)

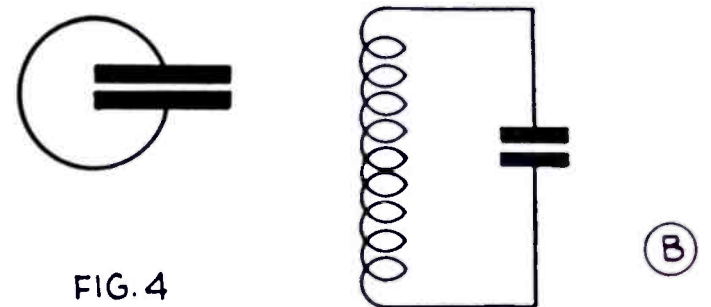

FIG. 4

Fig. 4—Illustrating two extremes for oscillating circuits. "A" shows a very small inductance with comparatively large capacity; at "B" a large inductance is used with a small capacity.

Fig. 5—Antenna arrangement for ten-meter operation.

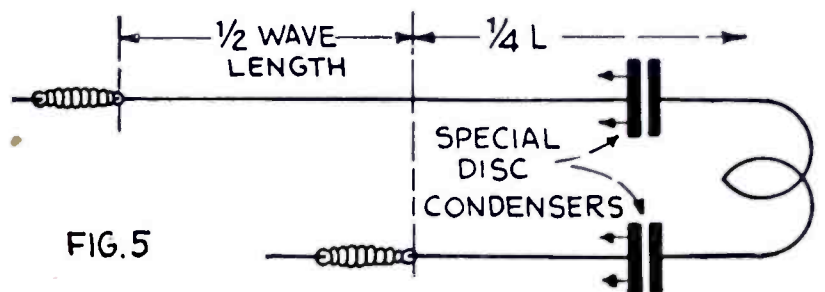

FIG. 5

The Influence of the Earth's Atmosphere on the PROPAGATION of RADIO WAVES

By DR. J. FUCHS

PART III.

Dr. Fuchs, famous European expert on short-wave phenomena, explains in an interesting way such important subjects as—Skip Distances—The Echo Problem—What Wave Velocity Shall We Use?—Signals That Encircle the Earth Three Times.

the ionized medium, the waves a, b and c are destroyed in setting the ions in motion. The ions which are moved then create again the same number of waves at the end. If we now look at a certain wave-phase, it has in the meantime—perhaps a second—moved ahead a certain distance. Its velocity is the previously-mentioned wave-velocity or phase-

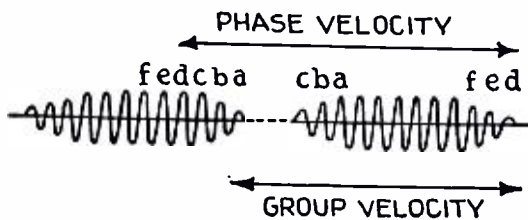

Fig. 12.

Illustrating phase velocity and group velocity.

velocity, while the velocity of the entire wave-group, which is constantly changing and being renewed by the continual restoration of energy at the rear, comes out considerably smaller: this is the group velocity.

Absorption of Energy

There is another very important conception to consider here: the conditions under which absorption of energy can occur. I previously remarked that in the continual reproduction of the wave-group no loss of energy could occur because the energy removed from the head of the wave is supplied again behind it.

But if an ion which was forced into mechanical oscillation under the influence of the changing field of the radio wave should collide with other ions or atoms (this is very possible if the light electrons or the gas ions of ordinary type, a thousand times greater in mass, are present at the same time), then during the passage of the wave-group it will lose the energy of motion obtained from the head of this group, and the wave-group, after passing by, does not get back the energy originally lost.

From this, on the other hand, we recognize very well the importance of the average free path of the ions. The higher the radio wave can penetrate into the atmosphere, the longer this free path will be, and the less also will be the absorption, because there is a reduction of the possibility of the occurrence of such collisions, which are connected with the surrender of energy.

Three Velocities Present

To summarize, we accordingly have three velocities of a radio wave: (1) the velocity in a non-conducting vacuum, which is equal to the velocity of light and in which phase and group velocities alike have the same value; (2) the phase velocity, which determines the course of each wave, and is greater than the velocity of light; and (3) the group velocity, the only one we can measure, because the transfer of energy takes place in this manner, but which is always less than the other two. In this way the theory of relativity, which indeed is valid only for the pure transmission of energy, is absolutely followed.

Changing the Conditions of Propagation

I had formerly mentioned that, in the case of the echo phenomenon, the value of the velocity of light was used in calculating the average height at which radio waves travel. After what has just been said, we cannot regard this estimate as exact, because we cannot make any well-founded assumptions regarding the exact length of the course traversed in the air, or about the angle of deflection, which determines the velocity of propagation and the path over the distance from transmitter to receiver.

For this reason one cannot, in spite of knowing these relations, derive much actual profit from them, because too many conditions are still unknown to us. But these difficulties have their cause. Once we know the conditions relative to the velocity of propagation and the path of radio waves in the ionized atmosphere, then the problem of the propagation of radio waves in the atmosphere will be solved.

But today investigation must occupy itself with the questions of the quantitative distribution of ions in the atmosphere, in what respect this depends on the height above the earth, and the nature of the ions and in what proportions ions and electrons are present at the same time.

There are therefore a great many possibilities, and even today we cannot come to a definite decision. Later on more numerous comparisons of theory with observations will be able to settle matters.

(Continued on page 400)

AS for the other conception of velocity, matters are theoretical. If we make the very well-grounded assumption that the velocity of radio waves in un-ionized air, or in a vacuum, is equal to that of light (i.e., about 300,000 kilometers a second), the velocity in the ionized medium, in case the waves get into it, will be greater than that of light. This velocity is called the wave velocity or phase velocity. It is the velocity of the propagation of a single phase of, for example, an entire group of waves.

This fact, at first, is rather uninviting, since it seems to contradict the postulates of the theory of relativity. In reality it does not, for the following reason: the radio wave in the atmosphere follows the curved course due to its deflection, but its changing electric field brings the ions of the atmosphere out of their condition of rest and forces them to move back and forth in the rhythm of the frequency of the change of field. The work necessary for this has essentially to be performed by the front of the wave; the first waves of each wave-group are thereby robbed of their energy; the entire wave-group is, as it were, shortened by the head, and this is therefore the reason why the wave-group is late in arriving at the place of reception. Its time of travel appears to have become longer.

If the wave-group lasts for a definite time (as, for example, in a dot or dash of a Morse signal) the ions will continue their oscillating motions as long as they are under the influence of the changing field of the wave-group. When it has completely passed, however, the reverse process commences: the ions, continuing to oscillate through their inertia, now produce an electromagnetic field of the same frequency, which attaches itself to the rear of the wave-group which has passed and prolongs it. Since the oscillating ions now get no further supply of energy, but only give it off, their amplitude of oscillation will consequently soon die out; only then is the passing wave-group definitely ended.

Therefore, we have the interesting process that the kinetic energy imparted to the ion by the head of the wave-group is restored at the rear of the wave-group. In other words, a certain number of individual waves (individual phases) are taken away from the head of the wave-group and just as many are given back again at the rear. There has been no change in the amount of energy in the wave-group; only the phases of the definite individual waves have been displaced forward in relation to the whole.

Fig. 12 shows these conditions: of the original wave-group on the way through

Mr. Speaker tells us about the long and short wave radio apparatus carried on the famous Boeing System airplanes, which is probably the most comprehensive in the world, having over 3,000 miles of radio equipped airways.

How SHORT and LONG WAVES Link Planes With Ground

By ROBERT SPEAKER

PREVIOUS to the introduction of aircraft radio communication to the operation of the commercial air transport lines in this nation, there existed a pressing need for adequate communication between planes in flight and the ground personnel. This was required for keeping the planes on course when flying above or in fog; for landing safely after having reached the terminal airport in unfavorable weather; for transmitting weather information to the pilots in flight; for receiving information from the pilots in flight.

The solution to the first mentioned need was evolved with the development of the now-familiar Department of Commerce radio beacon, the "equi-signal" broadcast warning pilots of any deviation from the true line of flight. The



Photo above shows the latest microphone attachment to aircraft pilot's helmet. This device leaves the pilot's hands free and the "mike" can be swung up out of the way when not talking.

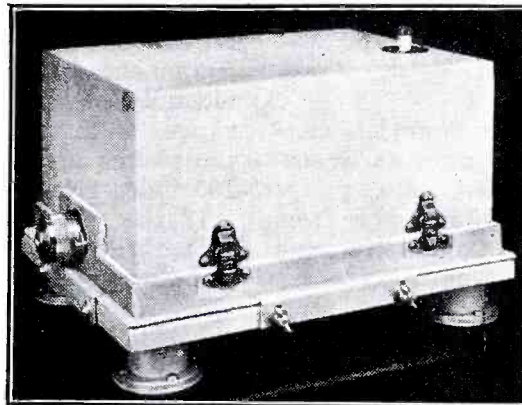
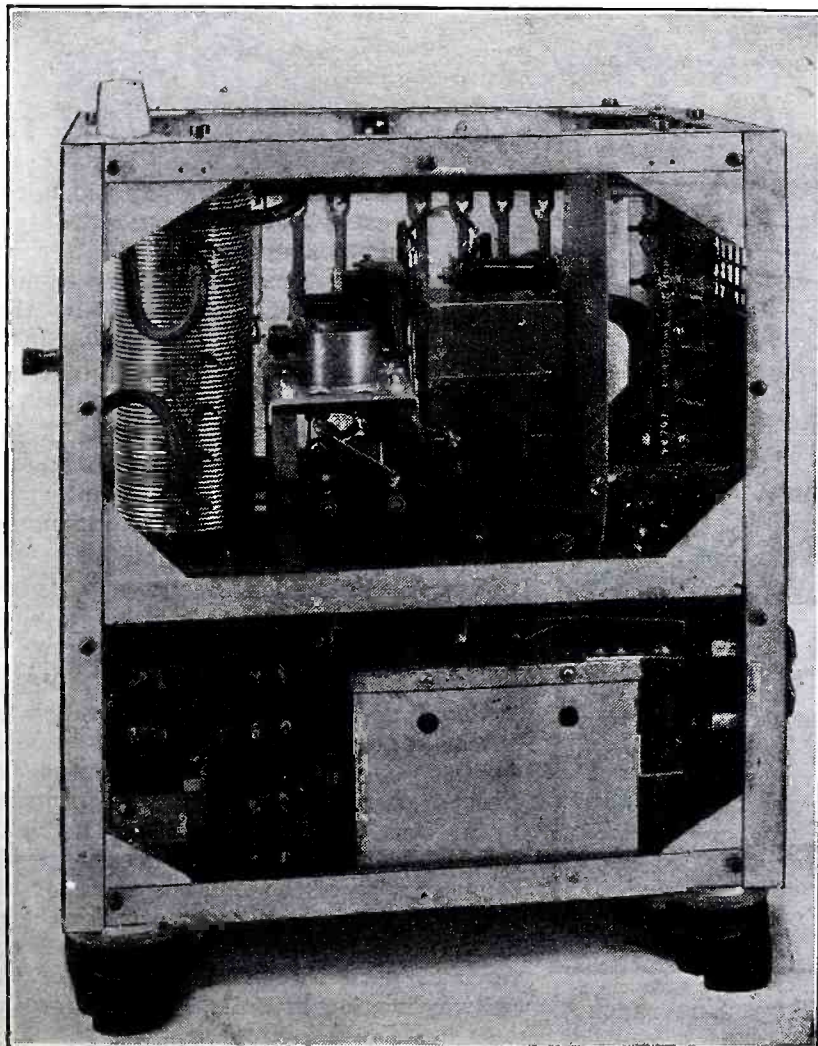

Photo at left shows Western Electric aircraft radio receiver; the long and short wave sets are both shielded.



Left: Note the compact and wonderfully engineered W. E. Co. radio transmitter, of the type used on the Boeing system's radiophone airplane installations. The 8 foot dural antenna fits in the post on top of the set.

ing June, 1930, a complete radiophone installation was placed in operation on the Chicago-San Francisco and Seattle-San Diego airways of Boeing System, with twenty-two ground transmitting and receiving stations in nine states, opening communication with the fifty-odd mail and mail-passenger planes of the company flying over the airways. This completion of the project marked the fruition of two years of research and experimentation on the part of the Boeing communications engineers.

Radio Plane Equipment Weighs 100 Lbs.

Radio equipment on the Boeing planes weighs approximately 100 pounds and is characterized by extreme compactness and simplicity of operation. Two receivers are required; one a high-frequency receiver to accommodate the two-way ground transmitters; and the other low-frequency, for the weather and directive beacon service.

aural beacon is now in use on major airways; but a more recent development is the visual beacon, utilizing the vibrating reed or small light signals.

With the development of the two-way radio telephony for aircraft communication, it now becomes apparent that the other needs have been satisfied. Dur-

The volume is controlled by the pilot, the remote-control units being placed just above the throttle; the two volume controls are at the right side and the two tuning controls at the left. After the equipment has been placed in the standby position, the pilot merely presses a button on his stick and talks into the microphone; and he removes his finger from the button to listen.

The extent to which the simplicity of operation has been pushed is illustrated in the model of the radio helmet. The microphone is attached to the pilot's helmet so that it is constantly in front of his lips; leaving his hands free for the manipulation of the plane's controls.

Power Supply

The power supply for the transmitter and receivers was given considerable effort, and was finally established in the form of two dynamotors, one for the transmitter and the other for the receivers, deriving their power from the storage battery in the plane. The transmitting dynamotor delivers 1,050 volts, and the receiving dynamotor only 200 volts.

The two dynamotors are mounted on a frame which can be removed from the plane and replaced in two minutes' time. All of the equipment which has any possibility of failing in service is similarly arranged for ready removal and replacement.

The mast type of antenna is employed on the Boeing planes; being used in preference to the trailing wire type; because of the latter's wind resistance and also the danger involved when flying at low altitudes.

The transmitter on the ground is electrically similar to the aircraft transmitter, with the addition of a power amplifier which boosts the power from 50 to 400 watts. The transmitter and rectifier are housed in separate frames, but are placed on the operating table alongside of each other. The receiver is of the same type as the high-frequency receiver used on the planes. During the daytime, transmission is on a frequency

Photo at right shows under - side of W. E. Co. receiving set of the type used on the Boeing system's airplanes. Note the heavy shielding which permits concentrating the individual apparatus.

of 5,600 kilocycles (53.54 meters); while during the night a frequency of 3,142 kilocycles (95.48 meters) is used.

Land Stations Every 200 Miles

The stations, located at two-hundred-mile intervals along the two airways operated by Boeing Systems, have an effective range of that distance. The equipment in the planes is effective at altitudes as high as 14,000 feet, and at ranges as distant as 200 miles; although the planes are never more distant than 100 miles from a ground station.

If the pilot reports anything wrong with the radio apparatus, it is removed and thoroughly tested until the cause of the failure is found. Before the ship is allowed to be released for duty over the Boeing lines, the radio mechanic gives the entire equipment in the plane a careful test; in addition, he tests the condi-

tion of the battery and generator. All of the readings he marks down on a form provided for that purpose, and this record is submitted to the radio man in charge. If the readings vary from the allowable limits, it is then his duty to determine the trouble and remedy it.

If a plane lands at an intermediate field with something wrong with the radio equipment, the operator in charge replaces the entire radio set with a tested reserve set and dispatches the plane. The disabled apparatus is then trans-

(Continued on page 414)

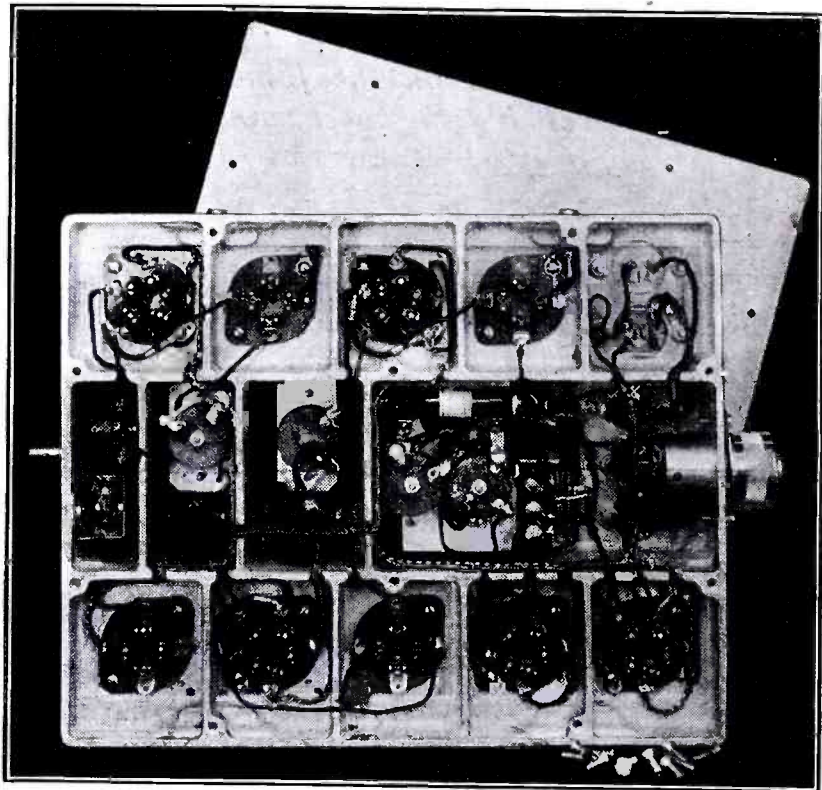

Away down in the Argentine — the short waves come rolling in

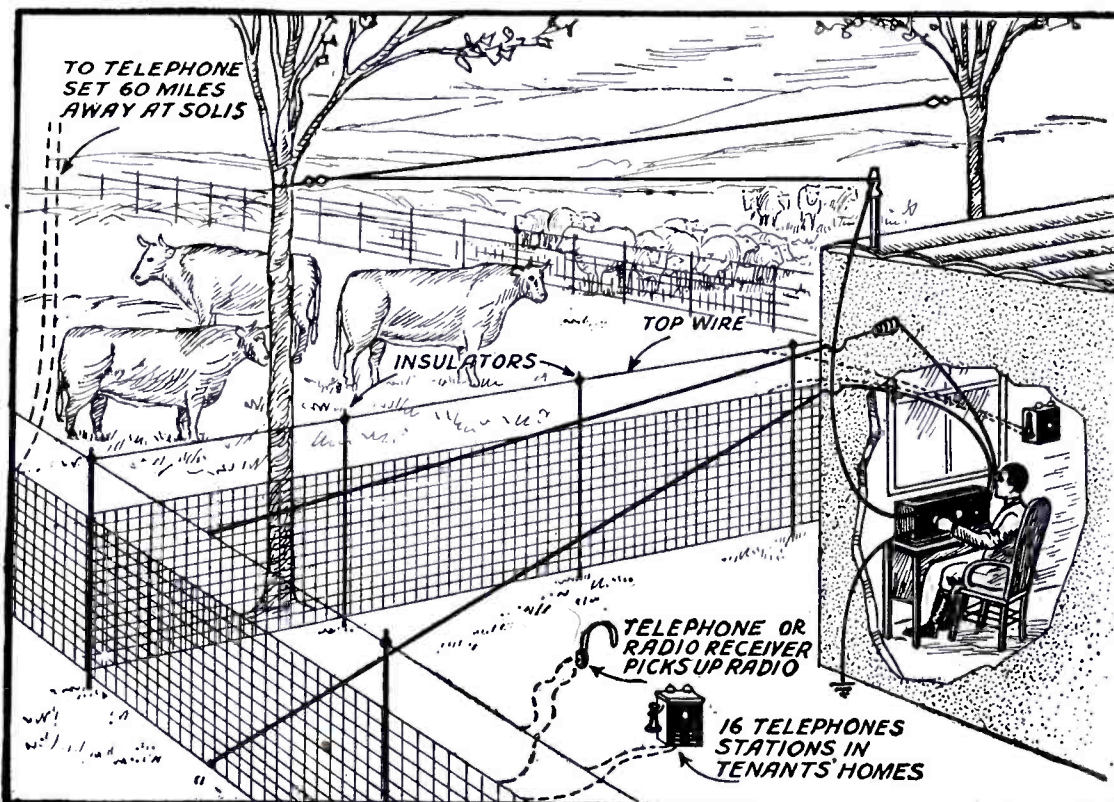

Short Waves brings the world's news to Mr. Kelley on his Argentine ranch, and the news is spread to his neighbors.

AWAY down in the Argentine, on a cattle ranch, sixty miles from the nearest city, Walter L. Kelley, native American, is even more closely in touch with world affairs than many city dwellers in the United States, with recent editions of the daily paper at call at almost any hour of the day.

The answer is radio. Walter Kelley has made radio his servant. He uses it in his business and for his entertainment, as well as the entertainment of help.

New York, London, Berlin, and Huizen are all available at the turn of a knob. He is in hourly touch with the news of the world and the markets of the world.

The Kelley estancia, which translated means ranch, is divided into fields, fields for cattle, some for sheep, others for linseed, corn, alfalfa, each field prepared in its own cycle of rotation. The fields are separated by wire fences and the topmost wire of the fence is used for the inter-communication system, which connects the house and office with all the tenants, with the hotel in front of the railway station at Solis, about sixty miles

(Continued on page 399)

Short-Wave Stations of the World

Kilo-Meters cycles
4.97-5.35 60,000-56,000—Amateur Telephony and Tele-
vision.

- 5.83 51,400—W2XBC, New Brunswick, N. J.
- 7.32 41,000—W8XI, East Pittsburgh, Penna.
- 8.57 35,000—W2XCU, Ampere, N. J.
- 8.67 34,600—W2XBC, New Brunswick, N. J.
- 9.68 31,000—W8XI, Pittsburgh, Pa.
- 9.96 30,105—Golfo Aranci, Sardinia. Telephone to Rome.
- 10.51 29,190—PK313, Sourabaya, Java, Wed. and Sat., 5:50-7:50 a.m.
- 11.55 25,960—G5SW, Chelmsford, England Experimental.
- 11.67 25,700—W2XBC, New Brunswick, N. J.
- W3XA, Philadelphia, Pa. Norden-Hauck El. Mfg. Co.
- 12.48 24,000—W6AQ, San Mateo, Calif. (Several experimental stations are authorized to operate on non-exclusive waves of a series, both above this and down to 4 meters.)
- 13.04 23,000—W2XAW, Schenectady, N. Y.
- 13.92 21,540—W8XK, Pittsburgh, Pa.
- 18.97 21,460—W2XAL, New York.
- 14.00 21,420—W2XDJ, Deal, N. J. And other experimental stations.
- 14.01 21,400—WLO, Lawrence, N. J., transatlantic phone.
- 14.06 21,320—DIV, Nauen, Germany.
- 14.15 21,130—LSN, Monte Grande, Argentina.
- W2XAO, New Brunswick, N. J.
- 14.28 21,000—OKI, Podesbrady, Czechoslovakia.
- 14.50 20,680—LSN, Monte Grande, Argentina, after 10:30 p. m. Telephony with Europe.
- FMB, Tamatave, Madagascar.
- PMB, Bandoeng, Java.
- FSR, Paris-Saigon phone.
- 14.62 20,500—W9XF, Chicago, Ill. (WENR).
- 14.89 20,140—DGW, Nauen, Germany. Tests 10 a.m.-3 p.m.
- 16.03 19,950—LSG, Monte Grande, Argentina. From 9 a.m. to 1 p.m. Telephony to Paris and Nauen (Berlin).
- DIH, Nauen, Germany.
- 15.07 19,900—Monte Grande, Argentina. 8-10 a.m.
- 15.10 19,850—WMI, Deal, N. J.
- SPU, Rio de Janeiro, Brazil.
- 15.12 19,830—FTD, St. Assise, France.
- 15.40 19,460—FZU, Tamatave, Madagascar.
- 15.45 19,400—FRO, FRE, St. Assise, France.
- 15.50 19,350—Nancy, France, 4 to 5 p.m.
- VK2ME, Sydney, Australia.
- 15.55 19,300—FTM, St. Assise, France. 10 a.m. to noon.
- 15.60 19,220—WNC, Deal, N. J.
- 15.94 18,820—PLE, Bandoeng, Java. 5:40-6:40 a.m. and from 2:40 a.m. Tues. and Fri.; 8:40-10:40 a.m. Tues. Also telephony.
- Saigon, Indo-China.
- 16.10 18,620—GBJ, Bodmin, England. Telephony with Montreal.
- 16.11 18,610—GBU, Rugby, England.
- 16.30 18,400—PCK, Kootwijk, Holland. Daily from 1 to 6:30 a.m.
- 16.35 18,350—WND, Deal Beach, N. J. Transatlantic telephony.
- 16.38 18,310—GBS, Rugby, England. Telephony with New York. General Postoffice, London.
- FZS, Saigon, Indo-China, 1 to 3 p.m. Sundays.
- 16.44 18,240—FRO, FRE, Ste. Assise, France.
- 16.50 18,170—CGA, Drummondville, Quebec, Canada. Telephony to England. Canadian Marconi Co.
- 16.52 18,150—PMC, Bandoeng, Java.
- 16.54 18,130—GBW, Rugby, England.
- 16.57 18,120—GBK, Bodmin, England.
- 16.61 18,050—KQJ, Bolinas, Calif.
- 16.70 17,950—FZU, Tamatave, Madagascar.
- 16.80 17,850—PLF, Bandoeng, Java ("Radio Malabar").
- W2XAO, New Brunswick, N. J.
- 16.82 17,830—PCV, Kootwijk, Holland. 3 to 9 a.m.
- 16.87 17,780—W8XK, Pittsburgh, Pa.
- 16.90 17,750—HSIPJ, Bangkok, Siam. 7-9:30 a.m., 1-3 p.m. Sundays.
- 17.34 17,300—W2XK, Schenectady, N. Y. Tues., Thurs., Sat. 12 to 5 p.m. General Electric Co.
- W8XL, Dayton, Ohio.
- W6XN, Oakland, Calif.
- W6AJ, Oakland, Calif.
- W7XA, Portland, Ore.
- W2XCU, Ampere, N. J.
- W9XL, Anoka, Minn., and other experimental stations.
- VE9AD, Glace Bay, N. S., Canada.
- 17.52 17,110—W00, Deal, N. J. Transatlantic phone.
- W2XDO, Ocean Gate, N. J. A. T. & T. Co.
- 18.37 16,320—VLK, Sydney, Australia. Phone to England.
- 18.40 16,300—PCL, Kootwijk, Holland. Works with Bandoeng from 7 a.m. Netherland State Telegraphs.
- WLO, Lawrence, N. J.
- 18.50 16,200—FZR, Saigon, Indo-China.
- 18.56 16,150—GBX, Rugby, England.
- 18.80 15,950—PLG, Bandoeng, Java. Afternoons.
- 19.50 15,375—F8BZ, French phone to ships.
- 19.56 15,340—W2XAD, Schenectady, N. Y. Broadcasts 1-3 p.m. relaying WGY.
- 19.60 15,300—OXY, Lyngby, Denmark, Experimental.
- 19.63 15,280—W2XE, Jamaica, N. Y.
- 19.66 15,250—W2XAL, New York, N. Y.
- W6XAL, Westminster, Calif.
- 19.72 15,210—W8XK (KDKA) Pittsburgh, Pa. Tues., Thu., Sat., Sun., 8 a.m. to noon.
- 19.83 15,120—Vatican City (Rome).
- 19.99 15,000—CM6XJ, Central Taincu, Cuba.
- LSJ, Monte Grande, Argentina.
- 20.50 14,620—WMI, Deal, N. J.
- XDA, Mexico City. 2:30-3 p.m.
- 20.70 14,480—W8XK, East Pittsburgh, Pa.
- GBW, Rugby, England.
- WNC, Deal, N. J.
- 20.80 14,420—VPD, Suva, Fiji Islands.
- 20.90 14,340—G2NM, Sonning-on-Thames, England. Sun-
days 1:30-3 p.m.
- 20.97-21.26 14,300-14,100—Amateur Telephony.
- 21.50 13,940—Bucharest, Roumania, 2-5 p.m. Wed., Sat.
- 21.59 13,800—Mombasa, East Africa.
- 22.20 13,500—Vienna, Austria.
- 22.38 13,400—WND, Deal Beach, N. J. Transatlantic telephony.
- 22.50 13,325—GFVW, S.S. "Majestic."
—GLSQ, S.S. "Olympic."

All Schedules Eastern Standard
Time: Add 5 Hours for Greenwich
Mean Time.

- Kilo-Meters cycles**
- 23.00 13,043—DBE, La Punta, Peru. Time Signals 2 p.m.
- "Radio-Moroc," Rabat, Morocco, 8-9 a.m. Tues., Thurs., Sat.
- 23.35 12,850—W2XO, Schenectady, N. Y. Antipodal program 9 p.m. Mon. to 3 a.m. Tues.; noon to 5 p.m. on Tues., Thurs. and Sat. General Electric Co.
- W6XN, Oakland, Calif.
- W2XCU, Ampere, N. J.
- W2XDO, Ocean Gate, N. J.
- W9XL, Anoka, Minn., and other experimental relay broadcasters.
- Rabat, Morocco.
- 23.86 12,630—VBS, Glace Bay, Nova Scotia, Canada.
- 23.90 12,550—GDLJ, S.S. "Homeric."
- 24.23 12,350—GBU, Rugby, England.
- 24.41 12,280—FTN, Ste. Assise (Paris) France. Works Buenos Aires, Indo-China and Java. On 9 a.m. to 1 p.m., and other hours.
- 24.46 12,250—KIXR, Manila, P. I.
- GBS, Rugby, England.
- 24.63 12,280—Airplane.
- 24.68 12,150—GBS, Rugby, England. Transatlantic phone to Deal, N. J. (New York).
- FQO, FQE, Ste. Assise, France.
- 24.80 12,090—Tokio, Japan. 5-8 a.m.
- 24.89 12,045—NAA, Arlington, Va. Time signals, 8:55-9 a.m., 9:55-10 p.m.
- 24.98 12,000—FZG, Saigon, Indo-China. Time Signals, 2-2:05 p.m.
- Oporto, Portugal.
- 25.10 11,945—KKQ, Bolinas, Calif.
- 25.24 11,880—W8XK (KDKA) Pittsburgh, Pa. Tues., Thu., Sat., Sun., noon to 5 p.m., and Sat. night Arctic programs. Television Mon. and Fri. 2:30 p.m., 60 lines, 1200 r.p.m.
- W9XF, Chicago (WENR).
- W2XAL, New York (WRNY).
- VUC, Calcutta, India. 8-10 a.m.
- 25.34 11,840—W2XE, Jamaica, New York (WABC).
- 25.36 11,820—KIXR, Manila, P. I., 5-6 p.m., 11:15 a.m.-12:15 p.m., 2-4 a.m., and (except Monday) 5-10 a.m.

(NOTE: This list is compiled from many sources, all of which are not in agreement, and which show greater or less discrepancies; in view of the fact that most schedules and many wavelengths are still in an experimental stage; that daylight time introduces confusion and that wavelengths are calculated differently in many schedules. In addition to this, one experimental station may operate on any of several wavelengths which are assigned to a group of stations in common. We shall be glad to receive later and more accurate information from broadcasters and other transmitting organizations, and from listeners who have authentic information as to calls, exact wavelengths and schedules. We cannot undertake to answer readers who inquire as to the identity of unknown stations heard, as that is a matter of guesswork; in addition to this, the harmonics of many local long-wave stations can be heard in a short-wave receiver.—EDITOR.)

- 25.42 11,800—UOR2, Vienna, Austria. Tues., 9-11 a.m.; Wed., 5-7 p.m.; Thurs., 5-7 a.m.
- W2XAL, New York.
- W9XF, Chicago.
- 25.53 11,750—G5SW, Chelmsford, England. 7:30-8:30 a.m. and 2-7 p.m. except Saturdays and Sundays.
- 25.60 11,720—CJRX, Winnipeg, Canada.
- 25.68 11,670—K10, Kahuhu, Hawaii.
- 26.00 11,530—CGA, Drummondville, Canada.
- 26.10 11,490—GBK, Bodmin, England.
- 26.20 11,440—KIXR, Manila, P. I. 11:15-12:15 p. m., 2-4 a.m., 5-10 a.m.
- 26.22 11,435—DHC, Nauen, Germany.
- 26.60 11,280—Brussels, Belgium.
- 26.70 11,230—IBDK, S.S. "Elettra," Marconi's yacht.
- 27.30 10,980—ZLW, Wellington, N. Z. Tests 3-8 a.m.
- 27.75 10,800—GBX, Rugby, England.
- 28.00 10,710—CTIBO, Lisbon, Portugal.
- Casablanca, Morocco.
- 28.20 10,630—PLR, Bandoeng, Java. Works with Holland and France weekdays from 7 a.m.; sometimes after 9:30.
- 28.44 10,540—WLO, Lawrence, N. J.
- 28.50 10,510—DRRL, Leningrad, U.S.S.R. (Russia)
- VLK, Sydney, Australia. 1-7 a.m.
- 28.80 10,410—PDK, Kootwijk, Holland.
- KEZ, Bolinas, Calif.
- 28.86 10,390—GBX, Rugby, England.
- 28.97 10,350—LSX, Buenos Aires, Argentina. Testing, 8-10 p.m. Transradio Internacional, San Martin 329, Buenos Aires.
- 29.00 10,340—Paris, France. 1:30-3 p.m. daily; 9 a.m. Sundays.
- 29.50 10,160—HS2PJ, Bangkok, Siam. Sun., Tues., Fri., 8-11 p.m.
- 29.98 10,000—CM2LA, Havana, Cuba.
- Belgrade, Yugoslavia. Monday 3-4 p.m.
- 30.15 9,940—GBU, Rugby, England.
- 30.20 9,930—W2XU, Long Island City, New York.
- Posen, Poland.
- 30.30 9,890—LSN, Buenos Aires, phone to Europe.
- 30.50 9,830—NRH, Heredia, Costa Rica. 5-6 and 10-11 p.m. Amanda Cespedes Marin, Apartado 40.
- 30.64 9,790—GBW, Rugby, England.
- 30.75 9,750—Agen, France. Tues. and Fri., 3 to 4:15 p.m.
- WNC, Deal, N. J.
- 30.90 9,700—WMI, Deal, N. J.
- 31.10 9,640—Monte Grande, Argentina, works Nauen irregularly after 10:30 p.m.
- 31.23 9,600—LGN, Bergen, Norway.
- 31.26 9,590—PCJ, Hilversum (Eindhoven) Holland. Thu. 1-3, 6-10 p.m.; Fri. 1-3, 7-12 p.m. Philips Radio.
- KIXR, Manila, P. I.

- Meters cycles**
- 31.28 9,580—W3XAU, Byberry, Pa., relays WCAU daily.
- VK2ME, Sydney, Australia.
- VPD, Suva, Fiji Islands.
- 31.35 9,570—WIXAZ, Springfield, Mass. (WBZ).
- 31.36 9,560—Königswusterhausen, Germany. 10 to 11 a.m., 11:30 a.m. to 2:30 p.m., and 3 to 7:30 or 8:30 p.m. Relays Berlin.
- NAA, Arlington, Va.
- KIXR, Manila, P. I.
- ZL2XF, Wellington, New Zealand.
- 31.48 9,530—W2XAF, Schenectady, New York. Mon., Tues., Thurs. and Sat. nights, relays WGY 5:30-11 p.m., daily. General Electric Co.
- W9XA, Denver, Colorado. Relays KOA.
- Helsingfors, Finland.
- 31.56 9,500—DZ7RL, Copenhagen, Denmark. Around 7 p.m.
- VK3ME, Melbourne, Australia.
- 31.60 9,490—DXY, Lyngby, Denmark. 1 p.m.
- 31.70 9,460—Radio Club of Buenos Aires, Argentina.
- 31.80 9,430—Posen, Poland. Tues. 1:45-4:45 p.m.; Thu. 1:30-8 p.m.
- 32.00 9,375—EH9DC, Berne, Switzerland. 3-5:30 p.m.
- DZ7MK, Copenhagen, Denmark. Irregular after 7 p.m.
- 3UZ, Melbourne, Australia.
- W8XAO, Detroit, Mich.
- 32.06 9,350—CM2MK, Havana, Cuba.
- 32.13 9,330—CGA, Drummondville, Canada.
- 32.26 9,290—Rabat, Morocco.
- 32.40 9,250—GBK, Bodmin, England.
- 32.50 9,230—FL, Paris, France (Eiffel Tower) Time signals 4:56 a.m. and 4:56 p.m.
- VK2BL, Sydney, Australia.
- 32.59 9,200—GBS, Rugby, England. Transatlantic phone.
- 32.80 9,110—SUS, Cairo, Egypt.
- 33.26 9,010—GBS, Rugby, England.
- 33.81 8,872—NPO, Cavite (Manila) Philippine Islands. Time signals 9:55-10 p.m.
- 33.98 8,810—WSBN, S.S. "Leviathan."
- 34.00 8,820—VK3UZ, Melbourne, Australia, Mo., Wed., 3-5 a.m.
- 34.10 8,780—GLSQ, S.S. "Olympic."
- GFVW, S.S. "Majestic."
- 34.50 8,690—W2XAG, Schenectady, New York.
- HKF, Bogota, Colombia.
- 34.68 8,650—W2XCU, Ampere, N. J.;—W9XL, Chicago.
- W3XE, Baltimore, Md. 12:15-1:15 p.m., 10:15-11:15 p.m.
- W2XV, Long Island City, N. Y.
- W8XAG, Dayton, Ohio.
- W6XN, Oakland.
- W4XG, Miami, Fla.
- And other experimental stations.
- 34.74 8,630—W00, Deal, N. J.
- W2XDO, Ocean Gate, N. J.
- 35.00 8,570—RB15, Khabarovsk, Siberia. 5-7:30 a.m.
- 35.70 8,400—VBS, Glace Bay, N. S., Canada.
- 35.89 8,530—WSBN, S.S. "Leviathan."
- 36.00 8,330—K3AA, Leningrad, Russia. 2-6 a.m., Mon., Tues., Thurs., Fri.
- 36.74 8,160—Mombasa, East Africa.
- 36.92 8,120—PLW, Bandoeng, Java.
- 37.02 8,100—EATH, Vienna, Austria. Mon. and Thurs. 5:30 to 7 p.m.
- J1AA, Tokyo, Japan. Tests 5-8 a.m.
- HS4PJ, Bangkok, Siam. Sunday 8-10 a.m.
- 37.36 8,030—NAA, Arlington, Va. Time signals 8:55-9 a.m., 9:55-10 p.m.
- 37.43 8,015—Airplanes.
- 37.65 7,980—VK2ME, Sydney, Australia.
- 37.80 7,930—DOA, Doberitz, Germany. I to 3 p.m. Reichspostzentramt, Berlin.
- 38.00 7,890—VPD, Suva, Fiji Islands.
- 38.30 7,830—PDV, Kootwijk, Holland, after 9 a.m.
- 38.60 7,770—FTF, Ste. Assise, France.
- PCK, Kootwijk, Holland. 9 a.m. to 7 p.m.
- 39.15 7,660—FTL, Ste. Assise.
- 39.40 7,600—Riobamba, Ecuador.
- 39.76 7,550—S.S. "Bremen."
- HKF, Bogota, Colombia, 5-7 p.m., 11 p.m.-1 a.m.
- 40.00 7,500—"Radio-Touraine," France.
- 40.20 7,460—YR, Lyons, France. Daily except Sun., 10:30 to 1:30 a.m.
- 40.50 7,410—Eberswalde, Germany. Mo., Thu. 1-2 p.m.
- J1AA, Tokio, Japan (Testing).
- 41.00 7,310—Paris, France ("Radio Vitus") Tests.
- Moscow, USSR, 7-7:45 a.m.
- 41.46 7,230—DOA, Doberitz, Germany.
- 41.50 7,220—HB9D, Zurich, Switzerland. 1st and 3rd Sundays at 7 a.m., 2 p.m.
- 41.70 7,190—EAR58, Canary Islands (Spain). Testing 5:30 p.m.
- 42.12 7,120—OZ7RL, Copenhagen, Denmark. Irregular. Around 7 p.m.
- 42.50 7,060—Liakov Islands (north of Siberia).
- 42.70 7,020—EAR125, Madrid, Spain. 6-7 p.m.
- 42.80 7,000—F8KR, Constantin, Algeria.
- 43.00 6,980—EAR 110, Madrid, Spain. Tues. and Sat., 5:30 to 7 p.m., Fri. 7 to 8 p.m.
- CT1AA, Santos, Portugal, Friday, 4-5 p.m.
- 43.50 6,900—IMA, Rome, Italy, Sun., noon to 2:30 p.m.
- 43.60 6,875—F8MC, Casablanca, Morocco. Sun., Tues., Wed., Sat.
- D4AFF, Coethen, Germany, Sundays 4-6 a.m.; Tuesdays, Fridays, noon-2 p.m.; Thursdays 4-6 p.m.
- 43.70 6,860—KEL, Bolinas, Calif.
- 43.84 6,840—VRY, Georgetown, British Guiana. Wed. 7:15-9:15 p.m.; Sun. 5:45-8 p.m.
- 44.40 6,753—WND, Deal, N. J.
- 45.00 6,600—Berlin, Germany.
- 46.05 6,515—W00, Deal, N. J.
- W4XG, Miami, Fla.
- 46.70 6,425—W2XCU, Ampere, N. J.;—W9XL, Anoka, Minn.; and others.
- 47.00 6,380—CT3AG, Funchal, Madeira Island. Sat. 5-7 p.m.
- HC1BR, Quito, Ecuador, 8-11 p.m.
- 47.35 6,335—W10XZ, Airplane Television.
- VE9AP, Drummondville, Canada.
- Casablanca, Morocco.
- 48.00 6,250—"Radio-Moroc," Rabat, Morocco
- MTH, Rio de Janeiro, Brazil.
- 48.30 6,205—HKC, Bogota, Colombia. 9:45-11:30 p.m.
- 48.62 6,170—HRB, Tegucigalpa, Honduras. 2-12 p.m., Mon., Wed., Fri., Sat. Int. S. W. Club program. Sat. 11:30-12 p.m.

(Continued on page 414)

A LOW-POWER PHONE Transmitter for the Beginner

By R. WM. TANNER,
W8AD

A RADIOPHONE transmitter for the beginner must, necessarily, be simple in construction and economical in cost. However, in order to transmit a good quality of speech with a minimum of interference to others, a master-oscillator power-amplifier circuit, modulated by some system capable of 100 per cent. variation of the carrier, is almost a requirement. Economy in cost means low power; therefore the constant current system of modulation is recommended. This will require at least four tubes and, preferably, five. Many might look upon such a radiophone as being quite complicated but this is not the case. Anyone who can construct a successful four- to five-tube broadcast receiver will have no trouble in building and operating a five-tube radio telephone.

Master Oscillator and Power Amplifier Used

In Fig. 1 will be seen the circuit of a very efficient five-tube, master-oscillator,

No special skill or expensive apparatus is required to build and operate this elementary phone transmitter. It uses five ordinary tubes and is no more trouble to construct than a 5-tube receiver. Power output 14 watts: Tested Range 100 to 300 miles.

tion peaks may be expected. The writer advises all beginners to start their amateur career in the 150-to-175 meter band; therefore this outfit is designed for these waves.

to the grids of the neutralized, push-pull power stage, using two '71A's operated as a type-C amplifier. The modulator consists of a single '45, operated at a higher plate voltage than the power amplifier, in accordance with modern 100 per cent. modulation methods. The speech amplifier employs a '26 tube, which steps up the weak microphone currents to a value sufficient to swing the grid of the modulator to full output.

Data on Oscillator Coils

The oscillator grid and plate coils L3 and L2 are wound on 2-inch bakelite tubes, 3 inches long. Each consists of 20 turns of No. 18 S. or D. C. C. wire, slightly spaced. The plate coil L2 is tapped in the exact center, for connection to "B+." Both L2 and L3 are tuned by .0005-mf. variable condensers of the receiving type. The grid condenser C7 has a capacity of .00025-mf. and is shunted by a 10,000-ohm grid leak. The R. F. chokes RFC are all of the same type; each consists of 200 turns of No. 36 enamelled wire,

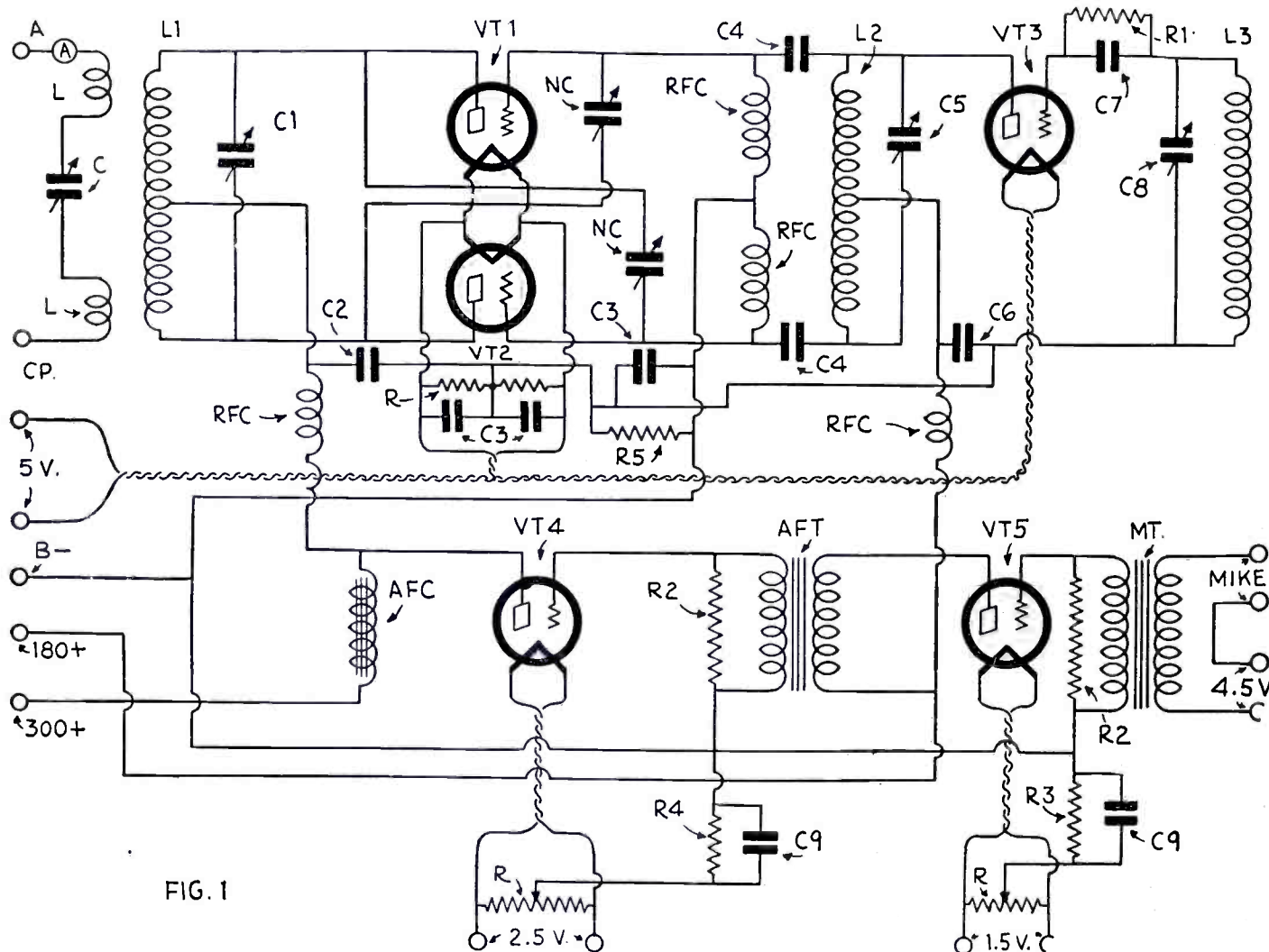

FIG. 1

Fig. 1. Mr. Tanner's simple design of low-power phone transmitter is of particular interest to all short wave beginners as it can be built at small cost and utilizes ordinary tubes like those you employ in your receiver. The speech amplifier tube VT5 is a '26; the modulator tube VT4 is a '45; the oscillator tube VT3 is a '12A, while the power amplifier tubes VT1 and VT2 are two '71A's. Instructions for tuning and the best size of aerial to use are given in the text.

power-amplifier. All of the tubes are of the receiving type, operated from an '80 rectifier, transformer and filter. A power output of 12 to 14 watts on the modula-

The oscillator employs a '12A tube in a high-C tuned-grid, tuned-plate circuit, giving a high degree of constancy in frequency. The output furnishes excitation

wound on a 3/4-inch wooden dowel, approximately 3 inches long.

The coupling condensers C4 may be anything from .0001- to .0005-mf., .00025-

being a convenient value. They must be fairly accurately matched, however, so that both '71A grids will receive the same degree of excitation.

The modulated power amplifier plate coil L1 and the pair of antenna coils L2 are wound on a 2-inch bakelite tube 10 inches long. No. 18 bell wire is advisable for these; since the turns may be close-wound, making for a better balance between the extremities of L1 and each L2. The plate coil consists of 30 turns center-tapped, and each L2 has 6 turns. Because of the low power, one-inch coupling is sufficient; but both spacings must be exactly alike, or one of the '71A tubes will furnish most of the power to the antenna. The leads on all of the coils are soldered to lugs and fastened to the forms by means of short brass machine-screws.

To eliminate the possibility of the turns becoming loosened, the writer finds it best to wind on the required turns temporarily; then removing the form and clamping one end in a vise. The kinks should be taken out by drawing the hand with a piece of rag along the wire; the loose end may then be attached to its terminal on the bakelite form. By turning the form in the hands, at the same time walking towards the vise, the wire may be wound tightly and evenly.

The tank tuning condenser in this circuit is also a receiving type, variable with a maximum capacity of .00035-mf. The antenna condenser C has a capacity of .0005-mf. An 0-to-1-ampere hot-wire or thermocouple ammeter is connected in the antenna lead to indicate resonance.

In order not to bypass any of the higher audio frequencies from the modulator unit, when speaking into the microphone, a relatively small plate bypass condenser is required for C2; this should not be greater than .00025-mf. or smaller than .0001-mf.

Neutralizing

The neutralizing condensers NC are of the midget type, with a maximum of .000025-mf. All filament resistors are 60 ohms each. In order that the antenna power shall vary as the square of the plate voltage, the grids must be operated with a negative bias twice that necessary for plate current cutoff. With a plate voltage of 180, the cutoff point is obtained with a bias of 60 volts. Fortunately, with a power supply of 300 volts, normal plate and grid voltages are possible. With the circuit arrangement of Fig. 1, the modulator is operated at a higher voltage than the output amplifier; even though no reducing resistor is in the P. A. positive high-voltage lead. This is due to the 120-volt drop, across the 6000-ohm resistor R5, which is applied to the grids of the '71A's. The bias is then automatic in case the power unit supplies slightly more than 300 volts or excitation increases.

Battery bias may be considered preferable, since a constant voltage is applied to the grids at all times; then if the excitation is removed, the plate current will fall to zero. On the other hand, with resistor bias, the plate current will rise to

an unsafe value if, for any reason, excitation is removed. By taking the proper precautions while tuning up (to be described later) no trouble should be experienced.

Modulator Choke

The plate circuit of the modulator contains an A. F. choke, with an inductance

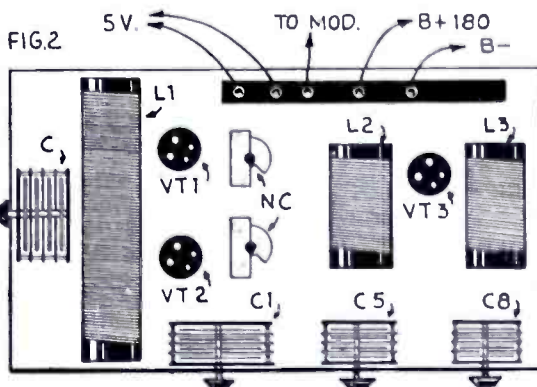

possible, procure a Western Electric or Kellogg desk-stand unit, like those used in regular telephone communication. Generally these are of the high-resistance type and are not suited for use with a microphone transformer designed for radio work. It is necessary only to purchase one of the many microphone buttons, easily obtainable from nearly any

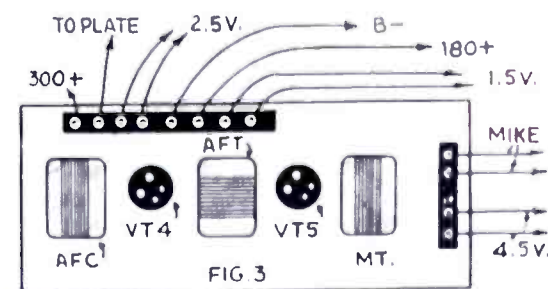

Fig. 2 (left). Layout of the R.F. phone unit and at right, Fig. 3, arrangement of the A.F. unit; MT is the modulation transformer and "mike" means to microphone.

of from 20 to 30 henries. The plate current of both the power amplifier and modulator flows through this; so it will be necessary to select a part capable of carrying the total current without too great a decrease in inductance. Although the total current is only (approximately) 60 mills., the operator would do well to purchase one rated at 85 mills., which would allow a large margin of safety.

A voltage of 250 is applied to the plate of the '45 modulator tube, with a negative bias on the grid of 50 volts; the latter being obtained from a 1600-ohm resistor R4 connected from "B-" to the center tap of the 2.5-volt filament resistor. A high-quality audio transformer, AFT, couples the '26 speech-amplifier tube to

radio or electrical supply house, and use this as a replacement for the regular one. Now the switching arrangement on the receiver arm may, with a few modifications, be used as a microphone switch. As they are, when the arm is in the "up" position, the contacts are closed. This will have to be changed so that the contacts are closed when the arm is held down. By taking the stand apart, it will be readily apparent to the constructor what modifications are needed.

In operation, the arm is held down with one of the fingers while talking. When switching over to receive, the microphone circuit is automatically opened thereby reducing the drain on the battery.

The diaphragms of these transmitter units are such that the higher range of audio frequencies are passed more easily than the lower. This may be overcome by the use at AFT of an audio transformer which has a strong rising characteristic somewhere below about 80 cycles. The audio frequencies flowing to the output power amplifier are then more nearly uniform throughout the entire range.

Power Supply

Any type of power supply which can give voltages of 300 and 180 volts at approximately 70 to 80 mills. may be employed. The taps on the voltage divider must be properly bypassed by condensers no smaller than 1-mf. In addition to the plate voltages, 5-, 2.5- and 1.5-volt supplies are needed for the filaments. If the power pack does not have the filament windings specified, a separate transformer will be required.

The complete transformer should be constructed in two units: the oscillator and modulated power amplifier in one; and the speech amplifier and modulator in the other. This allows the audio unit to be well spaced from the R. F. unit, thereby lowering the possibility of R. F. feedback to the audio amplifier. In Fig.

(Continued on page 391)

Next Issue!
—SPECIAL—
Amateur Phone Transmitter
with Special Diagrams and
Photos showing exactly how
to build it.
By
C. H. W. NASON,
*Radio Engineer and
Short Wave Expert.*

the modulator. Bias for the grid of the '26 is taken from the 1500-ohm resistor R3. All the bypass condensers C9 have a capacity of 1 mf.

The modulation transformer MT may be of any modern type now available; its secondary is shunted by a 100,000-ohm grid-leak type resistor. If good quality of transmitted speech is a requisite, do not use the old familiar Ford coils, or any of the old types of modulation transformers.

Now for just a few words in regard to the selection of the microphone. If

Ultra Short Waves

Newest Ultra Short Wave Work in Germany

By DR. FRITZ NOACK
(Berlin-Schlachtensee)

THE first experiments as to the practical application of ultra-short waves (that is waves below 10 meters in length) in Germany were, as well known, performed by Professor Esau of the University of Jena; and Prof. Esau has attained remarkable results. His experiments were, however, primarily to investigate the suitability of transmitting tubes for ultra-short-wave operation; likewise to attain increase in power and suitable modulating arrangements for telephonic operation, also proper reception arrangements. He also made some experiments as to range, but not at very great distances.

Utilizing the preliminary work of Prof. Esau, the firm of C. Lorenz, Berlin, is making a detailed study of the construction of apparatus, so that it may be serviceable in practice. Above all, experiments are being performed which are to determine the practical significance of ultra-short waves. These are

being carried out partly with Prof. Esau, and partly with the radio division of the German Aeronautical Institution (Deutsche Versuchsanstalt für Luftschiffahrt), under Prof. Fassbender. On behalf of the Lorenz Co., it is chiefly Messrs. W. Hahnemann, Gehrt, and Scheppmann, who are dealing with these problems.

Various interests are concerned in the use of ultra-short waves. Primarily these are those of aviation and the railroads, the army and navy, of course, and under certain circumstances, the telegraph organizations.

The experiments thus far have shown, first, that ultra-short waves in their propagation behave like light waves. That is, like light waves, they show only a limited radius of activity, which is bounded by the horizon at the surface of the earth. The maximum range of the ultra-short waves may be increased, if both the sender and the receiver are placed as high as possible above the surface of the earth. Let us assume that Fig. 1 represents a cross-section of the earth. *T* is the place where the transmitting antenna is located, *h* the height of the transmitter above the earth, *r* the radius of the earth, and *x* the greatest possible distance covered between the transmitter and the receiver *R*.

By simple geometry, we shall find that

the distance *x* from the transmitter *T* to its horizon *R* (supposing the earth to be uniformly curved, or "level," all the way) will be 6,467 times the square root of the height *h*, if the latter is measured in feet, above the surface of the ground. This is a rough calculation, but will do for all ordinary heights and distances. (As a matter of fact, the visibility of a light, as at sea, persists over a longer distance, because of the refraction of the atmosphere.—Editor.) For instance, here are values of *h* and *x*:

<i>h</i> in Feet	<i>x</i> in Feet	<i>h</i> in Miles	<i>x</i> in Feet	<i>x</i> in Miles
25	32,333	6	400	129,334
36	38,800	7	900	194,000
64	51,734	9	1,600	258,668
100	64,667	12	3,600	388,000
225	97,000	18	10,000	646,670

If both the transmitter and the receiver are elevated above the earth, supposing that no intervening point is high enough to come between them, the possible range will be found by taking the

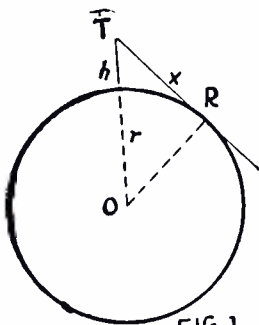

Representation of the range *X*, in the case of transmitter at height "*h*".

Curve below shows relation of range of direct radiation and transmitter height.

Fig. 3. Photo (right) shows the short wave part of the 3 meter transmitter used in the tests.

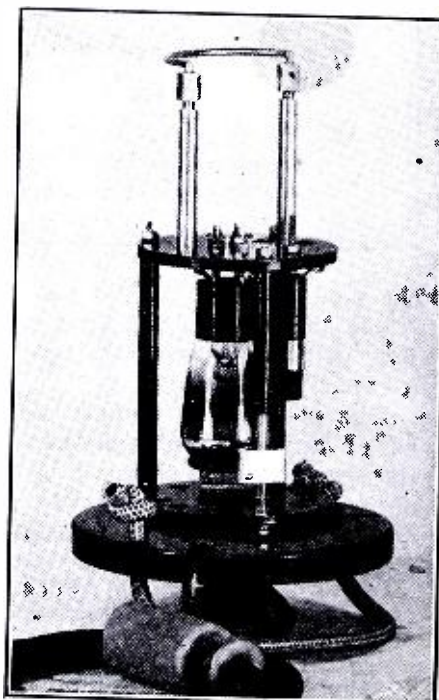
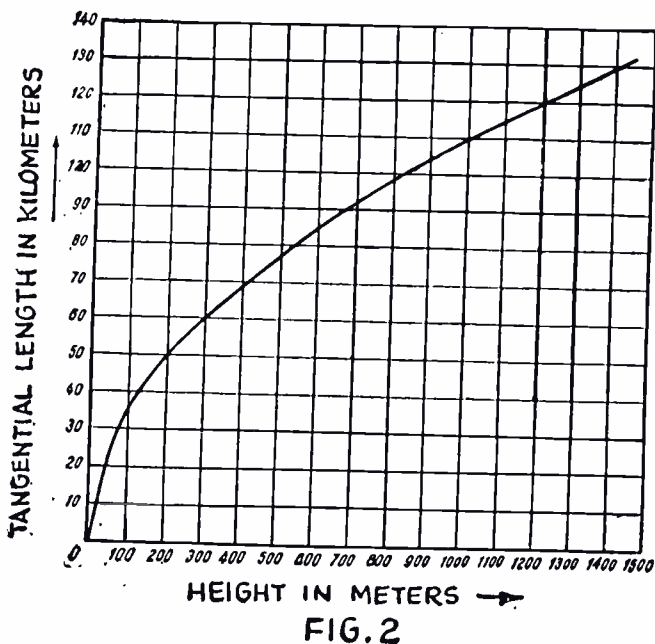
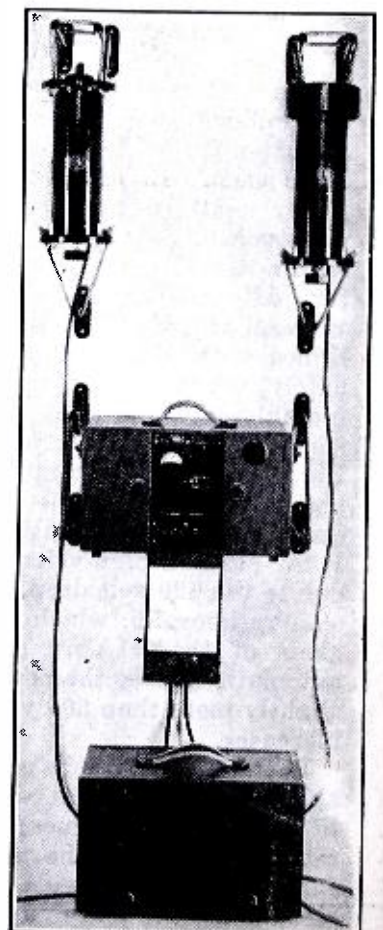

Fig. 5.— (Right) shows at left of picture, 3 meter transmitter; at right of photo, 3 meter receiver, both used for phone work. Short wave sets proper hung on springs (above); below—the amplifier and battery box.



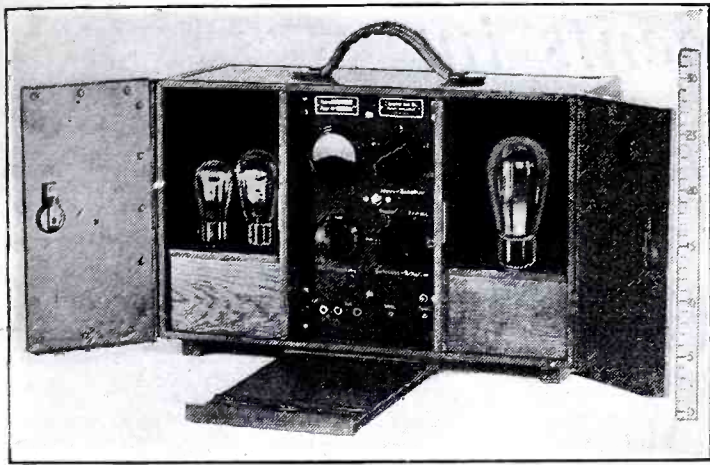
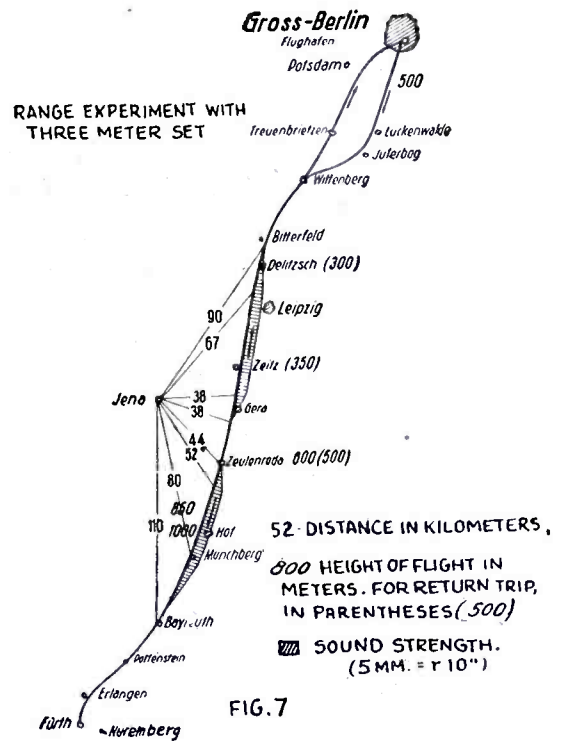

Fig. 6, Left. Low frequency part of the 3 meter set; modulation for the transmitter and amplifier for the receiver.

Fig. 7. Route of airplane's flight in ultra short wave tests.



square root of the height of each separately; adding the two results together, and multiplying the sum by 6,467, as before. A little consideration will show that the raising of both points will greatly increase the possible range of direct vision and, consequently, of direct ultra-short wave radiation.

Fig. 2 shows the dependence of the possible range on the height of the transmitter above the earth, presupposing, of course, that the power of the transmitter is sufficiently great to produce in the receiver a perceptible strength of field.

From the previous results the ultra-short waves seem to obey the Law of Inverse Squares, which applies to light. It has, furthermore, been determined that diffraction of the wave radiations is possible, as in the case of light rays. As with light, too, objects of all kinds seem to produce a shadow effect.

Tests of Reception Strength Between Airplane and Ground

To investigate whether the above assumption holds true for the propagation of ultra-short waves, experiments were undertaken in an airplane. For this there served as transmitter and receiver the sets shown in Figs. 3 to 6. The two units were enclosed in water-tight boxes, containing both the telephonic modulator of the transmitter and the amplifier of the receiver. The transmitter had an oscillating power of one or two watts; the receiver contained a super-regenerative receiver with two stages of audio-frequency amplification.

For the experiment a Junker cabin plane was used. The transmitter was fixed outside the fuselage on springs, while the receiver was right inside the cabin; the radio-frequency side of it being fastened to the window by springs. No antenna was used.

At first the experiment was so performed that only transmitting was done from the plane, the reception being arranged at a station on the ground. First the range was determined, when the plane flew at an altitude of 3,250 feet. Up to a range of twenty miles, reception strength of about R8 to 10 (old scale) was established; this decreased at greater distances, until reception completely failed at thirty-two miles. At distances up to about six miles, the reception was

(Continued on page 397)

WHY I DON'T READ "SHORT WAVE CRAFT"

A Bit of Constructive Criticism.

Editor SHORT WAVE CRAFT:

1921. Got my start in radio from a Boy Scout handbook in June. Physics textbook in Fall and learned code thoroughly during Summer.

1922. Built crystal receiver and spark set. The latter worked at once. Heard the first crystal set Nov. 22, 1921. First three-circuit Armstrong receiver in this community Summer of 1922. December—crystal set started after four months "correspondence training" from National Radio Institute.

1923. Subscribed to "Q. S. T." in March. Applied short wave transmitter principles to crystal receiver and boosted its range from 25 miles to 1,000 miles. (KFKX, Hastings, Nebraska, received regularly until aurora began cutting out DX stations.)

1927. Graduated from the Institute and worked a 1 k.w. spark set (KFCN) on the Great Lakes. Learned nothing I hadn't known for several years; a great waste of time. Returned home and built a little low power Hartley transmitter. Used it for a receiver in place of "Standard" circuit. My "knowledge" of radio dates from November, 1927.

At present I have ten single tube short wave sets. All hook-ups and different ranges of frequency. Six inches of notebooks full of data which I am unable to "understand."

Practical men never do understand what they know about radio. "Without understanding there can be no wisdom"—"With all thy getting; get Wisdom!"

I combed the libraries for texts on Radio Principle. NONE! There are exactly zero "useful" (not practical) radio texts. Arc and Spark sets are not in my line. Radio begins and ends with a study of



The $\frac{ab}{r} [2.303 \log 10] \times r^2 y = L 2 Z$ of tuned

GREETINGS

HERE is a real criticism from one of our readers and we are delighted to publish it.

We would very much like to receive comments from other readers on Mr. Clarence Gerren's criticism, for the following reasons:

This magazine is published for the Short Wave Fraternity and it is up to the readers to tell the editors what sort of material they want to read.

The editors have no preference as to the material printed and they can make it just as "theoretical" or just as "practical" as our readers wish, and as in all things, a vote by the majority will decide the future policy of this magazine.

Inasmuch as this seems to be an important subject, we trust that our readers will be prompt in writing us.

In order to keep all of the material relative to this particular controversy together, please address all letters as follows:

Editor SHORT WAVE CRAFT
"Theory vs. Practice"
98 Park Place, N. Y. C.

circuits means nothing to me. I hope it never will.

And then! Oh! Then Bert Smith wrote an article in "Q. S. T." and wotta an article it was! Honest to radio principles! It explained the difference in filter condensers and between D.C. and working voltage. I got my first taste of atomistics. And meager as the picture of atoms was, it unraveled the mystery of capacity completely.

$$C = \frac{an}{t} k$$

Area \times number of plates, divided by thickness \times quality of dielectric. Why?

Simple because A LINE of electric force is a series, a path, of normal atoms, whose outer rings are mechanically strained, with centrifugal force, against the electric attraction, from the nucleus, away from the negative plate toward the positive.

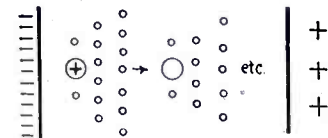

Now the formula; "a" adds to the number of such paths in parallel, more (atoms) units in which to store up energy; increasing "n," the same. K increased means that the atoms are more tightly bound together, or have more electrons to the atom and therefore more ability to hold mechanical strain.

But that little + had me guessing. One night, I hit the hay, determined to see through it before I went to sleep. In the inky blackness, I drew a mental line 3 feet long, with a pair of condensers in it, in series. Why were they just half as much as one? (in capacity,

(Continued on page 411)

Practical Experiments in ULTRA SHORT-WAVE Communication

By C. C. WHITEHEAD

Mr. Whitehead gives the interesting results of a large number of "actual experiments" with ultra-short waves. He describes a special transmitter and receiver suitable for sending and intercepting waves as short as 2.5 meters, and he also describes the method of calibrating the receiver. This is one of the most valuable articles on ultra-short waves that the editors have seen, and they feel sure that the readers will enjoy it, as the author tells just what kind of apparatus he employed in the various experiments. The transmitter input power was limited to 50 watts. These experiments were made in England by Mr. Whitehead.

As the result of the experiments to be described, the writer has formed the opinion that when the technique of their use and application has been mastered to the same extent as that of longer waves, ultra-short waves will occupy a special and extremely useful niche of their own in the field of radio-communication.

The definition of "ultra-short" waves is probably not yet standardized, but if we are to classify them according to what is so far known about their behavior in regard to propagation (the only logical method of classification, from the radio engineer's point of view), we can conveniently term waves less than 6 meters in length "ultra-short."

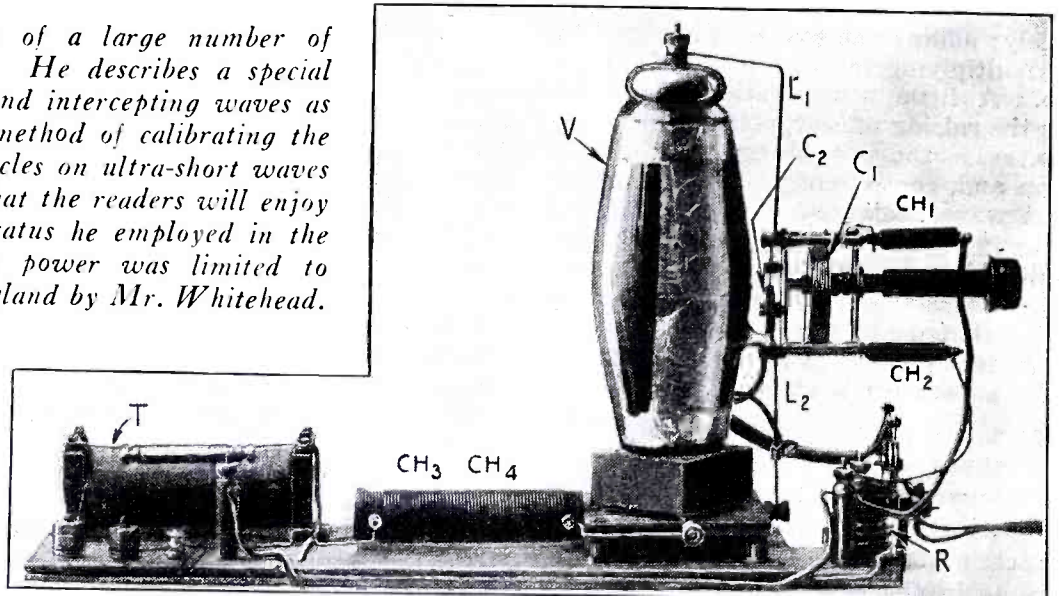
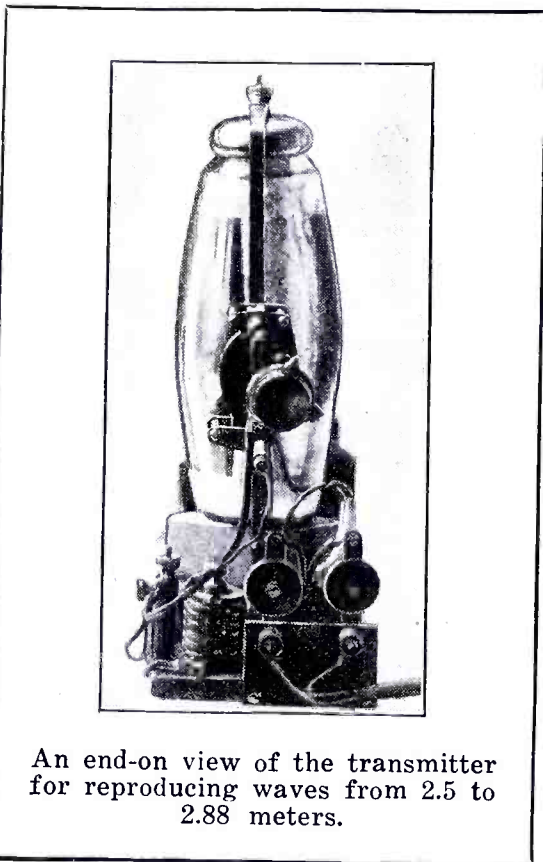

General view of transmitter for producing waves below three meters; the letters correspond to diagram fig. 4.

Under the above system of classification, the normal "short-wave" band of waves used for long-distance communication seems to have its lower wavelength limit somewhere just below 9 meters. As yet, this limit does not seem to have been accurately defined.

The present experiments were carried out upon a wavelength (or rather, a narrow band of wavelengths) well within the "ultra-short-wave" region, *i.e.*, just below 3 meters. Their object was to determine whether these waves could be used with any reasonable amount of success for communication at ground level, as in normal wireless telegraphy. (Up to the time of writing, no notable success has been attained in this direction, though communication by means of these waves has been quite successful under special conditions.) With this object in view, the first task was the design of a simple, stable, and practical outfit for the generation and reception of these waves. This is dealt with in the first two sections of the article.

The whole of the work is set out under the following headings:

Section (A). Experimental Design and Construction of Transmitter.

Section (B). Experimental Design and Construction of Receiver.

Section (C). Range Tests, and experiments upon Propagation.

Section (D). Conclusion.
Appendix.

(A). The Transmitter

The experimental design of the transmitting portion of the apparatus was undertaken first. No definite wavelength band was decided upon in advance, though it was decided to limit the input power to 50 watts, as this was judged to be sufficient for the purpose. During the actual range tests, however, less than half this amount of input power to the transmitter proved amply sufficient for the work in hand.

The first difficulty experienced was one in connection with the valves (tubes), entirely apart from the circuit arrangement used, and one, moreover, which seemed to be present to a greater or less extent in the case of every valve tried. This was the upper frequency (or lower wavelength) limit at which the valve could be made to give a reasonable output. This was not the limit set by the

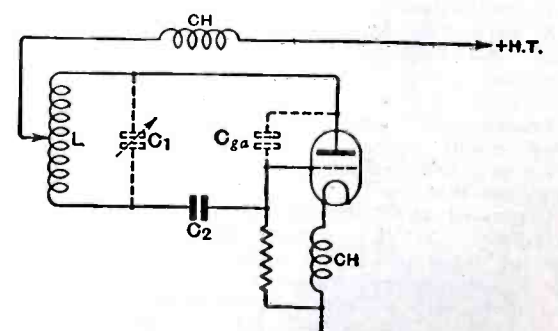

Fig. 1.—The first oscillator circuit tried by the author.

structural design of the valve. As the working frequency was increased, there came a point (long before the smallest possible circuit dimensions had been reached) where the output from the valve suddenly decreased, and fell to zero, or nearly so. This usually occurred at frequencies corresponding to wavelengths between 4 and 5 meters.

The cause of this trouble was only deduced after the remedy had been accidentally found.

If we set the oscillator frequency above this critical point, the output is zero, *i.e.*, the valve is not oscillating. Upon placing the hand, or other conductor or semi-conductor, in close contact with the outside of the valve envelope, the original value of the output (or nearly so) is restored, even though the frequency is perhaps twice the critical value.

In practice, this difficulty was overcome by covering about 60 per cent. of the surface of the valve envelope with tinfoil, pasted on with shellac or varnish, or seccotine. Nearly the whole of the surface (except for a margin of about 1/2 inch just below the anode cap), can be covered in this way, but this is not necessary or advisable, since it hinders the dissipation of heat from the valve.

It did not seem to matter what part of the envelope was covered in this way, so long as the covering was there, and in close contact with the glass.

Whatever valve was tried, this expedient invariably had the effect of raising the frequency limit at which the valve could be made to work at reasonable efficiency.

The second problem was the choice of the circuit to be used. Many well-known workers (Mesny, Esau, and Hollmann, and others) have strongly advocated the use of twin-valve circuits of the "push-pull" type. They have pointed out that the primary requisite, in ultra-short-wave work, is a circuit which is *electrically symmetrical*, and the use of a circuit of this type is a great aid in attaining this end, since, if we choose a pair of valves with (as near as possible) similar characteristics, and mechanical

~~~~~

Front view of receiver used to intercept waves below three meters; the letters correspond to diagram fig. 5.

~~~~~

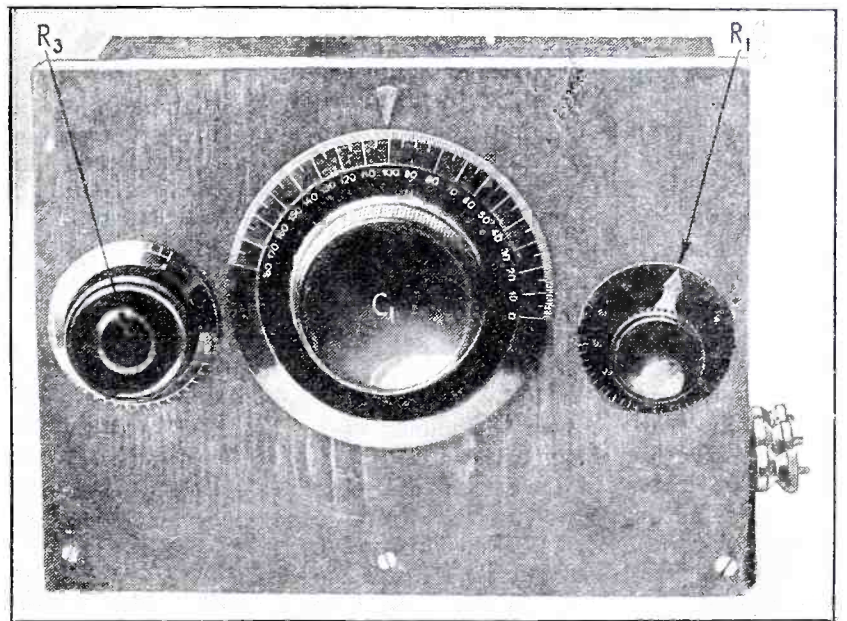

structure, arranging the associated circuit so as to be mechanically symmetrical, we automatically obtain electrical symmetry, to a close approximation.

Though this type of circuit was tried

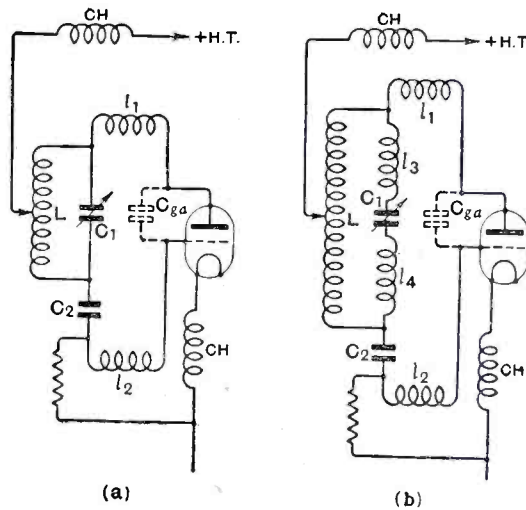

Fig. 2—Two of the oscillator circuits discussed by the author in the text but discarded for reasons mentioned in the article.

it was abandoned, finally, in favor of a single-valve circuit, of suitable design.

When we say "a single-valve circuit, of suitable design," we practically limit ourselves to one or the other of the two arrangements now to be discussed.

The first circuit tried was the popular one (at least for short waves) shown in Fig. 1. This circuit is usually satisfactory (with standard valves) when

~~~~~

Rear view of ultra-short wave receiver with a range from 2.5 to 2.88 meters; letters correspond to diagram fig. 5.

~~~~~

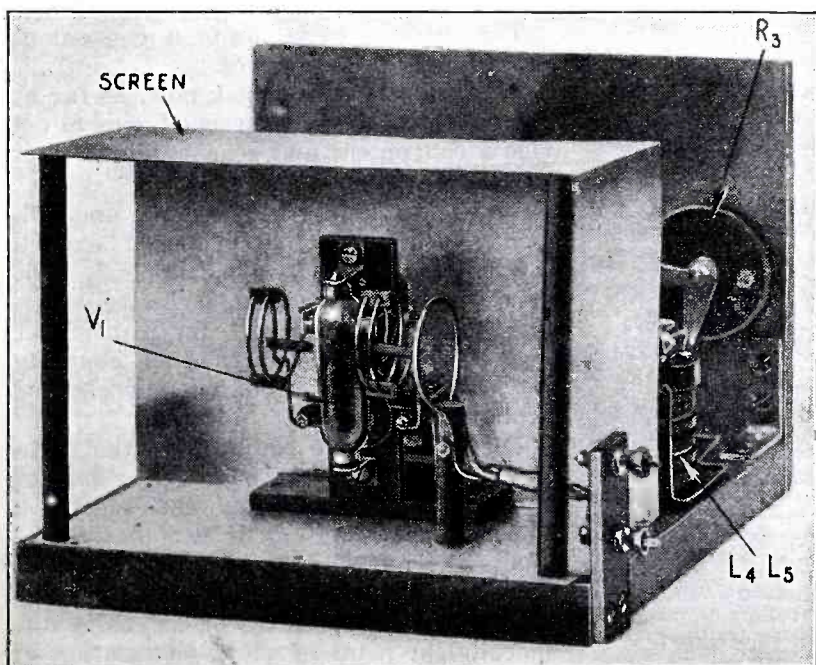

we simply wish to work on a single frequency, and if the circuit capacity consists only of the grid-anode capacity of the valve, *i.e.*, if the capacity " C_1 " in Fig. 1 is omitted. The capacity " C_2 " is not important so long as it is much larger than " C_{ga} ."

The trouble commences when we try to arrange a tuning control on our oscillator. In considering what follows, it must be borne in mind that in the normal type of valve, when used in this connection, the inductance of the internal connections to the valve electrodes forms a large part of the total inductance of the circuit when working at wavelengths of the order of those under consideration.

Thus, when we connect " C_1 " in Fig. 1, to work as a tuning control, whilst we fondly imagine that we are still using (1) the circuit shown in Fig. 1 (with " C_1 " added) we are in reality using one or the other of the circuits shown in Fig. 2 (a) or (b). Here " l_1 " and " l_2 " represent the inductances formed by the internal connections to the electrodes of the valve, and " l_3 " and " l_4 " the inductances formed by the leads used to connect " C_1 " (including the inductance of " C_1 " itself, which may be by no means negligible, at these frequencies). This arrangement leads to all sorts of troubles (including that of sudden changes of frequency as " C_1 " is varied).

The only circuit which seemed to offer immunity from these troubles was the one shown in Fig. 3, and first used in practice by Gill.*

This circuit also had another and apparently exclusive merit, namely, that it never failed to oscillate, provided only that " C_1 " exceeded a certain critical value.

The use of the grid and anode chokes is not essential to the working of the fundamental circuit, but, since " C_1 " is to be used as a tuning control, we insert the chokes so as to allow H.F. potentials to be developed across it, otherwise the shunting effect of the mutual capacity of the grid and anode current leads would render it ineffective in this direction.

A peculiar effect observed was that,

*The writer believes that this circuit has recently attained popularity in the U. S. A. under the name of the "Huxford oscillator."

though the circuit would oscillate quite readily when the grid and/or anode chokes were dispensed with, it could not be induced to work at all if the filament chokes were omitted. This was assumed to be due to an unavoidable electrical asymmetry of the circuit. This did not cause any trouble in practical working, in fact, it was later turned to good account, sufficient H.F. voltage being available at this point to excite a tiny "absorption" type wavemeter with lamp indicator attached here. (H.F.=high frequency.)

The next problem was the choice of a suitable valve to use with the circuit. A number of valves were tried and the most satisfactory type proved to be a Marconi-Osram D.E.T.1 S.W. This valve was used complete with its normal base and mounted as shown in detail in Fig. 11. For practical purposes this is essential, since we cannot go to the trouble of "decapping" a valve and building it into the apparatus every time a replacement is required.

The choice of valve proved to be a happy one, for the following reasons:

(a) Its mechanical construction is eminently suitable, the internal leads to the electrodes being very stout, and suitable for carrying the comparatively heavy H.F. currents which they are called upon to carry when the valve is used in this manner, as they form an integral part of the oscillatory circuit.

(b) An approximate mathematical investigation, taking into account all known factors, showed that the working A.C. resistance of the valve and the effective impedance of the associated circuit were in the ratio 1 : 2, which is the optimum condition.

(c) Its comparatively low A.C. re-

Rear view of receiver with vacuum tube removed; letters correspond to diagram fig. 5.

istance (3,500 ohms at $V_a=400$, $E_g=0$) enables us to obtain the output required, without the use of an inconveniently high anode voltage.

The use of pure C.W. was not deemed practicable, at least for a commencement, so arrangements were made to modulate the output. As the simple and least expensive method,

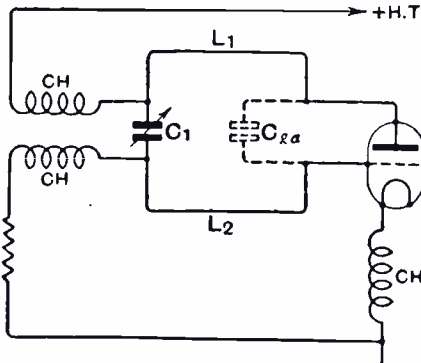
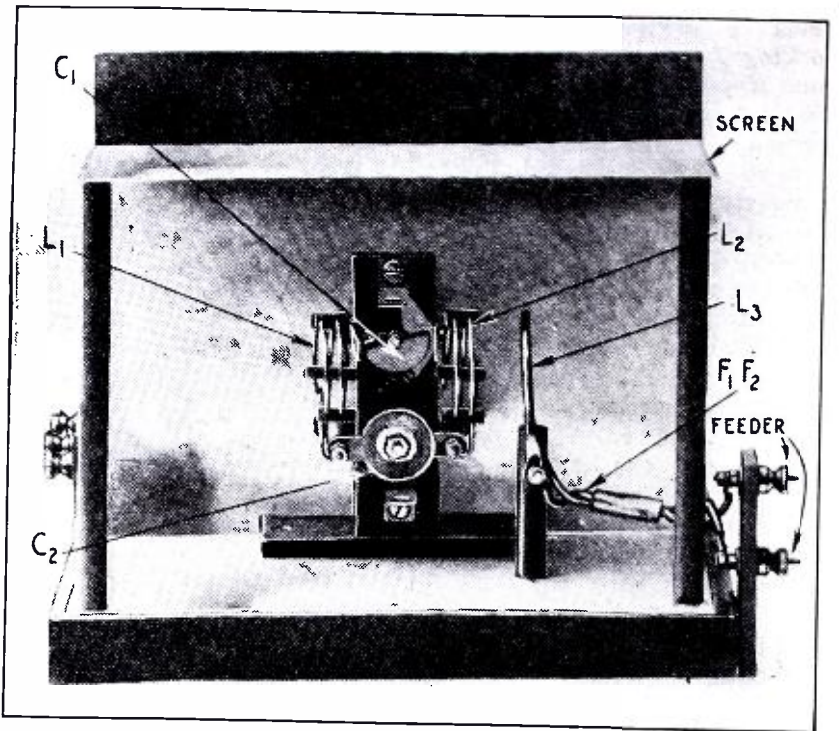

Fig. 3—This circuit never failed to oscillate.

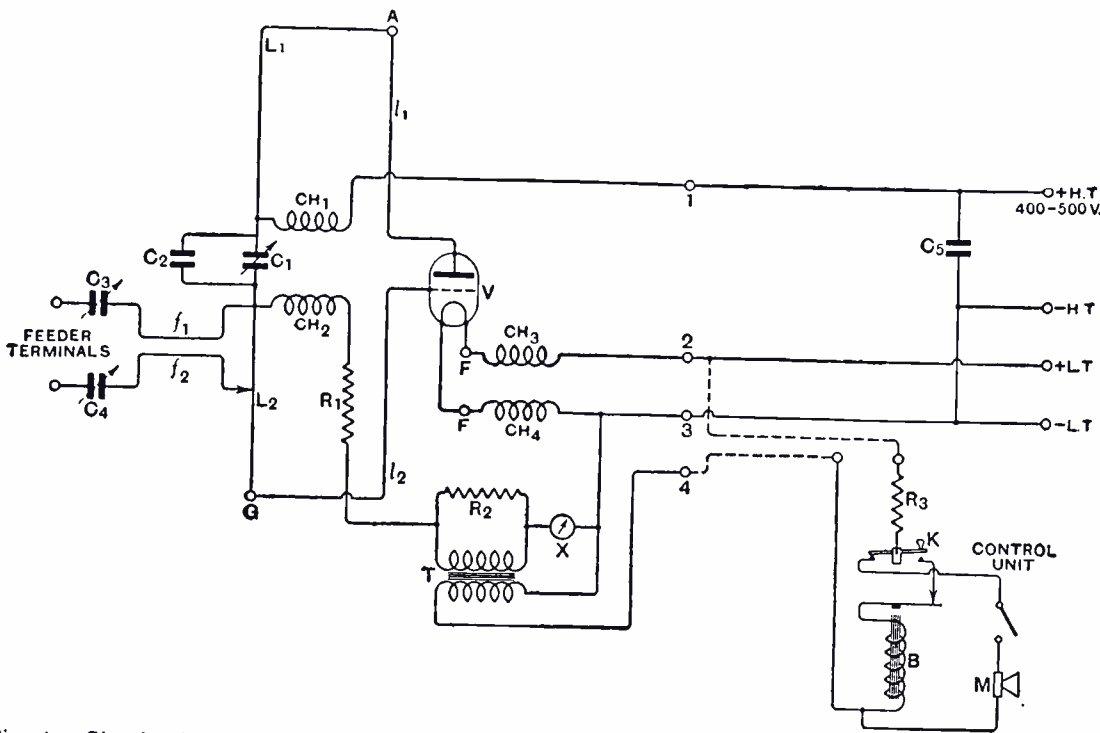

Fig. 4.—Circuit of transmitter. A, G, F, F—terminals of tube socket. V—tube, Marconi-Osram D.E.T.1 S.W. (6v. 2A.). l_1, l_2 —portion of loop-circuit formed by internal structure of tube. L_1, L_2 —plate and grid portions, respectively, of external part of inductance of loop-circuit. C_1 —tuning condenser, variable, .0001 m.f. max. C_2 —auxiliary fixed condenser, to "set up" the minimum capacity of C_1 , .00003 m. f. C_3, C_4 —feeder blocking condensers, .0001 m.f. each. C_5 —H.T. "Reservoir" condenser; actual capacity depends upon source of H.T. supply; in the apparatus herein described, using a good H.T. D.C. generator (free from bad commutator "ripple"), .3 m.f., to work at 500v. D.C. Ch_1, Ch_2 —plate and grid feed chokes, respectively. Ch_3, Ch_4 —filament chokes; actually, one choke, with bifilar winding. R_1 —grid leak, 6000 ohms, total grid leak resistance=resistance of grid leak, plus resistance of microphone transformer secondary winding (3,000 ohms=9,000 ohms. R_2 —Resistance in parallel with secondary winding of microphone transformer, 250,000 ohms (grid leak type). R_3 —20-30 ohms. T—microphone transformer. K—Morse Key. B—buzzer (Ericsson type used in present arrangement). M—microphone (carbon-granule "inset" type). f_1, f_2 —feeder coupling leads. X—grid-current meter, 0.5 mA.

grid circuit modulation was first tried and, proving very satisfactory, was retained. In the first series of tests, to be described in this article, a Morse key and buzzer were used in the primary circuit of the modulating transformer, these being replaced by a microphone, for telephony, the source of current being the D.C. E.T. supply (6v.). As it was assumed that it would be more convenient to operate the transmitter from a distance (on account of the possible effect of the presence of the operator) four leads only were brought out (1, 2, 3 and 4, Fig. 4) from the oscillator baseboard. It was found advisable to use a small fixed condenser (C_2 , Fig. 4) in parallel with the tuning capacity C_1 to "set up" the minimum to a point just above the critical value. When the circuit dimensions were finally fixed, the wavelength band covered by the apparatus was measured.

This measurement was carried out by the well-known Lecher-wire method, and the results obtained were:

Range of wavelengths: — 2.68 — 2.82 meters
 = range of frequencies: — 106.3 — 112 Megacycles
 = Tuning range of 5,700 Kilocycles.

This proved to be quite a convenient tuning range, in practice.

The sole remaining task now, as far as the transmitter was concerned, was to devise a convenient and reasonably efficient radiating system.

The most simple, convenient, and efficient aerial for the proposed experiments was the half-wave "dipole." This type of aerial was used exclusively during the experiments, both for transmitter and receiver. The method of coupling the aerial to the oscillator now claimed attention.

Direct inductive coupling to the oscillator (by proximity, Fig. 4(a) was, of course, successful from the electrical point of view, but as it was desired to change frequently the plane of polarisation of the emitted wave, this arrangement had serious drawbacks from the mechanical point of view, as rotation of

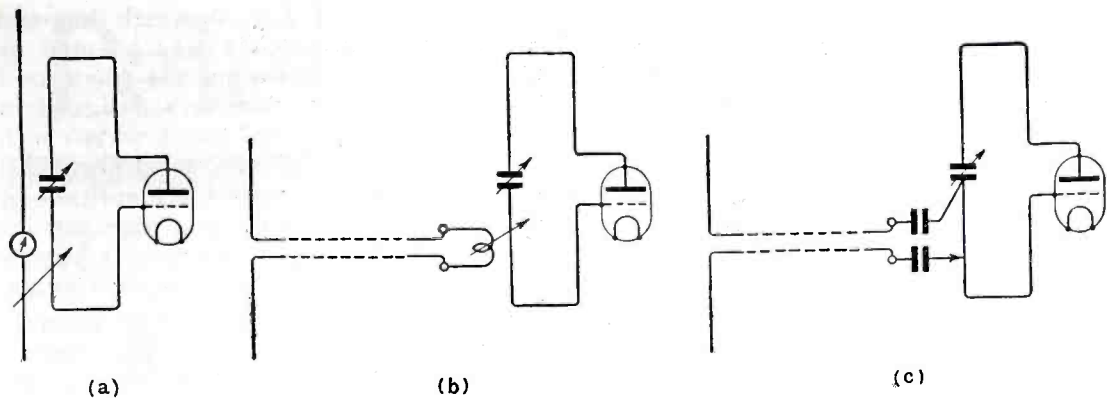

Fig. 4 (a, b, c): a—Diagram shows direct inductive coupling of oscillator and aerial; b—shows coupling of feeder by means of small coil; c—shows direct inductive coupling to the oscillator which proved very satisfactory.

the plane of polarisation would involve rotation of the whole of the oscillator and aerial assembly. Moreover, for the purpose of the range tests, it was desirable to have the aerial situated outdoors, whilst the oscillator should be under shelter and handy to the operator. This called for the use of a feeder system. The "dipole" was divided at the center and fed by a pair of Lecher wires (Fig. 4(d)). At the aerial end of the feeder this proved to be the most efficient arrangement, but a little difficulty was experienced at the input (oscillator) end. An attempt to couple the feeder by means of a small coil was not successful (Fig. 4(b)), either the coupling could not be made close enough, or the adjustment was too critical; finally, the method shown in Fig. 4(c) was used, *i.e.*, direct inductive ("auto-transformer") coupling to the oscillator inductance. This proved very satisfactory and efficient. Referring again to Fig. 4 (the complete diagram of the oscillator assembly) it will be seen that as the feeder is coupled directly to the grid circuit inductance L_2 , it is necessary to interpose the two small (adjustable) condensers C_3, C_4 in the leads to the feeder terminals, in order to isolate the feeder and aerial system from the grid modulating potential and D.C. bias (imposed during operation by the leak R_1). If adjustable, these condensers also serve to make small adjustments in the surge impedance of the feeder.

Provision was made for a "control unit," comprising Morse key, buzzer and microphone, to be situated at some distance from the oscillator. Though this precaution was adopted in the preliminary experiments, with direct antenna coupling, with the feeder system finally adopted, it proved to be unnecessary, the presence of the body of the operator in proximity to the oscillator seeming to have no noticeable effect.

The feeder finally used consisted of a length of twin twisted 7/30 "Cabtyre" flex, 3.5 meters in length. (Its "electrical length" was therefore 1.5 wavelengths.) This enabled the aerial to be placed upon a wooden pole, outside the building, whilst the oscillator was accommodated upon the work-bench, indoors.

The aerial current was first of all measured in the usual manner, by means of a thermal ammeter placed at the junction of the feeder and antenna (when

this was excited *via* the feeder). Once the satisfactory operation of the apparatus had been verified by this means, the reading of the grid-current meter (X , in Fig. 4) was noted for various values of aerial current, at the given input. Subsequently, this was used as a check upon the satisfactory operation of the transmitter.

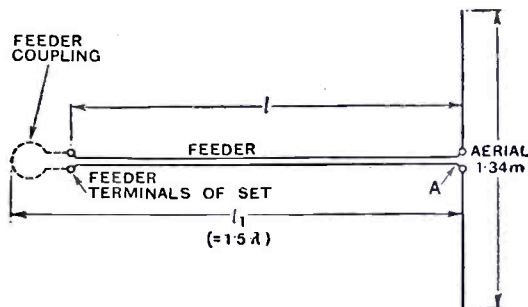

Fig. 4d, showing how "dipole" aerial was divided at the center and fed by a pair of Lecher wires.

When the transmitter is in use, the valve is oscillating continuously, and during modulation the aerial current is increased by some 15 to 20 per cent. This method of operation gives very steady and clean-cut Morse signals. The speech quality is quite good.

The working test gave the following result:

Input & 500 v. 60 ma.—30 watts.

Aerial current, aerial coupled direct (by proximity) to oscillator — .1875 A.; aerial current, aerial coupled *via* feeder to oscillator — .15A., during the "spacing" period.

Side view of ultra-short wave receiver, showing general layout of the parts lettered as in diagram fig. 5.

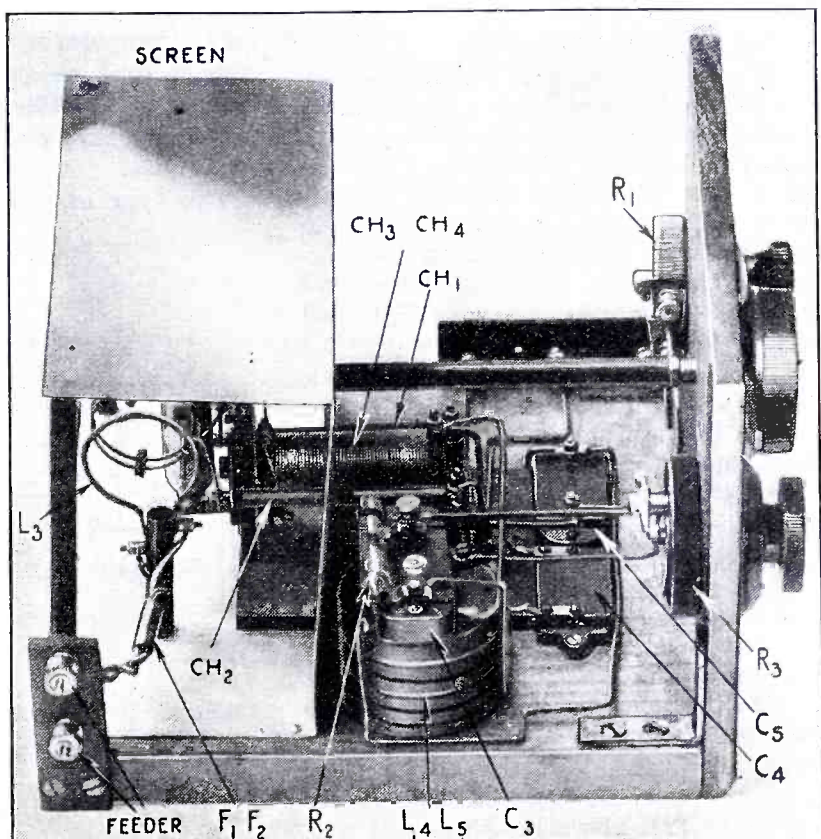

This indicates aerial powers of 3.13 and 2 watts, respectively.

The actual "power conversion efficiency" of the oscillator is about 12 per cent., which seems rather low. The chief reason for this has been pointed out by Hollmann and others, namely, that the oscillation time-period is comparable with the time of transit of the electrons constituting the "space-current." In this particular instance, the loss due to this cause is estimated at about 40 per cent. of the input energy.

The feeder loss, also, is apparently high, about 35 per cent., mainly dielectric losses.

For the purpose of checking the results given in Section D, the transmitter has recently been adapted for automatic operation, from a P.O. Wheatstone transmitter. This is discussed under that section.

(B). The Receiver

It is in the design of a suitable receiving apparatus for these very short waves that the greatest scope for technical improvement seems to exist.

Out of the region of the direct field, the attenuation of these waves is apparently so rapid that, if they are to be successfully used for communication at or near ground level, an entirely new technique in receiver design is likely to be required.

At long ranges, or under difficult conditions, the field strength at the receiver is extremely small, and variable according to local conditions. This calls, primarily, for an extremely sensitive and efficient detector, as at these frequencies pre-detector "boosting" of the received energy is, at the present stage of development, out of the question.

The only solution or partial solution of the problem at the moment is the use of "super-regeneration."

The receiver used finally, consisted then

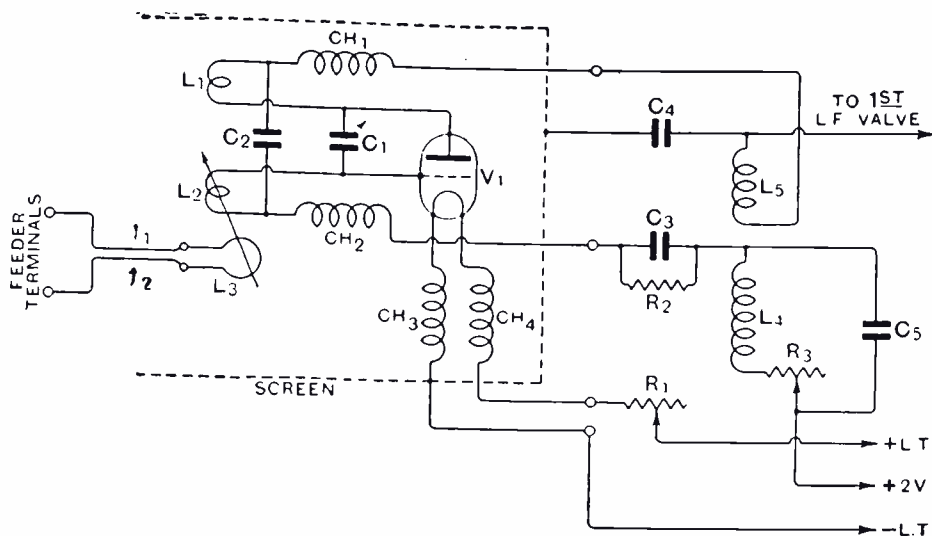

Fig. 5 — Circuit of receiver. L_1, L_2 —plate and grid portions, respectively, of circuit inductance. L_3 —feeder coupling inductance. f_1, f_2 —feeder coupling leads. CH_1, CH_2 —plate and grid chokes, respectively. CH_3, CH_4 —filament chokes (same remarks apply as to transmitter filament chokes, see constructional details.) C_1 —tuning condenser; capacity =

1.3 cm. max. (approx. 1.3 m.m.f.), see constructional details. C_2 —blocking condenser, .0001 m.f. (special grid leak, 3 megohms). C_3 —grid condenser, .001 m.f. (normal pattern). R_1 —filament rheostat, 5 ohms max. R_2 —quenching circuit reaction winding, 2,000 microhenries approx. C_4 —quenching circuit blocking condenser (fixed), .002 m.f. R_3 —quenching circuit reaction control, 400 ohms max. V_1 —detector tube Marconi-Osram V24 (or D.E.V.) (L.T., 4V.). The L.F. amplifier is not described, as this follows standard practice.

of a detector circuit, arranged for operation with or without super-regeneration, followed by a conventional two-stage A.F. amplifier.

Before commencing work upon the receiver, it was decided that a "low-capacity" (V.24) type of valve would be essential as the detector and no attempt was made to use any other type. Having found the "Gill" circuit a sure oscillator, in connection with the design of the transmitter, it was decided to use this circuit (or a modification of it) in the design of the receiver. This proved successful from the first, and the final form of the receiver (less the A.F. portion, which is not described, since it follows normal practice) is shown in Fig. 5. The signal-frequency portion of the apparatus shown in the figure is that part contained within the dotted lines representing the screen.

It is, as remarked earlier, the circuit of Fig. 3, with the following modifications:

- (1) C_1 is of fixed value.
- (2) The tuning control, in this case, consists of a small variable capacity (maximum capacity, approximately 1.5 cms.) in parallel with C_{ga} . (The use of a parallel tuning capacity is quite justified in this case, notwithstanding the remarks made in Section (A), because the valve used here has such short internal leads (about $\frac{1}{4}$ in.) that the above remarks do not apply.)
- (3) A certain amount of magnetic coupling is introduced between L_1 and L_2 . (The mutual inductance is negative in sign.)

The correct size of the Coils L_1 and L_2 was determined by practical experiment, after preliminary calculation made to determine their approximate dimensions. They were made just a trifle larger than the estimated value, and "cut down" until the tuning band of the transmitter occupied the center of the receiver tuning scale over an arc of about 60° .

C_1 was built into the valve-holder. (The reason for this construction will be obvious from (2), above.)

No attempt was made, at first, to embody a reaction control, and the writer was much surprised to discover that control of the filament-temperature performed this function most efficiently. (This was all the more surprising since anyone who has tried this method of reaction control on receivers designed for longer waves, will know how very unsatisfactory it is.) However, though other methods of reaction control were tried, the writer returned finally to this method. Its outstanding merit was, that it caused no appreciable frequency change during adjustment (with normal working limits), a disadvantage found to be present, to a large extent, with other methods. It also has the obvious merit of simplicity.

The receiver, as above described, was used in the earlier experiments with a half-wave "dipole" aerial directly coupled, as at first tried in the case of the transmitter. The ranges obtained with this arrangement, however, were very disappointing, so it was decided to couple the receiving aerial, also, by means of a "feeder," and to employ "superregeneration" to give greater sensitivity.

The type of quenching circuit shown

(that portion of Fig. 5 which has not already been described) was adopted as this had been found a success when used in connection with receivers designed to work upon the normal short wavelength band. The only difficulty when first tried was to control efficiently the amplitude of the quenching E.M.F. (R_3 was not included, at this time), as this is rather critical when dealing with weak signals.

If the quench is not strong enough, weak signals are not sufficiently amplified, and if it is too strong, the signals are "drowned" by the enormous amount of "mush" that is brought in. "Mush" is probably an inaccurate description of this noise, 90 per cent. of which undoubtedly originates within the circuit itself. For this reason the writer is of the opinion that the amount of this noise heard, when the receiver is in operation, is no criterion whatever of its sensitivity, and seems to depend to a large extent (other things being equal) upon the method of rectification used.

The quenching frequency is not critical, any frequency between 10 and 100 kc. being satisfactory. It is preferable to use a frequency well above audibility (about 30 kc.), for the following reasons:—

- (1) The quench coils, etc., can be smaller in dimensions.
- (2) Separation of quenching and audio-frequencies is easier. But chiefly:—
- (3) The use of a quenching frequency just upon the verge of audibility (8-12 kc., according to the individual human ear) has been found, in many cases, to produce a very unpleasant kind of mental strain or fatigue, when the receiver is in use for more than a few minutes at a time. (Regarding this as somewhat analogous to "eye-strain," one might term it, "ear-strain.") Whether all operators are affected in this manner the writer cannot say, but every operator of his acquaintance, who has had the experience of long "watches" on a super-regenerative receiver has observed this effect, which is very peculiar and hard to describe. One experiences a great

(Continued on page 403)

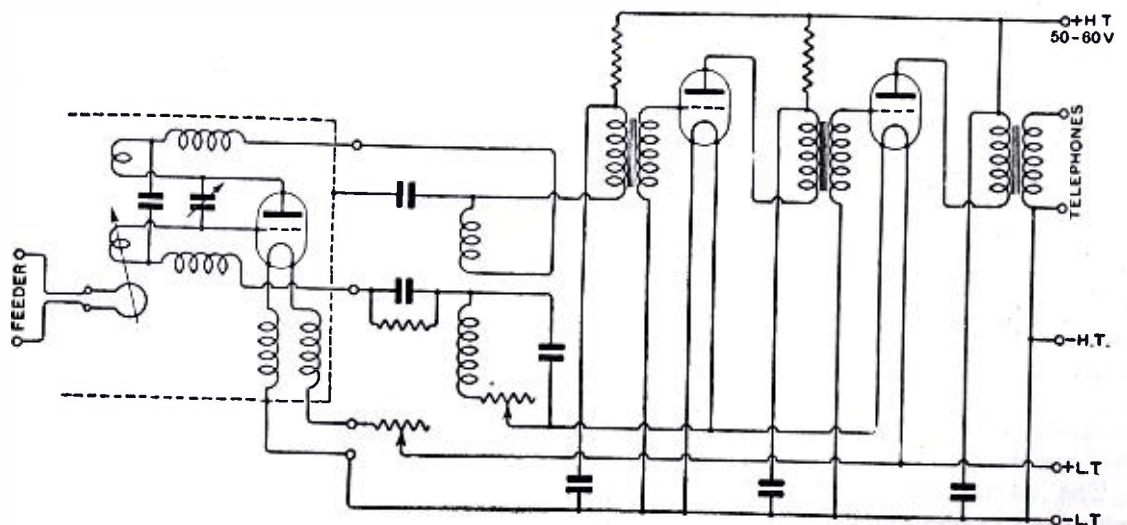

Fig. 6—Ultra short wave receiver circuit, complete with two stage, "audio frequency amplifier.

Television on Short Waves

HOW TO BUILD

A Good *Television* Receiver

By R. WILLIAM TANNER, W8AD

A short-wave receiver suitable for the perfect reception of Television image signals is not the easiest apparatus to design. Mr. Tanner, who is well-known for his research and practical achievements in short-wave work, here presents full details for building a first-class television receiver and he discusses both the radio and audio frequency amplifiers clearly and accurately. If you intend to build a television S-W receiver, don't fail to study Mr. Tanner's valuable suggestions.

THIS season has the promise of being a big one for television. Many stations are now on the air, transmitting motion-picture films and direct-pickup subjects, as well as silhouette movies in black and white. The films are not lacking in interest, but are filled with plenty of action to compensate for lack of detail. The direct-pickup subjects are of famous persons, vaudeville acts, etc., and some of them have sound accompaniment.

It will be remembered that, about two years ago, television received a great amount of publicity; its lack of progress was due to the fact that poorly-designed

reproducing equipment, and ordinary short-wave receivers, were sold to the experimentally-inclined public. At that time only silhouette movies were transmitted. Is it any wonder that television was looked upon as something yet very far away?

With the high-grade reproducing apparatus now available, there is no reason why television should not be more popular.

For some time the writer has been experimenting with television. It has been found that most of the problems lie directly in the receiver and the audio amplifier. Contrary to general opinion, the

usual form of short-wave receiver is entirely unsuitable for even fair pictures. The use of a regenerative detector results in excessive selectivity, which cuts off the sidebands and thereby the pictorial values of the picture. The audio amplifier, employed in such receivers, not only gives insufficient gain but is incapable of amplifying the required range of frequencies.

A special receiver is an absolute necessity; but there are a number of major problems involved in the design of such a receiver, to which the average experimenter assigns little or no importance.

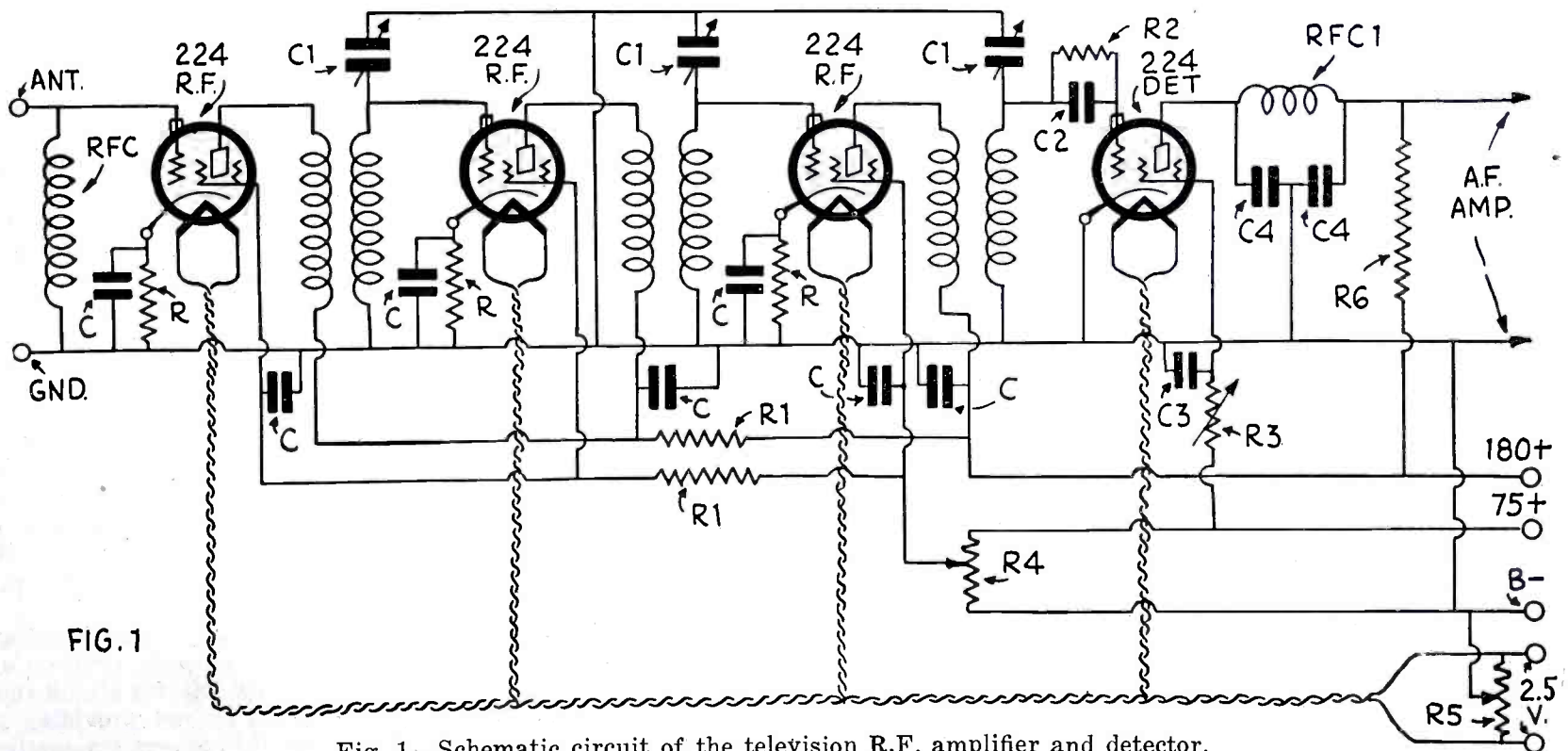

Fig. 1—Schematic circuit of the television R.F. amplifier and detector.

- | | | |
|--|--|--|
| RFC... Short-wave R.F. choke | C 4.... .00015 mf. by-pass condensers | R 4.... 0 to 50,000 ohm variable resistor |
| RFC1.. Short-wave R.F. choke | R..... 500 ohm bias resistors | R 5.... 30 ohm center-tapped filament resistor |
| C..... .006 mf. by-pass condensers | R 1.... 10,000 ohm decoupling resistors | R 6.... 250,000 ohm plate resistor |
| C 1.... .00014 mf. 3 section condenser | R 2.... 1 to 2 megohm grid leak | |
| C 2.... .00015 mf. grid condenser | R 3.... 0 to 100,000 ohm variable resistor | |
| C 3.... .1 mf. by-pass condenser | | |

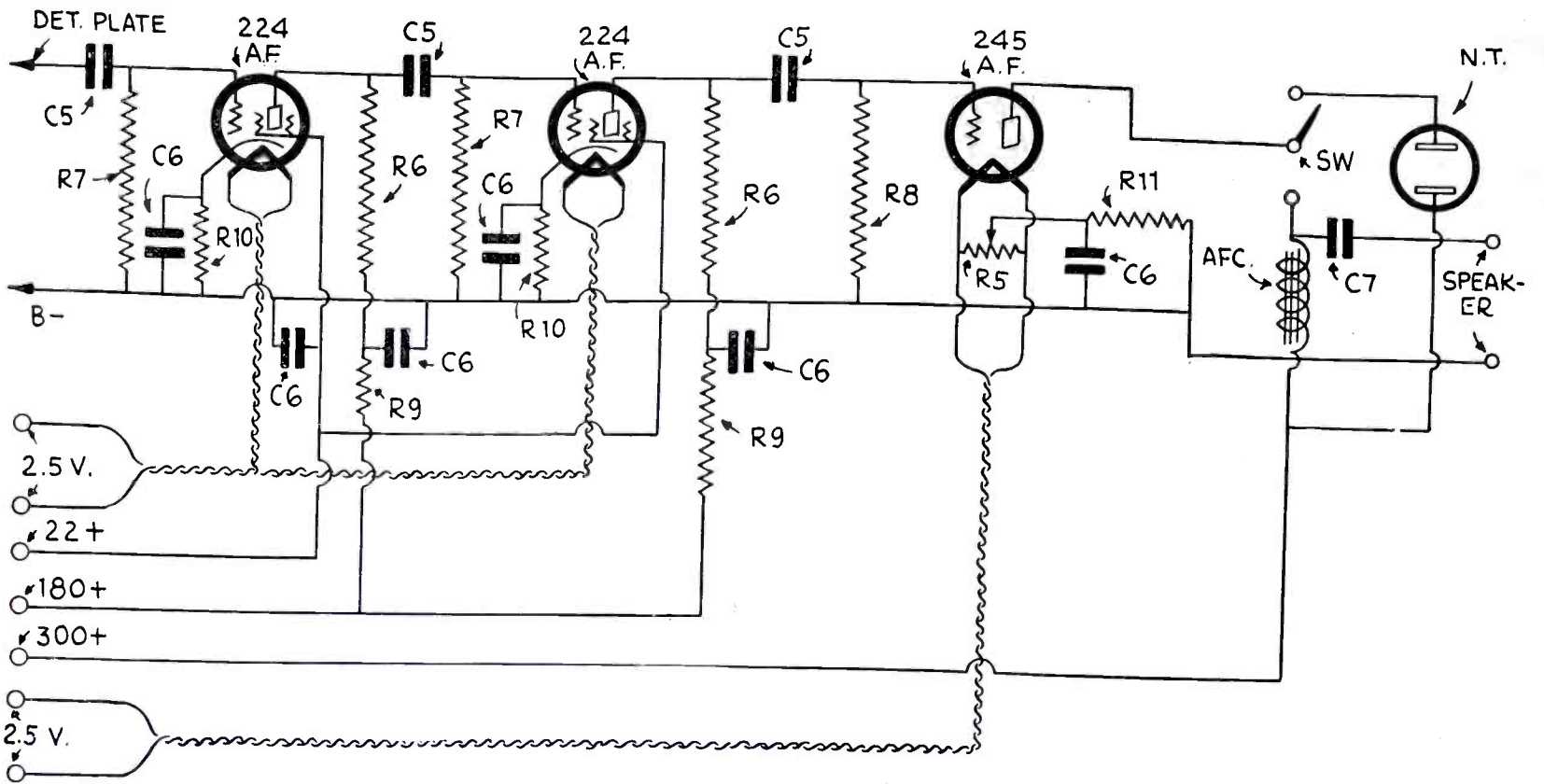

Fig. 2—Circuit of television audio amplifier with filters to prevent motor-boating, and switch to change from pictures to voice.

- R 6... 250,000 ohm plate resistors
- R 7... 500,000 ohm grid resistors
- R 8... 250,000 ohm grid resistor
- R 9... 20,000 ohm filter resistors
- R 10... 1,000 ohm bias resistors

- R 11... 16,000 ohm bias resistor
- C 5... .01 mf. audio coupling condensers
- C 6... 1 mf. 250 volt by-pass condensers

- C 7... 2 mf. 600 volt speaker condenser
- AFC... 30 Henry A.F. choke
- NT.... Television or neon tube

Requirements In a Successful Television Receiver

It is the purpose of this article to point out these problems and to offer suggestions as to their cure, as well as to give the reader constructional plans. These major problems are:

- (1) Sufficient gain, in both radio- and audio-frequency amplifiers, to provide good clear pictures at reasonable distances from the transmitting stations.
- (2) The radio-frequency amplifier must pass a band sufficiently wide to include all frequencies encountered in television. As these frequencies are from (approximately) 15 to 25,000 cycles, the tuned R.F. circuits will have to pass a band 50,000 cycles or 50 k.c. wide.
- (3) The R.F. and detector circuits must be free from regenerative effects, in order not to cut off any of the higher frequencies.
- (4) The audio amplifier must consist of the correct number of stages to provide a "positive" picture.
- (5) Motorboating or audio howling (feedback) must be entirely eliminated.
- (6) In order to obtain a picture of good visibility, the last or power audio stage will require a tube drawing a relatively high plate current. The larger the tube, the better the picture—up to certain limits.

The use of one untuned, and one tuned R.F. stage, ahead of a grid-leak type detector will generally prove quite satisfactory over a distance of a hundred miles or so; however, results might

be inconsistent. Therefore, at least two tuned stages should be included wherever possible.

An untuned or ballast stage ahead of the two tuned stages is almost a necessity when single control is employed. Construction of the R.F. transformers is then simplified, since all are wound alike; and antenna effects are entirely absent. The additional gain obtained from this stage is not great, but sensitivity is not its purpose.

Screen-grid tubes will, of course, be needed in the R.F. amplifier; as the gain per stage, below 200 meters with three-electrode tubes, is too low to be of much use.

Necessity of Proper Shielding

The use of multi-stage R.F. amplifiers on short waves brings up the question of feedback. Complete shielding of all coils, tubes, variable condensers, and leads carrying high-frequency currents is a requirement which has previously been met in a half-hearted way by designers of short-wave receivers. The writer has yet to operate a manufactured, tuned-R.F., short-wave receiver in which feedback was low enough to bring in the details of halftone television signals.

Placing the components of each stage within a separate shield box is almost as bad as no shielding at all; since feedback from the plate to the grid circuits, resulting in considerable regeneration if not oscillation, is altogether possible.

If television is to become popular with the general public, single control of the tuned circuits will be necessary. As the waveband now in use for this service (Commercial and Amateur) lies between

100 and 175 meters, plug-in coils are not needed; this greatly simplifies construction. Trimmer condensers, in parallel with the main tuning condensers, can be employed to bring the various stages into resonance; exactly as in broadcast receivers.

In order to gang two or more tuned circuits successfully, the stray capacities should be reduced to the lowest possible value and be made as nearly equal (in each circuit) as practical. In addition, the operation of the controls should not change any capacity except that of the tuning condensers. Even with a well-made ganged condenser, the percentage of difference in capacities is generally greater at the low end of the scale than at the high. Because of this, it is well not to work at too low a value of tuning capacity; therefore the trimmers may be as high as 25 mmf. (.00025-mf.). Minor variations are thus decreased in importance.

While the use of a band-pass filter is, undoubtedly, the best means of obtaining the required 50- to 60-kc. width, nevertheless plain, broadly-tuned coupled circuits will give practically as good results and offer greater ease in construction.

The mention of broadly-tuned coupling transformers brings us to the problem of regeneration. In the detector circuit this is easily eliminated by not providing a tickler, but in the R.F. stages the matter is entirely different. Even though the elements within the screen-grid tubes are shielded, it is possible that external couplings, either magnetic or capacitive, may be so great that regeneration is present. This will sometimes (unfortu-

nately, quite frequently) cause the amplifier to oscillate. Broadly-tuned transformers accentuate the already existing feedbacks. Therefore, these feedbacks must be eliminated to the highest possible degree.

All circuits (such as screen-grid, plate and cathode) should be properly bypassed. The use of "decoupling" resistors is far more effective in reducing feedback than the usual type of R.F. choke in the individual leads. If the tube sockets and transformers are separated any distance, the plate and grid leads MUST be run in metal tubing; preferably copper or brass. Although the stray capacities will be increased, that is something which cannot be helped.

Design of Suitable Image-Frequency Amplifier

A peculiar condition exists in a television audio amplifier. If a grid-leak type of detector is employed, an *odd* number of A.F. stages must be used; with a biased detector, an *even* number is needed. The reason for this is that,

employed with some success, one or two '45s will give much better pictures. One is generally sufficient for the average receiver.

Now that we have an understanding of the problems of the television receiver, together with an idea of how these are solved, let us advance to the constructional details.

Fig. 1 is the schematic circuit of a three-stage R.F. amplifier (the first stage being untuned) and a non-regenerative grid-leak detector. This makes a comparatively inexpensive arrangement and will give good results at a distance of five hundred miles or more from the transmitting station. (Note—the range of a station is much less when transmitting pictures than with music or speech.) It will be noticed that the detector also uses a screen-grid tube.

Values of Required Components

The ballast stage employs a radio-frequency choke in place of the usual resistor for coupling to the antenna. This permits greater freedom from interfer-

When R.F. transformers are enclosed within metal shield "cans," the diameter of the winding forms should be rather small, in order to reduce losses to a minimum. A diameter of 1¼ inches is a very good size. Threaded bakelite tubing of this diameter can be procured from all radio supply stores, and is sold in 2-inch lengths. These forms are threaded for 64 turns per inch and are best suited for No. 30 enamelled wire. One length will make two transformers.

Assuming that this type of form will be used, cut one in half and drill four holes in each form, along one edge, for soldering lugs. Wind the secondary with 41 turns of No. 30 wire, and solder the leads to two of the lugs. (The lugs are attached to the form by means of 8/32 machine-screws, ¼-inch long.) The primary is then wound, starting at the end near the lugs. Wind 40 turns of No. 34 S. C. C. wire in between the secondary turns, and solder the leads to the two remaining lugs. All transformers are wound alike, and all coils in the same direction.

The top lead (farthest from the lugs) of the secondary goes to the grid and the top lead of the primary goes to the plate. All three transformers must be connected into the circuit in the same manner; otherwise ganging will be impossible.

The metal tubing for the plate and grid leads should be of ¼ inch stock, and grounded to "B —." The exact length of each will depend upon the separation of the tube sockets and R. F. transformers.

Overloading of the detector and audio amplifier is prevented by the volume control R4, which has a value of 50,000 ohms. This is connected to vary the screen-grid voltage, on the R. F. tubes, from zero to 75 volts.

The variable resistor R3 in the screen-grid lead to the detector is employed to provide the highest degree of sensitivity possible. This has a maximum resistance of 100,000 ohms.

The circuit for the audio amplifier is shown in Fig. 2. Two screen-grid intermediate stages precede the power stage; all stages are resistance-coupled to pass all frequencies from 15 to 50,000 cycles. Connections for the audio filter resistors R9 are clearly shown.

A switch (SW) in the plate circuit of the '45 power stage is provided to allow either a speaker or neon tube to be used at will. The speaker filter (AFC-C7) is the usual choke-condenser combination.

It will be noticed that a voltage of 300 is specified for the plate of the '45 tube; this is not excessive since 50 volts is required for grid bias. Any type of "A and B" eliminator can be used, providing the voltage and current ratings are high enough.

Construction and Operation of the Receiver

Since equipment of this type will appeal more to the advanced radio constructor than to the beginner, only the most important constructional details will be

(Continued on page 396)

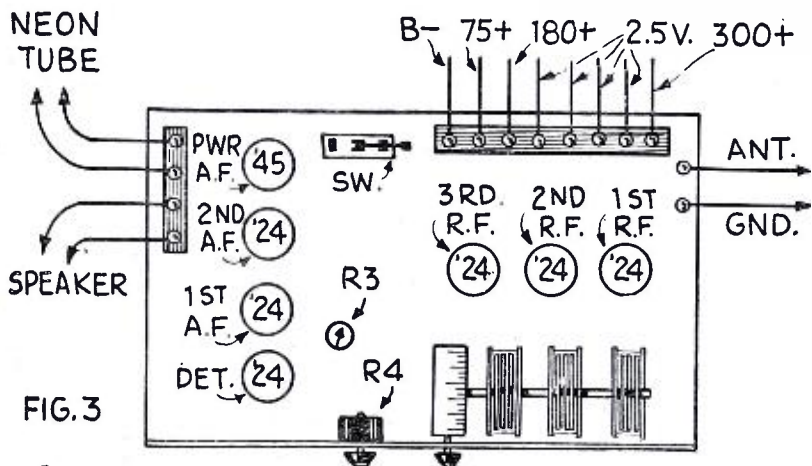

Fig. 3 — Layout of parts on a Silver-Marshall type 721 metal chassis.

when a signal is passed through a vacuum tube, it shifts in phase 180 degrees; this means a complete reversal of the picture in each stage. In grid-leak detection, rectification takes place in the grid circuit and a 180° shifting of phase occurs ahead of the audio amplifier.

Therefore, in the practical receiver, three audio stages will be needed when the detector is of the grid-leak type; and four stages for the biased detector.

Resistance coupling becomes a requirement when the wide band of frequencies is considered; but even then the lower frequencies will not be passed efficiently unless the coupling condensers are of relatively high capacity. The resistors should be of the finest quality obtainable; preferably those having pigtail connections and soldered into circuit permanently, rather than of the kind that plug into clips.

Audio feedback or motorboating is easily eliminated by the use of audio filters, connected in the "B+" leads to the detector and intermediate A.F. stages. Such filters are simple, consisting merely of fixed resistors and high-capacity bypass condensers.

To provide proper illumination of the television or neon tube, the power tube should be one drawing at least 20 milliamperes. While '71A tubes can be em-

ence by nearby stations. This antenna coupler may be a standard choke or a coil consisting of 50 turns of No. 30 wire on a bakelite form, one inch in diameter.

Bias for the R.F. amplifiers is obtained in the usual manner; by means of 500-ohm resistors (R) connected in the cathode leads. These are shunted by .006-mf. bypass condensers.

The decoupling resistors R1 have a value of 10,000 ohms each, and are connected in the 180- and 75-volt leads between the third and second R.F. stages. This method is employed in many commercial short-wave receivers, and has proven far superior to the usual R.F. chokes. The "postage-stamp" type of bypass condensers, .006-mf. capacity, will give as good results as larger ones and have the advantage of small dimensions and extremely low inductive effect.

The ganged, three-section tuning condenser C1 may be a regular .00035-mf. broadcast type with all rotor plates, except three per section, removed. A unit having extra-heavy plates and of solid construction should be selected. A three-compartment shield will be needed for this. There are a number of parts manufacturers now making three-gang .00015-mf. shielded condenser; and one of these should be given preference over a modified .00035-mf.

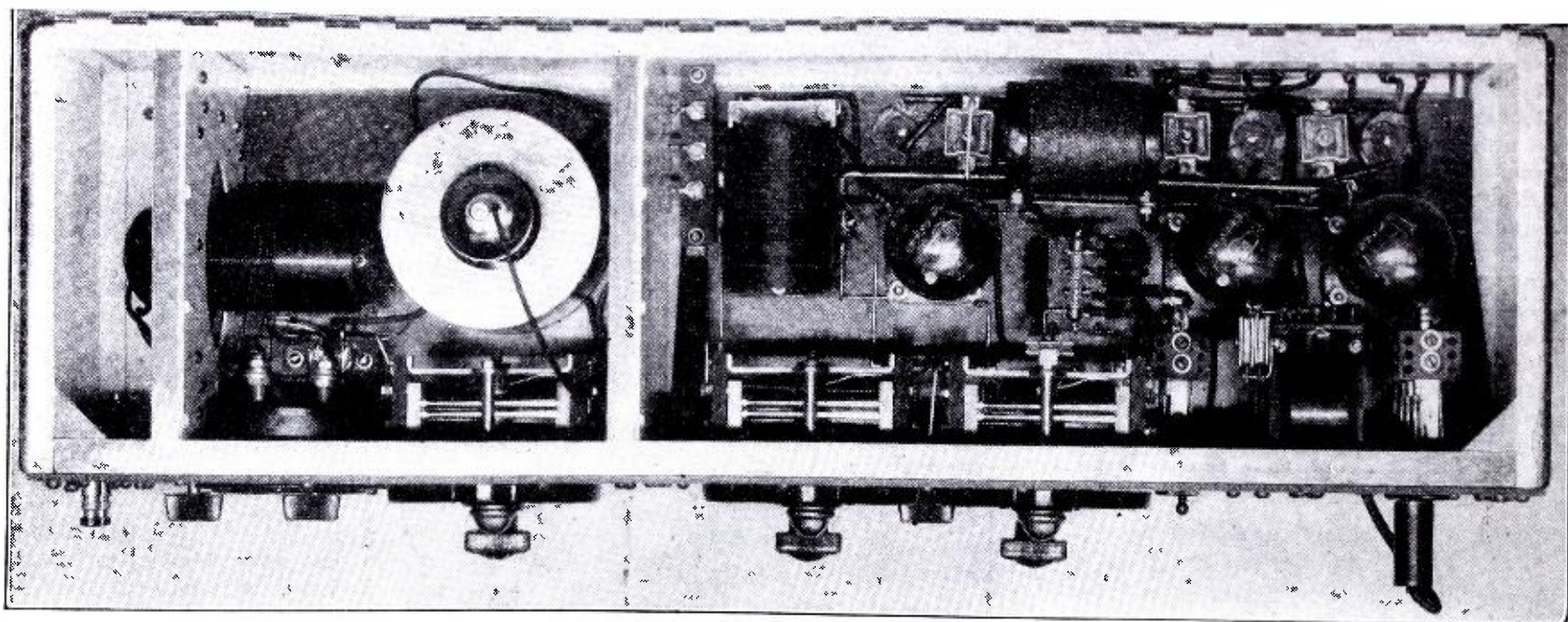

Looking into the shielded cabinet of the short-wave receiver used on the "Chelan". This receiver is a piece of standard commercial engineering; but the constructor may readily duplicate the circuit with parts available to him. While coil data are not given, any short-wave kit may be used. Note how primary of first R. F. coil (at the left) is partially shielded from the secondary. The three-connection panel strip at left of larger compartment permits leads to the screen-grid tube compartment to be rigidly shielded. R. F. chokes of the pancake variety are used.

The COAST GUARD'S BEST SHORT WAVE RECEIVER

By S. R. WINTERS

A SHORT-WAVE radio receiving set installed on the Coast Guard Cutter *Chelan* and more recently used on the U. S. S. *Utah* during a south American good-will tour demonstrated such extreme sensitivity as to equal the performance of a 6- or 7-tube outfit. Designed by the General Electric Company, this high-frequency set employs only four tubes.

Details of a New Four-Tube High-Frequency Set, With R. F. Screen-Grid Stage, Used by the Government Services

detector and two stages of transformer coupled audio-frequency amplification complete the circuit. The four-element tube is of type '22; the regenerative detector is a high-mu tube of type UX-841; and the two stages of audio-frequency amplification use type '10's. However, the type of tubes employed is a flexible factor and instead of those just outlined the high-mu tube type '40 may be used in the detector stage; and a type '01A in the audio-frequency amplification stages.

compensates for any apparent deficit in the number of tubes employed. This four-element tube is employed in the stage of tuned radio-frequency amplification and this together with a regenerative

Details of Tubes and Coils
The use of a screen-grid tube com-

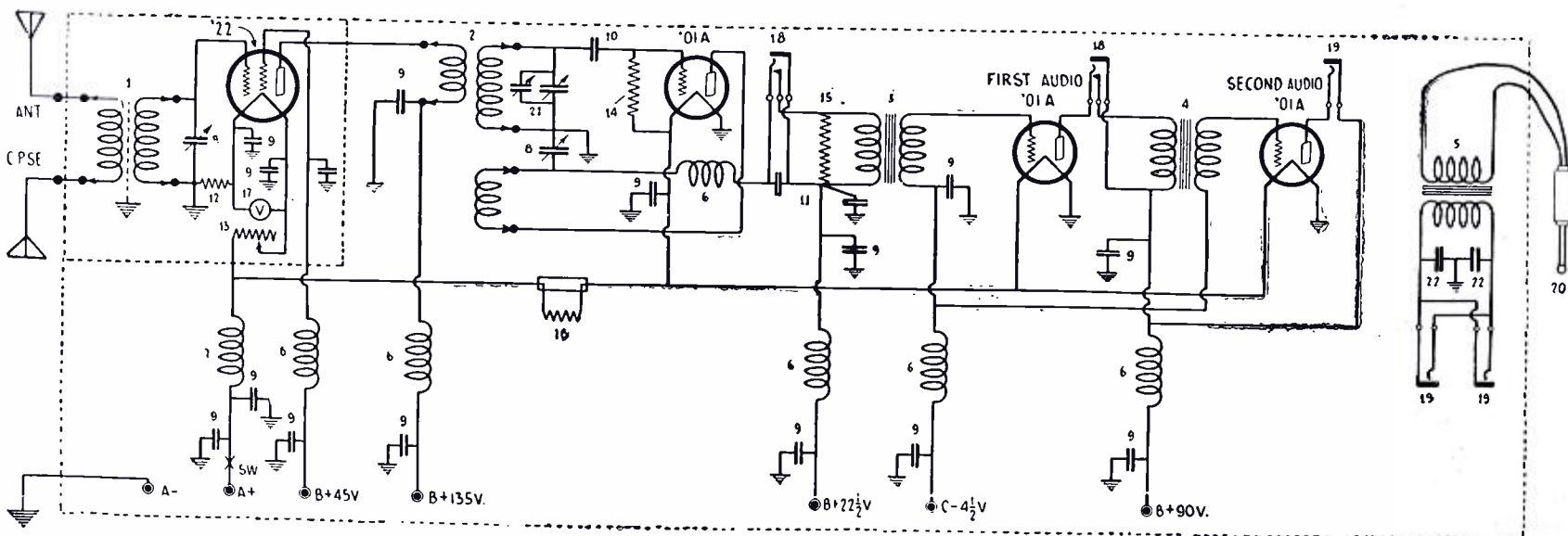

Schematic circuit of the four-tube receiver designed for the U. S. Coast Guard and the Air Service. Note the liberal use of by-pass condensers; 01-mf. capacity is used, and the filament connections are made at the tube sockets. All leads must be as short as possible; condenser ground leads less than two inches. Bias for the screen-grid tube is obtained from resistor 12; all shielding is grounded to "A-". Interesting combinations are possible with the little unit shown at the right. Units 22 are .005 mf., with center connection grounded; detector jack 18 is by-passed by .002-mf.

This ultra-sensitive short-wave receiver is designed to cover a band of wavelengths from 12 to 80 meters but this limit may be extended to 250 meters by the addition of tuning coils not ordinarily included in this particular design. As now constituted, there are four sets of interchangeable inductance coils—embracing, respectively, 12 to 18 meters, 17 to 28 meters, 26.5 to 45.5 meters, and 45 to 80 meters. Each set of tuning coils contains two units—one for insertion in the compartment devoted to the stage of tuned radio-frequency amplification and the other coil is plugged into the detector compartment. To facilitate the interchange of different coils, each set bears its wavelength range, engraved thereon. Any standard kit of coils of good design, obtainable on the market, may be used in their stead.

The tuning controls are provided with a variable ratio vernier drive, and a small vernier is found on the tuning condenser of the detector compartment for fine control of the beat note. This vernier is situated between the detector-tuning and regeneration dials on the lower part of the panel.

There are three tuning controls and in addition to these are the following knobs which are manipulated as needs justify: Input coupling, filament voltage on the type '22 tube, the filament switch, and a stage change plug and jack system. Regeneration and *wavelength* increase with dial setting.

To intercept a continuous-wave signal, regeneration is maintained near but slightly above the point of oscillation as the tuning control is manipulated. *Simultaneously, the input tuning is kept in resonance by noting the increase of background noise.* The extreme sensitive setting of regeneration represents the minimum of regeneration which will permit the detector to oscillate and a beat note to be perceived. Radio telephone signals are best tuned in by keeping regeneration in close proximity to and slightly under oscillation.

The volume of the output of the receiver may be cut down in one of three ways—increasing regeneration beyond the critical value, reducing the input coupling, or by manipulating the plug and jack system.

The Audio System

All of the battery leads in this receiver are provided with radio-frequency

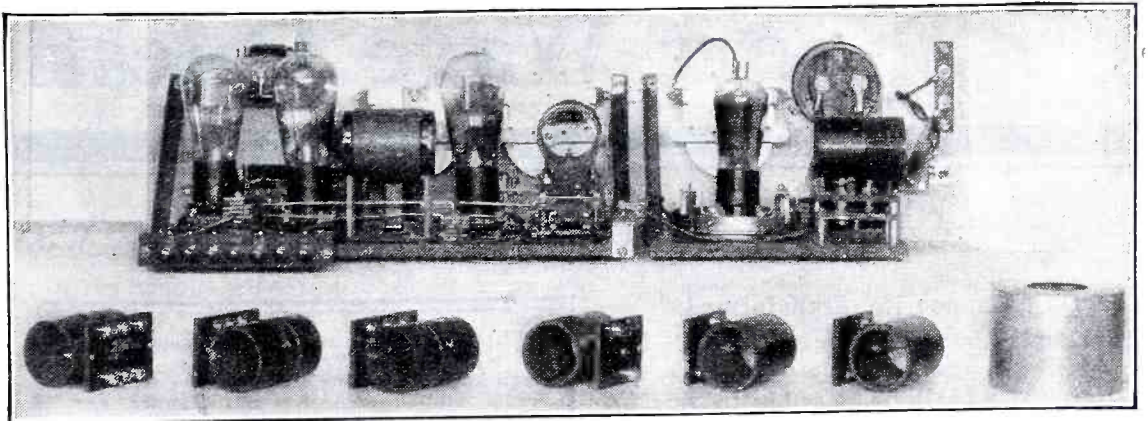

Rear view of the receiver, removed from its cabinet and shields. Two coils cover each of four bands from 12 to 80 meters; they are of the plug-in type shown in the foreground.

filters, and by the application of an audio filter-system to the amplifier two or more receivers may be operated from one battery supply. Without the audio-frequency filters, however, "cross talk" would develop when using more than one receiving set. The use of the output of this receiver is a variable factor—that is, it may be tapped for use in a number of ways. For instance, head telephones may be plugged into either the detector stage or the jacks of the first or second audio-frequency stages. Or the primary winding of the output transformer (external plug and cord) may be inserted in the detector stage, first audio-frequency or second audio-frequency jacks and the head telephones plugged into either of the two upper head-telephone jacks. The output transformer supplied with this set has a 3-to-1 step-down ratio. When employing type '10 audio tubes the output transformer is intended to work into a 1,200-ohm transmission line, and when type '01A tubes are used this output transformer functions best in a 3,000-ohm transmission line. The input to this receiver may be a doublet, a transmission line, or an aerial and ground connection.

The power plant for this ultra-sensitive 4-tube receiving outfit is quite elaborate. If type '10 vacuum tubes are employed in the set, the power requirements are: Plus "A," 8-volt storage battery; minus "C," 18 volts grid biasing; detector, plus 67½ volts; four-element tube's screen-grid, plus 45 volts; radio-frequency amplification, plus 135 volts; audio-frequency amplification, plus 250 volts. If type '01A tubes are used in

this receiver, the power requirements are as follows: Plus "A," 6-volt storage battery; minus, 4½ volts grid biasing; detector, plus 67½ volts; four-element tube screen-grid, plus 45 volts; radio-frequency amplification, plus 135 volts. In the use of either type of tubes, the minuses of the "A" and "B" batteries and the plus of the "C" battery and ground are joined together to the minus "A" binding post. The filaments of all of the tubes are connected in parallel and the failure of a tube to light is an indication that it has burned out. If the audio amplifier oscillates, it is a sign that the "B" batteries are exhausted or their energy is running low. A one- or two-microfarad condenser across the battery will temporarily correct this condition, but the "B" battery should preferably be replenished.

Used by Air Corps

When this high-frequency receiver was originally designed, it was subjected to preliminary trials in the flying radio laboratory of the Air Corps, United States Army. Captain Paul S. Edwards, the radio officer, sensed the extreme sensitivity of this circuit and indicated that it would qualify as *standard equipment* for the Air Corps aircraft short-wave receiver development. Subsequently, when the new Coast Guard Cutter *Chelan* went on its so-called "shake-down" cruise, it was noted that this receiver eclipsed the performance of standard Coast Guard radio outfits, although the former employed fewer tubes.—*Courtesy Radio-Craft.*

\$2,000 Radio Amateur Contest—Over One Hundred Prizes

HERE is positively the greatest radio amateur prize contest that has ever been held. This announcement is made so that you may join at once in the contest, which will run in SHORT WAVE CRAFT for several months and close April 10, 1931.

The prizes will be awarded for the most interesting amateur station photographs (accompanied by the best short technical descriptions of your sets and the most novel "Q.S.L." cards

—that's all. List prizes in next issue. The editors of SHORT WAVE CRAFT will be the judges.

The rules are simplicity itself. Every amateur, in the United States or any other part of the world, can enter without any formality.

Just send a GOOD photograph of your set (at least 5x7 inches), also your "Q.S.L." card, and description of your set: you MUST give following data:

Power in watts (input to last stage) of station? Wavelengths usually used? At what hours (Greenwich Civil Time) do you operate? Crystal-control? Phone?

You do not have to be a subscriber to SHORT WAVE CRAFT to compete.

Address all entries in this contest to:
Editor, Radio Amateur Prize Contest,
SHORT WAVE CRAFT Magazine,
98 Park Place, New York City.

Short Wave Question Box

Edited by R. William Tanner, W8AD

D.C. Cannot Be Transformed

Garland Crandall, Norwich, N. Y., would like to know:

Q. 1. Would it be possible to rectify the line-voltage, before applying it to the primary of a B-eliminator transformer?

A. 1. No. Only alternating currents can be stepped up or down through a transformer. The output of a rectifier is a pulsating direct current.

Dimensions of Hertzian Antenna

James E. Shannon, Sunnyside, L. I., requests the following information:

Q. 1. The dimensions of a single-wire, voltage-fed Hertz that may be used in both the 20- and 40-meter bands.

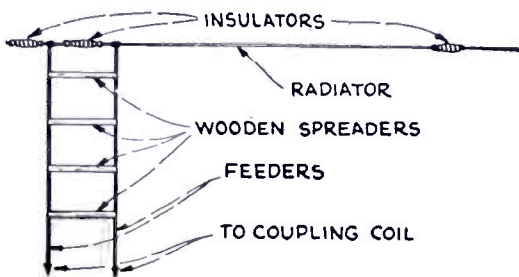

Fig. 1—Connection of feeder to single wire Hertzian Antenna.

A. 1. The radiator wire should be a single No. 14 enamelled wire, 62.5 feet long, and as high as possible. The feeder should be connected exactly 8 feet 8 inches from the center, at either side. The length of the feeder has no effect upon the radiator.

Q. 2. A circuit using two-510 tubes as class B amplifiers, two-224s as a buffer stage and two-227s as oscillators.

A. 2. The circuit is given (Fig. 2). In order to obtain satisfactory frequency stability, the capacity of the oscillator tuning condenser must be rather high—.00025 mfd. for 40 meters and .00015 mfd. for 20 meters; if the tubes will oscillate with higher capacities by all means use them. That of the tuning condensers for the power and buffer stages should be as low as possible—about .00005 mfd. Higher capacities here will reduce the output.

Q. 3. Will the oscillator-buffer arrangement, with the tubes specified, properly excite the 510s?

A. 3. Yes, if the adjustments are made carefully. With push-pull oscillator and buffer, do not try to tune the oscillator to half the radiated frequency and then double in the buffer stage.

"Super-Wasp" and New 2-Volt Tubes

E. A. Poteet, St. Louis, Mo., asks:

Q. 1. Can a Pilot "Super-Wasp" be adapted for use with the new 2-volt tubes, and what changes are necessary?

A. 1. These changes are practical and desirable. It is necessary only to remove the regular rheostat and replace it

THIS question and answer department is edited by Mr. R. William Tanner, well known operator of short-wave amateur radio station W8AD. Mr. Tanner has written a great many articles for the radio press and has had considerable experience in designing and constructing both short-wave transmitters and receivers. Not more than three questions should be asked and all letters containing questions should be addressed to the Editor, Short-Wave Question Box, at the publishers' address. State your questions briefly. Questions cannot be answered by mail.

with one having a resistance of 30 ohms. The filament supply should then be not higher than 4.5 volts.

Q. 2. How far should the volume control be advanced, when removing turns from the tickler?

A. 2. The tickler turns should be just sufficient to produce oscillations when the regeneration or volume control is set at or near maximum with the tuning condenser at maximum.

"De Luxe 1930" Coil Data

Kenneth Lum King, Honolulu, T. H., wants to know:

Q. 1. The coil details for the circuit on page 49 (June-July issue)?

A. 1. A coil table is given herewith.

Turns No.	Turns Grid	Turns Plate	Band Meters
L1	L2		
7	7	6	20
13	13	7	40
25	25	9	80
48	48	15	160

Q. 2. The lead from the R. F. plate

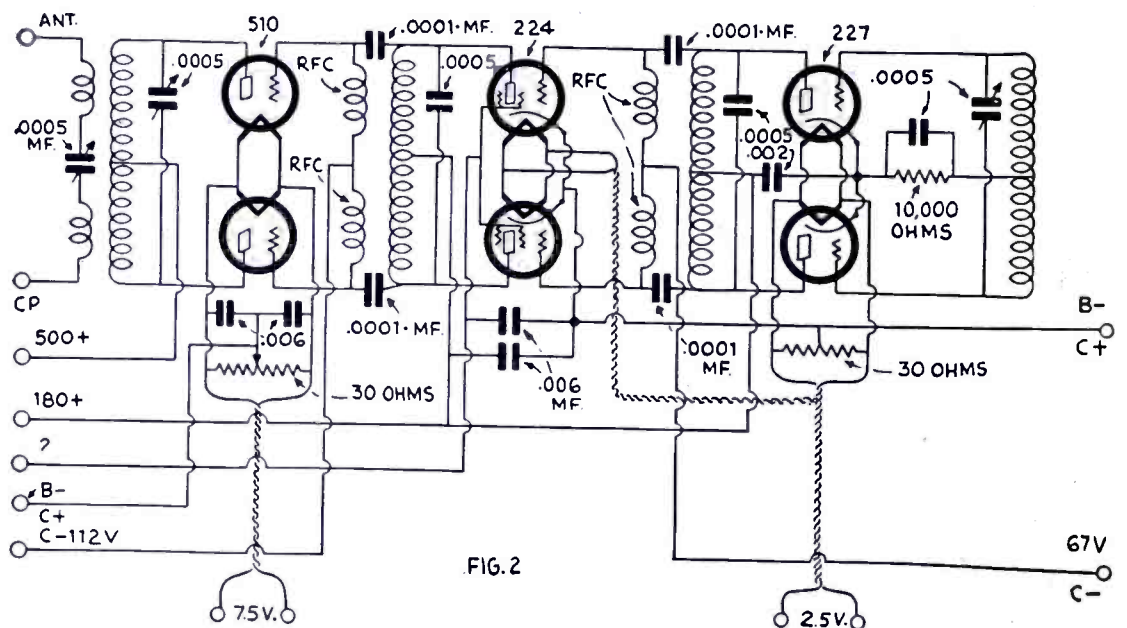

Fig. 2—Circuit for an efficient push-pull transmitter. 75+ volts is applied on the shield grids of the 2-224's.

through the R. F. choke is marked "B-135." Is this correct?

A. 2. No. It should be "B + 135".

Q. 3. I do not use a metal baseboard. What shall I do with all of the "grounds" shown?

A. 3. Merely connect all of the grounds to the ground post of the set.

Low-Power 2,000-Mile Transmission

Joseph E. Deville, Algiers, La., inquires:

Q. 1. Would it be possible to transmit 2000 miles, or anywhere in the U. S. A., with a receiving tube and 180 volts on the plate?

A. 1. I hesitate to make a statement upon the range of such a transmitter. It might be possible on 20 or 40 meters, if conditions were just right. Many amateurs have been heard thousands of miles, with low-power sets.

Hum Elimination

B. J. Rider, Easton, Pa., sends in the following questions:

Q. 1. Is it necessary to filter the filament circuit to eliminate the hum, or do the characteristics of the tubes do this?

A. 1. Filtering, as usually considered in radio circuits, is a process following rectification. There have been many attempts to provide D. C. filament supply by means of a rectifier and filter (the so-called "A" substitutes of a few years ago), but these devices have not proven entirely satisfactory. The heater type of tube has removed the necessity for such devices. However, humless operation requires great care in the design of the set.

Q. 2. Will the Pilot plug-in coils, 180, 181, 182, 183 and 184, with three separate coils on each form, be suitable for a tuner

having a range of 17 to 600 meters?

A. 2. Yes, if used with a .00015-mfd. tuning condenser.

Q. 3. What method of shielding do you recommend? Would an all-aluminum box give the best results?

A. 3. Copper shielding of heavy gauge is always the ideal, especially when all laps are soldered. However, with proper care in the location of parts, one may use aluminum shielding, which necessarily requires screwed or riveted laps. In general, a coil shield should have a clearance of at least 2.5 times the diameter of the coil, and be continuous. If a box shield is used around the whole tuned system, it must be electrically as continuous as possible, and as far removed from the coil as practicable.

Q. 4. In regard to any circuit, is it necessary to use the same capacities as specified?

A. 4. Any change in the values of the tuning or blocking condensers in the tuned circuits will change the wavelength range. Otherwise, nothing is critical.

S-W Receiver Circuit

John Repa, Quakerstown, Pa., requests:

Q. 1. Circuit for a short-wave tuner, using the S-M 110 series of coils, which are tuned with a .00035-mfd. condenser.

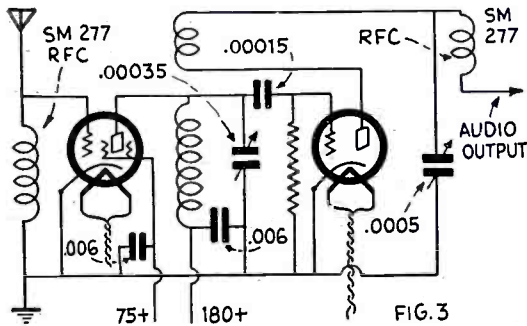

Fig. 3—Circuit for use with S-M 110 series coils with .00035 m.f. tuning condenser.

A. 1. The circuit is shown in Fig. 3. Tuning with such large condensers will be almost impossible below about 100 meters, even with a really high-ratio vernier dial. There is still another great disadvantage in the use of a .00035-mfd. tuning condenser; and that is loss of sensitivity. As a vacuum tube is a voltage-operated device and a large capacity in a tuned circuit reduces the voltage the reason is quite apparent.

Q. 2. Can these coils be used with a smaller condenser, such as one having a capacity of .00015-mfd.?

A. 2. This would be possible by changing the number of turns. To cover the short-wave spectrum, four coils would be needed; having respectively 5, 12, 25 and 45 turns for the secondaries and 5, 6, 10 and 15 turns for the ticklers.

Q. 3. Can the audio amplifier from a battery set be used for the reproduction of phonograph records?

A. 3. This can, undoubtedly, be done; but results in recording will not be very satisfactory unless the last stage consists of two 171A tubes in push-pull.

Lecher Wires for Measuring Wavelength

Aloys F. Geiersbach, Milwaukee, Wis., writes as follows:

Q. 1. I have been experimenting with ultra-short waves and, while measuring the wavelength with a pair of Lecher wires, I noticed that the plate current in-

creased when the slider was at certain points on the parallel wires. By measuring the distance between any two points, would this give the true wavelength? And how is the Lecher system of measuring for accuracy?

A. 1. Yes, the distance (back and forth) between any two points of maximum potential difference on the Lecher wires would give the true wave of the oscillator. The Lecher system is by far the most accurate known method.

Short-Wave R.F. Chokes

John Steers, Bethlehem, Pa., inquires: Q. 1. Re the article on page 135 (August-September issue), can a Hammarlund 85-mh. radio-frequency choke be used at R. F. C. in Fig. 3?

A. 1. Yes, and also one may be used in the "B+" lead to VT1. A bypass condenser, about .006-mfd., should be connected from the low-potential end of the primary to ground.

Q. 2. What is R, and what is its value?

A. 2. This is a resistor, providing the required grid bias for the R. F. tube, and should have a value of 10 ohms.

Variometer Data

Harvey Beecher, Hoosic Falls, N. Y., would like to know:

Q. 1. The dimensions of the variometer in the Aero automatic tuning unit?

A. 1. The variometer has 4 3/4 turns of No. 24 D. S. C. wire on the stator which is 1 7/8" in diameter, while the rotor is 1 1/8" in diameter and has 4 1/2 turns of No. 24. The tickler is wound close to the stator with 5 turns of No. 28 D. S. C. wire.

Q. 2. How many turns of wire are on the S-M type 277 short-wave R. F. chokes?

A. 2. These chokes consist of 188 turns in each of the three slots, or a total of 564 turns.

Adding Screen-Grid to Super-Wasp

J. G. Reaney, Brooklyn, N. Y., desires the following information.

Q. 1. What changes are necessary to add a screen-grid detector to a Pilot "Super-Wasp"?

A. 1. The screen-grid detector circuit is given in Fig. 4. It will probably be necessary to increase the plate voltage

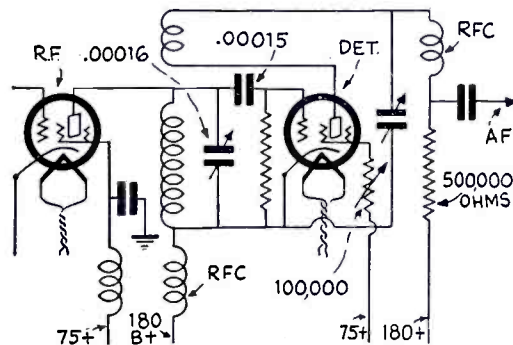

Fig. 4—Screen-grid detector circuit for "Super-Wasp."

to 180 and, possibly, the tickler turns must be increased. A zero to 100,000-ohm variable resistor must be connected in the screen-grid lead, to ensure stable oscillation.

What Causes Roar With Converter?

C. C. Campbell, Tampa, Fla., asks:

Q. 1. I have built one of the Tanner Super S. W. converters and have been having trouble with a loud roar. I am using it in conjunction with a Majestic "Model 121." When working properly stations are brought in louder than on the 200- to 600-meter band. The roar is not heard except at certain points within the tuning range. Can you give me any idea as to what is wrong?

A. 1. I believe your trouble lies in the detector (converter) tube. You might try using an 85-millihenry R. F. choke, in place of the tuned circuit. If detector oscillation is the cause of the roar, this will cure the trouble. I also suggest that you try grid-leak detection in place of bias detection.

Improving S.W. Super-Het

R. J. McCloy, New York, N. Y., asks for:

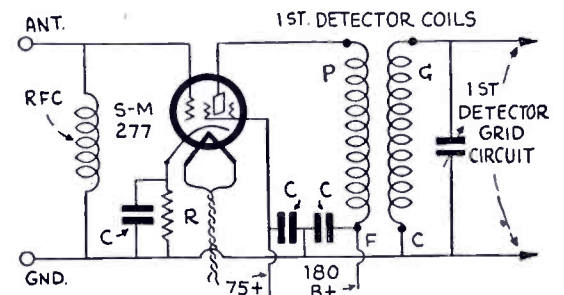

Fig. 5—Connections for R.F. unit to add to the Tanner Super-Het.

Q. 1. Instructions covering the addition of an untuned R. F. stage ahead of the first detector of the short-wave Super-het described on page 150 (August-September issue).

A. 1. The circuit is given here. The antenna primary coils L, in the original, should be removed and replaced by windings having two-thirds the number of turns on the secondaries. These are connected in the plate circuit of the R. F. tube. R is the biasing resistor, of 400 ohms. The bypass condensers C have each a capacity of .006-mfd.

Loud-Speaker Reception on Super-Regenerator

Robert H. Goodell, Lancaster, Pa., asks for:

Q. 1. The circuit of a super-regenerative short-wave receiver capable of giving loud-speaker reception on S. W. broadcasts?

A. 1. You are referred to the article on page 31 (June-July issue) of SHORT-WAVE CRAFT. This would require only the addition of a two-stage audio amplifier.

B-Eliminator for S-W Receivers

Paul Ankrum, Oak Hill, W. Va., wants to know:

Q. 1. Is a B-eliminator which delivers humless direct current, suitable for short-wave receivers and radiophone transmitters?

A. 1. Yes—providing the eliminator in question DOES deliver humless direct current. Many of the present-day units are not suitable for short-wave sets, since their filters are not good enough.

You Can Learn the Code

Easily With This Home-Made Device

By PAUL SKITZKI

THIS code practice outfit has been designed to reproduce the sing-song note of a real code station in the headphones of the listener. The circuit may be easily recognized as that of the Hartley, used in this case as an audio oscillator. This set has been used by many amateurs who wished to speed up their code sending.

The main ensemble, consisting of the transformer, T1; the tube, V1; the rheostat, R1, and the jack, J1, is mounted in a cigar box, C1. The lid of the box was removed and the box is used in an inverted position; i.e., bottom up. On the top of the inverted box is the first key, K1. Box C2 contains only the other jack, J2, and the second key, K2.

Two cords, one double- and one single-wire, were cabled and run from C1 to C2. These wires may be as long as desired, depending upon the distance from C1 to C2; over five feet is ideal. The transformer used should be a small one, which will rest easily in the box, and so located that it does not interfere with the placement of the tube, which is mounted on an end. The other parts may be placed where desired.

The keys may be made at home of the following material: two strips of 1/8-inch copper, 1/2-inch wide and 4 inches long; two 1-inch lengths of the same material; two pillars, about 3/8-inch high, to support the far end of the key; and two small porcelain knobs.

It is necessary that the "A" battery leads be correct in polarity, for the set will not work unless they are so. If nothing is heard in the phones when the key is depressed, after everything has been connected, reverse the leads to the primary on the audio transformer.

An old A.F. transformer, 1 tube, batteries, phones, keys and some wire to connect the apparatus—then you're all set to learn the code.

signal, and so does the operator at C2. When the operator at C2 in turn presses K2, he also hears his own signal. This feature allows each operator to judge his own signal and to know whether he is sending out a steady one.

The tube used should be either a '99 with dry cells, or an '01A with a storage battery. When one operator wants to work alone, he disconnects the cable running from C1 to C2.

The cigar box is far too short for a good arm rest for keying work, so another box may be placed end to end with it for the purpose.

May I make a suggestion and say this: Wouldn't it be a good idea to put down on a paper all the letters of the alphabet and numerals, together with some "Q" signals, and paste them on the box near the key? Sometimes this has been a great aid to the beginner.

Since you probably have a copy of the code, it will not be repeated here in full. However, we shall try to instruct you how to grasp the key and how to gain speed in code. As soon as you have memorized the letters and figures, try to recognize them on either a short-wave or long-wave receiver. You may be able to copy only five out of ten, but you will gather speed if you continue to do this daily. By listening to code signals on a receiver, and by using this code set, you should be able to do ten words a minute in about two months.

The correct way to grasp the key is to hold it lightly. The thumb should be against the left side of the knob, while the first and second fingers are bent a little and placed partly on top and partly on the right side of the knob. A wrist motion—never the whole arm—

(Continued on page 406)

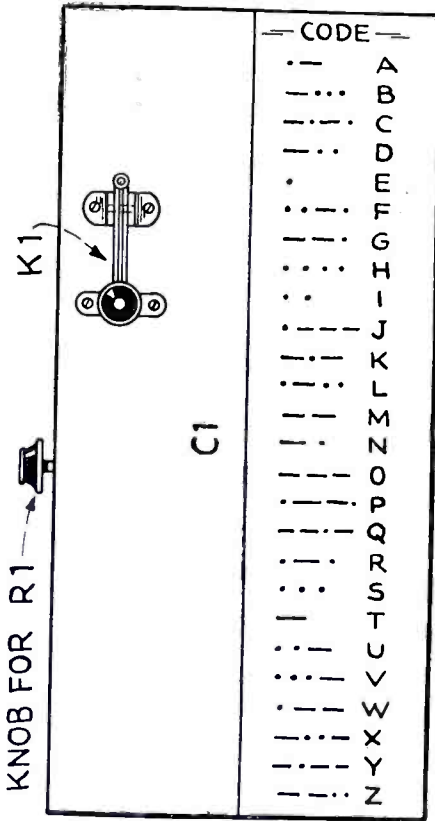

Top of code instrument with key and copy of the code in a handy position.

Methods of Practicing

The operation of the set is very simple. The operator at C1 dons headphones and adjusts the tone by turning rheostat. When he presses K1 he hears his own

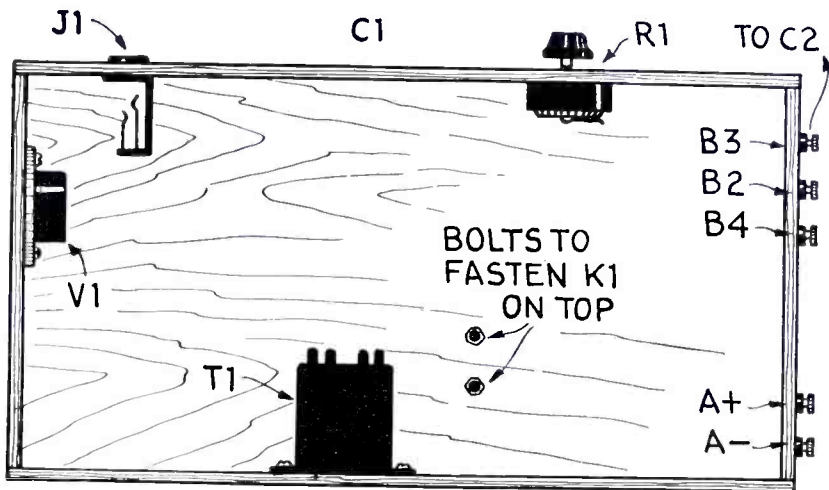

View showing interior of box containing "code teacher" apparatus.

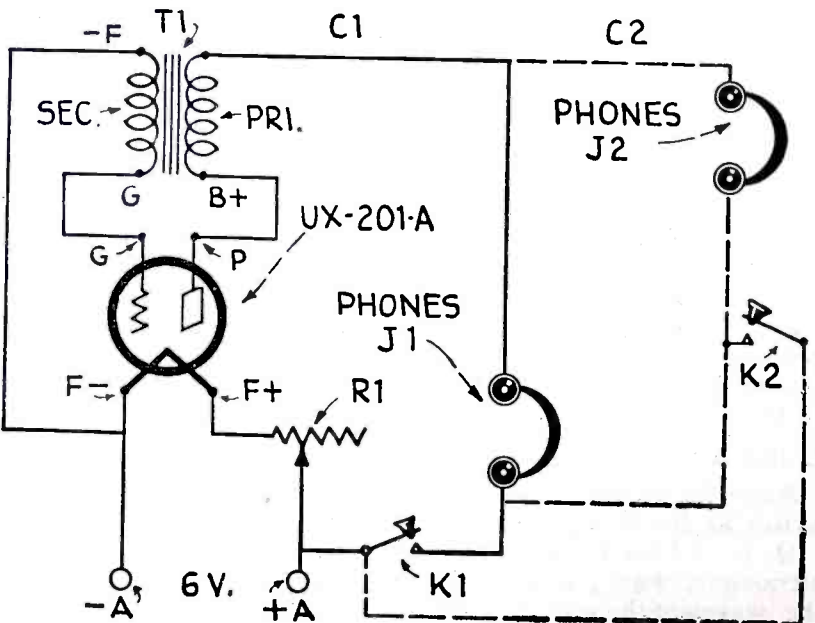

Simple "code teacher" circuit used in connection with 201-A or other tube, low ratio audio transformer T1 phones and keys illustrated.

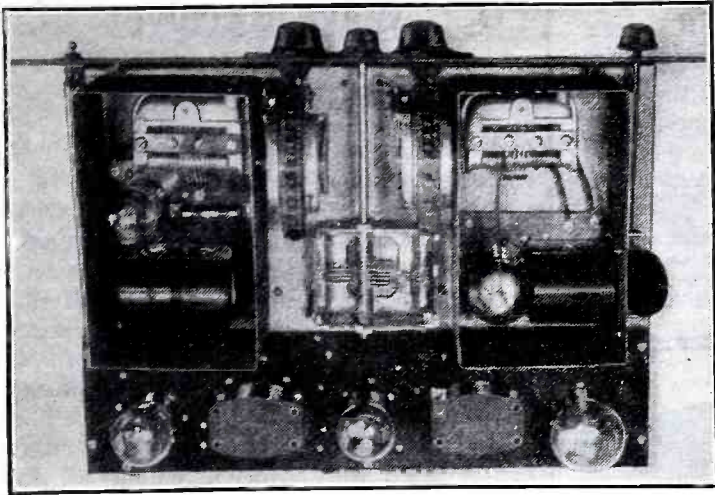

Left: Top view of new A.C. "Conqueror" all-wave receiver, with shield covers removed.

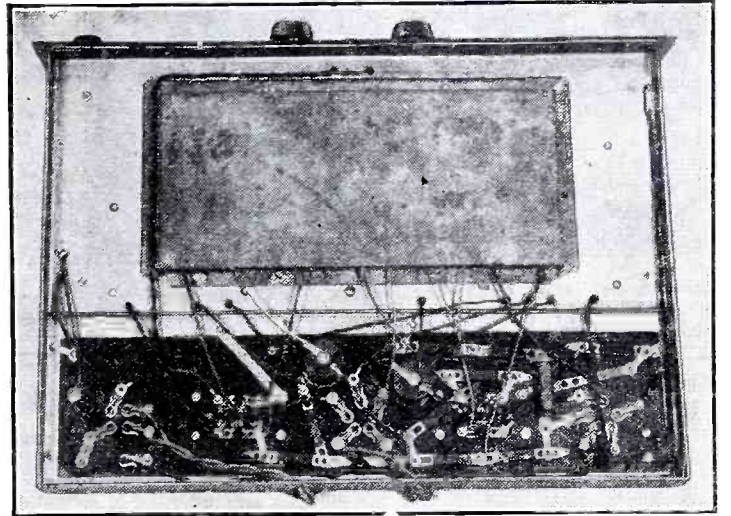

Right: Bottom view of the new A.C. "Conqueror" receiver.

The A.C. "CONQUEROR" Picks Up Both SHORT and BROADCAST Waves

By ALEX. G. HELLER*

HERE'S the latest long and short wave receiver and it's A. C. operated—no batteries are required. By means of new style improved plug-in coils any wave length from 17 to 600 meters can be tuned in. Regeneration is controlled by a variable condenser. The set uses one '24 tube, three '27's and a '45 in the output stage.

The circuit comprises a one-stage radio-frequency amplifier, regenerative detector, and three-stage audio-frequency amplifier. It is the typical short-wave type, with plug-in coils to cover the entire short-wave and broadcast bands. Five tubes are used: A screen-grid type '24, three type '27's and a type '45. In the power pack is a type '80 rectifier.

Fig. 1 shows the set diagram. The one-stage radio-frequency amplifier uses the

'24 screen-grid tube. The detector, using a '27 tube, is regenerative by means of the tickler feed-back coil. This allows stations to be tuned in by means of the heterodyne whistle and also gives extreme sensitivity. Regeneration is controlled by means of the variable condenser, C3, shown in Fig. 1. An audio-frequency transformer couples the detector to the first audio stage. The second audio stage is resistance coupled, and the third one, using the '45 output tube, is transformer coupled. The use of a three-stage audio amplifier gives great volume—so necessary for short-wave reception. The excellent tone quality obtained is due to the use of the combination of transformer and resistance coupling, transformers of good characteristics being used. The '45 output power tube handles the enormous power with sufficient facility to operate a dynamic speaker. The power pack is built into

a separate unit, as shown in the photographic views. This will be described in detail later.

Now we come to the apparently insignificant yet important points in the design of this set that account for its amazing success. Taking them in order, we have first what is called the "Capacitively shielded inductive coupling to the antenna system. In plain English, this means that there is a fine wire screen or copper sieve, placed between the antenna coil. L, Fig. 1, and the first or input r.f. coil in the set. It is made of copper and is grounded. All the signals have to pass through it by magnetic induction in order to get into the set. It makes the set independent of the antenna system. In other words, no matter what size, type, or location of aerial you have, the set tuning and control will always be

(Continued on page 405)

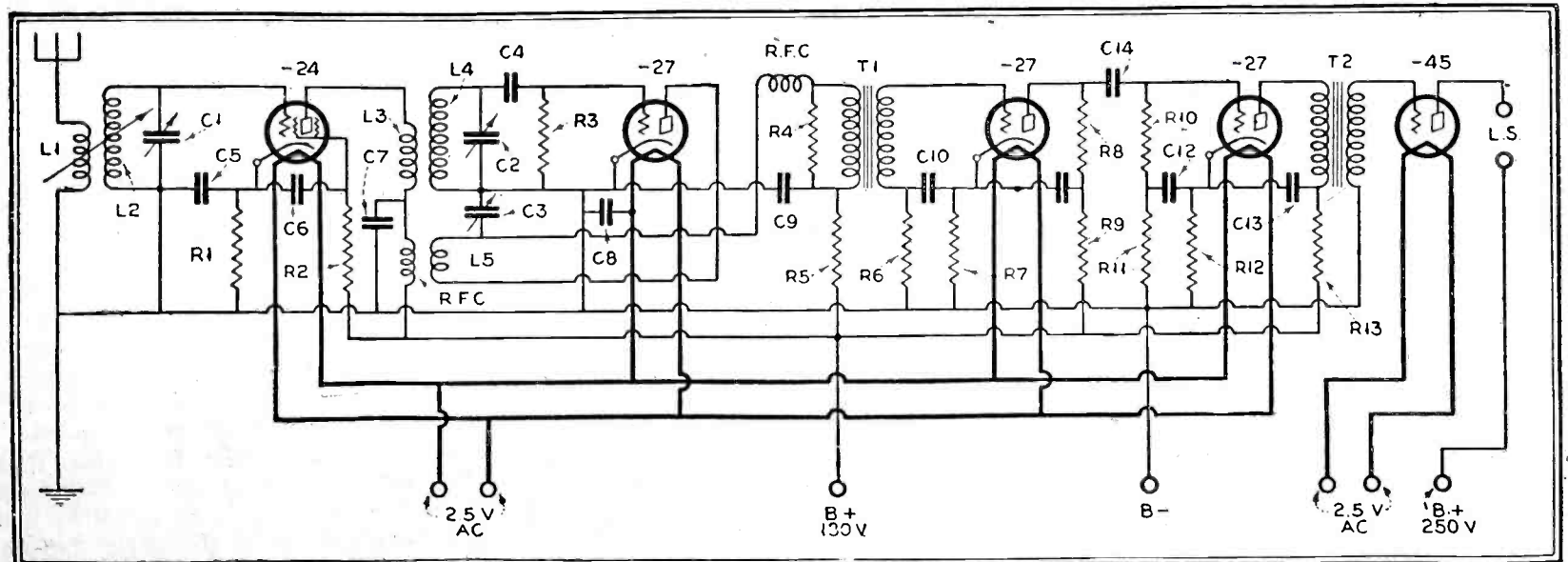
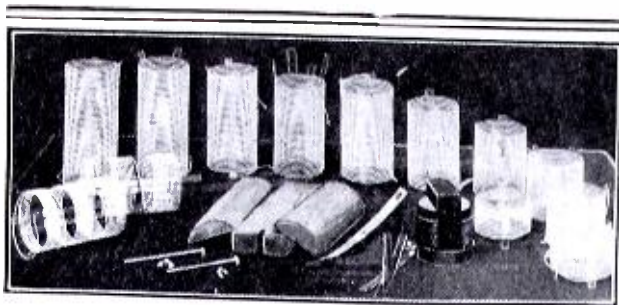

Diagram of connections for the A.C. "Conqueror" short wave receiver.



condenser sizes for all short waves. Why pay \$10 for a few now!! You'll be surprised. Complete Kit, \$1.89 Postpaid. We are sole manufacturers.

DELFT All-Electric Short-Wave Receiver Kits

NO SIR!! NOT \$5! Why? Easy. You want RESULTS don't you? Take our advice; DON'T BUY CHEAP S.W. SETS!! That's WHY We do NOT sell as cheap as \$5. You NEED AT LEAST TWO TUBES TO GET GOOD RESULTS!! BUT you can get a COMPLETE KIT for \$10.95 POSTPAID WITH A COIL WINDER THROWN IN!! THESE KITS furnish all parts (baseboard, panel—everything) for neat, sensitive, long-range, short-wave sets as shown in photo. Receive stations DIRECT from THOUSANDS OF MILES away regularly and foreign countries easy. SOME THRILL!! Add more tubes later for greater distance. Also full instructions (6 pages). Kits listed below are similar. Two-Tube Kit, \$10.95, postpaid. 3-Tube Kit (2 Audio Stages) \$12.95. Short wave-tested Tubes \$1 each (list at \$1.50). You can use the new 2 Volt Tubes with above Kits with same results (require only 2 dry cells for ill. supply). 2-Volt Tubes, \$1.80 each (list at \$2.20). (All Kits on the market are priced without head-phones and tubes.) Fine head phones, \$1.75 pair. KITS FOR OPERATION FROM LIGHT SOCKET: Two-Tube Kit, \$12.95. Postpaid. Three-Tube Kit (2 audio stages) \$14.95. Filament transformer (eliminates A battery) \$3.00 (has ample capacity to furnish 6 type 27 tubes or screen grids.) 3 tubes give speaker volume. Tested A.C. tubes, \$1.50 each.

Never Before at Such Prices!!

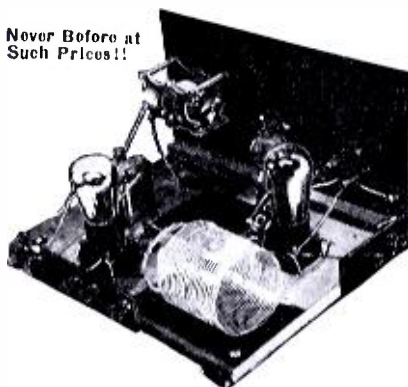

DELFT Short-Wave Portable Receiver Kit

Photo shows front of case removed. Set can be used for any portable use in autos, planes, yachts, etc. Uses 2, new 2-volt tubes. Receives 1,000 miles and more on 10-ft. aerial; 3,000 and more on longer wire. Measures 8" by 18"; depth 5". Sturdy but light in weight. Complete in itself; entirely enclosed. Hinged front lets phones slip inside. Special, easy tuning. Uses tube-base coils (1 in. diam.); plug in at top of case to change to different wavelength bands. Compact but efficient. Kit includes ALL parts and knocked down case (all hinges, etc.), also full, simplified assembly instructions, showing values to use for any short-wave band, etc. Complete Kit, \$16 (less tubes, batteries (2 dry cells and one 45-volt size), and phones). Tubes, \$1.80 each; Phones: \$1.75 pair. Kit shipped absolutely complete, \$22.00. Portable Receiver shipped complete (assembled, tested, finished in dark oak, and adjusted to any desired waveband, \$27.00 (with suitcase handle and carrying straps).



DELFT All-Short-Wave Wavemeter, \$6.95

This fine sturdy wavemeter finds short-wave foreign broadcasting stations on your short-wave receiver dial, without wasting time hunting for them. Long distance is easy with this wavemeter. First you look up the station wavelength in the magazine. Next you set the wavemeter to that wavelength (marked on the dial). Then you tune your receiver to the wavemeter. This wavemeter tunes from 15 to 125 meters. It is well shielded from hand-capacity. It comes complete with extra, sturdy plug-in coils, wavelength calibrations chart and full, simplified instructions telling how to operate it for best results with any short-wave set. Complete Wavemeter, only \$6.95 Postpaid. Others charge from \$12 to \$20. Why pay more? Easy to operate and ACCURATE!

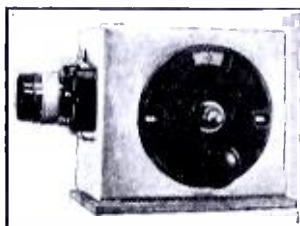

Special Amateur Band Wavemeter

The above wavemeter works with a transmitter too. But we have a special amateur-band wavemeter which looks just like the one above, but gives the required accuracy (1/4 of 1%) demanded by the Gov't. For \$5.85 Postpaid, you get the complete wavemeter, all instructions, and calibrated coil for any one amateur band with this accuracy. Calibrate for the other bands yourself. Or, for each extra band, add \$1.60 for the extra required calibrated plug-in coil.

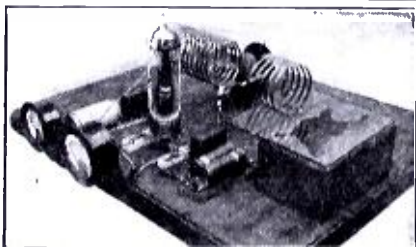

DELFT Short-Wave Transmitter Kit, \$8.00

This Kit supplies absolutely all transmitting parts except baseboard, tube and meters, which are not needed to operate it. Start sending with a receiving tube and use a larger tube later. Uses plate supply from your receiver (batteries or light socket). Six pages instructions tell how to build it, increase power, aerial sizes, etc., etc. Material furnished for copper ribbon coils covering 20, 40 and 80 meter bands. Assemble one and learn! Use it on the air when you get your license! Complete Kit, \$8.95 Postpaid. This set works at least 3,000 miles with a single 5-watt tube! Can be used for phone transmission (easy to get this kind of license!) Instructions show how. You can use a new 2-volt tube with this set, so only 2 dry cells will work it. Phone attachment (without microphone), \$1.00.

PLUG-IN-COILS!!—There is SOME difference between different makes of PLUG-IN-COILS! We test ours in a short-wave set. (They look like the coil shown on the wavemeter in this ad, but have finger handles so the windings are protected.) Tube-base coils (fit a UX (4 prong) socket) for R.F. amplifier use, 15 to 125 meters, using either a .0001, .00014 or .00015 condenser. Set of 3 (with finger handles), \$1.30. Same kind of coils but with tickler windings also (for detector) \$1.85.

NOTICE the items that are sent postpaid; you save postage, collection and M.O. fees. We save you PLENTY on postage too, so the ACTUAL COST DELIVERED IS LOW! C. O. D. orders cheerfully sent; send \$1 in stamps, pay rest to postman. Money in bills, small amounts in stamps; wrap well, register letter if necessary.

ASK about our used radio parts. We can supply coils, fixed and variable condensers (all sizes), rheostats, sockets, transformers, posts, panels, etc., at prices ranging from 1/10 to 1/4 regular prices. All O. K. Perhaps a little solder on the lugs, or slight scratches. Order an Experimenter's Surprise Package; Contains \$10 worth of parts, coils, condensers, etc. Price \$2.

DELFT

Phone: Higate 0748

524 Fairbanks Avenue,
OAKLAND :: CALIFORNIA

SHORT - WAVE
RADIO
SPECIALISTS

How to Operate a Short Wave Receiver

By ARTHUR G. GREEN

(Continued from page 349)

tries and news is gathered from all the corners of the earth. This news is printed each month in a magazine which is mailed out to members. Developments in the short-wave field, news of which is received up to within three days of publication, is printed and mailed out, reaching the members in time to be of vast importance in tuning. The headquarters of this club is at Klondyke, Ohio, U. S. A.

For the past year we have been carrying a beginner's section which we find has proved very helpful. It is as follows in our latest edition:

Listeners in Eastern U. S. A. should try for the following stations: HRB, Tegucigalpa, Honduras, which is found a little under W2XE on 48.62 meters, on Mon., Wed., Fri. and Sat. from 9 to 12 p. m., E. S. T.

HKC, Bogota, Colombia, is found just under HRB on 48.35 meters almost any night after 9:45 and until 11:30 p. m.

VRV, Georgetown, British Guiana, although changing their wavelength regularly to avoid interference, may be found above the 40-meter code band and WND, the American telephone station at Deal, N. J.), on waves between 44.5 and 45.5 meters from 7:15 to 9 p. m. on Wed., and from 5:45 till 9 p. m. on Sundays.

The station at Zeesen, Germany, announcing at Koenigswursterhausen, may be found just under W2XAF on 31.38 meters. Due to the effects of light, this station's audibility is greatest from 3 to about 6 p. m.

PCJ, at Eindhoven, Holland, although announcing as 31.4, is really under Zeesen and on 31.26 meters. (Our own W3XAU is on this same wave but they graciously remain silent on Thursdays from 6 till 10 p. m. and Fridays from 7 till 12 p. m., at which times PCJ is on the air. Above and below this group may be found many telephone stations.

The 25-meter band offers the listener G5SW, Chelmsford, England, on 25.53 meters, which is between W8XK and CJRX. They are on the air from Monday till Friday, from 1 to 6 p. m. in summer and from 2 to 7 p. m. in winter.

Slightly above CJRX may be found, occasionally: IBDX on Marquis Marconi's yacht "Elettra"; KIO, Hawaii, and DHC, Nauen, Germany, in the afternoons from noon till early evening.

Just below 25 meters may be found a number of ship stations in the daytime and early evening. Quite a number of telephone stations, who send music on occasions, may be found from 14 to 18 meters from daybreak until 4 p. m.

Western fans may tune for RA97, Khabarovsk, U. S. S. R., on 70.1 meters from 2 till 9 a. m., E. S. T. Most Western fans get up in the early mornings for the "easy" stations.

HS2PJ at Bangkok, Siam, when testing on 49.3, may be found after 6:30 a. m. just under where W9XAA is heard.

VK2ME, Sydney, Australia, is now on the air twenty-four hours a day on 15.5, 18.37, 28.5 and 37.67 meters.

K1XR, Manila, is also on several waves and heard at intervals on each. They are found just under W2XE on 48.8, on the same wave as W3XAU on 31.3, and just above CJRX when on 26.1 meters.

This list is not complete. In one month members of the International Shortwave Club reported hearing 72 foreign short-wave stations.

American Short-Wave Work

Short waves do not naturally mean long distance, either. The programs of the N. B. C. can be heard over W3XAL, W8XK, W2XAF, W2XAD, W8XAL and other stations. The Columbia programs can be heard over W3XAU, W2XE and others; and there are many independent stations such as W9XAA, W9XF and W2XAL.

Airplanes and airport stations may be heard in daytime just above the 49-meter broadcasters (W9XAA, W3XAL,

etc.), and at night above the police station WCK.

These police stations also offer a new form of entertainment. There are some fifteen or twenty of these, located in our largest cities, which are used to broadcast news of crime and accidents to police and police cars on duty, and many interesting incidents are heard every day over these stations. They are heard mostly on waves from 100 to 175 meters.

In conclusion, I will say that the era of short-wave broadcasting is at hand and short waves are developing at a rapid pace. In one month 22 new stations were heard in the United States. Nearly all of these were new stations on the air.

The old "bugaboos" of "skip-distance" effects, poor modulation, and lack of stations have been overcome to a great extent, and the march of progress calls for more and more short-wave listeners.

A Low-Power Phone Transmitter for the Beginner

By R. WM. TANNER

(Continued from page 373)

2 is depicted the layout of parts for the R. F. amplifier. A half-inch wooden baseboard, 10 by 14 inches, will accommodate all of the parts without overcrowding. A 5 by 14-inch bakelite panel may be used if desired, and upon this may be mounted the four tuning condensers. The modulator and speech amplifier is mounted, according to Fig. 3, on a baseboard 6 by 10 inches. Both baseboards have a pair of inch-high sub-panel brackets attached to the under side. The bypass condensers, resistors and R. F. chokes are then located underneath. In wiring, it is advisable to use No. 14 wire, for its greater mechanical strength.

The inductances should be fitted with short lengths of 1/2-inch brass strip, fastened to the ends. Small General Radio upright insulators may then be used as mounting bases.

Complete details of the mounting and wiring procedure will not be given, because of the wide differences in sizes and shapes of the various manufactured parts. Merely space the parts sufficient to prevent appreciable feed-back.

Adjusting the Transmitter

When this radiophone transmitter is all wired, the few adjustments can be made. First, make all external connections to the R. F. unit except the output amplifier "B+". Connect a 2.5-volt flashlight bulb to three turns of bell wire; closely couple this to the oscillator plate coil L2. By listening in on a receiver, the correct wavelength of the oscillator may be found. A wavemeter should be employed, if one is at hand, rather than a receiver. But, generally, the beginner does not have one; so the receiver is given as second choice. Now, couple the tuning lamp to the output inductance L1, and vary the plate tuning condenser until the lamp lights. Then adjust *together* both neutralizing condensers NC, so that the bulb cannot be made to show signs of brilliancy at any setting of C1. Neutralizing will then be complete. The high voltage may now be connected to the

power amplifier; and the antenna circuit tuned to resonance, as indicated on the radiation meter in the antenna lead.

With the R. F. unit operating properly, make all connections to the modulator and speech amplifier. Speaking into the microphone will increase the antenna current slightly.

In regard to the antenna for 160-meter operation: a single No. 12 or 14 enamelled wire, 125 feet long and as high as possible, may be used. The height should be no less than thirty feet if the operator desires to transmit over distances greater than about twenty-five miles. A counterpoise, similar to the antenna, should be stretched not over eight feet high. This need not necessarily be located underneath the antenna. Somewhat better results may be obtained by making the counterpoise only about a hundred feet long; the voltage node is then brought closer to the coils L.

This efficient low power radiophone can cover great distances, providing the antenna system is a good one. On one occasion, the writer worked three hundred miles at four o'clock in the afternoon. This was, undoubtedly, a freak; however, a consistent night range of at least a hundred miles may be expected.

List of Parts for Radiophone Transmitter

- L—Antenna coils;
- L1—P. A. plate coils;
- L2—Oscillator plate coil;
- L3—Oscillator grid coil;
- C—.0005-mf. antenna condenser;
- C1—.0001-mf. P. A. tank condenser;
- C2—.0001-mf. P. A. bypass condenser;
- C3—.002-mf. bypass condensers;
- C4—.00025-mf. coupling condensers;
- C5—.0005-mf. oscillator tank condenser;
- C6—.001-mf. bypass condenser;
- C7—.00025-mf. oscillator grid condenser;
- C8—.0005-mf. oscillator grid tuning condenser;
- C9—1-mf. bypass condensers;
- R—60-ohm center-tapped filament resistors;
- R1—10,000-ohm oscillator grid leak;
- R2—100,000-ohm resistors;
- R3—1500-ohm '26 biasing resistor;
- R4—1600-ohm '45 biasing resistor;
- R5—6000-ohm P. A. bias resistor;
- AFC—30-henry 85-mill. choke;
- AFT—High quality audio transformer;
- MT—Modulation transformer;
- VT1, VT2—'71A power amplifier tubes;
- VT3—'12A oscillator tube;
- VT4—'45 modulator tube;
- VT5—'26 speech amplifier tube.

The answers to your questions on building, testing and repairing radio sets

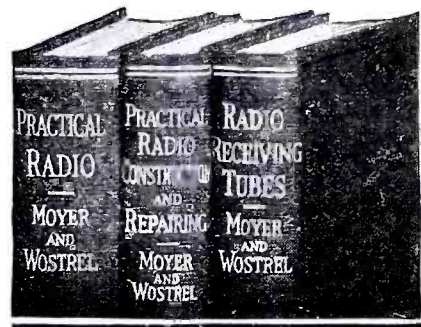

The three volumes of this library cover the entire field of building, repairing and "trouble-shooting" on modern radio receivers. The Library is up-to-the-minute in every respect and is based on the very latest developments in the design and manufacture of equipment. The rapidly-growing interest in short-wave reception is thoroughly covered in a complete section which deals with the construction of this type of apparatus.

Radio Construction Library

By JAMES A. MOYER and JOHN F. WOSTREL

Faculty, University Extension, Massachusetts Department of Education

Three Volumes — 993 Pages, 6x9 561 Illustrations

VOLUME I: presents the fundamental principles of radio so clearly and simply that anyone of average training will be able to read, understand and apply them. In one chapter alone, it gives actual working drawings and lists of materials for the construction of eight typical sets.

VOLUME II: fully discusses all of the elementary principles of radio construction and repair. An explanation of the necessary steps for "trouble-shooting," repairing, servicing and constructing radio sets successfully. Practical data is also given on antenna systems, battery eliminators, loud speakers, chargers, etc.

VOLUME III: covers the essential principles underlying the operation of vacuum tubes in a non-technical manner as is consistent with accuracy. It discusses the construction, action, re-activation, testing and use of vacuum tubes; and an interesting section is devoted to remote control of industrial processes; and precision measurements.

EXAMINE these books for 10 days FREE This Library is not only a thorough home-study course, but a handy means of reference for the more experienced radio experimenter, repair man, and radio shop-owner. To these men, as well as to those who desire to advance in the radio profession, this offer of a 10 days' Free Examination is made.

Simply clip, fill in, and mail this coupon

McGRAW-HILL FREE EXAMINATION COUPON

McGRAW-HILL BOOK COMPANY, INC.
370 Seventh Avenue, New York.

Gentlemen: Send me the new RADIO CONSTRUCTION LIBRARY, all charges prepaid, for 10 days' Free Examination. If satisfactory I will send \$1.50 in 10 days and \$2.00 a month until \$7.50 has been paid. If not wanted I will return them at your expense.

Name

Home Address

City and State

Position

Name of Company..... SWC-1-31

A few ITEMS from Our Latest Catalog!

"CHI-RAD" Power Transformer

No. 104—110-115 volt primary with four secondaries. No. 1—400-0-400 volts, 100 M.A.; No. 2—2½ volts, 14 amps.; No. 3—2½ volts, 3 amps.; No. 4—5 volts, 2 amps.

POWERFUL, STURDY and of very NEAT and PLEASING appearance, sums up in a few words this new "Chi-Rad" Transformer. The core is stamped from high grade Silicon steel and is of the E type with special jointing which reduces the magnetic leakage to a minimum. The case has been made of a heavy material which practically eliminates coupling. Another important improvement is the method of bringing the leads from the coil to the terminal strip which is in the bottom of the case. The coil is vertical with one end toward the terminal strip and the leads are brought out so that they go directly to their proper lug without crossing or coming close to one another.....NET \$4.95

"CHI-RAD" No. 700 Filter Choke

No. 700—30 Henry, 100 M.A. choke with a D.C. resistance of 200 ohms. Completely shielded. E type Silicon steel core. Built to stand the gaff. NET \$1.95

COMPLETE PARTS for NEW NATIONAL S.W. RECEIVER

ACSW5—NATIONAL complete set of parts for 5-tube AC Short-Wave Thrill Box. List \$79.50.....NET \$46.75

DCSW5—NATIONAL complete set of parts for 5-tube Battery operated Short-Wave Thrill Box. List \$75.00. NET \$44.10

We can have either of the above sets of parts wired up for you at an additional list price of \$10.00.....NET \$5.88

When desired completely wired add the letter (W) to our catalog symbols.

Type 5880 AB Power Supply (less tube) for use with above AC Short-Wave Thrill Box. List \$34.50.....NET \$20.30

(Licensed under R.C.A. patents)

**CHICAGO RADIO
APPARATUS CO., Inc.**
No. 415 South Dearborn St.
Chicago

When to Listen In By ROBERT HERTZBERG (Continued from page 361)

GERMANY

A station at Zeesen regularly rebroadcasts the programs of the Berlin stations. It is on 31.38 meters, and operates between 8.00 a. m. and 7.30 p. m., E. S. T. Its owners are the Reichs-Rundfunk-Gesellschaft, Potsdamer Strasse 4, Berlin W9, Germany.

There is also a station at Doberitz, on 67.65 meters or 4.434 kilocycles. It transmits Monday, Wednesday and Friday from 5.00 to 6.00 a. m. and 1.00 to 2.00 p. m., E. S. T.

There is also a flock of short-wave phone stations in Germany, engaged in communication with South American cities. We know that their call letters all begin with DH, but we have not been able to obtain authentic information about them.

HAWAII

KIO, at Kahuku, on 25.68 meters or 11,680 kilocycles, is engaged in commercial telephone traffic with KEL, and has been reported by many people in the States. No regular schedule is followed.

HOLLAND

PCJ, Eindhoven, Holland, is probably the most widely-heard of all short-wave stations. Transmits on 31.26 meters or 9,590 kilocycles, on following schedule, E. S. T.: Wednesday, 11.00 a. m. to 3.00 p. m.; Thursday, 1.00 p. m. to 3.00 p. m., and 6.00 p. m. to 10.00 p. m.; Friday, 1.00 to 3.00 p. m., and 7.00 p. m., to 1.00 a. m. Saturday morning. Announcements are made in Dutch, English, French, German and Portuguese, all by the same man!

There is also a whole nest of short-wave radio telephone stations engaged mainly in traffic with the Dutch East Indies. These may usually be heard during the early morning hours, between about 5.00 and 10.00 a. m., E. S. T. There are PCK on 16.28 meters, PCV on 16.81 and PCL on 26.1; also, PCO on 15.68, PCS on 16.6 and PDM on 16.12. They are operated by the Dutch State Post Telegraph Service and are located at Kootwijk, Holland.

HONDURAS, CENTRAL AMERICA

HRB, Tegucigalpa, Honduras, is an old favorite. Uses 48.62 meters or 6,170 kilocycles; and is on the air Monday, Wednesday, Friday and Saturday from 8.15 to 11.00 p. m. Central Standard Time. It expects soon to be on the air every night. Kenneth H. See is manager, and the Tropical Radio Telegraph Company, with headquarters in Boston, Mass., is the owner.

INDIA

VUS, Calcutta—English and Hindu programs are broadcast on 25.27 meters between about 8.00 and 10.00 a. m., E. S. T.

INDO-CHINA

The city of Saigon harbors a number of stations: including PZS on 16.32 meters and FZR on 18.5 meters, for the link to France; and an independent station of considerable power that specializes in broadcasting. The latter is on 49 meters and is owned by the Indo-Chinese Film Corporation, the schedule Monday, Friday and Wednesday, 4.30 to 5.30 a. m., Pacific time; Tuesday, Thursday and Saturday, 4.30 to 7.15 a. m., Pacific time. Each musical number is preceded by the stroke of a gong.

ITALY

Station 13RO in Rome is the latest sensation of the short-wave channels, being a regular visitor to the United States. It uses 25.4 meters or 11,810 kilocycles and 80 meters or 3,750 kilocycles. May usually be heard during the afternoon along the east coast.

JAPAN

We understand that a station JIAA in Tokyo is operating on 37 meters, testing

with KEL in California after 6.00 a. m., E. S. T. It is probably part of a new trans-Pacific radiophone service.

MEXICO

Station XDA in Mexico City, which makes such a big hole in the ether with its modulated telegraph signals, has become articulate and now broadcasts news dispatches in voice every day at 2.30 p. m., E. S. T. The wavelength is 20.5 meters. Reports of reception may be sent to the Trans News Agency, 13 Colon St., Mexico City.

NEW ZEALAND

ZLW, Wellington, on 27.3 meters, testing with VK2ME over the radiophone circuit; early morning hours in the U. S. A.

ZL3ZC, Broadcasting Service, Ltd., Edin Hall, 230 Taum St., Christchurch. On 50 meters, Wednesday 10.30 p. m. to midnight, and Saturday 2.30 to 4.00 a. m., E. S. T.

PHILIPPINE ISLANDS

KLXR, relaying the programs of KZRM, has been flitting from wave to wave, 31 meters apparently being the latest. Its schedule in E. S. T. is daily, 5.00 to 6.00 p. m.; 11.15 p. m. to 12.15 midnight; 2 to 4 a. m. and 5 to 10 a. m. Owners: Radio Corporation of the Philippines, Plaza Morago, Manila, P. I.

ROUMANIA

Bucharest. The Electro-Technical Institute of the University of Bucharest, is operating an experimental station on 21.5 meters, Wednesday and Saturday afternoon, E. S. T. Reports are desired and should be sent to the Institute Electrotechnique Universitaire, Rue Victor Emanuel III, 16, Bucharest, Roumania, Europe.

SIBERIA

Stations RV15, located at Khabarovsk, Siberia, on 70.2 meters, is heard quite easily on the West Coast, and occasionally as far east as Ohio. Its own announcements of its schedules are conflicting, but it seems to be on the air regularly between 2.30 and 7.30 a. m., Pacific time. English is used freely and the station may readily be identified.

A station RA48, in Tomsk, Siberia, has been reported by one man, but nothing definite is known about it.

SIAM

The interest of the royal family in radio has led to the establishment of several fine stations. These are: HS1PJ, 16.9 meters, 7.30 to 8.30 a. m., E. S. T. on Saturday; HS2PJ, on 29.5 meters, 8.00 to 11.00 a. m., E. S. T., Tuesday, Friday and Saturday; and HS4PJ, 37.6 meters, schedule unknown. Announcements are made in French, English, German and Siamese. A swell letter of acknowledgment that is well worth framing is the reward of those who send in reports of reception. Address Royal Siamese Post and Telegraph Department, Bangkok, Siam.

SWEDEN

A 60-kilowatt station in Oslo, is now broadcasting on 135 meters. While this is not really a "short" wave, it is well below the broadcast band. It falls in the middle of the experimental television channels of the United States; so the "hash" in that neighborhood may prevent reception here.

SHIP AND SHORE STATIONS

Much interesting reception has been provided by the radio-telephone experiments conducted between a number of Atlantic liners and shore stations in New Jersey, Canada and England. The *Leviathan*, WSBN, uses 72.9, 68.3, 35.89 and 33.98

meters. The **Olympic**, GLSQ, and the **Majestic**, GFVV, use 22.5, 34.1 and 72.7 meters. The **Homer**, GDLJ, uses 24.23 and 70.2 meters. Other vessels are being equipped with radio-telephone apparatus.

The American shore stations are all in New Jersey. They are WOO, Deal, on 17.52, 23.36, 34.76, 63.13 and 96.03 meters; WND, Ocean Township, on 16.36, 22.4, 32.7, and 44.4 meters; WLO, Ocean Township, on 14.01, 18.44, 28.44 meters; WMI, Deal, on 15.14, 20.5 and 30.9 meters; and WNC, Ocean Township, on 15.61, 20.73, and 30.77 meters.

The Canadian stations are all at Drummondville. They are CGA on 16.5, 26 and 32.12 meters.

The British stations are as follows: GBU, Rugby, on 16.10, 24.41 and 30.15 meters; GBW, Rugby, on 16.54, 20.77 and 30.64 meters; GBS, Rugby, on 16.39, 24.69 and 33.26 meters; GBX, Rugby, on 18.56 and 27.5 meters; and GBK, Bodmin, on 16.57, 26.1 and 32.4 meters.

The new Television stations as reallocated by the Department of Commerce as of December 8, 1930 and in effect on December 15, 1930, are:

2,000-2,100 Kilocycles			
Call	Power.	Company.	Location.
W3XX	5,000	Jenkins Laboratories, Wheaton, Md.	
W2XCR	5,000	Jenkins Tel. Corp., Jersey City	
W2XAP	250	Jenkins Tel. Corp. Portable.	
W2XCD	5,000	DeForest Radio, Passaic.	
W9XAO	500	Western Tel. Corp., Chicago.	
W2XBU	100	*Harold E. Smith, Beacon, N. Y.	

*One hour daily, 1 to 2 P. M.

2,100-2,200 Kilocycles			
Call	Power.	Company.	Location.
W3XAK	5,000	N. B. C., Bound Brook, N. J.	
W3XAD	500	RCA-Victor Co., Camden, N. J.	
W2XBS	5,000	N. B. C., New York City.	
W2XCW	20,000	General Electric, Schenectady.	
W8XAV	20,000	Westinghouse, E. Pittsburgh.	
W9XAP	1,000	Chicago Daily News, Chicago.	

2,750-2,850 Kilocycles			
Call	Power.	Company.	Location.
W2XBO	500	United Research, Long Island City.	
W9XAA	1,000	Chicago F. of L., Chicago.	
W9XG	1,500	Purdue University, W. Lafayette, Ind.	

2,850-2,950 Kilocycles			
Call	Power.	Company.	Location.
W1XAV	500	Short Wave and Tel. Lab., Boston	
W2XR	500	Radio Pictures, Inc., Long Island City.	
W0XR	5,000	Great Lakes, Downer's Grove, Ill.	

W2XAF Can Send Code, Voice and Photos Simultaneously

By GUY BARTLETT

(Continued from page 345)

tennas were used, the signal invariably reached the country to which it was addressed. For example, for months, special two-way conversations were carried on one day a week with Sydney, Australia. During the period where Admiral Byrd and his expedition were at "Little America" (Antarctica), W2XAF, using a directive antenna, put its program to the explorers fortnightly, on Saturday nights.

With the new transmitters, and 35 kilowatts of power, W2XAF should put an exceptionally strong signal east, west or south. In fact, engineers believe that the ratio of signal to noise or static should be such that the station may be held continuously by a listener during a broadcast.

Be sure to send the Editors a photo of your station.

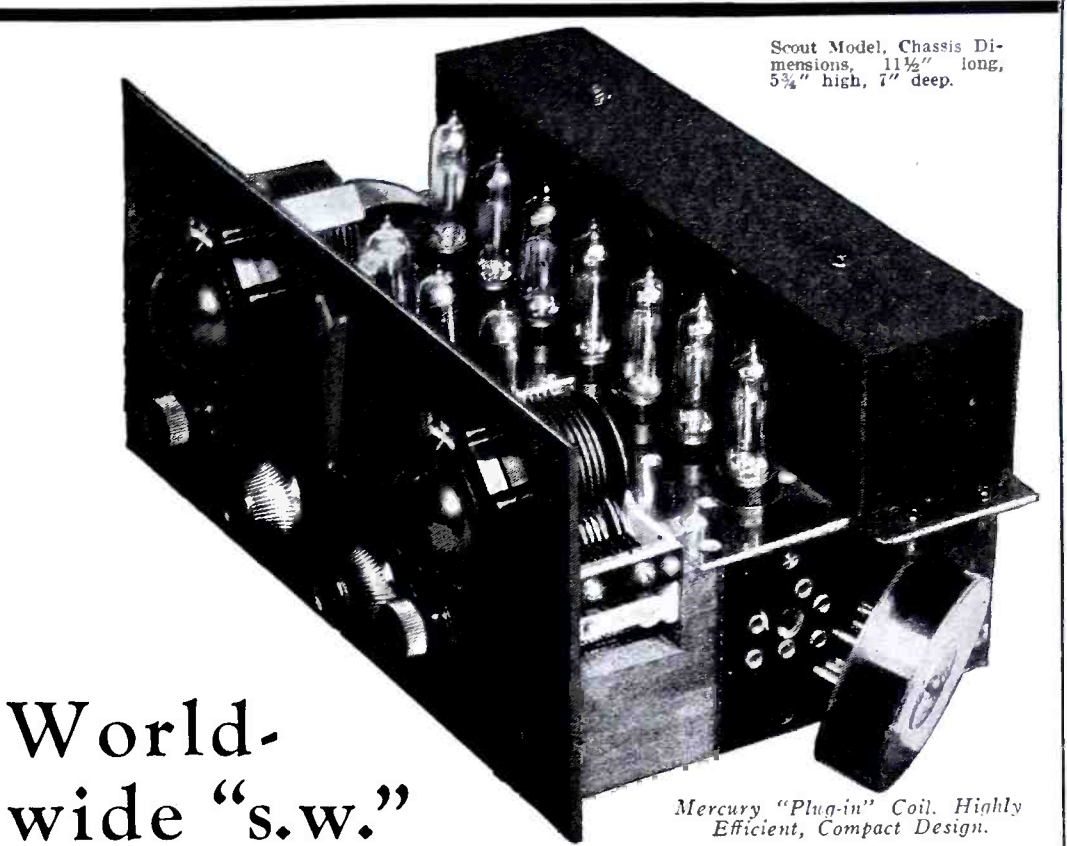

Scout Model, Chassis Dimensions, 11 1/2" long, 5 3/4" high, 7" deep.

Mercury "Plug-in" Coil. Highly Efficient, Compact Design.

World-wide "s.w." reception assured with the MERCURY 10-tube Super!

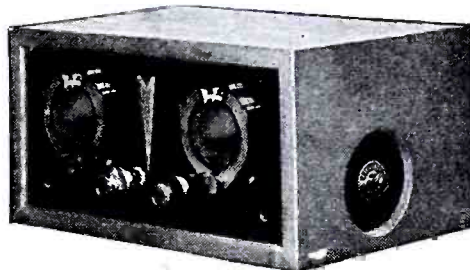

The Most Compact Short-wave and Standard Broadcast Receiver Conceivable. Cabinet Dimensions only 12 1/2" x 9" x 6 3/4". Each Receiver Individually Assembled and Tested for DX in our own Laboratory.

For consistent, world-wide short-wave reception you can't do better than own the MERCURY "Scout" 10-tube Superheterodyne, for results are assured with every set we build. MERCURY owners all over the United States and Canada are getting regularly short-wave broadcasts, trans-oceanic telephone conversations, and amateur and commercial code from Australia, South and Central America, India, Russia, Java, England and other foreign lands. Uses 10 tubes in an improved Superheterodyne circuit and operates from either power apparatus or batteries.

Combination Long and Short Waves

The MERCURY "Scout" Super does the work of TWO receivers. Although designed primarily for short-wave phone and broadcast reception, wavelengths from 13 to 5,000 meters and upwards can be covered *without loss of efficiency*. Waveband between 13 and 190 meters covered by 4 sets of low-capacity, "plug-in" coils. Special split-condenser arrangement on ultra-short-waves (13 to 32 meters) spaces the stations evenly over the entire range of the receiver.

10-Tube "Super" Circuit

The MERCURY 10-tube Superheterodyne Circuit uses the R-215A tube (known as the "N" tube in U. S. Navy) and provides 4 Stages R. F. Amplification and 2 Stages Audio. Total current consumption only 1/2 ampere at approx. 5 volts; drain on "B" Batteries, 12 milliamperes.

Calibrated Dial Settings of the "Scouts"

Station	Wavelength	Coil	Dial
PLE	15.92	9-22	50
GBS	16.54	9-22	55
PHI	16.88	9-22	58
W2XAD	19.56	9-22	82
G2NM	20.9	9-22	91
W8XK	25.25	22-32	36
G5SW	25.53	22-32	39
CJRX	25.6	22-32	40
KIO	25.65	22-32	40+
VK2ME	28.5	22-32	63
NRH	30.88	22-32	83
PCJ	31.3	22-32	87
Zeesen	31.38	22-32	87+
W2XAF	31.48	22-32	89
VRY	44.6	32-80	46
HKC	48.35	32-80	53
W2NE	49.03	32-80	54+
W9XAA	49.34	32-80	56
W9XF	49.83	32-80	58
HRB	49.95	32-80	59+

Mail this Coupon—Get this Short-Wave Book FREE

THE H. M. KIPP COMPANY, Ltd.,
447-A Yonge St., Toronto, Ont., Canada.

SWC-5

Send me FREE your 16-page Short-wave Booklet giving prices and describing in detail the MERCURY Short-wave Receiver.

MERCURY
"The Messenger of the Gods"

Name
Address
City State



The revolutionary I. C. A. Conqueror Short Wave Set gets them all!

HERE is the short wave set that stands head and shoulders above anything at its low price and is the equal of any short wave set at any price.

The I. C. A. Conqueror is of unique and superior design, the work of I. C. A. engineers in collaboration with a foremost ship-to-shore short wave expert. The coils are a masterpiece of scientific design and precision manufacture.

But the performance of the I. C. A. Conqueror is the thing that counts. How far will it reach? Half way round the world—no set can go farther. How about selectivity? Simple tuning gives absolute hair line separation. Ease of op-

eration? The most inexperienced tuner gets foreign stations at the first try.

The I. C. A. Conqueror A.C. Model

uses a 224 screen grid in the R. F., 3—227 tubes, and a 2+5 in the special transformer - resistance - transformer type audio. The Conqueror is also to be had in Battery Model. For broadcast - band reception, special coils are supplied.

Dealers, professional set builders and service-men can make real money assembling and selling the I. C. A. Conqueror. Easy to make part- or full-time profits.

Order from jobber or mail order house. If they can't supply, send direct. List price of set (either AC or Battery Model) \$65—Net \$39. A. C. Power Pack list price \$34.50—Net \$20.70. Send for catalog and full information free on request.

READ THIS LETTER

Here is world-wide reception for you! Read what Mr. Bruce Nichols, of St. Jean de Luz, France, has to say:

"The Conqueror short wave set purchased from you on October 3rd is a marvel. Results are absolutely satisfactory. All I can say is that with good conditions reception is world wide. The range is unlimited. Chicago, New York, Buenos Aires, Schenectady, Sydney, San Lazaro, Java, Nairobi, Manila, Bangkok (Siam) have all been received. (Signed) BRUCE NICHOLS, St. Jean de Luz, France."

INSULINE CORP. OF AMERICA, 78 Cortlandt St., New York

S - T - O - P !

NOW that you have seen SHORT WAVE CRAFT, we know that you don't wish to do without a copy. To new subscribers we have a special offer that will be void after February 10th.

Those who believe in this publication and wish to receive their copy every other month, NOW have the opportunity to subscribe at a considerable saving. You will receive SHORT WAVE CRAFT at a 33 1/3 % reduction from the regular subscription rate — also the three first issues GRATIS.

Fill out the coupon and rush it in before you forget it. IT IS A CHANCE YOU WILL NEVER GET AGAIN.

Short Wave Craft,
93B Park Place, New York City.

Gentlemen:

Please enroll me as a subscriber to SHORT WAVE CRAFT for which I enclose herewith \$2.00 for one year's subscription, and am to receive the three first issues GRATIS. (\$2.50 CANADA AND FOREIGN.) I understand that the full subscription price is \$3.00 a year.

NAME

ADDRESS

CITY AND STATE

A One-Coil Super-Het Converter

(Continued from page 353)

forms; the grid winding may be of No. 18 gauge enamelled, and the regeneration or tickler winding of No. 26 D.S.C. It should be noted that the turns of this winding are placed between the turns of the grid winding.

For "B" supply, 90 to 135 volts upon the detector and 45 volts on the oscillator works admirably.

Increasing capacity of C2 the needle of the meter should kick upwards; this indicating that the oscillator is generating local oscillations and that "all is well".

The best operating conditions will be when the plate current of the oscillator is about 1 to 3 M.A., more than that shown when the tube is not oscillating.

It is assumed that this converter will be used with a broadcast receiver having its "A—" and "B—" common to ground; but, should it be ascertained that the said receiver has "B—" joined to "A+," it will be necessary to insert a large-capacity (1 microfarad) condenser between the negative output binding post of the converter and the "Gnd" binding post on the broadcast receiver. The ground lead should then be connected to the ground binding post on the converter, and not to the broadcast receiver as well.

Should "A—" and "B—" be common, then all is well to connect up the converter's positive output lead to the aerial terminal of the receiver, and the converter's negative lead to the ground post of the receiver.

With one converter which I constructed, I found that when a signal built up enormously—as they sometimes do—a roar was experienced which I could not trace to the converter or the broadcast set. I did find, however, that this annoying occurrence was completely eliminated by building the converter entirely in an aluminum box, made of 14-gauge aluminum and measuring about 12x10x7 inches high.—E. T. SOMERSET.

AIRWAY INTERMEDIATE TRANSMITTING CONDENSER

The Airway Intermediate Transmitting Condensers were designed to meet the need for a condenser in low-power installations where weight and space are essential factors.

They are made entirely of aluminum, which accounts for a weight of 3 1/2 ounces, for the 50 mmf. size and 8 ounces for the highest capacity manufactured, which is 150 mmf. The space occupied by the latter is 2 3/4" x 5".

Here are some of the special features of the Airway Intermediate Condenser: Rigid phosphor bronze spring, which insures perfect contact; extension shaft, which permits ganging, and three-post supports for the end plates, which guarantees absolute rigidity, thereby eliminating all possibility of change in adjustment. If desired a single-hole mount can be supplied at slight extra cost, as well as brackets for base mounting. Voltage breakdown rating 1,500 volts.

Adding Untuned R.F. Stage to Walker Flexi-Unit

(Continued from page 355)

in the radio frequency stage, and a '99 tube in the detector socket of the Walker Flexi-unit. Later a B eliminator was substituted for the B supply, the one used being one of the well known All-American type, which was built with extra large choke coils and which yields practically humless B supply current. The A supply was furnished in one case from the 4 volt terminals of a Knapp A eliminator, and in another series of tests by a 4 volt A eliminator of the Balkite type. Practically no hum was noticed in any case, even though many short wave enthusiasts shout loud and long for "batteries only." With slight modifications this circuit can be re-arranged to use a '24 screen-grid tube in the radio frequency stage and a 227 A.C. tube in the detector stage, using an ordinary 2.5 volt filament transformer for the heater supply and any good B eliminator such as the one mentioned above for the B supply.

Where a fairly long aerial is used or in the event that too many dead spots are noticed in the tuning, the midget con-

denser connected between the terminals 6 and 8 on the Walker Flexi-unit, may be connected in series with the antenna and by turning this condenser the dead spots can be eliminated. In the writer's case varying the coupling condenser served a similar purpose.

The list of parts needed in adding this untuned radio frequency stage to the Walker Flexi-unit is as follows:

- 1—Variable resistor 10,000 to 100,000 ohms; Bradleyohm, Clarostat, etc.
- 1—Adjustable 6 to 10 ohm resistor
- 1—15 to 20 ohm filament rheostat
- 1—2 M.F. by-pass condenser, 250 volt rating
- 1—85 M.H. radio frequency choke
- 1—50 MMF. midget condenser for coupling plate circuit to Walker Flexi-unit
- 1—0 to 1,000 ohm variable resistor; Bradleyohm or Clarostat, etc.
- 1—Bradleystat or other filament rheostat to add in series with A battery to Walker Flexi-unit
- 1—'22 Screen Grid tube
- 1—Detector tube, '99, etc., depending upon filament voltage used.

A New, Popular Portable S-W Receiver

By A. BINNEWEG, JR.

THE short waves offer such wonderful opportunities for good distance reception with a small number of tubes, that portable receivers are bound to be popular for a great variety of uses. Such sets are particularly useful for use in automobiles, airplanes, yachts, etc. It is really surprising to receive stations from thousands of miles distance while traveling leisurely along in one's car. Only a short aerial (easily strung up in the car) need be used on a short-wave set of this kind.

Uses New 2-Volt Low-consumption Tubes: The Delft Radio Co., has placed on the market an inexpensive portable receiver in kit form (also completely assembled) to meet the demand for such sets. The kit itself can be assembled in a short time by even a novice. The efficiency of the usual portable set has been improved and the weight has been reduced, by using the new 2-volt tubes, which operate for a very long time on only two ordinary dry cells.

This portable set is very light in weight, measures only 8" by 18" and has a depth of only 5". Yet the design is such that high efficiency is maintained. It is very sturdily built. The set is entirely independent of all external sources. A hinged lid at the front allows the phones to be slipped inside, after use, before "moving on." The vertical construction of this set is such that it is very convenient to carry, or to mount in a plane or automobile. It can be operated easily, anywhere in field work, from a sitting or kneeling position, as the dials are just the right height. The set has a detector and stage of audio amplification, and will also use any of the usual tubes, should this at any time

be desirable. It, of course, receives either code or broadcast music.

The illustration herewith shows the front of the case removed. A 10 ft. length of aerial, or more, is normally used as antenna. Two posts at the rear, top, provide terminals for the aeri-als and ground connections. A spike, driven in the ground, usually furnishes a good enough ground connection for short wave use. In a car, the frame is used as ground.

A special tuning condenser is used to provide easy tuning. Tube-base coils are easily plugged in at the lid, to change the wavelength to which the set tunes. Extra coils can be carried in the case with the phones.

This set will meet all the requirements for a portable receiver and will therefore be quite popular where such a set is necessary.

Portable-Delft.

Latest Short Wave Portable set, useful in motor - car, boat or 'plane. It uses the new 2-volt low consumption tubes. The case contains set, phones and batteries.

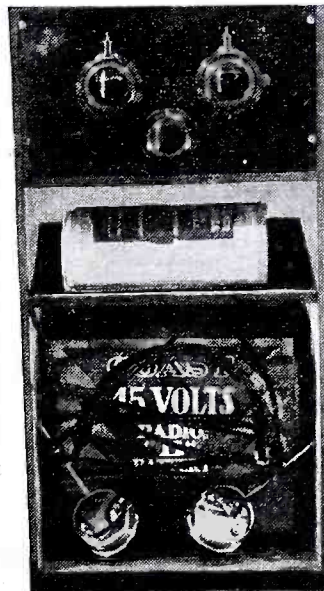

For Stronger SIGNALS and Improved QUALITY

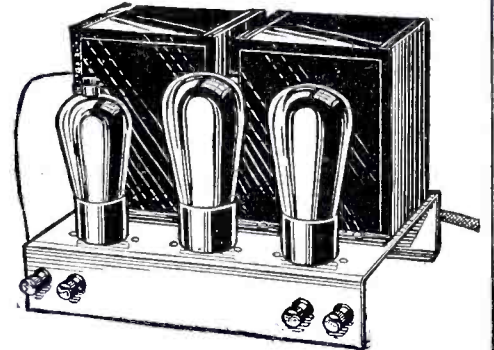

The

Licensed under R.C.A. and Loftin-White Patents

ELECTRAD Model A-245 Loftin-White AMPLIFIER

WHAT a wallop it gives to those way-off signals—and tone that is a musical revelation!

The Electrad A-245 Amplifier is simplicity itself, because it embodies the famous Loftin-White Direct-Coupled Circuit which makes tubes work as they never worked before.

Delivers 1.6 watts undistorted output with but three tubes—one 224, one 245 and one 280 full-wave rectifier.

The A-245 is the ideal amplifier for short-wave work, whether you listen with phones or speaker—and its cost is low. Only \$40, completely assembled, less tubes, or in convenient kit form, less tubes, for \$35.

Electrad also makes two higher-powered amplifiers, using a 250 type tube for output and two 250 tubes in push-pull.

Mail Coupon for Data

ELECTRAD, INC., Dept. SW-1, 175 Varick St., New York.

Please send me Electrad Loftin-White Amplifier circular.

Check here for literature on complete Electrad line of resistors and voltage controls.

Name

Address

ELECTRAD INC.

RADIO MAP OF NORTH AMERICA

Showing all Countries States and Provinces and all Cities having a broadcasting station.

*Printed on good paper, 22 x 22
with cover.*

*Simple method of measuring distances.
Time zones accurately shown.*

Contains complete list of broadcasting stations arranged geographically, with power, call letters, frequencies and key for instant location on map.

Price only 25 cents

Every radio listener should have one.

RADEX, The Radio Fan's Own Magazine. Contains the most complete, accurate and up-to-date list of broadcasting stations published.

Cross-indexed by dial numbers, frequencies, wave-lengths, call letters and countries, states and cities.

So arranged that merely entering dial numbers calibrates any set thus showing exactly where to set dials even for stations never before received. "What's on the Air Tonight?" and "What's Wrong With My Set?" are two regular and interesting features.

25c per copy, \$1.75 per year

THE RADEX PRESS, 1311 E. 6th St., CLEVELAND, OHIO

How to Build a Good Television Receiver

By R. WILLIAM TANNER, W8AD

(Continued from page 383)

given. All experimenters have their own pet ways of set-building and makes of various parts. Even when "point-to-point" details are given in descriptions of receivers, such men always work in accordance with their own ideas. For this reason, the writer assumes that the builder will do likewise with this set and he therefore does not add a lot of unnecessary words.

His experimental television receiver was only a breadboard model, and far from being a good looking job; therefore specifications are given herewith for a permanent, modern layout. A "721" S. M. pierced metal chassis should be purchased, together with six UY five-prong and one UX tube sockets, sub-panel type. These are mounted as shown in the layout (Fig. 3).

If the builder does not care to go to the trouble of constructing the R. F. transformers and shield cans, Silver-Marshall "Type 123" broadcast transformers may be used, by removing turns from both the primaries and secondaries. A total of 50 turns should be left on the secondaries and 40 on the primaries.

These transformers may be readily mounted, in the holes provided, directly under the gang condenser. All fixed resistors, bypass condensers and R. F. chokes should be mounted underneath the metal chassis.

No. 14 insulated tinned wire must be used for the filament circuits; though No. 18 is large enough for the R. F. and other circuits.

After the set is completed, connect it to a good power pack and insert the tubes. Assuming that the set is ready to operate, tune in, say, W2XCR (in Jersey City, N. J.) on approximately 105 meters. This is done by listening in on the speaker. Then switch over to the neon tube and start the scanning-disc motor.

A Jenkins "Model 100" radiovisor was used by the writer; so the operation of this will be described. Turn the motor rheostat up so that the disc passes through and beyond synchronous speed; and then retard its speed slightly by cutting down on the rheostat. Reduce the speed still further by braking the motor shaft with the thumb and forefinger; until the picture appears. If the picture tends to progress to the right, the speed of the motor is too high, and the rheostat should be cut down still more. If the progress is to the left, either the speed of the motor is too slow or the braking was not done correctly.

After synchronization has been reached, the picture may "hunt" slightly but, in time, will steady down of its own accord. The effect may be hastened by braking the motor shaft each time the picture swings to the right.

Framing the picture, either horizontally or vertically, is accomplished by means of the hood covering the neon tube; this is supplied with the radiovisor kit.

The standard scanning disc used at most transmitting stations is the 48-hole type, so this should be specified when purchasing the radiovisor.

Very little has been written on the subject of television, especially in regard to the R. F. end; therefore this article should be helpful to those interested in the most fascinating branch of short waves.

The writer will be glad to advise anyone on other details upon receipt of a stamped envelope.

Short Wave Oscillations

(Continued from page 348)

Other work being carried on includes 24-hour continuous transmission (using directive radiators) on the 28 megacycle band (around 10.7 meters) during each Sunday in January, from midnight to midnight, Greenwich time. In March, over the whole of each Sunday, the British amateurs will endeavor to work "at least all Europe" on the upper amateur 1750-kc. (171-meter) band.

Newest Work in Germany on Ultra Short Waves

By DR. FRITZ NOACK
(Continued from page 375)

equally strong, whether the plane flew at the height of 300 or 36,000 feet. Below three hundred meters, a decrease in the volume was observed; below a hundred meters in height, it entirely ceased.

At a height of three hundred feet, the first telegraphic signals were received at a strength of R4 to 6. The range was then six miles. But, frequently, reception failed within this range; which was probably attributable to the fact that the plane screened the receiver from the transmitter. It was also found that reception in the plane also began to weaken at three hundred feet, and ceased at a hundred. It made no difference whether telephony or telegraphy was used. The energy of the transmitter, used on the ground, was likewise from one to two watts; evidently insufficient, if planes having many metal parts were used.

In consequence further flights were undertaken, a transmitter being set up on a tower near Jena; it had a power of 70 watts and operated on a tripolar or Hertzian antenna.

The flight was made between Berlin and Nuremberg; Fig. 7 shows what results were obtained. In the graph, both the sound strength and the distance of the plane from the Jena transmitter are given; likewise the altitudes of flight, both ways. The numbers not in parentheses behind the names of the places indicate the flying height in meters in the flight from Berlin to Nuremberg, while the figures in parentheses indicate the flying height on the return flight. The width of the shaded parts indicates the volume of reception; the widest shading shown corresponds to about R10.

The transmitter was first heard at a distance of 28 miles from Jena, at a height of 2,000 feet, the strength being R4 to 5; at a height of 3,200 feet it rose to R9 to 10. During further flight the strength remained practically constant within a distance of from thirty to fifty miles. At a distance of sixty-two miles, reception entirely ceased.

On the return flight the transmitter was first heard at a distance of twenty-five miles at a height of 1,600 feet. The transmitter could be received up to a distance of fifty-five miles, the altitude being, however, only 1,140 feet. At a greater distance from the transmitter, the latter was no longer to be heard.

It is to be noted that reception in the plane commenced only when the latter had the transmitter at one side; and that it became strongest when the plane was flying away from the transmitter.

The results seem to confirm the theory outlined above, but shielding disturbs reception to an extraordinary degree.

(To be concluded)

HUMBLESS

A. C. Operation

on the Short Waves with the New A. C. Thrill Box

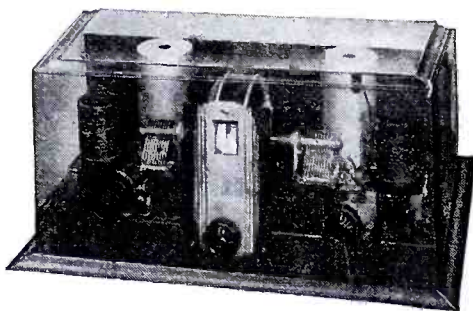

COMBINES every requirement of the expert Short-Wave Experimenter and Amateur, and the Radio Enthusiast who wants good loud speaker reception of SW broadcasts from all over the world. Not a compromise between a Short-Wave and Broadcast circuit. A.C. Model gives FULL A.C. OPERATION. No hum, even with head phones. DOUBLE SCREEN-GRID with grid-leak detection. Special New R-39 Type R.F. Coupling Transformers. No special tubes required. Uses standard heater tubes throughout. Single dial operation, easy to operate and log. Uses New NATIONAL Projector Dial. No grunting or backlash, no hand capacity; Loud Speaker operation from Foreign Stations; push-pull audio with special phone-jack after first stage.

Thoroughly shielded chassis. Easy to assemble and wire. Ideally suited not only for Short-Wave Broadcast reception, but for all S. W. amateur and communication uses. Easily adapted for still wider spread of amateur bands, if desired. Perfect performance down to 9 meters, using NATIONAL R.F. Transformers No. 10.

Also available in new battery model, using the new UX 230, 231 and 232 tubes.

NATIONAL

PRECISION SHORT-WAVE RADIO PRODUCTS



EVERY new issue of SHORT WAVE CRAFT brings out the most important developments in short wave radio—both American and European improvements. Contributions and renowned short wave experts are found among the pages of every issue of SHORT WAVE CRAFT.

The New NATIONAL A. C. SW-5 THRILL BOX is easily assembled by anyone with genuine NATIONAL Radio Parts. Some of the more outstanding of these are described below.

R. F. Transformers



Standard set of four pairs covering from 21.2 to 2.61 m.c. Special coils can be supplied for the 33—21.2 m.c. and the 2.61—1.5 m.c. ranges. Forms are moulded R-39, the new low loss coil material, developed by Radio Frequency Laboratories.

Blank forms also available for winding experimental coils.

The Condensers

The type S-100, specially designed for short-wave work, not a cut-down broadcast condenser. Insulated main bearing and constant impedance pigtail. 270 degrees straight frequency line plates.

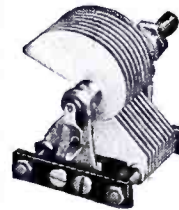

The Dial



The NATIONAL Projector Type Drum Dial, standard equipment on the A. C. Thrill Box has the same easy control that is characteristic of the National Velvet-Vernier Dials. Equipped with non-metallic drive, avoiding clicking and de-tuning. The dial scale is projected in magnified form on to

a ground glass screen which reads the same from any position, without parallax. The escutcheon, of beautiful modern design, is finished in brush silver.

The Power Unit

A separate unit, with handy cable and soft rubber-covered connecting plug. Designed for humless operation, incorporating special R. F. filter in addition to double section hum-filter. Employs UX-280 Rectifier tube and licensed under R. C. A. Patents.

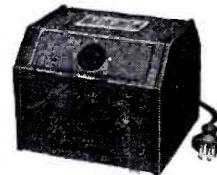

NATIONAL CO., INC. SWC-2
Sherman, Abbott and Jackson Sts.
Malden, Mass.

Gentlemen:
 Please send me, free, Short Wave Bulletin No. 111.
 Enclosed, please find 50c (stamps or coin) for your new NATIONAL SHORT WAVE HANDBOOK, describing all the new Short Wave Circuits (just off the press).

Name
Address

**Radio Men
Everywhere—ENDORSE
KEITH HENNEY'S
"RADIO"**

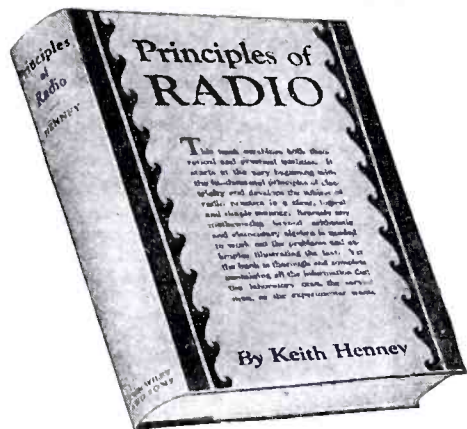

**PRINCIPLES
of RADIO**

By Keith Henney

Formerly, Director of the Laboratory
Radio Broadcast Magazine

Keith Henney's book on Radio scored an immediate "hit" on its publication a few months ago. Thousands have already purchased it and are enthusiastic about the valuable material which the author has made available.

This book brings together within one cover the kind of information on radio which will appeal to the practical interest of every radio experimenter, technician, engineer, and fan. It contains the latest data and the most modern methods. It treats in a thoroughly practical way everything from the production of radio currents to their reception and transmission. Scarcely any mathematics beyond arithmetic and elementary algebra is needed for a complete understanding of the theory and applications.

See a Copy
on Ten Days' Approval
Price, \$3.50

A Wiley Book

JOHN WILEY & SONS, Inc.,
440 Fourth Avenue, New York.

Gentlemen: Kindly send me on approval Henney's "Principles of Radio". I agree to remit the price (\$3.50) within ten days after its receipt or return the book post-paid.

Name

Address

Reference

SWC 1-31

Transmitting on Ten Meters

By A. BINNEWEG, JR.

(Continued from page 367)

experiment to employ a circuit like B at a wavelength of ten meters, if a tube is available; the effect, however, can even be noticed on low power. With high power, the usual precautions should be observed to prevent burns. For high voltages, the condenser used in the oscillating circuits should have a wider separation between plates; but this is easy at ten meters, because the required capacity is very small. The lower the losses in the oscillating circuit and associated equipment, the higher the voltages built up. Thus one can compare the efficiencies of various coils and condensers for use in the ten-meter band of frequencies.

Design of Antenna System

Of course, a transmitting amateur naturally wants to put the transmitter on the air, after it has been properly tested. It is often difficult to couple a transmitter properly to the antenna at extreme frequencies, because of the relatively large effects of small factors. Even the introduction of an ordinary antenna ammeter into the antenna circuit may throw the antenna out of proper balance, because of the inductance inside the instrument! All ordinary apparatus must be viewed with suspicion and not assumed to be faultless at lower frequencies. For example, an attempt to use an ordinary variable condenser in series with a ten-meter antenna will show some interesting "loading" effects; the minimum capacity alone may be more than enough in itself; naturally any attempt at tuning, then, results in confusion. Therefore, one must use more or less special apparatus if best results are to be obtained.

By "special" we do not mean expensive; for all the necessary apparatus which is at all "special" can easily be constructed in a short time. For example, the disc condensers which have been found especially useful and effective for tuning a Zeppelin antenna for ten-meter use, can easily be constructed from a pair of parallel plates and a pair of wall insulators. The round copper (or brass) plates are soldered to pieces of copper tubing at their centers; the tubing is flattened at the ends, and holes drilled to fit over the screws on the wall insulators. Round plates, 4 inches in diameter, will ordinarily serve for all-around use. Fig. 5 shows the ten-meter antenna in detail, while Fig. 3 shows how it is coupled to the oscillator by means of the special disc condensers.

It is not so easy to adjust properly one of these antennas, for best operation at these frequencies, because small changes have large effects on results. It is necessary that the waves be in proper relation on the wires for proper cancellation in the feeders of the Zeppelin antenna (this applies at other frequencies also). Any small change may so affect the relations of the waves on the wires that

proper cancellation is impaired, or radiation is at some unknown angle. Therefore it is best to so design the antenna and feeders (this, too, is a simple problem, because the necessary lengths are short) that one can easily reach them for testing with a small neon tube or pencil.

By proper adjustment, followed by an actual test, one can be assured that the antenna is operating properly. After that, the reflector wires can be installed as described later.

Reflectors for Short-Wave Transmission

At ultra-short wavelengths, of the order of ten meters, reflectors become of convenient size; so that one can realize a generous gain in signal strength by simply hanging up a few tuned wires. This is much cheaper than installing equipment to increase the signal strength at a given location by a corresponding amount. By using reflecting systems at both the transmitting and receiving stations, highly reliable communication results with a minimum of interference and apparatus. The simplest type of reflector consists of a single wire, spaced one-quarter wavelength from the transmitting aerial. This wire must be carefully tuned, in order to absorb from the transmitting aerial as much energy as possible.

The action of a reflecting aerial is perhaps not at first apparent to the average short-wave experimenter. This wire must be carefully tuned, so that it has a natural period corresponding to the frequency transmitted. When it is tuned, considerable energy is absorbed. The usual explanation, so often found in popular radio journals, is that the "reflector" wire reflects the wave striking it; though in one sense this is true, this explanation is not quite scientific. The reflector aerial absorbs energy from the main aerial (in some systems both systems are excited, but here only the "main" antenna is assumed to be directly excited by the oscillator) and reradiates it.

Thus, the reflector wire gives the wave in the direction of transmission an increase in strength, just as the old one-tube "bloopers" used to do in the vicinity; the strength of the received signal was increased so much that even crystals could receive apparently over thousands of miles!

Technically, the spacial relations and the phase differences of the oscillations in the two wires are such that there is cancellation at the rear of the reflector and reinforcement in the direction of transmission.

The reader, perhaps, wonders whether the gain in signal in a given direction is marked. In experiments it has been found that the power radiated in a given direction is practically doubled by the addition of only a simple wire structure. Moreover, the energy is then directed in the desired direction.

SWAPPERS

SWAPPERS are swappers of correspondence. During the past few years we have noted that Short-Wave enthusiasts love to get acquainted with each other by mail in order to swap experiences.

That's the reason we have opened a department for them under the above heading, in which we will print the names and addresses of all those who wish to correspond with others. As we know we will be deluged with requests, please be sure to follow these simple rules: Use a postcard only. Never write a letter. Address postcard as follows:

SWAPPERS
c/o SHORT WAVE CRAFT
96-98 PARK PLACE
NEW YORK, N. Y.

On the blank side of the postal PRINT clearly your name, address, city and State. Don't write anything else on card. We will then understand that this is your request to publish your name and address and that you wish to enter into correspondence with other short-wave readers. There is no charge for this service.

—EDITOR.

- EDWIN AFFLERBACH**
19 Belmont Avenue, Quakertown, Pa.
- EDWARD ANDERSON**
9606 San Antonio Avenue, South Gate, Calif.
- JAMES AUSTIN**
835 Federal Street, Camden, N. J.
- ERIC BLANHFELD**
715 Fifth Avenue, East, Ashland, Wis.
- EARLE B. BROWN**
152 Cottage Street, Everett, Mass.
- C. A. CONKLIN**
Madrid, Iowa
- JACK COSTELLO**
445 Gramatan Avenue, Mount Vernon, N. Y.
- JOHN DIETZ**
1660 Crotona Park, East, New York, N. Y.
- RUDOLPH DOSTAL**
5241 West 25th Street, Cicero, Ill.
- JOSE S. DULAY**
P. O. Box 769, Pocatello, Idaho
- RICHARD B. EDWARDS**
36 Patterson Avenue, Greenwich, Conn.
- EDMUND EISENMEIER**
3122 Foster Avenue, Baltimore, Md.
- W. A. ELMORE**
113 Fairley Street, Laurinburg, N. C.
- ORA S. EMIL**
28-W. Roosevelt Road, Oak Park, Ill.
- H. F. FELDMANN**
Wauzeka, Wis.
- JOHN E. FREELAND, 8WPH**
Mount Ayr, Iowa
- I. CLIFFORD GOODMAN**
14 Sunny Side Way, New Rochelle, N. Y.
- RICHARD J. GREGG**
1709 Euclid Avenue, Cleveland, Ohio
- RICHIE T. HEPBURN**
Rogers, Ohio
- WILLIAM E. HUNTER**
129 Cleveland Street, Central Falls, R. I.
- ROBERT JOHNSON**
R. F. D. 3, Box 252, Kent, Ohio
- CLAUDE L. JONES**
Bayshore, Florida
- JOHN KEMP**
54 Cochasset Street, Worcester, Mass.
- RUSSELL KICK**
2237 81st Street, Brooklyn, N. Y.
- LOUIS KOLLATH**
1722 Manhattan Avenue, Youngstown, Ohio
- JOSEPH MATHEW KRYNITZKY**
84 High Street, Mystic, Conn.
- ALIX KUCHARWICZ**
219 Adam Street, Newark, N. J.

- JOHN LARKIN, Jr.**
829 34th Street, Milwaukee, Wis.
- HARRY G. MEEKS**
2808 Buren Avenue, Camden, N. J.
- GLEN D. MEREDITH**
530 Rock River Avenue, Three Rivers, Mich.
- RALPH MILLER**
R. F. D. No. 2, Wellington, Ohio
- FREDERICK G. NATHO**
2011 Hollins Street, Baltimore, Md.
- O. G. NELSON**
38 St. Anthony Street, Worcester, Mass.
- O. T. NIEHOUSE, Jr.**
1208 Hodiament Avenue, St. Louis, Mo.
- CLIFFORD J. NIEMEYER**
4417 Vermont Avenue, Covington, Ky.
- W. H. NILSSON**
19 Seventh Street, Savannah, Ga.
- JAMES R. OLIVER, W8CPW**
First Street, Waterville, Ohio
- JOS. RICARD**
2117 Nash, Sioux City, Ia.
- EDW. SAUNDERS**
1804 Henley Street, Glenview, Ill.
- NAT F. SCHILLING**
961 Eastern Parkway, Brooklyn, N. Y.
- LOUIS SELTZER**
2808 W. Lehigh Avenue, Philadelphia, Pa.
- WILLIAM SHAINLINE**
West Side Apt., Apt. 4, Locke Street, South, Hamilton, Ontario, Canada
- SIDNEY SKEMER**
32 Saratoga Avenue, Yonkers, N. Y.
- ROBT. S. SPRINGER**
Normal Station, Conway, Ark.
- DANIEL E. STEVENS**
6524 Lebanon Avenue, Philadelphia, Pa.
- C. R. SWENSON**
738 Spring Street, Hot Springs, Ark.
- HERBERT RITTER VAN HOOSE**
3815 Fifth Avenue, Morningside, Sioux City, Iowa
- RAY A. WALTERS**
418 W. North Street, Danville, Ill.
- BERYL C. ZUMWALT**
Robertsville, Mo.

Away Down In The Argentine

(Continued from page 370)

from Buenos Aires. The main house and outbuildings are connected by a sixteen station Western-Electric inter-communication system, so that from any room in the house it is possible to talk with anyone on the outside fence system. The telephone system therefore serves a double purpose. It may be used for communication purposes on affairs of the ranch, or, in the evening, Mr. Kelley may distribute to his tenants via the fence line, the output of his "short wave" radio receiving set. With a suitable receiver it is possible to tune in on the radio program at any point on the fence. This enables Mr. Kelley to set his receiver for a particular station and then at the hour stock or produce market reports are on the air, to tune in at whatever point of the ranch he happens to be at that time. Radio reception from the fence at any point requires only an ordinary sensitive telephone receiver without batteries.

Mr. Kelley finds the radio invaluable in his business. He listens for cattle market reports. If they are favorable he immediately ships some of his stock to the market. He thus gains several hours on those dealers who wait for the following morning's papers for the price quotations of the previous day.

"SHORT and Sweet"

The shorter they are, the sweeter the thrills, say short-wave fans. But it takes real equipment to bring 'em in and hold 'em. Short-wave experimenters everywhere praise the performance of Hammarlund Condensers and Coils.

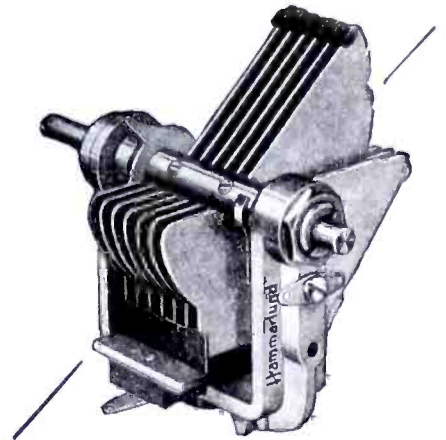

The new Hammarlund Short-Wave Condenser has heavy, widely-spaced plates for strength. Less chance for accumulation of dust, causing capacity changes in close tuning.

"Parmica" insulation, the remarkable new material which so closely matches the ideal dielectric efficiency of dry air. Current loss greatly reduced; sensitivity and selectivity improved.

Double cone, smooth-operating bearings—easily adjusted for wear. Non-corrosive brass plates, with tie-bars. Strong aluminum alloy frame.

A real short-wave condenser in the three most desirable sizes: 150, 125 and 100 mmf.

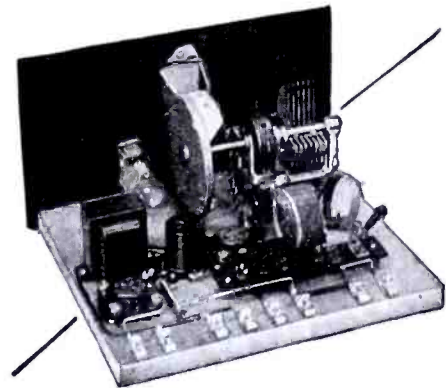

Here's fun for the short-wave fan. A remarkably efficient two-tube distance getter, with regenerative detector and one audio-stage. Designed for use with the new 230-type, 2-volt battery tubes. Easily constructed from the Hammarlund kit, containing all parts as illustrated.

It includes the famous Hammarlund Drum Dial, the new Hammarlund wide-spaced short-wave "Midline" condenser and the improved Hammarlund space-wound plug-in coils. Covers 15 to 105 meters. Extra coils are available covering wave bands from 10 to 225 meters.

Makes a wonderful tuning unit for the short-wave experimenter.

Write Dept. SW-1 for data on these and other Hammarlund Short-Wave Equipment.

HAMMARLUND MFG. CO.

424-438 W. 33rd Street, New York

For Better Radio
Hammarlund
PRECISION
PRODUCTS

RADIO and TELEVISION **\$3** Home Study Course Only

*Valuable Lesson Helps, Code Chart,
Books and Supplies Furnished FREE!*

This most unusual offer is a part of the nation-wide good-will campaign of Station WCFL, Chicago. Secured in any other way such a course would cost you a lot of money, but WCFL needs your friendship and, as a means of getting better acquainted, makes you this astonishing offer—

Complete Radio and Television Home Study Course With All These Supplies:

- HANDY LOOSE-LEAF FLEXIBLE LESSON BINDER
- RADIO AND TELEVISION POCKET DICTIONARY
- SIMPLIFIED RADIO ELECTRIC THEORY
- ELEVEN VALUABLE LESSON STUDY HELPS
- RADIO CODE CHART AND STUDY HELP
- LARGE RADIO SCHEMATIC AND TEMPLATES
- MEMBERSHIP IN WCFL RADIO STUDY CLUB
- WCFL RADIO MAGAZINE FOR ONE YEAR

All for Only \$3 — Nothing More for You to Buy!

WCFL, the only station owned and operated by Organized Labor, is now engaged in a desperate battle for the preservation of the freedom of the air and for equitable radio facilities for the toiling masses. In this struggle against oppression, WCFL urgently needs your moral support, and to gain your friendship makes you the unusual offer listed above.

WCFL is a pioneer in radio and television experimentation. It was the first station to broadcast television on an aural wave-length, and is now engaged in world-wide short-wave tests—W9XAA, 6080 k.c. and 11,840 k.c. The results of these costly experiments are available to you through the WCFL Radio and Television Home Study Course.

More than 85,000 students are now enrolled. The course is in its second year of successful operation. Many of our students earn money right from the start servicing radio sets. Here is your big opportunity. Grasp it today.

WCFL Radio Study Club, 623 So. Wabash Ave., Chicago, Ill.

WCFL Radio Study Club, 623 So. Wabash Ave., Chicago, Ill.

For the attached Three Dollars enroll me in the WCFL Radio Study Club and send me the WCFL Radio and Television Home Study Course, and the booklets, lesson helps, code chart and supplies just as listed above, also WCFL Radio Magazine for one year.

Name.....
Street Address.....
Post Office.....State.....

Propagation of Radio Waves

By DR. J. FUCHS

(Continued from page 368)

It is surely not without interest that, on the mention of an ionized terrestrial atmosphere, students of terrestrial magnetism are glad to point out that as early as 1882 Balfour Stewart, and, in 1886, A. Schuster assumed the existence of a conducting stratum in the highest terrestrial atmosphere, in order to account for the variations of the terrestrial magnetic field occurring in the period of a day. They were therefore some twenty years ahead of Kennelly and Heaviside, who indicated its existence solely on the basis of the phenomena of radio waves. The unfortunate fact about this joint hypothesis is that

the phenomena of radio propagation require a very different constitution of the higher strata of the atmosphere than those of terrestrial magnetism. So far it has not been possible to reconcile in a convincing manner the necessary figures to explain both theories.

Perhaps we cannot summarize the present situation better than by stating that it has been determined that terrestrial magnetic disturbances have a great influence on wired telegraphy, both over the land and under the sea; that in times of terrestrial magnetic disturbances of great intensity, which occur together with extensive displays of the

Aurora Borealis, wired telegraphy is often actually crippled, but so far we have been unable to determine with equal certainty the effect of these terrestrial magnetic disturbances upon the propagation of radio waves. For this purpose extensive observations have been made recently in Canada and Alaska, very near the northern magnetic pole, dealing at the same time with terrestrial magnetism, auroral lights, and radio reception. It has been only possible to determine that, for practical purposes, there is no connection. Likewise three years of observation at the Meudon observatory of terrestrial magnetism near Paris have been unable to show any connection.

As against these negative observations there are only a few observations which favor a connection of the two series of phenomena.

For these reasons it appears permissible to assume, at present, that the effect of terrestrial magnetism upon the propagation of radio waves must be called practically unimportant.

Why they attributed in former times so much significance to terrestrial magnetism is, I now think, due to the fact that the effect of another phenomenon on the propagation of radio waves, a phenomenon showing a far more complicated behavior, was also unsolved.

There is no evident connection between the weather and radio reception. The influence of cloudiness could never be demonstrated, and the investigation of the influence of air pressure and temperature was equally without result—or, rather, there was an equal amount of pro and con.

As to such investigations it is impossible to conceal the difficulties which prevent a satisfactory solution.

I mentioned, at the beginning of my article, that the conductivity of the surface of the earth has a great effect on the propagation of radio waves, especially those of great wavelength, and therefore that propagation over the ocean is better than over the land.

As for propagation over the ocean the conditions are fairly independent of the weather; the electrical qualities of the surface of the ocean do not change, whether it is clear weather or rainy. This is not so over the continents. Downpours greatly change the conductivity of the ground; the ground continues wet for some time, even when the purely meteorological conditions are no longer suitable for rain. And, for example, the relation of temperature to rain is subject to changes with the time of year. In the summer precipitation is connected with lower temperatures, in winter with higher.

Finally, in the case of the longer waves (over 100 meters) we have the troublesome circumstance that their propagation is influenced both by the surface of the earth through its conductivity and by the terrestrial atmosphere through its ionization.

If conditions are to be explained systematically, it is necessary at least to consider separately the simultaneous influences of the terrestrial atmosphere and the surface of the earth.

This has become actually possible by the use of wavelengths below 100 meters, because of the circumstance already mentioned: that these can go high above the surface of the earth and travel in the high stratosphere, while they are almost undetectable on the surface of the earth itself. In this case we have the assurance that, if essential changes occur in the propagation of these radio waves, they must have their location entirely in the stratosphere. (*The stratosphere is the upper region of the air, above the troposphere, in which changes of weather take place. The stratosphere is believed to maintain the same temperature unchanged. It is very rarified and highly electrified.*)

But to eliminate any possible effect of the surface of the earth, the observations in question were made between stations in Europe and America, where the chief distance lay over the Atlantic Ocean, which is unchangeable as to conductivity. The results could therefore be regarded as practically independent of precipitation.

The investigations which I undertook under these conditions (see *Zeitschrift für Hochfrequenztechnik*, vol. 32, October, 1928) indicated that all changes in the signal strength of the overseas stations certainly correspond exactly to the changes in air pressure in the stretch between; in this sense, that low air pressure increases the dead zone, while high air pressure lessens it. No relation to the temperature was observed.

Any other conclusion would have been surprising. For, after all, the air pressure is the meteorological factor which indicates at least one peculiarity of the

atmosphere above us and, indeed, of the entire atmosphere: namely its mass.

As to the connection between these changes in air pressure and the extent of the dead zone, I can give here the results of a still unpublished investigation of mine:

The increase in the area of the dead zone is due to a decrease in the angle of deflection of the waves; and that, again, to a decrease in the ionization. Therefore the enlargement of the dead zone with decreased air pressure is due to the lessened number of ions per cubic centimeter. Every quantitative change in the mass of air which occurs over a locality causes a proportional change in the ionic concentration in the air.

THE OUTLOOK

It is quite indubitable that all the changes which we observe in the propagation of radio waves have their origin in the changes in the atmosphere of the earth, as well as indirectly on the surface of the earth. With a sufficient amount of observational data, therefore, it will surely be possible to deduce the still missing relations; such as, for example, the temporary changes of the conductivity of the ground during and after precipitation and with relation to the temperature of the mass of air above it, and other factors. If cause and effect can once be shown here, then it must become possible, by considering the accepted facts as to phenomena occurring in the ionized atmosphere, to analyze exactly the course of the radio waves. But here we come closer to a problem, the general solution of which is of eminent practical importance: the foretelling of the propagation conditions of radio waves, in the closest connection with the methods and practices of meteorology.

I believe that this will be practicable at a not too distant time.—*Das Funkmagazin.*

Falkland Islands Hear W2XAF and G5SW

By WILLIAM T. MEENAM

(Continued from page 351)

the story of Bobby Jones' victory in the Open Golf Championship at Hoylake, Liverpool. They switched back to 5SW in time to hear Big Ben boom midnight, as the clocks at Stanley indicated 7:00 p. m. At 9:00 o'clock they tuned back to WGY and "to our amazement we heard the voice of President Hoover as he was about to present Admiral Byrd and members of his Antarctic Expedition, the award of the National Geographic Society. The words of the President could be heard distinctly and but for the impression of the voice rising and falling, the speaker might have been in the very room." This entire program was also distributed to all subscribers of the local telephone service being relayed to the homes over the telephone wires.

Radio reception is no longer first page news in most countries but it is and will probably remain a feature story for residents of the Falkland Islands. Reference books disclose that the Falkland Islands are four weeks away from England by mail. There are 100 islands with a population of less than 2,500, most of whom are interested in sheep farming, the chief activity of the island. Stanley, on the east coast of East Falkland, has a population of 905 people. The climate is equable with an average of temperature, during two midsummer months, of 47 degrees Fahrenheit and during two mid-winter months of 37 degrees. Rain or drizzle, as it is mostly, is felt 250 days of the year and the wind blows almost unceasingly, often reaching the proportions of a hurricane. In such a country, radio broadcast programs mean something.

NEW...

THE

MID WAY



FEATHERWEIGHT

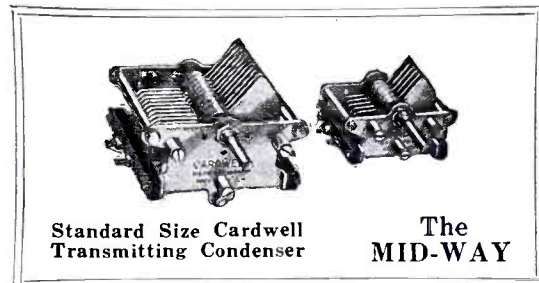

Standard Size Cardwell Transmitting Condenser

The MID-WAY

Note the Difference in Bulk!

A COMPACT, feather-weight variable condenser for purposes where reduction of bulk and light weight are desirable in transmitters, receivers and oscillator-amplifier outfits.

A smaller CARDWELL (not a "Midget"), but having the same solid, strong construction for which the larger CARDWELL has so long been famous.

Aluminum is used throughout with a few minor exceptions. As a result the largest sizes (.000150 mfd. for transmitting and .000365 mfd. for receiving) weigh only 7 ounces, the smallest only 4 ounces, and a panel space of only 2 3/4" x 2 1/8" is required.

Here are the sizes and prices—Receiving "Midways" (airgap .031 inch), (also suitable for low power transmitters using '10 type tube).

.000026 mfd.....	\$2.10	.000150 mfd.....	\$2.40
.000050 mfd.....	2.20	.000260 mfd.....	2.75
.000070 mfd.....	2.30	.000365 mfd.....	3.00

Transmitting "Midways" (Airgap .070 inch). (Suitable for transmitters using up to 75 watt tube.)

.000022 mfd.....	\$2.60	.000070 mfd.....	\$3.60
.000035 mfd.....	2.80	.000100 mfd.....	4.25
.000050 mfd.....	3.20	.000150 mfd.....	5.50

Send for literature for additional information. If unable to get from your dealer, order direct.

The Allen D. Cardwell Manufacturing Corp.

85 Prospect St., Brooklyn, N. Y.

"THE STANDARD OF COMPARISON"

GUARANTEED RADIO TUBE SALE

All Tubes Guaranteed for 6 Months

FOR THE FIRST TIME, a standard brand of radio tubes is sold at extraordinarily low prices, yet each and every one of the tubes is guaranteed in all respects for 6 months.

All tubes are date stamped and any tube that fails to make good for ANY reason will be replaced free of charge within 6 months.

Radio tube users have become wary of so-called cheap tubes. Such tubes are nearly always "seconds"; that is, tubes that have failed to pass the manufacturer's tests. These tubes do not give good service and therefore are never guaranteed for any length of time.

NEONTRON tubes are manufactured by one of the oldest, reliable Eastern tube manufacturers and we have made special arrangements for this unparalleled sale. You will find here tubes that you cannot buy elsewhere, yet the price is low when you figure the long service that these tubes will give you. There are no better tubes made than NEONTRON, regardless of price.

Order from this page and please note particularly the following terms.

No orders accepted for less than \$3.00.

All prices are F. O. B. New York.

No replacements after six months.

If you wish a tube replaced, it is necessary to return it to us and we will send you a new one immediately.

It is not necessary to send full amount of cash with order, so long as you send 20% of the value with your order.

Shipment will go forward to you by express collect.

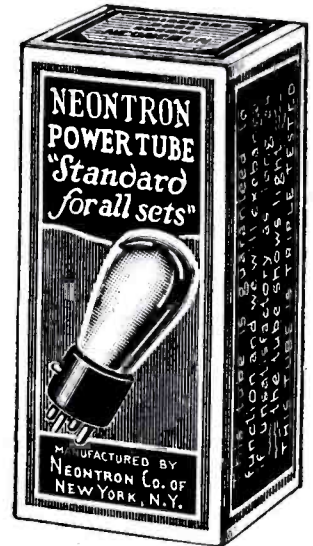

All tubes come in this attractive carton.

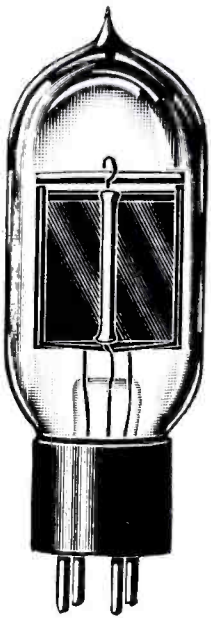

Telion Television Tube \$3.90

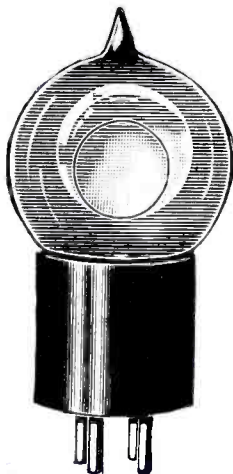

2-Inch Photo-Electric Cell, \$3.90



High Grade (Hi Mu) 201A Type—better vacuum—works and fits in any set. \$.85

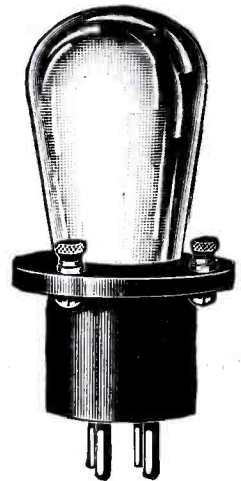

A.C. Adapter Tubes to convert battery sets into A.C. Electric sets—furnished for 226, 227, 171A. \$.85



Switch Tube \$.85
Switch is used when one filament burns out, tube therefore has twice normal life. With switch on acts as 171 or 112 Power Tube—with switch off it is 201A Tube.

Tubes Shipped Immediately

TYPE	PRICE
UX-201A—Amplifier or Detector—Standard for all purposes.....	\$.50
UX-226 —Used as amplifier tube for A.C. operation.....	.60
UY-227 —Used as detector amplifier for A.C. operation.....	.65
UX-171A—Power output amplifier for A.C. or D.C. operation, 1/4 amp.....	.65
UX-171 —Same characteristics as the 171A on tungsten filament, 1/2 amp.....	.70
UX-240 —Designed for impedance and resistance coupling.....	.70
UX-120 —Power amplifier used in last stage of audio frequency of battery set using dry cells ..	.70
UX-199 —Detector and amplifier tube, long prongs.....	.70
UX-199 —Same characteristics as UX-199 only short prongs.....	.70
UX-112 —Power amplifier tube, 1/2 amp.....	.70
UX-112A—Power amplifier tube for low current consumption, 1/4 amp.....	.70
UX-200A—Detector tube recommended for weak signals and good reception.....	.70
UY-224 —Screen grid, four-element, used as frequency amplifier and linear power detector in special circuits.....	.70
UX-245 —Power amplifier tube used in last audio stage—for low plate voltage.....	.85
201A—Quadrode 5-prong, for special circuits.....	.85
200A—Special detector tube, a supersensitive detector.....	.85
201A—Special radio frequency, a supersensitive detector.....	.85
201A—Special audio frequency, a supersensitive detector.....	.85
171 —Special A.C. 1/2 amp. extra coated filament—good for electric sets.....	.85
T-14 (201A High Mu), high emission.....	.85
Switch tube, 201A or 112 or 171, double life.....	.85
226, 227, 171A—Adapter tubes, to convert battery sets into A.C., each.....	.85
UX-210—For power amplifier, high voltage.....	1.60
UX-250—Power amplifier used in last stage of audio frequency.....	1.60
201A—All bakelite shield tube.....	1.60
UX-222—Screen grid tube for D.C. operation. Radio frequency amplifier.....	1.60
Telion television tube.....	3.90
Photo-electric cell—2 inches.....	3.90

RECTIFIER AND CHARGER BULBS

125 mil. rectifying tube (B. H. type).....	2.15
2 amp. old and new type charger bulbs (list \$4.00), our price.....	2.95
5 and 6 amp. old type charger bulbs (list \$8.00), our price.....	4.85
UX-280—Used as a fullwave rectifier tube for high emission.....	.75
UX-281—Characteristics similar to the 280, but used as half-wave rectifier of high emission....	1.60
Freshman rectifying tube, especially designed for use with Freshman Master "B" Eliminators, UV brass base, limited quantity.....	.60

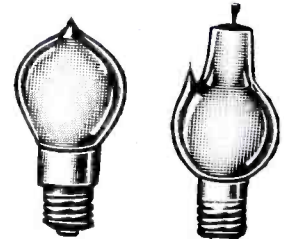

2-Ampere Charger Bulbs. \$2.95

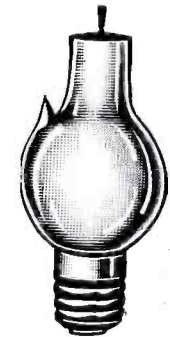

5 and 6-Amp. Charger Bulbs. \$4.85



5-Prong 201A \$.85

RADIO TRADING CO., 25A West Broadway NEW YORK

Practical Experiments in Ultra Short Wave Communication

By C. C. WHITEHEAD
(Continued from page 380)

feeling of relief when the quench is switched off, and the receiver used as a "straight."

This latter effect is not produced when the quenching frequency is well above audibility, as in the case of the receiver described.

The increase in range obtained by the use of super-regeneration was remarkable. With the "straight" receiver, the signals were never readable at a greater distance than 500 yds., under the conditions obtaining during the range tests, even when the improved aerial coupling arrangement, with feeder, was used.

The aerial and feeder used is identical with that described in connection with the transmitter. (A reference to the photographic illustrations will prove more helpful in explaining the constructional arrangements than any amount of written description.) It was found essential to screen partially the signal-frequency portion of the receiver, and the screen shown was very effective, no trace of frequency-shift due to movements of the operator being noticeable during operation.

The use of metal foil in contact with the envelope of the detector valve was not necessary, nor did it seem to make any difference when it was used.

Observations upon the sharpness of tuning of the receiving circuits were interesting. When the valve was not oscillating, the tuning was extremely flat, the signals being heard over the whole of the tuning scale. As reaction was applied, the tuning became sharper, until, with reaction adjusted to the optimum value, it was found difficult to tune in the signal, even when close to the transmitter! This applies to the "straight" receiver only. The effect of bringing the "quench" into operation was to flatten the tuning once more, to the extent that the signal was audible over about 5° of the tuning scale, when Morse (I.C.W.) signals were being received. As previously remarked, the use of the receiver as a "straight" was soon abandoned, in view of the much greater efficiency of the super-regenerative arrangement. The quench can, of course, be put into or out of operation, at will, by means of the quench-reaction control (R₃, Fig. 5).

The feeder was coupled to the grid coil of the detector by means of the small single-turn coil L₃ (Fig. 5).† This coupling was not at all critical, though, of course, it affected the optimum setting of the reaction controls. Under ordinary working conditions, the amount of signal-frequency reaction (controlled by the filament rheostat, R₁) was not critical (so long as the valve was oscillating, of course, for super-regeneration)

though careful control of the quench reaction was essential.

The final stage was the calibration of the receiver. This was carried out with the aid of the transmitter oscillator and a pair of Lecher wires coupled to its feeder terminals. The receiver was situated at the far end of the same room, and tuned as closely as possible to the transmitter frequency, this being checked upon the Lecher wires, for each individual setting of the tuning dials.

This provided an accurate calibration, as the receiver tuning was very sharp, but, unfortunately, the greatest frequency range possible upon the transmitter only covered a portion (about ¼) of the receiver tuning scale.

Eventually, however, this difficulty was solved (with the aid of the "quench") without having to go to the trouble of building a special oscillator (or modifying the existing one) to cover the whole range.

The tuning range covered (by the receiver) proved to be as follows:—

Wavelength — 2.56 — 2.88 meters.

Frequency — 104 — 117 megacycles.

= tuning range of 13,000 kilocycles.

After the whole of the apparatus had been constructed, and before any range tests were undertaken, some simple working tests were carried out at short ranges to find out how the apparatus "handled" in practical use. The results were very satisfactory, the following being some of the points noted:—

(1) The tuning range (even in the case of the transmitter) was sufficiently wide to accommodate ten channels of communication without mutual interference. (In the case of the receiver, 30.)

This was with the use of super-regeneration. Had it been possible to work at reasonable ranges without recourse to this, the possible channels would have been at least ten times the above numbers.

(2) The frequency band covered could be accommodated very easily without the necessity for adopting any arrangement for adjusting the precise length of aerials and feeders to suit the particular frequency in use at the moment.

(3) With the final form of the apparatus, no trouble at all was experienced from hand or body capacity effects, and it proved remarkably easy to handle. Once the receiver reaction controls had been set (in itself no difficult matter) *the setting remained good over the whole of the tuning range*, so long as no part of the apparatus was moved bodily. Thus the receiver has, virtually, a "single-dial" control.

* Reprinted by special permission from "Experimental Wireless and the Wireless Engineer" (London).

† I.e., the method shown in Fig. 4(c).

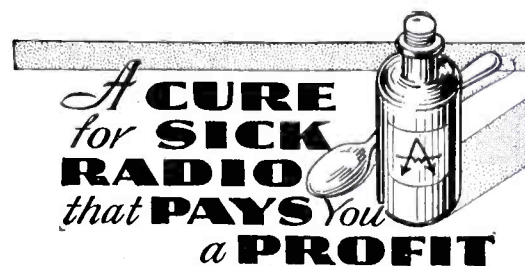

AMPERITE automatically corrects line voltage variations, up and down, to exact requirements, between 100 and 140 volts. Saves tubes, prevents overloading, improves tone, reduces set upkeep.

A type for every radio, including mantel models. Can be installed in five minutes, without chassis changes.

Ask your dealer or write to Dept. SW-1 for Installation Chart.



AMPERITE Corporation
361 BROADWAY, NEW YORK

AMPERITE
Self-Adjusting
LINE VOLTAGE CONTROL

Aluminum BOX SHIELDS

Beautiful Silver Dip Finish

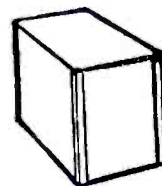

5x 9x6\$1.87

6x10x7, monitor size 3.25

5x 5x5 knockdown coil shield (like picture at left)..... 1.00

We make any size to order. Drum dial cable for Majestic, Radiolas, etc. Sponge Rubber Phone Cushions, fits all phones, 25c each.

Phone Cushions, fits all phones, 25c each.

"BUDDY" Test Prod

Always sharp pointed using phonograph needles, 4 ft. wires, spade or phone tips. Colored nipples identify each lead.

75c. each.

We specialize in radio parts exclusively — parts furnished for any kit in any magazine.



Please include sufficient postage

Blan, The Radio Man, Inc.

Dept. SW-2

89 Cortlandt St. New York, N. Y.

LOFTIN-WHITE

—LICENSED—

Direct Coupled Amplifiers

for

Phonograph, Radio, Recording and

Public Address Systems

Midget-Amplifier with Tremendous Power and Perfect Frequency Curve
List Price \$45.00

SOUND SYSTEMS, Inc.

Amplifiers for Every Purpose
1600 BROADWAY, NEW YORK

Be sure to read the announcement on page 420 if you are interested in securing back issues of SHORT WAVE CRAFT.

BOOK REVIEW

THE MANUAL OF SHORT WAVE RADIO, compiled and edited by Zeh Bouck. Size 11 1/2" x 8 1/2", flexible paper covers, pages 64, profusely illustrated, price \$0.50. Published by The National Company, Malden, Mass.

This valuable short wave manual, lists among its authors, such well-known experts as R. S. Kruse, James Millen, Fred A. Schnell, L. W. Hatry and Thomas A. Marshall. To men experienced in radio and particularly in short waves, these men stand as a guarantee for the contents of this valuable book. Among the articles listed are: How to Build the Cornet S-W Receiver, which is clearly explained and illustrated with diagrams and photos; The All-Purpose Short Wave Receiver, suited for international broadcasting, amateur phone and amateur radio-telegraphy; An Analysis of A.C. Operated Short Wave Receiver Design; How to Build a Short Wave Superheterodyne, and many other articles of interest and value to the short wave fan.

RADIO VISION, by C. Francis Jenkins. Cloth covers, size 9 1/2" x 6", pages 140, profusely illustrated, price \$2.50. Published by Jenkins Laboratories, Inc.

A beautifully printed and interesting illustrated history of transmission of pictures by radio; particularly covering the apparatus and successful demonstrations of the Jenkin's system. Other apparatus illustrated and discussed are the Braun tube receiver; the R.C.A. Photo-radio apparatus; the A. T. & T. Company system, and the Belin machine.

PRACTICAL RADIO—INCLUDING THE TESTING OF RADIO RECEIVING SETS, by James A. Moyer, S.B., A.M., and John F. Woestrel. Cloth covers, size 8" x 5", pages 378, illustrations 223, price \$2.50. Published by McGraw-Hill Book Company, Inc.

Everyone will find this volume of the utmost

practical value as the authors have explained in text and diagrams, for the practical-minded student, such interesting subjects as telephone receivers and crystal sets; various types of aerials; current sources for vacuum tubes; audio and radio frequency amplification with hook-ups; loud speakers and how they work; various radio receiving sets with diagrams and just how they work, including the details of construction and testing of receivers; battery eliminators and chargers; common troubles and their remedies.

PRACTICAL RADIO CONSTRUCTION AND REPAIRING, by J. A. Moyer, S.B., A.M., and J. F. Woestrel. Cloth covers, size 8" x 5", pages 354, illustrations 163, price \$2.50. Published by McGraw-Hill Book Company, Inc.

This handbook is one that every radio set tester and general student will want to read carefully. These experts have given a very complete description of instruments used to test and repair modern radio sets, together with complete diagrams of

many modern receiving sets, with explanations on how to test the radio and audio frequency stages, for faults. Details of loud speaker construction are given; also short wave and superheterodyne receivers; eliminators and chargers; trouble-shooting on radio sets in general.

EXPERIMENTAL RADIO, by R. R. Ramsey, Professor of Physics, Indiana University. Cloth covers, size 7 1/2" x 5 1/2", pages 256, illustrations 168, price \$2.75 postpaid. Published by Ramsey Publishing Company.

This book by Professor Ramsey, is written in the nature of an experimental radio course and contains 128 experiments, illustrated and described in a clear and interesting style. The experiments cover such valuable subjects as, A test on a loud speaker; the impedance of coils; construction of filter, screen grid tube, and beat note; audio oscillation; measurement of power in amplifiers; wavelength of closely coupled circuits; superheterodyne; and wave meters.

PRINCIPLES OF RADIO COMMUNICATION, by J. H. Morecroft, Professor of Electrical Engineering, Columbia University. Cloth covers, size 9 1/2" x 6", pages 988, profusely illustrated, price \$7.50. Published by John Wiley & Sons, Inc.

A radio classic indeed, is Professor Morecroft's very complete text book which covers such important radio phenomena as, the action in condensers; self and mutual induction in a circuit; phase and phase difference; effective condensers and coils on wave shape; resonance frequency of coupled circuits; skin effect in coils; antenna resistance; transformers; vacuum tubes; radio frequency alternators; modulation and circuits; amplifiers and filters. A good index is given at the end of the book.

**BIG PRIZE
ANNOUNCEMENT
IN NEXT ISSUE!
DON'T MISS IT!!
\$2,000.00 in Prizes.
(See page 385 this issue)**



Back Number SALE! Any 3 copies for \$1.00

Single Copies at Fifty Cents Each

HERE is a great opportunity to make a complete set of the issues of **SHORT WAVE CRAFT**—at a most sensational saving. This *back number sale* enables our readers to make a comprehensive file of all the latest material in the Short Wave field. These few complete books, which are easily accessible, might be used as a permanent reference.

Each issue on the newsstand sells for fifty cents per copy. This sale will be the *first and last* at such a tremendously low price of **ANY THREE FOR ONE DOLLAR**. Of course single copies must be sold at fifty cents each. Fill in the coupon at the left and mail NOW! Your copies of **SHORT WAVE CRAFT** will be sent to you immediately.

MAIL COUPON NOW!

SHORT WAVE CRAFT
96-98 Park Place
New York, N. Y.

SHORT WAVE CRAFT SWC-231
96-98 Park Place, New York, N. Y.

As per your special offer, I enclose herewith One Dollar for which please send me the three issues of **SHORT WAVE CRAFT** indicated below:

Single Copies at Fifty Cents Each

- June-July
- August-September
- October-November
- December-January

Name

Address

City State

The A.C. "Conqueror" Picks Up Both Short and Broadcast Waves

By JOSEPH HELLER
(Continued from page 389)

the same. This is a great convenience. In addition, the antenna coil is mounted on a shaft so that it can be rotated by means of a knob on the front of the panel. This allows variable coupling between it and the first r.f. coil, and no matter how the coupling is varied, the tuning of the set remains unchanged—thanks to the screen. This variable coupling feature aids greatly in the discrimination of received stations, or selectivity, and in the case of powerful local stations is an ideal volume control.

Of the utmost importance in short-wave receiver design is the use of filtered connections and supply circuits. In this set all connections are thoroughly filtered by means of resistors and large by-pass condensers.

Dead spots in the tuning range of some short-wave sets were found to be due to the absorption of energy by the interconnecting wires—and not because of resonance points in the antenna system, as was generally supposed. It's the resonance points in the interconnecting wires that caused the trouble, killed regeneration and prevented oscillation at many points on the dial. In this set the dead spots are completely wiped out by the use of the filters. Regeneration can

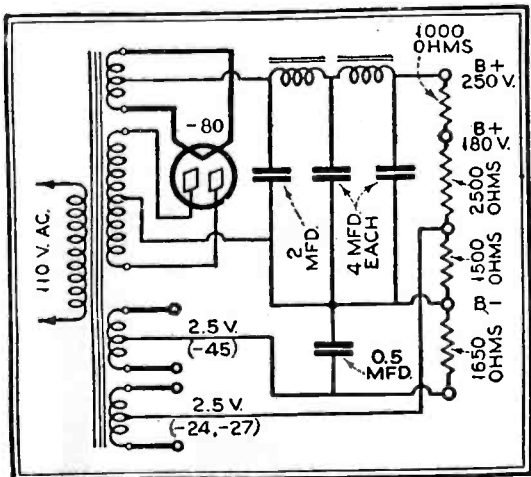

Circuit of "B" supply unit.

be increased to the point of oscillation gently and gracefully throughout the entire tuning range.

"Fringe howl," that annoying audio-frequency groan occurring when a set is adjusted so as to be just on the verge of oscillating, was also traced to improperly by-passed and filtered circuits, allowing audio-frequency feed-back through modulation of the generated r.f. current. Needless to say, fringe howl has been completely eliminated in this set by correct filtering.

You will note in the diagram, Fig. 1, the resistors in the plate leads of the audio amplifier tubes, by-passed to ground by the large fixed condensers. The grid returns of the first two audio stages are also filtered by resistors and condensers.

(Continued on page 407)

FREE!

The Very Meter You Want Most!

**Take Your Choice
of 9 Instruments!**

YOU finish building a set or power pack. You want to test it for voltage and current. You need some particular meter to make the test complete. Always the necessity for that meter, like recurring hunger! What wouldn't you give to have that meter here, **NOW!** No more need to endure such irritating deprivation. You are hereby given your choice of any one of nine different meters free! Please use the coupon.

CHOOSE ONE OF THESE NINE METERS!

- | | | |
|---|--|---|
| <input type="checkbox"/> 0-6 Voltmeter D.C. No. 326 | <input type="checkbox"/> 0-10 Amperes D.C. No. 338 | <input type="checkbox"/> 0-100 Milliamp. D.C. No. 390 |
| <input type="checkbox"/> 0-50 Voltmeter D.C. No. 337 | <input type="checkbox"/> 0-25 Milliamp. D.C. No. 325 | <input type="checkbox"/> 0-300 Milliamp. D.C. No. 399 |
| <input type="checkbox"/> 6-Vt Chge Tester D.C. No. 23 | <input type="checkbox"/> 0-50 Milliamp. D.C. No. 350 | <input type="checkbox"/> 0-400 Milliamp. D.C. No. 394 |

Put a cross in the square next to the meter you desire, and fill out and return coupon below.
All meters except No. 23 are panel mount types; size of hole, 2 5/64"

WHAT RADIO COMPANIONSHIP DO YOU ENJOY?

ARE you meeting weekly the best minds of radio? Do you keep abreast of all the new circuits, the intimate details on perfecting existing sets, and get the inside track on sensitivity, distance reception, tonal quality, and how to achieve them? Do you keep fully abreast of the news of radio, technical and non-technical? If not, here is your chance to enjoy the writings of Dr. Lee De Forest, McMurdo Silver, J. E. Anderson, Herman Bernard and a host of other radio engineers who contribute their knowledge to you through the medium of Radio World, the first and only illustrated national radio weekly (eighth year!).

You will find Radio World specializes in most intimate revelations of the ins and outs of the best circuits, with technical accuracy second to none. Enjoy the weekly companionship of Radio World's famous contributors, and glean the news of radio, from the four quarters of the earth.

Short waves? Radio World will tell you all about them. Extremely sensitive broadcast receivers? Their construction and operation are fully discussed with confident regularity. Power supplies—push-pull or otherwise? AC receivers? Screen grid tubes? Large receivers that give a super-abundance of performance—small, economical receivers that give performance out of all comparison to their size? Automatic volume controls? Band-pass filters? New tubes? Are you interested in these? Then you're interested in Radio World. Send \$1 now for 8 weeks subscription, one copy a week (regularly \$1.20) and meter you select will be sent FREE!

RADIO WORLD, 145 W. 45th St., N. Y. C.
Published Weekly—All Newsstands—15c copy—
\$1.50. 3 months—\$3, 6 months—\$6 a year.

RADIO WORLD
145 West 45th Street, New York City
Just East of Broadway

Enclosed please find \$1 for which send me Radio World for eight weeks (one copy each week), and also send me FREE, at once, the one meter checked below.

- | | | |
|----------------------------------|----------------------------------|----------------------------------|
| <input type="checkbox"/> No. 326 | <input type="checkbox"/> No. 338 | <input type="checkbox"/> No. 390 |
| <input type="checkbox"/> No. 337 | <input type="checkbox"/> No. 325 | <input type="checkbox"/> No. 399 |
| <input type="checkbox"/> No. 23 | <input type="checkbox"/> No. 350 | <input type="checkbox"/> No. 394 |

Name

Street Address

City State

Right Now!!

Send for Our

NEWEST CATALOG

Largest Assortment and Biggest Bargains in
RADIO SETS AND PARTS

All Merchandise at Wholesale!

S. HAMMER RADIO COMPANY

142 Liberty Street, N. Y. City Dept. G Hitchcock 4-1152

TRANSMITTING and RECEIVING PARTS and TUBES . . .

Biggest Discounts to Amateurs

Every make of AC and DC parts, kits, accessories, and cabinets of merit always in stock . . . 12 brands of tubes.

Free Technical Information and Advice by Experts.

Buy in Seattle at Chicago and New York Prices

Wedel Company, Inc.

SEATTLE, WASH.

RADIO and ELECTRICAL JOBBERS SINCE 1888

PANELS TUBING & RODS

FORMICA, BAKELITE AND HARD RUBBER—STANDARD OR SPECIAL SIZES

Cut While You Wait

Drilling, Engraving and Special Work

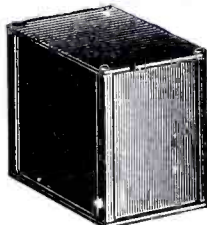

All Sizes of ALUMINUM

CANS, PANELS AND CHASSES

Made and Cut to Order

Neutralizing Screw Drivers, Short or Long Sizes



COUPLINGS in Brass and Bakelite for 1/4 inch Shafts

INSULATING BUSHINGS for all size Shafts

TEL. CORTLANDT 4885

Mail Orders Filled Immediately

United Radio Mfg. Co.

191 Greenwich St. New York

ELECTRIFY YOUR RADIO FOR ONLY \$6.85 COMPLETE

Why discard your present good set when you can electrify it for only \$6.85, and banish the annoyance and expense of buying new "B" batteries?

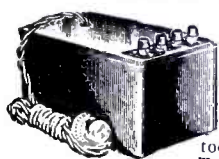

Over 150,000 Townsend "B" Power Units in Use Hooked up in a few minutes. Use same tubes—no changes. Works on A.C. (any cycle) or D.C. You'll be amazed at the improvement in reception. Send name and address today for full details, proof and Free Trial Offer.

TOWNSEND LABORATORIES

409 W. Superior Street

Chicago, Illinois

You Can Learn the Code Easily

By PAUL SKITZKI

(Continued from page 388)

should be used in sending. Also, it is necessary to send steadily and keep the wrist muscles under control, although never tensed. This procedure brings about speed as well as efficiency in sending out a steady, clean-cut note.

Keying on this instrument gives a fine signal without making any external noise and without any harsh key-clicks in the earphones. Since it is an audio oscillator, it does not create any interference, and therefore the beginner need have no fear of being mauled by some enthusiastic radio fan.

Truly, this outfit is worth the time and money spent on it, and it can always be used to good advantage. When you have mastered the code you will find someone who is willing to purchase the set from you.

The parts used in the construction of the set were:

- Two cigar boxes (C1 and C2);
- Two keys (K1 and K2);
- One 20- to 50-ohm rheostat (R1);
- Two single phone jacks (J1 and J2);
- Eight binding posts ("A+," "A—" and B1, B2, B3 for C1; B4, B5, B6 on C2);
- One UX tube socket and tube (V1);
- One small audio transformer, 3-to-1 ratio (T1);
- One battery, suitable for tube used;
- Two sets headphones; and
- Other miscellaneous necessities, such as wire, bolts, etc.

New Test Prods for the Set Builder

The "Buddy" Test Prods here illustrated will be found extremely useful to all set builders using meters in their testing work. The insulated handles are made of 3/8" diameter Ebonite and on one end of each handle there is mounted a small chuck, which will grip a standard steel phonograph needle. These needle tips enable the test to be made without removing or destroying insulation on the wires to be tested.

The test prods are furnished with four-foot flexible leads having glazed cotton insulation over 1/32" rubber, the

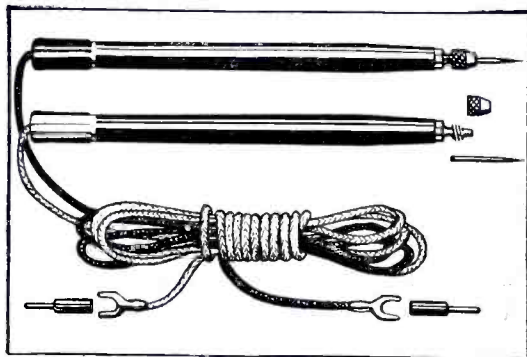

ends of which can be furnished with spade lugs or phone tips. Nipples on the end of Ebonite handles are available in four colors, enabling the experimenter to distinguish the polarity of his test prods instantly. The name of the manufacturer of the "Buddy" test prods will be furnished upon request.

In your Spare Time

service radio sets Make Extra Money

RADIO-CRAFT shows you HOW!

In RADIO-CRAFT, the magazine endorsed by thousands of Radio Service Men throughout the country, you will find most important articles telling how to service any make radio receiver. These articles are written by men outstanding in the radio profession, and among them we find John F. Rider, Sylvan Harris, Bertram M. Freed and others.

RADIO-CRAFT also contains important reviews of the latest developments in Short Waves, Television, Sound Projection, Airplane Radio, Automobile Radio, Midget Sets, Construction of Test Laboratories, Cause and Cure of Interference; Service Men's Notes, New Apparatus, Money-saving Kinks and many other subjects described every month.

25c the Copy

On All Newsstands

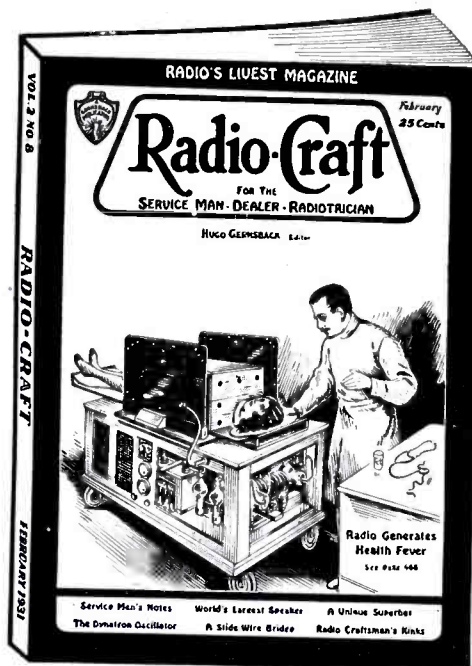

Special Offer!

By returning the coupon below with One Dollar, you will receive the next eight issues of RADIO-CRAFT. This is much lower than the regular subscription price and a big saving for you.

EIGHT MONTHS FOR \$1.00

Mail Coupon Today!

RADIO-CRAFT SWC-5
96-98 Park Place, New York, N. Y.

As per your special offer, I enclose herewith One Dollar, for which you are to send me the next eight issues of RADIO-CRAFT.

Name

Address

City..... State.....

The A.C. "Conqueror" S-W Receiver

(Continued from page 405)

The two 2,000-ohm resistors are for obtaining the proper "C" biasing voltages. The r.f. chokes shown in the radio-frequency amplifier and detector plate leads are also important for efficient filtering.

Excessive a.c. hum in short-wave sets was traced to the detector. Probably the a.c. magnetic field surrounding the detector heater causes modulation of the plate current by affecting the electron stream. However, this has been completely wiped out by proper filtering. In the first place, the detector heater is maintained at a positive bias of 65 volts—by means of the bias resistor in the power pack, Fig. 2. This biasing voltage, together with the .001 mfd. by-pass condenser connected between the detector heater and cathode and placed directly at the detector socket, reduces a.c. hum to a point where it is imperceptible—even with headphones connected to the output of the three-stage audio amplifier.

The Power Supply

The power supply is clearly shown in the diagram of Fig. 2. It supplies the 180- and 250-volt plate leads and the two 2½-volt filament leads to the set by means of a cable connecting it to the set. It is built separately in a metal case as shown in the photographic illustration.

An objectionable feature with many sets is the fluctuation of voltage supplied by the power pack when operating the set. With a regenerative detector, the detector plate current varies considerably, depending upon the degree of regeneration. On power packs in which an unusually high ohmage resistor is used to cut down the voltage to the desired amount, the variation in load, caused by the variation in regeneration, produces a great voltage fluctuation, resulting in unstable and unreliable set operation and difficulty in tuning. In this power pack an unusually low ohmage bleeder resistance is used. This causes a rather large current drain from the power pack—large in proportion to the drain caused by the detector tube of the set. Therefore, any change in detector plate current has little effect on the supply voltage and steady operation is obtained.

Mechanical Features

The mechanical features, or general layout and assembly of the parts, together with the electrical values as given in the diagrams, should enable anyone to build the set in a very short time. However, for convenience in assembling, the parts are furnished by the Insuline Corporation in kit form, partly wired and so arranged that only a screwdriver is required to complete the job. Strip connectors, instead of wires, are used. These are held with small screws, which eliminate all soldering. The resistors and by-pass condensers are mounted underneath the base, as shown in the photographs. Two shield cans are used, one for the r.f. stage and one for the detector. The plug-in coils go inside of these cans, in sockets provided for them.

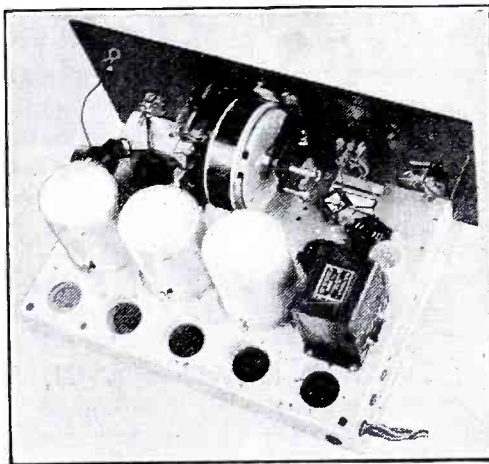

COMPLETE KITS

HY-7—6-tube battery
HY-7—6-tube A.C.

Comes assembled, ready to wire, with all parts and instructions.

Get our catalog and complete information, 25c: HY-7 A.C. circuit, details of HY-7 types and prices. Other data and prices on many useful radio parts. Limited edition.

The HY-7B

(NOT AVAILABLE IN KIT FORM)

Fundamentally right! So basic changes were unnecessary BUT—

The HY-7B is an HY-7 model especially for the short-wave broadcasts. Either A.C. or Battery models have complete in the chassis these features: Two audio stages; 231, 171a or 245 power-tube.

Special H & Y tone control.

Ganged tuning—controls are: 1. Tuning dial. 2. Volume and switch. 3. Tone-control. (No oscillation switch.)

Seven tubes, 4 screen-grid.

HY-7's used by WCFL; Univ. of La.; Hello-World Broad. Corp.

AMATEURS: the w-k HY-7 6 tube, somewhat modified in built-to-order style is the out-standing C.W. and fone outfit: runs loud-speaker, 2v., 6v. or A.C., get the dope

Hatry & Young

119
Ann St.



Phone
5-2733

HARTFORD, CONN., U. S. A.

New Jiffy Tester

CHROMIUM-PLATED CASE AND
ACCURATE METERS

A NEW and improved Jiffy Tester, improved in both performance and appearance, is Model JT-N.

The meters are of the moving iron type. Tested on precise batteries, they show errors not exceeding 2%.

As for appearance, the case is first copper plated, then nickel plated, then chromium plated, giving a lustrous, permanent, non-peeling non-rusting finish. It is the same finish found on hardware in fine automobiles. The handle and lock strap are genuine leather.

Jiffy Tester, Model JT-N, consists of three double-reading meters, with cable plug, 4-prong adapter, test cords and screen grid cable, enabling simultaneous reading of plate voltage, plate current and filament or heater voltage (DC or AC), when plugged into the socket of any set. The ranges are filament, heater or other AC or DC: 0-10 v, 0-140 v; plate current: 0-20, 0-100 ma; plate voltage: 0-60, 0-300 v. It makes all tests former models made. Each meter is also independently accessible for each range. The entire device is built in a chromium-plated case with chromium-plated slip-cover. Instruction sheet will be found inside. Order Cat. JT-N, @ \$11.40.

GUARANTY RADIO GOODS CO.

143 WEST 45th STREET (Just East of Broadway) NEW YORK, N. Y.

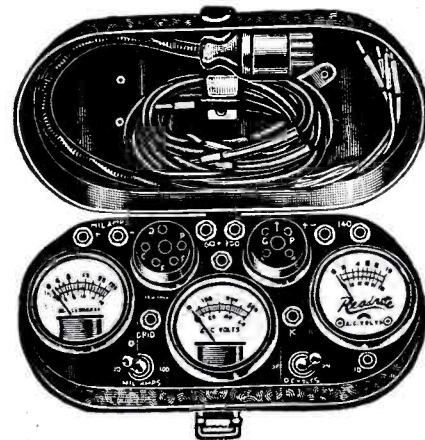

PATENTS TRADE MARKS

All cases submitted given personal attention by a member of the firm.

Information and booklet free
**Lancaster, Allwine &
Rommel**

475 Ouray Bldg., Washington, D. C.

Short Wave EQUIPMENT

Silver-Marshall, 737 Bearcat A.C. short-wave receiver, wired, \$82.50; net kit, \$70.00. S-M 738 Short Wave converter, wired, \$40.75 net. All S-M parts in stock. 40% and 2% to hams.

Write for Our Special Bargain List

Radio Inspection Service Co.
26 Allyn St. Hartford, Conn.

GIGANTIC PRE - REMOVAL SALE!

Prices cut to save trucking charges. Compare the "Old" with the "New." (These prices in effect only until stock on hand is exhausted!)

	Old	New
THORDARSON 250 watts—1200 v. center tapped, two 7.5 and one 3 v. windings.	\$5.75	\$4.75
THORDARSON 175 watts—1150 v. center tapped, same filament.	\$4.25	\$3.50
THORDARSON 100 watts—700 v. center tapped, one 5 and one 2.5 v. windings.	\$3.75	\$2.75
THORDARSON 100 watts—same as above but for 25 cycle use.	\$4.25	\$3.25
AMERICAN 2.5 v. filament for 866 tubes. Two windings at 11 and 3 amps.	\$3.75	\$2.75
JEFFERSON step-down, gives 110 from 220 volts	\$1.75	\$.95
THORDARSON Filter Choke, 30 henri—150 mils	\$3.25	\$2.75
AMERICAN Filter Choke, 30 henri—300 mils	\$24.00	\$9.00
R.C.A. Double Filter Chokes, contain two 30 henri, 100 mil windings.	\$1.75	\$.95
THORDARSON Filter Choke, Double type, contains two 18 henri—250 mil windings	\$6.25	\$4.75
DUBILIER 1 1/4 mfd. condenser, 3 mfd. at 1000, 2 mfd. at 600 and 4, 5, and .25 mfd. at 160 D.C. working voltage.	\$3.75	\$2.75
FLECHTHEIM HIGH TENSION Filter Condensers, with porcelain insulators, guaranteed.		
1500 volts—1 mfd.	\$ 2.70	
2 mfd.	5.10	
4 mfd.	8.70	
2000 volts—1 mfd.	6.00	
2 mfd.	9.00	
4 mfd.	15.60	
Write for special prices on 3000 volt condensers and type HS & HV.		
DUBILIER 1 3/4 mfd. 1000 D.C. working voltage	\$1.75	\$1.15
DUBILIER 7 mfd. 600 D.C. working voltage	\$2.50	\$2.00
DUBILIER 4 mfd. 600 D.C. working voltage	\$1.80	\$1.25
DUBILIER Plate Stopping Condenser, .000125 mfd. at 1000 volts	\$.50	\$.35
AEROVOX 7 mfd. Block, 2 mfd. at 1000, 2 at 800 and 3 at 400 v. D.C. working volts	\$3.00	\$2.50
GENUINE R.C.A. UV-213 Rectifying Tubes, full wave, same voltages at 280.	\$.95	\$.65
GENUINE R.C.A. 216-B Rectifying Tubes, 7.5 volt filament, 550 plate volts.	\$2.35	\$1.95
KENOTRON Rectifying Tubes, filament voltage 8 to 10, plate 550 volts.	\$.50	
WESTERN ELECTRIC VT-2—5 watt tubes—standard base	\$2.50	
GENUINE DE FOREST Transmitting Tubes shipped you direct from factory:		
503-A, \$30.00; 511, \$30.00; 545, \$33.75 (50 watt oscillators, modulators, etc.)		
552, \$24.25 (75 watt oscillator and R. F. amplifier, low internal capacity.)		
566, \$9.00 (half wave mercury rectifier, filament 2.5—plate 1500 volts.)		
BRADLEYSTAT, type E210, 10 amps. (for low internal capacity)	\$.95	\$.65
WARD-LEONARD—13600 ohm heavy duty resistor tapped at 6000, 6000, 1600.	\$1.50	
R.C.A. Power Rheostats, 15 amps. for high powered tubes	\$3.00	
R.C.A. Rotary Grid Chopper Wheels	\$.75	
CENTRALAB Gain Controls for fone xmtrs, 0-250,000 ohms	\$.75	\$.50
AMERICAN 50 watt sockets	\$2.45	
AMERICAN 250 watt sockets	\$2.55	
UNIVERSAL 1089 200 ohm modulation transformer for double button mike	\$6.85	
AMERICAN DOUBLE BUTTON MICROPHONE, will respond to frequencies from 30 to 7000 cycles, low carbon hiss, 100 ohms per button	\$31.50	\$27.50
UNIVERSAL AND GENERAL INDUSTRIES MICROPHONES, DESK STANDS AND MOUNTS		
—Write for special discounts.		

APOLOGY: Due to the fact that we are temporarily tied up in moving to our new 15,000 sq. ft. quarters, KEY-KLIX for December, 1930, and January, 1931, were not published. KEY-KLIX is a definitely established publication and will reach you regularly.

AMERICAN SALES CO.
21-S Warren St., New York City

The A.C. "Conqueror" S-W Receiver

(Continued from page 407)

You will note that the antenna coil is clamped on the side of the shield can. The antenna coupling coil is wound in a form between two hard rubber disks and is mounted on a shaft controlled from the panel. It can be rotated so as to be close and parallel with the can or at right angles to it. The first plug-in coil containing the winding is mounted inside the shield can.

The variable condenser, C1, for regeneration control is mounted in the center of the base at the rear and is controlled by means of a long shaft connecting to a knob at the center of the panel. This mounting eliminated hand capacity. The two tuning condensers are mounted in the shield cans. The a.c. line switch, at the extreme right, completes the panel layout. The panel measures 7" by 18" and the metal base 17" by 12" by 1 1/4" deep. A bakelite panel is mounted on the rear of the metal base, on which the a.f. transformers and tube sockets are mounted. The whole arrangement is of the utmost simplicity and should cause no trouble in building.

Accurately made, rigid, well-balanced coils are essential to properly cover the entire range and maintain selectivity and proper regeneration control. The coils are probably the most important part of the set. The form is of genuine hard rubber, 2" in diameter, rigidly held on metal end supports. The wire is wound in grooves in the hard rubber and cannot slip. The wire ends are connected to socket terminals on the coil base. Plug contacts are placed in the set. The absence of plug contacts on the coil makes it less vulnerable to damage when lying about not in use.

THE COILS

17-28 Meters

R.F. coil 6 turns.
Det. coil 4 turns on the secondary, 1 turn on the primary, 4 turns on the tickler.

27-45 Meters

R.F. coil 11 turns.
Det. coil 8 turns on the secondary, 3 turns on the primary, 6 turns on the tickler.

40-80 Meters

R.F. coil 19 turns.
Det. coil 18 turns on the secondary, 4 turns on the primary, 8 turns on the tickler.

75-150 Meters

R.F. coil 34 turns.
Det. coil 30 turns on the secondary, 10 turns on the primary, 15 turns on the tickler.

145-300 Meters

R.F. coil 54 turns.
Det. coil 54 turns on the secondary, 15 turns on the primary, 18 turns on the tickler.

295-600 Meters

R.F. coil 107 turns.
Det. coil 139 turns on the secondary, 30 turns on the primary, 50 turns on the tickler.
Antenna coil is 1-15/16" in diameter 10 turns.

The complete set of coils covers the range of from 14 to 600 meters. Two coils are used to cover the broadcast band. This is an advantage; it spreads the low wavelength broadcast stations over the entire dial and they are more

easily separated and tuned in. As far as broadcast reception is concerned, this set ranks with the best. This type of coil is the same as that used in almost all ship and shore stations.

The two tuning condensers and the regeneration control condenser are each of the "bathtub" shielded type and have nine plates. Two illuminated drum dials give ease in tuning and control. No dial is used for the regeneration control condenser.

After the set and power pack have been assembled and the leads brought out to the correct binding posts, the two may be connected together and tested. Standard types of tubes are used, and when placed in the correct sockets and the aerial and ground connected, the set is ready for operation. A good dynamic speaker is recommended, although any type of magnetic speaker may be employed. Sometimes one tube will work better than another as detector; therefore all of the '27's should be tried after a station is tuned in to find the one which gives the best results.

It is a good plan to start with the broadcast coils and get familiar with the set's operation by tuning in the broadcast stations. The dial settings on the two tuning condensers should be about the same. The important controls are the regeneration control and the antenna coupling, both of which may be used for controlling the volume, although the antenna coupling should be reduced as much as possible, as this increases selectivity.

After testing the set on the broadcast band, a set of short-wave coils may be inserted and further tests made. It is well to try all the coils and make sure that the set oscillates easily throughout the entire range. It will give no trouble from this source if all the connections were correctly made.

In tuning in short-wave stations, extreme care should be used as regards the tickler adjustment. It is best to tune the stations in first by means of the heterodyne whistle and then adjust for maximum volume without oscillation, in the case of phone stations. Remember that short-wave stations sometimes fade considerably and are received differently at different times of the day. Furthermore, static interferes sometimes, but it was found that even in the tropics there was absolutely no static at wavelengths below 30 meters. Above 30 meters static increases considerably. Man-made static, such as noises caused by sign flashers, motors, and other electrical machinery seems to cause more annoyance in the short-wave band than in the broadcast band. Therefore, if you have any noisy machinery in your vicinity, be sure to take the proper steps to thoroughly filter the apparatus.

The best type of aerial to use with this set cannot be definitely described. Sometimes the "worst" type gives the best results.

THE BIGGEST RADIO VALUE IN AMERICA TODAY!

Official RADIO SERVICE MANUAL

and Complete Directory of all Commercial Wiring Diagrams

IN LOOSELEAF, FLEXIBLE, LEATHERETTE BINDER

NEVER in the history of radio has there ever been published a manual, so complete as this new OFFICIAL RADIO SERVICE MANUAL. It is a veritable encyclopedia of service information — worth several times its regular price. It is invaluable not only to the Service Man, but to everyone interested in radio.

HUGO GERNSBACK, Editor
CLYDE FITCH, Managing Editor

For this Manual there has been collected available wiring diagrams and data of nearly every commercial set, of which there is any record, manufactured since 1927, and many earlier ones.

Over 1,000 Illustrations, Diagrams, etc.

352 Pages — 9 by 12 inches — Weight 3 lbs.

Additional service data for new receivers, as they appear on the market, will be supplied at a trifling cost so that the Manual might be kept up-to-date at all times. But that is not all.

Service Information

The OFFICIAL RADIO SERVICE MANUAL contains a comprehensive instruction course for the serviceman, giving practical information from every angle on how to service the set. Here are only a small number of the articles mentioned:

- Antennas, Amplifiers, Automotive Condensers, Detectors, Eliminators, Meters, Radio Power Systems, Tubes, Radio-Phonograph Equipment, Resistors, Short Wave Sets, Speakers

You simply cannot realize what a tremendous work this is until you have held a copy in your hands and have gone through the 352 pages.

What They Say

NOTHING CAN COMPARE WITH IT

I have received my copy of the OFFICIAL RADIO SERVICE MANUAL. I expected it would be good for I think you know as much as any of them what the average radio man wants, but I'll wager not very many expected to receive a book comparable to this one. I think you deserve a lot of credit for being the first to put out a real service manual that the amateur or professional can make good everyday use of. It's a good practical book and one that every service man will be proud of.—E. D. HANA, Haslett, Mich.

BEST BOOK IN THE FIELD

I received your book OFFICIAL RADIO SERVICE MANUAL and I find it is as yet the best book I have found in this field of radio. You are well justified in that this is the peer of service manuals. I wish you all the success possible in the publishing of future books on radio which are sure of great necessity.—WILLIAM R. BROWN, Brown Radio Service, 1010 Buckingham Street, Toledo, Ohio.

WORTH A GREAT DEAL MORE

Received your copy of OFFICIAL RADIO SERVICE MANUAL and am greatly pleased with same. It is worth a great deal more than it costs.—HAROLD AIGLER, 41 Rutland Ave., Arlington, N. J.

A VERITABLE GOLD MINE

I received the OFFICIAL RADIO SERVICE MANUAL. I am well pleased. It is a veritable gold mine for the Service Man.—EUGENE BINFORD, Arkansas City, Kansas.

MAGNIFIQUE

Received my copy of the OFFICIAL RADIO SERVICE MANUAL this A.M. "She is what you call him? Magnifique! Exquisite!" A timely aid for the troubled sets. Thanks.—E. BOICE, 1118 W. Dauphin, Philadelphia, Pa.



\$3.50 A COPY

MAIL COUPON

TODAY!

GERNSBACK PUBLICATIONS, Inc. SWC-1
96-98 Park Place, New York, N. Y.

As per your special offer, I enclose herewith \$3.50 for which you are to send me, postpaid, one copy of the OFFICIAL RADIO SERVICE MANUAL.

Name, Address, City, State fields for the coupon.

Prepared Especially for the Radio Service Man!

BARGAINS

At the tremendously low prices at which the merchandise below is offered, every radio dealer, service man or mechanic should equip himself with stock for future use. It is probable that such low prices will not prevail for long.

Utah 9-inch Balance Shielded Dynamic A.C. Chassis, 110 V.

Utah Balanced Shielded Dynamic Chassis is the highest development in sound reproduction. This speaker is built for those who desire to handle volume quality of tone over the full range of musical instruments.

Utah Model 33 Dynamic Chassis for 110 volt A.C. current.

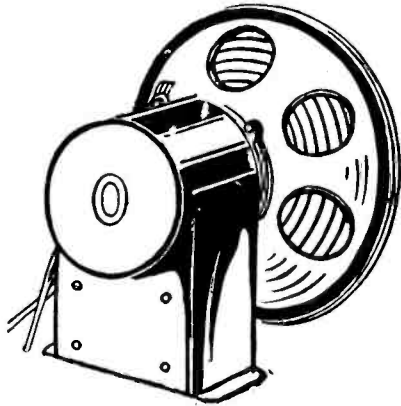

List Price \$30.00 **Our Net Price, \$7.50**

Paratone Duo-Magnet Unit

Two Tungsten Steel Magnets.

Direct Drive. With Mounting Brackets. Withstands 600 Volts.

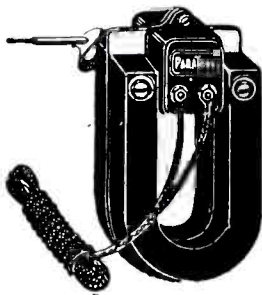

Do not confuse this with ordinary units.

List Price \$6.50 **Our Net Price, \$2.50**

245 POWER TRANSFORMER

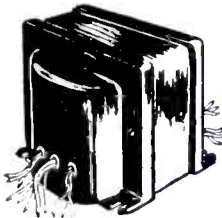

For use with a 280 rectifier tube, to deliver 300 volts D.C. at 100 milliamperes, slightly higher voltage at lower drain, from 105-125-volt A.C. line (marked 110 v.). 50-60 cycles. The primary is tapped at 82½ volts in case a voltage regulator is used. The black primary lead is common. If no voltage regulator is used the other primary lead is the red and black form the circuit. The secondary voltages are all center-tapped: 672 volts A.C. for 280 plates, 2½ v. 3 amps. for 245 output, single or push-pull; 5 v. 2 amps. for 280 filament; 2½ volts 16 amps. for up to eight 224 or 227 tubes. Center taps are red and all leads are identified on name plate. Laminations are hidden except at bottom. Eight-inch leads emerge from the sides, but if preferred may be taken off through the bottom of the transformer by pushing them through the rubber grommets. Shipping weight, 12 lbs. Overall size: 5" extreme width x 4½" high.

for 280 plates, 2½ v. 3 amps. for 245 output, single or push-pull; 5 v. 2 amps. for 280 filament; 2½ volts 16 amps. for up to eight 224 or 227 tubes. Center taps are red and all leads are identified on name plate. Laminations are hidden except at bottom. Eight-inch leads emerge from the sides, but if preferred may be taken off through the bottom of the transformer by pushing them through the rubber grommets. Shipping weight, 12 lbs. Overall size: 5" extreme width x 4½" high.

Our Net Price \$7.35

No. 250 POWER TRANSFORMER

Our Net Price Same as above \$8.50

No. 171 POWER TRANSFORMER

Our Net Price Same as above \$5.50

245 B SUPPLY CHOKE

100 m. choke coil for B filtration in 245 circuits; 200 ohms D.C. resistance, inductance 30 henrys. A continuous winding tapped in two places, giving three sections and four outleads, and permitting a "choke input" to filter. This method lengthens rectifier tube life and filter condenser life, yet filtration is splendid. The black lead goes to the rectifier filament center, the red, green and yellow leads are next in order. Capacities suggested: black, none; red, 1 mfd.; green, 8 mfd.; yellow, 8 mfd. In shielded polished aluminum case. Shipping weight 4 lbs.

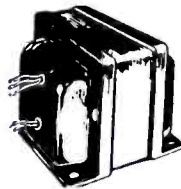

Our Net Price \$3.65

R.C.A. MAGNETIC CHASSIS

This chassis is the identical one used in the R.C.A. Model 100A and 100B Speakers, WHICH LIST FOR AS HIGH AS \$35. Note built-in OUTPUT TRANSFORMER—this enables the speaker to be used with voltage applied to it as high as 600 volts, without any trace of distortion, rattling or blasting. Equipped with GENEROUS OVER-SIZED MAGNETS. The thick armature is ACCURATELY CENTERED. The STURDY METAL FRAME IS LINED WITH A SPECIAL FABRIC, greatly improving the acoustic properties of this sensational speaker!

NOTE THE CORRUGATED SURFACE OF THE CONE, AN EXCLUSIVE FEATURE—ENHANCES PERFECT TONAL REPRODUCTION QUALITIES CONSIDERABLY.

Most compactly made: 9" outside diameter, 4½" deep overall.

Our Net Price, \$3.25

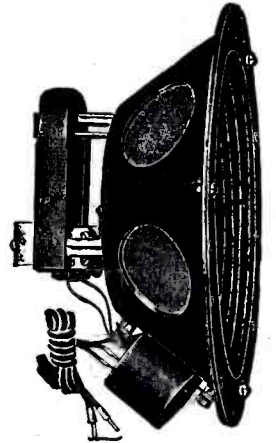

BARGAINS IN TUBES



Regular SILVER SHIELD or PAR Vacuum Tubes—100 per cent replacement within three months provided they still light.

X201A	\$0.35	X281	\$1.05
X22640	X250	1.25
Y22750	X210	1.25
Y22475	UX19960
X24550	UV19965
X28075	UX12065
X171A50	WD1175
X112A50	WD1275



No Less Than Ten Tubes Sold at One Time

DIEHL

Spring Mounted, 110 volt, 60 cycle, A.C.

INDUCTION MOTORS and TURNTABLES

These have AUTOMATIC STOP and SPEED REGULATOR. No Brushes—No Hum. The very motor for electric home-recording devices and phonograph drive.

OUR NET PRICE \$7.95

Only one drawback about this item—They won't stay with us long, so get yours quickly.

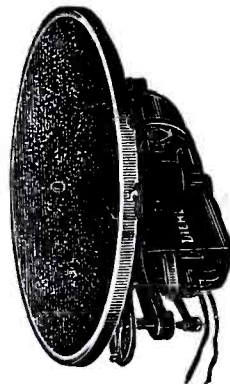

POWERTONE WAVE TRAP

Genuine moulded bakelite casing, panel or sub-panel mounting option, or placement atop of cabinet, marks this new model wave trap that cuts out interference.

OUR PRICE EACH \$0.75



Victor Audio Transformer with Voice Coil

For Replacement in All Victor Sets

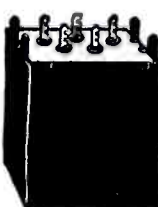

Can be used for any tube of high impedance. Has special winding for phonograph pickup. Magnetically shielded, preventing inter-stage feed back. RATIO 3½x1. Terminals are numbered: 1—Phono coil, 2—B plus, 3 Ground, 4—Plate, 5—Grid.

OUR PRICE \$0.95

3 and 6—Primary (110 V. input), 2 and 4—2½ volts.

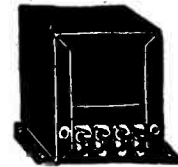

EDISON AUDIO TRANSFORMER

Ratio 3½:1

Each 85c
Dozen \$9.00

Edison Push-Pull Input Transformer

1—Grid. 2—Fil. 3—Fil. 4—Grid. 5—Plate. 6—B plus.

Our Price, 95c

RATIO 3x1—For replacement for use with 171A, 245, 250 tube. Electrostatically shielded.

POWERTONE TONE CONTROL

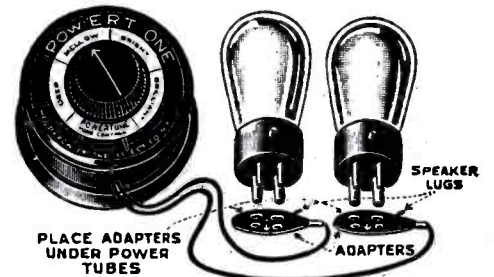

A scientifically designed instrument for the regulation and control of tonal quality. Classical music, great singers, famous artists can be heard the way you have always longed to hear them. The tone control is easily and quickly installed without the use of any tools.

List Price, \$3.00.

Our Price, \$2.55

All offers are F. O. B. New York, and subject to prior sale. Terms: A deposit of 20 per cent is required with every order. Balance may be paid on delivery. Or, deduct 2 per cent if full amount is sent with order.

GRENPARK TOOL CO., Dept. SWC, 245 Greenwich Street, New York, N. Y.

SHORT-WAVE COILS

Tube Socket Models

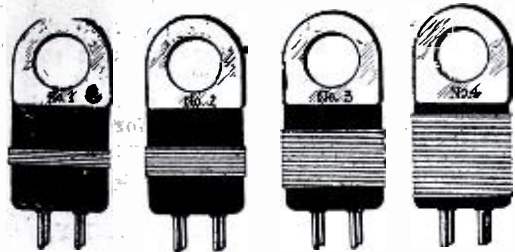

Coils fit in standard UX (4-prong) tube sockets, for .00014 mfd. tuning. Four coils to a set (15 to 150 meters; use .00014 mfd.). Order Cat. FHC @ \$1.50. The coil forms are equipped with finger handles.

CONVERTERS

A.C. model short-wave converter (Cat. AP-AC-CON) includes drilled, socketed panel, cabinet, two Hammarlund .0005 mfd. SFL, two National VB dials, five precision deluxe coils (Screen Grid Coil Co.), filament transformer, everything else (less three 227 tubes required). Price \$24.70.

- Hammarlund .0005 SFL tuning condenser (Cat. H-SF-5) \$3.30
- Heath Radiant .00014 tuning condenser (HR-4) 1.25

GUARANTY RADIO GOODS COMPANY

143 West 45th Street New York, N. Y.
(Just East of Broadway)

GUARANTY RADIO GOODS CO.,
143 West 45th Street, New York, N. Y.
(Just East of Broadway)

Enclosed please find \$..... for which please ship:

- Cat. FHC @ \$1.50
- Cat. AP-AC-CON @ 24.70
- Cat. H-SF-5 @ 3.30
- Cat. HR-4 @ 1.25

Your Name

Street Address

City State (SWC)

FOR BOOKS

to read during your spare time, we suggest that you turn to page 340 of this issue. On that page you will find many books to complete your hours of pleasure.

The New Pilot "Universal Super-Wasp"

(Continued from page 352)

distance away from the set proper, and there still remained the plug-in coils to be juggled around.

The next logical pair of improvements has just been achieved for the first time in a commercial set with the announcement of the new Pilot "Universal Super-Wasp," which is an outgrowth of a receiver that is known and used all over the world. These improvements are the elimination of the plug-in coils and the final union of the tuner and the power-supply unit. Instead of pushing in and pulling out coils, the operator merely turns a knob on the front panel, and he can cover any wave band between 15 and 650 meters! The power pack is an integral part of the chassis, and is designed to work best with the specific tube combination that is used.

This new receiver, which will undoubtedly be received with interest by short-wave fans, has not been released yet officially, but a general description of its features has been made available to SHORT-WAVE CRAFT. A longer article, illustrated with photos, describing the outfit in great detail will appear in the next issue.

The set consists electrically of six tubes, arranged as follows: screen-grid tuned R.F. amplifier, screen-grid regenerative tuner, 227 first audio stage, 171A push-pull output stage, and 280 rectifier for plate supply. The hook-up is shown in the accompanying diagram. Regeneration is controlled by a potentiometer in the screen-grid lead of the detector, this arrangement being superior to ordinary condenser control, in that it does not affect the tuning of the grid circuit.

The rather wide range of 15 to 650 meters is covered by means of four pairs of fixed coils, double-section tuning condensers for both the R.F. and detector stages, and a highly ingenious cam switch for throwing the coils and condensers into various combinations for the various ranges. This switch, which has seven positions, is the "heart of the receiver," and is very cleverly made. It cannot be described very well in words, as its construction is altogether out of the ordinary. It will be fully illustrated in the next article. The switch is in two sections, each bearing four coils and each being mounted in a shielded compartment. A simple worm gear drive gives direct control from the front panel.

The chassis of the set is of aluminum. The receiver is the most spectacular looking short-wave job that has ever appeared, and exhaustive, long distance reception tests prove that it works as well as it looks.

Why I Don't Read SHORT WAVE CRAFT

(Continued from page 375)

I mean), and why would they stand twice as much strain? As sleep came on, they gradually slid together. (Psychology is one of my hobbies.) And when they were exactly together, the middle plates dropped out. I awoke with a start. Why, certainly! Condensers in series simply increases the thickness of the dielectrics,—puts more atoms in series in each line, dividing the "a" given variable voltage among

All You Need to Learn TELEGRAPHY

Morse or Continental with **Teleplex**

LITERALLY thousands of ambitious men, women and boys have mastered code this easy way—right in their own homes without any other training than TELEPLEX gives them.

TELEPLEX is more than a machine—it is a SYSTEM.

All you need is an ear to listen and a hand to practice. You can't help learning to read and send just as the experts do.

TELEPLEX teaches Morse or Continental Code—equips you efficiently for amateur work or for a good-pay operator's position.

TELEPLEX—the Master Teacher—is used by the U. S. Army and Navy and by leading radio and telegraph schools.

Write for Folder SW-1

Teleplex Co.
76 Cortlandt St.
New York

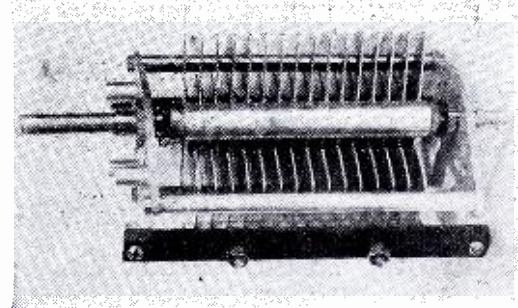

ANNOUNCING An Intermediate Transmitting Condenser

Especially suitable for airplane or similar sets where light weight is the chief factor. Available in capacities ranging from 50 mmf. to 150 mmf.

Write for Literature
AIRWAY CONDENSER CO.
56 Christopher Ave., Brooklyn, N. Y.

PATENT YOUR INVENTIONS Register Your Trademark

If your invention is new and useful it is patentable. I PROTECT your rights by U. S. and Foreign Patents. Call or send me a sketch or model of your invention. Consultation free.



Z. H. Polachek
Reg. Patent Attorney, Consulting Engineer. One Two Three Four Broadway, N. Y.

1234 Broadway
New York City

Leading Circuits for Short Waves

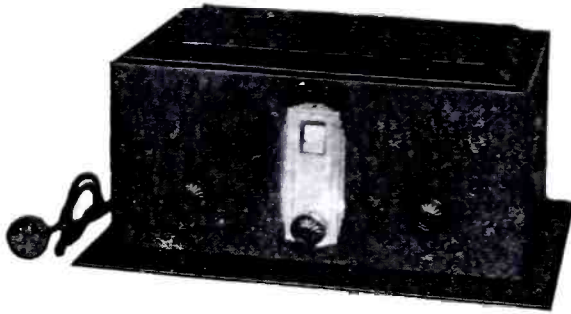

NATIONAL 5-TUBE THRILL BOX—A remarkably sensitive short-wave outfit, noted for reception of foreign stations. (Front view illustrated above.) This outfit costs money, but the results are there. It is so good it is standard equipment on planes of several passenger air lines, besides being the standby of amateurs and custom set builders. If you've an appetite for short waves, the Thrill Box is your meat. Uses 224 RF, 224 detector, 227 first audio, 227 push-pull second audio. A separate A and B supply is required. See below. Standard set of four pairs of coils included (21.2 to 2.61 megacycles). Humless operation, even on earphones. Single tuning control. No grunting, no backlash, no hand capacity. Product of National Co., makers of the finest parts. Order Cat. AC-SW-5, list price, less tubes, less B supply, \$79.50; net price.....\$46.74

WIRED MODEL AC THRILL BOX—Order Cat. AC-SW-5-W. Tested for performance, using foreign stations only. List price, \$89.50, less tubes, less power unit; net price.....\$52.62

NATIONAL SW POWER UNIT—Furnishes heater voltage and B voltage for the AC Thrill Box. Uses 280 rectifier. Comes in wired form only. Licensed under RCA patents. Order Cat. 5880, list price, less tube, \$34.50; net price.....\$20.28

BATTERY MODEL THRILL BOX—This uses the new 2-volt tubes; two 232 screen grid, three 230 and one 231, in same general circuit. Order Cat. DC-SW-5, list price, \$75; net price.....\$44.10

WIRED MODEL BATTERY THRILL BOX—Order Cat. DC-SW-5-W. Tested for performance, using foreign stations only. List price, \$85, less tubes; net price....\$49.98

HAMMARLUND SW TUNER—For one stage of RF and detector; battery operation; uses two 230 tubes or any other pair of battery-operated general purpose tubes. Coils cover 15 to 105 meters. Order Cat. SWR-2, list price \$36, less tubes; net price.....\$21.15

Guaranty Radio Goods Co.
143 West 45th Street
New York, N. Y.

New Style

SHORT WAVE PLUG-IN COILS

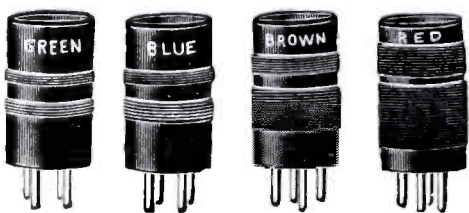

THESE new style coils are moulded in genuine bakelite to fit UX sockets. Coils come in different colors bakelite, as indicated in illustration, for quick identification. Smallest and most efficient coils produced as yet. Wound with special wire to avoid all possible losses.

Set includes four coils to cover range from 15 to 210 meters when used with a .0001 midget condenser. Just plug coil into UX socket.

Every radio amateur, every experimenter, requires a set of these fine coils. Sizes: 2 3/4 in. overall by 1 1/4 in. Coil dimension: 2 1/2 x 1 1/4 in.

List Price, \$3.75 per set of 4 coils.

YOUR SPECIAL PRICE, \$1.90
POSTPAID.....

RADIO TRADING CO.

25 A West Broadway New York City

more atoms, producing less strain on each one.



Now, I ask you, why can't these "practical" Birds tell us something like that? HEY???

At that time, 1928, I had a set with a range between one and ten meters by plug-in (with bolts) coils and condensers. It would oscillate from 9.33 to 10 meters but not below. All my experience, training and reading had failed to make it percolate below 9.33 meters. So I started thinking!

Reading stimulates that, thass all! The important thing is thinking. A well "thot out" man is far better educated than a "well read" man. But without reading, where would I be? A Practical, Useless * ! ! x ? ? like the rest of the radio tinkers called "Practical Engineers"—Oh my yes!

The result of my thinking along the line of atoms and molecules led to changes in the set that made it oscillate (allowed it to, rather) down to .985 meters. Now, I have one that

tunes from .25 to .75 meters by making various changes.

So-called "practical" dope never helped me any. "Q. S. T." is a waste of money for me now. I am past the Q. S. T. stage. I read Mills: "Within the Atom"; Luckiesh, "Foundation of the Universe"; Russell, "A-B-C of Atoms," and although it seems there is no connection between quantum-numbers, possible orbits and valence, electrons, and radio, I "figger" when a little bit helped so much, at 1 to 10 meters, more of it won't hurt from .1 to 1. meter.

Chemistry is the study that connects Atoms with Radio and I am starting in on it this month, so I can produce "shorter" waves. It may not be "practical" but it certainly is useful. If a lot of guys would forget this "practical" stuff long enough to get useful, the world would be a different place.

Yours sincerely,

CLARENCE GERREN, WSCSY,
Mutual Telephone Co.
"The Wasp."

"Where Theory Comes First and Performance Follows as a Natural Result."

Among the Hams

(Continued from page 365)

FROM HONDURAS

Editor SHORT WAVE CRAFT:

I have built the famous "SUPER WASP" receiver, which permits me to listen to many broadcast stations that I could not "fish" with my 200-550 meter receiver. On this band, the SUPER WASP is equal to a six-tube receiver; good volume on loud speaker. On short-waves I have had regular success. I have listened very clearly to WGY, Schenectady; WENR, (W9XF), Chicago; KDKA-W8XK, Pittsburgh; WLW-W8XAL, Cincinnati, all between 27-53 meters. I have listened to the station El Prado, of Rioamba, Ecuador (South America). I have not had outstanding results, because I use a D.C. eliminator for plate current, and the direct current at this port fluctuates up and down too much. The difference of time between foreign broadcasting stations and stations in this city do not permit me to listen to them, because there is no current during the day at this port, only during the night for light service. In order to avoid all these difficulties I have ordered a rechargeable power "B" battery, 180 volt; and I shall use one 171A tube on the last audio stage.

J. HECTOR LEIVA,
Ampala, Honduras Rep.
C. A.

(We were glad to receive your letter, Señor Leiva, and we trust to receive many more from our other readers abroad, of whom we have a considerable number.)

We are always glad to hear from SHORT WAVE CRAFT readers from other countries and to get their viewpoints. Their letters help to establish relations between them and American readers, all of which tends to make SHORT WAVE activities greater all over the world.—Editor.)

THAT SHORT WAVE SUPERHET

Editor SHORT WAVE CRAFT:

Your Short-Wave Super sure made a hit with me. It was the first time I really felt like making one, having made everything but.

Now to come down to facts. When anybody designs a set they are more than likely to have a set of coils that would take a fellow plenty long to finish. But as to yours they are very simple. The one reason I made it was the I.F.A. which was simplest. "I saw and made." A fellow who works hasn't very much time to mess with elaborate coils, so I guess that's the reason so many fine circuits go on the rocks. Congratulating you and the "Short Wave Craft" staff I remain,

CHARLES PARSON,
325 N. Ewing,
St. Louis, Mo.

P. S. You sure have a fine book.

(Glad to hear from you, Charles. We have had hundreds of letters on this Superhet and they all seem to like it. Let's hear from other readers how it works out for them.—Editor.)

WE'RE GLAD TO COMPLY

Editor SHORT WAVE CRAFT:

I have just finished your SHORT WAVE CRAFT magazine, Dec-Jan. issue. I sure enjoyed reading this magazine. Would like to correspond with short wave fans, especially fans who are interested in code.

Will you please print the above letter in your Ham's section.

JAMES B. ALEXANDER, JR.
915 N. Leithgow St.,
Philadelphia, Pa.

(Glad to oblige you, James, and it would serve you right if all the code hounds would "snow you under."—Editor.)

HERE Y'ARE

M. U. FIPS, Secretary,
Short Wave Phone Hound,
c/o SHORT WAVE CRAFT,
96 Park Place,
New York, N. Y.

Dear Sir:—

Please send me full particulars on your society.

Thanking you in advance, I remain,

THOMAS A. FINNERTY,
382 Riverway,
Roxbury, Mass.
November 19, 1930.

ANSWER

(The editor was good enough to hand me your letter and I am delighted to give you the full particulars as to our illustrious society herewith, pronto!

1. In the first place you are not eligible no matter what race, color or creed you belong to, unless you have taken a chromium-plated oath that you can sit up until at least 5:40 in the morning, listening to foreign short wave phone stations.

2. A real "short wave phone hound" is not supposed to know anything about code. His sole knowledge being a fairly good interpretation of the S.O.S. signal.

3. A "short wave hound" must possess a good pair of phones in addition to the loud speaker and—ahem—a short wave set.

4. A "short wave phone hound" must be ready to write to transmitting phone amateurs that he has heard them and ask for their verification cards.

5. A "short wave phone hound" should have a card of his own, but if he hasn't this society will furnish him acknowledgment cards at a slight expense.

These are by no means the full particulars of our illustrious society, which is at present in a formative state and we are open to more suggestions and regulations from all other REAL "short wave phone hounds," and I sincerely trust that they will get busy and assist me in this titanic undertaking.

MOHAMMED ULYSSES FIPS, Secretary,
(Short Wave Phone Hounds of the Universe.)

Removal Sale

Due to the tremendous growth of our business, we are forced to move to larger quarters, where we can give our customers prompt and efficient service and handle a larger variety and greater quantity of select radio merchandise.

SEND FOR OUR FREE BIG BARGAIN CATALOG!

BAL-RAD Replacement Block for Majestic "B" Eliminator



The condensers in this block are composed of high voltage condensers. Guaranteed for 1 year. Each **\$2.95**

PEERLESS A.B.C. Power Transformer



For use with 245, 280, 224, 227. Also has a 3-volt winding for 199 tubes or Amperite voltage control. Our Price **\$3.75**

EARL & FREED Power Transformers



Our Price **\$4.50**

YAXLEY 2,000 - Ohm Volume Control



For Radiola 17, 18, 32, 42, 44, and practically all sets. Insulating strip (easily removed) for metal panels. List Price 1.95. EA. **45c**

POLYMET



11-Volt 1 mfd. Filter Condenser. 300 Volts D.C. Each **35c**

Complete stock of replacement parts—all models
Brunswick-Radiola receivers

RPA-1 AP 947	RPA-3 AP 950	RPA-4 AP 832	RPA-5 AP 952	RPA-7 AP 991
Volume Control Potentiometers	Rectifier and Power Amplifier Assemblies Fixed Capacitors	Receiver Assemblies Catacombs		

Write Us For Prices

BAL-RAD HY VOLTAGE

Surge-Proof Condensers for General Repair and Power-Pack Work
We guarantee these condensers for 100 per cent. free replacement. Repairmen should carry a few dozen in stock.

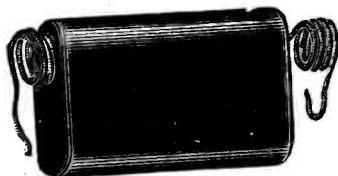

	MFD.	Working Volts	Each
One	600	"	30c
Two	600	"	40c
Four	600	"	60c
One	800	"	50c
One-half	300	"	25c

- Brach Bell Ringing Transformer\$.85
- Naald Replacement Transformer—Ratio 3-150
- Philco Power Transformer—Model 87 3.95
- R.C.A. No. 64 Power Transformer 10.90
- United Electric Motor and Turntable 7.95
- Pacent Phonovox 4.95
- R.C.A. Power Transformer, Part No. 8335 3.95
- R.C.A. Part No. 8333 1.50
- R.C.A. Part No. 599635
- Zenith Power Transformer... 3.50
- Zenith Audio Transformer.... .95
- Zenith Output Transformer... .90
- Zenith Inter-Stage Audio Transformer 1.25
- Freshman Replacement Transformer45
- Edison Audio Transformer... .85
- Crosley double 30 henry Chokes 1.50
- Polymet 2 mfd.55
- Potter 1/2 mfd. Condenser25
- Crosley 1/2 mfd. Condenser25
- BalRad Replacement Block Majestic B Eliminator 2.95

- Kolster Condenser Block.....\$.95
- Quam Magnetic Speaker..... 3.75
- Muter Dynamic Speaker..... 8.95
- R.C.A. 106 Speaker..... 14.50
- Kolster K-6 Speaker..... 4.95
- R.C.A. 100B Speaker..... 4.50
- R.C.A. 103 Speaker..... 5.25
- Brandes Cone Speaker..... 2.45
- Brandes Type "H" Speaker... 1.45
- R.C.A. No. 103 Speaker Chassis 3.25
- Kolster K-6 Speaker Chassis.. 2.45
- Baldwin Rival Unit..... .75
- Westinghouse PT Meters..... 1.00
- 4 Gang Condenser..... 1.50
- H & H Toggle Switch..... .20
- H & H Rotary Snap Switch... .25
- Freed-Earl Wood Knobs per dozen 1.00
- Insulated Staples....per 1,000 .95
- Lead-in Wire.....100 ft. rolls .31
- Shielded Lead-in Wire—50 ft. rolls, \$.60; 100 ft. rolls 1.00
- Hook-up Wire.....25-ft. coils .12
- Push Back Wire...100-ft. roll .50
- Crosley Crystal Detector..... .15
- Sonora 15 Volt Tubes.....ea. .75
- Sonora SO-1 Tubes..... 1.60
- Western Electric VT 1..... .35
- B.H. Type Tubes..... 1.85

PIGTAIL CARBON RESISTANCES

Ohm	Ohm	Ohm
500	15000	10000
1000	25000	20000
	Megohm	
4700	2	75000

\$1.00 Per doz.

VICTOR PUSH-PULL TRANSFORMER
Input and Output

Can be used with 171A-245 or 250 type tubes. Output matches moving coil on all dynamic speakers.
With Metal Jacket \$2.50
Without Metal Jacket \$1.50

TERMS: 20% with order, balance C.O.D.
2% discount allowed for full remittance with order only.
NO ORDERS ACCEPTED FOR LESS THAN \$2.50

BAL-RAD Replacement Block For Atwater Kent No. 37

This unit contains the proper chokes and high voltage condensers. All flexible wire colored leads identical to the original. Fully guaranteed. **\$4.95** anted. Ea.

Thordarsoon Power Transformers
For Replacement in Zenith Sets

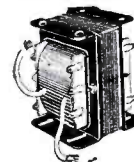

Models ZB 10-33-33X-34. This transformer can also be used for circuits employing the following type tubes: 5-227-1-171A-1-250. Our price.. **\$2.75**

RCA CHOKE COILS
15 Henrys



Impregnated in Rosin. Ideal choke for use in "B" Elim. and A.C. Sets. D.C. Resistance 500 ohms. Each **25c**

POLYMET By-Pass Tubular Condenser



1 mfd., 200 volts. Can be used across Choke Terminals in Victor Sets to reduce hum. Per dozen **\$1.00**

TOGGLE SWITCH



For Electric or Battery Sets. 20c each

BALTIMORE RADIO CORP. 47-S MURRAY STREET, NEW YORK CITY

Learn About Short-Wave Converters!

IN the November 8th issue of RADIO WORLD, the first and only national radio weekly, there began a remarkable series of articles dealing with the construction of short-wave converters that really do work, and that work well. Besides, the cost of parts is low. One model, 30 to 110 meters, no plug-in coils, may be built of parts costing less than \$5, for battery operation, or for AC with extra filament transformer external. Another model, 10-200 meters, two plug-in coils, using somewhat superior parts, filament transformer built in, can be made up by you for less than \$10. Surely these prices are within the reach of all.

Low price and high achievement go hand in hand in these designs by Herman Bernard.

The series ran in the November 8th, 15th, 22nd and 29th, and December 6th, 13th and 20th issues.

Send \$1 and we will forward these seven issues and a blueprint of the AC \$5 model.

RADIO WORLD,
145 West 45th Street, New York, N. Y.

Enclosed please find \$1.00, for which send me the November 8th, 15th, 22nd and 29th, and Dec. 6th, 13th and 20th issues, containing the series of articles on short-wave converters of extremely low price, and a blueprint of the AC \$5 model.

Name

Address

City..... State.....(SWC)

Short-Wave Stations of the World

(Continued from page 371)

Meters	Kilo-cycles	Stations	Meters	Kilo-cycles	Stations
48.74	6,155	W9XAL, Chicago, Ill. (WMAC) and Airplanes.	72.87	4,116	WOO, Deal, N. J.
		—VE9CL, Winnipeg, Canada.	72.90	4,110	WSBN, S.S. "Leviathan."
		—W2XDE, Bell Telephone Laboratories, New York.	74.72	4,105	NAA, Arlington, Va. Time signals 8:55-9 a.m., 9:55-10 p.m.
48.83	6,140	K1XR, Manila, P. I. 3-4:30, 5-9 or 10 a.m., 2-3 a.m. Sundays.	80.00	3,750	F8KR, Constantine, Tunis, Africa. Mon. and Fri.
		—W8XK, East Pittsburgh, Pa. Tu., Thu., Sat., Sun., 5 p.m. to midnight.			—13RO (Prato Smeraldo) Rome, Italy and Fri.
48.91	6,120	7LO, Nairobi, Kenya, Africa. 11 a.m. to 2 or 3 p.m.	82.90	3,620	DOA, Doberitz, Germany. (Television.)
48.99	6,120Motala, Sweden. "Rundradio." 6:30-7 a.m., 11-4:30 p.m. Holidays, 5 a.m.-5 p.m.	84.24	3,560	OZ7RL, Copenhagen, Denmark. Tuesday and Fri. after 6 p.m.
		—NAA, Arlington, Va.	84.46-85.66	3,550-3,500	Amateur Telephony.
		—Chi-Hoa (Saigon), Indo-China. 6:30-7:30 a.m.	86.50-88.00	3,490-3,460	Aircraft.
		—W2XE, New York City. Relays WABC. Atlantic Broadcasting Co.	92.50	3,256	W9XL, Chicago, Ill.
		—FL, Eiffel Tower, Paris, 5:30-5:45 a.m., 5:45-12:30, 4:15-4:45 p.m.			—W6XBA, S.S. Metha Nelson, Fox Film Corp. and other experimental stations.
	Toulouse, France. Sunday 2:30-4 p.m.	94.76	3,166	WCK, Detroit, Mich. (Police Dept.)
		—MTH, Rio de Janeiro, Brazil, 5-7 p.m.	95.48-97.71	3,142-3,070	Aircraft.
		—EAR25, Barcelona, Spain, 3-4 p.m.	96.03	3,124	WOO, Deal, N. J.
49.07	6,110	VVB, Bombay, India. Testing. Mo., Wed., Fri., 12:30-1:15 p.m.	97.15	3,088	WIOXZ, Airplane Television.
49.15	6,100	W3XAL, Bound Brook, N. J. (WJZ, New York). 5-6:30 p.m., 11 p.m.-1 a.m.	97.53	3,076	W9XL, Chicago, Ill.
49.17	6,095	VE9GW, Bowmanville, Ontario, Canada. Daily, 1:45-5 a.m., noon to 7 p.m. Sundays, 5 a.m. to 7 p.m. Gooderham & Worts, Ltd.	98.95	3,030Motala, Sweden. 11:30 a.m.-noon, 4-10 p.m.
49.26	6,090Copenhagen, Denmark.	101.7	to 105.3	meters—2,850 to 2,950 kc. Television.
49.31	6,080	W2XCX, Newark, N. J. Relays WOR.			—W1XAV, Boston, Mass.; —W2XNR, New York, N. Y. 4-6:30, 7:30-10 p.m.
		—W9XAA, Chicago, Ill. (WCFL). 6-7 a.m., 7-8 p.m., 9:30-10:15, 11-12 p.m. Int. S.-W. Club programs. Sat. from 10 p.m. to 6 a.m. Sunday	104.4	2,870Milan, Italy. After 2 p.m.
		—W6XAL, Westminster, Calif.	105.0	2,855	W1XY, Tilton, N. H.
49.40	6,070	HS2PJ, Bangkok, Siam. 6-6:30 a.m.	105.9	2,833	W6XAN, Los Angeles, Calif.
		—UOR2, Vienna, Austria. 5-7 a.m., 5-7 p.m. Tues. and Sat., 9-10 a.m. Thu.			—W2XAB, Spokane, Wash.
49.46	6,065	SAJ, Motala, Sweden. 6:30-7 a.m., 11 a.m.-4:30 p.m.	105.3	to 109.1	meters—2,750 to 2,850 kc. Television.
49.50	6,060	W8XAL, Cincinnati, Ohio. Relays WLW. 6:30-11 a.m., 1:30-3 p.m., 6 p.m.-1 a.m., daily.			—W2XBO, Long Island City, N. Y.
		—W9XU, Council Bluffs, Iowa. Relays KOIL.			—W9XAA, Chicago, Ill.
		—W3XAU, Hyberry, Pa., relays WCAU.	110.2	2,722	Aircraft.
49.67	6,040	W9XAQ, Chicago, Ill. (WMAQ).	112.1	2,938	W6XAF, Sacramento, Calif. State Dept. of Agriculture.
		—W2XAL, New York.	122.3	2,452	W7XU, Portland, Oregon, Police Dept.
		—PK3AN, Sourabaya, Java. 6-9 a.m.	124.2	2,416	W7XP, Seattle, Wash., Police and Fire Depts.
49.80	6,020	W9XFB, Chicago, Ill.	125.1	2,398	W9XL, Chicago, Ill.; —W2XCU, Ampere, N. J. And other experimental stations.
49.97	6,000	W2XBR, New York, N. Y. (WBNY).			—W2XAD, W2XAF, Schenectady.
		ZL3ZC, Christchurch, New Zealand. 10 p.m.-midnight, Tuesdays, Thursdays and Fridays.	125.4	2,392	WIOXAL and WIOXAO, Portable. National Broadcasting Co.
		—HRB, Tegucigalpa, Honduras. 9:15 p.m.-midnight, Mo., Wed., Fri. From 11 p.m. to midnight Sat., Int. S. W. Club programs.	128.0-129.0	—Aircraft.	
		—EAR25, Barcelona, Spain. Sat. 3 to 4 p.m.	129.0	2,325	WIOXZ, Airplane Television.
		—RFN, Moscow, Russia. Tues., Thurs., Sat. 8 to 9 a.m.	130.0	2,306	DDDX, SS "Bremen" and "Europa" testing.
		—Eiffel Tower, Paris, France Testing 6:30 to 5:45 a.m., 1:15 to 1:30, 5:15 to 5:45 p.m., around this wave.	135.0	2,220Stockholm, Sweden.
50.23	5,970Vatican City (Rome).		Oslo, Norway.
51.40	5,833	HK7, Barranquilla, Colombia. 8:30 to 10:30 p.m., exc. Sun.	136.4	to 142.9	meters—2,100 to 2,200 kc. Television.
52.00	5,770	AFL, Bergedorf, Germany.			—W2XBS, New York, N. Y., 1,200 R.P.M., 60 lines deep, 72 wide.
52.50	5,710	VE9CL, Winnipeg, Canada.			—W2XCW, Schenectady, N. Y.
52.72-54.44	5,690-5,510	Aircraft.			—W3XAK, Bound Brook, N. J. (Portable.)
52.80	5,680	OCTU, Tunis, No. Africa.			—W8XAV, Pittsburgh, Pa., 1,200 R.P.M., 60 holes, 1:30-2:30 p.m., Mon., Wed., Fri.
54.02	5,550	W8XJ, Columbus, Ohio.			—W9XAP, Chicago, Ill.
54.51	5,500	W2XBH, Brooklyn, New York City (WBBC, WCGU).	142.9	to 150	meters—2,000 to 2,100 kc. Television.
56.70	5,300	AGJ, Nauen, Germany. Occasionally after 7 p.m.			—W2XAP, Jersey City, N. J.
58.00	5,170	OKIMPT, Prague, Czechoslovakia, 1 to 3:30 p.m., Tues. and Fri.			—W2XCR, Jersey City, N. J. 8-10 p.m., Mo., Wed., Fri., 3-5 p.m.
59.96	5,000Bratislava, Czechoslovakia.			—W3XK, Wheaton, Maryland. 8-10 p.m.; Mo., Wed., Fri., 3-5 p.m.
60.30	4,975	W2XAV, Long Island City, N. Y.			—W2XBU, No. Beacon, N. Y. (1-2 p.m.)
60.90	4,920	LL, Paris, France.			—W2XCD, Passaic, N. J. 8-10 p.m., exc. Sat. and Sun.
61.22	to 62.50	meters—4,800 to 4,900 kc. Television.	150	2,000	RA72, Smolensk, USSR.
		—W8XK, Pittsburgh, Pa.; —W1XAY, Lexington, Mass.; W2XBU, Beacon, N. Y.; —WENR, Chicago, Ill.	149.9-174.8	—2,000-1,715	Amateur Telephony and Television.
62.56	4,795	W9XAM, Elgin, Ill. (Time Signals.)	174.0	1,723	ZL2XS, Wellington, New Zealand.
		—W3XZ, Washington, D. C.	175	1,715	W9XAN, Elgin, Ill.
		—WSXDD, portable. Bell Telephone Laboratories, New York.			—W6XK, Los Angeles, Calif. And other experimental stations.
62.69	4,785	Aircraft.	175.2	1,712	WKDU, Cincinnati, Ohio. (Police Dept.)
		—And other experimental stations.			—WMP, Framingham, Mass. 11 a.m., 1 and 5 p.m. daily. Music and police reports.
62.70	4,785	VZA, Drummondville, Canada.			—WRBH, Cleveland, O. (Police Dept.)
62.80	4,770	ZL2XX, Wellington, New Zealand.			—KGJX—Pasadena, Calif., (Police Dept.)
63.13	4,750	WOO, Deal, N. J.		St. Quentin, France.
		—WXDD, Ocean Gate, N. J.			—F8FY, Cannes, France. 5 p.m. Wed.; 4 a.m. Sunday.
63.79	4,700	W1XAB, Portland, Me.	176.5	1,700Orly, France.
65.22	to 66.67	meters—4,500 to 4,600 kc. Television.	178.1	1,684	WDKX, New York, N. Y. (Police Dept.)
		—W6XC, Los Angeles, Calif.	180.4	1,662Michigan State Police.
67.65	4,430	DOA, Doberitz, Germany. 6 to 7 p.m. 2 to 3 p.m. Mon., Wed., Fri.	186.6	1,608	W9XAL, Chicago, Ill. (WMAC) and Aircraft Television.
68.30	4,340	WSBN, S.S. "Leviathan."			—W2XY, Newark, N. J.
70.00	4,280	OHK2, Vienna, Austria. Sun., first 15 minutes of hour from 1 to 7 p.m.	187.0	1,604	W2XCU, Wired Radio, Ampere, N. J.
70.20	4,273	RB15, Khabarovsk, Siberia. 5:30-10:30 a.m.			—W2XCD, DeForest Radio Co., Passaic, N. J. 8-10 p.m.
		—GDLJ, S.S. "Homeric."			—W2XAD—W2XAF, Schenectady.
72.70	4,120	GLSQ, S.S. "Olympic."			—W9XX, Cartersville, Mo.
		—GFVV, S.S. "Majestic."			—W5XN, Dallas, Texas.
71.77-72.98	4,180-4,100	Aircraft.			—W2XDD, portable.
				Ornskoldvik, Sweden.
					—And other experimental stations.
			187.9	1,596	WRBC, New York, N. Y. (Fire Dept.)
					—WKDT, Detroit, Mich. (Fire Dept.)
					—W7XP, Seattle, Wash. (Police and Fire Depts.)
			189.4	1,584	WIOXAL, WIOXAO, Portable (N. B. C.)
			192.3	1,560Scheveningen, Holland.
			194.3	1,544	W2XOA, New York.
			96	1,530Karlskrona, Sweden.
					(Standard Television scanning, 48 lines, 900 R.P.M.)

How Short and Long Waves Link Planes With Ground

(Continued from page 370)

ferred to the nearest repair depot which is equipped to handle the repairing and testing of the equipment.

Perhaps the greatest single problem, encountered in the development of the two-way radio telephony, was the elimination of the interference emanating from

various sources. The plane itself, with its ignition system and the effects of static electricity arising from metallic friction, had to be completely shielded and bonded for the effective installation of radio.

RADIO'S GREATEST BARGAINS

THIS month we are offering a great variety of battery sets at such ridiculously low prices that they cannot fail to astonish you. These sets are so-called store demonstration models and are not sold as brand new. However, all sets have been carefully tested and put into good shape and we guarantee them to be in good working order. All other merchandise listed on this page is brand new and is shipped in

original factory sealed cartons and carries the same guarantee of absolute satisfaction.

Act immediately as the supply is limited and we reserve the right to return remittances as soon as items are sold out.

In many instances, our sale prices are lower than the actual manufacturer's cost. For terms, see bottom boxes.

Radiola 25 Superheterodyne

The "25" is a loop-operated set requiring 6 "X-199" tubes. No outside aerial is needed. The receiver has "10-kc selectivity. Tuning of this receiver is accomplished through large "thumb-operated" tuning drums, so designed that stations may be "logged" directly on the drums. The small center knob controls a multiple contact switch which changes the circuit to include one or two stages of A.F. A two-tone mahogany veneer cabinet of original pattern houses the chassis and batteries. Its overall dimensions are 28x19x12 inches high. Shipping weight, 55 lbs. List Price \$285.00. **YOUR SPECIAL PRICE \$10.95**

Stromberg-Carlson 523

This fine set uses 4 201A and 1 200A tubes. The cabinet is one of the finest ever made for radio sets. A slanting, beautifully grained wooden panel carries the tuning es-cutechons. The panel controls include a "Long-Short Antenna" switch; 3-ohm and 20-ohm rheostats; "On-Off" snap switch; audio output jack; and a Weston 0-7 volt-meter. The jack on the panel is for phonograph pickup. A neutrodyne circuit is used. 26 long x 14 deep x 13 inches high. Shipping weight 75 lbs. List Price \$160.00. **YOUR SPECIAL PRICE \$24.95**

Utah Dynamic A.C. Power Speaker—Model 33A

110-volt, 60-cycle A.C. light socket supply for field excitation with Westinghouse dry rectifier, 9 in. high, 9 1/2 in. wide, 7 1/2 in. deep. Speaker comes packed in wooden crate. It is one of the most powerful as well as best reproducers in the market. 9-inch cone. List Price \$50.00. **YOUR SPECIAL PRICE \$7.50**

A.C. Phonograph Motor

SYNCHRONOUS—revolves EXACTLY 30 turns per minute despite any voltage variations. Most compact made—only 1 1/4 in. thick—mounts in any limited space. For 110 volt, 60 cycle, A.C. Complete with turntable. Shipping wgt. 10 lbs. List Price \$15.00. **YOUR SPECIAL PRICE \$4.25**

245 A.C. Power Transformer

For five 224 (or five 227), two 245, one 280 A.C. tubes. OR ANY COMBINATIONS OF 2 1/2-VOLT TUBES. All secondary windings CENTER TAPPED. 600-VOLT HIGH VOLTAGE SECONDARY. 75 WATT CAPACITY. Size 5 1/4 x 4 1/4 x 3 3/8 inches. For 110 volt, 60 cycle, A.C. Shipping weight 12 lbs. List Price \$15.00. **YOUR SPECIAL PRICE \$3.40**

2 1/2 Volt A.C. Fil. Transformer

Two windings, both center tapped. One "lights" six 227 or six 224 2 1/2-volt tubes, and the other lights two 245 tubes. Total: 14 amps. For 110 volt, 60 cycle, A.C. Size 4 1/4 x 2 1/2 x 3 1/4 inches. Shipping weight 6 lbs. List Price \$10.00. **YOUR SPECIAL PRICE \$2.75**

Radiola 28 Superheterodyne

is a "Second Harmonic" superheterodyne. However, the circuit of the "28" includes 7 type X199 tubes and 1 type X120 tube. The Radiola 28 includes 3 S.L.F. condensers, 2 1-mf. safety-lamp by-pass condensers; center-tapped loop (necessitated by the stage of neutralized R.F.); 1 off-on switch; 2 filament rheostats; 1 4-coil R.F. inductance; 2 jacks; and the special 8-socket "catacomb" containing the I.F., R.F. and A.F. transformers. Coast to coast reception is a rather usual accomplishment! Uses 2 drum dials—space for station logging thereon. Many easy ways of electrifying this receiver. Revolving loop—greatly assists tuning. Access to battery compartment obtained by raising receiver on hinge. The mahogany cabinet imitates a secretary. List Price \$295.00. **YOUR SPECIAL PRICE \$24.98**

600 Volt Condenser Sections

Impregnated in pitch. Flexible lead terminals.

5 mfd. 25c	2 mfd. 40c
1 mfd. 30c	4 mfd. 60c

Radiola Superhet. AR-812

One of the most famous radio sets in America. This set placed on a table, the battery switch turned to "on," and music will be heard,—without an outdoor antenna; it works with a loop aerial built inside the cabinet. The set is super-sensitive and, in certain localities, it is possible, on the east coast, to hear west coast stations. The cabinet holds all the batteries for the six "dry-cell" tubes required. Some experimenters tune in short wave stations and use the AR-812 as the INTERMEDIATE FREQUENCY AMPLIFIER. In that way the tremendous amplification obtainable from this receiver is used to the fullest extent. A push-pull switch (center) turns the set on and off; another, (lower left) cuts in either one or two stages of A.F. amplification. Although the cabinet is 35 inches long, 11 1/2 deep and 11 1/2 high, the panel of the receiver is only 19 inches long and 9 inches high. The difference lies in the two end compartments for "A" and "B" batteries. Six type UV199 tubes are required for this receiver. Dry-cell power tubes, the type "20," may be used in this set if a Naald or similar adapter is used. Shipping weight 45 lbs. List Price is \$220.00. **YOUR SPECIAL PRICE \$10.95**

The Radiola 20

Two stages of tuned frequency amplification, a regenerative detector, and two stages of A.F. amplification, using 4 type X-199 tubes and a X-120 for the last audio stage, is the arrangement of this receiver. The A.F. transformers used in this set are perfectly designed for the required performance. Heavy, soft iron encases the windings, and the frequency characteristic is exceptionally good. Cabinet is mahogany. Overall dimensions are: 19x16x11 inches high. Shipping weight 35 lbs. List Price \$102.50. **YOUR SPECIAL PRICE \$12.50**

Atwater Kent 20 Compact

Five 201A tubes are used in this very sensitive and selective tuned radio frequency set. Dimensions: 20x6 1/2 x 6 1/2 inches high. A six-wire cable, "color coded," 6 ft. long, is included. Cabinet is finished in walnut. The panel is metal, finished in flat brown. Variable condensers having 16 plates are used. The variable condensers are independent of the receiver chassis. 3 brown molded "full vision" dials are used. A 3-point switch on the panel selects taps on the first R.F. coil, for "local" or "distance" reception. Non-oscillating. Easily re-wired for A.C. operation. Shipping weight 20 lbs. List Price \$60.00. **YOUR SPECIAL PRICE \$10.95**

Freshman "Masterpiece" A

It is of the tuned Radio Frequency type. Requires 4 201A, 1 171A tube. Has 2 A.F. transformers, and 3 variable condensers. Overall dimensions are: 20 1/2 x 12 x 9 1/4 inches; mahogany bakelite panel. The cabinet is finished in mahogany. 3 19-plate variable condensers used. The dial settings are read through recessed windows, 2 jacks mounted on panel. Shipping weight 25 lbs. List Price \$80.00. **YOUR SPECIAL PRICE \$7.00**

Allen Hough ROTROLA

This remarkable new instrument enables you to play phonograph records through your radio loud speaker. Plugs into any radio set, whether same uses batteries or A.C. Connected to your radio in a jiffy. Equipped with fine electric motor operating only on A.C., 60 cycles, 110 volts. New Webster pick-up; volume control; special constant speed electric motor. Beautiful portable cabinet. Full bronze trimmings. In factory sealed case. Shipping weight 18 lbs. List Price \$45.00. **YOUR SPECIAL PRICE \$13.50**

Replacement Power-Pack Condenser Blocks

Exact duplicate, physical size, placement of connection terminals, and electrical specifications of original blocks. For Majestic 171 type receivers... **\$5.00**
For Majestic 250 type receivers.... **\$5.00**
For Majestic 245 type receivers..... **5.00**
For Atwater Kent 37..... **4.95**
For Freshman M-12 **5.00**
For Majestic "B" Eliminator..... **2.90**
For Majestic Master "B" Eliminator. **2.90**
For Majestic Special Master "B" Eliminator **3.00**
For Majestic "A" Eliminator..... **3.25**

FREE

We have just issued our new "RADIO SERVICE TREATISE." It's red hot all the way through. 52 new hookups and circuit diagrams. 110 illustrations.

Partial contents: Modernizing old radio sets. How to convert battery to power sets. Selection of tubes. The detector tube. The power tube. Changes in grid or "C" bias circuits. Push pull amplifiers. Replacing audio transformers. Phono attachments. How to choose power transformers. Voltage dividers. Wattage of power transformers. Selecting and installing replacement parts in radio sets. Filter condensers. Repairing "R" eliminators. ALL BRAND NEW DOPE—NOT A REPRINT. Chuck full of REAL radio information all the way through. Even the catalog section has dozens of hookups—never found anywhere before.

WRITE TODAY. A postal card brings it by return mail.



RADIO SERVICE TREATISE
AND
RADIO BARGAIN CATALOG
FOR RADIO SERVICEMEN—RADIOTICIANS—RADIO DEALERS
RADIO TRADING CO.
25 WEST BROADWAY
NEW YORK CITY

Ware Type T. Neutrodyne

This is the most economical in operation of all radio sets. The circuit is that of a REFLEXED NEUTRODYNE incorporating 3 UV-199 tubes. The mahogany cabinet is 14 in. long and 13 in. deep. This design provides room for the "A" supply of 3 dry cells, 2 "B" and 1 "C" battery. There are 2 15-plate variable condensers, 2 neutrodyne-type R.F. transformers, 2 A.F. transformers, rheostat, 2 jacks, R.F. choke, 2 tuning dials, shock-absorbing mounting for the 3 tubes. Shipping weight 16 lbs. List Price \$65.00. **YOUR SPECIAL PRICE \$5.95**

R.C.A. Double Filter Chokes (No. 8336)

This heavy-duty, extremely strong, double filter choke can be used for all types of filter circuits, experimental work, power amplifiers, receivers, eliminators, power packs, converted sets, etc. Known as R.C.A. replacement part for all Radiola models, particularly Nos. 33, 17 and 18. Each choke D.C. resistance, 500 ohms. Connected in parallel, these double filter chokes have a rating of 15 Henries at 160 Mills; connected in series, 60 Henries at 80 Mills. Fully shielded in heavy metal case with special insulating compound. Size 5 1/4 x 3 3/4 x 2 7/8. Shipping weight 6 lbs. List Price \$10.05. **YOUR SPECIAL PRICE 95c**

Atwater Kent Model 35

One of the most compact receivers ever offered to the public 3 stages R.F. 3 variable condensers are used. Overall dimensions are: 17 1/2 x 8 3/4 x 5 1/2 inches. The chassis is housed in a brown crackle-finish pressed metal cabinet. This is a "one-dial control" receiver. Incorporated in this set is a 6-wire cable, each wire of which is rubber insulated and "color coded." This shielded receiver has very high "gain" and may be used with antennas of any length, without in the least affecting the tuning. The variable condensers are of the "single bearing rotor" type. This set takes the following tubes: 5 type-201A and one type-112A or 171A tubes. Shipping weight 16 lbs. List Price \$65.00. **YOUR SPECIAL PRICE \$14.95**

Earl Power Transformer

Make money revamping the old battery set. This power transformer used in Earl Model 22 receiver supplies "A," "B" and "C" potentials for: two '27's (for screen-grid '24's), three '26's, two '71A's and one '80 rectifier; total current output of high-voltage winding at maximum output (about 200 volts) is 80 ma. High voltage secondary, filament winding for '27's, and for '71A's are center-tapped. May be used in any number of combinations. Suitable resistors, a couple of 4-mf. filter condensers, two 30-henry chokes and by-pass condensers complete fine power pack. Size 3 1/4 x 3 x 2 1/4 inches. 16 long leads and full wiring directions. Shipping weight 5 lbs. List Price \$7.50. **YOUR SPECIAL PRICE \$1.75**

WE ARE A WHOLESALE HOUSE AND CANNOT ACCEPT ORDERS FOR LESS THAN \$3.00. If C. O. D. shipment is desired, please remit 20% remittance, which must accompany all orders; balance on delivery. If the full cash amount accompanies the order, you may deduct 2% discount. Send money order—certified check—U. S. stamps (any denominations.)

Radio Trading Co.
25A West Broadway
New York, N. Y.

Should you wish goods shipped by parcel post, be sure to include sufficient extra remittance for same. Any excess will be refunded.

Order from this page; you will find special offers from time to time in this magazine. Get our big FREE catalog for the greatest Radio Bargains in the U. S.

Headquarters For Replacement Parts For All A. C. and D. C. Sets

We can replace any A. C. Power Transformer, Condenser Block, etc.,
WITH AN EXACT ELECTRICAL DUPLICATE!

SEND FOR OUR FREE CATALOG

No order accepted for less than \$3.00. We accept checks, money orders and stamps in all denominations. Include postage allowance—any excess refunded. In absence of postage allowance, shipment will go forward, express collect. C. O. D. Shipments require 20% deposit remittance with order. We guarantee complete satisfaction.

Thordarson Power Transf.

All types listed below furnish all plate and filament voltages for any A. C. set.

MODEL 171 PUSH-PULL
For 4-226, 1 or 2-227, 1 or 2-171A, 1-280. **\$2.55**

MODEL 245 PUSH-PULL
For 3 or 4-227 or 245, 2-227, 2-245, 1-280. **\$3.25**

MODEL 250 PUSH-PULL
For 5 or 6-227 or 224, 2-250, 2-281. **\$5.55**

2 1/2 Volt Fil. Transf.
Two windings, both center tapped.
Total Cap. 16 Amperes **\$3.75**

For Radiolas 17, 18, 33, 51; for 4-226, 1-227, 2-171A, 1-280 **\$4.90**

For Radiolas 44, 46, for 3-224, 1 (or 2)-245, 1-280 (and 2-227) **\$4.65**

For Radiolas 60, 62, for 6 or 7-227 (or 224), 1 or 2-171A, 1-280 **\$5.80**

For Radiolas 64, 67, for 8-227 (or 224), 2-250, 2-281 **\$10.90**

For Radiola 66, for 6-227, 1 (or 2)-245, 1-280 **\$5.95**

For A-K 36, 37, 38, 40, 42, 43, 44, 52, for 4-226, 1 or 2-227, 2-171A, 1-280 **\$4.25**

For A-K 55-55 C, for 2-224, 2-227, 2-245, 1-280 **\$4.95**

For Kolster K-24, for 4 or 5-226, 1-227, 1 (or 2)-210 (or 250), 2-281 **\$9.40**

Hundreds of other models for ANY STANDARD SET are listed in our catalog.

Convert Any Battery Set for A.C. Operation, Using Super-Powerful 245 or 250 Push-Pull Amplifier.

Simply connect detector plate lead of any battery set to input terminal. Keep using present 4 or 6 volt tubes in present tuner. No rewiring of battery set—no changing of sockets or coils. Whole change-over takes a few minutes. Battery set audio amplifier stages, or tubes, not used. Use any 2500 ohm, 110 volt D.C. dynamic, such as the PEERLESS, listed on this page. Can also be used with any magnetic or A.C. dynamic speaker.

As illustrated, less tubes **\$27.85**
Same, but uses 2-250, 2-281, 2-227 **\$45.50**

UNITS AVAILABLE SEPARATELY

The RADAX power amplifier can be used with any tuner, phonograph pick-up, or in any public address system.

*245 Amp. Unit, and A.C. "ABC" Power Supply **18.75**

*250 Amp. Unit, and A.C. "ABC" Power Supply **\$35.75**

4-6 Volt "A" Unit (2 1/2 amps.) Bone-Dry. **11.95**

*Choice of AC fil. supply for tuner—either 12 amps, 2 1/2 volts, or A.C. Filament current for 4-226, 2-227.

Kolster K-6 Speaker

So realistic in reproduction it almost rivals a good dynamic, even though it is actually a magnetic speaker! Will operate PERFECTLY with any receiver, using 171-245 or even 250 tubes. Never blasts—nor distorts! 12 1/2 inches high. Very attractive cabinet. Reg. \$35.00 **\$4.90**

Condenser-Choke Block for A-K 37-38 etc.

Contains three chokes and four filter condensers. Original color leads **\$4.95**
A-K 40, 41, 42, 44
A.C. POWER SUPPLY
Contains above block, plus A.C. power and fil. transf., housed in meta box. Ideal for any A.C. set using 4-226, 2-227, 2-171A, 1-280 **\$11.50**

Dubilier-Majestic Cond. Blocks

For "Super" and "Master B" eliminators **\$2.75**
For "Special Master B" eliminators **\$3.85**
For MAJESTIC 171 Sets **\$5.45**
For MAJESTIC 245 Sets **\$5.45**
For MAJESTIC 250 Sets **\$7.45**
For ANY eliminator or power pack.

Surge-Proof "Hang-Up" Filter Condenser Units

Dipped in black pitch, with long flexible leads protruding.

	450 VOLT	
.5 mfd.		23¢
1 mfd.		26¢
2 mfd.		38¢
4 mfd.		55¢
	600 VOLT	
1 mfd.		30¢
2 mfd.		40¢
4 mfd.		60¢
	800 VOLT	
1 mfd.		45¢
2 mfd.		75¢
4 mfd.		\$1.10
	1000 VOLT	
1 mfd.		75¢
2 mfd.		\$1.10
4 mfd.		\$1.60

Dry Electrolytic Condensers

No. Anodes	Total Cap.	Price
1	1 mfd.	\$.38
1	2 mfd.	.65
1	4 mfd.	.85
1	8 mfd.	1.25
3 (2-4-8)	14 mfd.	2.85
2	16 mfd.	2.13
3	24 mfd.	2.75
4	32 mfd.	3.38

Loftin-White Direct Coupled Amplifiers

Affords more than sufficient volume, sufficient for most dance halls, schools, small auditoriums, etc. The very finest of parts only are used—made of finest parts. Also furnishes all ABC voltages to any 2 1/2 volt A.C. tuner. Easily connected by any novice. **\$13.90**

250 MODEL **\$24.50**
Requires 1-250, 1-281, 1-224

103 RCA Speaker Chassis

Has built-in transformer—will stand big volume without any distortion, rattling or blasting. 9 in. outside diameter, 4 1/2 in. deep. Can be mounted in any radio console, or against any baffle arrangement. **\$3.25**
For 100A Speakers **\$4.95**

Build A Peerless 9 Tube AC 3 or 4 Screen Grid Receiver

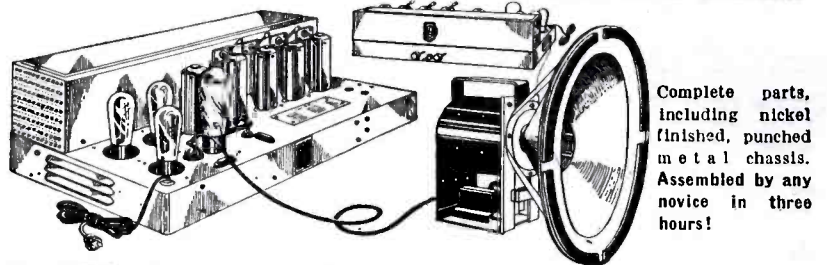

Complete parts, including nickel finished, punched metal chassis. Assembled by any novice in three hours!

Uses THREE SCREEN GRID TUBES! LINEAL POWER DETECTION! PUSH PULL 245 AMPLIFIER! PHONOGRAPH ATTACHMENT! RECEPTACLE FOR SHORT-WAVE SUPERHETERODYNE ATTACHMENTS! TUBE VOLTAGE REGULATOR! TOTALLY SHIELDED! IMMENSE POWER PACK! TONE CONTROL! Requires 3-224, 2-227, 2-245, 1-280 and AMPERITE VOLTAGE REGULATOR. Operates with a 15 foot aerial—even picks up 2,000 miles on same. Designed for any 110 volt D. C. dynamic speaker, 2500 ohms resistance—Use any MATCHED Peerless speaker listed below. For 25 or 60 cycles. 21" x 9 1/2" x 12" deep. FULLY GUARANTEED. **\$22.50**

Amperite Voltage Regulator **\$1.75**
Set of 8 A. C. Tubes **\$7.50**
(Note: We can furnish this chassis assembled for \$29.50)

Peerless 16 inch Dynamic Speakers

110 v. D.C. MODEL 2500 ohms resist. Produces super auditorium volume, with uncanny perfection of realism of reproduction. Contains push-pull output transformer. Can be used with any set. **15.95**

110 v. A.C. MODEL—16" Diam. Model Uses a 280 Rectifier tube—more superior than metallic disc rectification. No finer speaker made! **\$19.75**

12" 110 V. A.C.	\$14.50
12" 110 V. D.C.	\$10.50
9" 110 V. A.C.	\$10.95
9" 110 V. D.C.	\$10.00
Special UTAH 110 VOLT A.C. DYNAMIC	\$7.50

Radax General Replacement A.C. Power Packs

Can be connected in 30 minutes. Detailed instructions and diagrams included. 171-A "B" ELIMINATOR. 200 volt output, and 45, 67, 90, and 135 volt terminals. Requires 280 Rectifier. **\$6.75**

Same as above, but also furnishes A.C. filament current for 5-226, 2-227, 2-171A, 1-280 tubes **\$8.25**

245 "B" ELIMINATOR. Output 250 volts, and 45, 67, 90, 135 and 180 output terminals. Also furnishes 3 amps., 2 1/2 volts A.C. for lighting TWO 245 tubes. Proper "C" bias for these tubes also provided. Requires 1-280 rectifier tube **\$10.45**

Same as above, but also furnishes A.C. filament current for 6-224 or 227 tubes, 2-245 tubes, 1-280 tube. MAKES AN IDEAL ENTIRE A.C. POWER PACK REPLACEMENT UNIT **\$12.45**

NOTE: All of the above models contains two filter chokes—for \$2.00 additional ANY MODEL will be made to furnish 110 volts D.C. for D.C. dynamic field coils.

Build a Radax "Round the World" Short Wave Set

Most compact 3 tube set made! Noted for extreme long distance reception. Tunes 10 to 200 meters. Can be assembled in one hour! Requires 2-201A, 1-112A or 1-171A. Our big leader! **\$12.50**

Build a Three Stage, Double Push-Pull Auditorium Super-Amplifier and ABC Power Pack

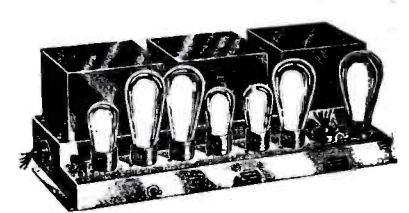

Here is the very last word in power amplifiers. Use with any Radio Tuner, as a PHONOGRAPH AMPLIFIER of exceptional efficiency, or as a PUBLIC ADDRESS AMPLIFIER. Input feeds into a 227 1st A.F. stage, followed by a PUSH-PULL 2nd A.F. stage using two 227's followed by a 3rd A.F. PUSH-PULL STAGE, using TWO 250 super-power tubes. Amplification produced ample for huge auditoriums or outdoor gatherings. AMPLIFIES WITHOUT DISTORTION! Requires 2-281, 2-250, 3-227 tubes. Furnishes 45, 67, 90, 135, 180 volts "B" for tuner, as well as choice of 2 1/2 volt or 1 1/2 volt and 2 1/2 volt A.C. filament current for any tuner. Also furnishes 110 volt field current for any 2500 ohm D.C. dynamic—for exceptional results, use the 16" 110 volt D.C. PEERLESS DYNAMIC! Can be assembled by any novice—detailed diagram included. For 110 volt, 60 cycle A.C. 21 1/2" x 8" x 7" high. **\$39.75**

Wired, ready for use **\$47.50**

245 MODEL Requires 3-227, 2-245, 1-280 tubes **\$28.25**

Wired, ready for use **\$33.75**

Build a Peerless 3-4 Screen Grid A.C. Tuner

Can be used with any amplifier. Requires external A.C. filament and plate supply. Shielded r.f. coils. Tube shields. Uses either a 227 LINEAL POWER DETECTOR, or a 224 SCREEN GRID DETECTOR. Modernize any old battery or A.C. receiver with this marvellously efficient tuner. Requires 4-224, or 3-224 and 1-227. Most unusual value! **\$14.95**

Elkon M-16 Rectifier

Ideal for ANY "A" ELIMINATOR or MOST ANY A.C. DYNAMIC SPEAKER. Furnished as illustrated, or with new base, with 5 heavy brass strip lugs **\$2.95**

“Do you . . .

or do you not want to

go up?”

Here's *the*

RADIO TRAINING

you've been waiting for



If “Yes” is your answer to these questions . . . then you cannot ignore this vitally important message . . . You will not lay it down until you have read it word for word, until the very end.

ARE you looking backward or forward? Are you speeding ahead or plodding along? Is your future tied to the vanishing fortunes of the industries of yesterday . . . or, are you prepared to share in the success that is coming to the rapidly growing industries of tomorrow?

Never before have there been such opportunities as now exist in this business that is progressing by leaps and bounds. Where has there ever been such rapid growth as this? Think of what radio offers to the man who actually trains for success in this interesting work! If at present you are not happy in your work, your opportunities and your future, you should be

interested in radio. You can obtain the training you need under the direction of RCA Institutes, a division of Radio Corporation of America, which thoroughly trains men in every branch of radio. You learn radio by actual experience on the very latest types of radio equipment.

**BOARD OF MANAGERS OF
RCA INSTITUTES, Inc.**

The names of these men are known throughout the world as the greatest names in radio. Their experience will guide you in your training.

Chairman of the Board
GENERAL JAMES G. HARBORD
Chairman of the Board
Radio Corporation of America

President
RUDOLPH L. DUNCAN

Vice-President
F. R. BRISTOW

WILLIAM BROWN
Vice-President and General Counsel
Radio Corporation of America

W. A. WINTERBOTTOM
Vice-President
RCA Communications, Inc.

CHARLES J. PANNILL
Vice-President
Radiomarine Corporation of America

GEORGE S. DE SOUSA
Treasurer
Radio Corporation of America

E. A. NICHOLAS
President, E. A. Nicholas, Inc.

A. E. REOCH
Vice-President, RCA Photophone, Inc.

CHARLES HORN
General Engineer
National Broadcasting Company

You study under the direction of nationally known experts. You can learn to be a ship operator, a shore station operator, or, if you prefer, you can learn all about radio servicing and selling, radio telephony and telegraphy, and airplane radio equipment . . . also instruction in sound motion picture installation, maintenance and repair.

*Easy to learn at home
with complete laboratory equipment*

An hour or so a day will give you the inside

facts about radio. An outlay of modern apparatus supplied to every student enables you to learn to solve radio problems such as installing, servicing and repairing fine sets. Only RCA Institutes gives you such thorough instruction and latest up-to-date equipment as this. Here is the practical knowledge and training you need to hold a well paid position.

Read this free book

Here is your answer to the problem of a successful career. Tie your future to a live, growing and profitable business. Send for your copy of this free book, “Radio, The Field of Unlimited Opportunity.” Many pages of pictures and text, telling you all you need to know about your opportunities in radio . . . all about RCA Institutes, Inc., what it has done for others and *what it can do for you?*

Clip this coupon now . . . start **TODAY** on your road to success in radio!



RCA INSTITUTES INC.

RCA INSTITUTES, Inc., Dept. W.S.1.
75 Varick St., New York, N. Y.

Please send me catalog describing your resident school (classroom) instruction.

Name

Address

Occupation

World Famous Radio Receivers

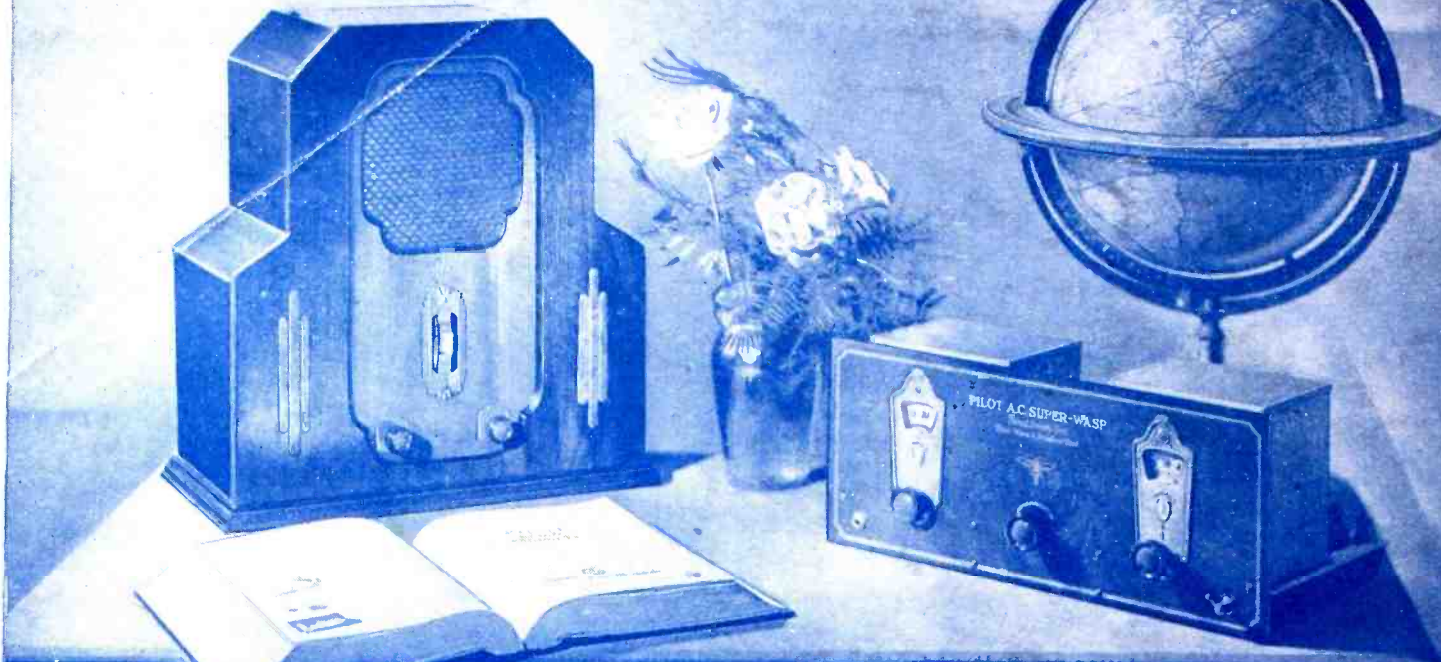

Console Quality

in a Midget Broadcast Receiver
You Can Place Anywhere

PILOT MIDGET

This attractive two-tone walnut miniature A. C. receiver has proved the equal of high priced consoles in many locations throughout the country. Because—it embodies console features; 2-224 Screen Grid stages, 1-224 Screen Grid Power detector, 1-227 Audio stage, 1-245 Power Audio output stage and specially designed electro dynamic speaker. A super powered 280 voltage supply gives trouble-free operation from any 110-20 volt house current line.

Pilotron tubes are standard equipment because Pilot retailers know none are more reliable.

PRICE
Complete in
Modernistic
Cabinet

\$59.50 less tubes

PILOT
RADIO
TUBES

ENDORSED BY
PROFESSIONALS



LICENSED UNDER
RCA PATENTS

For World-Wide Radio Reception

Short and Long Waves, 14 to 500 Meters

PILOT Super-Wasp

Rev. J. W. Nilsen, Bolonque, Congo-Belge Africa says: "Here in the heart of Africa I have received 9LO, JB, 2BL, 5SW, AFK, PCJ, WGY (W2XAF), WRNY (W2XAL) and more stations on loud speaker with my Pilot Super-Wasp."

David W. J. Jones, Brisbane, Australia says: "I have received on my Super-Wasp all the test transmissions between W2XAF (Schenectady, U. S. A.) and VK2ME (Sydney NSW), PCJ Holland, GS5W England and Sydney—London phone service."

Austin R. Baldwin, St. Raphael (Var.) France, says: "I heard from KDKA 25.4 meters, 'We will now rebroadcast a concert from London.' Shortly after the music from London came in clearly, having twice crossed the Atlantic."

Pilot Super-Wasp Comes in KIT FORM which can be assembled in a few hours

BATTERY SET KIT

\$29.50

Kit K-110: The battery-operated Super-Wasp. Batteries and Tubes extra.

A. C. SET KIT

\$34.50

Kit K-115: The A.C. Super-Wasp. Use your own ABC pack or Pilot K-111, specially designed for the Super-Wasp. Power Pack and Tubes extra.

PILOT RADIO

At Dealers Everywhere or Write to

PILOT RADIO & TUBE CORPORATION

LAWRENCE, MASS.

Chicago Office:
231 S. Wells Street

New York Office: 525 Broadway
OFFICES IN PRINCIPAL COUNTRIES OF THE WORLD

San Francisco Office:
1278 Mission Street