

SHOP
EQUIPMENT
NUMBER

SERVICE

THE TECHNICAL JOURNAL OF THE TELEVISION-RADIO TRADE

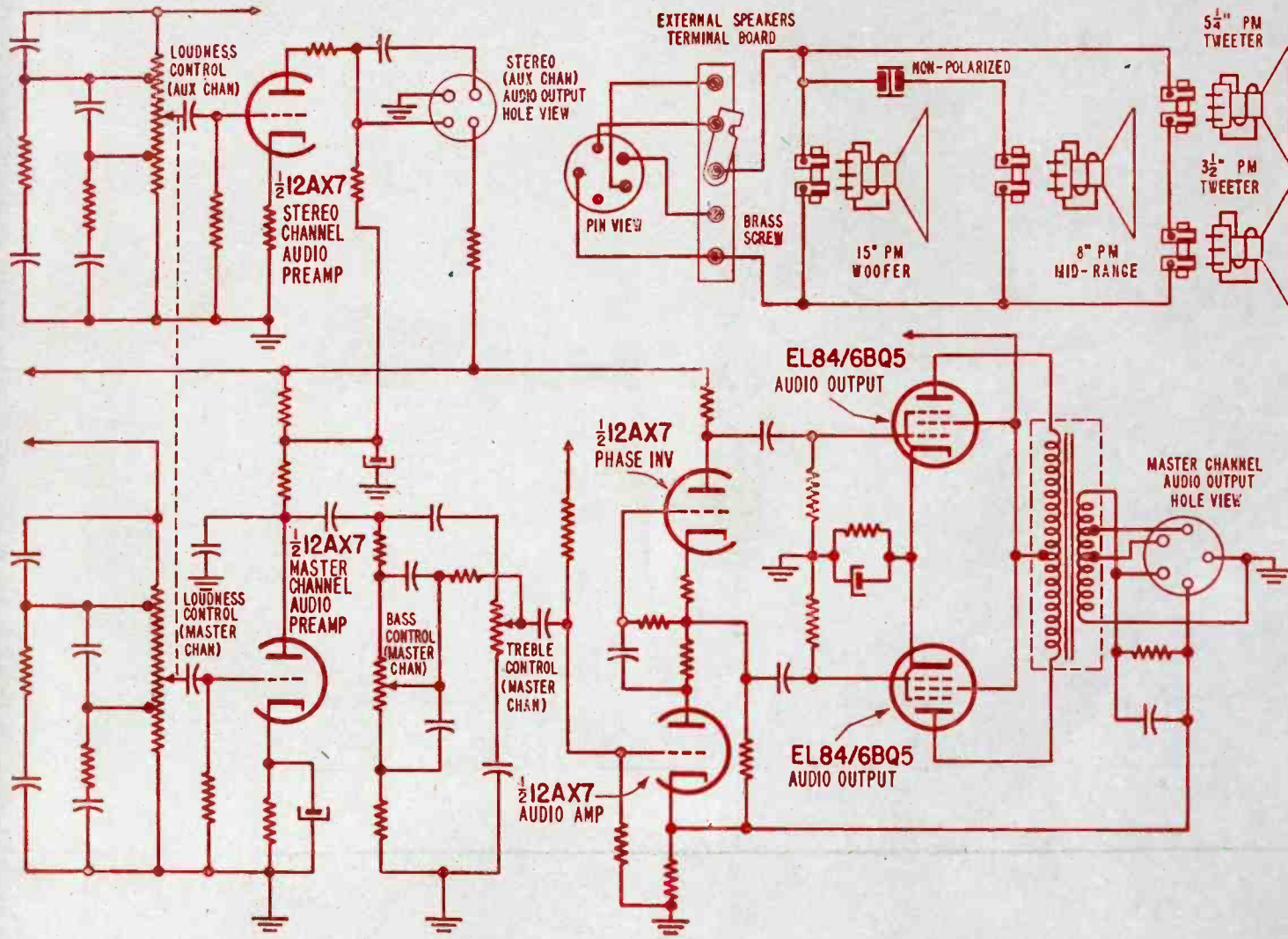

Main amplifier and stereo preamp in new dual-channel radio phonograph.

See circuit analysis, this issue.

F H FINGADO
 1653 CALIFORNIA ST
 DENVER 2, COLO
 2-60

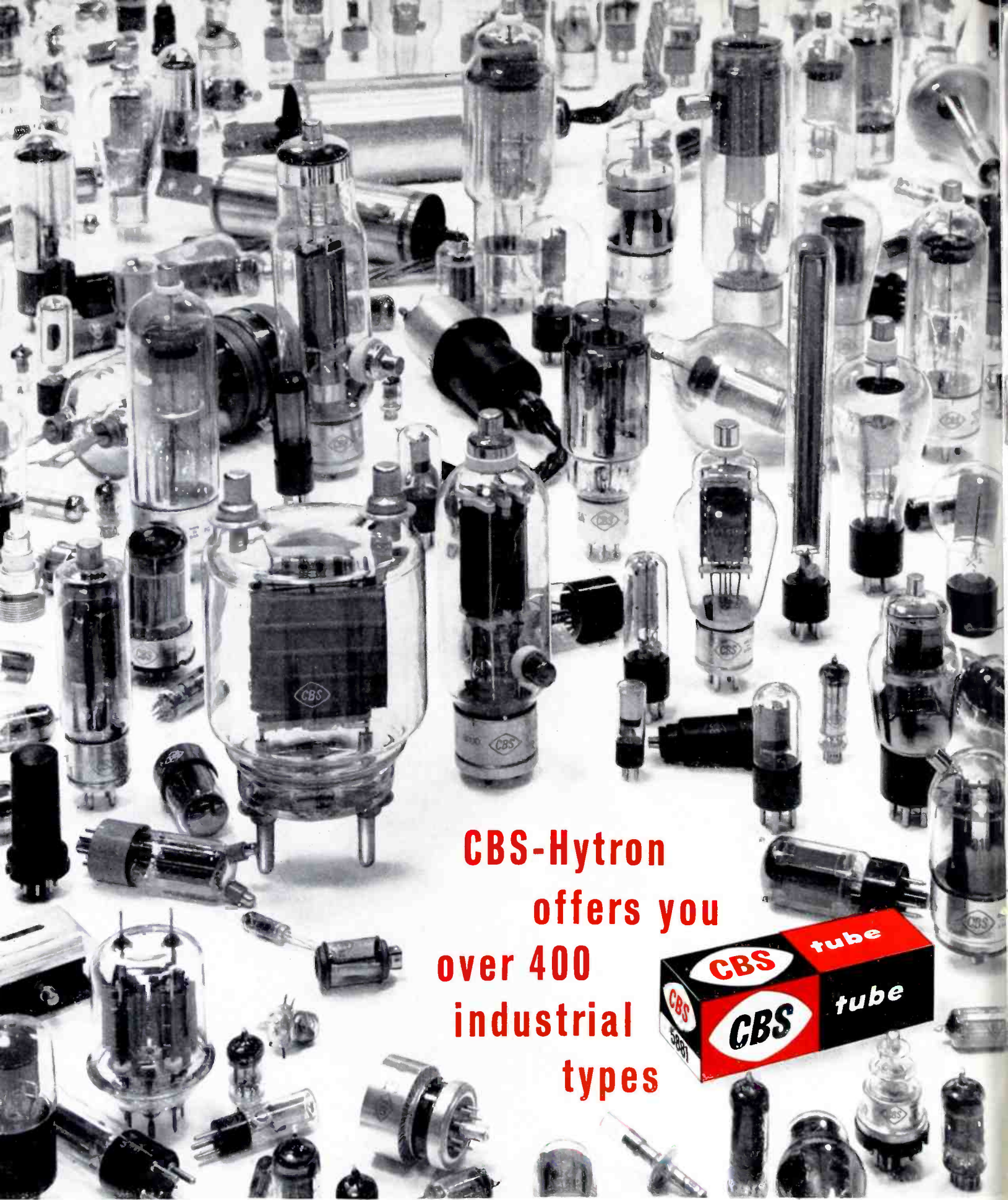

CBS-Hytron
offers you
over 400
industrial
types



You will find CBS-Hytron's expanded industrial tube line the most comprehensive and the most dependable. See it at your distributor's. Ask him or write us for the CBS-Hytron catalogs you need: Power Tubes, E-290T . . . Military and Special-purpose Tubes, E-290S . . . Gas Tubes and Power Rectifiers, E-290C . . . Phototubes and Photocells, E-290P. *More reliable products through Advanced-Engineering*

CBS-HYTRON, Danvers, Massachusetts • A Division of Columbia Broadcasting System, Inc.



THE TECHNICAL JOURNAL OF THE TELEVISION-RADIO TRADE
Including RADIO MERCHANDISING and TELEVISION MERCHANDISING
Registered U. S. Patent Office

FEATURES

- 5 This Month in SERVICE
- 6 New Stereo Radio-Phono Combination Features Input for Tape S. E. Roberts
- 8 Automatic Coded-Card Tube and Transistor Tester
- 10 New Transoceanic Portable Receiver
- 12 The Need for Critical Tube Tests (Service Engineering) H. McKay and L. G. Sands
- 14 New Instrument for Shunt-Testing Electrolytic Filter Capacitors
- 14 Personnel
- 18 Installing Outdoor Sound Systems L. A. Randall
- 20 New Instruments for Service Shops
- 24 New Tools and Shop Equipment
- 28 Soldering Iron with Built-in Temperature Control Donald R. Fegley

CIRCUIT DIAGRAMS

- 7 Admiral 12B1 AM-FM Tuner-Amplifier with Stereo Preamp
- 8 Typical Coded-Card Tube-Test Circuits
- 11 Zenith Royal 1000 Transoceanic Portable Radio
- 18 Outdoor Sound System Control Assembly
- 29 Simplified Grid-Emission Tube Tester
- 29 Basic Dynamic Mutual Conductance Tube Tester

31 ADVERTISERS IN SERVICE

© 1958 by Bryan Davis Publishing Co., Inc. All rights reserved.

Second-class mail privileges authorized at New York, N. Y.; additional entry at the Post Office, Norwalk, Conn. . . .
Subscription price: \$2.00 per year (\$5.00 for 3 years) in the U. S. A. and Canada; 25 cents per copy, \$3.00 per year
in foreign countries; 35 cents per copy.

Subscription orders, notices of change of address and undeliverable copies should be sent to Bryan Davis Publishing
Co., Inc., 52 Vanderbilt Ave., New York 17, N. Y.

**OLD-STYLE
PARALLEL-CONNECTED
HEATERS**

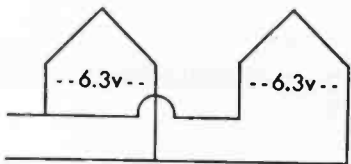

... used small wire which was easily bent, contributing to heater-cathode short-circuits.



**NEW G-E
SERIES-CONNECTED
HEATERS**

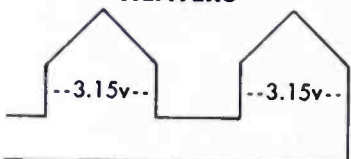

... use wire twice as thick, that holds its shape. Short-circuits have been reduced.



ABOVE: LINT AND DUST ARE BANNED during "Snow White" assembly of General Electric receiving tubes, in order to reduce the possibility of short-circuits. G-E workers and supervisors wear lint-free garments; air is filtered and conditioned; floors are kept immaculately clean.

LEFT: NEW HEATER DESIGN CUTS SHORTS ... heater to cathode ... in 6BQ7-A and 6BZ7 cascade RF amplifiers. Here is an example of how G.E. constantly improves Service-Designed Tubes. New G-E series-connected heaters use heavy wire that resists bending, crimping, arc-overs.

Improved tube design—superior manufacture—mean fewer shorts with G-E Service-Designed Tubes!

GENERAL ELECTRIC Service-Designed Tubes *stay installed*. Short-circuit inoperatives are kept at a minimum. You save time by making fewer callbacks. You increase your service reputation with repair-work that seldom has to be done over—in a few days, even a few hours—because a tube has shorted internally ... perhaps burning out other components of the TV circuit.

In design, as with the 6BQ7-A and 6BZ7 heaters—in manufacture, where every advanced technique is called on to remove lint and dust—General Electric gives you, as a television technician, tubes you can install with complete confidence.

Yet Service-Designed types cost no more! Your G-E tube distributor has these high-quality tubes. Phone him! *Distributor Sales, Electronic Components Division, General Electric Company, Owensboro, Ky.*

G-E SERVICE-DESIGNED TUBES INCLUDE:

1B3-GT	6AF4	6BG6-GA	6BX7-GT	6SN7-GTB
1J3	6AF4-A	6BK7-B	6BZ7	12SN7-GTA
1X2-A/B	6AL5	6BQ6-GA/6CU6	6CB6/A	25BQ6-GA/25CU6
5U4-GB	6AV5-GA	6BQ6-GTB	6CD6-GA	25BQ6-GTB
5Y3-GT	6AX4-GT	6BQ7-A	6J6	25CD6-GB

Progress Is Our Most Important Product

GENERAL  ELECTRIC

11-11-125



Editor
Solomon R. Kunis

Associate Editor
David E. Pearsall II

Consulting Technical Editors
Howard Jennings
Arnold Gewirtz

Field Editor (Midwest)
Rudolph T. Plemich

Art Director
Anthony R. Aliff

Supervisor, Circuit Diagrams
Michael D. Bellezza

BUSINESS DEPARTMENT

Business Manager
B. S. Davis

Assistant Business Manager
B. Earley

Assistant Advertising Manager
Astrid Kelly

Circulation Manager
A. Goebel

Assistant Circulation Manager
A. Kiernan

Mailing Supervisor
L. Trubia

PACIFIC COAST

Leo Sands, District Manager
 920 Commercial Street
 Palo Alto, California
 Tel.: YORKshire 8-4478

Published Monthly by
Bryan Davis Publishing Company, Inc.
 52 Vanderbilt Ave., New York 17, N. Y.
 Tel.: MURray Hill 4-0170

B. S. Davis, Pres. A. Goebel, Secy.



Printed in U.S.A. by
O'Brien Suburban Press, Norwalk, Conn.

**Customers Impatient?
 It's full speed ahead**



**with
 Centralab[®]
 Hi-Kap*
 Ceramic
 Capacitor
 Kits**

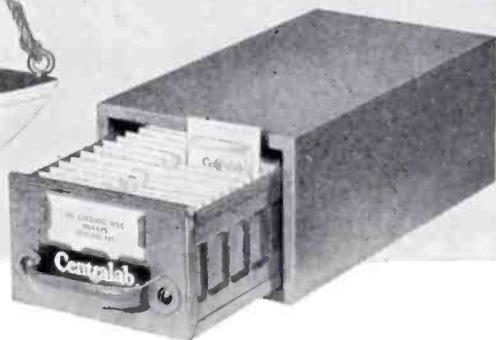

No delays! It's always smooth sailing when you use Centralab ceramic capacitor kits. No extra trips to your distributor, no wasted time. The units you need are on hand when you need them.

To keep you on an even keel, these heavy gauge steel kits contain balanced inventories of the most frequently used values. Individual values are prominently and clearly labeled, so you can locate the Hi-Kap you need, instantly. The new rigid plastic package permanently separates and protects the units—yet is easily opened to remove a single capacitor.

So don't be left at sea. Ask your distributor about these four time-saving kits—and while you're at it, be sure to get your free copy of Catalog 30, listing the full line of Centralab capacitors and other quality components.

FREE: \$4.75 cabinet (4"x7"x11") with each kit.

- D6K-200 Kit—200 Tubular Ceramic BC Hi-Kaps (27 values)
- DDK-200 Kit—200 Standard Ceramic Disc Hi-Kaps (31 values)
- TCK-80 Kit—80 TC (Temp. Compensating) Hi-Kaps (40 values)
- HVK-150 Kit—150 High Voltage Disc Hi-Kaps (19 values)

Centralab products are listed in COUNTERFACTS, PHOTOFACTS, and THE RADIO-ELECTRONIC MASTER.



*Trademark

D-5829

A DIVISION OF GLOBE-UNION, INC.
 934H E. KEEFE AVE., MILWAUKEE 1, WIS.
 In Canada: 804 Mt. Pleasant Rd. • Toronto, Ontario

**SWITCHES • PACKAGED ELECTRONIC CIRCUITS • CERAMIC CAPACITORS
 CONTROLS • ENGINEERED CERAMICS • SEMI-CONDUCTOR PRODUCTS**

*Mr. Service Dealer:
Show Your TV-Radio Service Customer
Where His Dollar Goes!*

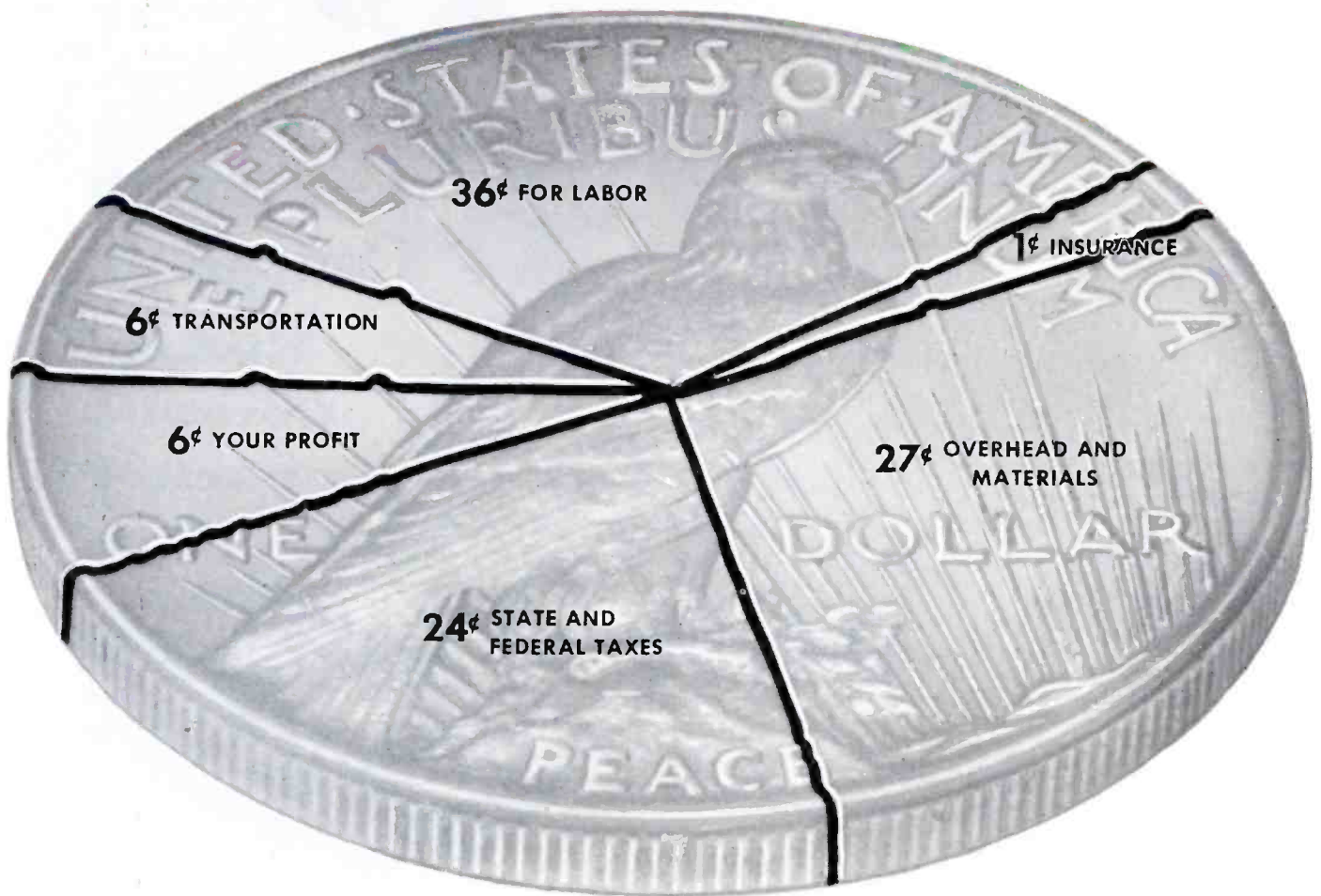

Let your customers know how much they get and how little you make on an average service call. Show them this chart. It was compiled by an independent organization for Raytheon and is based on research of Independent TV-Radio Service Dealer costs from coast to coast. It might be a good idea if you studied it carefully to see if any phase of your business is costing more than it should.

And remember: This 6¢ piece is your profit on a call. Don't lose it. One of the best ways to protect it is to avoid costly call-backs. And the best way to avoid call-backs is to always replace with Raytheon quality TV and Radio Tubes. Ask your Raytheon Tube Distributor to fill your orders with Raytheon Tubes.



COMING SOON! Your Chance To Climb On The GOLDEN LADDER



RAYTHEON MANUFACTURING COMPANY			
Distributor Products Division			
NEWTON 58, MASS. 55 Chapel Street	CHICAGO, ILL. 9501 Grand Ave. (Franklin Park)	ATLANTA 6, GA. 1202 Zonolite Rd. N.E.	LOS ANGELES 7, CALIF. 2419 So. Grand Ave.
Raytheon makes all these	Receiving and Picture Tubes, Reliable Subminiature and Miniature Tubes, Semiconductor Diodes and Transistors, Nucleonic Tubes, Microwave Tubes.		
			 <i>Excellence in Electronics</i>

THIS MONTH IN SERVICE

AUGUST SHOP EQUIPMENT NUMBER--The current issue of SERVICE features a representative sampling of the latest tools and shop equipment, and reports on a number of new testers for electronic servicing. . . . Purpose is to permit Service Men, suffering from the usual summertime loss and misplacement of tools, to replenish their stock with better and more efficient ones.

COMMERCIAL TUBE STANDARDS RAISED--Details of nine extra values to be built into its regular line of 70 types of receiving tubes used in television sets were revealed by General Electric on July 24. . . . The improvements will extend to television some of the high reliability features originally developed for military tubes. . . . The move is one way in which GE is implementing the slogan "Buy Now for Extra Values" in its Operation Upturn campaign initiated at the annual shareholders' meeting in April.

SYLVANIA REPORTS BUSINESS UPTURN--Don G. Mitchell, chairman and president of Sylvania Electric Products Inc. reported last month the company's second-quarter operations reflected "a definite upturn in the company's business," with earnings 21 per cent above those of the first quarter and sales about 5 per cent higher than those of the previous period. . . . June factory sales of television sets by Sylvania were the highest for any June and 55 per cent greater than June, 1957, Robert L. Shaw general marketing manager of Sylvania home electronics, a division of the company, also reported. . . . Marion E. Pettegrew, a senior vice president of Sylvania, predicted that 1958 will be the "biggest new product year" in the history of the company's home electronics division.

COLOR TV SALES UP--Color television sales now account for 25 per cent of the TV dollar volume of the Radio Corporation of America, James M. Toney, vice president and general manager of the RCA Victor Television Division, declared recently. . . . An independent survey conducted by Printers' Ink revealed that color television sales are up 30 per cent over a year ago.

HI-FI CONTINUES TO GROW--Hi-fi set, equipment and phonograph record sales will reach an annual figure of close to \$2 billion by 1968, it was predicted last month by Douglas F. Hudson, president of Fidelitone, Inc., which manufactures high-fidelity phonograph needles. . . . High fidelity, is also having its effect on the nation's service technicians. . . . Eighty-five per cent of the Service Men polled in a survey by the Institute of High Fidelity Manufacturers are involved in the installation and repair of high fidelity components such as speakers, tuners and amplifiers.

EMERSON BUYS DU MONT UNIT--Emerson Radio & Phonograph Corp. has purchased the consumer products division of Allen B. Du Mont Laboratories, Inc., for a reported \$6 million. . . . The division manufactures TV sets, phonographs and high fidelity equipment. . . . The agreement permits the use of the trademark "Du Mont" in connection with home-entertainment instruments.

STATION BOOSTS ANTENNA CHECK-UP--WPIX, New York's Channel 11, has inaugurated a campaign to improve television reception for all channels in the Metropolitan area, it was announced today by Otis S. Freeman, the station's chief engineer. . . . The campaign is based on the premise that poor television reception is often caused by faulty or damaged antennas and antenna systems. . . . An on-the-air spot campaign of 25 announcements a week, for four weeks, will be tied in with direct contact for the area's more than 2000 TV Service Men.

BUSINESS OUTLOOK IMPROVING--Milton J. Shapp, president of the Jerrold Electronics Corporation told stockholders at the company's annual meeting in June that Jerrold currently has an approximate \$1,000,000 backlog of contracts for the construction of master television antenna and closed circuit television systems. . . . Orders received by Zenith Radio Corporation at the company's June sales convention, for radio, television, and high fidelity instruments for delivery through the month of August, were substantially ahead of the comparable period in 1957, it was announced last month by Hugh Robertson, Zenith president.

BOGEN WINS AWARD--David Bogen Company, a Division of The Siegler Corporation, was the recipient last month of one of the two Gold Medals awarded United States corporations for outstanding industrial product design at the Eleventh Triennale in Milan, Italy, according to an announcement by Lester H. Bogen, president.

New Stereo Radio-Phono Combination

Features Input for Tape

[See Front Cover]

by S. E. ROBERTS

CONTINUING THE TREND in new stereo combinations, a new AM-FM-phono unit¹ with an input for stereophonic tape recording and playback has recently been introduced. Like most stereo systems, the unit is housed in a master console and a separate auxiliary cabinet.

Housed in the main cabinet is an FM-AM tuner² with the stereo hi-fi phonograph.³ In the auxiliary stereo unit is the second-channel hi-fi amplifier.⁴

Hi-fi stereo amplifiers in both the master cabinet and in the auxiliary cabinet contain push-pull outputs preceded by an audio amplifier and a phase inverter. The master cabinet houses both the stereo channel audio preamp as well as the master channel audio preamp. The amplifiers between the two units are, of course, connected by a cable.

Shown in the schematic diagram, Figure 1, is the FM-AM tuner with its hi-fi output amplifier in the master console. This is always used as the left channel output for stereo playback of disc or tape, reproducing sound intended for the left ear. For proper listening, the main cabinet is installed on the left side facing the observer, while the auxiliary cabinet is on the right.

FM-AM RF Stages

Two separate built-in antennas are included. The FM antenna is composed of 300-ohm transmission line mounted to the cabinet while the AM antenna is a ferrite-rod type mounted atop the 12B1 chassis next to the tuning gang.

The FM section includes a separate *rf* amplifier, a separate FM mixer, and a separate FM oscillator. A conventional *rf* amplifier and mixer are employed. The output of the mixer is brought out to the tap of transformer T2. This is done to provide an impedance match both to the secondary of T2 and to the output impedance of the tube.

A tuned-grid or Armstrong oscillator is used as the FM oscillator with

C8 and the associated coil as the tank. Close tolerance capacitors (1.5%) such as C4 and C8 prevent appreciable drift in the oscillator and grid load of the mixer. Choke coils prevent *rf* oscillations from affecting the cathode and plate voltages of the oscillator tube and the oscillator control tube. A separate first FM *if* stage boosts the gain of the signal.

In the AM radio section, V7 is used as a combination oscillator-mixer with the oscillator being of the series Hartley type.

Feeding the common FM-AM *if* is the output of the AM oscillator-mixer and the output of the first FM *if* stage. Stage V4 functions as the FM limiter when the FM is operative and as the AM detector when the AM is operative. A ratio discriminator detects the FM signal. For monaural playback, RC compensation is provided.

Hi-Fi Audio Amplifier Section

Two 12AX7's and two EL84/6BQ5's form the amplifier output for the FM-AM tuner, single-channel phono, and the left-channel phono for stereophonic reproduction. The stereo channel audio preamplifier V8A is not used with the former two outputs.

Loudness, treble and bass controls with compensation are included in the master channel audio preamp V8B. There are duplicate controls in the second-channel amplifiers in the auxiliary unit.

A series-connected audio amplifier and phase inverter stage are used. The audio input is to the grid of the audio amplifier V10B, whose output feeds the grid of the phase inverter V10A through C5 and R63. The output of the audio amplifier is also developed across R61. From here conventional push-pull amplifier stages V11, V12 develop as much as 9 watts output per channel. The amplifier in the auxiliary channel, which is not

¹Manufactured by Admiral Corp.

²Model 12B1. ³Model RC 688-165.

⁴Model 5T4A.

shown in the schematic diagram provides an equal output.

Tape Recorder Inputs

Tape recorder receptacles are located both on the master cabinet back panel and on the auxiliary cabinet. Each provides both input and output for an external tape recorder. For monaural use, the input plug of the tape recorder is connected to the *record* jack of the master channel receptacle. For playback, plug the tape recorder output plug to the jack marked *play*. When using a stereo tape recorder, make identical connections of the second channel of the recorder to the tape recorder receptacle in the auxiliary cabinet.

In hi-fi equipment a wise servicing procedure to be sure the amplifier is in the best working order is to check the amplifier gain and frequency response. Equipment required are an audio oscillator, *vtvm*, and a resistive load of 3.2 ohms, 15 watts. Turn all controls fully clockwise. Connect the audio oscillator to the high side of R40B, the 3.2-ohm load across the secondary of the output transformer, and the *vtvm* across this 3.2 ohm load.

Service Hints

Increase the 1000-cycle audio signal to obtain almost the rated power level of the amplifier. In this instance 5 volts will be just below the 9-watt output. The input audio generator voltage should be about 0.06 volts.

$$5.0V$$

$$\text{The gain is } E_o/E_{in} \text{ or } \frac{5.0V}{0.06V} = 83.$$

A 1000-cycle audio generator signal is normally chosen since the response of the amplifier is fairly flat at this frequency.

Frequency response is checked, using the same set-up as that for the gain. As the bass and treble controls are rotated fully counterclockwise (minimum setting), the output decreases from 5 volts to 0.5 volts for the *bass* rotations with a 100-cycle audio signal and 0.22 volts for the *treble* rotation with a 10-kc audio signal.

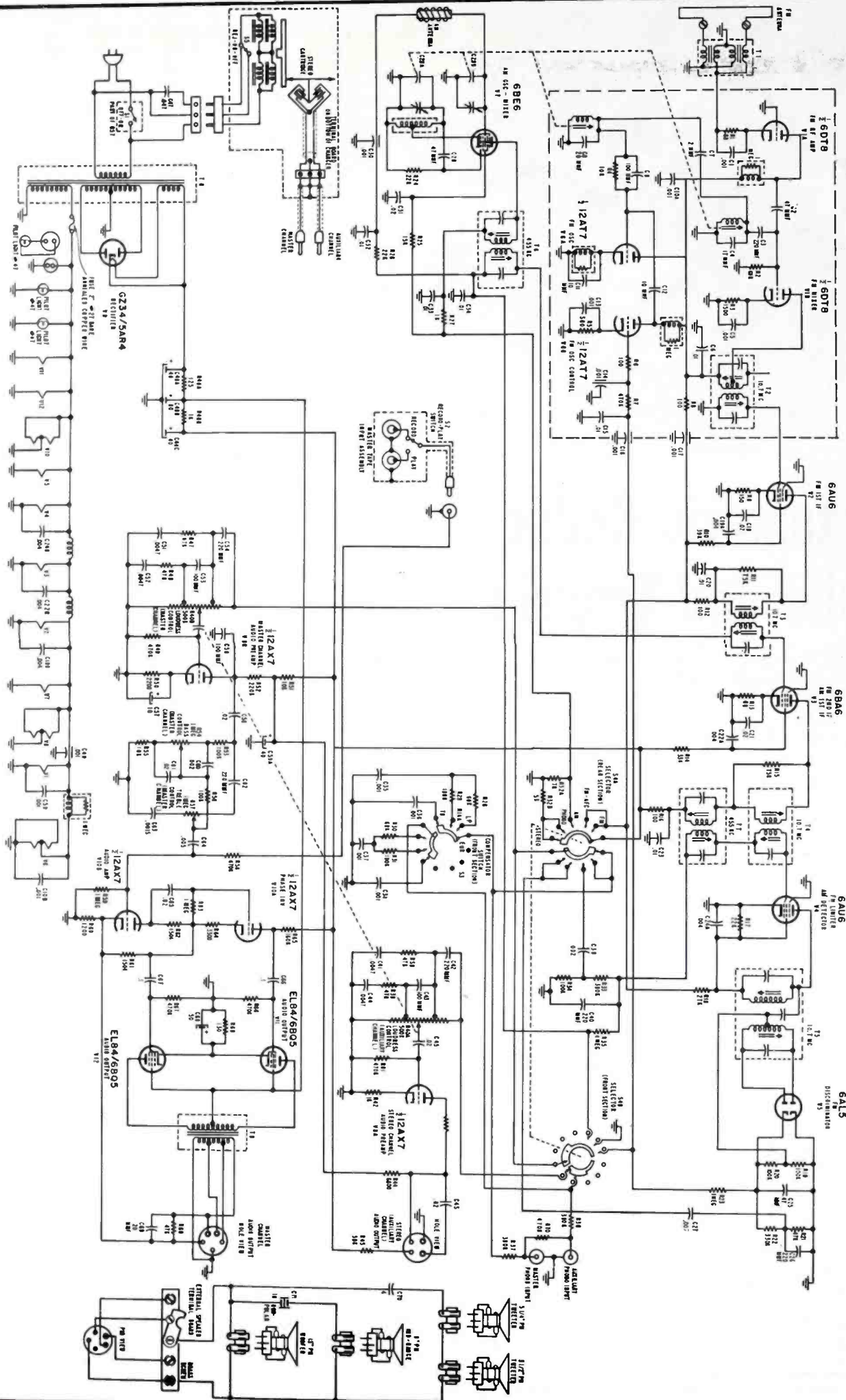
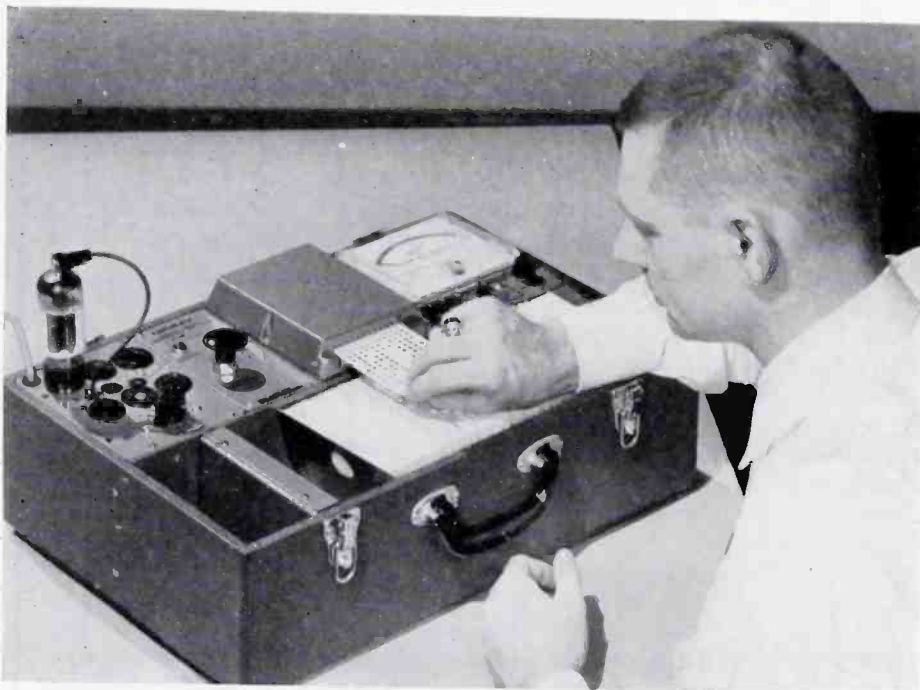

FIG. 1: SCHEMATIC DIAGRAM of Admiral 12B1 AM-FM radio phono chassis designed for stereophonic reproduction. Only the master amplifier is shown here. A second amplifier with an equivalent output is utilized in the auxiliary cabinet.



Automatic Coded-Card Tube and Transistor Tester

AN ADEQUATE TUBE TESTER—one which tests more than cathode emission—has been necessarily heavy on the number of switching operations required per tube. Recently, however, a high-speed portable tube tester¹ has been developed incorporating an automatic multiple-contact switch with a low contact-to-pin resistance (.0002 ohms nominal) which is activated by a coded card. This tester, illustrated above, provides an almost infinite number of possible switching combinations.

Provision is included for 320 different heater voltages, 140 fixed-bias potentials, 640 plate voltages, 640 screen voltages, 100 self-bias settings and 4,000 tube performance sensitivity ranges to permit a high degree of accuracy in testing all tube elements.

A file-type card tray, located in the front of the case, holds the coded cards in proper alpha-numerical sequence. Standard tube and transistor performance checks can be accomplished by means of the varied tests provided by this equipment.

The mutual transconductance test—important in triode and pentode type voltage amplifiers—applies a small *ac* voltage to the grid and measures the *ac* component of the plate current. Fig. 1a shows a triode with fixed bias under test while a pentode with self bias is being evaluated in Fig. 1b. Figure 1c illustrates the knee test for plate current under low plate and screen voltage. The knee test is so called because the tube is operated below the bend in the plate voltage versus plate current family of curves. Peak current knee tests are important

in evaluating TV horizontal amplifier tube performance.

Zero bias and current cutoff considerations are most important in testing multivibrator, blocking oscillator and control tubes. Tubes can be tested under handbook specifications with controlled emission tests simulating specific operating conditions for high-power receiving and low-power transmitting types.

Highly sensitive shorts and inter-element leakage tests give automatic indication on five neon lamps. Heater-to-cathode leakage may be read directly on the meter leakage scale.

A gas test provides qualitative indication on a red-green gas scale and quantitative indication in microamperes on the 0-10 linear scale. Grid emission is indicated on the short neon lamps when the tube reaches operating temperature.

A special switch provides for testing independently each section of twin-type tubes. The first section is checked for shorts, quality and gas with the button in its normal position. The test conditions are transferred to the second section by depressing the button.

The flexible circuitry of this tester makes possible tailored tests under special sets of conditions. For example, the 6SN7 which is used as a class A amplifier in the Williamson circuit, is also used as a multivibrator in TV and computer circuits. Meaningful tests for these two applications are widely different.

Three 6SN7 cards are furnished. The first card provides a complete test for the 6SN7 when it functions as an amplifier. Cards 2 and 3 are tailored tests which check the tube for zero bias plate current and cutoff bias plate current respectively—important conditions for a multivibrator.

A transistor and semiconductor diode test has been incorporated in this equipment, permitting performance checks to be made.

¹Model 121 Cardmatic, Hickok Elec Instrument Co.

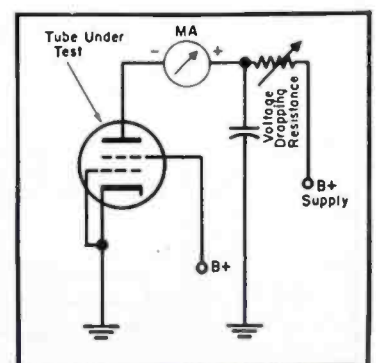
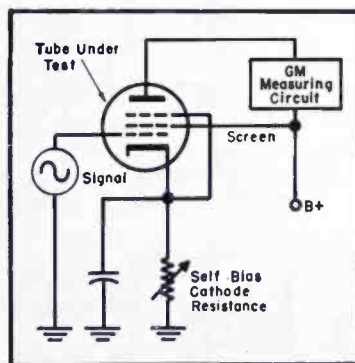
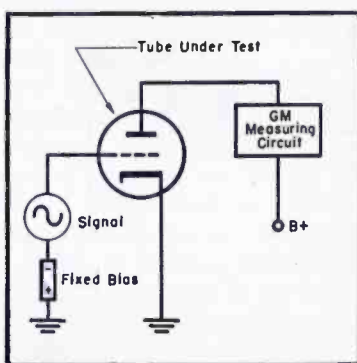
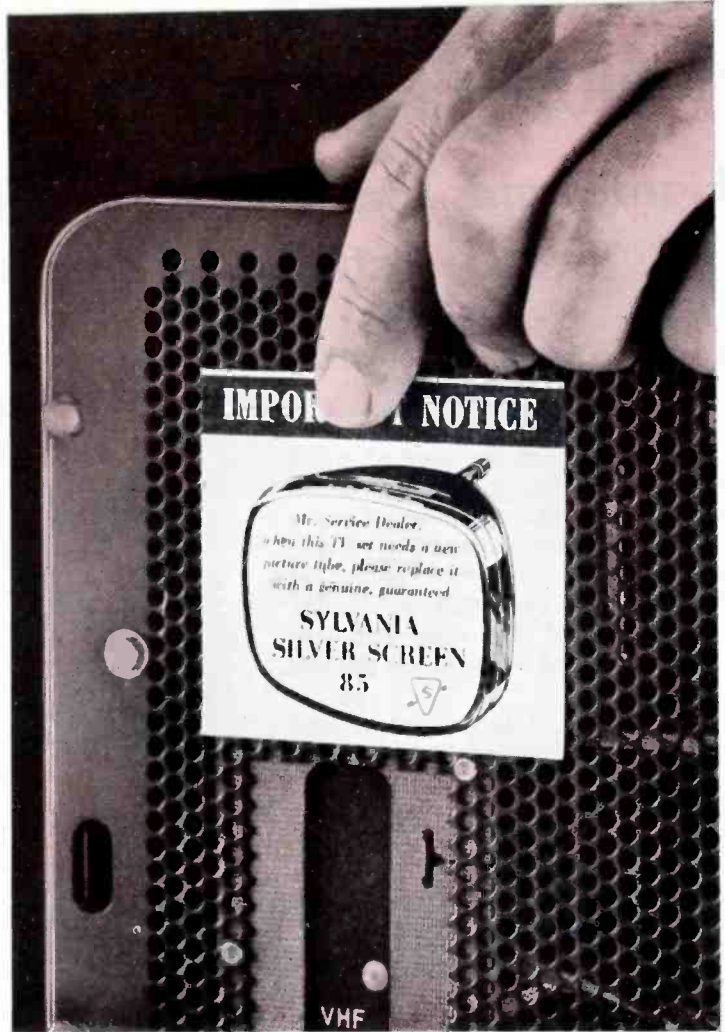
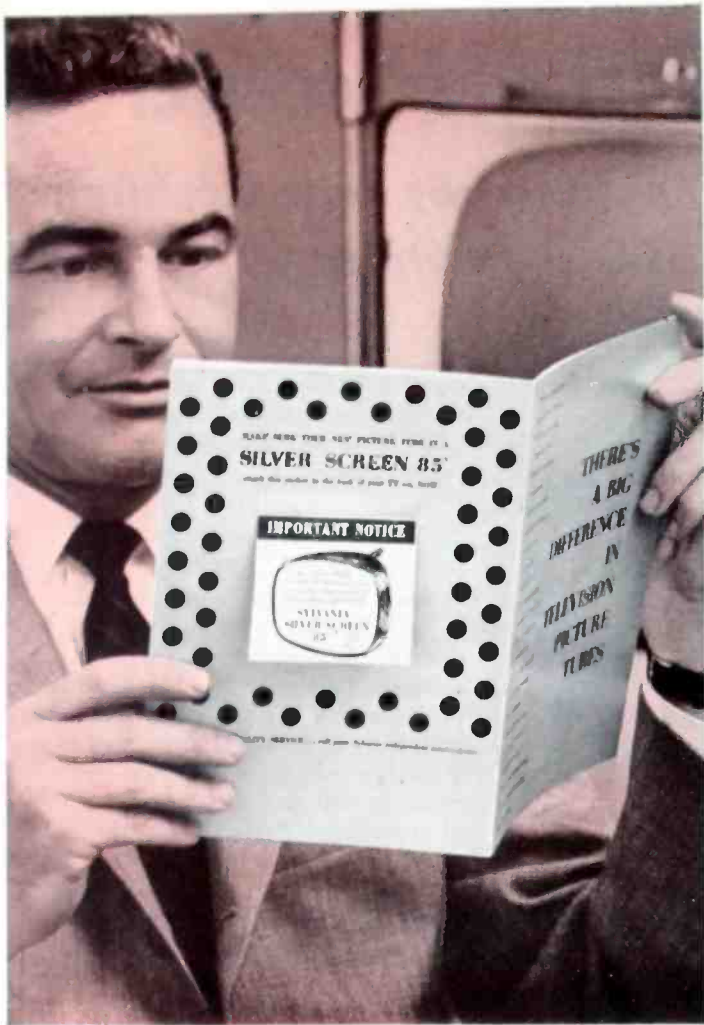

FIG. 1: TYPICAL TEST CIRCUITS utilized in model 121 tester. A triode with a fixed bias under test is shown at left, while a pentode with self bias is being checked in center illustration. The knee test is illustrated at right.



This label is your signal that a value-minded customer has been sold up to Silver Screen 85.

New consumer booklet from Sylvania helps you

SELL UP TO SILVER SCREEN 85

Free booklet tells the story of Silver Screen 85's superior performance—detachable sticker lets the consumer tell you he's *presold* on Silver Screen 85

Leave a copy on every service call or make a complete mailing to your customers and prospects. Either way, Sylvania's new booklet, "There's A Big Difference In Television Picture Tubes," can help you sell up to more profits through more Silver Screen 85 sales.

In layman's language, this booklet details the difference between Silver Screen 85 and cut-rate off-brand tubes. It's chock-full of facts as they were revealed in Sylvania's recent test of a

nationwide sample. What's more, there's a handy sticker on the back of each booklet for the customer to attach to the back of his TV set. This is your signal that he's *presold* up to Silver Screen 85.

Get on the bandwagon. Let Sylvania help you sell up. Give each of your customers and prospects a copy of this new booklet. It's available free, complete with mailing envelope, from your Sylvania Distributor. Or write for a sample copy.



Bill Shipley's your No. 1 Salesman in the industry's biggest consumer advertising campaign.

 **SYLVANIA**

SYLVANIA ELECTRIC PRODUCTS INC.
1740 Broadway, New York 19, N. Y.
In Canada: Sylvania Electric (Canada) Ltd.
University Tower Bldg., Montreal

LIGHTING • TELEVISION • RADIO • ELECTRONICS • PHOTOGRAPHY • ATOMIC ENERGY • CHEMISTRY-METALLURGY

SERVICE, AUGUST, 1958 • 9

New Transoceanic Portable Receiver

Eight-band, nine-transistor set, powered by nine flashlight batteries, delivers 500 mw output

by RUDOLPH T. PLEMICH

ONE EXAMPLE of the marked trend brought about by the use of transistors in commercial equipment is a new 8-band, 9-transistor portable receiver* delivering an undistorted output of 500 milliwatts. The unit, shown in Fig. 1, is powered by nine flashlight batteries, one of which feeds the dial light.

Featurewise, it has a rotary band selector, band-spread tuning, and three antennas: a detachable antenna, a telescopic vertical antenna concealed in the handle and a standard antenna. A 4-inch, Alnico V speaker is used with provision for a 15-ohm impedance earphone.

Circuitwise, the receiver is a conventional superheterodyne. An amplifier employing a 121-44 transistor precedes the 121-49 mixer; a separate local oscillator 121-48 feeds the mixer. All three are PNP transistors of the four-terminal *rf* type, having an emitter, base, shield, and collector. The shield is built into the transistor to increase the frequency range of operation. These types of transistors are necessary in the front end since the 13-meter band runs well into 22 megacycles.

In the schematic diagram (see Fig. 2) the switches for the radio are shown in the standard broadcast position. With the fixed loop L9 connected to J1, the tap of L9 is grounded with the antenna trimmer C27 and C31A part of the tuning gang from pin 7 of J1 to ground. The other end of L9 is connected to the emitter of the *rf* input stage through the parallel combination of C3 and the 1000-ohm resistor.

Output from the *rf* transistor is delivered by primary of L18 which is connected to the collector of 121-44. This output is tuned by C31B and C31C and injected into the mixer emitter circuit through the secondary of L18.

The oscillator signal is injected into the mixer through C4. Sections S1-5R and S1-5F switch in the desired LC

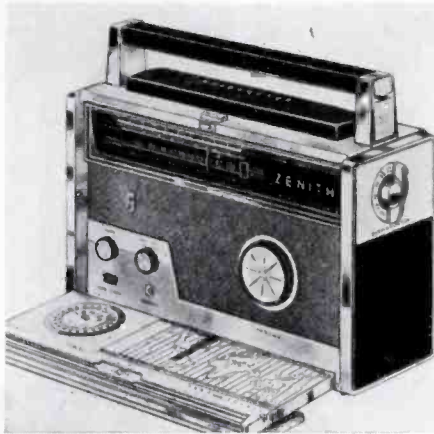

FIG. 1: ZENITH ROYAL 1000 transoceanic transistorized portable features eight bands and a 500 mw output.

combinations of L26, C31D, C42, C43, and C38 to form a tuned-collector (similar to a tuned-plate) oscillator.

For the other bands, various LC combinations are switched in to obtain the correct antenna resonance input, mixer injection, and oscillator frequency.

Standard 455-kc *if* is produced. Note that this is double-tuned with the first *if* and second *if* mutually coupled through C10. Neutralization is employed in both *if* amplifiers. In the 1st *if* stage, the 4700-ohm resistor and C8 form the neutralization network, while C13 forms the neutralization network in the 2nd *if*.

A 103-22 diode is used and is mounted inside the diode detector assembly T5 with the detector *pi*-filter network. AGC feeds the *rf* stage through the 470-ohm resistor to the base. Following the base voltage change is the emitter AGC circuit, the 1.5K, C2, and the 680-ohm isolation resistor for the mixer base.

Output from the detector circuit is fed to the first audio amplifier. Feeding the class B push-pull output stages is a driver. Both the audio amplifier and driver are 121-46 transistors. The output stages are a matched pair of 121-47 transistors and replacement should be according to the same color code.

Thermister T3 provides a constant bias to the matched transistors for

varied climates and temperatures. To prevent oscillation from frequencies slightly above the 455-kc *if*, network C49, C51, and the 330-ohm resistor are employed.

Servicing Transistor Portables

Since low battery potential is used, it is best that a *vom* be used to measure all voltages. The voltage readings indicated on the schematic diagram (see Fig. 2) were measured with a *vom*, no signal input, and with a battery voltage of 12 volts. Voltage readings will also vary with a change of transistors. Transistor conductivity varies from one transistor to another; therefore, voltage readings will differ. All voltage readings will be negative with respect to chassis because of the PNP-type transistor employed.

First check the battery when the radio is presented for service, since the battery voltage decreases with use and age. The battery voltage should be checked at the battery cable connections with the receiver turned on, and after at least five minutes of operation. Batteries have a tendency to reactivate (recharge) when not in use, and a true test of the battery's capabilities can not be determined until sufficient current (14.5 ma with no signal) has been drawn from the battery.

If the battery is found to be dead, the receiver should be checked for a short circuit before the replacement battery is installed. Disconnect battery and measure resistance with an ohmmeter at the battery cable connections. Ohmmeter will indicate approximately 1500 ohms with positive lead to chassis. Remove transistors from sockets. Replace batteries when the sound output is found to be muffled or distorted or when there is a noticeable decrease in total output.

When using an ohmmeter to check continuity and resistance readings, caution must be observed. Keep in mind the internal battery voltage of the ohmmeter as damage could result from excessive voltage being applied to the circuit by the ohmmeter. Know the battery polarity of the meter

(Continued on page 15)

*Zenith Royal 1000 Transoceanic.

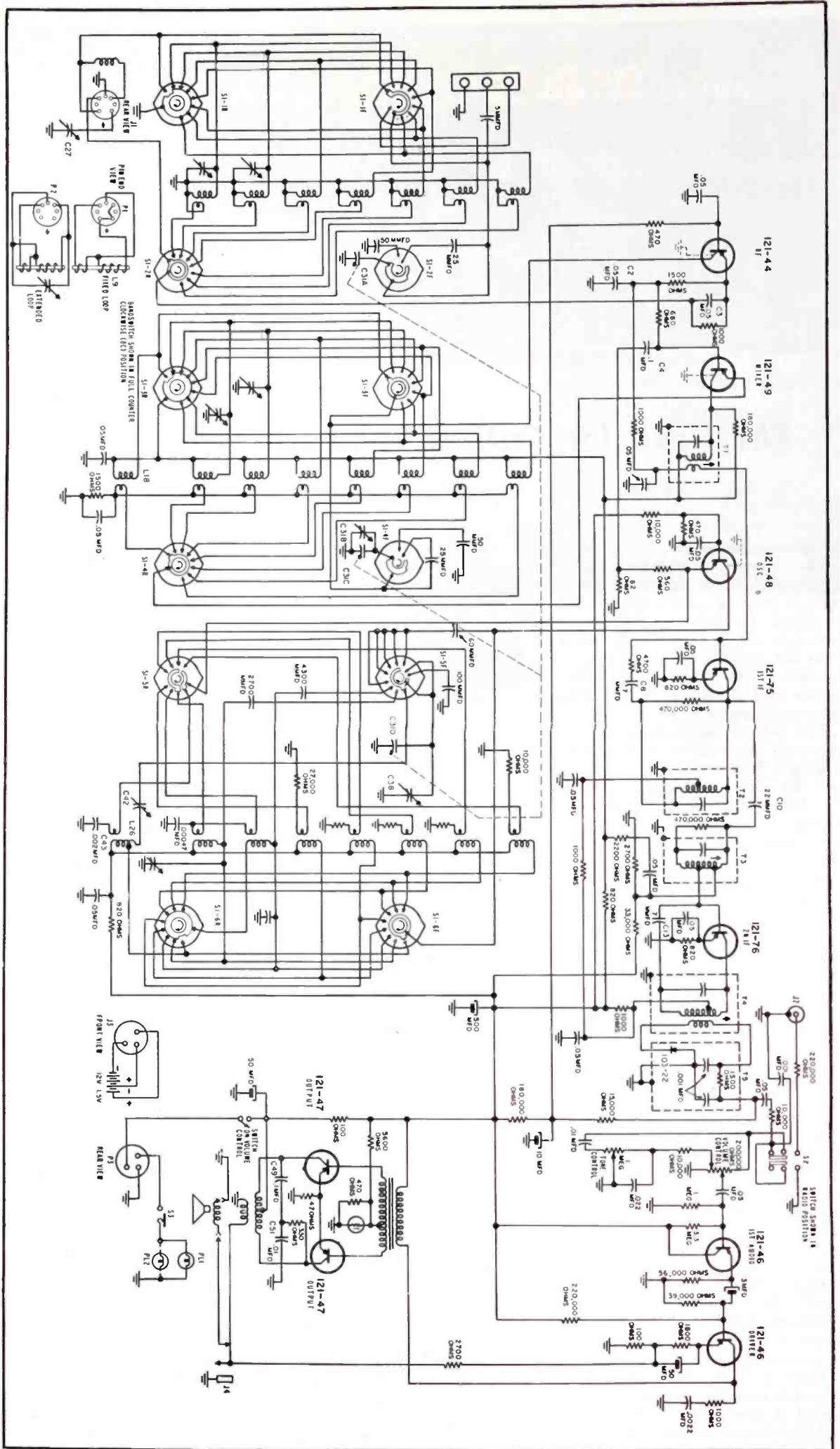

FIG. 2: SCHEMATIC DIAGRAM of Zenith model Royal 1000 all-transistor transoceanic portable receiver which features band-spread tuning, a rotary band selector and three antennas.

service engineering

INDUSTRIAL
ELECTRONICS

The Need for Critical Tube Tests

by H. McKAY and L. G. SANDS

IT IS COMMON knowledge in the electronics industry that tubes cause over 75% of failures in electronic devices in spite of exacting quality-control methods employed by tube manufacturers. All branches of the industry are concerned with this problem. Now that the service business is expanding to industrial electronics and computers, the problem is even more serious.

The sale of replacement tubes is an important source of income for the radio-television Service Man. It is good business for him to sell replacement tubes, but he is faced with a problem. The failure of a set may be caused by a single tube, or it may be the cumulative effect of aging on several tubes.

A routine test of all the tubes in the set may reveal many that need changing in addition to those that caused the current complaint. If he does not change these, he runs the risk of a call-back when these tubes do fail. Yet to accurately forecast the life of a tube is impossible. The Service Man is also faced with the problem created by the fact that he is physically able to lug just so much equipment into the customer's premises. His tube supply, tools and test meters amount to a sizable load.

On the tubes he himself installs, he may look with a fair degree of safety, but only if he has pretested and preaged the new tubes before putting them into stock.

How a tube should be tested is another matter. In some cases the only good test is testing in the circuit in which it is to be used. One Service Man, for example, reports that 40% of the new 12AT7's he has in stock and which check OK in his tester will not work properly in the squelch circuit of certain types of mobile communications equipment.

There are many reasons why vacuum tubes fail to deliver the performance expected of them and not all of them can be blamed upon the tube manufacturers. In the design of the circuit in which the

tube is to be used, it is generally true that conditions will not be imposed upon it which exceed the maximum values as established by the tube manufacturer.

Ordinarily the design center would be recommended. However, original circuit designs are often altered in the laboratory to suit operating or production requirements, and it may be impossible to create an optimum environment for all of the components in the assembly. Further, neither the tube or apparatus manufacturer has any control over the unit once it is in the user's hands, and it is often difficult to foresee the possible uses and abuses to which it might be subjected.

The matter of temperature, for instance, is of considerable importance in the life of a tube. A General Electric Company study of one tube type revealed that 4% of the tubes observed failed in 300 hours when the temperature was held to 115° C. At a temperature of 260° C. it was found that 26% failed in the same length of time.

Operating voltages also affect the life of a tube. The Bell Telephone System obtains a great deal more life from tubes

in repeaters and carrier systems by operating 40-volt (heater) 407A tubes at 38.5 volts.

Most failures in new tubes occur in the first fifty hours of use. During this period the tube is put to its first real working test and manufacturing defects usually show up under these operating conditions. Yet even if a tube passes this phase, there is no reliable way of knowing how much longer it will last.

The remaining life in a tube is often estimated by cathode activity tests. These tests are made by lowering the voltage on the heater of the tube and observing the amount by which the mutual conductance is dropped. This is sort of a negative test, however, and only warns that it would be wise to change the tubes that read low, because they are nearing the end of their useful life. The test will give no positive guarantee as to how long the good tubes may last before failing from some other cause. Like a blood test for parenthood, it will only tell what isn't so.

Tube Troubles

Among the shortcomings of vacuum tubes is the matter of balance in multi-unit devices like the dual-triode. In many cases where these units are used as single entities in a circuit, balance is unimportant. However, in differential and relay applications, such as might be encountered in computer or communications systems, failure in this respect can be serious.

Some circuit designs get around this problem by using a built-in adjustable bridge arrangement, whereby a potentiometer can be adjusted to overcome the unbalance of the tube units. In other cases, laborious tests must be made to select tubes that meet the balance requirements.

In addition to the problem of unequal transconductance in such tubes, there is also the matter of variation in interelectrode capacitance. This may vary from one specimen tube to another, and may also vary between units in dual tubes. Again, this variation may make the tube unsuitable for certain applications, particularly at high frequencies.

Probably one of the least suspected, but most troublesome conditions encoun-

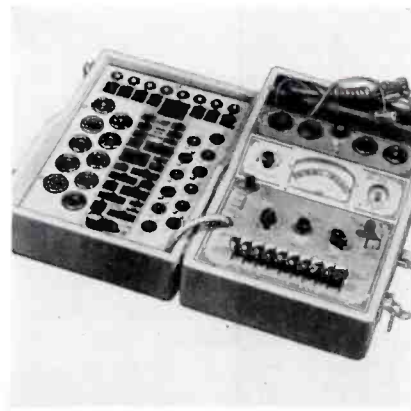
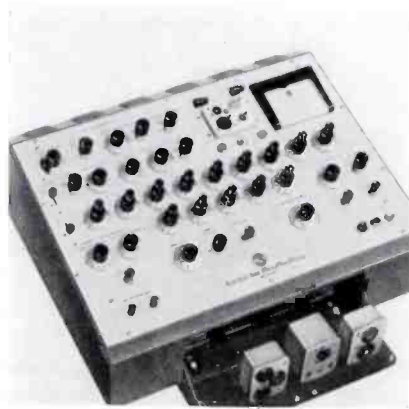

RCA MODEL WT-100A (left) laboratory-type tube tester permits wide variety of conditions to be placed on each pin of the tube sockets. Seco Model 107 (right) tube tester has dynamic mutual conductance test features as well as an electron-eye tube for checking grid emission.

tered in vacuum tubes is *grid emission*. This may be due to a variety of causes, among which can be heating of the control grid by the cathode. This would seem to be borne out by the fact that high transconductance tubes which have close electrode spacings seem to be most prone to this trouble. In practice, grid emission behaves much like gas in the tube; that is, it causes grid current to flow when it should not. The amount of current is in the microampere range, and the effects may sometimes be subtle.

In most grid circuits the grid is isolated from ground by a high resistance path. This is usually permissible because no current flow through it is contemplated in the design. However, if current does flow, even though it is minute, enough drop can develop across the high resistance to change the bias and hence the operating characteristics of the tube.

In cases where several grids are connected to a single lead, the effect can become manifest in all of the tubes so connected. Grid emission in one tube thus may cause a complete circuit failure. Grid emission is particularly troublesome in sync, age, and sweep circuits. A clue to grid emission is often found when it is discovered that a tube will work well in one socket of a television set, but not in another.

Tube Testers

It would seem from the foregoing that more critical methods of testing tubes are needed by the industry. This need has given rise to specially developed devices for making tests which are not made by the ordinary tube tester.

Laboratories working on equipment requiring close balance of dual-triode tubes have developed testing units for this specific purpose. Companies like the Bell System, which are concerned with the remaining service life of tubes, use special test units for measuring cathode activity. In fact, many telephone circuits are now designed with built-in resistors in the cathode and plate circuits for this purpose. Leads from these resistors are brought out to external jacks where special meters and switches may be connected, thus making an in-service test of the tubes.

Routine tests of tubes on a regular tube tester are favored by some, but frowned upon by others. Often the mechanical shock of removing the tube from its socket and placing it in the tester can cause it to fail, while if left alone it might have given service for years to come. This happens particularly in cases where tubes run very hot in horizontal positions, causing sagging and brittleness of the elements.

Tube testers come in a variety of classifications. The simplest and cheapest check only for inter-element shorts and cathode emission. The most satisfactory testers measure mutual conductance on a dynamic basis. A predetermined set of conditions is placed on the tube and an ac signal is applied to the grid. A balance circuit in the

(Continued on page 29)

look what **\$24⁵⁰** buys
in test equipment!

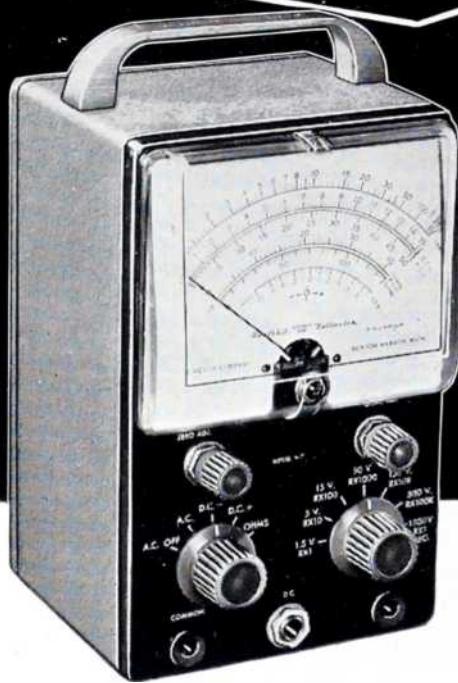

**HEATHKITS
GIVE YOU
TWICE AS MUCH
equipment for
every dollar
invested**

The famous model V-7A Vacuum-Tube-Voltmeter is a perfect example of the high-quality instruments available from Heath at 1/2 the price you would expect to pay! Complete, only **\$24⁵⁰**



Get the most out of your test equipment budget by utilizing HEATHKIT instruments in your laboratory or on your production line. Get high quality equipment, without paying the usual premium price, by dealing directly with the manufacturer, and by letting engineers or technicians assemble Heathkits between rush periods. Comprehensive instructions insure minimum construction time. You'll get more equipment for the same investment, and be able to fill your needs by choosing from the more than 100 different electronic kits by Heath. These are the most popular "do-it-yourself" kits in the world, so why not investigate their possibilities in your particular area of activity! Write for the free Heathkit catalog now!



Contains detailed descriptions of Heathkit models available, including VTVM's, scopes, generators, testers, bridges, power supplies, etc.



Also describes Heathkit ham gear and hi-fi equipment in kit form. 100 interesting and profitable "do-it-yourself" projects!

FREE catalog

Mail coupon below for your copy—Now!

HEATH COMPANY
A SUBSIDIARY OF DAYSTROM, INC.,
BENTON HARBOR 11, MICHIGAN

Name _____

Address _____

City & Zone _____

State _____

New Instrument for Shunt-Testing Electrolytic Filter Capacitors

by HOWARD JENNINGS

ELECTROLYTIC CAPACITOR problems—especially those in radio and TV power supplies—are often quite troublesome because of the temporary *self-healing* phenomenon which faulty electrolytics exhibit. An example of this phenomenon occurs when an electrolytic suspected of causing hum in a TV set is shunted by a replacement unit. Here, the momentary heavy voltage discharge from the suspect unit into the replacement shunted across it can produce *healing* in the faulty unit.

Because of this temporary *self-healing*, Service Men can appreciate the advantage of being able to shunt-test an electrolytic filter without the accompanying charging surge. Such a test could eliminate many callbacks since the faulty electrolytic often begins acting up again *after* the set has been returned to the customer's home.

An *Electrolytic Substitute*¹ designed to eliminate this charging surge has recently been developed. Constructed in probe form, the unit in its *reset* position connects a resistance in series with the electrolytic under test and eliminates the charging surge for all practical purposes. A neon lamp indicates when the unit under test is charged.

The negative terminal probe-mounted clip of this *Electrolytic Substitute* is connected to either the chassis or to B— of the set being tested. The set should be on. The red positive lead is connected to the positive terminal of the suspect electrolytic. When the neon indicator reaches full brilliancy, the function switch should be turned to the *test* position. The effect of this on the set being tested should be noted. The function switch can then be moved from *test* to *reset* to determine if performance of the set

¹D-600, Doss Electronic Research.

would be improved by replacing the electrolytic. There will still be no surge and the electrolytic under test will stay charged in the *reset* position. This method allows the Service Man to demonstrate to the customer, if necessary, the advantages of replacing the electrolytic.

The range switch on this probe unit covers *LO* and *HI*. *LO* should be used for checking electrolytic values up to 40 mfd. Electrolytic values of 50 mfd and higher should be checked in the *HI* position.

Electrolytics with extremely sensitive *healing* characteristics—those that will heal even at the touch of a probe—should be checked by connecting the *Electrolytic Substitute* across the suspect capacitor *before* turning the set on. To determine if a set is giving electrolytic trouble before turning it on, it would be wise to question the customer on the symptoms the set has shown.

These extremely sensitive electrolytics are often the ones which develop *rf opens*—the condition where an electrolytic exhibits good power-supply filtering action but allows regeneration due to insufficient bypass action to *rf*. This defect is most often found in radio sets. FM and TV receiver design usually incorporates separate *rf* bypass capacitors across the electrolytics. Certain types of sets frequently exhibit this problem and it is readily recognized. If this trouble seems to be present the output electrolytic should be shunted with a .05-mfd capacitor—a good safety precaution in any event.

The probe-mounted clip on the electrolytic substitute may be unplugged and replaced if necessary. When attached to the chassis it prevents the unit from dangling awkwardly to the chassis and also makes the necessary negative connection. This compact *Electrolytic Substitute* may be carried in the tool box—ready for shunt-testing of power-supply electrolytics.



FIG. 1: DOSS MODEL D-600 ELECTROLYTIC SUBSTITUTE shunt-tests an electrolytic filter capacitor without the charging surge normally encountered. Probe-mounted clip at left prevents tester from dangling and supplies necessary negative connection.

PERSONNEL

DAVID R. HULL, vice president of defense programs of Raytheon Manufacturing Co., has been elected president of the Electronic Industries Association. . . . Other officers are James D. Secrest, executive vice president; Sidney R. Curtis of Stromberg Carlson, vice president, military products division; Russell E. Cramer, Jr., of Radio Condenser Co., vice president, parts division; A. L. Chapman of CBS-Hytron, vice president, tube and semiconductor division; and C. Russell Cox of the Andrew Corp., vice president, technical products division. Leslie F. Muter was reelected to his 23rd term as treasurer.

FREELON M. FOWLER has been appointed public relations director of the Institute of High Fidelity Manufacturers, Inc., 125 E. 23rd St., New York 10, N. Y.

WILLIAM C. WEBER, JR., has been named executive secretary of The Representatives of Electronic Manufacturers, Inc., 600 S. Michigan Ave., Chicago 5, Ill.

ROBERT BEEBE has been appointed assistant sales manager of Antenna Specialists Co., 12435 Euclid Ave., Cleveland 6, Ohio.

FRED J. KIRKMAN has been elected president of Burgess Battery Co., Freeport, Ill. . . . Dan W. Hirtle, formerly president, has been elected vice chairman of the board.

ANTHONY C. VALIULIS has been named executive vice president of General Cement Manufacturing Co., 400 S. Wyman St., Rockford, Ill. . . . Russell D. Gawne has been made vice president in charge of sales.

GORDON E. BURNS has been promoted to distributor sales manager of the electronic components division, General Electric Co., Owensboro, Ky. . . . George O. Crossland has been named central region equipment sales manager for receiving tubes with offices at 3800 N. Milwaukee Ave., Chicago, Ill. . . . William F. Flanagan heads up a new district office in the Hibernia National Bank Bldg., New Orleans, La. . . . David N. Platt has been appointed new sales manager in Atlanta, Ga., with offices at 1330 W. Peachtree St. . . . E. Kyle Cooper has moved into the Birmingham, Ala., office at 10 Office Park.

Transoceanic Portable

(Continued from page 10)

leads. Incorrectly placing the ohmmeter leads across an electrolytic capacitor with a low working voltage may damage the capacitor by excessive reverse current.

If the meter battery voltage is greater than 15 volts, the *rf*-type transistor rating will be exceeded and may be damaged. A diode action will be experienced when attempting to check the resistance readings with the transistors in the circuit. It is advisable to remove all transistors from their sockets before making ohmmeter checks.

Use caution in soldering as excessive heat may easily damage a transistor. The transistors must be removed from their sockets before soldering at the socket pins. Heat may also damage other components such as resistors. Therefore, dissipate the heat to the component by grasping the component lead with a pair of long-nose pliers.

If a transistor is suspected of being defective, substitution is the only reliable check. Checking resistance readings of a transistor with an ohmmeter will indicate only a shorted or open transistor. When inserting a transistor in its socket, make sure the transistor's leads line up with the socket holes. If a transistor substitution is made in the *rf* or *if* circuit, realignment may be necessary.

When soldering components at the base of the transistor socket, it is suggested that the transistor be removed to avoid any possibility of excessive heat being transferred through the socket to the transistor. When soldering low-voltage electrolytics and germanium diodes, it is suggested that the wire be held with a pair of long-nose pliers while soldering. The long-nose pliers will act as a heat sink. Miniature as well as close-tolerance components are used throughout the radio, therefore, these components should be replaced with exact duplicate parts.

Trouble in a transistor radio can easily be isolated by using a signal generator and listening to the speaker. Circuit tracing, from the base of the output stage back through the receiver to the antenna, should quickly reveal which stage is not functioning properly. When injecting the signal, use a 50 mfd electrolytic (negative to base) in the audio circuit, a .5 mfd capacitor in the *if* or *rf* stages and inductive coupling to the antenna.

Replace with the TV manufacturers' choice...



AUTOMATIC PT5 SILICON RECTIFIER

- Easy pigtail installation
- Hermetically sealed
- No pressure contacts used
- No heat sinks required

General Instrument Distributor Division
RADIO RECEPTOR COMPANY, INC.
Subsidiary of General Instrument Corporation
240 Wythe Avenue, Brooklyn 11, N. Y. EVERgreen 8-6000





Diamond Needles for Stereo Pickups

AUDIO
INSTALLATION AND SERVICE
Phono • Tape • PA
Cartridges • Needles • Amplifiers • Speakers

by DOUGLAS F. HUDSON
President, Fidelitone, Inc.

ONE OF THE most important aspects of stereo discs and stereo pickups is that both are completely compatible with LP. In other words, a stereo record can be played on any standard LP set with a standard LP pickup and produce excellent results, while the stereo pickup can be used on an LP disc without creating distortion.

A comparison with color television best explains this phenomenon. In telecasts, the black and white TV set performs the same whether the television transmission is made in color or black-and-white. The color TV set, however, will reproduce the program in color when the transmission is in color, and will reproduce the program in black-and-white when b-w transmission is used. The same versatility applies to the new stereophonic record system.

Small Radius Required

However, any pickup used to reproduce this new stereo record needs a new needle which must have a much smaller radius on its hemispherical point if proper tone quality is to be achieved. To understand the reason for this, it may be helpful to recall that a few years back before the advent of the LP record, all phonograph needles had ball-shaped points .006 to .008 inch in diameter or 3 to 4 mils in radius. When the LP records were developed with the grooves only about $2\frac{1}{2}$ mils wide at the surface of the record, it was necessary to reduce the needle point to one mil so the record could be played. This forced the phonograph industry to design

pickups which included two separate needle systems; one needle with a 3-mil radius for 78-rpm discs and the other with a 1-mil radius for LP's. The new stereo record will not require a third needle, but it will necessitate that the one-mil point be reduced to a little less than $7/10$ of a mil.

Here is why the new stereo record requires a needle with a smaller radius. First, the number of lines per inch on the stereo disc and on the LP disc are exactly the same, which means the playing time is the same and therefore, the width of the grooves are the same. Obviously, then, the needle has not been made smaller to prevent it from jumping the grooves. The reason for the reduction in size is directly related to the decision of the record industry to retain the valuable feature of longer playing time in each record. Without going into the mathematical complications, it can be reasoned that when two simultaneous bits of information as in stereo recording are being transcribed in an area where only one bit of information was formerly transcribed, more room is needed.

Amplitude Reduced

Something had to be compromised in the design of the new groove, and since the feature of long play was too important to give up, the industry decided that the amplitudes of modulation had to be drastically reduced. This would enable the standard $2\frac{1}{2}$ -mil microgroove widths to be retained. The amount of this reduction in amplitude velocity will range from 3

to 10 decibels for all existing types of LP recordings.

To illustrate, suppose a standard LP record is played at normal volume level with a standard 1-mil needle pickup, and suppose that the voltage level of this setting was recorded as 1 volt. Now, if this LP record were replaced with a stereo record which is down 6 decibels in recording level, the voltage in the output for this same setting would be only $\frac{1}{2}$ volt—a 2 to 1 reduction in sound level. This could create an objectionable condition because, though the music level drops by a 2 to 1 ratio, the scratch or noise level remains the same, so the noise ratio is twice as high.

Greater Voltage Generated

Tests have shown that a great deal of this drop in volume level can be overcome if a smaller radius is used on the needle point. This is because the better fit to the groove will create a greater movement of the needle point and therefore generate more voltage in the pickup.

However, the smaller tip, while reducing distortion and improving tone quality, has created a serious problem for the needle manufacturer. Since the point is so microscopic, it is also more fragile than ever before. For this reason, the diamond, the hardest substance known to man, will be much more widely used in stereo pickups. It is the only material that will perform satisfactorily for long periods of time under these conditions.

To meet these exacting requirements, we have developed a new technique to control the mounting of the diamond stylus in its exact crystallographic orientation with respect to the record groove. This technique

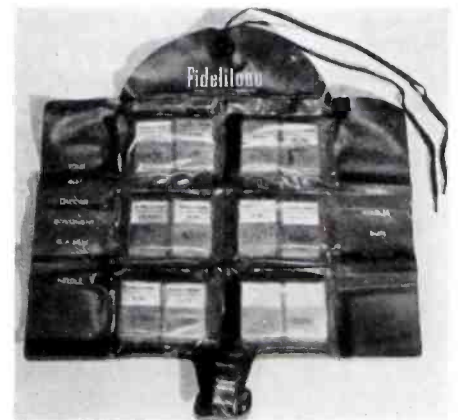

FIG. 1: SERVICE MEN'S NEEDLE KIT, developed by Fidelitone, contains 12 diamond needles and magnifying glass for detecting needle wear.

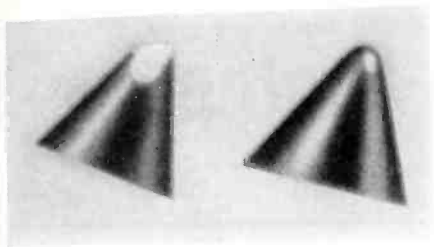

FIG. 2: WORN DIAMOND NEEDLES seen under a magnifying glass. The needle at the right is still usable; the needle on the left must be replaced.

will minimize clearance plane chipping and also insure that the hardest molecular plane of the diamond is presented to the abrading surface of the side walls of the record's grooves. This means that the diamond will last longer in spite of the increased buffeting it will take both in the stereo and LP records.

Examining Needles

As the demand for stereophonic sound mounts, Service Men will be called on increasingly to install and service diamond needles. To help him do a better job, we have developed a special Service Man's needle kit (see Fig. 1) which contains 12 of the most popular needle types, both stereo and monaural. Also included in this kit is a magnifying glass for detecting needle wear.

Examination of a suspected needle under a glass is the only way to determine whether the needle should be replaced. The contour of a slightly worn, though still usable, diamond needle appears at the right in Fig. The needle should be replaced before the point assumes the chisel-edged shape shown at the left.

Profit in Stereo

The informed Service Man has the best chance of cashing in on the new marvel of stereophonic sound. If his customers recognize him as an authority in all phases of this field—from needles to speaker enclosures—he can profit handsomely from the coming mass conversion to stereo equipment.

• • •

Free Courses Offered

Free courses in radio and television service will be offered by the William E. Grady Evening Trade School, located at Brighton 4th Road and Banner Avenue, Brooklyn 35, N. Y. Registration for all classes will take place at the school on September 8 and 9, from 7:00 to 9:00 P.M.



SUITS NEED PRESSING— MERIT DEFLECTION YOKES DO NOT!

Merit deflection yokes are cosine wound TO FORM, not pressed. Pressing can lead to distortion and poor focusing. Pressing after winding frequently causes breakdown.

MERIT COILS AND TRANSFORMERS HAVE "BUILT-IN" ADVANTAGES.



Each Merit yoke is
100% LIVE TESTED



COMPARE IT WITH MERIT

MERIT COIL AND TRANSFORMER CORP.
MERIT PLAZA • HOLLYWOOD, FLORIDA

Installing Outdoor Sound Systems

by L. A. RANDALL
Special Products Div., Stromberg-Carlson
Co.

THE INSTALLATION, OPERATION and servicing of outdoor sound systems offer a challenge to the sound system specialist. An even greater challenge to meet is the modernization of an existing system. It is interesting work, for seldom will two projects require identical equipment and services.

In general, outdoor sound systems can be broken down into four main categories. These are stadiums, race tracks, ball parks and airports.

While there is a similarity to the system requirements in these categories, there are also some striking differences in the problems involved. Stadium stands are usually one-deck affairs without a roof to impede the projection of sound. Race tracks and ball parks generally have a roof over the grandstand and sometimes are two decks high. This can increase the problem of uniform sound coverage. Airports normally require many microphones for announcing purposes, as well as a combination of indoor speakers at relatively low level and outdoor speakers operating at a much higher level.

However, stadium and ball parks are often used for other events than the primary purpose for which they were built. Sometimes these special events are in the form of entertainment before and between double header ball games. At other times the stadium is used for boxing, political and religious rallies or pageants. A quantity of microphones is usually required to pick up the special events taking place on the playing field. This is another reason for minimizing the sound coverage on the playing field, so as to reduce the possibility of acoustical coupling (feedback) between the speakers and the microphones.

It is no problem, when the installation is being made, to locate a few weatherproof microphone outlets at the edge of the spectator areas and wire them to the amplification and control cabinet location. Plugging in a microphone having a long cord into one of these receptacles is a simple matter. It becomes more complicated

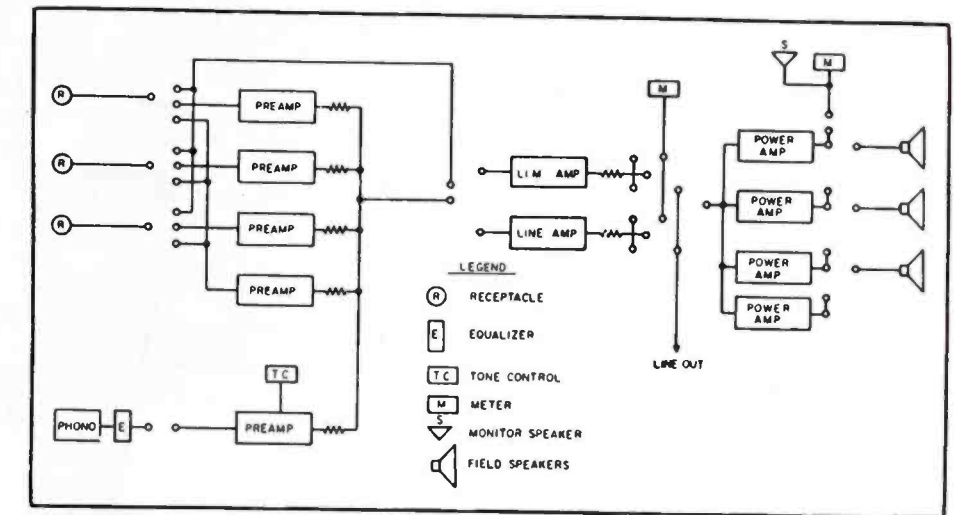

FIG. 1: SCHEMATIC DIAGRAM of main control cabinet assembly. System includes four pre-amps for controlling and mixing four microphone channels and a space pre-amplifier.

when several microphones are required to pick up and mix the program. Even though the required number of microphone outlets are conveniently located, remote mixing is never as satisfactory as on-the-spot mixing.

On-the-spot mixing can be accomplished by using a portable preamplifier at the edge of the field, where the operator will not obstruct the vision of the audience. The required microphones are connected to the pre-amplifier. The operator monitors and mixes the program by using a headset connected to the amplifier output. The zero level (500-600 ohms) output of the amplifier is connected to one convenient microphone receptacle, thus saving running three or four microphone lines to the control location.

Forethought in the assembly and wiring of the control portion of the amplifier cabinet makes this possible. The switch at which the microphone line terminates has an extra position, which connects the line to the line amplifier, thus, in effect, changing the microphone line to a zero level transmission line. The other switch positions controlling each microphone line are: off, preamplifier, spare pre-amplifier. Thus the line can be used as a microphone or zero level input line. Some sound specialists advocate the use of jacks and patch cords instead of switches for maximum flexibility of switching facilities.

This arrangement reduces the number of stadium microphone receptacles required and results in a better

system at less cost. The cost of the portable preamplifier is more than offset by the reduced material and labor cost of the fewer microphone lines required, plus the smaller quantity of preamplifiers required in the amplifier cabinet assembly.

When coverage from one group of speakers is proposed, a careful study of the available locations is necessary. Cellular horns are the commonly accepted type used, either alone or in combination with weather-proofed 15 inch cone woofer reproducers. The configuration of the cellular horns and the audio power allotted each speaker must be plotted to reduce reflected sound to a minimum. Thus, the angle of projection is exceedingly important, in order to provide a uniform level of coverage.

The primary concern is to provide high quality reproduction of speech and music, which will be clearly understandable above the normal inherent noise levels encountered in the spectators areas, but not the spasmodic cheering of an aroused crowd.

After carefully plotting the sound projection pattern and selecting the cellular horns which provide the correct configuration for a uniform coverage level, it is necessary to determine the audio power required to drive the speakers at the desired level in the areas each covers.

Sound pressure level charts show that each time the distance is doubled, the sound level drops 6 db. The charts also show that to raise the level 3 db, the input power must be doubled, and to raise the level 6 db,

the input power must be quadrupled.

The brief sound pressure chart data shows that as we double the distance the level drops 6 db.

Distance	Input Watts	Sound Pressure Level
4'	1	115.2
8'	1	109.2
16'	1	103.2
32'	1	97.2
64'	1	91.2
128'	1	85.2
256'	1	79.2
512'	1	73.2

Using the data above, the following example may be helpful for an arbitrary assumption. The desired level is 85 db at 128 ft., 256 ft. and 512 ft. but a 6 db reserve should be figured, making our reserve level at least 91.2 db minimum.

SOUND PRESSURE LEVEL IN DB							
Dis- tance	Watts Input						
	1	2	4	8	16	32	64
128'	85.2	88.2	92.2				
256'	79.2	82.2	85.2	88.2	91.2		
512'	73.2	76.2	79.2	82.2	85.2	88.2	91.2

It is clearly seen that the horns covering the 512 ft. distance areas should be equipped with dual throats and drivers. The system must also incorporate the recommended cross-overs and transformers specified by the manufacturer.

A football stadium seating 29,000 spectators in stands on each side of the playing field will use the system described below. It illustrates the type of equipment and services generally specified, although many fine systems use the cellular horns only and do not install the larger low frequency woofers.

The speaker system will be in two sections on each side of the score board, which is located about 100 ft. back of the end zone at one end of the field. Each speaker section includes four 2 x 5 cellular horns, having a 400 cps cut-off and a distribution angle of 40° vertical and 100° horizontal. Each horn is equipped with a driver unit or units, having a 40 watt capacity above 400 cps. Two 15 inch cone low frequency units, having 10½-lb. Alnico V Magnets, are enclosed in weatherproofed utility cabinets, incorporating acoustical labyrinths and projectors. Six line matching transformers for the correct allotment of the audio power complete each speaker section of the main system.

The main system control cabinet assembly is shown schematically in Fig. 1. It includes four preamplifiers

for controlling and mixing as many as four microphone lines, plus a spare preamplifier which can be substituted for any preamplifier in difficulty. A sixth preamplifier, equipped with tone controls, provides amplification for a record changer and equalizer assembled in the cabinet.

The outputs of the preamplifiers are connected through a switch to either a broadcast quality limiter amplifier or to a line amplifier as shown in Fig. 1.

The power amplifier cabinet assemblies contain four 250-watt power amplifiers, which are driven by the limiter or line amplifier in the control

cabinet. A broadcast type VU meter is included for visually indicating the level of the power amplifier input line. The output of each power amplifier is connected to a monitor speaker panel through a rotary selector switch, so that the output of each power amplifier can be selectively connected to the monitor speaker panel for visual and aural checking.

A separate 25-watt amplifier, in the amplifier cabinet assembly, serves an independent press box system. Press box speakers are small re-entrant horns.

[To Be Continued]

Can You Handle This Problem?

What minimum value would you use for C?

(answer printed below)

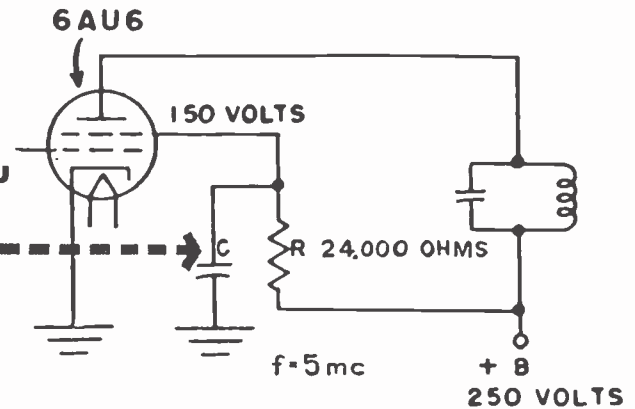

To many technicians this is a difficult problem. Yet it involves a common principle, fundamental to almost every known electronic circuit. With manufacturers' diagrams the solutions to such problems are simple . . . but can you do them accurately by applying only fundamental theory?

Electronic fundamentals are the key to all electronic equipment. The man who understands these "mental tools" is not tied down to repairing common defects. The great advances in electronic devices demand the services of men who "think electronics"!

Take Home Electronics, for instance. Of course there's a need for men who

can identify and repair common defects in television receivers. But who's going to service the new electronic home devices . . . the garage door openers, "radar" cooking stoves, closed circuit television, electronic air conditioners, ultra-sonic washing machines, heat controls, burglar and fire alarms, complex hi-fi systems, etc.?

Regardless of your success with the above circuit, it will pay you to find out how you can increase your income by adding to your kit of "mental tools."

Answer to problem above:

Answer: C=25 Micromicrofarads
See coupon below for how to figure this:

Cleveland Institute of Radio Electronics
4900 Euclid Avenue, Dept. S-15, Cleveland 3, Ohio

Please send me detailed solution to problem above and information on how I may prepare for the increasing opportunities in electronics. There is no obligation.

NAME

ADDRESS

CITY..... ZONE..... STATE.....

Accredited by The National Home Study Council.

S-15



New Instruments for Service



Line of decade boxes which includes three capacitance models, three resistance models and four inductance models. Multiple-dial units have highest value multiplier on left-hand side so that readings are made from left to right. (Distributor Div., Aerovox Corp., New Bedford, Mass.)

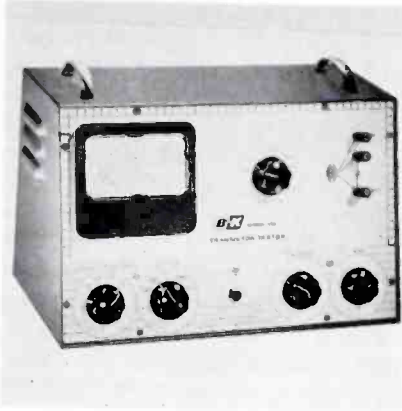

Transistor tester with a true, small ac signal. Tests PNP or NPN, audio, rf, power or industrial transistors. Junction and other diodes may be tested accurately for forward to reverse current ratio. (150; B&K Manufacturing Co., 3726 N. Southport Ave., Chicago 13, Ill.)



Transistorized direct-reading field strength meter for measuring TV signal strengths. Input is designed for both 75 and 300 ohm applications. (TMT; Jarrold Electronics Corp., 15th and Lehigh, Philadelphia 32, Pa.)



Printed-circuit vtm kit featuring low-leakage switches and film type 1% precision resistors. Seven dc and ac rms ranges are included as well as seven ac peak-to-peak ranges and six resistance ranges. (83 Y 125; Allied Radio Corp., 100 N. Western Ave., Chicago 80, Ill.)

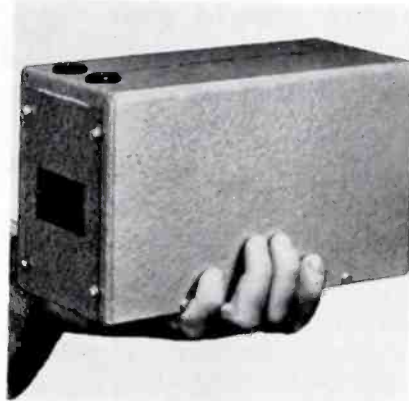

Automatic line voltage regulator said to be only about 10% of the size and weight of conventional units. Available for single or three phase inputs of 115 or 280 v nominally, with outputs from 575 va to 2300 va. (British Industries Corp., 80 Shore Rd., Port Washington, N. Y.)



Instrument for measuring flutter or wow in recorder drive mechanisms. Ranges are 0-1.5% and 0-3%. (Fluttermeter; Kay Electric Co., Dept. SE, Maple Ave., Pine Brook, N. J.)



Miniature multitester featuring a 38 micro-amp D'Arsonval movement with jewelled bearings and 23 dc and ac voltage, dc current, resistance and decibel ranges. (AR-660; Argonne Electronics Manufacturing Corp., 165-11 South Rd., Jamaica 33, N. Y.)



High-gain signal tracer kit for tracing rf, if and audio signals in either tube or transistor AM or FM receivers. Contains a noise locator circuit to permit isolation of noisy and intermittent components. Signal strength is indicated aurally and visually. (T-4 Heath Co., Benton Harbor 11, Mich.)

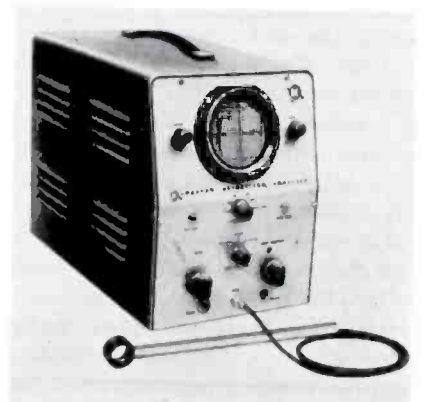

Wave-form analyzer with electrostatic coupling probe said to minimize loading of circuit. Twelve-position rotary tuner, with a variety of interchangeable clips makes it possible to tune to frequencies from 3 mc to 240 mc. (EA-1; Kingston Electronic Corp., Medfield, Mass.)

Shops



Dual audio-output level indicator incorporating two independently damped RC meter movements with scales calibrated in vu and percent for balancing stereo equipment. Input impedance is 10,000 ohms per channel. (Lafayette Radio, 165-08 Liberty Ave., Jamaica 33, N. Y.)



AM-RF generator with a frequency range of 100 kc to 280 mc for aligning TV receiver oscillator coils on all channels, as well as other service needs. (7200; Philco Corp., Accessory Div., C and Westmoreland Sts., Philadelphia 34, Pa.)



Generator featuring both sine and square wave output over the range from 5 cycles to 600 kc in five bands. Sine wave output level is 10 v rms into 600 ohms. Square wave output level is 10 v peak-to-peak. (E-310; Precision Apparatus Co., Inc., 70-31 84th St., Glendale 27, L. I., N. Y.)
(Continued on page 22)

A must
for TV and
radio
service
technicians



with built-in **MAGNASTAT**
temperature control

... automatically maintains correct soldering temperature



MODEL TC-40—40 watts.
Controlled lower temperature for
printed circuits, etc.

\$8 00
list price



MODEL TC-60—60 watts.
Controlled temperature for light
to medium electrical soldering.

\$9 00
list price



MODEL TC-120—120 watts.
Controlled temperature for me-
dium to heavy electrical soldering.

\$10 50
list price

Here's another "first" from Weller, long time leader in the soldering field. New soldering irons with *built-in MAGNASTAT temperature control* for more reliable soldered connections. Never any overheating. Proper soldering temperature automatically remains constant. Plus these other exclusive features:

- Saves current when idling
- Reaches full heat quickly
- Approximately 1/2 the weight of uncontrolled irons
- Delicate balance—cool handle
- All structural parts are stainless steel
- Cord plugs into handle
- Guaranteed against defects in material and workmanship



Sensing device is in the tip

... fully protected by a sheath of stainless steel. Tips are tapered for heat efficiency and screw on simply and securely.

Order **NOW** from your **Electronic Parts Distributor**
or write direct for catalog bulletin

WELLER ELECTRIC CORP.

601 Stone's Crossing Rd.
Easton, Pa.



MAKE SURE IT FITS!

OXFORD SPEAKERS

When you order a speaker (for replacement or original installation), demand units that meet your most exacting needs.

Each OXFORD SPEAKER is "tailor-designed" to actually "fit the application."

The next time you specify speakers, make certain they fit the job by selecting OXFORD . . . unsurpassed quality for over thirty years.

Write for the latest Oxford catalog



OXFORD Components, Inc.
 Subsidiary of Oxford Electric Corp.
 556 West Monroe Chicago 6, Ill
 Export: Robun Agencies, New York City
 In Canada: Atlas Radio Corp., Ltd., Toronto

<p>RADIO & TV SPEAKERS</p>  <p>OXFORD Speakers are used by more original set manufacturers — find out why!</p>	<p>OUTDOOR SPEAKERS</p>  <p>For rugged, steady performance under any conditions, OXFORD Weather-proof speakers will meet the need.</p>
<p>DUAL CONE HI-FI SPEAKERS</p>  <p>Oxford's newest development to provide maximum performance. For Hi-Fi and rear deck applications.</p>	<p>PORTABLE RADIO SPEAKERS</p>  <p>More Oxford speakers are used in portable sets than ever before . . . there must be reasons!</p>

The NEW YEATS "Shorty" STATION WAGON & PANEL PICK-UP appliance dolly

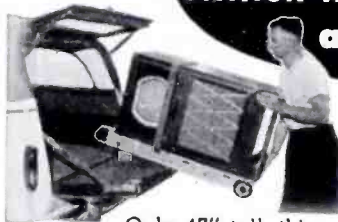

YEATS Model No. 5
 Aluminum alloy
 Height 47"
 Weight 32 lbs.

Only 47" tall, this new YEATS dolly is designed for TV and appliance men who make deliveries by station wagon or panel truck. No need to detach appliance for loading into the "wagon" or pick-up . . . the YEATS "Shorty" will slide into your vehicle with ease. Has aluminum alloy frame with padded felt front, quick fastening (30 second) strap ratchet, and endless, rubber belt step glide. New YEATS folding platform attachment, at left, saves back-breaking work handling TV chassis or table models. Call your YEATS dealer today!



Folding platform is 13 1/2" x 24 1/2"
 —attaches instantly. (Platform only) \$9.95.

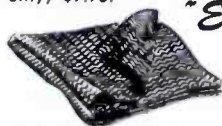

Furniture Pad

SEND postcard for full information on our complete line TODAY!

"Everlast" COVERS & PADS

YEATS semi-fitted covers are made of tough water repellant fabric with adjustable web straps and soft, scratchless white flannel liners. All shapes and sizes—Write.



TV Cover

YEATS appliance dolly

2109 N. 12th St.

sales co.
 Milwaukee, Wis.

New Instruments

(Continued from page 21)



VTVM featuring seven each dc, ac and ordinary ohm ranges, plus a special EIA ohm scale to check standard color-coded resistance values and tolerance limits. Incorporates shift-lever type function switch. (208; Seco Manufacturing Co., 5015 Penn Ave. S., Minneapolis, Minn.)



Battery tester said to check all types of dry and mercury cell batteries under optimum load as specified by manufacturers. Battery chart, listing more than 1,000 types by manufacturer's number, is attached to the back. Operating instructions are printed the back. (BT-101; Service Instruments Corp., 171 Official Rd., Addison, Ill.)



VTVM with an input impedance of 22 meg-ohms. DC/AC/ohms probe features Time-saver Tip which permits hanging probe on a lead wire for continuous readings and provides positive pressure contacts for point-to-point measurements. (311; Simpson Electric Co., 5200 W. Kinzie St., Chicago 44, Ill.)



Pencil-type neon tester for checking outlets and determining if voltage is present at fuses, sockets, switches, lines and terminals. (Sico Electro-Probe; Superior Instruments Co., 2435 White Plains Rd., New York 67, N. Y.)

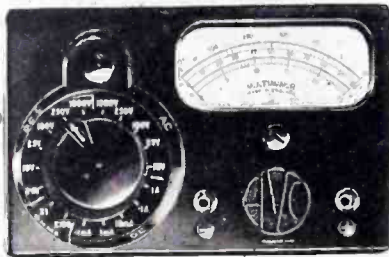

Miniaturized multimeter which measures dc voltages from 2 mv to 1,000 v in seven ranges; ac voltages from 200 mv to 1,000 v; current from 2 microamps to .1 amp and resistance from 5 ohms to 2 megohms. (AVO Multiminor; British Industries Corp., 80 Shore Rd., Port Washington, N. Y.)



Voltage and continuity tester combined with compact flashlight housed in a case no larger than a pack of cigarettes. Comes with two 12-in. test leads. (Meter-Lite; Cessco Industries, 55 Church St., Albany 1, N. Y.)

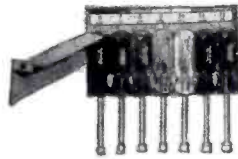

... Superbly made and designed for Radio, T.V. and Electronic Technicians. See your Distributor ... only one quality ... the finest — whether you choose individual items or the handy kits ...

Use the Tools the Professionals use!

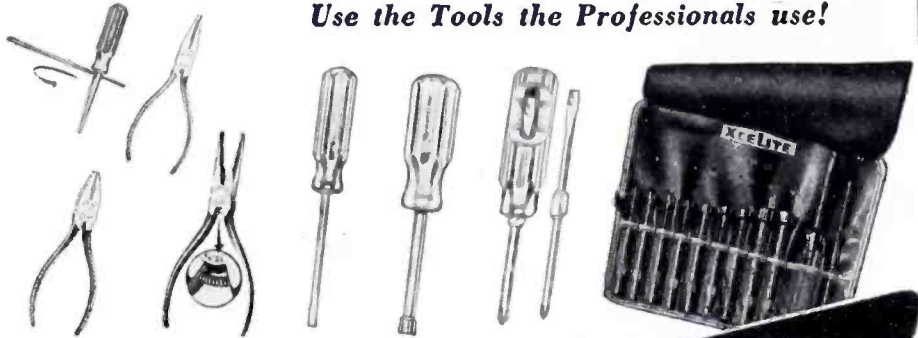

XCELITE, INCORPORATED
ORCHARD PARK, NEW YORK
Canada: Charles W. Pointon, Ltd., Toronto

XCELITE
Quality Hand Tools
PREFERRED BY THE EXPERTS

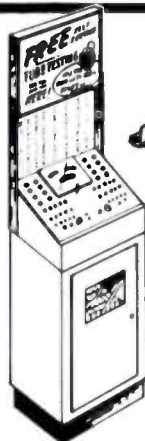

**THESE
TUBE SALES
CAN BE YOURS!**

Century's self-service tube testers start at **\$9850**

A self-service tube testing route is a natural for servicemen. It's just like having branches of your shop in drug stores, luncheonettes, super-markets and other retail locations in your area, testing and selling tubes for you 12 hours a day — 7 days a week. Each Century self-service tube tester you place can net up to \$1000 a year ... and there is no limit to how many you can handle.

Century's low manufacturer-to-you prices enable you to place more units with less investment ... yet you are assured of the most versatile, accurate and durable testers available. Century backs you up with a proven plan of operation, sales literature, window streamers, etc. Learn how you can make money automatically and keep your income growing, without giving up your present source of revenue. Write today for FREE booklet that tells all about this booming business.

**MAIL THIS
COUPON
TODAY FOR
FREE
BOOKLET!**

CENTURY ELECTRONICS CO., INC.

Dept. 608, 111 Roosevelt Avenue, Mineola, N. Y.

Please send me without obligation, FREE booklet and particulars about setting-up a self-service tube tester route. I understand no salesman will call.

Name

Please print clearly

Address

City

State



get this TV
COUPLER
FREE!

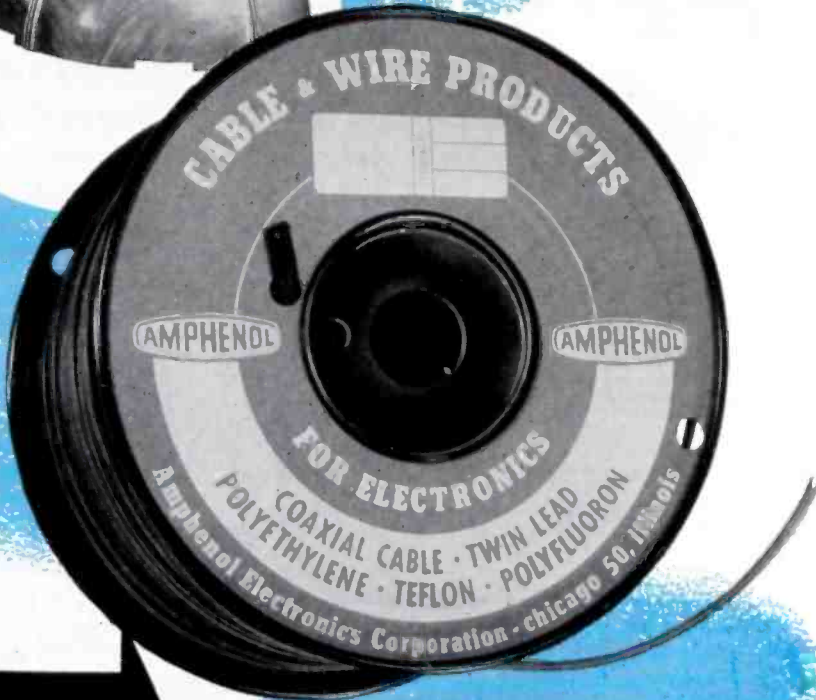

when you buy
1000 feet of
TWIN LEAD

IT'S THE
AMPHENOL

SPECIAL "1001 PACKAGE"

Here's a Special Offer that puts extra profits in your pocket! For a limited time, your AMPHENOL Distributor is stocking a special "1001 Package" – 1000 feet of AMPHENOL's popular 214-056 Twin Lead and 1 free 114-097 two set Color Coupler. You pay only for the Twin Lead, the Color Coupler is free!

If you already sell or use Color Couplers, you know how good a bargain this package is; if not, here is an opportunity to become acquainted with, and sell at a 100% profit, one of the finest two set couplers available!

See your AMPHENOL Distributor and order the special "1001 Package*" today!

* Part number is 214-056-02



AMPHENOL ELECTRONICS CORPORATION
chicago 50, illinois

New Tools

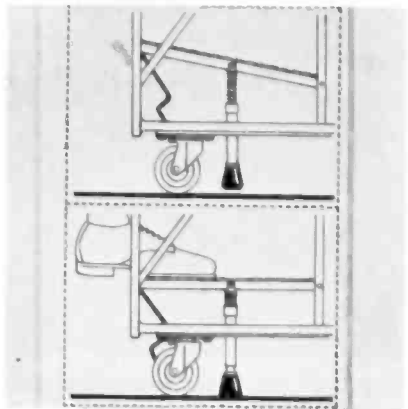

Automatic locking device for pyramid design Hi-boy safety-step steel ladders. First step of ladder automatically actuates lock, fixing ladder to floor. Lock releases at a touch of the foot. (Ballymore Co., Lincoln and Garfield Aves., West Chester, Pa.)

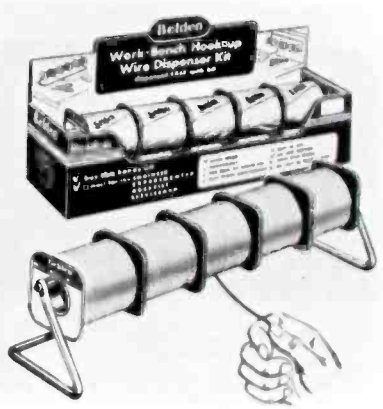

Hook-up wire dispenser kit for bench or wall mounting. Available with 14 popular assortments of vinyl, vinyl-nylon, textile and teflon insulated wires. (Belden Manufacturing Co., 415 S. Kilpatrick Ave., Chicago 44, Ill.)

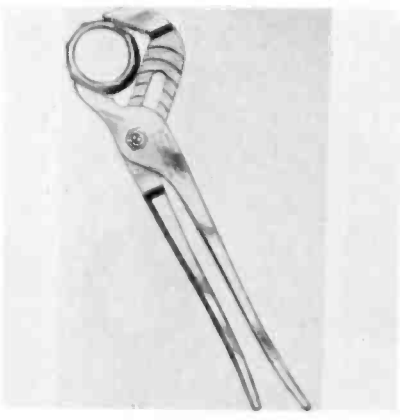

12 in. groove-joint plier for tightening connectors on electrical conduit boxes as well as general purpose use. Parallel jaws open to 2 1/8 in. Available with smooth jaws for use on chrome-plated material. (HL112; Diamond Tool and Horseshoe Co., Duluth 7, Minn.)

and Shop Equipment

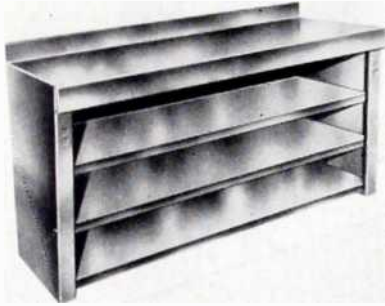

Cabinet bench featuring closed ends and back. Available with doors, drawers and shelves as desired. Made with 12 gauge steel, masonite on steel, maple or plastic bonded tops. Comes in 4, 5 and 6 ft. lengths. (Equipto, Div. of Aurora Equipment Co., Aurora, Ill.)

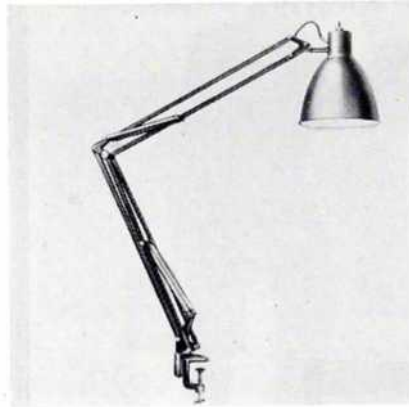

Work lamp featuring a combination of spring and friction balance construction. Said to move to any position and stay put. Covers a wide work area and directs light where it is wanted. (Crown Lite; Luxo Lamp Corp., 102 Columbus Ave., Tuckahoe, N. Y.)

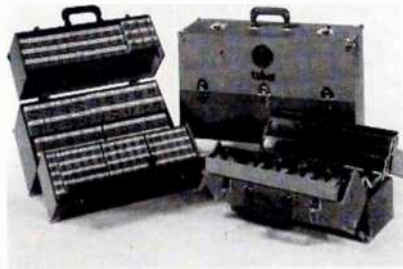

Orange and gray service cases for carrying tubes and tools. Available in two sizes; for 240 tubes and for 160 tubes. Matching tool case has four compartmented swinging shelves. (Authorized General Electric tube distributors.)

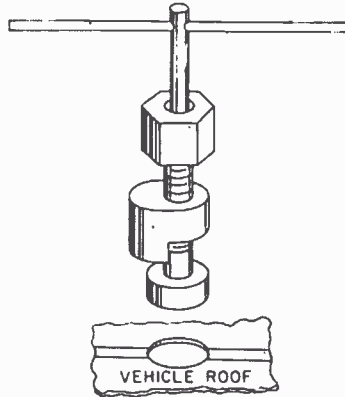

Antenna mounting tool to aid installation on '58 Ford roof tops. Consists of a $\frac{3}{8}$ in. screw with a case hardened $\frac{3}{4}$ in. head; a hardened, eccentrically constructed clamp; a lock nut and a tightening lever. (Motorola C&IE Inc., 4910 W. Flournoy St., Chicago 44, Ill.)

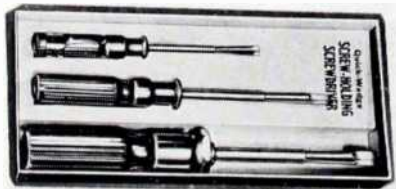

Screw-holding screwdriver package with three popular sizes. Drivers are said to hold, start and drive screws. Blades are spring steel. Handles are shockproof, fireproof, unbreakable plastic. (Quick-Wedge; Kedman Co., 233 S. 5th W., Salt Lake City 1, Utah.)

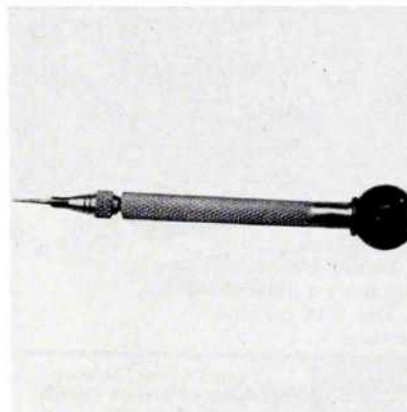

Spring-tensioned screwdriver with pointed plunger which runs through bit to exert steady pressure upon miniature screws. Bit is double-ended, with two sets of points. Handle is equipped with a rotating knob. (S.E. 2348; Suttle Equipment Corp., 135 S. LaSalle St., Chicago 3, Ill.)

Servicemen! Technicians! READ THIS FREE BOOK



It May Start You Toward More Pay in RADIO-TV ELECTRONICS

Thousands of men have sent for it. They read it—and now they are well advanced toward their goal toward a better job with more pay, plus the security and confidence that comes with it.

Get the details yourself and see what opportunities, through advanced CREI training, await you. *Mail coupon today.* You can qualify for CREI training if you have had a high school education and experience in electronics.

CAPITOL RADIO ENGINEERING INSTITUTE
ECPD — Accredited Technical Institute
Curricula — Founded 1927
Dept. 318-E, 3224 16th St. N.W. Wash. 10, D. C.
Please send me your course outline and Free Illustrated Booklet, "Your Future in the New World of Electronics."

CHECK
FIELD OF
GREATEST
INTEREST

- Radar, Servo and Computer Engineering Technology
- Electronic Engineering Technology
- Broadcast (AM, FM, TV) Engineering Technology
- Television Engineering Technology
- Aeronautical Electronic Engineering Technology

Name Age.....

Street

City..... State.....

Check: Home Study Residence School Korean Vet



AT LEAST THEY AGREE ON FIDELITONE—Competitive Radio-TV-Hi-Fi servicemen may disagree on tweeters and woofers but it's handshakes all around when it comes to phonograph needles. Every repair man knows that Fidelitone is first in the field of quality — preferred by his customers. Fidelitone's thirty-year reputation of leadership is your assurance of customer satisfaction and profitable repeat calls. Stock and sell the needles that most record buyers know and want. Ask your Distributor for Fidelitone.

Fidelitone

Chicago 26, Illinois
"Best buy on records"

New Tools

(Continued from page 25)



Portable electric jigsaw which can cut through 2 in. wood and 1/8 in. steel. Tilting base and angle index allow cutting angles up to 45° on either side of line of cut. Fitted with bakelite top grip handle. (441; Thor Power Tool Co., Prudential Plaza, Chicago 1, Ill.)



Soldering kit featuring 16 interchangeable tips and tippets providing temperature variation from 650° to 1,000°. Extra length tippets provide easy access to hard-to-get-at locations. (250 Deluxe Soldering Kit; Ungar Electric Tools, Inc., 4101 Redwood Ave., Los Angeles 66, Calif.)

MORE ACTIVE! EFFECTIVE!



THE BEST FOR TV-RADIO WORK . . . EVERYTHING ELECTRICAL—Kester "Resin-Five" Core Solder is better and faster than any solder ever developed. It has an activated flux-core that does a perfect job on all metals including zinc and nickel-plate. The flux residue is absolutely non-corrosive and non-conductive.

Available in all practical Tin-Lead Alloys; 40/60, 50/50 and 60/40 in diameters of 3/32", 1/16", 3/64", 1/32" and others.

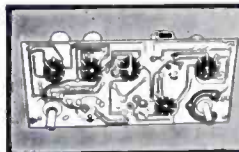

Printed Circuit Soldering
On Copper-etched boards use 60% Tin-40% Lead Alloy . . . for those that are Silver-surfaced use 3% Silver-61 1/2% Tin-35 1/2% Lead

KESTER SOLDER COMPANY

4248 Wrightwood Avenue, Chicago 39, Illinois • Newark 5, New Jersey, Brantford, Canada

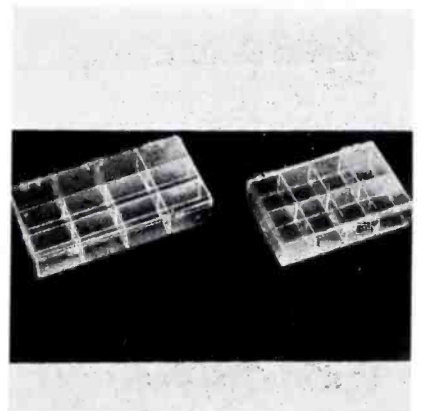

Clear plastic boxes for storage of small parts. Available in ten types ranging from one to 18 compartments, in sizes from 2 1/8 in. x 1 5/8 in. to 10 3/8 in. x 6 in. All types have hinged covers. (Waldom Electronics, Inc., 4625 W. 53rd St., Chicago 32, Ill.)

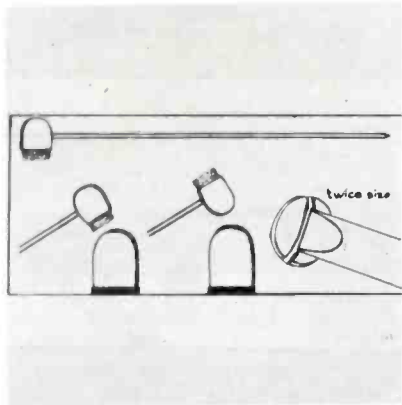

Combination tube tapper, probe and screwdriver. 12 in. unit has one screwdriver end. Tapping end has a hard portion for normal shock tests and a sponge portion for ultra sensitive tests. Made of unbreakable plastic. (Tip Tapper; Walsco Electronics Manufacturing Co., 100 W. Green St., Rockford, Ill.)

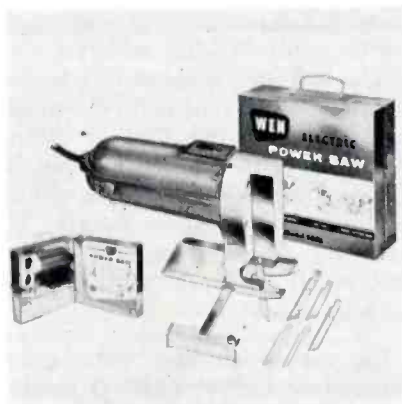

Power saw kit consisting of a metal carrying case, saw with blade inserted, a perfect circle cutter and rip-sawing attachment, three wood cutters and two metal and plastic cutters. (Wen Products, Inc., 5806 Northwest Highway, Chicago 31, Ill.)



Five-in-one tube caddy consisting of four separate boxes plus a cover. Snap-lock catches on each section permit any combination of boxes to be carried as one unit. Complete caddy holds more than 350 tubes plus tools, instruments and accessories. (555; Westinghouse Reliatron tube distributors.)

When Converting Your Phono to Stereo...Use

The ERIE AUDIO-AMPLIFIER KIT

featuring
"PAC" and an ERIE Printed Wiring Board

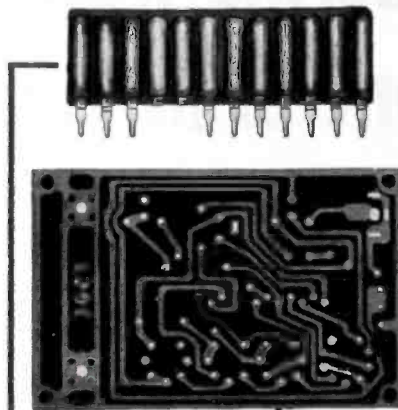

With these Plug-in Components:

- ERIE "PAC" (Pre-Assembled Components)
- ERIE PRINTED BOARD
- OUTPUT TRANSFORMER
- FILTER CAPACITOR
- VOLUME CONTROL and SWITCH
- TUBE SOCKETS
- CAPACITORS
- TONE CONTROL
- TUBES

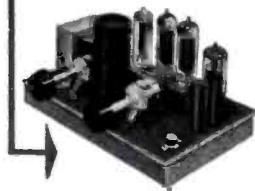

MODEL
PAC-AMP-1

SPECIFICATIONS FOR ERIE STANDARD AUDIO-AMPLIFIER

- Frequency Response: 30 cycles to 12,000 cycles +0, -3.5 db.
- Sensitivity: 0.56 volt RMS (input at 1 KC) for 2 watt output.
- Power Output: 2 watts • Input Impedance: 2 megohms.
- Output Impedance: 4 ohms • AC Power Consumption: 17 watts.
- Overall Dimensions: 6 $\frac{3}{8}$ " L x 4 $\frac{1}{16}$ " W x 3 $\frac{7}{8}$ " H • Shipping Weight: 2 lbs.

See and hear it at
your local distributor
or *Write* for
nearest source.

ERIE Electronics Distributor
DIVISION
ERIE RESISTOR CORPORATION
ERIE, PA.



Here's How You Can Make MORE PROFIT on TV Repairs

PAYS FOR ITSELF IN A VERY SHORT TIME

- The new Tel-A-Turn service cradle increases efficiency and output of any Electronic Technician.
- Simplifies part replacement, soldering, test probing.
 - Prevents breakage and damage to above-chassis components.
 - Ideal portable bench for "on-the-spot" work.
 - A self-locking worm and gear provides 360° chassis rotation for the most convenient position for servicing above or below-chassis components.
- Quick-operating clamps hold chassis from 9" to 25" wide, and up to 200 pounds.
- Adjustable swivel lamp permits placing light for best visibility.
- A built-in PM speaker eliminates removing speaker from TV cabinet.
- Two hot outlets are provided for soldering iron and test equipment.
- Cheater cord, switch and pilot light provide safe, easy means of supplying and cutting off power to chassis under test.
- Tel-A-Turn is mounted on ball bearing rubber casters for smooth, easy mobility.
- Made of heavily ribbed cast aluminum. Weighs only 37 pounds.

"Here-at-Last," a practical service cradle for servicing Radio and TV chassis. Record Changers, Amplifiers and other Electronic Equipment. No service tool is more useful or profitable. Write Dept. SE-88 today for descriptive literature. Dealer inquiries invited.



ROGERS MANUFACTURING CO.
LINDSEY, OHIO-U.S.A.

Lightweight Soldering Iron With Built-In Temperature Control in Tip

by DONALD R. FEGLEY
Chief Engineer, Weller Electric Corp.

SERVICE MEN TODAY are obliged to work with increasingly complex and more precise equipment including printed and modular circuitry and smaller and smaller parts that are often difficult to reach while servicing. The use of transistors in radio, TV and other electronic equipment has made desirable the use of precision tools for repair work. A versatile precision soldering tool for both conventional and printed-circuitry use is particularly useful.

An ultra-lightweight iron with precise temperature control built into the tip has recently been developed to fulfill this need. This unit is manufactured in 40, 60 and 120-watt ratings. The 40-watt unit, designed primarily for radio and TV servicing, is shown in Fig. 1.

The iron automatically maintains correct soldering temperature both while in use and when idling. This prevents overheating and yet assures that the iron is always ready for use. Precise tip temperature control reduces radiation loss and increases efficiency by eliminating temperature peaks or lows which cause faulty soldering. While idling, the iron con-

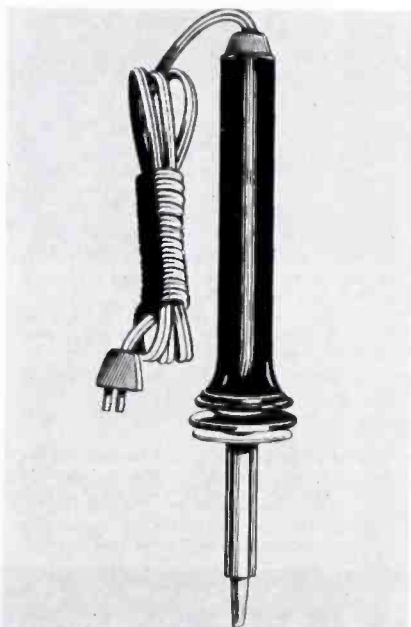

FIG. 1. WELLER TC-40 soldering iron.

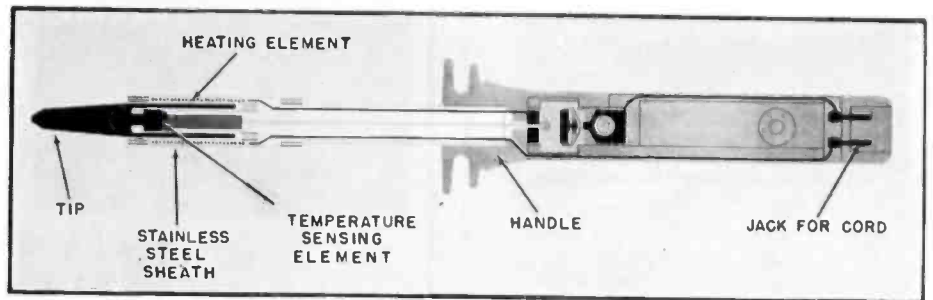

FIG. 2: CROSS-SECTIONAL VIEW of soldering iron with temperature control built into tip.

sumes approximately one-half of the working wattage.

The temperature-control element (see Fig. 2) sets a ceiling on the tip heat. This results in decreased copper tip wear and makes retinning less frequently required.

In printed-circuit repair work, an increasingly important area of the Service Man's activities, excessive temperature can ruin the bond between the printed wiring and the laminated plastic board. Conventional soldering often loosens the metal from the base and may possibly damage the entire printed-circuit board through buckling, blistering or other distortion.

Printed-wiring repair requires a low-temperature solder—60% tin and 40% lead—which has a melting point of 370° F. The temperature of most conventional soldering irons exceeds 600° F and this causes a corresponding risk when working on printed circuits and miniaturized components.

This danger is greatly reduced with this iron which has a maximum tip temperature of 600° F and a variable control for setting temperatures below this level.

This controlled-tip soldering iron weighs 5.5 oz. with cord attached. The detachable cord can be removed for storage of the iron, a feature which makes the tool easy to handle. The cord is very flexible and will not ordinarily knot, kink or buckle. The iron itself, which is made of stainless steel in all structural parts, reaches full heat quickly.

The use of an iron with built-in temperature control makes it possible to maintain an efficient soldering temperature range at all loads. The performance of this type of iron compared with two conventional irons is illustrated in Fig. 3. These data apply to 60-watt and 120-watt irons only.

¹TC-40 Magnastat, Weller Electric Corp.

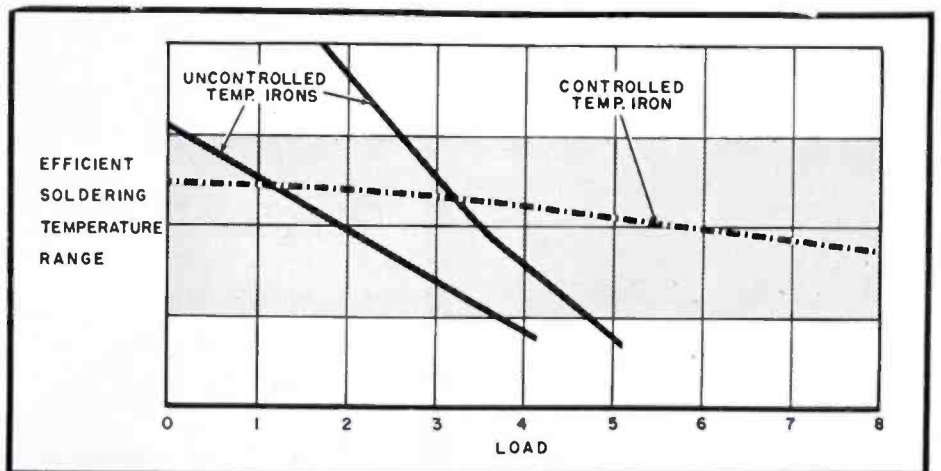

FIG. 3: TYPICAL PERFORMANCE CURVE of soldering irons (Weller 60 and 120 watt models) with and without temperature controls. The efficient temperature range shown is 600° to 700° F.

Critical Tube Tests

(Continued from page 13)

plate circuit then enables the meter to read the plate current swing caused by the grid current change. This measures true dynamic mutual conductance (see Fig. 1).

However, in spite of recent improvements in general purpose tube testers, some engineers and Service Men still feel the need for specialized equipment. At a military base it was found that grid emission in 6J4's caused a number of failures. A study was made which revealed that over a definite period 127 of these tubes were changed after an average of only 243 hours of service. Following a program of pretesting for grid emission, the same number of tubes were observed for a similar length of time. Now only 39 tubes failed and these served an average of 436 hours.

Grid Emission Tests

In a general-purpose tube tester, grid emission and gas in the envelope are usually checked by means of a resistor in the grid circuit which is shorted out in other tests. If grid current flows, a voltage drop will be developed across this resistor and it can be measured. As little as .25 microampere of grid current can be detected by this method.

There are those who claim, however, that 90% of tubes with grid emission will not show up as defective in this type of test. As a result, special instruments for testing for this defect have been developed. One such unit consists basically of a dc amplifier connected to the grid of the tube under test. The presence of reverse current in the grid causes a change in the input voltage applied to a high-gain dc amplifier which is indicated by an electronic eye indicator tube (see Fig. 2). This feature is now

(Continued on page 30)

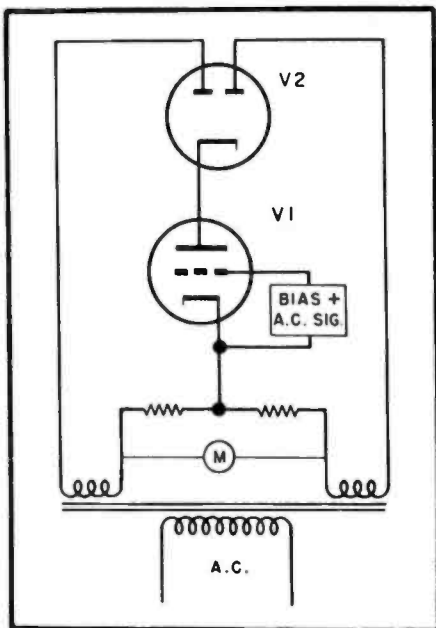

FIG. 1: BASIC CIRCUIT of a dynamic mutual conductance tube tester checking tube V1. Meter M is pulled equally and alternately in each direction, indicating the actual audio signal in plate circuit.

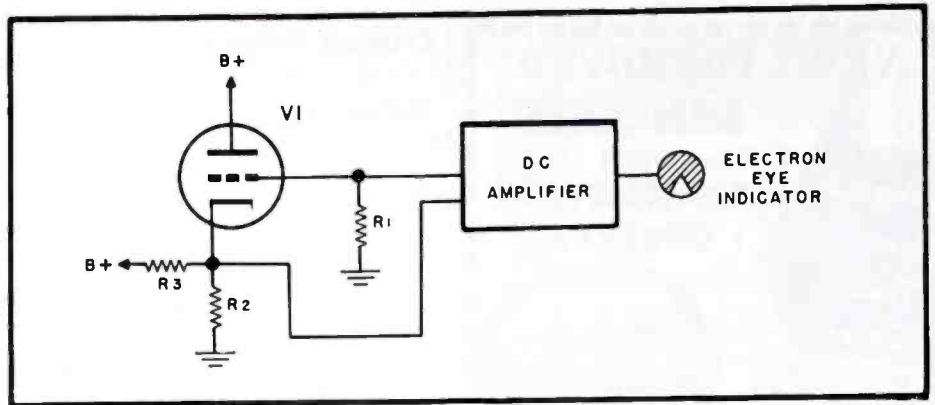

FIG. 2: SIMPLIFIED DIAGRAM of grid emission tester checking tube V1. If grid error exists, bias on grid will drop and will be indicated on electron eye tube because of change in voltage applied to the dc amplifier.

ADDS INCOME 2 WAYS

1. Tests and Repairs Picture Tubes (110° Tubes and Color Tubes too, with new C40 Adapter)
2. Makes New Tube Sales Easier

CATHODE REJUVENATOR TESTER

CRT 400 PROVES REAL MONEY-MAKER

Thousands of servicemen today make money and keep customer good-will by checking and correcting b&w picture tube troubles with the famous B&K CRT 400, right in the home without removing tube from set. Restores emission and brightness. Repairs inter-element shorts and open circuits. Checks leakage. Indicates picture quality customer can expect. Life Test checks gas content and predicts remaining useful life of picture tube. Makes new picture tube replacement sales easier! Model 400 (without adapter) Net, **\$59⁹⁵**

NEW MODEL C40 ADAPTER DOUBLES VALUE OF B&K CRT

Designed for use with all B&K Models 400 and 350 CRT's. Makes it easy to test and rejuvenate TV color picture tubes and 110° picture tubes. Isolates and detects difficult color troubles. Tests and rejuvenates each gun of the color picture tube separately the same way as a black & white tube. Model C40 Adapter Net, **\$9⁹⁵**

See your B&K distributor, or write for Bulletin AP12-5

New C40 Adapter for 110° Tubes and Color Tubes



Makers of CRT, DYNA-QUIK, DYNA-SCAN and CALIBRATOR

B & K MANUFACTURING CO.

3726 N. Southport Ave. · Chicago 13, Illinois



NEW! IMPROVED!

SENCORE

TRC4

**TRANSISTOR
CHECKER**

Another
Sencore
Time-
Saver

America's newest,
most popular test
instruments

NOW CHECKS:

- ★ **Transistors**
for opens, shorts,
leakage and cur-
rent gain. In-
cludes new
gain test on
power transistors.
- ★ **Crystal Diodes**
checks forward to reverse
current ratio on all
diodes.
- ★ **Selenium Rectifiers**
checks forward and re-
verse currents.

Controls are accurately
set for each transistor
by referring to replaceable set-up chart on rear.
Test leads or socket provides for fast hook-up.
See your parts distributor.

Mfg by **SERVICE**
INSTRUMENTS CORP.
171 OFFICIAL RD., ADDISON, ILL.

Cut out this ad now for further information

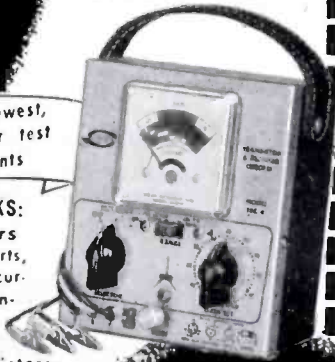

ONLY \$17.95
Dealer Net
Cannot become
obsolete.
Approved by
leading
manufacturers

Critical Tube Tests

(Continued from page 29)

incorporated in a general purpose tube tester.²

A laboratory type tube tester³ is probably the ultimate for critical testing. These instruments differ from the usual tube tester in that facilities are provided whereby the operator may put any set of conditions on the tube, not just certain ones listed on a chart.

This is done by means of variable controls whereby the condition on each electrode can be varied over a wide range. Thus the tube handbook conditions—maximum or design center—can be set up, or the conditions the tube is going to meet in a specialized application can be simulated. A laboratory type tester also will test amplification factor and plate resistance. A null test is available in some testers for precise measurements of G_m .

While a need for more critical tube testing most certainly exists in every branch of the electronics business from factory to service shop, economic and human factors have placed a limit on what has been done so far. In the latter category is the Army's experiment on the man/machine relationship in connection with the electron tube test set TV-2/U. Results of the experiment showed that the test set was too complex for human operators to make accurate measurements. So it has been recommended that an instrument be developed which is compatible with human engineering demands as well as with electronic requirements.

Quick-Test Instruments

Probably at the opposite end of the scale from this situation are the tube testers now making their appearance in drug stores, gas stations and supermarkets where the public may test their own TV and radio tubes. Some of these instruments are of the multiple socket type, where the tube need only be inserted in the right one of a mass of sockets in order to be tested.

This tester has but one socket for each kind of tube base (including sub-miniatures). With each instrument comes a pack of post-card size plastic cards which are punched with a number of holes. A card is supplied for each type of tube to be tested.

The drug store customer is not the only person interested in quick tube checking. The television Service Man, if he is to test each tube in each set he services, can waste valuable time. Possibly unavoidable is the time spent in waiting for tubes to heat up. This should be two or three minutes for each tube and can take up the best part of an hour when servicing a TV set. Much time is spent turning roll-charts and twisting knobs.

Efforts have been made by the manufacturers of tube checkers to make quick-test instruments. Some have abandoned the roll chart in favor of flip-charts or books of cards containing the settings.

Others use multiple-socket arrangements with pre-set values for the commonly used radio and TV tubes.

One such tester⁴ checks a tube for shorts, dynamic mutual conductance, gas, grid emission, leakage and life expectancy in 12 seconds, according to the manufacturer.

Industrial establishments which must test thousands of tubes are usually better off when making repetitive tests on many tubes of the same type, thus avoiding the lost motion of resetting the tester for each tube. Devices like the punch card system may have an industrial appeal for this reason. In some cases, special test circuits like the one mentioned above for balance may prove to be the answer.

Tube Aging

Manufacturers of test equipment or other precision apparatus usually find it prudent to age their new tubes before attempting to use them. Some companies have large aging racks which cook tubes for up to 100 hours before they are even given their first test. An interesting side light on this procedure is the fact that a short-circuit test involving the heater usually isn't necessary. Because of the high-amperage filament supply, a shorted tube will often explode as soon as it is plugged in.

Companies which require great reliability in their product may find that a high percentage of tubes fail to meet test requirements after having received the aging treatment. Often the rejected tubes are salvaged and diverted into other trade channels where the requirements are less critical.

Among the troubles which will show up in the aging process are leakage, shorts, grid emission, gas, and heater-to-cathode breakdown, which like grid emission can have disastrous results on bias circuits. The aging process has proved worthwhile because many of these troubles would not develop in the two or three minute warmup time usually allowed when testing tubes. Indeed, many borderline cases can only be proved by momentarily raising the heater voltage to double its normal value and then lowering it again before making the test.

On the other hand, the aging process may often permit a tube to redeem itself. Brand new tubes, when operated for the first time often show a degree of super-operation that fades down to normal after a few hours. If adjustable electronic circuits are calibrated around such a tube, the circuit may fail as the tube ages in service.

No Simple Solution

Sometimes new tubes which show leakage or other troubles when first used will clear up to a satisfactory condition after heating up for a few hours.

More critical testing of tubes is a pressing problem today, and one which does not seem to have a simple solution.

²Seco 107. ³RCA WT-100A, Hickok 700. ⁴B & K Dyna-Quik.

**STAMP
OF
APPROVAL!**

QUIETROLE

Only Known Merit marks a product as the "BEST"

for quieting Noisy Controls and Switches
QUIETROLE produces results superior to any other product. That's why it's known as the "Best" and that's why more users prefer it to any other. It's the dependable Original product of its kind... a first in the Industry.

**QUIETROLE
Spray-
Pack**



or the **QUIETROLE**
Bottle with the Eye Dropper Cap
QUIETROLE offers you both types of containers. Either way assures you of the same un-failing results that **QUIETROLE** is known for.



In 2 oz. bottle with dropper and 6 oz. **QUIETROLE SPRAY-PACK**

The Lubricant Cleaner of the Electronic World. Tailored for the industry by over 15 years of authentic research, plus 4 years of rigid and exacting tests before marketing.

Ask for **QUIETROLE** and be sure you get it!

manufactured by
**QUIETROLE
COMPANY**

Spartanburg, South Carolina
Export Representative:
Riise International Corp.,
201 E. 28th St., New York 16, N. Y.

ADVERTISERS IN SERVICE

AUGUST, 1958

Amphenol Electronics Corp.....	24
B&K Manufacturing Co.....	29
Bussmann Manufacturing Co. Inside Back Cover	
Capitol Radio Engineering Institute...	25
CBS-Hytron	Inside Front Cover
Centralab, A Div. of Globe-Union, Inc.	3
Century Electronics Co., Inc.....	23
Cleveland Institute of Radio Electronics	19
Erie Resistor Corp.....	27
Fast Chemical Products Corp.....	31
Fidelitone, Inc.	26
General Cement Manufacturing Co., Div. of Textron, Inc.....	31
General Electric Co., Electronic Components Div.	2
Heath Co.	13
Kester Solder Co.....	26
Merit Coil & Transformer Corp.....	17
Oxford Components, Inc.....	22
Quietrole Co.	30
Radio Corporation of America, Electron Tube Div.....	Back Cover
Radio Receptor Co., Inc.....	15
Raytheon Manufacturing Co.....	4
Rogers Manufacturing Co.....	27
Service Instruments Corp.....	30
South River Metal Products Co., Inc.	31
Sylvania Electric Products, Inc.....	9
Weller Electric Corp.....	21
Xcelite, Inc.	23
Yeats Appliance Dolly Sales Co.....	22

CATALOGS—BOOKS

Chicago Standard Transformer Corp., 3501 Addison St., Chicago, Ill., has announced an auto-radio transformer replacement guide listing replacements for over 400 models of 37 manufacturers, including a special section on transistorized auto radios. They are listed by auto and radio manufacturer, as well as by year of use. Replacement data for vibrator, audio, driver and interstage transformers is given for all models listed.

Columbia Wire and Supply Co., 2850 W. Irving Park Rd., Chicago 18, Ill., has issued a four-page catalog supplement listing many new items in the wire and cable field.

Electro Products Laboratories, 4500 N. Ravenswood Ave., Chicago 40, Ill., has announced two four-page illustrated folders covering the uses and specifications of two power-supply kits. One folder describes a dual-purpose filtered *dc* supply for powering transistor circuits, hybrid sets and 6-12 volt auto radios without hum. The second folder describes a filtered *dc* supply for transistor, hybrid and vacuum tube auto radios.

International Wire and Cable Co., 1665 N. Milwaukee Ave., Chicago, Ill., has announced a 20-page catalog covering lead-in line, microphone cables, audio and intercom cables, hook-up wire, coaxial cables, guy wire, and power supply cords.

Merit Coil and Transformer Corp., 2027 Sherman St., Hollywood, Fla., has published a Service Technician's Handbook, a comprehensive guide listing replacements for products of 135 TV, radio and electronics manufacturers.

J. W. Miller Co., 5917 S. Main St., Los Angeles 3, Calif., has released a TV Technician's Coil Replacement Guide covering picture and sound if transformers, adjustable ion traps, video peaking coils, antenna matching coils, adjustable linearity and width controls, and horizontal oscillator and sync control coils.

Perma-Power Co., 3100 N. Elston Ave., Chicago 18, Ill., has issued illustrated catalog B-138 describing radio-control systems for industrial-commercial and residential uses. Technical data and prices are included so that most applications can be completely specified from the catalog.

RCA Service Company, Inc., Commercial Service Section, Camden 8, N. J., has announced an illustrated booklet—Living Stereo—which explains stereo principles, methods of recording, elements of Stereo-Orthophonic high-fidelity *Victrola* instruments and details of the 45-45 recording system—priced at 50c.

Sylvania Electric Products, Inc., 1100 Main St., Buffalo 9, N. Y., has released a booklet—There's a Big Difference in Picture Tubes—describing precision manufacturing materials and techniques that contribute to the life and performance of quality picture tubes. Booklet points up reasons why tube brightness and life suffer where inadequacies in manufacturing techniques exist.

FAMOUS!



STEAM IRON CLEANER

ADVERTISED IN
LIFE

REJUVENATES
SLUGGISH IRONS!

- Ends Sputtering
- Cleans INSIDE
- More steam
- Safe, odorless

Also for VAPOR-
IZERS, STERILIZERS,
KETTLES

—USE IT YOURSELF—
IDEAL FOR RESALE

Suggested Retail **\$1.00**

Manufacturer Recommended

ORDER TODAY from your jobber or WRITE
Dept. S for name of your nearest supplier.



FAST CHEMICAL PRODUCTS CORP.
20 Gunther Ave., Yonkers, N. Y.

NEW *Ge* SERVICE AIDS

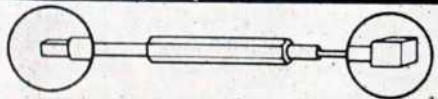

G-C TRANSISTOR I.F. CORE ALIGNMENT TOOL
Nylon tool for many transistorized sets. Square end .055, rectangle nib end .047 x .078 to reach bottom slugs.
No. 9440—11 3/4" long List \$1.00



G-C TINNEMAN NUT REMOVER
Remove large and small Tinnerman nuts with just a twist; won't break studs.
No. 9355 List \$1.47

G-C COMBINATION INSPECTION LIGHT
Includes 3-way outlet and cheater cord, with clamp-on inspection light.
No. 707 List \$5.00

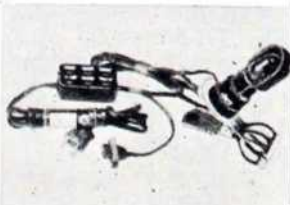

FREE CATALOG ... WRITE TODAY!

GENERAL CEMENT MFG. CO.

division of **TEXTRON INC.**
Western Plant: Los Angeles 18, Calif.
Main Plant: **ROCKFORD, ILLINOIS, U.S.A.**

ask the
"Man-on-the-Roof"
why he prefers

South River

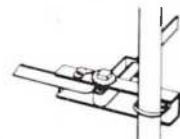

TWO
TO A
SET

**RATCHET TYPE
CHIMNEY MOUNT**

Model RT (Galv. Banding)
Model RT-ST
(Stainless Banding)

**FASTEST, SIMPLEST, MOST
CONVENIENT EVER MANU-
FACTURED** — Mounts in 2
simple steps. Completely fac-
tory assembled with no eye-
bolts, banding clips, nuts, etc.,
to handle. Furnished with
flat-lay, non-colling banding,
heavy gauge embossed, welded
steel construction. Forged
heat treated Alum. ratchets.
Write for **NEW 1958 Catalog**

SOUTH RIVER
METAL PRODUCTS CO., INC.
South River, New Jersey

pioneer &
outstanding
producer of
finest line
of antenna
mounts

Association News

RTA, Santa Clara Valley, Calif.

The vast difference in ideas on the licensing of TV and radio Service Men was discussed at a recent meeting of the Radio and TV association of Santa Clara Valley. An outline of apprenticeship for service shops was presented by *Charles R. Mulkey*, educational advisor of the association and electronics coordinator of the *S. J. Jose Unified School District*. He described the opportunities for young people as limited and said that a training program sponsored by the association would provide a channel for attracting young men who want to go into servicing. This program would establish a goal for men entering the service business—a planned course of study and training which would qualify him as a journeyman upon successful completion of four years as an apprentice. Mulkey said the program could be set up to operate under the direction of a committee including representatives of City College and RTA member firms. A representative of the Department of Apprenticeship Standards would work with the committee in setting up the operation. Advantages outlined by Mulkey included a higher standard of employee, stabilizing training conditions, a surer return on the employer's investment, stability in pay scales and retention of employees in servicing.

During an open discussion of licensing at the meeting the pros and cons were discussed. Objections to licensing included interference with free enterprise, regimentation, possibility of unfair control and policing problems. Benefits from licensing were added prestige to the industry as a whole in the eyes of the public, elimination of *screwdriver mechanics*, general upgrading of the industry and protection for the general public.

The association members agreed that many controls which could generally upgrade the industry and protect the public could be handled by using existing laws.

At the end of the meeting cards containing a list of standard service charges were distributed to the members.

WVETA, Terre Haute, Ind.

The Wabash Valley Electronic Technicians Association has been formed with headquarters in Terre Haute. At present there are 23 members in the group.

TSADV, Philadelphia, Pa.

Ray Cherrill, president of the Television Service Association of Delaware Valley, and *Charlie Knoell*, publicity director, recently were guests on a popular Philadelphia radio program—the Frank Ford Show. The two men discussed TV business conditions in the Delaware Valley, the TV racket, and bait advertising and other sources of degradation within the industry. The broadcast was a result of an article published in TV GUIDE which had been reviewed by the association, at the request of the magazine, prior to publication. Because TV GUIDE mentioned that the article had been approved by TSADV, Ford invited the association to answer some of the laymen's questions on his show.

AMETA, Michigan

John Stefanski has been elected president of the Alliance of Michigan Electronics-Television Associations. Other new officers are *Clifford Bennett*, first vice president; *C. Geer*, second vice president; *Mike Moser*, secretary; and *John Hawkins*, treasurer.

IESA, Indiana

The Indiana Electronic Service Association has announced that its annual convention will be held at the Antlers Hotel in Indianapolis from October 3rd through 5th. Clinic sessions will cover both business and technical aspects of the TV repair industry. No exhibit space is being sold this year but manufacturers wishing to display goods during the convention can arrange with the hotel for suites. Cost of the convention will be financed solely through the sale of advertising in a special program issue of THE HOOSIER TEST PROBE, the association publication.

ITTA, Indianapolis, Ind.

At a recent meeting of the Indianapolis Television Technicians Association members discussed past and future plans for cooperation with other associations, but delayed any action for a future meeting. The distributor function committee was reactivated with *Bob Sickels* as chairman.

Tom Holsworth of Electronic Guard Company demonstrated a new type radar alarm system manufactured by his company. *Gibb Fisher*, *Leon Howland* and *Bob Shuck* were door-prize winners at the meeting.

WNYEG, Buffalo, N. Y.

William Berger and *George Schafer* of Sunset Electronics presented a demonstration of the Kingston Absorption Analyzer at a recent meeting of the Western New York Electronics Guild.

TCEWA, Minneapolis, Minn.

A group of electronic parts distributors—the Twin City Electronic Wholesalers Association—has been formed. Purpose of the group is to guide general electronic activity in the area such as promoting good will to dealers, consumers and students, and also to offer factory educational programs for the service industry. The association expects to promote a show and seminar for the industry on an annual basis in cooperation with manufacturers and their representatives. A program is being planned to encourage broadcasting stations to improve summer programming so that customers will be induced to keep their radio and TV sets in repair during the off season and to better support the service trade. The group will perform independently of any national organization. Present members of the group are *George W. Bauman*, *R. Ray Bauman*, *Lewis J. Bonn*, *Don Countryman*, *Eugene M. DeLonais*, *H. C. Gerner*, *David S. Goode*, *Clyde Lauzon*, *W. S. Meyers*, *Burton S. Phillips* and *Harry D. Stark*.

NATESA, Chicago, Ill.

NATESA has announced the acceptance of nine new affiliates. Included in the group are: TESA of Central Missouri, Jefferson City; Lackawanna Radio Television Technicians Association, Scranton, Pa.; Television & Electronic Association of Morin, Mill Valley, Calif.; TESA of the Evangeline Country, Opelousas, La.; Electronic Technicians Association of Lancaster County, Ephrata, Pa.; TESA of Lake County, Waukegan, Ill.; Tri-State TV Association, Texarkana, Ark.; TESA of Florida Parishes, Hammond, La.; and Radio Television Service Association, Yakima, Wash.

RTSEA, Anderson, Ind.

RTSEA recently held its 11th annual banquet honoring past presidents of the association. At its regular monthly meeting the group discussed the second draft of a proposed license law.



Save time and trouble by furnishing BUSS — the fuses your customers know and prefer!

You never have to stop and explain why you furnish BUSS fuses because . . . your customers accept BUSS fuses as the finest available.

The BUSS reputation for fuses of unquestioned high quality is built on the dependable protection millions upon millions of BUSS fuses have provided in homes, farms and industry over the past 43 years.

Selling and installing BUSS fuses, and other KNOWN items, does

more than save you time . . . it helps protect your reputation for service and reliability.

It further pays you to standardize on BUSS fuses because they are 'trouble-free'. There are no 'kicks' or complaints about their operation and no 'call-backs' or adjustments to cut into profits.

The time you save, the trouble you avoid, the satisfied customers you keep and the full profit you

make are all good reasons for furnishing genuine BUSS fuses.

For more information on BUSS and FUSETRON Small Dimension fuses and fuseholders, write for bulletin SFB.

Bussmann Mfg. Division,
McGraw-Edison Co., University at
Jefferson, St. Louis 7, Mo.

BUSS fuses are made to protect — not to blow, needlessly



Makers of a complete line of fuses for home, farm, commercial, electronic, automotive and industrial use.

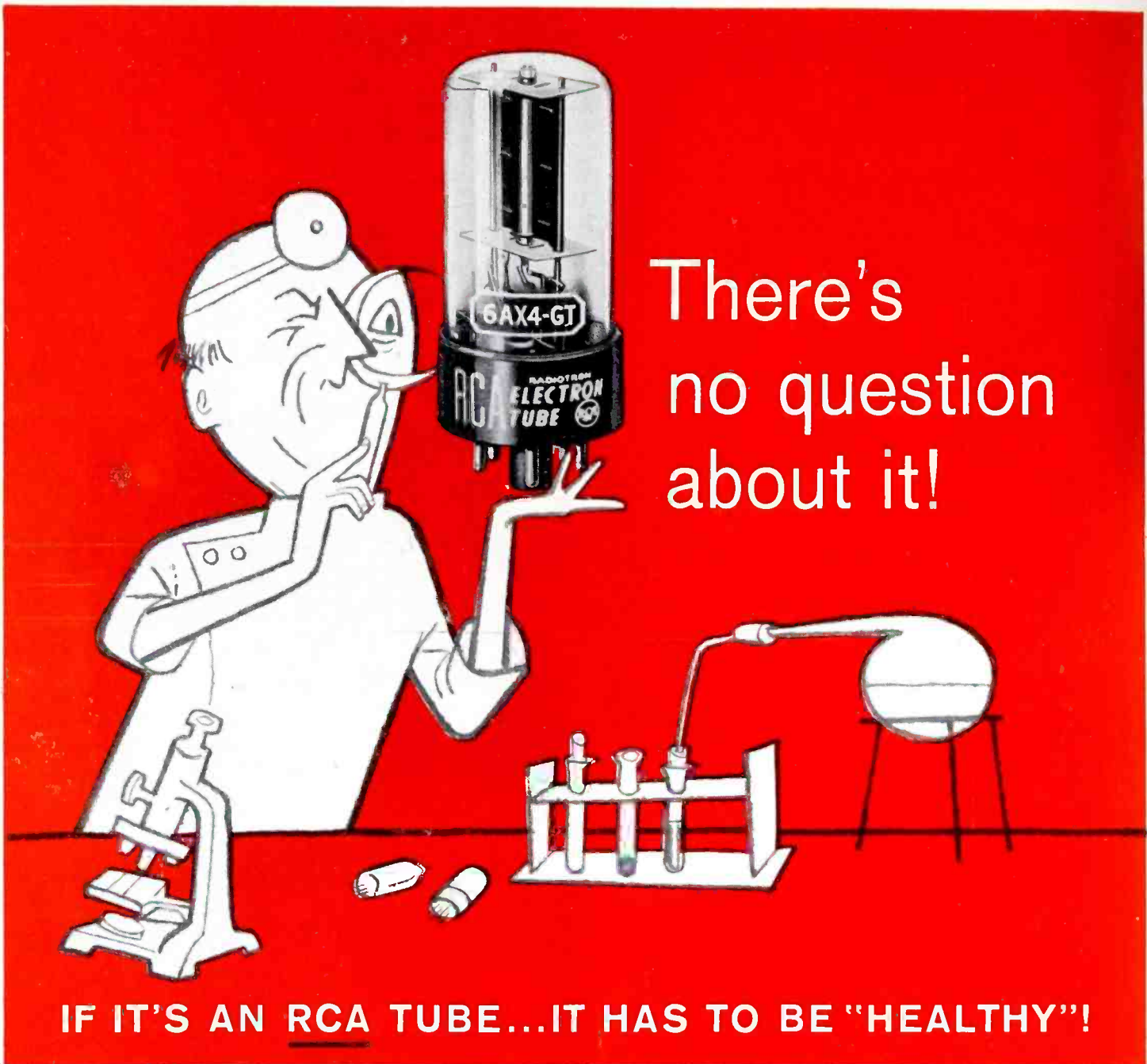

There's
no question
about it!

IF IT'S AN RCA TUBE...IT HAS TO BE "HEALTHY"!

RCA specializes in the production of "healthy" tubes. Take the RCA-6AX4-GT, for example. It features important built-in safety factors that minimize internal breakdowns and "arc-over", reducing early-hour failures—while providing reliable performance in TV damper circuits. Here are some of the ways RCA builds this "good health" into the 6AX4-GT:

Heater wire has been specially developed to improve welds, thereby reducing early-hour failures due to an open circuit at the weld point. Heater-spacer assemblies are pre-fired to eliminate leakage-producing contamination during tube production. And micas are specially sprayed to control plate-to-cathode leakage.

These are some of the reasons why many designers and manufacturers of TV sets specify RCA's 6AX4-GT—the very same reasons why you should always ask your RCA Tube Distributor to "Ship RCA Only"!

**RCA Technical
Booklet Available**

RCA Receiving Tubes and Picture Tubes for AM, FM, and Television Broadcast (1275-H) ... includes socket information and useful data for more than 700 tube types. Ask your RCA Tube Distributor for your copy today!



RADIO CORPORATION OF AMERICA

Electron Tube Division

Harrison, N. J.