

SERVICE  
TRAINING  
SCHOOLS  
BOOKS

JULY, 1958

# SERVICE

THE TECHNICAL JOURNAL OF THE TELEVISION-RADIO TRADE

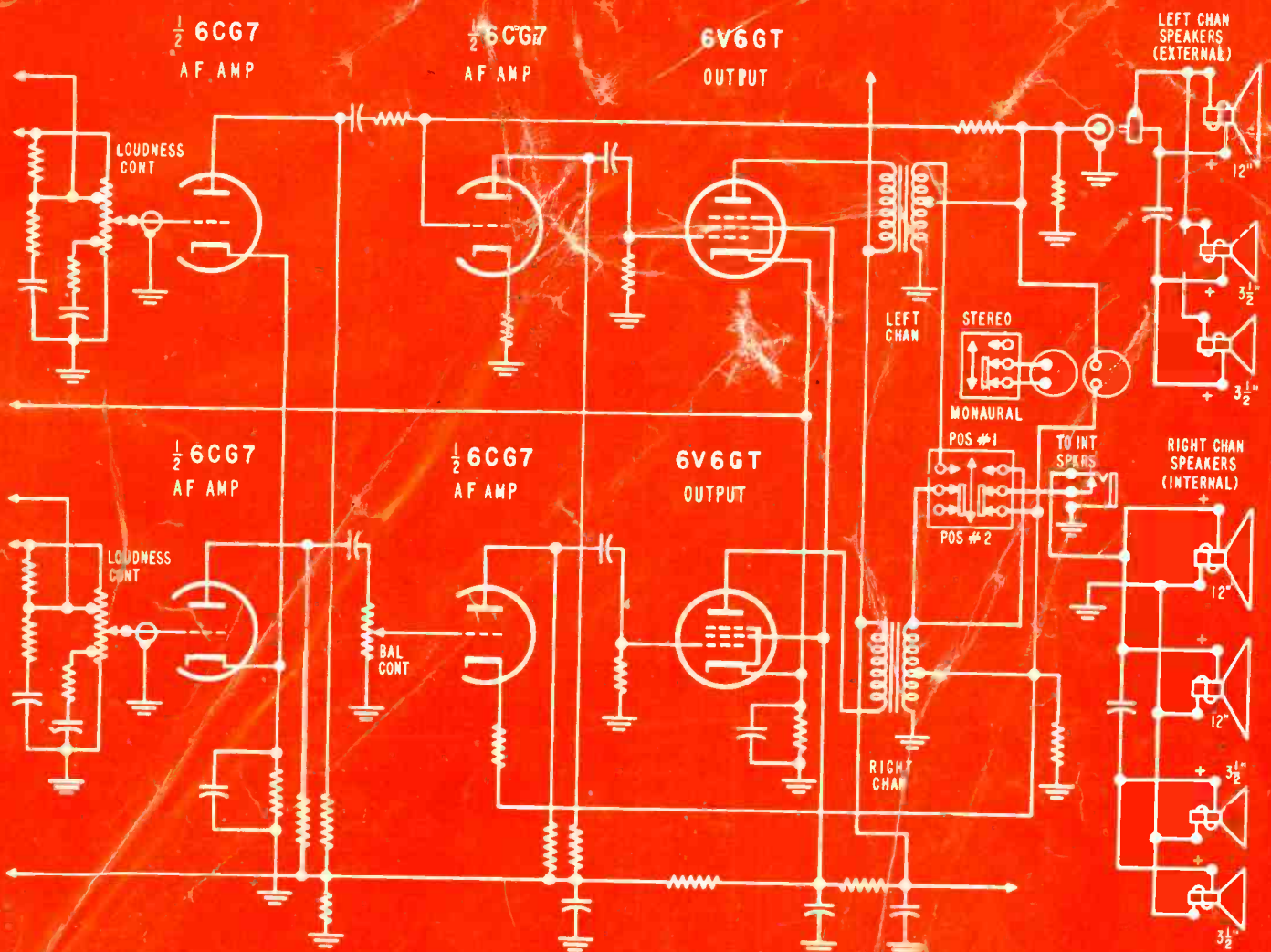

Audio amplifier section of new stereo-  
phonic radio-phono combination.

See circuit analysis, this issue.

33 S 9-30-57  
CLEVELAND, OHIO  
D  
W. TARR  
8-60

# MINIATURE ELECTROLYTICS FOR MINIATURE SETS

*designed for transistorized radios, hearing aids, wireless microphones, miniature tape recorders, auto receivers, and similar miniature electronic products.*

## FOR POINT-TO-POINT WIRING AND FLAT MOUNTING ON PRINTED WIRING BOARDS



Sprague's new and improved 85°C Littl-lytic\* Capacitors are the *tiniest* reliable electrolytic capacitors made to date . . . and their performance is better than ever. Their remarkable dependability is the result of a new manufacturing technique in which *all the terminal connections are welded. No pressure joints . . . no "open circuits" with the passage of time.* Littl-lytics are hermetically-sealed and aluminum-encased. And check this for low leakage current: for a 2 $\mu$ f, 6 volt capacitor . . . only 1.0  $\mu$ a max.; for a 300  $\mu$ f, 6 volt capacitor . . . 3.5  $\mu$ a max.! There are no transistor burn-out troubles when you use Littl-lytics. Available in the largest list of ratings in the industry! Request Bulletin M-753.

## FOR UPRIGHT MOUNTING ON PRINTED WIRING BOARDS



Space-saving Verti-lytic\* Capacitors are designed for easy manual upright mounting on printed wiring boards. Keyed terminals assure fast mounting and correct polarity. Their low leakage current and high purity aluminum foil construction provide top performance and excellent protection against expensive transistor burn-outs. Sturdy premolded phenolic shell with resin end-fill gives excellent protection against drying-out of the electrolyte or the entry of external moisture. The phenolic case eliminates the necessity for any additional insulation. Request Bulletin M-757.

*Be sure to see these new and improved 'lytic capacitors at your distributors. Check Sprague's other transistor capacitors while you're at it. You'll find that Sprague has the most complete ratings in the industry. Ask your*

*distributor for your copy of Sprague's Bulletins M-753 and M-757, or write Sprague Products Co., Distributors' Division of Sprague Electric Company, 61 Marshall Street, North Adams, Massachusetts.*

\*Trademark

**don't be vague . . . insist on**

# SPRAGUE®

*world's largest capacitor manufacturer*

SPRAGUE RESEARCH IS CONSTANTLY PRODUCING NEW AND BETTER CAPACITORS FOR YOU



**Men 17 to 55—GET FREE FACTS!**

See How **DeVry Tech** Can Prepare You For A Profitable Future In Many Fields

from **Communications** to **Guided Missiles, etc.**



**No Previous Technical Experience Or Advanced Education Needed!**

Laborers and bookkeepers, store clerks, shop men farmers, salesmen—men of nearly every calling—have taken the DeVry Tech program and today have good jobs or service shops of their own in Electronics. You don't have to quit your present job. If you are 17 to 55, see how you may get yourself ready for a future in the fast-growing Electronics field.

Whether you prepare at home or in our well-equipped Chicago or Toronto Laboratories, you get sound, basic training in both principles and practice. At home, you use educational movies. You build actual circuits and test equipment. You read simple directions, follow clear illustrations. When you finish, you are prepared to step into a good job in this excitingly different field. You may even start a service shop of your own. Mail coupon for free facts today.

Get **FREE** Booklet!

We'll give you a free copy of an interesting booklet, "Electronics and YOU." See for yourself how you may take advantage of the opportunities in this fast-growing field.



**FREE EMPLOYMENT SERVICE**

Puts you in touch with job opportunities—or helps you toward a better position in the plant where you are now employed.

**Draft Age?**

We have valuable information for every man of draft age; so if you are subject to military service, be sure to check the coupon.







**DeVry** Technical INSTITUTE

**Chicago 41, Illinois**

Formerly DeFOREST'S TRAINING, INC.

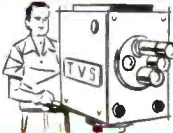
"One of North America's Foremost Electronics Training Centers"  
Accredited Member of National Home Study Council



	<b>Radar</b>
	<b>Automation Electronics</b>
	<b>Television</b>
	<b>Micro-Waves</b>
	<b>Computers</b>
	<b>Broadcasting</b>
	<b>Your Own Service Shop</b>

DeVry Technical Institute  
4141 Belmont Ave., Chicago 41, Ill., Dept. ST-7-O  
Please give me your FREE booklet, "Electronics and YOU," and tell me how I may prepare to enter one or more branches of Electronics as listed above.

Name \_\_\_\_\_ Age \_\_\_\_\_  
Please Print  
Street \_\_\_\_\_ Apt. \_\_\_\_\_  
City \_\_\_\_\_ Zone \_\_\_\_\_ State \_\_\_\_\_  
 Check here if subject to Military Training.  
DeVry Tech's Canadian Training Center is located at 626 Roselawn Avenue, Toronto 12, Ontario  
2040

Performance  
proven in more  
than 500,000  
homes



# UHF CONVERTERS

No matter where you are — primary or fringe area — there's a B-T UHF converter that makes any TV set a modern, powerful 82-channel receiver. New FCC tuner standards\* are met by these B-T Converters.

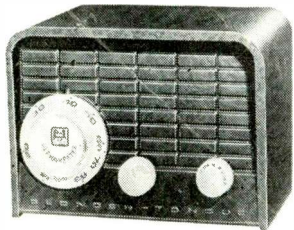

for superior reception  
in fringe areas the

## BTU-2<sub>R</sub>

precise 300-ohm impedance match; high gain—high stability; low noise factor; double tuned input; dual speed channel selector for easy, accurate tuning only 39.95

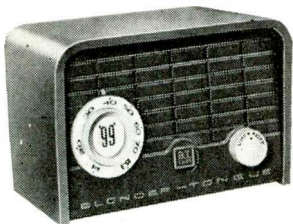

for primary areas — top  
performance at low cost

## MODEL 99<sub>R</sub>

precise 300 ohm impedance match; double tuned RF section; one knob tuning; drift-free performance only 22.95

B-T converters are UL approved, CSA approved and approved by actual performance in more than 500,000 American homes.

Sold by Electronic Parts Distributors  
For further information write: Dept. S-7  
Blonder-Tongue Laboratories, Inc.  
9 Alling Street Newark 2, N.J.

\*Models 99r and BTU-2r comply with tuner limits of FCC rules, Part 15, of 1000 CV/M — Hazeltine Research Corp. — report #57041.



# SERVICE

THE TECHNICAL JOURNAL OF THE TELEVISION-RADIO TRADE  
Including RADIO MERCHANDISING and TELEVISION MERCHANDISING  
Registered U. S. Patent Office

Page

### FEATURES

- 5 Editorial: Service Know-How and Education
- 6 Education for the Service Man
- 9 New Stereo Radio-Phono Combination With Integrated Two-Channel Amplifier (Cover Circuit)
- 15 Technical Books for the Service Man ..... John F. Rider
- 17 Crystal and Ceramic Pickup Servicing ..... Albert H. Binash
- 18 High Fidelity in Public Address Systems ..... Victor Brociner
- 20 Analysis of Directional Couplers and Filters ..... Ben H. Tongue
- 24 New Signal Generator for Color Servicing ..... Howard Jennings
- 26 Safeguarding Tube Life and Reliability ..... David Saslaw
- 28 Technical Books and Manuals
- 29 Association News
- 30 The Third Dimension in Reproduced Sound (Audio Installation and Service) ..... R. S. Lanier
- 34 Latest in Stereophonic Sound Equipment

### CIRCUIT DIAGRAMS

- 10 RCA Victor SHC-4 Stereo Radio-Phono
- 20 Blonder-Tongue A-104 4-Set Antenna Coupler
- 20 Blonder-Tongue A-102 2-Set Antenna Coupler
- 20 Blonder-Tongue A-105 High-Band Low-Band Antenna Coupler
- 22 Phono Cartridge Output Loss and Frequency Response Test Circuit
- 23 Blonder-Tongue A-107 VHF/UHF Antenna Coupler
- 24 Superior TV-50-A Signal Generator
- 38 Speaker Polarity Test Circuit

### ADVERTISERS IN SERVICE

© 1958 by Bryan Davis Publishing Co., Inc. All rights reserved.

Second-Class mail privileges authorized at New York, N. Y.; additional entry at the Post Office, Norwalk, Conn. . . . Subscription price: \$2.00 per year (\$5.00 for 3 years) in the U.S.A. and Canada; 25 cents per copy, \$3.00 per year in foreign countries; 35 cents per copy.





Editor  
**Solomon R. Kunis**

Associate Editor  
**David E. Pearsall II**

Consulting Technical Editors  
**Howard Jennings**  
**Arnold Gewirtz**

Field Editor (Midwest)  
**Rudolph T. Plemich**

Art Director  
**Anthony R. Aliffi**

Supervisor, Circuit Diagrams  
**Michael D. Bellezza**

**BUSINESS DEPARTMENT**

Business Manager  
**B. S. Davis**

Assistant Business Manager  
**B. Earley**

Assistant Advertising Manager  
**Astrid Kelly**

Circulation Manager  
**A. Goebel**

Assistant Circulation Manager  
**A. Kiernan**

Mailing Supervisor  
**L. Trubia**

**PACIFIC COAST**

**Leo Sands**, District Manager  
920 Commercial Street  
Palo Alto, California  
Tel.: YOrkshire 8-4478

Published Monthly by  
**Bryan Davis Publishing Company, Inc.**  
52 Vanderbilt Ave., New York 17, N. Y.  
Tel.: MURRAY HILL 4-0170

B. S. Davis, Pres.                      A. Goebel, Secy.



Printed in U.S.A. by  
**O'Brien Suburban Press, Norwalk, Conn.**

# FREE! FREE!

## also PHONO DRIVE INVENTORY CASE

### with WALSCO PHONO DRIVES

Designed especially for servicemen, the Walsco Phono Drive Inventory Case has these important advantages for you:

- Keeps your stock up-to-date—instantly tells you when and what to re-order
- Covers 90% of all your replacement needs
- Compact enough to carry with you on house calls
- Contains an up-to-date cross-reference replacement chart—instantly tells you the right drive to use
- Keeps drives neat and orderly—makes it easy to find the right drive

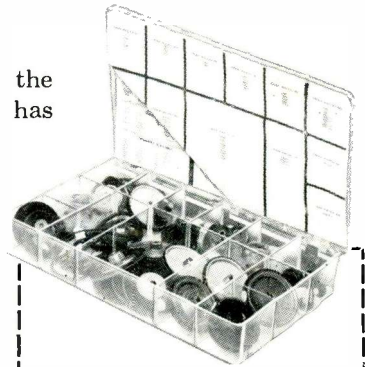

This indispensable kit is \$2.50 dealer net. It's free with your next phono drive order of \$10.00 or more.

## EXTRA SALES and EXTRA PROFITS

... come your way when you sell your customer a new drive or belt. A phonograph or recorder that is old enough to need service of any kind needs a new belt or drive for good performance. Suggest it to your customer next time you service a phono or recorder—see how easy it is to get Plus Profits.

## 19 NEW DRIVES and BELTS

...make Walsco the most complete line ever

Nineteen new items, including replacements for Admiral, Collaro, Garrard, Monarch, Philco, RCA, Revere, Viking, and Webcor are now listed in the Walsco catalog, along with hundreds of other units for all standard phonographs and recorders. Tires, belts, idler wheels and pulleys, and many more to fill your every replacement need.

**FREE:** Walsco Identification Wall Chart—with actual size reproductions and detailed cross-reference listings of all replacement drives and belts—lets you instantly identify the one you need. See your Walsco distributor or write directly to Walsco.



Catg. No. 1479  
(Garrard) \$2.25 List



Catg. No. 1490-01  
(RCA) \$1.10 List



Catg. No. 1492-01  
(Webcor) \$2.25 List



**Walsco ELECTRONICS MFG. CO.**  
A Division of Textron Inc.  
West Coast Plant: Los Angeles 18, California  
MAIN PLANT: 108 W. GREEN ST., ROCKFORD, ILL., U.S.A.  
In Canada: Atlas Radio Corporation, Toronto 10, Ontario

INDEPENDENT SERVICE DEALER:

how many of  
your tube dollars  
are helping  
your "competitors"?



Not a single one of them, if you standardize on Raytheon TV and Radio Tubes because Raytheon does not make TV and Radio sets — does not have a factory controlled TV and Radio Service organization — does not compete with you for profitable service business.

On the contrary, Raytheon's sole aim is serving you, the Independent Service Dealer — by making available to you the finest quality TV and Radio Tubes money can buy — tubes that are perfect for replacement work because they are designed to

provide quality performance in all makes and models of sets.

Independent Raytheon Tube Distributors from coast to coast are as near as your phone — ready to fill your tube needs — eager to supply you with the hundreds of shop and sales aids Raytheon makes available to you to help make your job easier, more efficient and more profitable.

You win all ways when you ask your Raytheon Tube Distributor for Raytheon TV and Radio Tubes — the tubes that are Right . . . for Sound and Sight!



### RAYTHEON MANUFACTURING COMPANY

Receiving and Cathode Ray Tube Operations

NEWTON 58, MASS.      CHICAGO, ILL.      ATLANTA 6, GA.      LOS ANGELES 7, CALIF.  
55 Chapel Street      9501 Grand Ave. (Franklin Park)      1150 Zepherite Rd. N.E.      2419 So. Grand Ave.

Raytheon makes all these } Receiving and Picture Tubes, Reliable Subminiature and Miniature Tubes, Semiconductor Diodes and Transistors, Nucleonic Tubes, Microwave Tubes.





27th YEAR  
OF  
CONTINUOUS  
PUBLICATION

# SERVICE

THE TECHNICAL JOURNAL OF THE TELEVISION-RADIO TRADE

## Service Know-How and Education

A RECENT EDITORIAL IN SERVICE urged readers to embark on a policy of specialization and diversification in order to enlarge their base of operation and to increase profits. This editorial produced a good deal of comment on how such a policy can best be carried out.

The problem of specialization, as we see it, is primarily one of education. No one becomes a specialist in any field without first broadening and intensifying his knowledge of it. This is true of auto radio, closed circuit TV, mobile communications or any of the other electronic specialties which are rapidly opening up. The best repair jobs and the most lucrative service contracts go to the Service Man who has acquired the knowledge and the skill to handle them.

Providing the know-how which helps the Service Man to become an electronic specialist has always been a prime purpose of this magazine. SERVICE is the only publication in its field which is not engaged in a popularity contest. We do not try to amuse or entertain our readers, nor do we fill our columns with trivia which is easy to read but of no real value. Throughout the 27 years of its existence, SERVICE has always endeavored to provide the progressive Service Man with the latest, most accurate, and most useful technical information concerning each electronic specialty as it developed.

We have every reason to believe that the electronic service field appreciates the efforts we have made in this direction. Circulation figures, audited by the Audit Bureau of Circulation, show that SERVICE has consistently attracted the largest percentage of independent professional service and maintenance specialists, the men who are going furthest and fastest in their specialized fields.

Because self-improvement through education is of genuine concern to our readers, SERVICE this

month presents a survey and analysis of the electronic training field. Our purpose in doing this is to provide our readers with a picture of the various types of schools and training programs which are available for their continuing educational requirements. We also hope to provide the Service Man, who is generally regarded as a technical authority in his community, with the necessary information for the guidance of potential student technicians among his customers and friends.

Finally, we are undertaking this program of publicizing the scope and activities of these schools in just recognition of their largely successful efforts in training the many newcomers in the electronic field. Our technical training schools may well pride themselves for having helped create the cadre of well-trained, competent technicians and Service Men who are so vital to the continued growth of the electronic industry and to the safety of our nation.

• • • •

ONE ELECTRONIC SPECIALTY which has achieved tremendous importance within the last three months is the field of stereophonic sound. Virtually every manufacturer of sound equipment has incorporated some stereo feature in his new product line. By its very nature, stereo equipment can seldom be properly installed or serviced by the consumer, making this field an extremely fruitful area for specialization.

For this reason, this issue of SERVICE features a number of articles in this new and exciting field. There is a general article on stereo theory and practice, a circuit description of a stereophonic radio-phono combination, and a new products round-up of the stereo equipment being offered by representative manufacturers—all of which are expected to be in wide use this fall.

## ...utes Offers Advanced Training

by C. E. TOMSON  
Registrar, RCA Institutes, Inc.

AT A TIME when science and technical education signify front page news, increasing contributions are being made to America's pool of trained electronic and radio technicians by RCA Institutes, Inc., one of the oldest radio-training schools in the country.

The greatly increased demands of government and industry for trained electronic specialists already has touched off a program of expansion in facilities and curricula which is making a radical change in the Institutes' appearance and function.

The bulging resident enrollment—2,900 now compared with 1,300 in 1946—necessitated the acquisition last fall of a third entire floor at the headquarters building at 350 West Fourth Street, New York City.

Still further plant enlargement is planned for next fall, when the Institutes will take over the entire ground floor of this conveniently located building. Acquisition of this fourth floor will make possible the consolidation of all Institutes activities under one roof.

A technical institute offering instruction at college level in advanced electronics technology, and a vocational school providing courses in television and general electronics, television servicing and marine communications, RCA Institutes also has a thriving home study school which now has 11,000 active students. The Institutes offers Resident School training in computer systems and conducts special evening classes in color TV and transistors for engineers and technicians in the industry.

RCA Institutes offers four different full-time residence courses, on two levels of instruction, plus two part-time courses. All full-time courses include both lecture classes and laboratory work. Classes meet 25 hours per week in the day school, 8½ hours per week in the evening. The school year is divided into four terms of 12 weeks each, for both day and evening classes.

The Advanced Electronics Course (T-3) is a collegiate level course, stress-



C. E. TOMSON, REGISTRAR (left), and Harold Fezer, Director of Training at RCA Institutes Resident School.

# Education for

## A Survey of the Scope and For Electronic

*A variety of educational facilities is available to meet the greatly increased demand for technically trained men in the electronics field. These include trade schools, technical institutes, home-study courses, and industrial*

ing thorough training in the broad general principles of electronics, as well as their practical application to communications, entertainment and general industry. The course is approved by the Engineers' Council for Professional Development, an accrediting body representing the combined engineering societies.

Graduates are frequently admitted with advanced standing to degree-granting engineering colleges and universities. However, by the elimination of purely cultural subjects and those related to associated branches of engineering, it qualifies a high school graduate to find profitable employment in advanced technological work in electronics in the short period of two and a quarter years instead of four or more. The course is also attractive to engineering college graduates wishing the more thorough training in specific branches of electronics provided by the work of the last five terms.

Three complete courses, which make lesser demands on the student's mathematical ability, are: the Television and General Electronics Course (V-7), the Radio and Television Servicing Course (V-3), and the Radio Telegraph Operating Course (V-5).

Code Instruction (V-4), offered only in the evening school, is not a complete program in itself, but meets the special needs of qualified persons requiring such instruction.

Preparatory Mathematics, Physics and English is offered to qualify candidates for courses V-3, V-5 and V-7. Students in this term who do outstanding work, and who meet all other requirements, may be admitted to T-3 upon the recommendation of their instructor.

Enrollment in the Home Study School has more than tripled in the past three years, with eighty per cent of the students taking the Electronic Fundamentals course which teaches the principles of radio, television and electronics. Graduates of the Electronic Fundamentals course may progress to the new Industrial Electronics course when it becomes available within a few months, or

training programs for Service Men.

To provide our readers with a picture of the technical education field, we have invited a number of representative schools to submit articles covering the scope and content of

to the television servicing courses now available.

Founded in 1909, the Institutes' Golden Anniversary will be celebrated next year. In this 50-year span the RCA Institutes has become one of the country's foremost schools in the area of technical education through careful attention to the needs and trends of the electronics industry and by adherence to sound educational practice.

## DeVry Stresses Education For On-the-Job Assurance

by W. A. ROBINSON  
Advertising Manager, DeVry Technical  
Institute

THE SERVICE MAN's chief value lies in the practical know-how he can give to the job on which he is working. At DeVry Tech this know-how is developed by a combination of training aids tested and proved since 1931. A student may enroll for resident training in Chicago or Toronto, or take the regular home-study program.

In training men at home for many different careers in electronics, DeVry Tech stresses theory with well-written, well-illustrated, up-to-date reading assignments. A staff of experienced men continuously reviews lessons and other written material revising where necessary, so that the subject covered represents current practice. As new circuits and new equipment are put into general use by industry, these are covered in lessons or practical laboratory assignments.

Theory, of course, is only half the knowledge required of the electronic technician. Manual skill or practical know-how is equal in importance. To develop this skill, DeVry Tech supplies its home students with shipments of actual electronic parts with which they perform many construction and test procedures.

After the home portion of the program has been completed, a student may, if



# the Service Man

## Content of Training Programs

### Service Field

their training programs. The educational institutions discussed below are by no means the only ones which provide suitable training in electronics. There are undoubtedly other fine facilities in your neighborhood.

One word of caution, however. It

he desires, come to Chicago and receive further instruction at the resident school laboratories. Thus, he is able in many cases to work with the same type of commercial equipment he will find on the job. This includes working with computer circuits, broadcast studio equipment, Radar transmitters and receivers, servo-mechanisms, or other equipment of interest.

Through the home training method, on-the-job assurance is developed three ways: by reading, doing, and seeing. This procedure applies in all regular DeVry Tech home programs in television and radio, communications, instrumentation and control, and automation electronics.

For the man who can come to Chicago or Toronto for training in DeVry Tech's laboratories, a choice of day or evening programs is available. In periods ranging from 36 weeks to 96 weeks, day students can prepare for careers in television and radio, electronic controls for automation systems, communications, (including preparation for FCC licenses with radar endorsement) and electronic technology and design. Evening programs, of course, take a longer time to complete.



**JACK DEMPSEY**, former heavyweight boxing champion and now DeVry Tech director of public relations, looks on as student operates analog computer.

takes anywhere from six months to two years to turn a beginner into a reasonably competent technician. Do not waste your time and money on any course which claims to do this for you in six weeks or makes other rash promises.

In resident training, students have access to commercial electronic equipment for training purposes. In the industrial electronics section, for instance, students work with photo-electric cells, motor controls, temperature controls, high frequency heating, automatic welding controls, and so on. In the program dealing with electronic controls for automation, many circuits are built up and studied until the student is familiar with principles now being used in automatic electronic control systems.

Completion of the 96-week day program in Chicago entitles the graduate to an Associate Degree in Applied Science. This program is accredited by the Engineers' Council for Professional Development.

### Cleveland Institute Head

#### Sees Challenge Ahead

by CARL E. SMITH

President, Cleveland Institute of Radio Electronics

LIKE THE SNOWBALL we are rapidly rolling toward tremendous growth in the field of electronics—and our problems are growing more rapidly than we can solve them. From initial research and design right through to routine maintenance, the industry is faced with a serious shortage of trained technicians. One of the reasons for the engineer shortage lies in the lack of competent technicians. If there were enough qualified technicians, graduate engineers could devote their skills to the areas for which they were trained.

Before I go any further with this discussion I think we should understand what is meant by the term *electronic technician*. Unless we have a frank and objective picture of a technician, we won't have a solid basis for understanding the problem.

There are many thousands of men presently engaged in the home receiver repair field. Most of these men have had

some formal training in this type of work. The rest have learned on the job or by reading books and magazines. However, regardless of the manner by which they learned, many are lacking in their understanding of fundamentals.

Good technical training is the key to the really fine opportunities. As M. O. Pyle of the RCA Service Company says, "I want to emphasize the importance of a good understanding of electronic fundamentals. Train a man to really understand these circuits and he will be able to handle all types of electronic equipment in industry as well as in the home. The man who fails to understand fundamentals will be a tube puller, not a top technician."

Nelson Cooke, one of the leading electronic engineers, points the finger right at the weak spot in our present set up when he says, "In spite of the fact more men are being trained every year, it appears that the demand for competent technicians and engineers will exceed the supply for many years. The problem may, however, be intensified by a program that trains a student only to locate and correct trouble within certain types of equipment, at the expense of a good grounding in fundamentals. Such a program may save time, but it does not produce technicians."

Don't be misled by the word *fundamentals*. It does not mean low-level or beginning materials. Fundamentals refer to the key concepts of any technical field. Graduate engineers must constantly work to improve their understanding of fundamental math and theory. They are the mental tools of a technician's profession.

The events of the past year or two have clearly demonstrated our shortage of competent technicians. As a prominent instrumentation expert recently stated, "the lack of technicians is a major cause of recent missile failures."

Success in any field depends mostly on a man's ability to understand the problems involved and to think the problem through to a successful solution. This requires good training. There are no short cuts.

### Coyne Electrical School

#### Established for 59 Years

by S. C. NARLAND

General Manager, Coyne Electrical School

THE COYNE ELECTRICAL SCHOOL was organized in 1899 and has been in continuous operation since that time. During this period of over 59 years, more than 200,000 students have received their training in our school.

From the beginning, Coyne introduced short terminal courses of training in various trades and pioneered the practical *learn-by-doing* method of school instruction. Since 1920, all training has been devoted to electricity and allied subjects such as industrial electricity, electronics, radio and television. Through the years, shop equipment and training features

(Continued on page 12)

Sylvania comparisons point out—

# The big difference in Picture Tubes!

Here's the inside story on why local "off-brands" don't measure up to Silver Screen 85® standards

If you're like most dealers, you know off-brand tubes don't have the same quality standards as first-line tubes. To help you see how big the difference is, Sylvania purchased a nationwide sample of sixty 21YP4A's made by 19 different local tube makers. These tubes were put through the same production tests that all Sylvania tubes must pass.

Not a single local off-brand passed all 54 mechanical and electrical tests! Many of these were minor defects making little or no difference in whether or not the tube "lit up." But look how loose manufacturing controls can affect the important features of light output, focus, and life!

## LIGHT OUTPUT

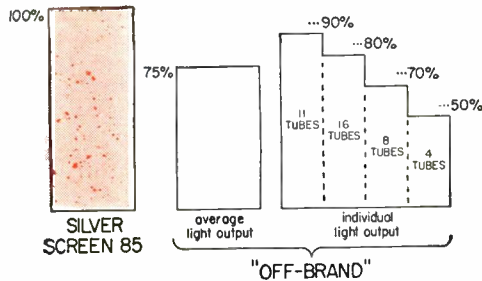

So far, 39 off-brand tubes have been compared with the *minimum* light output of Silver Screen 85. Five additional tubes couldn't even be tested. Eleven tubes were less than 90% as bright as the minimum for Silver Screen 85; 16 were less than 80%; 8 were less than 70%; and 4 were *less than 50%* as bright. Since most Silver Screen 85 tubes average as much as 125% of minimum standards, the difference becomes even greater. Small wonder that Silver Screen 85 is the easy way to more satisfied customers.

## FOCUS

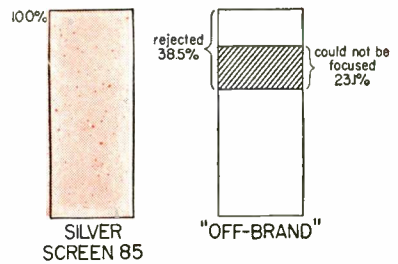
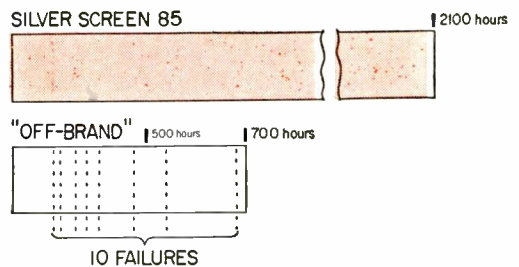

Chart 2 shows how these same 39 tubes stacked up to registered limits on focus voltage. 38.5% were rejected under these limits. Over half of all those rejected could not be focused in a TV receiver. Small wonder then that "Silver Screen 85" pictures are sharper, brighter, clearer.

## LIFE TEST



Nineteen off-brand tubes were placed on Sylvania's standard 2000-hour life test. Chart 3 tells you how fast these tubes developed slow-heating cathodes. Over half, or ten units, failed to go beyond the 700-hour mark. Small wonder then that Silver Screen 85 gives you less troublesome callbacks.

Of all the off-brand tubes tested, Sylvania engineers estimate that 43% probably would not have operated properly in a TV set. Why gamble your reputation, customer satisfaction, and success. It's just *good business* to sell up to "first line" picture tubes; Silver Screen 85 picture tubes.



# SYLVANIA

SYLVANIA ELECTRIC PRODUCTS INC.  
1740 Broadway, New York 19, N. Y.  
In Canada: Sylvania Electric (Canada) Ltd.  
University Tower Bldg., Montreal

LIGHTING • TELEVISION • RADIO • ELECTRONICS • PHOTOGRAPHY • ATOMIC ENERGY • CHEMISTRY-METALLURGY



# New Stereo Radio-Phono Combination With Two-Channel Amplifier

[See Front Cover]

A STEREOPHONIC SOUND SYSTEM requires two separate amplifier channels, one to feed each of the two speaker units. On hi-fi installations composed of separate components, this is usually achieved by adding a second amplifier to the existing monaural system. In packaged units, however, adding a second amplifier and integrating it into the assembly already in the cabinet can present a design problem.

One way of solving this problem may be observed in a group of AM-FM-phono combinations<sup>1</sup> introduced early in June. The amplifier circuit in these units has been designed so that it is truly integrated and fully utilized in the set regardless of whether it is operating stereophonically or monaurally.

A typical unit<sup>2</sup> which utilizes an integrated amplifier system is shown in Fig. 1 and is illustrated schematically on the cover and in Fig. 2 on page 10. The amplifier consists of two channels. Each audio channel contains a pre-amplifier (V10A or V10B), two stages of voltage amplification (V11A and V12A or V11B and V12B) and the power output (V13 or V14). Inverse feedback, derived from the secondary

of the output transformer (T10 or T11) is applied to the third audio amplifier stage (V12A or V12B).

When the Stereo-Monaural Switch (S6) is in the *stereo* position, the two amplifier channels are operating independently, with separate single-ended output stages each driving its own speaker system. With the switch in *monaural* position, the two output transformers are connected in parallel. Since the two channels are 180 degrees out of phase and the primaries of the two output transformers are connected with opposite-winding polarities to obtain an in-phase condition at the output transformer secondaries, this produces what is in effect a single amplifier operating in push-pull and utilizing all the stages in both channels. Seven watts are delivered at the output of each transformer, making a total of 14 watts available at the right channel speakers when the system is operating monaurally.

## Right Channel System

The right channel speaker system consists of two 12-inch woofers and two 3½-inch tweeters which are mounted internally in the console. The left channel speakers are not furnished with the basic unit, but any one of a number of matching external auxiliary speaker systems<sup>3</sup> may be used for this purpose. It is important that the external speakers be properly phased with the internal speakers, for both speaker systems are operating in unison when a monaural record is being played.

A speaker selector switch (S5), located on the back of the chassis, permits the two audio channels to be operated in parallel when there is no external speaker system connected. When this switch is in

*position 1*, the two output transformers are connected in parallel and a proper impedance is applied to match the internal speakers. If an external speaker system is added later, this switch must be moved to *position 2*.

One-half megohm dual tone controls and loudness control provide equal and simultaneous regulation of tone and volume in each channel. A ½ meg balance control, which is set by the Service Man when the auxiliary speakers are installed, balances the outputs of the two speaker systems. Two 47-ohm loading resistors prevent a build-up of excessive voltage on the output transformers in the event that there is improper loading of the output tubes by the speakers.

The AM-FM radio tuner employs standard circuitry except for the triode section of the 6AV6 (V7B), which operates as a phase inverter for signals fed to one of the audio amplifier channels. As a result, signals which are 180 degrees out of phase are fed to the respective channels. This is the same signal pattern produced by the stereo cartridge whose two signal outputs are similarly displaced. Another significant feature is that ceramic plates are employed in each of the

(Continued on page 38)



FIG. 1: RCA VICTOR MARK IV AM-FM radio-phono combination designed to play back stereophonic or monaural records.



FIG. 3: COMPATIBLE TONE ARM on record changer plays either stereo or monaural records. Cartridge is equipped with 0.7-mil diamond sapphire for LP records and 3-mil sapphire for 78-rpm discs.

<sup>1</sup>RCA Victor "Mark" series stereo-orthophonic instruments.

<sup>2</sup>RCA Victor Mark IV (model SHC-4).

<sup>3</sup>RCA Victor models SHS-7, SHS-8 or SHS-9.

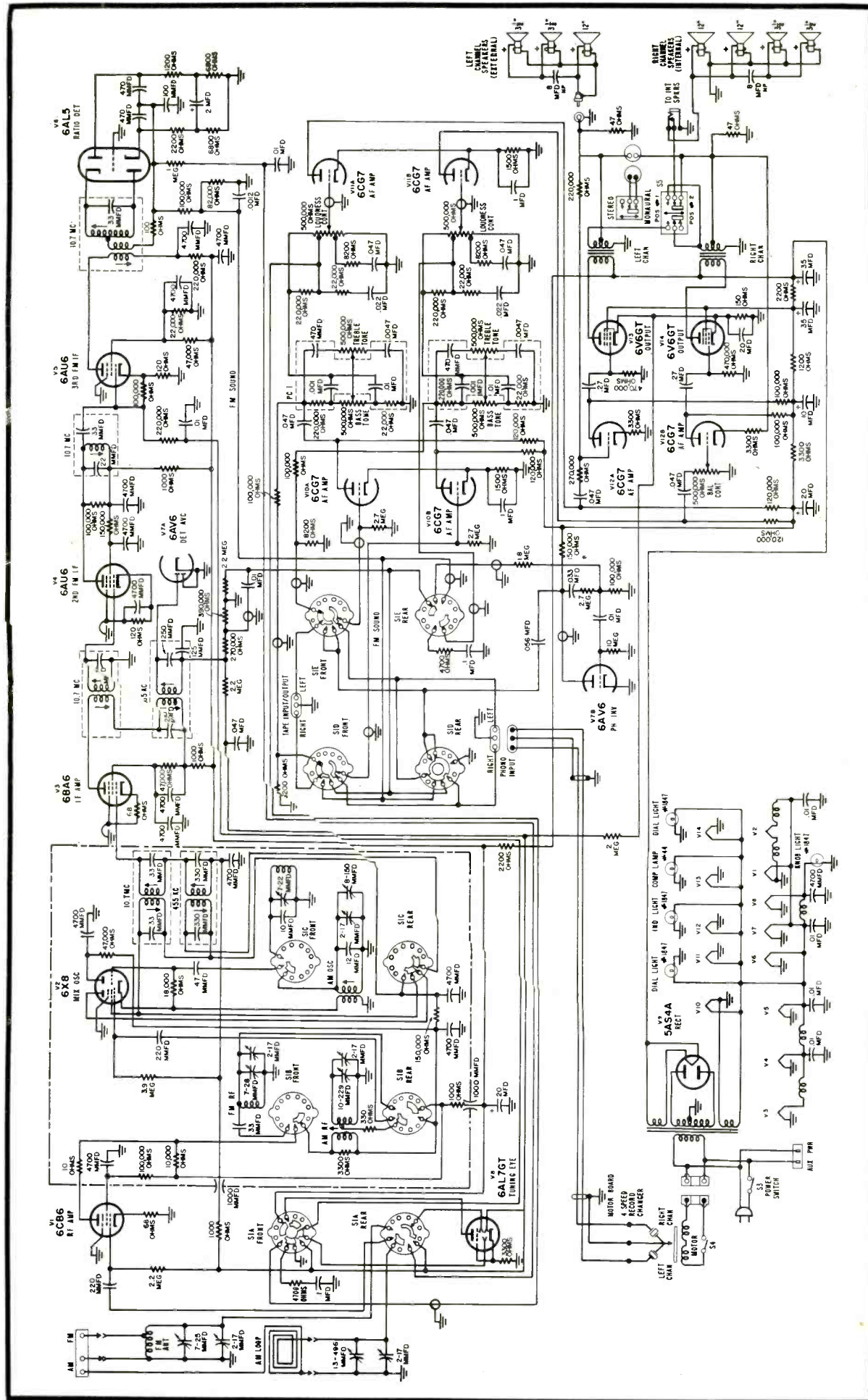

FIG. 2: SCHEMATIC DIAGRAM OF RCA VICTOR model SHC-4 chassis used in Mark IV combinations. Amplifier has two integrated audio channels, both of which are fully utilized for either stereo or monaural reproduction.



# ASK THOSE WHO "TORTURE TEST" WESTINGHOUSE RELIATRON® TUBES!

From coast-to-coast, TV tube distributors are putting Westinghouse RELIATRON Tubes through the most grueling "torture test" ever devised. Locked inside 87 standard make TV sets, these

tubes have racked up an amazing total of 425,000 hours' *continuous* operation—and are still going strong! Visual proof that when it comes to cutting call-backs... you can rely on RELIATRON Tubes.

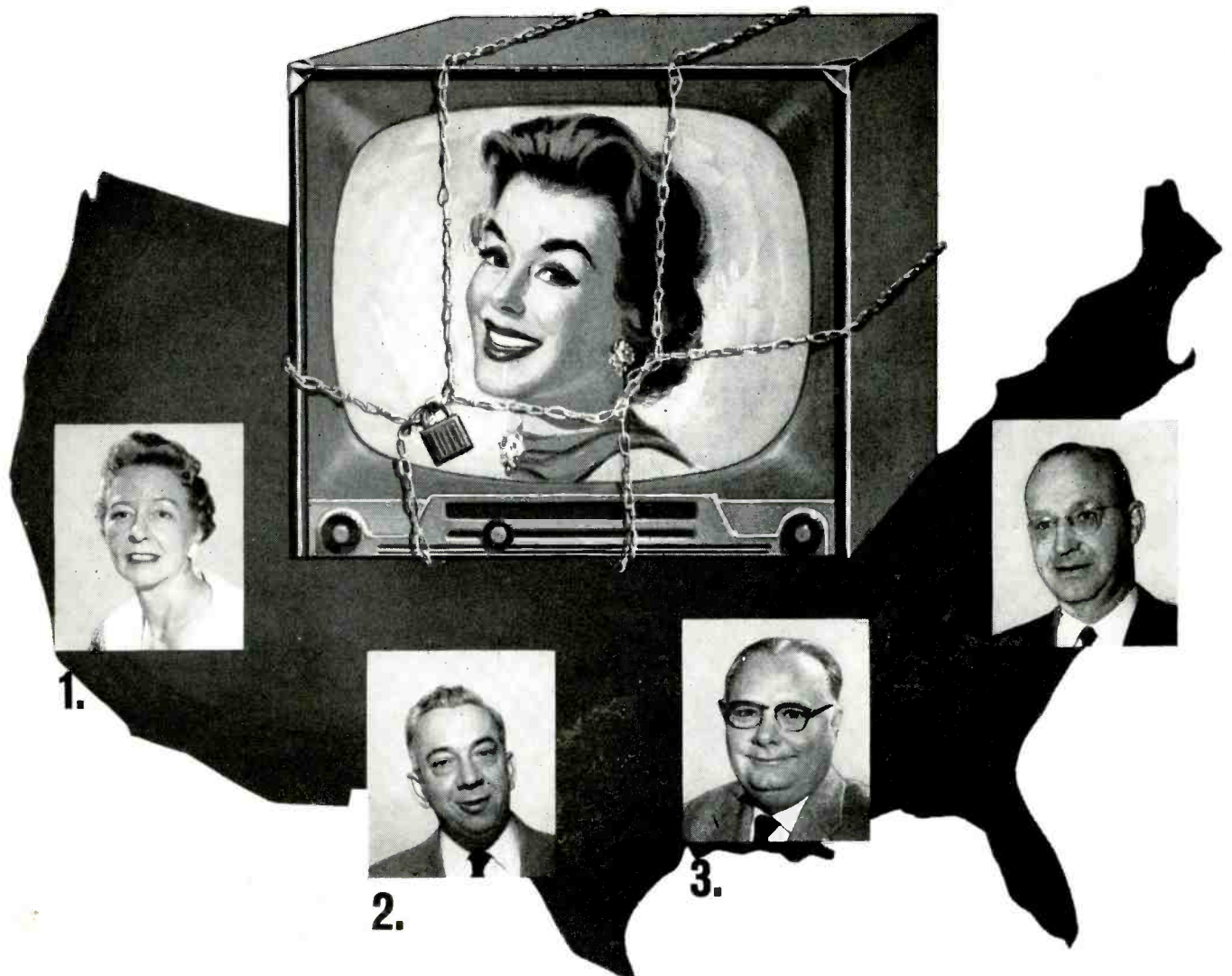

**1.** Louise Miller of Miller's Radio & Television Supply, Oakland, Calif., says: "I padlocked Westinghouse RELIATRON Tubes inside a TV set 8,436 hours ago . . . turned the set on . . . and it's been running ever since! No wonder my Westinghouse Tube sales are booming!"

**2.** Bill Sutton of Sutton Radio-TV Company, Ft. Worth, Texas, says: "My 'Locked TV' has been operating steadily for 8,916 hours with RELIATRON Tubes! At this rate, my service dealers will certainly cut call-backs."

**3.** Charlie Goebel of Manhattan Radio Equipment Co., Kansas City, Missouri, says: "My 'Locked TV'

set has been turned on 9,936 hours without a single RELIATRON Tube failure! How's that for long tube life!"

**4.** I. Goldenberg, Sherwood Distributors Inc., Union, New Jersey, says: "8,649 hours have passed since I turned on my 'Locked TV' and it's still working fine. That's one reason why I've been selling more RELIATRON Tubes than ever before."

**YOU CAN BE SURE... IF IT'S**

## Westinghouse

*Electronic Tube Division, Elmira, New York*

# Education for the Service Man

(Continued from page 7)

have undergone many changes to keep pace with the tremendous growth in these fields and to meet the requirements of industry.

The school now occupies its own building which is of steel and concrete fireproof construction and contains approximately 55,000 square feet of floor space.

Coyne is chartered under the laws of the State of Illinois as an educational institution not for profit and is registered by the Illinois Department of Registration and Education. It is an approved training agency under the various Veterans Training and Education Benefit Bills, and for many years has co-operated with various State Rehabilitation Agencies in the training of disabled men.

At the present time, resident courses are offered in electricity, electronics, radio, television, and various combinations of these subjects. Full-time training is offered in our day school and part-time training is offered in evening classes. The time required to complete our full-time courses is 24 to 60 weeks, depending upon the course. The time required to complete evening courses is 48 to 120 weeks, also depending upon the course.

Home training is offered in television-radio including color TV. This instruction includes 104 illustrated lessons and supplementary instruction material including practical job guides giving specific instructions for doing servicing jobs. Instruction is also given in starting and operating a business and getting ahead in a job or a business enterprise. Examinations are corrected and graded as completed and returned with helpful suggestions and comments.

The resident instruction given in Coyne courses is a combination of technical and practical training on full-size commercial equipment. The training method can be described as consisting of three phases or steps.

Step No. 1 consists of lectures and

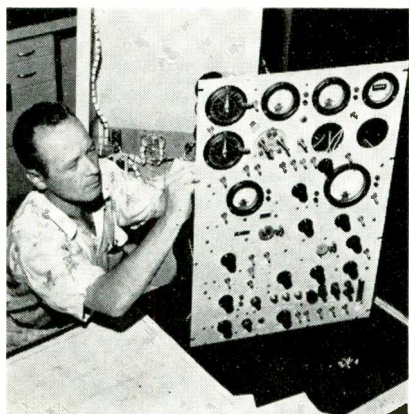

**STUDENT TECHNICIAN** in lab at Radio Electronics Television School



**ELECTRONIC LABORATORY** at Heald Engineering College.

class discussions covering essential theory and technical applications. Extensive use is made of modern training aids, such as slide films, sound films, blackboard drawings and printed diagrams.

Step No. 2 in the Coyne training program consists of equipment demonstrations in connection with which instructors demonstrate typical job projects on the equipment itself and explain the working parts and details of operation. These demonstrations are conducted both in lectures and during shop work periods.

In Step No. 3, students apply the theory they learned in previous steps by working out practical job projects on standard electronic equipment that is typical of that in common use.

## Technical Institutes Develop Engineering Aides

by **KARL O. WERWATH\***  
President, Milwaukee School of Engineering

THE TECHNICAL TEAM of the United States includes several types of technical personnel: the professional, namely the scientists and engineer; the semi-professional, the scientific and engineering technician; and the craftsman, which includes the artisan. To meet the demand made by technological advances, the United States needs to develop increasing numbers of personnel in each of these categories each year. The shortage of graduates in the sciences and engineering calls for a critical review of all phases of the educational processes which develop this personnel. We are here concerned, however, only with supporting technical personnel to the professional scientists and engineer.

One way to help meet the shortage is to increase the supply and quality of supporting technical personnel who can assume certain duties now performed by professional people, releasing more time of the professional person for strictly professional pursuits. If efficiency in scientific and engineering effort, for instance, could be increased by 10% we would have the equivalent of providing 70,000 additional scientists and engineers. This would do much to relieve the situation

in the immediate future. But such development is dependent on the availability of an adequate supply of qualified supporting technical personnel for both scientific and engineering pursuits.

We are now graduating only a fraction of the required number of highly skilled scientific and engineering technicians through accredited or approved courses in the United States. In emergencies, such personnel is now being developed by other means, such as upgrading certain trade personnel by supplementing their practical experience with spot-training in higher level mathematics, graphics, language and the physical sciences. There is also some upgrading by similar correspondence courses. The crucial need, however, is for scientific and engineering technicians who have sufficient formal higher education and training of collegiate level to communicate successfully with the professional scientists or engineer in carrying out technical work and who are men capable of assuming the responsibilities of a scientific and engineering technician.

The scientific technician and the engineering technician have become a necessary part of the American industrial team, with increasing responsibilities. While the engineer plans, the technician makes and does; while the engineer creates, the technician applies. The scientific or engineering technician often provides the liaison between the professional man and the craftsman and may thus have varying degrees of leadership responsibilities. He must have the same basic characteristics and fulfill the same fundamental educational requirements as his professional counterpart, except that his interest and education are more in the direction of application, with less mathematical and theoretical depth. He takes the instructions of the professional scientists or engineer and either personally translates them into action or directs their execution by other supporting technicians and craftsmen. Therefore, his preparation must of necessity be offered in the area of higher education.

The Technical Institute Curriculum is a specific type of higher education leading to specific occupations in direct support of engineers and scientists. Student transfers from technical institute curricula to other collegiate curricula during the program, or from one technical institute curriculum to another, are relatively few in number. Although credits are not generally designed to be applicable to a baccalaureate degree, such basic subjects as mathematics, language and

\*Based on the Final Report to the President's Committee on Scientists and Engineers prepared by the Working Committee for the Development of Supporting Technical Personnel of which Mr. Werwath was chairman.



the physical sciences are usually of collegiate level and when offered on a credit basis generally transfer for comparable collegiate academic credit on an individual basis.

High school graduation or its equivalent is required for admission to technical institute type curricula and most institutions of higher learning have additional academic entrance requirements. Technical institute type courses are briefer and more practical in content than those of the professional engineering curricula. They are generally two academic years in length. They include a heavy schedule of specialized technical subjects which make up approximately one-half the curriculum in class time and total student effort. These are integrated with related studies of college level, including mathematics, physical sciences, graphics, English, economics, industrial commerce, management, and general studies.

### Home-Study Transistor Course Available

by D. CHRISTIANSEN  
Publicity Manager, CBS-Hytron

ONE OF THE MOST valuable in a series of educational aids introduced by CBS-Hytron in recent years is its Transistor Home-Study Course. Designed primarily for independent radio and television service-dealers, the course has evoked enthusiastic response from engineers and technicians as well as from schools, colleges and electronic equipment manufacturers.

The course — which has been sent to countries all over the globe including Switzerland, Cuba, Thailand, the Philippines, Israel and Palestine—features a do-it-yourself approach that enables the student to learn about transistors while using them.

The ten lessons, prepared for CBS-Hytron by A. C. W. Saunders, a recognized expert in the field of education, cover simplified basic theory, with practical experiments and servicing techniques for transistor amplifier, oscillator and rectifier circuits.

Here is how this home-study course works. Following enrollment, the student receives Lesson One and a complete bill

(Continued on page 16)

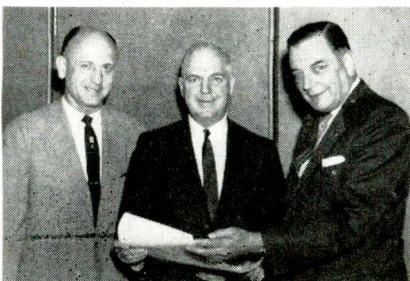

**AN AWARD FOR ADVANCEMENT of technical education is presented to A. L. Chapman, CBS-Hytron president, (right) by Russell Keany, acting president of Massachusetts Council of Private Schools as J. H. Mauer, distribution manager of CBS-Hytron, looks on.**

*when your reputation depends on*

## PUBLIC ADDRESS QUALITY

*install these fine*

# American MICROPHONES



### D22 *The Perfect Choice* D4 *Series Microphones*

**FOR PRESTIGE INSTALLATIONS**

**CAN TAKE LOTS OF PUNISHMENT!**

This fine public address and general purpose microphone provides studio quality performance and great versatility. Its smooth peak-free response (from 40 to 13,000 c.p.s.) means you virtually eliminate feedback problems and get excellent performance. "Slide-Lock" permits easy removal from the stand for hand or suspension use. Simple linkage bar adjustment quickly varies impedance from 50 to 40,000 ohms.

These omni-directional dynamic mikes are extra rugged! they're shock resistant, with guarded grill and swivel head. That's why they are so widely used in public address, paging, and communications where a microphone takes a lot of abuse. Another reason for their popularity: their smooth response from 45 to 8,500 c.p.s., approaching studio requirements.

This slender, graceful black-and-gold microphone is a real stand-out in performance and appearance. If you want to take pride in a sound installation—if you want to assure your good reputation—choose the rugged, dependable, efficient American D22. List Price \$99.50.

The versatile D4 Series Microphones are available in both low and high impedance models. Their low price makes them your best microphone choice where budget is as important as quality and durability. The D4 (low impedance) model has a list price of \$28.00. List price of the D4T (high impedance) is \$31.00.

Write for your free copy of the AMERICAN MICROPHONE catalog—a complete line of microphones, cartridges, and handsets, for every application.



**American Microphone** MANUFACTURING COMPANY  
a division of GC-Telexon Inc.

West Coast Plant: Los Angeles 18, California  
MAIN PLANT: 418 SOUTH WYMAN STREET, ROCKFORD, ILLINOIS, U.S.A.  
Export and Canada: Telesco International Corporation, 36 W. 40th St., New York, N.Y.

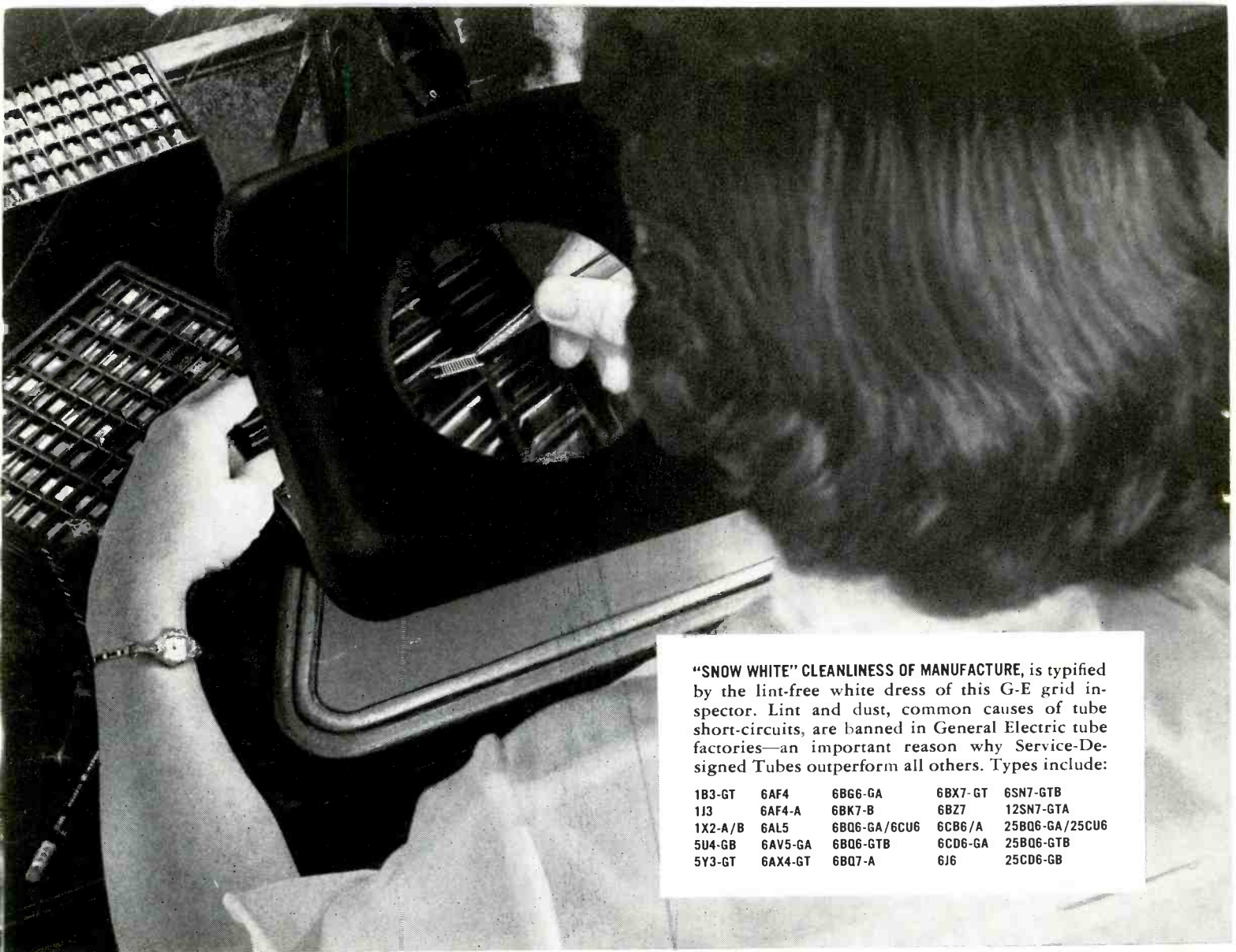

"SNOW WHITE" CLEANLINESS OF MANUFACTURE, is typified by the lint-free white dress of this G-E grid inspector. Lint and dust, common causes of tube short-circuits, are banned in General Electric tube factories—an important reason why Service-Designed Tubes outperform all others. Types include:

1B3-GT	6AF4	6B66-GA	6BX7-GT	6SN7-GTB
1J3	6AF4-A	6BK7-B	6BZ7	12SN7-GTA
1X2-A/B	6AL5	6BQ6-GA/6CU6	6CB6/A	25BQ6-GA/25CU6
5U4-GB	6AV5-GA	6BQ6-GTB	6CD6-GA	25BQ6-GTB
5Y3-GT	6AX4-GT	6BQ7-A	6J6	25CD6-GB

## Individual grid inspection! 300 such quality checks mean fewer callbacks with G-E Service-Designed Tubes!

More than 300 inspections, checks, and tests are given General Electric Service-Designed Tubes before they are approved for shipment.

Prior to assembly, tube materials are exhaustively analyzed, weighed, and tested. Parts—like the grids shown above—are inspected for accurate workmanship. Pre-assembly checks on a 6BQ6-GA sweep tube, for example, total 215 . . . definite proof how wide is the range of General Electric's quality control!

A 6BQ6-GA still must pass 109 successive inspections during tube assembly—must undergo 13 final electrical and mechanical tests, every

tube, before shipment. Other General Electric Service-Designed types are given inspections and tests that are equally exhaustive.

Fewer servicing callbacks? You can rely on this, with testing so extensive and rigid. Yet Service-Designed Tubes cost no more. Phone your G-E tube distributor! *Distributor Sales, Electronic Components Division, General Electric Company, Owensboro, Kentucky.*

*Progress Is Our Most Important Product*

**GENERAL  ELECTRIC**

11-11-124



# Technical Books for the Service Man

by JOHN F. RIDER  
President, John F. Rider Publisher, Inc.

ALTHOUGH THE SERVICE MAN today is concerned primarily with the repair of television and radio receivers, his position represents a considerable change from the early days of radio. During the 1930's, many technicians could state with pride that they knew the tube basing of every conventional radio receiving tube on the market, as well as the circuitry and component values of many of the more popular radio receivers. As entertainment-type equipment grew more complex and more varied with the growth of television receivers, transistor radios, high-fidelity tuners, amplifiers, and tape recorders, it became readily apparent that a certain amount of technical book study, and in some cases schooling, was necessary to enable the Service Man to maintain his position in the field.

A few technicians have remained in the servicing profession, using strictly the trial-and-error basis to gain experience. In most cases, these men are limited to changing tubes, looking for broken leads or burnt parts, and other obvious means to locate the source of trouble. As a rule, their repair work is generally more expensive to the set owner because of the extra time required for the repair. In addition they often do not get to the source of the trouble, and a strong likelihood of a callback exists.

For those who undertook the study of technical books and publications, the complexity was removed from modern electronic equipment. When trouble occurred, not only was the educated Service Man able to get at the source of the trouble rapidly, but because of his knowledge of circuit theory, he gained considerable experience based on the sound, sight, or meter reading made during the repair.

Today electronic equipment is even more complex. Computer manufacturers advertise nationally for Service Men to enter this field. Manufacturers compete for technicians who are familiar with servo mechanisms, magnetic amplifiers, transistor circuits, magnetic cores, telemetry, thyratrons, pulses, radar, industrial control circuits, and a host of other types of electronic equipment.

How can the technician learn the circuitry and techniques involved in the operation of this special equip-

ment? The only logical answer is through the reading of technical books and magazines on the various subjects of interest to the technician. Fundamentally, the action of the generally used triodes and pentode vacuum tubes is no different today than it was years ago, but many new vacuum tubes involving new principles of operation have been conceived, as well as new ways of utilizing the well-known capabilities of conventional tubes.

Recently, the owner of a machine shop complained bitterly that he had a piece of electronic equipment in need of repair. Though he had a guarantee on his equipment, the manufacturer was located over 1000 miles away and it took several days for the field engineer to get to him. He thought he could solve the problem by giving a local Service Man an opportunity to make the necessary repair. Several service technicians were called, but not one felt sufficiently competent to undertake the job.

Finally the field engineer arrived and quickly made the repair. One relay contact was badly pitted; however, its operation affected several circuits. This is just one case history of reduced income to a Service Man be-

cause of unfamiliarity with a somewhat different type of electronic equipment.

What does all this mean? It means that the Service Man must begin to take a broader view of his profession. The servicing industry is not functioning at a static level of technological development. It is a dynamic industry in which technology never stands still. The demands of industry are continually stimulating the needs of the design engineer. These demands result in new approaches, new techniques—new ways of serving mankind.

The world is not made up of television and radio sets. The electronic industry is constantly expanding, and there are many opportunities outside these fields. They wait for the wide-awake Service Man who is willing to set aside some of his valuable time to study the broadening field of electronics. Technical books help provide the answer.

There are technical books on virtually every topic in the electronic field. While many of these are highly technical and mathematical, there are many others skillfully written and illustrated that enable the technician to learn the basics and fundamentals

(Continued on page 36)

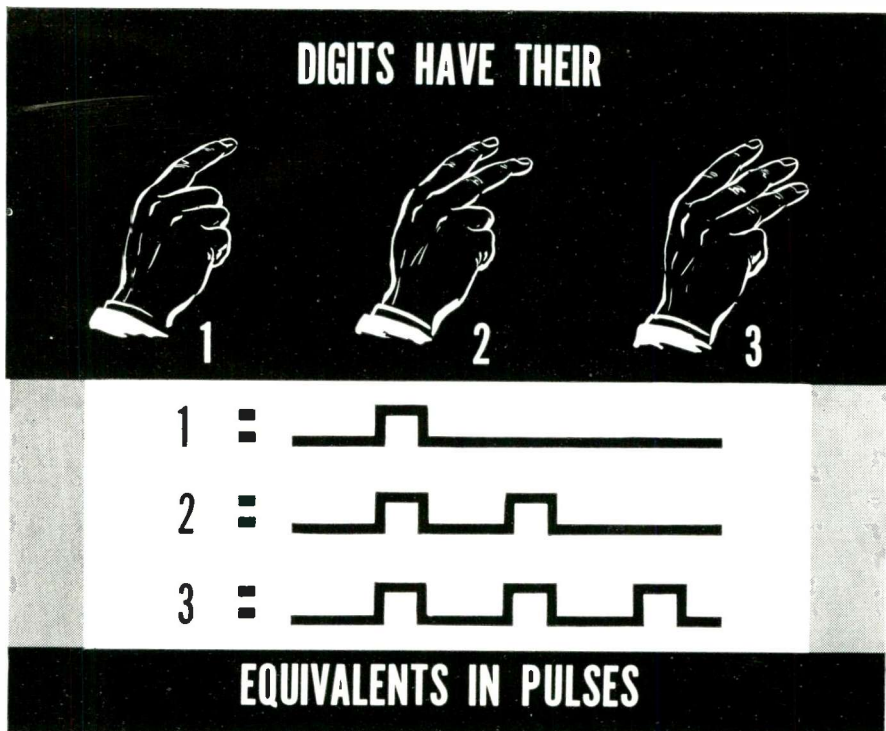

FIG. 1: TYPICAL PICTORIAL used in modern instruction books illustrates a simple way of expressing the relation between digits and pulses. This artwork appears in J. Murphy's "Basics of Digital Computers" published by John F. Rider Publisher, Inc.





get this TV  
**COUPLER**  
**FREE!**



when you buy  
1000 feet of  
**TWIN LEAD**

IT'S THE  
**AMPHENOL**

## SPECIAL "1001 PACKAGE"

Here's a Special Offer that puts extra profits in your pocket! For a limited time, your AMPHENOL Distributor is stocking a special "1001 Package" — 1000 feet of AMPHENOL's popular 214-056 Twin Lead and 1 free 114-097 two set Color Coupler. You pay only for the Twin Lead, the Color Coupler is free!

If you already sell or use Color Couplers, you know how good a bargain this package is; if not, here is an opportunity to become acquainted with, and sell at a 100% profit, one of the finest two set couplers available!

See your AMPHENOL Distributor and order the special "1001 Package\*" today!

\*Part number is 214-056-02



AMPHENOL ELECTRONICS CORPORATION  
chicago 50, illinois

### School Roundup

(Continued from page 13)

of materials listing the components necessary to perform all experiments. Most service-dealers have these components on hand or can easily obtain them.

At the end of the lesson is a series of questions which are answered by the student and mailed for correction. The corrected lesson is returned along with Lesson Two. All ten lessons include this correction service—as well as a consulting service to answer pertinent questions the student may have.

Those who wish to accelerate their progress in the course may choose to receive all ten lessons initially as a complete package. These students can thus return lessons for correction as fast as they desire.

A folder, PA-176, which lists the complete table of contents and illustrates the do-it-yourself approach is available through CBS-Hytron distributors or from CBS-Hytron Advertising Service Department, Parker Street, Newburyport, Mass.

### Philco Technological Center Provides Electronic Training

by HARVEY W. MERTZ  
Philco TechRep Division

The Philco approach to electronics training is threefold. For the beginner, it is first necessary to provide efficient and thorough training in the fundamentals. To this end, the Philco Training Devices have been developed. For the experienced technician, correspondence courses in advanced topics and new developments are provided through the Philco Technological Center. For technicians and engineers at all levels, technical support is provided by training manuals on both general subjects and specific equipments.

It has been shown many times that the most efficient and lasting teaching results from a combination of three basic factors—capable and experienced instructors, properly designed visual-aural devices and laboratory equipment which allows the student to demonstrate to himself the principles discussed by the instructor during a lecture. The material presented during a course must be continuous, making a complete unit rather than a series of disconnected parts, and must be presented in a manner which arouses and maintains student interest. An uninterested student is merely exposed to the information, and retains little, if any, of it.

A lecture demonstration unit is designed to provide the visual demonstrations essential in good lectures and the practical laboratory experience necessary in retaining the information given during the lectures.

The instructor uses these training aids to develop the principles of radio, up to and including the superheterodyne receiver. During the lecture the power supply can be installed and such items as ripple voltage can be easily shown,

(Continued on page 25)



# Crystal and Ceramic Pick-Up Servicing

by ALBERT H. BINASH

Sales Manager, American Microphone Co.

WITH THE ADVENT of hi-fi, the quality of phonograph components has taken on added importance. One component essential for providing high quality sound is the cartridge or pickup.

The phonograph cartridge changes mechanical energy to electrical energy through the use of reluctance, magnetic or piezoelectric elements. Often referred to as *crystal* cartridges are those using a Rochelle salt crystal or a ceramic element. Voltage is produced in these pickups when the element is physically deformed by twisting or bending. The *twister* type *crystal* pickup is illustrated in Fig. 1; the *bender* type *ceramic* pickup in Fig. 2.

## Twister Element

In Fig. 1 the motion given to the needle by the phonograph record is transmitted to the needle chuck. From the needle chuck this twisting motion is transferred through a folded rubber pad to the crystal element. The needle chuck is supported in two tubular rubber bearings and rotates back and forth with them reducing some of the motion to smooth the frequency response. The crystal element is held by the two rubber damping pads at this end and the leads of the crystal are soldered to the pin plug terminals at the rear of the cartridge case.

In Fig. 2 the damping washer is placed further toward the center of the *ceramic* element. The rear contact assembly also differs with its contact sleeve, contact strip, element contact and contact cap surrounding the rear clamp of the ceramic element.

A single crystal is cut from a slab of raw material. The thickness and the

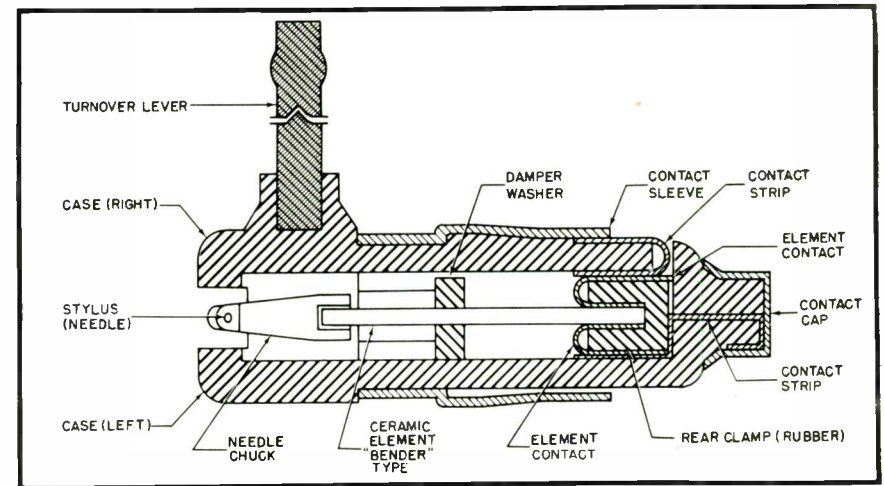

FIG. 2: TYPICAL BENDER CERAMIC ELEMENT type of turnover cartridge in American Microphone model B-810.

angle at which the crystal elements is cut determines its temperature coefficient, frequency response and other operating characteristics.

Unlike crystals, however, ceramic elements lend themselves to a wide variety of sizes and shapes. This makes it possible for the basic properties of the ceramic element to be controlled in the manufacturing process itself. A crystal does not have this advantage.

For increased output, two crystal or ceramic plates are frequently connected together and operated in series or parallel. Crystals are generally connected in parallel because higher sensitivity results from the same voltage applied to each plate. Parallel connection also provides maximum capacitance.

## Moisture Protection

Rochelle salt crystals are soluble in water, and when exposed to high humidity, the crystal tends to dissolve

at the moist surface. The salt crystal forms a *salt solution* which is conductive and shorts out portions of the crystal. Under severe moisture conditions, the crystal may become permanently damaged.

## Checking Output Loss

Should the crystal be exposed to excessively dry conditions, the crystal will also lose its *water of crystallization*. Both of these conditions are avoided by potting the crystal in some compound such as silicon grease, oil, or a protective coating applied directly to the crystal. Protected crystals rarely fail because of moisture and are not a servicing problem.

If there is a loss of gain in the phono system and the cartridge is suspected, it can easily be checked with a *vtvm* and an average phonograph record (Fig. 3). Of course the reading will not be at all consistent due to the music on the record, but it will indicate whether the cartridge is putting out a substantial voltage or not.

Another method is to use a test record (available from most record manufacturers) and compare with the cartridge manufacturer's specifications on the cartridge in question. If possible, use the same record as specified since test records are recorded at different velocities.

To test frequency response, a test record, a *vtvm*, a cartridge and tone arm, and turntable are required. The units should be connected as

(Continued on page 22)

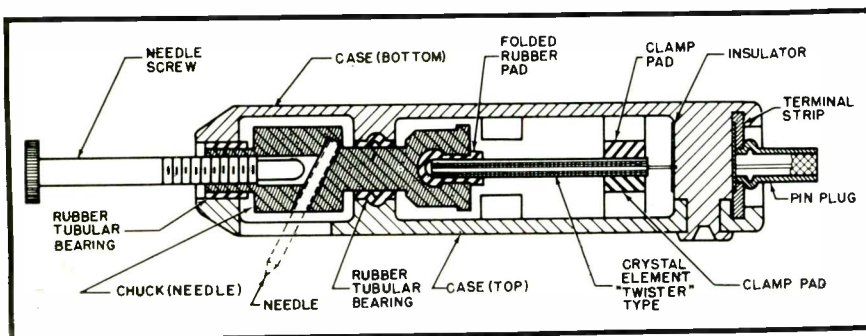

FIG. 1: TYPICAL TWISTER CRYSTAL ELEMENT type of cartridge in American Microphone model CR-1 pickup cartridge assembly.

# High Fidelity in Public Address Systems

by VICTOR BROCHNER

Staff Consultant, University Loudspeakers, Inc.

PUBLIC ADDRESS SPECIALISTS and Service Men would do well to consider the impact of the popularity of high fidelity on the PA market. The increasing demand for quality sound opens up new opportunities for installation of hi-fi PA, sound reinforcement, and music distribution systems, for rentals and particularly for renovation of installations that are being made obsolete by present-day requirements.

The application of hi-fi in systems used purely for public address should not be overlooked. Although intelligibility is the prime consideration here, it is by no means the only one. In installations other than those for military, police, or emergency purposes, it is also important that the sound be pleasant and not fatiguing to listen to, especially for extended periods.

The real field for hi-fi sound is certainly where PA is used for entertainment; that is, in combined announce and music systems, and in sound reinforcement. Some examples of this class of use for hi-fi sound are schools, churches, concert halls and similar applications.

## Hi-Fi Requirements

Now, what does hi-fi require in the way of equipment? Until fairly recently there was a wide difference between speakers for PA and those classed as hi-fi. The latter were not suitable for most hi-fi PA installations, while the former were definitely not hi-fi. Now, however, a series of speaker systems specifically designed for hi-fi PA is available. Before going into a description of these, let us consider what performance characteristics are desirable.

The first set of requirements that comes to mind is a frequency range of 20 cps to 20,000 cps, low distortion and wide dispersion. Now, this may represent ideal specifications for a home music system, but it does not necessarily follow that it applies to PA systems. Such performance may not be feasible economically or in terms of the space required, or even technically desirable.

Let us consider the technical aspect

further. Do we want good dispersion? Sometimes. But in some situations, a relatively narrow angle of dispersion may be needed to provide adequate penetration. Low distortion is of course also desired. But this requirement is not nearly as rigid in a PA system as it is in a home installation, where comparatively closeup, low-level listening is done. At high sound levels one can tolerate somewhat greater amounts of distortion, due to certain characteristics of the hearing mechanism.

As far as frequency range is concerned, let us first consider the bass end. For intelligibility in PA, a low-end cut-off of several hundred cps is customarily used. This is, of course, entirely unsatisfactory for music reproduction. On the other hand, it is

seldom necessary to reproduce frequencies as low as those demanded by the audiophile in his home. This is partly due to the enhancement of the bass by reverberation in auditoriums or halls having little absorbing material.

## Low-Frequency Response

What this all adds up to is, simply, that good response down to the 50-150 cps range will provide extremely satisfying performance, at moderate cost, in reasonable space. Moderate low-frequency requirements put much less of a burden on the amplifier, in which the cost of power at very low frequencies comes high.

The high frequencies contribute a great deal to a sense of realism. Most good PA speakers have good treble response; extended range is designed into special hi-fi PA speakers.

What kind of speakers are required to accomplish the required results? Several typical units of varying size are illustrated in Fig. 1. Note that all

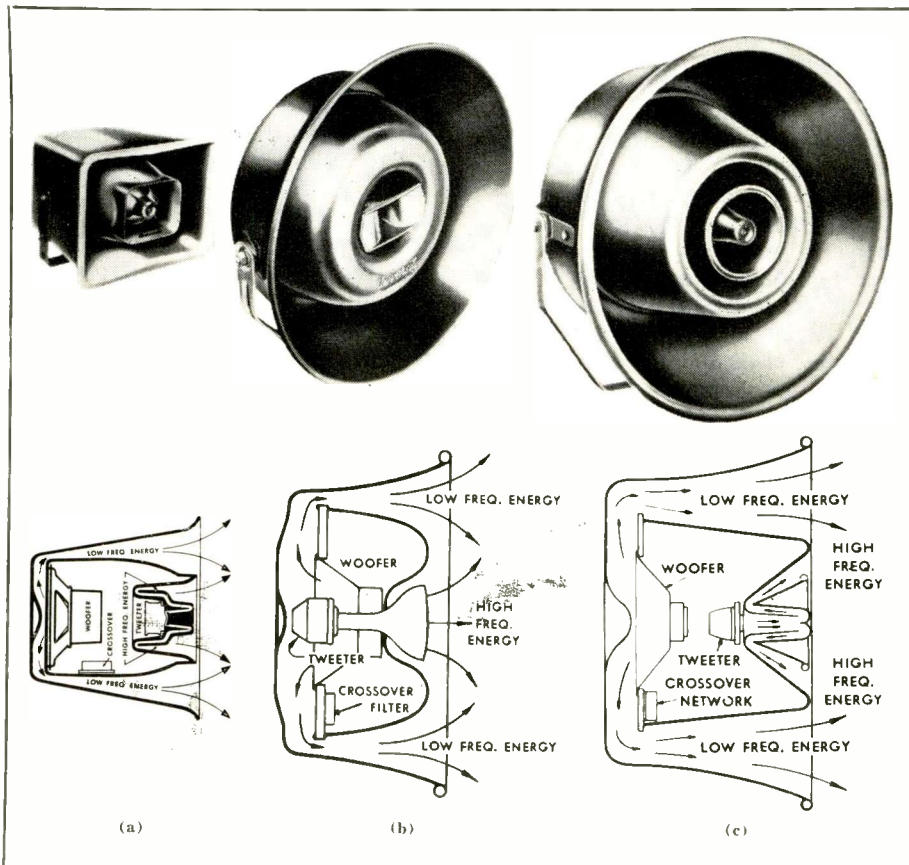

FIG. 1: FRONT AND CROSS-SECTION VIEWS of three coaxial speakers designed by University for high fidelity PA systems. The model MLC (Fig. 1a) handles 15 watts and is 12 $\frac{3}{4}$ " x 9 $\frac{1}{8}$ " x 10 $\frac{5}{8}$ " deep. Fig. 1b is the model BLC rated at 25 watts and measuring 22 $\frac{3}{4}$ " in dia. by 9 $\frac{1}{4}$ " deep. The 30-watt, heavy-duty model WLC, 33 $\frac{1}{2}$ " in dia. and weighing 72 lbs., appears in Fig. 1c.



of them are horn types. This is important because horn speakers are characterized by high efficiency, and higher efficiency, in turn, means lots of sound in return for comparatively little input power. Since amplifier cost increases rapidly with power output, the fact that well-designed horn-loaded speakers have efficiencies several times as great as direct radiators is pretty important.

A typical high fidelity PA speaker<sup>1</sup> recently introduced is shown in Fig. 1a. The speaker is rated at 150 to 15,000 cps and useful output is obtained down to 80 cps with good audible bass response. Its rectangular shape is economical of space and facilitates stacking.

This speaker will handle 15 watts and at this power input will produce an output level of 117 db at a distance of 4 feet. It has a dispersion angle of 120°, weighs 10 lbs., and is 12½ in. wide, 9½ in. high, and 10½ in. deep. The speaker is a true two-way system consisting essentially of two folded-horn loudspeakers nested one within the other, with the low-frequency horn driven by a 6-inch woofer instead of the more usual single compression driver unit used for the entire range. The large diaphragm drives the low-frequency horn without excessive voice coil movement at very low frequencies, thus reducing distortion.

#### Closed Back Air Chamber

A closed back air chamber eliminates any possible interference due to back radiation from the woofer.

A crossover network provides two-way operation, and permits the high-frequency compression driver unit to operate without being impeded by the necessity for handling low frequencies. The horns themselves are molded of Fiberglas-reinforced epoxy resin and are weatherproof, non-resonant and shock-resistant.

Another coaxial speaker intended for applications requiring a more extended bass range appears in Fig. 1b. It is rated at 25 watts and has a frequency response of 70 to 15,000 cps. A level of 119 db at 4 feet is obtained with 25 watts of input. This weatherproof speaker is 22¼ in. in diameter and 9½ in. deep. Its dispersion angle is 120°.

A still larger coaxial-system speaker<sup>3</sup> is illustrated in Fig. 1c. This weatherproof, heavy-duty unit has a 30-watt rating and a range of 50 to 15,000 cycles per second. It has a 30-watt rating, 90° dispersion and ability to deliver a 120 db sound

<sup>1</sup>University model MLC.

pressure level at 4 feet with smooth, distortion-free response. It is 33½ in. in diameter, 20 in. deep, weighs 72 pounds and is weatherproof.

#### Amplifiers and Pickups

Now, how about the equipment to be used with these hi-fi loudspeakers? The old law about the chain being no stronger than its weakest link still applies. The amplifiers, the record or tape players, the microphones, and tuners used in hi-fi systems must be of good quality. This means that they must have adequate frequency range, low distortion and be free from peaks in response. But it is not necessary to go overboard. Most good PA amplifiers are suitable for hi-fi PA. The better crystal and ceramic pickups of moderate price that are now available, have good performance.

Turntable rumble will not be much of a problem, because the system response at rumble frequencies will be low. Constancy of speed and absence of flutter are definite requirements, however. Microphones need be little, if any, different from those customarily used in PA work. For

music reinforcement, the microphone response should be wide-range and smooth, to complement the performance of the amplifiers and speakers.

Placement of the speakers themselves should involve no problems that will be new to the experienced Service Man. Perhaps a little more attention will have to be paid to uniform sound distribution and to tonal balance between highs and lows.

#### Equipment Available

As far as the equipment for hi-fi PA is concerned, the situation can be summed up by stating that it is readily available, easily installed and involves no difficult problems. Hi-fi PA speakers can be used with much of the usual accessory PA equipment. In this day of increased competition, hi-fi PA gives the Service Man something new and different to sell, something that is in tune with a definite trend—improved sound—and something that will command a good price per installation.

<sup>2</sup>University model BLC.

<sup>3</sup>University model WLC.



AT LEAST THEY AGREE ON FIDELITONE—Competitive Radio-TV-Hi-Fi servicemen may disagree on tweeters and woofers but it's handshakes all around when it comes to phonograph needles. Every repair man knows that Fidelitone is first in the field of quality—preferred by his customers. Fidelitone's thirty-year reputation of leadership is your assurance of customer satisfaction and profitable repeat calls. Stock and sell the needles that most record buyers know and want. Ask your Distributor for Fidelitone.

## Fidelitone

Chicago 26, Illinois  
"Best buy on records"

# Analysis of Directional Couplers and Filters

by BEN H. TONGUE

President, Blonder-Tongue Laboratories

AT THIS TIME of the year, not only antennas but accessories such as couplers and line splitters assume a great importance for the Service Man. Two antenna couplers have recently been introduced which utilize high-impedance coiled transmission lines. In addition there are two new multi-section filters employing operating principles of great interest to the Service Man who installs antennas. A circuit analysis of each of these accessories is contained in this report.

## Four-Set Coupler

The circuit for the four-set coupler<sup>1</sup> is shown in Fig. 1. The double coil L1 is a coiled transmission line of 173-ohm impedance. Coil L1 actually consists of two windings, each of 23 turns of nylon-coated No. 22 wire. These coils are intermeshed sufficiently to produce enough distributed capacitance between them to produce a characteristic impedance of 173 ohms. The coils themselves produce the series inductance. The capacitance between the wires, insulated by the nylon, provides the shunt capacitance.

This transmission line, which is one-quarter wavelength in the low band and three-quarter wavelength in the high band, transforms the antenna impedance of 300 ohms to 100 ohms. Each TV set terminal has a 100-ohm resistor in series with it, making 400 ohms. The four 400-ohm TV set resistor combinations are connected in parallel to make a 100-ohm load for the quarter-wave transformer L1.

If no resistors were used, this would be a true impedance coupler. A true impedance coupler has only 6 db of loss, provided all the TV set loads are pure 300-ohm resistances. However, most TV sets off channel have very high mismatches and may

<sup>1</sup>Blonder-Tongue model A-104.

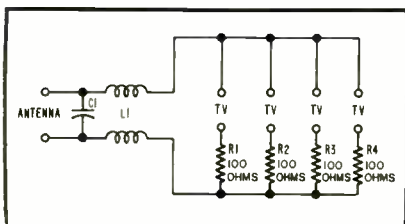

FIG. 1: CIRCUIT DIAGRAM of four-set antenna coupler.

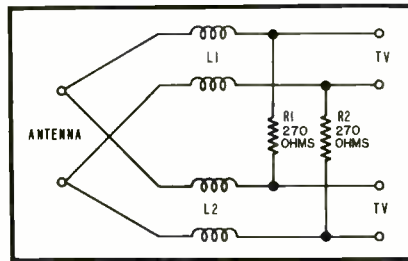

FIG. 2: SCHEMATIC DIAGRAM of two-set coupler with two high-impedance coiled transmission lines.

appear as open circuits or short circuits at certain frequencies. It is easy to see that a low impedance connected across any one of the TV terminals would short out the signal from all the others.

The 100-ohm resistors are added to produce about a 1½ db extra loss. They provide resistive isolation which prevents any one TV set from shorting the signal out of any of the other sets. The net result is a coupler which gives between 7½ and 8 db loss to each TV set and provides a high degree of isolation between TV sets.

## Two-Set Coupler

The two-set coupler<sup>2</sup> consists of two high-impedance coiled transmission lines. This time the two coils of each line are spaced further apart than in the four-set coupler. This reduces the distributed capacity between them and increases the characteristic impedance of the line to 420 ohms. The lines are one-quarter wave long and act as quarter-wave impedance transformers, transforming the impedance of each TV set from 300 ohms to 600 ohms. The two 600-ohm impedances are connected in parallel at the antenna terminals to present the antenna with a 300 ohm load.

If the antenna is a true 300-ohm matched source, and each TV set is of the same impedance, it may be seen from Fig. 2 that the two 270-ohm resistors absorb no power since they are across points of the same potential. The unit acts as a conventional impedance coupler giving only 3 db coupling loss. Isolation between TV sets is much higher than in the conventional impedance coupler be-

<sup>2</sup>Blonder-Tongue model A-102.  
<sup>3</sup>Blonder-Tongue model A-105.

cause of the directional coupling characteristics of the circuit.

To see this, assume that a voltage is applied to one of the TV terminals and the voltage appearing at the other set of TV terminals is measured. There are two paths for the signal to get from one pair of terminals to the other. One path is through the two 270-ohm resistors. The other path is through one coiled transmission line which is shunted with the antenna impedance and then through the other coiled transmission line. Since each transmission line is approximately one-quarter wave long, the signal passes through a half-wave length of transmission line, resulting in a 180-degree phase shift. The values of the resistors are such that the signals received through the transmission lines and through the resistors are of equal magnitude but are 180 degrees out of phase.

Theoretically, the two signals cancel and no signal is received at the second TV set. In practice, the antenna is not a pure 300-ohm source and the transmission lines are not always operated at exactly one-quarter wave length. The lines are designed to be one-quarter wave long in the center of the LO Band and three-quarter wave long in the center of the HI band. The isolation between TV sets varies between 12 db on channels 2, 6, 7, and 13 and up to 25 or 30 db on channels 4 and 10.

## High-Low Coupler

The high-band low-band TV coupler<sup>3</sup> (see Fig. 3) is a multi-section high-pass filter and a multi-section low-pass filter. The low-pass filter has a high frequency cut-off of 125 megacycles to pass channels 2 through 6 and FM. The high-band filter has a low frequency cut-off of 125 megacycles to pass channels 7 through 13. These filters are connected in parallel at the combined input in such a way

(Continued on page 23)

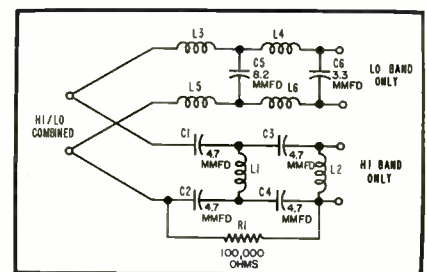

FIG. 3: HIGH-BAND LOW-BAND TV coupler circuit consisting of multi-section high-pass and low-pass filters.





## Save Time and Trouble by Standardizing on BUSS Fuses

**YOU'LL FIND THE RIGHT FUSE EVERYTIME... IN THE COMPLETE BUSS LINE**

By using BUSS as your source for fuses, you can quickly and easily find the type and size fuse you need. The complete BUSS line of fuses includes: single-element (both quick blowing and for normal circuit protection) and dual-element (slow blowing) types... in sizes from 1/500 amp. up — plus a companion line of fuse clips, blocks and holders.

**BUSS TRADEMARK  
IS YOUR ASSURANCE OF FUSES OF  
UNQUESTIONED HIGH QUALITY**

Over the past 43 years, millions upon millions of BUSS fuses have operated

properly under all service conditions. Thus, BUSS fuses have earned a reputation for accurate and dependable electrical protection.

To make sure this high standard of dependability is maintained... BUSS fuses are tested in a sensitive electronic device. Any fuse not correctly calibrated, properly constructed and right in all physical dimensions is automatically rejected.

**LET BUSS FUSES HELP PROTECT YOUR PROFITS...** The dependability of BUSS fuses helps you avoid 'kicks'

and complaints that the fuses you sold or installed failed to protect or blew needlessly. This safeguards you against costly adjustments and 'call-backs'. It pays to refuse to take a chance with anything less than BUSS quality in fuses.

For more information on BUSS and FUSETRON Small Dimension fuses and fuseholders... Write for bulletin SFB.

Bussmann Mfg. Division McGraw-Edison Co., University at Jefferson, St. Louis 7, Mo.

*BUSS fuses are made to protect — not to blow, needlessly*



BUSS MAKES A COMPLETE LINE OF FUSES FOR HOME, FARM, COMMERCIAL, ELECTRONIC, AUTOMATIVE AND INDUSTRIAL USE.

# When Converting Your Phono to Stereo...Use

## to Stereo...Use

### The ERIE AUDIO-AMPLIFIER KIT

featuring  
"PAC" and an ERIE  
Printed Wiring Board

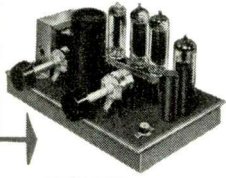
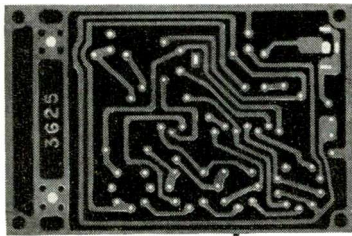
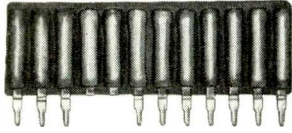

MODEL  
PAC-AMP-1

#### With these Plug-in Components:

- ERIE "PAC" (Pre-Assembled Components)
- ERIE PRINTED BOARD
- OUTPUT TRANSFORMER
- FILTER CAPACITOR
- VOLUME CONTROL and SWITCH
- TUBE SOCKETS
- CAPACITORS
- TONE CONTROL
- TUBES

#### SPECIFICATIONS FOR ERIE STANDARD AUDIO-AMPLIFIER

- Frequency Response: 30 cycles to 12,000 cycles +0, -3.5 db.
- Sensitivity: 0.56 volt RMS (input of 1 KC) for 2 watt output.
- Power Output: 2 watts • Input Impedance: 2 megohms.
- Output Impedance: 4 ohms • AC Power Consumption: 17 watts.
- Overall Dimensions: 6 3/4" L x 4 1/8" W x 3 7/8" H • Shipping Weight: 2 lbs.

See and hear it at  
your local distributor  
or *Write* for  
nearest source.



## Crystal Pickup Servicing

(Continued from page 17)

shown in Fig. 3. Measure the voltage at each frequency from 50 to 10,000 cycles and plot on semi-log paper with frequency along the horizontal axis and output voltage along the vertical axis.

A tolerance of  $\pm 3$  db is typical of most phono cartridges on the market selling for under \$10.00.

### Needle Replacement

Needles should be replaced whenever a noticeable *flat* is worn on the point. This *flat* will cut into the records and shorten their life considerably. The needle should be checked under a microscope.

The life of the needle is difficult to pin down as it depends to a great extent on the condition of the records played and also on the type of records. On records cut with high recording velocities, the needle will not last as long as if they were cut at lower velocities.

The average recording velocity on today's good records is about 6 centimeters per second, but this is often greatly exceeded, depending on the music content. These high velocities will have their effect on the needle. Of course, needle life also depends on the weight of the pickup.

The material of which the needle is constructed is the most important factor in determining its quality and life expectancy. Thus a diamond needle is good for approximately 8,000 playings, while a sapphire begins to show wear after 200 plays and osmium after only 20.

These figures cannot be construed to be exact, however, as each playing condition is different and too many variables are involved.

The best thing for the Service Man to do is to try to educate his customers to have their needles checked periodically, and sell them on the idea of regular replacement to save their records and to provide quality sound.

# MORE ACTIVE! EFFECTIVE!



**KESTER**  
**"RESIN-FIVE"**  
**CORE**  
**SOLDER**

**THE BEST FOR TV-RADIO WORK . . .**  
**EVERYTHING ELECTRICAL**—Kester "Resin-Five" Core Solder is better and faster than any solder ever developed. It has an activated flux-core that does a perfect job on all metals including zinc and nickel-plate. The flux residue is absolutely non-corrosive and non-conductive.

Available in all practical Tin-Lead Alloys; 40/60, 50/50 and 60/40 in diameters of 3/32", 1/16", 3/64", 1/32" and others.

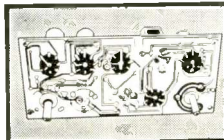

**Printed Circuit Soldering**  
On Copper-etched boards use 60% Tin - 40% Lead Alloy . . . for those that are Silver-surfaced use 3% Silver-61 1/2% Tin-35 1/2% Lead

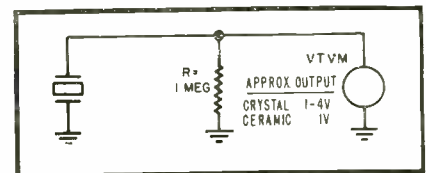

**FIG. 3: TEST CIRCUIT** for checking output loss and frequency response in phono cartridges. Load resistor is not required for output test but is advisable for checking frequency response.

## KESTER SOLDER COMPANY

4248 Wrightwood Avenue, Chicago 39, Illinois • Newark 5, New Jersey, Brantford, Canada



## Antenna Couplers

(Continued from page 20)

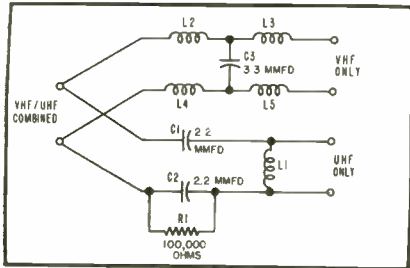

**FIG. 4: CIRCUIT OF VHF/UHF COUPLER** is similar to high-band low-band unit except that each filter has fewer sections.

that the input impedance of one filter acts as the appropriate terminating reactance of the other filter.

The basic low-band filter consists of a shunt C, series L, shunt C, series L, shunt C network. The shunt C at the HI-LO combined terminals is provided by the two capacitors C1 and C2. In the low-band the reactance of inductance L1 is low and may be neglected. The high-band filter consists of a shunt L, series C, shunt L, series C, shunt L network. The shunt L at the HI-LO combined terminals is provided by L3 in series with L5. In this case, in the high band the reactance of C5 is so low that it may be neglected.

### UHF/VHF Coupler

The UHF/VHF coupler\* is similar to the high-band low-band VHF unit except that each filter has fewer sections (See Fig. 4). The VHF filter is a low-pass filter of the shunt C, series L, shunt C, series L, shunt C variety. The shunt capacitor at the VHF terminals is provided by the stray capacitance between the terminals. The shunt C at the combined UHF/VHF terminals is provided by C1 in series with C2. At VHF frequencies the inductive reactance on L1 is very low.

The UHF filter is of the band-pass variety consisting of a parallel LC in shunt with the input, a series LC as the series connected element and a parallel LC across the output terminals. L1 and the distributed capacitance across the UHF terminals provide one parallel LC. L2 in series with L4 in combination with a stray capacitance across the UHF/VHF terminals provides the other parallel LC. C1 and C2 in combination with their series lead inductance provide the series LC circuit. The cut-off frequency of the VHF filter is about 300 megacycles. The low-frequency cut-off of the UHF filter is also 300 megacycles, while the high cut-off is about 1000 megacycles.

\*Blonder-Tongue model A-107.

look what **\$24<sup>50</sup>** buys  
in test equipment!

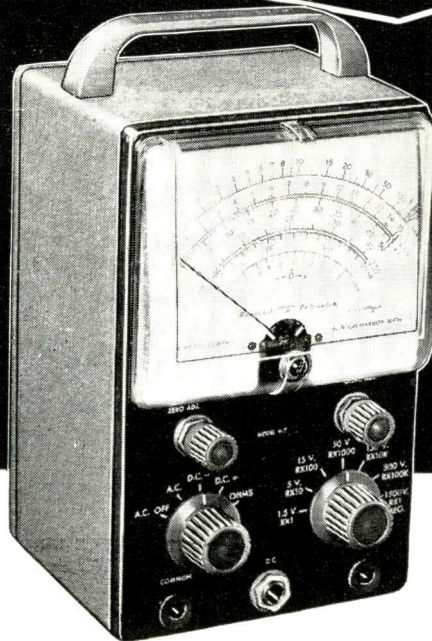

**HEATHKITS  
GIVE YOU  
TWICE AS MUCH  
equipment for  
every dollar  
invested**

The famous model V-7A Vacuum-Tube-Voltmeter is a perfect example of the high-quality instruments available from Heath at 1/2 the price you would expect to pay! Complete, only **\$24<sup>50</sup>**

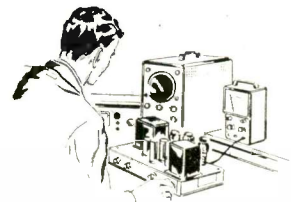

Get the most out of your test equipment budget by utilizing HEATHKIT instruments in your laboratory or on your production line. Get high quality equipment, without paying the usual premium price, by dealing directly with the manufacturer, and by letting engineers or technicians assemble Heathkits between rush periods. Comprehensive instructions insure minimum construction time. You'll get more equipment for the same investment, and be able to fill your needs by choosing from the more than 100 different electronic kits by Heath. These are the most popular "do-it-yourself" kits in the world, so why not investigate their possibilities in your particular area of activity! Write for the free Heathkit catalog now!

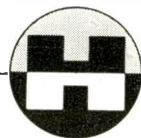

Contains detailed descriptions of Heathkit models available, including VTVM's, scopes, generators, testers, bridges, power supplies, etc.

**FREE catalog**

Mail coupon below for your copy—Now!



Also describes Heathkit ham gear and hi-fi equipment in kit form. 100 interesting and profitable "do-it-yourself" projects!

**HEATH COMPANY**  
A SUBSIDIARY OF DAYSTROM, INC.,  
BENTON HARBOR 11, MICHIGAN

Name \_\_\_\_\_

Address \_\_\_\_\_

City & Zone \_\_\_\_\_

State \_\_\_\_\_

# New Signal Generator For Color Servicing

by HOWARD JENNINGS

VERSATILITY IN LABORATORY or bench test equipment makes more rapid, efficient and economical use of the Service Man's time. A good example of the equipment manufacturer's attempt to incorporate this feature in his product may be found in a new signal generator<sup>o</sup> which has recently been introduced. This multi-purpose test unit is actually a combination *rf* signal generator, *af* generator, horizontal and vertical bar generator, cross-hatch generator, dot pattern and marker generator.

All these functions are incorporated in a single circuit which utilizes one half of a 12AT7 tube as an *rf* (Hartley) oscillator which is plate modulated by the other half of the 12AT7. (See Fig. 1.) This tube receives its drive from a 6C4 400-cycle (Hartley) oscillator or from the output of an astable multivibrator (6J6) operating as a variable audio generator with peaked wave output. This tube also functions as the horizontal bar generator. Another 6J6 working as a multivibrator is the vertical bar generator.

The *rf* signal generator provides the various frequencies required to align the intermediate and radio fre-

quency sections of conventional AM broadcast and short-wave receivers. Alignment of FM receivers incorporating discriminator or ratio detector circuitry is readily accomplished.

The range of frequencies covered is from 100 kc to 60 megacycles in five bands and from 45 megacycles to 180 megacycles on harmonics. Three output ranges are provided; low, medium and high. Each of the three levels is individually controllable by means of the calibrated *rf* attenuator. The *rf* is available separately (unmodulated) or modulated by the built-in 400-cycle sine wave oscillator. The *rf* may also be modulated by the internal 300 to 20,000 cycle variable audio oscillator, or by any external modulating source injected into the unit through the *external modulating* jack.

The audio frequency generator provides the frequencies required to test and check audio amplifier performance and video amplifiers as well. With an oscilloscope as an indicating device, distortion in an amplifier can readily be determined by observation of waveforms throughout the system. Frequency response of speakers, turns ratio of transformers and impedance of reactive circuits may be evaluated.

The horizontal and vertical bar generator section is used to produce equally spaced bars across the face of the television picture tube. These bars

are used for adjustment of the linearity controls. The linearity check may be made by feeding an *rf* signal, modulated by either the horizontal or vertical bar generator, directly into the antenna. The TV receiver should be perfectly tuned to channel 2, 3, 4 or 5. By adjustment of the *variable audio* control to a frequency between 600 and 2000 cycles, an adequate number of horizontal bars can be obtained. Adjustment of the vertical linearity controls for equal spacing between bars completes the alignment. This method also permits localization of troubles in the tuner section of the TV receiver.

Synchronization for the vertical bar generator is obtained by connecting the clip end of the sync lead around the insulation of the lead coming from the *hot* side of the horizontal output transformer of the receiver to the deflection yoke of the picture tube. The tip end of the sync lead goes into the tip jack marked *Sync*. The *Freq* knob is then adjusted until the vertical bars come into synchronization with the receiver. Both of the procedures outlined above may also be accomplished by feeding the signals directly into the video amplifiers.

The crosshatch function is accomplished by feeding the outputs of both vertical and horizontal bar generators to the receiver simultaneously. The resulting pattern may be used for adjustment of the linearity and focus and for correct positioning of the ion trap.

With the function switch set to *White Dots*, the crosshatch function is modified to produce a pattern of sharp white dots on the face of a color picture tube. Convergence voltages may be properly adjusted by observing the pattern as displayed.

Another feature of this test unit is incorporated in its marker generator section. A marker generator is used in conjunction with a sweep generator to locate specific frequencies across the swept band. This equipment includes the most frequently needed marker points which are required in the servicing of AM, FM and TV receivers, both color and black and white.

By proper use of this piece of test equipment, the average test bench set-up can achieve greater amount of flexibility than with any assortment of *home-brew* companion pieces that are so frequently seen surrounding an *rf* signal generator.

<sup>o</sup>Superior Instruments Co. Genometer model TV-50-A.

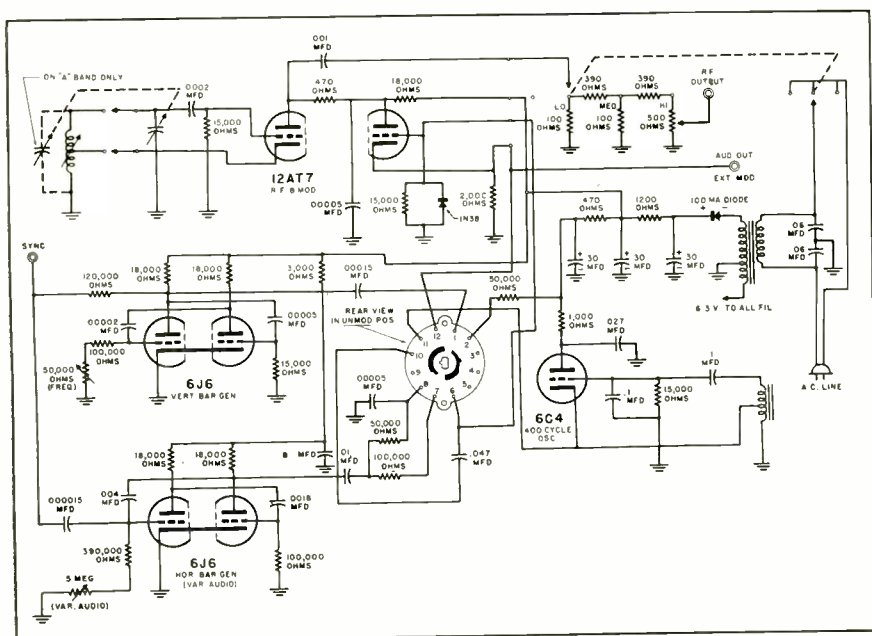

FIG. 1: CIRCUIT DIAGRAM of model TV-50-A manufactured by Superior Instruments Co.



## School Roundup

(Continued from page 16)

and data of interest, such as the frequency and amplitude of the ripple, can be written directly on the panel with an ordinary grease pencil. The effects of various troubles are easily demonstrated by merely replacing various components with others which are defective. At the conclusion of the lecture, the instructor gives a short oral quiz on the material covered.

Later, in the laboratory, the student performs an experiment designed to bring out the features discussed in the lecture. Using a laboratory circuit analysis chassis, the student demonstrates to himself the principles, including such items as ripple voltage, and, after completing the experiment, receives practical experience in troubleshooting.

In this same manner, other circuits and groups of circuits are taught, each building upon preceding circuits and becoming a part of the foundation for succeeding circuits. Such a procedure establishes the course as a complete unit rather than as a number of individual parts.

Other courses such as radar fundamentals can also be taught with the basic training devices. However, to increase their versatility and permit special topics to be studied, optional extra panels and chassis have been developed for such special topics as FM, sonar, and microwave studies.

## Technical Institutes Play Important Training Role

by R. ADM. D. M. AGNEW,  
U.S.N. (Ret.)

Vice President for Public Relations, Capitol Radio Engineering Institute

The 25th Annual Report of the Engineers' Council for Professional Development accredited one hundred and nine curricula of some thirty-five technical institutes. Of these specialized programs one hundred seven are listed as being by resident instruction, while two of them are offered by correspondence study. These thirty-five leading technical institutes provide the means whereby the ambitious serviceman may, by his own initiative and effort, up-grade himself.

The electronics Service Man or artisan will probably continue working with his hands in the capacity of journeyman unless and until he has sufficient ambition and initiative to provide his own self-motivation to something better. Such advancement or up-grading doesn't "just happen." It always has to be planned, and invariably it must be self-executed.

Any individual with sufficient ambition for self-improvement can probably generate the necessary motivation. Also it is probably equally true that anyone with the necessary self-motivation can find the means to effect the training or to acquire the education needed. It is only in the matter of time to effect it that

(Continued on page 37)

# An Unadulterated Statement To All Radio And TV Servicemen

I'm calling this an "unadulterated" statement because my employers have promised me that what I want to say will be printed exactly as written by me, not "gobbledygooked" up by some fancy-writing advertising agency.

My name is Shephard Litt. For the past 25 years I have been designing test equipment—everything from the simplest kind of a continuity tester through specialized equipment for Army, Navy and Air Force contracts during World War II and finally the TV Test Equipment produced by my employers, Superior Instruments Co.

This first and probably last piece of writing I will ever attempt is in regard to the Model TV-50A Genometer described in this issue. I'm not concerned with the price, that is decided by management. But, I do know everything there is to know about the design of the tester. I should—it represents the experience and know how I have acquired in 25 years of real hard work and application in my highly specialized field.

The TV-50A is not simply a Signal Generator slightly modified to provide the other many services. Each and every one of the services—R.F., A.F., Bar Generator, Cross Hatch, Dot Pattern and Marker—yes, each of the services can stand on its own.

You'll have no trouble when you use the R.F. service to align the R.F. and I.F. sections of radio and TV receivers. For I use a dual triode, employing one section as a modulator and isolation stage. This prevents interaction between the receiver being aligned and the signal generator itself—a common cause of trouble.

The 400 cycle tone is used primarily for modulating the R.F., but because of its almost perfect sine wave, it may also be used for oscilloscope analysis in testing Hi-Fi amplifiers.

Now about the variable audio service. I can honestly say I was amazed when I found what could be accomplished with the variable 300 to 20,000 cycle audio generator section. Here I purposely use a spiked wave form, rich in the harmonics I wanted for the ever recurring problem of distortion in Hi-Fi amplifiers. The sine wave I tried first didn't work out nearly as well because the spiked wave is actually closer to the wave form produced by music and voice.

I guess color TV is here to stay, so I paid proper attention to the color TV services. I found after much experimentation that two 6J6's in a multi-vibrator circuit gave me the best results for the bar generator and cross-hatch section. You can spend hundreds of dollars for equipment to adjust linearity, yoke and ION traps in TV receivers—yet I claim the stable cross hatch and bar patterns provided by TV-50A will give you equally good results, and much quicker.

I need make no apology at all for the color dot generator section. Here again you can pay more for a dot generator than for the complete TV-50A Genometer. Compare both. I feel sure you'll be convinced in favor of the TV-50A after you do so.

I personally have never cared for marker generators because use of this service necessarily requires a complex involved set-up. Most of the time F. M. and TV alignment problems can be resolved in simpler manner but there are instances when a marker generator is necessary and I, therefore, did include that service in the Model TV-50A Genometer

Sincerely,

*Shephard Litt*  
Shephard Litt

(Advertisement)

# Safeguarding Tube Life and Reliability

by DAVID SASLAW  
Engineering Department, Amperex Electronic Company

IN RECENT YEARS a great deal of attention has been given to the need for reliability of components for military applications. We can all understand the need for a high degree of reliability in military equipment. However, the use of reliable replacement tubes and components for commercial service and repair work is equally important.

The use of reliable tubes builds confidence in your integrity and increases your reputation. All tube manufacturers mark their premium quality tubes with some distinguishing symbol and have gone to great expense to advertise the significance of this symbol. When your customer sees that you use these premium quality tubes he will be inclined to feel that your service is premium quality also.

In addition to prestige, however, there are some very real financial rewards to using premium-quality reliable tubes. The most direct and significant gain will be the reduction in call backs due to tubes which fail in a short period of time. These call backs are costly both in time and in good-will.

In a practical sense, when we speak of reliability in relation to a tube we are talking about the amount of useful life we can obtain from it. Useful life, of course, means the amount of time wherein the tube characteristics remain fairly constant, although as can be seen from the life curve given in Fig. 1 the characteristics actually taper off gradually. To be more precise, however, tube reliability is de-

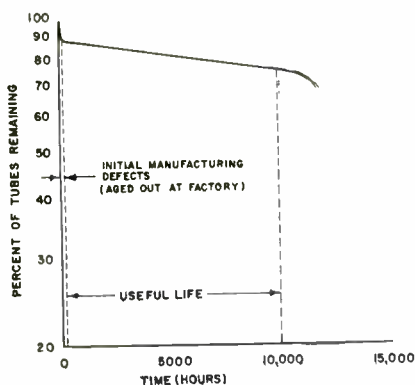

FIG. 1: IDEALIZED LIFE CURVE shows the rate at which tube failures occur among a large batch of tubes after a given number of hours of operation.

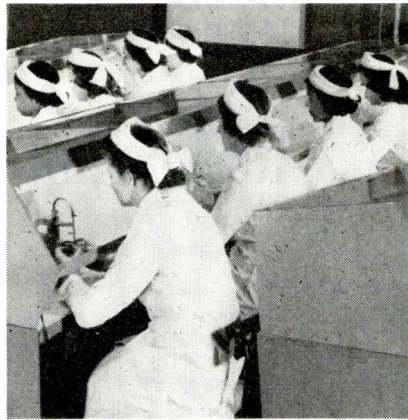

FIG. 2: TUBE ASSEMBLERS at Amperex plant work under hoods in air conditioned rooms. Dacron coats are worn to prevent dust from clothing settling on the tube components.

finied in terms of the failure rate, that is the rate at which tube failure occurs in a large batch of tubes. Perhaps one of the best ways of understanding reliability is to observe what the tube manufacturer does to increase reliability and decrease the failure rate.

## Two Types of Failures

The failures that vacuum tubes are subject to can be divided into two categories, sudden failures and gradual failures. In general, the sudden failures can be attributed to manufacturing problems, while the gradual failures are due to normal wear and tear of components.

Sudden failures may be due to broken connections, short circuiting between electrodes, cracks in the glass and heater-cathode insulation breakdown. In vacuum tubes, practically all broken connections occur at or near welds. Tube manufacturers have done extensive research into welding techniques to improve the quality of a spot weld by controlling the manufacturing process more closely. Factors checked include the pressure on the weld, the time of the current cycle, the shape and surface of the electrodes, and the atmosphere in which a joint is made.

Short circuits due to direct contact between two electrodes are easy to detect during production and are, therefore, extremely rare. A much more difficult problem is the prevention of partial short circuits arising from foreign particles in the tube. These particles may be due to dust, metal particles, lint from clothing and similar causes.

To reduce these sources of contamination, the area in which tubes are manufactured is air filtered and air-conditioned. Assembly of the internal components is performed under hoods and the assemblers wear dacron laboratory coats to prevent dust from their clothing floating into the assembly area (see Fig. 2).

After the electrodes have been mounted on metal rods fused into a glass base, the base is sealed into a glass envelope on an automatic sealing machine. In order to insure reliability of the machine, each production run is preceded by a pilot run. After production is started, samples are taken every hour and tested thoroughly.

One type of failure that is due to a gradual process and yet occurs suddenly without any warning is the breakdown of the insulation between the heater and the cathode. The nickel tube of an indirectly heated cathode is heated to a temperature of 750-800°C by a tungsten filament, which operates at a temperature of about 1100°C.

In most cases the heater-cathode insulation does not have to satisfy very stringent requirements. For example, in a high-frequency amplifier with the heaters connected in parallel, the potential difference between the cathodes and the middle of the heater is only a few volts. It is quite another matter, however, in circuits where the heaters are connected in series or where the cathode is used as the output electrode and is at high potential with respect to ground. There is then the danger that the insulation will ultimately break down owing to grad-

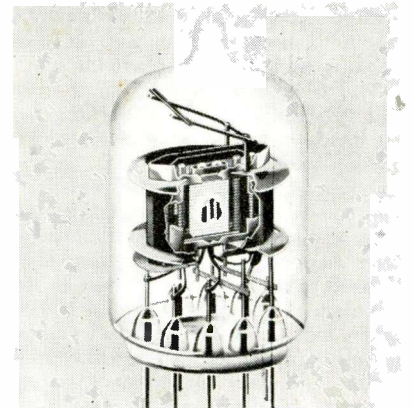

FIG. 3: FRAME-GRID CONSTRUCTION, shown in cut-away view of tube above, positions grid wires for optimum electrical function, greatly reduces microphonics and provides good heat dissipation.



ual electrolytic action. After a time, determined by the heater-to-cathode voltage and the temperature of the heater, the insulation between the cathode and the heater will suddenly break down, possibly resulting in a complete short circuit.

To counteract cathode-heater shorts in larger tubes, it is necessary to prevent contact between the cathode and the heater insulation. This method is used, for instance in booster diodes for television receivers in which peak voltages of many thousands of volts occur between cathode and heater. In smaller tubes, the method adopted is to coat not only the heater but also the inside of the cathode tube with a layer of alumina. It has been found that tubes with cathodes treated in this way function five to ten times longer before insulation breakdowns occur, or for the same equivalent life the heater-to-cathode voltage can be appreciably higher.

#### Gradual Failures

Gradual failure implies slowly declining emission (associated with a drop in transconductance and in output power), deteriorating insulation, and rising grid current. Gradual failures usually fall into two categories, cathode effects and migration of emissive material.

Most tubes have an indirectly-heated oxide-coated tubular cathode. A tungsten wire inside the tube heats the cathodes and causes emission of electrons from the cathode. High emission is dependent on the oxide mixture having precise amounts of free barium atoms present. During operation, however, certain processes take place in the tube that tend to decrease this quantity, resulting in a gradual decline in emission. The processes are of two kinds, poisoning and evaporation.

Poisoning of the cathode may be due to residual gas or the release of various absorbed compounds under electron bombardment.

To reduce poisoning effects, the electrodes and shields are placed so that no electrons will strike the glass or mica, components are kept scrupulously clean and the assembly area is kept dust-free.

The cathode temperature rating is kept as low as possible while still allowing a safety margin for heater voltage fluctuations.

Material evaporating from the cathode forms a conducting film on the mica spacers, the glass base of the tube and on the control grids. The use of passive cathode material, keep-

ing the cathode temperature as low as possible, and applying a coating of magnesium oxide on the mica spacers decrease these failures.

Differences in electrical characteristics among various tubes manufactured at the same time can usually be traced back to small variations in the dimensions or clearances between electrodes. As a major step in solving this problem, Amperex has pioneered the development of the frame-grid construction (see Fig. 3). In this construction, the grid wires have a purely electrical function. The mechanical function is fulfilled by a

sturdy frame consisting of two molybdenum rods separated by four jig-located, spot-welded molybdenum strips. Very thin tungsten wire is then wound tightly around the frame.

With this tight winding, the grid wires are positioned for best electrical function and to greatly reduce the sensitivity of the grids to microphonics. An additional advantage of the frame-grid construction is the excellent heat dissipation characteristics because of the relatively large mass of the molybdenum rod.

The enormous increase in the use  
(Continued on page 36)

No. 7 of a series of questions for progressive technicians

## Can You Handle This Problem?

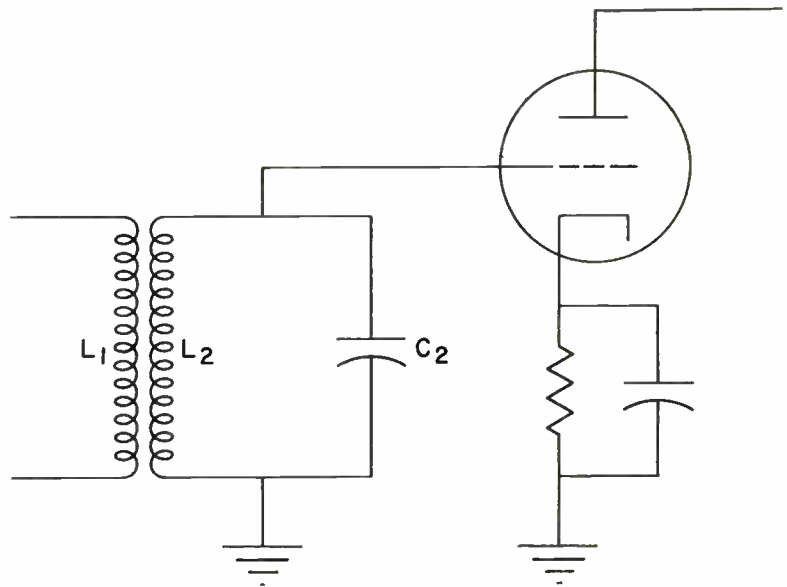

No circuit is in more common use than the simple tuned grid circuit, the components of which are designated by  $L_2$  and  $C_2$  in the figure.

But Is It A Parallel Circuit Or A Series Circuit?

## What do you think?

For a complete answer, without obligation, fill out the coupon below and send it to the address shown.

Cleveland Institute of Radio Electronics

4900 Euclid Avenue, Dept. S-14, Cleveland 3, Ohio

Successful  
Electronics  
Training

Please send me detailed solution to problem above and information on how I may prepare for the increasing opportunities in electronics. There is no obligation.

NAME .....

ADDRESS .....

CITY ..... ZONE ..... STATE .....

Accredited by The National Home Study Council

S-14

**NOW . . . Check Vibrators  
In ANY Tube Checker**

**Another Sencore Time-Saver**

**"VIBRA-DAPTOR"**

MODEL VB-2

**2 ADAPTORS IN**

**Checks Both Three and Four Prong Vibrators**

• Merely plug into any tube checker. Set for 6AX4 (or 6SN7) for 6 Volt Vibrators and 12AX4 (or 12SN7) for 12 Volt Vibrators.  
• Two lamps viewed through top of adaptor indicate whether or not vibrator needs replacing.  
• Replaceable but unbreakable #51 indicating lamps.  
• Operates easily with Sencore LC2 Leakage Checker.  
• Complete instructions screened on front.

**ONLY \$275**  
DEALER NET

**POPULAR SENCORE PRODUCTS**

- Transistor Tester
- Leakage Checker
- Filament Tester
- Handy "36"
- Vibra-Daptor

At leading distributors everywhere

MANUFACTURED BY **SERVICE INSTRUMENTS CORP.**  
171 OFFICIAL RD. ADDISON, ILL.

repairing P. A.  
for the right replacement



you'll find it  
faster in the

**MASTER**

new 1958 edition—world's largest electronic catalog only \$3.50 at your local parts distributor—now

**THE RADIO-ELECTRONIC MASTER**  
60 MADISON AVE., HEMPSTEAD, N. Y.

## Technical Books and Manuals

From John F. Rider Publisher, Inc., 116 W. 14th St., New York 11, N. Y.

**Basics of Digital Computers.** A three-volume picture-book course covering the fundamental principles of digital computers. Each page is devoted to a single concept together with at least one clear illustration of the text material. Volume one covers the development of computers from ancient times and then furnishes a solid background in digital computers explaining binary data representation, computer arithmetic, programming and control. Second volume introduces the combination of circuit components which together form a logical unit and highlights the elemental uses of vacuum tubes, crystal diodes and magnetic cores in digital computers. Then examples of the combined use of logical units and elemental circuits are given. Volume three deals with the major logical systems in a digital computer and thoroughly explains the processes of storing and transferring data within the computer. Input-output units are also discussed. Details of memory, timing pulses, control and other units are applied to an explanation of the overall operation of digital computers.—priced at \$6.95 per set.

**Impedance Matching,** edited by Alexander Schure. Volume provides detailed information on how to obtain maximum power transfer between any type of generator and load. Impedance matching devices, power transformers, impedance matching at audio frequencies and at radio frequencies are a few of the areas covered. Discussion of the various resistive components of electrical and electronic circuits includes impedance matching in transistor circuits.—priced at \$2.90.

**Repairing Portable and Clock Radios** by Ben Crisses and David Gnessin. Text is primarily concerned with differences between portable and clock radios and conventional superheterodynes. A detailed analysis of the power supplies and switching circuits in AC/DC portable radios is made. Coverage includes transistorized units as well as standard tube types. Mechanical troubles, general troubleshooting, repair and replacements, alignment and design improvement are discussed. Information on clock mechanisms and their electrical connections, servicing instructions, cleaning and lubrication, and alarm and switch adjustments is included.—priced at \$2.75.

**Vacuum Tube Rectifiers.** Covers physical characteristics of rectifiers, single-phase rectifiers, polyphase rectifiers, output filter circuits and rectifier and filter design data. Theory and circuitry is given for half-wave and full-wave rectifiers, voltage-multiplying circuits polyphase rectification and filter circuits. Tables of tube characteristics supplement design theory discussed in the text.—priced at \$1.50.

From Supreme Publications, 1760 Balsam Rd., Highland Park, Ill.

**Most-Often-Needed 1958 Radio Diagrams and Servicing Information.** Contains large-size diagrams, alignment data, parts lists, voltage values, stage gain information, trimmer locations, dial stringing, chassis photos and service hints. For many models printed circuit boards are shown in phantom view for easy association with correspondingly connected parts. Covers all types of radios including combinations, record players, clock radios, FM, auto sets and transistor portables.—priced at \$2.50.

**Most-Often-Needed 1958 Television Servicing Information.** Contains circuit explanations, alignment data, test patterns, response curves, waveforms, voltage charts, chassis views, troubleshooting hints and large-size schematics.—priced at \$3.00.

From CBS-Hytron (through authorized distributors).

**Transistor Home Study Course** by A. C. W. Saunders. Features simplified basic theory with practical experiments and servicing techniques. 10-lesson course covers semiconductor theory, fundamental transistor circuitry, biasing methods for transistors, typical transistor amplifiers, push-pull transistor amplifiers, transistors in radio receivers, basic transistor oscillators, transistorized power supplies and transistor parameters. It is supplied with a correction and consulting service.

From McGraw-Hill Book Co., Inc., 330 W. 42nd St., New York 36, N. Y.

**Calculus For Electronics** by A. E. Richmond. Presents simultaneously the processes of calculus and their application to problems in electrical and electronic circuits. Beginning with fundamental concepts of calculus, book develops basic operations of differential and integral calculus and advances to such special topics as the complex exponential representation of a physical sinusoid, Taylor's expansion of functions of two independent variables, Fourier's series, and an introduction to differential equations. Application of calculus methods to television, radar, loran and transistors are also included.—priced at \$8.25.

From Sylvania Electric Products, Inc., 1100 Main St., Buffalo 9, N. Y.

**Performance Tested Transistor Circuits.** Booklet contains a variety of circuits plus information on how to build transistorized hi-fi components, test equipment, photo light meters, and special equipment such as burglar alarms and organ metronomes. In addition to a section on elementary transistor theory, there are 36 circuit descriptions, complete with schematic diagrams and parts lists.—priced at 35c.

(Continued on page 36)



# Association News

## TSA, King County, Washington

Fred T. Grant, regional manager for Westinghouse tubes, presented a short talk on the new Westinghouse customer brochure which explains the intricacies of television and the problems of service at a recent meeting of the King County Television Service Association. A color-slide tour through a Westinghouse tube plant was also presented. TSA has awarded *Friends of Service* designations to the following firms who do not operate retail departments, do not sponsor or promote captive service operations in competition with independent service, and have given statements of sales policies in writing to TSA which are consistent with the generally accepted function of a wholesaler or manufacturer: The F. B. Connelly Co., Capitol Electronic Supply, and Garretson Radio Supply, all of Seattle; and Tung-Sol Electric Company. Radiotel Service Company (*William Worden*) and Messer's TV Service (*Paul Messer*) have been accepted as new members of TSA.

## RTA, Pasadena, Calif.

Members of the Radio Television Association of Pasadena recently enjoyed a behind-the-scenes tour of engineering operations at the National Broadcasting Company's Burbank television studios. Close-up viewing of b-w and color studios and stages, gave a good once-over of cameras, lighting equipment, studio monitors and controls, film cameras, color cameras and video tape.

## ARTSNY, New York City

A ten-week course on color TV repair was recently conducted for members of the Associated Radio-Television Servicemen of New York. Instructor for the sessions was *Paul Goldberg*.

The group used an RCA 21CD8725 color set for classwork and found it to be one of the easiest to converge. It was also noted that the controls of this set are easily accessible.

At present ARTSNY is making plans for a series of technical lectures on all subjects of interest to members. The group has also made available to members the privilege of obtaining a course on any electronic subject, provided a minimum of 30 members request the class.

## TSADV, Philadelphia, Pa.

A milestone marking progress and advancement by the Television Service Association of Delaware Valley took place recently with the dedication of Settle Hall, a full-time service industry headquarters building at 4710 York Road, Philadelphia. The dedication address was delivered by *Ray H. Cherrill*, president of TSADV. *Mrs. Charles Settle*, widow of the former association leader for whom the building is named, unveiled a plaque and portrait dedicated to her husband. In a brief address, she paid tribute to the association for carrying on the work to which her husband had devoted most of his life.

*Harry Fallon* of Radio Electric Service Company also addressed the gathering and paid tribute to Mr. Settle and the service industry. Among those present at the ceremonies were *Richard Barnett* of Barnett Brothers; *Al Green* of Almo Radio Company; *Henry Lapinski* of Hot Point Appliance Company; *Al Steinberg* of Albert M. Steinberg and Company; and *Frank Schuslag* of Allied Electric Parts Company.

(Continued on page 40)

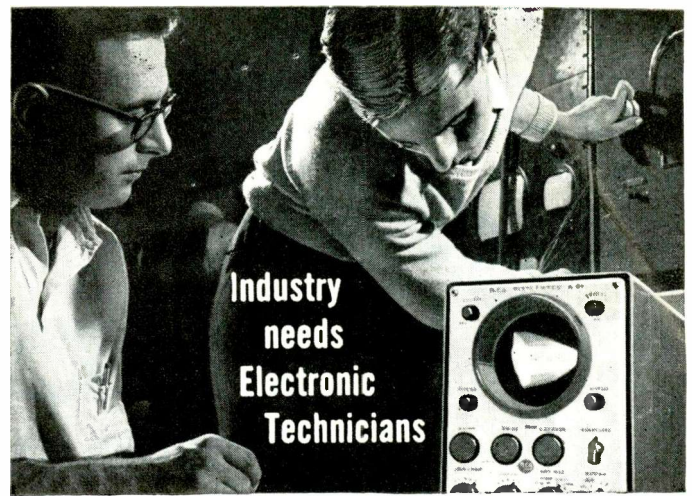

# Let RCA train you in Advanced Electronics

This is the college-level training you need to work with professional engineers on research, development or production projects in such fields as: automation, guided missiles, radar, television, computers and other advanced electronic applications. RCA Institutes Resident School in New York City offers this comprehensive course that prepares you for any field of electronics you may choose.

It's the blue ribbon course at RCA Institutes Resident School—among several to suit your inclination and ambition. Other courses in TV & General Electronics, Radio & TV Servicing, and Radio Telegraph Operating.

Classes start four times each year. Applications now being accepted. Approved for Veterans



## RCA INSTITUTES, INC.

School of Television and Electronic Technology  
A Service of Radio Corporation of America

RCA Institutes, Inc., Dept. S-78  
350 W. Fourth St., N. Y. 14, N. Y.

Please send me your FREE catalog of Resident School courses in N. Y.

Name.....  
Please print

Address.....

City..... Zone..... State.....

HOME STUDY Correspondence Courses also available in Radio-TV Electronics; TV Servicing; and Color TV. Catalog on request.



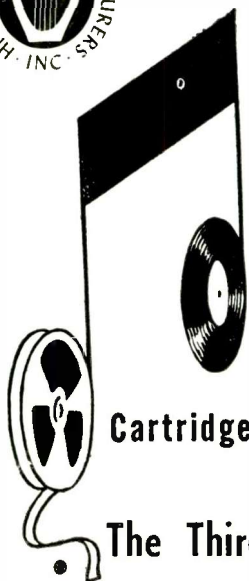

# AUDIO INSTALLATION AND SERVICE

Phono • Tape • PA  
Cartridges • Needles • Amplifiers • Speakers

The Third Dimension in Reproduced Sound

by R. S. LANIER

Audio Engineering Society\*

STEREO IS TAKING the sound industry by storm this year. The demonstration last fall of a practical method of putting two sound tracks into one groove on a disc started the rush. Practically all manufacturers are now making stereo models, and all the record makers will have stereo discs out by this fall. More stereo programs are planned for FM radio and even juke boxes will be stereo soon.

The Service Man will begin to feel the stereo flood around his feet by the end of this year. But a lot of his customers are going to be very confused shortly by the many different kinds of equipment being offered for stereophonic sound. A short review of history and technical fundamentals may be useful to Service Men getting braced for the stereo rush. Detailed information on the technical underpinning of stereo can be found in the lecture notes of the Audio Engineering Society.

The idea of stereo is very old. A public demonstration of stereo, using telephone equipment, was given in Paris in 1881. An experimental stereo radio program was put on the air in New Haven, Connecticut, in 1925 using two AM transmitters. Famous public demonstrations were given in this country by Bell Telephone Laboratories in 1933 and 1940. The

\*Based on a lecture on *Multi-Channel Sound Systems* delivered by Bruce P. Bogert of Bell Telephone Laboratories under the sponsorship of the Audio Engineering Society.

movies have used stereo sound commercially for many years. Stereo sound, however, should not be confused with stereo *sight*, or 3D as it was frequently called. But high cost and technical difficulty have kept stereo out of the home until stereo tape came in on a small scale a few years ago. Now with the stereo disc, a major turnover is taking place.

Stereo reproduction is the use of two or more simultaneous channels of sound to bring a kind of third dimension into reproduced music. This is much like the use of two pictures, taken simultaneously, to give the illusion of a third dimension in photography. In two-channel stereo, which is the kind we are now getting commercially, the two sound pickups are from different positions in the recording studio, producing somewhat different sounds in the two channels just as stereo photography takes two pic-

tures from slightly different positions. The two samples of sound are carried by the two channels, without mixing, all the way to two loudspeakers in the living room.

A two-channel disc stereo system, in other words, starts with two separate microphones in the recording studio; then utilizes two recording amplifiers, a dual recording cutter that puts two sound tracks on the record, a pickup that recovers the two separate sound channels from the groove, two preamplifiers, two amplifiers and two loudspeakers. This method of recording two sound channels by the commonly used 45-45 system is diagrammed in Fig. 1.

When all this equipment is used properly, from microphone to speaker, the stereo disc will seem to spread the instruments out across the room, each in its proper place. The sound will have *openness* and *depth*, a sense of space unlike anything one gets from a monaural record.

What is the technical background for this illusion of direction and space in the music? It all depends on the fact that we have two ears and a fantastic analytic system in our brains connected with them. First, we use our ears as direction finders. By "measuring" the difference in the time of arrival of a sound at the two ears, we can tell what direction a sound is coming from to within one or two degrees as shown in Fig. 2. This means that our hearing centers in the brain can measure intervals as short as 20 millionths of a second!

Not only differences in arrival time, but differences in phase (in sounds up to about 1500 cps) and differences in loudness produced by the shadowing effect of the head (at higher frequencies) give us information about the direction and character of a sound. Again, it is the difference between the sounds at the two ears that gives the

(Continued on page 32)

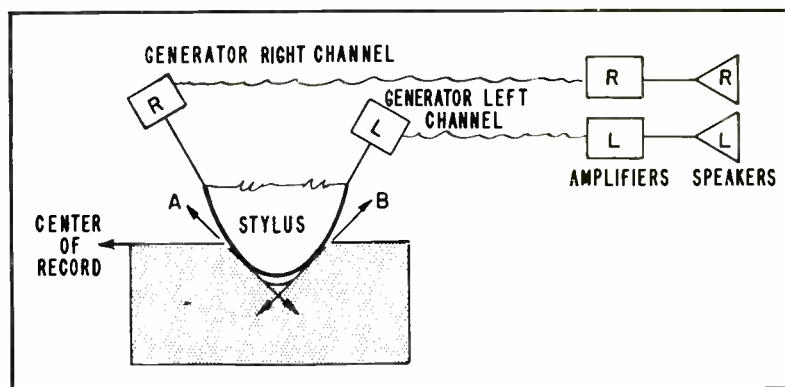

FIG. 1: STYLUS IN 45-45 STEREO moves along two lines at right angles to each other, and at 45 degrees to surface of record as shown above. Individual sound tracks from separate microphone placements are cut on each wall of the groove. Generator R, for right channel, responds to motions along Line A; generator L, for left channel, to motions on Line B.



Superior's New  
Model TV-50A

# GENOMETER

## 7 Signal Generators in One

- ✓ R.F. Signal Generator for A.M.
- ✓ R.F. Signal Generator for F.M.
- ✓ Audio Frequency Generator

- ✓ Bar Generator
- ✓ Cross Hatch Generator
- ✓ Color Dot Pattern Generator
- ✓ Marker Generator

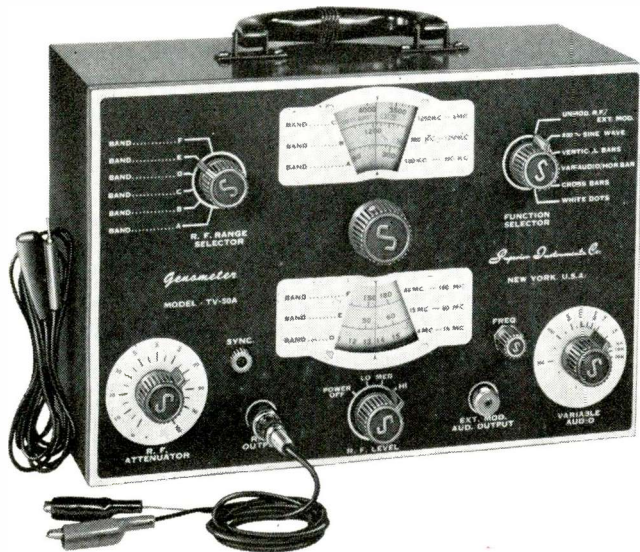

This versatile All-Inclusive  
**GENERATOR** Provides ALL  
the Outputs for Servicing:

- A.M. RADIO • F.M. RADIO
- AMPLIFIERS
- BLACK AND WHITE TV
- COLOR TV

### SPECIFICATIONS:

#### R. F. SIGNAL GENERATOR:

The Model TV-50A Genometer provides complete coverage for A.M. and F.M. alignment. Generates Radio Frequencies from 100 Kilocycles to 60 Megacycles on fundamentals and from 60 Megacycles to 180 Megacycles on powerful harmonics. Accuracy and stability are assured by use of permeability trimmed H-Q coils. R.F. is available separately, modulated by the fixed 400 cycle sine-wave audio or modulated by the variable 300 cycle to 20,000 cycle variable audio. Provision has also been made for injection of any external modulating source.

#### VARIABLE AUDIO FREQUENCY GENERATOR:

In addition to a fixed 400 cycle sine-wave audio, the Model TV-50A Genometer provides a variable 300 cycle to 20,000 cycle peaked wave audio signal. This service is used for checking distortion in amplifiers, measuring amplifier gain, trouble shooting hearing aids, etc.

#### BAR GENERATOR:

This feature of the Model TV-50A Genometer will permit you to throw an actual Bar Pattern on any TV Receiver Screen. Pattern will consist of 4 to 16 horizontal bars or 7 to 20 vertical bars. A Bar Generator is acknowledged to provide the quickest and most efficient way of adjusting TV linearity controls. The Model TV-50A employs a recently improved Bar Generator circuit which assures stable never-shifting vertical and horizontal bars.

#### CROSS HATCH GENERATOR:

The Model TV-50A Genometer will project a cross-hatch pattern on any TV picture tube. The pattern will consist of non-shifting, horizontal and vertical lines interlaced to provide a stable cross-hatch effect. This service is used primarily for correct ion trap positioning and for adjustment of linearity.

#### DOT PATTERN GENERATOR (For Color TV)

Although you will be able to use most of your regular standard equipment for servicing Color TV, the one addition which is a "must" is a Dot Pattern Generator. The Dot Pattern projected on any color TV Receiver tube by the Model TV-50A will enable you to adjust for proper color convergence. When all controls and circuits are in proper alignment, the resulting pattern will consist of a sharp white dot pattern on a black background. One or more circuit or control deviations will result in a dot pattern out of convergence, with the blue, red and green dots in overlapping dot patterns.

#### MARKER GENERATOR:

The Model TV-50A includes all the most frequently needed marker points. Because of the ever-changing and ever-increasing number of such points required, we decided against using crystal holders. We instead adjust each marker point against precise laboratory standards. The following markers are provided: 189 Kc., 262.5 Kc., 456 Kc., 600 Kc., 1000 Kc., 1400 Kc., 1600 Kc., 2000 Kc., 2500 Kc., 3579 Kc., 4.5 Mc., 5 Mc., 10.7 Mc. (3579 Kc. is the color burst frequency.)

The Model TV-50A comes absolutely complete with shielded leads and operating instructions. Only

**\$47<sup>50</sup>**  
NET

# SHIPPED ON APPROVAL NO MONEY WITH ORDER — NO C. O. D.

Try it for 10 days before you buy. If completely satisfied then send \$11.50 and pay balance at rate of \$6.00 per month for 6 months—No Interest or Finance Charges Added. If not completely satisfied, return to us, no explanation necessary.

MOSS ELECTRONIC DIST. CO., INC.  
Dept. D-508 3489 Tenth Ave., New York 34, N. Y.

Please rush one Model TV-50A. If satisfactory I agree to pay \$11.50 within 10 days and balance at rate of \$6.00 per month. If not satisfactory, I may return for cancellation of account.

Name \_\_\_\_\_

Address \_\_\_\_\_

City \_\_\_\_\_ Zone \_\_\_\_\_ State \_\_\_\_\_

All prices net. F.O.B., N.Y.C.

# ANOTHER ADVANCE FROM SONOTONE

—world leader in ceramic cartridges:

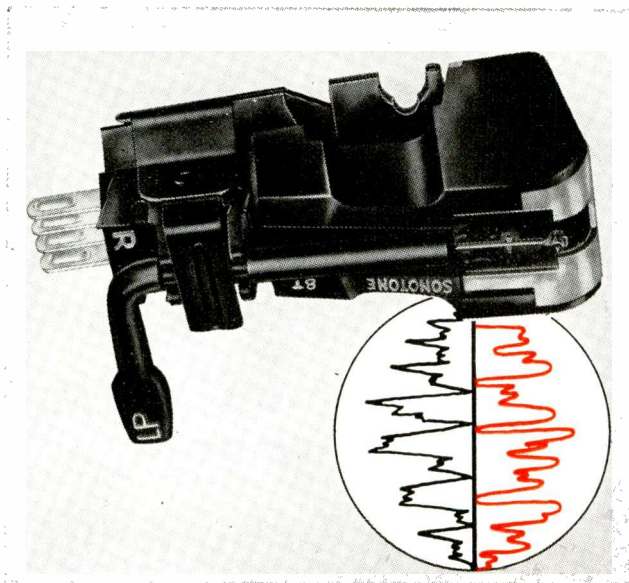

## STEREO MODEL 8T COMPATIBLE CERAMIC CARTRIDGE

*Plays both stereo and regular discs!*

- Opens the door now to the biggest equipment boom since LP!
- Plays all 4 speeds—does *not* obsolete present equipment!
- Has Sonotone's unique, built-in vertical rumble suppressor so vital to stereo use! Doesn't need pre-amp!
- Famous Sonotone quality with top specifications!

<b>The best thing that's happened to stereo discs!</b>		<b>Priced at only</b>	
Response .....	Smooth from 20 to 12,000 cycles, gradual rolloff beyond.	<b>\$14<sup>50</sup></b>	LIST
Output Voltage .....	0.3 volt.		sapphire
Compliance .....	$2.0 \times 10^6$ cm/dyne.	<b>\$24<sup>50</sup></b>	
Recommended Load .....	1-5 megohms.		
Tracking Pressure .....	5-7 grams.	LIST	diamond sapphire
Cartridge Weight .....	7.5 grams.		
Channel Isolation .....	20 decibels.		
Stylus .....	Dual jewel tips, 0.7-mil microgroove and 3-mil 78 rpm.		
Mounting Dimensions .....	Standard 7/16 to 1/2 inch centers.		

**Sonotone** CORP.  
Electronic Applications Division, Dept. CS-78  
ELMSFORD, NEW YORK

### Stereo Fundamentals

(Continued from page 30)

hearing system its cues. Without any conscious effort, in very small fractions of a second, the hearing system presents to our conscious minds a sense of sound direction that is highly accurate.

An extension of this ability is apparently the source of the space effects we get with two-eared hearing. In any seat in a hall where music is being played, we get, of course, a complicated blend of sound, a mixture of the sounds travelling directly from the instruments, with numerous reflections of those same sounds from walls and ceilings. The total of reflected sound, or reverberation, may be as strong as, or even stronger than, the direct sound.

But the direct sound, travelling over the shortest path, always reaches the ears a little sooner than the reverberation. Exhibiting an ability called the *precedence sense*—the hearing system decides the true direction of the sound from that first arrival. We fasten onto the direct sound, which arrives a fraction of a second before the reverberation, to tell us where the instruments are and to get our basic impression of the music.

But the reverberation carries vital information, too. From the strength and character of the reverberation, our hearing system tells us how big the hall is and something of its acoustic character. The reverberation, in other words, gives us a sense of the space around the music. It also adds greatly to the richness and liveliness of the music.

#### Monaural Recording

In monaural recording, we are unable to exercise the *precedence* ability and reverberation must be carefully controlled to avoid confusing the music. Much less reverberation can be used than in a stereo recording. The

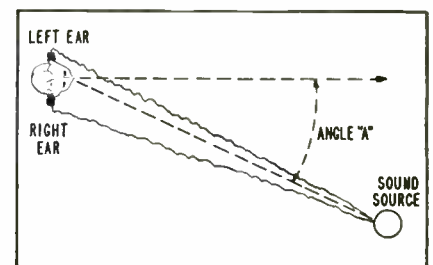

**FIG. 2: THE USE OF TWO EARS as direction finders is illustrated above. Sound arrives at the right ear a little before it does at the left ear. Centers in brain measure the difference and produce in hearer a sense of the magnitude of angle A. Phase and loudness differences are also taken into consideration.**



recording industry has learned from more than fifty years of experience how to use a moderate amount of reverberation to give some illusion of space in monaural recording. We have accepted this compromise as highly satisfying, which indeed it is, when well done.

With stereo recording, the reverberation can be increased until it is near its *natural* levels for any given space. When the recording is well made and played on properly installed stereo equipment, the two ears get a chance to use the reverberation for *space* information and suddenly the hall is *there*. One of the greatest advantages of stereo is that it can make large-hall music like symphony concerts, sound much more natural in a small living room. It does create a strong illusion of a big space around the music.

### Two Possible Approaches

Two different approaches to two-channel stereo are possible. We have already outlined the equipment used with loudspeaker stereo. Another form called *binaural*, uses a dummy head in the recording studio, with a microphone at the position of each ear. Each sound channel is carried to a headphone on the listener's corresponding ear. There is no mixing of any kind between the two channels. The two kinds of stereo reproduction are illustrated in Fig. 3.

Binaural recording and reproduction produces really startling stereo effects. The listener's two ears are

almost literally carried back to the recording studio or hall and can there perform all their miracles of direction and space analysis practically as well as though the listener were present. But headphone listening has been rejected as impractical for home use.

When the two channels are projected into a room from two loudspeakers, however, there is considerable mixing of the channels before the sound reaches the ears. We are doing something different. Instead of taking the listener's ears back to the studio, we are bringing a kind of *curtain front* of the music into the living room. We try to spread the music out right in the room, so the two ears will have something like the original to work on right there.

To do this perfectly with loudspeaker projection would take many, many channels of sound, not just two. Two-channel stereo with loudspeakers, in other words, is a compromise itself. It is a big step toward true two-eared listening, but not the whole distance. Binaural reproduction, with headphones, does the whole thing.

This is why the two-channel stereo you hear will vary tremendously in quality. Again, the skill of the recording companies in producing a compromise illusion will be the determining factor. There will be partial successes mixed in with good recordings. But even if some of the first stereo records are not quite perfect, you can be sure that stereo is here for good. Give the boys a little time; they have had more than half a century to perfect monaural recording.

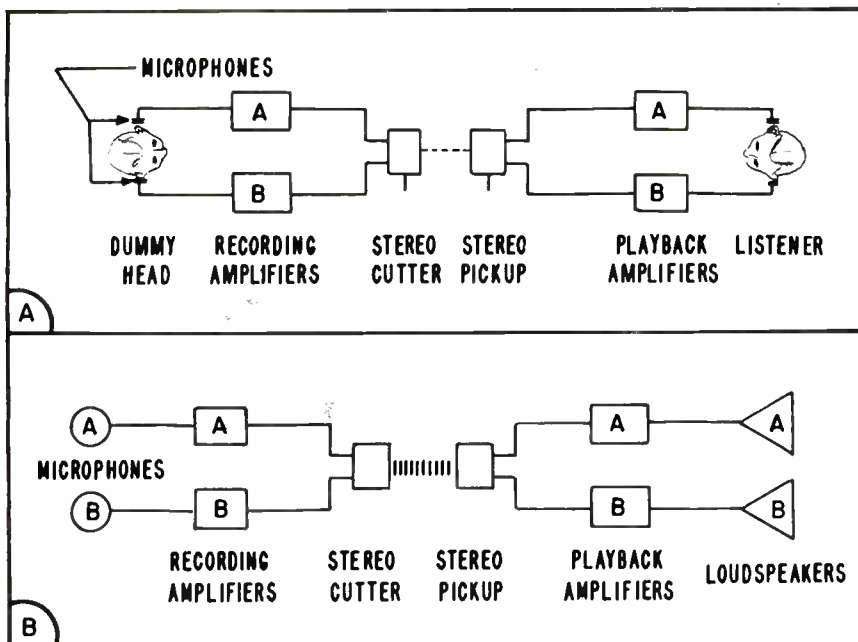

FIG. 3a: BLOCK DIAGRAM of typical binaural recording and reproducing hook-up. A two-channel stereo system, which utilizes speakers instead of headphones, is illustrated in Fig. 3b. The distance between the microphones in stereo recording varies with the sound source being recorded and the loudspeakers are spaced 3 to 5 feet apart.

Your choice of school is highly important to your career in



INDUSTRIAL ELECTRONICS



RADIO-TELEVISION



ELECTRONICS COMMUNICATIONS

Become an

**ELECTRICAL ENGINEER**

or an

**ENGINEERING TECHNICIAN**

at

**MSOE in Milwaukee**

Choose from courses in:

**ELECTRICAL ENGINEERING**

Bachelor of Science Degree in 36 months—  
Communications or  
Electrical Power.

**ENGINEERING TECHNOLOGY**

Associate in Applied Science degree in 18 months—  
Electronics Communications  
Electrical Power or Computers.

MSOE—located in Milwaukee, one of America's largest industrial centers—is a national leader in electronics instruction—with complete facilities, including the latest laboratory equipment, visual aid theater, amateur radio transmitter—offers 93 subjects in electrical engineering, electronics, radio, television, electrical power, and electricity.

Advisory committee of leading industrialists. Courses approved for veterans. Over 50,000 former students. Excellent placement record. Previous educational, military, and practical experience is evaluated for advanced credit.



QUARTERS BEGIN SEPTEMBER, JANUARY, MARCH, JULY

Choose wisely—your future may depend on it. Mail coupon today!

**MILWAUKEE**

SCHOOL OF ENGINEERING

Dept. SV-758, 1025 N. Milwaukee St. Milwaukee, Wis.

Please send free illustrated career booklet (please print)

I'm interested in.....

Name..... Age.....

Address.....

City..... State.....

Are you eligible for veterans educational benefits?.....

Discharge date.....

MS-57

# Latest in Stereophonic Sound Equipment

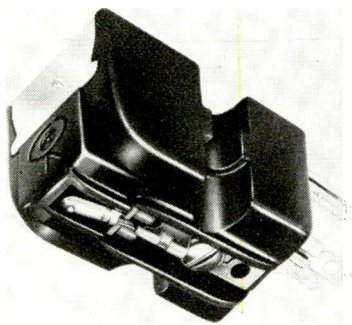

Constant displacement dual-ceramic cartridge. A .0008-inch diamond stylus is designed to play single-groove stereo records, 33 $\frac{1}{3}$ , 45 and 78 monaural records. Channel separation in excess of 20 db is claimed. Frequency response is 30 to 20,000 cycles. Recommended tracking pressure is 5 to 7 grams. (SC-1; CBS-Hytron, 100 Endicott St., Danvers, Mass.)



Recording amplifier for converting tape recorders to stereo. Two units supply magnetic tape heads with necessary audio, bias, and erase power. Amplifier can be used with either standard 1/2-track, 2-channel stereo tapes, or 1/4-track, 4-channel stereo tapes. (RA-100; The Nortronics Company, Inc., 1015 S. Sixth St., Minneapolis 4, Minn.)

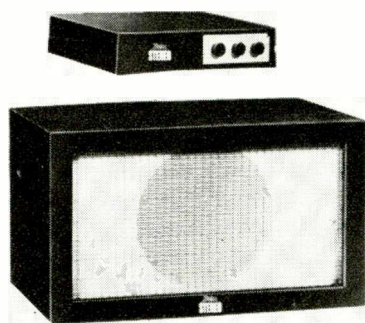

Stereophonic conversion kit for mass-market monaural phonos consisting of a 4-watt push-pull auxiliary amplifier; two tone controls; a separate auxiliary loudspeaker in a specially baffled cabinet and a 4-wire ceramic stereo cartridge said to adapt to most existing tone arms. (Walco Products, Inc., 60 Franklin St., East Orange, N. J.)

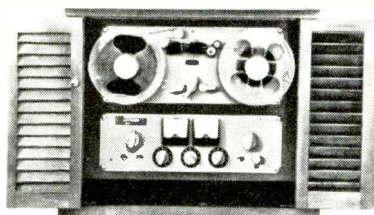

Two-speed tape recorder with stacked-in-line stereo or half-track monaural playback and recording functions. Frequency response is 50 to 12,000 cps  $\pm$  2 db at 7 $\frac{1}{2}$  inches per second. Gain controls for each channel and master volume control are incorporated. (Stereo Magnecordette; Magnecord, Division of Midwestern Instruments, Tulsa, Okla.)

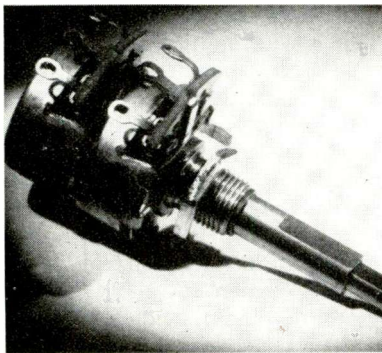

Dual concentric control with positive clamping and declutching arrangement for individual and combined volume control in dual-channel amplifiers. (Stereo D47 [15/16-in. dia.] and Stereo D37 [1 $\frac{1}{8}$ -in. dia.]; Clarostat Manufacturing Co., Inc., Dover, N. H.)

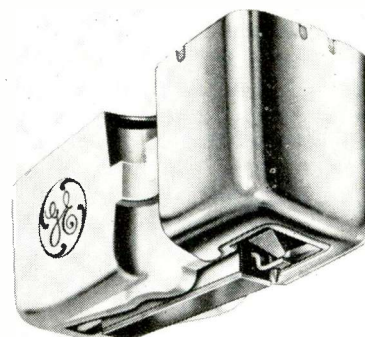

Magnetic variable reluctance cartridge with frequency response from 20 through 17,000 cycles. Can be used in either a three or four wire stereo system. Separation between channels is said to be 20 db. Recommended tracking pressure is from 3.5 to 7 grams. Available with .5 and .7 mil diamonds or .7 mil synthetic sapphire styli. Frequently response of .5 mil diamond version is 20 through 20,000 cycles. (Stereo Classic GC-5, GC-7 [diamond needles] and CL-7 [sapphire needle]; Specialty Electronic Components Dept., W. Genesee St., Auburn, N. Y.)



Dual-channel amplifier-preamplifier with 14-watt stereo output; 28-watt monaural output. Controls for tape, phono and broadcast stereo sources are included. Has ganged level controls and separate balance control. (HF81 [kit or factory wired]; EICO, 33-00 Northern Blvd., Long Island City 1, N. Y.)

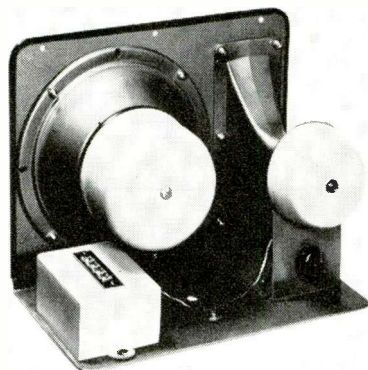

Directive element speaker setup assembled on a rotating chassis which is placed in top section of specially designed acoustic enclosure. Setup illustrated is for use with 3-way systems and contains an 8-inch middle-frequency speaker, compression-driver tweeter, network and control. (Stereo Director; Jensen Manufacturing Co., 6601 S. Laramie Ave., Chicago 38, Ill.)

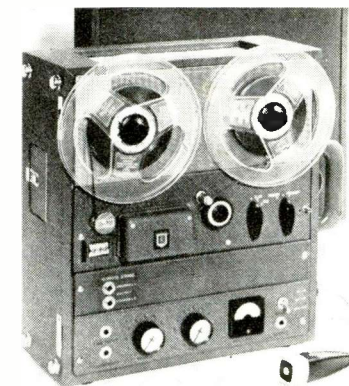

Two-speed stereo tape recorder featuring wide range, stacked head which permits playback flat within  $\pm$  2db from 40 to 15,000 cps. Hysteresis-synchronous motor holds wow and flutter to a minimum. (90-S; Roberts Electronics, Inc., 1028 N. La Brea Ave., Hollywood 28, Calif.)



# CORNELL-DUBILIER CAPACITORS

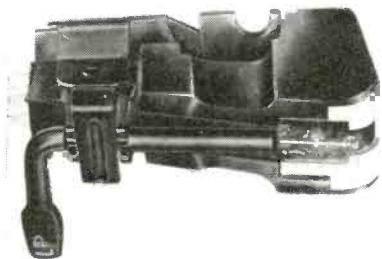

Ceramic stereo cartridge with a built-in rumble suppressor, jewel-tipped styli which play 16, 33, 45 and 78 rpm records and flip under, replaceable needles. Voltage output provides a signal strong enough to drive amplifiers without use of separate preamps. Needle size for the stereo side is .7 mil. (8-T; Sonotone Corp., Elmsford, N. Y.)

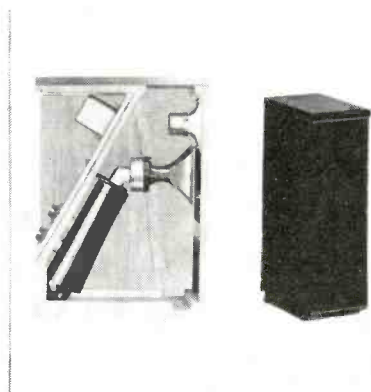

Loudspeaker system designed to eliminate the need for a second full-range loudspeaker for stereo reproduction. Produces only frequencies needed for stereo effect—sounds above 300 cps. Comprised of high quality mid-bass, treble and high-frequency drivers in a compact enclosure. (Stereon; Electro-Voice, Inc., Buchanan, Mich.)

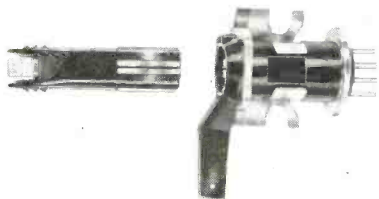

Cartridge holder, mounting bracket assembly and plug-in ceramic cartridge with a .7 mil sapphire tip for playing stereo and LP records. When cartridge is rotated 180° 3-mil tip is brought into playing position for 78 records. Cartridge has two separate ceramic elements with a pair of individual terminals for each element. Frequency response is 20 to 15,000 cps. Recommended tracking pressure is 5 to 7 grams. Channel separation of 25 db is claimed. (13-TB; The Astatic Corp., Conneaut, Ohio.)



## The extra values are "on the house"

Want more capacitor for your dollar? Here's how:

Cornell-Dubilier has originated a "preferred-type" program on twist-prong electrolytics. Now, a relatively few types fill over 90% of all replacement requirements. You need less — to do more. Fewer types means improved production efficiency, lowered costs — savings to you. How is it done? Instead of producing hundreds of types with odd and critical capacitance and voltage ratings, each "preferred type" carries the *highest* value and rating called for in each category. In most cases you get *more* capacitor at *lower cost* — plus added safety factor, improved performance and "call-back" protection. It's on the house! To get more capacitor for *your* dollar, ask your C-D Distributor about *Preferred Type* Twist-Prong Electrolytics or write Cornell-Dubilier Electric Corporation, South Plainfield, New Jersey.



# CORNELL-DUBILIER CAPACITORS

Consistently Dependable

## Technical Books and Catalogs

(Continued from page 28)

From General Electric Company (available through authorized tube distributors). **Color TV Principles and Practices.** Covers the three color fundamentals: colorimetry, standard color specifications of the National Television System Committee adopted by the FCC, and special receiver circuitry. Short and concise explanations of the basic concepts of hue, saturation, luminosity and the use of a chromaticity diagram are included. Volume is illustrated with clearly-arranged diagrams explaining circuitry, humorous but pointed drawings which illustrate functions without tedious written explanations, and 18 color plates demonstrating service problems.

From Coyne Electrical School, 500 S. Paulina St., Chicago 12, Ill. **Pin Point Color TV Troubles in 15 Minutes** based on check chart system developed by Harold P. Manly. A practical troubleshooting volume which covers 150 types of faulty pictures with over 1,000 possible causes. Detailed cross references permit rapid location of picture trouble source. Check-charts point out possible troubles. Accompanying charts are explanations of circuits and designs used in the majority of both b-w and color TV receivers. Illustrations include a four-color picture pattern section.—priced at \$5.95.

From John F. Rider Publisher, Inc., 116 W. 14th St., New York 11, N. Y.

**Industrial Control Circuits** by Sidney Platt. Explains the circuits that govern the initiation, processing and finishing stages of industrial electronic equipment. Specific industrial applications are used to graphically describe the problems of industrial control. Every phase of control circuits is discussed including electronic relay control and timing circuits, photo-electric control, power controls and industrial control instrumentation.—priced at \$3.90.

**Electrostatics**, edited by Alexander Schure. Volume considers fundamental physical units and quantities preparatory to the study of Coulomb's Law and Gauss' Law. The electric field is considered both quantitatively and qualitatively, making use of worked out examples. Cgs and mks unit systems are explained; nature and characteristics of electric field are discussed; electrical potential, capacitance and capacitors are analyzed. Final chapter is devoted to electrostatic applications such as the Van De Graff generator and natural phenomena like thunderstorms.—priced at \$1.35.

## Tube Reliability

(Continued from page 27)

of electronic equipment in mobile applications has made it essential that tubes be able to withstand severe vibrations and shock. With the slightest amount of play between the mica spacer and the glass envelope, or between the mica and the component which it holds in place, the mica will begin to wear excessively when the tube is exposed to vibrations. The first of several harmful results will be increased microphonic noise. In an advanced stage, the increased play may allow shorts between two electrodes. In addition, the mica may release cathode contaminants and, of course, in addition to all this, mechanical fatigue will eventually lead to rupture of welds.

To improve a tube's ability to withstand adverse mechanical conditions, it is necessary to restrict the forces acting on the components. This is done by using the lightest possible components and by avoiding mechanical resonances under 500 cycles. In addition, a more efficient form of mica spacing is employed. With this configuration, the electrodes receive much greater mechanical support.

## Books for Service Men

(Continued from page 15)

of topics normally thought highly complex.

Pictorial representations are often used to supplement text in such complex fields as computers. Fig. 1 illustrates a simple way of expressing the relationship between digits and pulses as used in digital computers. In this way complicated thoughts have been simplified through the use of a picture book approach. Entire books have been written in this manner, and many more are being written with these aids.

Through the study of technical textbooks the Service Man can compete and advance successfully in the future of what promises to be a highly technical electronic field. He must be prepared to allocate a certain amount to study and to reading in order to be certain of attaining a high position in his profession.

## Diamond Needle for Stereo

Fidelitone is marketing a diamond needle which fits all existing stereo equipment. As new manufacturers enter the field, replacement needles will be made to fit the new stereophonic sets, the company announced.

# For an Ever Increasing Market

## Perma-Power Garage Door Opener

### RADIO CONTROLLED

Just press the dashboard button . . . the garage door opens and the light goes on. Press again to close and lock securely. It protects at night and during bad weather. Any member of your family can open or close the door, as easy as ringing a bell . . . and from the comfort of your car.



**Perma-Power FEATURES:**

- ★ ASSURED RELIABILITY
- ★ One year guarantee
- ★ Meets F.C.C. Requirements
- ★ Easy installation with illustrated instructions
- ★ Completely automatic safety devices
- ★ Operates from over 100 ft.
- ★ Low cost; complete package
- ★ BUY NOW!

**Perma-Power COMPANY**  
3100 N. ELSTON AVE. CHICAGO 18, ILLINOIS  
Manufacturers of Electronic Equipment Since 1928

Just Press the Button



## School Roundup

(Continued from page 25)

most of us are lacking. Another way of saying this is, time lost in the past can never be regained.

The road through self-improvement may appear to be a hard rocky one that most of us are too lazy to follow. But once started many have learned that it is completely self-rewarding.

I am extremely proud of the fact that the curricula of both the Resident School and the Home Study School of Capital Radio Engineering Institute, with which I am affiliated, are accredited by the Engineers' Council for Professional Development.

## Heald Engineering Offers Radio-TV Course

by Dr. W. E. SANNER  
Dean, Heald Engineering College

IT TAKES 12 MONTHS to complete the radio-television course at Heald Engineering College in San Francisco when attending day school and somewhat longer in evening or part-time school. A complete course is offered. The student learns theory as well by doing.

The first quarter includes instruction on radio theory covering such subjects as electrical circuits, batteries, magnetism, electron tubes, alternating currents, receivers, measurements, detectors and amplifiers. In addition, the student works in the laboratory where he makes simple electrical tests and constructs radio receivers.

More advanced theory is taught during the second quarter. The student learns about resonance, superheterodyne receivers, power supplies, test equipment including oscilloscopes, *rf* and *af* amplifiers and advanced vacuum tube theory. In the laboratory, the student actually repairs home and auto radios.

Television is the main subject studied during the third quarter. The subject is covered thoroughly and includes transmission as well as reception. The fourth quarter covers color TV. The lab is well equipped with both color and black and white TV receivers as well as up-to-date test equipment.

Heald Engineering College is almost 100 years old, having been founded in 1863. Its graduates include many who have become famous. In fact, Charles Sharpe, vice president of the school, points out that *Who's Who in America* lists more Heald graduates than those of any other college of its type in the West.

## Modern Trade School Blends Psychology with Electronics

by ROBERT MIDDLETON  
International Director of Technical Information, Radio Electronic Television Schools

ELECTROMAGNETIC WAVES were discovered in the latter part of the nineteenth century, and put into elegant mathematical formulation by James Clerk Maxwell.

(Continued on page 39)



*For my Money*  
**XCELITE Tools are**  
*the Finest!*

... Superbly made and designed for Radio, T.V. and Electronic Technicians. *See your Distributor* ... only one quality ... the finest — whether you choose individual items or the handy kits ...

*Use the Tools the Professionals use!*

**XCELITE, INCORPORATED**  
ORCHARD PARK, NEW YORK  
Canada: Charles W. Pointon, Ltd., Toronto

**XCELITE**  
*Quality Hand Tools*  
PREFERRED BY THE EXPERTS



**THESE TUBE SALES CAN BE YOURS!**

A self-service tube testing route is a natural for servicemen. It's just like having branches of your shop in drug stores, luncheonettes, super-markets and other retail locations in your area, testing and selling tubes for you 12 hours a day — 7 days a week. Each Century self-service tube tester you place can net up to \$1000 a year ... and there is no limit to how many you can handle.

Century's low manufacturer-to-you prices enable you to place more units with less investment ... yet you are assured of the most versatile, accurate and durable testers available. Century backs you up with a proven plan of operation, sales literature, window streamers, etc. Learn how you can make money automatically and keep your income growing, without giving up your present source of revenue. Write today for FREE booklet that tells all about this booming business.

**MAIL THIS COUPON TODAY FOR FREE BOOKLET!**

**CENTURY ELECTRONICS CO., INC.**  
Dept. 607, 111 Roosevelt Avenue, Mineola, N. Y.

Please send me without obligation, FREE booklet and particulars about setting-up a self-service tube tester route. I understand no salesman will call.

Name ..... Please print clearly  
Address .....  
City ..... State .....

# COLOR TELEVISION

Home Study for Technicians

**NOW AVAILABLE THE MOST COMPLETE, COMPREHENSIVE COLOR TV HOME STUDY COURSE ILLUSTRATED WITH NEW BLOCK-A-MATICS**

This new seven-lesson HOME STUDY COURSE in COLOR TELEVISION was compiled by Albert C. W. Saunders, internationally noted author-lecturer on Radio and TV Servicing, and is the best course available today. It is just off the press with the latest technical information. Lessons are fully illustrated with simplified diagrams including BLOCK-A-MATICS — *The New Look in Schematics*. Also Color Illustrations.

Seven-lesson course in binder without correction service ..... **\$10.00**

With correction service **\$15.00**

## SAUNDERS ELECTRONICS CORRESPONDENCE SCHOOL

285 HUNTINGTON AVENUE  
BOSTON 15, MASSACHUSETTS

### FOR FASTER SERVICE:

USE ZONE NUMBERS — THEY'RE PART OF YOUR ADDRESS — INCLUDE THEM IN YOUR RETURN ADDRESS!

### GET YOUR COMMERCIAL TICKET EASIER WITH...

Kaufman's  
RADIO OPERATOR'S LICENSE Q AND A MANUAL

now available  
6th EDITION  
up to the minute



The BEST book for FCC License Preparation  
Covers elements 1 thru 8.

The only book with complete discussion of answers to every technical question in the FCC Study Guide. Makes it very easy to answer multiple choice questions.

Used by leading schools and industry.  
Only \$6.60 at jobbers, bookstores or direct from:

JOHN F. RIDER PUBLISHER, INC.  
116 West 14th Street, New York 11, N. Y.

## Stereo Combination

(Continued from page 9)

tone control circuits, simplifying wiring and reducing chassis size.

The record changer<sup>4</sup> employed in this unit is a four-speed model with a ceramic stereo pickup cartridge. (See Fig. 3) The 0.7-mil pickup needle is diamond tipped on the LP side, and a 3-mil sapphire is used on the 78-rpm side. A stylus force of between 4 and 5 grams is required to keep record wear to a minimum. There is a screw adjustment on the pickup arm for adjustment of the stylus force.

The recommended room placement of this unit and the auxiliary speaker system for providing good stereophonic sound is shown in Fig. 4. If this layout is followed, the basic unit will play back the output of right amplifier channel while the auxiliary system reproduces the output of the left channel. The result will correspond to the sound pattern which prevailed at the studio or concert hall when the recording was made. The two speaker systems should be between six and 12 feet apart, and the listener should be seated at least six feet away and approximately midway between the speakers.

If an auxiliary speaker system of another manufacturer is used, check the over-all impedance of the external speakers which should have a total of 3.5 ohms. It is also advisable to check the phasing of the speakers. The phasing of the woofers is of primary importance. The phasing of the tweeters, either with respect to each other or with the woofers, is of relatively little consequence.

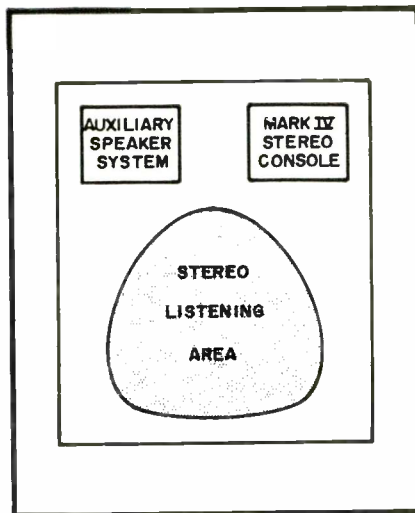

FIG. 4: RECOMMENDED PLACEMENT of basic and auxiliary speaker systems for providing good stereophonic sound in rectangular room.

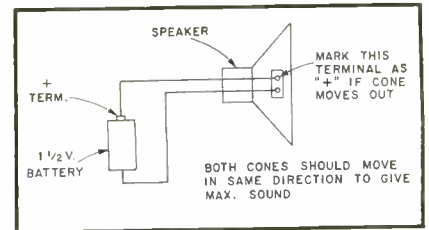

FIG. 5: HOOKUP FOR DETERMINING polarity of speaker. This test is used in phasing speakers for stereo systems.

To phase a group of speakers connect a 1½-volt dry cell across the voice coil of the speaker, and note the movement of the speaker cone, as shown in Fig. 5. If the cone is pushed out when the contact is made, mark as plus that terminal of the speaker to which the positive terminal of the battery is connected. Apply the same test to the other speakers and mark their terminals similarly. The terminals marked alike are then connected together for proper phasing.

The unit may be operated in conjunction with a tape recorder in several ways. To tape the AM radio, FM radio or phono output of this instrument, connect the tape recorder to the tape input-output receptacle, and set the function switch (S1) to position 1 for phono, 2 for AM radio or 3 for FM. To play back a tape either stereophonically or monaurally through the unit's amplifier and speaker system, connect the output of the tape recorder to the tape output jack and set S1 to position 4.

The internal speakers in this unit may also be used for playing back one of the two channels of a stereophonic tape. To do so, connect the output of the tape recorder to the internal speaker jack on the stereo unit. The other channel is reproduced by the speakers in the tape recorder.

When making a monaural tape recording, connect the high side of the audio interconnecting cable to either outside terminal of the tape input-output receptacle *but not to both*. The two output signals are 180 degrees out of phase, and connecting the two high-side terminals will result in cancellation of the signals. When playing back from a monaural tape recorder, connect the high side of the audio interconnecting cable to *either* outside terminal. This tape input-output receptacle has been designed to accommodate the new tape cartridge instruments<sup>5</sup> which can record stereophonically in addition to their usual tape functions.

<sup>4</sup>RCA Victor RP-205G1.

<sup>5</sup>RCA Victor models AC-2, SCP-2 and SCP-3.



## ADVERTISERS IN SERVICE JULY, 1958

American Microphone Manufacturing Co.	13
Amphenol Electronics Corp.	16
Blonder-Tongue Laboratories, Inc.	2
Bussmann Manufacturing Co.	21
Century Electronics Co., Inc.	37
Cleveland Institute of Radio Electronics	27
Cornell-Dubilier Electric Corp.	35
Coyne Electrical School	39
DeVry Technical Institute	1
Erie Resistor Corp.	22
Fidelitone, Inc.	19
General Cement Manufacturing Co., Div. of Textron, Inc.	39
General Electric Co., Electronic Components Div.	14
Heath Co.	23
Kester Solder Co.	22
Milwaukee School of Engineering	33
Moss Electronic Distributing Co., Inc.	25, 31
Perma-Power Co.	36
Radio Corporation of America, Electron Tube Div.	Back Cover
Raytheon Manufacturing Co.	4
RCA Institutes, Inc.	29
John F. Rider Publisher, Inc.	38
Saunders Radio and Electronic School, Inc.	38
Service Instruments Corp.	28
Sonotone Corp.	32
Sprague Products Co.	Inside Front Cover
Sylvania Electric Products, Inc.	8
United Catalog Publishers, Inc.	28
University Loudspeakers, Inc.	Inside Back Cover
Walsco Electronics Manufacturing Co.	3
Westinghouse Electric Corp., Electronic Tube Div.	11
Xcelite, Inc.	37

## School Roundup

(Continued from page 37)

well. In the same period, Charcot and his illustrious students were building the foundations of modern psychology. These two paths of enlightenment, seemingly divergent, meet today at the streamlined superhighway of the electronics training program.

Electronics training today is directed by highly selected men, whose backgrounds and talents provide the required blend of electronics and human engineering factors. As would be expected, the modern director of education has little resemblance to the radio mechanic who piloted the students' course in yesterday's "radio school."

The student has been studied no less diligently than the circuits and equations presented in the classroom and shop. There is more to the electronics training program than meets the eye.

The learning process, motivation, retention, and individual differences are typical human-engineering principles which form the invisible backdrop of the electronics training program. Effective rapport of instructor and student is stressed. The impersonal and sometimes harsh taskmaster of the "radio school" has been relegated to oblivion with the catwhisker detector.

Modern electronics instructors are practical psychologists. To qualify as instructor, the aspirant must demonstrate his ability to solve learning problems as effectively as electrical problems. We assert that if the student does not learn, the instructor has failed.

## Technical Developments Change Education Concepts

by L. J. ROSENKRANZ  
President, National Technical Schools

TECHNOLOGICAL DEVELOPMENTS of the last decade, in addition to revolutionizing the methods of modern industry, have also changed the concepts of technical education in the science of electronics. Regardless of the particular facet of the electronics field a man proposes to enter, the learning processes involved in his preparation have of necessity, been steadily elevated from the relatively simple to the complex.

More knowledge of his field, more analytical ability, and more personal initiative in keeping pace is demanded of the technician. This is a pyramiding condition which never ends; it continues in direct proportion to the growth of electronic uses, varied circuits, and instruments required in their testing and operation.

To National Technical Schools, all this means that no longer should a man be trained to hold only a specific job in radio, television or some special type of electronics. Rather, it means that a man must be prepared on a broader basis, to become a member of the electronics industry. It means that a man must be technically developed to possess all of the fundamentals involved, plus the ability and capacity to satisfactorily progress in any phase of the field.

## Schools Provide Training for Electronics Service Industry

by MILTON GOLDSTEIN  
Director, American Television Institute  
of Technology

ELECTRONICS, America's foremost growing industry, has for many years experienced a tremendous shortage of trained service technicians. Even as early as 1935, the problem plagued the industry at all levels of employment, from the production worker and technician to the design and research engineer.

To provide the needed technicians, the American Television Institute of Technology was founded, and it soon developed a training program of the technical institute type. This early program was initiated and based on the needs of the embryo industry. The course consisted of lectures in basic electronics, radio and television principles, correlated with the corresponding laboratory work. This basic curriculum was designed to be flexible, and has since been modified to include training in the newer developments of the field.

Industry has arrived at a crossroads, where it is now necessary to recognize the new areas of opportunity, and to act to bring them into the proper camp. Training is a vital part of this action, and whether it is formal, as in a school, or of the on-the-job variety, it must be organized and designed to most effectively meet the needs of an ever-changing economy.

## GE TRANSISTOR Z5 SILICONE COMPOUND



To be used every time a transistor is replaced; maintains efficient heat transfer from transistor to chassis. 1 oz. tube.  
No. 8101... List \$2.25

## G-C ELECTRONIC OIL ASSORTMENT KIT

Contains every commonly used special purpose oil used in electronic servicing. Six oils in handy vial dispensers.

No. 9400... List \$3.50

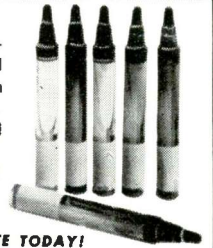

FREE CATALOG... WRITE TODAY!

## GENERAL CEMENT MFG. CO.

division of TEXTRON INC.  
Western Plant: Los Angeles 18, Calif.  
Main Plant: ROCKFORD, ILLINOIS, U.S.A.

## GET INTO ONE OF THESE TOP OPPORTUNITY FIELDS

# ELECTRICITY

- Electronics or

# TELEVISION

- Radio-Color TV

TRAIN IN THE GREAT SHOPS OF

# COYNE

OLDEST, BEST EQUIPPED  
SCHOOL OF ITS KIND IN U.S.

Veterans and Non-Veterans—Prepare for a better job NOW that offers a real future, too! Get practical training in TELEVISION—RADIO—ELECTRICITY—ELECTRONICS—(Refrigeration & Electric Appliance Repair can be included). Learn on real equipment—no advanced education or previous experience needed. Lifetime employment service to graduates.

Finance Plan—enroll now, pay most of tuition later. Part time employment help to students.

FREE BOOK Clip coupon for Big Free Illustrated Book. No salesman will call. Act NOW.

B. W. COOKE, JR., President  
**COYNE** FOUNDED 1899  
**ELECTRICAL SCHOOL**

A TECHNICAL TRADE INSTITUTE OPERATED NOT FOR PROFIT  
500 S. PAULINA ST., CHICAGO, DEPT. B 8-9C  
ELECTRICITY • TELEVISION • RADIO • REFRIGERATION • ELECTRONICS

B. W. COOKE, JR., Pres., COYNE ELECTRICAL School  
500 S. Paulina St., Chicago 12, Ill., Dept. B-8-9C

Send FREE BOOK and details on:

- TELEVISION-RADIO  
 ELECTRICITY-ELECTRONICS

NAME.....

ADDRESS.....

CITY.....STATE.....

# Association News

(Continued from page 29)

## ETAT, Toledo, Ohio

At a recent meeting of the Electronic Technicians Association of Toledo, the members voted to affiliate with NATESA. After hearing a talk by *Marvin Miller*, East Central secretary of NATESA, on the benefits gained by belonging to the national group, all members attending felt that ETAT would gain in strength and stature by joining. The ETAT application for NATESA membership will be sent in before August 1st.

• • •

## Atlantic City Convention

Telerama '58, sponsored by the Television Service Association of Delaware Valley, the Allied TV Technicians of New Jersey and Atlantic TV Service Association of New Jersey, combined a weekend of relaxation with technical enlightenment at Atlantic City on June 20-22.

The three-day meeting, which included technical sessions, business meetings and a banquet, brought together the members of the three sponsoring groups and many visitors from associations throughout the east.

Keynote speaker at the Saturday night banquet was *Solomon R. Kunis*, editor of *SERVICE*, who discussed the effects of the current recession on the service industry. He predicted a hopeful future but urged that Service Men improve their promotion policies and develop new electronic specialties like color TV and stereo.

The technical sessions included a talk on color servicing by *Wally Fulroth* of RCA Service Company, and lectures by *Douglas Vining* of TACO and *Jack Beever* of Jerrold Electronics. The problems of Service Man licensing were discussed at the Sunday business session.

Guests included a number of officers from out-of-state groups. Among those present were *Murray Barlow*, Radio and Television Guild of Long Island; *David Drage*, Electronic Technicians Association of Winston-Salem, N. C.; *Jim Maynard*, Television Service Dealers Association of Delaware; *Bert Bregenzer*, Federation of Radio and Television Servicemen's Associations of Pennsylvania; and *Frank Tesky*, co-editor of the Hoosier Test Probe in Indianapolis.

• • •



**ASSOCIATION OFFICERS AND EDITORS** at Telerama '58 meeting in Atlantic City. From left to right are *Ray Fink*, Editor *TSA News*; *Ralph Newby*, Business Manager *TSA News*; *Louis J. Smith*, Corresponding Secretary *TSA*; *Joseph Papovich*, President Allied TV Technicians of N. J.; *Solomon R. Kunis*, Editor *SERVICE*; *R. H. Cherrill*, President *TSA*; and *Gordon Delaney*, Co-ordinator Telerama '58.

## TEA, Texas

The sixth annual clinic and fair of the Texas Electronics Association will be held August 1st through 3rd at the Statler Hilton hotel in Dallas. Twenty seminars covering both management and technical procedures will be conducted. Emphasis of the meeting will be on servicing of b-w and color TV.

Keynote speaker for the clinic is *Morris L. Finneburgh*, vice president of the Finney Company, who will speak on *The Future Belongs to Those Who Prepare For It*. Other principal speakers include *P. P. Wickman*, General Electric, who will speak on *Community Responsibility and Public Relations*; *Gail S. Carter*, NEDA, who will cover the *Need of Closer Cooperation Between Parts Distributor and Service Dealer*; *A. W. Bernsohn*, NARDA, will discuss *Your Need for an Association*; and *C. C. Turnbaugh*, P. R. Mallory and Company, who will speak on *Thoughts to Bolster Your Confidence in the Future*.

*Horace Childers*, president of TEA, will deliver an opening address for the three-day convention. *T. P. Robinson* of Robinson Radio and TV, Dallas, will speak on *You Don't Have to be Big to be Good*.

Technical seminars and leaders include: *Service Transistor Circuits*, *Leo Smith* of Zenith; *Service TV Printed Circuits*, *George Saler*, of Philco; *Color TV Service*, *John R. Meagher* of RCA; *High Fidelity Service*, *Ray J. Yeranko* of Magnavox; *Antenna Service is Vital to TV Service*, *Sam Schlüssel* of Channel Master; *Merits of Quick Check Tube Checker*, *Jack Alschuler* of B&K; and *What to Do About So Many Tube Types*, *Robert B. Tomer* of CBS-Hytron.

At management sessions the following topics will be discussed: *How to Advertise the Service Business* by *R. M. Andrews* of Tung-Sol; *Volume-Costs-Profits* by *Gordon E. Burns* of General Electric; *How to Hire and Keep TV Technicians* by *W. D. Renner* of Howard W. Sams.

Other management talks are: *How to Price TV Service Bills* by *W. J. Inman* of Inman's Radio and TV; *Will Your Insurance Cover It* by *F. G. Neuback* of Liberty Mutual Insurance Company; *Importance of Detail Service Records* by *John Bennett* of Philco; and *Service Contracts Can Be Profitable* by *Russ Hansen*, of RCA Service Company.

*Ted Leitzel* of Zenith will discuss *Pay TV May Benefit the Independent TV Service Dealer*. A technical panel discussion will be moderated by *Kenneth H. Brown*, Westinghouse service manager. *L. W. Sharp* of Porter Burgess Company will discuss *Sales and Service—The Ideal Partners*. A management panel will be led by *D. R. Creato* of RCA Service Company.

*Tilman Babb* is chairman of the fair and clinic. Committee co-chairmen are *Julius Burke*, *Roger Dickey*, *W. J. Inman*, *Gus B. Moore*, *Dee Sponsel*, *J. Lloyd Williams* and *Marvin Dickey*. *Mrs. Gilbert Smith* is chairman of the ladies' program.

• • •

## ETA, Winston-Salem, N. C.

Members of the Electronic Technicians Association have formed an Electronic Technicians Association Credit Bureau to help in establishing customer credit ratings.



Want REAL high fidelity in a weatherproof speaker?

Only University's LC series offers  
**3 GENUINE DUAL-RANGE SYSTEMS**  
 with separate bass and treble drivers

**BETTER LOWS:** Balanced "compression" folded horn, starting with large throat and energized by top quality woofer drivers provides more lows than other designs.

**BETTER HIGHS:** Driver unit tweeters with exclusive patented wide-angle horn designs transmit more highs with greater uniformity . . . high frequency response that you can hear!

**BETTER EFFICIENCY:** Dual range theater-type system permits uncompromising design of the woofer and tweeter sections for greatest efficiency. These speakers penetrate noise with remarkable fidelity and intelligibility.

**LESS DISTORTION:** Separate

low and high frequency driver systems with electrical cross-over reduce intermodulation and acoustic phase distortion found in other systems which use two different horns on a single diaphragm.

**BETTER ACOUSTICS:** Smooth projection characteristics, devoid of excessive peaks or "hot spots," help prevent echo and combat reverberation effects . . . every installation is a successful one.

**MORE DEPENDABLE:** Experienced mechanical engineering and careful electrical design meet the challenge of diversified application and environmental hazards. Rugged and conservatively rated—you can rely on the LC series speakers.

All LC series speakers boast these outstanding features of design, construction and performance. And for maximum economy in amplifier power, equipment and installation costs, each particular model was developed to perform its own special function *without compromise*. An added feature is the sturdy serrated "U" bracket for quick easy setups, horizontal or vertical. Choose the specific LC speaker best suited to your next high fidelity installation, indoor or outdoor: sound trucks, auditoriums, stadiums, office buildings, restaurants, church interiors, patios, lawns, etc.



**MODEL WLC... Heavy Duty System** The largest of the series, the WLC has brought full range high fidelity performance to auditoriums, concert halls, parades and stadiums throughout the world for well over a decade. All the refinements, all the innovations that come of this extensive field experience are embodied in the present production. For exceptional uniformity of response and dispersion of full-bodied sound at higher output levels . . . the WLC is the *only* answer.

Power capacity: 30 watts. Frequency response: 50-15,000 cps. Impedance: 8 ohms. Dispersion: 90°. Sound pressure level\*: 120 db. Diameter: 33½". Depth: 20". Shpg. wt.: 72 lbs. List: \$250.00.

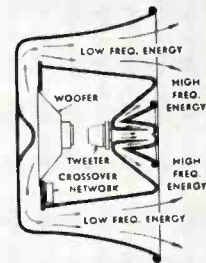

**MODEL BLC... For General Applications** A sensation the moment it was introduced, the BLC has continued to set new standards for general applications in high quality p.a. work . . . for voice and music, indoor and outdoor. Relatively light in weight, shallow in depth and easy to transport, the BLC can be installed anywhere. It may be used in place of trumpet/driver units (price compares favorably) except under *extremely* noisy conditions or where *maximum* penetration is required.

Power capacity: 25 watts. Frequency response: 70-15,000 cps. Impedance: 8 ohms. Dispersion: 120°. Sound pressure level\*: 119 db. Diameter: 22¾". Depth: 9¼". Shpg. wt.: 21 lbs. List: \$86.00.

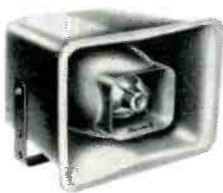
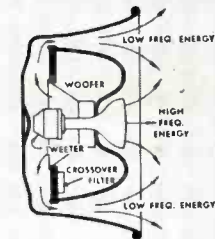

**MODEL MLC... Compact Version for Music/Voice** Newest in the LC series, the MLC is especially suited for low level speaker distribution systems or for coverage of moderate-size crowds or areas. Unusually good articulation and musical balance make the MLC ideal for paging or sound reinforcement systems where naturalness is important, with no harsh blare or "hot spots." The highly efficient MLC operates easily off existing high fidelity systems for music outdoors at low cost.

Power capacity: 15 watts. Frequency response: 150-15,000 cps. Impedance: 8 ohms. Dispersion: 120°. Sound pressure level\*: 117 db. Diameter: 12¾" w. x 9¼" h. Depth: 10¾". Shpg. wt.: 10 lbs. List: \$54.50.

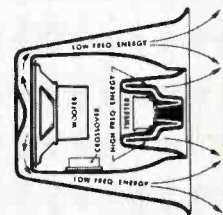

\*Taken at 4 ft., 750-1250 cps. with 1 cps. sweep.

Send for the all-new 64-page UNIVERSITY TECHNOLOG Invaluable reference and guide book for planning public address loudspeaker systems. \$1.00

Only book of its kind—packed with the solid, factual information you need to save time and money in planning sound systems. Authoritatively covers in detail: how to select the proper driver

for the specific job, directional vs. wide-angle horns, best use of radial trumpets, high fidelity in P.A., coping with reverberation, overload protection, etc. Includes comprehensive specifications, charts, diagrams, latest product information and the exclusive SOUND SYSTEM DESIGN CHART — effective guide for planning typical installations. Send \$1.00 to Desk X-5, University Loudspeakers, Inc., 80 So. Kensico Ave., White Plains, N. Y.

LISTEN

University sounds better

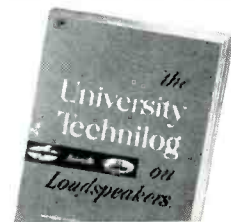



**FREE!**

## RCA MAGNETIC TOOL/RAK

REPLACE WITH  Silverama PICTURE TUBES

with each purchase of an RCA Silverama Picture Tube

The new RCA Magnetic TOOL/RAK is a workbench "must" for every TV Service Technician. Smartly designed in appearance and functionally sound in use...this magnetic "grip" TOOL/RAK facilitates easy, orderly placement of your tools when they are not in use. Just place tools on the RCA Magnetic TOOL/RAK—they stay put! Installed close at hand, the TOOL/RAK saves valuable time and eliminates fussing and fumbling for misplaced tools on crowded workbenches.

Now, for a limited time only, you can obtain one RCA TOOL/RAK FREE, with each and every RCA Silverama Picture Tube you purchase from your Authorized RCA Tube Distributor.

Get your TOOL/RAKS while they last—place your order today!



**RADIO CORPORATION OF AMERICA**

Electron Tube Division

Harrison, N. J.

DOZENS OF PRACTICAL USES!

