

ELECTRONIC
PARTS
DISTRIBUTORS
SHOW

SERVICE

THE TECHNICAL JOURNAL OF THE TELEVISION-RADIO TRADE

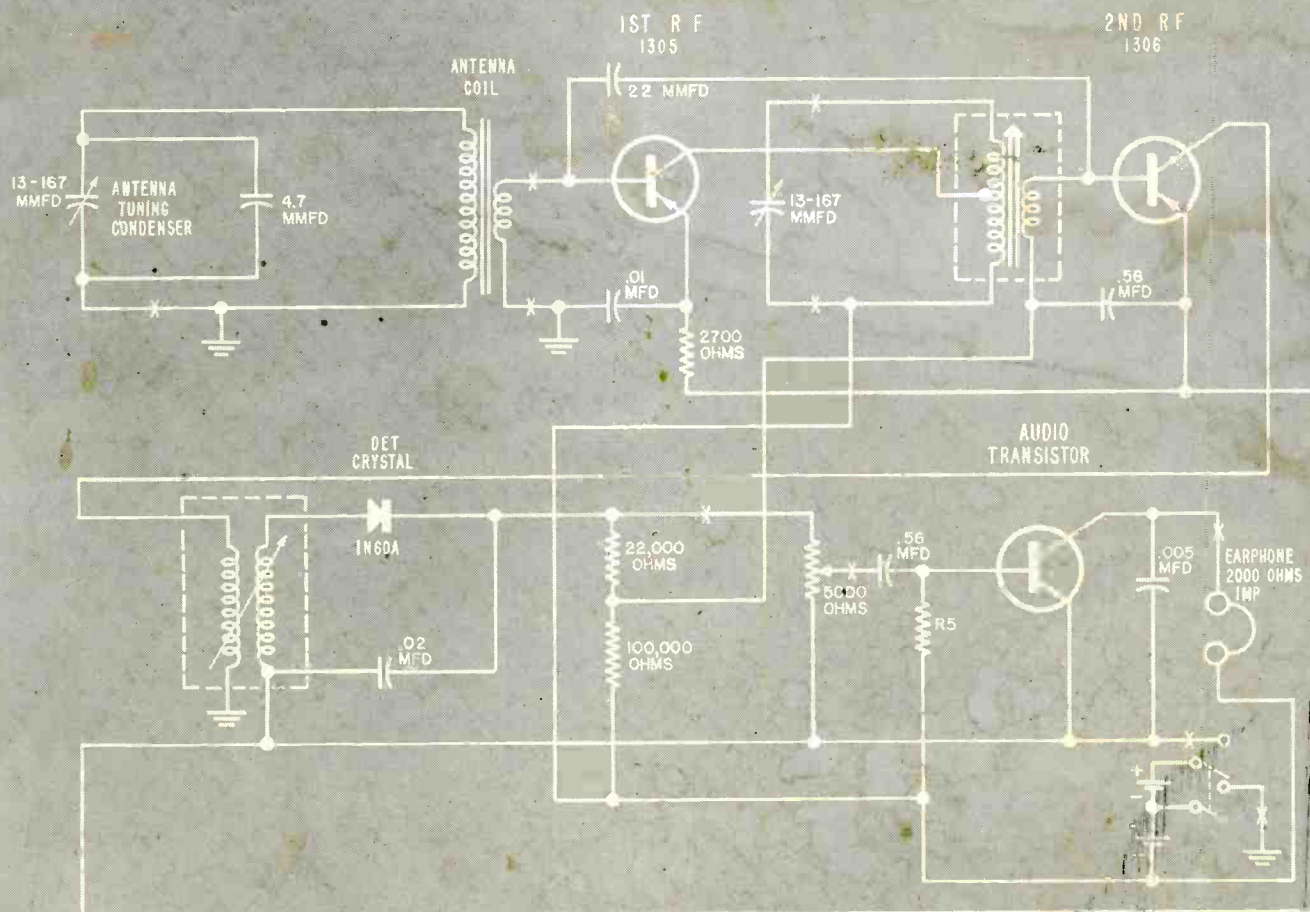

**Tiny three-transistor portable radio
with earphone output.**

See circuit analysis, this issue

J W TARR
RD 1
CORTLAND, OHIO
8-60
35 S 9-30-57

DEALERS!

YOU CAN WIN!

YOUR CHOICE!

FORD, PLYMOUTH OR CHEVROLET!

Del Rio Ranch Wagon

Custom Suburban

Brookwood Station Wagon

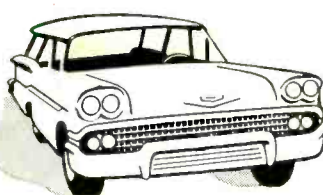
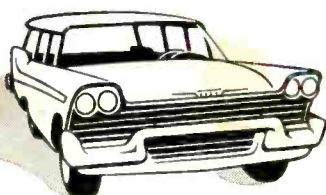
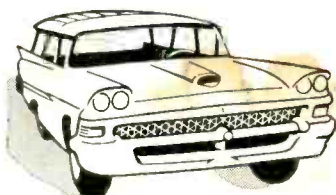

IN ALLIANCE TENNA-ROTOR

EXTRA PROFIT SATELLITE CONTEST

1207 PRIZES

Valued at \$11,800!

SUPREME PRIZE:

Your choice Ford Del Rio Ranch Wagon, Plymouth Custom Suburban or Chevrolet Brookwood Station Wagon

200 GRAND PRIZES:

100 Alliance Electric Fry Pans and 100 Sessions Electric Clocks

1,000 SPECIAL PRIZES:

Crestline Kitchen Tool Sets (seven pieces, coppertone handles)

6 EXTRA PRIZES:

Alliance Genie Automatic Garage Door Operators (Radio Control)

IT'S EASY TO WIN

ask your Tenna-Rotor Jobber to visit us in

ALLIANCE BOOTH No. 321

And Hospitality Suite

2105-6-7 and 8

at the Electronics Parts Show

**Conrad Hilton Hotel
Chicago, May 19 thru 21**

for contest details

THE ALLIANCE MANUFACTURING COMPANY, INC.

(Division of Consolidated Electronics Industries Corp.)

Alliance, Ohio

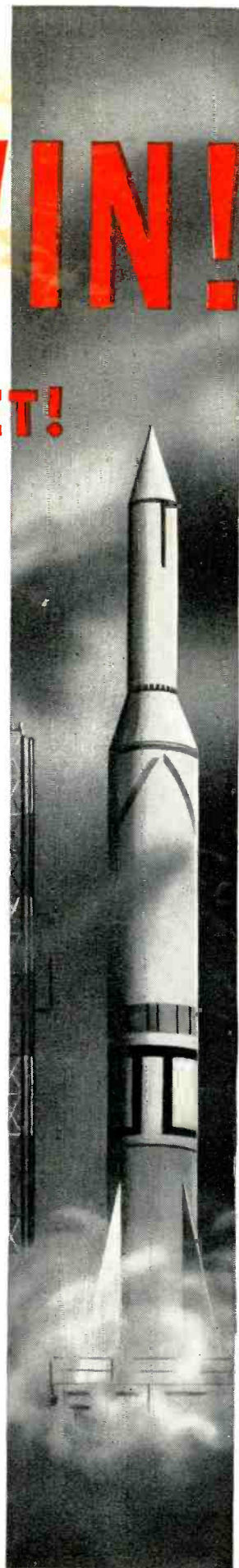

CASH IN ON **ZENITH'S**
Tremendous Customer Acceptance
AND PERFORMANCE



**USE
 ZENITH
 QUALITY
 PARTS**

IT'S ZENITH FOR
DEPENDABILITY
 YOU CAN COUNT ON!

There's a reason...

Universally designed parts are of necessity manufactured to broad tolerances...and they may not give the maximum in performance and reliability.

Components in a Zenith Radio, Television or High Fidelity Instrument are built to be perfectly matched and balanced for superior performance. To keep Zenith sets operating at original performance, use Zenith quality service components.

When you use Zenith components in Zenith sets, it's a custom repair that both you and your customers can depend on.

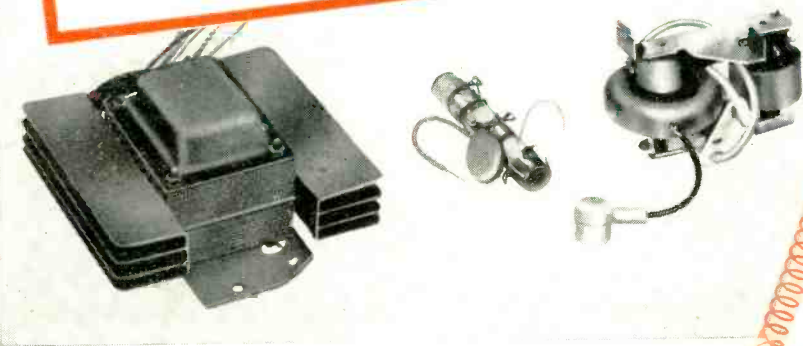

You can safely guarantee Zenith repairs when you use dependable Zenith components.
 Buy parts by Zenith... backed by 39 years of leadership in radionics exclusively. The quality goes in before the Zenith name goes on.

SEE YOUR ZENITH DISTRIBUTOR



**MEANS
 QUALITY**

ZENITH RADIO CORPORATION • PARTS AND ACCESSORIES DIVISION
 6001 W. Dickens • Chicago 39, Illinois

SAVE UP TO 22%

on a genuine Argos Tube Caddy... newly designed "Pacemaker" models for the thrifty buyer... ruggedly built with Argos

Craftsmanship in Cabinets

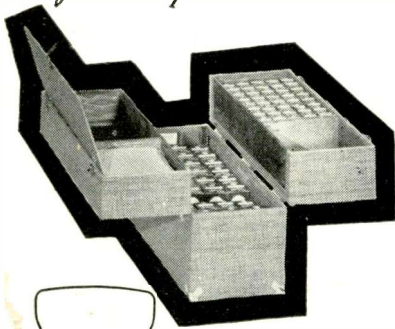

Pacemaker
tube caddy

TC-100
\$12.35

Quickly pays for itself. Holds up to 262 tubes, plus tools, meter, etc. Same size as Argos "Carry-All" Tube Caddy.

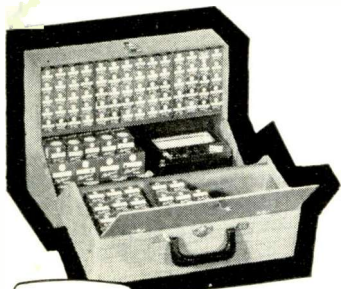

Pacemaker Jr.
tube caddy

TC-200
\$8.95

Low cost Tube Caddy for quick trips. Holds up to 143 tubes, plus tools, meter, etc. Same size as Argos Tube Caddy "Junior."

®Registered TM of the Argos Products Co., originator and sole manufacturer. Ask your Distributor NOW!

or Write Dept. S

ARGOS

PRODUCTS COMPANY
GENOA, ILLINOIS

Also wall and corner baffles, hi-fi speaker enclosures and kits.

Vol. 27 No. 5

MAY, 1958

27th YEAR
OF
CONTINUOUS
PUBLICATION

SERVICE

THE TECHNICAL JOURNAL OF THE TELEVISION-RADIO TRADE
Including RADIO MERCHANDISING and TELEVISION MERCHANDISING
Registered U. S. Patent Office

COVER CIRCUIT

All-Transistorized Portable Radio Receivers (Philco) 10

FEATURES

Editorial 9

All-Transistorized Portable Radio Receivers Robert A. Magnant 10

Installing Hi-Fi Speakers and Enclosures to Improve Sound System
in Home Robert Miller and Frederic Zeller 14

DC Power Supply for Transistorized Equipment and Low-Voltage
Devices R. C. Crossley 16

Electronic Parts Show Roundup 18

New Indoor Antenna With Dipole Matching Transformer (Antenna Digest)
Rudolph T. Plemich 21

Earth's Field Effects on Color TV Tubes (Tube News) 22

Hi-Fi Amplifiers for TV Receivers (Audio Installation and Service)
Perry Sheneman 24

Signal Distribution Pattern of Ultrahigh Antenna System 28

Repairing Printed-Wiring Board Chassis Leroy Wolff 30

Miniaturized Compensation-Type UHF Tuner Fred J. Kitty 32

Installing Master Motel Antennas Tom Shea 34

Servicing Upright Home Vacuum Cleaners E. A. Mueller 40

Association News 44

Books and Catalogs 46

Personnel 47

CIRCUIT DIAGRAMS

Admiral Hi-Fi Sound Amplifier for TV Receivers 24

Electro Products EFB Filtered DC Power Supply 16

Philco T-3 Transistor Portable Radio 10

Philco T-701 Transistor Portable Radio 11

Speaker Crossover Network 14

INDEX TO ADVERTISERS 47

© 1958 by Bryan Davis Publishing Co., Inc. All rights reserved.

Second-Class mail privileges authorized at New York, N. Y.; additional entry at the Post Office, Norwalk, Conn. . . . Subscription price: \$2.00 per year (\$5.00 for 3 years) in the U.S.A. and Canada; 25 cents per copy, \$3.00 per year in foreign countries; 35 cents per copy.



Editor
Solomon R. Kunis

Associate Editor
David E. Pearsall II

Consulting Technical Editors
Howard Jennings
Arnold Gewirtz

Field Editor (Midwest)
Rudolph T. Plemich

Art Director
Anthony R. Aliffi

Supervisor, Circuit Diagrams
Michael D. Bellezza

BUSINESS DEPARTMENT

Advertising Manager
Aaron L. Lafer

Assistant Advertising Manager
Astrid Kelly

Business Manager
B. S. Davis

Assistant Business Manager
B. Earley

Circulation Manager
A. Goebel

Assistant Circulation Manager
A. Kiernan

Mailing Supervisor
L. Trubia

PACIFIC COAST

Leo Sands, District Manager
920 Commercial Street
Palo Alto, California
Tel.: YOrkshire 8-4478

Published Monthly by

Bryan Davis Publishing Company, Inc.
52 Vanderbilt Ave., New York 17, N. Y.
Tel.: MUrray Hill 4-0170

B. S. Davis, Pres. A. Goebel, Secy.



Printed in U.S.A. by
O'Brien Suburban Press, Norwalk, Conn.

Customers Impatient? It's full speed ahead



with
Centralab
Hi-Kap*
Ceramic
Capacitor
Kits

No delays! It's always smooth sailing when you use Centralab ceramic capacitor kits. No extra trips to your distributor, no wasted time. The units you need are on hand when you need them.

To keep you on an even keel, these heavy gauge steel kits contain balanced inventories of the most frequently used values. Individual values are prominently and clearly labeled, so you can locate the Hi-Kap you need, instantly. The new rigid plastic package permanently separates and protects the units—yet is easily opened to remove a single capacitor.

So don't be left at sea. Ask your distributor about these four time-saving kits—and while you're at it, be sure to get your free copy of Catalog 30, listing the full line of Centralab capacitors and other quality components.

FREE: \$4.75 cabinet (4"x7"x11") with each kit.

D6K-200 Kit—200 Tubular Ceramic BC Hi-Kaps (27 values)
DDK-200 Kit—200 Standard Ceramic Disc Hi-Kaps (31 values)
TCK-80 Kit—80 TC (Temp. Compensating) Hi-Kaps (40 values)
HVK-150 Kit—150 High Voltage Disc Hi-Kaps (19 values)

Centralab products are listed in COUNTERFACTS, PHOTOFACTS, and THE RADIO-ELECTRONIC MASTER.

Centralab

*Trademark

D-5829

A DIVISION OF GLOBE-UNION, INC.
934E E. KEEFE AVE. • MILWAUKEE 1, WIS.
In Canada: 804 Mt. Pleasant Rd. • Toronto, Ontario

SWITCHES • PACKAGED ELECTRONIC CIRCUITS • CERAMIC CAPACITORS
CONTROLS • ENGINEERED CERAMICS • SEMI-CONDUCTOR PRODUCTS

Sylvania comparisons point out—

The big difference

Here's the inside story on why local "off-brands" don't measure up to Silver Screen 85® standards

If you're like most dealers, you know off-brand tubes don't have the same quality standards as first-line tubes. To help you see how big the difference is, Sylvania purchased a nationwide sample of sixty 21YP4A made by 19 different local tube makers. These tubes were put through the same production tests that all Sylvania tubes must pass.

Not a single local off-brand passed all 54 mechanical and electrical tests! Many of these were minor defects making little or no difference in whether or not the tube "lit up." But look how loose manufacturing controls can affect the important features of light output, focus, and life!

LIGHT OUTPUT

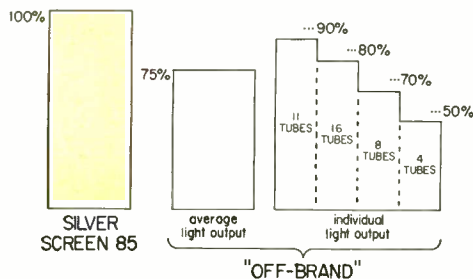

So far, 39 off-brand tubes have been compared with the *minimum* light output of Silver Screen 85. Five additional tubes couldn't even be tested. Eleven tubes were less than 90% as bright as the minimum for Silver Screen 85; 16 were less than 80%; 8 were less than 70%; and 4 were *less than 50%* as bright. Since most Silver Screen 85 tubes average as much as 125% of minimum standards, the difference becomes even greater. Small wonder that Silver Screen 85 is the easy way to more satisfied customers.

FOCUS

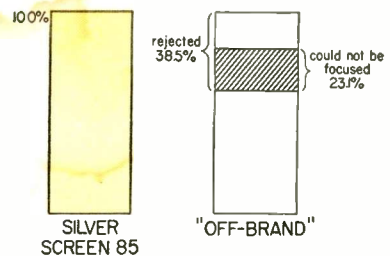
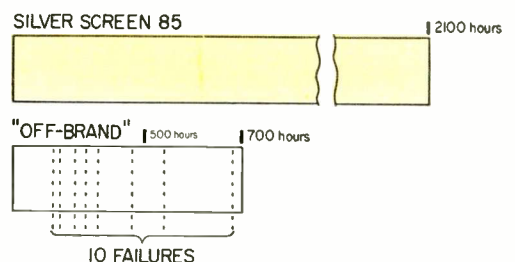

Chart 2 shows how these same 39 tubes stacked up to registered limits on focus voltage. 38.5% were rejected under these limits. Over half of all those rejected could not be focused in a TV receiver. Small wonder then that "Silver Screen 85" pictures are sharper, brighter, clearer.

LIFE TEST



Nineteen off-brand tubes were placed on Sylvania's standard 2000-hour life test. Chart 3 tells you how fast these tubes developed slow-heating cathodes. Over half, or ten units, failed to go beyond the 700-hour mark. Small wonder then that Silver Screen 85 gives you less troublesome callbacks.

Of all the off-brand tubes tested, Sylvania engineers estimate that 43% probably would not have operated properly in a TV set. Why gamble your reputation, customer satisfaction, and success. It's just *good business* to sell up to "first line" picture tubes; Silver Screen 85 picture tubes.

in Picture Tubes!



Take it from Bill Shipley: "Silver Screen 85' consumer advertising makes it easy to *sell-up* to 'first line' picture tubes."

New TV Campaign dramatizes test results . . . sells consumers up to "first line" picture tubes . . . builds more profitable sales and satisfied customers for dealers everywhere.

Sylvania's fabulous new family, "The Real McCoys," is one of the top new television shows of the season and has been named the "Sleeper of the Year." Week after week, on the "Real McCoys" Sylvania is making millions of set owners aware of the big difference in picture tubes.

New commercials like the "Brightness Test" are pre-selling consumers on the "first line" performance of Silver Screen 85.

For dealers everywhere it means more and more customers asking for "Silver Screen 85"—Pre-sold customers make satisfied customers—strengthening your business reputation and building long-range profitable growth.

Sylvania has designed this powerful new selling tool for you. Get behind it and *sell-up* to "first line" Silver Screen 85 picture tubes.

Highlights of Sylvania's TV "Brightness Test."



"Don't be fooled by picture tubes that look alike—they don't act alike."



Sylvania's Silver Screen 85 is over twice as bright as this "off-brand" tube.

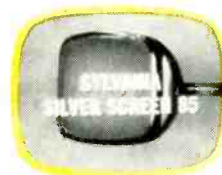

"Insist on a nationally known 'Silver Screen 85'—there's one to fit every make TV."



SYLVANIA

SYLVANIA ELECTRIC PRODUCTS INC.
1740 Broadway, New York 19, N. Y.
In Canada: Sylvania Electric (Canada) Ltd.
University Tower Bldg., Montreal

LIGHTING • TELEVISION • RADIO • ELECTRONICS • PHOTOGRAPHY • ATOMIC ENERGY • CHEMISTRY-METALLURGY

SERVICE, MAY, 1958 • 5

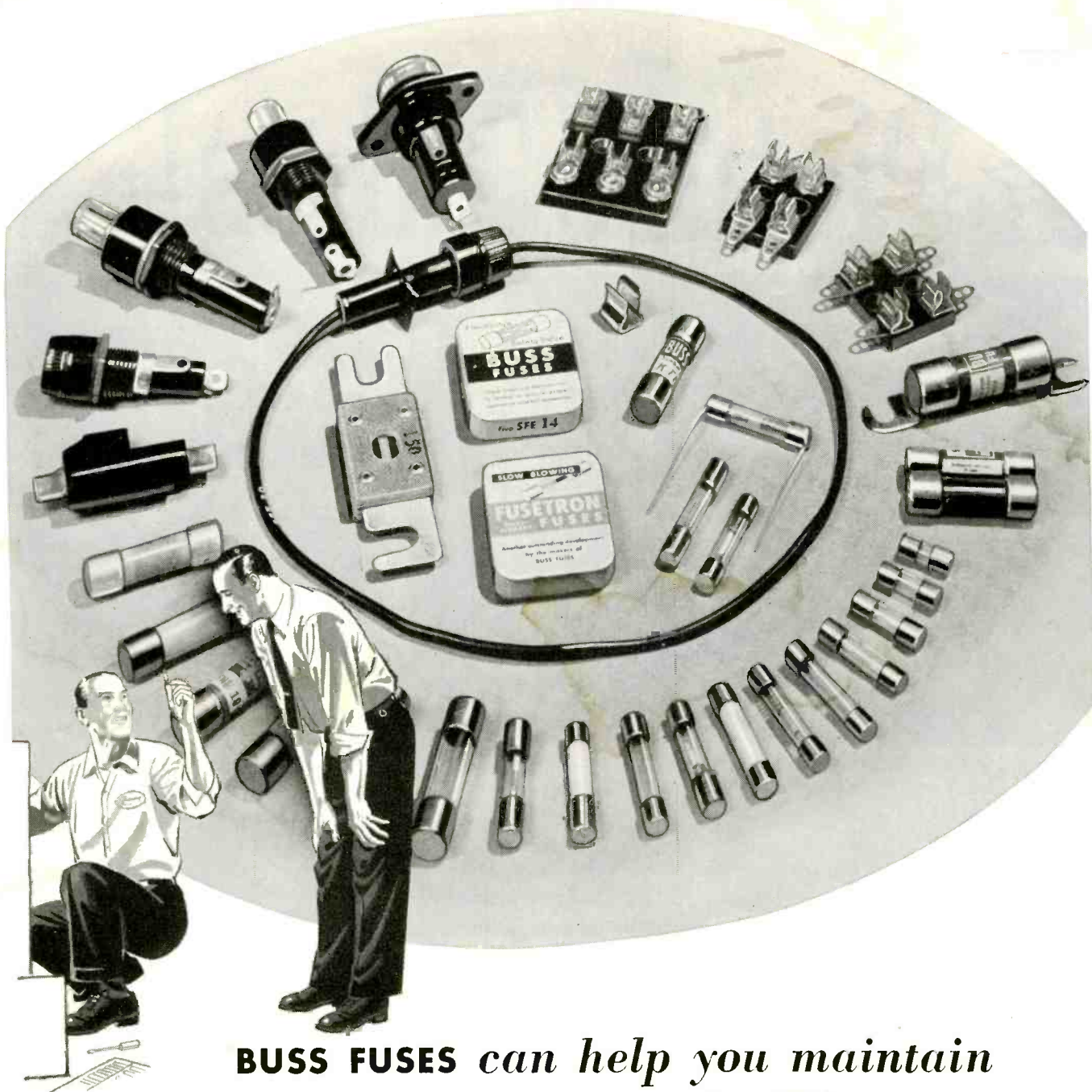

BUSS FUSES *can help you maintain customer good-will!*

Your customers stay satisfied with BUSS fuses because . . . BUSS fuses provide, dependable, 'trouble-free' electrical protection under all service conditions.

Every BUSS fuse you sell or install is tested in a sensitive electronic device. Any fuse not correctly calibrated, properly constructed and right in all physical dimensions is automatically rejected.

BUSS fuse dependability helps you gain satisfied customers — and BUSS fuses help you avoid adjustments or call-backs that cut into your profits.

BUSS fuses can further help you maintain your reputation for quality and service because BUSS is the KNOWN brand of fuses. The universal acceptance of BUSS fuses as the finest available is built on the millions upon millions of BUSS

fuses used in home, on farm and in industry over the past 43 years.

For more information on the complete line of BUSS and FUSETRON Small Dimension Fuses and Fuse-holders, write for bulletin SFB.

Bussmann Mfg. Division McGraw-Edison Co. University at Jefferson, St. Louis 7, Mo.

S-558

BUSS fuses are made to protect — not to blow, needlessly



A COMPLETE LINE OF FUSES FOR HOME, FARM, COMMERCIAL, ELECTRONIC, AUTOMOTIVE AND INDUSTRIAL USE.

THOUSANDS OF E-V STEREO CARTRIDGES

are now in use, accepted as the standard of the industry. Don't stock up on high-fidelity cartridges until you've read this vital *stereo report*.

SPECIFICATIONS

RESPONSE: 20-16000 cps \pm 2.5 db to RIAA
ELEMENTS: Ceramic
OUTPUT: (Westrex 1A) .5 volt rms.
COMPLIANCE: 2×10^{-6} CM/dyne
TRACKING FORCE: 6 grams
WEIGHT: 2.4 grams
STYLUS: .7 mil
MOUNT: EIA (RETMA) Standard $\frac{1}{2}$ "
and $\frac{7}{16}$ " centers
CHANNEL ISOLATION: 20 db

THE MISSING LINK to popular-priced stereophonic sound reproduction is here: It's the new Electro-Voice TOTALLY COMPATIBLE Stereo Cartridge . . . plays the new stereo discs superbly . . . LP's too . . . even better than existing cartridges.

By breaking the stereo cartridge cost bottleneck, Electro-Voice has made popular-priced quality stereo a reality. E-V's ceramic stereo cartridge (Model 21D with .7 mil diamond stylus) sells for only \$19.50 (Audiophile net).

FULL PAGE COLOR ADS & SPREADS IN Popular Electronics, High Fidelity, Hi-Fi & Music Review, Hi-Fi Music at Home, Audio, etc., are telling the E-V Stereo Story to ALL OF YOUR CUSTOMERS RIGHT NOW.

Here are some of the answers to your questions concerning stereo:

Q How does the COMPATIBLE E-V Stereo Cartridge differ from CONVENTIONAL cartridges?

A It has the ability to play both the new type stereophonic discs and conventional records. Inherent in its design is an improved monaural performance. *Exclusive* design for rumble suppression of 15 db or better will permit the use of Electro-Voice's Stereo Cartridge *with any type of changer or transcription player!*

Q Are stereo discs compatible with conventional cartridges?

A Most cartridges damage the stereo record. **STEREO DISCS SHOULD NOT BE PURCHASED UNTIL AN E-V STEREO CARTRIDGE IS INSTALLED.** Then, you may play monaural or stereo discs monaurally. When a second speaker and amplifier is added, you have stereophonic sound.

Q What about modification problems?

A Using an Electro-Voice Stereo Cartridge, which is constructed so that its output is already corrected to the RIAA curve, you will not require the equalization of the *second* amplifier. Inserting the cartridge is simple. It will fit virtually any standard tone or transcription arm. The addition of a second amplifier and speaker is not complicated.

Q What about record availability?

A Recordings by major record manufacturers will be available in mid-1958.

Q What effect will stereo cartridges and records have on present equipment?

A Only the cartridge will be obsolete. All other components are compatible with stereo.

Q What if the customer doesn't have a HI-FI system now . . . should he wait?

A NO. He should proceed as before—with one exception: he should use a stereo cartridge initially. When he is ready for stereo, he need add only a *second* speaker and amplifier.

Q How do you order the cartridges?

A Contact your Electro-Voice representative or distributor, or write directly to the factory for complete information. Ask for E-V Stereo Model 21D with .7 mil diamond stylus or E-V Stereo Model 26 DST Turnover with .7 mil diamond Stereo tip and 3 mil sapphire tip for monaural 78 rpm records (\$22.50).

STEREO IS HERE! STEREO

don't stock up on obsolete cartridges . . . sell the totally compatible Electro-Voice stereo cartridge



Electro-Voice®

ELECTRO-VOICE, INC.
BUCHANAN, MICHIGAN
CANADA: E-V of Canada Ltd., 73 Crockford Blvd., Scarborough, Ontario

FOREMOST IN ELECTRO-ACOUSTICS . . .

Microphones, Phono-Cartridges, High-Fidelity Loudspeakers and Enclosures, Public Address Speakers, Marine Instruments, EVI Professional Electronic Instruments and Military Material.

How to make more money as an independent

RAYTHEON BONDED ELECTRONIC TECHNICIAN

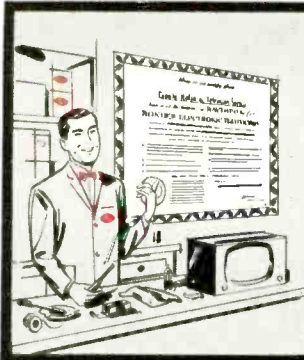

Prominently display your Raytheon Bonded Certificate. It impresses your customers just like a doctor's diploma or lawyer's certificate.



Feature the Raytheon Creed Display and the Bonded Dealer Decal in your windows. The Creed Display shows potential customers your Code of Business Ethics. The Decal identifies you as a nationally advertised Bonded Dealer.



Carry "ID" Cards. You and your technicians should always carry your Raytheon Identification Cards. Presenting the card puts your customers at ease when you must remove a set from the home.



Advertise your Bonded Dealer standing. Use the newspaper mats Raytheon makes available to you for local newspaper advertising. Rates are low, results high. Scripts for radio and TV spots are also available to you at no cost.



Use the Yellow Pages. List your shop as a Bonded Dealer shop in the Classified Telephone Directory — many customers select service dealers from this source.



Make Mailings to Potential Customers. Raytheon has available to you many attractive Post Card mailers and a special Bonded Dealer self-mailer. Regular mailings stimulate service business.



Identify your shop. This traffic stopping metal sign will tell all passersby that you are the Bonded Dealer in your community — the Bonded Dealer that Raytheon is presenting to America as the top TV-Radio technician in the country.



Finally, make the most of the hundreds of helpful sales and shop aids Raytheon has available to you. They're all shown in this Raytheon Business Builders booklet. Get a copy from your Raytheon Tube Distributor, today.

P.S.

If you're not a Raytheon Bonded Dealer call the Raytheon Tube Distributor who sponsors the Bonded Program in your neighborhood. He'll tell you if you can qualify.

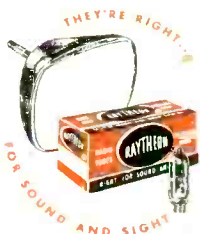

RAYTHEON MANUFACTURING COMPANY

Receiving Tube and Semiconductor Operations

NEWTON 58, MASS. CHICAGO, ILL. ATLANTA 8, GA. LOS ANGELES 7, CALIF.
55 Chapel Street 9501 Grand Ave. (Franklin Park) 1150 Zonolite Rd. N.E. 2419 So. Grand Ave.

Raytheon makes all these } Receiving and Picture Tubes, Reliable Subminiature and Miniature Tubes, Semiconductor Diodes and Transistors, Nucleonic Tubes, Microwave Tubes.





SERVICE

THE TECHNICAL JOURNAL OF THE TELEVISION-RADIO TRADE

Parts Jobber and Service Man: Mutual Interdependence

IN MANY WAYS the Parts Jobber is one of the best friends the Service Man has. He functions as a vital link in a national supply chain which enables the Service industry to obtain needed replacement parts quickly and efficiently. The fact that most jobbers carry only standard-brand packaged parts produced by reputable manufacturers has been a boon to the Service Man, providing him with reasonable assurance that the part he installs will stand up in use.

Many jobber organizations have gone to great lengths to be helpful to the Service Man. They have provided him with technical information on new products and developments. Some distributors even maintain laboratories for checking test equipment and components, and the results of their investigations are available to the Service Man. Parts jobbers also aid Service Men by maintaining proper and business-like credit relations with them and by joint efforts in promotion and advertising campaigns.

It is for these reasons that SERVICE salutes the Parts Jobber on the occasion of the 21st annual Electronic Parts Distributors Show which is being held in Chicago on May 19-21. We extend our best wishes to the Electronic Industries Association, the National Electronic Distributors Association, the Association of Electronic Parts and Equipment Manufacturers and the other sponsoring organizations and urge them to continue to promote the interests of the Service Man as well as their own interests in a spirit of mutual interdependence.

Friendship is a two-way street, and the Parts Jobber depends on the Service Man, too. It is only by working together to handle and resolve the problems which face both mutually that the Service Industry and the Parts Distributor can assure a bright future for both groups.

THE LAST WORD on color is that this field is moving forward at a far faster pace than most people realize. Addressing shareholders at RCA's 39th annual meeting early this month, president John L. Burns pointed out that color television continues to advance not only in programming but also in merchandising.

Sales of color sets to consumers are running well ahead of last year, he reported, and intensive color promotions in many parts of the country are producing excellent results. Dealers are becoming convinced that their greatest future profits will be realized in color TV receivers.

The quality and performance of color TV sets improved considerably in 1958, Mr. Burns stated, and he looks forward to future increases in sales during the rest of the year. Progressive Service Men would be well advised to prepare now for a demand for color TV servicing that is sure to come sooner than most of us realize.

* * *

ANOTHER FIELD which is also moving rapidly forward is mobile radio systems. Despite generally unfavorable economic conditions, the mobile radio business has continued to grow at a rapid pace and those in a position to know believe this is only the beginning.

An indication of the expected growth in this field is contained in the testimony before a House Committee by Curtis Plummer, chief of FCC's Safety and Special Services Bureau. Mr. Plummer predicted an increase of 100,000 stations in the coming fiscal year.

The 425,000 stations now licensed, he pointed out, use approximately one and a half million fixed and mobile stations. Here is another activity which bears watching by the alert Service Man.

All-Transistorized Portable Radio Receivers

[See Front Cover]

New Series Utilizes 3 to 9 Transistors With Stable Temperature Parameters

by ROBERT A. MAGNANT
Group Supervisor, Engineering Dept., Philco Corp.

TEMPERATURE STABILITY is always an essential part of good radio design, and it becomes especially important in a transistor radio. One of the best ways to insure good temperature stability is to choose transistors in which the temperature-dependent parameters are of the proper value to have little effect on the circuit operation. By the use of surface barrier transistors in the *rf*, *if* and detector stages, especially good results are obtained in this respect. Another method is to provide current stabilization, usually by means of an emitter resistor. Most audio stages require this type of temperature stabilization because of higher operating temperatures generated by the higher power levels.

A new line of transistorized portable radios¹ has just been placed on the market which makes use of both systems to insure stability within the desired temperature range. The sets range in size from a tiny three-transistor model to a nine-transistor all-wave portable. A description of the circuitry utilized in some of these sets follows.

Three-Transistor Portable

The smallest unit² in the line, approximately as large as a king-sized pack of cigarettes is shown in Fig. 2 and illustrated schematically on the cover and in Fig. 1. It will fit into a shirt or vest pocket, and an ear-phone attachment permits the owner to use the set without disturbing other people in the area.

This model uses two tuned *rf* stages followed by a diode detector and an audio output stage which drives the earphone. Because of the low power requirements of the earphone, it was possible to use a battery voltage of

only 2.6 volts. Since the current drain is also small, it was decided to use small mercury cells which are consistent with the size of package but which would give a reasonable battery life. For this reason two P630 cells were used which allow approximately 150 hours of use.

One of the major problems in any radio is that of obtaining good stage tracking without elaborate precautions which add to the cost. This was handled on this set by use of a dual tuning knob which provides both coarse and fine tuning. The antenna and first *rf* tuning condensers have separate knobs which are loosely coupled mechanically. This permits them to be rotated together easily and still provide individual adjustment of each condenser so that both stages may be perfectly tuned to the incoming signal. The exact tuning obtained by this dual-knob method often surpasses that achieved on

more expensive sets with standard one-knob tuning systems.

After the incoming signal is amplified by the tuned antenna and first *rf* stage it is fed to a broad-band second *rf* stage for further amplification and thence to a diode detector. The detected audio is then fed to the audio amplifier which raises the level high enough to drive the earphone.

A newer version of this model will soon be on the market with improved sensitivity. This is being achieved in the same package size by the addition of *audio reflexing* to the first *rf* stage. Reflexing is the principle of using one transistor to amplify signals of two different frequencies. In this case, the detected audio signal is fed back to the first *rf* stage where it is further amplified before being applied to the audio output stage, thus considerably improving the sensitivity of the receiver.

Seven-Transistor Portable

A seven-transistor radio³ which operates as a high-performance portable

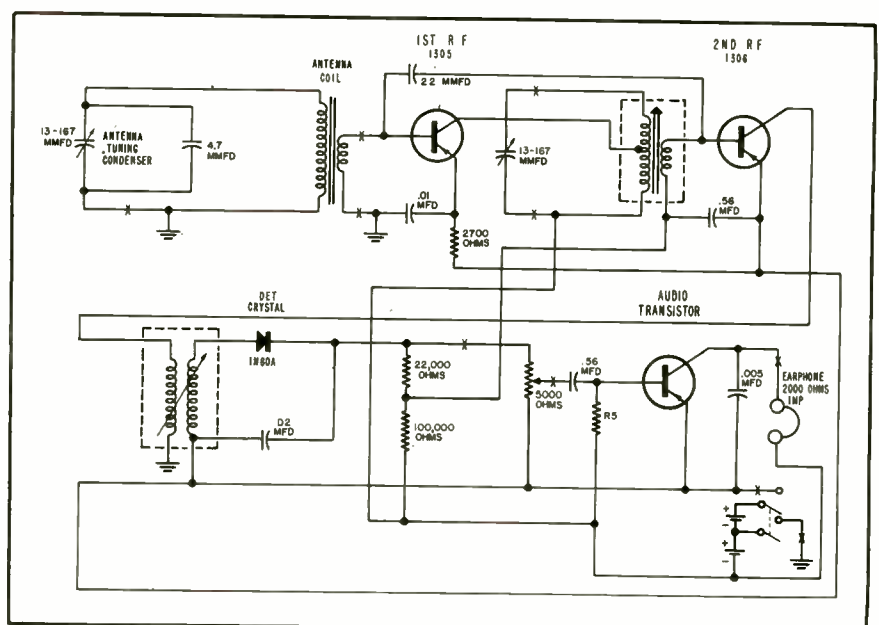

FIG. 1: SCHEMATIC DIAGRAM of Philco model T-3 portable radio receiver which utilizes only three transistors in the entire circuit.

¹Manufactured by Philco Corp. ²Philco model T-3. ³Philco model T-701.

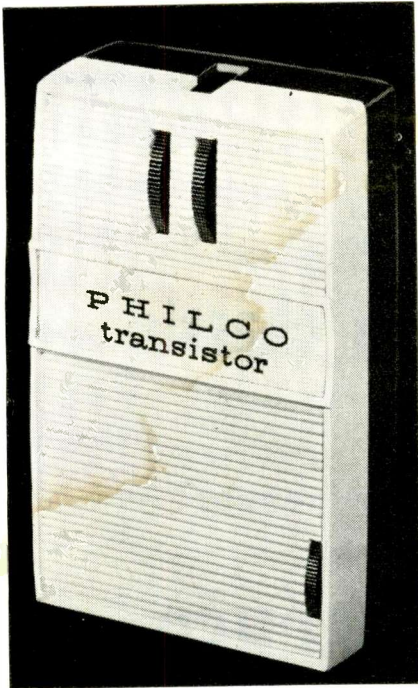

FIG. 2: THREE-TRANSISTOR portable radio is approximately same size as pack of king-sized cigarettes.

and yet has sufficient power output to take the place of conventional line-powered table model radios is also included in this series. This set, shown schematically in Fig. 4, has a 200 mw class B push-pull output system with a heavy-magnet 4-in. speaker and operates from four standard D-size flashlight batteries. Since a heavy-magnet speaker is considerably more efficient in converting electrical power to acoustical power, this 200 mw system will provide a sound volume equal to that produced by sets with much greater power output but employing a light-magnet speaker.

Dual Antenna System

To take full advantage of a good output system it is necessary to have sufficient gain ahead of it to receive

all the desired stations without noise interference. This is greatly aided by the use of the dual *Magnecor* scan-tenna used on this set. By proper phasing of the coils on the dual *Magnecor* during assembly, considerably more power is obtained from a given broadcast signal than is possible with single antennas usually used in this size of radio.

Transistor Stages

In addition to the antenna, seven transistors are used in the set to provide the necessary gain. The system makeup is as follows: converter stage, two *if* stages, a transistor power detector, an audio amplifier stage, and the push-pull output stage. The operation of these stages is conventional, except that there are four tuned *if* circuits instead of the usual three to provide better adjacent channel attenuation. The transistor detector provides both detection and amplification and is an important factor in the overall gain picture.

Nine-Transistor Portable

The largest set in this series is a nine-transistor all-wave portable radio.⁶ It has seven bands including the broadcast band, a 2 to 4 *mc* band, a 4 to 8 *mc* band and four spread bands at 16, 19, 25 and 31 meters. This portable set is shown in Fig. 3.

The set uses a tuned *rf* stage, a separate oscillator which has its own power supply for frequency stability, a mixer stage, two *if* stages, a transistor detector stage, an audio amplifier stage, and a push-pull class B output stage. The power supply is 6 volts, provided by four standard D-size flashlight batteries, for the main part of the set. Two separate flashlight batteries for collector and emitter stabilization of the oscillator



FIG. 3: PHILCO'S ALL-WAVE PORTABLE model T-9 utilizes nine transistors and is powered by D-size flashlight batteries.

are also included. The power output is 250 mw into a heavy magnet 4-inch speaker.

Four-Transistor Model

There is also a coat pocket or purse size model⁶ employing four transistors and powered by four pen-light cells. The *Magnecor* antenna is followed by a converter stage, and two stages of *if* amplification. The *if* signal is demodulated by a diode detector and the resulting audio signal is reflexed in the second *if* stage which takes the place of an audio driver. This amplified audio signal is then applied to the audio output stage for sufficient power amplification to drive the speaker. This set has a class A output stage which provides 25 mw to a 2 $\frac{3}{4}$ -in. speaker.

⁴Philco model T-700. ⁵Philco model T-9. ⁶Philco model T-4.

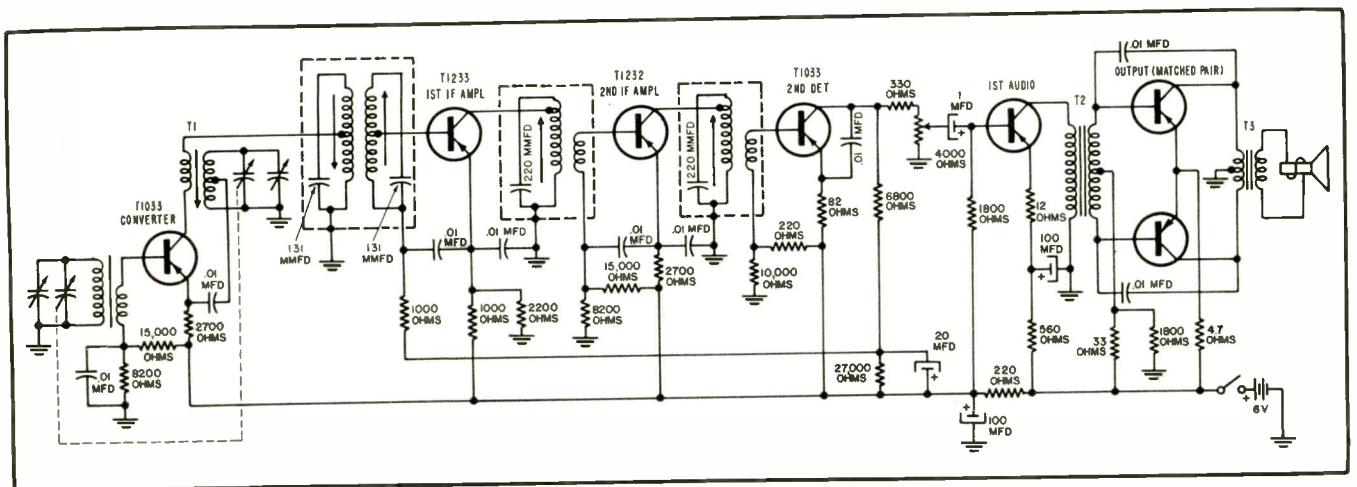

FIG. 4: CIRCUIT DIAGRAM of seven-transistor Philco model T-701 portable radio.

EVEN THOUGH THE DADDY OF

3 reasons why there are
NO printed circuits in Zenith TV chassis



standard HANDcrafted circuitry means:

1

LESS SERVICE HEADACHES



standard HANDcrafted circuitry means:

2

**EASIER SERVICING FOR DEALER
AND SERVICEMAN ALIKE**



standard HANDcrafted circuitry means:

3

**MORE SATISFIED CUSTOMERS
FOR ZENITH DEALERS**

We think it's worth the extra cost and extra care of HANDcrafted standard circuitry to get the best performance and least service headaches and so do thousands of dealers who would sooner sell customer satisfaction than a price tag.

ZENITH RADIO CORPORATION
Chicago 39, Illinois

The quality goes in before the Zenith name goes on.
Backed by 39 years of leadership in radionics exclusively.
Also makers of Radio, High Fidelity Instruments and fine Hearing Aids.



PRINTED CIRCUITRY IS HEAD OF
ZENITH'S RESEARCH DEPT.*, THERE'S

NO PRINTED CIRCUITRY IN ZENITH TV CHASSIS



*Even though Dr. Alexander Ellett, head of Zenith's research department, is recognized as the daddy of printed circuitry through his work on radio proximity fuses, still Zenith uses no printed circuitry in its TV chassis because it means more service headaches and often causes service delays.

QUALITY BY
ZENITH®

The Royalty of Television

Installing Hi-Fi Speakers and Enclosures To Improve Sound System in Home

by ROBERT MILLER*
and FREDERIC ZELLER

SERVICE MEN are frequently asked by their customers if it is possible to build a hi-fi installation which will utilize standard radio or TV receivers now functioning in their homes. The answer is that very often a startling improvement can be made in the sound quality by modifying or adding to the speaker in the original equipment, and that this constitutes a good start toward a more fully developed high fidelity system.

The weakest link in console radios, phonographs, TV sets and packaged hi-fi sets is usually the speaker. Almost invariably the amplifier circuit used in these units is capable of producing a much closer approximation to hi-fi than can the commercial loudspeakers which the manufacturer is forced to use in order to keep his price at a competitive level. Considerably better sound quality can often be obtained by the substitution or addition of hi-fi loudspeakers. This may be done in many different ways, depending on the requirements and budget of the customer.

The simplest and least expensive way is the addition of a simple capacitor network, balance control and *tweeter* (Fig. 1) to a system that has a single large-cone speaker. Most speakers of this type tend to be deficient in the high-frequency range above 5000 cps.

The inclusion of a 4-mfd capacitor with an 8-ohm *tweeter* will give a crossover frequency of 5000 cps and immediately add surprising highs and brilliance to the reproduction. The balance control allows adjustment of *tweeter* level to suit personal listening

*Technical Service Manager, University Loudspeakers, Inc.

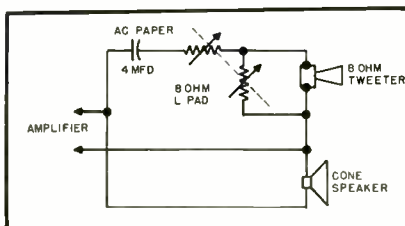

FIG. 1: CIRCUIT DIAGRAM of simple capacitor network.

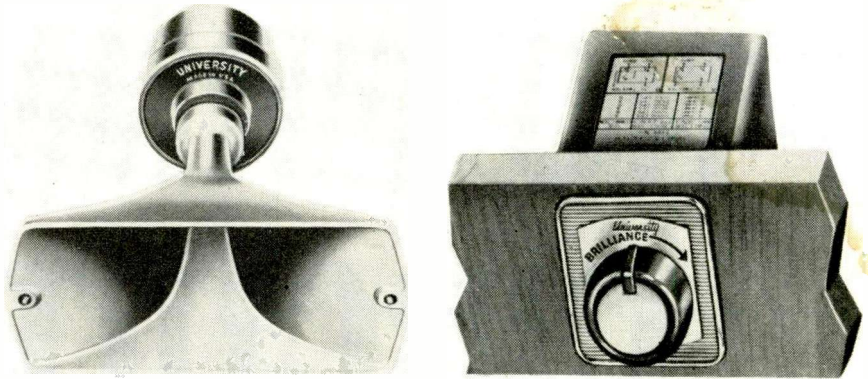

FIG. 2: TYPICAL HORN TWEETER is shown at left and a crossover network with balance control at right.

taste. For more accurate frequency separation, standard networks¹ are available from various high fidelity speaker manufacturers. A typical horn tweeter and a crossover network with balance control are shown in Fig. 2.

Although the addition of a *tweeter* results in greater sharpness and clarity, response will be still further improved if a wide-range hi-fi speaker were substituted for the commercial one in the set. By itself, a wide-range speaker should be capable of handling frequencies from low bass up to 13,000 cycles, and with *tweeter* and network added the range is increased well beyond 15,000.

While some of the amplifiers used in commercial equipment have a selection of output impedance taps available, most have a basic output impedance of 3-4 ohms. Matching such amplifiers with 8-ohm high-fidelity speakers is no problem, however, since a slight mismatch is often permissible. A slight loss in power may sometimes result, but the higher efficiency of the new speaker will usually compensate for this. When the power loss seems too great, and quality of reproduction seems to suffer, the use of a 4-ohm to 8-ohm line matching transformer should be utilized.

When an 8-ohm tweeter is used with 3-or-4-ohm original equipment speaker, more energy will be passed to the cone speaker, which has a lower impedance. This can create a desirable situation in that the listener frequently wants more bass than most systems deliver. Since the added horn-type tweeter has inherently

greater efficiency, tweeter output will still be sufficient to balance the increased energy from the cone woofer. This sometimes eliminates the need for a balance control on the tweeter.

Where space is cramped or cutting an additional hole for a tweeter is difficult, a coaxial or three-way speaker provides a good solution. These are available in 8-inch to 15-inch models and usually have built-in networks. The best type of coaxial speaker usually consists of a large cone woofer for bass and middle range and a separately driven horn-loaded tweeter for high-frequency reproduction. (Fig. 3). In this type of coaxial design there is no interaction between the two components, and quality of reproduction can be as good as that of most comparable two-speaker systems.

One of the greatest difficulties experienced with any speaker is the reproduction of bass notes. The part played by the enclosure in assisting a speaker to reproduce low frequencies is often overlooked. A speaker operating in open air without any enclosure does not reproduce any bass, even though low-frequency cone movement is readily observed. A "short circuit" exists between the front and rear of the speaker cone, and when the path length from the cone front to cone rear is of a distance equivalent to the speaker diameter, low frequencies are cancelled before the acoustic waves can form sufficient length to be heard.

Since the wave length of a 50-cycle

¹Such as University model N1 shown in Fig. 2.

note is approximately 22 feet long, it becomes immediately apparent that a simple baffle board measuring 11 feet by 11 feet produces a strongly audible 50-cycle note because the path length of sound from speaker front to speaker rear is 22 feet. *Folding* this baffle board produces a correspondingly smaller, open-backed box, and adding a back panel completes the basic closed box or *infinite baffle* which is the simplest of speaker enclosures.

Bass Reflex Port

In order to obtain good results from a 12-inch speaker, an *infinite baffle* would have to be at least 8 and 15 cubic feet, respectively. However, it is possible to obtain excellent results from a much smaller more convenient enclosure by making use of various design approaches. Perhaps the simplest and most extensively used of these is the *phase-inversion* method. This provides an additional opening in the baffle board on which the speaker is mounted—called a *bass reflex port*. Further, the interior of the enclosure is heavily padded to absorb the higher frequencies. The *port*, therefore, allows the rear radiations of lower frequency to reinforce the directly radiated sound to provide an *acoustic bass boost*. The size of the

bass reflex port depends on the resonant frequency of the speaker employed and on the cubic capacity of the enclosure. Precise information can usually be obtained from the speaker manufacturer.

Commercial equipment usually encountered by Service Men use open-back enclosures. This is true of even many of the so-called hi-fi packaged sets. Obviously, this results in bass cancellation at some point in the frequency range, the precise point depending on the path length of sound from the front to the rear of the speaker. To compensate for this the original speaker is often designed with a *bump* in the higher bass range to create an illusion of deeper bass, and so circumvent the higher cost of a sealed and properly modified enclosure.

Some larger commercial radio, TV and phonograph cabinets of the console or floor variety lend themselves to complete "sealing" of the speaker enclosure space and Service Men have often done just that to improve the sound quality when substituting hi-fi speakers. Obviously, many of these enclosures are not of optimum size for maximum performance. Nevertheless substantially improved reproduction is possible by sealing available

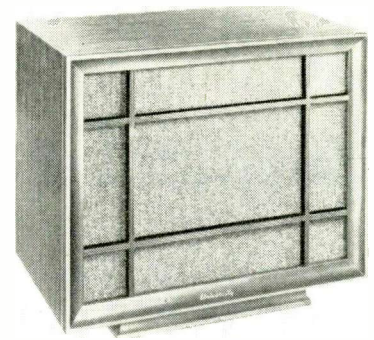

FIG. 4: PRE-ASSEMBLED UNIT complete with speakers and network.

space wherever practicable to make an airtight enclosure.

Before this is done, however, it is advisable to strengthen the corners of the future enclosure by the addition of $\frac{3}{4}$ -inch x $\frac{3}{4}$ -inch cleats. Any panel added for sealing should be of $\frac{3}{4}$ -inch minimum thickness plywood. The added panels should be secured with a screw in every corner and additional screws along the edges no more than 4 in. apart. A layer of fibreglas at least 1-inch thick should be used to cover all of the back panel, all of one side panel, and all of the top panel. For optimum lower frequency response, a *bass reflex port* as discussed earlier should be cut.

Certain higher quality packaged hi-fi units may already have some sort of an enclosure. If such a system fails to meet the specifications previously given, improvement of the enclosure or the substitution or addition of better speakers will result in improved sound quality. The ideal solution of course, is to hook up a separate enclosure complete with hi-fi speakers to the existing radio, TV or phonograph. It is important to note in this connection that most commercial radio, TV, phonographs have a low output power rating, sometimes no more than 2½ watts, so that a high efficiency speaker system should be employed.

There are several methods of adding a separate enclosure. The simplest way is to simply buy a pre-assembled unit complete with speakers and networks, ready to connect. (Fig. 4). These units often make attractive pieces of furniture which can be accommodated either in a corner or against the wall of a room.

Another method is to buy an enclosure, choose a suitable speaker or speakers, and then mount and connect them. This has the advantage for the customer in that he can start with a single wide-range speaker and progressively expand his system according to taste and budget.

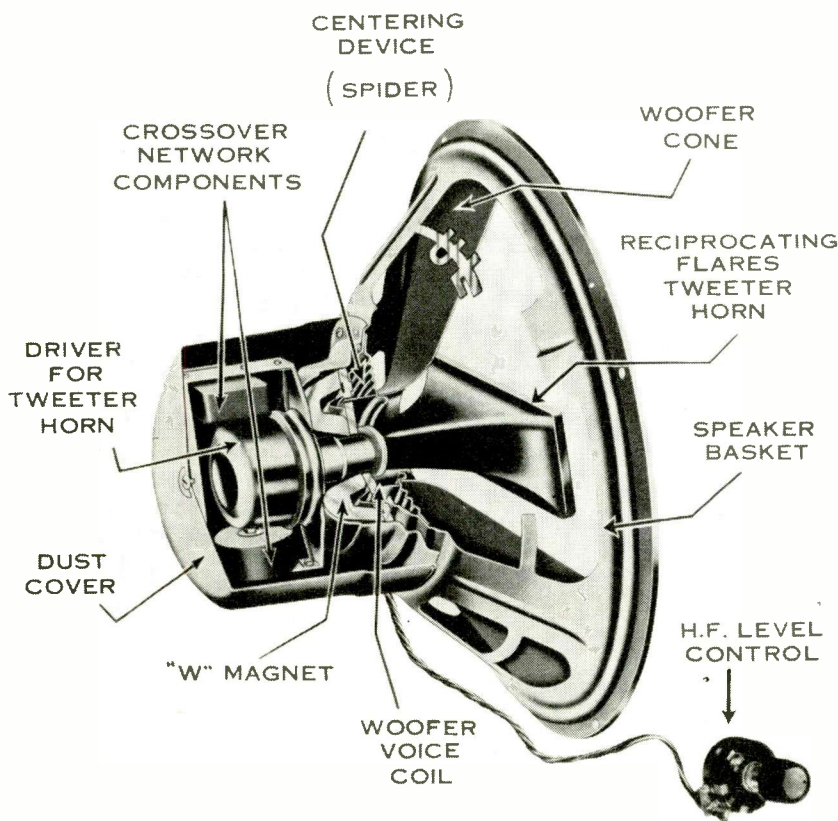

FIG. 3: COAXIAL SPEAKER consisting of large cone woofer for bass and middle range and a horn-loaded tweeter for high frequencies.

(All photographs courtesy of University Loudspeakers, Inc.)

DC Power Supply For Transistorized Equipment and Low-Voltage Devices

by R. C. CROSSLEY
Electro Products Laboratories

ORIGINALLY DESIGNED to meet the needs of an engineer for transistor design work, this power supply has become a service instrument because of its acceptance and usefulness in the field. The unit is a dual-range power supply, 0-32 v (at continuous currents up to 40 amps) and 0.16 v (at continuous currents up to 8 amps), with both ranges continuously and smoothly variable over both ranges. Important to the design engineer and useful to the Service Man is the maximum *rms* ripple voltage figure of less than 0.1%.

Utilizing a patented method of conduction cooling, the heat normally generated during operation of the selenium rectifiers is more efficiently dissipated by mounting the rectifiers directly to the sides of the cabinet. Adequate air ventilating louvers are provided at the top of the unit, as shown in Fig. 1.

Component Features

Component-wise, the *dc* power supply, illustrated schematically in Fig. 2, has a line filter which minimizes the effects of transient voltages that might be carried on the supply line. Also included is a heavy-duty carbon brush control transformer for smooth adjustment of the output voltage and D'Arsonval meters. A full-wave selenium rectifier bridge feeds a two-section *lc* filter, each with its own bleeder resistor. An ammeter monitors the

° Electro Products model EFB.

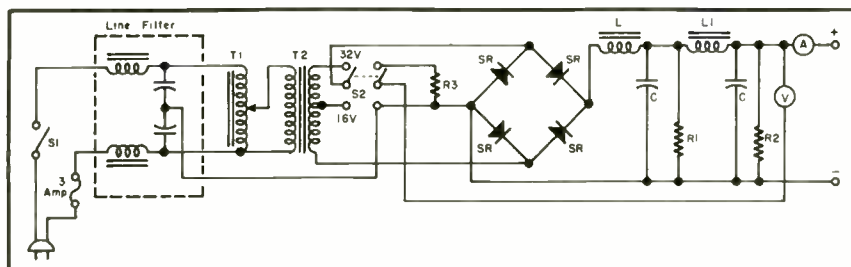

FIG. 2: SCHEMATIC DIAGRAM of Electro model EFB filtered *dc* power supply.



FIG. 1: DC POWER SUPPLY suitable for servicing transistorized and other low-voltage equipment.

high-side output current and a dual-range voltmeter across the arm of the bridge reads the output voltage.

Controls

The single-knob control, shown in Fig. 1, determines increments on transformer *T1* for output voltage adjustment. The toggle switch, used to select the desired output voltage-current range, automatically selects the corresponding voltmeter scale.

Two square clear-plastic panel meters with D'Arsonval movements assure accuracy in output voltage and current readings. Clearly labeled and color-coded multi-purpose output terminals are located on the front panel.

A 3-amp *ac* line fuse also is easily accessible from the panel. Perhaps equally important and often overlooked is the rating information printed directly on the front panel. This enables anyone not familiar with the equipment to know exactly the load the power supply can safely handle. This information is printed just below the *dc* ammeter.

Servicing Features

To anyone interested in servicing not only transistorized equipment but also relays, solenoids, telephone circuits and other low-voltage devices, the output performance characteristics are extremely useful. These are graphically illustrated in Figs. 3 and 4.

A separate set of curves for each of the two output voltage ranges completely describes *dc* voltage, *dc* current and *rms* ripple voltages. For example, when the user is drawing 3 amps at any voltage on the 0-32 v output range, the guaranteed maximum *ac* ripple voltage present at the output terminals will not exceed 7.7 *mv*. Also, should the user be drawing

(Continued on page 29)

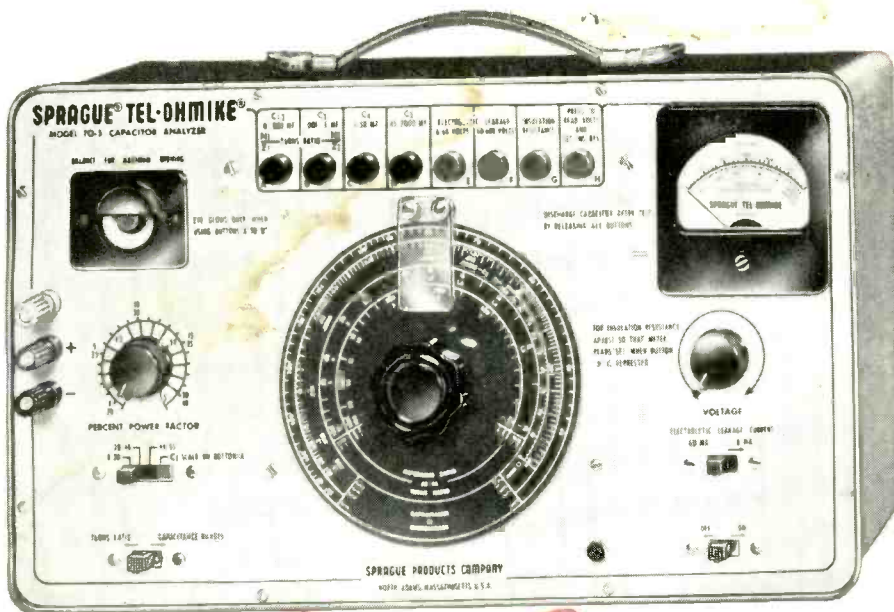

**NEW TO-5 TEL-OHMIQE®
capacitor analyzer**

measures all 4 . . . plus

1 CAPACITANCE	2 POWER FACTOR	3 LEAKAGE CURRENT	4 INSULATION RESISTANCE	extra feature TURNS RATIO
Measures up to 2000 μf in five overlapping ranges . . . including an accurate 1 to 100 μf range, exclusive with Sprague.	Power factor of electrolytic capacitors is measured by the highly accurate bridge method. Reads up to 55% in three ranges for convenience in measurement.	Leakage current of electrolytics is measured directly on the meter, with exact rated voltage up to 600 v. applied from continuously adjustable power supply. Two ranges — 0-6-60 ma.	Insulation resistance of paper, ceramic, and mica capacitors is read directly on meter . . . up to 20,000 megohms.	In addition to its function as a complete capacitor analyzer, the TO-5 also measures the turns ratio of power and audio transformers.

The NEW TO-5 TEL-OHMIQE Capacitor Analyzer is one of the fastest and surest ways of measuring . . . capacitance, power factor, leakage current, insulation resistance, and turns ratio. This compact, easy-to-use instrument has the highest accuracy of any instrument of its type available to the service trade.

New jumbo dial makes meter reading easy. Special color-keyed pushbuttons permit instant range selection . . . and allow automatic safety discharge of capacitors after testing. Magic-eye tube simplifies bridge balancing for capacitance and power factor measurements.

SEE THE NEW TO-5 TEL-OHMIQE IN ACTION . . . AT YOUR DISTRIBUTOR!

This 4-in-1 test instrument is only 8 $\frac{1}{8}$ " high, 14 $\frac{5}{8}$ " wide, and 6 $\frac{1}{8}$ " deep . . . weighs a mere 12 $\frac{1}{2}$ pounds. The complete price for . . .

MODEL TO-5 (115 VAC/50-60 cy) . . . Only **\$83⁹⁰_{net}**

Also available: Model TO-5X for 115-230 V/25-60 cy. . . . \$89.90 net
Model TP-5RM for rack mounting \$93.90 net



SPRAGUE PRODUCTS COMPANY, DISTRIBUTORS' DIVISION OF SPRAGUE ELECTRIC COMPANY, NORTH ADAMS, MASS.

Electronic Parts

Precision and Miniaturized Equipment Featured at the Hilton

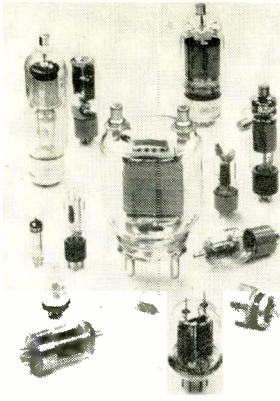

FIG. 1: CBS-HYTRON industrial tube line.

THE ELECTRONIC Parts Distributors Show, being held in Chicago at the Conrad Hilton hotel from May 19th through 21st, shows a shift in the industry toward precision and industrial-type components and equipment, as well as further emphasis on miniaturization. Many manufacturers in the audio field are exhibiting stereophonic equipment which has sprung into overnight prominence.

Replacement components have been refined or entirely redesigned to provide greater reliability and to make the job of installation easier. New packaging methods have been adopted throughout the industry to make the stocking and selection of replacement parts faster and more convenient.

Among tube manufacturers the production trend points toward the increasing importance of industrial and special purpose tubes (Fig. 1) in addition to further refinements in original equipment and replacement units.

In the rectifier field a wide variety of silicon diode types are being stressed. Units are being manufactured in top-hat, double-anode, multiple-junction high-voltage and reference element types (Figs. 2, 3). A miniaturized silicon voltage variable capacitor is being shown by International Rectifier Corporation.

All-purpose high-density selenium replacement rectifiers are featured by the General Instrument Distributor Division. A series of selenium contact protectors for arc suppression in ac circuits is also being introduced by International Rectifier Corporation.

A self-service merchandising dis-

play of *Discap* ceramic capacitors with 5-of-a-kind units packaged on a 3 x 5 card is featured in the P. R. Mallory and Company booth. Display is being used to introduce the units to the service trade.

Clarostat Manufacturing Company's exhibit features many precision units in addition to their standard line of replacement resistors and potentiometers (Fig. 4). Also on display is the *Greenohm V* vitreous enamel power resistor line.

A compact flat-loopstick radio replacement antenna designed for greater signal pickup and increased selectivity is being shown by Superex Electronics Corporation.

In the television antenna field the Finney Company is featuring its twin-driven *Geomatic* models, custom-designed models for particular areas, and a high-power antenna developed for tracking of earth satellites.

A new parabolic *uhf* antenna (see page 28) is featured in the Channel Master exhibit.

Trio Manufacturing Company is featuring their *Colorite* antenna designed specifically for b-w and color reception in metropolitan and suburban areas.

An antenna rotor (Fig. 5) featuring a direction indicator which automatically gives compass direction of antenna is being introduced by The Alliance Manufacturing Company.

Blonder-Tongue Laboratories are showing an all-channel *vhf* two-set booster (Fig. 6) designed to bring in sharper and clearer pictures. Unit amplifies signal on one or two sets whether both or just one set is in operation.

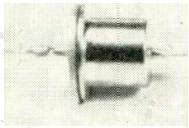

FIG. 2: GENERAL INSTRUMENT PT5 top-hat silicon rectifier.

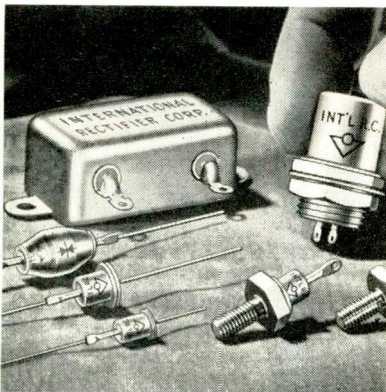

FIG. 3: INTERNATIONAL RECTIFIER silicon voltage regulator and reference diodes.

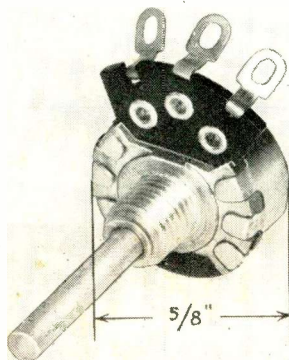

FIG. 4: CLAROSTAT miniature carbon potentiometer.

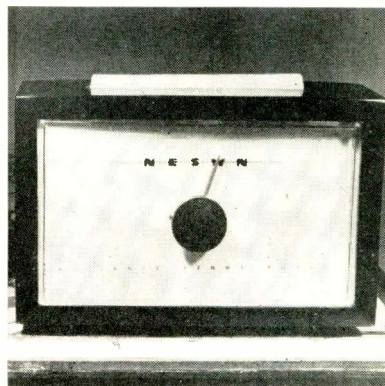

FIG. 5: ALLIANCE T-12 Tenna-Rotor.

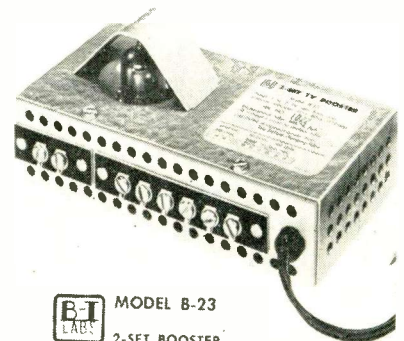

FIG. 6: BLONDER-TONGUE B-23 two-set booster.

Show Roundup

and Stereo Components to Be Hotel in Chicago

An extra-heavy adjustable auto radio antenna *Super 8* with 8-ball mount that allows adjustment up to 35 degrees is being exhibited by Ward Products Corporation. Unit has a 54-inch lead cable.

Electro Products Laboratories is featuring a dual-purpose *dc* power supply kit (Fig. 7) for servicing transistor portable radios and 12-volt auto sets.

Fourteen work-bench hook-up wire dispenser kits (Fig. 8), each containing a metal dispenser rack and an assortment of popular sizes and colors of vinyl, vinyl-nylon, textile, or teflon insulated hook-up wires are being introduced by Belden Manufacturing Company. Kits are available in sizes 20 through 26 and contain either 5, 8 or 10 different colored spools.

Vaco Products Company is introducing its *Red Cap* screwdriver line (Fig. 9) with tempered steel blades and red, shockproof plastic handles. Seven units in the line are a No. 1 Phillips with a 3-inch blade, No. 2 Phillips with a 4-inch blade, 3/16-inch round blade in both 4 and 6-inch lengths, 1/4-inch round blade in 4 and 6-inch lengths, and a 5/16 inch round blade 6 inches long.

A knee-hole work bench with eight drawer-cabinets (Fig. 10) is included in the *Equipto* line. More than 16 bench and cabinet units are available in a wide variety of combinations.

Jensen Industries is exhibiting a new line of 32 phono cartridges (Fig. 11) designed to replace 80% of existing units. Cartridges feature a simplified needle changing method and a built-in needle guard.

A low-mass damped *true pivot*

stylus arm construction is featured in the *RG 666* phono cartridge shown by the Recoton Corporation.

Ronette Sales Corporation is exhibiting its *Binofluid* stereophonic cartridge said to be compatible with both monaural and stereo discs. Unit can be used as a replacement cartridge in existing phonos.

A pictorial self-service replacement-needle catalog designed for the servicing field is being introduced by the Duotone Company. Featured in the catalog are photos of nearly all phono-graph models produced since the introduction of long-playing records.

American Microphone Manufacturing Company is featuring a tape recorder-conference microphone (Fig. 12) with a push button that can be depressed to talk or switched on permanently for conference use. Included is a clip-on stand for resting the unit on conference tables. Stand can also be used as a lavalier to support the microphone in speaking position on the chest.

A hi-fi speaker system in a low-boy enclosure is being exhibited by University Loudspeakers. Model is available with two different three-way speaker systems or as an enclosure only.

David Bogen Company is introducing a stereophonic adapter amplifier, *ST10*, designed to convert existing monaural systems for two-channel use. Unit is said to require only an extra speaker to achieve stereophonic reproduction. Adapter can be used with a tape recorder (with proper playback heads); magnetic, crystal or ceramic stereo cartridges; or with an FM-AM stereo tuner.

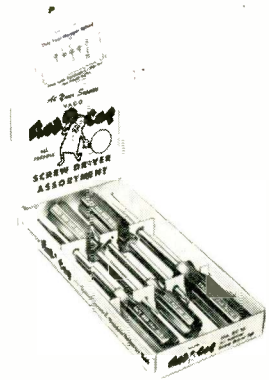

FIG. 9: VACO Red Cap screw driver line.

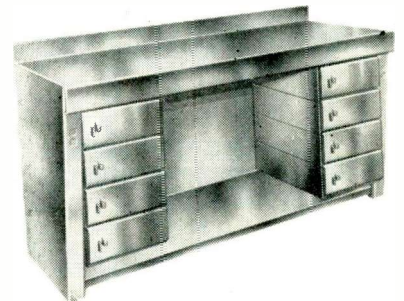

FIG. 10: EQUIPTO work bench.

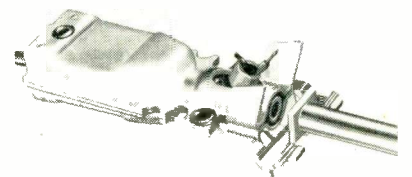

FIG. 11: JENSEN INDUSTRIES replacement cartridge.

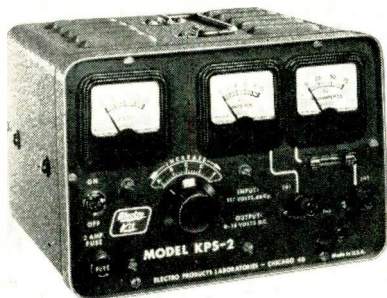

FIG. 7: ELECTRO-PRODUCTS KPS-2 transistor dc power supply kit.



FIG. 8: BELDEN hook-up wire dispenser kit.

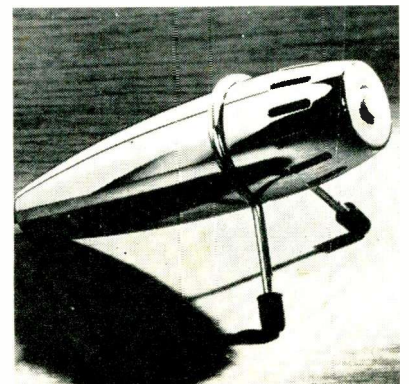

FIG. 12: AMERICAN MICROPHONE 204 tape recorder-conference mike.

**NEW
COMPLETE**

**DIRECT
VIEWING**

TELEVISION ANALYST

**test each stage
SEPARATELY**

and watch the
result on the
TV set itself

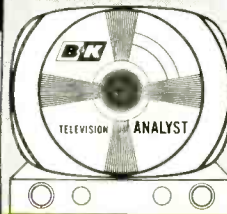
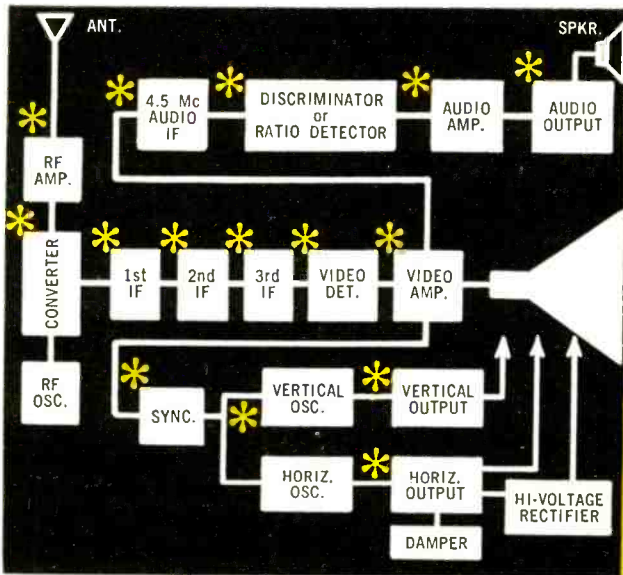

UNIQUE NEW SIGNAL-INJECTION TECHNIQUE
Saves TV Trouble-Shooting Time and Work

- R.F.** Supplies complete r.f. and i.f. signals with video and audio modulation to quickly trouble-shoot each stage in each of the sections of the TV receiver. Enables you to check the r.f. sensitivity and AGC settings of TV receivers.
- I.F.** Reproduces a complete test pattern on the screen of the TV picture tube and injects signals into each video stage of the TV receiver for fast, visual trouble-shooting and correction—anywhere, anytime. Makes it easy to check bandwidth, resolution, shading and contrast capabilities of the TV set.
- VIDEO** Provides composite signal, sync positive and negative.
- SYNC** Provides separate vertical and horizontal driving pulses for trouble-shooting deflection circuits.
- SWEEP CIRCUIT DRIVING PULSES** Test signal injection also aids in locating intermittent troubles.
- INTERMITTENTS** Provides a 4.5 mc sound channel, FM modulated with approximately 25 kc deviation. (This audio carrier is modulated either from a built-in 400 cycle tone generator, or from your own external audio source.) Injection of the 400 cycle tone signal simplifies trouble-shooting of the audio section.
- AUDIO** Enables you to trouble-shoot and signal trace color circuits in color TV sets. Generates white dot and crosshatch patterns on the TV screen for color TV convergence adjustments. Generates full color rainbow pattern of orange, red, magenta, blue, cyan, green to test color sync circuits, check range of hue control, align color demodulators, etc.
- COLOR** Enables you to check and adjust the vertical and horizontal linearity, size and aspect ratio of television receivers.
- SET ADJUSTMENT**



NEW



**MODEL
1075**

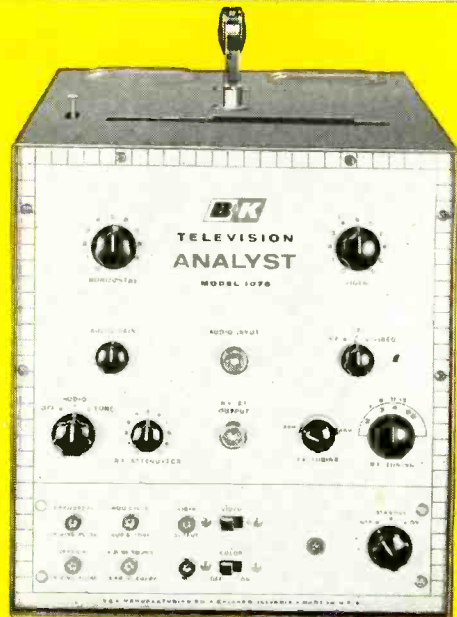

QUICK, DIRECT, COMPLETE TV TROUBLE-SHOOTING

Now, by point-to-point signal injection and test pattern reproduction, you can easily trouble-shoot and signal trace *any stage throughout the video, audio and sweep sections* of black & white and color TV receivers. With the remarkable new Model 1075 B&K TELEVISION ANALYST, you can quickly isolate and diagnose TV troubles (including intermittents). By use of the generated test pattern, you can *actually see* the condition directly on the picture tube of the television set itself. No external scope is needed. The TELEVISION ANALYST is practically a *complete* TV service shop in one instrument! **Net, \$259.95**



See your B&K Distributor or write for Bulletin AP12-S

B & K MANUFACTURING CO.
3726 N. Southport Ave. • Chicago 13, Illinois

Canada: Atlas Radio Corp., 50 Wingold, Toronto 10, Ont.

Export: Empire Exporters, 458 Broadway, New York 13, U.S.A.

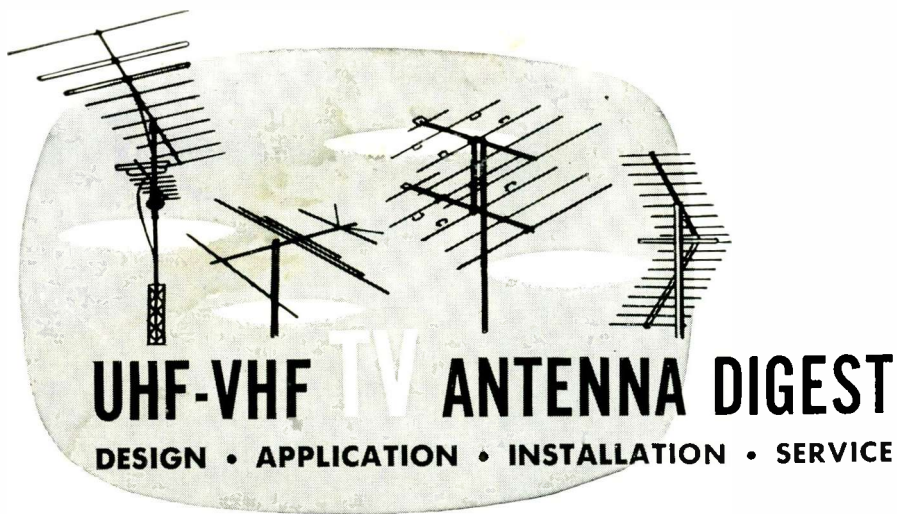

by RUDOLPH T. PLEMICH

IN THE EARLY days of television, primary signal areas generally were inadequate to provide sufficient signal strength for TV sets in large metropolitan areas without the use of outdoor antennas. With the greatly increased number of TV receivers, outdoor antenna roof space became increasingly difficult to obtain, especially in large apartment buildings, and was often a source of friction between landlord and tenant. For these reasons many set owners in large cities were forced to operate with indoor antennas, though the results were rarely as satisfactory as with an outdoor installation.

In the last few years, however, primary signal areas have been expanding as TV transmitting stations have increased their output, raised the height of transmitting antennas or both. As the effective radiated power of TV stations has increased, the results obtained with indoor antennas have shown corresponding improvement, and their use has even become possible in what were formerly secondary and fringe signal areas.

Most indoor antennas in use today, however, have a number of objectionable features. The styling is often bulky, they have long dipole elements, and often require channel switching. These have been a source of constant annoyance to set owners and are probably largely responsible for limiting the spread of indoor-antenna use.

A new indoor antenna, designated the Vi-Fi[®], has been developed recently which eliminates these objections. This antenna is shown in Fig. 1 with the dipole elements fully

extended, with the elements telescoped and folded into the case, and with the roll-up dust cover closed. When fully closed, the indoor antenna measures 9½ in. long, 3 in. wide, and 1½ in. high.

Dipole Matching Transformer

Physically, the dipole is about the simplest type of antenna. It is a well-known fact that a simple dipole has a characteristic impedance of 72-ohms while the nominal TV set input is usually 300-ohms. Practically, this 4 to 1 impedance mismatch not only results in lower signal to the TV input, but produces all sorts of trick effects, such as ghosts. Folding the dipole

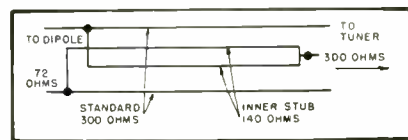

FIG. 2: OPERATING PRINCIPLE OF dipole matching transformer.

changes the impedance to 300-ohms, but this presents mechanical problems which would impair the basic simplicity of the design.

This basic matching problem was solved by utilizing the electrical principle illustrated in Fig. 2. Inside the ordinary 300-ohm lead are placed two additional strands of wire. The center matching stub (two inner wires) is 35½ in. long, and the outer set is 39 in. long. Effectively, the two outer wires constitute an open wire transmission line of a quarter-wave length. This length is cut for the center of the TV band.

The two inner wires also constitute a quarter-wave transmission line with an impedance of about 140 ohms since the two wires are spaced closer together. Note that one end of the line is shorted. Hence, the two tied together give an impedance of approximately 72 ohms, the nominal impedance of the dipole.

Each dipole element for *vhf* channel 13 is only 27 in., while that for channel 2 is 48 in. Measurements show that elements 27 in. long provide impedance mismatches as high as

(Continued on page 26)

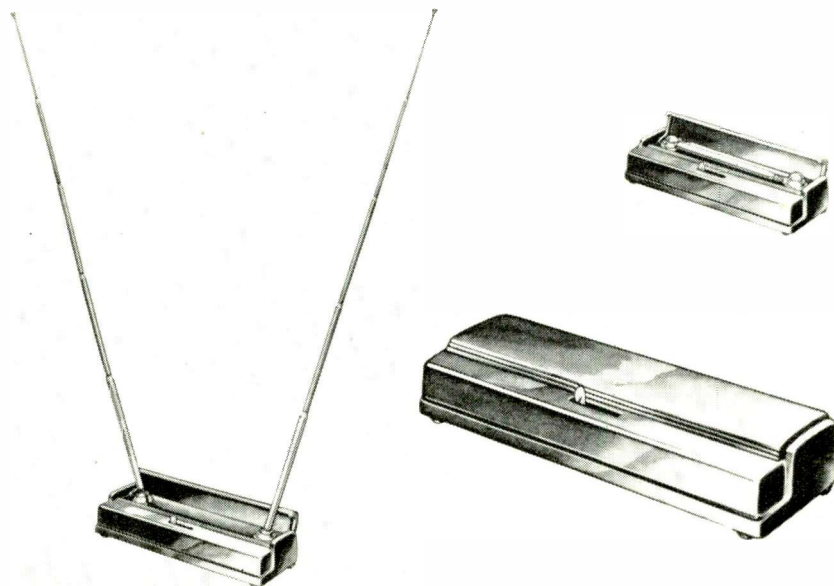
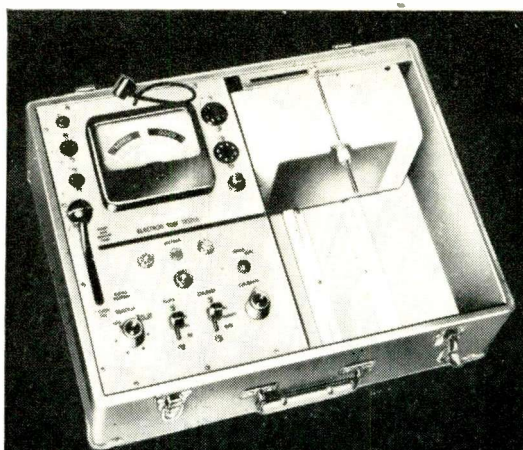

FIG. 1: THREE VIEWS OF VI-FI indoor antenna show unit with elements fully extended, with dipoles telescoped and folded into case, and with dust cover closed.

*Registered trade mark, Amphenol Corp.

The Tube-Tester that's always up-to- date!

- fast...
- fully automatic...
- pays for itself



RCA WT-110A Automatic Electron Tube Tester

\$199.50* includes 239 punched cards locked in sequence—covers 95% of active TV types...

USER PRICE (Optional) *Prices higher in Hawaii and Alaska

Plus—at no extra cost...



These bonus accessories... 24 additional punched cards, 24 unpunched cards, and sturdy new card punch!

With RCA's exclusive accessory punch and card kit, your WT-110A tester is always up-to-date as fast as new tube type punching information is announced. When you use the RCA WT-110A—the ultra-modern way to test tubes—you gain speed and accuracy for extra service income, and improved efficiency which pays for the tester in a very short time!

Remember, when you choose RCA's WT-110A Automatic Electron-Tube Tester, you also choose a brighter profit picture—now and in the future.

- Fully automatic! Sets up all socket connections and all operating voltages for heater, control grid, plate, screen grid, and bias.
- Checks for shorts and leakage between each element and all others consecutively—plate, screen, control grid, cathode. Multiunit tube sections checked individually.
- Checks amplifier tubes for transconductance—green scale indicates normal range of tube's transconductance.
- File capacity for 700 cards.
- High- and low-sensitivity ranges for gas and leakage tests.
- Automatically selects correct test conditions from 220 different heater voltages (from 0.1 volt to 120 volts) at currents up to 4 amps., 10 bias voltage, and 11 values of cathode resistance.
- Rectifier-type tubes tested for emission under heavy load currents (up to 140 ma per plate).
- 12-volt plate-and-screen supply for testing new auto-radio tubes.

See Your Authorized RCA Test Equipment Distributor!



RADIO CORPORATION OF AMERICA

Electron Tube Division

Harrison, N. J.

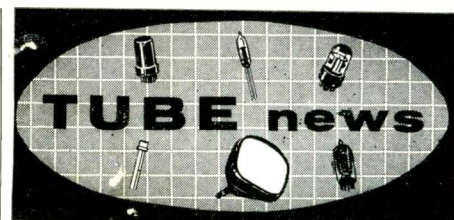

Earth's Field Effects on Color TV Tubes†

DUE TO BULB shape, the distance traveled by an electron is greater for the edge of the screen than for the center. Considering first the vertical component of the field, the deflection, the motion of the apparent source of electrons in the deflection plane, and the misregistration in color-TV tubes between beams and dots will obviously be larger for the two sides of the screen than for the center. At the top and bottom of the screen, while the distance traveled is the same as for the sides, the vertical field is not normal to the beam path. The net effects are actually somewhat less at top and bottom than at the screen center. When the center of the screen is purified, there is a misregistration of about .002" at the sides and less than .001" in the opposite direction at top and bottom. If there is also a horizontal component perpendicular to the tube axis, as when a tube is aimed east or west, the pattern is, of course, similar but rotated. In the frame-type tube, this effect is attenuated sufficiently so that other effects are more significant.

The field component parallel to the tube axis has a different effect. All beams scanned to the edge of the screen have a radial velocity component which is perpendicular to this axial field component resulting in a tangential displacement of as much as three to four mils, in some locations. This is counter-clockwise when the tube is aimed in a northerly direction, clockwise when it is aimed in a southerly direction and zero when the tube is aimed east or west. No correction can be designed into the tube, although a steel aperture mask is of some help in reducing the effect. The best method of compensating for this effect is a so-called *field neutralizing coil* which is wound around the large end of the tube and connected to a variable *dc* source. This coil produces an axial field which bucks out the

†Part II of an article based on a talk delivered at the IRE-EIA Fall Meeting, Toronto, Canada, by G. A. Burdick, TV Picture-Tube Division, Sylvania Electric Products, Inc. Part I appeared in March 1958 issue of SERVICE.

axial earth's field component—not perfectly, but adequately.

Up to now, it would appear that the steel mask and frame are the answer to such a problem, since they provide free shielding. Actually, the frame has been termed a fluxshunt rather than a shield, since its action is more aptly described by this name. While the frame attenuates the field, it also distorts it. It is difficult to measure the magnitude and direction of this distorted field, since the field is weak and varies rapidly near the frame, necessitating the use of a small but sensitive gaussmeter. It is equally difficult to present a picture of a three dimensional vector field on a slide. Fig. 1, a two dimensional plot, illustrates the major distortion; the drawing represents a plot of the field in the plane of a rectangular frame, the arrows representing magnitude and direction. Only the component in this plane is represented on this figure, the axial component being ignored. In the vicinity of the frame, the field is actually reversed in direction, which tends to counteract the effect of the field further back in the cone region of the tube. The apparent electron source, therefore, appears to be closer to the axis for the top and bottom of the tube than for the center and sides.

The field is, of course, different for each frame-mask assembly and for each orientation of the tube and variation in the earth's field. To determine accurately a multitude of fields and raytrace electron paths is a practical impossibility if not a theoretical one.

Color-TV tubes being made at the present time, such as the 21CYP22, normally require a compromise purity magnet adjustment and may require some external aid in the form of a shield, field neutralizing coil, or adjustable magnets for some of the possible geographical locations and orientations, but may be satisfactory without external help in other orientations. Adjustable magnets have the advantage of flexibility and cost, while the field neutralizing coil has the advantage of simplicity of adjustment.

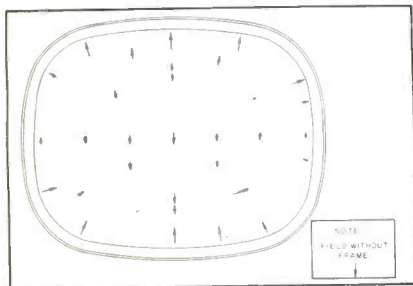

FIG. 1: TWO DIMENSIONAL PLOT of a field in the rectangular frame of a color tube; arrows represent magnitude and direction.

BURTON BROWNE New York

When a Serviceman Needs a Friend

PYRAMID

**CAPACITORS
SELENIUM RECTIFIERS
CAPACITOR TEST EQUIPMENT**

He uses Pyramid's unsurpassed Capacitor-Resistor Test Equipment to determine defective components in his repair jobs.

...And he replaces

Capacitors and Selenium Rectifiers
with top quality Pyramid Components.



PYRAMID
ELECTRIC COMPANY
North Bergen, New Jersey

Export: 458 Broadway, New York 13
Canada: Wm. Cohen, Ltd.,
7000 Park Ave., Montreal

Hi-Fi Amplifiers For TV Receivers



by PERRY SHENEMAN

HIGH FIDELITY is generally associated with complex circuitry and expensive components. A new series of amplifiers^o provides quality sound reproduction with a minimum of component parts. These high-fidelity amplifiers are used by the manufacturer in its better-quality television receivers and phonographs.

Basically, the amplifiers consist of a printed-wiring board and utilizes a phase inverter, audio amplifier and push-pull output stages. By using various tube types and design considerations, four amplifiers have been developed ranging from five to thirty

watts. A typical circuit of this hi-fi amplifier is shown in the schematic diagram, Fig. 1.

Service of these amplifiers is similar to most amplifiers. In soldering components on the printed wiring board, apply heat carefully. Excess heat may cause a break in the bond between the chassis board and the printed wiring. If the bond does become broken, a jumper wire can be soldered between the damaged portions.

When replacing a speaker or adding an additional one, all the speakers should be phased to insure optimum sound reproduction. When in use the cones of all speakers should move in the same direction at the same time.

To phase a speaker properly, place the voice coil leads across a 1.5-volt flashlight battery and note the direction of the cone movement. Find which lead, when connected to the positive terminal of the battery, moves the cone forward. Connect this lead on all speakers to the high side of the output transformer.

The amplifier may be checked for gain and frequency response by using an audio oscillator with a flat output from 40 cycles to 40 kilocycles and a vacuum tube voltmeter, preferably with a decibel scale. To perform these checks first disconnect speakers and then connect a 3.2-ohm 10-watt resistance across the secondary of the output transformer. Connect the ground lead of the audio oscillator to the chassis and the audio oscillator signal lead to the audio input socket. Allow a one-minute warm-up period.

To check amplification, adjust audio oscillator output to 0.7 volts at 1000 cycles as measured from the audio input socket to chassis ground. Measure the output voltage across the 3.2-ohm resistive load.

To check the frequency response, adjust the audio oscillator output to 0.7 volts and change the oscillator frequency in uniform steps between 40 and 14,000 cycles. Readjust oscillator output to 0.7 volts each time a new frequency setting is made. The amplifier output voltage at each step should be 5 volts \pm 1 db.

^oManufactured by Admiral Corp.

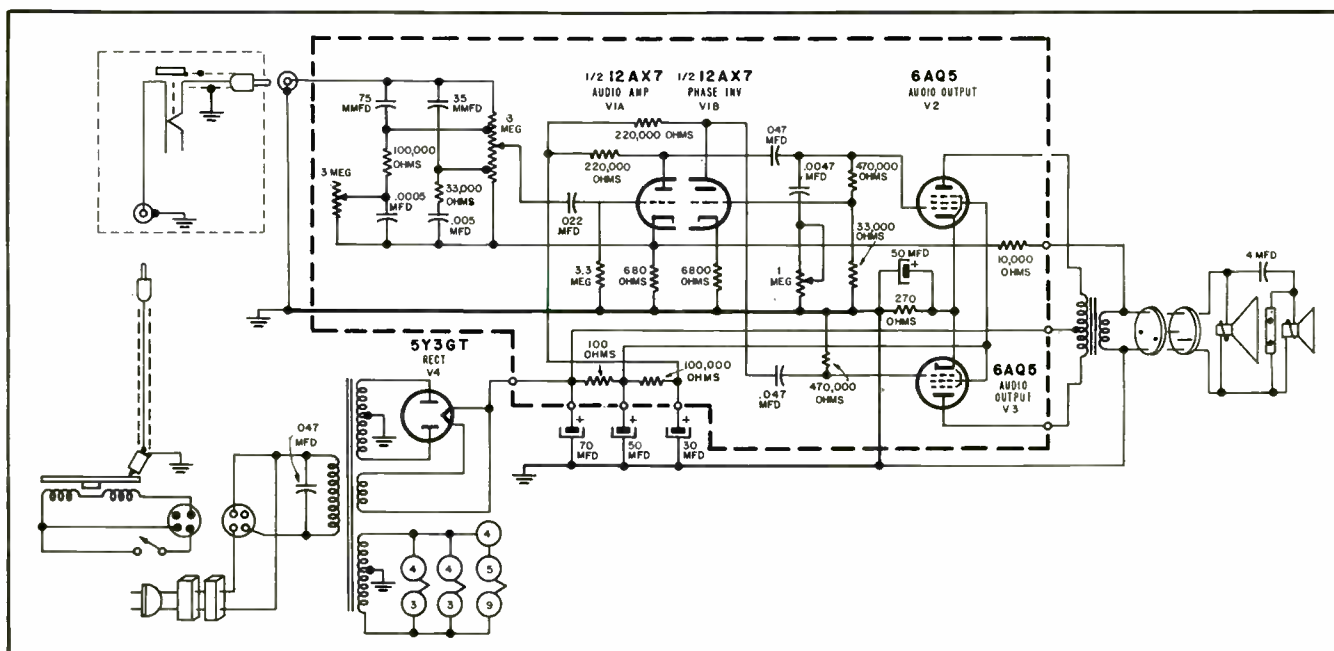

FIG. 1: CIRCUIT DIAGRAM of typical Admiral amplifier which is used in the manufacturer's better-quality TV receivers and phonographs.

NOW, "SNOW-WHITE" TUBE MANUFACTURE . . . PLUS VITAL DESIGN IMPROVEMENTS!



IMMACULATE CLEANLINESS marks the assembly of all General Electric Tubes. Lint and dust—common causes of tube shorts—are banned by the use of lint-free white garments by all workers . . . by cleaning floors frequently and with special care . . . by filtering and conditioning the air.



YOU CAN SEE WHY the Service-Designed 1J3 out-performs its prototypes! The new spiral-wound filament shield (right) won't bend from electrostatic pull. Filament distortion, and the shorts it causes, are cut 'way down. The 1J3 takes high peak anode voltages in stride!

CUT CALLBACKS WITH NEW G-E SERVICE-DESIGNED 1J3 HV RECTIFIER TUBES!

Customer complaints from rectifier-tube failures will drop sharply once you install new General Electric Service-Designed 1J3's. These tubes will stand up under the severe peaks common both with high line voltages, and where TV sets employ exceptionally high picture-tube voltages.

Every Service-Designed 1J3 is tested at 23,000 volts DC, 28,000 volts inverse. The tube is interchangeable with the 1B3-GT, and priced the same.

Two other new Service-Designed Tubes will cut your callbacks, build owner goodwill, increase your business—the 6AF4 and 6AF4-A. They're two bulb sizes of General Electric's sensational new UHF triode that once installed, *remains efficient* . . . no excess snow, no sudden loss of picture!

Now, 25 Service-Designed Tubes—all with su-

perior performance. And Service-Designed Tubes cost no more! Order from your G-E tube distributor! *Distributor Sales, Electronic Components Division, General Electric Company, Owensboro, Kentucky.*

G-E HIGH-QUALITY, LOW-CALLBACK SERVICE-DESIGNED TUBES INCLUDE:

1B3-GT	6AF4	6BG6-GA	6BX7-GT	6SN7-GTB
1J3	6AF4-A	6BK7-B	6BZ7	12SN7-GTA
1X2-A/B	6AL5	6BQ6-GA/6CU6	6CB6/A	25BQ6-GA/25CU6
5U4-GB	6AV5-GA	6BQ6-GTB	6CD6-GA	25BQ6-GTB
5Y3-GT	6AX4-GT	6BQ7-A	6J6	25CD6-GB

Progress Is Our Most Important Product

GENERAL  ELECTRIC

11-11-122

Short description of a Small Efficient TV System...

1 antenna .. IN
8 set lines .. OUT
10 db signal .. GAIN

all with
the



DISTRIBUTION AMPLIFIER

model DA8-B

approved
for
Color-TV

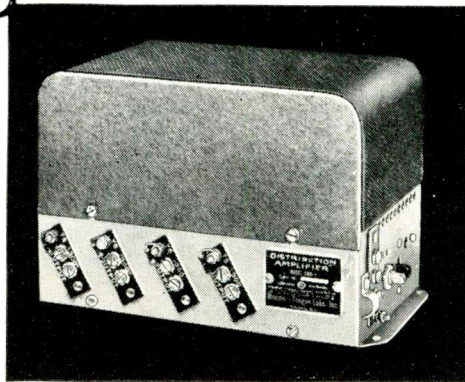

\$94⁵⁰ List

Ideal for garden apartments, motels, TV showrooms, deluxe home installations and other small TV systems. The DA8-B is a broadband, all-channel unit that requires no tuning, impedance matching devices, preamps or other special fittings.

Features and Specifications:

- Low noise all-triode circuit
- More than 10db gain on all VHF Channels
- Inter-set isolation in excess of 22db
- Provision for 75-ohm cable or 300-ohm twin lead
- Prevents overload through 10:1 gain control range
- Built-in power supply
- Designed for continuous duty operation

NOTE: For larger systems, Blonder-Tongue will furnish Free planning service on request.

Sold by Radio-TV Parts Distributors and Jobbers.

Write for Installation Details and FREE Booklet—"TV for 2, or 3, or More"

Dept. S-5

BLONDER-TONGUE
LABORATORIES, INC.
9 Alling St., Newark 2, N. J.



Manufacturers of TV Cameras, TV Amplifiers, Boosters, Converters, Accessories and Originators of the Masterline and 'Add-A-Unit' Master TV Systems.

Antenna Digest

(Continued from page 21)

30 to 1 in the low *vlf* bands and 7 to 1 in the high *vlf* bands. These mismatches are apparently due to a large capacitive reactance. The picture appears with numerous *ghosts* and *smears*.

Cancellation of the large value of capacitive reactance is accomplished by adding an equal inductive reactance to each dipole element. This brings the dipole element to resonance at a particular frequency and thereby provides a good impedance match. An additional problem arising is that of keeping the impedance matched from channel to channel. Slug tuned coils, mechanically ganged as shown in Fig. 3, provided the answer.

Two ferrite rods are held together by a plastic rod made of Cyclocac[®]†, which does not affect tuning. Note that the tuning tab is not centered on the rod. This is done in order to have the ferrite in the coil on the left just enter the coil at the B end while the ferrite on the right is just entering its coil at the C end. Each dipole element is thus balanced and its length is adjusted electrically.

Advantages of Slug Tuning

This method of slug tuning eliminates one of the major problems of indoor antennas. When a dipole element length is adjusted by hand a body capacitance is added to the antenna. A properly adjusted picture obtained in this fashion may fade away or distort in one form or another when the hand is removed from the dipole element. The *slide tuner* on the Vi-Fi antenna tends to overcome this defect.

Experimental impedance values of the antenna were measured, with the tuner and the matching transformer installed. The mismatch across the high *vlf* band had dropped as low as 3 to 1 while the low band *vlf* values dropped as low as 1.5 to 1. The com-

†Registered trademark, Marbon Chemical Div. of Borg-Warner Corp.

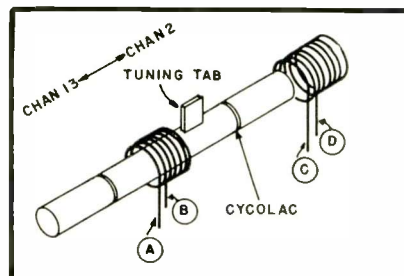

FIG. 3: ARRANGEMENT OF SLUG-TUNED coils in Vi-Fi indoor antenna.

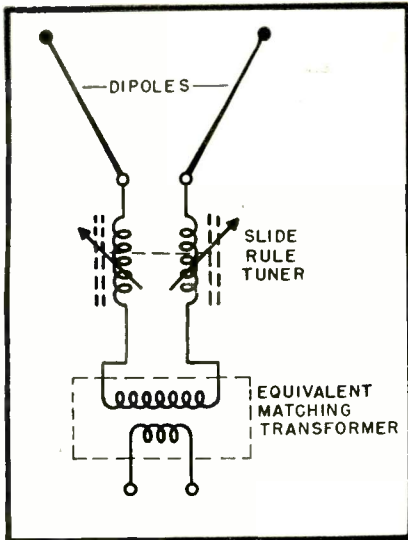

FIG. 4: SCHEMATIC DIAGRAM of Amphenol Vi-Fi Indoor Antenna.

plete schematic for the antenna appears in Fig. 4.

The *vlf* dipoles were collapsed to their shortest length, and the impedance was measured in the *uhf* band. Plotted values netted a mismatch which ran as high as 20 to 1. This was attributed to the fixed inductance in each leg of the dipole. Since this inductance could not be switched or tuned out, without affecting the performance of the *vlf* antenna, a separate folded dipole was designed, mounted under the bottom cover, and a standard length of 300-ohm twin lead was used for connection to the set. Experimental measurements were then taken and the mismatch had dropped to an average of 3 to 1 over the entire *uhf* band.

The antenna was field tested in several metropolitan areas with satisfactory results.

HEAVY-DUTY TV TOWER

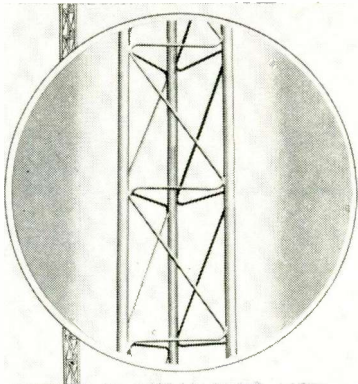

COMMUNICATION AND HEAVY-DUTY TV tower featuring 12½ in. equilateral triangular design, 1¼ in. extra-heavy-gauge tubing for side rails and zig-zag solid-steel cross bracing. Said to be self-supporting up to 50 ft. heights or guyed up to 150 ft. Available in hot-dipped galvanized or enamel finish. (No. 25; Rohn Manufacturing Co., 116 Limestone, Bellevue, Peoria, Ill.)

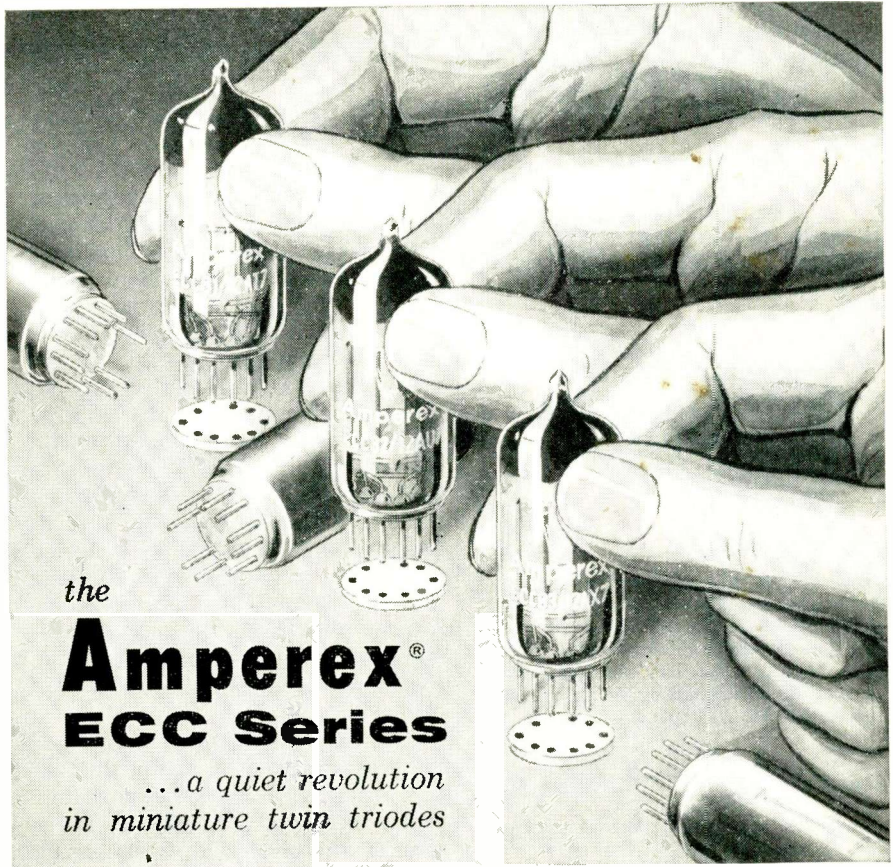

the

Amperex® ECC Series

...a quiet revolution
in miniature twin triodes

IMPROVED PLUG-IN REPLACEMENTS for the 12AT7, 12AU7 and 12AX7

Have you noticed, in the tube line-ups of the latest and finest audio and radio equipment, that the designations "12AT7," "12AU7" and "12AX7" are gradually disappearing and are being replaced by "ECC81/12AT7," "ECC82/12AU7" and "ECC83/12AX7" instead? This has been happening quietly, without much fanfare, because the Amperex ECC series twin triodes are not very different from their conventional equivalents. Not *very*—but different *enough*, improved *enough*, to be inevitably and invariably preferred by those who know and care. The difference is in the internal tube structure, as seen in the illustration below, and in the special manufacturing techniques developed for this series by Philips of the Netherlands, world pioneers in audio tube research. In every way, it is good engineering sense to plug an Amperex ECC81, ECC82 or ECC83 into any socket that accepts a 12AT7, 12AU7 or 12AX7—because the ECC's are better tubes and (most important of all) they cost no more!

- ① Electrode structure completely rigid and immobile—for greatly reduced tube noise and microphonics.
- ② Tungsten filament is double helical—for significant hum reduction through magnetic cancellation.
- ③ Filament structure has no sharp bends—for prevention of the type of burn-out that shortens life of conventional folded type.

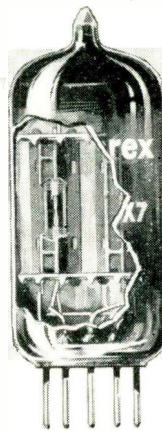

OTHER AMPEREX TUBES
FOR HIGH-FIDELITY AUDIO APPLICATIONS:

EL84/6BQ5:	9-pin power pentode; 17 W PP
6CA7/EL34:	High-power pentode; 100 W PP
EF86/6267:	Low-noise high- μ pentode
ECC85/6AQ8:	High- μ dual triode for RF
GZ34/5AR4:	Cathode-type rectifier; 250 ma.
EZ80/6V4:	9-pin rectifier; cathode; 90 ma.
EZ81/6CA4:	9-pin rectifier; cathode; 150 ma.

At All Leading Electronic Parts Distributors



ask **Amperex**

about special purpose tubes
for hi-fi, radio and TV

Detailed data, as well as applications engineering assistance to manufacturers and professional designers, available from Semiconductor and Special Purpose Tube Division, Amperex Electronic Corp., 230 Duffy Avenue, Hicksville, Long Island, N. Y.

**CONVERT TV PROBLEMS
INTO PROFITS !**



**INTERFERENCE
ELIMINATORS
SERVICE SAVERS**

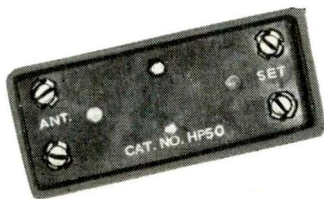

Knock out RF, diathermy, FM, and other TV interference without affecting signal strength. Feature lumped constants circuit, high Q capacitors and air core coils. Write for JFD Service-Saver brochure showing 40 money-making TV accessories now at all JFD distributors.

model	description	list
HP50	Eliminates TV interference below 50 mc	\$4.50
HP88	Eliminates TV interference caused by FM	5.95

Pioneers in electronics since 1929
JFD Electronics Corp.
Brooklyn 4, New York

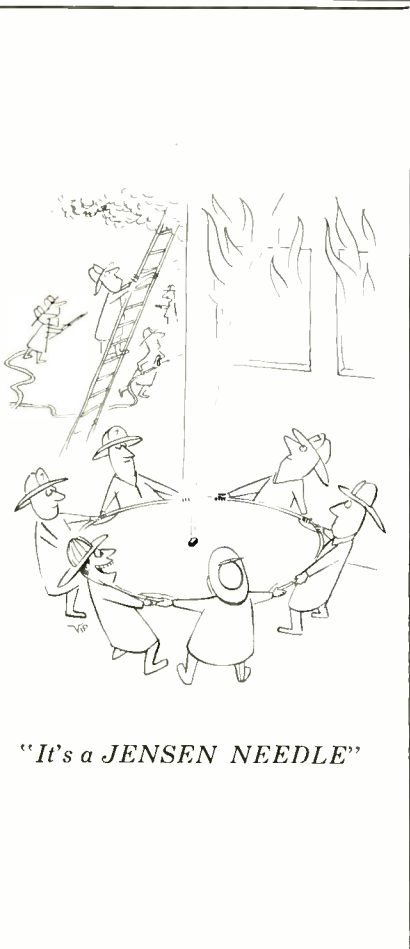

Signal Distribution Pattern of Ultrahigh Parabolic Antenna System

A NUMBER OF READERS have expressed interest in the *uhf* parabolic antenna described in a recent report¹ and have requested further clarification of the antenna distribution patterns discussed and illustrated in this article. The authors pointed out that all antennas have a natural tendency to develop a narrower beam as frequency increases. Most of the time this is a desirable feature. However with parabolic antenna, too narrow a beam in the dipole system would be a disadvantage since it would prevent the dipole from picking up reflected signal from the outer edges of the screen. A major objective in the design of this antenna, therefore, was to maintain a uniform beam width over *all uhf* channels.

Fig. 1 shows the antenna and three patterns produced by it. For the sake of clarity, the diagram shows the antenna acting as a transmitter rather than as a receiver. This is permissible since the theory of reciprocity states that the patterns of an antenna are identical regardless of whether the antenna is used to receive or transmit the signal.

Fig. 1a shows the ultrahigh parabolic antenna² discussed in the article

¹*Ultrahigh Parabolic Antenna System Design and Installation, Harold Harris and Paul Mattern, SERVICE, APRIL, 1958.*

²*Para-Scope antenna produced by Channel Master Corp.*

in its normal operating position. The ideal distribution pattern, which the designers of this antenna strove to obtain at all frequencies, is illustrated in Fig. 1b, where the beam is wide enough to illuminate the entire surface of the screen. With higher frequencies, however, the dipole asserts its natural tendency toward a narrower beam, producing the pattern shown in Fig. 1c. Only the inner part of the screen is illuminated by this signal, with a resultant decrease in gain. This tendency is overcome by varying the design of the feed system.

Overcorrecting the feed system will produce too wide a pattern as shown in Fig. 1d. This pattern is also inefficient because a portion of the signal escapes beyond the outer edges of the screen and is not utilized. A properly designed antenna will hold the beam width constant so that the entire screen is illuminated over the full range of the ultrahigh frequencies.

Although the horizontal pattern is normally of more concern to the Service Man, the vertical pattern is of equal importance in an antenna of this type. The feed system receives its signal from a round screen, as illustrated in Fig. 1a. Therefore both horizontal and vertical beam widths must be matched as closely as possible so that the dipole can receive signals with equal efficiency from all points on the round screen.

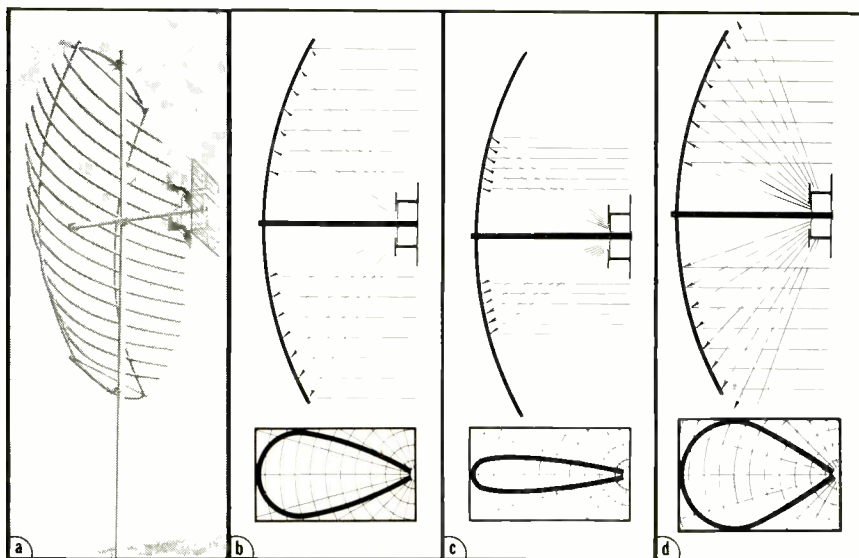

FIG. 1a: PARABOLIC ANTENNA in normal operating position. **Fig. 1b: Ideal distribution pattern** produced by this type of antenna. **Fig. 1c: Signal distribution pattern** with a narrow beam which is not properly corrected. **Fig. 1d: Pattern resulting from an overcorrected beam** which is too wide to be fully reflected by the screen. The patterns shown in both Figs. 1c and 1d result in decreased gain.

Power Supply

(Continued from page 16)

8 amps at 16 v on the 0-16 v range, a sudden reduction in the current from 8 to 4 amps will cause the output voltage to rise to 18.8 v. In this way the performance of this unit may be noted at all varying loads.

The floating output terminals make it easy to supply the required polarity to the circuits under test. All transistor car radios as well as transistor portables can be checked over the range of supply voltage variations that may be anticipated. This power supply also facilitates servicing of hybrid-type automobile receivers, since hybrid tubes are especially susceptible to ripple in the voltage supply.

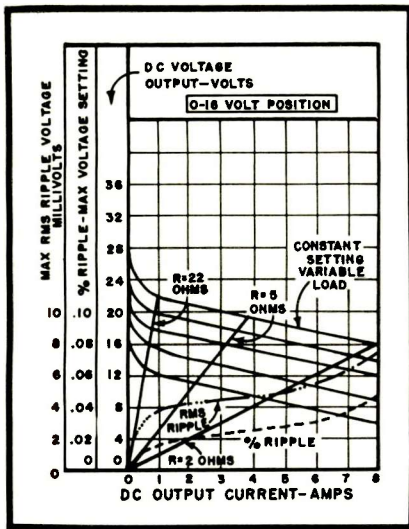

FIG. 3: PERFORMANCE CHARACTERISTICS of type EFB power supply in the 0 to 16 volt range.

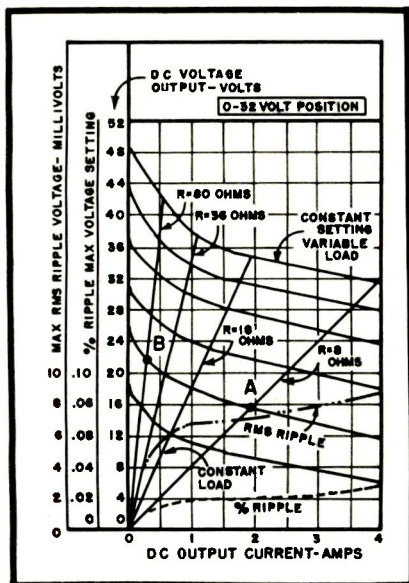

FIG. 4: PERFORMANCE CURVES of DC power supply unit in the 0 to 32 volt position.

Servicing is faster with SONOTONE CERAMIC CARTRIDGES



Because
50 manufacturers
use them in 417
phonograph models

No wonder you can finish replacement jobs faster. Sonotone is the standard cartridge of the phonograph industry—no more custom fitting or time-wasting adjustment. Sonotone fits over 90% of all your quality calls—means less inventory to stock and check, too.

But that's only half the story. When you put in a Sonotone, you give your customers great sound. Flat response from 20 to 20,000 cps, whether they have pre-amp and equalizer or not! Either way, you can't miss with a Sonotone.

Order Sonotone Ceramics from your dealer now. For full information, including replacement charts, write:

Sonotone CORP.
Electronic Applications Division, Dept. CS-58
ELMSFORD, NEW YORK

So simple it's
like magic...

Grommes Little Genie HI-FI KITS



LAYER-BUILT • COLOR-GUIDE

Before you build another kit see this new method of Kit Assembly. Each kit is complete with all parts and the new exclusive "Little Genie" Instruction Book.



NEW
LJ-6K
\$24.95

LJ-6K 10 Watt Amplifier (Little Jewel). Highest value in the low priced field, with built-in pre-amplifier and record compensator on phono channel.

Freq. Response: ± 1 DB 20 to 20,000 CPS at 1 watt. Distortion: 2% harmonic or less at 10 watts. In Charcoal and Brass. Shpg. Wt. 10 lbs. Complete Kit and instructions.....Net 24.95

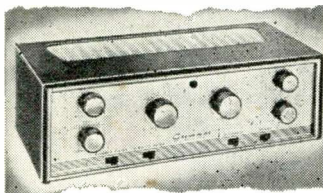

NEW
207AK
\$44.50

207A-K Hi-Fi Preamplifier. The ideal control unit with self-power feature for use with any basic amplifier. True flexibility with 10 separate controls. Feedback throughout for low distortion and wide frequency response. In charcoal gray and brass. Shpg. Wt. 10 lbs.

Complete Kit and instructions.....Net 44.50

NEW
250A-K

60 Watt Basic Hi-Fi Amplifier. For use with a preamplifier (such as 207A-K). New advanced circuitry for true high fidelity with exceptional reserve power. Shpg. Wt. 40 lbs. Complete Kit and instructions.....Net 79.50

61PG-K

20 Watt Amplifier. With built-in pre-amplifier and all controls. Modern flat compact design for tabletop or cabinet installation. Shpg. Wt. 20 lbs. In Charcoal and Brass. Complete Kit with instructions.....Net 59.50

See your Hi-Fi Dealer or write . . .

Grommes Div. of Precision Electronics, Inc.
Dept. S-5 9101 King Ave., Franklin Park, Illinois

Send complete Kit details.

Name

Address

City..... Zone..... State.....

Repairing Printed-Wiring Board Chassis*

by LEROY WOLFF, Field Service Engineer, Motorola, Inc.

IN REPAIRING p-w boards, the solder pot should *not be used* to solder the parts into the new board; this can be done much more efficiently with a soldering iron. *Be sure the iron tip is clean and well-tinned.* Apply the tip of the iron to the lead or lug, installed in its mounting eyelet on the board, long enough to heat it sufficiently to flow solder. Use 60/40 resin-core solder. The solder should be applied to the lead or lug long enough to allow solder to flow down it, the mounting hole filled and a little protrusion formed on the other side of the board; then the iron should be removed immediately. A joint made in this way will never cause trouble, nor is there any danger of damaging the board. A little intelligent practice will soon provide the facility of operation needed to make a good connection every time, and to do it swiftly without damage to the board. One should

bear in mind that the mass of the lead or lug will be a factor in the length of time the iron must be applied, and this can only be judged by observation and experience.

The board should be supported adequately while assembling and soldering it.

Replacement of Individual Parts

Standard Two-Lead Resistors and Capacitors: Sometimes, where positive indication that a resistor or capacitor is defective exists, it may be possible to replace the defective unit without removing the chassis from the cabinet. If the leads of the defective unit are long enough, they should be clipped as close as possible to the





*Third and final part of a series on this subject. For earlier articles, see SERVICE, Jan. 1958 and Feb. 1958.

MAKE SURE IT FITS!

OXFORD SPEAKERS

You obtain the finest sound reproduction when you select the proper speaker for the specific application. Each OXFORD SPEAKER is "tailor-designed" to actually "fit the need."

Specify OXFORD when you next require quality speakers. Remember: Oxford quality has consistently been superior for over thirty years.

<p>RADIO & TV SPEAKERS</p>  <p>OXFORD Speakers are used by more original set manufacturers — find out why!</p>	<p>OUTDOOR SPEAKERS</p>  <p>For rugged, steady performance under any conditions, OXFORD Weather-proof speakers will meet the need.</p>
<p>DUAL CONE HI-FI SPEAKERS</p>  <p>Oxford's newest development to provide maximum performance. For Hi-Fi and rear deck applications.</p>	<p>PORTABLE RADIO SPEAKERS</p>  <p>More Oxford speakers are used in portable sets than ever before... there must be reasons!</p>



Our new catalog is available . . . write for yours NOW!



OXFORD Components, Inc.
Subsidiary of Oxford Electric Corp.
556 West Monroe Chicago 6, Ill
Export: Robum Agencies, New York City
In Canada: Atlas Radio Corp., Ltd., Toronto

VISIT DISPLAY ROOMS 551A & 553A AT THE MAY PARTS SHOW

good idea

for making service calls more profitable

9 out of 10 phonographs need new needles

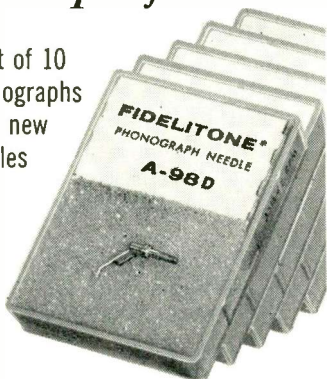

On your next service call, ask your customer if you can check his phonograph needle. Chances are nine out of ten that it's worn to the point of damaging records. With a stock of Fidelitone Needles in your service kit, you've made a profitable sale.

A Fidelitone Diamond is the best replacement buy

A Fidelitone Diamond gives your customers the maximum number of safe playing hours. This high quality needle is scientifically produced to cartridge manufacturers' specifications; always precision mounted for perfect alignment and orientation.

Be ready to make the sale

It's far easier to make the sale if you have the right needle with you. Even though there are hundreds of needle types made, you can replace the majority by carrying a minimum of Fidelitone needles. Carry a representative stock of Fidelitone with you and include the fast selling Diamonds for more profit on service calls. Call your Fidelitone Distributor today.

Fidelitone

Chicago 26, Illinois

"Best buy on records"

unit, and these leads should be used to connect and solder the replacement unit.

Res-Cap Assemblies

Multi-element assemblies of resistors and capacitors as used by Motorola are designated as *res-caps*. Usually, if one component in such an assembly fails, the lead or leads connecting the unit to the board can be clipped loose and an individual component of the same value can be connected in its place, avoiding the necessity of replacing the entire unit. This is permissible, but care must be used in tracing connections to be sure that, because of an internal connection in the *res-cap* itself, some other component will not be left floating. For instance, in an intertube coupling assembly, the connections from the *res-cap* to the grid of the second tube may be connected inside the *res-cap* to one side of the interstage coupling capacitor and to the grid resistor of this tube. If the coupling capacitor shorts or becomes leaky and has to be replaced, it can be done by clipping the *res-cap* lead at the grid and also the lead from the coupling capacitor to the plate of the preceding tube and then using an individual unit of the same value. But, since clipping the original grid lead also removes the connection to the grid resistor, a separate grid resistor must also be installed; otherwise the grid would be left floating, which could lead to some unusual symptoms.

Excessive Heat Harmful

Res-cap connections are vulnerable to damage if excessive heat is allowed to travel up the leads and to their junction with the various components which have a Durez coating. Care should be exercised to protect them from this type of damage by good soldering technique.

Complete removal of *res-caps*, such as would be necessary in a transfer of components from a broken board, should always be made with the use of a soldering pot.

Multi-Lug Components

A soldering pot should be used for the removal of sockets transformers, electrolytics, gangs, etc. As previously mentioned, such items can be removed with an iron, but the operation is very slow and can easily result in damage to the board or component,

"OUTPERFORMS THEM ALL"



I. J. Saltzman, *Globe Sound Service, Jamaica, N. Y.*, experienced commercial sound engineer, says: "On side by side comparison test, the CJ-44 outperforms them all."

NEW! ATLAS "King Cobra-Jector" CJ-44



Shown with GB-1 Universal Mounting Bracket

Complete with "Acousti-Match" Built-in Driver Unit

List \$72.50

NET \$43.50

A wide-angle, all-purpose, all-weather Public Address Speaker, complete with integral high-power super-efficient "Acousti-Matched" driver unit. "Acoustic-Matched" means "Controlled Response" within the frequency limits most useful in P. A. and high level music reproduction. "Controlled Response" offers conversion efficiency never before obtainable in high-powered speakers. "Controlled Response" results in smooth reproduction — free from peaks which so often create and sustain acoustic feedback.

The CJ-44 conserves costly amplifier output power — fewer speakers do a complete job. The speaker horn is easily rotated for horizontal or vertical dispersion patterns.

The CJ-44 is the only high-powered P. A. speaker that can be equipped with the new Atlas Universal Mounting Bracket, permitting quick and secure directional adjustment on both planes. Simple to make a horizontal or vertical adjustment as a final "touch-up" to the installation.

The CJ-44 is designed for the "tough jobs." No gimmicks, no fluffs, no wild claims — just a reliable super-efficient speaker for all applications.

Input Power:	30 watts constant 50 watts peak
Input Impedance:	16 ohms
Response:	150-9,000 cps
Dimensions:	Bell 23" x 13"; Over-all length 19"
Net Weight:	16 lbs.

Write for free Catalog 58.



ATLAS SOUND CORP.

1442-39 St., Brooklyn 18, N. Y.
Atlas Radio Ltd., Toronto, Canada

now... see what \$ **39⁹⁵** buys
in a **DC POWER SUPPLY**



NEW dual purpose KPS-2



... powers transistor circuits,
"hybrid" and 12 volt auto radios *without hum*

Compare with any other kit and see how many more safety and time-saving features the new ELECTRO KIT KPS-2 offers you ... and yet, it costs less than other kits.

Two output ranges: one for transistor circuits... one for today's 12 v. auto radios.

Low ripple: up to 5 amps. 0.5%... up to 75 MA 0.15%.

Milliammeter indicates minute transistor current variations.

Transistor protection provided by extra fuse.

Conduction cooling: patented for long life.

Send for literature giving full details
ELECTRO PRODUCTS LABORATORIES

4501-B N. Ravenswood Ave., Chicago 40, Ill.

Canada: Atlas Radio Ltd., Toronto



8376

Miniaturized

Circuitry Analysis of

by FRED J. KITTY

General Instrument Corporation

THE UHF TV BAND was opened to commercial use late in 1952. This band, extending from 470 to 890 mc, afforded 70 additional channels (14 through 83) to provide properly for the anticipated growth of telecasting.

Since its inception, however, *uhf* has been in a difficult competitive position vis-a-vis *vhf*. One reason for this was the entrenched position of *vhf* at the time *uhf* was introduced. In addition, *uhf* also suffered in a technical comparison with *vhf* because of the higher frequencies involved.

The performance of a *uhf* receiver is established by the *uhf* tuner. Due to the technical advantages favoring *vhf*, the history of *uhf*-tuner development has been basically a continuing struggle to improve performance particularly as regards noise factor. As a result of this effort, *uhf* receiver noise figures have improved by approximately 10 db in the last five years as compared to an improvement of perhaps 1 or 2 db in *vhf* receivers.

The key questions to be answered in the early days were: "Can you see a picture? How far is the station?" As noise figures improved, requirements were added involving such parameters as *if*, image and unbalanced signal rejection as well as antenna match. Somewhat later, maximum oscillator radiation limits were set by FCC. With the advent of color, oscillator drift and stricter passband specifications entered the picture.

While these technical requirements were being added, TV set prices were continuously being reduced. Consequently, TV set components, including both *vhf* and *uhf* tuners were being reduced in price and size. Thus, technical and economic factors dictated that the design of modern *uhf* tuners be quite sophisticated. In this regard, it might be noted that mechanical design was a major engineering element since the evolving TV set required a small, but sturdy, and utilitarian package.

As the state of the art advanced, it became clear that the most efficient

Sparkling New!

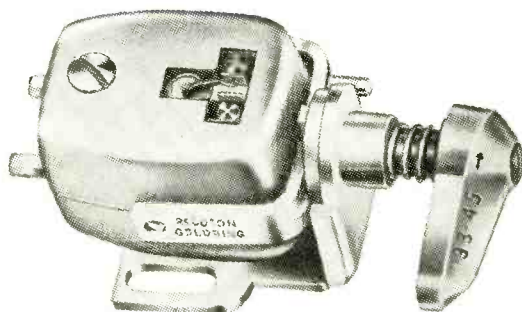

TRUE PIVOT RECOTON-GOLDRING RG 666

The New RECOTON-GOLDRING 666 employs a new low mass damped *True Pivot* stylus arm construction which provides very high compliance combined with *true pivoting* action. This results in excellent extended frequency response with extremely low distortion.

See it
at Booth 314
the ELECTRONIC
PARTS
DISTRIBUTORS
SHOW
May 19 to 21
Conrad Hilton
Hotel - Chicago



Recoton CORPORATION

52-35 Barnett Ave., Long Island City 4, N. Y.

In Canada: Quality Records, Ltd., Toronto

Compensation-Type UHF Tuner

Ultrahigh Development With Radiation-Suppression Features

uhf receiving system, considering economic and technical factors, as well as FCC regulations, would be a single superheterodyne using a 6AF4A (or equivalent) as the oscillator and a crystal diode (IN82A or equivalent) mixer-converter, and an *if* frequency of 41.25 mc (sound) with no *rf* amplification ahead of the mixer.

Practically all present day *uhf* tuners are built along these lines. Furthermore, a variable capacitor assembly has evolved as the most common tuning method. Thus, assuming the basic merit of the circuits previously chosen, it is seen that the design of modern *uhf* tuners has become a matter of circuit and structural refinement.

Of the several areas of operation open to the designer, the one affording the most profit is that involving the design of the preselector and oscillator coaxial lines, which with variable capacitors, are the basic tuning elements. Two preselectors are provided to afford sufficient skirt selectivity. A single preselector would provide lower insertion loss and consequently a better noise factor, but image rejection specifications of 40-db minimum require two preselectors at the band-widths and *if* frequencies involved. Further, and regardless of the image specifications, two preselectors are required to insure adequate blocking of the local oscillator frequency; i.e., 43.5 mc above the signal frequency. Otherwise excessive oscillator energy will appear at the tuner antenna terminal and consequently the radiation will be above FCC limits. The loaded Q of the preselector circuit is governed by skirt selectivity; i. e., image rejection and oscillator radiation requirements. Since the insertion loss of a preselector varies inversely as the unloaded-to-loaded Q ratio, it is evident that a high unloaded Q is desirable. Loaded Q 's in *uhf* tuner preselectors run in the order of 25-50. To keep the insertion loss below $\frac{1}{2}$ db per preselector requires an unloaded-to-loaded Q ratio of 20. This, in turn, sets the requirement for unloaded Q 's in the 500-1000 range. The unloaded Q depends upon the impedance of the line (which in turn

is a function of the dimensional relationship between inner and outer conductors) and the length of the line.

An additional requirement on the preselector lines is the ability to tune over the 470-890 mc range with a

reasonably sized set of capacitor plates. The amount of tuning capacity required is also a function of the impedance and length of the line. Prior to the development of the model

(Continued on page 36)

No. 5 of a series of questions for progressive technicians.

Can You Handle This Problem?

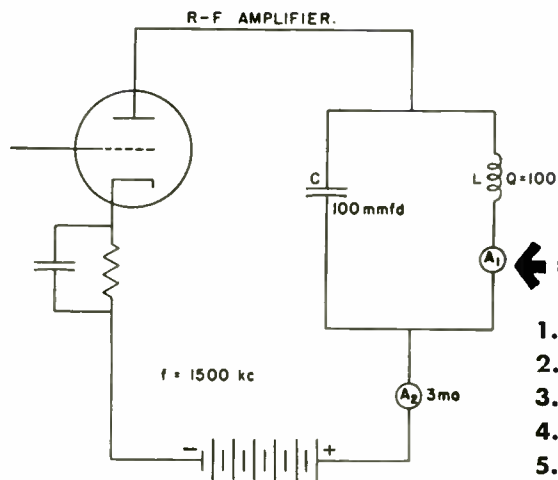

**What Will
RF Meter
Read?**

(Answer printed below)

1. Zero, or nearly so.
2. A little less than 3 ma.
3. 3 ma.
4. A little more than 3 ma.
5. Many times more than 3 ma.

How'd you do on this one? Was it easy . . . middling hard . . . or tough?

It was easy or tough depending on how well you know your electronics fundamentals.

That's the way it is on the job too. Day after day we get the same kind of reports from ambitious men like yourself in the field. "I was interested in these problems . . . your training gave me the principles . . . I solved the problems . . . I got a better job . . . and now I make more money."

Why put a ceiling on your income . . . and on the satisfaction you can get out of doing the more challenging jobs. Get your fundamentals more solidly—then take off and really go!

The answer to our little problem is given below. If you want a complete solution, just fill out and mail the coupon.

5. Many times more than 3 ma (approximately 300 ma).

Cleveland Institute of Radio Electronics
4900 Euclid Avenue, Dept. S-12, Cleveland 3, Ohio

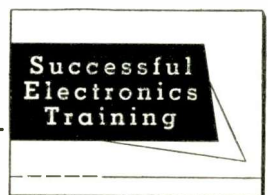

Please send me detailed solution to problem above and information on how I may prepare for the increasing opportunities in electronics. There is no obligation.

NAME

ADDRESS

CITY ZONE STATE

Accredited by The National Home Study Council

S-12

Installing Motel Master Antennas

by TOM SHEA

Sales Engineer, Blonder-Tongue Laboratories

MANY MOTELS are now installing central antenna systems in place of individual antennas for each TV set. A discussion of the advantages of a master antenna installation and a description of a system suitable for use in 90 percent of existing motels appeared in a previous report.¹

Before considering the installation and servicing of master antenna systems, the basic design principles must first be established. For this purpose, we may consider the typical installation described previously¹ which is illustrated in Fig. 1. A proper understanding of design considerations will be extremely useful in troubleshooting and servicing the system.

The basic design principle may be

summed up briefly. First, satisfactory picture must be obtained on all desired channels with a standard broadband antenna feeding a standard TV receiver. Then, if the gain at the head end is equal to or greater than the calculated loss in the distribution section, satisfactory reception will be assured at all outlets.

There are four basic steps to be followed in the design of a motel master antenna system. First is the layout of the main cable run. Next the type of tapoffs to be used must be determined. The next step is to calculate the distribution system loss. Finally an amplifier must be selected which will overcome this loss.

Blueprints or a drawing of the motel will be helpful in determining the layout of the main cable run. As in the motel design shown in Fig. 1, horizontal cable runs are most economical for long, low structures. These are best located in an attic or a crawl space. RG 11/U coax should be used, and the run should be split into the number of branches that permit the shortest possible cable runs.

The type of tapoff used will depend upon the physical requirements to be met within the structure. For new construction, a flush-mounted single wall outlet is generally preferred. A single-outlet tapoff suitable for outdoor system installation is used where an indoor run system is not feasible, and an indoor two-outlet tapoff may be utilized where an attic or crawl space main cable run is possible. The motel system shown in Fig. 1 utilizes two-outlet indoor tapoff as conditions will allow for them. This installation, which provides two outlets with each tapoff, cuts installation time and labor costs in half.

Calculating Losses

The total system loss is calculated from the last TV set on the longest branch line to the head end. This will determine how much gain will be required in the amplifier to be used. The unit for measuring signal gain or loss used in system calculations is the db. The db is used for practical reasons because it allows for simple addition or subtraction in arriving at the resultant loss or gain of signal strength.

The four losses that must be taken into account are the main cable loss,

¹Installing Master TV Antenna System in Motels, Tom Shea, SERVICE; April, 1958.



IN A SMALL PACKAGE



Tarzian SERIES

Silicon Rectifiers

- COMPACT—no special holder required . . . supported by pigtail leads
- VERSATILE—will fit into the smallest pocket portable . . . yet enough power for the biggest color television receiver
- ECONOMICAL—Tarzian's mass production means lower cost to you
- PROVED-PERFORMANCE—in all electronic applications

Send for data sheets.



The Handy Five-Pak
(Shirt Pocket Size)

SPECIFICATIONS

	40K	K-200		40K	K-200
MAX. AC INPUT VOLTAGE	130	130	APPROX. RECTIFIER VOLTAGE DROP	2	2
MAX. PEAK INVERSE VOLTAGE	400	360	MAX. OPERATING TEMP.	100 C.	100 C.
MAX. PEAK CURRENT (MA)	7500	2000	MAX. SURGE CURRENT (AMPS)	30	20
MAX. DC CURRENT (MA)	750	200	MIN. SURGE LIMITING RESIS. (OHMS)	7.5	10

DIMENSIONS

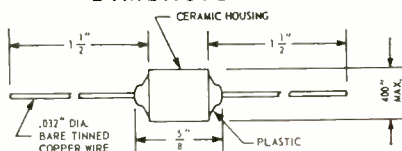

Sarkes
Tarzian
INC.

DEPT. S-3, RECTIFIER DIVISION, 415 N. COLLEGE AVE.
BLOOMINGTON, INDIANA

IN CANADA: 700 WESTON RD., TORONTO 9, TEL. ROGERS 2-7535 EXPORT: AD AURIEMA, INC., NEW YORK CITY

FIG. 1: TYPICAL MASTER antenna system suitable for use in 90% of existing motels.

the tapoff isolation loss, the tapoff insertion loss and the splitter loss. In a main cable consisting of 300 feet of RG-11 U coax, such as is used in the installation previously described and illustrated in Fig. 1, the loss is approximately 9 db. The tapoff isolation loss was previously¹ given at 17 db and the tapoff insertion loss at 0.5 db for each tapoff in the branch line being considered. With 15 tapoffs in each branch, the total tapoff insertion loss may be regarded as 7.5 db. Finally the two-way line splitter² described in this installation provides a loss of 3 db. Adding up the losses, we arrive at a total distribution loss of 36.5 db for the entire system.

With a system loss of 36.5 db to overcome, an amplifier with at least that much gain must be used. It is also desirable to use a broadband amplifier which will amplify all VHF channels. The broadband amplifier³ described in this installation has a gain of 37 db. After subtracting the 36.5 db system loss, the net gain in the last TV set in each branch is 0.5 db over the original antenna signal strength. If fewer than 15 tapoffs are used in each branch or the length of the cable is less than 300 feet, the resultant signal gain at the last TV set will be increased.

Testing Installations

The master antenna installation described here may be checked for proper signal strength and direction at various test points designated in Fig. 1. The required test set-up is shown in Fig. 2 and requires an attenuator, a matching transformer, and a portable TV set. The attenuator pad provides a 0 to 45 db range of attenuation in 3 db steps. The basic requirement at all test points is that snow-free and interference-free re-

(Continued on page 38)

¹Blonder-Tongue MDC-2.

³Blonder-Tongue type MLA.

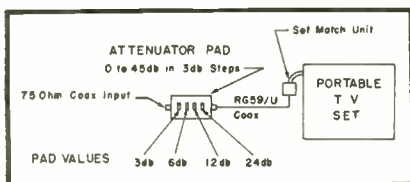
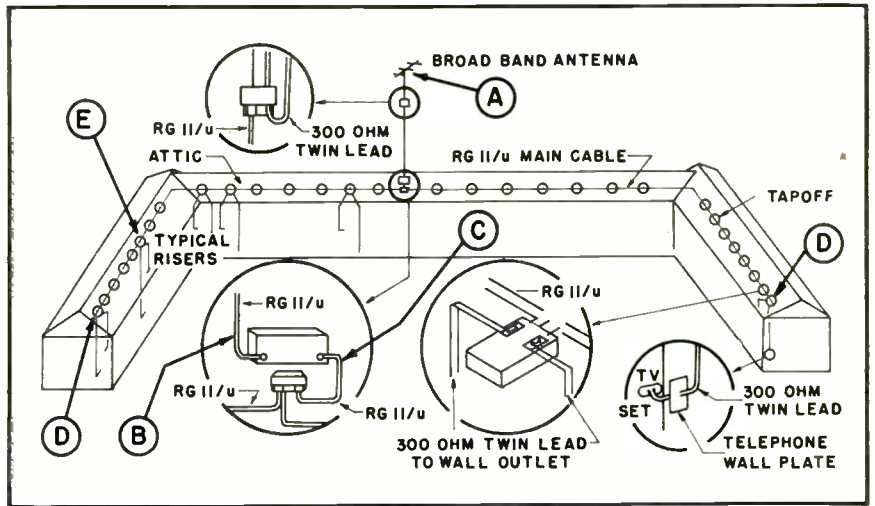

FIG. 2: TEST SET-UP and connections required for checking installation of master antenna system from various test points.



Compare just released Model 77 to ANY peak-to-peak V. T. V. M. made by ANY manufacturer at ANY price!

Superior's New Model 77

VACUUM TUBE VOLTMETER

WITH NEW 6" FULL-VIEW METER

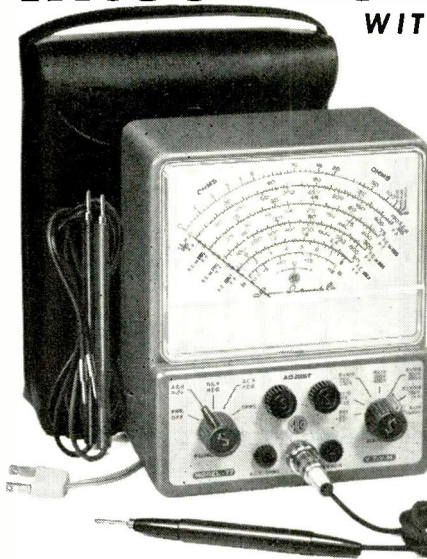

- ✓ Model 77 completely wired and calibrated with accessories (including probe, test leads and portable carrying case) sells for only \$42.50.
- ✓ Model 77 employs a sensitive six inch meter. Extra large meter scale enables us to print all calibrations in large easy-to-read type.
- ✓ Model 77 uses new improved SICO printed circuitry.
- ✓ Model 77 employs a 12AU7 as D.C. amplifier and two 9006's as peak-to-peak voltage rectifiers to assure maximum stability.
- ✓ Model 77 uses a selenium-rectified power supply resulting in less heat and thus reducing possibility of damage or value changes of delicate components.
- ✓ Model 77 meter is virtually burn-out proof. The sensitive 400 microampere meter is isolated from the measuring circuit by a balanced push-pull amplifier.
- ✓ Model 77 uses selected 1% zero temperature coefficient resistors as multipliers. This assures unchanging accurate readings on all ranges.

SPECIFICATIONS

AS A DC VOLTMETER: The Model 77 is indispensable in Hi-Fi Amplifier servicing and a must for Black and White and color TV Receiver servicing where circuit loading cannot be tolerated.

AS AN AC VOLTMETER: Measures RMS values if sine wave, and peak-to-peak value if complex wave. Pedestal voltages that determine the "black" level in TV receivers are easily read.

AS AN ELECTRONIC OHMMETER: Because of its wide range of measurement leaky capacitors show up glaringly. Because of its sensitivity and low loading, intermittents are easily found, isolated and repaired.

• DC VOLTS — 0 to 3/15/75/150/300/750/1,500 volts at 11 megohms input resistance. • AC VOLTS (RMS) — 0 to 3/15/75/150/300/750/1,500 volts. • AC VOLTS (Peak to Peak) — 0 to 8/40/200/400/800/2,000 volts. • ELECTRONIC OHMMETER — 0 to 1,000 ohms/10,000 ohms/100,000 ohms/1 megohm/10 megohms/100 megohms/1,000 megohms. • DECIBELS — -10 db to +18 db, +10 db to +38 db, +30 db to +58 db. All based on 0 db = .006 watts (6 mw) into a 500 ohm line (1.73v). • ZERO CENTER METER — For discriminator alignment with full scale range of 0 to 1.5/7.5/37.5/75/150/375/750 volts at 11 megohms input resistance.

Model 77 comes complete with operating instructions, probe and test leads. Use it on the bench — use it on calls. A streamlined carrying case, included at no extra charge, accommodates the tester, instruction book, probe and leads. Operates on 110-120 volt 60 cycle. Only

\$42.50
NET

**SHIPPED ON APPROVAL
NO MONEY WITH ORDER — NO C. O. D.**

Try it for 10 days before you buy. If completely satisfied send \$12.50 and pay balance at rate of \$6.00 per month for 5 months. — **No interest or Finance Charges Added.** If not completely satisfied, return to us, no explanation necessary.

MOSS ELECTRONIC DISTRIBUTING CO., INC.

Dept. D-473, 3849 Tenth Ave., New York 34, N. Y.

Please rush one Model 77. I agree to pay \$12.50 within 10 days after receipt and \$6.00 per month thereafter. Otherwise I may return, cancelling all further obligation.

NAME _____
ADDRESS _____
CITY _____ ZONE _____ STATE _____
All prices net, F.O.B., N.Y.C.

THE VERY BEST IN CUSTOM TELEVISION

BY **TECH-MASTER**

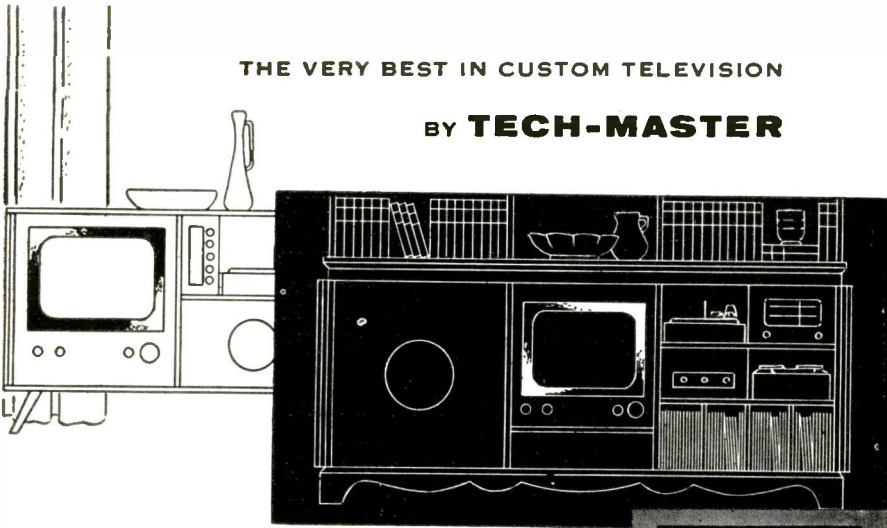

FOUND IN THE FINEST OF INTERIORS

As the custom installation signifies the ultimate in well-chosen decor . . . so the name Tech-Master stands for the utmost in Custom television. The reputation established with the manufacture of the renowned Model 630 chassis is further enhanced by the outstanding Tech-Master Audiophile and Sound Theatre.

See your local distributor today . . . or write

TECH-MASTER CORPORATION
75 FRONT STREET, BROOKLYN, NEW YORK

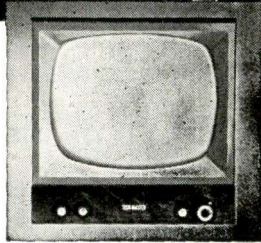

ONLY TECH-MASTER HAS THESE OUTSTANDING PLUS FEATURES:

- World-famous 3 tube synchrolok picture circuit for constant picture stability.
- 30 tubes fully used.
- "Full Frame Mounting" . . . just a simple cutout is required for installation.
- High fidelity picture as well as exceptional audio reproduction.

Miniaturized UHF Tuner

(Continued from page 33)

described* requirements were achieved through the use of lines 3" long. In this model the lines are 2 7/16" long, allowing a reduction in tuner length from 3 3/4" to 2 3/4", an important consideration in the small, shallow TV sets of the present era. The key to this size compression was in the choice of the proper compromise in coax-line dimensions resulting in a line impedance close enough to afford almost optimum Q and at the same time allowing for reasonable tuning capacity.

With the proper selection of cross section dimensions to afford proper Q and tunability, the remainder of the preselector design is that of setting the loadings at antenna and mixer together with the coupling between the two circuits. These parameters are adjusted to give a bandpass slightly overcoupled at the extremes of the range and critically coupled at mid-band. Loadings are determined by the shapes and locations of the antenna and mixer coupling loops in the coaxial lines.

The design of the oscillator is governed by three basic requirements:

- (1) Provide sufficient output to drive the mixer crystal at an efficient operating point.
- (2) Keep power output level low enough to avoid excessive radiation.
- (3) Keep thermal drift low.
- (4) Provide essentially linear frequency calibration.

The basic circuitry used in the oscillator is a grounded plate, tuned-grid modified Colpitts.

It is to be noted that the first two requirements above are in contradiction and compromises have to be made. In general, too, at uhf peculiar resonances and nodal points are encountered with resultant oscillator weak or dead spots. It is important to eliminate these in order that the oscillator drive be not excessive at some frequencies in compensating for the low activity points. In this tuner these dips have been eliminated, as shown by proper oscillator activity over the entire band with B+ voltages as low as 40 v at the oscillator plate.

The main advantage derived from operation at low plate voltages is a

*G. I.-F. W. Stckles model 204.

MORE ACTIVE! EFFECTIVE!



KESTER "RESIN-FIVE" CORE SOLDER

THE BEST FOR TV-RADIO WORK . . . EVERYTHING ELECTRICAL—Kester "Resin-Five" Core Solder is better and faster than any solder ever developed. It has an activated flux-core that does a perfect job on all metals including zinc and nickel-plate. The flux residue is absolutely non-corrosive and non-conductive.

Available in all practical Tin-Lead Alloys; 40/60, 50/50 and 60/40 in diameters of 3/32", 1/16", 3/64", 1/32" and others.

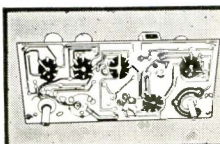

Printed Circuit Soldering
On Copper-etched boards use 60% Tin-40% Lead Alloy . . . for those that are Silver-surfaced use 3% Silver-61 1/2% Tin-35 1/2% Lead

KESTER SOLDER COMPANY

4248 Wrightwood Avenue, Chicago 39, Illinois • Newark 5, New Jersey, Brantford, Canada

CONVERT TV PROBLEMS INTO PROFITS!



OUTDOOR TV SET COUPLERS SERVICE SAVERS



Ferrite core transformer for minimum insertion loss — maximum set isolation provides higher signal transfer. Quick secure U-bolt mast mount design. Write for JFD brochure showing 40 money-making TV accessories now at all JFD distributors.

model	description	list
AC40	Joins 2 sets to 1 antenna	\$3.50
AC60	Joins 3 sets to 1 antenna	4.00
AC70	Joins 4 sets to 1 antenna	4.85

Pioneers in electronics since 1929
JFD Electronics Corp.
 Brooklyn 4, New York

design affording radiation within FCC limits. In the past this has been achieved only with the costlier plate-tuned grid type of oscillator where the ground currents are lower than in the tuned grid-grounded plate design. To achieve such relatively uniform activity each possible absorbing element had to be carefully tracked down and eliminated, detuned or de-coupled.

Drift Compensating Capacitors

A more difficult problem was that of making provision in the design for the addition of drift compensating capacitors. Addition of capacity lowers the maximum frequency obtainable with a given impedance. Modifying the impedance to allow more capacity results in decreased oscillator efficiency. Thus a proper compromise must be arrived at. An additional handicap here is that in small size tuners there is a greater amount of minimum capacity (due to geometry) than is the case for larger sized tuners. Heretofore, full compensation had been achieved only in larger tuners. The importance of proper compensation is vastly multiplied for color-TV, since a relatively slight change in frequency will cause loss of color in the picture. With the compensation provided there is now a maximum drift in the order of 200-300 kc. This should be compared to drifts upwards of 1½ mc in uncompensated tuners.

the specs are the proof . . .
 the BEST BUYS are **EICO**
 for COLOR & Monochrome TV servicing

NEW COLOR
 and Monochrome
 DC to 5 MC LAB & TV
 5" OSCILLOSCOPE

#460
 Factory-wired
 and tested **\$129⁹⁵**
 Also available as kit **\$79⁹⁵**

• Features DC Amplifiers!

Flat from DC-4.5 mc, usable to 10 mc. VERT. AMPL.: sens. 25 rms mv/in; input Z 3 megs; direct-coupled & push-pull thruout; K-follower coupling bet. stages; 4-step freq-compensated attenuator up to 1000:1. SWEEP: perfectly linear 10 cps-100 kc (ext. cap. for range to 1 cps); pre-set TV V & H positions; auto. sync. ampl. & lim. PLUS: direct or cap. coupling; bal. or unbal. inputs; edge-lit engraved lucite graph screen; dimmer; filter; bezel fits std photo equip. High intensity trace CRT. 0.06 usec rise time. Push-pull hor. ampl., flat to 400 kc, sens. 0.6 rms mv/in. Built-in volt. calib. Z-axis mod. Sawtooth & 60 cps outputs. Astig. control. Retrace blanking. Phasing control.

NEW TV-FM SWEEP GENERATOR & MARKER

#368
 Factory-wired
 and tested **\$119⁹⁵**
 Also available **\$69⁹⁵**
 as kit

Entirely electronic sweep circuit (no mechanical devices) with accurately biased inductor for excellent linearity. Extremely flat RF output; new AGC circuit automatically adjusts osc. for max. output on each band with min. ampl. variations. Exceptional tuning accuracy: edge-lit hairlines eliminate parallax. Sweep Osc. Range 3-216 mc in 5 fund. bands. Variable Marker Range 2-75 mc in 3 fund. bands; 60-225 mc on harmonic band. 4.5 mc Xtal Marker Osc., xtal supplied. Ext. Marker provision. Sweep Width 0-3 mc lowest max. deviation to 0-30 mc highest max. dev. 2-way blanking. Narrow range phasing. Attenuators: Marker Size, RF Fine, RF Coarse (4-step decade). Cables: output, scope horiz., scope vertical.

NEW DYNAMIC CONDUCTANCE Tube & Transistor Tester

#666
 Factory-wired
 and tested **\$109⁹⁵**
 Also available **\$69⁹⁵**
 as kit

COMPLETE with steel cover and handle.

SPEED, ease, unexcelled accuracy & thoroughness. Tests all receiving tubes (and picture tubes with adapter). Composite indication of Gm, Gp & peak emission. Simultaneous sel. of any 1 of 4 combinations of 3 plate voltages, 3 screen voltages, 3 ranges of continuously variable grid voltage (with 5% accurate pot). New series-string voltages: for 600, 450, 300 ma types. Sensitive 200 ua meter. 5 ranges meter sensitivity (1% shunts & 5% pot). 10 SIX-position lever switches: free-point connection of each tube pin. 10 pushbuttons: rapid insert of any tube element in leakage test circuit & speedy sel. of individual sections of multi-section tubes in merit tests. Direct-reading of inter-element leakage in ohms. New gear-driven rollchart. Checks n-p-n & p-n-p transistors: separate meter readings of collector leakage current & Beta using internal dc power supply.

CRA Adapter \$4.50

See the 50 EICO models IN STOCK at your neighborhood distributor. Write for FREE Catalog & Prices 5% higher on West Coast

EICO 33-00 Northern Blvd., L. I. C. 1, N. Y.

GE ZERO-MIST

FINDS TROUBLE FAST!

Cool circuits instantly and isolate intermittent defective components. Zero-Mist sprays on quickly and saves you time.

No. 8667 (16 oz. can)
 List \$3.25



G-C SPRAY GUN HANDLE makes a spray can easy to use. You get trigger-quick and accurate spraying. Fits any spray can.
 No. 9288 List Price \$1.49

G-C SPRA-O-WAX—Now famous G-C Creme-O-Wax in a 16 oz. spray can. Gives a hard glossy finish.
 No. 96-12 (16 oz. can) List \$1.99



GENERAL CEMENT MFG. CO.

division of TEXTRON INC.
 Western Plant: Los Angeles 18, Calif.
 Main Plant: ROCKFORD, ILLINOIS, U.S.A.

PICTURE TUBE BRIGHTENER



A PICTURE-TUBE brightener, SP 110, for use with RCA-type 110° tubes, has been introduced by Anchor Products Co., 2712 W. Montrose Ave., Chicago 18, Ill.

Adjustment is said to adapt unit for either series or parallel-wired filaments. Can be used on electrostatic or electromagnetic-focus tubes. [SERVICE]

Perma-Power

TRANSISTOR POWER SUPPLY

MODEL A-400

Especially designed to operate, service and test transistor portable radios and low power transistor circuits.

Highest quality components combined with careful engineering make this instrument extremely reliable and useful for laboratory and service applications.

\$6450 from Electronic Parts Distributors only

"TRULY A VARIABLE BATTERY"

SPECIFICATIONS

Input: 115 Volts 50/60 cycles
 Output Voltage: 0-15 Volts and 0-30 Volts
 Output Current: 0-15 MA and 0-60 MA
 Accuracy: 2% on both voltage and current
 Ripple: Less than 500 microvolts (.002% at full output)
 Regulation: 1.2 Volts Maximum; Zero to full load current
 Internal Impedance: Less than 20 ohms DC to Radio Frequencies (including 7.0 ohm Meter Fuse, optionally removable)
 Terminals: 5-Way Binding Post
 Size: 10" x 6 1/2" x 5 3/4"
 Weight: 16 pounds

FEATURES

- Continuously adjustable output using variable autoformer control, setting of all transistor battery voltages.
- Two output voltage ranges for accurate setting of all transistor battery voltages.
- Two output current ranges monitor current for single transistor or entire set.
- Extremely low ripple for testing lowest level transistor circuits.
- Very low internal impedance providing excellent regulation.
- Precision D'Arsonval meters provide laboratory accuracy.
- Millimeter protected by front panel fuse; additional internal line fuse.
- Output isolated from line and case.
- Attractive Slope — Front, Maroon Hammerloid Cabinet — Rubber feet.

Perma-Power

Manufactured by

COMPANY 3100 N. ELSTON AVENUE CHICAGO 18, ILL

There's always something new being developed by Perma-Power

SEE US AT THE MAY PARTS SHOW — BOOTH #411

Motel Antennas

(Continued from page 35)

ception be obtained on all desired channels.

Test point A, directly off the antenna, is taken with the attenuator and set-matching transformer by-passed, producing no attenuation. Test point B, the input to the amplifier, is also taken without attenuation. Before checking test point C, the output of the amplifier, connect the attenuator so that 36 db of attenuation is provided. Test point D checks the end of each branch before the tapoffs are installed and requires 24 db attenuation. The last test point E, at each TV outlet, requires no attenuation and consequently is made with the attenuator and set matching unit by-passed.

Picture Troubles

Any sudden marked change in reception is a sure indication of trouble. The type of picture trouble often gives a good hint as to what may be wrong with the system. A weak snowy picture indicates insufficient signal, weak amplifier tubes, open or poorly made connections, defective transmission lines. To correct a weak signal, increase the amplification.

Multiple ghosts or smear is often a sign of an open or short circuit in transmission line or of improper line or equipment termination. "Windshield wiper," "herringbone pattern," complete picture breakup, or "ride through" of one channel into several others are usually caused by an overloaded amplifier or unbalanced signals in the line. To correct overloading of the amplifier, reduce amplifier gain.

Diagonal lines in pix, light herringbone pattern, Venetian blind, swirling patterns, or complete pix blackout may be the result of RF interference from FM stations, other radio service, TV-set local oscillator radiation, line amplifier oscillation, co-channel or adjacent channel interference from another TV station. Local TV-set oscillation can be cured only by checking individual sets and tapoffs for proper connections. Coax cable in the vicinity of the receiver must be grounded.

Dark moving horizontal bars in pix may be caused by an improperly tuned TV set. If the set is tuned properly and bars still appear, then the difficulty is due to 60-cycle ac in the picture signal. Examine the am-



For my Money
XCELITE Tools are
 the Finest!

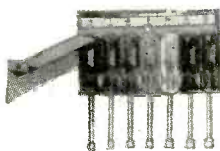

... Superbly made and designed for Radio, T.V. and Electronic Technicians. See your Distributor ... only one quality ... the finest — whether you choose individual items or the handy kits ...

Use the Tools the Professionals use!



XCELITE INCORPORATED
 ORCHARD PARK, NEW YORK
 Canada: Charles W. Pointon, Ltd., Toronto

XCELITE
 Quality Hand Tools
 PREFERRED BY THE EXPERTS

GE SLIDE SWITCHES

A complete line to meet every modern engineering need. You get convenience in low cost switches constructed for long trouble-free service.

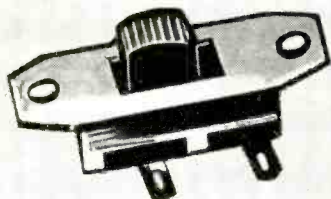

Single-Pole, Single-Throw with or without spring returns

Single-Pole, Double-Throw

Printed Wiring Terminal Types

Double-Pole, Double-Throw with or without spring returns

Triple-Pole, Double-Throw

3-Position, 4-Position Special Purpose Types

FREE Switch Catalog . . . write today

GENERAL CEMENT MFG. CO.

division of **TEXTRON INC.**

Western Plant: Los Angeles 18, Calif.

Main Plant: **ROCKFORD, ILLINOIS, U.S.A.**

ERSIN Multicore
FIVE CORE
WORLD'S FINEST SOLDER!
CONTAINS 5 CORES OF NON-CORROSIVE FLUX

Made especially for the
RADIO AND ELECTRONIC MARKET

**Guarantees your work —
FASTER! SURER! NO CALL-BACKS!**

**LOWEST POSSIBLE PRICES —
PROMPT DELIVERY**

**SOLD ONLY THROUGH
RADIO PARTS DISTRIBUTORS!**



DEPT. ME-1078

**MULTICORE SALES CORPORATION
PORT WASHINGTON, NEW YORK**

plifier for detective tubes, rectifiers, *dc* filter condensers, or other power supply components. If *ac* bars appears in just one receiver, look for *ac* trouble in that receiver rather than in the line.

Light streaks shooting horizontally through *pix* indicate interference from automobile ignition, neon or fluorescent lights, electric motors, high voltage power line or intermittent cable connections. This may be corrected by a high-pass *rf* filter used at the amplifier inputs.

A weak signal on some channels with normal signals on others is usually due to a mismatched, open, or short-circuited transmission line. These line faults occur in such a way as to form a trap for the channels affected. Check all line terminations and connections.

The following hints will prove useful to the Service Man installing a master antenna system of this type. First make sure to ground all equipment. Use a lightning arrester to save equipment from possible damage from lightning. Make certain that the antenna mounting is structurally sound. Use guy wires when necessary. Finally pay careful attention to all basic installation techniques, especially soldering. A poorly soldered connection may be difficult to locate after the system has been installed.

PORTABLE TUBE TESTER

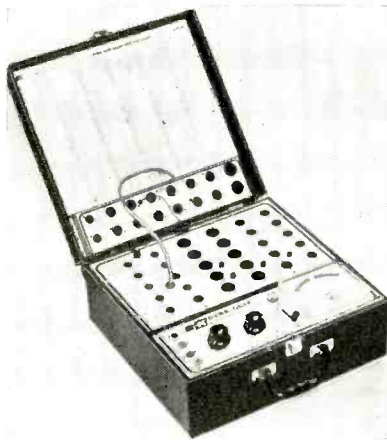

A MULTIPLE-SOCKET dynamic - mutual-conductance tube tester, 500B Dyna-Quik, with tests for shorts, grid emission, gas content and leakage, has been announced by B&K Manufacturing Co., 3726 N. Southport Ave., Chicago 13, Ill.

Unit shows tube condition on good-bad scale and in micromhos. Life test is said to show life expectancy of tubes in set. One switch is used for all tests. Popular tube-type settings are listed directly on socket panels; complete quick reference chart inside cover. Bridge monitors line voltage for automatic compensation. Seven and nine-pin straighteners on panel. Further information in bulletin TAD-18. [SERVICE]

FAMOUS!



STEAM IRON CLEANER

ADVERTISED IN
LIFE

**REJUVENATES
SLUGGISH IRONS!**

- Ends Sputtering
- Cleans INSIDE
- More steam
- Safe, odorless

Also for VAPORIZERS, STERILIZERS, KETTLES

—USE IT YOURSELF—
IDEAL FOR RESALE

Suggested Retail **\$1.00**

Manufacturer Recommended

ORDER TODAY from your jobber or WRITE Dept. S for name of your nearest supplier.

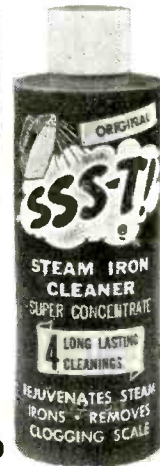

FAST CHEMICAL PRODUCTS CORP.
20 Gunther Ave., Yonkers, N.Y.

CONVERT TV PROBLEMS INTO PROFITS!



INDOOR SET COUPLERS

SERVICE SAVERS



Make one antenna do the work of two — at a neat profit for you. Low loss ferrite core transformer design for top-notch set isolation and signal transfer. Write for JFD Service-Saver brochure showing 40 money-making TV accessories now at your JFD distributor.

model	description	list
BC2	Joins 2 sets	\$2.85
BC3	Joins 3 sets	3.20
BC4	Joins 4 sets	3.60

Pioneers in electronics since 1929
JFD Electronics Corp.
Brooklyn 4, New York

look what **\$24⁵⁰** buys
in test equipment!

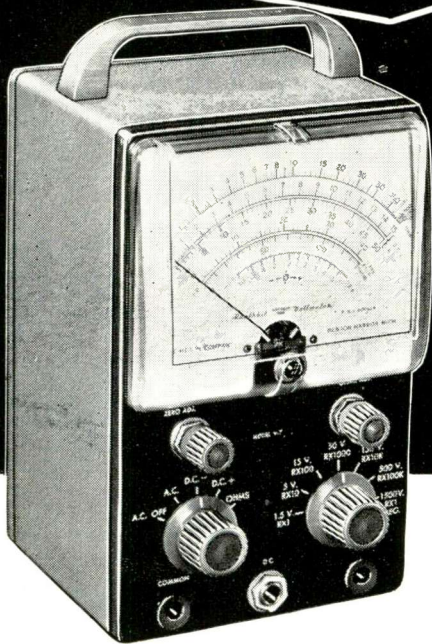

**HEATHKITS
GIVE YOU
TWICE AS MUCH
equipment for
every dollar
invested**

The famous model V-7A Vacuum-Tube-Voltmeter is a perfect example of the high-quality instruments available from Heath at 1/2 the price you would expect to pay! Complete, only **\$24⁵⁰**

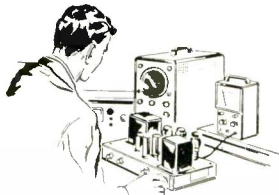

Get the most out of your test equipment budget by utilizing HEATHKIT instruments in your laboratory or on your production line. Get high quality equipment, without paying the usual premium price, by dealing directly with the manufacturer, and by letting engineers or technicians assemble Heathkits between rush periods. Comprehensive instructions insure minimum construction time. You'll get more equipment for the same investment, and be able to fill your needs by choosing from the more than 100 different electronic kits by Heath. These are the most popular "do-it-yourself" kits in the world, so why not investigate their possibilities in your particular area of activity! Write for the free Heathkit catalog now!



Contains detailed descriptions of Heathkit models available, including VTVM's, scopes, generators, testers, bridges, power supplies, etc.



Also describes Heathkit ham gear and hi-fi equipment in kit form. 100 interesting and profitable "do-it-yourself" projects!

FREE catalog
Mail coupon below for
your copy—Now!

HEATH COMPANY
A SUBSIDIARY OF DAYSTROM, INC.,
BENTON HARBOR 11, MICHIGAN

Name _____
Address _____
City & Zone _____
State _____

Servicing Upright

by E. A. MUELLER

A RECENT REPORT¹ discussed the opportunities in the small appliance servicing and points out that the Service Man, because of his retail experience and specialized training, is in an ideal position to develop this field as a source of supplementary income. One of the most common of these small appliances is the home vacuum cleaner, and a few hints on their servicing may prove useful to the Service Man.

As is generally known, there are two distinct types of vacuums in the home cleaning field. The older of the two styles is commonly called an *upright* cleaner, and is operated by a handle from the motor unit. It has an exterior bag or dirt container, and in almost all cases employs the principle of a revolving brush mounted in the nozzle. The brush is driven by a rubber belt operating from a pulley which is in effect an extension of the rotor, or armature, shaft.

The nozzle of the *upright* vac is adjusted about 1/4 in. above the carpet surface, so that in operation the area of carpet immediately under the nozzle is lifted by suction into contact with the nozzle providing an air pocket between carpet and floor. This air pocket acts as a cushion against which the revolving brush beats and agitates the carpet to loosen grit and dirt imbedded in the base of the nap. This makes it possible for the suction to draw air through the carpet, taking with it the loosened grit. The disadvantage of the *upright* cleaner is that attachments for cleaning edges of wall-to-wall carpet, furniture and drapes are clumsy to use and lack sufficient power for straight-suction cleaning.

A second variety of vacuum is the straight suction cleaner, either the tank type² or the canister type.³ These cleaners operate on the principle of straight suction without agitation, and necessarily employ a much higher degree of suction than the *upright* style. It is generally much more efficient for accessory cleaning, and the attachments are more convenient to use.

Modern tank units are built with varying degrees of mobility and utilize a flexible hose, with swivel couplings, to connect the motor and with a multi-

¹Small Appliance Service Opportunities, E. A. Mueller, SERVICE, February, 1958.

²Such as the Electrolux.

³Such as General Electric models.

Home Vacuum Cleaners

Electric Sweeper Service Co.

tude of attachment tools. Theoretically, the disadvantage of this type for use on carpeting is that its lack of revolving brush prevents brushing of the nap and agitation of imbedded grit, making it efficient only for surface cleaning.

As these two styles are quite different, it is to be expected that the servicing procedures, except for the motors, would vary from one to the other. In this article we will consider the servicing problems common to upright cleaners. Tank-type cleaners and vacuum-cleaner motors, which are common to both styles, will be covered in a later report.

Aside from faulty motors, the four most common complaints encountered in servicing uprights are those associated with the bag or dirt container, the brush and belt, the cord and switch, and the fan or impeller. These difficulties account for between 60 and 75 per cent of vacuum repairs and are far easier to remedy and generally much more profitable than the more difficult motor repairs.

Bag or Dirt Container

The condition of the bag or dirt container ranks first as a trouble source because so few users understand its function. A bag must be efficient in two respects. It must be of a material woven and chemically treated to retain dust with a minimum of leakage, but it must also be sufficiently porous to permit a volume of air to pass through which is in direct proportion to the volume drawn in through the nozzle creating suction. If there is, or has been, a moisture condition in the cloth bags, if the bag is not emptied often enough, or if the pores of the material become dust clogged by long use, then it is possible there may be as much as 60% loss in efficiency. These cloth bags *cannot be washed*, they must be replaced.

A quick way to test bag efficiency is to turn on the cleaner and then compress the bag between the flat of your hands. If it compresses easily and without effort, the chances are it is in good condition. However, if the bag offers resistance and is blown up "hard," it is definite evidence that the bag needs replacing.

Many uprights are now sold with a special zippered cloth bag which holds paper disposable inserts. It is

important ANNOUNCEMENT about the TOBE contest and on the next two pages!

Did you know that Tobe is the fastest growing service capacitor line in the U.S.? Even so, we still are getting letters every day from dealers who want to enter our big 50-Prize contest (see ad on next spread) but can't... because their nearest distributor is not yet stocking new Tobe Service Capacitors.



For this reason we are *extending* the Tobe contest from May 30 to June 30—and *making a very special offer besides!* We want YOU to have a chance at that Ford Ranch Wagon, the mink stole and all the other prizes. And we want you to familiarize yourself with Tobe—since 1922 one of America's most popular original equipment capacitor lines.

SPECIAL OFFER! THREE FREE CAPACITORS.

Send in your contest entry (entry blank on next page) today... *without a boxtop*. It only takes a minute to write a good entry. Enclose with your entry an order for any Tobe capacitor described below. We will remove the boxtop and attach it to your entry. Send no money—we will bill you through your distributor. And we will also include, with your Tobe Capacitor, *three* of our tough little "Tobemite" molded plastic tubulars for popular applications *absolutely free*. Send in your entry—and order as many Tobe's described below as you want—today!

WRITE FOR THESE TOBE SERVICE CAPACITORS TODAY

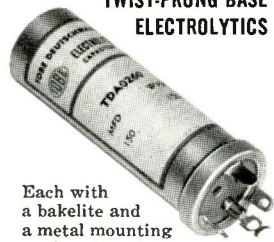
(all prices are dealer net)

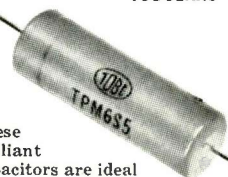
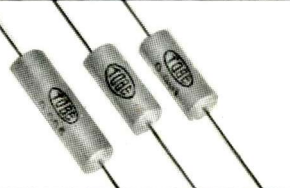
<p>TWIST-PRONG BASE ELECTROLYTICS</p>  <p>Each with a bakelite and a metal mounting washer. Popular "Preferred Type" plan.</p>	<p>"JET" ELECTROLYTIC TUBULARS</p>  <p>Tubular electrolytics hermetically sealed into aluminum containers protected in a transparent red plastic sleeve.</p>	<p>MYLAR * TUBULARS</p>  <p>These brilliant capacitors are ideal for use in humid climates—thanks to DuPont's Mylar, world's finest insulation.</p> <p>*A DuPont Trademark</p>
<p>ALSO: Metal Cased Paper Capacitors, Threaded Neck Capacitors, Disc Ceramic Capacitors, Metal Cased Tubulars, Phenolic-Cased Printed Circuit Capacitors.</p> <p>YOU'LL RECEIVE FREE: 3 "TOBEMITE" MOLDED PLASTIC TUBULARS in popular applications. These are America's finest molded tubulars, and they're far smaller than other equally rated capacitors.</p> 		



TOBE SERVICE CAPACITORS

CLIP THIS ORDER FORM TO YOUR CONTEST ENTRY BLANK (SEE NEXT PAGE)

TOBE DEUTSCHMANN, Service Division, 2900 Columbia Ave., Indianapolis 5, Ind.

Please send me _____ Tobe Replacement Service Capacitors as follows:

Quantity Indicate Rating & Characteristics

Mylar		
Jet Electrolytic		
Twist-Prong . . .		
Tobemite		

Remove the boxtop before shipping and hold with my contest entry attached.

Please send me the complete Tobe Capacitor Catalog.

FIRM NAME _____

ADDRESS _____

CITY _____ ZONE _____ STATE _____

SIGNED _____

MY JOBBER IS _____

I understand I will also receive 3 Tobe Molded Tubular Capacitors absolutely FREE. My jobber will bill me for the other capacitor(s) indicated. (Offer ends midnight, June 30, 1958.)

25 WORDS

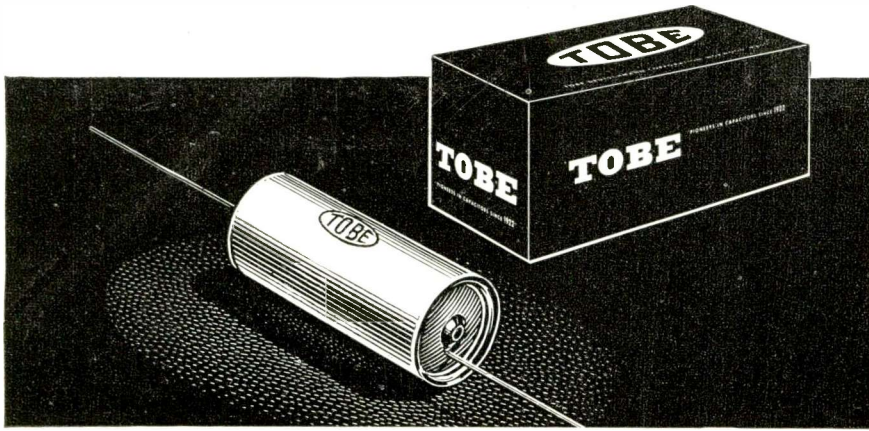

Tell Why You Like Tobe Service Capacitors

Your 25 words can win the Ford Ranch Wagon

And Here Are the TSC* Features to Help You Win • No substandard materials can possibly enter the manufacture of TOBE SERVICE CAPACITORS, because *everything* is quality-checked beforehand • Highest grade dielectric materials prevent voltage breakdown in service • TSC's are designed for high-temperature operation — will not dry out or deteriorate in service • Copperweld leads soldered directly to foil insure you against opens • Moisture-tight seals guard against shorts • Pigtail leads will not pull out or break off • No danger of hot soldering iron opening internal connection or melting sealing compound • TSC's will maintain specified capacity over entire operating temperature range • TSC's receive 100% quality-control inspection prior to shipment • Continuous production-line testing automatically rejects "duds" • Maintenance of large inventories on complete line means faster delivery to your TOBE DISTRIBUTOR and you.

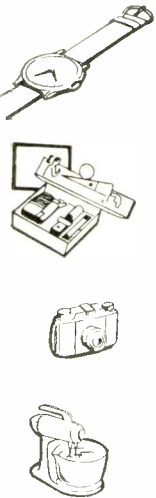

Tobe Service Capacitors

**HERE'S YOUR
ENTRY BLANK**



Tobe Deutschmann Corporation, Dept. C
2900 Columbia Avenue, Indianapolis 5, Indiana

"I prefer Tobe Service Capacitors in my work because _____

NAME _____

ADDRESS _____

CITY _____ ZONE _____ STATE _____

I enclose a Tobe boxtop

more convenient for present day housewives to discard the paper unit when full and zip in a fresh insert. These special zipper units can be obtained for all upright cleaners, even where not a part of original equipment.

Brush and Belt

Number two source of complaint is the condition of the brush and belt. Belts are molded of rubber so that there can be stretch tension to drive the brush. Even the best of crude rubber will stretch and deteriorate with age and then no longer drive the brush. The more important difficulty is that many housewives pick up safety pins, hairpins and similar objects in careless operation of the cleaner. One pin can slice a brand new belt in two. Make sure the belt is in good condition, and sell the customer an extra one as a spare.

Except for the Hoover cleaner, most revolving brushes have a method of lowering the brush within the nozzle to compensate for wear, extending its life two to four times. Common-sense inspection of the brush-end mounting will reveal this to any mechanically inclined person. For instance, the Royal brush has a square mounting piece on the brush end which is off center and each side is numbered. The numeral 1 is faced up on each end when a new brush is installed, and as the bristle wears the ends are turned one-quarter turn lowering the brush in the nozzle.

Other makes such as Hamilton Beach and G.E. have spring clip adjustment in the nozzle mounting. The Hoover, with its barrel construction and metal bar beater, has no such adjustment and the bristled metal strips which insert into the barrel must be replaced every six to nine months. The brush bristle in all cases should extend about 1/16 in. through (or outside of) the nozzle opening for best operation.

Revolving brushes are prone to collect thread, strings, and lint, and should be watched and kept free and clean. It is not unusual for a careless housekeeper to bring a cleaner in for repair with so much thread and lint bound around the brush that the bristle is matted down solidly and the brush is useless. Care must be taken in checking to make sure the tufts of bristle are not thinned out.

Cord and Switch

The most common cause of complete failure is a break in the cord. Just as preventive service in other re-

spects is usually disregarded by the housewife, it is even more forgotten when it comes to vacuum cleaners. Cord ages, cracks, becomes brittle and unsafe, and should be replaced when these symptoms are noticed. Most frequently a break appears at the two major wear points, the wall plug and the switch.

Reconnecting Switch

If the general appearance of the cord is good, and continuity check indicates there is a break, a safe procedure is to cut about six inches off the cleaner end of the cord and reconnect to the handle switch, and about three inches from the opposite and install a new *spring action* rubber male plug. With continued use switch contacts and springs will wear and a new switch can be easily installed.

Occasionally, either by accident or carelessness, a solid object such as a small piece of gravel, metal screw or nut, or even a chip of porcelain is picked up and, in going through the fan chamber, chips or breaks one or more of the blades of the suction fan. This causes the blade to be out of balance, and the turning at high speed literally shakes the unit to pieces.

Fan Blade or Impellor

Almost all fan blades are threaded directly onto the armature or motor shaft, and except for Kirby, the belt pulley also threads onto the shaft and locks the fan in place. In the case of Kirby, the fan and pulley are one-unit assemblies, and are threaded on together. In the case of Hoover, late-model Apex, and Eureka, the fan just slides on the shaft and the pulley is threaded on against the fan hub, holding it tightly by pressure.

LONG-NOSE PLIERS

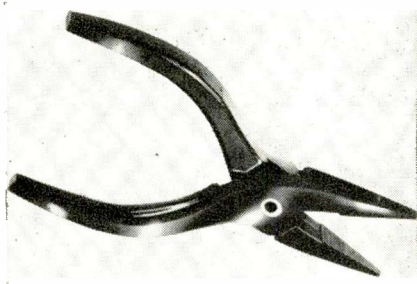

INSULATED LONG-NOSE pliers, 8387, for repairing high-voltage sections of TV sets, have been announced by General Cement Manufacturing Co., 400 S. Wyman St., Rockford, Ill.

Pliers are constructed of high-impact plastic, are non-magnetic and will not interfere with circuit operation. [SERVICE]

WIN THIS FORD

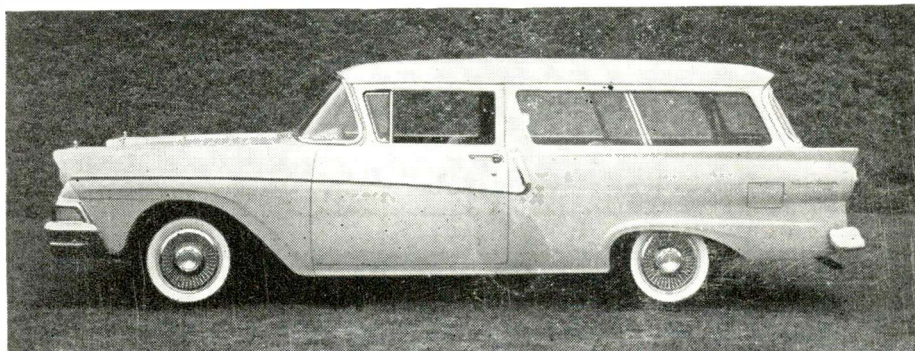

RANCH WAGON

Or one of 49 other valuable prizes



Here's all you do . . . In 25 words or less, tell us why you prefer TOBE SERVICE CAPACITORS.

Then, send your entry to us with the top from any TOBE capacitor carton, or the plastic box some TOBE capacitors are packed in.

That's all there is to it. Enter as many times as you wish, providing each entry is accompanied by a TOBE carton top or the plastic box. Use entry blank below. Additional entry blanks can be obtained from your TOBE DISTRIBUTOR.

Contest closes June 30.

Contest is open to all service-men over 21 years of age residing in the continental United States. Employees of the TOBE DEUTSCHMANN CORPORATION and their advertising agency are excluded. All entries become the property of TOBE DEUTSCHMANN CORPORATION. Decisions of the judges are final. In case of ties, duplicate prizes will be awarded. Contest closes June 30, 1958. Winners will be announced July 31st.



TOBE
RADIANT
CAPACITORS

Tobe Deutschmann Corporation, Dept. C
2900 Columbia Avenue, Indianapolis 5, Indiana

"I prefer Tobe Service Capacitors in my work because _____

NAME _____

ADDRESS _____

CITY _____ ZONE _____ STATE _____

I enclose a Tobe boxtop

CORNELL- DUBILIER CAPACITORS



Thoroughbreds when the heat's on

Here are two types of C-D tubulars so thoroughly entombed in high-grade plastic that they're virtually unaffected by heat, cold and humidity. And, because they employ superior dielectrics, these capacitors have a 15%-25% greater voltage breakdown margin. That makes them the ideal replacement capacitors on all servicing jobs.

The C-D CUB, shown, is available with HT COMPOUND or DYKANOL "C" dielectric. The C-D PM utilizes the superior dielectric qualities of DUPONT "MYLAR." Both types maintain excellent electrical characteristics at high temperatures.

For a lasting service job, use C-D CUBS or PM'S. Your local C-D distributor carries complete stocks. For full data, ask for catalog 200D-3, or write Cornell-Dubilier Electric Corporation, South Plainfield, New Jersey, Dept. S-58B.



CORNELL-DUBILIER CAPACITORS

Old Hands at Dependability

ASSOCIATIONS

NATESA

REPRESENTATIVES of 51 Service Men's associations attended the NATESA Spring Directors Meeting at Springfield, Mo., on April 27th.

George Crossland of General Electric's tube department spoke to the group about *Customer Relations*.

Another feature of the program was the demonstration of test equipment by *Winston Starks*, president of Winston Electronics, and *Norm Peterson*, engineer of Kingston Electronic Corp.

Friends of Service Management awards were presented to Sylvania Electric Products, CBS - Hytron, Sprague Products Company, Howard W. Sams and Company, and P. R. Mallory and Company.

Subjects discussed by the NATESA directors included captive service, licensing, emblems, membership extension, wholesale abuses, state association status, phony trade schools, adverse publicity, and the NATESA advertising and publicity program.

It was voted to open membership to all state groups. Fourteen new groups were accepted as members at the meeting, bringing the total membership to 98 associations. Plans were made for the Annual NATESA convention which will be held at the Congress hotel in Chicago from August 21st through 24th.

TSG, San Francisco, Calif.

Edwin R. Hawkins has been elected president of the San Francisco Television Service Guild. Other officers include *J. Jerome Strauss*, vice president; *Bill Finnerty*, secretary; and *Mrs. Gibson Bories*, treasurer. Directors for the year are *Andy Cerisier*, *Earl Crocker*, *Ned Gramlich*, *Walt Kolbuss*, *Bryant McGrath*, *Jim Miller* and *Roy Norton*. *B. Gross* was reappointed executive secretary.

ARTS, New York City

THE Associated Radio-Television Servicemen of New York have issued a chart of minimum labor rates for TV repair work. Chart is included on a suggested bill form that has been distributed to members of the group.

FRTSA, Pennsylvania

THE Federation of Radio and Television Service Associations passed a resolution condemning "certain" radio, TV and hi-fi manufacturers for "footballing free labor and service for periods of up to one year," at a recent meeting.

The group questioned the use of these policies by manufacturers who

fix fees that may be charged by independent Service Men fulfilling warranties.

The group also drafted a letter to be sent to the Bell Telephone Company of Pennsylvania in which the telephone company's free service listings in classified directories are labeled as "another form of bait advertising."

Milan Krupa was named to head a committee formed to look into the possibility of cosponsoring a Radio Repair Month in conjunction with the Pennsylvania Broadcasters Association.

CETA, New York City

At a recent meeting the Certified Electronic Technicians Association elected *Robert Cornell*, president; *John Hendricks*, vice president; *Nick Colon, Jr.*, treasurer; *Charles Baines*, recording secretary; *Alfred Schab-huttl*, corresponding secretary; and *Graham Holzhausen*, sergeant at arms.

RTA, Pasadena, Calif.

Reese Thomas, general manager of the Pasadena Merchants Association, presented a lecture on "Collecting Your Bills" at a recent meeting of RTA.

ESFETA, New York

At the annual meeting of the Empire State Federation of Electronic Technicians Associations *Robert Larsen* was elected president. Other new officers of the group are *Irving J. Toner*, vice president; *George Carlson*, secretary; *Dan Hurley*, treasurer; and *Frank Kurowski*, sergeant at arms.

TTSDA, Benton Harbor, Mich.

William Toth has been elected president of the Tri-County Television Service Dealers Association. *Robert Wiley* was named vice president; *Ray Blackburn*, recording secretary; *Jim Clupper*, corresponding secretary; *Ed Roscher*, treasurer; and *Carl Janke*, trustee.

TA, South Oakland County, Mich.

The South Oakland County Television Association has chosen *Sam Baldwin* as president. Other new officers of the group are *John Hengel*, vice president; *John Palmer*, secretary; and *Harold Ingalls*, treasurer.

Members of the board of directors are *John Werbinski*, *Dick Schneider* and *Mike Mosier*.

CORNELL-DUBILIER VIBRATORS



Built to last... a type for every radio

The C-D brand name on a vibrator is your guarantee of dependable performance, long trouble-free service. Because C-D vibrators are built to last, you can use them with full confidence. That's why it pays to reach for a C-D when a replacement is called for.

Remember, too, that there's a C-D vibrator type for every make and model car on the road. And the C-D VIBRATOR REPLACEMENT GUIDE makes it quick and easy for you to select the exact type required. Ask your local C-D distributor for a free copy of VIB-3, or write to Cornell-Dubilier Electric Corp., South Plainfield, N. J. Dept. S-58A



CORNELL-DUBILIER VIBRATORS

Old Hands at Dependability

SUCCESSFUL TECHNICIANS RELY ON RIDER SERVICE 'AIDS' FABULOUS "picture-book" COURSE NOW AVAILABLE

BASIC TELEVISION, by *Alexander Schure*. This new 5 volume addition to the famous "picture book" courses is the most understandable presentation of black and white television receiver theory at the basic level ever published. It starts with the transmitter and discusses in detail the following subjects: Volume 1, the transmitter; the handling and the operation of the camera; formation of the picture signal and the general content of the transmitter. Volume 2 covers the organization of the entire TV receiver treating each section individually from antennas to picture tube. Volumes 3, 4 and 5 treat with TV receiver circuit explanations. Each volume covers a specific number of sections in the receiver. #198—soft cover, 5 vols, 688 pages \$10.00 per set. #198-H all 5 volumes in a single cloth covered binding, \$11.50.

HOME AIR CONDITIONING by *J. Derman, H. Seaman, F. Makstein*. Modern up-to-the-minute text provides a firm foundation air conditioning theory upon which the practical know-how for installation and repair can be built. Starting with the basic physics of air conditioning, all component parts including compressors, condensers, capillary tubes etc. and their functions are covered. Typical window and packaged installations are described and illustrated. Smaller commercial installations are included. Troubleshooting and repair techniques explained. Recent and future developments in air conditioning covered. More than 100 illustrations support text. \$3.50.

REPAIRING HI-FI SYSTEMS, by *David Fidelman*. This book deals with finding the troubles and repairing faults in hi-fi equipment with no test instruments—simple equipment—and elaborate equipment. Typical troubles are analyzed and repaired through a system of logical steps. Soft cover, 212 pp., illus. #205. \$3.90.

REPAIRING TELEVISION RECEIVERS, by *Cyrus Glickstein*. The most modern completely practical book, written by an expert with long experience in television receiver repair. Devoted to troubleshooting and repair techniques which are modern, yet down-to-earth. Covers the use of simple as well as elaborate test equipment of all kinds. Profusely illustrated. Soft cover, 212 pp., 5½" x 8½", illus. #191, Only \$4.40.

3rd SUPPLEMENT to the RECEIVING TUBE SUBSTITUTION GUIDEBOOK, by *H. A. Middleton*. A must for every technician! Contains more than 830 latest receiving tube substitutions • more than 200 picture tube substitutions • more than 230 American to European tube substitutions • more than 200 European to American tube substitutions • a cumulative index listing the tube types treated in the basic book and all 3 supplements. It pays for itself almost immediately! #139-3—Soft cover, 72 pp., 8½" x 11", illus. Only \$1.35.

RECEIVING TUBE SUBSTITUTION GUIDEBOOK, by *H. A. Middleton*. #135—Soft cover, 224 pp., 8½" x 11", illus., \$3.00.

FIRST SUPPLEMENT, #139—Soft cover, 48 pp., 8½" x 11", illus., \$.99.

SECOND SUPPLEMENT, #139-2—Soft cover, 48 pp., 8½" x 11", illus., \$.99.

ADVANCED TV SERVICING TECHNIQUES, by *Zbar and Schildkraut*. A complete advanced TV servicing course, developed by the Radio-Electronics-Television Manufacturers Association. Shows how to use every conceivable type of test equipment, how to service every part of a TV receiver. Explains latest techniques. Soft cover, 8¼" x 11".

MAIN TEXT, 192 pp., illus. #161. \$3.60.

LABORATORY WORKBOOK, 32 pp. #161-2. \$.95.

TV PICTURE TUBE-CHASSIS GUIDE, by *Rider Lab Staff*. This easy-to-use TV tube type chassis guide covers all picture tube types used in TV receiver production from 1946 to February 1957—over 7,000 listings. Organized by chassis number, and in some cases, by models so that the technician can immediately locate the correct picture tube type simply by knowing the chassis number. #204, Only \$1.35.

RIDER'S NEW S D O SERVICE

("single diagram only")

ONLY 50¢ PER CHASSIS AT YOUR LOCAL JOBBER



RIDER'S TV 22
NOW
AVAILABLE
only \$24.00

Rider books, manuals, S D O are available at your Parts Jobber. Look for the Rider Bookseller. If these books are not available, order direct. 8-5



JOHN F. RIDER PUBLISHER, INC.
116 West 14th Street, New York 11, N. Y.

CATALOGS—BOOKS

CHICAGO STANDARD TRANSFORMER CORP., 3501 Addison St., Chicago 18, Ill., has issued a wall chart, DH-1, listing Stancor replacement flybacks and yokes by original manufacturers' part numbers. Set manufacturers are listed alphabetically. [SERVICE]

GENERAL ELECTRIC Co., Television Receiver Dept., Syracuse, N. Y., has published volume 3 of G.E.'s *TV Service Guide* covering TV receivers manufactured from 1955 to 1957, including the 110° line. Also contains production-change information and component-location diagrams. Features included are a photo index; schematic diagrams of chassis, *vhf* and *uhf* tuners; a replacement parts list of appearance items, electrical components and main chassis; diagrams describing tube and trimmer locations as well as test points in both top and bottom chassis views. [SERVICE]

NELSON PUBLISHING Co., P.O. Box 36, Redding Ridge, Conn., has published *Television Interference, Its Causes and Cures* by *Philip S. Rand*. Book is divided into 10 chapters covering TV interference sources and types, locating interference, TV receivers, transmitters, shielding and filtering, special *vhf* problems, design and use of high and low-pass filters, external harmonic generation and industrial, medical and public-utility interference. Included is a bibliography, list of TV interference committees, frequencies of amateur band harmonics, table of U.S. TV channels and frequencies, tables of worldwide TV standards and channels and excerpts from FCC rules.—56 pages; priced at \$1.75. [SERVICE]

ELECTRONIC PUBLISHING Co., Inc., 180 N. Wacker Drive, Chicago 6, Ill., has issued a new edition of *Dave Rice's Official Pricing Digest* with resale prices for over 63,000 replacement parts. A table of flat rate and hourly service charges showing regional and national averages is included. Price data are arranged alphabetically by manufacturers and products numerically by part number. Priced at \$2.50. [SERVICE]

ETCO, 33-00 Northern Blvd., Long Island City 1, N. Y., has released a 16-page illustrated catalog, C-158, covering an FM tuner, preamplifier, integrated and power amplifiers, bookshelf and floor speaker systems, *vtvms*, *voms*, scopes, tube and transistor testers, signal and sweep generators, battery eliminators, substitution boxes, flyback tester, battery tester, RCL bridge, electronic switch, voltage calibrator and accessory probes available in both kit and wired form. [SERVICE]

GENERAL ELECTRIC Co., Semiconductor Products Dept., Syracuse, N. Y., has released a 4-page illustrated brochure, ECG-292, with specifications and performance graphs on 2N43 and 2N44 germanium alloy junction transistors. [SERVICE]

installing TV antennas?
for the right accessories
to do the best job

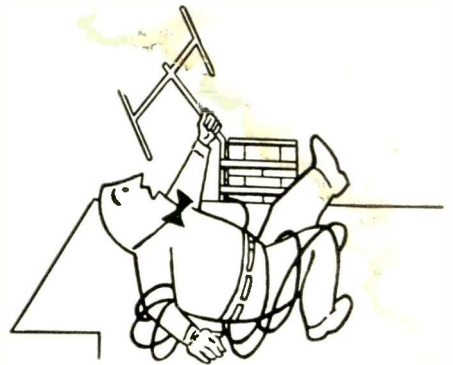

you'll find it
faster in the

MASTER

new 1958 edition—world's largest
electronic catalog only \$3.50 at
your local parts distributor—now
Free! Write for Panel Lamp Chart.

THE RADIO-ELECTRONIC MASTER
60 MADISON AVE., HEMPSTEAD, N. Y.

Cut Down Call Backs...

INSTALL A  WUERTH

SURGISTOR

ON EVERY SERVICE CALL

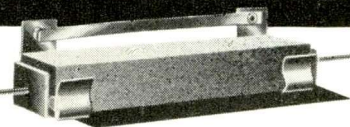

G-C Wuerth No. 5301
... For Black & White
TV List \$1.65

G-C Wuerth No. 5302
... For Color TV Sets
..... List \$1.95

Stops harmful voltage surges to picture and radio tubes. Sell your customers tripled tube life and you'll profit on each installation. Simply connect directly into power line. Functions like a combination resistor-relay to preserve electrolytic capacitors, dry disc rectifiers, transformers, pilot bulbs and other components as well as tubes.

Available right now from your local
electronics parts distributor or
write direct to:

G-C ELECTRONICS MFG. CO.

division of G-C TETRON INC.
Western Plant: Los Angeles 18, Calif.
Main Plant: ROCKFORD, ILLINOIS, U.S.A.

ADVERTISERS IN SERVICE

MAY, 1958

	Page
Alliance Manufacturing Co., Inc.	37
American Television and Radio Co.	48
Amperex Electronic Corp.	27
Argos Products Co., Inc.	2
Atlas Sound Corp.	31
B&K Manufacturing Co.	20
Blonder-Tongue Laboratories, Inc.	26
British Industries Corp., Multicore Sales Corp. Div.	39
Bussmann Manufacturing Co.	6
Centralab, A Div. of Globe-Union, Inc.	3
Cleveland Institute of Radio Electronics	33
Cornell-Dubilier Electric Corp.	41, 42, 43, 44, 45
EICO	37
Electra-Craft Appliance Co.	48
Electro Products Laboratories	32
Electro-Voice, Inc.	7
ESSCO, Inc.	48
Fast Chemical Products Corp.	39
Fidelitone	31
General Cement Manufacturing Co., Div. of Textron, Inc.	37, 39, 46
General Electric Co., Electronic Components Div.	25
Heath Co.	40
Jensen Industries, Inc.	28
JFD Electronics Corp.	28, 37, 39, 47
Kester Solder Co.	36
Moss Electronic Distributing Co., Inc.	35
Oxford Components, Inc.	30
Perma-Power Co.	38
Precision Electronics, Inc.	30
Pyramid Electric Co.	23
Radio Corporation of America, Electron Tube Div.	22, Back Cover
Raytheon Manufacturing Co.	8
Recoton Corp.	32
John F. Rider Publisher, Inc.	46
Service Instruments Corp.	47
Sonotone Corp.	29
Sprague Products Co.	17
Sylvania Electric Products, Inc.	4, 5
Sarkes Tarzian, Inc., Rectifier Div.	34
Tech-Master Corp.	36
Tope Deutschmann Corp.	41, 42, 43, 44, 45
United Catalog Publishers, Inc.	46
University Loudspeakers, Inc.	Inside Back Cover
Xcelite, Inc.	38
Zenith Radio Corp.	1, 12, 13

MULTIPLE-SOCKET TUBE TESTER

A 41-SOCKET tube tester, FC-2, has been announced by Century Electronics Co., Inc., 111 Roosevelt Ave., Mineola, N. Y.

Two settings are used for quality, interelement short and leakage, gas content and life expectancy tests said to check more than 600 tube types. Circuitry has been designed to accommodate new tubes without modification; new listings are issued periodically.

Uses D'Arsonval type meter protected against burnout. Tester is line-isolated and line-voltage compensation is included. Has 7- and 9-pin straighteners on panel. Picture tube adapter cable allows unit to be used as a picture-tube tester-rejuvenator for all picture tubes including short-neck 110° types. [SERVICE]

PERSONNEL

ROBERT WECHSLER has been named advertising, sales promotion and public relations manager of American Geloso Electronics, Inc., 312 Seventh Ave., New York 1, N. Y.

THOMAS & SUKUP, INC., 5226 N. Keystone Ave., Indianapolis, Ind., has been appointed as representative for Amperex Electronic Corp., Inc., in Indiana and Kentucky.

GERARD CAFARO and GEORGE KULPER have been named sales engineers for the rectifier division of Audio Devices, Inc., 444 Madison Ave., New York 22, N. Y.

AMES F. GIORDANO has been appointed chief engineer of Blonder-Tongue Laboratories, Inc., 9-25 Alling St., Newark 2, N. J.

ROLAND A. REUTHER has been named assistant to the vice president of Cleveland Institute of Radio Electronics, 4900 Euclid Ave., Cleveland 3, Ohio.

ROBERT G. FURLONG has been appointed sales manager of the television receiver division of Allen B. Du Mont Laboratories, Inc., 750 Bloomfield Ave., Clifton, N. J.

DON JONSON has been named sales manager of G-C Electronics Manufacturing Company division of G-C Textron, Inc.

PETER HUMENIUK has been appointed manager, engineering of the television receiver department of General Electric Co., Electronics Park, Syracuse, N. Y.

JOSEPH R. OWEN has been named manager of advertising and sales promotion of the specialty electronic components department of General Electric Co., Syracuse, N. Y.

JOHN A. MCCORMICK has been appointed manager of system sales for two-way radio units, communication products department, General Electric Co., Syracuse, N. Y.

JERRY MELTZER has been named sales manager of the newly formed General Instrument Distributor Div., 240 Wythe Ave., Brooklyn 11, N. Y.

D. O. REINERT has been named manager, mobile and microwave service sales, technical products department, RCA Service Co., Inc., Camden 8, N. J.

CONVERT TV PROBLEMS INTO PROFITS!



OUTDOOR ANTENNA COUPLERS SERVICE SAVERS



Combine any Hi-Lo VHF, UHF-VHF or Hi-Lo VHF-UHF antenna into a single weather-proof system using one downlead. Low loss R-L-C networks (band pass, high pass and low pass combinations.) Fast, secure U-bolt mounting. No clumsy straps. Write for Service-Saver Brochure showing 40 money-making TV accessories now at all JFD distributors.

model	antenna systems	list
AC10	Joins Ch. 2-6 to 7-13	\$3.50
AC20	Joins Ch. 2-13 to 14-83	3.75
AC30	Joins Ch. 2-6 to 7-13 to 14-83	4.85

Pioneers in electronics since 1929
JFD Electronics Corp.
 Brooklyn 4, New York

NEW! IMPROVED!

SENCORE TRC4 TRANSISTOR CHECKER

Another Sencore Time-Saver

America's newest, most popular test instruments

NOW CHECKS:

- ★ Transistors for opens, shorts, leakage and current gain. Includes new gain test on power transistors.
- ★ Crystal Diodes checks forward to reverse current ratio on all diodes.
- ★ Selenium Rectifiers checks forward and reverse currents.

Controls are accurately set for each transistor by referring to replaceable set-up chart on rear. Test leads or socket provides for fast hook-up. See your parts distributor.



Mfg by **SERVICE INSTRUMENTS CORP.**
 171 OFFICIAL RD., ADDISON, ILL.

Cut out this ad now for further information VISIT BOOTH #116 AT THE MAY PARTS SHOW

Operate your . . .

- tape recorder
- P. A. system
- portable TV set
- hand tools

FROM YOUR CAR, Boat or Plane!

with

ATR

INVERTERS

FOR CHANGING YOUR STORAGE BATTERY CURRENT TO

A.C. HOUSEHOLD ELECTRICITY ANYWHERE . . . in your own CAR, Boat or Plane!



OPERATES
PORTABLE TV SET
directly from your car!

OPERATES

- TAPE RECORDERS
- DICTATING MACHINES
- PUBLIC ADDRESS SYSTEMS
- ELECTRIC SHAVERS



MAKE YOUR CAR, BOAT OR PLANE
"A ROLLING OFFICE!"



OPERATES
• RADIOS
• RECORD PLAYERS
• MIXMASTERS, ETC.
directly from your car!



mounted out of sight under dash or in trunk compartment

ATR UNIVERSAL INVERTERS

Especially designed to change 6 or 12 volt D.C. to 110 volt A.C. 60 cycles. for . . .

- EXECUTIVES
- SALESMEN
- OUTDOOR MEN
- POLICEMEN
- REPORTERS
- FIREMEN
- PUBLIC OFFICIALS

MODELS 6U-RHG (6 volts) 125 to 150 watts. Shipping weight 27 lbs. List price . . . \$89.95

DEALER NET PRICE . . . \$59.97

12U-RHG (12 volts) 150 to 175 watts. Shipping weight 27 lbs. List price . . . \$89.95

DEALER NET PRICE . . . \$59.97

Write for literature on other Sizes and Models of ATR INVERTERS, priced as low as \$9.95 list.

SEE YOUR JOBBER OR WRITE FACTORY

- ✓ NEW MODELS
- ✓ NEW DESIGNS
- ✓ NEW LITERATURE
- "A" Battery Eliminators
- DC-AC Inverters
- Auto Radio Vibrators

ATR

AMERICAN TELEVISION & RADIO CO.
Quality Products Since 1931
SAINT PAUL 1, MINNESOTA, U. S. A.

AUREL G. PETRASEK has been promoted to manager, merchandising, receiving tubes, RCA Electron Tube Div., Harrison, N. J.

GEORGE SAPIN has been appointed manager, advertising and sales promotion—entertainment market, RCA Electron Tube Division.

ROBERT L. SHAW has been named general marketing manager and HARRY H. MARTIN general manufacturing manager of Sylvania Home Electronics, Batavia, N. Y.

MERLE W. KREMER has been appointed vice president and general manager of the parts division of Sylvania Electric Products, Inc., Warren, Pa.

RAYMOND H. HILGERS has been named sales representative for the mid-west region of the electronic tube division of Westinghouse Electric Corp.

HARRY SCHECHTER has joined Zenith Radio Corp., 6001 Dickens Ave., Chicago 39, Ill., as merchandising assistant to the vice president and director of sales.

JOHN K. RUSSELL has been appointed district sales representative for Cleveland, Detroit, Columbus, Grand Rapids and Saginaw by Zenith Radio Corp.

HARRY RONAN has been promoted to manager, two-way radio sales, for the communications and industrial electronics division of Motorola, Inc., 4501 W. Augusta Blvd., Chicago 51, Ill.

ROBERT B. MEANS has been appointed manager, western district, entertainment sales, of the RCA Electron Tube Div., Harrison, N. Y.

H. J. BENHAM has been appointed manager, central service region, technical products service department of RCA Service Co.

CHESTER A. GRONZIK has been named works manager of Entron, Inc., 4902 Lawrence St., Bladensburg, Md.

NORMAN CAPLAN has been appointed manager, communications products department, telecommunications division, RCA, Camden, N. J.

ROBERT M. BOWIE has been named vice president of Sylvania Research Laboratories, Bayside, N. Y.

PORTABLE APPLIANCE SERVICE FOR INCREASED PROFITS!

1. SAME TOOLS!
2. SAME STORE SPACE!
3. SAME PERSONNEL!
4. SAME CUSTOMERS!

TEMPERATURE METER FOR ADJUSTING IRON THERMOSTATS



THE ONE NEEDED TEST UNIT FOR WORK ON ELECTRIC HAND IRONS. ACCURATE — DEPENDABLE — EASY TO USE.

ONLY \$14.50

IRON & TOASTER CORD SETS

- #16-2 HPT, 7' LONG.
- HEAVY DUTY.
- MOLDED PLUG. LEGS FIBRE-GLASS TIED.

LIST PRICE \$1.25

No. SM 16-2

Dealer Net 60c
Lots 10 56c
Lots 25 54c

ALSO —

- ✓ VAC CLEANER PAPER BAGS
- ✓ POWER TOOL PARTS
- ✓ FAN PARTS—HEATER PARTS
- ✓ PROFITABLE COUNTER SALE ITEMS

ALL CATALOGS AND SUPPLEMENTS STILL AVAILABLE.

WRITE —

ESSCO, INC.

2034 EUCLID
CLEVELAND 15, OHIO

OR

ELECTRA-CRAFT

348 W. 42nd STREET
NEW YORK 36, NEW YORK

CONTACT NEAREST SUPPLIER!

To AVOID amplifier and speaker WASTE... choose from

4 University WIDE-ANGLE SPEAKERS

For uniform dispersion of sound over a wide area

CHOICE OF 5 DRIVERS FOR CLH OR COBREFLEX

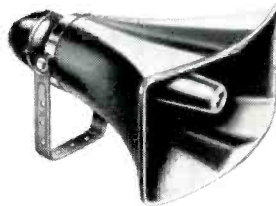

CLH 4½ ft. air column. Exclusive omni-directional bell and mounting bracket helps "tune out" reverberation and "dead spots." \$44.50 list.



COBREFLEX All die-cast aluminum one piece construction resists a life-time of physical abuse. 2½ ft. air column. \$38.33 list.



CIB Built-in hermetically sealed driver. Excellent for "talk-back." Exclusive Positive-Lok omni-directional mounting bracket. \$42.00 list.

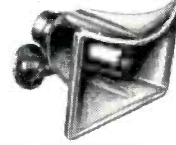

CMIL Smaller than CIB, perfect for voice. Built-in driver packs mighty wallop at low input power. Ideal for close quarter installations. \$29.75 list.



MA-25 \$27.50 list
85-6500 cps. 25 W.



SA-HF \$36.00 list
80-10,000 cps. 30 W.



SA-30 \$47.50 list
built-in matching trans.
80-10,000 cps. 30 W.



PA-HF \$47.50 list
70-10,000 cps. 50 W.



PA-50 \$57.50 list
built-in matching trans.
70-10,000 cps. 50 W.

Only University gives you the choice of speakers you need to ensure greatest economy of amplifier power, equipment and installation costs. No wasteful, "cure-all, do-all" compromises here. Each speaker is designed to do its specific kind of job most efficiently and reliably, with plenty of room for future expansion. Each speaker incorporates many exclusive features to fulfill every possible application. The chart below graphically shows the relative differences between these four speakers in terms of sound out-

put, input power, and low frequency response. Simply choose the intended application and determine the appropriate speakers. Or, depending upon existing operating prerequisites, select the speaker(s) capable of doing the job. That's all there is to it.

NOW AVAILABLE—Free Product Catalog. Or send \$1 for the NEW 64-page University TECHNOLOG, the complete speaker system planning manual. Desk X-4, University Loudspeakers, Inc., 80 S. Kensico Ave., White Plains, N.Y.

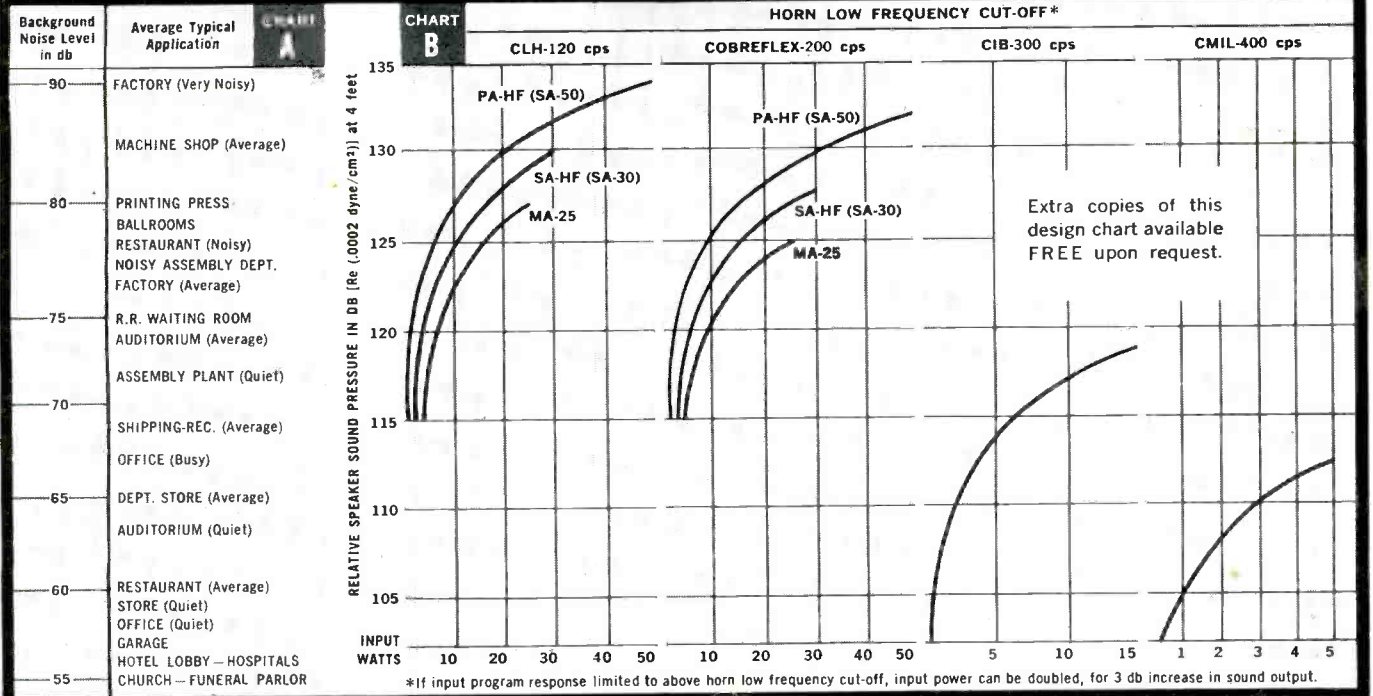

HOW TO USE THIS CHART

- Determine sound pressure needed by finding noise level from Chart A, add loss of db in Table C and add adjusting factor in Table D.
- Draw horizontal line across Chart B corresponding to the db figure just calculated. This now establishes which speakers can be considered.
- A vertical line drawn to the base of Chart B shows the input power needed for each qualifying speaker.
- Now, further selection may be based upon frequency

response necessary (see Horn Cut-Off, Chart B), initial cost, operating economy and reserve power desired.

5. The CIB and CMIL may also be used in high noise levels by employing several throughout the listening area.

Example: Factory — noise level 90 db, 320,000 cu. ft., live acoustics, music and speech
90+25+5=120 db required

Qualifying speakers are CLH or Cobreflex, with any of the drivers. Final choice is determined by driver characteristics and installation problems. (Send for TECHNOLOG or Product Catalog.)

ROOM VOLUME CU. FT.	INDOORS			OUTDOORS	
	LIVE	NEUTRAL	DEAD	FURTHEST DISTANCE FT.	DB LOSS
1,000	0	3	6	4	0
3,200	5	8	11	8	6
10,000	10	13	16	16	12
32,000	15	18	21	32	18
100,000	20	23	26	64	24
320,000	25	28	31	128	30
1,000,000	30	33	36	256	36

PROGRAM ADJUSTING FACTOR	INDOORS DB		OUTDOORS DB	
	SPEECH	MUSIC	MUSIC & SPEECH	MUSIC & SPEECH
		4	7	11



University sounds better



You are invited to see us in Booth 871 and display rooms 542A-544A during the Electronic Parts Show, at Conrad Hilton, Chicago, May 19-21

anatomy
of the
tube...
LESSON #1



GRID

How RCA builds special
prescription grids...extends 6AF4-A life!

RCA's redesign of the 6AF4-A has resulted in minimized slump, product uniformity, and projected average life of 4,000 hours or more!

Here are some of the materials RCA "prescribes" in manufacturing the new 6AF4-A. The grid is plated with Palladium, a rare metal capable of withstanding high temperatures. The use of this grid structure minimizes interelectrode leakage, prevents grid loading, and as a result, provides stable tube performance. The cathode, a nickel alloy, is specially selected to reduce interface resistance and thus minimizes slump. The use of pins which are silver-plated reduces skin effect at ultra-high frequencies and improves tuner performance.

All these features, in addition to dynamic life tests, help to assure long and dependable performance. No wonder RCA's 6AF4-A is tops!

So, here's the #1 lesson in radio, phonograph, and TV service—when ordering tubes for replacement, specify "RCA Tubes only."



RADIO CORPORATION OF AMERICA
Electron Tube Division

Harrison, N. J.