

# SERVICE

THE TECHNICAL JOURNAL OF THE TELEVISION-RADIO TRADE

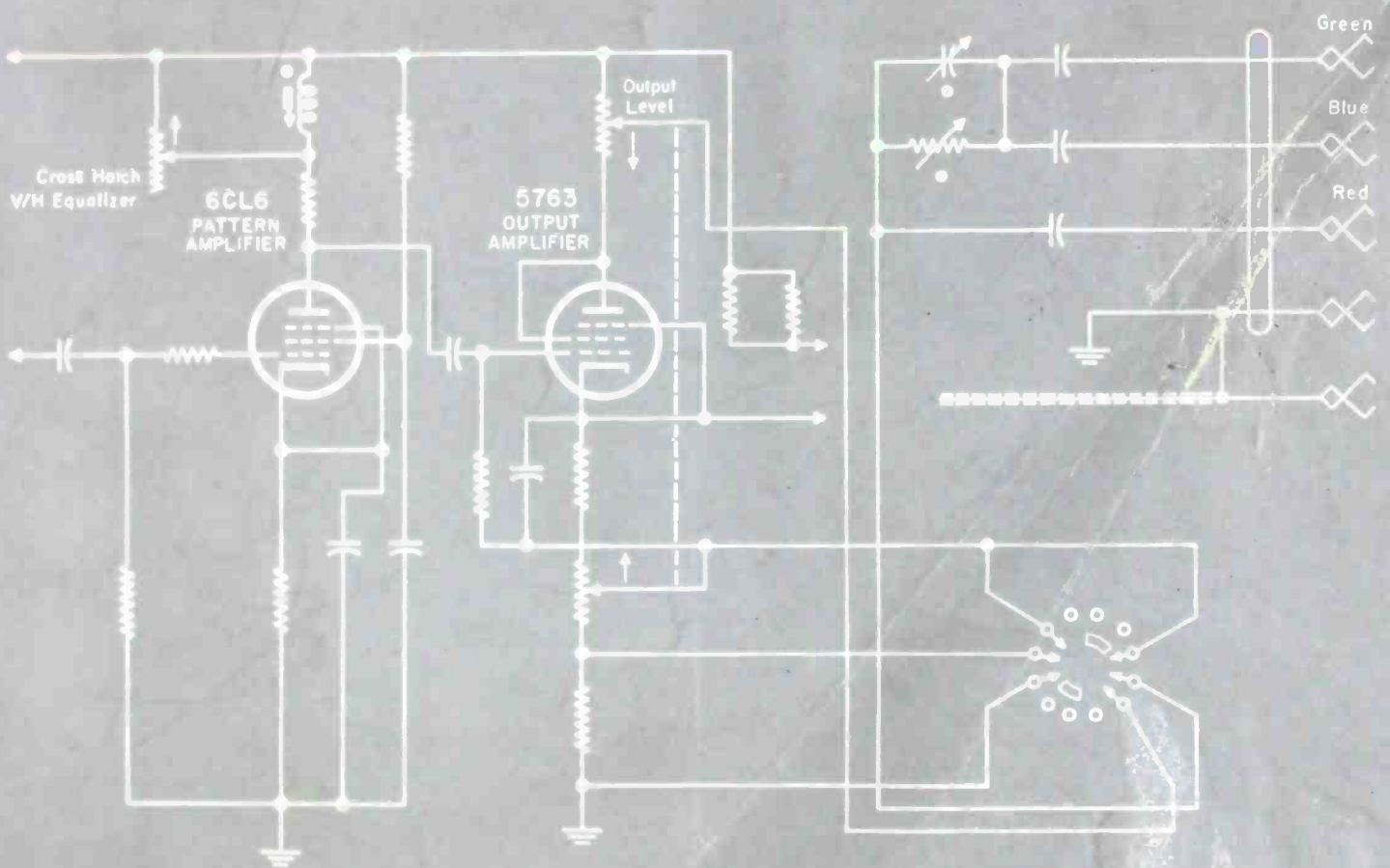

Pattern and output amplifier of color-TV video generator.

See circuit analysis, this issue

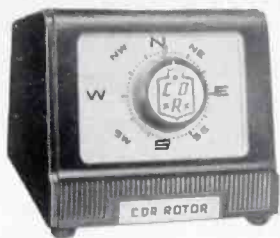

AR-22



TR-2



TR-4

# 5-star feature...

## 1 the best color TV picture

the growth of color TV means an even greater demand for CDR Rotors for pin-point accuracy of antenna direction.

## 2 a better picture on more stations

CDR Rotors add to the pleasure of TV viewing because they line up the antenna perfectly with the transmitted TV signal giving a BETTER picture . . . and making it possible to bring in MORE stations.

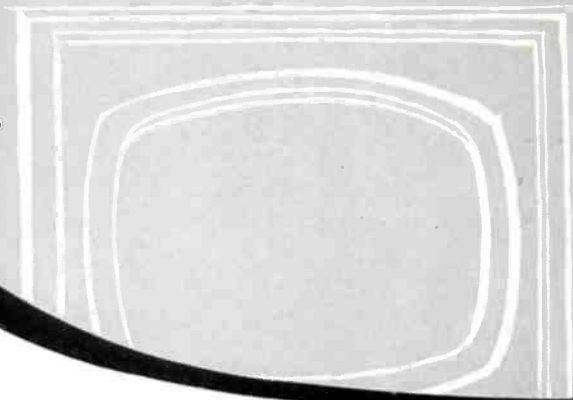

# CDR ROTORS



TR 11 and 12



AR 1 and 2

## 3 tested and proven dependable

thousands and thousands of CDR Rotors have proven their dependability over years of unflinching performance in installations everywhere in the nation. Quality and engineering you know you can count on.

## 4 pre-sold to your customers

the greatest coverage and concentration of full minute spot announcements on leading TV stations is working for YOU . . . pre-selling your customers.

## 5 the complete line

a model for every need . . . for every application. CDR Rotors make it possible for you to give your customer exactly what is needed . . . the right CDR Rotor for the right job.



CORNELL-DUBILIER  
SOUTH PLAINFIELD, N. J.



THE RADIART CORP.  
CLEVELAND 13, OHIO

# Westinghouse casts a vote of confidence for the independent service dealer!

Westinghouse  
ELECTRIC CORPORATION



ELECTRONIC TUBE DIVISION

P.O. BOX 284  
ELMIRA, NEW YORK

TO: INDEPENDENT RADIO-TELEVISION SERVICE DEALERS

A great deal of written and verbal discussion has been going on in our industry just recently on the subject of "factory service" for television and radio sets. This discussion has been of considerable importance to Westinghouse from both the tube and set viewpoint; and, after lengthy consultation with Mr. E. J. Kelly, General Manager of the Radio & Television Division, Westinghouse does not contemplate going into factory service operation for Westinghouse sets.

We have confidence in the independent service dealers to supply replacement parts and render the necessary service for television sets in our very rapidly expanding industry that is forecast to double in size again in the next ten years.

We presently feel that the best interests of the ultimate consumer are served by the continued utilization of the vast coverage and experience of the independent service dealers. The Westinghouse Tube Division has supported independent servicemen in the past and this support will be continued in the future.

May I take this opportunity to congratulate you and your independent service organization on the vital role you have played so well in the television industry.

Cordially,

R. T. Orth  
Vice-President

YOU CAN BE SURE... IF IT'S Westinghouse

## YOU CAN BE SURE... IF IT'S Westinghouse

# ELECTRO DC POWER SUPPLY

0-32 V. up to 15 Amps.  
Continuously Variable



**one...  
for all**  
these applications

#### 6 Volts

Auto Radio Servicing\*  
Transistor Circuit Design  
Plating Operations  
Laboratory Work  
Battery Charging

#### 12 Volts

Auto Radio and Accessories  
Servicing\*  
Marine and Aircraft Equipment  
Mobile Communications  
Equipment  
Model Train Operation  
Battery Charging  
Transistor Circuit Design

#### 18 Volts

Tank Mobile Equipment Servicing

#### 24 Volts

Relay Operation  
Telephone Circuits  
Aircraft Ignition Servicing

#### 28 Volts

Aircraft Equipment Servicing

#### 32 Volts

Farm Radio Servicing  
Railroad Mobile Equipment

\*Both Transistor and Standard Sets

Special filter circuit broadens range in all low voltage applications. Has all EPL patented features, plus many new ones, available only in the "NFA."

**\$195 net**

Send for new bulletin today:

### ELECTRO PRODUCTS LABORATORIES

4501-V Ravenswood Ave.,  
Chicago 40, Ill.

Canada: ATLAS RADIO LTD., Toronto

633



Vol. 26 No. 1

# SERVICE

JANUARY, 1957

The Technical Journal of the Television-Radio Trade  
Including RADIO MERCHANDISING and TELEVISION MERCHANDISING.  
Registered U. S. Patent Office.

## COVER CIRCUIT

Pattern-Output Amp of Color-TV Video Generator (RCA WR-46A) ..... 10

## FEATURES

Editorial .....	Lewis Winner	6
B-W/Color-TV VHF Tuner Mixers and Local Oscillators ..	Wayne S. Rial	8
Color-TV Video Generator For Convergence Adjustments (Cover; With Complete Circuit) .....	Rhys Samuel	10
In-Circuit Horizontal System Analyzer To Check Flybacks (With Complete Circuit) .....	Robert G. Middleton	13
Resistive Line-Voltage Regulators .....	Glenn Hall	15
Adjustable Bias Supplies . . 'Scope Modifications For TV-Set Alignment (Servicing Helps) .....		16
Maintenance of Communications Equipment in Santa Clara County, Calif. (Service Engineering) .....	Robert A. Mason	20
This Month in SERVICE .....		24
Color-TV Picture-Tube Adjustments .....	John T. Jans	27
Rooftop TV-Antenna-Mast Multiple-Set-Coupler Installations .....		28
Instruments-Procedures Used In Plants to Check TV Tubes (Tube News) .....	Earl G. Bond	32
A Report on The Useful Life of Hi-Fi Components and Accessories .....		34

## CIRCUIT DIAGRAMS

Superhet Frequency Conversion Equivalent Circuit .....	8	Simpson 382 In-Circuit Horizontal-System Analyzer (Complete Circuit) .....	13
VHF-Tuner Triode-Mixer Stage .....	9	In-Circuit Horizontal-System Short Test Circuit .....	13
VHF-Tuner Pentode-Mixer Stage .....	9	Telematic Adjustable TV Bias Supply .....	16
RF-Output Convergence Generator .....	10	Voltage Boost For CRT Cathode .....	16
Video-Output Convergence Generator .....	10	Heater-Circuit Change To Limit Hum .....	17
RCA WR-46A Video Generator Block Diagram .....	10	'Scope Amp Modified to Increase Gain .....	17
RCA WR-46A Video Generator (Complete Circuit) .....	11	'Scope Amp Three-Step Attenuator .....	17
		Blocking TV Oscillators .....	32

## DEPARTMENTS

Service Engineering .....	20	Latest in Audio .....	36-38
TV Antenna-Accessory Developments .....	29	Components .....	39
Catalog and Books .....	31	Bench-Field Tools .....	44
Tube Tubes .....	32	Association News .....	46
Instruments .....	33	Ten Years Ago in SERVICE .....	46
Audio Installation and Service .....	34	Personnel .....	48

Index to Advertisers ..... 47

Entire Contents Copyright 1957, Bryan Davis Publishing Co., Inc.

Second-Class mail privileges authorized at New York, N. Y.; additional entry at the Post Office, Norwalk, Conn. . . . Subscription price: \$2.00 per year (\$5.00 for 3 years) in the U.S.A. and Canada; 25 cents per copy. \$3.00 per year in foreign countries; 35 cents per copy.



**EDITOR and PUBLICATION DIRECTOR**

**Lewis Winner**

- Associate Editor: **David E. Pearsall II**
- Assistant Editor: **Robert D. Wengenroth**
- Editorial Assistant: **Arnold Gewirtz**
- Editorial Assistant: **Howard Jennings**
- Art Director: **Anthony R. Aliffi**
- Supervisor, Circuit Diagrams: **Michael D. Bellezza**
- Editorial Production: **Astrid Kelly**

**CIRCULATION DEPARTMENT**

- Circulation Manager: **A. Goebel**
- Ass't Circulation Mgr.: **A. Kiernan**

**ADVERTISING DEPARTMENT**

- Advertising Mgr.: **Aaron L. Lafer**
- Pacific Coast: **Leo Sands, Dist. Mgr.**  
535 Ramona St.  
Palo Alto, Calif.  
Tel.: DAvenport 5-3716

**Published Monthly by**

**Bryan Davis Publishing Company, Inc.**  
52 Vanderbilt Ave., New York 17, N. Y.  
Tel.: MURray Hill 4-0170

B. S. Davis, Pres.      Lewis Winner, Vice-Pres.



**LOOKING?**  
*for the right dual-control replacement*

*You'll find it's*  
**ALWAYS IN STOCK** at your  
**Centralab Fastatch®**  
**distributor**

- With Centralab's unique Fastatch system, your distributor can afford to carry a *complete line* of dual-concentric replacements for all popular TV, radio, and auto sets.
- Each Fastatch control unit is factory assembled, tested, and guaranteed.
- Ask your Centralab distributor's salesman or counterman about Fastatch duals. Or send coupon for bulletin 42-218.

**Centralab**

**A DIVISION OF GLOBE-UNION INC.**

934A East Keefe Avenue, Milwaukee 1, Wisconsin

B-5622

Send me Fastatch bulletin 42-218.

Name \_\_\_\_\_

Company \_\_\_\_\_

Address \_\_\_\_\_

City \_\_\_\_\_ Zone \_\_\_\_\_ State \_\_\_\_\_



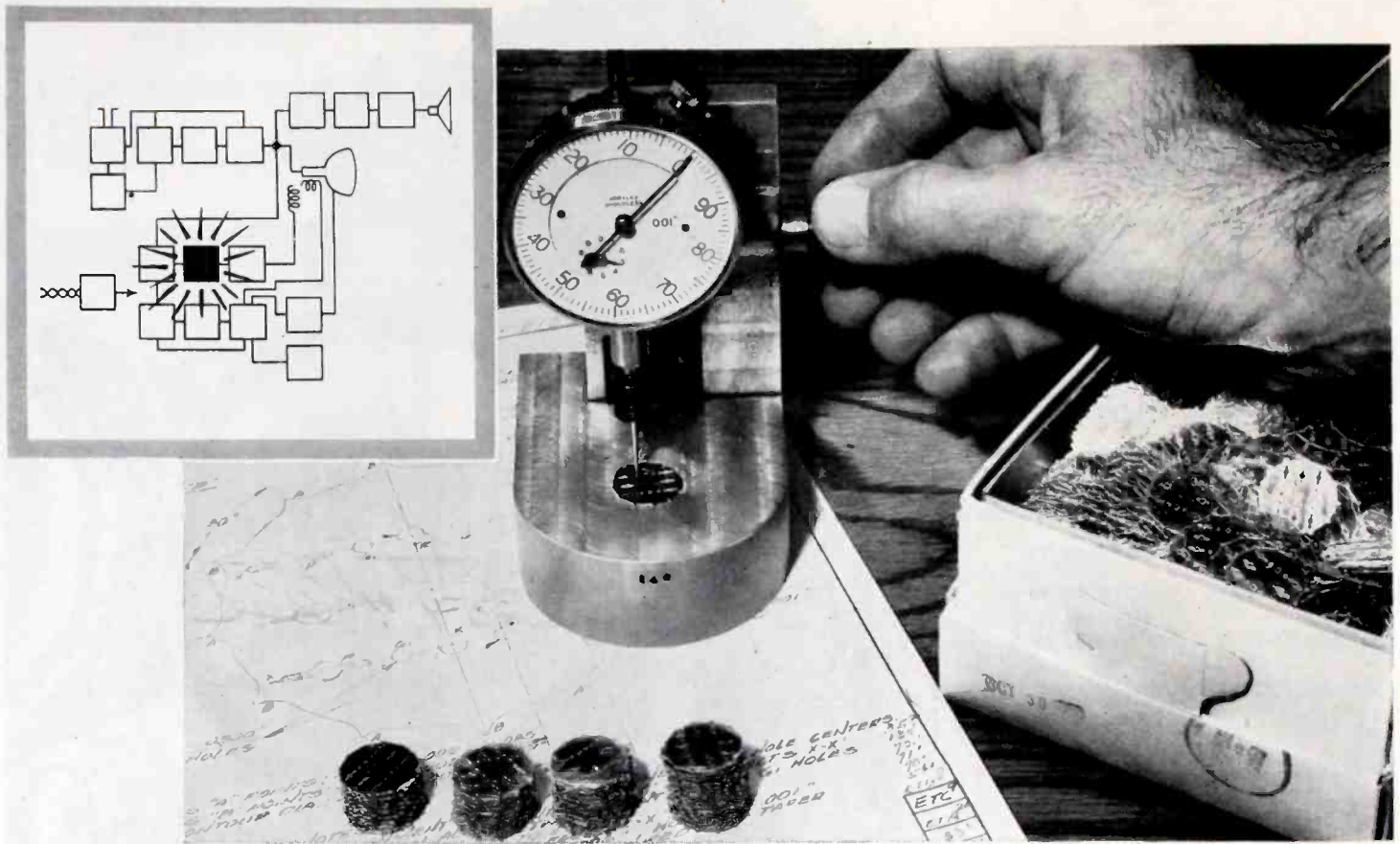

## Close mica specifications of G-E vertical-sweep tubes cut microphonics, help prevent picture "jitter"!

THE tapered-pin micro-gage above, shown checking the diameter of a grid side rod aperture in a G-E tube mica, helps you to service TV sets with increased assurance of owner satisfaction. Within .0005 inch the mica aperture must meet exact size requirement, in order that General Electric grids, once inserted, will fit tightly, have minimum microphonics.

TV owners see microphonics in vertical-oscillator-and-output tubes—as image-jitter on their screens. General Electric keeps down your call-backs from this cause by holding to the industry's most rigid standards of mica measurement on 6CM7's, 6BL7-GT's, and other vertical-sweep tubes.... by precision-building and micro-checking the grids and other parts, and by

a final tube test for low microphonic properties.

In many other ways, General Electric vertical-sweep tubes are better built for a superior job in your customers' sets. Careful checking for zero-bias plate current, plus improved plate design and other advancements, reduce sharply the risk of picture foldover, short sweep, and top stretch. The tubes receive a special sensitive test for tap shorts, and life-rack performance must show electrical stability at all times.

For every socket in the sets you service, there is a General Electric tube with quality as outstanding as that of G-E vertical-sweep types. See your G-E tube distributor! *Electronic Components Division, General Electric Company, Schenectady 5, New York.*

*Progress Is Our Most Important Product*

**GENERAL  ELECTRIC**

161-1A1



# Sizes and Types for every Fuse need

*you'll quickly find the right fuse for the job  
-in the complete BUSS fuse line!*

Standard type, dual-element (slow-blowing), renewable and one-time type fuses are all available from one source—BUSS. You'll save time and trouble by turning first to BUSS when you need fuses.

And of great importance, there are no 'kicks' or complaints from your customers about the operation of BUSS fuses—for to assure dependable protection under all service conditions,

BUSS fuses are tested in a sensitive electronic device. Any fuse not correctly calibrated, properly constructed and right in all physical dimensions is automatically rejected.

### Capitalize on the BUSS trademark

The universal trade and consumer acceptance of BUSS fuses is based on the millions upon millions of BUSS

fuses used in homes, on farms and in industry over the past 42 years. Sales are easier to make when you handle BUSS . . . the Known brand of fuses.

For more information on BUSS and FUSETRON Small Dimension fuses and fuseholders . . . Write for bulletin SFB. Bussmann Mfg. Co. (Div. of McGraw Electric Co.), University at Jefferson, St. Louis 7, Mo.

*BUSS fuses are made to protect  
-not to blow, needlessly*



Makers of a complete line of fuses for home, farm, commercial, electronic, automotive and industrial use.

## Bright Prospects for '57

THERE'LL BE UNLIMITED opportunities for Service Men in the year ahead: So have scores and scores of industry experts forecast in their annual reports.

Looking forward to the huge quantities of components and accessories that will be required as replacements in the increasing number of home and portable radios, auto sets, TV chassis, phonos and tape recorders and commercial equipment, industry heads said that they were gearing production for the highest levels on record.

CAR RADIOS will play a prominent role in the maintenance-repair field, it was reported, because of the 6.5-million new radio-equipped cars that are scheduled for the market in '57. This number of new cars, plus the 26-million with radios now on the road will, it was emphasized, not only boost sales of tubes and parts, but develop the biggest year for auto-radio antennas and vibrator-powered supplies.

COLOR-TV was also described as a factor which will contribute substantially to the progress picture of '57. The new year will witness acceleration on all fronts of color-TV as a new dimension in entertainment, education, news and sports, as well as advertising and merchandising.

To this end, NBC-TV declared that they are not only aiming for at least two color programs nightly during '57, but complete evenings devoted to color. Throughout the network structure, it was said, color service has already spread nationally; 95 per cent of all TV homes are within reach of color signals, and about thirty stations on the network are originating their own live color shows.

The increased program plans, improvements in transmission and general receiver design, has generated a vigorous interest among many manufacturers who have announced that they'll be on the color bandwagon this year. One set maker said that he felt that industry sales should total at least 3/4-million units before the year is out.

The color push has prompted one manufacturer in the midwest to announce that he was planning to halt all b-w production in the early spring and thereafter devote his entire facilities to color.

\*See page 13, this issue, for an exclusive report on an in-circuit horizontal-system analyzer. \*\*An exclusive report of a video generator designed for color convergence appears on page 10 of this issue.

ANTENNA MANUFACTURERS have hailed the color program for '57, declaring that replacement sales will soar because of the color. With color-TV, they pointed out, the fringe area moves closer to the transmitter, developing the need for better antennas than are now being used in the same areas. And, it was emphasized, those who are now getting by with marginal reception in black and white will find the situation intolerable with color, and require completely new antenna installations.

THE FULL-FLEDGED EMERGENCE of practical semiconductors for not only portable radios, but audio and TV, also appears on the horizon for '57. This breakthrough was expected to more than double the '56 volume of \$32-million for a total of between \$65 and \$70-million for over 20-million units.

Circuit engineers predicted that the unique properties of the semiconductors (transistors, germanium and silicon diodes and rectifiers) would multiply design possibilities and dictate the production of completely new types of components, accessories and assemblies.

Typical of the new-look components that will be used more widely in '57 because of the semiconductor trend and improvements, too, in miniaturized tubes are leadless ceramic capacitors, encapsulated resistor-capacitor assemblies and print-wire boards.

UNDERScoreD IN EVERY REPORT was the fact that all shops will need a full complement of test equipment and tools to handle the towering assignment for '57.

The tight-area chassis, featured in most of the new equipment, will make it necessary to use instruments and tools that can pinpoint problems and affect repairs in a minimum of time. One type of instrument which, it was said, would become particularly popular for compact chassis work would be the in-circuit component testers, with which it is possible to make assorted checks without disconnecting an army of parts.\* Vital, too, for speed testing will be the new accessory instruments designed to expand the usefulness of sweep generators, scopes and oscillators. For color, new families of test gear have been developed to streamline installation and repair.\*\*

THE MONTHS AHEAD will be the busiest on record for those Service Men who prepare themselves for the big job.—L.W.





## Answers Independent Service Dealers' Questions About "Captive Service"

### What is "Captive Service"?

It is the repair work done by service companies owned by set manufacturers — companies established by them to handle the profitable TV and radio set maintenance on receivers of their own manufacture — work that otherwise would be handled by Independent Service Dealers.

### Will "Captive Service" affect my volume of business as an Independent Service Dealer?

A conservative estimate by service association spokesmen indicates that in 1957 Captive Service Companies could do close to \$250,000,000 worth of TV and radio repair work.

### Does Raytheon compete with me through a "Captive Service" organization?

*No, indeed!* Raytheon does not have a captive TV-Radio service organization — does not now manufacture TV or radio receivers.

*Raytheon believes service is your business — serving you is Raytheon's.*

### How can I compete with the "Captive Service" organizations of big national companies?

Raytheon helps you do this. If you can qualify as a RAYTHEON Bonded ELECTRONIC TECHNICIAN, your service and parts guarantee is backed by a bond — a bond issued through Continental Casualty Company, one of the country's largest insurance companies. Here is real prestige for you. What's more, your work on all makes and models of sets is *bonded*.

### Will becoming a Raytheon Bonded Dealer mean I'll lose my "independence"?

Not at all. You become one of a group of TV-radio technicians known from coast-to-coast as the best in the business, yet you retain your own "independence." The Raytheon Bonded Program is nothing new. It's a proven program Raytheon has provided for more than 11 years — that has successfully helped build premium customer business for Independent "Bonded" Service Dealers. It's Raytheon's investment in your future.

### How does being a Raytheon Bonded Dealer help me compete with "Captive Service" companies?

- (1) Your TV-radio repair service is nationally advertised by Raytheon in TV Guide Magazine.
- (2) Western Union "Operator 25" is retained in 23,000 cities and towns by Raytheon to send customers to Raytheon Bonded Dealers.
- (3) You are *bonded* to service *all* makes and models of sets — a big advantage.

### Will I have other advantages over "Captive Service" organizations?

Yes, you'll be using Raytheon TV and Radio Tubes. They are perfect for your replacement work because Raytheon Tubes are designed to give quality performance in all Television and Radio sets.

### How do I get the whole story on the Raytheon Bonded Program?

Ask your nearest Raytheon Sponsoring Bonded Tube Distributor.

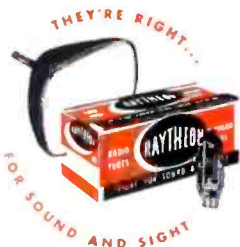

## RAYTHEON MANUFACTURING COMPANY

Receiving and Cathode Ray Tube Operations

Newton, Mass. • Chicago, Ill. • Atlanta, Ga. • Los Angeles, Calif.

Raytheon makes all these { Receiving and Picture Tubes, Reliable Subminiature and Miniature Tubes, Semiconductor Diodes and Transistors, Nuclear Tubes, Microwave Tubes.



# B-W/COLOR-TV VHF Tuner Mixers and

## A Report on the Characteristics Tubes and Circuits Must Have to

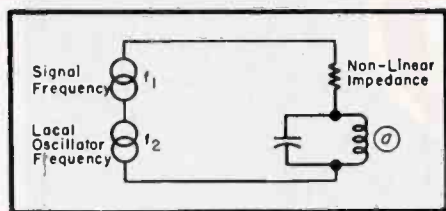

**FIG. 1: EQUIVALENT CIRCUIT** of super-het frequency conversion. Tank circuit (a) is tuned to  $f_2 - f_1$  which equals the if.

THE OPERATION OF A TV TUNER (of other frequency converting device) is based on the principle that a high-frequency signal containing intelligence components can be translated to a different frequency without losing or distorting any of the original signal components. This frequency conversion is accomplished by mixing the original signal with an unmodulated signal (at a different frequency) in a device called a mixer or frequency converter. The output signal of the device contains all of the original signal components, except at a frequency different from that of the original signal containing the same intelligence components. The new frequency to which the original signal has been converted is the frequency at which the TV receiver's high gain, wide-band *if* amplifier operates.

In TV tuners the incoming TV channel signal and local oscillator signal are combined in a non-linear impedance, the mixer stage. Four principal frequency components appear in the plate circuit of the mixer stage (due to frequency mixing). These are: (1) The two original signal frequencies fed into the mixer; (2) incoming TV signal and local oscillator signal; and (3) sum and difference frequencies of the incoming and local oscillator signals.

Since the tuned circuit appearing in the plate circuit of the mixer stage is tuned only to the difference frequency, only this frequency will appear at the output of the mixed stage. The difference frequency is now the desired intermediate frequency and it contains all of the signal components of the original incoming TV signal.

The complete *vlf* tuner usually contains three separate stages; the *rf*

by **WAYNE S. RIAL**

Application Engineer  
Electronic Tube Division  
Westinghouse Electric Corp.

amplifier, mixer and local oscillator stages. The purpose of the mixer is to convert by heterodyne action the incoming signal frequency (which has been amplified by the tuner's *rf* amplifier) to the desired intermediate frequency.

The purpose of the local oscillator stage is to generate an unmodulated signal of large amplitude (compared to the amplitude of the incoming TV signal). This locally-generated frequency combines with the incoming TV signal in the mixer stage so that the output frequency of the mixer becomes the intermediate frequency.

The general requirements for *vlf* tuner mixer stages are: (1) Low noise output; (2) reasonable gain; (3) stability; (4) low grid-to-plate signal feed-through; (5) correct bandwidth over the operating range; (6) linear stage operation; and (7) low *if* reflection.

The general requirements for *vlf* tuner local oscillator stages are: (1) Good frequency stability; (2) constant output amplitude; and (3) sufficient isolation from other stages and tuner antenna terminals.

### Mixers

Present *vlf* tuner tube mixers use plate detection of the applied signals. In the plate-detection system, both signal and local oscillator voltages are applied simultaneously to the tube's control grid and the control grid bias is adjusted to near cutoff. Detection takes place because a full cycle of input signal produces less than a full cycle of output plate current. Mixing action between the incoming signal and the local oscillator signal takes place in the plate-current saturation region of the tube's characteristic

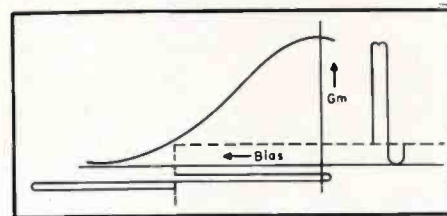

**FIG. 2: CURVE** illustrating the signal-grid transconductance of an amplifier as a function of the local oscillator voltage. This condition would be encountered in present mixer stages.

curve where the curve is quite non-linear. It must be remembered that mixing of two different frequencies can only take place when both signals are applied to a non-linear impedance. (An amplifier's  $G_m - E_v$  curve is quite non-linear near plate-current saturation).

In the plate-detection system the amplitude of the local oscillator voltage is usually large compared to the incoming *rf* signal voltage amplitude. In this way, the proper bias point on the mixer's characteristic curve can easily be established by adjusting the local oscillator output voltage that is applied to the mixer grid. Also, this bias point can be shifted, because present *vlf* tuner mixers used grid-leak biasing for establishing the bias voltage of the mixer stage. If the grid circuit of present mixers is considered the same as the grid circuit of ordinary voltage amplifiers, the signal-grid transconductance (conventional amplifier transconductance) can be assumed to be a function of the local oscillator voltage.

It has been found that maximum detector action for mixer stages takes place when the grid is biased about 50% greater than recommended class A bias. It is desirable that mixers using grid-leak biasing be sharp cutoff tubes. The sharper cutoff the mixer tube has, the less oscillator voltage amplitude would be required for establishing mixer bias; Fig. 2.

Any tube operating as a mixer has some special characteristics over the same tube operating as a conventional voltage amplifier. One of the predominant traits of tubes used as mixers is the tube's low conversion conductance. This conversion conductance is about 25% of the transconductance of the same tube used as

# Local Oscillators

## Produce Maximum Performance

a conventional voltage amplifier. Conversion conductance is the ratio of incremental plate current at the intermediate frequency to the incremental grid voltage at the incoming signal frequency.

Thus, if a tube functioning as a voltage amplifier is operating at 5000  $\mu$ inohs into a 4000-ohm plate-load impedance, the stage voltage gain would be:

$$A_1 = g_m \times Z = 5000 \times 10^{-9} \times 4 \times 10^3 = 20$$

The same tube operating as a mixer into the same plate load would have a stage voltage gain of about:

$$A_2 = g_c \times Z = 1250 \times 10^{-9} \times 4 \times 10^3 = 5$$

Values of mixer-stage voltage gains usually run between two and five in *vhf* tuners. Mixer-stage voltage gain is defined as the ratio of output voltage at the intermediate frequency to input voltage at the incoming signal frequency.

Another characteristic typical of mixer stage operation is high noise output from the mixer tube. Triode and pentode mixers may have four times the noise output compared to the same tubes operating as conventional voltage amplifiers. For this reason, tuner mixer tubes and mixer circuits must be very carefully designed.

The principal reason why multigrad mixer tubes (converters such as the 6BE6) are not used in tuners is because their noise output may be 10 to 20 times the noise output of a pentode mixer. The additional converter noise is due to excessive partition

noise. Another reason why multigrad mixers are not used is because they exhibit excessive conversion instability.

There are two types of tube mixer circuits used in present *vhf* tuners; those using triodes and those using pentodes. Each type of circuit has certain advantages over the other.

The triode mixer has low noise output compared to the pentode mixer. (Mixer noise output is one of the prime considerations for mixer operation). But the pentode mixer has greater conversion gain than the triode circuit. (Conversion gain is the other most important consideration for mixer operation). Also, the triode mixer gives greater stage stability, but has greater grid-to-plate signal feed-through than the pentode stage. Pentodes have the further advantage of lower *if* signal reflection feed-through than do triode mixers.

The circuit for a typical *vhf*-tuner triode-mixer stage might look like that shown in Fig. 3.

It will be noticed that neutralization is not required for triode mixers as it was for tuner triode-amplifiers. This is so because any triode amplifier (which is what a triode mixer stage is) that has its plate circuit tuned to a different frequency than that to which the grid circuit is tuned, does not have the tendency to become unstable, providing the two frequencies are far enough removed from each other. In the case of a *vhf* tuner mixer stage, the mixer tank circuit is only resonant at the intermediate frequency, and no input signal frequencies appear across this tank circuit because the tank circuit looks like

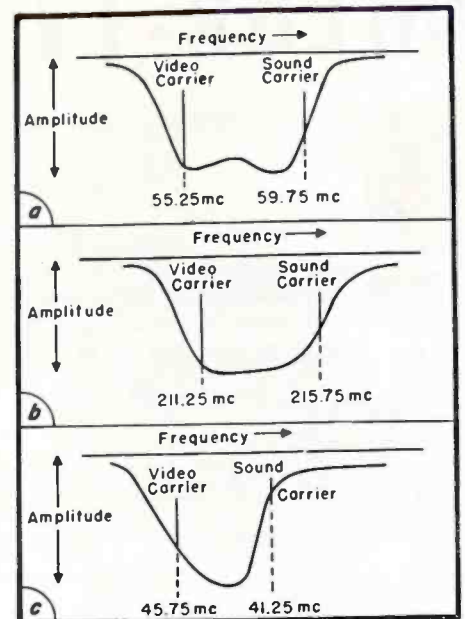

FIG. 5: WAVEFORMS appearing at test points. At a is a typical grid test point alignment waveform on channel 2. A typical grid test point alignment waveform on channel 13 is shown in b. Alignment bandpass waveform appearing at the output of the mixer stage (viewed at the grid of receiver's first *if* amplifier) for a 44 mc *if* is shown in c.

a short circuit to any frequency except the *if*.

The circuit for a typical *vhf*-tuner pentode-mixer stage might look like that shown in Fig. 4.

Many circuit arrangements are possible using either type of tube as a mixer. Among the special circuit considerations is the method of mixer output coupling to the grid of the receiver's first *if* stage, and the method of coupling the local oscillator voltage to the mixer grid circuit.

In mixer tubes, the tube's inter-electrode capacities and lead inductances are critical, as they are in tuner *rf* amplifiers, because the tube's capacities and inductances form a large part of the stage's tuned circuit elements.

Another characteristic peculiar to mixer stages is the *if* reflection factor,

(Continued on page 30)

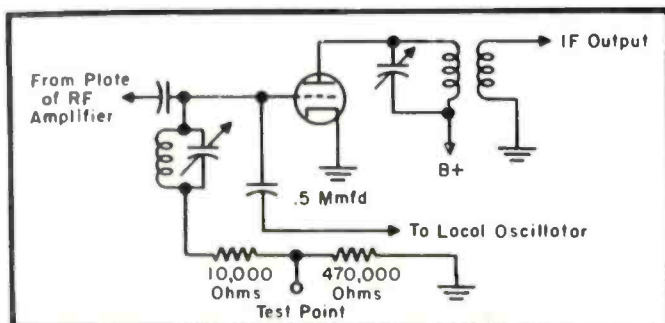

FIG. 3: CIRCUIT for a typical *vhf*-tuner triode-mixer stage.

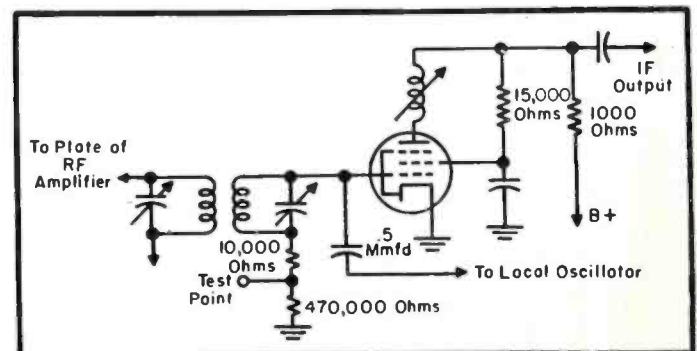

FIG. 4: TYPICAL *vhf*-tuner pentode-mixer stage.

# COLOR-TV Video Generator For Convergence

## Instrument Provides Either Vertical-Bar, Horizontal-Bar, Dot, or Crosshatch-Pattern Output

by RHYS SAMUEL

Tube Division, RCA

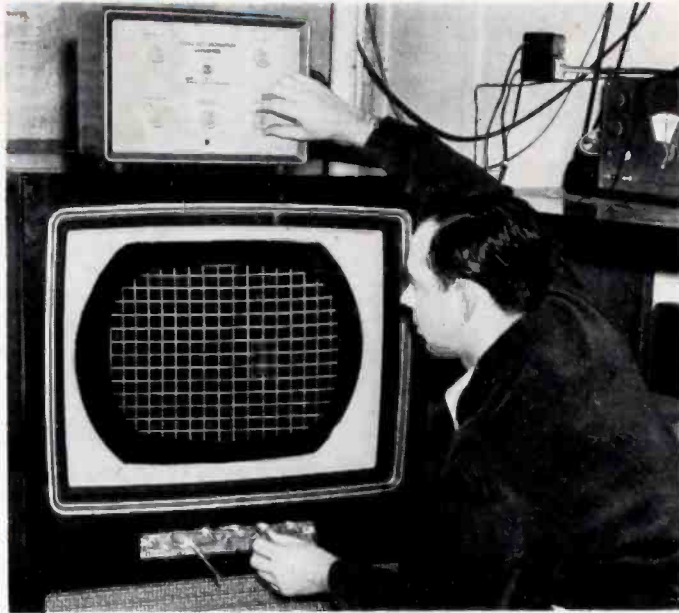

FIG. 1: AUTHOR at controls of color-TV receiver and video generator adjusting for convergence.

WITH COLOR-TV production getting into high gear, manufacturers and Service Men are taking a renewed interest in the special test instruments that are required for color, such as the convergence-pattern generator.

Convergence-pattern generators provide an output signal which will produce a dot, crosshatch, or bar pattern on the picture tube of a color-TV receiver. These patterns enable one to adjust the impingement of the three electron beams in the color picture tube upon the red, green and blue dots on the tube screen. Both *dc* (static) and dynamic convergence adjustments, which require the use of a special pattern, must be checked whenever a color receiver is installed in a customer's home or, occasionally, even when the receiver is moved about or turned to a different direction. Consequently, the convergence generator is a basic color-servicing instrument.

Two types of generators are currently used in making convergence

[ See Front Cover ]

adjustments. One is the *rf*-output type, which provides a signal at one of the *vhf* TV channel frequencies. This signal is modulated by a video-frequency signal, which produces the convergence pattern on the screen of the color picture tube. Because the output is on a TV-channel frequency, the generator output must be fed into the antenna terminals of the TV receiver. The other type of generator provides an output signal which is fed directly into the video-amplifier section of the color-TV receiver or, preferably, directly into the color picture tube at the output from the video amplifier or at the tube socket.

Any dot, bar, or crosshatch generator designed for convergence measurements must meet several definite requirements, if it is to be satisfactory for shop work, service calls, and the installation of new receivers.

In Fig. 4 (and partially on the cover) appears the circuitry of a recently developed video dot/crosshatch generator<sup>o</sup> that provides a choice of vertical-bar, horizontal-bar, dot, or crosshatch patterns on video frequencies. All of these patterns may be required for optimum convergence adjustments on some receivers. The number of dots or bars in a vertical row is adjustable from approximately 10 to 25; the number of horizontal bars is fixed at 15. A brightness-equalizer control is provided to permit adjustment of the brightness ratios between the vertical and horizontal bars. Both + and - outputs are available, and the output leads are *dc* isolated, permitting the signal to be introduced at any point in the video amplifier. In the rear of the instrument are three video-output leads, a sync-pickup lead, and a ground lead; the output leads are color-coded red, green, and blue for connection to the *red*, *green* and *blue*

(Continued on page 12)

<sup>o</sup>RCA WR-46A.

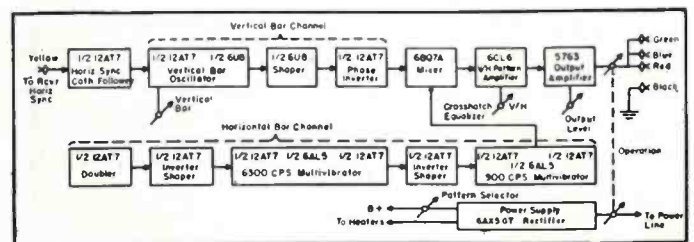
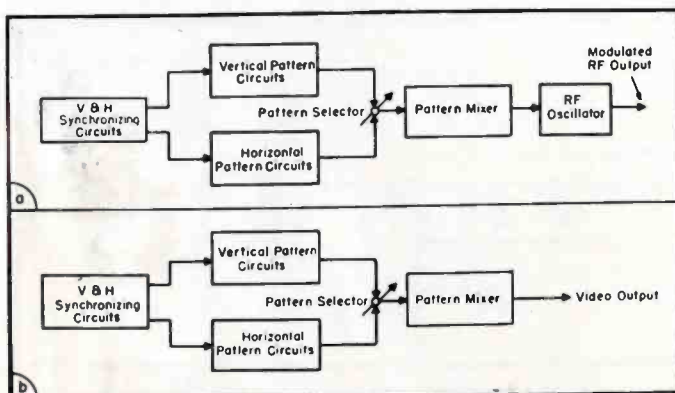

(Left)

FIG. 2: BLOCK DIAGRAMS of *rf*-output convergence generator (a) and video-output convergence generator (b).

(Above)

FIG. 3: BLOCK drawing of video generator. The horizontal sync cathode follower circuit is linked to the 12AT7 doubler.

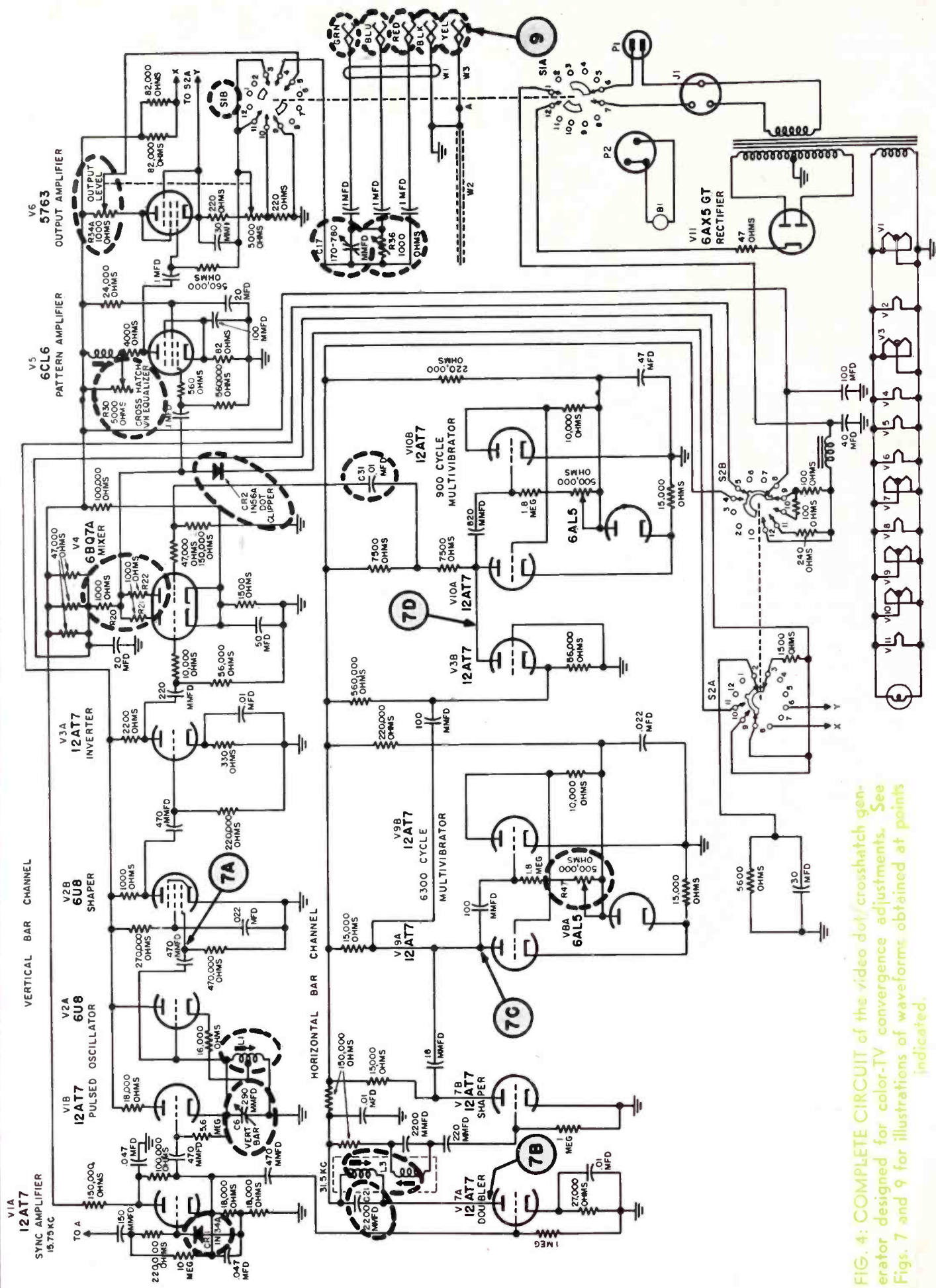

FIG. 4: COMPLETE CIRCUIT of the video dot/crosshatch generator designed for color-TV convergence adjustments. See Figs. 7 and 9 for illustrations of waveforms obtained at points indicated.

# COLOR-TV Video Generator

(Continued from page 10)

grids of the color picture tubes in those receivers which do not utilize the picture tube for matrixing.† The output voltage is properly divided by a network in the generator, so that correct voltage ratios are available at the output leads. In receivers which utilize the picture tube for matrixing††, only one lead need be connected to the common cathode circuit.

## Circuit Analysis

The generator, which utilizes 11 tubes, including the power-supply rectifier, can be divided into five basic sections:

**Synchronizing Section**—This is primarily a cathode-follower input

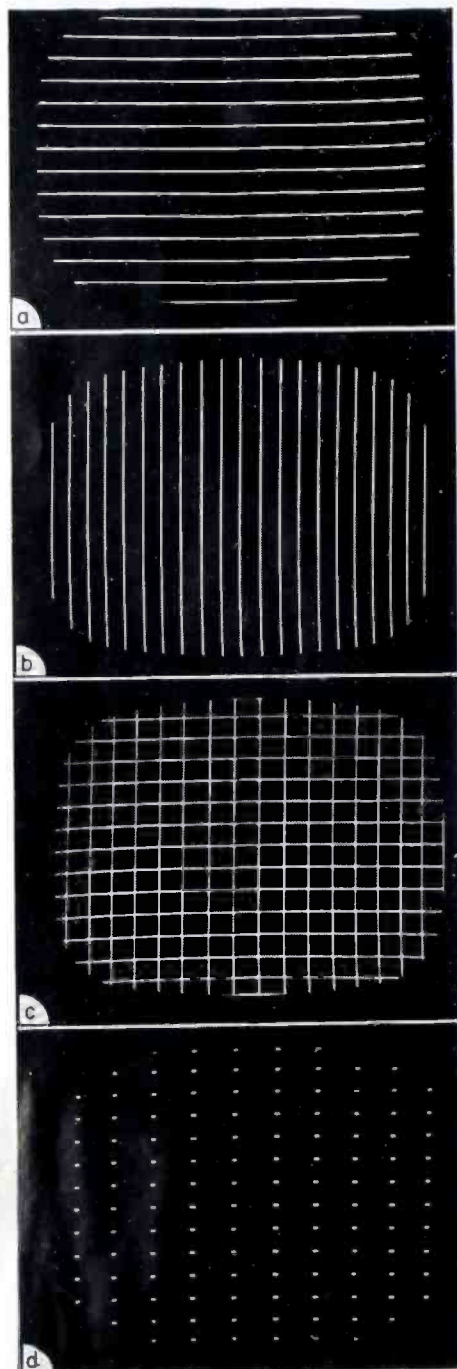

stage into which a horizontal-sync pulse is coupled from a horizontal yoke lead of the receiver.

For best convergence results, the horizontal and vertical sync in the color receiver should be locked together in the normal relationship which exists when the receiver is tuned to a station signal. Unless the sync is locked together, it may not be possible to obtain proper dynamic convergence when receiving a broadcast color picture.

In this video generator<sup>o</sup>, proper synchronization of vertical and horizontal deflection is achieved by first tuning the receiver to a broadcast signal, so as to obtain locked-together vertical and horizontal sync, and then feeding part of the horizontal-sync signal into the instrument. This signal, obtained by clipping the pickup lead across one of the horizontal yoke leads, is capacitively coupled into a 12AT7 sync amplifier,  $V_{1A}$ , serving as a cathode follower. A crystal,  $CR_1$ , serves as a clamping diode to limit the bias which would otherwise be developed at the grid of  $V_{1A}$ . The sync amplifier, in turn, feeds a sync signal of the proper level to both the horizontal- and vertical-bar sections of the generator, assuring that the vertical and horizontal elements of the output signal have the proper sync relationship. The cathode-follower is designed to work over an input signal range of approximately 10 to 80 volts peak-to-peak.

**Vertical-Bar Section**—This section consists of four stages, including a 12AT7 and a 6U8 ( $V_{1B}$  and  $V_{2A}$ ) as a pulsed oscillator, a 6U8 serving as a shaper ( $V_{2B}$ ), and the second half of the 12AT7 ( $V_{3A}$ ) as an inverter; these generate, shape, and amplify the signals which produce the vertical bars and vertical elements in the dot pattern.  $V_{1B}$  and  $V_{2A}$  comprise a ringing-oscillator circuit which is pulsed by the 15,750-cps signal from  $V_{1A}$ . The frequency of this oscillator is determined by a 290-mmfd variable ( $C_6$ ) and a slug-tuned inductor ( $L_1$ ) and can be adjusted from approximately 140 to 410 kc by means of  $C_6$ , so as to produce approximately 10 to 25 vertical bars.

(Continued on page 40)

†Such as the RCA CT-100.

††Such as those models in the RCA CTC-5 and 21-CT-660 series.

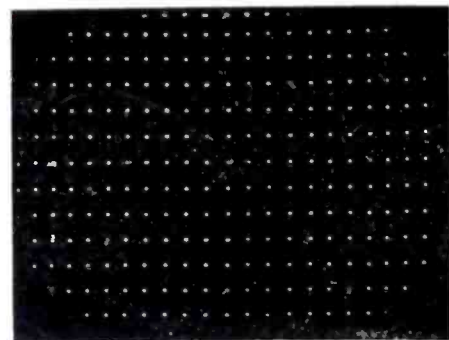

(Above)

FIG. 6: PHOTO of video convergence pattern which illustrates how the pattern permits adjustments while monitoring station signal in background.

(Below)

FIG. 7: WAVESHAPES produced by video generator: (A) = Waveform of signal at output of the 6U8 pulsed oscillator; (B) = resultant waveshape (developed by sync signal from sync amplifier) at pin 1 of the 12AT7 doubler; (C) = waveshape at pin 6 of one-half of 12AT7 ( $V_{3A}$ ), the 6300-cps multivibrator, and (D) = pulse developed by 12AT7 which serves as a cathode-driven amplifier and inverter.

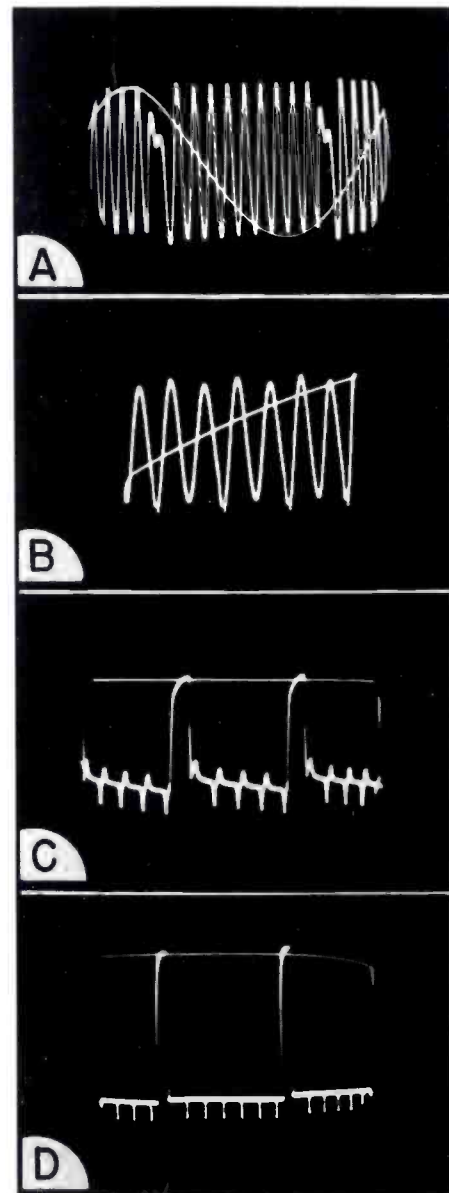

FIG. 5: CONVERGENCE patterns produced by video generator: (a) = horizontal bars; (b) = vertical bars; (c) = crosshatch, and (d) = dots.

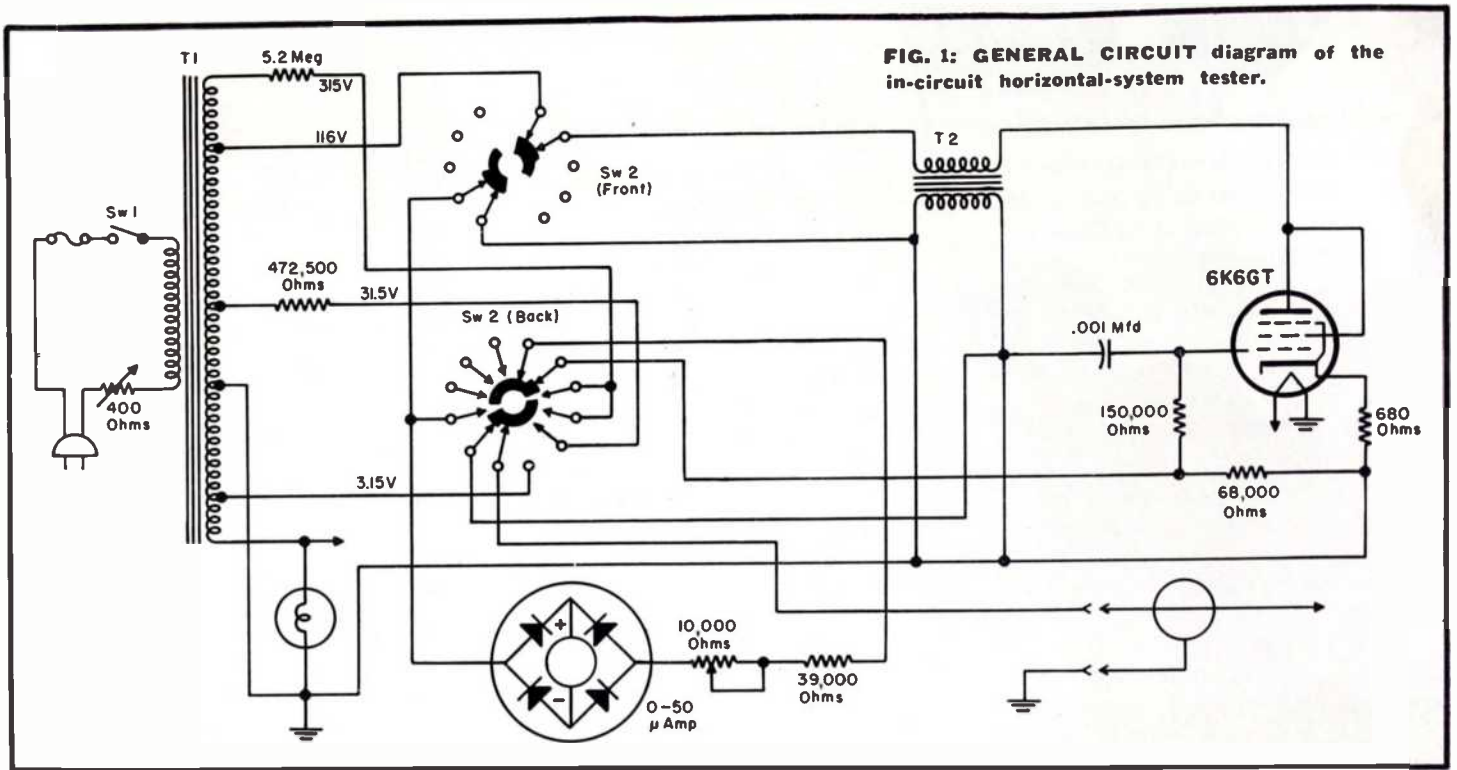

FIG. 1: GENERAL CIRCUIT diagram of the in-circuit horizontal-system tester.

TROUBLE AREAS in flyback transformers or horizontal yokes can be pinpointed, it has been found, by in-circuit checks.

One piece of test equipment,<sup>1</sup> recently designed for this purpose, is illustrated in Fig. 1. In use, the transformer, yoke, or complete horizontal system under test is placed in shunt with the grid circuit of a 1-kc oscillator. The oscillator provides a test voltage in the form of 1-kc bursts spaced at 60-cycle intervals. The level of the oscillator output depends upon the  $Q$  of the grid circuit, and the grid-circuit  $Q$  is, in turn, dependent upon the ratio of reactance to  $ac$  resistance encountered by the test leads; a shorted turn in a winding under test results in a lowered  $Q$ , which reduces the level of the oscillator output.

The oscillator output level is indicated by a 50-microampere meter and instrument-rectifier arrangement, which is tapped down on the oscillator grid leak to minimize the loading imposed by the meter circuit. Use of a full-wave bridge rectifier doubles the deflection which would be obtained with a conventional half-wave and bypass configuration.

This  $Q$ -type short test can be applied in-circuit, with no disconnections other than removal of the plate cap from the horizontal-output tube. To test in-circuit, the *hot* lead from the instrument is clipped to the plate-cap lead of the output tube, and the ground lead is clipped to the receiver chassis; the receiver, of course, must be turned off. When a high-impedance horizontal system is under test,

# In-Circuit Horizontal-System Analyzer To Check Flybacks

by **ROBERT G. MIDDLETON**  
Chief Field Engineer  
Simpson Electric Company

the *good-bad* scale of the meter can be used. A single shorted turn in either the flyback transformer or the horizontal yoke winding will cause the pointer to fall back into the *bad* sector on the meter scale.

Low-impedance horizontal systems require use of the logging scale on the meter. In a low-impedance system, the operating  $Q$  is normally reduced, and hence the *good-bad* scale is not applicable. Instead, a comparative check is required on the logging scale. Once a reference has been established for a given type of low impedance system, the logging-scale reference

can be noted and utilized in future tests of similar systems.

To localize the source of trouble, tests of *individual* components can be made, following the *system* test. For example, the primary, secondary, high-voltage flyback, and horizontal yoke windings can be checked individually for shorted turns. In this manner, a shorted turn or turns can be localized to the transformer or yoke, or to a particular winding on the transformer.

A complete check-out also requires a continuity test, since an open circuit in a winding will pass the shorted-turns test. In this tester an  $ac$  ohmmeter is switched into the circuit to provide this information; it impresses

(Continued on page 30)

FIG. 2: CONFIGURATION of the analyzer's shorts test circuit.

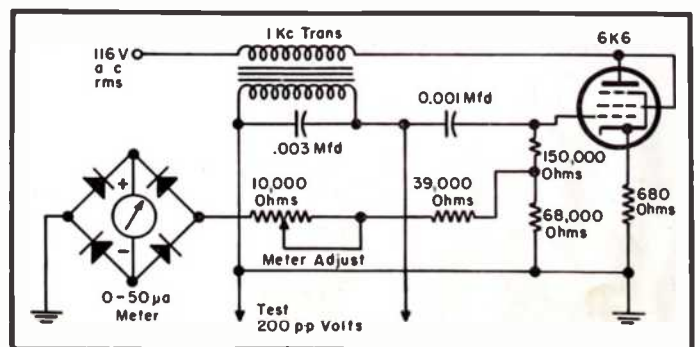

<sup>1</sup>Simpson model 382.

No antennas ever made can match the performance and sales appeal of these outstanding Channel Master models.

**"Showman"** indoor antenna  
models for VHF or VHF-UHF reception

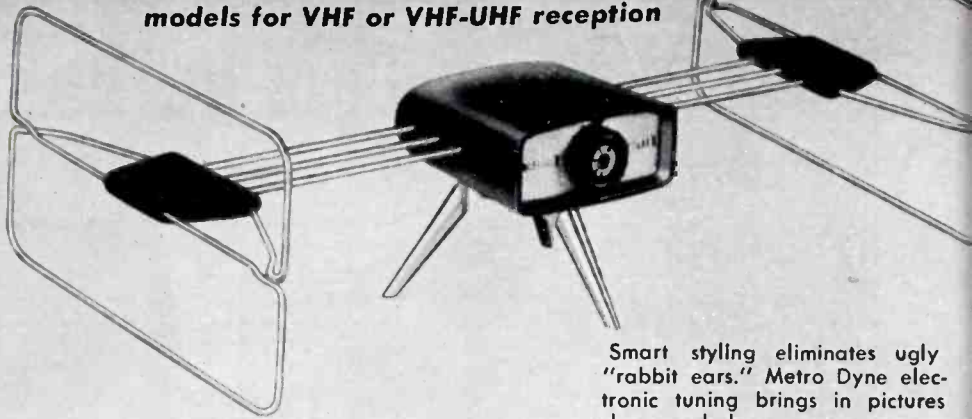

Smart styling eliminates ugly "rabbit ears." Metro Dyne electronic tuning brings in pictures sharp and clear.

**T-W** outdoor antenna

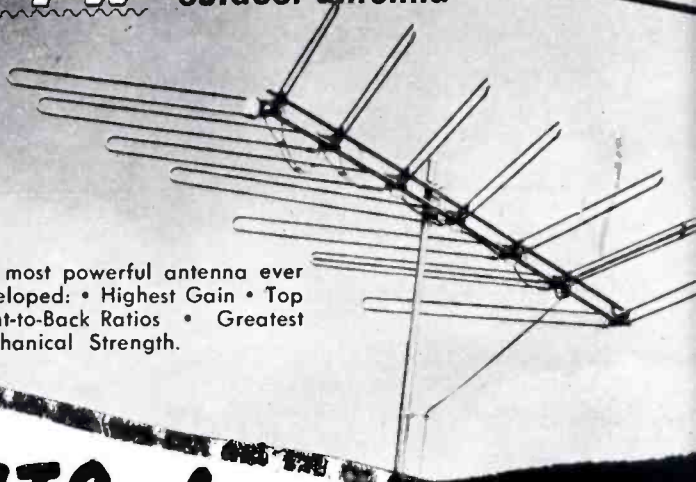

The most powerful antenna ever developed: • Highest Gain • Top Front-to-Back Ratios • Greatest Mechanical Strength.

# MORE PROFITS for CHANNEL MASTER dealers

In every TV reception area Channel Master dealers are racking up new sales records with the most popular TV antennas on the market today. Superior products plus consistent consumer advertising is a double-barrelled profit combination you can't beat. When you feature the Channel Master line you always have that extra selling edge . . . that extra PLUS that means faster turnover . . . easier sales . . . bigger profits.

*Isn't it time you called your Channel Master distributor?*



Channel Master's massive national and local advertising program . . . establishes you as the local TV authority . . . is creating loads of new prospects right in your own selling area . . . and is opening millions of homes to antenna replacement.



# Resistive Line-Voltage Regulators

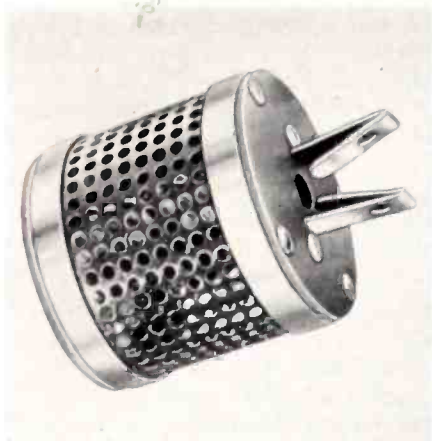

## How To Select Proper Values To Minimize Effect of Line-Voltage Fluctuations

by **GLENN C. HALL**, *ClaroStat Manufacturing Co., Inc.*

FOR A NUMBER of years resistive line-voltage regulators have served as a reliable means of protecting tube filaments and other components not only in *ac-dc* radio receivers, but in TV chassis, too.

This type of regulator is used as a protective device and voltage stabilizer to prevent line voltage fluctuations from burning out tube filaments. Power lines in large rural communities are sometimes heavily loaded during some parts of the day. To maintain a voltage high enough for inductive loads during these heavy load periods, the voltage of the line is set at a high value; it has been known to run as high as 140 volts. If, for any reason, part of the load is removed, an increase in voltage will be applied to other ap-

pliances still connected to the line, due to the reduction of current flow in the line. Resistive line-voltage regulators have been designed to minimize the effects of these fluctuations and give protection to the radio and TV sets with which they are used; for maximum protection they must be properly selected for the load.

Since heat is generated in the regulator when in operation, it must be located so that it does not come in contact with combustible materials, such as, drapes, etc.

Resistive line-voltage regulators obtain their voltage-regulating properties through a resistance change, due to temperature change in the resistance element; with a given load and a given regulator, when voltage is applied, heat is generated

in the resistance element. If the voltage is raised, then the temperature of the regulator element will also rise. This temperature rise is due to the increase in current flow through the element. As the temperature rises in the element the resistance of the element increases, thus increasing the voltage drop across the element. A decrease in the line voltage will decrease the current flow so that the element cools; therefore, we have a smaller drop across the element. These regulators will not under any circumstances deliver to the load a voltage greater than that of the source. They do have a certain amount of ballast action due to the type of wire used in the element. Usually this wire is of nickel alloy,

*(Continued on page 43)*

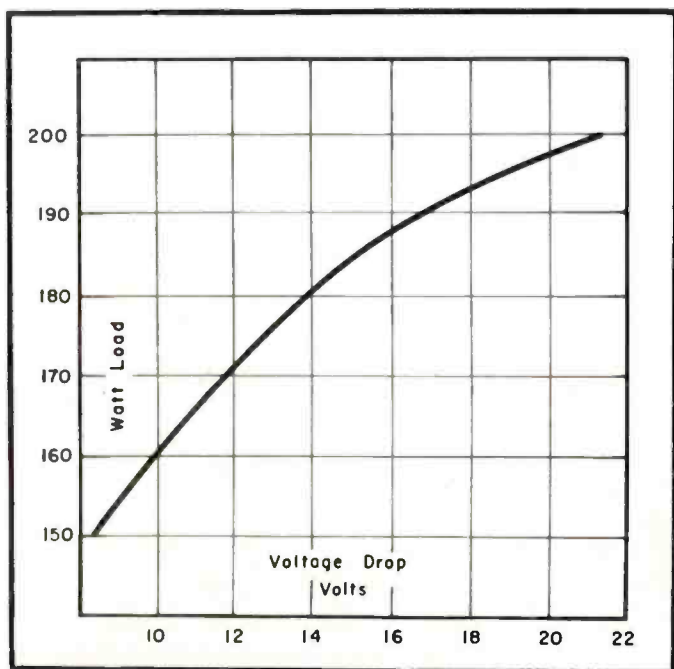

FIG. 1: GRAPH illustrating watt-load versus voltage drop for a 150-200 watt resistive regulator.

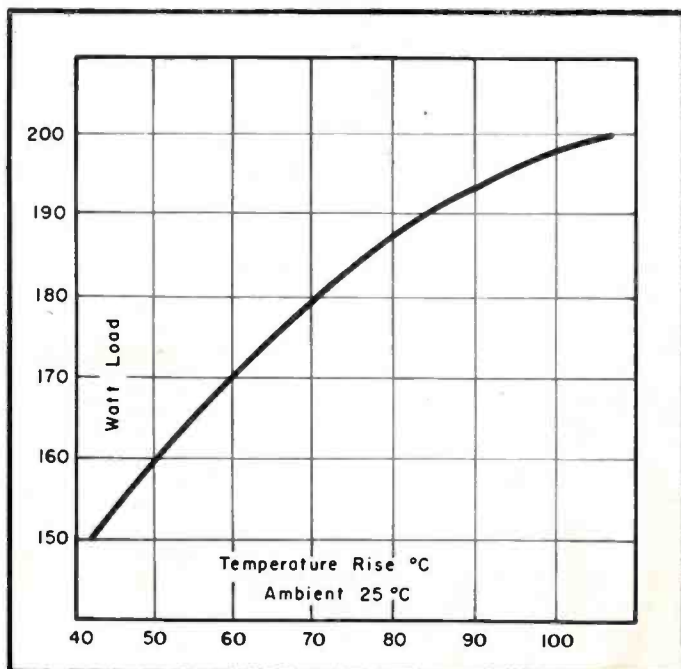
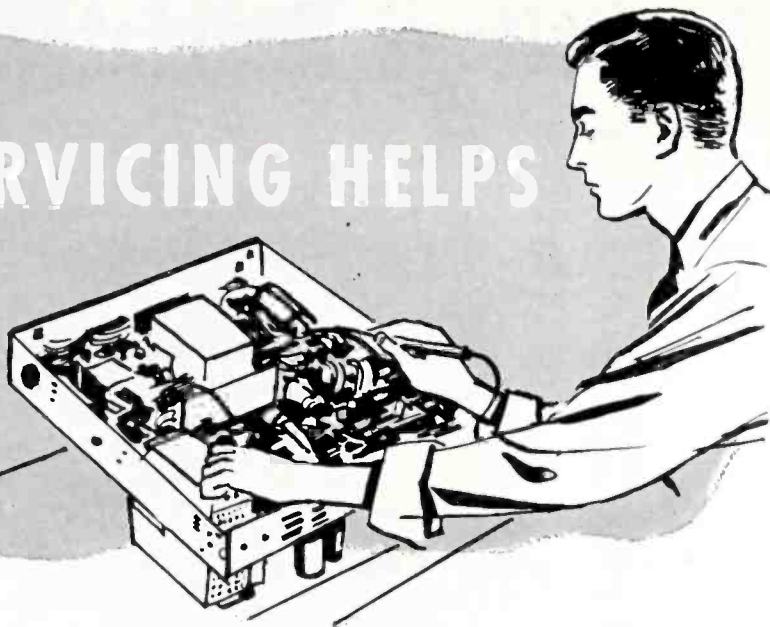

FIG. 2: WATT-LOAD/temperature-rise results obtained when a 150-200 watt resistive regulator is used.

# SERVICING HELPS



## Adjustable Bias Supplies For B-W/Color-TV Receivers<sup>1</sup>... 'Scope Modifications For Alignment Work<sup>2</sup> . . . UHF Tuner Control Precautions . . . Replacing 6AF6 Tubes In Audio Circuits . . . Intercarrier Sound Problem Cures

THE MODERN TV receiver usually employs some form of amplified *agc* applied in different proportions to the *rf* amplifier and the first two of three *if* amplifiers.

It is common to adjust the *agc* voltage dividers so that the *rf* amplifier cuts off completely at a signal level which will provide adequate input to the converter and first *if* amplifier to override the thermal noise generated in these stages. Until this level is reached, the *rf* amplifier is held at maximum gain by means of a clamp diode to obtain the optimum signal-to-noise ratio in this stage. The determination of the correct crossover

point (where the *rf* stage is to be cut off) can be determined by a controlled bias on this stage, followed by adjustment of the clamp diode current and *agc* bleeder to simulate the curve obtained with the bias box.

### IF Overload Problem

The three-stage *if* amplifier presents an overload problem. The three controlled stages have a limited dynamic range and each stage tends to overload at some level of signal, often requiring the inclusion of a local-distance switch in the design.

The receiver can be balanced for optimum large signal response by the following technique: A multiple adjustable bias source should be connected to each of the three *if* stages through 50,000-ohm resistors (bypassed). The signal level should then be increased to the point where the last *if* stage draws grid current, as evidenced by a changed potential at the grid end of the 50,000-ohm resistor. The bias must then be increased at this stage until overload appears at

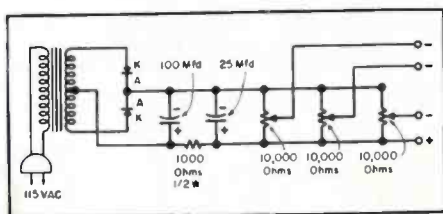

**DIAGRAM** of bias-voltage supply that provides three independently adjustable bias sources, with each variable supplying from 0 to 20 v.

the second stage and not at the last. The same procedure should then be repeated for the second and first stages until the biases are so balanced that simultaneous overload occurs in at least the last two stages. The bias on the last stage (which is not normally on *agc*) can then be replaced by cathode bias and the plate current (and therefore the transconductance) is restored by increasing the screen potential. The plate load of this stage should be as uniform as possible over the band to prevent plate current limiting at some frequencies. This requires tuning to the center of the band, a situation indicated further by the rather low detector load impedance. Since the maximum signal for a given tube lineup is determined by the output capabilities of the last *if* amplifier, there will usually be no problem with grid clipping in the first *if* and the bias of this stage can be the same as that of the second *if*. In some cases, however, it will be desirable to tap these stages to different *agc* potentials, a situation which can be determined by adjustment of the individual controls on the bias supply.

### 'Scopes for Alignment

MOST SERVICE SHOPS have on inventory one or more 'scopes which either are not being used or not being given the use they deserve.

Since high gain and wide bandwidth are not required in a 'scope used exclusively for TV visual alignment work, one can adapt one 'scope specifically for alignment work, make a permanent hookup to the sweep generator and free the wide-band item for the special jobs for which it was designed.

For sweep alignment the 'scope must have good response at 60 cps and provide a good, sharp trace on the face of the tube. Of these two requirements, sharpness of trace is the one most likely to be lacking; this can be improved by increasing the high-voltage supply to the *crt* cathode. A small power transformer can be used

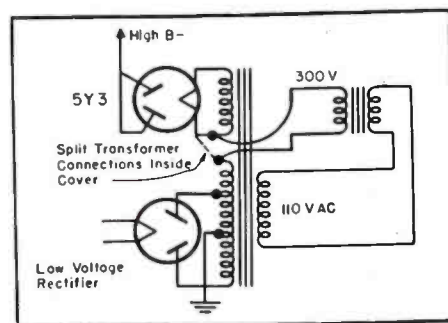

**INCREASED HIGH VOLTAGE** obtained by splitting hv winding inside power transformer and bringing extra leads out to small transformer wired in series.

<sup>1</sup>From a report by Robert Jarmolow, chief engineer, Telenatic Industries, Inc.

<sup>2</sup>From notes prepared by K. Bramham.

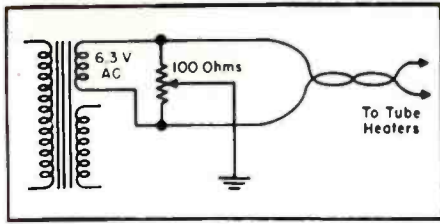

**HUM-LEVEL CONTROL** by lifting tube-heater circuit above ground and inserting potentiometer.

for this purpose, wiring its secondary winding in series with the high-voltage supply; should this result in a decrease rather than an increase in voltage, then the phasing is wrong and the wiring should be reversed. A 900 to 1100-v boost can be achieved to produce a considerably improved trace in most cases.

As the average older type 'scope produces voltages much less than the limits set by the *crt* manufacturer, such a voltage increase will not produce any harmful effects. Too much high voltage will, however, stiffen the electron beam and lower the effective gain of the instrument. Voltage ratings of filter capacitors should be checked, but the type of capacitor usually encountered in these circuits will survive voltages 15% higher than their rated limits for long periods. Should there be room on the chassis to install an extra filter capacitor, then this step should be made; a potential source of hum will thus be removed.

#### Other Sources of Hum

The other major sources of 60-cycle hum are in coupling capacitors and grounded 6.3-v heater circuits. To eliminate hum picked up in vertical-amplifier coupling capacitors a grounded shield should be slipped over the troublesome tube. Hum originating in the heater circuit can often be eliminated by reversing the connections to individual tubes; the power rectifier or first vertical amplifier tube is most likely to be effective. In a more elaborate method of hum control all heater connections can be lifted above ground and a hum level potentiometer installed.

Additions in amplifier gain can be made at the expense of bandwidth by increasing the size of all coupling capacitors in the vertical amplifier circuit. This can be carried a step further by increasing the value of plate load resistance along with each coupling capacitor. An increase in plate load will, of course, result in a drop in plate voltage, unless the supply voltage can be raised by removing the

associated dropping resistor and bypass capacitor.

Increased gain without a step attenuator is of little use, so a single-cathode follower stage with a 3 step attenuator can be introduced for step-up. Although the overall gain of this stage will be less than zero, it does provide a low-impedance input to the first stage of an existing vertical amplifier which can now be modified to provide greater gain.

#### UHF Tuner Operating Precaution

ON THE UHF tuner in Magnavox chassis (type 700530) there is a molded plastic fine tuning shaft and cam. This cam can be rotated approximately 270° to provide proper fine tuning of the three channels covered by each position of the channel selector switch. There are stops on the cam to prevent the shaft from being turned beyond these limits.

*The plastic shaft will break if an attempt is made to force the shaft beyond the stop.* Set owners should be made aware of this to avoid accidental breakage.

#### 6W6 AF Replacements

WHEN SERVICING Bendix T14 series chassis that exhibit what appears to be complex or multiple symptoms, one should always try replacing the 6W6 audio output tube. The 155-v B+ line is regulated and supplied through the cathode of the 6W6 audio output tube. Defects or failures in the 6W6 will affect the line that supplies the video *if*, sound *if*, mixer, video, sync and noise elimination stages. Because of this voltage distribution, a defect in the 6W6 may create a condition that will affect any or all of the above stages.

#### Intercarrier Sound Problems—Cures°

IN INTERCARRIER SOUND chassis the picture and sound carriers are ampli-

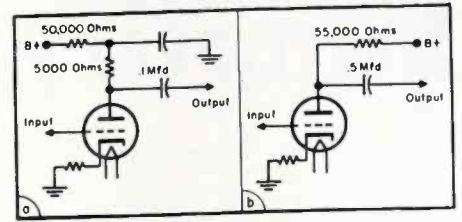

**ORIGINAL 'SCOPE amplifier circuit (a) modified to give greater gain at 60 cps at the expense of higher frequency response (b).**

fied by a common *if* amplifier system.

In addition to the economy offered by this system, there are other advantages that are present in its design. The sensitivity of sound system is excellent and requires only a single pentode to drive the ratio detector. The fact that the 4.5-mc beatnote is determined at the transmitter, makes the beatnote independent of the frequency of the receivers' local oscillator. The effects of drift in the local oscillator are then minimized as the picture carrier can tolerate considerable detuning (approximately  $\pm 250$  kc) without adversely affecting the picture quality. Also, disturbances created by frequency modulation of the local oscillator by hum and microphonics, are not noticeable in the sound reproduction.

The 4.5-mc beatnote is developed in the video detector and represents the *difference* frequency of the picture and the sound carriers. The 4.5-mc beatnote is generally amplified in the video amplifier, together with the video signal before being removed, but depending on the design of the receiver the beatnote may be *taken off* at the detector. The frequency of the 4.5-mc signal varies directly with the intelligence modulated on the sound carrier. This signal is fed to an FM detector and then to a conventional audio amplifier system.

The FM detector has the ability

(Continued on page 19)

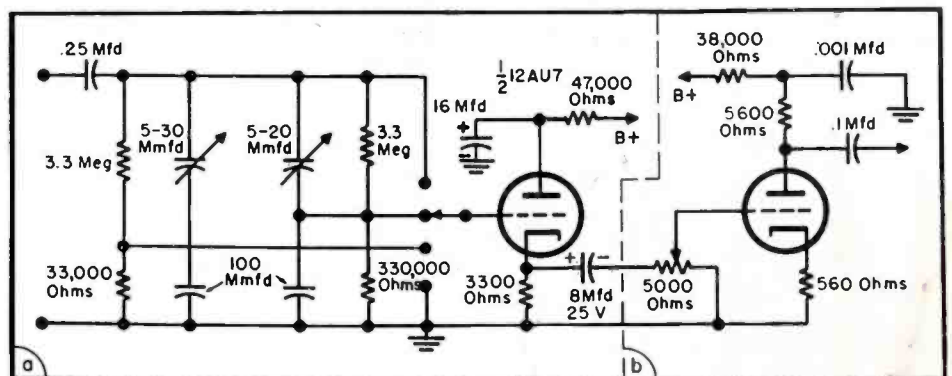

**THREE-STEP ATTENUATOR** and cathode-follower stage designed to give flat response and provide low impedance input to a modified 'scope amplifier.

# Simplify Rectifier Servicing

with *Federal's*  
miniaturized

## HI-DENSITY

Selenium Rectifiers



**JUST 5 TYPES**  
handle 90%  
of all Radio-TV  
replacements!

ACTUAL SIZE  
New vs. Old

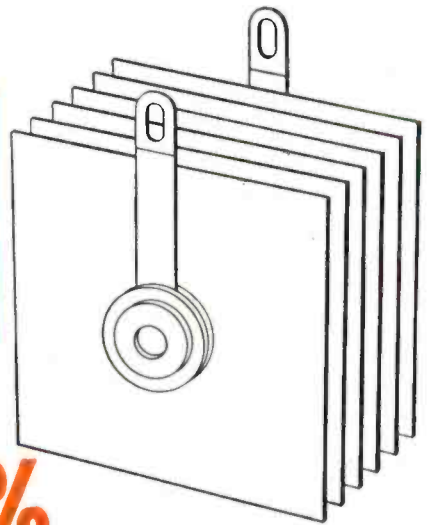
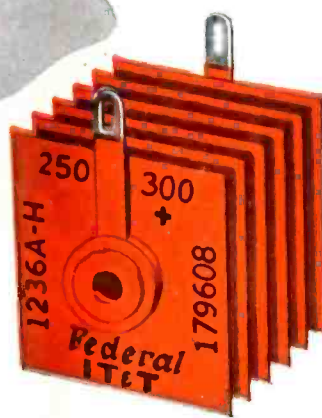

UNIT SIZE REDUCED NEARLY **50%**

—by unique, time-tested production process!

Federal's HI-DENSITY Rectifiers mark one of the most significant advances in miniaturized types since Federal originated them in 1946!

Manufactured by an entirely new, exclusive-with-Federal process, the efficiency, dependability and long life of these lighter, *smaller-plate*, high-temperature rectifiers have been proved-in by the most rugged service testing.

Just 5 types ranging from 65-100 MA to 600 MA handle 9 out of 10 radio-TV replacements.

Call your Federal Distributor today about Federal's specially-processed Hi-Density rectifiers...simplify rectifier servicing...get the same top profits with fewer types and less bother...!

Smaller size permits packaging that saves up to 50% in shelf space:



ONE dozen Hi-Density rectifiers occupy 1/2 the shelf space of one dozen former types!

Now there's no need to carry a big variety of rectifier types to meet today's replacement requirements.

Federal's Hi-Density rectifiers make servicing simpler than ever...save shelf, bench and kit space...save time on calls...make calls more profitable...all with just FIVE types...!

Order Federal's Hi-Density Rectifiers today through your Federal Distributor!

Federal Selenium Rectifiers are listed in Howard W. Sam's Counter-Facts and Photo Facts

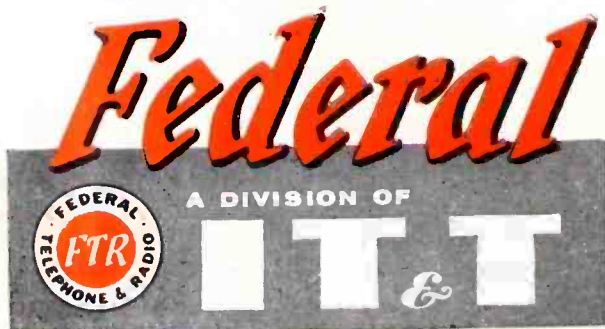

**Federal Telephone and Radio Company**

A Division of INTERNATIONAL TELEPHONE AND TELEGRAPH CORPORATION  
COMPONENTS DIVISION • 100 KINGSLAND ROAD • CLIFTON, N. J.

In Canada: Standard Telephones and Cables Mfg. Co. (Canada) Ltd., Montreal, P. Q.  
Export Distributors: International Standard Electric Corp., 67 Broad St., New York

## Servicing Helps

(Continued from page 17)

to reject AM modulation in certain degrees; therefore, it is necessary to reduce the amplitude modulation to a level that can be satisfactorily rejected by the FM detector. The amplitude modulation of the 4.5-mc beatnote can be caused by the amplitude modulation of the picture carrier. To eliminate this condition, the design of the receiver must be such as to have the sound carrier at least 26 db below the peak picture carrier level at the video detector.

### Sound Carrier Control

With the sound carrier attenuated to this degree, changes in the audio volume will occur when the sound carrier is tuned up and down the slope of the *if* curve, unless a method of control is utilized. This control can be obtained through the use of limiting or an *avc* circuit can be used prior to the signals' detection.

### Causes of Sound Loss

The intercarrier sound system exhibits certain characteristics that are inherent in its design. The sound system is dependent upon the use of both carriers (sound and picture) for the reproduction of the sound. Any disruption of either carrier results in the loss of sound. In early type receivers the picture carrier was not necessary for sound reproduction. Any difficulty at the transmitter resulting in loss of the picture carrier could affect the sound.

### Sync Buzz

Another effect that is not uncommon in intercarrier systems is that of *sync buzz*. *Sync buzz* is not an intended design feature in any receiver, but with malfunctions and misadjustments, it is possible to create this condition. The *sync buzz* is generally caused by the temporary loss of the 4.5-mc beatnote at the vertical sync frequency of 60 cps; when the sound is taken off of the video amplifier plate circuit. This occurs when the video amplifier is overloaded to the point where sync pulses are clipped from the composite signal and interrupts the 4.5-mc beatnote. The signal is also being interrupted at the horizontal frequency of 15,750, but is not generally audible to the human ear.

\*From Bendix Radio service department field engineering notes.



## 5 IMPORTANT REASONS WHY



## IS YOUR BEST BUY IN CONICALS!

Full line to select from; 8 single array antennas, 8 stacked antennas and 8 "Do-It-Yourself" antenna kits.

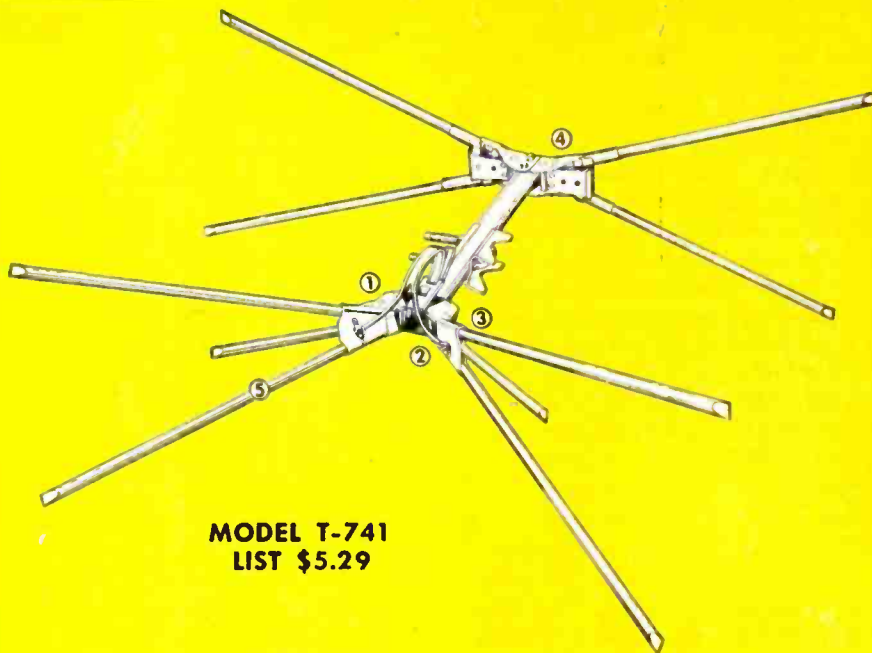

MODEL T-741  
LIST \$5.29

## The Facts Prove It!

### FACT No. 1

Completely pre-assembled. "Presto" Instant Mount Assembly opens antenna as easily and quickly as an umbrella.

### FACT No. 2

New Polyethylene Cable Anchor takes all tension off of terminals, prevents cable from breaking at terminal points.

### FACT No. 3

Front Bracket made of heavy spring temper aluminum alloy with High Q molded plastic insulator.

### FACT No. 4

Rear Bracket is made of heavy gauge aluminum to assure long life and resist heavy ice and strongest gales.

### FACT No. 5

Arrays are full size and of all aluminum construction. Elements are doweled to increase strength and prevent whistling.

The **Tenna** Manufacturing Co.  
CLEVELAND 25, OHIO

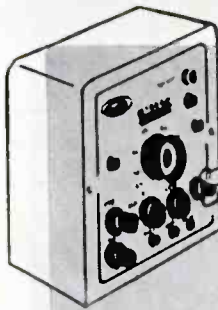

# service engineering

## FIELD AND SHOP NOTES

Industrial . . . Commercial . . . Institutional

Communications . . . Audio . . . Television Installation . . . Maintenance . . . Repair

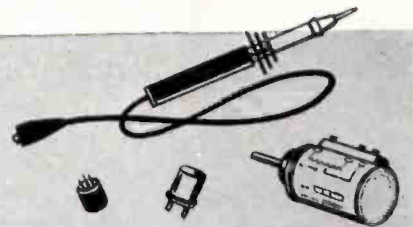

## Maintenance of Communications Equipment in Santa Clara County, Calif.

In 2-WAY SYSTEM operation, maintenance is a vital factor. All equipment must be carefully checked regularly to avoid drop-outs which are not only costly, but dangerous. The 2-way ties must be kept going all the time.

In our area, we maintain an integrated radio-communications network consisting of 22 base radio stations, 220 mobile units and 12 portable two-way radio units, representing a plant investment of about \$250,000. To render this service our parts and tubes stock is replenished on a regular basis, being checked every two weeks.

Maintenance of the base stations and the mobile and portable two-way units is handled by one maintenance center which serves the various communities and county departments on a shared-cost basis. It is possible, therefore, to operate with great efficiency and at the same time do a better maintenance job, than if each department and community made its own arrangements for service.

The shop is equipped with four benches. Test equipment is pooled and is available to all service engineers. Benches are provided with both *ac* and 6 and 12 volts *dc* for operation of radio equipment.

Cross-indexing card file records are kept of each radio unit, whether

by **ROBERT A. MASON**

*Supervisor of Communications  
Santa Clara County, California*

mobile, portable or fixed. Color flags are used to call attention to routine preventive maintenance dates. Entries are made on the file cards each time a piece of equipment is serviced. This procedure permits extracting information on the major causes of failure, tube life, etc.

Mobile units are seldom serviced in the vehicle. Generally, the equipment is removed and is replaced with freshly serviced equipment. All equipment, after servicing, is appropriately tagged and stored on shelves ready for use. Base station equipment is often necessarily serviced at the base station locations.

We employ a standard servicing procedure. The mobile units are inspected, cleaned, realigned and carefully checked for performance. The most frequent service operation involves retrimming of tuned circuits. Testing and replacement of tubes is next.

Tubes are checked carefully in a tester and in the set, since the best test is made under normal operating conditions. To simulate the jostling

encountered in the trunk of an automobile, tubes are vigorously tapped with a small mallet. By careful screening we have been able to get unusually long tube life and in-service failures have been minimized. When a tube has performed 20,000 hours, we throw it out even if tests indicate it to be satisfactory.

We have standardized on one brand of radio equipment so that our spare parts inventory and bench test jig requirements will be at a minimum. Universal interchangeability is, of course, not possible, since all of the equipment is not of the same vintage or identical type.

Materials and supplies are purchased from local parts jobbers who give us excellent service. Our department reviews and recommends purchase of all electronic equipment for the county, even when purchases are made for the account of another county agency.

While our operation is not for profit-making purposes, the independent service shop operator can profit by adopting some of the techniques we use to handle a large volume of work with great efficiency.

Since the inception of the communications department as a function of

*(Continued on page 23)*



**NERVE CENTER** of the communications department of Santa Clara County.

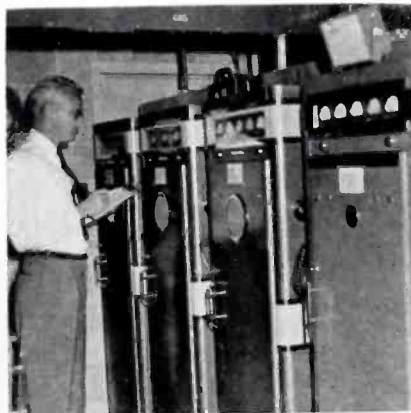

**ROBERT A. MASON** checking the meter readings of bank of transmitters at Santa Clara County communications headquarters.



**CHECKING** tubes on tube testers as well as in the set.

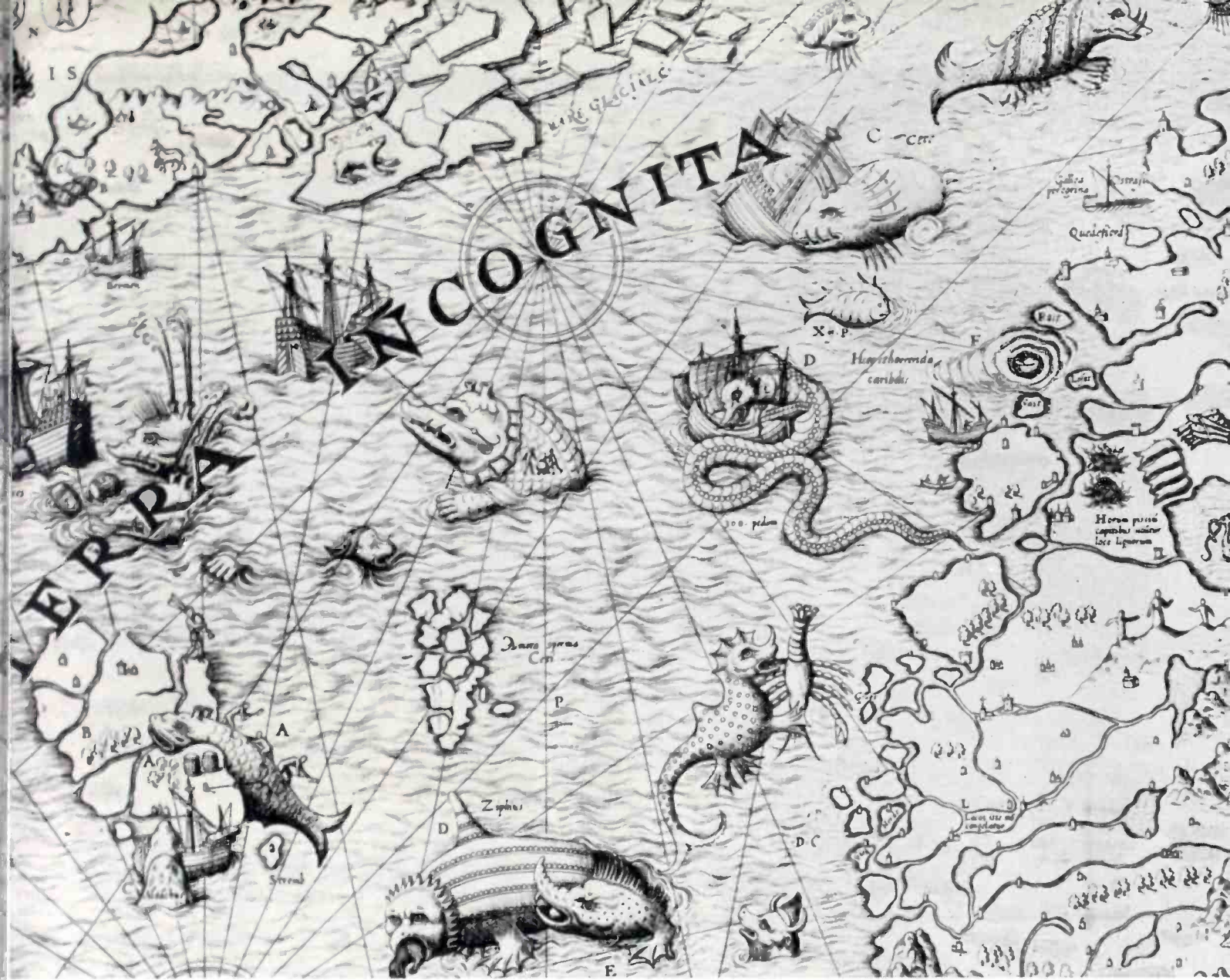

## An UNKNOWN WORLD Awaits Us, Too

TERRA INCOGNITA — the Unknown World. This was the challenge to men of earlier centuries . . . to venture into the mysterious, unexplored regions of the Earth. They met the challenge and found new lands.

While no continents or uncharted seas remain for us to discover, an unknown world awaits us too. The challenge to men of our times is to venture still farther into the unexplored realms of scientific knowledge. Today's scientists are opening new worlds as truly as did Magellan and Columbus. Helping them speed their discoveries are the men who design and build Remington Rand Univac® electronic computing systems. Univac recognizes the importance of the contributions of their engineers and technicians in this new age of discovery. They are important men . . . and Univac treats them accordingly.

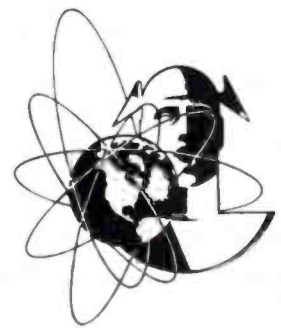

### IMMEDIATE OPENINGS FOR:

**FIELD LOCATION ENGINEERS** with a college degree in a scientific or engineering field and experience in electronics. Extensive electronic background may substitute for some college. Many opportunities for rapid advancement.

**FIELD LOCATION TECHNICIANS** with technical school background and preferably some experience in electronics. These positions can lead to full engineering responsibility.

Send Complete Resumé to

**Remington Rand Univac**

DIVISION OF SPERRY RAND CORPORATION

at any one of these four plant locations

D. A. BOWDOIN  
Dept. PJ-28  
2300 W. Allegheny Ave.  
Philadelphia, Pa.

FRANK KING  
Dept. NJ-28  
Wilson Avenue  
South Norwalk, Conn.

CAL BOSIN  
Dept. YJ-28  
315 Fourth Ave.  
New York City

J. N. WOODBURY, Dept. SJ-28, 1902 W. Minnehaha Ave., St. Paul W4, Minn.

# SHOW ANY PICTURE or PATTERN

at any time — ON ANY TV SET

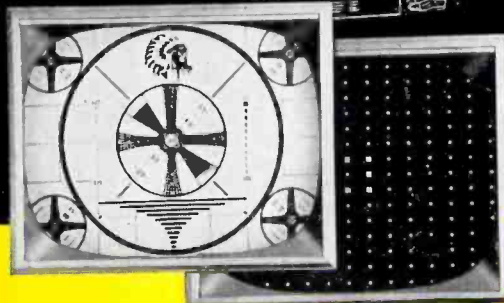

### For Both Black & White and Color TV

Provides standard Indian Head Test Pattern for proper TV set alignment, and stable White Dot and White Line Patterns for color convergence adjustments.

### For Merchandising & Industrial Uses

Provides closed circuit TV system. Transmits pictures or messages for advertising, educational and commercial visual communication.

MODEL 1000



# DYNA-SCAN PICTURE AND PATTERN VIDEO GENERATOR

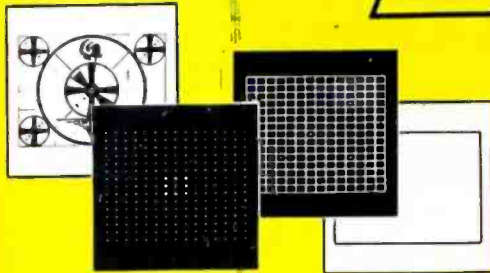

### 3 TEST PATTERN TRANSPARENCIES AND ONE CLEAR ACETATE SUPPLIED

- 1 Indian Head Test Pattern
- 2 White Dot Pattern
- 3 White Line Crosshatch Pattern

These are broadcast-quality transparencies, and assure accurate, high-definition TV images. You can also transmit your own transparencies of any subject you wish. The clear acetate can be used for special messages. Extra transparencies and acetate available.

Make the most of this *Complete Flying Spot Scanner*. It produces a composite video and sync signal that operates any standard black & white or color TV receiver. Can be used with one or more TV sets or fed into a master antenna system or community antenna system. Maximum resolution capability is well in excess of 450 lines; band width in excess of 5 mc. Projects and reproduces pattern or picture with high definition from any slide transparency. Transmits messages typed or written on clear acetate. Makes convenient stand-by and break-in for community distribution operation. Rugged, compact, portable, and ready to operate. **NET \$199.95**

See your B&K Distributor, or Write for Bulletin No. 1000-S

**B & K MANUFACTURING CO.**

3726 N. SOUTHPORT AVENUE · CHICAGO 13, ILL.



Model 950 Dyna-Scan Pickup and RF Generator only. Enables you to make your own picture and pattern video generator, at a saving. Supplied with three test pattern transparencies and one clear acetate. Net, \$69.95



Model 500 DYNA-QUIK  
Dynamic mutual conductance tube tester. Accurately tests tubes faster. Net, \$109.95



Model 400 CRT  
Cathode Rejuvenator Tester. Tests and repairs TV picture tubes. Net, \$54.95



Model 750 CALIBRATOR  
Designed to check and adjust test instruments with laboratory accuracy. Net, \$54.95



## Service Engineering

(Continued from page 20)

county government in 1948, its operation has been aimed towards four objectives:

- (1) To provide a system where the latest techniques of communications equipment and operations can be applied to the using agencies, so as to increase its effectiveness by providing better service and better use of its manpower.
- (2) To provide a means where governmental agencies within the county may coordinate themselves efficiently and effectively, deriving the benefits of a single entity, without the loss of identity of the individual agencies.
- (3) To provide a central intelligence and information center for the reception and dissemination of emergency information including geographical locations, jurisdictional boundaries, etc.
- (4) To provide an economical means wherein centralized emergency telephone answering and dispatching service can be made available to governmental agencies, without the duplication of manpower necessary for such service if it was provided on an individual agency basis.

The major function of the department is the operation of a county-wide coordinated radio system embracing police, fire, and other public safety agencies. From '48 to '52, normal expansion of the system took place in line with departments making use of a new service. Since that time the rapid expansion of the county has caused a similar rapid expansion of our services.

The Saratoga and Milpitas fire districts, the Mt. View, Los Gatos, Sunnyvale and Stanford University fire departments have been added to the system, as have units in the County Fire Marshal's Office and the California Division of Forestry. The fire system now covers every fire agency within the county with the exception of Gilroy, city and rural, and the cities of Morgan Hill and Campbell. In the law enforcement system we have added the police departments of Milpitas, Campbell and Los Altos and will very shortly add the City of Alviso, establishing 100% coordination of law enforcement agencies within the county.

In '53 a complete radio system was engineered for the county engineer's office to provide communications be-

(Continued on page 26)

... another  
**MALLORY**  
service-engineered  
product

New, long lasting switch  
with "floating rings"\*

stops  
control job  
call-backs

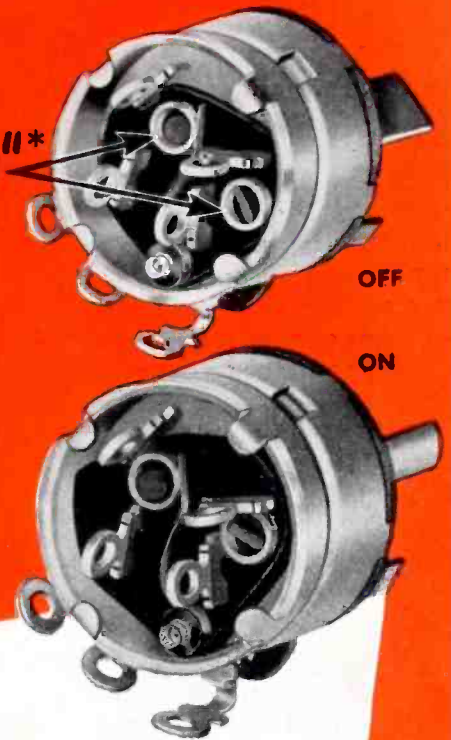

There's something new on Mallory volume controls—a line switch with unique contact action. Make and break is accomplished by spring-snapped motion of "floating" rings of special Mallory contact alloy. Rings rotate with each switch operation . . . presenting a constantly changing contact surface . . . providing these performance extras:

**Far Longer Life** . . . cleaner make and break . . . less wear and arc erosion.

**Overload-proof** . . . Snap spring carries no current . . . won't soften when overloads occur.

**Positive snap action "feel"** . . . with minimum torque.

These extra features come at no extra cost to you. On your next replacement job . . . insist on Mallory controls with these new switches . . . put extra value into every control replacement!

\*Patent applied for

P. R. MALLORY & CO. Inc.  
**MALLORY**

P. R. MALLORY & CO. Inc., INDIANAPOLIS 6, INDIANA

- Capacitors
- Controls
- Vibrators
- Switches
- Resistors
- Rectifiers
- Power Supplies
- Filters
- Mercury and Zinc-Carbon Batteries

# THIS MONTH IN SERVICE

FCC SEES NEED FOR COMPLETE OVERHAUL OF ALL ALLOCATIONS--The mounting pressure for more bands by broadcasters and commercial agencies has become so acute, the FCC reported recently, that it may become necessary to revise the entire allocation structure. . . Commenting on this situation in their annual report to Congress, the Commission said that there are many existing. . . "safety and special radio services who are bursting at the seams and seek additional frequency space." . . . Included in this category are those engaged in manufacturing, distributing and servicing; in construction and building supply operations; and in other commercial pursuits. . . In addition, the report added, many of these interests, to the inclusion of stores and banks, are clamoring for their own microwave systems, frequencies for which are in short supply because of priority consideration to the public safety services, such as police, fire and the public utilities. . . In the common carrier field, too, it was noted, there is urge for more elbow room for such radiotelephone operations as long-haul microwave relays and the short-haul point-to-point services. . . Reviewing the broadcast problem, the FCC said that the AM band is, generally speaking, so crowded that only local daytime stations, for the most part, are now able to shoehorn in. The veryhigh portion of the TV bands was described as practically used up in populous areas, with the only room for national expansion being in the uhf range.

ASSORTED SUGGESTIONS to resolve the problem have been posed by industry and members of the Commission. Recently, one of the FCC experts offered a plan which would add another 25 vhf TV stations to a number of markets where only two veryhigh stations now exist. . . It was emphasized that the project would require voluntary shifts of some v stations to meet current standards. . . Existing mileage separations would be respected to allow for the future use of the ultrahighs. . . Nearly everyone in the Commission's office has declared that they favor the eventual use of the u bands for more stations and believe that practically all TV sets will soon be of the all-band variety.

NATIONWIDE 110° TV CHASSIS SERVICE CLINICS SET UP--Approximately 300 service clinics, featuring talks and demonstrations on 110° magnetic-deflection TV receivers, will be held soon under the sponsorship of a leading tube and set maker. . . The clinics, set up in cooperation with distributors in franchised territories, will be conducted by the manufacturer's district service managers and distributor service personnel. . . A total of about 10,000 Service Men are expected to attend the meetings.

CLOSED-CIRCUIT TV/INTERCOM SYSTEM ADOPTED FOR OUTDOOR BANKING--A closed-circuit TV, electric-eye traffic control and two-way intercom system is now in operation in a drive-in bank in Chicago. . . The electric eye serves to control a car turntable: As a customer's car is driven onto the table an electric eye is triggered and traffic lights flash. As traffic clears, the table automatically begins to move and continues until the car is in a customer lane. . . Overhead lights disclose windows in operation. . . Customer and teller converse through a two-way speaker and signatures are checked on a TV receiver mounted in the cage and connected by cable to a camera at the bank's main signature file.

FRSAP REELECTS BREGENZER--Bert Bregenzler has been reelected to his third term as president of the Federation of Radio Servicemen's Association of Pennsylvania. . . Dave Krantz is now vice-prexy of the group, and Leon Helk continues as corresponding secretary.

PHILADELPHIA COUNCIL TO HOLD THREE-DAY MEETING IN ATLANTIC CITY--The Council of Radio and Television Service Associations, headquartered in Philadelphia, has announced that it will hold a three-day conference, April 12-14, at the Ritz-Carlton Hotel in Atlantic City.

# Eliminate unsightly top-of-the-set indoor TV antennas

WITH THE FABULOUS



## Magic Genie

THE CONCEALED INDOOR ANTENNA THAT GIVES YOU OUTDOOR ANTENNA RECEPTION!

this is all you see on top of your TV

1. The Magic Genie conceals behind the set—does not clutter up TV cabinet tops—beautifies room decor.
2. The Magic Genie is the first indoor antenna to utilize a printed circuit.
3. The Magic Genie ball-joint action provides complete all-angle adjustability for finest reception of signals from any direction—in black and white and color.\*
4. The Magic Genie will pull in VHF and UHF stations never before possible with any indoor antenna.
5. The Magic Genie attaches easily and securely to the back of any set—all you see is the golden jewel-like 12-position selector dial.
6. The Magic Genie wipes out snow, ghost and interference on all channels.
7. The Magic Genie is unconditionally guaranteed to perform better than any other indoor antenna in any location.

only  
**\$14.95**

the magic is hidden in the Printed Circuit "Clarifier" that is concealed behind the set



SEE YOUR JFD PARTS DISTRIBUTOR



WORLD'S LARGEST MANUFACTURER OF TELEVISION ANTENNAS

ELECTRONICS INC., BROOKLYN 4, N. Y.

pioneers in electronics since 1929

INSTALLS BEHIND SET

the magic is hidden in the  
*Magic Genie*  
Printed Circuit  
"Clarifier"—



an exclusive electronic miracle!

TEAR OFF AND DISCARD BEFORE MOUNTING MAGIC GENIE

## Service Engineering

(Continued from page 23)

tween the field forces in both the engineering and road maintenance aspects. Since that time the Parks and Recreation Department, as well as the county executive office have become part of this system, and the Building Inspector's Department will be added shortly.

We have expanded our telephone answering and dispatching service from its origin with the Los Gatos Police Department and the Central Fire District to now encompass seven law enforcement agencies, four fire departments and the engineer's office. Through this we have eliminated duplication of manpower in twelve separate agencies, either on a 16 or 24 hour a day basis. In conjunction with this, a new master street index file listing every named street, road, and even driveway within the county has been established. At present there are over 6,000 entries in the file, used on an average of 30 to 50 times a day.

The expansion of our services to the various agencies described has made a similar expansion of the facilities and work load of the technical division in installing and maintaining communications equipment used by these and other agencies. Engineering analysis and installation was made on sound reinforcement systems for the Sunnyvale City Council Chambers, the County Hospital, where a complete paging system was installed, and the county fairgrounds. At the fairgrounds, there are approximately 50 public address systems which are maintained by our department. We engineered and installed major sound systems in an exposition hall, the horse barn area, and the Swine and Sheep Building. Intercom systems have been engineered and installed in the new west side Corporation Yard and the William F. James Boys' Ranch.

Department administrators have made many detailed studies of the latest methods of communication systems operation and administration resulting in a new and time saving method for logging radio traffic. A revised radio numbering identification system was developed and placed in operation and has now been adopted by the San Joaquin County Fire Department and the Marin County Communications system.

Many of our accomplishments during these years cannot be measured or shown in either monetary cost or in any other terms. If, through the prompt action of our dispatchers, a rescuator is dispatched and a child's life is saved; a dangerous criminal is apprehended through the coordination of the system; a home is saved from fire loss by our exact dispatching of fire equipment; how can you measure these in terms of worth or accomplishment? Underlying our whole operation are these intangible factors which provide the citizens of Santa Clara county with another tool in the overall protection of life and property.

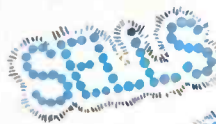
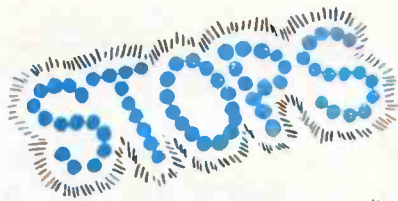

Thousands of dealers have increased their sales of two set couplers with this beautiful AMPHENOL Telecoupler display. They are reaping *plus* profits from the growing second set market in TV, black & white and color.

Don't let plus profits escape you!  
See your AMPHENOL Distributor!

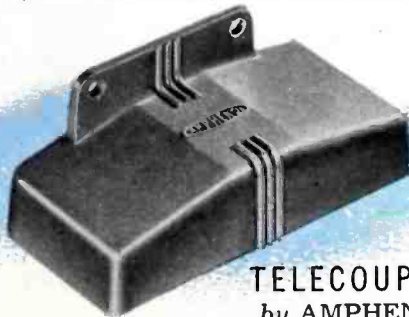

TELECOUPLER  
by AMPHENOL



AMPHENOL ELECTRONICS CORPORATION

# COLOR-TV Picture-Tube Adjustments\*

by JOHN T. JANS

Applications Engineer

TV Picture-Tube Division, Sylvania Electric Products, Inc.

DYNAMIC CONVERGENCE is necessary to converge all three colors over the face of the tube instead of just at the center. The need for dynamic convergence is illustrated in Fig. 1. If the picture tube face and mask were spherical with a center at the deflection center, no such need would exist, but a picture tube face of that shape would be impractical.

Dynamic convergence adjustments can be made with a dot or crosshatch pattern on the picture tube. The dynamic convergence is accomplished by passing a parabolic current wave through a coil having the same core and magnetic path as the static convergence magnet. Parabolic currents of both the horizontal and vertical frequencies are supplied, variable in amplitude to about 10-ma peak-to-peak and in shape from a sawtooth to a parabola. The coils should be of an impedance whereby the field they produce will move the spots about  $\frac{1}{4}$ ".

Dynamic convergence requires adjustment of the horizontal size and shape controls for all three colors, and then the vertical size and shape controls for all three colors. The dots need not be made to overlap each other, but only to have the same position relative to each other over the entire screen. The static convergence magnets can then be used to overlap all spots perfectly. After static and dynamic convergence correction, all colors of all the dots in the dot pattern should overlap within less than  $\frac{1}{16}$ " over the entire screen face. This adjustment requires considerable practice and patience, but it can be done with the convergence components, tubes and circuits now available<sup>1</sup>.

After convergence and purity adjustments have been made, the remaining impure color patches along the edge of the picture can be improved by adjusting the rim magnets. These magnets are fastened around the face of the color tube and create a field that causes the beam to move about on the screen face in the area near the magnet.

A field neutralizing coil is sometimes used in place of or in conjunction with the rim magnets. This coil creates a field parallel to the axis of the tube around the edge of the tube, which causes the beams to shift on the dots in a manner shown in Fig. 2 (p. 45). The field-neutralizing coil is controlled by a pot that varies the dc through it both in polarity and amount. On new model color receivers the field-neutralizing coil has been eliminated.

The yoke position, purity, rim magnet, and field-neutralizing coil adjustment should be checked on all three (red, green and blue) colors, so that each field is pure in itself and, when all three colors are added to make a white field, it should be a pure white. Sometimes a slight adjustment of the rim magnet can improve the white

(Continued on page 45)

\*Initial installment of this report appeared in December, 1956, SERVICE.

<sup>1</sup>See Ken Kleidon convergence-adjustment report in October, 1956, SERVICE, which describes one step-by-step approach.

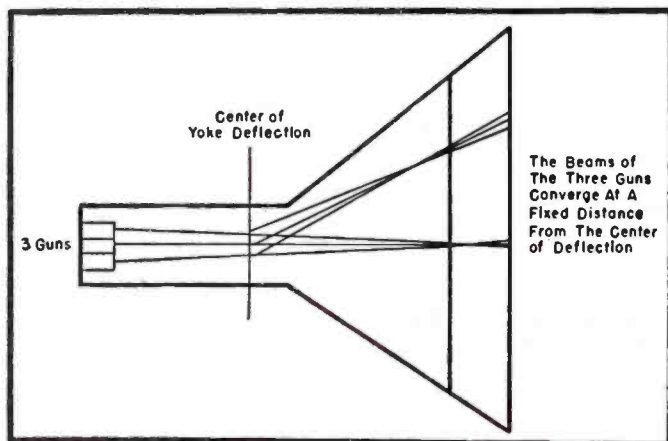

FIG. 1: NEED FOR dynamic convergence is illustrated in this drawing. Because the distance from the center of deflection to the screen is not constant, the beam convergence must vary as the beam moves over the face of the screen.

# 100,000 OHMS per VOLT

SELF SHIELDED

33 RANGES

RUGGED CORE MAGNET MOVEMENT



Simpson model 269

AC-DC VOLT-OHM-MICROAMMETER

BIG 7" SCALE

ADJUST-A-VUE HANDLE

If you've been running into tests that are difficult to handle with an ordinary VOM, Simpson's Model 269 is the answer. It can replace VTVM's for many voltage and resistance checks; takes readings in stray magnetic fields because it is self shielded; and speeds up testing in general! Ranges—

DC VOLTS: 1.6, 8, 40, 160, 400, 1600, 4000 . . . 100,000 ohms per volt.

AC VOLTS: 3, 8, 40, 160, 800 . . . 5000 ohms per volt.

AF OUTPUT VOLTAGE: 3, 8, 40, 160 volts.

VOLUME LEVEL IN DECIBELS: -12 to +45.5 DB in 4 ranges.

DC RESISTANCE: 0-2K ohms (18 ohms center); 0-20K ohms (180 ohms center); 0-200K ohms (1800 ohms center); 0-2 megohms (18K ohms center); 0-20 megohms (180K ohms center); 0-200 megohms (1.8 megohms center).

DC CURRENT: 0-16, 0-160 ua; 0-1.6, 0-16, 0-160 ma; 0-1.6, 0-16a. With leads and Operator's Manual . . . . . \$8800

SIMPSON MODEL 262 AC-DC Volt-Ohm-Milliammeter Similar to Model 269, but 20,000 ohms per volt DC. With Manual . . . \$5950



At Electronic Parts Distributors

SIMPSON Electric Company

WORLD'S LARGEST MANUFACTURER OF ELECTRONIC TEST EQUIPMENT

5200 W. Kinzie St., Chicago 44, Illinois Phone: EStebrook 9-1121

In Canada: Bach-Simpson Ltd., London, Ont.

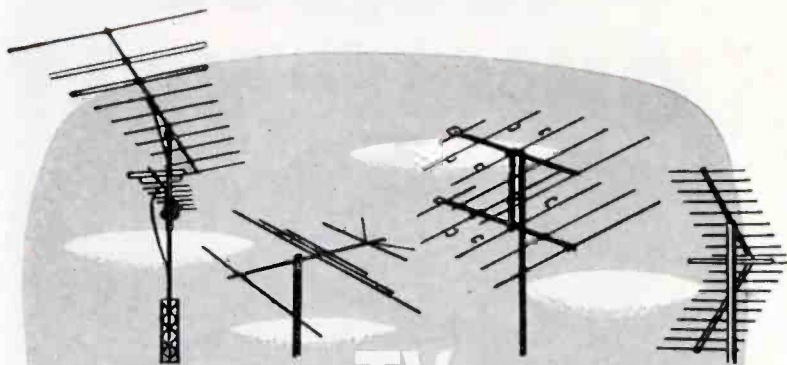

# UHF-VHF TV ANTENNA DIGEST

DESIGN • APPLICATION • INSTALLATION • SERVICE



**INSTALLING A TV-set coupler on antenna mast.**

**CLOSEUP OF antenna-mast coupler installation.**

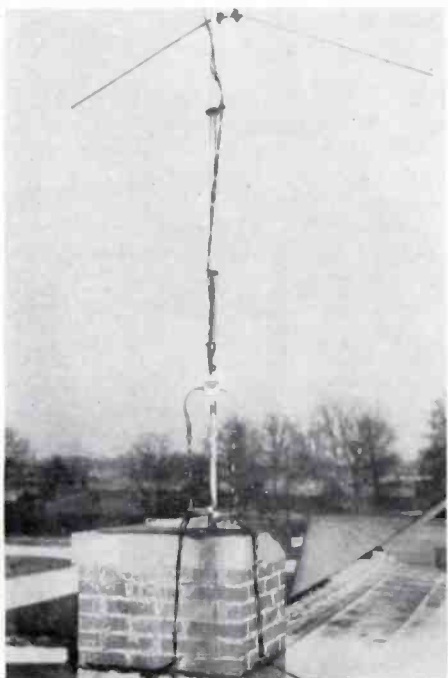

## Rooftop TV-Antenna-Mast Multiple Set-Coupler Installations

THE GROWING MARKET for two or more TV sets has opened up entirely new avenues for the sale of accessories, such as multiple-set couplers, necessary for the efficient operation of these second sets.

In coupler installations there is always the problem of the particular location for the items, that will afford best results.

It has been found that couplers mounted on the antenna mast usually provide improved performance because of balanced lines and the absence of the stubbing effect. We are all aware of the standing waves on an antenna lead. When a coupler is located close to one set and at a greater distance from the second set, the length of the shorter lead can affect set performance.

For example, if the short lead is 3' in length, there may be good picture clarity on channels 9 and 5, but at the same time, channels 2 and 7 may have weaker pictures. If the short antenna lead is increased to 3' 4", the reverse may be true of 9 and 5 having poor pictures, with 2 and 7 having good pictures. It is practically impossible to cut the antenna lead exactly to the right spot so that all stations on the set serviced by this short lead will have equal input. However, if the leads are of equal

length or approximately equal length, with both coming from the antenna mast, the foregoing difficulties can be resolved.

With the installation of a coupler on the antenna mast or any outdoor location, there is the problem of moisture in the form of condensation or leakage into the coupler, resulting in corrosion; a condition that can be particularly severe in locations near salt water. To eliminate this potential source of trouble, weatherproof, sealed couplers have been developed. In one such coupler<sup>1</sup>, the assembly is hermetically sealed in an anodized or galvanized case. To avoid the problem of condensation, there is a slight inert gas pressure inside the coupler.

Another problem, depending on the location of the antenna, is one of interference rejection or signal gain. These, too, are factors that influence the type of coupler selected for the installation. It has been found impractical to build a single coupler that features both broad band and maximum gain simultaneously, because of circuit complexity. Some couplers have high gain; others, low gain with better interference rejection.

To solve the circuit variance requirements, one manufacturer<sup>1</sup> has developed three models of couplers: One is for normal signal gain with

<sup>1</sup>R-Columbia Humi-Kup.

# TV Antenna—Accessory Developments



**IRVING ROZAK** checking multiple TV-set couplers in lab of the R-Columbia Products Co.

normal interference rejection; another, with low loss and normal interference rejection, is for installation where the insertion of a coupler into the antenna system causes snow on one or more channels. The third model, for maximum interference rejection with normal signal gain, has been designed to eliminate interference on the second set due to the local oscillator radiation. In addition, due to the coupler's broad response, it is possible to connect up an FM and a TV set to the same antenna line.

The outdoor coupler installation represents a very profitable operation for Service Men. A substantial quantity of leadin and a number of stand-off insulators must be used. There is also the additional time required for the installation; and while the installation is being made, one has an opportunity to inspect the antenna and, if it is in poor condition, the sale of a new antenna becomes a possibility.

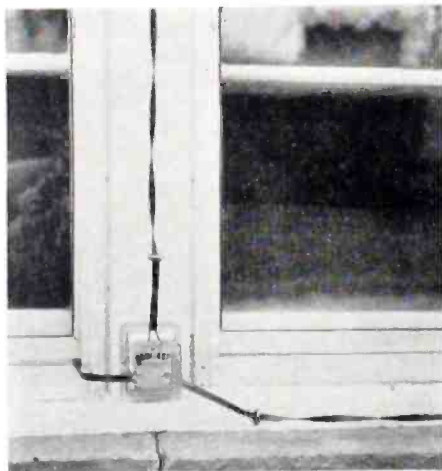

**VIEW OF** an installation of a coupler outside a window; short lead to one TV set is approximately 4' long; while long lead for second TV set is approximately 18' long. This short/long-lead situation usually impairs picture performance.

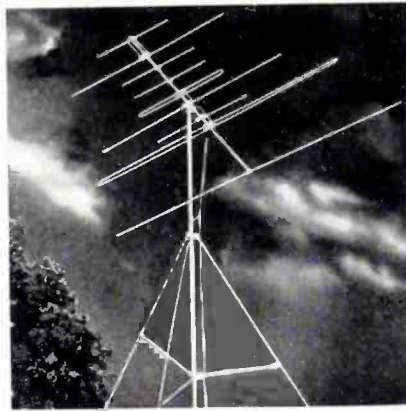

**FACTORY-ASSEMBLED** antenna package which includes a 10' aluminum tower, antenna with attached leadin and insulators, standoff insulators, ground wire, ground rod, and lightning arrester. Tower features a base which, it is said, mounts on any roof angle from 0° to 45°, and has guy rods to support tower. (Minute Mount; Winegard Co., Burlington, Ia.)

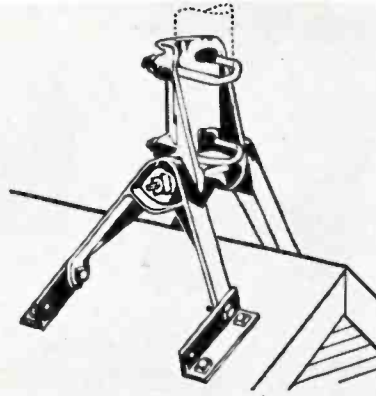

**CAST ROOF MOUNT** that snaps into place when upright, then locks in that position by tightening hinge bolt. (Rohn Manufacturing Co., 116 Limestone, Bellevue, Peoria, Ill.)

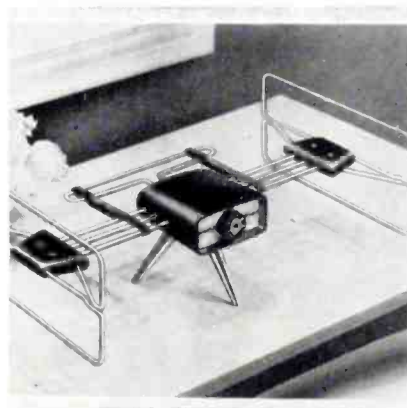

**VHF-UHF indoor antenna** with metrodyne tuning. On uhf antenna is said to operate as a folded dipole and reflector antenna, with the vhf elements functioning as parasitic reflectors. Has separate leads for uhf and vhf input. (Showman Model 3905; Channel Master Corp., Ellenville, N.Y.)

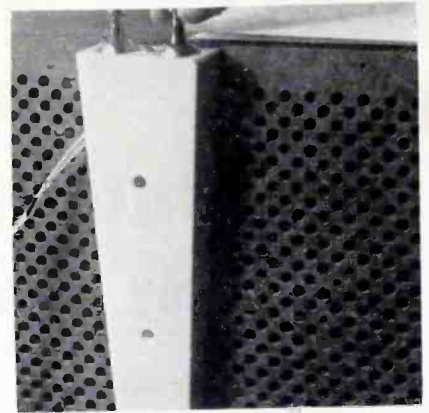

**Miniature TV antenna** featuring 4, 5 or 6 ball-socket nickled-brass telescoping sections encased in an injection-molded high-impact styrene housing, that mounts permanently to back of TV receiver. Said to be designed as standard equipment for 10", 14" and 17" Admiral, Crosley, Emerson, General Electric, Hotpoint, Motorola, Philco, Westinghouse and Zenith portable TV. (Periscope models TA 154-5-6; JFD Manufacturing Co., Inc., 6101 16th Ave., Brooklyn 4, N. Y.)

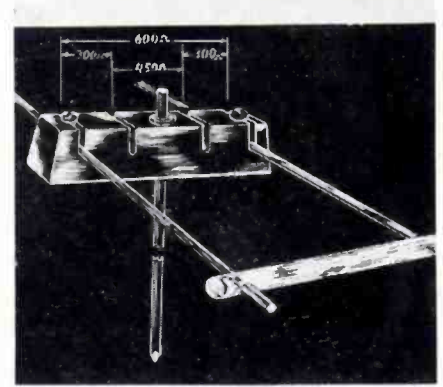

**TWO-INCH spaced 600-ohm open line** of 12 gage hard drawn Copperweld, random spaced to avoid tuned trap circuits. Available in 250' or 500' spool's. (Saxton Products, 1661 Boone Ave., N. Y. 60, N. Y.)



**HELIX ANTENNA** on roof of home at Furnace Creek Ranch in Death Valley, California, 178 feet below sea level, said to provide reliable reception from Los Angeles stations 180 air miles away. (Courtesy JFD)

# "SURE, I use CLEAR BEAM Antenna Kits...they've doubled my installation business!"

Using Clear Beam Antenna Kits makes sense right from the start! Attractive packaging and do-it-yourself label creates customer interest in a new or replacement antenna—makes it a cinch to sell complete installations.

Servicemen installing Clear Beam Antenna Kits have eliminated "loose stock" inventory problems and are now able to price installation jobs accurately and profitably due to fixed material costs!

Start doubling your installation business with Clear Beam Antenna Kits now. Display them in your shop—show them from your service truck—let Clear Beam's self-selling antenna kits clinch extra installation sales for you!



Kits for Conicals, Arrows, Yagls, Dipoles, UHF, VHF  
complete with mast, lead-in and all necessary hardware ready to install!



**CLEAR ANTENNA CORP.,**  
**BEAM** CANOGA PARK, CALIF.

Warehouses in Seattle, Portland, San Francisco, Honolulu, Dallas, Kansas City, Detroit, Baltimore

## B-W/Color-TV Tuners

(Continued from page 9)

which may be defined as the ratio of amplitude of *if* voltage appearing at the grid to the amplitude of *if* voltage appearing at the plate of the mixer tube. The undesirable effect of the *if* signal appearing in the mixer grid circuit is to change the input impedance of the mixer stage from the correct value for proper bandpass. Naturally, a triode mixer has a higher *if* reflection factor than does a pentode mixer, because of its greater grid-to-plate capacity (assuming that the grid-to-plate capacity external to the tubes are equal).

It will be noticed that a test point is located in the grid circuit of most *vlf* tuner mixer stages; Figs. 3 and 4. Sometimes the mixer test point is found at the mixer plate and in one of the latest color-receiver tuners, three test points are located within the tuner. With the test point located in the mixer grid circuit, the *rf* amplifier bandpass curve can be viewed with a conventional scope because the *rf* waveform appearing at this point is rectified; the grid-to-cathode circuit of the mixer tube acts as a rectifier. Typical alignment waveforms can be seen in Figs. 5a, b and c (p. 9).

At present, it appears as though most tuner manufacturers prefer to use a pentode over a triode mixer. This is probably because more performance per dollar can be obtained by using the pentode circuit. Apparently, the increase in conversion gain of a pentode over a triode is more beneficial to circuit operation, than is the improvement in tuner noise of a triode over a pentode mixer.

## In-Circuit Horizontal Analyzer

(Continued from page 13)

200 peak-to-peak volts across the winding under test. The meter is first set to an adjust line and the test leads are then connected across the transformer or yoke windings, as for a shorted-turns test. If the winding is continuous, the pointer will deflect into the *good* sector of the scale, but an open or a break in the winding with resistive char between will cause the pointer to fall in the *bad* sector of the scale.

The continuity function finds additional application in checking out wiring and identifying terminal pairs in the horizontal system, or elsewhere in the receiver circuits. In such applications, it serves the same purpose as an ohmmeter.

When faulty operation of the horizontal flyback system is not due to shorts or opens in the transformer or yoke windings, the trouble is, in many cases, in faulty capacitors. For this reason, the unit also has a 3-range capacitance meter, with direct-reading scales.

Capacitance values which can be measured range from 10 mmfd to .1 mfd.

The capacitance meter is of the *ac* reactance type; no bridge is used in the arrangement.



## CATALOGS—BOOKS

HOWARD W. SAMS AND CO., INC., 2201 E. 46th St., Indianapolis 5, Ind., has announced publication of a 240-page *Hi-Fi Handbook, HFB-1*, by William F. Boyce. Chapters cover fidelity, sound theory and distortion, loudspeakers, baffles and enclosures, amplifiers, preamplifiers and controls, program source equipment, and system design, selection and installation. Priced at \$3.

HEATH CO., Benton Harbor, Mich., has published a 56-page illustrated catalog, *Heathkits for 1957*, with specifications, data and schematics on high-fidelity equipment, amateur radio gear and test instrument kits.

SARKES TARZIAN, INC., Rectifier Div., 415 N. College Ave., Bloomington, Ind., has released two catalog data sheets, 1 and 2, with specifications and ratings on silicon rectifiers for commercial design purposes and TV receiver use, respectively.

RAYTHEON MANUFACTURING CO., Receiving and Cathode Ray-Tube Operations, 55 Chapel St., Newton 58, Mass., has published an 8-page booklet on *Semiconductor Products*, with specifications, characteristics, and physical dimensions of seven classifications of diodes and 34 different types of transistors.

PARKWAY SPECIALTIES CO., Box 5795 Beech Branch, Detroit 39, Mich., has issued a catalog covering universal and custom *Aud-O-Grill* speaker kits, grilles, accessories and hardware.

ROGERS ELECTRONIC CORP., 49 Bleecker St., New York 12, N. Y., has released a TV transformer replacement manual and subscription service cataloging a complete line of TV coils, yokes and fly-backs. Subscription service consists of supplement sheets mailed periodically to manual users to keep reference up to date; available through distributors.

### Antenna Plant Visitors



Why Waste Time and Energy? Save With This  
Complete "Starter" Assortment  
Plus A Bonus For You!



NEW  
STACKPOLE  
CARBON  
RESISTOR  
KIT



YOU GET 30 BOXES OF THE MOST  
USED 1/2, 1, 2 WATT RESISTORS...

No more fumbling around the bench or tool kit... or running down to the jobber for a single resistor! Here's a kit that has the 30 most used values, scientifically packaged to prevent damage... famous Stackpole Resistors used by all leading TV set makers. And to "sweeten the deal," here's a big

G-C 60 LINE  
CARBON  
RESISTORS

PLUS—THIS HANDSOME ALL-  
METAL RACK FREE For your bench or wall!

BUY THE RESISTORS... GET RACK FREE!

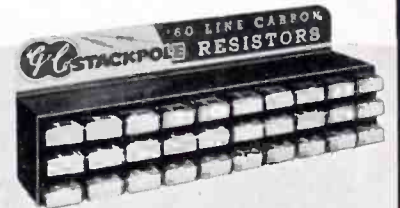

World's Finest Carbon Resistors—Color-Coded and Labeled—In Hinged Cover Plastic Boxes

FREE YOUR G-C CATALOG  
... send postcard today.



ASK YOUR ELECTRONICS  
DISTRIBUTOR ABOUT THIS  
KIT—No. 5245—IF HE  
DOESN'T HAVE IT, TELL  
HIM TO GET ONE FOR YOU.  
COSTS YOU JUST \$18.00...

**G-C ELECTRONICS MFG. CO.**

Division of General Cement - Textron Inc.  
400 South Wyman Street • Rockford, Illinois

(Left)

WARD PRODUCTS district sales reps, during a recent tour of the company's plant at Ashtabula, O., conducted after a sales meeting in Cleveland. Left to right: Adolph Schwartz, New York; Maitland Smith, Atlanta; Donald Blech, Ward sales manager; Robert Anderson, Boston; Robert Peters, Cleveland; Richard Farris, Kansas City; William Linz, Chicago, and Robert Hood, plant superintendent.

(Right)

TED ATCHERLEY (right), Sylvania Electric electronic products merchandising manager, beams on amazed Arnold Brundage during skit announcing new color-TV correspondence course at recent Sylvania sales meeting in Florida. Course, now available to TV Service Men, was prepared by the Radio Television Training Assn.

### New Color-TV Course



## USE LOW COST



### IMPEDANCE MATCH ACCESSORIES

with coax cable

improve reception as much as 6db

Eliminate Signal Losses, Smear, Ghosts and Other Picture-Degrading Conditions Resulting From Antenna-to-Line or Line-to-Set Mismatch.

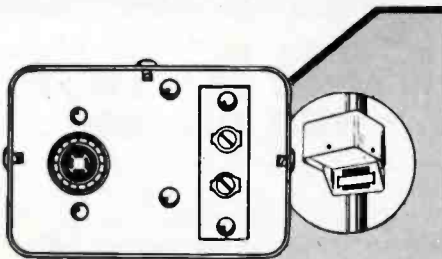

#### B-T BALUN model MB

\$900 list

Mounts on antenna mast or strut. Provides exact impedance match between 75-ohm unbalanced line and 300-ohm balanced line or antenna. Has 75-ohm coax fitting and 300-ohm screw terminals. Built into weather protecting cowl housing.

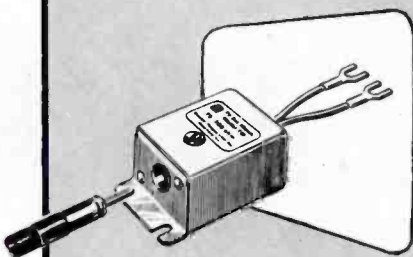

#### B-T TV SET MATCH model TM

\$350 list

Used at TV receiver to match 75-ohm cable to 300-ohm TV set input. Cable plug and jack permit quick, easy disconnect. Has heavy duty, 300-ohm output leads.

At electronic parts distributors. For complete accessory catalog, write to Dept. SA-8.

**BLONDER-TONGUE LABS., INC.**  
9-25 ALLING STREET, NEWARK 2, N. J.

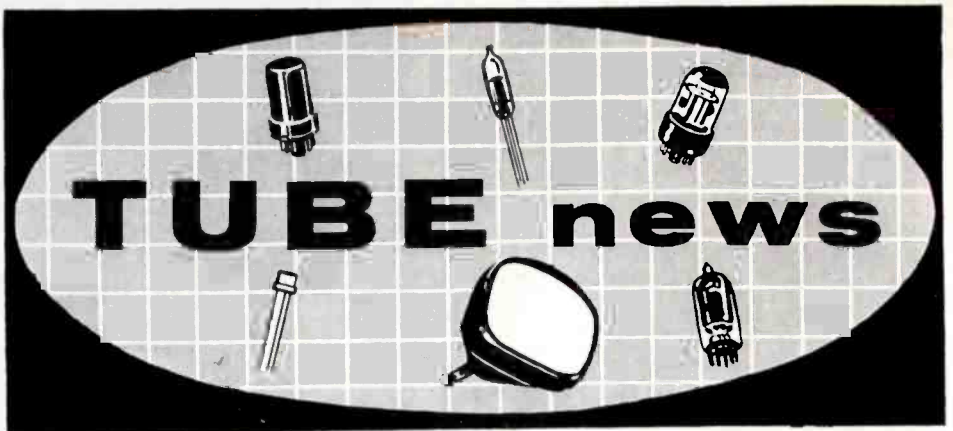

## Plant Instruments-Procedures Used to Check TV Tubes

by **EARL G. BOND**

Application Engineer  
Receiving Tube Dept., General Elec. Co.

NEAR THE TOP OF THE list of critical circuits is the oscillator circuit. An analysis of the circuit will provide the application engineer clues upon which to base tests that define the requirements of the tube in its application. Let us take the case of the blocking oscillator as an example.

For many problems, the circuit can be broken down into a simplified form. We know the function of an oscillator is analogous to the action of a mechanical switch. In Fig. 1 we have (a) the schematic of a typical blocking oscillator circuit, and (b) the analogy using a switch as the tube and a box marked *control*, that will act in the same manner as sync and feedback in the oscillator circuit. The action of the switch, as well as the action of the tube, is to discharge the capacitor that has been charged or partially charged to the value of the  $B+$

voltage or *boost* voltage through the high-resistance height control. The tube must cut off immediately after discharging the capacitor. In the mechanical analogy, the switch must open immediately upon the discharge of the capacitor and remain open until signaled to close by the sync pulse.

Although the actual operation of the blocking oscillator is somewhat more complicated through the need for feedback and the requirements for certain time constants for proper operation, the switch analogy may be used in a quick analysis of the tube requirements in the circuit.

The first requirement that must be met by the imagined switch is that it must be able to carry the current required to discharge the capacitor without overheating, burning, or pitting. The switch must close very quickly when signaled and open just as quickly when the capacitor has been drained of its charge. Therefore, we apply these specifications to the tube used in oscillator applications. The tube, when acting as a switch, must be able to furnish a pulse of current that is usually higher in amplitude than the *class A* rated value of current. The power involved per cycle is usually considerably lower than rated, so the dissipation rating is not exceeded. If the emission of the tube is limited by some defect in heater or cathode, the operation of the oscillator will be impaired. A test must, therefore, be devised to point out any change that will alter the pulse current capabilities of the tube. The conditions of such a test will approximate or even duplicate the actual operation of the oscillator tube.

The examples cited<sup>1</sup> should emphasize the fact that the requirements placed on electron tubes cannot be satisfied simply by testing the tubes without regard to the principal applications for which the tube is intended. The ever-diverging specifications that are placed on tubes by equipment manufacturers in their never-ending search for different and improved circuits require that the characteristics of electron tubes be defined with ever-increasing accuracy.

<sup>1</sup>See December, 1956, issue of SERVICE, for report on other tube tests employed in factory to study TV tubes.

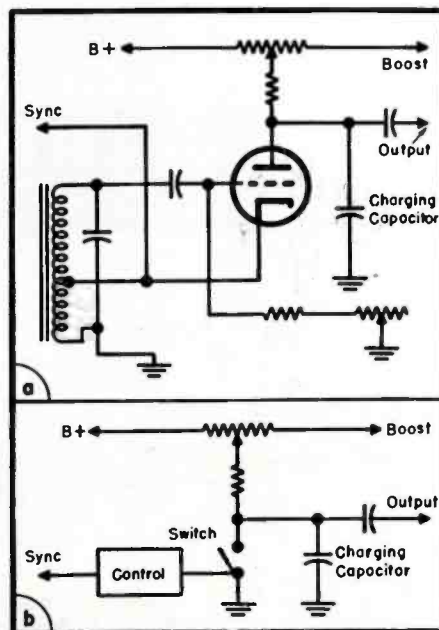

**FIG. 1: TYPICAL BLOCKING oscillator circuit appears in (a); while (b) offers an operational analogy using a switch as the tube and box marked control, that acts in the same manner as sync and feedback in the oscillator circuit.**

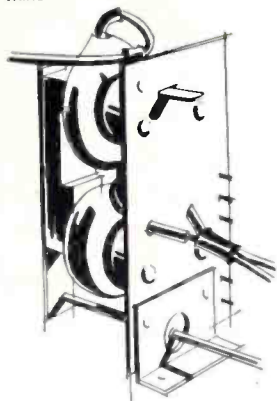

HVO-66 replaces part 24K736488 in 85 Motorola models and chassis

# ONLY MERIT

... always first with the latest

exact replacement

exceed original equipment specifications to eliminate call-backs... and no electrical or mechanical changes are necessary.



BC-358 sub-miniature IF input transformer for printed circuits—455KC



MDF-85 for G.E. RLD-041 & 045



HVO-62 replaces Magnavox part 360580-1, 360604-1, 360610-1



BC-359 sub-miniature IF output transformer for printed circuits—455KC



MDF-84 for G.E. RLD-025

# MERIT

MERIT COIL AND TRANSFORMER CORP.  
4427 N. Clark St., Chicago 40, Ill.

## INSTRUMENTS

### TRIPLE-CHECK TUBE TESTER

A TRIPLE-CHECK tube tester, 107, featuring grid-circuit, dynamic mutual conductance and cathode emission tests, has been introduced by Seco Manufacturing Co., 5015 Penn. Ave. S., Minneapolis 19, Minn.

Grid-circuit test is said to check for intermittent leaks or shorts, gas content and reverse grid current (grid emission). Selector switch permits mutual conductance check on each section of twin as well as dual-type tubes. Tube setup data is printed on panel. Cathode-emission test for heavy-current tubes features a free-point selection setup for six popular socket types.

### PIX TUBE AND YOKE CHECKER

A PIX TUBE and yoke checker, *Telecheck*, accommodating the 8" 8AXP4 tube, has been introduced by Telematic Industries, Inc., 16 Howard Ave., Brooklyn 21, N. Y.

Unit consists of universal yoke; universal service extension leads for the pix tube anode and yoke, for use with the unit or for general service work; and a plastic mask and yoke support, calibrated, and molded of styrene. Checker is also said to be self-focusing and can work with electrostatic or electromagnetic tubes with 52°, 70° and 90° yokes.

### TRANSISTORIZED AUDIO OSCILLATOR

A TRANSISTORIZED beat-frequency audio oscillator, *Audiolator 1000*, designed for field service and commercial sound applications, has been developed by the Kay Electric Co., 14 Maple Ave., Pine Brook, N. J.

Unit is powered by mercury batteries. Single sweep of dial is said to cover audio range of 50 cycles to 15 kc. Provision has been made for zero beat adjustment and fine frequency control over entire range.

### MARKER-ADDER

A MARKER-ADDER, model 220, for *rf* and *if* alignment in color and *b-w* TV receivers, as well as FM sets, has been announced by Precision Apparatus Co., Inc., 70-31 84th St., Glendale 27, N. Y.

Unit is said to provide large-size markers without distorting sweep response curve; eliminate need to connect marker-signal generator to the tuned circuits of the receiver; make marker pip visible in traps and at other zero response points.



# FIX BLACK & WHITE TV COLOR

Repair more sets in less time!  
Examine this NEW handbook FREE!

HERE IT IS!... the newest, most complete, easy-to-follow television servicing guide ever published! Following the same clear approach that made the author's "Elements of Radio" a 1,000,000-copy

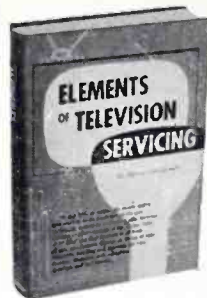

best-seller, this brand-new book gives you everything you need to know to make extra money fixing both black-and-white and color TV sets. Just master the first few chapters of this book and you are ready for business.

## Elements of TV SERVICING

by Abraham Marcus (co-author of famous best-seller, "Elements of Radio") and Samuel Gendler

- Reveals for the first time all details, theory and servicing procedures for the RCA 28-tube color Television receiver, the CBS Columbia Model 205 color set, and the Motorola 19-inch color receiver.
- Analyzes and illustrates, so you can actually see what to do, more TV defects than any other book, and provides complete, step-by-step procedure for correcting each one.\*
- Gives you tested money-making tips and time-saving methods for profitable TV repair servicing.

**PARTIAL CONTENTS:** Field servicing, how to install and adjust a new receiver, how to choose the proper antenna and how to erect it. 100 common defects (with actual photos of defects) and how to correct them. Bench servicing set-up for bench servicing—the heater circuit and low-voltage power supply, the horizontal sweep and high-voltage sections, vertical sweep section synchronization section, alignment, etc., etc. Color television—practical color television receivers, color tube adjustment, trouble-shooting the color television receiver, etc., etc.

**USE IT FREE FOR 10 DAYS!** Get this great new how-to-do-it TV Servicing book today. Just mail coupon below for 10-day Free-Examination Copy of "Elements of Television Servicing."

..... MAIL COUPON NOW! .....

PRENTICE-HALL, INC., Dept. 5849-A1  
Englewood Cliffs, N. J.

Send me, for 10 DAYS' FREE TRIAL, "Elements of Television Servicing." Within 10 days, I will either send \$6.95 plus postage, or return the book and owe nothing.

Name .....

Address .....

City.....Zone.... State.....

SAVE! Send \$6.95 with this coupon and we will pay postage. Same return privilege: refund guaranteed.



# AUDIO

## INSTALLATION AND SERVICE

Phono • Tape • PA  
Cartridges • Needles • Amplifiers • Speakers

## A Report on the Useful Life of Hi-Fi Components and Accessories

MANY BELIEVE that, since high-fidelity equipment has been designed to produce quality results, every component will last virtually forever. This premise does not hold at all, for hi-fi systems use electronic and mechanical parts with all of the life-problems found in most standard items. As an example, all tubes (except the ruggedized types) have a similar life; some perhaps shorter than others.

Some hi-fi amplifiers push the output tubes to the very limit, with the result that tube life is likely to be

shorter than the output tubes in a table-model radio. Some hi-fi makers have adopted a more realistic approach and are in this instance, content with a smaller output from the same pair of tubes; in this instance, the tubes do not require replacing quite so often.

Smoothing in the high-voltage supply of a power amplifier can deteriorate due to electrolytics that dry out, a problem quite common in TV or radio receivers. The effect is increased background hum or possibly a sort of hum modulation, because the supply to the output tubes becomes almost raw rectified *ac*; this can cause a sort of frog-in-throat reproduction, without noticeable hum background when the program is off. Smoothing capacitors are, if anything, more necessary to maintained performance in a hi-fi amplifier, than in a TV or radio receiver, because their deterioration can cause other troubles than just hum. So they should be replaced at more frequent intervals to insure top performance; one should not wait until they go.

Most modern preamplifiers utilize a considerable amount of switching, as well as a number of potentiometers for volume and tone-control functions. These controls are subject to the same troubles as corresponding controls on any TV or radio receiver and need the same kind of attention to assure

continued proper functioning without undue noise. Similarly, they are just as likely to become defective and require replacement. This is no more a reflection on the quality of the preamplifier, than is the necessity for replacing a brightness control on a TV receiver a reflection on the quality of that manufacturer's product.

A preamplifier has more small components than almost any other piece of equipment. This naturally means it is that much more susceptible to unpredictable faults. And, of course, tubes require periodic replacement, although their life should be about twice that of power tubes.

Similar remarks apply to high-fidelity tuners. Although these components are much more precision engineered than the radio section of the average radio or TV receiver, they are still subject to the same kind of deficiencies. Tubes age and need replacement. As tubes age they may also upset the alignment of the radio or *if* circuits, in just the same manner as any other receiver. Replacement of tubes should also be accompanied by realignment of the receiver.

Although many of the high-fidelity FM receivers now come equipped with automatic tuning control, this does not mean that the receiver will stay in alignment automatically. While the automatic tuning control may serve to disguise the fact that the receiver has gone out of adjustment, by helping it to continue performing *better*, the receiver does still go out of alignment. Thus it is important that this control should be checked periodically if peak performance is to be maintained. Automatic tuning control  
(Continued on page 36)



**TRANSISTORIZED** pa amplifier said to be capable of delivering ten watts. Incorporates preamplification. Powered by rechargeable 12-v 7-a hour dry batteries. Current drain averages .5 amp. Has 8" speaker and press-to-talk microphone. (Lustraphone; John Ould Ltd., 519 South Fifth Ave., Mount Vernon, N. Y.)



**TRANSISTORIZED** impedance-matching preamp, said to permit direct use of low-impedance, low-gain cartridges and microphones with high-impedance tape-recorders, amps, and pa systems. Unit is claimed to provide more than 30-db gain with no distortion at normal levels. (Micamp; Madison Fielding Corp., 863 Madison St., Brooklyn, N. Y.)



## WHAT HAS THIS SWIVEL MOUNT TO DO WITH...

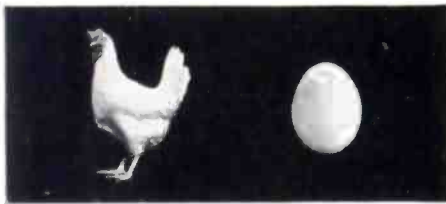

### Another great University first

As we've been saying... University "firsts" are worth having, worth working toward, worth waiting for. Not the first "Universal" joint to be incorporated into a bracket design, the new University omni-swivel bracket is the first that really works. It is also the only bracket that can fit directly on  $\frac{1}{2}$  inch pipe. Its *positive-lock* design, precision die-cast construction and versatility of application set new standards by which others will be judged.

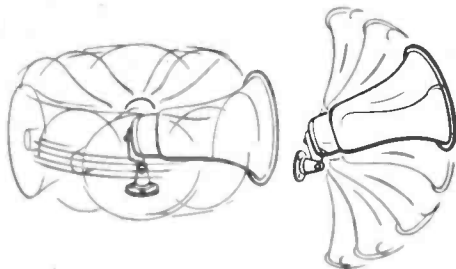

The University Positive-Lock OMNI-SWIVEL base is standard equipment on the Models IB and MIL series paging and talk-back speakers, and Models CMIL and CIB series wide-angle paging speakers. Additional models will be so equipped in the near future.



### Progress that makes waste

As we've been saying... *being* the first is not as important to University as being first with a new design of *proven* quality... even if it means discarding achievements that no longer meet *our own* high standards. The serrated, die-cast swivel bracket being replaced by the new omni-swivel, is still superior to any other on the market today... yet we willingly discard it for the sake of true progress, the most important commodity University has to offer.

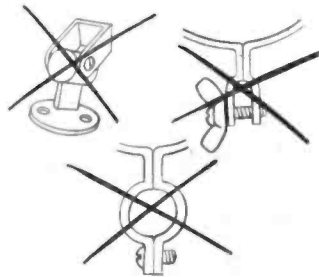

### Engineering that makes the difference

As we've been saying... the integrity and quality of good engineering is often where you can't see it, or touch it. Yet, these are what make the *difference* in brands... differences that spell success or failure of operation, really great value or a poor purchase. The drawing of the new University omni-swivel bracket unveils the ingenuity, meticulous detail and far-sighted design that are the ingredients of *every* University product.

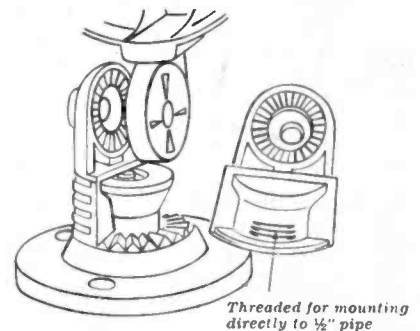

UNIVERSITY LOUDSPEAKERS, INC., 80 SOUTH KENSICO AVENUE, WHITE PLAINS, N. Y.

LISTEN

*University sounds better*



# OHMITE®

**DEPENDABLE  
RESISTANCE UNITS**

**INSURE** quality replacement  
**BUILD** customer satisfaction  
**INCREASE** your industrial  
and home electronic  
servicing business



### AXIAL-LEAD RESISTORS

Vitreous-enameled, power-type units designed to withstand high temperatures.



**LITTLE DEVIL®  
COMPOSITION RESISTORS**  
Meet all MIL-R-11A requirements. Rated at 70C rather than 40C. Available in 1/2, 1, and 2-watt sizes in all standard RETMA values.



**BROWN DEVIL®  
RESISTORS**  
Vitreous-enameled. In 5, 10, and 20-watt sizes.



**TYPE AB  
POTENTIOMETERS**  
Resistance material is solid-molded, noise-free. Rated at 2 watts.



**FR-7.5 FUSE  
RESISTOR**  
For easy replacement in all television receivers. 1 1/2" Tinned wire leads.

**WRITE FOR STOCK  
CATALOG**

Be Right with

**OHMITE®**  
OHMITE MANUFACTURING CO.  
3642 Howard Street, Skokie, Illinois

## Audio

(Continued from page 34)

is *not* intended to compensate for aging of the receiver; merely to make its operation easier by compensating for short-term frequency drifts during its day-to-day operation.

The manner in which components in a high-fidelity system, amplifier, preamplifier and tuner are mounted up in a cabinet merits close attention in the life issue. One must note if all the tubes have adequate cooling facilities. Running the system too hot can deteriorate, not only the tubes, but other components such as resistors and capacitors, which can get *baked* by overheating. Often the desire for a nice neat assembly or package results in crowding in a comparatively small compartment, where everything can seriously overheat. Such arrangements can shorten life much below normal expectancy. Components that would not otherwise become defective need replacing because the whole system overheats. So, in the customer's interest, it is wise to see how the equipment has been mounted.

### Speaker Replacement

Not only do parts and tubes need replacing from time to time, but loudspeakers, too. It is true a loudspeaker that is not abused will continue *working* almost indefinitely. But this does not mean that it maintains its new performance. There are many items,



**Snyder**  
PHILADELPHIA  
**IMPERIAL**  
television's  
most dramatic  
indoor antenna



"By Jove! Now how do you suppose he knew that Lady Peabody was carrying the **JENSEN NEEDLES?**"

Another  
Time-  
Saver

## SENCORE TRANSISTOR CHECKER

Model  
TDC22



**NOW WANTED and  
NEEDED by EVERY  
SERVICEMAN**

Quickly and accurately  
checks all transistors  
and crystal diodes.

Provides these 4 important  
checks on transistors:  
OPEN • SHORT • CURRENT  
GAIN • LEAKAGE  
Checks forward to backward  
resistance of diodes.

**Only  
\$15.95  
DEALER NET**

★ Complete set-up chart and instruction booklet attached to back ★ Will never become obsolete, with test leads, replaceable up-to-date set-up chart and gain control to vary battery voltage ★ Accurate and simple to operate — takes less than 30 seconds to test either TRANSISTORS or crystal diodes ★ Uses test leads which eliminates need of completely removing transistor from circuit.

At Leading Distributors Everywhere

Mfg by  
**SENCORE SERVICE**  
INSTRUMENTS CORP.  
171 OFFICIAL RD., ADDISON, ILL.

**POPULAR  
SENCORE  
PRODUCTS**

- Transistor Tester
- Leakage Checker
- Filament Tester
- Voltage Regulator
- Bias Supply



**MIKE SUPPORT** with flexible, 12" chrome-plated goose-neck arm mounted on spring-loaded swivel. Feed-through hole at mike end of goose-neck allows mike cable to be concealed within the arm. To prevent forward tipping, base casting is rear-loaded. Base rests on rubber bumpers. (Model SB-1; Atlas Sound Corp., 1451 39th St., Brooklyn 18, N. Y.)

even in modern loudspeakers, that deteriorate with age.

Earlier magnet materials lost their magnetism progressively with age. The modern Alnico V and corresponding products made by other magnet manufacturers do not deteriorate, for a long time at any rate. So, unless these materials are mistreated by

(Continued on page 38)



**SELF-CONTAINED** soundcasting system equipment for outdoor and indoor applications powered by flashlight batteries. One model, with a matched weatherproof speaker and microphone, incorporates a built-in switch. Battery housing serves as a base stand for the entire assembly; can also be hung from a nail or hook on walls, beams, superstructure, etc. Speaker has lock swivel bracket for beaming sound in desired direction. Uses seven 1½-v batteries. Second type, using six 1½-v pencil size flashlight batteries, has a jack built-in into the handle to accommodate an external 6 to 12 dc supply, as from vehicle and boat ignition systems. Handle, switches and microphone housing are a part of a die-cast aluminum assembly. Has reflex speaker integrally assembled. (Models PP-1 and PP-2 Portable and Pistolgrip Powerpage; University Loudspeakers, Inc., 80 S. Kensico Ave., White Plains, N. Y.)

**NOW THE**

*improved*

**SHURE**

**UNIDYNES**

the world's most widely used fine microphones

**PROVIDE**

- 41% higher output!
- The perfect microphone choice for use with low-gain P. A. systems and tape recorders ... in addition to their famed usage in finest quality public address systems.

*The best*

*is even better!*

The unidirectional dynamic Unidynes are now more than ever your best choice in those installations where feedback is a problem, and for all fine-quality public address, theatre-stage sound systems, magnetic recording and remote broadcasting—where critical standards call for the finest-quality microphone operation.

*Another example of the continuous creativity of the Shure Research and Development Laboratories.*

**55S Unidyne** List Price \$79.50  
**556S Broadcast Unidyne**

List Price \$120.00

IN ELECTRONICS SINCE 1925

*The Mark of Quality*

**SHURE**

**SHURE BROTHERS, INC.**

*Microphones ~ Electronic Components*

204 HARTREY AVENUE • EVANSTON, ILLINOIS

**Small**  
in size and cost  
**Big**  
in performance



**American's NEW  
TAPE RECORDER  
MICROPHONE**

Here's a new standard for high fidelity convenience . . . for the home or small studio. Attractively styled, and available in matching colors, this sensational new lightweight champ delivers a heavyweight performance throughout the entire tone range. Omni-directional pick-up pattern provides uniform fidelity when more than one performer or participant is being recorded at one time.

Versatility underscores the modern functionalism of this new design. It weighs only 2 ounces, only 3 3/4 x 2 1/2 x 9/16 inches in size . . . can be easily handled and used by standing persons, or it can be rested on a flat surface for conference type pick-up such as conference recording.

Quality in construction means quality in tonal reproduction. The microphone element is shielded, with very low hum pick-up. Model B-203, ceramic type, and Model X-203, crystal type are both available with RCA type or miniature phone plugs.

For high fidelity sound that is reproduced to last, use American tape recorder microphones.



full vision . . .  
full sound . . .  
where fidelity  
speaks for itself

**American  
microphones**

ELECTRONICS DIVISION  
ELGIN NATIONAL WATCH CO.

2435 North Naomi St., Burbank, Calif.

**Audio**

(Continued from page 37)

rough handling or placed near some demagnetizing source such as a strong ac field, the modern speaker magnet is not likely to deteriorate, so as to require replacement or remagnetization before the loudspeaker deteriorates seriously in other respects.

High-fidelity loudspeakers feature a very delicate design balance to produce their high quality of reproduction performance. The material of which the diaphragm, the spider and its suspension are made, are all critically controlled to produce the desired overall performance; but whether paper, impregnated or not, plastic, or even metal, are involved, continual use and time will deteriorate the qualities for which these materials were originally selected.

The spider and suspension, whatever they are made of, eventually suffer from fatigue, producing a tendency to develop what is known as the *oilcan* effect. This is caused by stretching of both the spider and the suspension so that the diaphragm tends to move without any opposition through the middle portion of its travel and suddenly comes up against opposition beyond this point. Two positions of rest will appear, due to the fact that the suspension or spider is stretched.

In some loudspeakers this defect can be cured by installing a replacement diaphragm assembly, consisting of moving coil, cone, spider and suspension complete.

Although plastic does not deteriorate, due to temperature and humidity changes as paper may well do, it is still subject (to the latest date of investigation, at any rate) to an aging effect. The plastic slowly becomes either more brittle, or else tends to become somewhat glutinous. Either way, its original characteristics are lost and the performance of the loudspeaker will deteriorate.

Even a metal diaphragm unit deteriorates due to fatigue caused by repeated flexing every time the diaphragm vibrates. But, whereas paper and plastic diaphragms deteriorate more on the basis of time (that is, the aging is not affected so much by how much they are used, as by how old they are) the metal diaphragm deteriorates more with use. If it has been kept a long while without being used, it will probably be as good as new, but if it is used constantly, life will be that much shortened.

**hi-LOW** with ATLAS  
high quality  
low price



**PAGING &  
TALK-BACK SPEAKERS**  
6 sizes and types.  
All impedances  
from 4 to 45 ohms.  
From 5 to 15 watts.  
From \$15.00 to \$24.00 NET.



**WEATHERPROOF LINE  
MATCHING TRANSFORMERS**  
For constant impedance  
or constant voltage systems.  
\$5.00 NET.



**HIGH-POWERED  
PUBLIC ADDRESS SPEAKERS**  
Four sizes from 2 1/2'  
to 6' air column.  
From \$10.00 to \$39.00 NET.



**U-I APPROVED  
EXPLOSION-PROOF SPEAKERS**  
For hazardous applications.  
Several sizes, all classes.  
From \$66.00 to \$75.00 NET.



**SUPER-POWER DRIVER UNITS**  
For all purposes,  
powers, frequencies.  
From \$15.00 to \$30.00 NET.



**MIKE STANDS & ACCESSORIES**  
All sizes and types:  
boom stands, desk stands,  
adapters, fittings, etc.



**NEW! SWITCHBOARD  
MIKE SUPPORT**  
Adjustable 12" goose  
neck. Use as desk support,  
for dispatcher office,  
dais, table, etc.  
#SB-1 . . . \$7.80 NET.



**NEW! "CHESTY"  
NECK-SUPPORTED  
MIKE STAND**  
Quick, easy 3-way  
adjustment. Lightweight.  
Multiple uses.  
#NS-1 . . . \$3.00 NET.



**NEW! MIKE FOOT SWITCH**  
Hand, foot or knee  
operation—shielded,  
grounded, noise-free,  
dependable, damage-proof.  
#FS-1 . . . \$7.20 NET.



SEND FOR COMPLETE  
FREE CATALOG  
**ATLAS SOUND CORP.**  
1442 39th St., Brooklyn 18, N. Y.  
In Canada: Atlas Radio Corp.,  
Ltd., Toronto, Ont.



# HICKOK

Model 290X

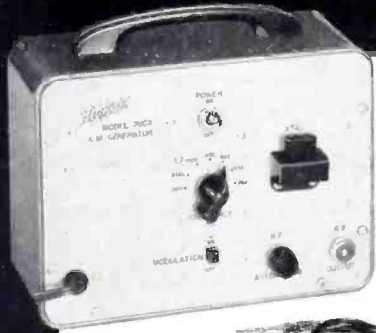

\$44<sup>25</sup> Net

## HIGHLY ACCURATE AM GENERATOR

Specifically designed to meet the accuracy and high speed requirements of today's radio servicing. All output frequencies easily obtained by dialing the front panel selector switch. Crystal accuracy through addition of crystal in holder provided.

THE HICKOK ELECTRICAL INSTRUMENT CO.

10521 Dupont Ave. • Cleveland 8, Ohio

## SERVICEMEN SEE New Source of Income



WITH AMAZING  
**SSS-T! Steam Iron  
CLEANER**

Steam Irons  
Need Cleaning  
Too!

- ★ Removes clogging scale.
- ★ Safe odorless easy to use.
- ★ Perfect for hard water areas.
- ★ Tested and recommended by appliance manufacturers.

Nationally Advertisied in Parents, Living, etc. **JOBBER!** Still a few choice territories available.

Resale \$1 (Full year supply)



ORDER TODAY from your jobber, or write direct for name of nearest dealer.

**FAST CHEMICAL PRODUCTS CORP.**  
65 Page Avenue Yonkers, N. Y.

# COMPONENTS

## MINIATURIZED CERAMICS

MINIATURIZED CERAMIC capacitors, for replacement on transistorized chassis, have been developed by the Sprague Products Co., North Adams, Mass.

Moisture-proof coating serves to protect against short circuits. Available in five values of capacitance from .005 to .1 mfd, rated at 50 v dc.

## BUTTON-LESS VIBRATOR

A VIBRATOR (series 1600) that is said to eliminate the usual button contacts, has been announced by P. R. Mallory and Co., Inc., 3029 E. Washington St., Indianapolis 6, Ind.

Design is said to afford greater contact area, increase vibrator life, and eliminate sticking of contacts. Mechanical hum is held at a low level, due to lighter vibrating mass.

Available in ratings suitable for replacement purposes in auto radios and other battery-powered equipment.



## TEMPERATURE-COMPENSATING DISC CERAMICS

TEMPERATURE-COMPENSATING disc ceramic capacitors, *Tiny MIKE* type C, designed to provide linear capacitance change to correct for temperature drift of other circuit elements, as in critical rf tuning and resonant-circuit applications, have been developed by Cornell-Dubilier Electric Corp., S. Plainfield, N. J.

## CAPACITOR SERVICE KIT

A CAPACITOR SERVICE kit, *Swing Bin Baby*, with 45 *Blue Point* molded plastic tubulars in nine popular values, has been announced by Astron Corp., 255 Grant Ave., E. Newark, N. J.

Swing bin, designed in clear plastic for quick viewing, swings to any position or angle. Hangs on the wall or work-bench.



the **BEST** because...

Only the CLEAR PICTURE Comes Thru!



with the NEW and AMAZING

# Dynamic FILTER TENNA

with the EXCLUSIVE built-in HI-PASS FILTER

T. M. Reg. Pat. Pend.

THE FIRST TRULY ELECTRONIC INDOOR TV ANTENNA TO GIVE CLEAR FILTERED RECEPTION.

List

\$18.95

SATIN BRASS,  
SATIN CHROME,  
SATIN COPPER FINISHES.



Beautiful!



The SECRET...

...is in the FILTER

Unmistakably...  
"THE FINEST!"

TV—FM  
HI-FI • PHONO  
ACCESSORIES



There is a **DYNAMIC** ACCESSORY or SERVICE AID for practically all needs. FULL LINE CATALOG ON REQUEST!

Manufactured By  
**DYNAMIC ELECTRONICS - NEW YORK, INC.**  
Forest Hills, Long Island, New York

# KESTER



Absolutely non-corrosive and non-conductive, KESTER "RESIN-FIVE" CORE SOLDER contains an activated type of resin that gives you that fast, positive action on all your jobs . . . including the most difficult.



KESTER SOLDER COMPANY  
4248 Wrightwood Avenue • Chicago 39, Illinois  
Newark 5, New Jersey • Brantford, Canada

# SOLDER

## Color-TV Video Generator

(Continued from page 12)

(The waveform of the signal at the output of  $V_{2A}$  is shown in Fig. 7A; p. 12.) The shaper stage,  $V_{2B}$ , is biased so that it conducts only on positive pulse peaks fed to it from the oscillator. Its output, consequently, is a series of narrow negative spikes.  $V_{3A}$  is a straightforward inverter stage which reverses polarity of the pulse. The output pulses from  $V_{3A}$  are fed to one of the grids of the 6BQ7A mixer stage,  $V_4$ .

**Horizontal-Bar Section**—The sync signal from  $V_{1A}$  is also applied to a 12AT7 doubler,  $V_{7A}$ , in the horizontal-bar channel.  $L_{10}$ , a slug-tuned coil and  $C_{21}$ , a 2200-mmfd capacitor, are tuned to 31.5 kc. (The resultant waveshape at pin 1 of  $V_{7A}$  is shown in Fig. 7B.) The output of  $V_{7A}$  is loosely coupled to the second half of the 12AT7 serving as a shaper,  $V_{7B}$ , through the secondary winding of  $L_{13}$ , also a slug-tuned coil.  $V_{9A}$  and  $V_{9B}$  (12AT7) comprise a monostable multivibrator which divides the 31.5-kc output signal so that it delivers one output pulse for each five input pulses. The timing of this multivibrator is set by means of a 500,000-ohm pot,  $R_{17}$ .  $V_{8A}$ , a 6AL5, is a clamp stage which holds the bias for  $V_{7B}$  at a suitable level. (The resultant waveshape at pin 6 of  $V_{9A}$  is shown in Fig. 7C.) The 6300-cps output from the multivibrator is fed to  $V_{3B}$ , which serves as a cathode-driven amplifier and inverter to produce a pulse having the shape and polarity shown in Fig. 7D.  $V_{10A}$  and  $V_{10B}$  (12AT7), and  $V_{8B}$  (6AL5) comprise a 900-cps multivibrator stage which divides the 6300-cps input by seven so as to deliver 900-cps output. This 900-cps output signal is applied to the mixer stage  $V_4$ , through a .01-mfd capacitor,  $C_{31}$ .

**Mixer and Output Stages**—The vertical and horizontal elements of the signal are combined in the mixer stage,  $V_4$ . The resulting composite signal appears at the junction of three 1,000-ohm resistors,  $R_{20}$ ,  $R_{21}$ , and  $R_{22}$  and is fed to the grid of the pattern amplifier,  $V_5$ , a 6CL6. When the pattern selector is set to dot, a 1N56A ( $CR_2$ ) clips the composite signal to produce the required waveform. When the pattern selector is set to V bar, B+ voltage is removed from the horizontal-bar section and no horizontal-bar signal is generated. In the H-bar position, B+ voltage is removed from the vertical-bar section and no vertical-bar signal is generated.

An important feature of the pattern amplifier is a crosshatch v/h (vertical-horizontal) equalizer. This control permits adjustment of the brightness-level ratio between the vertical and horizontal bars in the crosshatch pattern. Because the h and v bars have different frequency components (900 cps and 150-410 kc, respectively), the high-frequency (v bar) signals may be attenuated in some receivers. A 5000-ohm equalizer control,  $R_{30}$ , attenuates the low-frequency components (horizontal bars) of

for service and lab. work

## Heathkit PRINTED CIRCUIT OSCILLOSCOPE KIT FOR COLOR TVI

① Check the outstanding engineering design of this modern printed circuit Scope. Designed for color TV work, ideal for critical Laboratory applications. Frequency response essentially flat from 5 cycles to 5 Mc down only 1½ db at 3.58 Mc (TV color burst sync frequency). Down only 5 db at 5 Mc. New sweep generator 20-500,000 cycles, 5 times the range usually offered. Will sync wave form display up to 5 Mc and better. Printed circuit boards stabilize performance specifications and cut assembly time in half. Formerly available only in costly Lab type Scope. Features horizontal trace expansion for observation of pulse detail — retrace blanking amplifier — voltage regulated power supply — 3 step frequency compensated vertical input — low capacity nylon bushings on panel terminals — plus a host of other fine features. Combines peak performance and fine engineering features with low kit cost!



## Heathkit TV SWEEP GENERATOR KIT ELECTRONIC SWEEP SYSTEM

② A new Heathkit sweep generator covering all frequencies encountered in TV service work (color or monochrome). FM frequencies too! 4 Mc — 220 Mc on fundamentals, harmonics up to 880 Mc. Smoothly controllable all-electronic sweep system. Nothing mechanical to vibrate or wear out. Crystal controlled 4.5 Mc fixed marker and separate variable marker 19-60 Mc on fundamentals and 57-180 Mc on calibrated harmonics. Plug-in crystal included. Blanking and phasing controls — automatic constant amplitude output circuit — efficient attenuation — maximum RF output well over .1 volt — newly improved linearity. Easily your best buy in sweep generators.



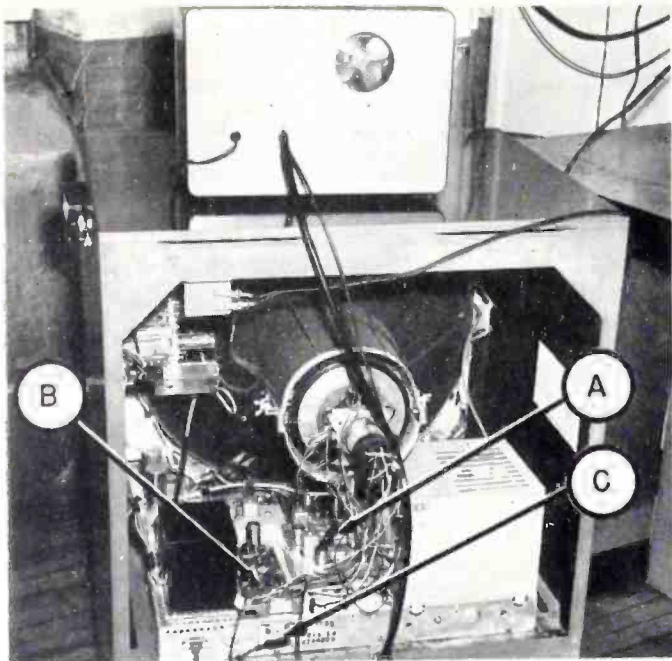

**FIG. 8: VIDEO-OUTPUT** generator connected to color-TV set: (A) = horizontal-sync pickup lead; (B) = video output lead, and (C) = ground lead.

the composite signal at the output and provides for adjustment of the brightness level of the horizontal bars.

The output of the amplifier is applied to the output amplifier stage which includes  $V_6$  (5763) and a 1000-ohm output-voltage control,  $R_{34A}$ . The output-signal polarity may be selected by means of a switch, S1B. The negative-polarity signal is taken from the plate circuit; the positive-polarity signal is taken from the cathode circuit.

A 170-780 mmfd variable ( $C_{17}$ ) and a 1000-ohm resistor ( $R_{30}$ ) in the output circuit permit adjustment of the voltage ratios between the red output and the green and blue outputs. These adjustments are factory set to provide blue and green output voltages which are approximately 70% of the red output voltage. These voltage ratios are required when the three output leads are connected into the three electron-gun circuits of the color picture tube.

Oscillograms for different output patterns from the generator as observed on a scope are shown in Fig. 9 (p. 42); the differences between the  $v$  and  $h$ -bar patterns can be seen by comparing  $a$

and  $b$ . The 410-ke  $v$ -bar waveform appears condensed because of the low scope sweep frequency employed. The shape of individual bar signals is defined better in  $b$  of Fig. 7. The relatively short square pulses are necessary to produce sharply defined bars on the picture-tube screen. In this generator, the  $v$ -bar pulses are approximately .5 microsecond wide when the  $v$ -bar control is set for 20 bars. The  $h$ -bars are only 2 lines high on the picture-tube screen. The corresponding output waveforms for dot and crosshatch patterns, respectively, appear in  $c$  and  $d$  of Fig. 9. It will be noted that the crosshatch-pattern waveform is a composite of the  $v$  and  $h$  signals.

One of the most important requirements of any convergence pattern generator is that the pattern produced on the picture tube be free of jitter and crawl. Jitter causes the pattern to jump up and down, and may appear in almost any type of pattern used for convergence adjustments. Crawl is an effect in which the individual lines in the raster seem to disappear at the bottom of the bar and reappear at the top of the same

(Continued on page 42)

**L-S "SIGNAL MASTER"**

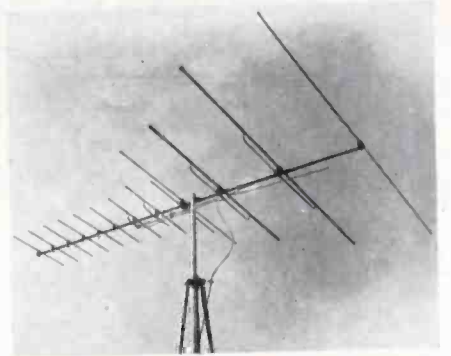

**POWERFUL FRINGE AREA VHF ANTENNA**

- ★ Completely factory assembled on boom, with quick-rigging that strengthens rather than weakens.
- ★ Re-inforced at all stress points, double-wall thickness boom.
- ★ New one-piece dipoles pre-attached to the boom.
- ★ Superb quality all-aluminum construction.
- ★ One of our vhf antenna line is just right for your area.

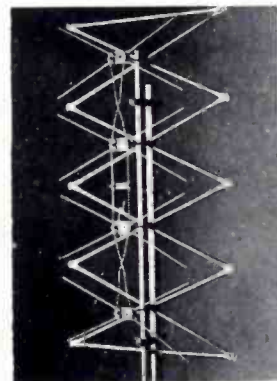

**ARE YOU LOOKING FOR QUALITY ALL-ALUMINUM UHF ANTENNAS?**

Pictured are two new antennas that give really "hot" UHF reception

- ◀ Model U-21
- ▼ Model U-22

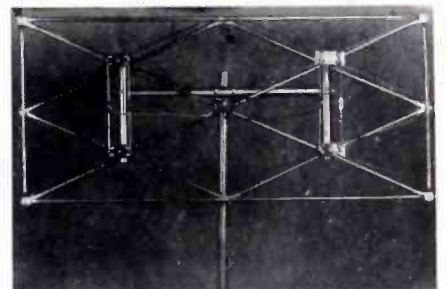

**THE SIX L-S UHF MODELS FEATURE**

- ▶ Quality construction found in no other uhf line.
- ▶ Low wind resistance.
- ▶ ALL-aluminum construction including aluminum nuts and bolts.
- ▶ Moderately priced.

**DISTRIBUTORS:** Your inquiries will receive our prompt attention.



**BEWARE OF IMITATIONS**

There Is Only One Original Dependable NO-NOISE

Volume Control and Contact Restorer with Perma-Film

2 oz. bottle. Net to servicemen \$1.00



Cleans, lubricates, protects not a carbon-tet solution. Still available in the new 6 oz. spray can.

Net to servicemen—\$2.25



Also available in 8 oz. bottles and quart cans.

At your nearest distributor.

**TUNER-TONIC**

with PERMA-FILM  
Cleans, lubricates, restores all tuners including wafer type. Won't change or affect capacitors, inductance or resistance. Won't harm insulations or precious metals, nor attack plastics. For television, radio and FM. Eliminates all noise, oxidation and dirt indefinitely.

Non-toxic, non-inflammable, insures trouble-free performance.

6 oz. aerosol can. Net to servicemen \$3.25  
Extra economical because a small amount does the job!

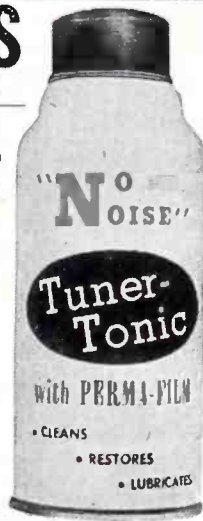

**ELECTRONIC CHEMICAL CORP.**

813 Communipaw Avenue

Jersey City 4, N. J.

# PROFITS JUMP **TELETEST**

WITH AMERICA'S NO. 1 TV TESTING INSTRUMENTS



RT-203

### REJUVAESTER

CRT tester and rejuvenator in one, compact featherweight unit, one knob control, large easy-to-read meter and neon short indicator. Restores normal performance on over 90% of all magnetically-deflected TV and industrial CRT's.

49.95 with carrying case **44.95**



CT-355

### CAPACITESTER

The first and foremost condenser tester designed to check coupling condensers, under load, without removal from the circuit. The elimination of grid current effects makes it superior to any volt-meter.

49.95 with carrying case **44.95**



FT-100

### FLYBACK TESTER

Engineered for the cost-conscious technician, here is the first and only flyback tester that doesn't require a reference transformer for comparison! Indicates true flyback condition under full operating voltage, 100% of the time.

49.95 with carrying case **44.95**

**TELETEST**

See your local jobber, or write TODAY.

121-08 14th Rd., COLLEGE POINT 56, N. Y.

(Continued from page 41)

bar; it is most noticeable on horizontal-bar and crosshatch patterns. Both jitter and crawl are highly undesirable and can cause considerable difficulty when it is necessary to concentrate upon a single dot or line on the picture-tube screen during convergence adjustments. These problems have been resolved through the use of the direct lock-in of the generator with station sync.

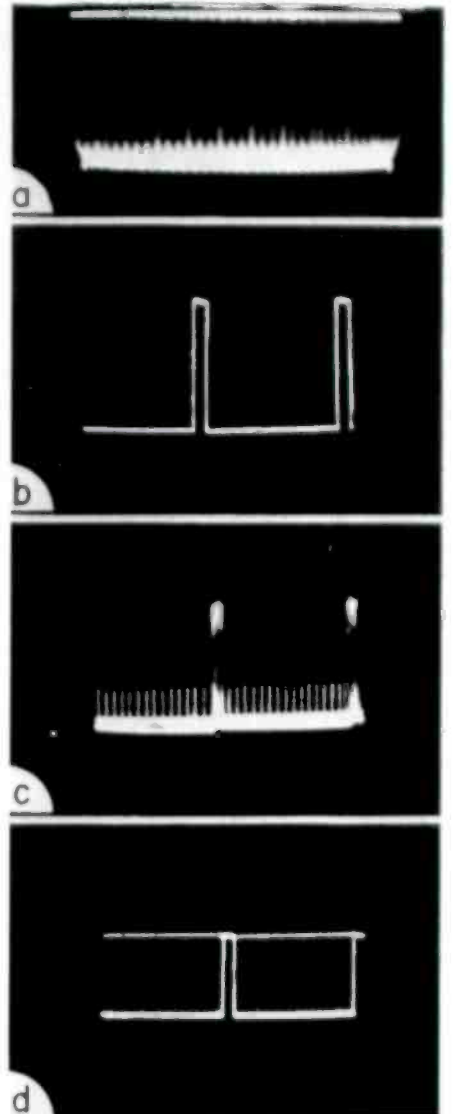

FIG. 9: WAVESHAPES observed at red output lead of generator: (a) = V bar; (b) = h bar; (c) = dot, and (d) = crosshatch.



## Don't Juggle a Heavy Chassis

WHEN A FINGER TIP WILL DO THE JOB FOR YOU...

How many times have you had to lift and turn a big chassis in order to get the light correctly focused so that you could make a solder connection...or look for a broken lead? All this extra work can now be eliminated if you put a LUXO LAMP above your bench.

**LIGHTWEIGHT AND PORTABLE... YET SO STURDY!**

The remarkable LUXO LAMP directs *all* the light where you want it. With just the touch of a finger, you can raise, lower, turn or tilt it to any angle... get just the desired focus, direction and intensity of light. Comfortable to work under, too, because it eliminates reflections and disturbing shadows... and provides glare-free illumination.

**INSPECT THE LUXO LAMP AT YOUR JOBBER TODAY!**

See for yourself why LUXO is the Ideal lamp for your service bench.



Approved by  
UNDERWRITERS  
LABORATORIES  
INC.

**LUXO LAMP CORPORATION • TUCKAHOE, N. Y.**

SAN FRANCISCO, CAL. • MONTREAL, QUEBEC



**IMPERIAL**

*television's  
most dramatic  
indoor antenna*

## Resistive Line-Voltage Regulators

(Continued from page 15)

which has a temperature coefficient of approximately 4800 ppm which accounts for the regulating characteristics.

The watt-load/voltage results obtained with a regulator designed<sup>o</sup> for a load range of 150 to 200 watts, are illustrated in the graphs shown in Figs. 1 and 2 (p. 15). It will be noted that with an increase in the watt load there is a corresponding increase in the current flow-voltage drop across the regulator element, and an increase in the temperature of the regulator.

### Selecting the Proper Regulator

The selection of the proper size regulator may involve several factors which will have effect on the result obtained or required. Regulators are made in several wattage ranges from 15 through 375 watts. The proper size regulator will to some extent depend on the conditions under which it will be operating. It is quite possible that the upper and lower limits of the regulator may not give the results required and the selection of a regulator on the range above or below will give better results. Generally, a regulator is used to prevent high voltage fluctuations from reaching the receiver and to act as a protective device to the set.

In selecting the proper regulator, it must be kept in mind that, with a given load, an increase in voltage across this load, will increase the power consumed by the load, and vice-versa, a reduction in applied voltage across the load will decrease the wattage consumed. Any change in this load will cause the voltage drop across the regulator to change. With an increase in load, voltage drop is increased; decreasing the load decreases the voltage drop. As the graphs indicate a 150-watt load gives approximately an 8½ volt drop across the regulator, whereas, with a 200-watt load, the voltage drop across the regulator is 21 volts.

If a 300-watt load is placed on this regulator, considerable heat would be generated in the element causing a large voltage drop. If the regulator did not burn out, we would find that the voltage drop would be so high that the voltage to the set would be undesirably low. On the other hand, if a set consuming 75 or 100 watts is used on this regulator, the voltage drop across the element would be so low as not to give protection to the set. With a drop of 8½ volts for 150-watt loads, a 75 or 100-watt load would be considerably less; therefore, if line voltage increases to 140 volts, the set could receive around 130 volts, which would be dangerously high to the set and its components.

Regulators are designed to handle a certain percentage of overload. However, overloads caused by high voltage, resulting in burn-out of the regulator prevents the high voltage from reaching the more expensive components in the set. It is preferable to have the regulator burn out than to have tubes and other components damaged by high voltage.

<sup>o</sup>Clarostat type C.

# 50 FREE



Perfect door opener—ideal maker of that extra sale—advertised in Life—Esquire—costs you nothing—the DFF\* Home Needle Tester Card. Lets you test needle in cartridge. Lets you sell needle each time. Write:

\*Duotone Fidelity Focus

THE DUOTONE COMPANY, INC.  
KEYPORT, NEW JERSEY

## Mr. Electronic Service Technician

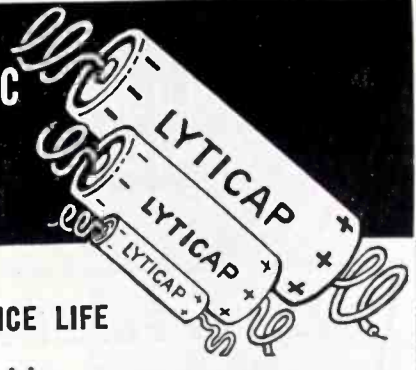

FOR LONGER SERVICE LIFE

you can rely on . . .

### LYTICAP\* ELECTROLYTIC CAPACITORS

You can recognize PLANET LYTICAPS by their shiny red cardboard jackets and their general neat workmanlike appearance. Available in all frequently used capacities from 3 to 500 volts, they are ideal for all types of service work—radio—television—industrial.

PLANET LYTICAPS are 100% tested for capacity and leakage; they receive a rigid mechanical inspection. Like all Planet products, they are fully guaranteed for one year. No wonder so many set manufacturers use them as original equipment!

Ask for PLANET LYTICAPS by name at your regular parts jobber.

\*Registered

PLANET SALES CORP.  
BLOOMFIELD, N. J.

## XCELITE Hand Tools

PREFERRED BY THE EXPERTS

MADE BY  
CRAFTSMEN  
—FOR  
CRAFTSMEN!



The "99" pocket roll kit was designed especially for the busy radio-TV-Hi-Fi man with the tools he needs, built the way he likes them. Those 9 chrome plated nut drivers have deep, draw-formed sockets for high accuracy and strength. The two Phillips and two regular screwdrivers are AISI6150 Electric furnace steel with true-fitting points. The king-size combination handle is made for a man's hand. And there's an extra pocket in your "99" for a supereamer—either the ¾" or the new ½" size. Your supplier has the "99" and any or all "99" parts for immediate delivery.

XCELITE, INCORPORATED  
Dept. V  
Orchard Park, N.Y.

In Canada—Charles W. Pointon, Ltd., 6 Alcina Ave., Toronto, Ont.

For Originality  
LOOK TO XCELITE



**Series or Parallel  
Booster!**



At All  
Distributors

manufactured by  
**Perma-Power COMPANY**  
4727 N. Damen Ave., Chicago 25, Ill.  
manufacturers of electronic equipment since 1928  
Export: SCHEEL INT., Chicago



**KEEP AHEAD**

by keeping informed. CORNELL-DUBILIER's pocket-size monthly magazine is loaded with technical articles that KEEP you ahead. PLUS a "Sell-Swap and Buy" section for your ad. Mailed FREE to your home every month for the asking.

CORNELL-DUBILIER ELECTRIC CORP.  
DEPT. S17 SOUTH PLAINFIELD, N. J.  
OK! Send me "The Capacitor"—Free

Name \_\_\_\_\_ Please Print!  
Address \_\_\_\_\_  
City \_\_\_\_\_ Zone \_\_\_\_\_ State \_\_\_\_\_  
My occupation or job title is \_\_\_\_\_

**BENCH-FIELD TOOLS**

**ELECTROLYTIC/TOOL KIT**

A COMBINATION ELECTROLYTIC capacitor-tool kit, *Pyra-Pak*, has been announced by Pyramid Electric Co., 1445 Hudson Blvd., North Bergen, N. J.

Kit contains both tubular and twist-mount electrolytics (in most frequently used values) packed in a metal tool box with a tool kit and two capacitor replacement booklets.

**FOUR-BLADE DRIVER KIT**

A STUBBY-SIZE screwdriver kit, *SK-20*, with four quick-change points, has been introduced by Xcelite, Inc., Orchard Park, N. Y.

Driver blades are double-ended, one with 3/16" regular and No. 1 Phillips; the other 1/4" regular and No. 2 Phillips. Blades are held in position by a 7/16" spring-loaded hex bushing imbedded in the handle, which doubles as a 7/16" nut driver.

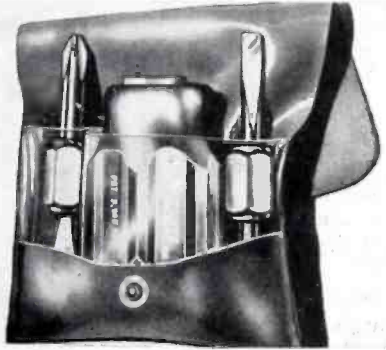

**SINGLE-POLE SOLDERING IRON**

A SINGLE-POLE soldering iron, *Gregg 250*, featuring a long tip for remote deep-in work, has been developed by Gregg Electric Co., 2 S. Broadway, Lawrence, Mass.

Replaceable tips are removed by unscrewing. Tips available include pencil point and chisel types.

**Successful Serviceman  
Does Better Job  
at Bench, in Field**

Direct-from-the-factory product information is the key . . .



**he finds it  
faster in  
The MASTER!**

The MASTER describes, illustrates, lists specifications of over 125,000 items necessary to radio-TV servicing. What's more—it offers thousands of other products that can lead to extra income in Hi-Fi, sound and industrial servicing. You can buy, sell and bill direct from The MASTER. It shows list prices! 1546 pages of current, direct-from-the-factory product information, systematically arranged for quick, easy reference.

1546 pages  
World's Largest  
Electronic Parts  
Catalog

**Get the NEW  
1957 Radio-Electronic MASTER**

at your parts distributor today

ONLY \$2.95 (21st edition)

The Radio-Electronic MASTER  
60 Madison Avenue, Hempstead, N. Y.

**ELECTRONIC CALCULATOR DISCS**

A SERIES OF electronic calculator discs covering Ohm's law, voltage or current versus decibels, capacitance reactance versus frequency and inductance reactance versus frequency, have been designed by Federated Purchaser, Inc., 1021 U.S. Route 22, Mountainside, N. J.

A different disc will be issued every month.

**THE KNOB YOU NEED—**

With the New

**UNIVERSAL  
KNOB SYSTEM**

- Any Knob . . . fits any stem . . . fits any shaft.
- 15 knobs . . . 10 stems . . . 1500 combinations

1 Choose your Knob  
any shape  
any type  
any color

2 Choose your stem—proper shaft type—right length.

3 Push together.

4 Presto  
The Knob  
you need.

*Instantly!*



Now you have no trouble or delay finding the knob you need. Yet you carry only a small stock of knobs at low cost.

See Your Jobber Today or Write  
COLMAN TOOL AND MACHINE COMPANY  
P. O. Box 7026 Amarillo, Texas

## COLOR-TV Picture-Tube Adjustments

(Continued from page 27)

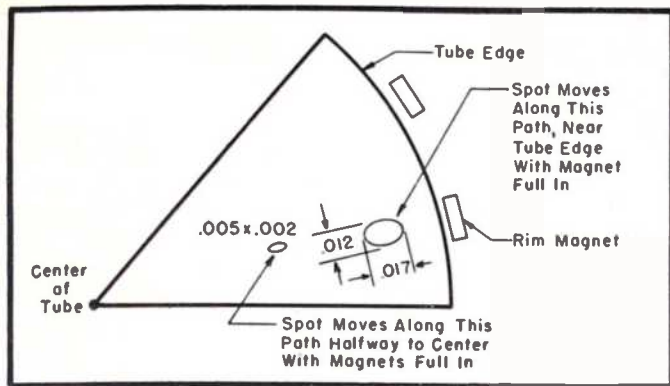

**FIG. 2: REACTION** of a field-neutralizing coil which creates a field parallel to axis of the tube around its edge, causing beams to shift on the dots.

field without harming the pure primary color fields.

When all of the foregoing adjustments have been made the receiver is ready to be adjusted for white balance. Usually the  $G_1$  and  $G_2$  controls have been radically changed in adjustment to obtain a blank color field and a complete readjustment must be made. With a vacuum-tube voltmeter, all the  $G_2$  voltages on all three guns should be set to some equal value of about 350 or about 200 v above the cathodes. The dot pattern should be removed and the receiver turned to a good monochrome signal. The contrast should be lowered to a minimum and the master brightness control turned until the raster is just blanked out. The red, green and blue-background controls, if present, should be adjusted, (often only green and blue are used) so that a very dim raster is neutral gray and not any particular color. The master brightness operation should then be checked. As the blank screen brightness is increased, the screen should always be some shade of neutral gray.

Now one should increase the contrast control until a normal picture appears. Both the highlights and the shadows should be a neutral gray in color. If the highlights are one color, the  $G_2$  voltage of that color should be raised. This also requires dropping the  $G_1$  voltage of the same color to give a neutral shade in the shadows. A monochrome receiver on the same channel is a good standard to match for white color. After the white balance has been found satisfactory, one should record the  $G_2$  and  $G_1$  voltages, as read with a *vtvm*. These settings

should not change throughout the useful life of the color tube and can easily be reset the next time the receiver is adjusted.

The remaining adjustments vary with the color mixing circuitry.

The color-mixing circuitry is usually described by the level at which the decoded color or chrominance signal is added to the luminance signal. In a low-level matrix circuit the decoded  $I$  and  $Q$  signals are added to the luminance signal to produce red, green, and blue signals, all of which are individually amplified and *dc* restored before being applied to the picture tube. A high-level matrix circuit, however, decodes the chrominance signal to color difference signals ( $R-Y$ ), ( $B-Y$ ) and ( $G-Y$ ), which are applied directly to the grids of the picture tube at the same time the luminance (or  $Y$ ) signal is applied to the picture tube cathode.

Most new-model receivers with 21-inch picture tubes use high-level matrixing. The luminance or monochrome signal is fed identically or in some fixed ratio to all three guns; thus there is no control over the video signal voltage to each individual gun. However, the actual beam current to each color screen can be varied by adjusting the  $G_1$  and  $G_2$  voltages on each gun. With a high-level matrix type of receiver, the background and  $G_1$  controls must be set to give a neutral gray on a very dim raster.

Thus far, all of the adjustments have been made to give a good b-w picture. With a receiver using a shadow-mask color-picture tube, a good b-w picture is the most difficult to obtain and such a picture indicates correct adjustment of the picture tube itself.

A color picture or color bar test pattern must be used to adjust the receiver color processing circuits. The fine tuning must first be adjusted until the colors are stable and the picture free of interference. Older color receivers were very critical for fine tuning, but the newer models have a fair range over which the fine tuning control gives a good color picture. The color hold control, if present, should be adjusted so there are no varying bars of color over the picture. The hue or color phase control is adjusted so the colors look correct. The best color to judge is flesh color, which can be varied with most hue controls from yellow-green to red. If flesh tones look right, all other colors will probably be correct. Chroma or color gain control adjusts the amount of color or saturation. If the control is set too low, the colors are more pastel than is natural. Control should be adjusted to suit the viewer's preference.

# TeleMatic

introduces

## FASTER SERVICING

with **TELECHECK**



### KIT INCLUDES:

- 8AXP4 Tube.
- Universal yoke with 6-foot leads and insulation piercing-clips.
- 6-foot CRT and anode extensions.
- Leatherette professional instrument case. Available with or without tube.



**FREE!** 16-page Booklet "Service Shortcuts"

Please send me **FREE** booklet!

Name \_\_\_\_\_  
Address \_\_\_\_\_  
City \_\_\_\_\_ State \_\_\_\_\_  
Distributor \_\_\_\_\_

**TELEMATIC INDUSTRIES, INC.**  
22 HOWARD AVE. • BROOKLYN 21, N. Y.



## REPUTATION

is what you make it. It will be the "best-in-town" if you read CORNELL-DUBILIER'S pocket-size monthly magazine chock full of reputation building service aids. Mailed **FREE** to your home every month for the asking—just use the coupon below.

CORNELL-DUBILIER ELECTRIC CORP.  
DEPT. S17 SOUTH PLAINFIELD, N. J.  
OK! Send me "The Capacitor"—Free

Name \_\_\_\_\_  
Please Print!

Address \_\_\_\_\_

City \_\_\_\_\_ Zone \_\_\_\_\_ State \_\_\_\_\_

My occupation or job title is \_\_\_\_\_

# Snyder

PHILADELPHIA

## IMPERIAL

television's  
most dramatic  
indoor antenna

**SAVE  
with  
SECURITY**



Because Wright Wire Strand comes to you pre-measured and uncoils without snarling, it gives to you unique economy. Quality wire, perfectly stranded and heavily galvanized, the bright Wright way. **SAVE** with Wright.

Prompt deliveries from stocks in Worcester, Chicago, Atlanta, New Orleans, Houston, Dallas and Los Angeles.

**G. F. WRIGHT STEEL & WIRE CO.**  
249 Stafford St. • Worcester, Mass.

## THE ALL-PURPOSE OSCILLOSCOPE

(MODEL 983)



A high gain, wide band scope which accurately reproduces waveforms comprising a wide band of frequencies.

No scope offers equal versatility and profit-making possibilities. High sensitivity of 15 millivolts per inch RMS makes it ideal for setting resonant traps, signal tracing in low level stages, as a general null indicator, phase characteristic measurements, sweep frequency visual analysis. At your distributor, or write for bulletin—R-36-A. WESTON Electrical Instrument Corporation, Newark 5, N. J. A subsidiary of Daystrom, Inc.

**WESTON** test equipment  
*The Quality Line*

## ASSOCIATIONS

### TESA, Chicago, Ill.

JOSEPH ISSAK has been elected president of TESA-Chicagoland, Ill. *William Larry Corlew* has been reelected first vice president. Also elected were: *John Cahill*, second vice president; *Clarence Wilhelm*, third vice president; *Sydney Terman*, secretary. *Bud Frohardt*, was reelected treasurer, *William Franz* is now sergeant-at-arms; *Fred Levine*, NATESA director; *Milton Stone*, NATESA Alternate. *Frank J. Moch*, was reelected chairman of the board.

### NATESA, Illinois

TESA, South Central Missouri and Radio and Television Technicians Guild of Florida, Inc., Dade County Chapter, have become affiliated with NATESA.

*James Rathbun* is president of TESA; *W. A. Pryer*, secretary-treasurer.

In the RTTG association *Samuel Kessler* is president; *Charles D. Pierce*, secretary.

### RTASCV, Santa Clara, Calif.

QUENTIN MUCHOW has been elected president of the Radio and Television Association of Santa Clara Valley, California, to fill the vacancy left by the resignation of *Al Limberatos*.

*Ben Floyd* has been named vice president.

### TEN YEARS AGO IN SERVICE

AN ERA OF specialization, featuring shops with Service Men teams expert in the repair of phonos, auto radio, home sets, FM and TV chassis, was predicted by industry heads. It was felt that such a program would not only assure better service, but expedite repair work and increase shop income. Associations applauded the forecast, declaring that such a trend would help everyone. A number of groups said that they would set up specialty clinics for their membership and call upon members of industry to supervise the classes. . . . New York University offered a series of courses in electronics, radio and TV for which there were no academic prerequisites. . . . Clarostat Manufacturing Co. released a volume-control cross-index guide. . . . Window antennas engineered for vertical polarization were announced by Ward Products. . . . TACO reported development of dipole antennas for FM and TV. . . . Members of the Radio Servicemen's Association of Luzerne County, Pa., were guests of FM station WIZZ and attended a clinic on receiver repair. . . . Centralab released the 11th edition of their volume control guide.



## ADVERTISERS IN SERVICE JANUARY, 1957

	Page
Allied Radio Corp.	47
American Elite, Inc.	48
Amphenol Electronics Corp.	26
Atlas Sound Corp.	38
B&K Manufacturing Co.	22
Blonder-Tongue Laboratories, Inc.	32
Bussmann Manufacturing Co.	5
Centralab, A Div. of Globe-Union, Inc.	3
Channel Master Corp.	14
H. G. Cisin	47
Clear Beam Antenna Corp.	30
Colman Tool and Machine Co.	44
Cornell-Dubilier Electric Corp. Inside Front Cover, 44,	45
Duotone Co., Inc.	43
Dynamic Electronics-New York, Inc.	39
Electro Products Laboratories	2
Electronic Chemical Corp.	41
Elgin National Watch Co., Electronics Div.	38
Fast Chemical Products Corp.	39
Federal Telephone and Radio Co., Div. of I. T. & T.	18
G-C Electronics Manufacturing Co., Div. of General Cement-Textron, Inc.	31
General Electric Co., Electronic Components Div.	4
Heath Co.	40
The Hickok Electrical Instrument Co.	39
The Institute of Radio Engineers Inside Back Cover	
Jackson Electrical Instrument Co.	48
Jensen Industries, Inc.	36
JFD Manufacturing Co., Inc.	25
Kester Solder Co.	40
Luper and Sundberg Manufacturers	41
Luxo Lamp Corp.	42
P. R. Mallory and Co., Inc.	23
Merit Coil and Transformer Corp.	33
Ohmite Manufacturing Co.	36
Planet Sales Corp.	43
Perma-Power Co.	44
Prentice-Hall, Inc.	33
The Radiart Corp. Inside Front Cover, 44, Radio Corporation of America, Tube Div. Back Cover	45
Raytheon Manufacturing Co.	7
Remington Rand Univac, Div. of Sperry- Rand Corp.	21
Service Instruments Corp.	36
Shure Brothers, Inc.	37
Simpson Electric Co.	27
Snyder Manufacturing Co.	36, 42, 45,
Telematic Industries, Inc.	45
TeleTest Instrument Corp.	42
Tenna Manufacturing Co.	19
United Catalog Publishers, Inc.	44
University Loudspeakers, Inc.	35
Westinghouse Electric Corp., Electronic Tube Div.	1
Weston Electrical Instrument Corp., A Subsidiary of Daystrom, Inc.	46
G. F. Wright Steel and Wire Co.	46
Xcelite, Inc.	43

### RTG, Long Island

CHRISTOPHER STRATIGOS and *Ralph Milne* have been elected president, and vice president, respectively, of the Radio and Television Guild of Long Island.

Stratigos succeeds *Murray Barlowe* as Guild president.

Others named include: *Bob Barasch*, recording secretary; *Jack Wheaton*, secretary; *Bob Larsen*, treasurer; and *Tim Barbash*, sergeant-at-arms.

Six were elected as trustees: *Bob Henderson*, *Henry Warwick*, *Earl Horton*, *Fred Strickland*, *Jim Holmes* and *Mike Toto*.

### RTTA, Pasadena, Calif.

AT THE ANNUAL ELECTION of the Radio Television Technicians Association, Pasadena, California, *Frank Fisher* was elected president.

Other officers elected were *Bill Yatty*, first vice president; *Ben Leff*, second vice president; *Ron Kealy*, secretary, and *Ray Doyle*, treasurer, *Ben Leff* was also named delegate to the California State Electronics Association.



**AT PRESENTATION of the NATESA Friends of Service Management award to CBS-Hytron, during a recent Garry Moore telecast, left to right: Frank Moch, NATESA executive director; Charles F. Stromeyer, president, CBS-Hytron, who received the award; Garry Moore, and Robert W. Hester, president of NATESA, who made the presentation.**



## SHOOT TV TROUBLE FAST

### With H. G. Cisin's Copyrighted RAPID "TV TROUBLE SHOOTING METHOD"

Without experience or knowledge, this guaranteed new method of servicing TV sets, enables you to DIAGNOSE TV troubles as rapidly as an expert. NO THEORY—NO MATH—you can locate all faults in record-breaking time regardless of make or model. "TV TROUBLE SHOOTING METHOD" is the most valuable aid to TV servicing ever written. Be a TV Trouble Diagnostician. Increase your present earnings. Open your own Profitable Business or get a high-paying skilled job.

It's all in this book . . .  
Nothing more to Pay—Nothing else to Buy

85 picture troubles, over 58 raster and 17 sound troubles. By this unique copyrighted method you know EXACTLY WHERE the trouble is: plus step-by-step instructions, including 89 RAPID CHECKS, enabling you to find the faulty part.

13 IMPORTANT PRELIMINARY CHECKS NEED NO INSTRUMENTS! Of the 89 Rapid Checks, OVER 65 ALSO REQUIRE NO INSTRUMENTS! Rapid checks include emergency checks for distorted pictures, defective tubes including PIX tube, plus 57 others. ALL EXPLAINED IN SIMPLE LANGUAGE. PERFORMED WITHOUT INSTRUMENTS. MANY CHECKS USE THE PICTURE TUBE AS A GUIDE.

H. G. Cisin, the author, is the inventor of the AC/DC midjet radio. He licenses RCA, AT&T, etc. He has also trained thousands of technicians now owning their own prosperous TV service organizations or holding highly paid TV positions. His years of experience are embodied in this remarkable new book.

Guaranteed, Money Back In 5 Days If Not Satisfied!

ABSOLUTELY FREE with each order:  
H. G. Cisin's newest book "TV & RADIO  
TUBE SUBSTITUTION GUIDE." Gives direct  
replacements of set and picture tubes.  
Most valuable servicing aid! ACT NOW—  
get both books postpaid at cost of only one! **\$1** Postpaid

RUSH COUPON NOW!

H. G. CISIN, CONSULTING ENGINEER,  
Amagansett, N. Y. Dept. S-34

Enclosed find \$1. Rush both books.

Name \_\_\_\_\_  
Address \_\_\_\_\_  
City \_\_\_\_\_ Zone \_\_\_\_\_ State \_\_\_\_\_



### BUILD YOUR OWN

## NEW knight-kit FLYBACK CHECKER KIT Helps You Earn More

only **\$19.50**

Race through TV deflection circuit repairs—boost your profits! This new Flyback and Yoke Tester checks all standard types of horizontal output transformers, deflection yokes, linearity and width coils. Positively indicates shorted turns for any coil with "Q" greater than 1, and inductance between .003 and 2 henries. Determines continuity of any circuit with resistance from zero to .5 meg. Checks much wider range of inductances than any other unit. Big 4 1/2" meter; 6S4-A pulsed oscillator circuit. Complete with case, all parts and test leads. Shpg. wt., 5 1/2 lbs.

Model 83 Y 118. Net only **\$19.50**

Net F.O.B. Chicago

**FREE**



### 356-PAGE ALLIED CATALOG

Lists dozens of other low-cost quality Knight-Kit test instruments, plus the world's largest selection of parts and equipment for service work. Write for FREE copy.

## ALLIED RADIO

ALLIED RADIO, Dept. 23-A-7  
100 N. Western Ave., Chicago 80, Ill.

Send Kit No. 83 Y 118. \$\_\_\_\_\_ enclosed  
 Send FREE 356-Page ALLIED Catalog.

Name \_\_\_\_\_

Address \_\_\_\_\_

**You're Ready  
for any Service Job**

with

**JACKSON**

*"Service Engineered"  
Test Equipment*

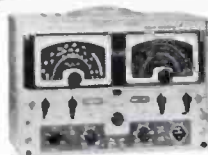

**TVG-2  
Sweep  
Marker  
Generator**

Dealer Net \$259.95

A complete TV generator plus crystal calibrator. Sweep 30KC through 216MC. Width adjustable from 0 through 18MC. Accurate Marker 4MC through 216MC. Crystal oscillator for frequencies to 20MC. Provision for Video Modulation.

**CRO-2  
Wide Band  
High Sensitivity  
5-inch Scope**

Dealer Net \$225.00



Flat within 1 db from 20 cycles through 4.5MC. Sensitivity from .018RMS volts per inch. Positive or Negative Internal horizontal sync. Saw tooth sweep 20 cycles through 50KC. Many accessories including low capacity probes.

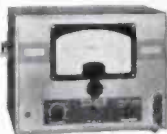

**Model 655  
Wide Range  
Audio Oscillator**

Dealer Net \$135.00

Highly stable RC sine wave generator. Range 20 cycles to 200 kc in 4 steps. Up to 500 milliwatt output at impedances of 10, 250, 500, 5000 ohms or HiZ. Frequency characteristic 1db., 30 to 15k cycles. Accuracy 3% or 1 cycle.

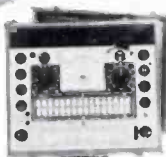

**Model 648A  
Dynamic<sup>®</sup>  
Tube Tester**

Dealer  
Net \$129.95

Fastest tester on the market—and featuring famous Jackson Dynamic Circuit. Meter calibrated in Good-Bad, as well as percent Transconductance. Correct test voltage for all tubes including latest 600-mil types. Line Voltage Indicator.

**JACKSON**  
ELECTRICAL INSTRUMENT CO.

World's largest exclusive makers of  
factory-built service test equipment.

16-18 S. Patterson Boulevard • Dayton 2, Ohio  
In Canada: The Canadian Marconi Co.

## PERSONNEL

LOUIS W. SELSOR, formerly distributor sales manager of Jensen Manufacturing Co., has joined Electro-Voice, Inc., Buchanan, Mich., as general sales manager. . . . Frank D. Lintern has been named assistant distributor sales manager. . . . C. E. Seaman is now sales manager of Power-Point phono cartridges.



Selsor



Lintern

JAMES H. OWENS has been appointed manager, advertising and market research, for the RCA components division, Camden, N. J. . . . G. G. Griffin has been appointed manager, product advertising and sales promotion, for the RCA tube division. . . . R. A. Huff is now manager, ad and sales promotion, entertainment market. . . . F. X. Banko has been named manager, ad and sales promotion, industrial market. . . . F. T. Vanacore is the new administrator for picture-tube renewal advertising. . . . E. B. May is now administrator, advertising and sales promotion for semi-conductors.

DELMAR F. ORE has joined CBS-Hytron, Lowell, Mass., as sales coordinator for semiconductors.

FRANK H. RUSSELL has been appointed manager of advertising and sales promotion for Lenkurt Electric Co., San Carlos, Calif.

THOMAS L. DOWELL has been promoted to jobber sales manager of The Alliance Manufacturing Co., Inc., Alliance, Ohio.

WILLIAM T. BUSCHMANN has been named electronic products merchandising manager of Sylvania Electric Products, Inc., 1470 Broadway, New York 19, N. Y. . . . E. P. Atcherly is now assistant to the sales manager for distributor sales.

HIRAM A. PRINCE has been promoted to assistant general sales manager of Permo, Inc., 6415 N. Ravenswood Ave., Chicago 26, Ill. . . . J. W. Crudgington is now Southwestern division sales manager.

GAIL S. CARTER has been elected to the board of directors and appointed assistant to the president of Merit Coil and Transformer Corp., 4427 N. Clark St., Chicago 4, Ill.



Gail S. Carter

Europe's  
largest selling  
electronic tubes  
... and at standard prices!

**TELEFUNKEN**

electronic pioneer  
since 1903



**NOT A REPLACEMENT  
BUT AN IMPROVEMENT!**

**NO  
RETURNS  
NO  
MICROPHONICS  
NO  
DISTORTION  
NO  
COMPROMISE  
WITH  
QUALITY**

Write for your Telefunken Tube Manual and  
for the name of your nearest jobber.

Exclusively imported by

**AMERICAN ELITE, INC.**

Dept. Z, 7 Park Avenue, New York 16, N. Y.

Exclusive importers also of Hi-Fi Home Systems,  
Microphones and Hi-Fi FM Car Radios.

# THE RADIO ENGINEERING SHOW

*moves to the COLISEUM!*

MARCH 18-21 · NEW YORK CITY

*SO BIG it takes all 4 floors of New York City's Coliseum to hold this year's great annual IRE Radio Engineering Show. For 4 phenomenal days the largest show ever assembled will open its doors to more than **41,000**\* engineers just 4 minutes from Times Square.*

IS IT TOO BIG—not for a 12 billion dollar and still growing industry! More than 200 papers presented by 22 professional groups at the Convention's 55 technical sessions will summarize all that's new in radio-electronics research and development... the 834 exhibitors will also represent over 80% of the productive capacity of the industry.

Not by a long shot is this show too big for what will soon be our nation's largest industry. Plan now to be at this vitally important radio-electronics show!

\*41,017 engineers and businessmen from coast to coast and in every field of radio-electronics attended the 1956 Radio Show... the forecast for 1957 is even higher!

**OVER 800 NEW IDEAS  
IN RADIO-ELECTRONICS  
ENGINEERING  
PRESENTED BY MORE THAN  
800 EXHIBITORS!**

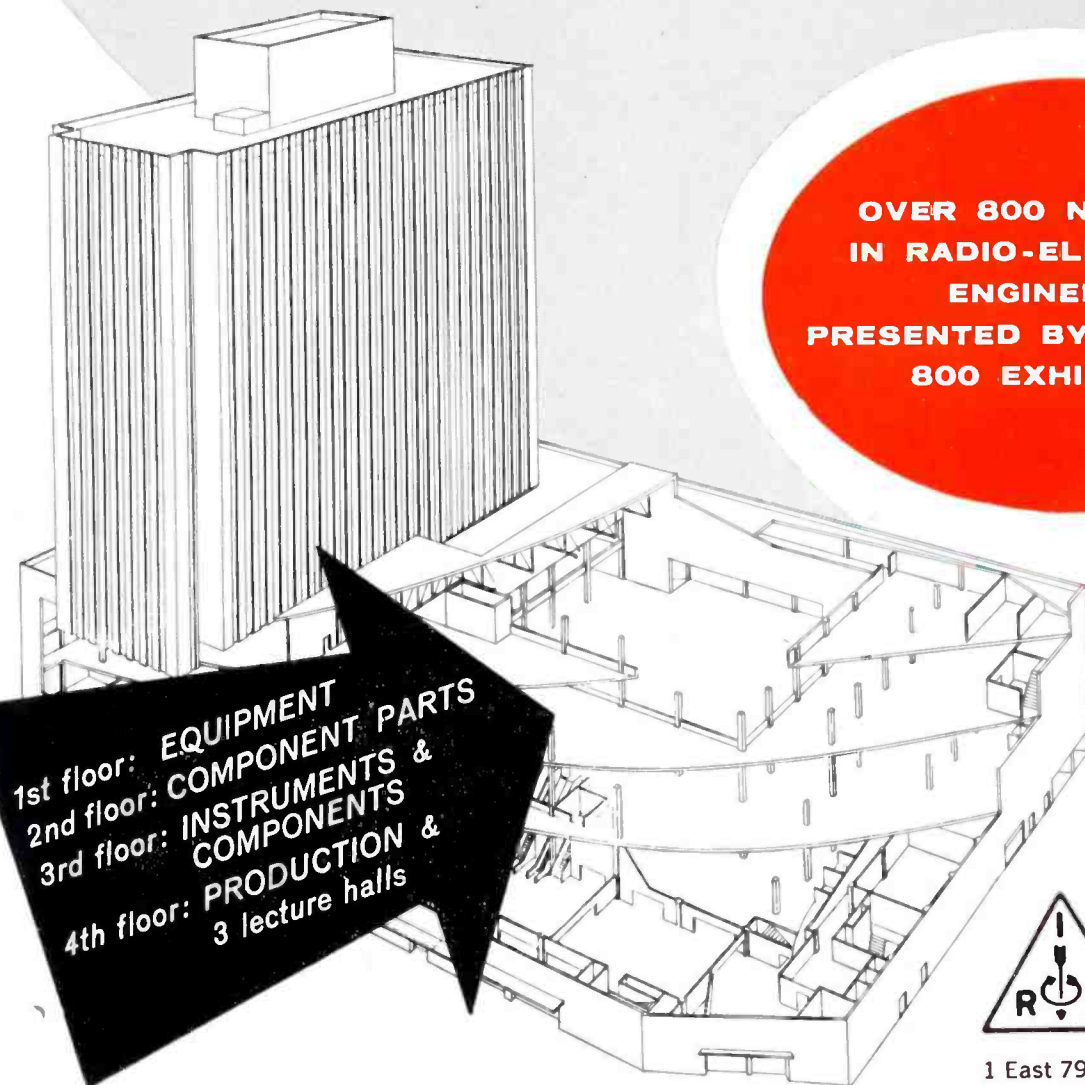

The  
Institute of  
Radio  
Engineers

1 East 79th Street, New York 21, N.Y.

IT TAKES TWO:

# RCA and YOU

**RCA**  
to produce high-quality Picture Tubes



**YOU**  
to sell and install them



When the customer says, "Why?", "What?", "How Much?", don't just talk tubes, talk:

- QUALITY** Tell them how an RCA picture tube must pass well over 100 careful inspections before it's good enough for you—or your customer.
- ACCEPTANCE** Remind them that more people view TV shows on RCA picture tubes than on any other brand.
- BRAND NAME** Emphasize RCA—the name that's first in electronics.
- WARRANTY** The Warranty Card you give your customers says the tube is an RCA tube; it says it's factory-fresh; above all it says: "warranted for a year."

Today, your customers are well-informed TV viewers who demand the best in picture tube performance. These are the people who, week in and week out, read the RCA Silverama story in Life, TV Guide, the Saturday Evening Post. These are the people who see and hear the RCA Silverama quality story on NBC's network radio and TV shows. And these are the very customers who say "yes" to RCA. So, team-up with RCA. You'll know the difference, and your customers will see it—big and bright as life.



## Silverama



### PICTURE TUBES

RADIO CORPORATION OF AMERICA  
Tube Division • Harrison, N. J.