

# SERVICE

THE TECHNICAL JOURNAL OF THE TELEVISION-RADIO TRADE

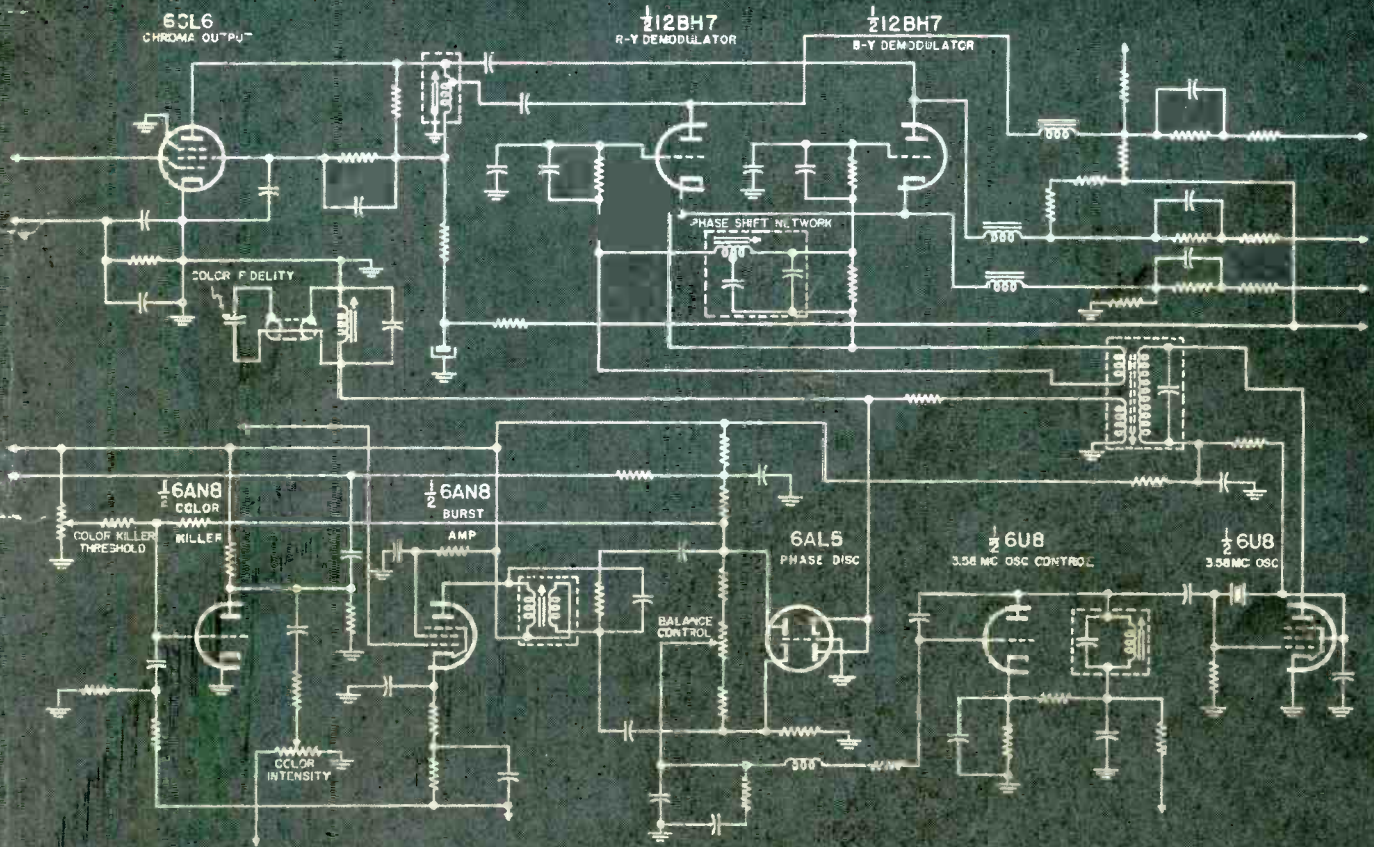

Color killer and high-level demodulator circuits in 21-inch 21-inch color-TV set. See circuit analysis, this issue

2-57  
 2125 N. SUPERIOR ST.  
 CHICAGO 12, ILL.  
 55-22-55

the fastest selling  
ROTORS

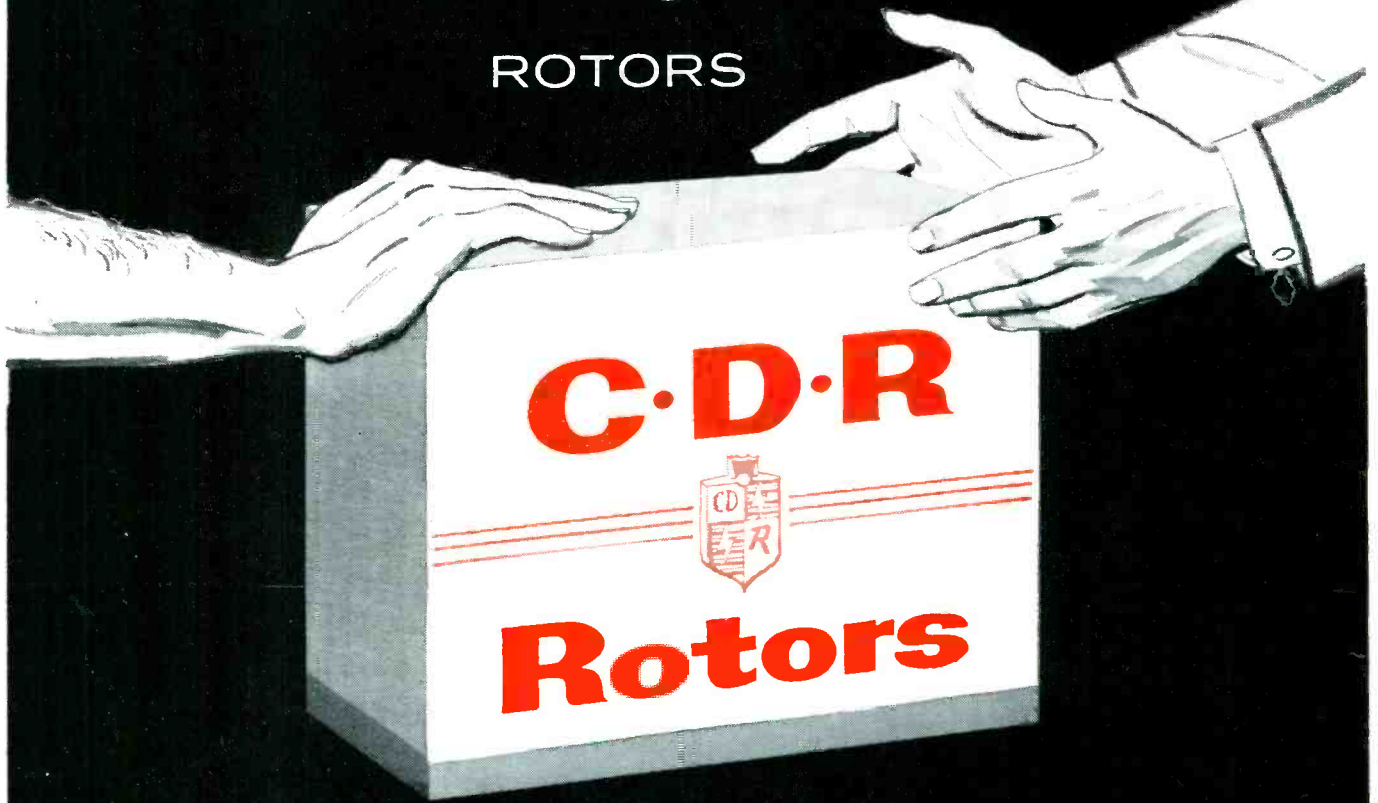

because...

- ✓ Pre-Sold to millions every week on TV
- ✓ The Most Complete Line... A Model for Every Need
- ✓ Superior Engineering... they're Tried-Tested-Proven

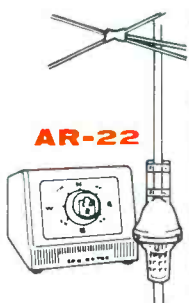

**AR-22**

Completely AUTOMATIC version of the TR-2 with all the powerful features that made it famous.

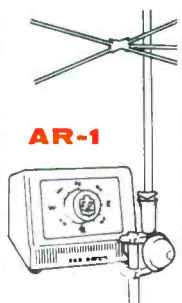

**AR-1**

Completely AUTOMATIC rotor, powerful and dependable. Modern design cabinet. 4 wire cable.

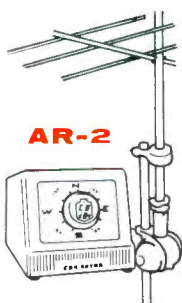

**AR-2**

Completely AUTOMATIC rotor with thrust bearing. Handsome cabinet, 4 wire cable.

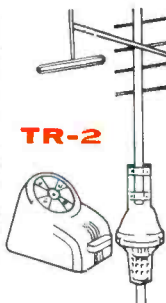

**TR-2**

Heavy-duty rotor with plastic cabinet, "compass control" illuminated perfect pattern dial, 8 wire cable.

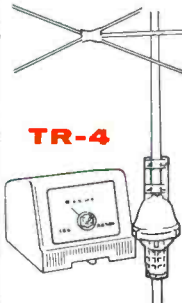

**TR-4**

Heavy-duty rotor, modern cabinet with METER control dial, 4 wire cable.

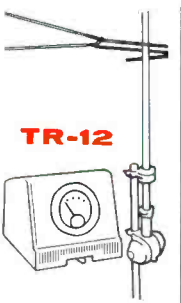

**TR-12**

Combination value... complete rotor with thrust bearing. Modern cabinet with meter control dial, uses 4 wire cable.

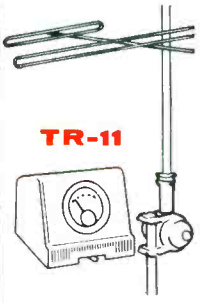

**TR-11**

Ideal budget all-purpose rotor, new modern cabinet featuring meter control dial, 4 wire cable.



**CORNELL-DUBILIER**  
SOUTH PLAINFIELD, N. J.



**THE RADIART CORP.**  
CLEVELAND 13, OHIO

these 3 hot dipped galvanized  
towers

are exclusive with

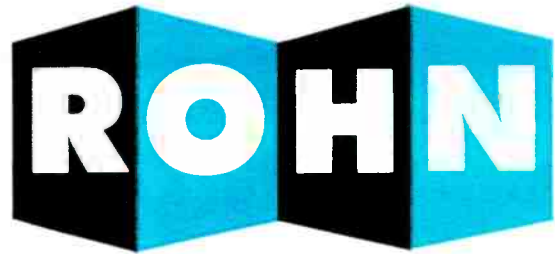

*No guying needed to 40—50—or  
60 feet! Guyed heights safely  
up to 200—300 feet!*

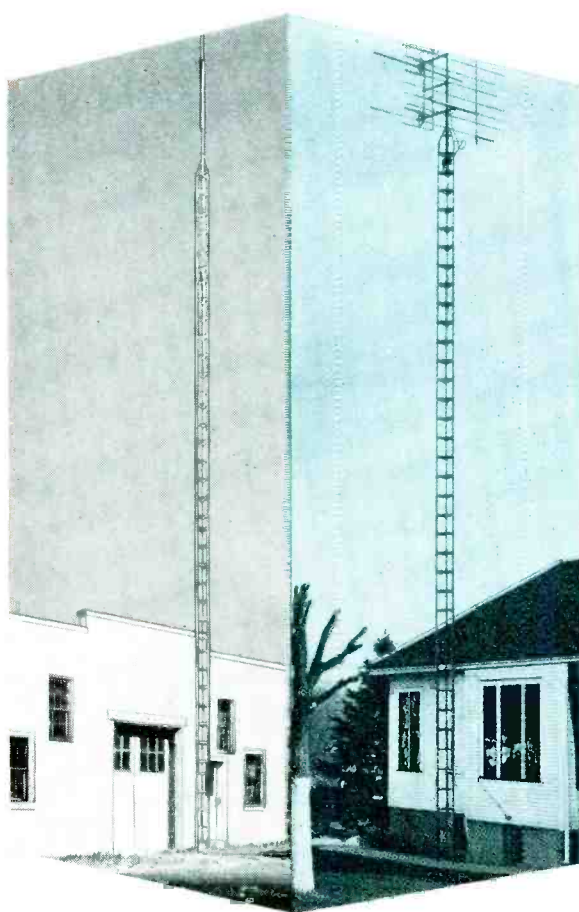

**NO. 6 TOWER**

Features unexcelled 12½" equilateral "magic triangle" design with electric welding throughout. Self-supporting to 50', the Rohn No. 6 is ideal for home TV installation.

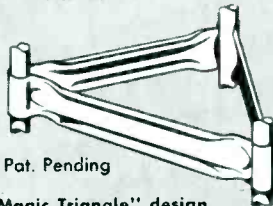

Pat. Pending

"Magic Triangle" design utilizes mass production machines — means sturdier towers, uniformity and lower costs!

**"PACKAGED" TOWER**

Constructed for ease in shipping and storage. A 43' tower comes in six 8' sections bound together in a single 8' x 20" package! Self-supporting and available in 24' to 64' sizes.

and now, a new and completely hot-dipped galvanized, heavy duty

**NO. 40 COMMUNICATIONS TOWER**

For extreme heights and communication purposes of all kinds, the Rohn No. 40 gives you strength and durability on which you can depend. The time tested and proven equilateral triangle design using extra heavy duty tubing and corrugated steel cross-bracing is utilized in this new Rohn Tower. The No. 40 is structurally sound so that you can install it for heights up to 300'; and is preferred for lesser heights when considerably greater strength is required because of excessive wind or antenna loading, etc. Check this tower for your requirements of this type. You'll find it just can't be beat, neither structurally nor price-wise!

Note: For lesser heights, use the Rohn No. 20 or No. 30 Tower . . . for experimental operation, use the Rohn "Fold-Over" Tower.

All Rohn Towers are quickly erected- shipped in easy-to-handle sections; and, Rohn-Designed accessories are available with each tower.

Check the complete line of Rohn Towers, including Roof Towers, Masts and Tubing . . . plus a full line of tower and TV installation products such as bases, house mounts, brackets, service tables, guy brackets and rings plus dozens of other items.

**ROHN** Manufacturing Company

116 LIMESTONE, BELLEVUE  
PEORIA, ILLINOIS

**MAIL THIS COUPON FOR FREE LITERATURE!**

Rohn Manufacturing Company  
116 Limestone, Bellevue  
Peoria, Illinois

Gentlemen: Please rush me complete details on the full line of Rohn Towers and Accessories.

Firm \_\_\_\_\_

Name \_\_\_\_\_ Title \_\_\_\_\_

Address \_\_\_\_\_

City \_\_\_\_\_ State \_\_\_\_\_

A New, **SLIM** Modern Dynamic

So **LOW** in Price

So **HIGH** in Quality

**ASTATIC** *Wide Range*

# Dynamike

M-352 LOW IMPEDANCE — M-350 HIGH IMPEDANCE



• For Public Address



• For Recording



• For Broadcasting



• For Telecasting



Shown  
Actual  
Size

**N**EVER before has such a versatile, high output, attractive dynamic microphone been available in high and low impedances at such a low price! The Dynamike has the response and performance found up to now only in higher priced models. Adaptable for hand, desk and floor stands — ideal for all-around use. Compactly styled, feather-weight (7 1/4 oz.), satin black glareproof finish with brushed chrome trim. Perfect for announcer and performer. Frequency response — 50 to 10,000 cps. Cable length 18 ft.

LIST PRICE

Model 352 less switch .....	<b>\$37.50</b>
Model 352S with switch .....	<b>40.25</b>
Model 350 less switch .....	<b>39.95</b>
Model 350S with switch .....	<b>42.70</b>



and **THERE'S MORE**  
**BIG NEWS**  
**NEXT MONTH**

... the Great New **FUTURA** Series

THE **Astatic** CORPORATION, CONNEAUT, OHIO

IN CANADA: A CANADIAN ASTATIC LIMITED, TORONTO, ONTARIO

Export Sales Representatives: 401 Broadway, N. Y. 11, N. Y. Cable—ASTATIC N. Y.



**EDITOR and PUBLICATION DIRECTOR**

**Lewis Winner**

Associate Editor: **David E. Pearsall II**  
Assistant Editor: **Robert D. Wengenroth**  
Editorial Assistant: **Eli Cohen**

Art Director: **Anthony R. Aliff**

Supervisor, Circuit Diagrams:  
**Michael D. Belleza**

Editorial Production: **Astrid Kelly**

**CIRCULATION DEPARTMENT**

Circulation Manager: **A. Goebel**

Ass't Circulation Mgr.: **A. Kiernan**

**ADVERTISING DEPARTMENT**

Advertising Mgr.: **Aaron L. Lafer**

Business Mgr.: **F. W. Boyd**

Mid-West Mgr.: **Stuart J. Osten**  
333 N. Michigan Ave.  
Chicago 1, Ill.  
Tel.: DEarborn 2-3507

East-Central Rep.: **James C. Munn**  
2253 Delaware Dr.  
Cleveland 6, O.  
Tel.: ERview 1-1726

Pacific Coast Rep.: **Brand & Brand**  
1052 W. 6th St.  
Los Angeles 17, Cal.  
Tel.: MADison 6-1371

Published Monthly By  
**Bryan Davis Publishing Company, Inc.**  
52 Vanderbilt Ave., New York 17, N. Y.  
Tel.: MURray Hill 4-0170

B. S. Davis, Pres. F. W. Boyd, Sec'y

# SERVICE

The Technical Journal of the Television-Radio Trade

Including SERVICE—A Monthly Digest of Radio and Allied Maintenance; RADIO MERCHANDISING and TELEVISION MERCHANDISING. Registered U. S. Patent Office.

## COVER CIRCUIT

Color Killer-High Level Demodulator Color System (Admiral 28Y1) . . . . . 14

## FEATURES

Editorial . . . . .	Lewis Winner	11
Service Engineering in Sacramento, Calif. (Field Report) . . . . .	L. Irl Wilson	12
Circuitry Report on Admiral Color-TV Chassis (Cover . . . . . With Complete Circuit) . . . . .	John Schumacher	14
Yoke Problem Service Chart (With Typical Patterns) . . . . .	Jess Dines	18
A Report on Transistorized Portables (With Complete Circuits) Ken Kleidon		20
SERVICE . . . The National Scene . . . . .		22
450-Mc Equipment Design-Maintenance (Service Engineering) G. A. Svitek		26
Drop Compensating Kilovoltmeter . . . . .	Ronald Ives	32
Increasing Transistor Set Sensitivity . . . . . TV Spurious Modulation Cures . . . . .		37
Antennas, Transmission Lines and Distribution Systems for Color TV . . . . .	J. D. Callaghan	39
Testing Tubes for Critical Circuits . . . . .		40
Portable Record Player Modification Improvements . . . . .	R. D. Wengenroth	42
Input Transformer Replacement Requirements . . . . .		50
Portable Phono Troubleshooting . . . . .		56
Circuit Diagrams In This Issue . . . . .		68

## DEPARTMENTS

Association News . . . . .		24
Ten Years Ago in SERVICE . . . . .		24
Personnel . . . . .		25
UHF/VHF TV Antenna Digest . . . . .		39
Tube News . . . . .		40
News . . . . .		46
Catalogs and Bulletins . . . . .		47
Audio Installation and Service . . . . .		50
Components . . . . .		57
Bench-Field Tools . . . . .		59
Instruments . . . . .		60
TV Accessories . . . . . Parts . . . . .		61
Index to Advertisers . . . . .		67

Entire Contents Copyright 1956, Bryan Davis Publishing Co., Inc.

Second-Class mail privileges authorized at New York, N. Y.; additional entry at the Post Office, Norwalk, Conn.  
 Subscription price: \$2.00 per year in the U.S.A. and Canada; 25 cents per copy. \$3.00 per year in foreign countries; 35 cents per copy.

**DETERIORATION  
PROOF**

**"The ONLY new development in TV transmission line in 10 years"**

*Columbia*  
**Permaline**  
**ELIMINATES**  
**RAPID**  
**DETERIORATION**

**Specify**

*Columbia*

**because it's  
 guaranteed up to  
 25 years to:**

- ★ Resist salt spray and salt air
- ★ Resist fumes from chemical plants and oil refineries
- ★ Resist severe low temperatures
- ★ Resist sunlight and ultra-violet light
- ★ Resist deterioration for countless other reasons

PERMALINE TV TRANSMISSION LINE reduces servicemen nuisance calls; means happier customers; provides better signals because of longer life.

Available at leading distributors!

*Columbia*  
**WIRE & SUPPLY CO.**  
 2848 Irving Park Road • Chicago 18, Ill.

*Dealers by the thousands are  
making the SWITCH*

*to this great insulator idea!*

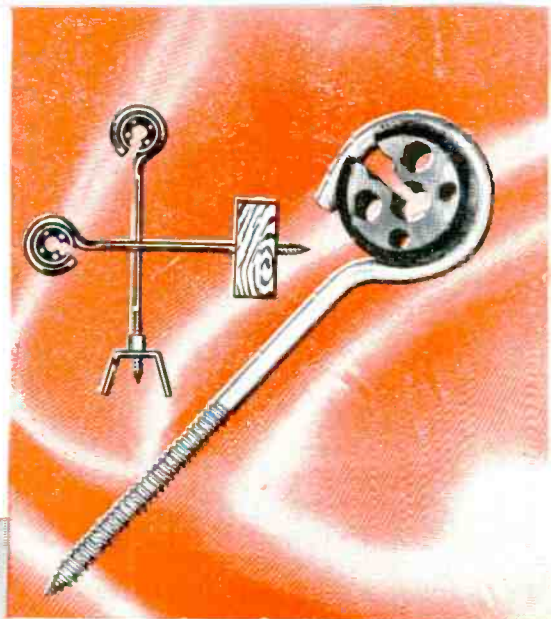

*when we say*

**SWITCH**

*we mean  
business!*



*New indoor antenna has  
gliding SWITCH*



Only **CHANNEL MASTER®**

**STANDOUT**

*insulators*

have this revolutionary  
**2 in 1 design**

*It's a wood-screw insulator  
... it's a machine-screw insulator  
... and it's BETTER in both applications!*

STANDOUT insulators and buckles are already outselling all others — after only a few months on the market! This remarkable record provides positive proof of the solid acceptance STANDOUTs have won among dealers all over the country.

Why has the response to STANDOUTs been so enthusiastic? BECAUSE they cut space and dollar investments in accessories by more than 65% . . . BECAUSE they increase space and dollar turnover by more than 200% . . . BECAUSE they are easier to install, stronger, more durable.

**Millions already sold!**  
**Here's why:**

**"T-Nut" buckle with 8 threads.**

More threads than any other buckle (nut type or extruded) — 8 full machined threads! Tighten as hard as you want, you can't strip it!



**Pointed Screw makes positive contact.**

Strap won't slip while you're tightening. Won't twist or slip on mast after installation. Straps have convenient "taper-tip."



**Needle-sharp point**

Finer thread, sharper point means easier starting — even in hardwood. Minimizes possibility of splitting.

**Ordinary standoff point.**



**STANDOUT point.**

All popular types and sizes available, including full assortment of specialized hardware. See your Channel Master distributor

**CHANNEL MASTER'S**

new **Glide-o-Matic**

**INDOOR TV ANTENNA**

The Glide-o-Matic's sensational low-loss **gliding switch** is different from all others! Provides highest electrical efficiency . . . AND — it's the most convenient to operate!

**Glide-o-Matic also gives you:**

- Maximum performance on all channels — VHF and UHF.
- Weighted tip-proof base — with "can't scratch" felt covering.
- Ready for COLOR TV.
- Powerful retail merchandising support.

Available in  
**4**  
popular color  
harmonies:

Mahogany	with brass	model no. 3700
Ebony	with brass	model no. 3701
Ivory	with brass	model no. 3702
Ebony	with aluminum	model no. 3703



® Trade-Mark Reg. U.S. Pat. Off.

**A performance hit with men...**

**A style hit with women!**

Glide-o-Matic practically sells itself. Smartly styled . . . blends into any setting. Packed in colorful "tell and sell" carton with convenient "carry away" handle.



**\$9.95**  
list

**Also available:**

**CHANNEL MASTER'S ALL-VU**  
model no. 381, all-VHF, all UHF.

\$8.95  
list



**CHANNEL MASTER'S PRE-VU**  
model no. 380 all-channel VHF.

\$7.95  
list



**CHANNEL MASTER CORP.**  
ELLENVILLE, N. Y.

WORLD'S LARGEST MANUFACTURER OF TV ANTENNAS AND ACCESSORIES

# Sprague Salutes the Independent Service Dealer

Ask your distributor  
for big, window-size  
blow-ups of this ad,  
or write directly to  
Sprague Products Co.,  
North Adams, Mass.,  
on your letterhead.

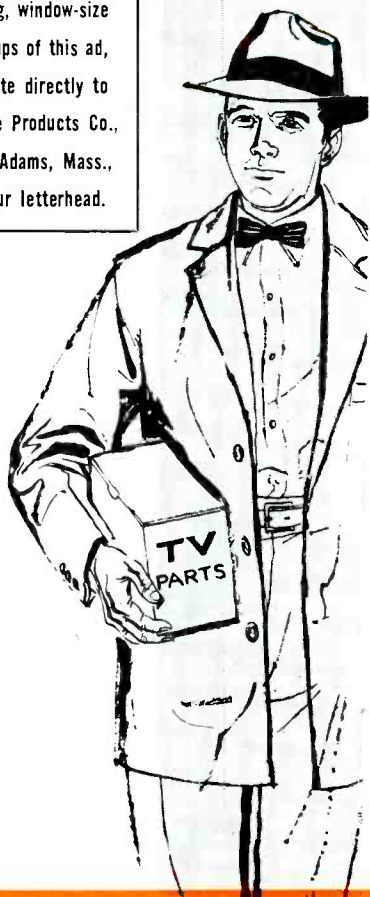

## HERE'S TO THE MAN

- ... who assures your enjoyment of the best entertainment in the land.
- ... who competently and conscientiously keeps your TV and radio in top operating condition.
- ... who has become a specialist in his chosen field like your doctor, lawyer, or dentist.
- ... who has the finest service equipment to operate his own business in your home community.
- ... who stands alone... serving no other boss than you, the customer.
- ... who has earned your patronage, respect, and confidence as an important asset to the community he serves.

**YOU CAN DEPEND ON THIS MAN**

# SPRAGUE

WORLD'S LARGEST MANUFACTURER OF ELECTRONIC COMPONENTS

®



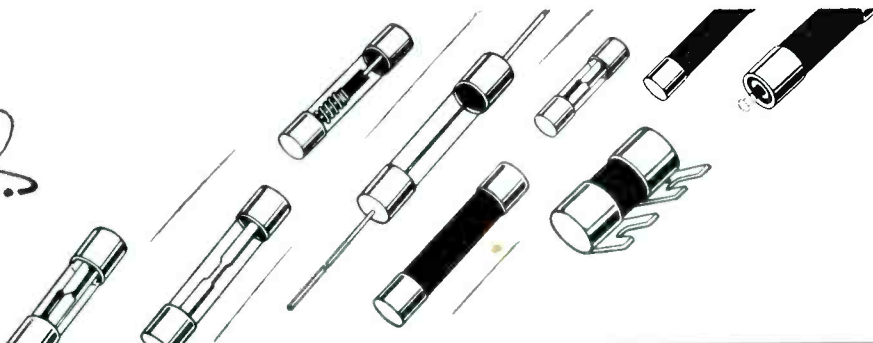
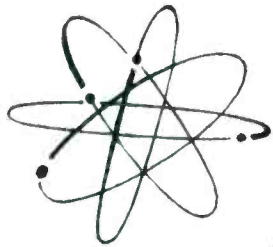

# dependable BUSS FUSES can help safeguard the good name of your Product or Service

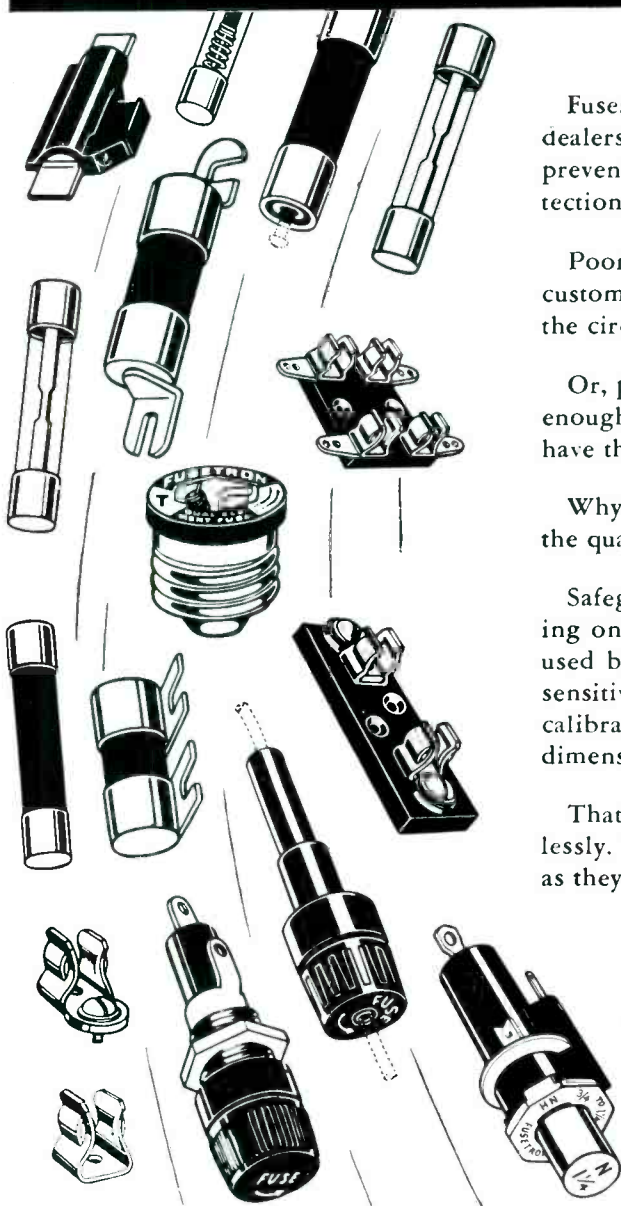

Fuses may be considered a small item by many service dealers and manufacturers—however, BUSS quality fuses can prevent endless trouble by giving dependable electrical protection under all service conditions.

Poor quality fuses can blow needlessly and shut down your customers' equipment — even though no trouble exists on the circuit.

Or, poorly made fuses might *not* shut down the circuit quick enough when there is an electrical fault — and your customers have the expense of replacing needlessly burned out parts.

Why chance having these troubles mistakenly blamed on the quality of your product or service?

Safeguard against loss of customer good will by standardizing on "trouble-free" BUSS fuses. Each BUSS fuse, normally used by the Electronic Industries, is electronically tested. A sensitive device automatically rejects any fuse not correctly calibrated, properly constructed and right in all physical dimensions.

That's why BUSS fuses blow only to protect — never needlessly. Thus they help safeguard your good name — as surely as they protect users.

Makers of a complete line of fuses for home, farm, commercial, electronic, automotive and industrial use.



S-356

**BUSSMANN MFG. CO.**

(Div. McGraw Electric Co.)

University at Jefferson St. Louis 7, Mo.

SERVICE, MARCH, 1956 • 7

**block by block, it spells**

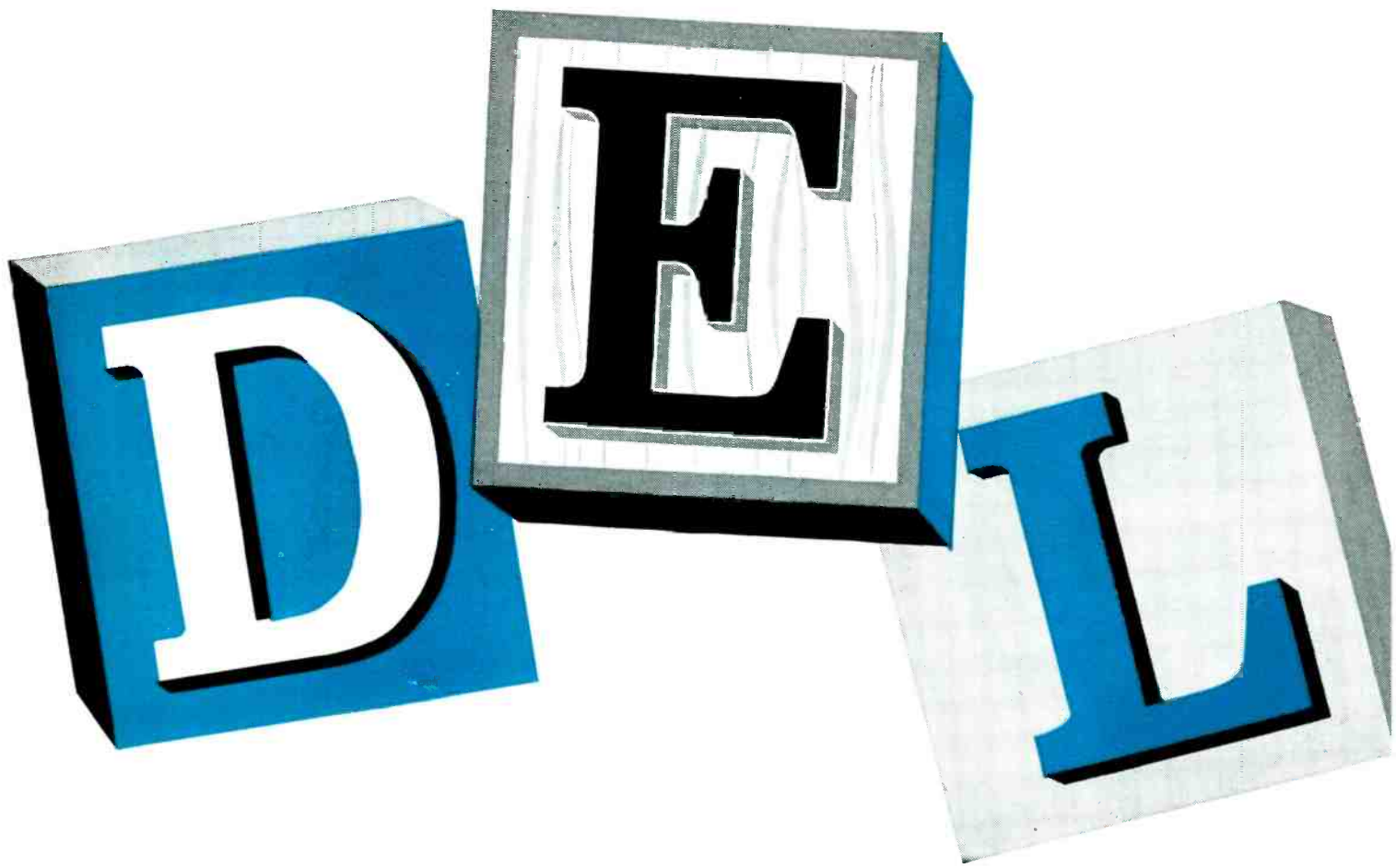

# better business...

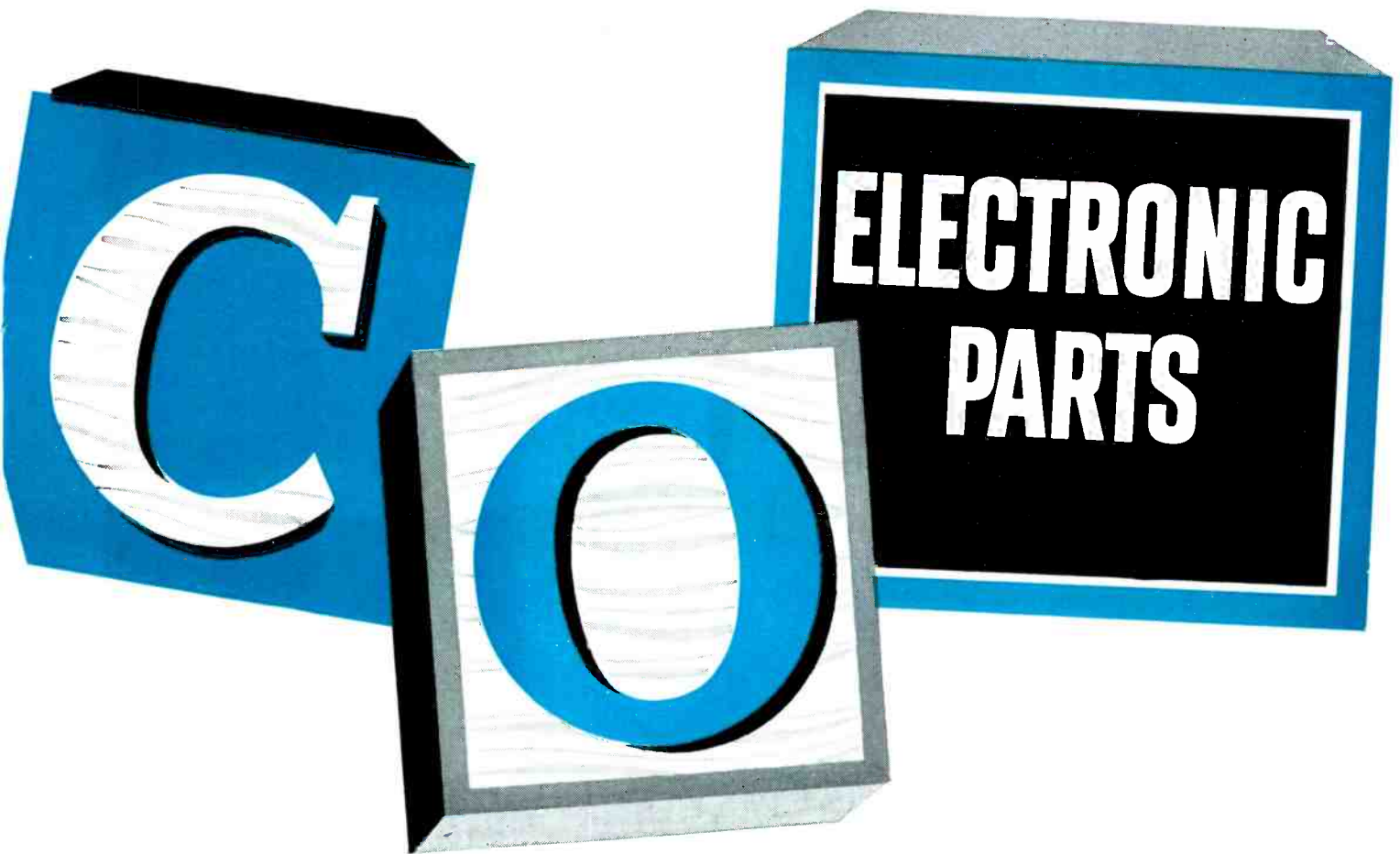

**and here's why:** A vast readymade market for Delco Radio original equipment parts, since more than half the radio-equipped cars on the road are equipped with *Delco* radios.

Fourteen different groups of fast-moving universal parts, all available from a single source—your Delco Electronic Parts distributor.

Two great names—Delco Radio and General Motors—with a reputation for quality and value that commands instant customer acceptance.

With Delco Electronic Parts, you've got the parts *and* the market—plus the selling power of two powerful names. Just about everything, in fact! Get full details from your Delco Electronic Parts Distributor . . . and put your business on a better paying basis by far!

## TURN UP YOUR VOLUME WITH DELCO ELECTRONIC PARTS

AUTRONIC EYE	VIBRATORS
SPEAKERS	TRANSFORMERS
RECEIVING TUBES	AUTO AERIALS
CONTROL KNOBS	CAPACITORS
PICTURE TUBES	RF & IF COILS
SPARK SUPPRESSION MATERIAL	
RF AND AUDIO CONTROLS	
AUTO RADIO HARDWARE	
RECEIVING TUBE SOCKETS	



**Modern service schools** offer an ideal example of Delco's service to the electronics industry. Instruction classes are held in the 30 General Motors Training Centers to keep technicians well up on the latest developments and repair techniques.



# ONLY PICTURE TUBES ...

## give you these major advantages

### CROSS-CHECK CONTROL

Raytheon Picture Tubes are *right* when you get them, thanks to RAYTHEON'S CROSS-CHECK QUALITY CONTROL. This comprehensive Raytheon quality control method includes daily tests made on tubes for pressure, base torque and outside coating adhesion. Engineering controls check screen color and brightness and tube life under both ideal and extremely adverse conditions. And, most important of all, a substantial percentage of every day's production is actually *unpacked and tested for physical appearance and electrical characteristics* before quality control headquarters will permit release of a single tube for shipment.

### CORONA INHIBITOR

This Raytheon development insures brightness rain or shine. Ordinary tubes lose up to 10% of their brightness on humid, damp days. Not so, Raytheon Picture Tubes. Tests prove *no loss of brightness* even under a water spray on the high voltage contact — thanks to *Corona Inhibitor*.

## ALUMINIZED

with

*Lumilac*

LUMILAC — a lacquer especially blended and used exclusively by Raytheon is the secret of the superiority of Raytheon Aluminized Picture Tubes. This amazing lacquer produces an extra smooth, unbroken surface for the pure aluminum coating, yet leaves no gas-producing residues which could impair cathode emission and shorten tube life.

The result — all the benefits of aluminized tubes, sharper picture, superior contrast, high light output — *plus excellent tube life.*

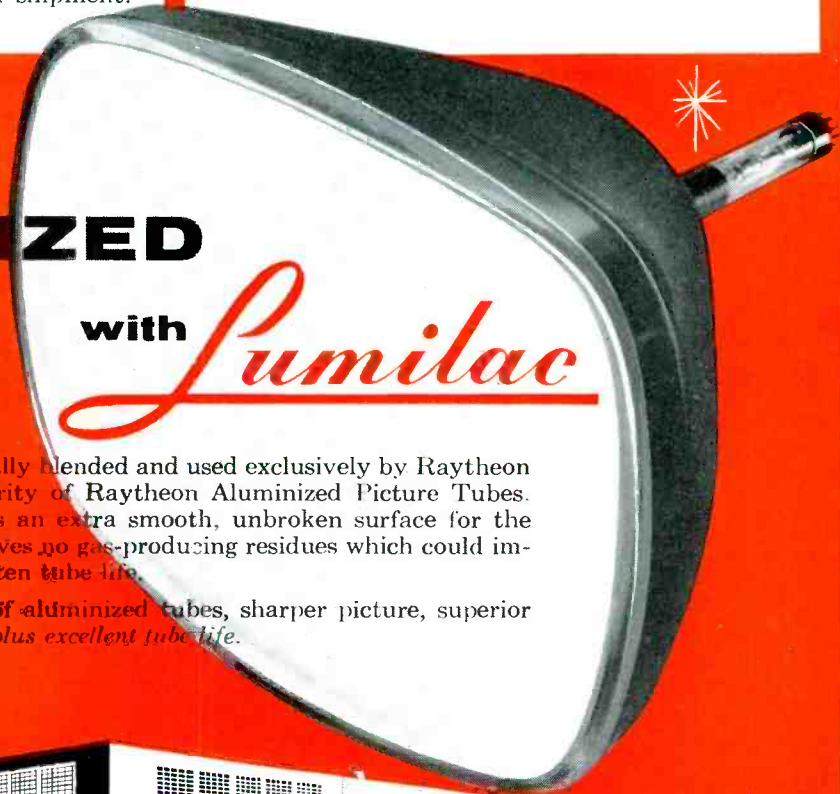

Raytheon Picture Tubes have the distinct advantage of precision production in one of the world's most modern plants. The Raytheon Cathode Ray Tube Plant in Quincy, Mass. houses some of the world's largest equipment and was designed and built solely for the manufacture of today's large screen Raytheon Picture Tubes.



## RAYTHEON MANUFACTURING COMPANY

Receiving and Cathode Ray Tube Operations

Newton, Mass. • Chicago • Atlanta, Ga. • Los Angeles, Calif.

Raytheon makes all these { Receiving and Picture Tubes, Reliable Subminiature and Miniature Tubes, Semiconductor Diodes, Power Rectifiers and Transistors, Nucleonic Tubes, Microwave Tubes



*Excellence in Electronics*

# SERVICE

The Technical Journal of the Television-Radio Trade

## The Biggest Outdoor Season Is Moving In

THE LARGEST RADIO-EQUIPPED fleet of pleasure traveling-vacation bound cars ever to hit the highways—nearly 25-million—will soon be rolling along, as the spring and summer months move in.

Millions will be asking their Service Men to inspect their auto sets thoroughly; check tubes, components, speakers, vibrators and antennas, and make all necessary replacements and repairs to insure smooth, reliable performance on the road. Auto-radio servicing income should hit the highest figure ever recorded.

Many dollars will be spent curbing power-supply defects, particularly those found in the 12-volt systems introduced over a year ago. Since these higher-voltage sources produce up to 16 volts *dc* at the vibrator socket for starting, we have the starting-arc problem to consider, especially under conditions of over voltage. Accordingly Service Men must bench test for 16-volt vibrator starting. If the difficulties persist, replacement of the buffer capacitors, transformers or vibrator must be made.

Ripple voltage control, also important in 12-volt supplies, will demand close supervision; ripple must not exceed one per cent of the *dc* voltage. Poor vibrators, defective buffers or filters can cause a higher ripple. The only solution is replacement.

The 'scope will also play a vital role in checking power supplies, particularly vibrators. It is the ideal tool to analyze waveforms and establish at once, the core of the supply problem.

### The Rosy Two-Way Market

AUTO RADIOS, designed for 2-way, and used in buses, taxis and trucks, represent another replacement-repair activity that will flourish during the outdoor months. With 2-way gear in over 25,000 buses, 15,000 trucks and 100,000 cabs, and the number growing daily, the service job will be a sizable one.

Citizens radio will also be a big factor in outdoor work this spring and summer. Thousands of sets (operating in the 460 to 470-mc bands) are now going to work for soft drink distributors, building supply dealers, laundries, milk suppliers, general delivery services, and even TV and radio shops, for 2-way truck and car use. The expansion of this handie-talkie service is rising sharply as more businessmen become aware of its technical and economic advantages. Manufacturers have launched aggressive sales campaigns which have boomed sales and upped the need for maintenance and service facilities.

SOUND, always a headliner during the outdoor months, will once again ring the bell for Service Men, keeping them busy installing and maintaining *pa* in amusement parks, boat yards, camps, playgrounds, at athletic events, parades and pageants, and especially on those electioneering trucks that will really be doing a rugged job in the months to come.

Resort hotels and motels, always heavy users of outdoor sound will up their requirements during the warm months. One motor hotel, now under construction, will use sound for its outdoor restaurant, swimming and wading pools, and recreational areas. More than 400 speakers will be put in for guest-room and public-area duty. The central control unit will include four AM/FM radio tuners, and sixteen separate amplifiers.

### Busy Days Ahead for Community TV

THE COMMUNITY TV SYSTEMS, that make possible good television in areas blacked out or shadowed because of geographic conditions, distance from transmitting stations or other factors which cause poor signal reception, will also begin the big push during the mild weeks that will soon be with us; plans are being made to install scores of systems using antennas on hills and mountains and extensive coax networks to subscribers' homes.

In one installation, recently blueprinted, antenna-stacking arrays, designed to minimize co-channel interference and maximize selectivity, will be mounted atop 500-foot towers. There'll be 24 antennas installed here to provide reception of five stations over 100 miles away. At another location, 32 antennas will be used for six-station reception. And about 40 miles of coax will be used to link TV sets to amplifiers and antennas.

### Boom Business for TV Antennas

ALSO ON THE OUTDOOR BANDWAGON are TV antennas as replacements and for new installations. The gales and hurricanes that have been hammering away at many cities and towns have created an enormous antenna market. Service calls for checking, strengthening or replacing poles and towers, guys, leadins, brackets, fastening hardware and antennas are higher than ever.

It has been estimated that the storms have sent millions of dollars of TV antennas to the scrap heap. During the outdoor months ahead, the replacement of these storm-lashed antennas will be in high gear—in the biggest outdoor season we have ever had.—L. W.

# Service Engineering in Sacramento, Calif.



(Left)

**Author entering his service engineering shop in Sacramento, California, set up to develop and complete special installations of TV, radio and audio systems.**

OUR SHOP, located in an area which a few years ago was just so many square miles of treeless land devoid of man-made structures, is today in an active shopping center, serving hundreds of California ranch type homes.

## *Accent on TV*

TV has become an extremely lively operation in this locale because of the variety of receiving possibilities that exist. The city is served by two *vhf* and one *uhf* stations. Reception from San Francisco, 90 miles away, is possible in most areas with a good antenna system. The *vhf* station in Stockton, which is actually atop Mt. Diablo just east of the San Francisco metropolitan area, puts in a good strong signal. Thus, we have both strong

signal and fringe area conditions and attendant problems.

## *Antenna Testing*

To determine what type of antenna to recommend for maximum signal from the San Francisco stations, it was necessary to conduct exhaustive service-engineering tests. Theoretically, a rhombic antenna with each leg several wavelengths long should provide extremely high gain. Here where the land is flat and clear of trees, we were able to build a rhombic antenna of sufficient size to anticipate realization of considerable gain. Although the experimental antenna was carefully laid out and correctly oriented in regard to azimuth, it was found that results did not equal those obtained

with conventional packaged high gain antennas.

## *Weather Problems*

A problem unique to the Sacramento Valley is intense heat, which can cause premature TV receiver failures. Our heat is very different from that encountered in the east. Relative humidity is low; it is hot and dry and is not as torturing as in damper climates.

The warm season is about six months long. Winters are rainy, but freezing temperatures are seldom encountered.

## *Air-Control Systems Designed*

To offset the effects of heat we experimented with a number of air-control systems. To cool a wall-mounted TV set, recently installed, a forced air circulation method was designed. The results were excellent.

To provide further insurance of long life, the receiver was so modified that plate voltages would not be applied until after tube filaments have been warmed up.

TV interference is also a problem that requires considerable attention in our shop.

Air traffic, which is heavy because of the proximity to two Air Force bases, in addition to the commercial airport, causes most of the TVI.

We are obliged to install a number of low and high-pass filters to screen out this interference.

## *Radio-Audio Activities*

Although emphasis has been on TV servicing, we get our share of radio

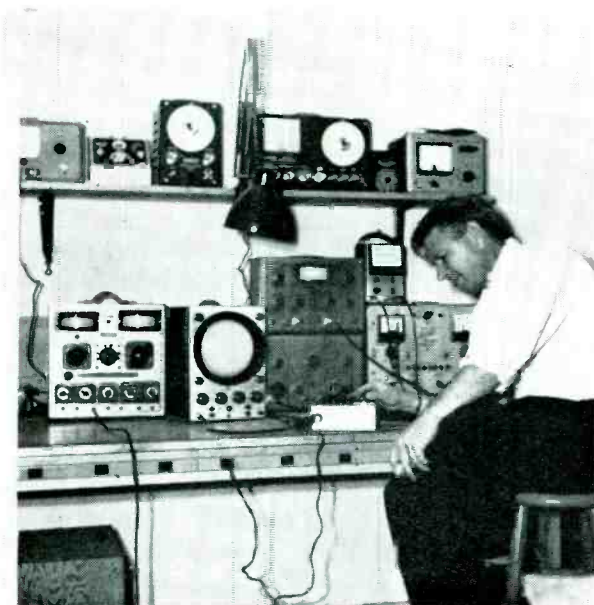

**Advanced instrument lineup in the Wilson shop: Grid circuit tube tester, vtm, capacitor tester, sine wave generator and wave analyzer for audio work, scopes, general tube checker and assortment of signal generators.**

# A Field Report

by L. IRL WILSON

(Right)

View of TV bench repair section of shop, showing array of test gear used for TV, radio and service engineering operations.

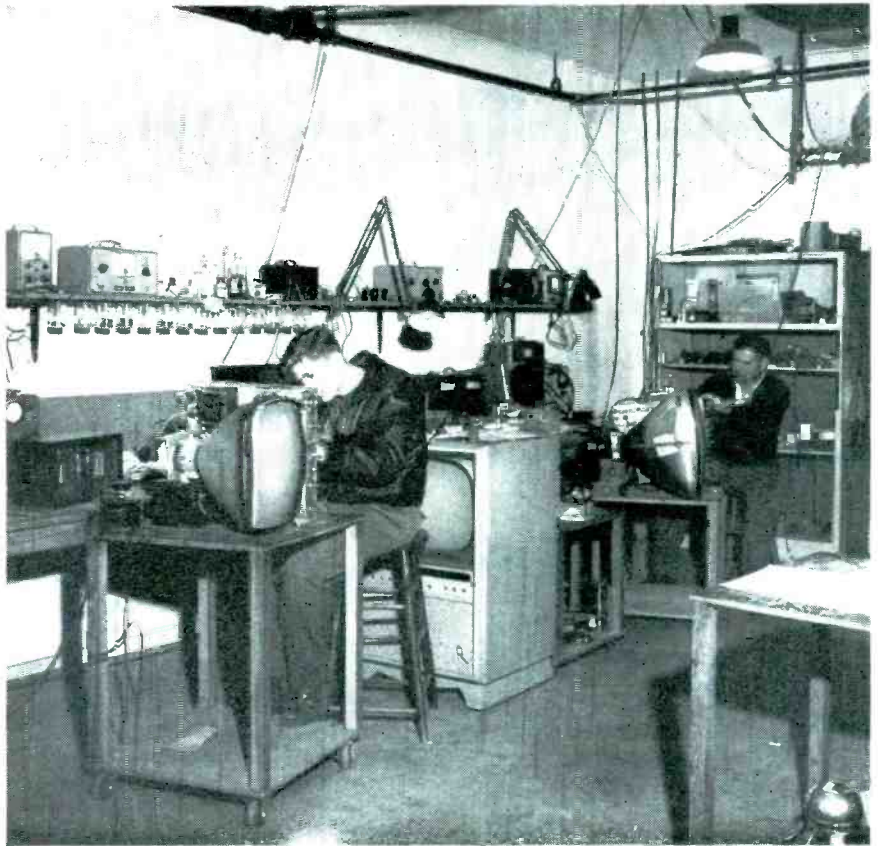

repairs. We are branching out into the audio business and plan to assemble tuners, amplifiers, speakers, record players, tape mechanisms and cabinets.

## *Development Work*

In addition to providing TV and radio servicing, we are involved in engineering development work.

One recent project was an electronic device for measuring the effectiveness of building insulation against heat.

## *Instrument Aids*

We also devised an attachment for a sweep generator which permits easier and more accurate alignment of TV receivers.

A series of pulses is produced on the screen of the TV set to which it is connected; an excellent procedure for home-servicing calls.

## *Educational Background*

This is our fifth year in business. Prior to setting up shop I taught electronics at a nearby junior college.

This background has been helpful in solving the many service engineering problems that face us daily in the installation, repair and maintenance of the complex gear now in the field.

## *Expansion Potential*

The need for service engineering techniques will increase considerably as color-TV, closed-circuit television and commercial audio expands in the months ahead.

(Below)

Wilson's auto fleet used for short and long haul installation, maintenance and repair activities.



# Circuitry Report on the Admiral

## COLOR-TV Receiver

### Analysis of Color-Killer and High-Level Demodulator Circuits Used In New Chassis

by JOHN SCHUMACHER, Engineering Department, Admiral Corp.

IN AN EFFORT to simplify color circuitry two new principles have been incorporated in our color chassis:‡ high level demodulation and amplification of burst and chroma in a common amplifier.

The high level demodulator was developed to drive the color picture tube directly so as to eliminate the costly adder, video output and *dc* restorer circuits used with low level demodulators. The *hl* demodulator not only eliminates the adder, video output and *dc* restorer, but also improves the *dc* stability with changes in drive and supply voltage; in addition its output is practically independent of tube characteristics so that no drift in chroma output or *b-w* setup will be experienced until the demodulator tube characteristics have seriously deteriorated. These advantages result from two factors; the demodulators are *dc* coupled to the grids of the color picture tube, and they are used as switches and will continue to act as switches as long as the tube has enough emission.

The operation of these high-level color demodulators, or color detectors is unique; they differ from the well-known diode detectors used in *b-w* TV and in the color set, too, to obtain black and white or luminance information. This is so for two reasons. First: Color information is transmitted by a suppressed-carrier system, and in order to detect these signals it is necessary to supply the carrier (in the receiver) which must be synchronized to the burst, the only color carrier transmitted. This reinserted carrier is supplied by a crystal oscillator which is *afc'd* to the burst. Second: To obtain three outputs,

(red, green and blue) from one signal it is necessary to detect the signal at phases, other than the carrier. Usually two signals are detected and the third is obtained by adding or matrixing together portions of the first two signals detected. In our chassis use is made of the picture tube to add together the chroma information received from the color detectors, and the black and white or luminance information received from the luminance amplifier to obtain the final red, green and blue signals. This is done by *dc* coupling the black and white information to the three cathodes of the picture tube, while the three outputs of the color detectors are *dc* coupled to the respective grids of the picture tube. As a result we do not detect red, green and blue in the color demodulators, but (*R-Y*), (*G-Y*), and (*B-Y*) where *Y* represents black and white or luminance signals.

In the circuit shown (*R-Y*) and (*B-Y*) are demodulated or detected at the plates of the detectors, and inasmuch as (*G-Y*) consists of negative amounts of (*R-Y*) and (*B-Y*), these amounts are added in a common cathode load to form (*G-Y*). The differential gains required for (*R-Y*), (*B-Y*) and (*G-Y*) are determined by the tap on the chroma-output coil together with the values of the plate and cathode-loads, which for (*R-Y*)

are 22,000 and 56,000 ohms in parallel, for (*B-Y*) are 18,000 and 22,000 ohms in series, and for (*G-Y*) is a 6800-ohm resistor. Resonant chokes serve to keep the 3.58 mc out of the detected signals, while a network of 100,000-ohm resistors and .01-mfd capacitors are added to *dc* isolate the differential background voltage. Three 2,700-ohm resistors provide additional filtering for the second harmonic of the 3.58-mc subcarrier. As the differential gains of the detected signals are determined by the turns ratio of the chroma output autotransformer, together with fixed plate and cathode resistors, the relative outputs of these color detectors are very stable. The actual detection of the chroma signal is accomplished by causing the two triodes in the color-detector circuit to act as grid controlled rectifiers or switches. A 3.58-mc sine wave from the crystal-controlled 6U8 subcarrier oscillator is applied between grid and cathode of the detector through a parallel resistance and capacitance network consisting of 10,000-ohm resistors and .02-mfd ceramics for the (*R-Y*) and (*B-Y*) detector. This sine wave is great enough so that the detector tube operates class *C*; that is, the tube draws current for only a very short time during each cycle. Thus, the tube operates as a switch turning on once each cycle, but for only a short time. The bias on the tube is determined by grid conduction, and by the parallel resistance-capacitance network in each grid.

This type of grid current bias is self-regulating and results in a high degree of *dc* stability. To detect at the correct phase for the so-called (*B-Y*) detector, a two-stage phase-

---

See Front Cover and

Pages 16 and 17 for the

Complete Circuit Diagram

‡Admiral 28Y1.



shift network is employed. This network delays the subcarrier applied to the (B-Y) detector so that correct outputs are produced. Thus, in one tube (the 12BH7) we can detect, add or matrix, and *dc* restore the chroma or color signal.

To use one circuit for amplifying both burst and chroma it was necessary to find some means of keeping the gain constant for the burst, while allowing the gain to vary for the chroma; in fact, when no burst is present the tube must be cutoff during the chroma time, while during burst time it should have full gain. This paradox was solved by a pulse technique. If a great enough positive-going pulse is applied to the grid of the 6CB6 common amplifier, so as to drive it into grid current, the grid conduction will charge the capacity in the grid circuit (mainly the .01-mfd ceramic) to a high enough voltage to bias the tube to cutoff. As the resistances in the grid circuits are in the megohms, the time constant is great enough so that the tube can be held at cutoff until the next positive pulse. Therefore under these conditions, we see that with the proper pulse we can operate the tube at zero bias (full gain), during the burst, and at cutoff during the remainder of the cycle. This pulse is supplied by a 6AN8, the color killer tube. The grid of this tube is coupled to a negative-going pulse from the horizontal-output transformer, divided down by a pair of resistors (1,000 and 12,000 ohms, respectively) to an amplitude just great enough to cut off the tube. When the tube conducts, this pulse becomes positive-going in the plate and is coupled to the grid of the common amplifier (6CL6) by a .01-mfd capacitor.

The other problem with a colorkiller circuit is the means used to actuate it. In our circuit use is made of the color-phase discriminator; when burst of approximately  $\pm 40$  volts is developed across the load resistors in the discriminator, while during black and white transmissions voltage drops to approximately  $\pm 12$ . Use is made of the negative voltage developed by this detector and two resistors (3.3 and 22 megohms) and a 180,000-ohm color-killer threshold control form a divider which is adjusted by the control, so that the voltage on the grid of the color-killer will be zero when the detector voltage falls to its minimum value on black and white transmission. The plate voltage on the color-killer tube is kept just great enough by a 47,000-ohm divider to produce a pulse which will cut off the common amplifier tube. This is

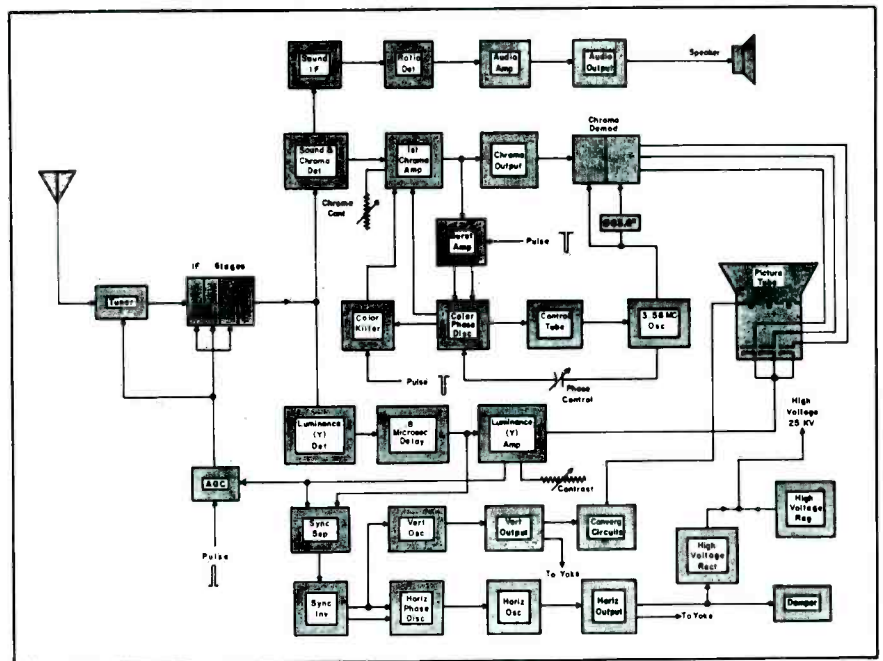

Block diagram of the color system used in Admiral 28Y1 models.

done so that the cutoff voltage of the color-killer tube is low, so that the differential in color-killer voltage between cutoff and full conduction is small, and thus produces a color-killer which will either be conducting full or be cut off. Thus, with the addition of but a single triode, a dependable color-killing circuit has been developed, which with the aid of the color-killer threshold control will operate

over a wide range of signals with various burst levels and amounts of noise.

#### Video If Channel

The video *if* channel consists of 4 stages of *if* amplification using three 6BZ6s and one 6CB6. The channel is designed for a 45.75-mc video car-  
(Continued on page 16)

#### Filament circuitry for the color chassis.

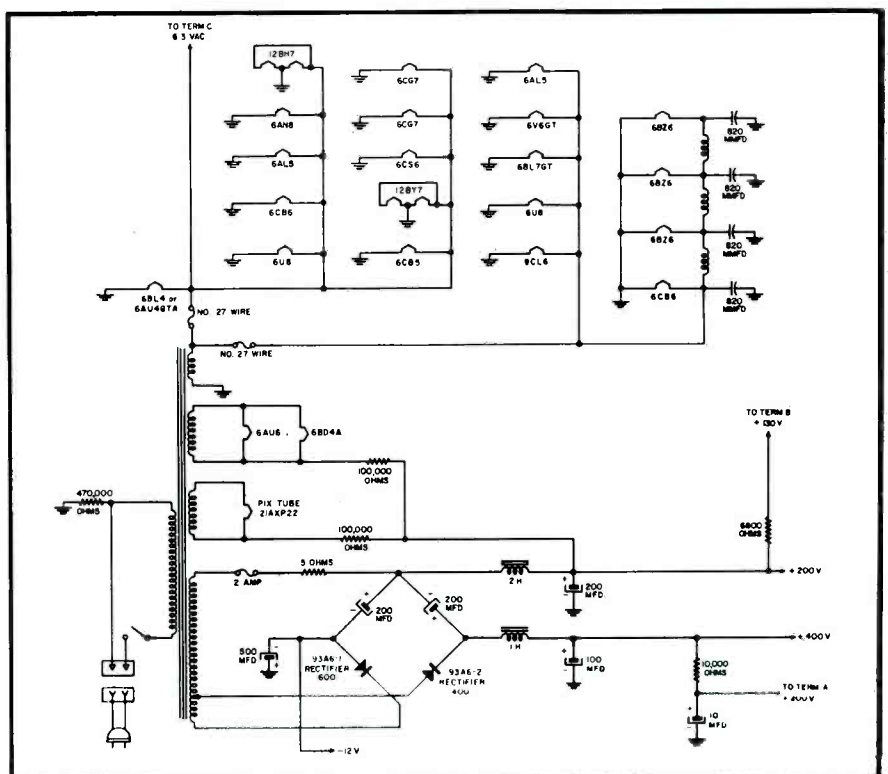

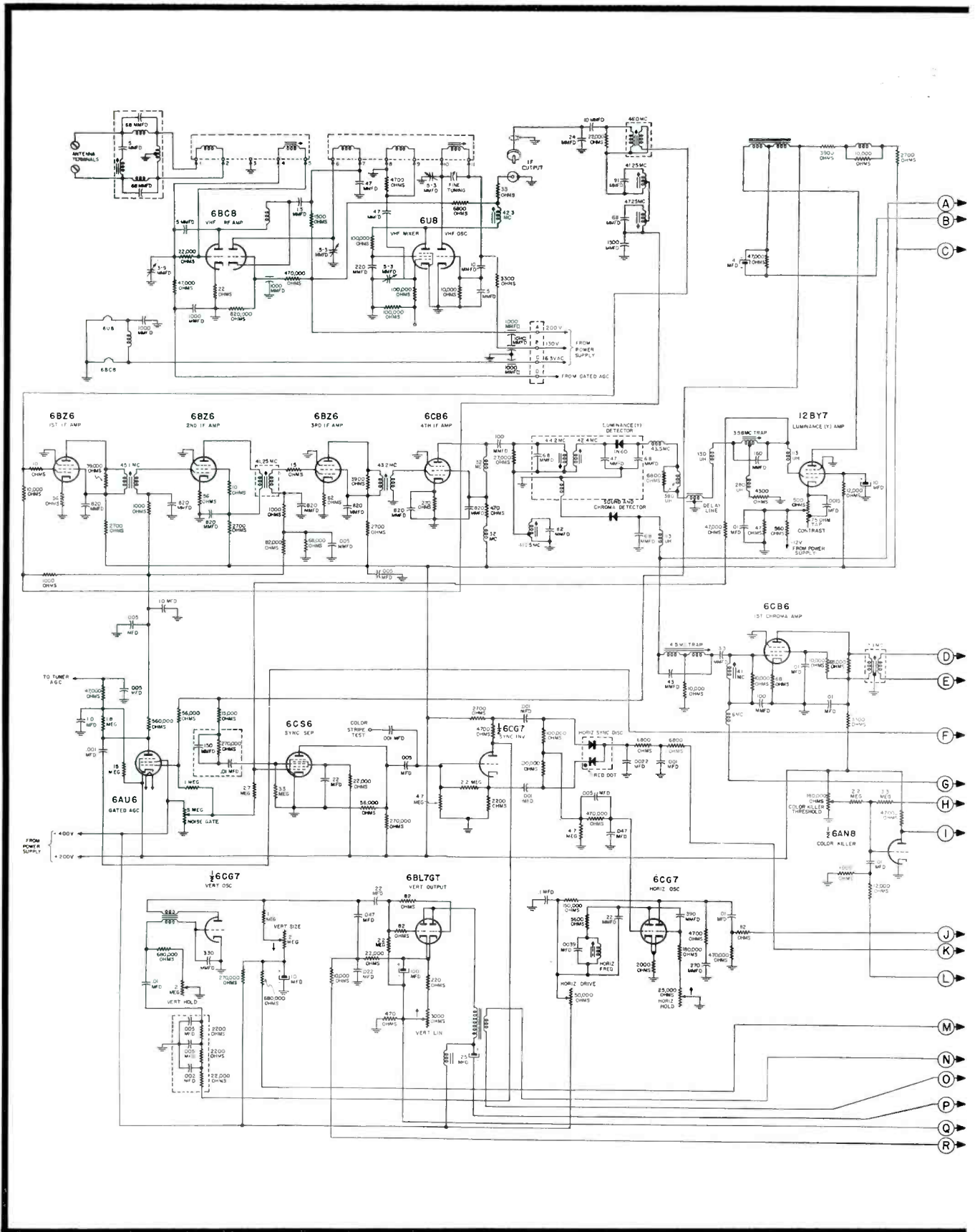

(Continued from page 15)  
 rier, a 42.17-mc color subcarrier and a 41.25-mc sound carrier. The first and second stages are tuned to the video and color subcarrier frequency

sides of the *if* response curve (46 and 45.1 mc) so that the sound carrier is kept at a low amplitude as long as possible to prevent further cross modulation. The third stage is tuned to

**Complete circuit diagram of Admiral**

approximately center of the *if* response passband (43.2 mc) and

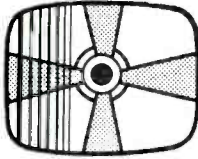
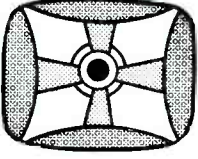
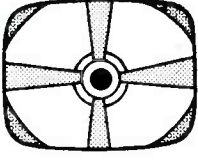
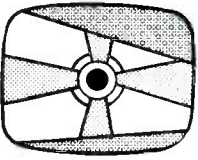
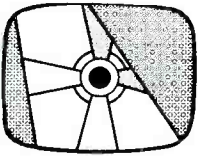
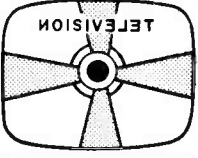
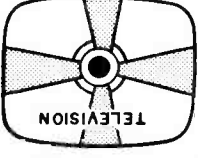
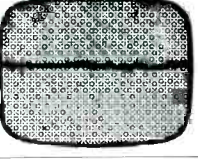
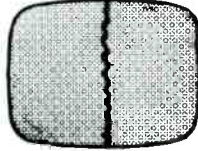

# Yoke Problem Service Chart by JESSE DINES ‡

Picture Trouble	Visual Indication	Cause	Remedy
<b>Ringing</b> Vertical white lines followed by dark ones at left side which diminish gradually (1)		No capacitor (or incorrect value) across high-side of horizontal yoke windings permitting inherent oscillations of flyback circuit to remain undamped. <b>See 56-mmfd capacitor; Fig. 2 (C.)</b>	Same capacitor as original yoke should be inserted and 5,000-ohm connected as in Fig. 1a, varying until ringing disappears. Pot resistance should be measured and fixed resistor inserted in its place. Anti-ringing network should be installed (Fig. 1b) and yoke leads dressed away from transmission line.
<b>Pincushioning</b> Raster sides caved in (2)		Cosine or cosine-squared-yoke, used for conventional-wound yoke.	Anti-pincushion magnets, or yoke with proper winding, should be installed.
<b>Barreling</b> Raster sides bulge out (3)		Conventional-wound yoke used for cosine or cosine-squared yoke.	Yoke with cosine or cosine-squared winding should be used.
<b>Keystoning</b> (Trapezoidal pattern) and <i>Short Height</i> (4)		Vertical winding shorted (or partially shorted); short between windings or from windings to core; yoke damping resistance value too low. <b>See 560-ohm resistors in Fig. 2 (C.)</b>	The 560-ohm resistors shown in Fig. 2 should be checked. Short should be eliminated by redressing leads or inserting plastic insulator sheets at arcing point. Yoke should be replaced.
<b>Keystoning</b> (Trapezoidal pattern) and <i>Short Width</i> (5)		Horizontal winding shorted (or partially shorted); short between windings or from windings to core; capacitance of yoke balancing capacitor too low (or defective). <b>See 56-mmfd capacitor in Fig. 2 (C.)</b>	The 56 mmfd capacitor in Fig. 2c should be checked. Short should be eliminated by redressing leads or inserting plastic insulator sheets at arcing point. Yoke should be replaced.
<b>Reversed Picture</b> (6)		Leads to horizontal windings reversed.	Leads to horizontal windings should be reversed.
<b>Upside Down Pictures</b> (7)		Leads to vertical windings reversed.	Leads to vertical windings should be reversed.
<b>Horizontal Line</b> Usually wavy (8)		Open in vertical windings. <b>See Fig. 2 (B, B-C, C.)</b>	Open circuit should be repaired or yoke replaced.
<b>Vertical Line</b> Usually wavy or <i>No Raster</i> (9)		Open in horizontal windings. <b>See Fig. 2 (B, B-C, C.)</b>	Open circuit should be repaired or yoke replaced.

‡Author of *Servicing TV Sweep Systems*.

# Streamlined Analysis of Defects and Their Remedies

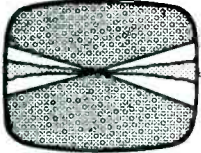
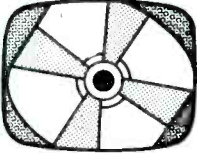
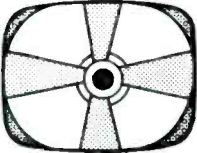
Picture Trouble	Visual Indication	Cause	Remedy
Bow-Tie Patterns (10)		Vertical windings wired incorrectly; horizontal windings wired incorrectly if pattern is vertical.	Yoke should be replaced.
Tilted Off-Center Picture with Neck Shadow (11)		Yoke not oriented properly; width and centering controls misadjusted.	Yoke should be reoriented, adjusting width and centering controls if necessary. Yoke cover should be replaced with one having centering device.
Neck Shadow (12)		Replacement yoke with improper deflection angle used (such as 70° for 90°); yoke not snug against picture tube flare.	Yoke with proper deflection angle should be installed and set firmly against picture-tube flare.

## Additional Problems — Solutions

**Non-Uniform Focusing:** Assuming no circuit fault, yoke used is incapable of producing proper edge-to-edge focusing; improper replacement selection. . . . Yoke with same electrical characteristics as original should be installed.

**Extreme Picture Stretching-Compression Rhombic Pattern** (With short width and height): Some of the yoke core segments are loose or missing. . . . Core segments should be tightened or yoke replaced.

**Horizontal Foldover, Non-Linearity, and Neck Shadow:** Horizontal winding inductance of replacement yoke is too low and is not firmly against picture tube flare causing neck shadow. . . . Yoke with same horizontal inductance as original should be installed and yoke reoriented.

**Insufficient Height and Vertical Non-Linearity:** Damping resistors across vertical windings are lower than rated value. . . . Resistors should be replaced with proper rated values.

**Cross-Talk or Cross-Modulation** (One or two vertical shaded bars): Stray radiation pickup between horizontal and vertical windings. . . . A 270-mmfd capacitor should be connected to vertical winding center-tap and horizontal winding low-side. Yoke should be replaced.

Fig. 1. Components that should be installed to eliminate ringing.

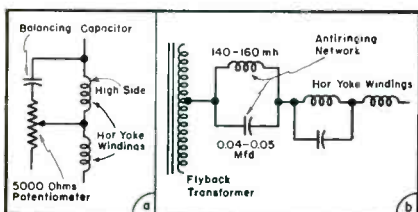
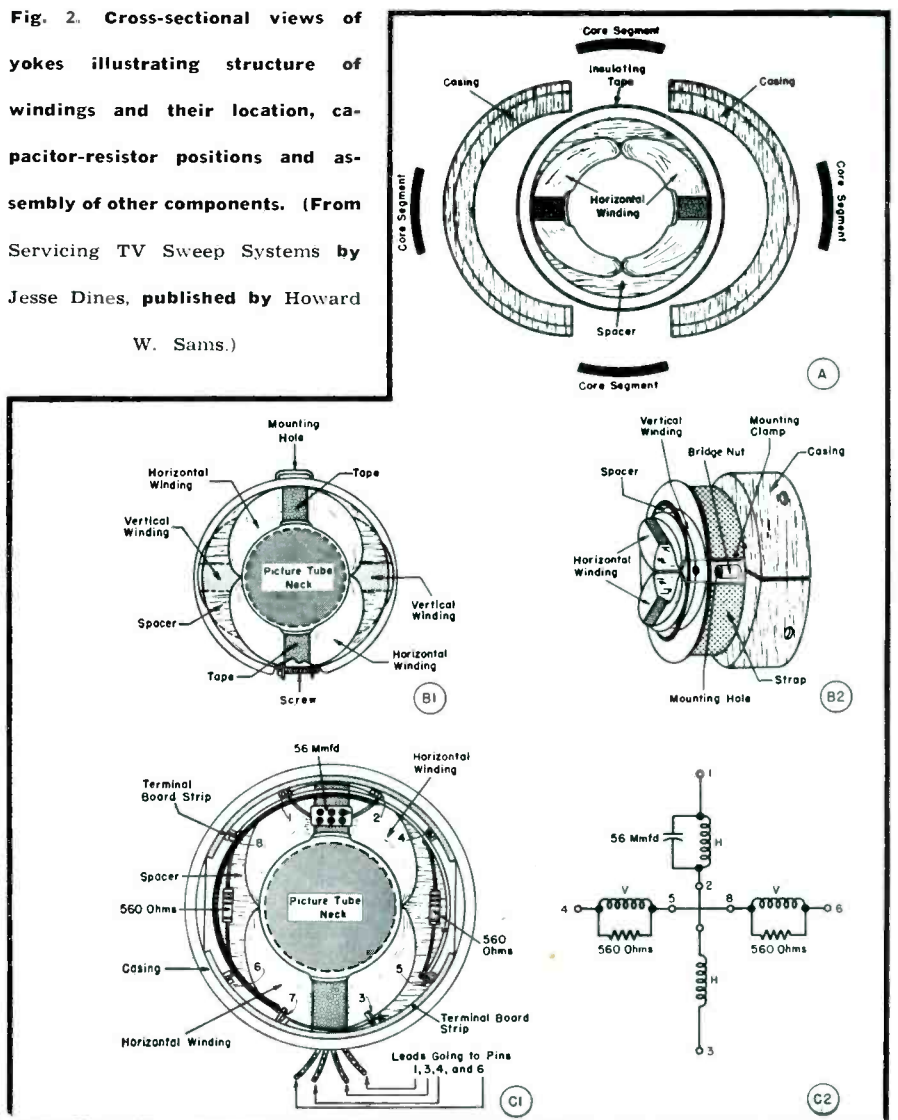

Fig. 2. Cross-sectional views of yokes illustrating structure of windings and their location, capacitor-resistor positions and assembly of other components. (From Servicing TV Sweep Systems by Jesse Dines, published by Howard W. Sams.)



# A Report on Transistorized Portables

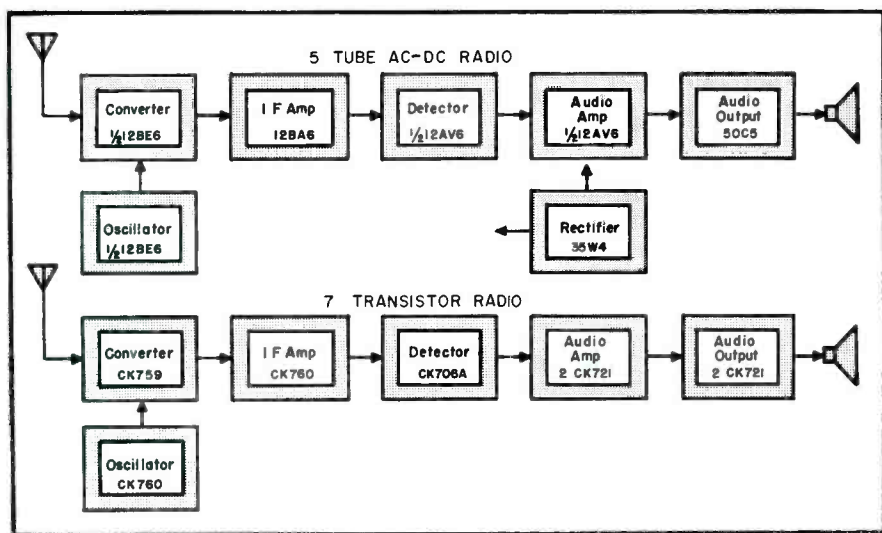

Fig. 1. Block diagrams of tube and transistor radios.

THE CURRENT ACCENT on transistor development has not only resulted in the design of many highly efficient types, but their production in such large quantities that it has become practical to specify them for a number of consumer products. As an example, at present, many radio manufacturers are making transistorized radios.

Our labs have designed four models that, it is expected, will operate from 100 to 2500 hours.

One model (T-100) employs four transistors operating from a 9-volt battery. Another, (T-150)†, is identical, except that it employs six transistors. The third set (T-500) uses seven transistors, and operates from four 1½ volt flashlight batteries. The largest set (T-2500) also uses a seven-transistor chassis, modified to incorporate two matched 5" speakers. A special 6-volt battery pack is included with this model; when necessary, four flashlight batteries may be used.

The circuitry employed in transistor radios resembles the tube-radio circuit. In the average five-tube *ac-dc* radio, two of the tubes are dual-purpose types, resulting in seven stages. A transistor radio employs the same stages (except for the rectifier) and each stage performs the same basic function. The oscillator and converter stages of the tube radio are contained in a dual-purpose tube; separate transistors perform these two functions. The detector and audio amplifier stages in the tube radio, make up the other dual-purpose tube. A crys-

tal detector and two transistors, as audio amplifiers, perform the same functions. In the transistor radio, the audio output stage employs two transistors in push-pull. Due to the low power handling capabilities of some transistors, the push-pull output stage is necessary to obtain a reasonable volume output.

## Transistor-Tube Differences

The transistor, often compared to a triode, does have three elements, but they are quite different from the tube's elements. In the triode tube, excluding the filament, we have the cathode, grid, and plate. In the transistor the three basic elements are

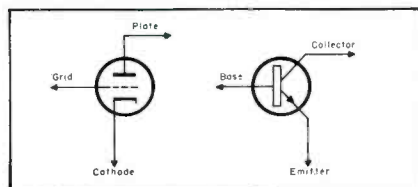
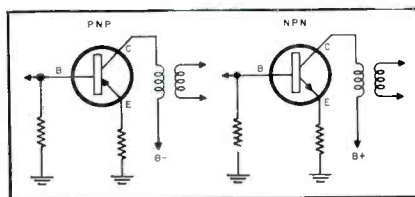

Fig. 2. Schematic comparison of npn transistor and triode.

Fig. 3. Circuits for pnp and npn transistors.



emitter, base, and collector. In a tube, the cathode emits electrons; the emitter in a *npn* transistor also emits electrons. The plate of a tube collects the electrons emitted by the cathode; the collector of the transistor collects the electrons from the emitter. In a tube, the grid controls the number of electrons passing between the cathode and plate. The base in the transistor basically performs the same function. But, in a transistor, conduction is accomplished in a solid rather than a vacuum; also the transistor is basically a current-amplifying device, whereas, a tube is a voltage-amplifying device. Also, in a transistor circuit, the input circuit has a low impedance and is not isolated from the output circuit as in a vacuum tube. Because of these reasons, the design of transistor radios, and the servicing approach, is different than a tube radio and must be handled accordingly.

There are essentially two types of junction transistors used in transistor radios at present; the *pnp* and *npn*. The only difference between these types is the method or the process of manufacturing. There is no particular advantage or disadvantage of each type; some sources do claim that the *npn* type will operate at a slightly higher frequency. The direction of the arrow in the emitter circuit indicates whether the transistor is a *pnp* or *npn* type. If the emitter arrow points toward the body of the transistor, it is a *pnp* type; if the emitter arrow points away from the transistor's body, it is a *npn* type. In the *pnp* transistor circuit, the collector is connected to *B-* through the transformer primary winding, and the *npn* collector is connected to *B+*. The *npn* transistor requires positive operating potentials similar to a triode tube, and the *pnp* is dissimilar in that it requires negative operating potentials. The middle character of the transistor designation, *npn* or *pnp*, denotes the polarity of the potential required; it simplifies identification of polarity, noting which operating potential or voltage is required for each type transistor. Both types will be found in current transistor models, and in some cases, both will be found in the same chassis. The important point to remember is that opposite polarity operating potentials are required for each type, and voltage and resistance checks when servicing must be measured accordingly. In transistor radios of our de-

# Complete Review of Circuitry Used in Raytheon Models . . . Servicing and Test Procedures

by **KEN KLEIDON**

Raytheon Manufacturing Company, Television and Radio Operations

sign only the *npn* type are used, and all references to circuit explanations and servicing procedures refer to this type.

In Raytheon's T-500 transistor portable, four 1½-volt batteries (type D) are used and connected in series; they supply all the required power for operation. The positive terminal of the battery is wired to ground and the direction of the emitter arrow on all transistors points toward the body of the transistor; this indicates that the *npn* type transistors are employed. In this chassis radio, all voltage readings will be negative due to the use of *npns*.

### Normal Battery Drain

Under normal operating conditions, (normal listening levels), battery drain has been found to be 18 to 20 milliamperes; static or no-signal battery drain is approximately 15 milliamperes corresponding to 25 to

† Numerical suffix indicates projected battery life.

30 milliamperes at maximum signal.

The push-pull output stage is operated at class AB to provide increased power output, and thereby, draws less current than if operated at class A. The negative six-volt supply voltage is connected directly to the primary center tap of the output transformer and all other supply voltages are coupled through a filter.

The receiver, with an *if* frequency of 455 kc (identical to an ordinary radio) uses a superhet circuit with seven transistors which perform the function of oscillator, converter, *if* amplifier, audio amplifiers (two) and push-pull audio output. *Aec* voltage is obtained by a network of ( $C_{18}$ ,  $R_{15}$ ,  $R_{16}$ ,  $R_{17}$ ,  $R_{14}$ ,  $R_{18}$ , and  $C_{19}$ ) and is applied only to the base of the converter stage through a filtered network ( $R_7$  and  $C_9$ ).

A ceramic ferromagnetic rod antenna is used in place of the ordinary loop antenna to provide improved sensitivity. The average sensitivity is

(Continued on page 30)

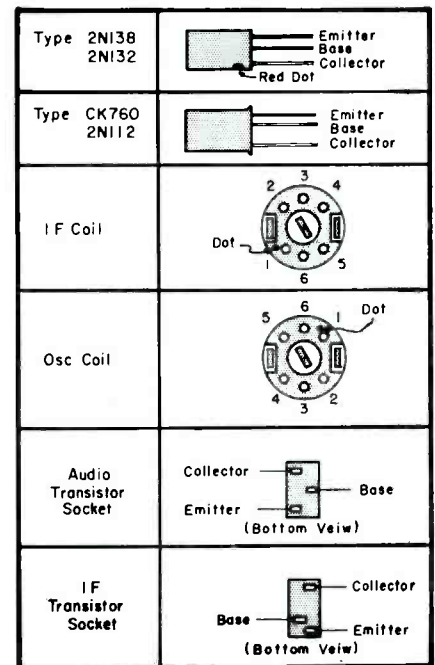

(Above)

Fig. 4. Cross-sectional views of transistors, sockets and *if* and oscillator coils used in transistor receiver.

(Below)

Fig. 5. Diagram of Raytheon model T-500 transistor portable.

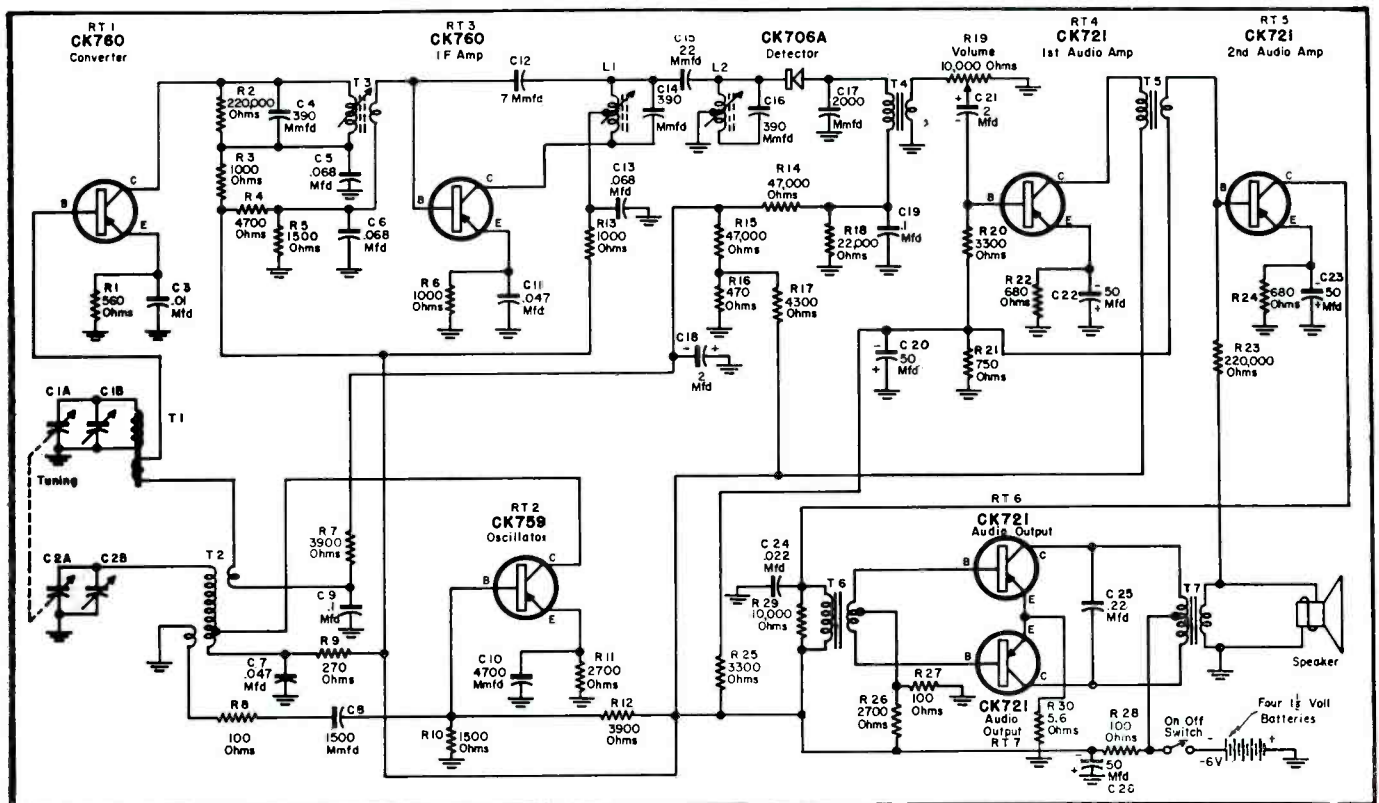

# SERVICE... The National Scene

COLOR-TV PRODUCTION PUSH WITH PRINTED CHASSIS TO START IN SUMMER--Stepped-up manufacture of streamlined color receivers, expected to retail below \$500, has been scheduled to start before July 1st. . . . Printed wiring for most of the models, designers note, will be playing the key role in bringing overall costs down. . . . One line of new chassis will feature six printed wiring boards, representing about 80% of the complete chassis, compared to one or two printed circuit-boards being used in current receivers. . . . More than a dozen of the major set makers have indicated that they will announce lower-priced color lines for the summer push.

FULL-SCALE PRODUCTION OF COLOR-TV SETS will introduce a large market for components. . . . According to the prexy of a leading capacitor manufacturer, color receivers require approximately 320 capacitors per chassis, in contrast to 60 found in the average black and white receiver.

BRIGHT OUTLOOK FOR UHF FORECAST--The anticipated relaxation of the uhf/vhf broadcast rules by the FCC within the next few months will result in a substantial increase in uhf activity and develop a brisk market for ultrahigh equipment, the executive vp of a TV-tuner manufacturer declared recently. . . . The upturn, he felt, would create a demand for at least a half-million of his company's uhf tuners for original and modification purposes. . . . Other tuner makers have been equally optimistic and predicted that they, too, will produce hundreds of thousands of new tuners, which could well bring the total output to nearly a million for uhf and vhf purposes.

CLOSED CIRCUIT TV-PROJECTION SYSTEMS NOW VITAL BUSINESS AID--Projection television, used in conjunction with closed circuit networks, has developed so rapidly during the past few years that it is now a candidate for expanded use in public displays such as sports events and particularly for conferences, meetings and sessions of national scope. . . . Projection systems for both radiated and closed-circuit operation are now available at moderate prices. . . . The erstwhile entertainer in the home is now becoming a commonplace aid to business and industry

UHF-TRANSLATOR PIN-POINT TRANSMITTER CABLE-DISTRIBUTION PLAN DEVELOPED--A novel scheme to extend TV coverage into hundreds of communities, now on the fringe of reception areas, was described recently to the FCC. The plan calls for the pickup of TV signals from network stations on a large antenna tower outside the fringe area community. The signals would then be amplified and converted to any of the top 14 ultrahigh channels and beamed in pea-shooter fashion to a receiving horn antenna located in the center of town. There the signals would be reconverted to the veryhigh bands and distributed to subscribers over a coax-cable system.

TRANSISTORIZED EQUIPMENT APPLICATIONS SPREADING--Transistors are now being built into an unusual variety of complete units and accessories. Recently a transistorized dynamic microphone for mobile radio was unveiled. The microphone features a dynamic element employed in conjunction with a built-in transistorized preamp. The transistor preamp, an integral part of the microphone, boosts the dynamic output to conventional transmitter input level, thus eliminating the need for preamplification at the transmitter. The amplifier draws its power from talking current supply. . . . In another development, a transistor bias oscillator has made it possible to build a tiny tape pack recorder with output sufficient to operate a loudspeaker. . . . The transistor march, which hit its stride in late '55, produced a 300% increase in sales for a total of nearly 4-million units, in comparison to slightly more than a million sold in '54. This year another 300% increase is expected.

THE ANNUAL IRE SHOW at the Kingsbridge Armory, March 19-22, will also feature a number of new transistor developments. On view will be voltmeters using hushed transistors, featuring essentially zero or reversed collector junction voltages. This unusual item, with a frequency range of 10 cps to 150 kc and a voltage range of 10 mv to 1 kv, is claimed to have an accuracy of 2%. . . . We'll be on hand at the IRE exhibition-conference in our booth (892 Audio Avenue) to discuss further these design advancements and what they mean to the Service Man. Drop in for a visit; we'll be looking forward to seeing you.



# A MUST for comprehensive audio-video testing

in **FM-AM-TV** (monochrome and color) **Systems:**

▶ **SINE-SQUARE WAVE ANALYSIS** is an essential part of modern performance testing procedure on high-fidelity audio amplifiers, TV video amplifiers and other wide-range electronic equipment.

▶ **SINE-SQUARE WAVE ANALYSIS** is a highly reliable test for frequency response, phase shift, amplitude distortion and other vital amplifier performance data.

▶ **THE PRECISION MODELS E-300 AND ES-550** have been specifically engineered to meet the needs of modern electronic amplifier and related circuit testing.

Individually, or as correlated instruments, they provide the ultimate in performance, quality and value for which **PRECISION** has been renowned for the past 23 years.

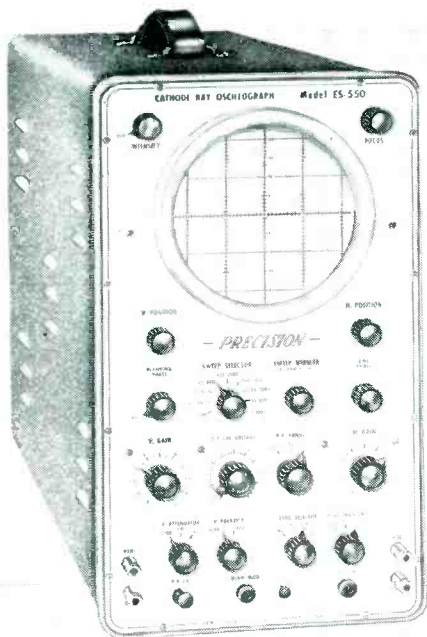

## Sine-Square Wave Analysis with **PRECISION** **MODEL ES-550** Wide-Band, High-Sensitivity **5" OSCILLOSCOPE** and **MODEL E-300** Audio-Video Range, Sine-Square Wave **SIGNAL GENERATOR**

### MODEL E-300...for dependable test signals

- ★ Variable-Frequency Sine Wave Ranges: 20 Cps. to 200 KC. in Four Bands.
- ★ Variable Frequency Square Wave Ranges: 20 Cps. thru 20,000 Cps. In Three Bands.
- ★ Four Fixed, High-Frequency Square Waves: for analysis of wide-band amplifiers up to 20 MC band width: 50 KC.—100 KC.—250 KC.—500 KC. steps.
- ★ Output Characteristics:  
Variable Frequency Ranges:  
0-2000 ohms, 0-10 volts RMS,  $\pm 1$  db.  
Accuracy:  $\pm 2\%$  from 50 cycles to 200 KC.  
 $\pm 1$  cycle from 20 cycles to 50 cycles.  
Distortion: Less than 1% from 20 cycles through 200 KC.  
20 KC Sq. Wave Rise Time: .5 microsec.  
Fixed High Frequency Square Waves:  
0-250 ohms, 0-5 volts P-P  
Rise Time: .05 microsecond  
Overshoot: Negligible

- ★ Tube Complement:  
1-5879, 1-6CL6, 1-6J6, 2-6AU6,  
1-6BL7, 1-6AH6, 1-6X4.
- ★ Separate Output Circuits:  
for the variable and fixed frequency ranges.
- ★ Terminated, Low-Loss, High Frequency  
Coaxial Output Cable
- ★ External 'Sync' Terminal Post:  
for synchronizing scope to H.F. square wave.
- ★ Etched-Anodized Tuning Dial and Panel

**MODEL E-300 DELUXE** (Illustrated): In blue-grey, hooded steel cabinet and 2-color brushed aluminum panel with contrasting knobs. 11 $\frac{1}{2}$ x13x6 $\frac{5}{8}$ ". Complete with tubes, coaxial output cable and instruction manual. Net Price: **\$195.00**

**MODEL E-300 STANDARD:** Standard black ripple finished cabinet with black anodized aluminum panel. 10 $\frac{1}{2}$ x12x6". Complete with all accessories, as above. Net Price: **\$190.00**

### MODEL ES-550...for reliable visual analysis

- ★ Push-Pull, Wide-Band Amplifier:  
10 MV/inch sensitivity, 2 Megohms, 22 mmfd.  
One DB from 10 cps. to 3.5 MC—3 DB at 5 MC.
- ★ Direct Reading, Peak to Peak Voltage Calibrator
- ★ Vertical Pattern Reversal Switching Facility
- ★ Push-Pull, Wide-Range Horizontal Amplifier:  
100 MV/inch sensitivity, 2 Megohms, 25 mmfd.  
One DB from 10 cps. to 1.0 MC—3DB at 2 MC.
- ★ Linear, Multi-vibrator Sweep Circuit:  
10 cycles to 100 KC with retrace blanking.
- ★ Amplified Auto-Sync Circuit
- ★ Four Way Sync. Selector provides for Internal Neg., Internal Pos., External and Line Sync.
- ★ 3000 Volt Intensifier Anode Potential provides utmost visibility of high frequency waveforms.
- ★ "Z" Axis Input for blanking, timing, marking.
- ★ Built-in 60 cps Phasing and Blanking Controls.
- ★ All 4 Deflection Plates Available directly (at rear), with full beam centering facilities.

- ★ Tube Complement: 12AV7 "V" Cathode Follower-Ampl. 6U8 "V" Ampl.-Phase Splitter, Two 6CL6 Push-Pull "V" Drivers, 6U8 "H" Cathode Follower-Ampl. 6C4 "H" Phase Splitter, Two 12BH7 Push-Pull "H" Drivers, 12AV7 Sweep, 6BH6 Auto-Sync. Ampl. 12AU7 Sweep Retrace Blanking Ampl. OA2 VR tube, 5V4 Rect. Two 1V2 High Voltage Rect. 5CP1/A CR Tube.
- ★ High Contrast, Filter Type, Calibrating Screen
- ★ Fully Licensed under AT&T and RCA patents.

**MODEL ES-550 DELUXE** (Illustrated): In custom-styled, blue-grey ripple finished steel cabinet; 2 color brushed aluminum panel and contrasting blue knobs. 8 $\frac{1}{4}$ x14 $\frac{1}{2}$ x18 $\frac{1}{2}$ ". Complete with all tubes, including 5CP1/A CR tube. Comprehensive Manual. Net Price: **\$235.00**

**MODEL ES-550 STANDARD:** In standard black cabinet with black anodized panel. 8 $\frac{1}{4}$ x14 $\frac{1}{2}$ x18 $\frac{1}{2}$ ". Complete as above. Net Price: **\$230.00**

Write for latest catalog describing the complete **PRECISION** line of test instruments for modern electronic applications in industry, laboratory and service.



**PRECISION Apparatus Company, Inc.**

70-31 84th Street, Glendale 27, L. I., N. Y.

Export: 458 Broadway, New York 13, U. S. A. Cables: Morhanex  
Canada: Atlas Radio Corp., Ltd., 50 Wingold Ave., Toronto 10

"MAKERS OF THE FINEST SETS  
USE 'EM!"



"Manufacturers of America's finest radio and TV sets are Tung-Sol customers. As a result, Tung-Sol Magic Mirror Picture Tubes and receiving tubes are made to the very highest of all set-makers' performance specifications!"

**ts TUNG-SOL®**  
Magic Mirror Aluminized  
**PICTURE TUBES**

TUNG-SOL ELECTRIC INC., Newark 4, N. J. Sales Offices: Atlanta, Columbus, Culver City, Dallas, Denver, Detroit, Melrose Park (Ill.), Newark, Seattle

## Associations

### TSA, Detroit, Mich.

THE TELEVISION SERVICE Association of Detroit has prepared an ordinance licensing all TV Service Men.

The measure, pending before the Detroit Common Council, carries heavy penalties for violation; possible loss of license and maximum \$500 fine as well as a 60-day jail sentence. License exams would be conducted by a seven-man board appointed by the mayor. Enforcement would be provided by the Detroit Department of Buildings and Safety Engineering.

### ARTSNY, N. Y.

MEMBERS OF THE Associated Radio and Television Servicemen of New York voted recently to adopt a program of self licensing.

According to board chairman *Max Leibowitz*, the program in essence will embrace the protective features of the licensing bill which died in a City Council committee in 1954.

The plan calls for the licensing of dealers and contractors, licensing of Service Men after they pass certain qualifying tests, issuing of permits for men to work under licensed Service Men and establishment of a supervisory committee to oversee the program and adjudicate customer grievances.

Members will be graded technically and activities of licensed members will be supervised. Each license holder will take an oath to a code of ethics and if it is determined that a member has dealt unfairly with the public, he will lose the association license.

*Peter La Presti* has been elected president of ARTSNY. Other officers include *Bob Olsen*, executive secretary, and *Jack Spegal*, treasurer.

### RTTG, Boston, Mass.

THE RADIO TELEVISION TECHNICIANS Guild of New England has announced that all its members are now registered Service Men. Members have pledged to abide by the Guild's code of ethics and servicing standards. Registration certificates are being issued for display in place of business.

### NATESA

THE SPRING board of directors meeting of NATESA will be held at the Blackstone Hotel in Omaha, Nebraska, on April 22. The meeting will be hosted by TESA-Omaha, of which *Tony Schneider* is local affairs chairman and *Bill Briza* national affairs chairman.

The Annual Convention of the National Alliance of Television and Electronic Service Associations will be held on September 14, 15 and 16 in Chicago.

### TEN YEARS AGO IN SERVICE

A NUMBER of TV transmitters began telecasting on a regular daily basis and installation activity began to boom. The anticipated receiving problems, centering on antenna installations, appeared everywhere and Service Men began boning up on the types of antennas that should be used and how they should be set up for best results. Associations set up clinics to familiarize members with the reception peculiarities that existed in the field and how they could be resolved by proper installation. . . . The first complete report on TV antennas and their installation appeared in *SERVICE*. Text served as a basic installation guide during service association clinic sessions. . . . *Hayden White* was elected president of the Radio Servicemen's Association of Luzerne County, Wilkes-Barre, Pa.; *Max Friedman* was named vice president; *Edward Buckman*, secretary; *C. F. Bogdan*, corresponding secretary; and *Ben Gerstein*, treasurer. Directors named included *Roy Stroh*, *Edmund Nowicki*, *Joseph Sincavage* and *Milan Krupa*. The association had 45 active members. To promote its activities, group initiated plans for a local advertising campaign.

# PERSONNEL

JACK R. MOSLEY has been named vice president and assistant manager of Mosley Electronics, Inc., 8622 St. Charles Rock Rd., St. Louis 14, Mo. . . . GEORGE E. MOBIS has been elected vice president in charge of sales and advertising.

JAMES BAXTER has been elected vice president of Cornish Wire Co., 50 Church St., New York 7, N. Y.



James Baxter



Robert T. Leitner



A. B. Du Mont, Jr.

ROBERT T. LEITNER has been promoted to chief engineer of Technical Appliance Corp., Sherburne, N. Y.

ALLEN B. DU MONT, JR., has been named assistant to the manager of the TV receiver division of Allen B. Du Mont Laboratories, Inc., 750 Bloomfield Ave., Clifton, N. J.

FRED GLUCK has been appointed director of engineering of The Astatic Corporation, Conneaut, O. He was formerly chief engineer of Fada Radio and Electric Company of New Jersey.

SAMUEL J. CHILDS has been named vice president and general manager of Weston Electrical Instrument Corp., 614 Frelinghuysen Ave., Newark 5, N. J. . . . JOHN D. MACNAMARA has been appointed field sales manager.

THOMAS T. GOLDSMITH, JR., has been appointed vice president and general manager of the government and research divisions of Allen B. Du Mont Laboratories, Inc., 750 Bloomfield Ave., Clifton, N. J.

SIDNEY GRACEN has resigned as general sales manager of IE Manufacturing Co., Chicago, Ill.

C. D. HALL has been named sales manager of Fretco, Inc., 406 N. Craig St., Pittsburgh 13, Pa.

BEN JACOBS has been appointed sales manager of the tube and component parts department of American Elite, Inc., 7 Park Ave., New York 16, N. Y.

JOHN B. SULLIVAN has joined Spencer-Kennedy Laboratories, Inc., 1320 Soldiers Field Rd., Boston 35, Mass., as instruments sales manager.

JON B. JOLLY has been named sales manager, semiconductors, for CBS-Hytron, 100 Endicott St., Danvers, Mass. . . . LOUIS H. NIEMANN is now equipment sales manager.

AL A. BOMBE has been appointed to the newly created position of regional sales manager of the Finney Company, Cleveland, O. His headquarters will be at 1640 Greenwood Lane, P. O. Box 164, Glenview, Ill.



Louis H. Niemann



Jon B. Jolly



A. A. Bombe

"FINEST FOR REPLACEMENT,  
TOO!"



"Whether you're a wholesaler or a service dealer, Tung-Sol Tubes—the tubes that leading set-makers use—are your best bet for highest profits and customer good-will. You can build a reputation on Tung-Sol quality!"

**ts TUNG-SOL®**  
dependable  
**RECEIVING TUBES**

TUNG-SOL makes All-Glass Sealed Beam Lamps, Miniature Lamps, Signal Flashers, Picture Tubes, Radio, TV and Special Purpose Electron Tubes and Semiconductor Products.

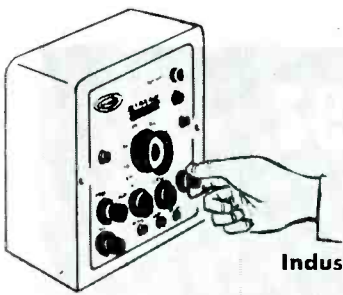

## FIELD AND SHOP NOTES

Industrial . . . Commercial . . . Institutional Communications . . . Audio . . . TV  
Installation . . . Maintenance . . . Repair

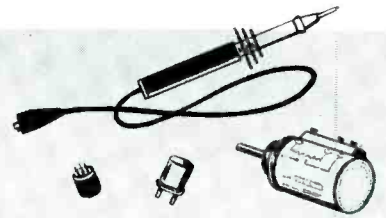

COMMUNICATIONS EQUIPMENT in the 450 to 470-mc band was preceded by 25 to 54- and 148 to 174-mc band gear. Equipment for these three different bands bear two common characteristics.

First, in each band we are dealing with truly precision equipment, particularly in the receiver. The receiver is called upon to receive intelligibly a signal of only .5 to 1 microvolt in the presence of a signal 10,000 times stronger located merely 40, 60 or 100 kc away and in the case of narrow-band, low-band equipment, only 20 kc away. And the frequency stability of both transmitter and receiver must be very precise.

In spite of this, the units have a second common characteristic; *ease of service*. Numerous test points have been engineered into equipment of all three bands, facilitating tuning or troubleshooting. The Service Man will find with experience that 450-mc equipment responds to those same basic techniques developed in servicing low and high-band gear.

The equipment itself is more complex at 450 mc than at either high or low band.

In a typical transmitter, the 6C4 buffer amplifier stage is a grounded

## 450-Mc Equipment Design and Maintenance

by **GEORGE A. SVITEK**, *Communications Training Counselor*  
*General Electric Company*

grid circuit, necessary to achieve a stability of 5 parts per million from the oscillator. The crystal is enclosed in an oven for the same reason.

Up to the second tripler stage the circuit design techniques are not new. The second tripler and power-amplifier stage, however, require the use of 2C39 lighthouse triodes in cavity circuits. Just above the *p-a* cavity is the output cavity used to reduce noise and spurious radiation from the transmitter. This cavity replaces the complex filters which serve the same purpose on low and high bands. (A similar cavity on low or hi band would be much larger than the transmitter chassis.)

To tune the transmitter a 0-30 20,000-ohm/voltmeter is required. A wattmeter is helpful, but not necessary. The *p-a* must be terminated in a 50-ohm load or proper antenna.

In maintaining a transmitter, a routine for periodic maintenance must be set up. Just as an auto requires sum-

mer changeover, winterizing, lubrication and tuneups for peak performances, mobile equipment requires periodic attention for best results. Measurements of the modulation, frequency, line or battery voltage, forward and reflected power, and B+ voltages should be made and recorded.

Where tune-operate switches are used, they should be checked to see that they are in the proper position. Relays should be checked for dirty or pitted contacts and a burnishing tool exercised where necessary. Vibrators should be replaced when B+ voltage drops to 70% of normal.

### Periodic Checks

Periodic checks should be made to see that all components are solid; they have not worked loose from their mountings. Loose nuts, screws, and parts as well as plugs can result from long periods of vibration. The cables should be checked for damage, and

(Continued on page 28)

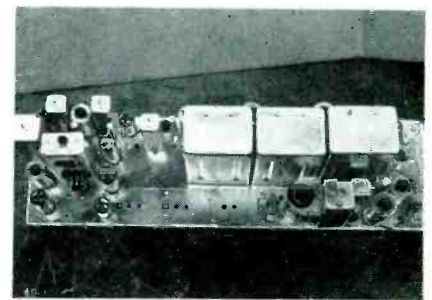
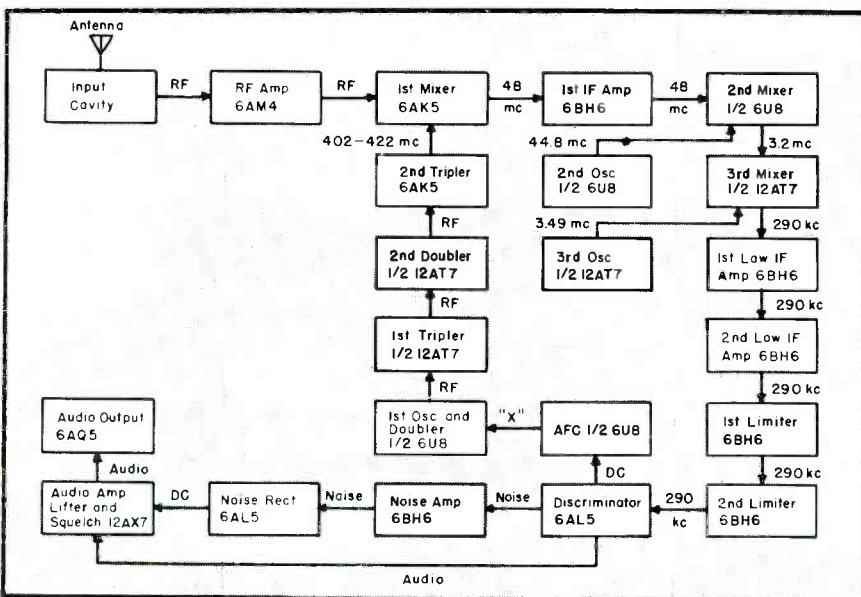

(Above)

Top view of the 450-470 mc receiver; model ER22A1.

(Left)

Block diagram of 450-470 mc communications receiver. X link between oscillator-doubler and alc is a crystal for tight control. The rf and multiplier component values vary depending on whether frequency range is 405 to 425 mc or 450-470 mc.

# limitless



## as the future of UNIVAC®

When planning your future, it is necessary to choose that company which presents the most complete program for you. The opportunity at Remington Rand Univac can only be limited by the individual. Excellent salaries, benefits and educational programs are yours to guarantee this limitless future.

At UNIVAC you will be working with men who developed much of the basic knowledge of computers—who designed and produced components being used by the manufacturers in the field—who set the standards that the others follow.

Now is the time to come to Univac where ambition and professional skill find their reward in limitless opportunities in an expanding organization.

### Immediate openings for:

**FIELD LOCATION ENGINEERS** with a college degree in a scientific or engineering field and experience in electronics. Extensive electronic background may substitute for some college. Many opportunities for rapid advancement.

**FIELD LOCATION TECHNICIANS** Technical school background and preferably some experience in electronics. These positions can lead to full engineering responsibility.

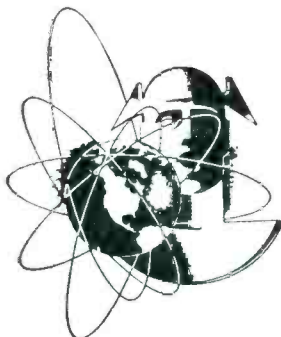

Send complete resumé to

## ***Remington Rand Univac***

DIVISION OF SPERRY RAND CORPORATION

AT ANY ONE OF THESE THREE PLANT LOCATIONS

MR. D. A. BOWDOIN  
Dept. MP-32  
2300 W. Allegheny Ave.  
Philadelphia, Pa.

MR. KURT PINKE  
Dept. MS-32  
1902 W. Minnehaha Ave.  
St. Paul W4, Minn.

MR. FRANK KING  
Dept. MN-32  
Wilson Avenue  
South Norwalk, Conn.

© Registered in U. S. Patent Office

# Merit

FIRST IN EXACT REPLACEMENT.

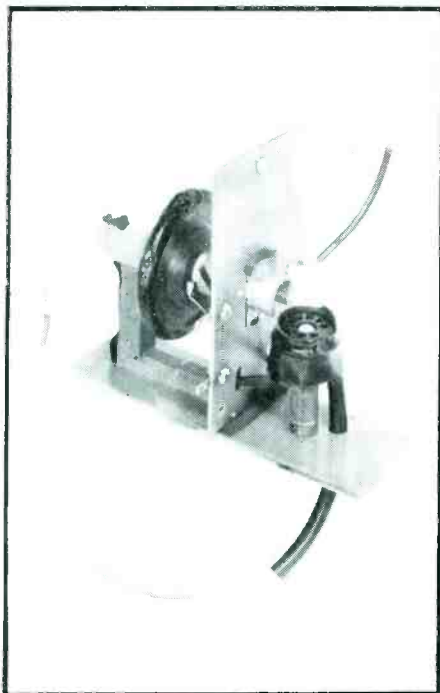

HVO-37 FOR EXACT REPLACEMENT IN over 125 models . . . CROSLY, HALLICRAFTERS, SENTINEL, SILVERTONE. Another in the complete Merit line of exact and universal transformers, yokes and coils. Merit is the only manufacturer of transformers, yokes and coils who has complete production facilities for all parts sold under their brand name.

# Merit

MERIT COIL & TRANSFORMER COMPANY  
4427 N. CLARK ST., CHICAGO 40, ILL.

## Service Engineering

(Continued from page 26)

the antenna and antenna base of mobiles wiped clean occasionally.

It would be well to record the driving voltages at all the grids when the set is new for future comparison. The *p-a* grid drive and plate current are especially important since if the proper value is exceeded, 2C39 life will be shortened. The *p-a* plate voltage should be measured as a check against low B+.

### The 450-Mc Receiver

In the receiver, an input cavity is used to give as much selectivity ahead of the *rf* amplifier as possible. A grounded-grid *rf* amplifier is used due to the many advantages it offers at high frequencies. The 6AM4 tube type employed is common in TV receivers and readily obtainable.

The receiver is a triple conversion superhet type. Since the first mixing frequency is of the order of 402 to 422 mc a complete multiplier chain is necessary to bring the oscillator frequency up to that level. The oscillator is a fundamental mode type because of the superior *afc* and rubbering characteristics of such a circuit. The first *if* is 48 mc, the second is 3.2 mc, and the third is 290 kc.

The discriminator is a conventional type, and the squelch and audio amplifier are quite similar to those found on lower frequency band equipment. An *afc* has been added to permit the use of an unheated crystal in the first local oscillator. The *afc* will act on signals approximately 20 kc away and will correct them by a factor of 8:1; i.e., 20 kc off would appear to be only 2.5 kc. The *afc* tube (6U8) is connected in parallel with a crystal through a 62-mmfd capacitor. This tube is a reactance tube and is controlled by *dc* voltages from the discriminator. Thus, off-frequency carriers cause large discriminator voltages which cause the frequency generated by the crystal to change in a correcting manner.

Tuning the receiver for maximum sensitivity requires peaking the multiplier chain, as with a transmitter, and then peaking input stage variables with following values: 1.98 to 7.83 mmfd (1250 v *dc* peak) and 2.53 to 12.78 mmfd (also 1250 v *dc* peak). This can be done with a 0-3 v 20,000-ohm/voltmeter or a suitable ammeter (0-100 microamps).

In tuning the multiplier chain, primary of the first *if* coil must be peaked and backed off 30% counterclockwise. This will insure stable op-

## Thumbs Down on CALL-BACKS

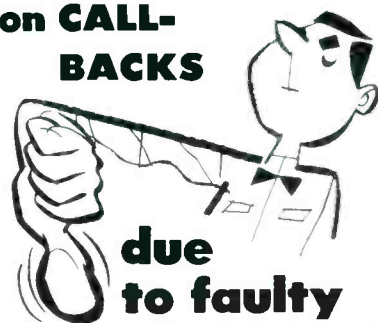

### due to faulty replacements

Be Right with

# OHMITE®

## DEPENDABLE RESISTANCE UNITS



COMPOSITION RESISTORS

Meet all MIL-R-11A requirements. Rated at 70 C rather than 40 C. Available in 1/2, 1, and 2-watt sizes in all standard RETMA values.



BROWN DEVIL® RESISTORS

Vitreous enameled. Available in 5, 10, and 20-watt sizes.

TYPE AB POTENTIOMETERS

Resistance material is solid-molded. Noise-free. Rated at 2 watts.

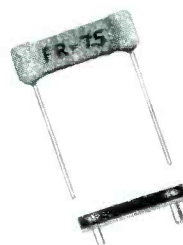

FR-7.5 FUSE RESISTOR

For easy replacement in all television receivers. 1 1/2" Tinned wired leads.

WRITE FOR STOCK CATALOG



OHMITE MANUFACTURING COMPANY  
3642 Howard St., Skokie, Ill.  
(Suburb of Chicago)

# OHMITE®

eration. During this adjustment the *afc* button must be depressed. The *afc* button can now be released and the rest of the multiplier chain tuned. The input-stage variables are peaked while reading unsaturated first limiter current and receiving a weak on-frequency signal, preferably from a suitable generator.

System performance can only be as good as the receiver sensitivity. It might be well to note some facts regarding the limiter current readings in FM receivers. An FM receiver has a built-in noise generator due to its high gain, and the effectiveness of this generator can be used to gauge the health of the receiver. The limiter currents are the barometers.

For the 450-mc receiver the first limiter is used as the indicator because the second limiter is saturated on noise alone. The first limiter current can drop to only four microamps, providing the set is properly tuned, and sensitivity will not be impaired. The fact that the first limiter reads more than this indicates there is reserve gain.

One significant thing should be noted. In a well-designed receiver the sensitivity is limited by the noise generated in the earliest stage of the set. After the first converter there is required a certain amount of gain. This gain is an amplification of both signal and *noise*. Any increase in this gain above the minimum required amount merely adds reserve gain, but doesn't increase set sensitivity, even though it will increase the limiter current reading.

Generally speaking, then, in the case of an insensitive 450-mc receiver, little can be gained by tuning or adjustments after the first converter, unless the first limiter current is below 5 microamps. However, any increase in first limiter current gained by tuning *ahead* of the first converter will contribute in direct proportion to better sensitivity. The areas to check closely would be coax relay, cavity, multiplier stage, and *if* amp.

The usefulness of limiter readings in pinpointing troubles is summarized below.

Limiter Readings as % of Normal		Area of Trouble
First	Second	
70%	Saturated	6AM4, C <sub>302</sub> or C <sub>307</sub> detuned; multiplier chain dead.
30%	Saturated	6AK5 mixer
15%	80%	6BH6 first <i>if</i> amp
Nil	60%	Second oscillator
Nil	20%	6U8 second mixer
Nil	15%	Third oscillator
Nil	5%	12AT7 third mixer
Nil	Nil	Low <i>if</i> amp

## Original components in these and other leading Radio and TV sets since 1948

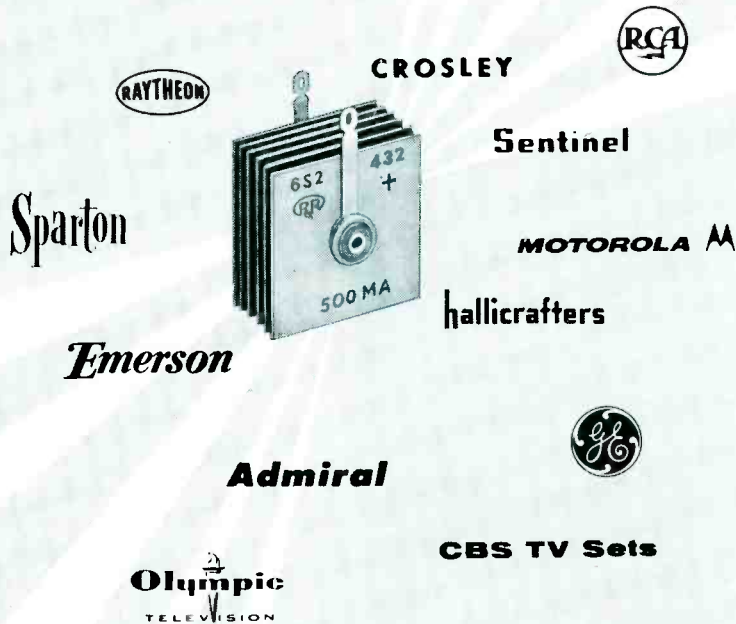

### RADIO RECEPTOR

Selenium



Rectifiers

*That's why they're the best replacements in any Radio and TV circuit!*

These famous trademarks represent a few of the many long-time users of RRco. Selenium Rectifiers. The complete list reads like a "Who's Who" in electronics.

Manufacturers' choice in so many models, RRco. "Safe Center" rectifiers are ideal replacements in *any* set. Your parts distributor can supply you with standard Radio Receptor replacements for sets of all radio and TV manufacturers. Demand "Safe Center" rectifiers and insure the quality of your repair work.



Semiconductor Division

**RADIO RECEPTOR COMPANY, INC.**

*In Radio and Electronics Since 1922*

240 WYTHE AVENUE, BROOKLYN 11, N. Y. • EVERGREEN 8-6000

# BEST BUY IN SCOPES



## new! Simpson COLORSCOPE MODEL 458

Compare the new Simpson Colorscope Model 458 with any oscilloscope on the market. It is an advanced, seven-inch, high-gain, wide-band scope especially designed for color-TV service. Ideal for black and white, too.

**100% RESPONSE** at 3.58 mc color-burst!

**DUAL bandwidth—narrow or wide!**  
**FLAT FREQUENCY RESPONSE**, within 1 db to 4.5 mc!

**RISE TIME** less than 0.05 microsecond (wide band)!

**FULL RANGE** compensated vertical attenuator!

Price with shielded input cable, manual . . . **\$229<sup>95</sup>**

Four accessory probes available for extra utility!

See your distributor for details or write—

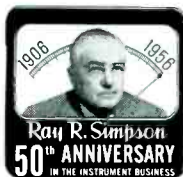

**SIMPSON Electric Company**  
WORLD'S LARGEST MANUFACTURER  
OF ELECTRONIC TEST EQUIPMENT

5200 W. Kinzie St., Chicago 44, Illinois  
Phone: E5tebrook 9-1121  
In Canada: Bach-Simpson Ltd., London, Ont.

## Transistor Portables

(Continued from page 21)

200 microvolts per meter; superior to the average five tube *ac-dc* radio.

Two CK-760 and one CK-759 transistors are used in those circuits operating at high frequencies, and four CK-721 transistors are used for audio frequencies. A CK-706A crystal serves as the second detector. The difference between the audio and high frequency transistors is merely the cutoff frequency. The CK-721 will operate up to approximately 200 kc, whereas the CK-759 and CK-760 transistors will operate up to approximately 2 mc. The interstage transformer ( $T_6$ ) provides phase inversion for the push-pull output stage which will deliver approximately 100 milliwatts at 10% distortion.

Since the *if* frequency is identical to an ordinary radio, the *rf* and *if* alignment is also similar. Alignment is accomplished by coupling an AM signal generator at 455 kc to the base of the converter stage and connecting an output meter in place of the speaker. Coils  $T_3$ ,  $L_1$  and  $L_2$  are adjusted for maximum on the output meter. The tuning trimmers are also adjusted for maximum meter reading at 1400 and 1600 kc, respectively.

Since a transistor has a very low input impedance, transformer coupling is employed in the audio circuits. *R-C* coupling between stages would prove very inefficient (approximately 7 to 10%) due to coupling from a high-impedance output to a low-impedance input; whereas, transformer coupling provides high efficient coupling. A 2-mfd electrolytic coupling capacitor ( $C_{21}$ ), from the volume control to the first audio amplifier, is required due to the low-input impedance of the first audio amplifier. The base resistor ( $R_{21}$ ) is only 3300 ohms and therefore, a large value coupling capacitor must be used to pass the lower audio frequencies. The resistor combinations of  $R_{20}$ - $R_{21}$ ,

$R_{22}$ - $R_{23}$ ,  $R_{10}$ - $R_{12}$ , and  $R_1$ - $R_5$  are simply voltage divider networks used to apply the proper bias voltage for the base of the respective stages. Resistor  $R_{23}$ , connected between the output transformer secondary winding and base of the second audio amplifier, is simply a voltage feedback circuit to improve audio fidelity. The 7-mmfd capacitor ( $C_{12}$ ), connected between the base and collector circuit of the *if* amplifier stage, is a neutralizing capacitor. Due to the high-base-to-collector capacity in a transistor, neutralization is required to prevent unstable operation, just as neutralization is required for a triode vacuum tube when operated above audio frequencies.

In the first audio amplifier stage in this model (whose operation is similar to a tube amplifier) the signal from the volume control is coupled through a coupling capacitor ( $C_{21}$ ) and developed across a base load resistor,  $R_{20}$ . The signal is amplified and developed across the collector load impedance, which is the primary of a transformer ( $T_5$ ) and coupled to the next stage by the secondary winding. The resistor ( $R_{22}$ ) and capacitor ( $C_{22}$ ) in the emitter circuit, supplies bias for the stage, similar to the cathode circuit of a vacuum tube amplifier. The emitter resistor is also a stabilizing component to compensate for variations in transistors and temperature changes. One of the disadvantages of the transistor is that gain varies with temperature changes; therefore, the emitter resistor is incorporated primarily as a stabilization device. Resistors  $R_{25}$  and  $R_{21}$ , connected between *B-* and ground, form a voltage-divider network, which develops a fixed bias for the base. This bias voltage determines the operating point on the transistor's characteristic curve in the same manner in which a fixed bias on the grid of a vacuum tube determines the operating point on the tube's characteristic curve.

Fig. 6. First *af* stage in transistor-radio chassis.

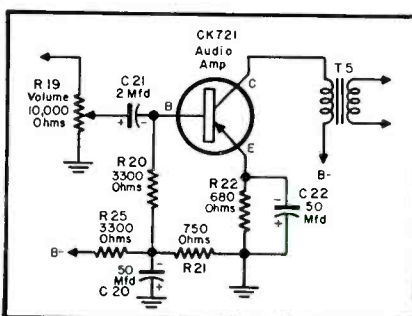

## WHEN YOU CHANGE YOUR ADDRESS

Be sure to notify the Subscription Department of SERVICE at 52 Vanderbilt Avenue, New York 17, N. Y., giving the old as well as the new address, enclose address labels from your last SERVICE copy, and do this at least four weeks in advance. The Post Office Department does not forward magazines unless you pay additional postage, and we cannot duplicate copies mailed to the old address. We ask your cooperation.



## Color-TV

(Continued from page 17)

ther remote by using a dropping resistor in the  $B+$  line.

### Luminance Channel

The luminance ( $Y$ ) channel function is similar to that performed in black and white receivers; that of amplifying the luminance information to the required amplitude to drive the picture tube and adjusting the peaking of the video circuits for fine detail in the picture. The  $Y$  channel consists of the luminance detector, delay line and one stage of amplification called *luminance output*.

The luminance detector, a germanium diode, is operated at 7 v peak output level. A crystal has a more linear characteristic resulting in better amplitude response for the gray portions of the picture. Also, a crystal diode was selected because its physical size provides easier shielding for *if* harmonics. The small diodes have less shunt capacity providing less loss to high frequencies. Immediately following the luminance detector is an *if* bypass and a series rejection coil tuned to 43.5 mc. These two components filter out any *if* or *rf* signals that may have passed through the luminance detector.

### Delay Line

Since the luminance signal has a wider over-all bandwidth than the chrominance channel, it must be delayed to insure that the two signals arrive at the picture tube at the same time. The luminance signal thus is delayed .8 microsecond in a delay line.

A series-peaking coil in the output of the delay line serves to minimize reflections. A modified bridged  $T$  trap following the delay line provides rejection at 3.58 mc. A 4,300-ohm resistor serves as a detector load, a termination for the delay line, and the center leg of the bridged  $T$ .

### DC Restoration Stage

A single-stage 12BY7 luminance amplifier is direct-coupled to the picture tube cathodes, thus achieving *dc* restoration. A variable resistance in the luminance amplifier cathode functions as a contrast control. To achieve greater gain and bandwidth in the plate circuit of the luminance amplifier, mutual inductance is used between peaking coils.

# C-D features the NEW COMPLETE line of Communication Vibrators

... in 6 and 12 Volt Series

that outlast  
them all!

Here is everything needed for complete service on communication vibrator replacements! Engineered to rigid U.S. Gov't specifications, these new C-D Vibrators outlast them all... out-perform others and give you the RIGHT vibrator for EACH application!

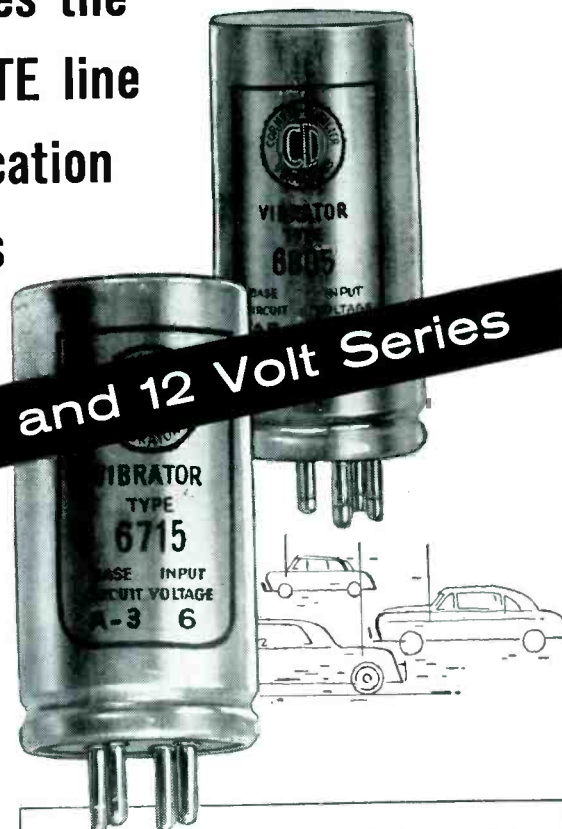

Ten Types Provide Complete Replacement for ORIGINAL Communication Equipment

New No.		Old No.
6 volt	6/12 volt	
5715	6715	5515
5718	6718	5518
5721	6721	*
5722	6722	*
5725	6725	*
5805	6805	5605
5820	6820	5620
5821	6821	5621
5822	6822	5622
5824	6824	*

For Specific Applications, see the NEW C-D Vibrator Guide



## Cornell-Dubilier Vibrators

PLANTS IN SOUTH PLAINFIELD, N. J.; NEW BEDFORD, WORCESTER AND CAMBRIDGE, MASS.; PROVIDENCE AND HOPE VALLEY, R. I.; INDIANAPOLIS, IND.; SANFORD AND FUQUAY SPRINGS, N. C.; SUBSIDIARY: THE RADIATOR CORPORATION, CLEVELAND, OHIO

### RADIO-TV TUBE CAMPAIGN



John T. Thompson (left), G.E. tube department distributor sales manager, and array of promotional material designed to create consumer demand for radio and TV tubes and service. Promotion, featuring a five circus ring program offers an over-all national campaign to convince consumers that regular tune-ups are essential; plus ad aids aimed to make shops of participating Service Men known as outstanding service centers; these include ad tie-ins, displays, wall and window banners, direct mail pieces, point-of-purchase selling aids, and TV-radio spot commercials. Circus atmosphere will be peaked at the point of sale by a variety of banners, posters, mobiles and air-motion boards, bow-ties, badges, a color book for children, envelope stuffers and other interest-exciter.

# Drop Compensating Kilovoltmeter

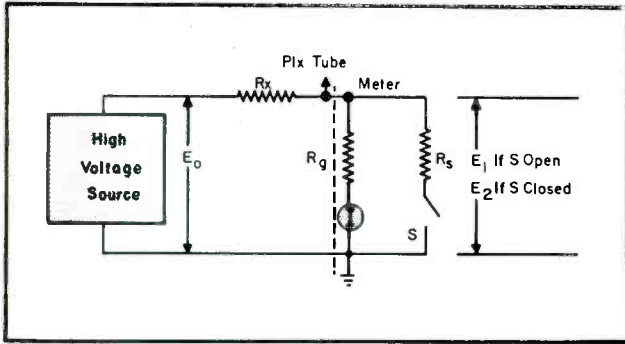

**Control Circuit Permits Accurate Measurement of Very High Voltages Applied to 'Scope and Picture Tube**

by **RONALD L. IVES**

Fig. 1. Circuit of a load-compensating kilovoltmeter.

MEASUREMENT of the very-high and essentially no-load voltages used in 'scopes and TV receivers can be difficult if the equipment used to measure the voltage loads the source, producing a voltage drop.

To determine the actual voltage applied to the 'scope or pix tube a low-drain voltmeter so arranged that the drop produced by it can be compensated for, preferably by some simple and direct means, with a minimum of computation, is needed.

If we apply two known loads successively to a voltage source, and determine the current drawn in each instance, it is possible to compute not only the voltages across each load, but also the no-load voltage and the resistance of the voltage source. This method, which requires the use of simultaneous equations, is outlined in any standard text, and is better suited for lab than shop use.

Procedure and computation can be greatly simplified if we use a micro-

ammeter; used in a circuit having a total resistance of 1,000 megohms, this meter reads kilovolts directly, and also reads the current in circuit (in microamperes) directly.

If, now, we shunt the microammeter-resistor combination by a 1,000-megohm resistor, the meter reading will indicate kv across the new load; and will also, at the same time, show current (in microamperes) through one half of that load. Total current will be twice the meter reading.

Employing this general principle, a simple practical circuit can be developed; and from it a shop instrument, which will permit determination of no-load kilovolts with a minimum of computation.

The circuit for a load-compensating kilovoltmeter is shown in Fig. 1. In this circuit, the instrument movement is calibrated in microamperes, and the fundamental designations are:

- $E_0$  = no-load kv
- $E_1$  = kv with meter load
- $E_2$  = kv with twice meter load
- $I_1$  = current in meter circuit (S open) in microamperes
- $I_2$  = current in circuit (S closed) in microamperes; this will be twice the meter reading with S closed.
- $R_s$  = internal resistance of voltage source
- $R_x$  = 1,000 megohms

With S either open or closed, the no-load voltage of the source is the voltage indicated by the meter, plus the drop in the internal resistance of the source, caused by the load.

Expressed algebraically:

$$(1) E_0 = E_1 + I_1 R_x \quad (S \text{ open})$$

$$(2) E_0 = E_2 + I_2 R_x \quad (S \text{ closed})$$

Solving both equations for  $R_x$ , we have

$$(3) \frac{E_0 - E_1}{I_1} = R_x \text{ and}$$

$$(4) \frac{E_0 - E_2}{I_2} = R_x$$

(Continued on page 62)

**Table 1. No-load kv readings. Because measuring the load will not increase the indicated voltage, no values exist for  $E_2 > E_1$ . And since doubling the load can never halve the indicated voltage, there are no values of  $E_0$  for  $E_2 < E_1/2$ .**

		No-load Kilovolts																			
E <sub>1</sub> (S open)	20	20	21.1	22.5	24.3	26.6	30.0	35.0	43.3	60.0	110										
	19		19	20.1	21.5	23.4	25.9	29.6	35.2	45.6	69.7	190									
	18			18	19.1	20.6	22.5	25.2	29.2	36.0	49.5	90.0									
	17				17	18.1	19.6	21.8	24.5	29.1	37.4	56.7	163								
	16					16	17.1	18.7	20.8	24.0	29.3	40.0	64.0								
	15						15	16.2	17.7	20.0	23.6	27.0	35.0	90.0							
	14							14	15.1	16.8	19.3	23.3	31.5	56.0							
	13								13	14.2	15.9	18.6	23.4	30.4	78.0						
	12									12	13.2	15.0	16.0	21.0	36.0						
	11										11	12.2	14.1	17.6	25.7	55					
	10											10	11.2	13.3	15.0	20					
	9												9	10.3	12.6	15	27				
	8													8	9.3	12	20				
	7														7	8	11.6	28			
	6															6	7.5	12			
	5																5	6.6	15		
	4																	4	6		
	3																		3	6	
	2																			3	6
	1																				2
																					1

# G-E BIG TOP COMING TO YOUR TOWN... YOUR STORE

## 5-Ring Circus of Service Values



1.

Now G-E Aluminized Picture Tubes  
with the new "100-Series"  
red seal for quality!

2.

Six more brand-new General Electric  
Service-Designed Tubes!

3.

TV-radio Tune-up Program,  
nationally advertised by G. E.!

4.

Powerful local advertising support!

5.

G.E.'s great TV-service finance plan!

FOLLOW THE PARADE OF  
SERVICE ATTRACTIONS...



GENERAL  ELECTRIC

**GE TUBES**

# G-E 5-Ring Circus



**NOW**

**ALUMINIZED PICTURE TUBES with the RED SEAL**

NATIONALLY ADVERTISED

FIRST and FINEST ALUMINIZED TUBE

The symbol of quality found only on G-E Aluminized Tubes

GREATER PROFITS

THE SEAL'S THE DEAL

100 SERIES

100% BRIGHTER  
100% MORE CONTRAST

**INSTALL SERVICE-DESIGNED tubes**

**WORLD FAMOUS PERFORMERS**



The original group of 16 that thrilled the world to top performance in all makes of TV.

6BZ7	6BZ7	6BZ7	6BZ7
6BZ7	6BZ7	6BZ7	6BZ7
6BZ7	6BZ7	6BZ7	6BZ7
6BZ7	6BZ7	6BZ7	6BZ7

These performance figures are for the 6BZ7 tube. All other tubes are guaranteed to give the same or better TV performance.

They positively out-perform their prototypes

## G-E ALUMINIZED TUBES WITH THE RED SEAL. FINEST EVER!

TV owners will learn about them through big G-E color ads—"100-Series" G-E Aluminized Picture Tubes with the *red seal*, finest ever built! The new *red seal* stands for top picture tube quality. Bright, sharp, clear pictures; dependable performance that lasts throughout tube life—these spell customer satisfaction, establish you as a dealer handling only the best. Large-scale G-E advertising of "100-Series" Aluminized Tubes with the *red seal*, soon to commence on a nationwide basis, will boost your tube and service sales. Here is a new and important business and profit-builder—with all the sales impetus behind it of a tremendous national advertising campaign!

## SIX MORE NEW G-E SERVICE-DESIGNED RECEIVING TUBES!

Ready to install: new types 1X2-B, 6AL5, 6BK7-A, 6BQ7-A, 6BZ7, 6CB6. Remember the fine reception given other G-E Service-Designed Tubes—how customer goodwill increased sharply, how service business boomed for dealers handling these superior tubes, made *only* by General Electric? The 6 new types will cut call-backs still more, increase your sales and profits further. A revolutionary new "lightning-rod" design, new low-level tube microphonics, greater sturdiness, longer tube life—these and many other vital improvements are included. Now—in all—you will have 20 G-E Service-Designed Tubes which will out-perform and outlast their prototypes!

**SURE-FIRE BUSINESS-BUILDERS, ALL 5 ATTRACTIONS!**

**TUBES**



# of Service Values

GET THE LION'S SHARE  
OF SERVICE BUSINESS

## TV-RADIO TUNE-UP PROGRAM

SHOOT  
YOUR SALES  
SKY HIGH

NATIONAL  
ADVERTISING  
WITH  
LOCAL TIE-IN



**STUPENDOUS  
DEALER  
ATTRACTIONS**

LOCAL

- ★ Newspaper Ads
- ★ Radio Spots
- ★ TV Commercials
- ★ Point of Sale
- ★ Direct Mail

**GE tubes**

## Use G-E'S GREAT TV SERVICE FINANCE PLAN

RIDE  
TO  
GREATER  
PROFITS  
with this  
great new  
selling plan!



TUBES PARTS  
**COMPLETE**  
SERVICE  
NATIONALLY  
ADVERTISED



**tubes**

### NATIONALLY ADVERTISED TV-RADIO TUNE-UP PROGRAM!

Biggest boost to TV-radio service ever undertaken! That's G.E.'s nationally advertised Tune-up Program. Through large G-E color ads in 6 national magazines—reaching every home in your neighborhood—your customers will learn that a TV-radio tune-up now is essential to high-quality pictures and clear, clean reception. Every ad will ask that readers see or phone you, their local independent technician. This plan for TV-radio service action will greatly increase your customer list, keep your telephone ringing busily. You will sell more profitable G-E Aluminized Picture Tubes, more receiving tubes and TV-radio parts, than you have ever sold before!

### MOST ATTRACTIVE DEALER ADVERTISING AIDS EVER OFFERED!

Strong local advertising tie-ins will increase your sales still more. G.E. has ready for you a real Big Top group of colorful displays and other helps. Many of them are shown on the following page. Besides wall and window-banners, they include window-stickers—TV-radio spot commercials—point-of-purchase selling aids—direct-mail pieces—other items. Vivid, fresh, new, these advertising aids underscore G.E.'s nationwide TV-radio Tune-up advertising, and focus its appeal to set-owners on your store or shop. Become the service center for your neighborhood by using these Big Top tie-ins! Your G-E tube distributor has them. Ask his salesman for details!

### G-E SERVICE FINANCE PLAN! YOUR CUSTOMERS CAN PAY OUT OF INCOME!

Most powerful stimulus ever given to tube, parts, and service sales, is G.E.'s great Service Finance Plan. Now the latest instalment methods are available for the benefit of dealers handling G-E tubes. Your customers' needs can be filled immediately and paid for out of income. They no longer will feel they must wait to replace worn-out picture tubes with new G-E Aluminized Tubes—instead, can afford, on an easy instalment basis, the best in tubes and service. Costly installation jobs will be far easier for you to sell. Your whole business will feel the beneficial effects of General Electric's pace-setting Service Finance Plan! Here is a Grade-A sales and profit-builder!

**NEXT PAGE: HOW G.E. SPOTLIGHTS YOU TO REAP THE BENEFITS!**



Every parent will want one or more of these fascinating books for their children's enjoyment. Amusing rhymes; appealing outline sketches to be filled in with crayons. A top-notch store traffic-builder!

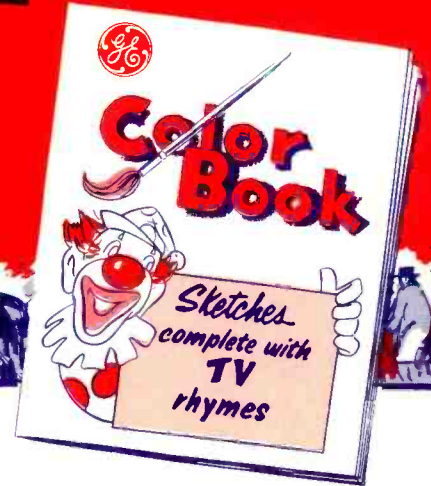

**G-E Big Top wall and window-banners, window-stickers, colorful tie-ins galore, will target your store as TV-radio service headquarters. All are available from your G-E tube distributor!**

Television-radio service—how much it means to high-quality performance; why owners should consult their local independent technician—will be pushed from coast to coast, border to border, during General Electric's TV-radio Tune-up campaign. Giant 2-page magazine ads in color will seize and hold readers' attention, show why regular service attention is a TV-radio "must". Six big national magazines will be used, all with many millions' circulation—Life, Look, Collier's, American Weekly, This Week, and TV Guide.

Tie-in displays are ready for you. Part are shown on this page—though justice can't be done here to their many bright colors, or smart and novel appeal. Eye-stoppers, every one! These Big Top tie-ins will focus sharply on your establishment all of General Electric's gigantic TV-radio service advertising effort.

Lead the TV-radio service parade! Profit from the business-building attractions G.E.'s Big Top holds! Your G.E. tube distributor is waiting to hear from you. Tube Dept., General Electric Co., Schenectady 5, N. Y.

**GENERAL  ELECTRIC**

LATE PRODUCTION transistorized G.E. portables<sup>°</sup> feature a crystal diode to increase overall sensitivity and audio output. This diode has been wired in series with the base of what was the detector transistor (a 2N78), as shown in Fig. 1.

When this diode was added, the value of the base bias resistor was changed from 39,000 to 22,000 ohms. A ½ watt, 10%, carbon resistor may be used.

Late production transistor models also use 2N135 transistors in the oscillator-converter and *if* amplifiers. Use of the 2N135 transistors requires installation of oscillator coil.<sup>°°</sup>

#### Curbing Drift on Continuous Tuners

LOSS OF SENSITIVITY or drift on the *uhf* section of Hoffman TV tuners can usually be remedied by tube or crystal replacement. Solder cracks represent another source of trouble. A shock-mounted sub chassis is used for the *uhf* section of the tuner; with the tuner shield removed, this sub chassis can be identified by its copper color. One should check here for solder cracks or separation of the corner joints of the chassis; such cracks should, of course, be resoldered with a good hot iron to make a smooth joint.

#### Spurious Modulation

SPURIOUS OR FALSE MODULATION often is more difficult to remove than obstinate intermittents or unwanted oscillation.

Whether modulation is true or false, several definite requirements must be present. At least two signals are needed as inputs to a modulator and a modulator is required. Some form of mixing may or may not be present prior to the actual act

<sup>°</sup>G.E. models 675 and 676; complete diagram of receiver appeared on cover of SERVICE, Oct., 1955.

<sup>°°</sup>G.E. RLC 140.

Fig. 1. Revised detector circuit of G.E. transistor radio (models 675 and 676) using crystal diode.

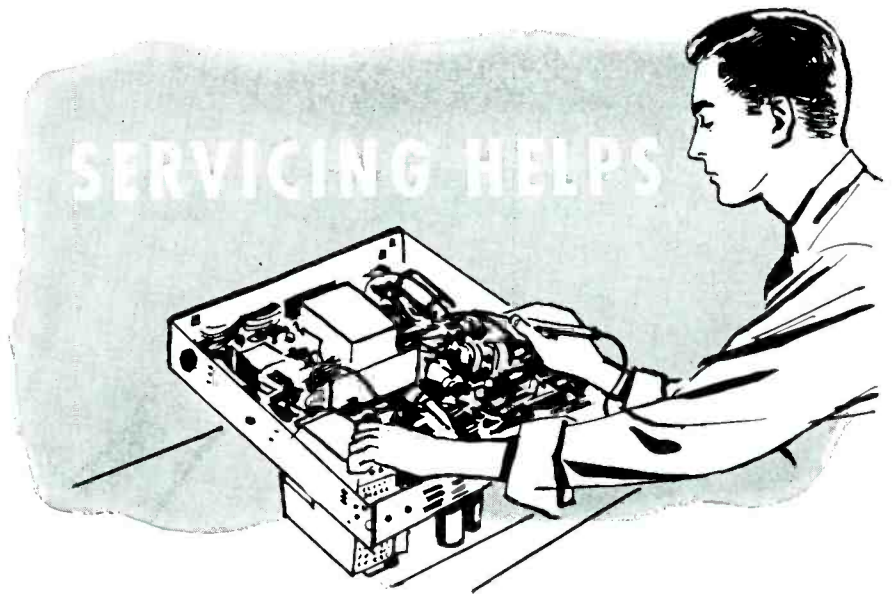
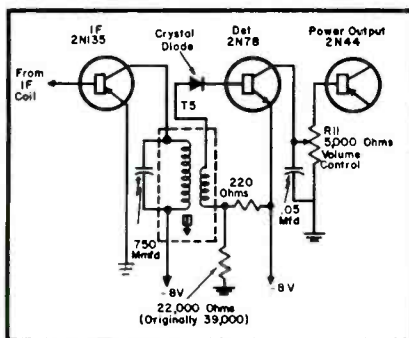

## Increasing Sensitivity of All-Transistor Sets . . . Curbing Drift on UHF/VHF Tuners . . . Troubleshooting Spurious Modulation Problems

of modulation; such mixing and modulation of one signal by the other is very common in cases of false or spurious modulation.

There are three principal types of modulation; amplitude, frequency, and phase.

The first step in analyzing unwanted modulation is to determine whether or not it occurs in the receiver itself. Others may have the same complaint and the problem could be at the transmitter.

If one suspects the receiver, then it is necessary to find out the type that is causing the trouble; frequency, amplitude, or phase modulation. If the trouble is on TV sound, which is

FM by nature, then the modulation most probably is FM or very strong amplitude modulation. Very strong AM may not be limited or removed by a ratio detector's AM rejection circuitry; the ratio detector is relatively ineffective against repetitive AM, such as the intercarrier buzz due to the repeating 60 pps vertical pulse group. One should not jump to the conclusion that the false modulation must be FM, because it arrives with an FM signal.

In the third step in the preliminary analysis, we must investigate the modulating means, and determine whether the unwanted modulating

(Continued on page 48)

Fig. 2. Block diagram of front end where first detector can serve as a modulator for spurious modulation. Return (cathode) circuits of the rf and audio are noted as the common impedance.

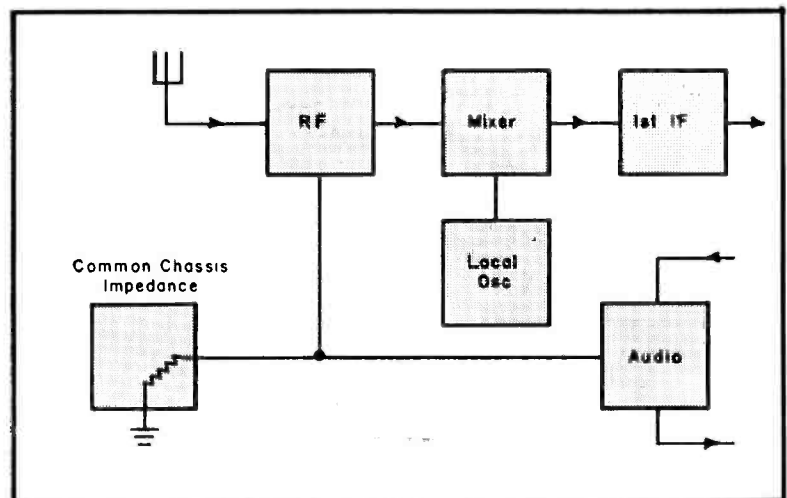

*I've Heard*

**ENOUGH**

*Claims...*

**-only "Staminized" Astron Capacitors really deliver better performance.**

Astron's capacitor "know-how" insures better performance 3 important ways — better designs, better materials, better production techniques — the secret of "Staminizing"

Learn the facts, as thousands of service technicians have, why Astron's extra-rugged capacitors build consumer satisfaction and repeat business — *eliminates callbacks!*

You'll find there's a dependable Astron exact replacement capacitor for every radio and TV requirement — **write for FREE "Astron Replacement Catalog AC-4D"**.

Ask your jobber for "Staminized" Astron Capacitors — today!

**PROVED BEST IN SERVICE!**

Be sure to see us at  
**BOOTH 368, MARCH IRE**



**ASTRON**

**C O R P O R A T I O N**

255 GRANT AVENUE

EAST NEWARK, N. J.



WEST COAST WAREHOUSE: 9041 WEST PICO BLVD., LOS ANGELES EXPORT DIVISION: ROCKE INTERNATIONAL CORP., 13 EAST 40TH ST., N. Y., N. Y.  
IN CANADA: CHARLES W. POINTON, 6 ALCINA AVE., TORONTO, ONTARIO



# Antennas, Transmission Lines and Distribution Systems for COLOR

COLOR SET (and good-quality black and white) performance, is dependent on a uniform response across the 6-mc channel. To obtain this result the total variation across each channel should not exceed 6 db; 2:1 variation in voltage. This includes the whole receiving system; the antenna, transmission line, receiver and any amplifiers and dividing networks. Since it is possible that deficiencies in any part of the system could add up, the efficiency of each part must be better than the allowable maximum.

The total variation in antenna response across any one channel should not exceed 2 db with the antenna fed into a matched load.

The allowable mismatch between antenna and transmission line is somewhat dependent on the match between the receiver and the line, and the length of the line. The mismatch is usually given in terms of voltage-standing-wave ratio (*vswr*) and, generally, should not exceed 4:1. In some cases, where the receiver presents an unusually good match, 8:1 or more can be tolerated at the antenna. Again, with poor receiver match or improperly-installed transmission lines, the match must be held within 2:1 at the antenna.

The antenna should be so located that it provides a signal substantially free of interference and reflections. A reflection with a path-length difference of  $\frac{1}{2}$  wavelength multiples at 3.58 mc, may cause cancellation of the color subcarrier, just as some reflections may cause picture-carrier cancellation and loss of sync on black and white. This trouble is difficult to observe without color transmission, but sometimes can be observed on a good b-w test pattern as a smear or cancellation of the vertical wedge

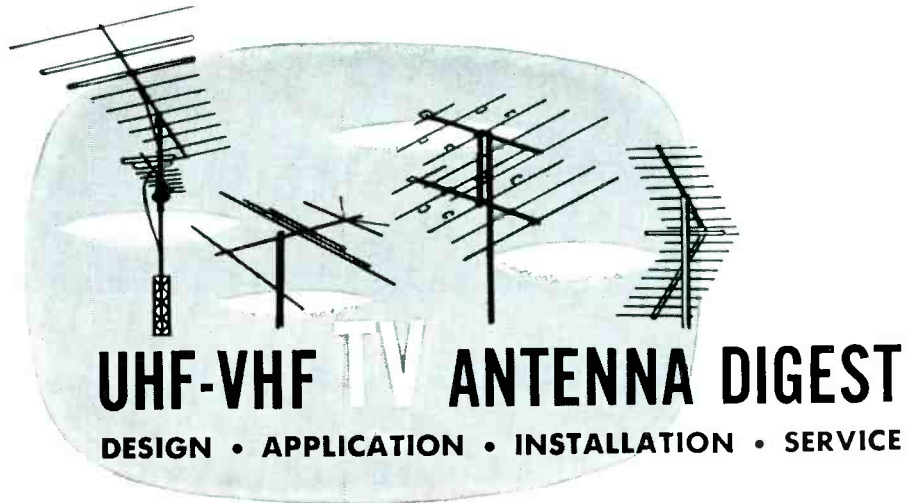

by **J. D. CALLAGHAN**, *Engineering Department*  
**RCA Service Company**

near the high-frequency cutoff; small end of wedge, about 285 lines.

There is one particularly annoying problem in color, *suckouts*, which causes a drastic reduction in signal over a narrow band or a hole in the response.

It has been found that this condition is acute with certain types of multiple-element antennas, where one of the elements acts to create a phase shift and a dip in signal response.

The transmission-line impedance must match the design input impedance of the receiver or amplifier; normally 70-75 or 270-300 ohms.

Care should be taken to prevent changes in transmission-line impedance and resulting mismatch due to faulty installation. This is most common in unshielded lines, and is usually caused by running the line too

close to metal objects or by use of poorly designed lightning arresters. Lightning arresters should be small. Their body should not be made of any moisture-absorbing material. Terminals and metal parts, directly attached to line should not only be as small as possible, but relatively distant from each other to keep stray capacity low.

All 300-ohm lines should be kept at least three inches from any parallel conductive surfaces, including brick, stone and concrete. Tacking to wood surfaces is permissible *indoors only*, on short runs. Long runs should be allowed to contact the wood only at intervals, or should be placed on stand-off insulators.

Master antenna amplifiers are satisfactory for color, provided they are

(Continued on page 65)

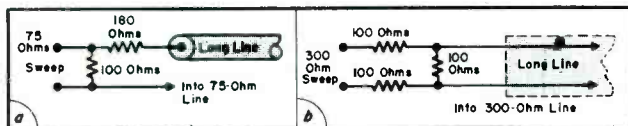

(Above)

**Fig. 1.** Series and shunt resistors included in 75- and 300-ohm lines to provide mismatch to output of sweep generator.

(Right, top)

**Fig. 2.** Bumps due to line reflections. Pattern at left illustrates excellent match; same as without line. Center pattern shows a good match; system will work satisfactorily in this instance. A poor match is illustrated in pattern at right; input circuits are defective in this case.

(Right)

**Fig. 3.** Correct method of installing color set in existing multiple b-w installation.

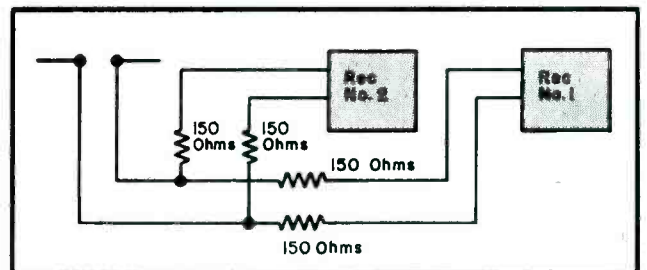
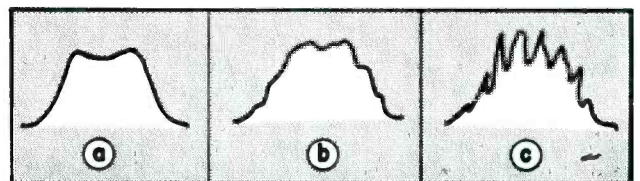



## Testing Tubes For Critical Circuits

BASIC FAMILIARITY with critical circuitry and particularly the performance required of the tubes in these circuits, does not only save one servicing time and effort, but reduces call-backs, by revealing potential sources of failure. All circuits are designed to operate with tubes and components having handbook characteristics, and a number will work with parts which are outside the usual tolerance limits or with tubes which are not at peak operating efficiency, but there are many circuits that are more restricted in latitude. Indeed, some tubes fail even before normal tube end-of-life is reached. Testing tubes in these more critical circuits must be done very carefully, bearing in mind the special restrictions applicable to each type.

Typical critical circuits include TV sweep and sync circuits, and radio and TV oscillators; in contrast linear voltage amplifiers and *if* stages are not normally critical.

TV sweep circuits impose severe requirements on tube performance. A horizontal output amplifier, for example, must meet two requirements if a linear sweep of sufficient amplitude is to be obtained: proper gain and am-

ple peak emission. Although transconductance tests will usually indicate a tube of insufficient gain, interpretation is required because the sweep width decreases in proportion to the *gm* of the tube. A decrease of 15 per cent is often enough to reduce the width beyond the range which the adjustments can correct, but average *good-bad* scales may be set for a 30 per cent or more reduction before rejection. In a sweep circuit where inadequate sweep is the complaint, a tube which produces a reading in the low part of the good region may therefore actually be bad. It is better to read the actual value of *gm*, comparing this with the nominal value before deciding if the tube is good or bad.

When the width obtained is satisfactory, but the linearity is poor, the cause of trouble may be inadequate peak emission. Emission tests check the average value of emission, so that, while a tube which shows low emission in the test is not usable, a tube showing good average emission may have low *peak* emission. While no direct test of peak emission is normally available, an indication can be obtained by reducing the heater po-

tential from 6.3 to 5 volts while checking average emission. If average emission falls off by more than a few per cent, the peak emission is likely to be inadequate.

Occasionally a circuit, which is usually very tolerant of tube condition, is found to be critical because several components have drifted to values near the tolerance limits. Although each component may still be within its nominal limits, the combination can cause the circuit to become critical.

Sync circuits are among those likely to be affected by apparently minor drifts in component values. Since tube cutoff is used in these circuits, the cutoff value is important. Tube tests do not directly check for cutoff, but a *gm* test provides a fair indication. When a tube with either slightly high or slightly low *gm* is suspected in a sync circuit, it is well to check the circuit values for drift. The real fault may be that the components have changed enough so that only selected tubes will operate properly. Since all tubes change as they age, it is important that the circuit values be corrected or the new tube will also give poor performance long before it should.

Radio and TV local oscillators are sometimes critical. This is especially true in *uhf-TV* where oscillators operate at frequencies which required very special tubes a few years ago. Local oscillators used in radio chassis are also known as being critical, particularly in some of the early *ac-dc* receivers. When an oscillator tube checks somewhat low in *gm*, careful consideration should be given to the circuit. If it is believed to be critical, the tube should be replaced.

A particular tube defect which may cause cross modulation or distortion in a receiver is the development of a *hot spot* on the tube cathode. Occasionally what appears to be normal current will be emitted, but all from a small portion of the cathode. Such a tube can have unusual characteristics. This is particularly true for a remote cutoff tube, where the varied grid spacing determines the tube's characteristics. With all current flowing through a small portion of the tube where the grid is uniformly spaced, the characteristic changes to that of a sharp cutoff tube. Cross modulation can result if the tube is in the *rf* stage of a receiver, and distortion will appear if it is in the *if* stage. On a tube tester such a tube may have a normal *gm*, a value which is higher than normal, or a value which is low. A check at reduced

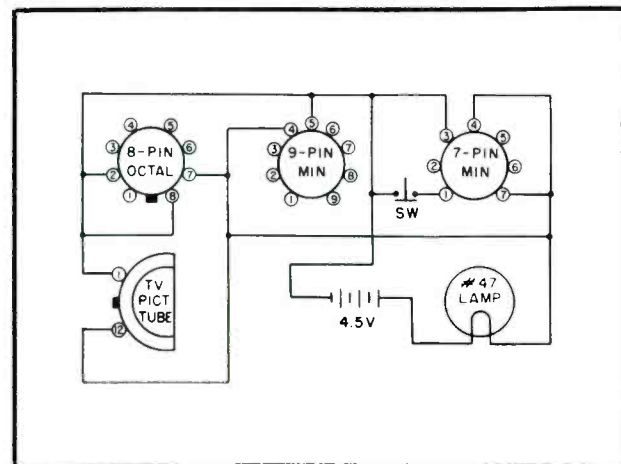

**Simplified tester for series - string TV tubes. Switch shown is optional to enable testing of 5AQ5 and similar tubes with internal connection between pins 1 and 7.**

(Courtesy CBS-Hytron)

(Continued on page 45)

Another ANTENN-GINEERED Original

by **Snyder**  
PHILADELPHIA

# TORQUE-T-ANTENNA

WITH EXCLUSIVE INTERCEPTOR DISCS



WEIGHS ONLY 27 OUNCES

- NEWEST ELECTRONIC DISCOVERY
- OUTMODES OLD FASHIONED ANTENNAS
- EQUAL/BETTER THAN ANY CONICAL
- QUICKER/EASIER 1-MAN INSTALLATION
- STACKS FOR FRINGE AREAS

## ATTENTION TECHNICIANS!

1ST TIME IN ELECTRONIC HISTORY A 1/2 WAVE  
LENGTH RESONANT ANTENNA WITH ONLY  
A 1/4 WAVE LENGTH PHYSICAL DIMENSION

*and Costs Less!*

*Unfold - Tighten - Erect*

# Portable Record Player Modifications For Improved Audio

by R. D. WENGENROTH

## Amplifier-Speaker Circuitry Revisions That Can Be Made to Provide Better Quality and More Gain

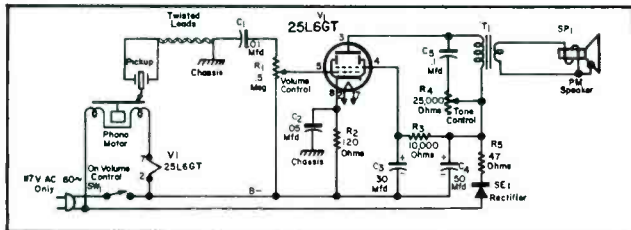

**Fig. 1. Typical portable phone amplifier schematic; Emerson chassis 120270-B.**

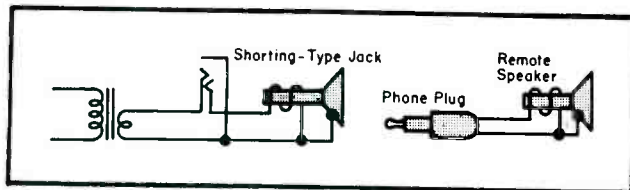

**Fig. 2. Modification of typical portable phone amplifier for feeding separate speaker.**

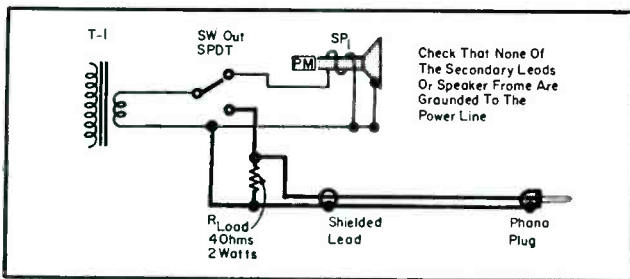

**Fig. 3. Modification of typical portable phone amplifier for feeding separate amplifier. This circuit provides isolation from shock and short circuit.**

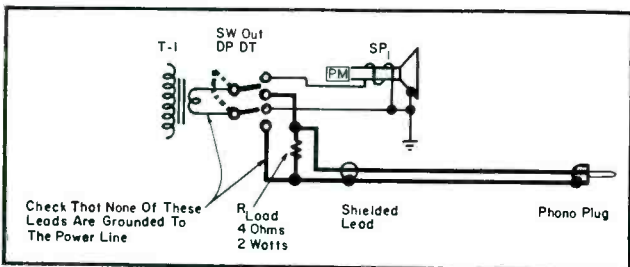

**Fig. 4. Simpler modification when speaker is not connected to chassis or line.**

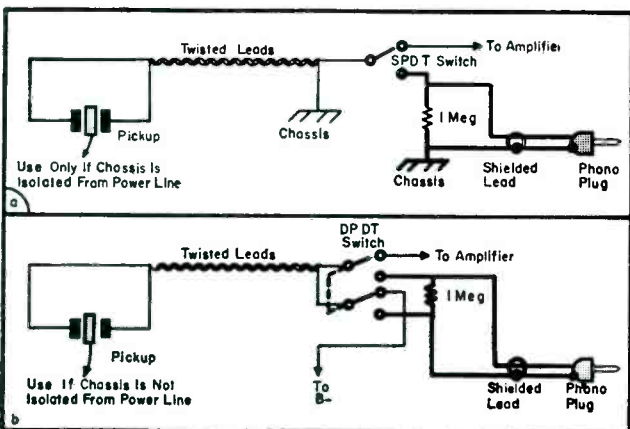

**Fig. 5. Modification to portable record player which eliminates phono amplifier from the circuit: (a) = For use only if chassis is isolated from power line. (b) = For use if chassis is not isolated from power line.**

MANY PORTABLE RECORD players and small radio receivers are basically capable of much better performance than that usually obtained. Normally, these items are limited by small cabinets or small amplifiers; but their performance can be improved if they are modified for use with larger external speakers or audio systems. Similarly, many radio receivers can be made more versatile by the installation of a phono jack which permits the use of record player attachments.

Several techniques are available for improving record player performance, depending upon the audio system. A primary consideration is safety, and modifications involving questionable safety never should be made. In the typical *ac-dc* amplifier, this situation presents a number of problems. Shorting of the line, shock, and hum all must be avoided and proper operation of the basic unit must still be preserved. Available alteration methods include: *if* phono oscillator, which is a nuisance, expensive, and usually unsatisfactory; remote speaker, which is the simplest modification; amplifier output fed to the phono input of an audio system, which might be a console-type receiver; or pickup output fed to the phono input, which is the most satisfactory change.

A phono input can often be added to a quality receiver without great difficulty, but similar precautions to those for the record player modification must be observed.

The typical one-tube phono amplifier used in a portable record player<sup>o</sup> shown in Fig. 1 can be modified in several different ways to provide better sound output. The output quality of the unit as shown is limited by the speaker system, inasmuch as a small speaker in the small cabinet supplied cannot provide low-frequency response. The *quantity* of sound (maximum volume) is limited by the pickup output; about ¼-watt peak output can be obtained, and distortion is low.

The simplest modification is shown in Fig. 2. A shorting type jack makes possible the connection of a larger speaker mounted in a better baffle, thus providing a considerable improvement in quality. The speaker must have the same voice-coil impe-

<sup>o</sup> Emerson chassis 120270-B.

(Continued on page 44)

“This portion of the Garry Moore Show is brought to you *in behalf of radio and television service-dealers* who use and recommend CBS Tubes.

“That’s the way you’re introduced. Later, I focus right on you — like this:

“ . . . television sets require trained service-dealers to keep them in good condition. And believe me, a qualified service-dealer *is a trained technician*. He has spent a lot of time and effort studying electronics, and a substantial amount of money for technical equipment.”

## Garry Moore sells your service

while he sells  
CBS Tubes\*



Garry  
Moore  
*famous CBS  
Television Star*

“See how CBS-HYTRON works side by side with you. The easy way for you to cash in is to use and recommend CBS Tubes. Because I keep reminding my listeners there are no better tubes made than CBS Tubes — and they have the Good Housekeeping Guaranty Seal.”

You’ll build profitable customer confidence and sales when you recommend CBS Tubes . . . the tubes with the Good Housekeeping Guaranty Seal.



\*On the CBS Television Network.

**CBS-HYTRON**, Danvers, Massachusetts . . . A DIVISION OF COLUMBIA BROADCASTING SYSTEM, INC.

SERVICE, MARCH, 1956 • 43

at



7 major quality checks

## ASSURE SUPERB CABLE PERFORMANCE

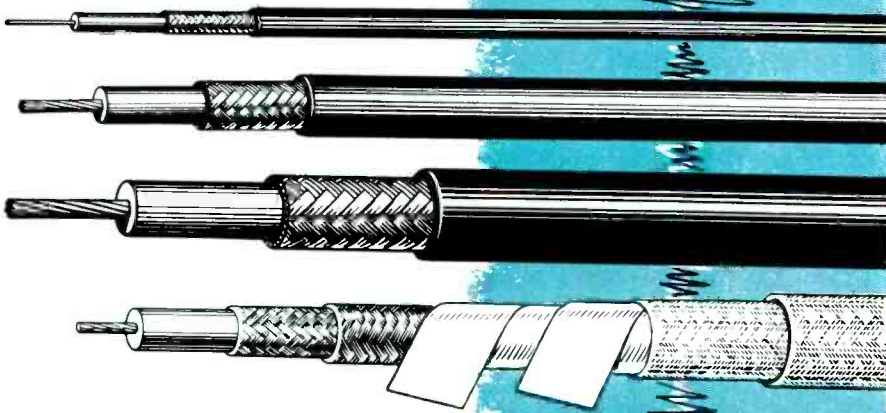

7 major quality checks, on the line and in the laboratory assure the top performance of dependable AMPHENOL coaxial cable.

- 1 Center conductor: lab check of mechanical and electrical characteristics.
- 2 Dielectric: rolling micrometer checks dimensions during extrusion.
- 3 Finished Core: micrometer checked again before jacketing.
- 4 Shielding: checked after braiding for percentage of coverage, loose ends, tightness.
- 5 Jacket: inspected 100% during extrusion.
- 6 Complete cable: special lab check of every run, electrically and mechanically.
- 7 Complete cable: every foot extruded is run through automatic machinery for final dimensional check.

Constant inspection and testing during manufacture, the use of fine materials, modern equipment, skilled workmen: all are combined at AMPHENOL. Specify and insist upon AMPHENOL coaxial cables!

 CHECK WITH YOUR AMPHENOL DISTRIBUTOR FOR EVERY CABLE NEED

AMERICAN PHENOLIC CORPORATION  
chicago 50, illinois  
AMPHENOL CANADA LIMITED toronto 9, ontario



## Record Players

(Continued from page 42)

dance as the record-player speaker. The output volume is the same as that of the player itself and is adequate for quiet listening, and the hum level should not be objectionable.

A second modification is shown in Fig. 3 (p. 42). When an audio system of better quality and higher output, such as a console radio with a phono jack, is available, this circuit provides substantially-improved performance. The output transformer, from which the output is taken for safety, provides isolation from the power line and from B+ of the amplifier. The installation itself is simple. Space for the switched load resistor can readily be found. Because the amplifier will be on, in any case, when the phono motor is turned on, this simple form of installation proves satisfactory. When the speaker frame is not grounded, the slightly simpler circuit of Fig. 4 (p. 42) can be used; electrically, it is the same as that of Fig. 3. *This circuit should be used only when the speaker circuit is not grounded to one side of the line.*

To eliminate the amplifier from the system, thus removing the hum, distortion, and the loss of frequency response which occur in the amplifier, the modifications shown in Fig. 5 (p. 42) can be employed. Special care must be taken to avoid hum pickup and shock when this connection is made to an *ac-dc* amplifier. Fig. 5a, which provides a common ground between the units, is usable only with a chassis isolated from ground; the more common *ac-dc* type of circuit requires the modification of Fig. 5b, which does not connect with the two chassis. The possibility of hum pickup exists in this circuit if the player mechanism is at line potential. Each circuit should be inspected to see if the player mechanism can be isolated from its amplifier chassis, and connected to the ground side of the phono-amplifier lead. Again, the dangers of possible shock should be investigated.

The modified circuits described can feed any receiver equipped with a *phono* input. Not all receivers are so equipped, but most could be modified for phono-amplifier service. Larger *ac*-type console receivers are readily modified; the technique is the same for *ac-dc* receivers, except for the added safety precautions required.

Some interest in modifying small table-model receivers exists for use with record-player attachments where these receivers are the only convenient amplifiers available. Here one

simply installs a phono jack, preferably with a switch to disconnect the receiver detector, ahead of the receiver volume control.

### Tube News

(Continued from page 40)

voltage will probably show a large change in *gm*; in this case, the tube should be replaced.

Another source of distortion or receiver overload is grid emission in *if* amplifiers. The emission causes current flow in the *avc* or *agc* system. The voltage drop subtracts from the *agc* voltage, causing the amplifier to have too much gain and therefore to overload. Grid-current tests would reveal this condition; the tube may have good emission and *gm* even though the grid current is high. When tube replacement clears overload trouble of this sort, even though the tube tests good, it probably has grid emission and must be replaced.

### Troubleshooting Series String Circuits

In series strings a burned-out tube automatically shuts off heater power to the entire string. The simplest way to find the defective tube is to check across each tube's heater terminals for the indication of full power-line voltage that will appear across the open heater. This can be accomplished if the underside of the chassis is exposed.

If only the top of the chassis is accessible, a heater continuity tester can be used to speed up troubleshooting.

The circuit of such a checker is illustrated on page 40.

### TV ANTENNA REPORT ON AIR



Harold Harris, vice president in charge of sales and engineering of Channel Master, discussing the purposes and functions of TV antennas and their importance to good TV reception, during recent Ruby Mercer Show, network radio show originating over New York's WOR. All types of reception areas, from big cities to rural fringe areas, were reviewed.



# BEST FOR COLOR TEST!

There's just one way to test the new color TV sets... WITH NTSC COLOR PATTERN. That's what Hycon's Model 616 Color Bar/Dot Generator offers... *all* standard colors, sequences and patterns easily selected and graphically shown *in actual color* right on the control panel. For color TV, get ready... GET HYCON!



### MODEL 617 3" OSCILLOSCOPE

The most for your scope dollar. Flat-face CRT gives edge-to-edge accuracy... laboratory precision *plus* field ruggedness. And at your electronic jobber, it's just... \$269.50.

*"Where Accuracy Counts"*  
**Hycon** ELECTRONICS, INC.  
A Subsidiary of Hycon Mfg. Company  
321 SOUTH ARROYO PARKWAY  
PASADENA, CALIFORNIA

**MAIL,  
please,  
for Catalogs  
616 and 617**

HYCON ELECTRONICS, INC. Dept. S  
P.O. Box 749 Pasadena, California  
Please send me the new model 616 and 617 catalogs.

Name \_\_\_\_\_  
Address \_\_\_\_\_  
City \_\_\_\_\_ State \_\_\_\_\_

## ROGERS ELECTRONIC SPONSORS SERVICE FORUMS

A series of company-sponsored technical service forums covering the theory and design of sweep circuits, and trouble-shooting techniques, has been announced by Rogers Electronic Corp.

Under the direction of Jack M. Gutzeit, chief field engineer, the forums are being held throughout this country and Canada.

## JAMES VIBRAPOWER INTRODUCES DESIGN SERVICE

The James Vibrapower Co., 4036 N. Rockwell St., Chicago, Ill., has announced a vibrator power supply design service.

Service includes production from samples to large quantities of both transformers and vibrator components.

## HAWAIIAN HIGH FIDELITY WEEK

The first Hawaiian high-fidelity week was held recently at the Reef Hotel in Honolulu under the sponsorship of local dealers, manufacturers and manufacturing reps.

*Gordon Dougherty*, sales manager of Brenna and Browne, manufacturers' reps, was chairman of the special week.

## NATIONAL WAREHOUSING FACILITIES SET UP BY GENERAL DRY BATTERIES

General Dry Batteries, Inc., has set up eleven warehouses throughout the country to expedite delivery. Depots include Atlanta, Ga.; Boston, Mass.; Cleveland, O.; Dallas, Tex.; Denver, Colo.; Dubuque, Ia.; Los Angeles, Calif.; Memphis, Tenn.; Portland, Ore.; San Francisco, Calif., and Silver Spring, Md.

## SENCO MERCHANDISE DISPLAY

A four-color display board for small service units is now available from Service Instruments Co., 171 Official Rd., Addison, Ill.

Board comes equipped with easels and hooks for hanging on wall or setting on counter.

## OLYMPIC BUYS DAVID BOGEN

Olympic Radio and Television, Inc., has announced the purchase of all outstanding stock of David Bogen Co., Inc., 29 Ninth Ave., New York, N. Y.

Present Bogen management, policies, brand name, sales organization and pattern of distribution will remain intact.

## SNYDER INTERNATIONAL SALES MEETING

A national-overseas sales and sales-promotion meeting was held recently in Las Vegas, Nev., by the Snyder Manufacturing Co.

Those present at the conference included Ben Snyder, company prexy; Dick Morris, director of sales; Vic and Jack Van Der Hout of Van Der Hout Associates, Ltd., Toronto, Canada; and M. W. Berns, president of Roburn Agencies, Inc., export division of Snyder.

## SPRAGUE TO PRODUCE SURFACE-BARRIER TRANSISTOR

The Sprague Electric Co., North Adams, Mass., has disclosed that it has been licensed by Philco to produce surface-barrier transistors.

Production is scheduled to start during the last half of this year.

A new plant to manufacture surface-barrier transistors will be built shortly in Concord, N. H. The new building will occupy 20,000 square feet adjacent to the Concord Airport.

It is expected that production will be well under way by fall of '56 with about 200 persons employed.

General manager of Sprague's Concord operations will be *Jesse Ault*.

## MERIT OPENS PACIFIC WAREHOUSE

The Merit Coil and Transformer Corp., 4427 North Clark St., Chicago, has opened a warehouse at 312 7th St., San Francisco.



## The Capacitor Package that means Quality 1 year service guarantee

When you see this package in the familiar red and black box, you know it contains "trouble-free" Planet capacitors—mechanically and electrically tested throughout manufacture.

This rigid system of quality control makes our unconditional one-year guarantee possible. But making Planet capacitors correctly from the start means reasonable prices too!

## PLANET SALES CORPORATION

225 BELLEVILLE AVENUE • BLOOMFIELD, N. J.

WRITE for Catalog 200—Lists Specifications on Stock Items

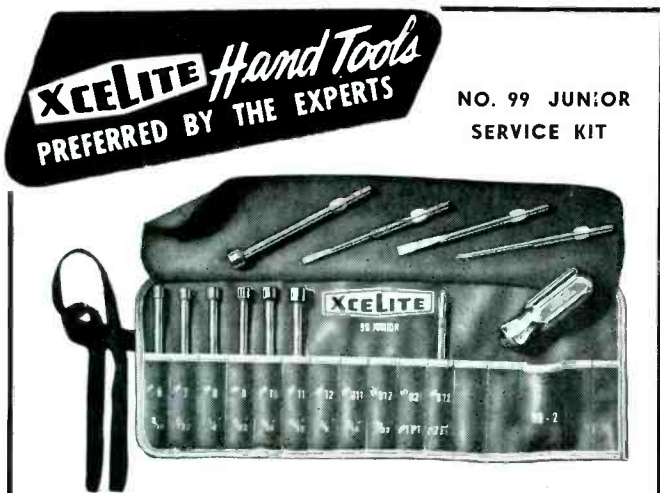

## APPROVED BY THE BEST JUDGE OF GOOD TOOLS — THE SERVICEMAN

That's because the 99 Junior gives a serviceman what he wants—a pocket roll kit with the screwdrivers and nut drivers he needs—the big, hand-filling Xcelite handle—screwdriver points and nut driver sockets of high strength and accurate fit. And best of all, a price tag that's not hard to take. Ask your supplier today!

**XCELITE**  
INCORPORATED  
Dept. V,  
Orchard Park, N. Y.

*For Originality*  
LOOK TO **XCELITE**



## CATALOGS — BULLETINS

RECTON CORP., 52-35 Barnett Ave., Long Island City 4, N. Y., has issued a 4-page bulletin, 5602, covering needle sales promotion and merchandise displays.

SYLVANIA ELECTRIC PRODUCTS, INC., 1100 Main St., Buffalo, N. Y., has released a 20-page service shop operation booklet, *A Guide to Good Business*, with information on original planning, surveying of market conditions, choosing right location, plus ideas and suggestions for arranging shop setups and service areas.

BLONDER-TONGUE LABORATORIES, INC., 526 North Ave., Westfield, N. J., has issued two bulletins covering TV distribution amplifier DA8-B, for eight amplified outlets from one antenna, and rotary cable stripper S-1.

SIMPSON ELECTRIC CO., 5200 W. Kinzie St., Chicago 44, Ill., has published catalog bulletin 3001, describing temperature and line meters, wattmeters, *vtvms* and *voms*. Also available is bulletin A-103, with information on 7" scope and white dot generator for *b-w* and color-TV.

BIENBACH RADIO CO., INC., 145 Hudson St., New York 13, N. Y., has released a brochure, 55-T, listing specifications on plastic sleeving and tubing.

CORNELL-DUBILIER ELECTRIC CORP., South Plainfield, N. J., has published a 20-page illustrated catalog, 616, covering disc, tubular, slug-type and special types of ceramic capacitors.

TUBE DIV., RCA, Harrison, N. J., has issued an *Interchangeability Directory of Industrial-Type Electron Tubes (1D-1020A)* and a *Picture Tube Replacement Directory (KB106)*. Interchangeability directory lists power tubes, vacuum and gas rectifiers, thyatrons, ignitrons, magnetrons, glow-discharge tubes, cathode-ray tubes, camera tubes and receiving types for communications and industry. Replacement directory offers ratings and characteristics of 60 pix tube types and recommended RCA replacements for more than 150 industry types.

COLUMBIA WIRE AND SUPPLY CO., 2850 Irving Park Rd., Chicago 18, Ill., has released a 4-page catalog supplement which includes price listings for all company products.

SYLVANIA ELECTRIC PRODUCTS, INC., 1740 Broadway, N. Y., 19, N. Y., has issued a TV color tube chart, illustrating how the tube works, and a TV pix tube comparison wall chart detailing complete characteristics of the majority of tubes now in use.

AUDAK CO., 500 Fifth Ave., New York 36, N. Y., has published a 22-page booklet covering pickups, styli, tone arms, turntables, styli wear tests, and record care.

SARKES TARZIAN, INC., 415 N. College Ave., Bloomington, Ind., has published a 6-page illustrated brochure with technical data on silicon rectifiers.

JAMES VIBRAPOWER CO., 4050 N. Rockwell St., Chicago 18, Ill., has issued a 12-v vibrator replacement and servicing chart for auto radios.

INTERNATIONAL RECTIFIER CORP., El Segundo, Calif., has released a service-aid booklet, *Tips*, the first of a series, containing articles, service hints and cartoons. IRC offers \$25.00 defense bonds in payment of accepted articles submitted by Service Men. In addition, it is said, four TV selenium replacement rectifiers will be given away for all useable *service hints*. Both articles and hints should be mailed to company.

# Here's The ANTENNA YOU CAN MAKE MONEY Installing

designed  
for 1 man...  
7 minute  
installation

NEEDS ONLY A  
HAMMER TO INSTALL

GENUINE *Color Beam*

**\$1495** COMPLETE LIST

YOU MAKE \$600  
ON ANTENNA  
SALE ALONE

 Exclusive with  
**WINEGARD**

ANY ANTENNA THREE YEARS  
OLD SPOILS THE TV PICTURE

\*designed for **BLACK and WHITE** and **COLOR**

Available at Leading Parts  
Distributors Everywhere or Write

**Winegard Company**  
Burlington, Iowa

For Pamphlet "How to Make Money  
on One Man Antenna Installation."



Antenna boxed—completely assembled—attached lead-in

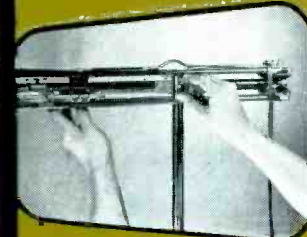

Raise main crossarm.

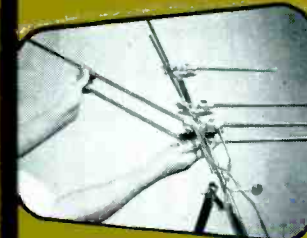

Snap secondary crossarms in place.



Nail up mounting bracket.

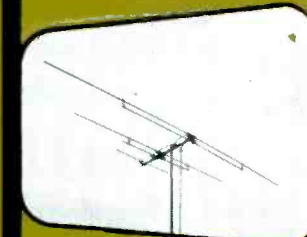

Drop lead-in wire.



Attach lead-in to TV set—special clip snaps on.

let **THIS** be your guide

**AEROVOX**

**ELECTROLYTIC CAPACITOR REPLACEMENT GUIDE**

ADMIRAL to ZENITH

Your Aerovox Distributor

DISTRIBUTOR DIVISION  
NEW BEDFORD, MASS.  
AEROVOX CORPORATION

**HERE IT IS!**

A complete, up-to-date replacement guide for all

electrolytic capacitors used in TV sets. Saves time, labor, money, on your service calls. In all cases, this Guide recommends

only **ONE** unit replacement for any given Manufacturer's Part No.

—not **TWO** units to replace **ONE**.

Ask your distributor for your copy. Or send 25c directly to...

**AEROVOX CORPORATION**

**DISTRIBUTOR SALES DIVISION  
NEW BEDFORD, MASS.**

In Canada: AEROVOX CANADA LTD., Hamilton, Ont.

Export: Ad Auriema, Inc., 89 Broad St., New York, N. Y. Cable: Auriema, N. Y.



**Servicing Helps**

(Continued from page 37)

signal modulates another signal, usually a wanted carrier signal which may or may not be modulated itself.

The fourth step comprises a search for the path by which the unwanted modulating signal gets to the modulator or to some mixing stage preceding the modulator. Does it enter by a common impedance route, electrostatic or capacitive feedback, electromagnetic or inductive feedback, or by some combination of these types? This step is generally most useful, because if one can eliminate the unwanted modulating signal, then the undesired modulation is eliminated.

Any non-linear amplifier can serve as a modulator, but those deliberately designed as detectors are the most common offenders: Mixer or first detector; picture, video or second detector; *dc* restorer diode; diodes of the FM detector, whether a ratio detector or a discriminator; even the horizontal *afc* diodes. The most common offenders are the first and second detectors.

Often local oscillator tubes develop a partial short circuit between its cathode and heater. The resulting symptoms are hum on the picture, but not on the raster on all station channels, and hum on the sound when a station carrier is present, but absent whenever the station carrier is absent.

The cathode is modulated by the heater current which appears because of the partial short circuit, causing modulation of the electron current leaving it. Thus we have AM modulation of the local oscillator voltage, which is presented to the mixer as one input to the mixer. The *rf* signal is the other input to the mixer which is also a modulator; the resulting output is the *if* which is only present whenever there is an *rf* input.

We thus have a definite clue as to the cause of the problem; no *rf* input, no *if* input and thus no hum, with the converse being true whenever a station signal produces an *if* input. The process of AM modulation in the mixer (modulator) also produces some FM as its invariable accompaniment; so we have the hum in the sound. Even if this were not true, the repetitive nature of the hum would permit its passage through a ratio detector and the following audio system to the speaker; there is enough AM sound modulation present (in most cases of this nature) to even pass some through a limiter or discriminator system. Naturally there is ample hum signal to produce the hum bar on the picture.

Now the second detector, or pix detector, could serve as a modulator equally well. How then does one know which is which; which causes the hum? This can be resolved with a instrument check. Output of an AM signal generator should be connected to the *if*, any stage will do, and set for the *if* frequency; AM modulation on the generator can be used to produce bar patterns on *rf* only (AM should be switched off if it is used to tune the generator to the *if*). If hum is modulating the signal prior to the point of injection of the generator signal, then you have no hum present and the modulation occurs prior to the point of injection. In making such a test, one ordinarily kills the signal channel prior (immediately prior) to the point of injection; you can inject at the first *if*, then remove the mixer tube. You learn from this test that the trouble spot (modulator) lies ahead or behind the point of injection. In the case just mentioned, the hum symptoms would appear on the picture and sound as soon as the signal injection was made at the mixer. Of course, the same symptoms would arise with the generator signal injected into the *rf* grid or plate circuits; you take your cue from the first point of injection at which the symptoms occur.

Another interesting spurious modulation case history recently encountered involved the first detector as the modulator. The *rf*, and to an extent, the mixer, picked up the audio signal with a remodulation out of phase to the *rf* carrier which produced a Donald Duck or interrupted sound as the symptom.

To probe this problem, the method of localizing the modulator and the pickup stage, similar to the preceding problem, was used; an injected signal from a generator was employed. First, the audio portion of the generator fed an audio signal to the set via the volume control. No matter how great the volume, the Donald Duck effect could not be created. The generator was next placed at the first *if* stage grid, and regardless of the strength of the input signal, interrupted sound still was absent. However, feeding the generator (an AM model modulated by 400 cycles) into the antenna terminals resulted in the odd sound effect. Feeding to the mixer grid also resulted in the sounds, but on a minor scale. Thus, it was found that the trouble developed at and prior to the mixer. In the chassis checked, the trouble was more pronounced at the *rf* input, even though this stage had very little gain.

# MAKE MORE MONEY on every service call

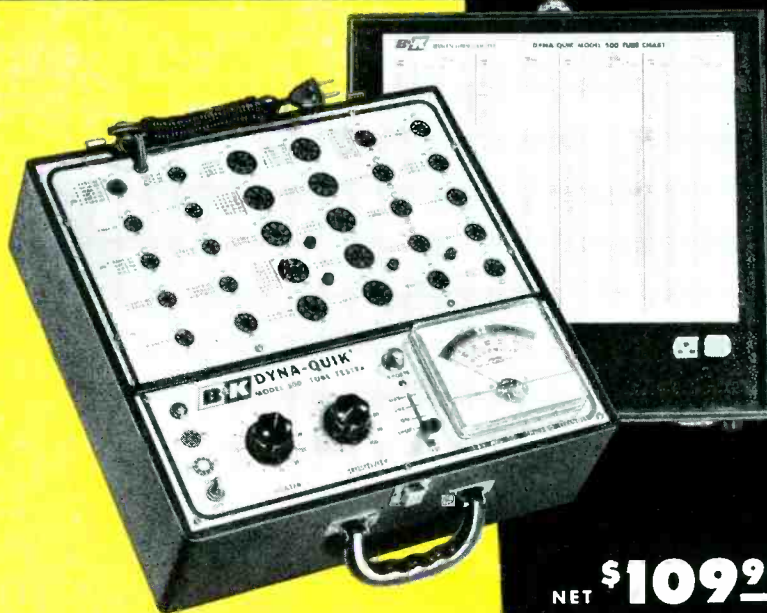

NET \$109<sup>95</sup>

**B&K**

## DYNA-QUIK MODEL 500

DYNAMIC MUTUAL CONDUCTANCE TUBE TESTER

### Tests over 95%

OF ALL POPULAR TV TUBES\*—IN SECONDS

You can cut servicing time—eliminate repeat calls—make more on-the-spot tube sales—give a better service guarantee—make new profits in minutes with DYNA-QUIK. This top quality, low cost, portable dynamic mutual conductance tube tester enables any serviceman to locate weak and inoperative tubes quickly and easily with laboratory accuracy right in the home.

DYNA-QUIK creates greater customer confidence because your customer sees for himself the true tube condition on "Good-Bad" scale. In just a few minutes you can check all the tubes in a TV set for shorts, grid emission, gas content, leakage, dynamic mutual conductance and life expectancy under the dynamic heavily loaded conditions that are the actual operating conditions of the set. Used in the shop or in the home—DYNA-QUIK will make money for you every day!

- Fast—a complete tube test in as little as 12 seconds.
- Easy—one switch tests everything. No roll chart—no multiple switching.
- Accurate—large 4½" plastic meter has two scales calibrated 0-6,000 and 0-18,000 micromhos.
- Always up to date—test procedure instructions for new tubes supplied by factory at regular intervals.
- Automatic line compensation—special bridge continuously monitors line voltage.
- 7-pin and 9-pin straighteners mounted on panel.
- Portable—luggage style carrying case with removable slip-hinged cover.
- Lightweight—15½ x 14½ x 5½ in. Weighs only 12 lbs.

\*Including new 600 mll series tubes.

**B&K**

Also makers of the famous CRT 400

Send for article on "Profitable TV Servicing in the Home" and Bulletin 500—S

**B & K MANUFACTURING CO.**  
3726 N. Southport Ave. • Chicago 13, Illinois

# Input Transformer Replacement Requirements



without any transformer, will produce so little output that the background noise from the input stage will be quite noticeable; assuming we have enough gain to be able to hear the program at all, but the frequency response would be satisfactory, as good as the pickup or microphone itself can provide.

If we use an output transformer with a step up ratio lower than recommended, the frequency response is likely to be better than with the recommended ratio; but to pay for this, the relative background noise will be higher, because the output voltage will be less. This means that one will have to turn the gain control up further to get the same program output, and the background noise will come up by as much as the gain control has to be turned up.

For example, if we used a step up of 50:1 where a 100:1 was originally used, 6 db more gain will be required to give the same output. This extra gain will increase the background noise by 6 db as well. But the frequency response will probably be extended over 4 times the original range. If the frequency response was within 1 db from 50 to 10,000 cps, the reduced step up would extend the response to within 1 db from 12.5 to 40,000 cps.

On the other hand, use of too much step up, say a 200:1 transformer (Continued on page 52)

INPUT TRANSFORMERS are now being used in increasing numbers, not only for phono systems, but for tape equipment, too. In tape recorders input transformers are used to step up the impedance of dynamic type microphones, and phono reproducers likewise require a pickup transformer in conjunction with moving-coil and ribbon-type pickups.

In selecting suitable replacements, one must know the answers to at least four vital questions: Does the replacement component provide the correct step up; is it correctly designed for the impedance of the pickup or microphone with which it is to be

used, or at least close enough to give satisfactory performance; what kind of frequency response will it give; and is it satisfactory as regards shielding, especially where the output from the microphone or pickup is at extremely low level.

## Step Up Ratios

The step up ratio that can be employed from a given impedance has certain basic limitations depending principally upon the frequency response that is required. A low-impedance microphone or pickup connected directly in the grid circuit,

**Fig. 1. Enlarged portion of low-frequency rolloff, to assist in making comparisons. Values illustrate following comparison: Known value is 2 db at 7.5 cps, which appears at a comparative frequency of 1.32; 20 cps is 2.67 times 7.5 cps, so the corresponding comparative frequency will be 2.67 times 1.32, or about 3.5, where the response is a little better than .4 db.**

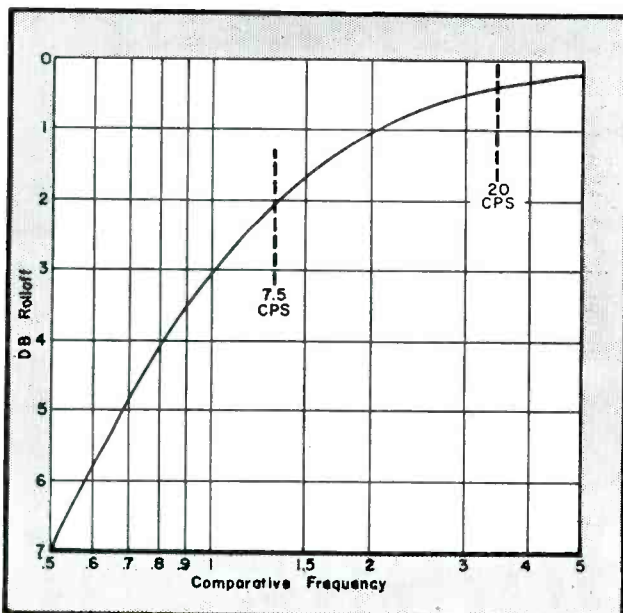

**Fig. 2. Enlarged portion of high-frequency rolloff. Values shown illustrate following comparison: Known value is 2 db at 40,000 cps, which appears at a comparative frequency of .765; 20,000 cps is half of 40,000 cycles, so the corresponding comparative frequency will be half of .765, or .3825; where the response is .6 db.**

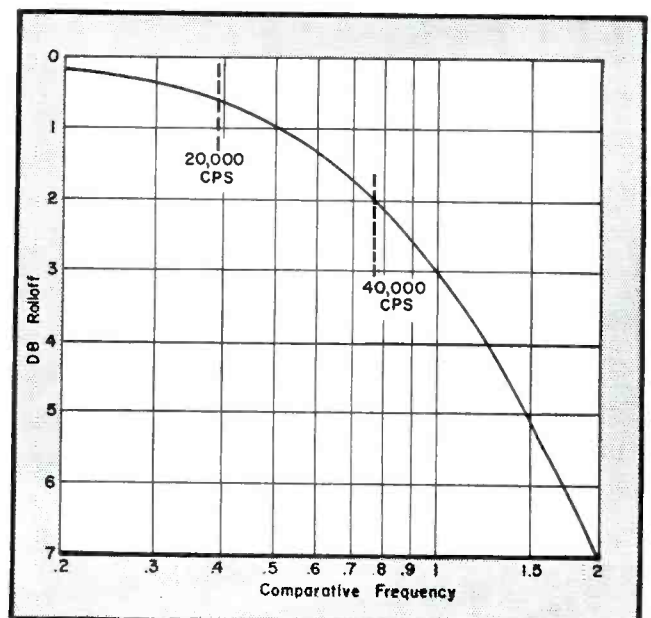

# TOP performance for TV anywhere!

## Federal's "ALL-STAR" LEAD-IN TEAM

*Urban, fringe or distribution system . . .  
heat, rain, dust, snow, ice, salt spray,  
polluted air . . . whatever the conditions  
you'll find a winner in these dependable  
Quality-Controlled Cables by "FTR"*

North, East, South, West . . . wherever there are TV customers . . . Federal's "All-Star" Lead-in Team can be depended upon to deliver *championship performance* . . . !

These six popular types are outstanding examples of the quality, ruggedness, efficiency and long life built into every foot of Federal Cable. Whatever the run requirements or local weather conditions the Federal "All-Stars" will score high in satisfaction . . . with you and your TV customers.

Federal lead-ins can be installed with utmost confidence, because they are engineered and manufactured by a *pioneer* cable maker . . . and "Certified by a World of Research" . . . through the International Telephone and Telegraph Corporation.

Check the high points of Federal's "All-Star" Lead-in Team . . . then get in touch with your Federal Distributor. Always specify "Federal" . . . keep those TV installation profits instead of paying them back in call-backs!

*"America's leading producer of  
solid dielectric cables"*

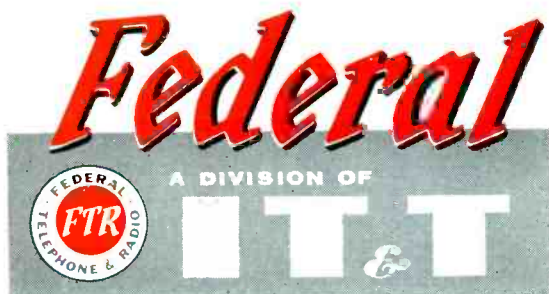

### High Volume-Low Price TV Lead-in



#### Economical and Efficient

TV-1190—300-ohm heavy-duty lead-in with 90 mil. web. Has 7/#28 copper strands. Economical and highly efficient. Insulated with Federal-developed "silver" polyethylene for long life. Also available in brown.



#### Another Low-cost Leader

TV-2000—300-ohm dumbbell-shaped lead-in with 55 mil. web. Has 7/#30 copper strands. A high-value, low-cost type for the average installation. Cinnamon-brown color is protection against ultra-violet.

### "Quality-Controlled" TV Lead-in & Cable



#### Heavy-duty Type

TV-1182—300-ohm deluxe type heavy-duty long life lead-in with 7/#28 copper strands, 100 mil. web. Available in "silver" or brown polyethylene. Resists weather, heat, sun. Very low line loss in fringe areas.



#### Quality plus Economy

TV-1184—300-ohm dumbbell-shaped, standard, economy type lead-in with 7/#28 copper strands, 70 mil. web, for urban areas with no unusual conditions. Cinnamon-brown color is highly effective in resisting ultra-violet.



#### Rotor Lead-in

TV-1188—Rugged, dependable, long-life rotor lead-in. Weather-resistant. Insulated with "silver" vinyl. Three 7-strand conductors of .0121 AWG soft bare and one conductor of .0121 AWG tinned soft bare.

### Community TV Lead-in



#### Secondary Lead-in

59/U Type—73-ohm coaxial lead-in. Highly efficient as a Community TV pole-to-house tap-off. Meets all needs wherever a high-grade installation is a must. Ideal for use with unbalanced input TV receivers.

For data on other types, write Dept. D-456A

### Federal Telephone and Radio Company

A Division of INTERNATIONAL TELEPHONE AND TELEGRAPH CORPORATION  
COMPONENTS DIVISION • 100 KINGSLAND ROAD • CLIFTON, N. J.

In Canada: Standard Telephones and Cables Mfg. Co. (Canada) Ltd., Montreal, P. Q.  
Export Distributors: International Standard Electric Corp., 67 Broad St., New York

a million  
perfect connections  
can't be wrong



A-MP® Solderless Terminals are making history every day in the electronic industry. They are performing perfectly in the most critical circumstances—where terminals have always been a problem.

Now, for instance, you can end antenna lead-in termination problems. The insulation support on A-MP Pre-Insulated Diamond-Grip Terminals provides needed tensile strength. And the Flanged Spade tongue insures easy and secure attachment of 300-ohm wire. These reliable terminals are now available to you through API.

Your local API salesman will be glad to make up a Custom Fitted Kit for you, containing the exact terminals you need plus a Super-Champ Hand Tool—most versatile tool you can have.



API branch offices stock popular A-MP terminals and tools for maintenance and repair purposes. Contact your local API office for a catalog.



Atlanta, Ga.  
Boston, Mass.  
Chicago, Ill.  
Cleveland, O.  
Dallas, Texas  
Detroit, Mich.  
Hawthorne, Cal.  
Maplewood, N. J.  
Philadelphia, Pa.  
Pittsburgh, Pa.  
St. Louis, Mo.  
San Francisco, Cal.

api  
Trade Mark

American Pamcor, Inc.  
A Subsidiary of Aircraft-Marine Products, Inc.  
181 Hillcrest Ave., Havertown, Pa.

## Audio

(Continued from page 50)

where the original was 100:1, will increase the available output, but at the expense of frequency response. So the band would be reduced to a range from 200 to 2500 cps, within 1 db, in this example.

### Impedance

The foregoing remarks assume that the transformer has been designed for *somewhere near* the proper working impedance. If it is not, then the frequency band may be shifted, as well as restricted or extended. To explain the way this happens, and what we mean by *somewhere near*, let us examine the operation of a pickup with an impedance rated at 50 ohms originally supplied with a 50:1 step up transformer.

This ratio will match the 50 ohms, connected to the primary, *up* by an impedance ratio of 50 squared, or 2500, to look like 125,000 ohms in the secondary. This transformer probably had a frequency response rating of within 2 db from 30 to 10,000 cps, and the primary impedance would be specified as 50 ohms.

Here is a point where methods of specification differ: Some catalogs list the step up as 50:1, and note the primary impedance as being 50 ohms, describing the transformer as *pickup or microphone to grid*; other catalogs list the transformer by nominal impedance instead of giving the ratio, specifying the primary impedance as 50 ohms and the secondary impedance as 125,000 ohms. These are just alternative ways of detailing what usually amounts to the same thing.

Now, let us suppose that we have a transformer with a step up of only 25:1. To evaluate the effect different impedance values signify, two possibilities can be considered: First, the primary impedance is still specified as 50 ohms, in which case a step up of 25.1 only reaches an impedance of just over 30,000 ohms instead of the original 125,000 ohms; in the second variant, the specified impedance ratio could use 200 ohms to the same secondary impedance of 125,000 ohms.

The purpose behind the use of a step up to a lower secondary impedance is usually to improve the frequency response; thus the first transformer will probably have a much better frequency response at the low end because it enables a larger number of primary turns to be applied. Usually such a transformer will also give a somewhat extended range at the high end, since the more liberal design allowance can reduce the effective secondary capacitance. A probable specification of the performance of this transformer would be; within .5 db from 20 to 20,000 cps. Nevertheless, as the transformer is going to be used for the impedance for which it is rated, the response published should apply.

In the second case, the transformer will probably have the same response rating given for the original transformer of 50:1 ratio, because the secondary impedance has a similar value. This, it will be remembered, was given within 2 db from 30 to 10,000 cps. Using only half the step up, however, means that the primary, now intended for 200 ohms, but using an actual 50 ohms, will produce an actual secondary impedance of only 31,000 ohms in place of the original 125,000 ohms. So the frequency response is likely to be extended at each end by about 4 times. This means it should be within 2 db from 7.5 to 40,000 cps.

From the *lf* and *hf* rolloff curves which are shown in Figs. 1 and 2 on page 50, which help to evaluate the re-

sponse at different points, it is probable that the loss at 20 cps would be about .4 db, while that at 20,000 cps the loss would be about .6 db. Accordingly, the performance of the second transformer is not much different from the first transformer, which gave a loss of .5 db at both these frequencies.

This similarity points up the fact that, if the specified impedance is within a reasonable range of the correct value, say a ratio of 4:1 each way, and the ratio is suitable, the response will not be very different. If a transformer is designed to be operated from *some impedance to grid*, changing the effective secondary impedance will usually change the frequency response in a somewhat similar fashion, extending it or restricting it at both ends.

Conditions that can produce more error of this nature occur where the impedances are totally different. For example, a 50:1 step up may be used to provide matching from a ribbon type pickup or microphone-to-line impedance. If the line impedance is 600 ohms, then the matching of 50:1, representing an impedance ratio of 2500:1, means that the ribbon impedance would be about .25 ohm.

Although this transformer might have the correct *ratio* for working from 50 ohms to grid, the impedance for which it is designed is only 1/200 of the actual. This means that the turns are probably deficient by a ratio of  $\sqrt{200}$ , or 14 to 1. As the primary inductance will be divided by the same ratio as the working impedance, 200:1, the frequency response will probably be extended upwards from the bottom end by this same ratio. Instead of giving a response within 2 db at 30 cps, it will be within 2 db at 200 times 30 or 6000 cps. As the high rolloff is due to secondary capacitance, the high-frequency end will probably not be improved appreciably, so the transformer should produce a response, under these conditions, within 2 db from 6000 to 10,000 cps.

On the other hand, if we are considering the replacement of a transformer connected between a ribbon mike or pickup and a line impedance of 500 or 600 ohms, and the required ratio is 50:1, the use of a transformer intended for 50 ohms to grid operation could be equally disastrous. In this case, the transformer would be very inefficient, because the winding resistances would be several times the working impedance. The resistance  
(Continued on page 54)

# search no further for CONCERT-HALL REALISM in your home!

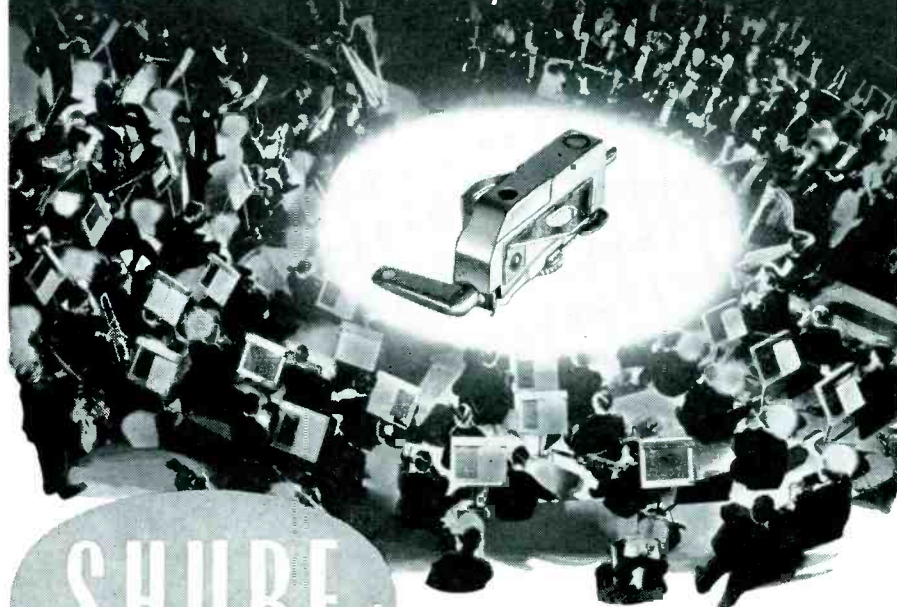

## SHURE

### Music Lovers

# CARTRIDGE

The "MUSIC LOVERS" Cartridge is a new, 3-speed, dual-needle ceramic cartridge, designed to enhance the quality of all the popular high fidelity equipment in use today. Mechanically interchangeable with magnetic pickups in practically all

record changers and transcription arms. Equipped for direct connection to magnetic inputs of amplifiers not yet provided with constant displacement ceramic inputs, thus allowing the full advantages of compensation circuits.

- ★ Eliminates induced hum
- ★ Eliminates cartridge "drag" caused by magnetic attraction to steel turntables
- ★ Increases record and needle life
- ★ Provides higher output
- ★ Response not affected by load resistance
- ★ 10-second needle replacement
- ★ Individual needle compliance eliminates needle interaction

**FREE!** COMPARATIVE ANALYSIS BOOKLET ON THE "MUSIC LOVERS" CARTRIDGE

SHURE BROTHERS, INC., 225 W. HURON ST., CHICAGO 10, ILLINOIS

Please send analysis booklet on your "MUSIC LOVERS" Cartridge

Name.....

Address..... City.....

S-3



**new**  
**AMERICAN**  
**"5-PAK"**  
**SERVICE**  
**KIT**

**sells**  
**9 out of 10**  
**CRYSTAL**  
**PHONOGRAPH**  
**REPLACEMENT**  
**CARTRIDGE**

**CUSTOMERS!**

Here's everything you need . . . in one convenient package!

American's high quality "Clear as Crystal" replacement cartridges are packed in this reusable plastic box . . . ideal as a small parts container. The box contains five of the most popular types of replacement cartridges . . . meets 90% of your customers' requirements.

In addition, you get an authorized repair service decal . . . five identification cartridge labels for your name . . . and a handy crystal cartridge replacement chart.

The whole package costs less, because you get more. And, you give your customers more, too. Why not call your nearby American distributor today and order the new "5-PAK" for yourself.



**American**  
replacement  
cartridges

ELECTRONICS DIVISION  
ELGIN NATIONAL WATCH CO.  
370 South Fair Oaks, Pasadena, California

**Audio**

(Continued from page 53)

of a transformer winding intended for 50 ohms would be at least an ohm; probably 2 or 3 ohms. Thus, when used with a ribbon microphone with an impedance of a fraction of an ohm, most of the output is going to get lost in the winding resistance.

But apart from this, the frequency response will suffer too. A transformer from ribbon to line would probably have a quoted frequency response at least as good as 1 db from 20 to 20,000 cps. The loss of 1 db at 20,000 cps would be due to the leakage inductance of the transformer. A similar transformer designed for use at 200 times the impedance would reduce the 1-db point at the high-frequency end by a ratio of 200:1; assuming a similar physical design of transformer. Therefore the use of the 50 ohm-to-grid transformer for ribbon to line would be within 1 db up to 1000 cps as a high-frequency rolloff. In practice it might not even be as good as this, because leakage inductance is not usually a *controlling* factor in 50 ohm-to-grid transformers, whereas it is in ribbon-to-line transformers. Of course, to offset this loss we would have a fabulous low-frequency response, extending to about 1/10th of a cycle, but since no one hears frequencies down there there is little compensation in this *lf* result.

*Frequency Response*

The *kind* of source impedance that is being used is extremely important when evaluating response factors. If the pickup or microphone is of the ribbon or one of the smaller moving-



*"I had a terrible night last night—dreamt we were out of JENSEN NEEDLES."*

coil types, the value quoted for the impedance will be almost a pure resistance, and hence any transformer with similar quoted frequency response should give similar performance. But, if the pickup is of the moving-iron type, or the microphone is one of the larger moving-coil type, there may be an appreciable com-

**Loudspeaker system using sphere of molded foam plastic, 18" in diameter, as enclosure. Spherical shape is aimed to eliminate baffle reflections. Enclosure is also available without speaker. Speaker normally supplied is an 8-inch coax unit with a built-in crossover network. Impedance is 8 ohms. (Bonn Sonosphere; Plastilex Products, Inc., 6515 N. 10 Street, Philadelphia 26, Pa.)**



**Triaxial speaker with tweeter unit fitted with a reciprocating flares horn through the center of the woofer and mid-range speaker assemblies. (Model 6303; University Loudspeakers, Inc., 80 South Kensico Ave., White Plains, N. Y.)**





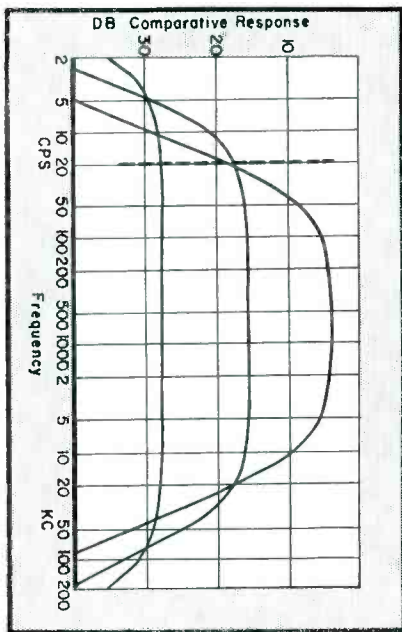

Fig. 3. Comparative frequency response, using different step up ratios. The center curve represents the original step up. The upper curve uses twice as much, and the lower curve half as much, as the original. The dotted lines serve to facilitate comparison at 20 cps and 20 kc.

ponent of inductance in its impedance.

For instance, the true impedance may be equivalent to 50 ohms with a series inductance of 1 millihenry. In this case, the inductance effect of the pickup or microphone itself will contribute to the frequency response. This means that the step up ratio must be restricted, as compared with the kind of device that looks like a pure resistance.

If the pickup or microphone is of a pure resistance, the step up ratio can be such as to give a secondary impedance of as much as 150,000 ohms, giving a reasonable frequency response. However, if the nature of the source is that of a resistance with an inductance in series, it may be necessary to restrict the step up to somewhere in the region of 50,000 ohms, or even lower.

### Shielding

The fourth point to watch is the shielding provided, especially with very low level instruments, such as ribbon microphones and pickups and also some of the moving-coil type pickups. If adequate shielding is not provided on the transformer, it will prove to be extremely susceptible to stray hum fields.

It is always best to check quoted reductions in hum. Often the method of specifying hum reduction based upon a *standard hum field*, can be

don't be a  
circuit  
juggler..

use  
**STANCOR**  
EXACT  
REPLACEMENT  
FLYBACKS

You just remove  
the old flyback  
and install the new one . . . No  
circuit changes are necessary  
. . . Even the leads are the  
proper length for quick, easy  
installation.

**FREE:** STANCOR  
TV Transformer Re-  
placement Guide listing  
over 8000 models and  
chassis of 117 manu-  
facturers . . . available  
from your distributor or  
by writing Chicago  
Standard.



**CHICAGO STANDARD TRANSFORMER CORPORATION**  
3507 ADDISON STREET • CHICAGO 18, ILLINOIS

Export Sales: Roburn Agencies, Inc., 431 Greenwich Street, New York 13, N. Y.

confusing. In making this measurement a coil of wire is placed on a former 1 foot square, to produce an *ac* field of calibrated intensity at the center of the square.

The transformer, complete in its shielding, is placed in this position and the pickup of hum measured at different orientations. Hum pickup is then compared against the condition when the transformer is mounted in the same position, but not in its shielding. This reduction is the value published.

Figures, based on this kind of measurement, are not always reliable, be-

cause practical hum fields are not created by a coil of wire 1 foot square, but by transformers and chokes which radiate a completely different kind of hum field. At the center of a 1-foot coil of wire the field is practically uniform, but transformers and chokes radiate a very irregular-shaped field.

The transformer, with its shielding, may give very considerable reduction in hum pickup in this test, but due to the construction of the shield it may not nearly be so effective when placed in a field that fans out as it

(Continued on page 56)

**DANGEROUS**

**FOR COMPETITION!**



**WATCH OUT FOR THESE MEN!**

They're revolutionaries. You'll see their picture in every Duotone Diamond Needle package. They're Duotone polishers shattering the old myth that all diamond needles are alike. These men polish each Duotone diamond tip by the radius control method—15,000 times—never less—to perfect concentricity. No chance then for the slightest microscopic burr to feather-cut delicate record grooves. You'll blast competition with this extra selling plus. Other Duotone extras: Automatic Selling Plan—National advertising profit deals—And more. May we tell you about them?

### **DUOTONE COMPANY**

KEYPORT, NEW JERSEY  
MANUFACTURER

In Con., Chas. W. Pointon, Toronto  
Exp. Div., Ad Auriemo, New York

## **Audio**

(Continued from page 55)

does from the corner of a line transformer or choke. In some instances, the hum reduction has been found to be negligible in this more practical condition.

### *Typical Hum Problem*

Some components, specified as having 30 db or more hum reduction, and which undoubtedly give this reduction under the calibrated test method, give little or no reduction under practical operating conditions.

### *Comparison Test Needed*

For this reason, some test or comparison should be made to be certain that the transformer gives its specified reduction, or at least a satisfactory reduction, under working conditions. The transformer should be checked in the actual circuit and mounting position if possible, making sure that it is not too critical of orientation to achieve a satisfactorily low hum level.

Pickup arm designed for records up to 12" and 16" in diameter. Arm proper is of tubular construction. The cartridge shell, made of die-cast aluminum, is attached to arm by means of a bayonet-lock arrangement. A slight twist in one direction is said to secure shell to arm, while a twist in the other direction permits removal. Cartridge shell has built-in silver-plated male pin-terminals which fit female socket in arm. Arm base is an aluminum die-casting with provision for raising and lowering the level of the arm to coincide with level of the turntable. Pivot assembly is on base. Dual, ball-bearing races are employed for movement in the horizontal plane; vertical compliance is achieved by use of bearing with 1-mm diameter chrome - steel balls.  
(Rek-O-Kut Co., 38-01 Queens Blvd., Long Island City 1, N. Y.)

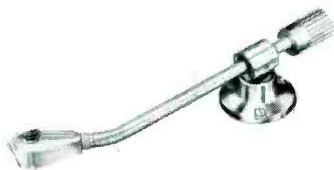

You can operate a **SECOND TV or FM set from ONE ANTENNA with Photocircuits!**

## **TWO SET COUPLER**

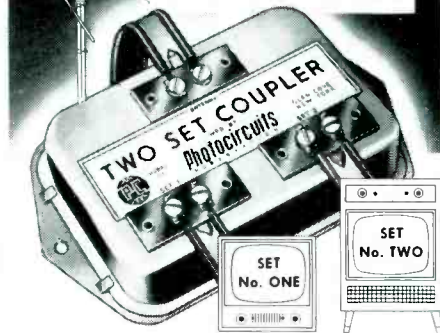

This NEW Two-Set Coupler provides perfect matching of both sets to ONE ANTENNA, and results in equal or better quality of both picture and sound . . . on every channel or frequency.

Latest printed circuit design (for low cost and best performance!). Eliminates a cause of "ghosts". No inefficient resistors or transformers. Both sets can operate simultaneously! Easy to install (just hook it up!).

For BEST SERVICE to your customers . . . install genuine Photocircuits TWO SET COUPLERS.



**Photocircuits**  
CORPORATION

Ask your distributor or write

Dept. S3, Sea Cliff Avenue  
GLEN COVE, NEW YORK

## **PORTABLE PHONO TROUBLESHOOTING**

A COMMON phono complaint is *rumble*. While most turntables have some rumble normally, the level is comparable with low surface noise, or amplifier noise. When the level becomes objectionable, the cause is probably a defective turntable bearing, or perhaps a rough idler or inner rim of the turntable.

In small model phono amplifiers, the common complaints are similar to the common troubles of comparable quality receivers. Transformerless amplifiers commonly develop hum from filter capacitor failure. Occasionally heater-cathode leakage produces the hum. Distorted sound may be due to a bad needle or stylus, or a cracked pickup. Amplifier distortion in a one- or two-tube amplifier is much less common; usually the volume decreases before the distortion becomes objectionable as a tube becomes weak.

The larger amplifiers in home consoles and *pa* systems suffer similar complaints. While hum may be caused by the filter capacitors, several other causes are also possible. Since

(Continued on page 58)

# COMPONENTS

## GRAYHILL PRINTED WIRING TEST JACKS

Miniature test jacks for test and monitoring points on printed wiring circuits, have been developed by Grayhill, 561 Hillgrove Ave., La Grange, Ill.

Jacks,  $\frac{1}{4}$ " od and approximately  $\frac{1}{4}$ " high, rivet to board like an eyelet. Colored phenolic snap-on insulating sleeves protect fingers from voltages and provide color-coding for test points.



## CG SUBMINIATURE REED RELAYS

Two subminiature resonant-reed relays, AR-2 (2 reed) and AR-3 (3 reed), for use in remote monitoring and radio and TV controls, have been introduced by CG Electronics Corp., 305 Dallas St., N.E., Albuquerque, N. Mex.

Minimum driving voltage is  $2\frac{1}{2}$  v rms. Reed frequencies can be tuned within 100-500 cps range.

## CLAROSTAT P-W WIRE-WOUND CONTROLS

Two watt wire-wound controls, for use in printed-wiring assemblies, have been introduced by Clarostat Manufacturing Co., Inc., Dover, N. H.

Units feature terminals designed to facilitate mounting and connections. Controls measure  $1\frac{1}{8}$ " in diameter by  $9/16$ " deep, and are available with or without tap. Resistance values range from 1 to 50,000 ohms. Further information in bulletin 754302.

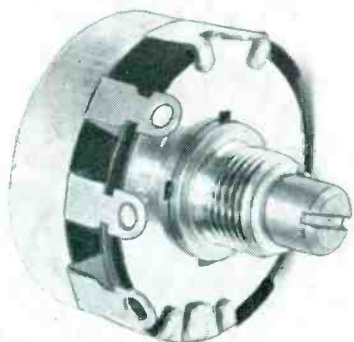

**NEW**

# The Solution to Your Troublesome INTERMITTENT Problems!



Model SL10  
**SECO**  
MONITRON

## SIGNAL TRACER AND INTERMITTENT LOCALIZER

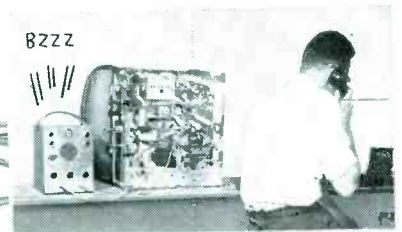

... monitors circuits without attention

**\$119<sup>50</sup>**

**NEW for Television and Industrial Use**

In servicing TV receivers, transmitters and similar electronic equipment where the output signal does not energize a sound producing indicator, a device is needed to actuate visible and audible alarm in case of a break in the signal path. The Seco MONITRON does just that and more!

Performs 4 basic functions:

1. Monitors circuits without attention.
2. Monitors 2 circuits at once (on same or separate chassis.)
3. Operates as a signal tracer.
4. Makes point to point gain measurements.

Another Serviceman's Timesaver joining these indispensable Seco Testers.



**SECO**  
Model GCT-5  
GRID CIRCUIT  
TUBE TESTER



**SECO**  
Model FB-4  
FLYBACK CIRCUIT  
AND INDUCTANCE  
ANALYZER

Your Jobber has 'em or write for information.



**SECO MFG. CO.** 5015 Penn Avenue S.  
Minneapolis, Minn.

## INTERNATIONAL AIRKORE SELENIUM RECTIFIER

A TV selenium rectifier series, Air-Kore, featuring an open-spaced six-contact spring, said to provide greater contact area and uniform temperature rise across surface of the rectifier plate, has been developed by the International Rectifier Corp., El Segundo, Calif.

Design, it is claimed, permits optimum circulation of air around plates, through core and spring itself, assuring maximum air flow in any vertical mounting position, regardless of degree of rotation of rectifier. Available in all TV selenium rectifier standard sizes, in both stud and eyelet types.

## RADIO RECEPTOR P-W MINIATURE SELENIUM RECTIFIERS

Miniature selenium rectifiers, 8Y1B and 8J1B, for printed-wiring boards, have been introduced by the Radio Receptor Co., Inc., 251 W. 19th St., New York 11, N. Y.

Units are half-wave stack types. 8Y1B is rated at 30 ma and 8J1B at 65 ma at off-the-line voltages, with capacitive load in an ambient temperature of 45° C. Both mount in  $3/32$ " diameter holes spaced on  $27/64$ " centers.

**ATLAS SOUND CORP.**  
1442 — 39 St., Brooklyn 18, N. Y.

Send **FREE** Buyer's Guide to save me money on public address Loudspeakers, Microphone Stands and accessories.

Name \_\_\_\_\_ Title \_\_\_\_\_

Firm \_\_\_\_\_

Type of Business \_\_\_\_\_

Address \_\_\_\_\_

City \_\_\_\_\_ Zone \_\_\_\_\_ State \_\_\_\_\_

## HOW to SAVE MONEY on LOUDSPEAKERS and MIKE STANDS



Fill in coupon and find out how ATLAS proves that better know-how can produce better products at lower cost to you. Depend on world-famous ATLAS—the complete quality line with specialist know-how since 1930.



**ATLAS SOUND CORP.**  
1442 -39th Street, Brooklyn 18, New York  
In Canada: Atlas Radio Corp., Ltd., Toronto, Ont.

## Audio

(Continued from page 56)

the pickup is typically of higher quality and lower output, hum is often the result of heater-cathode leakage in the preamp tube. Poor ground connections on leads to a separate turntable or changer also occur. Distorted sound may be caused by a poor stylus, or by a gassy tube or a leaky coupling capacitor.

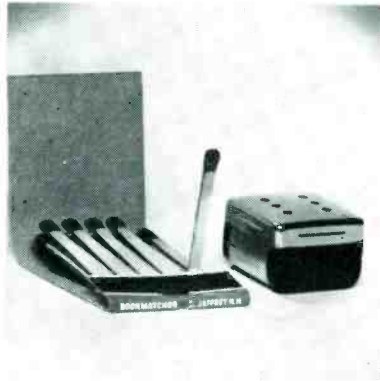

(Above)

Miniature dynamic speaker-microphone which weighs 1 1/3 ounces, and is housed in a steel and thermosetting plastic case. Externally mounted miniature transformer designed to match the microphone to the grid circuit is available. Dimensions of unit are 1" x 1" x 3/4". Unit, it is said, will deliver 120 db with 10 milliwatts of power input; nominal impedance is 10 ohms. (Mini-Mike, Telex, Inc., Telex Park, St. Paul 1, Minn.)

(Below)

Four way multi-flare horn system. Components: 15" bass driver (15 to 400 cycles); mid-range 30-watt horn driver (400 to 1500 cycles); high frequency 25-watt horn driver (1500 to 18,000 cycles). Bass horn has equivalent length of 17' axial length. Mouth area of horn is eight square feet. Flare cutoff is 15 cps. Mid-range horn has equivalent axial length of 17'; diameter of horn mouth is 3 1/2" by 11". Flare cutoff is 50 cps. (4D series; Stan White Inc., 725 South La Salle St., Chicago 5, Ill.)

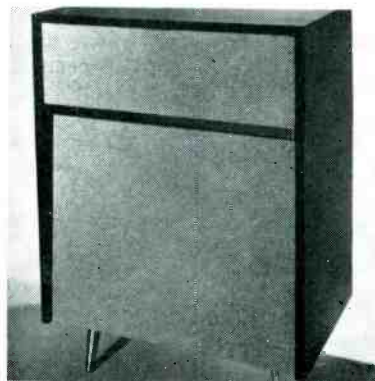

BELIEVE ME — YOU'LL GET  
PLENTY OF ACTION WHEN  
YOU START SELLING  
WALCO NEEDLES . . .



FOR FREE  
ILLUSTRATION  
OF ANITA, WRITE:  
**Walco**

TRADE NAME OF  
**ELECTROVOX CO., INC.**  
60 Franklin St., East Orange, N. J.

*Miss Quietrole Says...*



**"You can forget 'em  
all when you have..."**



**QUIETROLE**

TRADE MARK REG. U.S. PAT. OFF.

the quality product that does all the lubricating and cleaning jobs on TV and radio . . . nothing does the job as well as Quietrole . . . and you can depend on that."

*"A First in the Industry"*  
"Choice of Better Service Dealers Everywhere"



**QUIETROLE  
COMPANY inc.**  
Spartanburg, South Carolina

In Canada  
**ACTIVE RADIO & T.V. DISTRIBUTORS**  
58 Spadina Avenue • Toronto 2B Ontario

# BENCH-FIELD TOOLS . . .

## WELLER SOLDERING AID

A soldering aid, a pencil-shaped colored plastic holder fitted at one end with a tapered metal point and at the other with a notched blunt metal end, has been announced by Weller Electric Corp., 808 Packer St., Easton, Pa.

Aid can be used to twist wires into tight connections prior to soldering, untwist wires that are to be resoldered, hold work being brought to soldering heat and hold springs and other parts clear of points being heated for soldering.

## HEXACON SOLDERING GUN

An 8-ounce soldering gun with a 3/4" alloy tip for printed circuits and subminiature assemblies has been introduced by Hexacon Electric Co., 594 W. Clay Ave., Roselle Park, N. J.

Heating element of gun is in tip itself. Trigger control varies degree of heat. Has spotlight for illumination.

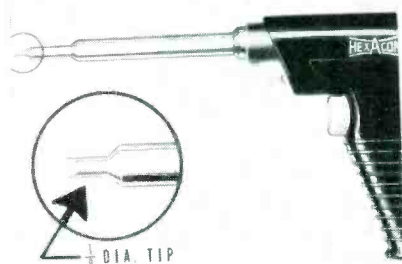

## KEDMAN MINIATURE SCREW-HOLDING SCREWDRIVER

A series of miniature screw-holding screwdrivers, *Quick Wedge Midget*, for holding, starting and driving 0 to 4 wood screws and bolts, and 2 to 4 sheet metal screws, has been announced by Kedman Co., 233 S. 5th West, Salt Lake City 1, Utah.

Units feature *Tenite II* handles, and spring steel hollow-ground blades. Blade diameter is 3/8". Available in 3" and 8" blade lengths.

## LUXO FLUORESCENT LAMP

A fluorescent lamp, featuring balanced-spring lightweight steel construction, and finger tip maneuverability, has been developed by Luxo Lamp Corp., Tuckahoe, N. Y.

A variety of brackets allow lamp to be clamped or mounted to flat surfaces or walls, or to be permanently or temporarily installed on desk, drawing board or wall. Available in several colors.

EVERY  
SERVICEMAN  
NEEDS THIS  
VOLTAGE  
ADJUSTOR

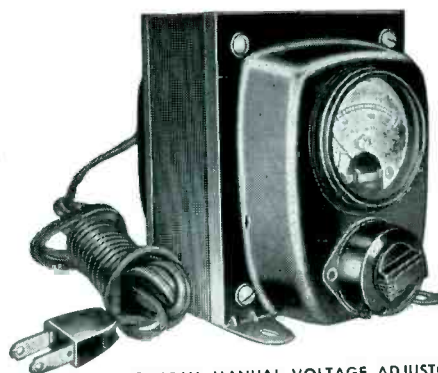

T-8394M MANUAL VOLTAGE ADJUSTOR

Where low voltage is affecting TV reception, the service man can detect the condition at once with a T-8394M Acme Electric Voltage Adjustor. And by a simple demonstration he can sell a Voltage Adjustor to the TV set owner. Sales are easy to make because demonstration while servicing a set quickly convinces its owner that the voltage regulation is essential to good TV reception.

## How To Use The T-8394M VOLTAGE ADJUSTOR on Service Calls

With the tap switch set at 115 volts, the meter reading will show incoming line voltage. Thus it can be instantly determined if line voltage is lower than normal required for good TV set performance.

The T-8394M Voltage Adjustor can also be used to reproduce the operating condition about which the customer complains by turning tap switch to the voltage which simulates such condition. For example, customer complains that evening program pictures flicker and shrink. When service man calls next day all operation appears normal — voltage tests out properly. But, by adjusting voltage to 97 volts the condition about which the complaint was made is reproduced. This indicates low voltage condition during evening that can be corrected with a T-8394M Voltage Adjustor.

## Not A Gadget — A High Quality Unit You'll Be Proud To Use

The T-8394M Voltage Adjustor can be installed instantly, no tools needed. Just plug into most convenient outlet. Then plug television cord into secondary receptacle on Voltage Adjustor.

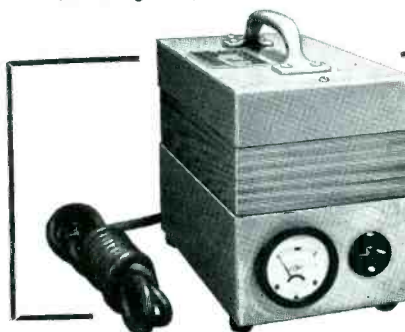

## FOR COMPLETELY AUTOMATIC VOLTAGE CONTROL

Regardless of line voltage supply, the Automatic Voltrol corrects voltage fluctuation over a range from 95 to 130 volts. The voltmeter supplied indicates secondary voltage while unit is in operation. A built-in relay automatically disconnects circuit when set is turned off.

Acme Electric  
TRANSFORMERS

ACME ELECTRIC CORPORATION  
MAIN PLANT: 4711 WATER STREET • CUBA, N. Y.  
West Coast Engineering Laboratories:  
1375 West Jefferson Boulevard • Los Angeles, California  
In Canada: Acme Electric Corp. Ltd.  
50 North Line Road • Toronto, Ontario

## SENCO UNIVERSAL JUMPER CORD

A universal jumper cord, JC2, for plugging into TV chassis outlet has been announced by Service Instruments Co., 171 Official Rd., Addison, Ill.

Cord, with two male and two female connectors, is said to fit any TV set. A *dptd* switch is incorporated to change over plugs, prevent shock hazards and turn off TV set from the rear. Two power outlets are provided for soldering iron and test equipment.

## U. S. E. INSTRUMENT HANDLES

Adjustable instrument handles, No. 1030, that vary in length from 3" to 6" in increments of 1/8", are now being made by U. S. Engineering Co., Inc., 521 Commercial St., Glendale 3, Calif.

Handles are made of brass and are nickel plated.

## FUSION SOLDERING PASTE ALLOY

Paste solders said to provide low resistance high conductivity joints are now available from Fusion Engineering, 4504 Superior Ave., Cleveland 3, O.

Fluxing, tinning and cleaning agents are contained in alloy.

## Non-Snarling, Pre-Measured Wire Strand

WRIGHT Wire Strand uncoils like this →

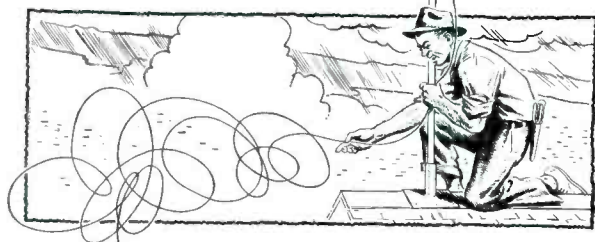

← WRIGHT unique process prevents this

Besides the important factor of no snarling, WRIGHT TV GUY WIRE is pre-measured. Every concentric coil measures two feet — time and money saver in guying antennas. WRIGHT TV GUY WIRE has great flexibility and is heavily galvanized . . . continuous connected coils.

Prompt deliveries from stocks in Worcester, Chicago, Atlanta, New Orleans, Houston, Dallas and Los Angeles.

**G. F. WRIGHT STEEL & WIRE CO.**  
249 Stafford St. • Worcester, Mass.

## INSTRUMENTS

### FUTURAMIC HIGH-OHMS PROBE

A high-ohms probe, 261, for extension of *vom* ohmmeter range by a factor of ten, has been developed by Futuramic Co., 2500 W. 23rd St., Chicago, Ill.

Probe converts the R x 10,000-ohms range to an R x 100,000-ohms range allowing measurement of values up to 200 megohms. Can be used with any 20,000 ohms/volt *vom* having a center-scale indication of 12 ohms and an internal ohmmeter battery of 7.5 v.

Unit has a gold-plated steel housing with color-coded lucite ends and is put into operation by plugging cord into meter in place of conventional test lead.

Also available are signal-tracing polarity-reversing and range-splitter probes.

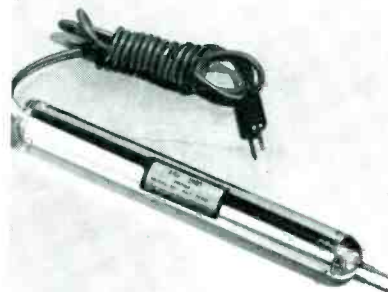

for service and lab. work

Heathkit

PRINTED CIRCUIT

### OSCILLOSCOPE KIT

FOR COLOR TV!

① Check the outstanding engineering design of this modern printed circuit Scope. Designed for color TV work, ideal for critical Laboratory applications. Frequency response essentially flat from 5 cycles to 5 Mc down only 1½ db at 3.58 Mc (TV color burst sync frequency). Down only 5 db at 5 Mc. New sweep generator 20-500,000 cycles, 5 times the range usually offered. Will sync wave form display up to 5 Mc and better. Printed circuit boards stabilize performance specifications and cut assembly time in half. Formerly available only in costly Lab type Scope. Features horizontal trace expansion for observation of pulse detail — retrace blanking amplifier — voltage regulated power supply — 3 step frequency compensated vertical input — low capacity nylon bushings on panel terminals — plus a host of other fine features. Combines peak performance and fine engineering features with low kit cost!

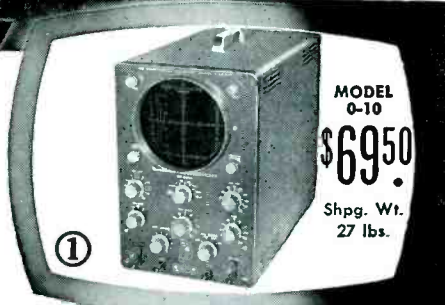

MODEL 0-10

\$69.50

Shpg. Wt. 27 lbs.



MODEL TS-4

\$49.50

Shpg. Wt. 16 lbs.

Heathkit TV

### SWEEP GENERATOR KIT

ELECTRONIC SWEEP SYSTEM

② A new Heathkit sweep generator covering all frequencies encountered in TV service work (color or monochrome). FM frequencies too! 4 Mc — 220 Mc on fundamentals, harmonics up to 880 Mc. Smoothly controllable all-electronic sweep system. Nothing mechanical to vibrate or wear out. Crystal controlled 4.5 Mc fixed marker and separate variable marker 19-60 Mc on fundamentals and 57-180 Mc on calibrated harmonics. Plug-in crystal included. Blanking and phasing controls — automatic constant amplitude output circuit — efficient attenuation — maximum RF output well over .1 volt — vastly improved linearity. Easily your best buy in sweep generators.



**Heath**  
COMPANY  
A SUBSIDIARY OF DAYSTROM, INC.  
BENTON HARBOR 11, MICH.

WRITE FOR FREE CATALOG  
...COMPLETE INFORMATION

### RCP TUBE-TRANSISTOR TESTER

A combination tube and transistor tester, 325, for testing *npn* and *pnp* type transistors and radio and TV tubes, including magnetically-deflected *b-w* and color pix and series-string heater tubes, has been introduced by the Radio City Products Co., Inc., Centre and Glendale Sts., Easton, Pa.

Dynamic mutual conductance test provided to measure effect of control grid on plate current flow. Signal and bias voltages are applied to tube grid. Separate high voltages are applied through separate loads to plate and screen.

Transistors are tested under operating conditions. Current amplification is measured using a constant-current bridge and low-impedance power supply. A diode-limiting circuit protects 50-micro-amp meter against burnouts due to shorted transistors.

### TRIPLETT LINE TESTER

A line tester, *Line Chek* 3000, for determining condition of line under load has been developed by The Triplett Electrical Instrument Co., Bluffton, Ohio.

Checking involves three steps: Wall cord is plugged into outlet to be tested; load switch is set to load position to be checked; and a button is pressed and held down only long enough for meter point to stop moving.

### SENCO LEAKAGE CHECKER

A leakage checker, LC2 (kit or factory wired), for testing grid to cathode, cathode to heater and capacitor leakage, has been developed by the Service Instruments Co., 171 Official Rd., Addison, Ill.

Checker is said to detect grid emission and gas in 70 popular tubes used in critical radio and TV circuits. Leakage of 100 megohms or below registers *bad* except in electrolytic capacitors where 50,000 ohms or under reads *bad*.



### HICKOK PORTABLE TUBE TESTER

A portable tube tester, 539B, with dynamic mutual conductance circuits, 6 micromho ranges, rectifier diode and *vr* ranges, and a noise test has been introduced by The Hickok Electrical Instrument Co., 10521 Dupont Ave., Cleveland 8, Ohio.

Four *ac* signals (.25, .5, 1 or 2.5 v) may be applied to grid of tube under test, in addition to *dc* bias. Separate *dc* voltmeter measures grid bias. Short test measures resistance directly in ohms (to 50 megohms) in addition to built-in neon lamp for *good-bad* checks.

### GE PORTABLE TRANSISTOR TESTER

A portable transistor tester has been developed by General Electric Co., Electronics Park, Syracuse, N. Y.

Tester, about the size of a pocket radio, can be used to check all junction transistors for short circuits, opens, leakage and current gain. Meter has two scales: lower scale for determining leakage and upper scale for checking current gain. Separate plug-in sockets for *npn* and *mpn* type transistors are incorporated on face plate. Included with unit are five universal type transistors and a transistor interchangeability chart.



**See\***

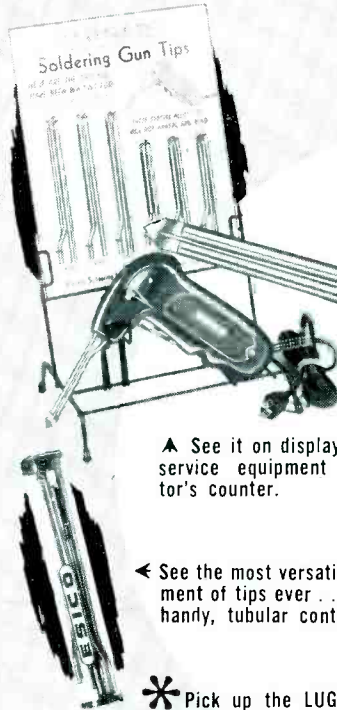

**FOR YOURSELF . . .**

- ★ how light
- ★ how beautifully balanced
- ★ how easy to use

is this **NEW**



▲ See it on display on your service equipment distributor's counter.

◀ See the most versatile assortment of tips ever . . . in new, handy, tubular container.

\* Pick up the LUGER . . . try it for balance, ease of handling, compactness. Its twin-lamped, ventilated housing needs no stand.

No service kit complete without this fast-heating, flexible Esico LUGER . . . newest achievement in soldering guns!

FOR EVERY SERVICEMAN'S NEED . . .

Non-annealing, non-bending tip shapes and sizes for

- remote connections
- previously inaccessible chassis
- deep, confined assemblies
- long service and fast changing

See it . . . GET YOURS today!

**ELECTRIC SOLDERING IRON Co., Inc.**

**ESICO**

Famous for Quality Soldering Equipment Since 1927

6256 W. Elm Street, Deep River, Connecticut

## TV PARTS . . . ACCESSORIES

### TRIAD REPLACEMENT FLYBACK TRANSFORMERS

Fourteen replacement flyback transformers for use in Admiral, Emerson, General Electric, Motorola, Philco, Sentinel, Wells-Gardner and Westinghouse TV receivers, have been announced by Triad Transformer Corp., 4055 Redwood Ave., Venice, Calif.

Items are said to be electrically and mechanically interchangeable with manufacturer's original equipment.

### WORKMAN PIX TUBE REJUVENATOR

A TV picture tube rejuvenator, *Bosipt*, has been announced by Workman TV, Inc., 309 Queen Anne Rd., Teaneck, N. J.

Unit is said to repair grid and cathode shorts, increase emission, decontaminate cathodes and restore brightness control operation.

**COMPONENT SALES BOOST  
CONTEST WINNER**



Bill Rutt, Sprague rep (left) congratulating George Schloss of Fischer Distributing Co., N. Y. C., as one of the winners of a gold wrist watch in the recently concluded sales-improvement program contest created by Harry Kalker, sales manager of Sprague Products Company.

**SHOOT TV AND RADIO  
TROUBLE FAST**

**NEW! NEW!**



Without experience or knowledge, this guaranteed new method of servicing AC/DC radio sets and TV sets, enables you to **DIAGNOSE** troubles as rapidly as an expert. **NO THEORY—NO MATH**—you can locate faults in record-breaking time, regardless of make or model. "SHOOT TV & RADIO TROUBLE FAST" is the most valuable servicing aid ever written. Be a radio & TV trouble Diagnostician. Increase present earnings. Open a profitable business.

**IT'S ALL IN THIS BOOK**

TV section has hundreds of picture, raster & sound troubles. This unique copyrighted method shows you **EXACTLY WHERE** trouble is; plus step-by-step instructions including **RAPID CHECKS**, over 65 of which require **NO INSTRUMENTS!** These include checks for distorted picture, bad tubes including Pix tube, plus 57 others. **ALL EXPLAINED IN SIMPLE LANGUAGE. PERFORMED WITHOUT INSTRUMENTS. MANY CHECKS USE PICTURE TUBE AS GUIDE.**

**AC/DC RADIO SECTION** contains alphabetical list of **SYMPTOMS** including almost every possible fault. Each symptom lists possible **CAUSES** & each **CAUSE** is referred to a **FAST RADIO TEST** which pin-points the defective part and gives the appropriate **REMEDY**. H. G. Cisin, the author, is the inventor of the AC/DC midjet radio. He licenses RCA, AT&T, etc. He has trained thousands of radio & TV technicians. His years of experience are embodied in this remarkable **NEW book.**

Only \$1.50 postpaid.  Rush This Book

**TV TROUBLE TRACERS**

H. G. Cisin's **TV TROUBLE TRACERS**—(4 volumes)—Each contains different **COPYRIGHTED** Trouble Indicating Tube Location Guides, covering hundreds of the most popular TV models. Each has over 70 illustr. & tube guides. 40 most common pix troubles illustr.

Vol. 1—Older Models Vol. 3—'53-'54 sets  
Vol. 2—'52-'53 sets Vol. 4—'54-'55 sets

EACH VOL. 50¢ postpaid

**RUSH**  Vol. 1;  Vol. 2;  Vol. 3;  Vol. 4.

**ANNOUNCING!**

**H. G. Cisin's Newest Book**

**"TV & RADIO TUBE SUBSTITUTION GUIDE"**  
Gives direct replacement of set and picture tubes. A most valuable service aid!

Only 50¢ postpaid.  Rush This Book

**FREE: TV & RADIO TUBE  
SUBSTITUTION GUIDE**  
with every purchase of \$2 or over

**5-day MONEY BACK GUARANTEE**

**RUSH COUPON NOW!**

H. G. CISIN CONSULTING ENGINEER  
Amagansett, N. Y. Dept. S-30  
Enclosed find..... Rush postpaid books checked above.

Name.....  
Address.....  
City..... Zone..... State.....

**Kilovoltmeter**

(Continued from page 32)

Then, because things equal to the same thing are equal to each other, we equate the left halves of (3) and (4), obtaining

$$(5) \frac{E_0 - E_1}{I_1} = \frac{E_0 - E_2}{I_2}$$

Solving this for  $E_0$ , the desired figure, gives us

$$(6) E_0 = \frac{E_1 I_2 - E_2 I_1}{I_2 - I_1}$$

This, the general equation for determining the no-load voltage of any circuit like that of Fig. 1, regardless of constants, may be simplified still further in this particular instance; one must remember that, with the constants in use, the meter reading in kv is numerically equal to the circuit current in microamperes.

In consequence

$$I_1 = E_1 \text{ (numerically) and}$$

$$I_2 = 2E_2 \text{ (numerically)}$$

Substituting these values in (6), we obtain

$$(7) E_0 = \frac{2E_1 E_2 - E_1 E_2}{2E_2 - E_1} = \frac{E_1 E_2}{2E_2 - E_1}$$

This requires the handling of only two numbers:  $E_1$ , the meter reading when S is open, and  $E_2$ , the meter reading when S is closed. Furthermore, even though this formula is very simple, it is entirely rigorous for the circuit in use, and is as accurate as the information fed into it.

A shop instrument, built in accordance with principles and formulas outlined, using, as major components, a

**Fig. 2. Regulation tester for small dry batteries.**

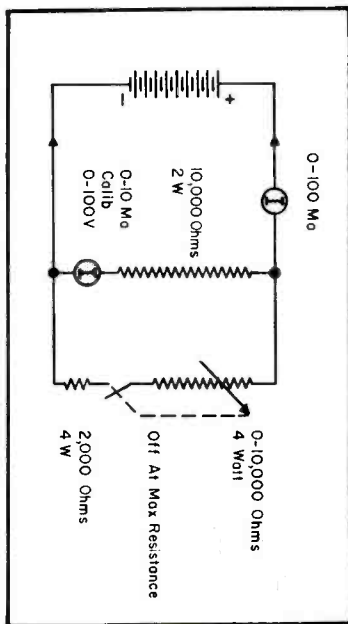

**NEW  
IMPROVED**



**Now ONLY \$2.75**

DEALER NET  
With Leads \$2.95

**MORE  
VERSATILE  
LOWER  
COST**

**COMPLETELY NEW**

- Automatically checks ALL TUBES including locals and pix tube.
- Continuity and voltage tester—no switches, merely plug in test leads.

Ask your Jobber to see the New Senco Checker.

**SERVICE INSTRUMENTS CO.**  
ADDISON, ILLINOIS  
"ADDISON INDUSTRIAL DISTRICT"

**Electron**

**Tube**

**Technicians**

*We now have openings for work in the fabrication and processing of experimental electron tubes.*

Applicants should be high school graduates with a natural aptitude for working with small parts. Experience in electronics, precision benchmark and experimental tube work is desirable.

*Address resume of experience and training to...*

**Hughes**

**RESEARCH AND DEVELOPMENT LABORATORIES**  
Technical Personnel Department  
Culver City, Los Angeles County, Calif.



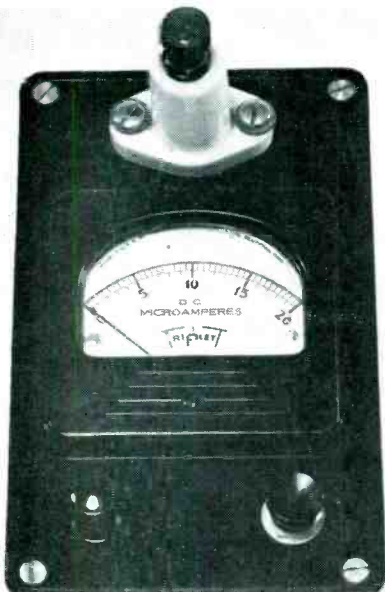

Fig. 3. Panel view of kilovoltmeter. Positive terminal is on insulator at top, ground terminal at left, push button at lower right.

3" square 0-20 microammeter, two 1,000-megohm resistors, a 3½" by 6" bakelite instrument case, and miscellaneous parts is shown in Fig. 3. The positive terminal here, which may be as much as 20,000 volts above ground, was mounted on a porcelain standoff insulator.

Interior construction of the instrument is shown in Fig. 4. Since insu-  
(Continued on page 64)

Fig. 4. Interior view of kilovoltmeter. Positive terminal extension is at top center. Resistors extend from it to points on the sub-panel in center; push button, redesigned for adequate spacing, is at lower left.



# When signal conditions demand a TOWER... choose one built by AERMOTOR

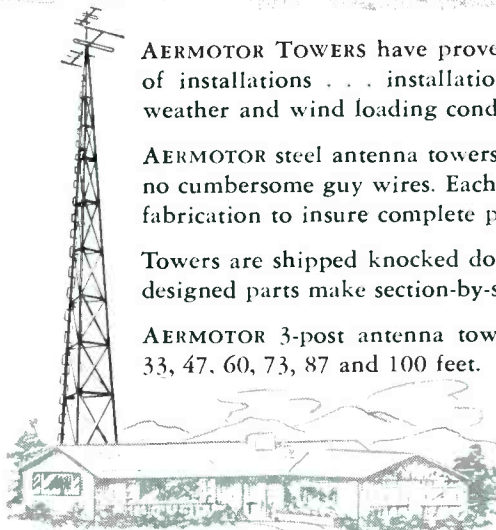

AERMOTOR TOWERS have proven their excellence in thousands of installations . . . installations exposed to the most severe weather and wind loading conditions.

AERMOTOR steel antenna towers are self supporting . . . require no cumbersome guy wires. Each part is heavily galvanized after fabrication to insure complete protection from exposure.

Towers are shipped knocked down in convenient bundles; well designed parts make section-by-section assembly easy.

AERMOTOR 3-post antenna towers are available in heights of 33, 47, 60, 73, 87 and 100 feet.

**WRITE FOR ADDITIONAL INFORMATION ABOUT THE AERMOTOR TOWERS AND A DEALER FRANCHISE IN YOUR TERRITORY.**

SINCE 1888, MANUFACTURERS OF QUALITY BUILT TOWERS

## • AERMOTOR COMPANY •

2500 W. ROOSEVELT RD.—CHICAGO 8, ILLINOIS U.S.A. DEPT. 14U3



### G-C RADIO-TELEVISION PRODUCTS AT YOUR DISTRIBUTOR

WRITE for your G-C Catalog or ask your supplier. FREE!



**G-C TEST SOCKET ADAPTER KIT**  
Complete, for all tests.  
No. 9250



**G-C VINYLITE CEMENT**  
Great adhesion; many uses;  
2 oz.  
No. 58-2



**G-C RADIO-TV SERVICE CEMENT**  
High grade adhesive.  
No. 30-2



**G-C SPRAKLEEN**  
Contact Cleaner  
No. 8666



**G-C 300-OHM LINE TOOL**  
Slot, strip, cut twin leads.  
No. 9220



**G-C DUAL SHEET METAL PUNCH**  
Two punches—7/8" x 1 1/2".  
No. 9260



**G-C DUAL TUBE PIN STRAIGHTENER**  
For both 7 and 9 pin tubes.  
No. 9092



**G-C TV CHASSIS SUPPORTS**  
Tilt chassis safely.  
No. 9176



**G-C ECONOMY TEST LEADS**  
Tenite 5" prods, 50" leads.  
No. 9190



**G-C ALIGNMENT KIT**  
Roll case and 9 matched alignment tools.  
No. 5023



**G-C K-27 PRINT-KOTE**  
Pressure spray silicone resin.  
No. 14-6



**G-C SPRAY DE-OX-ID**  
Cleaner for radio, TV controls.  
No. 19-6

GENERAL CEMENT MFG. CO.

901 Taylor Avenue • Rockford, Illinois

# The MASTER SETS YOU UP!

here's what's in it for you . . .

**DOLLAR-WISE PURCHASING**  
Shop before you buy! Do it right at your own bench through the supermarket pages of the industry-wide MASTER. Compare specs and prices first—then buy and save.

**BONANZA BUSINESS** Use The MASTER as your "geiger". Strike it rich with every repair. Take The MASTER right into your customer's home and sell direct from its pages. Watch it pay off!

- 100,000 items • Complete descriptions
- Specifications—Prices • 11,000 illustrations • 350 mfrs. • 8 x 11", 6 lbs.

**UNITED CATALOG PUBLISHERS, INC.**  
110 Lafayette St., New York 13

List \$7.50  
As low as  
**\$2.95**  
from parts distributors



## 1956 edition

FULLY CATALOGS:

TUBES — TRANSMITTERS  
TEST EQUIPMENT — COMMUNICATION  
RECEIVERS — RESISTORS — COILS  
ANTENNAS — TRANSFORMERS  
RECORDING & PA SYSTEMS  
CAPACITORS — HARDWARE  
RELAYS — TOOLS, ETC.

**1456 pages**  
**OFFICIAL**  
**BUYING GUIDE**  
**OF THE**  
**INDUSTRY**

## Kilovoltmeter

(Continued from page 63)

lation, at the voltages to be measured, is quite important (to minimize leakage and corona troubles), the infeed from the positive terminal was passed through an oversize hole in the case panel, to support the hot ends of the resistors directly. The cold ends of these resistors were brought out to lugs on a bakelite sub-panel, supported by the instrument screws. This sub-panel also served to support the

hot contact of a push button, designed to give a total throw of 17/32". This large gap was found essential, despite the 1,000-megohm series resistance, to prevent corona trouble in damp weather. Return spring of the modified push button, a jack spring, was mounted on the ground terminal with a brass bushing.

To protect case and instrument against skidding, scuffing, and drop-page, the embossed bakelite feet of the case were ground off, and 3/4" rubber feet were bolted to all four bottom corners.

In setting up the instrument, the ground is connected to chassis ground.

Plus of the instrument is then connected to high-voltage plus. One should use either an adequately-insulated high-voltage probe and lead for this connection, or the connection should be made with the power off and the filter discharged. High-voltage arc burns are painful and very slow to heal.

With the power on, the meter can be read and reading recorded. Then the button can be pressed and second reading made. If these readings differ, it will then be necessary to compute the no-load voltage from formula (7), or read from table I (p. 32) computed from the formula. If the drop, on pressing the button, is less than about 5 per cent, the no-load voltage can be determined by adding the drop to the first voltage read, the error in this instance being less than about 1 per cent, and hence inconsequential in most TV applications.

Use of this instrument in a variety of TV servicing applications disclosed some interesting information. With no known exceptions, commercially-manufactured TV receivers, using flyback high-voltage supplies, have good enough regulation, so that addition of two drain increments of up to 20 microamperes each produces no readable change in the voltage.

Poor regulation confined to the high-voltage circuits of a flyback type high-voltage supply is most commonly due to an open high-voltage winding, a gassy high-voltage rectifier, an open filter capacitor or a cracked filter resistor.

Several instances of lack of contrast, two of them coupled with very short picture tube life, were traced to extreme overvoltage, and the trouble

**opportunities**  
AT  
**BELL TELEPHONE LABORATORIES**

A career for you with one of the nation's leaders in research and development in communications and military electronics.

**ELECTRONIC TECHNICIANS      DRAFTSMEN**  
**ELECTROMECHANICAL TECHNICIANS**

Openings require previous training at high school, armed service school, or technical institute level and in general 2 or more years of applicable industrial or military experience.

Send your name and address for application, telephone collect within 100 miles for information, or visit us Monday through Friday. Evening interviews arranged.

**BELL TELEPHONE LABORATORIES**  
WHIPPANY, N. J. (Near Morristown)      EXTS. 2786, 300  
MURRAY HILL, N. J. (Near Summit)      EXTS. 3078, 3204  
CRESTVIEW 3-6000

remedied by insertion of a high resistance voltage divider.

One case of erratic brilliance, correlating in part with atmospheric humidity changes, in a TV receiver with an *rf* high-voltage supply, was found to be accompanied by poor regulation. Correction of the regulation, by replacing a *rf* oscillator tube, also stabilized the brilliance.

The same general principles can be used to make a load-correcting voltmeter or kilovoltmeter for other uses.

Circuit of a more involved instrument, used for testing batteries in portable equipment, is shown in Fig. 2 (p. 62). As should be well known, but unfortunately is not, the condition of small dry batteries is better shown by their regulation characteristics than by their terminal voltage under either light or medium loads. With a tester of this type, the battery voltage under two or more loads can be measured rapidly, and the behavior of the battery under any desired loads can be observed. Weak batteries, in general, not only have poor regulation, but also have rather rapid voltage dropoff after a short period of operation under load. No-load voltage of the battery, which is usually slightly higher than the rated or nominal voltage, can be computed from formula (6).

### Color-TV Antenna

(Continued from page 39)

correctly aligned and are not overloaded with excessive signal.

After an amplifier is aligned for flat response across the channel, it may sometimes be necessary to insert about 100 feet of transmission line between the sweep and the amplifier being aligned so that input tuning can be adjusted for minimum *vswr*. The line used should match the stated *input* impedance of the amplifier, but should be purposely mismatched to the *output* of the sweep generator from 2 to 4 times. This can be done by inserting series or shunt resistors; Fig. 1 (p. 39). This will allow the *bumps* due to line reflections to show more clearly, as illustrated in Fig. 2 (p. 39). Receiver *rf* units can be checked in the same fashion when poor line match is suspected.

Amplifiers that are overloaded in an attempt to get more than the rated output signal, will cross modulate between sound and color subcarrier, causing a 920-ke beat to appear on

(Continued on page 69)

from the VOICE OF AUTHORITY IN SWEEPS ...

# SPOT and FIX TV FAULTS FAST!

FREE RAM BOOK SHOWS HOW!

Typical latest field-proven servicing data you'll find in your RAM book:



FAULT: "Ringing."  
CAUSE: Incorrect value of balancing R-C network across one-half of H. Yoke winding.  
(A): H. Yoke current wave-form. Obtained by connecting scope across 10-ohm resistor inserted in series.

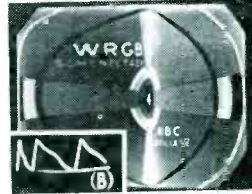

FAULT: Picture compression and stretching.  
CAUSE: Capacitance value of boost capacitor (connected to linearity coil) too low.  
(B): H. Yoke current wave-form. Leaky boost capacitor could cause similar effect.



FAULT: Picture stretching at left and compression at right.  
CAUSE: 0.02 mf boost capacitor (connected to linearity coil) used instead of 0.1 mf capacitor.  
(D): H. Yoke current wave-form.

For over 10 years, RAM has specialized and pioneered in sweeps exclusively. RAM designs them, makes them, counsels TV set manufacturers on them, field-services them, educates Servicemen on them — leads the industry.

No one but RAM can bring you such *proven* data — as shown here and in the RAM Manual. In manufacturing know-how and field experience, you can depend on RAM for ...

### THE VOICE OF AUTHORITY IN SWEEPS

Send coupon today — get the BEST information from the FOREMOST manufacturer now!



**RAM ELECTRONICS SALES CO.** • Irvington, N. Y.

Canadian Sales Division: Telequipment Mfg. Co., Ltd., Ontario

Export Dept: Dage Corp., 219 E. 44 St., New York, N. Y.

# KESTER



Absolutely non-corrosive and non-conductive, KESTER "RESIN-FIVE" CORE SOLDER contains an activated type of resin that gives you that fast, positive action on all your jobs ... including the most difficult.



KESTER SOLDER COMPANY  
4248 Wrightwood Avenue • Chicago 39, Illinois  
Newark 5, New Jersey • Brantford, Canada

# SOLDER



# anything to trade?

As a subscriber\* to the CORNELL-DUBILIER monthly magazine "THE CAPACITOR" you can use its famous "TRADING POST" section to run an advertisement\* to SELL—SWAP—OR BUY all sorts of electronic equipment and services helpful to you in your business.

**\*NO CHARGE FOR THE AD!**

**\*NO CHARGE FOR THE SUBSCRIPTION!**

"THE CAPACITOR" comes prepaid direct to your home every month—12 times a year. 16 to 24 pages, including full technical or constructional article.

*A service of*

**CORNELL-DUBILIER**

*world's largest manufacturers of capacitors*

**FREE EVERY MONTH**

Just fill in coupon below and mail today. Our new subscription list limited so get your request in now!

Editor—"The Capacitor"  
CORNELL-DUBILIER ELECTRIC CORP.

Dept. S-36, South Plainfield, N. J.

Yes Sir! Put me down for a FREE Subscription to Cornell-Dubilier's "THE CAPACITOR"

name \_\_\_\_\_ please print

address (home) \_\_\_\_\_

city \_\_\_\_\_ zone \_\_\_\_\_ state \_\_\_\_\_

my occupation or job title is \_\_\_\_\_

## TV Antenna—Accessory News

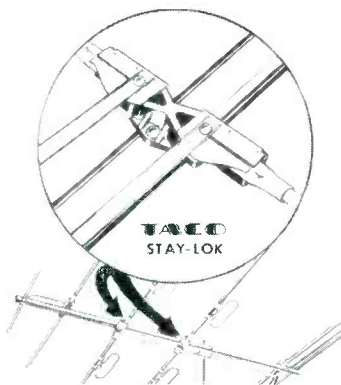

TV antennas with stay-lok design that, it is said, provides automatic lock of elements. Antenna can be collapsed by lifting of locking tab. Models also feature modified interconnecting phasing lines to provide additional high band gain. (Technical Appliance Corp., Sherburne, N. Y.)



TV transmission line made with 20 strands of No. 33 copper wire in each conductor. Line is made with virgin polyethylene. Wire is marked with deep impression every 10'. Available in 55, 80 and 100-mil web thicknesses. (Twin Twenty and Challenger series; Channel Master Corp., Ellenville, N. Y.)

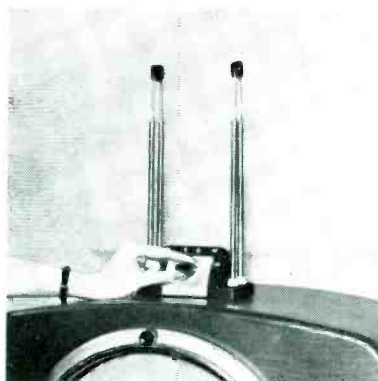

Indoor antenna with push buttons designed to aid station tuning. (Model 70 Tenna Tuner; Snyder Manufacturing Co., Philadelphia, Pa.)

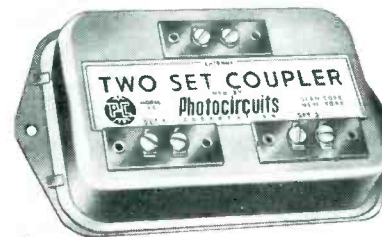

Two-set printed-board coupler with wound sections of copper ribbon wire on fibreglas support. Coupler permits operation of two TV sets, or one TV set and one FM radio, from a single antenna. (Photocircuits Corp., Glen Cove, N. Y.)

Super-fringe TV antenna, and standard broadcast radio and antenna rotator control unit described during a recent Bob Considine TV broadcast by Ira Kamen, Brach vice president in charge of electronic research (left) and Jerome Berger (right), plant manager at Brach.



Outdoor TV coupler that can be mounted on mast to permit running of leadins outside the house to rooms desired. Col-plast encapsulation is used and said to seal components in an air tight block. Uses distributed-line-parameter network of bifilar coils. Available in 3 models for matching of 2, 3 and 4 sets to 300-ohm antennas. (No. AC40 for 2 sets, AC60 for 3 sets, and AC70 for 4 sets; JFD Manufacturing Co., Inc., 6101 16th Ave., Brooklyn 4, N. Y.)

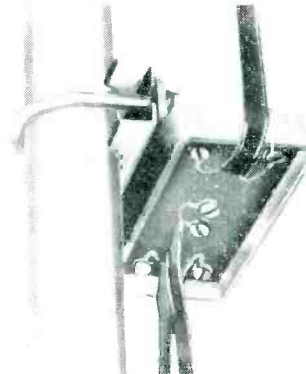

## ADVERTISERS IN SERVICE

MARCH, 1956

	Page
Acme Electric Corp.	59
Aermotor Co.	63
Aerovox Corp.	48
American Pamcor, Inc.	52
American Microphone Co.	54
American Phenolic Corp.	44
Astatic Corp.	2
Astron Corp.	38
Atlas Sound Corp.	58
B & K Mfg. Co.	49
Bell Telephone Laboratories	64
Bussmann Mfg. Co.	7
CBS-Hytron Div. Columbia Broadcasting System, Inc.	43
Channel Master Corp.	4, 5
Chicago Standard Transformer Corp.	55
H. G. Cisin	62
Columbia Wire & Supply Co.	3
Cornell-Dubilier Electric Corp.	Inside Front Cover, 31, 66
Duotone Co.	56
Electric Soldering Iron Co., Inc.	61
Elgin National Watch Co.	54
Federal Telephone & Radio Corp.	51
General Cement Mfg. Co.	63
General Electric	33-36
Heath Co.	60
Hughes Research & Development Labs.	62
Hycon Electronics, Inc.	45
Jackson Electrical Instrument Co.	68
Jensen Industries, Inc.	54
Kester Solder Co.	65
P. R. Mallory & Co., Inc.	Inside Back Cover
Merit Coil & Transformer Corp.	28
Ohmite Mfg. Co.	28
Perma-Power Co.	68
Photocircuits Corp.	56
Planet Sales Corp.	46
Precision Apparatus Co., Inc.	23
Quietrole Co., Inc.	58
The Radiart Corp.	Inside Front Cover, 31, 66
Radio Corporation of America	Back Cover
Radio Receptor Co., Inc.	29
Ram Electronic Sales Co.	65
Raytheon Mfg. Co.	10
Remington-Rand Div. Sperry-Rand Corp.	27
Rohn Mfg. Co.	1
Service Instruments Co.	62
Seco Mfg. Co.	57
Shure Brothers, Inc.	53
Simpson Electric Co.	30, 67
Snyder Mfg. Co.	41
Sprague Products Co.	6
Tung-Sol Electric, Inc.	24, 25
United Catalog Publishers, Inc.	64
United Motors System Div. General Motors Corp.	8-9
Walco-Electrovox Co., Inc.	58
Winegard Co.	47
G. F. Wright Steel & Wire Co.	60
Xcelite, Inc.	46

## Color TV Antennas

(Continued from page 65)

the screen. Installations having this trouble will require a reduction of input signal, which may make additional amplifiers necessary to supply the required number of outlets.

### Distribution Systems

With or without amplifiers, multiple-outlet distribution systems may introduce a major problem. Such common troubles as poor sync, distorted sound, reflection, smear, high peaking (white outlines), weak picture, and loss of color (3.58 mc) information can be caused by the improper isolation of receivers. It must be remembered that most receivers (and *rf* amplifiers) have input circuits which match the line *only* on the channel to which they are tuned. On any other channel, they may reflect anything from an open to a short circuit back into the line. Therefore, it is necessary that each receiver have *at least 6 db* of resistive isolation from the feed line.

In connecting two color sets on existing b-w outlets, the dual-network should be taken out and four 150-ohm resistors inserted at junction points, as shown in Fig. 3 (p. 39).

For distribution from a single point, to three to six receivers, using 300-ohm line, additional banks of resistors will have to be inserted; the values are shown in table 1. The 270-ohm terminating resistors should be connected across any unused outlets.

Distribution through transformers should be satisfactory if at least 6 *db* of resistive isolation is provided between each receiver and the transformer.

The foregoing requirements for color-TV are no more strict than for good black and white reception. Color will only make the defects in a system more noticeable to the set owner.

Number of Receivers	Resistor Value	Number of Resistors
3	270 ohms	6
4	390 ohms	8
5	510 or 470 ohms	10
6	560 or 620 ohms	12

Table 1. Banks of resistors required in multiple color-TV 300-ohm distribution setups.



**a Volt-Ohmmeter you can carry in your shirt pocket!**



**Simpson MIDGETESTER**  
MODEL 355  
SELF SHIELDED!

**\$29.95**  
including probe leads

The world's first practical shirt-pocket volt-ohmmeter. Rugged and accurate. Not affected by any outside magnetic influences. 10,000 Ohms per volt AC and DC! Fourteen ranges: 5 for AC voltages, 5 for DC voltages, and 4 for DC resistances.

**See your Parts Distributor**

**Simpson ELECTRIC COMPANY**  
WORLD'S LARGEST MANUFACTURER OF ELECTRONIC TEST EQUIPMENT

5200 W. Kinzie St., Chicago 44, Ill.  
EStebrook 9-1121

IN CANADA: Bach-Simpson, Ltd., London, Ontario

# JACKSON INSTRUMENTS

## make more profits

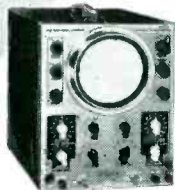

**Model CRO-2**  
**Wide Band Oscilloscope**  
**\$22500** Dealer Net.

Flat within 1 db, 20 cycles thru 4.5 mc.\* Maximum deflection sensitivity .018 r.m.s. volt-per-inch. Incorporates Horizontal Sweep Expansion, Sweep Polarity Reversal, big 5-inch CR tube, Linear Sweep Oscillator 20 cycles thru 50 kc.

\*NOTE: Scopes down 3 db at 4.5 mc. are actually down 30%



**Model TVG-2**  
**Television Generator**  
**\$25995** Dealer Net.

Complete television Signal Generator for VHF, IF, color. Sweep Oscillator 20 kc. thru 216 mc. all on fundamentals. Sweep width 0 thru 18 mc. Marker Oscillator 4 mc. thru 216 mc. Separate Crystal Oscillator.

**NEW!**

### Model 49 Tube Tester

with Plug-In Accessories

**\$4995**

Dealer Net.



Accessory Testers as low as \$6.95.

Brand new, fully flexible tube tester with plug-in accessories for making other tests. Lever action and big 4½" meter, plus speed chart for rapid testing. Accessories for measuring Heater Current, High Resistance Shorts to 2 megohms, and checking selenium rectifiers now available, others soon.

Available from Leading Distributors

# JACKSON

Service Engineered Test Equipment

16-18 S. Patterson Boulevard Dayton 2, Ohio  
In Canada: The Canadian Marconi Co.

## AT PRESS TIME

THE FIRST DEMONSTRATION of *uhf* color television transmission and reception was held recently in Philadelphia for nearly 100 foreign members of the CCIR, a subcommittee of the International Telecommunication Union, representing more than 25 countries. The power of the transmitter proper was 150 watts and antenna gain was provided to produce a strong signal at the receiving location.

FOUR AND A HALF MEGAWATTS of ultrahigh frequency radiated power at 537 mc (channel 23), the highest continuous-wave power ever achieved at that frequency, and more than four times the output of the most powerful existing *uhf* TV stations, was obtained during a recent test in Lancaster, Pa., by feeding approximately 100 kw, generated by a tube, into an antenna with a gain of nearly 50. Such power, it is believed, will serve to extend the area of primary coverage and offer improved TV service throughout the present so-called fringe or weak-signal areas.

A 10-TUBE PORTABLE TV receiver which features a 90° electrostatic-focus picture tube, having an outside diagonal measurement of 8½", has been developed. Chassis has four crystals, one tube rectifier, and a double selenium rectifier.

A LINE OF TRANSISTORIZED portable two-way handie-talkie radiophones, weighing from 7 to 15 pounds, with *rf* power output ratings from 1 to 8 watts, is now being marketed. Operates in the 25-54 and 144-174 mc range, in handset and speaker-palm type microphone versions.°

\* See National Scene, this issue (page 22) for additional transistor-development news.

### Circuit Diagrams In This Issue

Admiral Color-TV System .....	15
Admiral Color-TV Chassis Filament Circuitry .....	15
Admiral Color-TV Receiver; Model 28Y1 (Complete Circuit) .....	16-17
TV-Set Ring Cure Circuit .....	19
Tube-Transistor Radio Circuit Comparison .....	23
Circuits for NPN-PNP Transistors .....	20
Raytheon T-500 Transistor Radio .....	21
G.E. 450-Mc 2-Way Receiver .....	26
Transistor AF Stage .....	30
Load-Compensating Kilovoltmeter .....	32
G.E. Revised Transistor-Radio (Model 675-6) Detector .....	37
Series-String Tube Test .....	40
Emerson I20270-B Portable Phono Amp .....	42
Phono Amp Modified for Separate Speaker Feed .....	42
Portable Phono Altered to Accommodate External Amp .....	42
Portable Record Player Revised to Eliminate Phono Amp .....	42
Small Dry-Battery Test Circuit .....	62

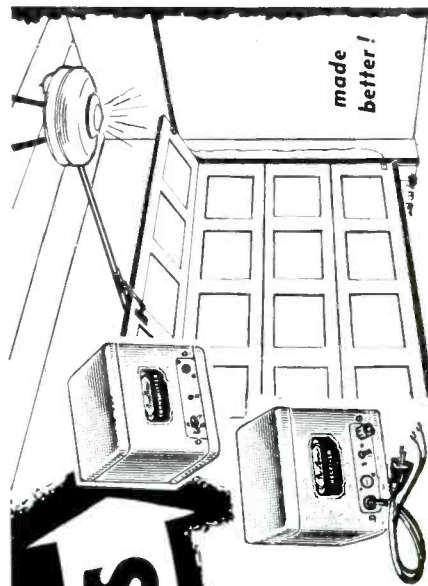

**NEW DESIGN means NEW SALES**

Now, the newest, finest Radio-Control Garage Door Opener styled in a modern spun-aluminum fixture that beautifies garage interiors. Convenience and safety features galore — New automatic shut-off, positive locking of door, FCC authorized radio frequency . . . and many more plus qualities! Write today for descriptive literature.

**Perma-Power's**

**NEW Garage Door Opener**

mfd by **Perma-Power COMPANY**

4727 N. Damen Ave., Chicago 25, Ill.  
Manufacturers of electronic equipment since 1928  
EXPORT: Schoel International, Chicago, Ill.

made better!



... another  
**MALLORY**  
service-engineered  
product

# Exact Duplicates

as you prefer them

### Want them ready to use?

Mallory can give you completely assembled dual controls in all the styles and characteristics to fit the most popular TV and auto radio sets.

### Want to assemble your own?

A small stock of Mallory factory-assembled sections, switches and shaft tips lets you make thousands of combinations to match each job. It takes you only a few minutes to complete the control you need, and you save all the time of shopping for the right combination.

**You're right either way —**  
**with Mallory.** Mallory Dual Controls assure you of duplicating the exact characteristics you require . . . with noise-free, long-lasting, stable controls that assure customer satisfaction. Your Mallory distributor carries a full stock of both types. See him today!

P. R. MALLORY & CO. Inc.  
**MALLORY**

P. R. MALLORY & CO. Inc. INDIANAPOLIS 6, INDIANA

• Capacitors • Transformers • Resistors • Controls • Switches  
• Rectifiers • Power Supplies • Filters • Mercury Batteries



## “BACKGROUND QUIETNESS”

... for new “front-end” performance!

**A MAJOR ENGINEERING FEATURE OF RCA RECEIVING TUBES**

Known for their ability to hold tube noise to surprisingly low levels—and produce a cleaner TV picture for the customer—RCA Receiving Tubes are making even more friends with servicemen the country over.

Take a few of the improvements that contribute to background quietness in the famous “front-end” tube—the RCA-6BQ7A: Gold-plated grids reduce reverse grid current; extra heater-to-cathode insulation lowers leakage current and reduces hum; larger grid and cathode connectors minimize “induced” grid noise... features that can give new “front-end” performance!

For increased “background quietness” and a cleaner picture, always replace with RCA Receiving Tubes—and say goodbye to costly callbacks.



**RECEIVING TUBES**  
RADIO CORPORATION OF AMERICA

