

SERVICE

THE TECHNICAL JOURNAL OF THE TELEVISION-RADIO TRADE

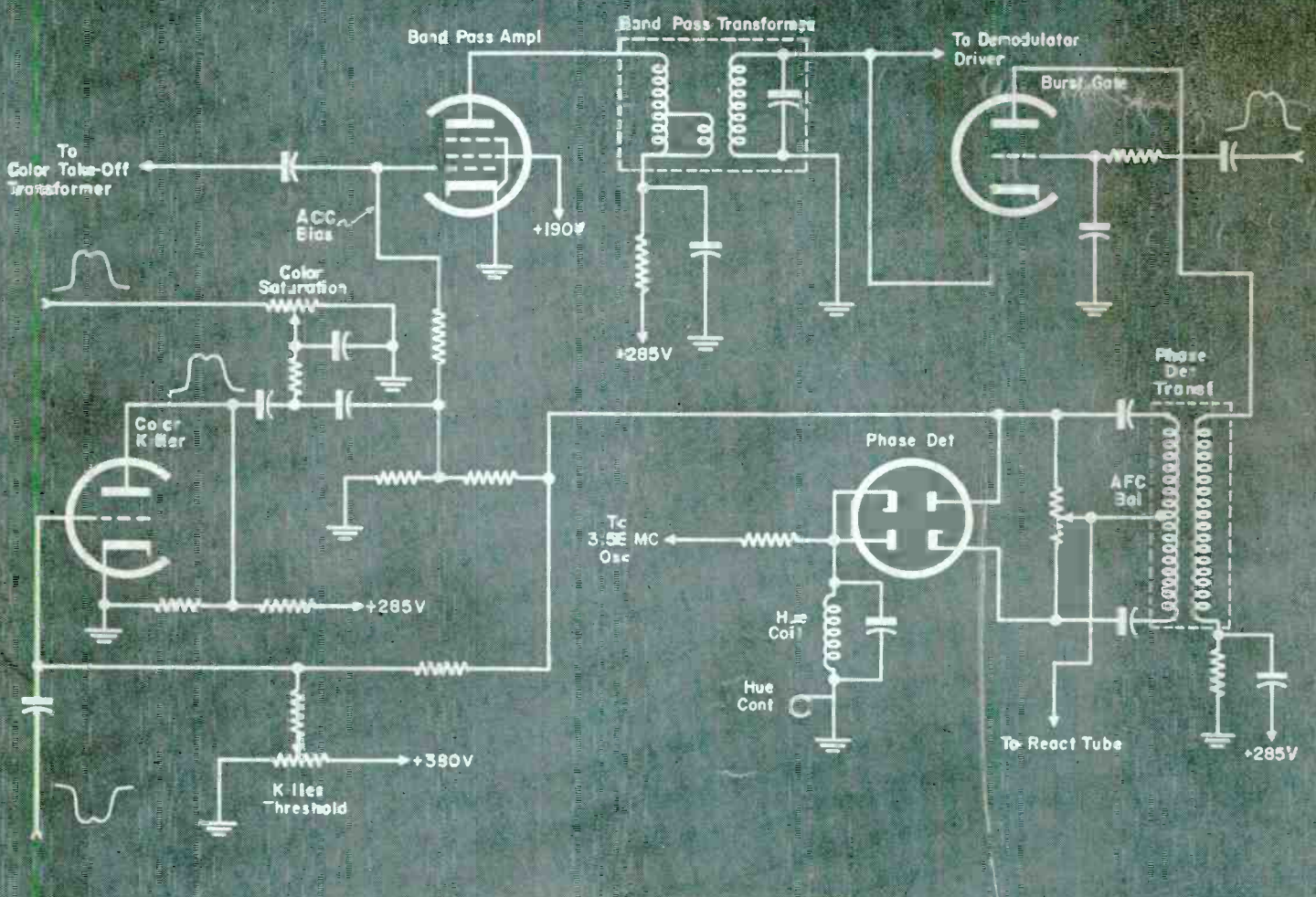

Automatic color control system in 21-inch color-TV chassis. See circuit analysis, this issue

R TURSE
 CLARKE W LANE
 POMPTON LAKES, N. J.
 10-57
 25 SAR 9-6-55

setting new selling records everywhere

AR-1

The completely AUTO-MATIC rotor, powerful and dependable, with a modern design cabinet. Uses 4 wire cable.

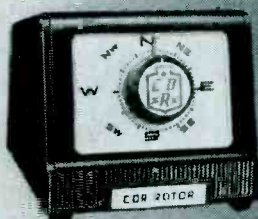

AR-2

Completely AUTOMATIC rotor with thrust bearing. Handsome cabinet, uses 4 wire cable.

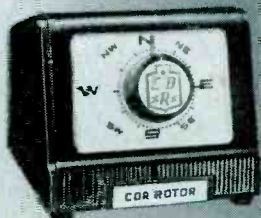

AR-22

Here is the completely AUTOMATIC version of the famous TR-2 with all the powerful features that made it so famous.

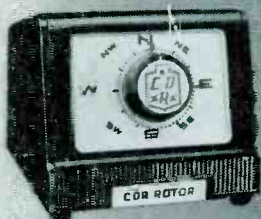

TR-2

The heavy-duty rotor with plastic cabinet featuring "compass control" illuminated perfect pattern dial. Uses 8 wire cable.



TR-4

The heavy-duty rotor complete with modern cabinet with METER control dial. Uses 4 wire cable.



TR-11

The ideal budget all-purpose rotor with new, modern cabinet featuring meter control dial. Uses 4 wire cable.

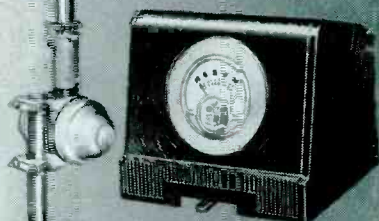

TR-12

A special combination value consisting of complete rotor with thrust bearing. Handsome modern cabinet with meter control dial, uses 4 wire cable.

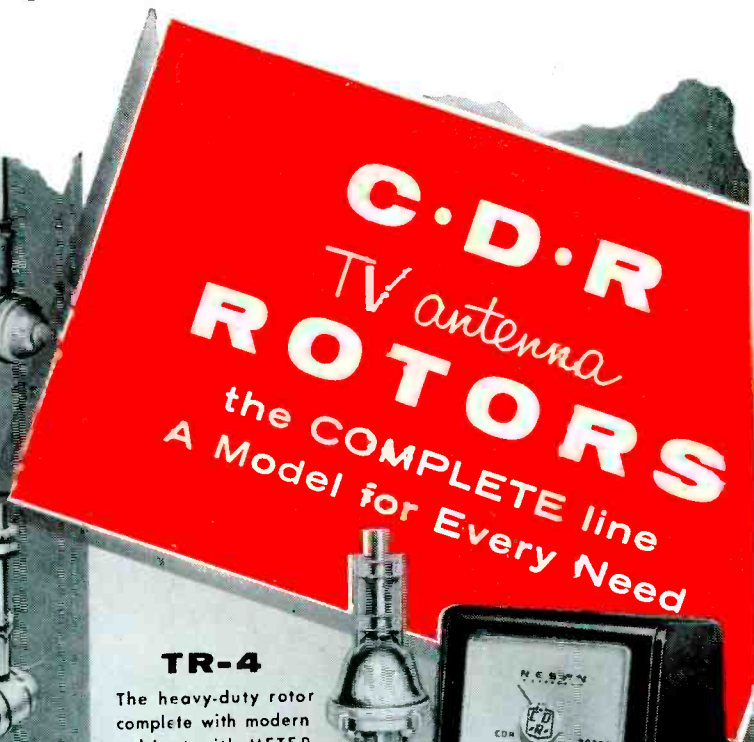
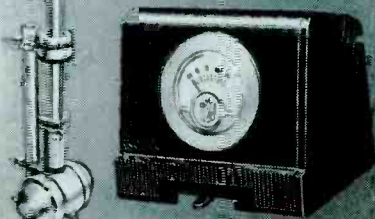







CORNELL-DUBILIER

SOUTH PLAINFIELD, N. J.

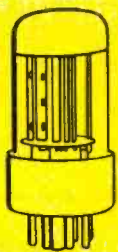

THE RADIART CORP.

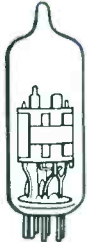
CLEVELAND 13, OHIO

<p>SYLVANIA</p> <p>6SN7GTB</p> <p>ELECTRONIC TUBE</p>		<p>SYLVANIA</p> <p>6AU6</p> <p>ELECTRONIC TUBE</p>	
	<p>SYLVANIA</p> <p>6BQ6GTA</p> <p>ELECTRONIC TUBE</p>		<p>SYLVANIA</p> <p>5U4GB</p> <p>ELECTRONIC TUBE</p>
<p>SYLVANIA</p> <p>GT</p> <p>NIC</p>		<p>SYLVANIA</p> <p>6CB6</p> <p>ELECTRONIC TUBE</p>	
	<p>SYLVANIA</p> <p>1B3GT</p> <p>ELECTRONIC TUBE</p>		

How to get the jump on call-backs in 6 easy moves

Here are six tube types called for most in your daily service work. Eliminate the call-backs from these types and your biggest share of headaches is over. It's easy to do just that, too, simply by getting into the habit of using only Sylvania tubes ... in the familiar yellow and black carton.

These 6 types alone incorporate over 14 design and production improvements to eliminate the most common causes for "quick failures" and costly call-backs. It's no wonder more and more servicemen consider the yellow and black carton their "calling card of top quality service."

 **SYLVANIA**[®]

SYLVANIA ELECTRIC PRODUCTS INC.
1740 Broadway, New York 19, N. Y.
In Canada: Sylvania Electric (Canada) Ltd.
University Tower Building, Montreal

LIGHTING • RADIO • ELECTRONICS • TELEVISION • ATOMIC ENERGY

SERVICE, NOVEMBER, 1955 • 1

25% more POWER

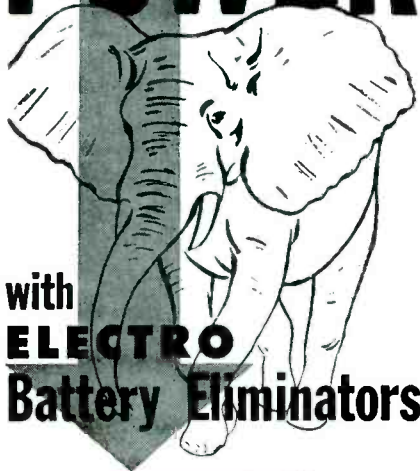

with
ELECTRO
Battery Eliminators



6/12-volt DC Power Supply . . .
operates all 6 & 12-volt auto radios
Same price range as Kits!

Heavy duty control transformer offers better regulation and withstands overloads for long service. Electro application of larger selenium rectifiers, combined with EPL patented conduction cooling increases rectifier power rating at lowest operating cost. Rugged, high quality construction, superior filtering, wide application. **\$39⁹⁵**

Only Electro offers actual proof
with performance charts

DC Output Voltage	Amperage Output		% AC Ripple
	Continuous	Intermittent	
0-8	0-10	20	5
0-16	0-10	20	5

Model "NF" DC Power Supply
0-28 volts up to 15 amperes

Less than 1% ripple at top load. Intermittent loads up to 25 amperes. Acclaimed in industry for its unmatched performance and construction at this **\$195⁰⁰** price. Certified performance.



SEND TODAY FOR
DETAILED BULLETINS!

111-55

ELECTRO PRODUCTS LABORATORIES
4501-5M N. Ravenswood Ave., Chicago 40, Ill.

Rush bulletin on
 Electro "D-612" Electro Model "NF"

NAME _____

COMPANY _____

ADDRESS _____

CITY _____ ZONE _____ STATE _____

The Technical Journal of the Television-Radio Trade
Including SERVICE—A Monthly Digest of Radio and Allied Maintenance: RADIO MERCHANDISING
and TELEVISION MERCHANDISING. Registered U. S. Patent Office.

COVER CIRCUIT

Automatic Chroma Control for Color-TV (RCA) 41

FEATURES

Editorial Lewis Winner 27

SERVICE . . . The National Scene 28

Independent Servicing in Sonora, Calif. Duncan K. Caldwell 31

Vertical TV-Chassis Horizontal and Vertical Oscillators Lee Scott 32

TV-Set Remote Control (With Complete Circuits) R. D. Wengenroth 34

Leakage Resistance in Capacitors G. S. Ryant 36

A Field Progress Report on Color-TV:
The 21-Inch Tricolor Picture Tube W. W. Lenz, Jr. 38

Automatic Chroma Control Circuitry (Cover) W. W. Cook 40

Test Equipment for Color-TV Receivers (With Complete Circuits)
E. R. Klingeman and S. Wlasuk 42

Interpreting VOM Measurements Norman Crowhurst 52

Blooming: Causes and Cures (Servicing Helps) 57

Field and Lab Tests for TV Antennas
G. N. Carmichael and J. F. Guernsey 58

Servicing of 450-Mc Communications Gear George A. Svitek 62

TV Ceramic Tubes . . . RF Pentodes . . . Audio Transistors (Tube News) . . . 64

Effect of Room Environment on Loudspeaker Reproduction Mark Vino 68

Tape Maintenance and Service Tips (Alignment . . . Circuit Troubleshooting) . . 76

Circuit Diagrams In This Issue 83

DEPARTMENTS

UHF/VHF TV Antenna Digest 58

Latest in Audio 69

Association News 75

Ten Years Ago in SERVICE 75

Instruments 81

Personnel 83

TV Accessories . . . Parts 84

Components 84

Bench-Field Tools 85

News 86

Catalogs and Bulletins 87

Jots and Flashes 88

Index to Advertisers 87

Entire Contents Copyright 1955, Bryan Davis Publishing Co., Inc.

Second-Class mail privileges authorized at New York, N. Y.; additional entry at the Post Office, Norwalk, Conn.

Subscription price: \$2.00 per year in the U.S.A. and Canada; 25 cents per copy. \$3.00 per year in foreign countries; 35 cents per copy.



EDITOR and PUBLICATION DIRECTOR

Lewis Winner

Associate Editor: David E. Pearsall II
Assistant Editor: Robert D. Weagenroth
Editorial Assistant: Jess Dines

Art Director: Anthony R. Alliffi

Supervisor, Circuit Diagrams:
Michael D. Bellezza

Editorial Production: Astrid Kelly

CIRCULATION DEPARTMENT

Circulation Manager: A. Goebel

Ass't Circulation Mgr.: A. Kiernan

ADVERTISING DEPARTMENT

Advertising Mgr.: Aaron L. Lafer

Business Mgr.: F. W. Boyd

Mid-West Mgr.: Stuart J. Ostlen
333 N. Michigan Ave.
Chicago 1, Ill.
Tel.: DEarborn 2-3507

East-Central Rep.: James C. Munn
2253 Delaware Dr.
Cleveland 6, O.
Tel.: ERIevue 1-1726

Pacific Coast Rep.: Brand & Brand
1052 W. 6th St.
Los Angeles 17, Cal.
Tel.: MADison 6-1371

Published Monthly By
Bryan Davis Publishing Company, Inc.
52 Vanderbilt Ave., New York 17, N. Y.
Tel.: MURray Hill 4-0170

B. S. Davis, Pres. F. W. Boyd, Sec'y



Always at your fingertips...

TV WIRE-WOUND CONTROLS

thanks to the

CLAROSTAT PD-1 PACKAGE



Here's a versatile assortment of wire-wound controls with a selection of the most popular Pick-A-Shaft field-attached shafts, packaged in an attractive, convenient, hinge-cover box.

The PD-1 includes eight different values of the well-known Clarostat Series A10 (4-watt) wire-wound controls, eight Pick-A-Shaft* shafts (two each of the four most popular types); and a handy mounting-nut wrench.

For focus controls alone, the assortment services over 2000 TV set models! Also provides for other functions such as width, linearity, balance and gain. Included is a data sheet listing TV manufacturers' part numbers with proper replacements from this assortment.

And of course the controls may be used in various test equipment, radios, hi-fi systems, industrial electronics, etc.

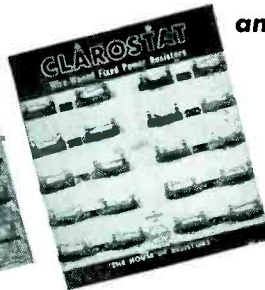

and don't overlook those

CLAROSTAT RESISTOR CARDS!

GK-1	20 most popular 10-watt wire-wounds	(1 ohm to 25K)
GK-2	32 most popular 2-watt wire-wounds	(5 to 2000 ohms)
GK-3	36 most popular 5-watt wire-wounds	(1 to 4000 ohms)
GK-4	54 most popular 5-watt wire-wounds	(1 ohm to 10K)
GK-5	50 most popular 10-watt wire-wounds	(1 to 9000 ohms)
GK-6	45 most popular 10-watt wire-wounds	(5 ohms to 50K)
GL-1	12 "Fuzohm"† 7.5-ohm fuse-type resistors	

Order Your PD-1 Package Today!

Clarostat distributors have it waiting for you. Take advantage of this time- and money- saving assortment. Ask for latest Clarostat Catalog—or write us.



†Trade-mark

Controls and Resistors

CLAROSTAT MFG. CO., INC., DOVER, NEW HAMPSHIRE
In Canada: Canadian Marconi, Co., Ltd., Toronto 17, Ont.

Reg U.S. Pat. Office

The "K.O." is Fantastic!

Features the highest front-to-back ratios ever recorded for any TV antenna:

- **Low band:** from 20:1 to 50:1 relative VOLTAGE.
 - **High band:** Up to 13:1 relative VOLTAGE.
- High gain:** Low band, 7 to 9 DB. High band, 8.5 to 10.5 DB. (Single bay figures). Balanced for COLOR.

Ends co-channel interference!
Knocks out "Venetian Blinds"!

Channel Masters "K.O." puts an INVISIBLE BARRIER in the path of rear signals, preventing co-channel interference. The "K.O." is completely preassembled with time-saving "Snap-Lock" Action. 100% aluminum.

LICENSED BY KAY-TOWNES ANTENNA CO., ROME, GA.

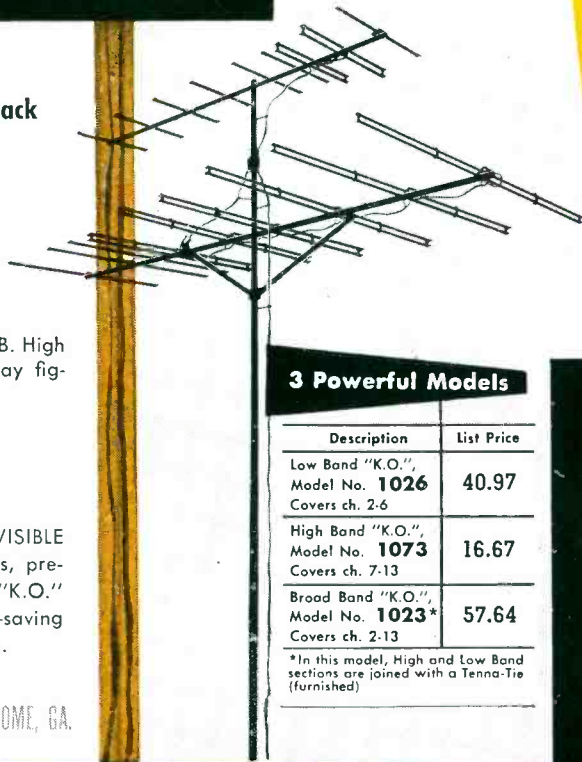

3 Powerful Models

Description	List Price
Low Band "K.O.", Model No. 1026 Covers ch. 2-6	40.97
High Band "K.O.", Model No. 1073 Covers ch. 7-13	16.67
Broad Band "K.O.", Model No. 1023* Covers ch. 2-13	57.64

*In this model, High and Low Band sections are joined with a Tenna-Tie (furnished)

**New
Antennas!**

**New
Accessories!**

**CHANNEL
MASTER
now
provides you**

The ^{new} Super Fan

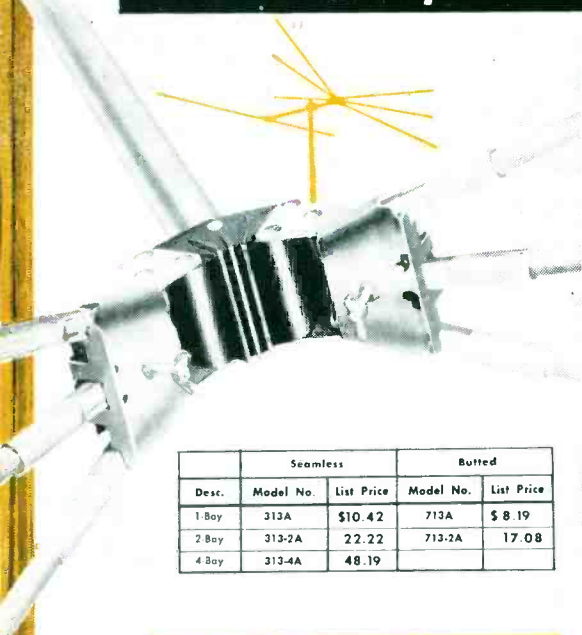

- "Super-Sembled"!
- Re-designed!
- Better than ever!

Channel Master's Super Fan is the original fan antenna. Famous for its superb quality, it has been in continuous demand for six years. Millions are in current use.

- Assembles with **NO HARDWARE** or tightening.
- Massive, heavy-duty, molded fan head. Unaffected by moisture and extreme temperatures.
- Reinforced elements. External sleeves prevent breakage.

Desc.	Seamless		Butted	
	Model No.	List Price	Model No.	List Price
1 Bay	313A	\$10.42	713A	\$ 8.19
2 Bay	313-2A	22.22	713-2A	17.08
4 Bay	313-4A	48.19		



CHANNEL MASTER CORP. ELLENVILLE, N.Y.

the world's largest manufacturer of television antennas and accessories

CHANNEL MASTER'S

new

TV TRANSMISSION LINE

The first TV wire to give you the benefits of **20** strands per conductor (20/33 pure copper).

with
EVERYTHING
but the roof!

installation. From now on, guarantee customer satisfaction with a **COMPLETE CHANNEL MASTER INSTALLATION — FROM TOP TO BOTTOM.**

It's a wood screw insulator



It's a machine screw insulator



All popular types and sizes available, including full assortment of specialized hardware. See your Channel Master distributor

it's got
FLEX-APPEAL!

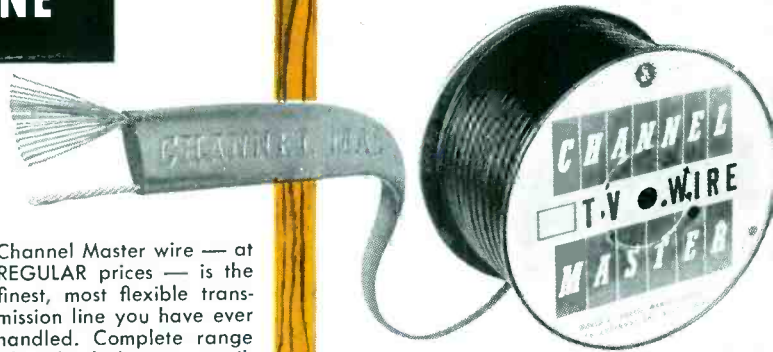

Channel Master wire — at REGULAR prices — is the finest, most flexible transmission line you have ever handled. Complete range of web thicknesses available. Colorful display packaging.

Two outstanding lines:

(both featuring exclusive 20-strand conductor):

"TWIN TWENTY"

- Marked every 10 feet. Saves time, ends waste.
- Full width. Available in silver or brown.
- Pure VIRGIN polyethylene.

"CHALLENGER"

Fine quality transmission line at today's VERY LOWEST PRICES.

new

STANDOUT insulators

Featuring this revolutionary new **2 in 1** screw thread design!

Eliminates the need for stocking separate machine and wood screws. Cuts your inventory investment in standoffs by more than 65%.

- Needle sharp point, made possible by finer thread. Easier to work in wood. Prevents slipping on mast.
- STANDOUT buckle has 8 machined threads.
- Convenient "Taper-Tip" strapping, available in galvanized or stainless steel.



Copyright 1955, Channel Master Corp.

An Open Letter

to the Television Serviceman:

RCA SERVICE COMPANY, INC.
A RADIO CORPORATION OF AMERICA SUBSIDIARY
CHERRY HILL, DELAWARE TOWNSHIP
GARDEN S., NEW JERSEY



November 10, 1955

E. C. CAHILL
PRESIDENT

TO: The Television Serviceman

Subject: Color Television

Color television opens a new era in electronic communications and adds a new dimension to the entertainment arts. It supplies a new stimulus for the entire television industry and opens the way for a significant advance in service to the public.

To you, the television serviceman, color television presents a new challenge. You have licked the challenge presented by black and white television and I am sure you will succeed in overcoming the many new obstacles presented by this new application of electronics.

The RCA Service Co., Inc. will maintain the same high servicing standards for color television as it has through the years for black and white TV. To accomplish this, the RCA Service Co., Inc. is continually developing new servicing techniques based on laboratory and actual field experience. As new servicing information is completed it will be made available to you so that your servicing of color television receivers will be accomplished in the same efficient manner as you are now performing your present television servicing.

We believe the new information on color television which you will find in this issue of Service Magazine will be useful to you in the months ahead. It is my sincere wish that you continue your successful business as we move into the era of color television.

Very truly yours,

E. C. Cahill
President

RADIO • TELEVISION • TUBES • "VICTROLAS" • RECORDS • ELECTRONICS
*VICTROLA TRADE-MARK REG. U.S. PAT. OFF.

ROHN NO. 6 TOWER "All-Purpose" Tower

Self-supporting to 50 ft., or guyed to 120 ft. Utilizes mass production techniques to give you lowest prices, yet highest profits for a tower of this type. Ideal for home and industrial requirements. Permanent hot-dipped galvanized coating inside and out. Dependability — a feature customers demand — is assured with the Rohn No. 6 Tower . . . designed to "stand up" for years to the rigors of weather and climatic conditions. Easy to climb for fast, efficient servicing. In 10 ft. sections.

ROHN PACKAGED TOWER "Space Saver" cuts storage space 300% or more!

Pat. Pending

Popular PT-48 has almost 50' of sturdy tower within a compact 8' x 20" package! "Magic Triangle" design is adapted to a pyramid shape using a wide 19" base with progressively decreasing size upward. Decreases your overhead . . . easy to transport and assemble; cuts shipping costs! Galvanized throughout. Available in heights of 24', 32', 40', 48', 56' and 64'.



Both Towers Feature . . .

1. MAGIC TRIANGLE CONSTRUCTION

Famous wrap-around design with full 2½" corrugated cross-bracing welded to tubular steel legs.

2. INTERLOCKING JOINTS

. . . formed by swaging tower ends so that they overlap each other, becoming a single unit in structure. Proved by tests to be superior.

3. WEATHER SEALED

. . . against condensation and moisture.

4. HOT DIPPED GALVANIZING

. . . both inside and out gives the finest protective coating known. This sales point is one of the best you can offer . . . the finest quality and at lower than competitive prices!

these two **HOT DIPPED GALVANIZED**
Rohn Towers
will satisfy 90% of your TV tower needs!

HEAVY DUTY NO. 30 TOWER

Heights up to 200' or more when guyed
Self-supporting up to 60'

Sturdy communication or TV tower that will withstand heavy wind and ice loading. Heavy gauge tubular steel, electrically welded throughout.

Weather resistant, non-corrosive double coating provides durable finish.

All sections in 10' lengths. Only 2-4 manhours required for installing 50' tower! Tremendous sales potential for you in this tower!

SPECIAL INSULATOR SECTIONS are available to permit the Rohn No. 30 Tower to be used as guyed "series fed" radiators for amateur and commercial uses.

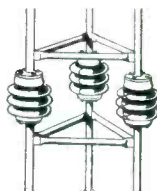

NEW LINE OF ROHN ROOF TOWERS



Four superior designed "Roof Towers" are available for inexpensive, yet sturdy roof installations. 3', 5' and 10' sizes are available.

These completely galvanized Rohn Towers have unbeatable sales appeal when this type installation is desired.

for • larger profits • customer satisfaction • greater ease in ordering, handling and shipping

CALL YOUR ROHN REPRESENTATIVE
FOR COMPLETE CATALOG, SALES
LITERATURE AND PRICES — OR WRITE —
PHONE — WIRE DIRECT

HANDLE THE COMPLETE LINE OF ROHN GALVANIZED ACCESSORIES

. . . house brackets, special bases, peak and flat roof mounts, instant drive-in bases, telescoping masts with matching bases, special Rohn Fold-Over Tower, guying brackets, UHF antenna mounts, erection fixtures, variety of mounts and supports for masts or tubing, tower installation accessories, TV service tables, mast and TV hot dipped galvanized tubing, guy rings, etc.

GET ALL YOUR REQUIREMENTS
FROM ONE RELIABLE SOURCE

ROHN Manufacturing Company

116 Limestone Avenue, Bellevue, Peoria, Illinois

SERVICE, NOVEMBER, 1955 • 7

FIELD REPORT NO. 7

NORTH, SOUTH, EAST AND WEST...
JFD IS VOTED BEST

SERVICEMEN EVERYWHERE AGREE ON JFD ANTENNAS

ON-THE-JOB PERFORMANCE IN TOWN AND COUNTRY PROVED IT TO THEM - NOT CLAIMS. JFD MAKES OVER 275 DIFFERENT ANTENNAS - ANOTHER ONE OF MANY REASONS WHY YOU, TOO, CAN DEPEND ON JFD ANTENNAS TO MEET ANY AREA OR PRICE REQUIREMENT. SEE YOUR JFD DISTRIBUTOR TODAY AND FIND OUT FOR YOURSELF.

RALPH H. NEWBY & NEWBY'S RADIO & T. V. SERVICE PHILADELPHIA, PENNA.

IN THE NORTHEAST PHILA. AREA MOST TAP ROOM OWNERS ARE INTERESTED IN RECEIVING N.Y. CHANNELS #9, #11 FOR THE VARIOUS SPORTING EVENTS. AFTER TRYING MANY DIFFERENT BRANDS AND MOD. EL'S OF HI GAIN ANTENNAS, WE HAVE SELECTED THE STACKED STAR-HELIX FOR ITS REMARK- ABLE GAIN ON ALL DISTANT CHANNELS, AND FOR ITS SUPERIOR FRONT TO BACK RATIO. AFTER NUMEROUS INSTALLA- TIONS WE ARE VERY PLEASED WITH CUSTOMERS' COMPLI- MENTS ON THE APPEARANCE AND PERFORMANCE OF THE STACKED STAR-HELIX.

BERNARD OSBALDESTON & BERNARD OSBALDESTON LTD. HAMILTON, ONTARIO

THE JFD FIREBALL IS A "MUST" WITH ME WHEN I'M UP AGAINST "GHOSTS." IT GIVES ME HIGH GAIN TO BOOT. THE INLINE CONSTRUCTION CUTS DOWN WIND RESISTANCE WHICH REALLY COUNTS IN HURRICANE WEATHER. EVEN THE HOME- OWNERS LIKE ITS LOOKS.

LOUIS B. DEMPSEY COLONIAL TELEVISION & APPLIANCE CO., INC. WILMINGTON, DELAWARE

RECENTLY, OUR WILMINGTON DISTRIBUTOR FOR YOUR JFD PRODUCTS INFORMED US ABOUT THE "STAR-HELIX" AN- TENNA, MODEL SX711. WE HAVE BEEN INSTALLING THEM IN SEVERAL CRITICAL AREAS WHERE RECEPTION IS VERY BAD. THE RESULTS ARE SO ASTOUNDING, WE ARE ACTU- ALLY RECEIVING CALLS FROM GREATLY SATISFIED CUSTOM- ERS. THIS ANTENNA ACTUALLY ELIMINATES THE GHOSTS FROM THE PICTURES.

CARMEN LASHEN HUTTNER RADIO INC. BROOKLYN 25, N.Y.

GHOSTS HAVE BEEN A BIG HEADACHE HERE BECAUSE OF ALL THE BIG BUILDINGS IN THE NEIGHBORHOOD. THERE WAS NOTHING WE COULD DO ABOUT GETTING RID OF THEM, BE- CAUSE NO MATTER WHAT AN- TENNA WE PUT UP, WE GOT GHOSTS. THEN CAME THE FIREBALL. IT JUST WIPE OUT THE GHOSTS LIKE THEY WERE NEVER THERE. I RECOMMEND THE FIREBALL.

VASTINE L. JANDA JANDA RADIO & T. V. SERVICE LA GRANGE, TEXAS

LET'S FACE IT. SERVICEMEN LIKE ME CAN'T AFFORD TO BELIEVE ANTENNA CLAIMS ANY MORE. THE PICTURE IS WHAT COUNTS. I SEE WHAT THE JFD STAR-HELIX CAN DO IN LOCA- TIONS THAT USED TO BE AS BAD AS "DEATH VALLEY." IT'S ONE OF THE FEW THAT LIVES UP TO ITS CLAIMS.

ELLIS E. HARRIS HARRIS RADIO AND T. V. SERVICE MEMPHIS, TENNESSEE

I AM USING THE JFD SUPER 13 ANTENNA IN MY T.V. INSTALLA- TIONS. IT PERFORMS GREAT ON ALL THE FOLLOWING CHAN- NELS, ESPECIALLY ON THE HIGH BANDS. CHANNELS 5 & 13 IN MEMPHIS, 125 MI. AWAY. CHANNELS 6 & 13 IN BIRMING- HAM, 100 MI. AWAY. CHANNELS 3 & 12 IN JACKSON, MISS., 150 MI. AWAY. CHANNEL 12 IN MONTGOMERY, 180 MI. AWAY. I HAVE HAD COMPLETE CUS- TOMER SATISFACTION WITH THIS ANTENNA

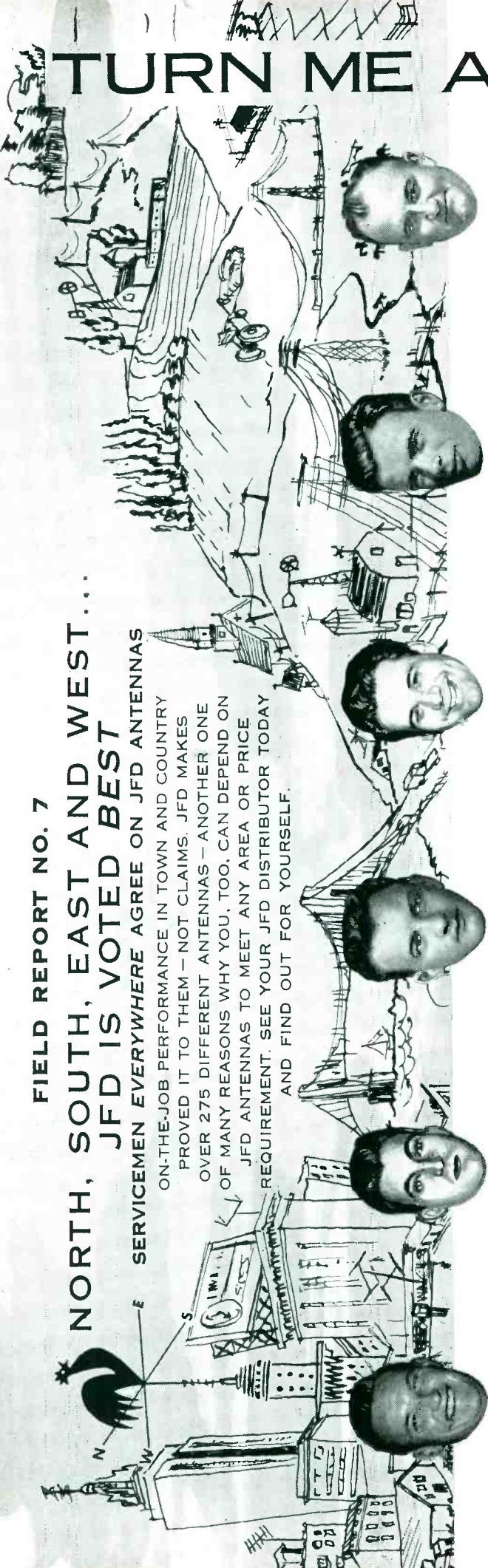

TURN ME AROUND

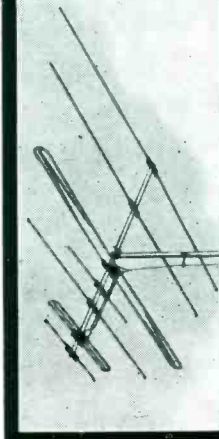

JFD FIREBALL

FB500 single \$17.35
 FB500S stacked \$36.65
 FB500S-68† 68" wide stacked \$36.65
 FB500S-96* 96" wide stacked \$38.60

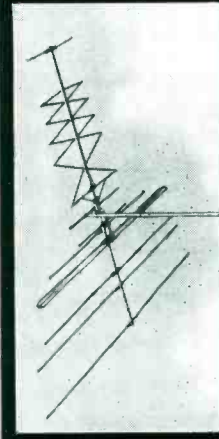

JFD SUPER-STAR HELIX

SX13 single \$35.00
 SX13S stacked \$72.50

*for added ch. 2-6 gain
 †for areas with co-channel and cross-channel interference

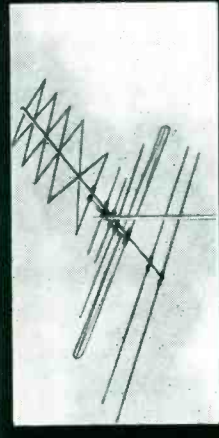

JFD STAR-HELIX

SX711 single \$25.50
 SX711S stacked \$52.50
 SX711S-96* 96" stacked \$55.00



MANUFACTURING CO. INC.
 BROOKLYN 4, N. Y.
 INTERNATIONAL DIVISION
 15 MOORE ST., N. Y., U. S. A.

GO FORWARD WITH JFD ENGINEERING!

Terrific Performance



...EVERYTIME WITH "STAMINIZED" ASTRON CAPACITORS

Right, everyone's applauding Astron's daring new design concept — "Staminized" capacitors — created specifically to more efficiently fill all servicing requirements.

"Staminized" capacitors are the highest perfection in the art of capacitor manufacturing . . . a unique balance of quality raw materials, selected with infinite care • positively controlled production techniques • surgically-clean assembly plus a score of stringent production tests backed by the famous Astron Guarantee . . . every "Staminized" unit is handcrafted with the precision you would expect to find in a fine watch . . . compact sizes and clear markings for super-easy installation.

The extra-ruggedness of "Staminized" Astron capacitors opens new profit areas for you! Everybody, but everybody, wants to get in on the act . . . you can too, see your jobber for "Staminized" Astron capacitors today!

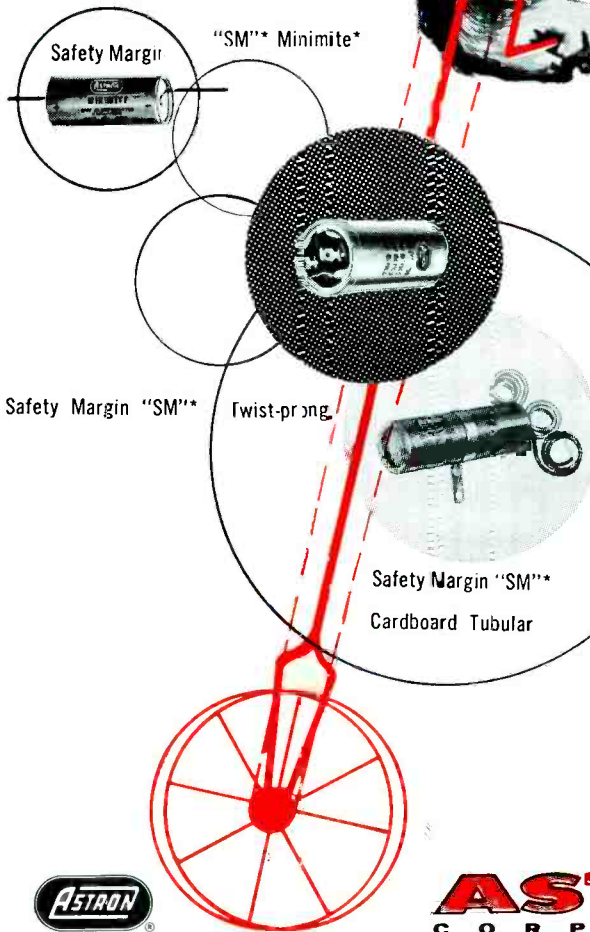

Blue•Point® Molded Plastic Paper Tubular

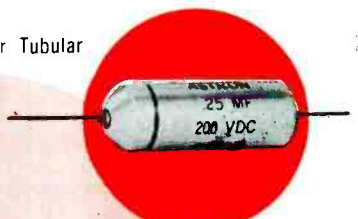

LAST CHANCE to get your Swing Bin Jr.



Famous Astron servicing aid plus 90 fabulous Blue•Point® molded plastic paper capacitors — a complete stock — **only \$16.95** You must act at once!

FREE SERVICING AID

Save time, use handy Astron, pocket-sized Replacement Catalog and Pricing Guide (AC-4D) — Write for your copy now!



*TRADEMARK

ASTRON
CORPORATION

255 GRANT AVENUE, E. NEWARK, N. J.

EXPORT: ROCKE INTERNATIONAL CORP., 13 E. 40TH ST. N.Y.C. IN CANADA: CHARLES W. POINTON, 6 ALCINA AVE. TORONTO 10



POWERAY

new
antenna
development

AMPHENOL

114-096
Four Bay
List 69.75

new FRINGE AREA antenna features revolutionary SLEEVE DIPOLE principle

The reason for the outstanding performance of the new AMPHENOL VHF POWERAY is a new design variation of the sleeve dipole principle. The POWERAY provides better pictures in fringe and deep-fringe areas because *only this new design* properly balances the three important reception factors: high gain, directivity and *exact impedance match* between antenna, lead-in and TV set.

new PRINCIPLE: how it works

The sleeve dipole principle of the POWERAY is based upon resonance of the overall length at a low frequency and resonance of a 3-wire transmission line section at a higher frequency. The result is ideal broadband performance and *proper balance* of very high gain, sharp directivity and exact impedance match.

PREASSEMBLED

The POWERAY is preassembled for less installer-time on the job. All long elements swing out and are held securely in place with a new, positive spring-locking device. The two and four bay models in which the POWERAY is available are quickly connected with one piece stacking harnesses.

performance proves SUPERIORITY

The POWERAY'S superior design is proved by its superior performance. *Try* the POWERAY for fringe area reception—and *see* for yourself why the POWERAY is the finest antenna ever built for fringe areas!

AMPHENOL

AMERICAN PHENOLIC CORPORATION
chicago 50, illinois

In Canada: AMPHENOL CANADA LIMITED, Toronto 9, Ontario

See Your AMPHENOL Distributor

114-095
Two Bay
List 34.75

GUIDE

AUTRONIC-EYE[®]

TRAINING COURSES

MEAN MORE

BUSINESS FOR YOU!



Courses for experienced service technicians provide latest repair information—enable you to do the job faster and more efficiently.

Quick, accurate circuit diagnosis and repair to factory specifications boosts your profits. That's why so many qualified auto technicians attend these Guide training courses at no cost other than transportation and living expenses.

The Guide Lamp diploma, awarded only to those who successfully complete the course, is proof that you're equipped to give more and better service to more people—and that means business.

If you're an auto radio service dealer, come yourself, or send your technicians. There's one of 30 GM Training Centers near you. Apply through your local United Motors Service Division Distributor or write

GUIDE LAMP DIVISION • GENERAL MOTORS CORP. • ANDERSON, INDIANA

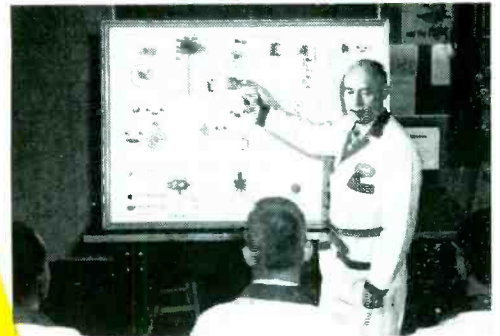

Jumbo-size operational panel of Guide's Autronic-Eye Circuit puts all parts out front for better, more efficient instruction.

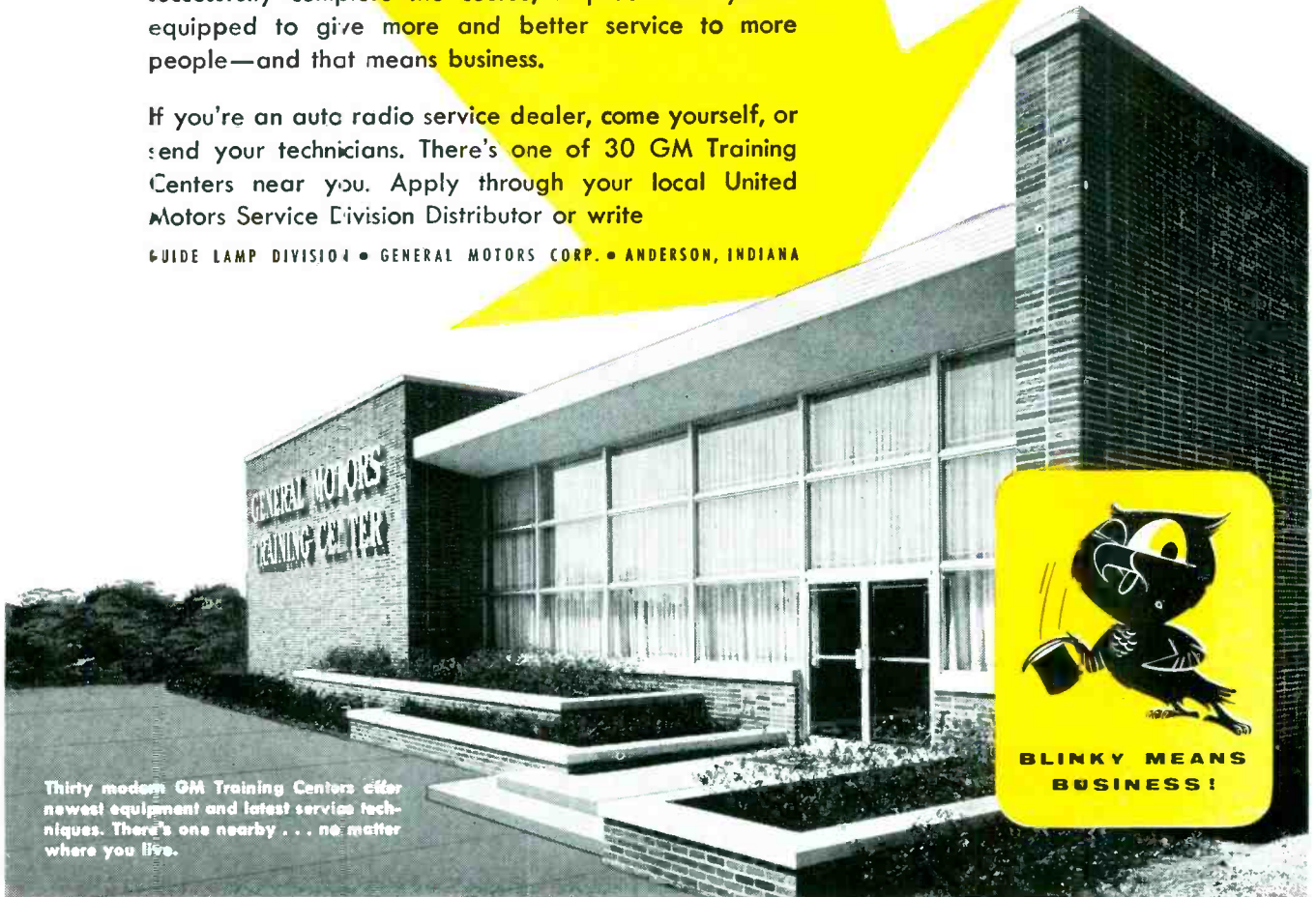

Thirty modern GM Training Centers offer newest equipment and latest service techniques. There's one nearby . . . no matter where you live.



BLINKY MEANS BUSINESS!

. . . You'll find the Type and Size Fuse you need

• • • IN THE COMPLETE LINE OF BUSS AND FUSETRON FUSES

The following is only a partial listing. The complete BUSS line of fuses includes dual-element (slow blowing), renewable and one time types — in sizes from 1/500 ampere up . . . plus a companion line of fuse clips, blocks and holders.

BUSS AGX FAST ACTING FUSES

1/4 x 1 in. Glass tube 1/500 to 2 amp.



BUSS IBM SIGNAL ACTIVATING FUSES

1/4 x 1 1/4 inch. Silverplated pin pops out when fuse is blown and activates signal or alarm.



FUSETRON MDL FUSES

1/4 x 1 1/4 inch. Dual-element — slow blowing type 1/100 to 30 amp.



BUSS ABC CERAMIC TUBE FUSES

1/4 x 1 1/4 inch. High interrupting capacity fuses 1/4 to 30 amp



BUSS GJV PIG TAIL FUSES

1/8 to 6 amp. Solder into circuit wires.

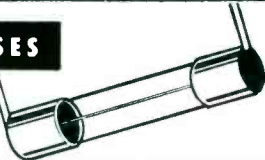

BUSS SFE STANDARD FUSES

Fuses of different amperages are different lengths — to make it impossible to insert too large a size.

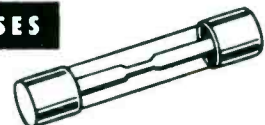

FUSETRON FNM FIBRE TUBE FUSES

1 3/32 x 1 1/2 inch. Dual-element — slow blowing type.



FUSETRON TYPE N and TYPE C FUSES and FUSEHOLDERS

Especially suitable for protection of TV

Ears on fuses match slots in holder.

Marking on fuse and fuseholder in direct view.

Safeguard against use of wrong size and type of fuse.

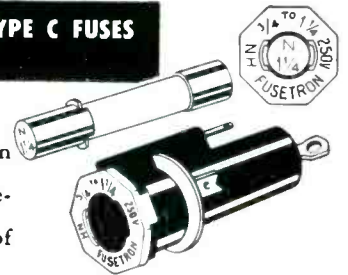

BUSS KLM HIGH INTERRUPTING CAPACITY FUSES

1 3/32 x 1 1/2 inch. Capable of safely interrupting 68,000 amps.



FUSETRON ACK CLAMP TYPE FUSES

20 to 300 amp., Dual-element type.



BUSS ACO AIRCRAFT FUSES

Mechanical Indicating — Limiter type 1 to 75 amp.



BUSS Series HJ and HK Non- Indicating FUSEHOLDERS

Panel mounted for 1/4 x 1 inch and 1/4 x 1 1/4 in. fuses.



BUSS Series HJ and HK Lamp Indicating FUSEHOLDERS

Panel mounted for 1/4 x 1 inch and 1/4 x 1 1/4 inch fuses.



BUSS No. 4051 ONE-PIECE CLIP and TERMINAL

Solder type terminal for 1/4 inch fuses.



BUSS No. 4409 FUSE BLOCKS

Small Base, solder type Side Terminals.



BUSS No. 4512 FUSE BLOCKS

Full Base, Screw type Terminals.

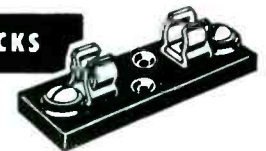

And in sales and service — it's just good business to handle only genuine BUSS fuses. The BUSS trademark has been firmly established by millions and millions of installations in home, farm and industry. That's why you should specify and insist on getting only BUSS fuses.

BUSSMANN MFG. CO.

Div. McGraw Elec. Co.

University at Jefferson

St. Louis 7, Mo.



Makers of a complete line of fuses for home, farm, commercial, electronic and industrial use.

S-1155

Another ANTENN-GINEERED *Original*

by **Snyder**
PHILADELPHIA

TORQUE-T-VENNA

WITH EXCLUSIVE INTERCEPTOR DISCS



WEIGHS ONLY 27 OUNCES

- NEWEST ELECTRONIC DISCOVERY
- OUTMODES OLD FASHIONED ANTENNAS
- EQUAL/BETTER THAN ANY CONICAL
- QUICKER/EASIER 1-MAN INSTALLATION
- STACKS FOR FRINGE AREAS

SAVES SPACE
FACTORY PREASSEMBLED
GOES UP FAST

and Costs Less!

Unfold - Tighten - Erect

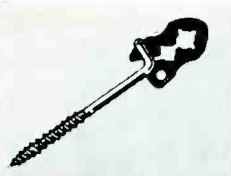

TELCOE-Z "SWING IN" STAND-OFF
Wood screw type, 3 1/2", UHF-VHF
No. EZ-8027 \$4.80 / C

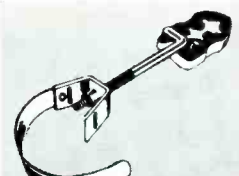

TELCO E-Z "KANT-STRIP" STAND-OFF
"Swing In" type, 3 1/2", 9" strap
No. EZ-8253 \$0.13

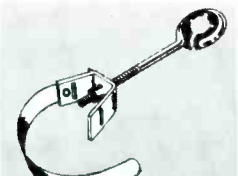

TELCO "KANT-STRIP" STAND-OFF
Round insulator, 3 1/2" 9" strap
No. 8253 NET \$0.11

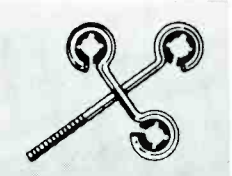

TELCO 3-WAY STAND-OFF
For 3-line use, 7 1/2" wood screw
No. 8397 NET \$0.21

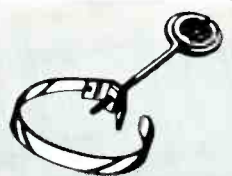

TELCO NUT-TYPE STAND-OFF
Welded 10-23 nut, 3 1/2", 9" strap
No. 8253-N \$0.12

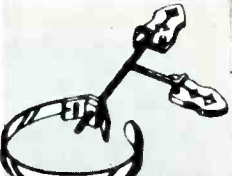

TELCO E-Z NUT-TYPE STAND-OFF
Tougher, inline duplex, 7 1/2", 9" strap
No. EZ-8258-N \$0.24



TELCO CHIMNEY QUICK MOUNT
Easy to install, complete
No. 8005 NET \$1.35

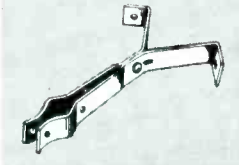

TELCO SNAP-IN CHIMNEY MOUNT
Fits masts to 1 3/4" complete
No. 8610 NET \$1.71



TELCO PEAK MOUNT
Masts to 1 3/4" 30" lower support
No. 8625 NET \$2.37

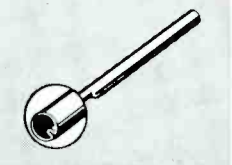

TELCO GALVANIZED ANTENNA MASTS
1 1/4" OD x 5' crimped end
No. 9013 NET \$0.78

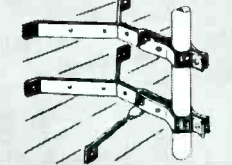

TELCO DELUXE SNAP-IN WALL MOUNT
Extra sturdy, 12" clearance
No. 8312 NET \$2.10



TELCO UNIVERSAL LIGHTNING ARRESTOR
Easy to install, UL approved
No. 8642 NET \$0.75



TELCO UHF-VHF GLOBE-TENNA
Handsome 12" globe plus built-in antenna
No. A-9265 \$12.95

Ask For These

SERVICE AIDS

...at Your Jobber

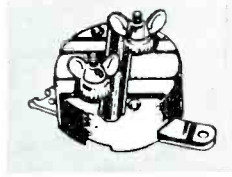

TELCO UHF-VHF LIGHTNING ARRESTOR
Universal type, UL approved
No. 9242 NET \$0.42

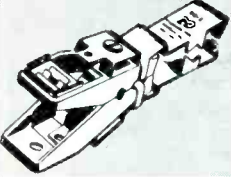

TELCO 3-WAY TV LINE KLIP
For straight side or plug-in
No. 9015 NET \$0.12

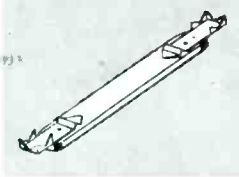

TELCO LOW-LOSS LINE KLIP
All one piece, plastic, metal ends
No. 9055 NET \$0.15

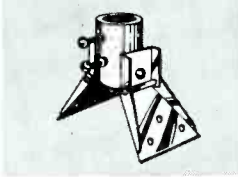

TELCO HINGED TYPE RIDGE MOUNT
Fits masts to 1 1/4" assembled
No. 9021 NET \$1.17

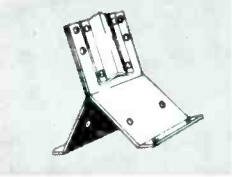

TELCO ALL-PURPOSE MAST BRACKET
Fits masts to 1 3/4" use every where
No. 8575 NET \$1.65

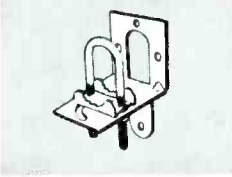

TELCO MAST HANDY MOUNT
For masts to 1 1/2", extra support
No. 8800-U \$0.33

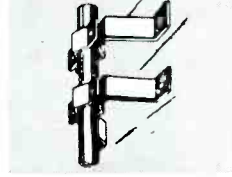

TELCO SPECIAL WALL MOUNT
For close-in (4") mounting
No. 9241 NET \$0.45

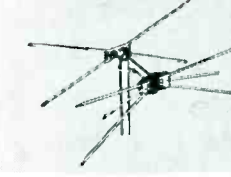

TELCO MASTER-LINE VHF CONICAL ANTENNA
Single bay, 10 element, all-channel
No. A-8700 \$4.20

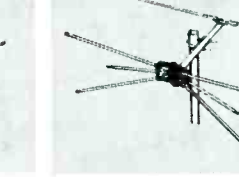

TELCO RANGER COLOR CONICAL ANTENNA
Single bay, 8 element, VHF-UHF
No. A-110 NET \$3.45

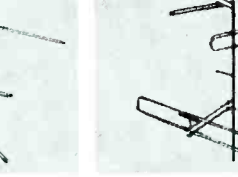

TELCO HI-LOW DIPOLE ANTENNA
VHF, covers channels 2 to 13
No. A-250 NET \$4.41

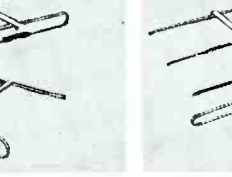

TELCO 5 ELEMENT VHF YAGI ANTENNA
12 models, custom cut to each
No. A-302 Ch 2 \$7.35
No. A-313 Ch 13 4.35

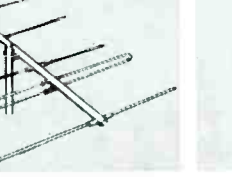

TELCO UHF-VHF DOUBLE V ANTENNA
Covers channels 2 through 83
No. A-9017 \$3.15

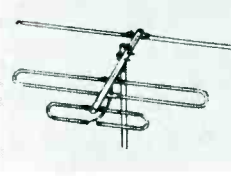

TELCO VHF INLINE ANTENNA
Channels 2-13, 1/2" seamless elements
No. A-9046 NET \$5.97

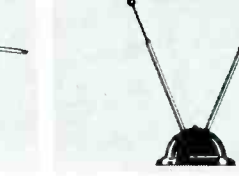

TELCO INDOOR UHF-VHF ANTENNA
DeLuxe brass, nickel-plated elements
No. A-8160-TP \$2.97

FREE!

Your copy of the complete, illustrated TELCO Catalog. Send postcard today.

TELEVISION HARDWARE MFG. CO.

Division of General Cement Mfg Co 901 TAYLOR AVENUE • ROCKFORD, ILLINOIS

start right . . . in **COLOR** with RCA field-proved instruments!



**WR-61A
COLOR-BAR
GENERATOR**



**WR-36A
DOT-BAR
GENERATOR**

The WO-91A 5" Oscilloscope incorporates features usually found only in more expensive instruments. It has all the 'scope functions you need to do both black-and-white and color TV service work . . . speedily and with top-grade results! Some of the outstanding features are front-panel switching of "V"-amplifier band width, response flat to 4.5 Mc in wide band position, voltage-calibrated frequency-compensated "V" amplifier step-attenuator, simplified, simultaneous waveshape display and voltage measurement on VTVM-type graph scales—you read volts directly from screen, sturdy single-unit low-capacitance/direct probe with built-in switch eliminates need for separate probe—and many more work-simplifying features! User Price **\$229.50***

*optional

If you want to get off to the right start in color-television servicing, add the RCA WR-61A Color-Bar Generator, RCA WR-36A Dot-Bar Generator and RCA WO-91A 5" Oscilloscope to your present black-and-white equipment. These three units, used with proper test facilities for servicing black-and-white receivers, give you complete test equipment for troubleshooting and servicing color-TV receivers. Lightweight, compact and portable, these instruments are designed for accuracy, stability, and simplified operation.

The WR-61A Color-Bar Generator generates signals for producing 10 different color bars simultaneously—including bars corresponding to the R-Y, B-Y, G-Y, I, and Q signals for checking and adjusting phasing and matrixing in all makes of color sets. Crystal-controlled oscillators insure accuracy and stability. Luminance signals at bar edges facilitate checking color "fit" or registration. Adjustable sub-carrier amplitude permits checking color-sync action. The WR-61A is now accepted as the standard for color-phasing accuracy in many TV stations and network operations. User Price **\$247.50***

The WR-36A Dot-Bar Generator provides a pattern of small-size dots for adjusting convergence in large-screen color receivers and H- and V-bars and fine-line crosshatch patterns for precise adjustment of linearity in both color and black-and-white TV sets. RF output on channels 2-6. High-impedance video output (plus and minus polarities). Choice of internal 60-cps vertical sync or external sync. The crosshatch pattern and the number of vertical and horizontal dots and bars are adjustable. User Price **\$147.50***

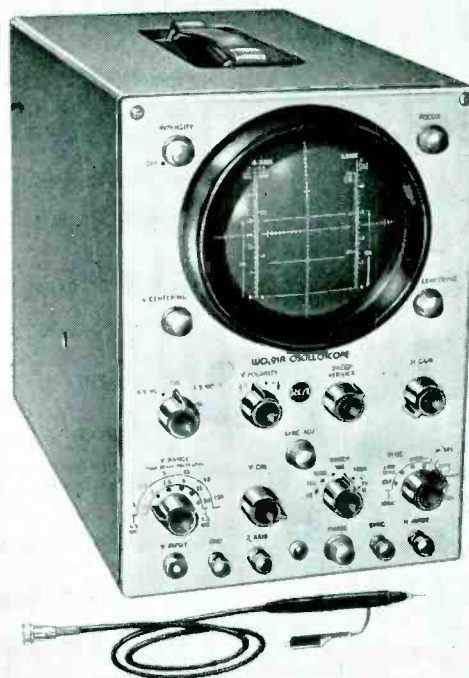

See your RCA distributor for details on these outstanding RCA test instruments for Color TV!

RADIO CORPORATION of AMERICA

TEST EQUIPMENT

HARRISON, N. J.

CROWN ...your best buy in antenna rotation



FOR STYLE • FOR ACCEPTANCE • FOR PROFITS



● **EASY TO READ DIAL**

Compass indicating dial, illuminated for easy reading even in darkened room . . . needle never fluctuates . . . instant and accurate directional indication without activating the motor.



● **RUGGED MOTOR DRIVE**

Lifetime lubricated capacitor motor operates on 115 volts. Built-in roller thrust bearing with 175 lbs. weight capacity. Smooth, constant, dependable operation under all conditions . . . 365° rotation . . . automatic brake prevents coasting or wind-milling. Protected by Crown's exclusive "Weather-Guard" design. UL and Canadian Standards Association listed.

Crown CAR6B Tenn-A-Liner Rotator, shown here with the exclusive Crown Tenn-A-Liner Planter, is your best buy for the highest profits in the TV antenna rotator field. It's also your customers' best buy because Crown's ruggedness, dependability and ease of operation assure long, trouble-free service. In fact, of all the Crown Tenn-A-Liners sold, only 1.06% required service. Crown Tenn-A-Liners are guaranteed and carry Crown's exclusive replacement policy (not a repair policy) that protects your customer and you.

The CAR6B Tenn-A-Liner is decorator designed in handsome three tone modern styling for greater sales appeal . . . and may be sold with or without the Tenn-A-Liner Planter.

Act now! Don't miss your chance to build bigger profits with Crown! Get the full story on Crown Tenn-A-Liners, the highest profit line in the TV antenna rotator field.

SELL WITH CONFIDENCE . . . SELL CROWN!

 **CROWN® CONTROLS Co., Inc.**

**NEW BREMEN,
OHIO**

Canadian Subsidiary Crown Controls Mfg. Ltd. Export Division, 15 Moore St., New York, N. Y., Cable—"Minthorne"

Federal

...America's pioneer
selenium rectifier

FIRST IN PREFERENCE!

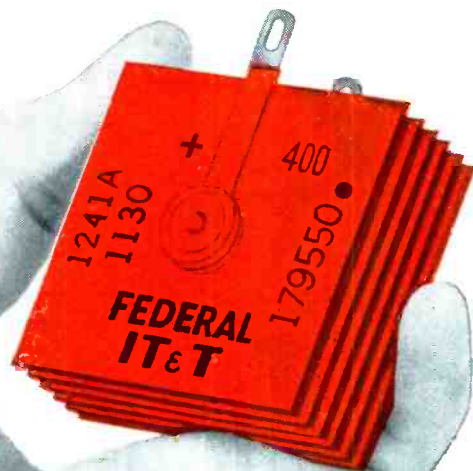

with **MORE**
Manufacturers

with **MORE**
Distributors

with **MORE**
Servicemen

More radio and TV manufacturers—through their design and component engineers—have placed their OK on Federal Selenium Rectifiers than any other make! Consequently, *more* distributors stock Federal to take care of *more* calls from servicemen for "replacement by Federal."

Literally tens of millions of Federal types have been factory-installed. Federal is OK with manufacturers because Federal means *dependable* receiver performance...

OK with distributors because Federal is in such high favor and big demand... OK with servicemen because Federal is profitable and customer-satisfying. Whatever *your* rectifier requirements you can meet them with Federal's *Universal* and *Regular* Lines... one source of supply for the radio-TV industry! Write today to Dept. F-156

**Here are the clinching reasons behind
Federal's coast-to-coast leadership:**

- Longer life
- Higher output voltage
- Lower temperature rise
- Superior humidity resistance
- More uniform quality
- Proven mechanical construction
- 85° C. UL acceptance
- Conservative ratings
- Largest plant capacity
- More engineering know-how

Federal Telephone and Radio Company

A Division of INTERNATIONAL TELEPHONE AND TELEGRAPH CORPORATION
COMPONENTS DIVISION • 100 KINGSLAND ROAD • CLIFTON, N. J.

In Canada: Standard Telephones and Cables Mfg. Co. (Canada) Ltd., Montreal, P. Q.
Export Distributors: International Standard Electric Corp., 67 Broad St., New York

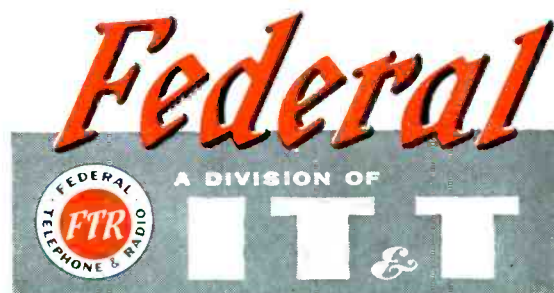

NEW G-E PICTURE-TUBE TV SERVICE DEALERS

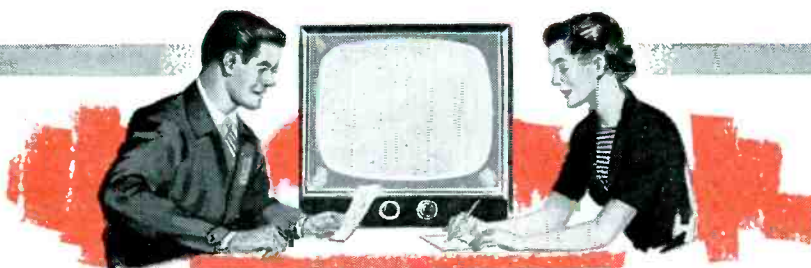

1.

How to get television service business where your customers cannot pay at once, in full.

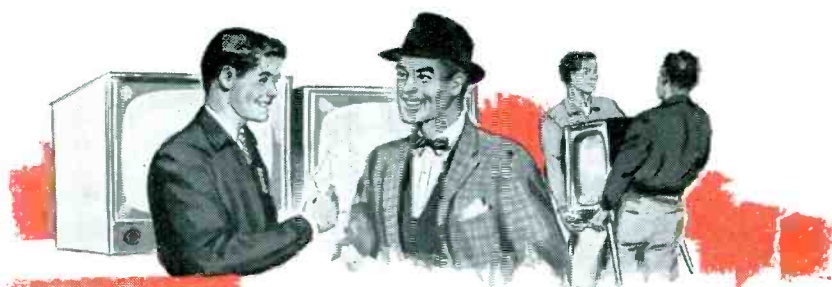

2.

How to move repaired TV sets now in your store, left there by owners unable to pay immediately.

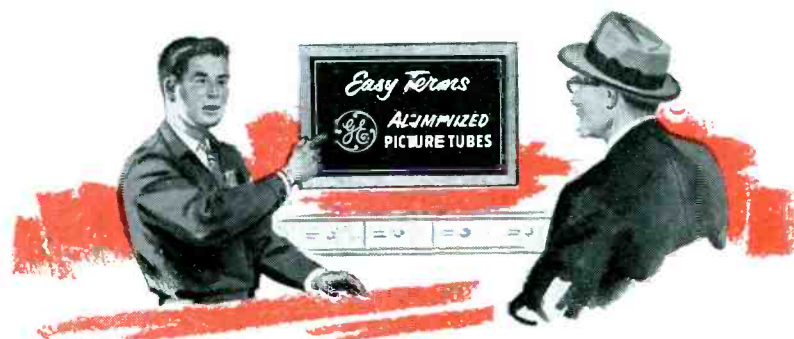

3.

How to keep down your book receivables, in order to free working capital for business growth.

YOUR G-E TUBE DISTRIBUTOR HAS FULL INFORMATION. ACT TODAY !

FINANCE PLAN HELPS SOLVE 3 MAJOR PROBLEMS

Widespread TV ownership has meant a steady uptrend in servicing volume. At the same time, demands on you have increased—demands on your time, facilities, and capital.

General Electric's consumer finance plan for complete picture tube installations, opens up to you, as a service dealer, credit resources which help you tap new and valuable markets. Markets where customers can't pay large television service bills immediately and in full—but can, and will, pay their bills out of income.

Up to now, your local credit facilities may have been inadequate to handle instalment

buying. So . . . G.E. makes available financing aid in order to help you get all the TV service business you can profitably undertake.

Local regulations and instalment-buying requirements will determine the operation of this plan in your area. Credit when judiciously employed helps you in this way: it permits you to offer your customers with good credit standing the opportunity to buy over a period of months, when cash isn't readily available.

Ask your G-E tube distributor to tell you how you may qualify for the plan! *Tube Department, General Electric Co., Schenectady 5, N. Y.*

CHECK THESE PLUS BENEFITS FROM G.E.'s FINANCE PLAN:



Your TV service customers now can afford to replace worn-out picture tubes immediately. They no longer feel obliged to wait.



You can do a Grade-A servicing job, complete with new receiving tubes and any needed parts . . . because your customers need only make part payment at once, the rest in easy instalments.



TV owners now can afford to buy the best from you. That means G-E Aluminized Tubes—G-E Service-Designed Tubes—other high-quality components.



You can successfully compete for the local consumer's retail dollar. You are offering the same up-to-the-minute credit-purchase terms as other progressive merchants in your neighborhood.

GENERAL



ELECTRIC

161-1A5

Crashes the Headlines at

NATIONAL HARDWARE SHOW

WEN Again

NEW ALL-DUTY ELECTRONIC SOLDERING GUN DRAWS ALL EYES

THIS MODEL #288 Only \$9.95 LIST

The crowd sure went for it. They know soldering tools and recognized it as combining proven WEN design features with latest engineering advances — to make it a highly efficient tool at a sensationally low price. On 110-120 V AC 60 cycle it delivers in 5 seconds intense heat for HEAVY DUTY WORK. Yet special tip design adapts it to LIGHT DUTY also. It's the ideal Gun for ALL soldering requirements 50 to 200 Watts. Light (only 2¼ lbs.) beautifully balanced, handle and case lustrous shatter-proof black plastic. Automatically spotlights the work without shadow. Tips (removable) are longer reach, more rigid, silverplated, longer lived. Fully guaranteed. And that PRICE! Only \$9.95 — compared to similar capacity guns \$12.95 up.

Also that new

WEN

POWER SAW

This small handy electric power saw operates 2650 strokes per minute on 110-120 V AC. Does the work of 7 saws (fig, rip, crosscut, band, hack, coping, scroll and keyhole) oftimes better and faster than devices costing to \$58.00. Guaranteed.

just **\$29.95** LIST

Build with the **WEN** *Line*



Quick-Hot SOLDERING GUNS		ELECTRIC SANDERS—POLISHERS		
#250	#199	#202	#303	#404 HEAVY DUTY
\$12.95	\$7.95	\$13.95	KIT \$16.95	KIT \$19.95

WEN PRODUCTS, INC.

5808 NORTHWEST HIGHWAY
CHICAGO 31, ILL.

Export sales, Scheel International, Inc., Chicago

ALL LOW PRICED—ALL HIGH QUALITY—ALL U. I. APPROVED—ALL FULLY GUARANTEED

**AGAIN
IN '55**

ALLIANCE GIVES YOU...

**biggest, longest
TV SPOT
CAMPAIGN**

**30,000,000
TV VIEWERS**
week after week



New

MODEL U-98—fully automatic—incorporates 32 distinct improvements—eliminates all arcing and consequent picture distortion—points directly, positively, instantly to target station—"just set it and forget it" . . . List Price, **\$39.95**



New

MODEL T-12—fingertip electrical operation. Rocker switch on top controls turning. Has direction indicator dial. Compact and smartly styled. Highly accurate! . . . List Price, **\$29.95**

When you sell Alliance Tenna-Rotor, you sell the pace-setter—the favorite for seven solid years!

30,000,000 folks see Alliance TV spots week after week . . . newspapers and magazines run hard-hitting Alliance ads all over the country . . . that's promotion—**sends sales your way!**

Alliance is sold the most, because it's seen the most. You profit most, coast-to-coast, with Alliance.

Don't be misled! Sell the acknowledged best-seller, best-money-maker . . . Alliance Tenna-Rotor!

IMPORTANT! COLOR is coming! Alliance Tenna-Rotor is the No. 1 TV accessory needed for sensitive color reception.

Nearly 2,000,000 Alliance Tenna-Rotors are in use.

THE ALLIANCE MANUFACTURING CO., INC.
Alliance, Ohio



SPEAKERS



VIBRATORS

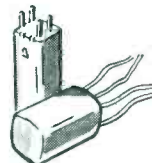

COILS



RECEIVING
TUBES



CONDENSERS



AUTO RADIO AERIALS



CONTROLS



CAPACITORS

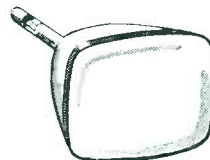

PICTURE TUBES

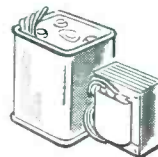

TRANSFORMERS

★ *Here's a man who can put*
New Life
in your electronics business

He's your Delco Electronic Parts Distributor. It's fair to ask, "What's he got that others haven't?"—or, "What makes Delco so outstanding?"

First, he's got two of the finest names in any business behind him—Delco and General Motors. They're both names that are respected for quality products, dependable service, and business integrity. When you handle his line of parts, you automatically add the prestige of these names to your business.

Second, Delco is outstanding in the electronic parts business because it is the sole

source for special application parts used for original equipment replacement on Delco auto radios. This is a readymade market of well over 13 million sets! Delco is also an important source of the most used universal replacement parts. So you can see how important the Delco line is to your business.

If you spend a few minutes with your Delco Electronic Parts Distributor, he'll explain how Delco's current bulletins and field schools also help to put new life in your electronics business. See him soon—you'll be glad you did.



A GENERAL MOTORS PRODUCT • A UNITED MOTORS LINE

She: *But, how do I know this is a good tube?*

You: *Because, this is a CBS aluminized Mirror-Back picture tube. There aren't any better.*

She: *And I see it has the Good Housekeeping Guaranty Seal, too. That's proof enough for me.*

Customer confidence really counts when it comes to the big tube. That's when CBS tube advertising helps you most. For CBS tubes have the Good Housekeeping Guaranty Seal and are nationally advertised to 76.9% of your customers . . . the women of America. And 53% of these women are influenced in their purchases by that seal of approval. You protect yourself and gain your customer's good will when you install a new CBS aluminized Mirror-Back picture tube.

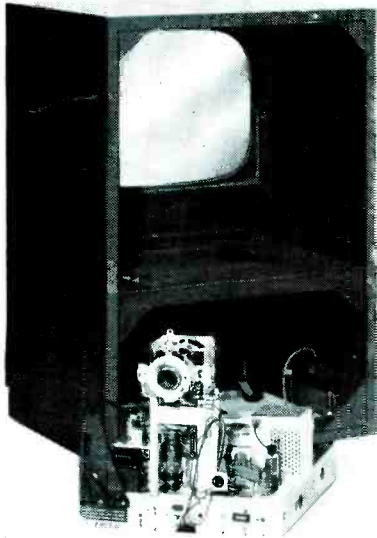

Show her the CBS carton with the Good Housekeeping Guaranty Seal.



CBS-HYTRON, Danvers, Massachusetts . . . A DIVISION OF COLUMBIA BROADCASTING SYSTEM, INC.



make the **ZEE-BEAM** test!

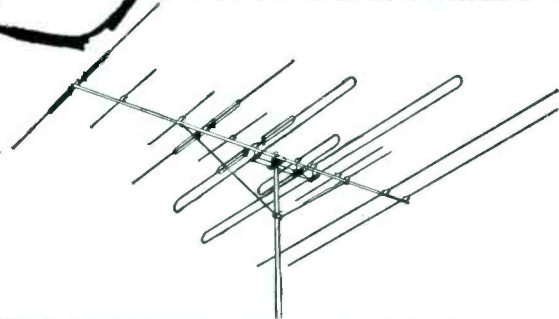

SUPER ZEE-BEAM ALL-CHANNEL VHF YAGI

Model 440

For extreme fringe areas. Features two pairs of dual reflectors and exclusive ZEE-X Electronic Elements.
List \$32.95

See Why **WELCO** Says:

Best Performance of Any Comparable Antenna...or Your Money Back!

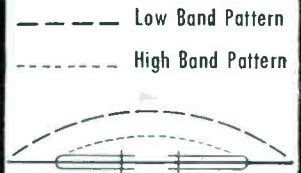

ZEE-X Electronic Element

... a basic Welco development that makes possible many new outstanding antenna designs. The first element to function with true half-wave dipole characteristics and full efficiency on both VHF bands. Patent pending.

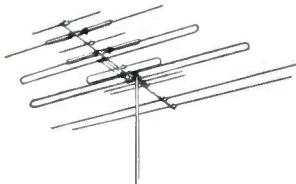

ZEE-BEAM ALL-CHANNEL VHF YAGI Model 220

For far fringe areas. Also features ZEE-X Element, exclusive with Welco.

List \$24.95

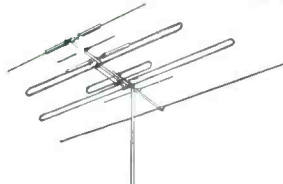

ZEE-BEAM ALL-CHANNEL VHF YAGI Model 110

For fringe areas. Includes ZEE-X Element; a remarkable antenna for the price.

List \$18.75

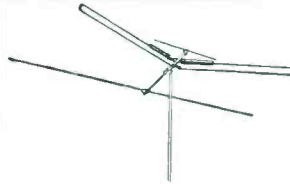

CONICAL ZEE-BEAM ALL-CHANNEL VHF Model 50

For primary signal areas. ZEE-X Element. Single bay style. (2-bay style available also).

List \$8.95

Send This Coupon in Today!

Prove to your own satisfaction ... see why we say the ZEE-BEAM Antenna gives you the best performance of any in its price range now on the market! Order your ZEE-BEAM Antenna now; shipped freight prepaid.

BE THE LEADING ANTENNA INSTALLER IN YOUR AREA!

WELCO MFG. CO.

Burlington, Iowa

WELCO MFG. CO., 225 South 3rd Street, Burlington, Iowa

Please rush freight prepaid my ZEE-BEAM Antenna order for test. I understand this is a 30-day money-back guarantee offer.

<input type="checkbox"/> Model 440	Dealer Net \$19.77	<input type="checkbox"/> Model 50	Dealer Net \$5.37
<input type="checkbox"/> Model 220	14.97	<input type="checkbox"/> Model S-2 Stacking Kit	.96
<input type="checkbox"/> Model 110	11.25	<input type="checkbox"/> Technical Material	NC
<input type="checkbox"/> CHECK ENCLOSED FOR \$ _____		<input type="checkbox"/> MONEY ORDER ENCLOSED FOR \$ _____	

Name of Jobber _____

His Address _____

NOTE: You must enclose your jobber's name and address in order to take advantage of this special offer, so he will receive credit for your order.

Name of Authorized Dealer _____

Address _____

City _____

Zone _____

State _____

HOTTEST DEAL IN YEARS!

SAYS SHELL SUPER SERVICE
STATION OWNER
RUSS SCHROTH



Above, Russ Schroth, owner of Russell's Super Service Station discusses his Dura-ramic business with Harry Bare, sales manager for Blumel Ignition Co. *At left*, Russ demonstrates Dura-ramic flexibility to a prospect.



reinforced Fiberglas car aerials

IN SIX COLORS

New! Exclusive!

WARD

Dura-ramic

TRADE MARK

Are you a dealer who is on the lookout for high profit items that move? Russ Schroth, owner of a Shell Super Service Station in Cleveland, is. He found just such an item in the new Ward Dura-ramic reinforced Fiberglas car aerial. Russ says, "Dura-ramics are an easy item to sell because two out of three cars that pull up to our pumps have dirty, corroded or bent aerials. Customers particularly like the Dura-ramic because it comes in six complementary colors, won't fade or corrode, is flexible and gives better radio reception." Furthermore, Dura-ramics take only minutes to install.

Don't miss this opportunity to cash in on big added profits. Ride the wave of color popularity in cars today. Sell the highly salable and profitable Dura-ramic car aerial in color. See your jobber for Dura-ramics. If he does not yet stock them, write us.

WARD

PRODUCTS CORPORATION

DIVISION OF GABRIEL CO.

1148 EUCLID AVENUE
CLEVELAND, OHIO

SERVICE

The Technical Journal of the Television-Radio Trade

The Pattern For '56

ONE OF THE MOST EXTENSIVE plant expansion programs ever planned, involving investments of nearly ten-million dollars, has been set for '56. And the lion's share of the budget is going to the three youngest members of the radio-TV family: Color-TV, transistorized chassis and plated-board circuits. Substantial sums have also been earmarked for enlarged b-w portable and wide-band TV production facilities.

Huge quarters that will house miles of specially-designed automatic machinery are already under construction.

To prepare for the surging installation-service activity that will certainly appear as the increased production lines begin to swing along, scores of manufacturers have been conducting national service clinics not only at the factory level, but in the field, too. These important technical meetings have underscored one fact: Test equipment will play a particularly vital role in the days ahead.

IN COLOR-TV, it has been stressed that it is not only necessary to have a complete lineup of black and white gear, but a complement of special color instruments that include dot and bar, and color-bar generators of the type described in this issue. In addition, it has been found that the 'scope is extremely useful too, taking the form of a wide-band affair, or the standard setup, supplemented by a wide-band amplifier that can hold the 3.58-mc color burst signal and extend frequency range. One such device has been designed to be used in place of the 'scope's narrow-band vertical amplifier; this unit features a 6BC4 as a cathode follower driving a 12BY7A amplifier, whose output is fed to a 6W6.

Other test gear, emphasized as valuable too for color, are video-frequency sweep generators, crystal calibrators and high-voltage testers, the latter serving to keep tabs on picture anode voltage, where drops can cause dimmed pictures, blooming or defocusing.

TRANSISTORIZED RADIOS and phonos have also been found to require a number of unusual instrument checks. To illustrate, to detect defects in transistors in chassis using both tubes and coupled-out-

put transistors, it is necessary to resort to quite a series of tests, using a 'scope and audio generator. The 'scope must be connected across the voice coil of the receiver, the generator set to a thousand cycles and then tied to the center tap of the set's volume control. By applying sufficient driving voltage to introduce a bit of clipping of the output at both top and bottom of the sine wave, one will find that the pair of units will clip within fifteen or twenty per cent of each other, if they are okeh; if one is defective, the output will resemble a half-wave rectified sine wave.

THE PLATED-BOARD CIRCUITS that are finding their way into an increasing number of radios and TV sets, too, have also focused attention on the importance of test setups. Although the *pc* units are not too complex, they do pose a number of odd problems because of their compactness and especially because of the frozen wiring and physical makeup of the leads. The tiny components mounted in close quarters and the delicate nature of the connecting leads require the careful application of instruments and assisting tools. For instance, one must use low-heat type soldering guns, and probes must have long, carefully aligned grippers.

In checking plated-sets and components, one must remember that the fixed wiring, with controlled distance between leads, introduces a number of electrical and physical limitations, and tolerances of parts are extremely important. The use of a component that is larger than the original or might have other variables can cause havoc. If the replacement has excessive inductance, erratic operation is certain to result. Inductive resistors in the *if*-amplifier cathode circuit can cause loss of gain due to degeneration.

To eliminate the risk of choosing incompatible components, instrument makers have come up with ingenious component checkers, that are destined to become increasingly popular as the months go by.

Instruments represent the all-important key to success in servicing the *big three for '56*—color-TV, transistor radios and phonos, and plated receivers.—L.W.

SERVICE... The National Scene

LOW-POWER BOOSTER STATIONS SLATED FOR MOUNTAIN-BOUND TOWNS--Thousands of walled-in communities, now faced with poor or no TV reception, received banner news a few weeks ago in an FCC ruling approving slave-station low-power boosters rebroadcasting on original channels. . . . Explaining the okeh, filed specifically for three communities in the state of Washington, the government examiner who issued the order said that while the new stations might create some interference, the problem was actually a minor one. For, he added, no longer would sets in these towns or elsewhere be . . . "discouragingly blank and quiet." Instead, it was emphasized, service will now be available, for the first time, to these blank-spot communities. . . . In other smaller mountain-bound towns and villages, another new class of TV-booster service may soon appear, in the form of unattended 1-watt ultrahigh translators, operating in a band of perhaps ten uhf channels. Government and industry experts believe that clusters of such small stations ringing the hills will serve to bring solid signals to blacked-out communities.

VHF EXPANSION PROGRAM PROPOSED FOR TWENTY AREAS--An unusual drop-in plan that would allocate twenty-five vhf channels to twenty cities throughout the country and include the use of cross-polarization to minimize any radiation toward existing stations was offered a few weeks ago to the FCC. The polarization shift would, it was said, require adjustments to receiving antennas or perhaps the installation of a pair of antennas to insure best reception. In the adjustment process, antennas would have to be tilted 90° to receive both horizontally and vertically-polarized signals that would be transmitted in the new scheme. . . . Cities cited for the expansion plan include Fresno, Calif.; Tampa and Jacksonville, Fla.; Macon, Ga.; Moline, Ill.; Terre Haute, Ind.; Baton Rouge and New Orleans, La.; Jackson, Miss.; Springfield, Mo.; Albany and Binghamton, N. Y.; Altoona, Pa.; Charleston, S. C.; Knoxville, Tenn.; Austin, Beaumont and Brownsville, Tex.; Norfolk, Va., and Green Bay, Wisc.

UHF RECEIVER DEVELOPMENT ACTIVITY MOUNTING--Research and development work on uhf chassis and tubes is livelier than ever, a leading manufacturer reported to the FCC recently. It was noted that extensive improvement projects are now under way on circuitry, tuners, tubes and antennas, too. . . . Advancements in tubes for use as rf amplifiers are now being pressed vigorously, the Commission was told. . . . Washington also learned that noise factors in ultrahigh sets, which ran as high as 18 to 25 db in some early receiver designs, have been reduced to 12 to 14 db. . . . It was also revealed that oscillator radiation has been reduced from about 3000 microvolts per meter at 100 feet, the standard three years ago, to a level of about 500 microvolts per meter at 100 feet. . . . The Commission was informed that receivers that will be available in '56 will reflect these significant improvements.

NOVEL REFLEX TYPE POWER SUPPLY DEVELOPED FOR TV CHASSIS--A power supply circuit, featuring the use of a 5U4G operated as a half-wave rectifier from an autotransformer, with heaters tied to a center-tapped 12.6 v winding on the same core, is now being built into a line of TV receivers. . . . The power supply is claimed to avoid the problems found in voltage-multiplier rectifier systems; the power transformer is operated as an autotransformer unit with an output of 270 v. According to the designers of the circuit, because line voltage is added to the high-voltage secondary voltage, more than forty per cent of the secondary, normally required, is eliminated. . . . The heaters of the tubes are connected to the 12.6 v center-tapped winding, but one 12 v tube, a 12L6 (audio), is connected across the entire winding. The remaining tubes are connected from ground to an end of the winding, with the load split evenly between the two halves, equalizing heating time throughout the heater chain. . . . A complete analysis of the circuitry involved in this unique power system will be featured soon in SERVICE.

you can't argue with acceptance

proven quality
100% inspected
accurate replacement
prompt delivery

the most
complete
line
of twist mount
dry electrolytic capacitors

Better than any claims we could make is the unqualified and enthusiastic acceptance by engineers and servicemen alike. These are some of the features on which this acceptance is based:

- Aluminum containers provide maximum protection against moisture.
- Low leakage, long shelf life.
- Designed for 85° C. operation.
- Complete with metal and bakelite mounting plates.
- Easy to mount.
- Extremely compact—yet highly dependable.

Pyramid capacitors are listed in Sams' Photofacts

Time saved means money. Ask your Pyramid jobber about the time saving serviceman's wrench for locking or unlocking the mounting ears of Pyramid's twist mounts.

DISTRIBUTOR DIVISION

PYRAMID
ELECTRIC COMPANY
1445 Hudson Blvd., North Bergen, N. J.

BUILD YOUR FUTURE ON A FIRM FOUNDATION with Matched *PRECISION* Test Equipment

for **A.M. - F.M. - TV**

(monochrome and color)

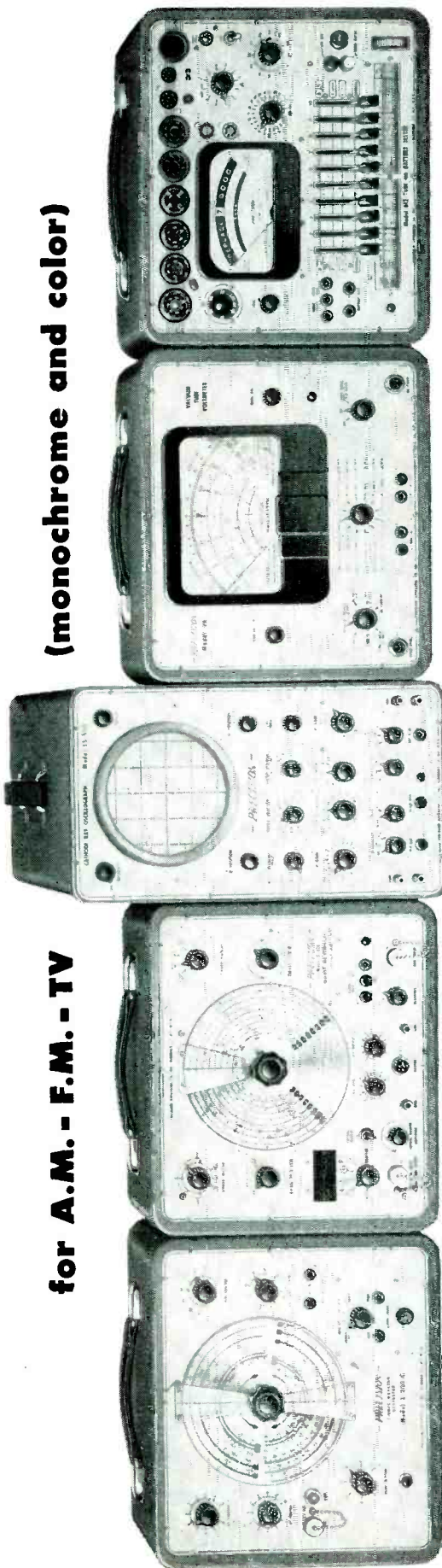

MODEL E-200-C

SIGNAL-MARKER GENERATOR
Direct Reading to 240 MC.
for AM-FM, and TV Alignment
Deluxe Model Net Price \$87.50
Standard Model Net Price \$62.50

MODEL E-400

SWEEP SIGNAL GENERATOR
Narrow and Wide Band Sweep
Direct Frequency Reading to 900MC
Deluxe Model Net Price \$150.00
Standard Model Net Price \$145.00

MODEL ES-550

5" OSCILLOSCOPE
5MC Bandwidth
10MV per Inch Sensitivity
Deluxe Model Net Price \$215.00
Standard Net Price \$210.00

MODEL 98-MCP

VTVM and ELECTRONIC OHMMETER
7" Full View Meter
P-P Voltage Ranges to 3200 Volts
Deluxe Model Net Price \$109.50
Standard Model Net Price \$104.50

MODEL 612-MCP

CATHODE CONDUCTANCE TUBE TESTER
and
Dynamic A-B-C Battery Tester
Deluxe Model Net Price \$66.75
Standard Model Net Price \$61.75

MODEL SP-5 - OSCILLOSCOPE TEST PROBE SET

for TV Signal Tracing,
Alignment, Trouble-
Shooting and Waveform
Analysis.

For use with all *PRECISION*
Oscilloscopes, ES-500, ES-500A,
ES-520 and ES-550. In vinyl
carrying case with four dif-



ferent, detachable probe heads, universal coaxial cable and operating
instructions. Net Price: \$23.50

MODEL TV-8 - HIGH VOLTAGE SAFETY TEST PROBE

PRECISION-engineered to
solve the high voltage test
problem with utmost safety
to operator and equipment.

Incorporates custom-molded high
voltage head and barrier plus
internal and external flash shield.
Extends range of Model 98
(above) to 60 KV D.C. Also
available for use with other *PRECISION* VTVM's and 20,000 ohms
per volt test sets. Net Price \$14.75



PACE

THE METER OF PRECISION

PRECISION Apparatus Company, Inc.

70-31 84th Street, Glendale 27, L. I., N. Y.

Export Division: 458 Broadway, New York 13, U.S.A.

In Canada: Atlas Radio Corp., Ltd., 50 Wingold Ave., Toronto 10

PRECISION Test Equipment is available and on display
at leading electronic parts distributors.

Write Directly to Factory for New 1955 Catalog.

Independent Servicing in Sonora, Calif.

IN THIS, a mountainous district, consisting of four small communities, in which our town is the county seat, there are six full-time and three part-time service shops.¹

Most of the dealers here do not have service departments. They use the facilities of the independent Service Man. Only two of the shops sell radio and TV receivers.

In small communities like ours, year-round transient trade is slim; during the summer, when the tourists come, we have a flurry of walk-in business, usually involving portables and phonos that require additional tubes, batteries and accessories. So with that prospect, we must have an operation that will keep us busy throughout the year. And since we are practically all neighbors, we must maintain the highest standards and offer the closest cooperation at all times.

In our shop we specialize in two-way system installation, maintenance and repair; we also handle radio and TV work.

If a service operator has the capital, the ability to obtain an FCC radio-telephone first or second-class license and the will to work he will find that

¹Population of the Sonora district is 15,000.



Above and below: The radio and TV benches in the Caldwell service shop. In the racks are the portable test gear used in 2-way work. Some components, tubes and accessories are housed in bench drawers; remainder in racks.

radio-telephone servicing can be very lucrative.

Those who set themselves up for two-way must not object to dirt. There's plenty around when you have to get at the gear in lumbering and contracting equipment.

Also, service engineers must purchase the finest test gear, including frequency and modulation measuring

equipment, and treat it right. Our frequency and modulation meters are enclosed in special cases lined with thick foam rubber to minimize the chances of error caused by vibration in transit.

The service engineer should also affiliate himself with one or more manufacturers of communication equip-

(Continued on page 65)

Left: Duncan Caldwell and his mobile truck and assortment of test gear used in 2-way service operations. Equipment includes battery-operated frequency and modulation meters, tube and tool case, test set, vom, field flashlight and hard hat.

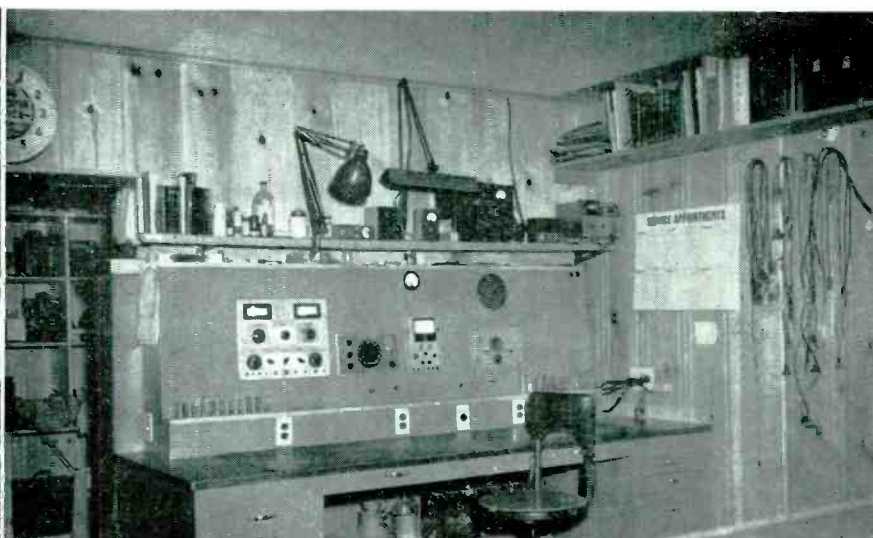

VERTICAL-TV CHASSIS

A Report on the Assorted Types That Have Been Adopted and

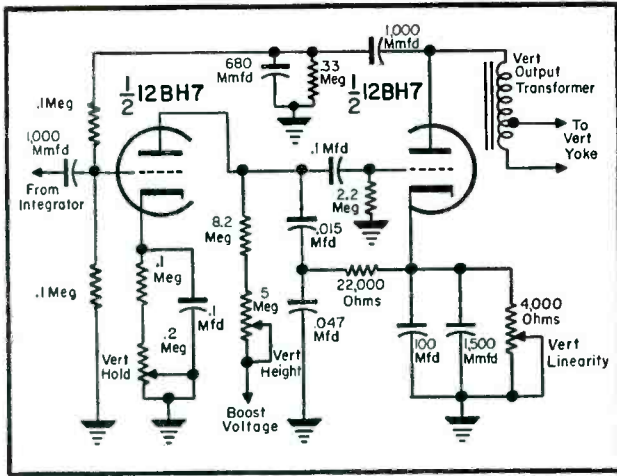

Fig. 1. Vertical oscillator circuit used in CBS-Columbia 1603 chassis.

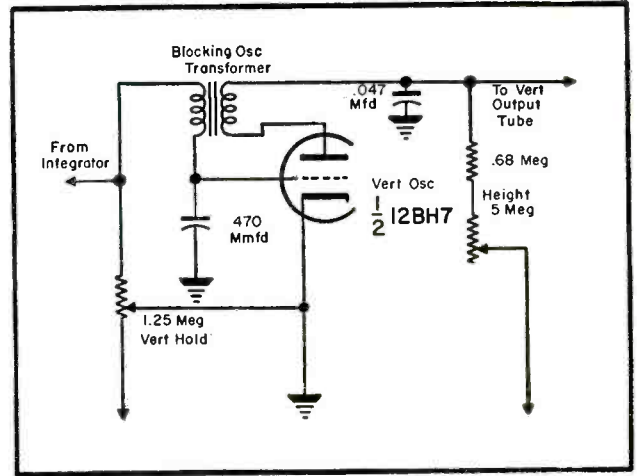

Fig. 2. Hallicrafters (model 1850) vertical oscillator circuitry.

HORIZONTAL CHASSIS usually employ one of four types of oscillators: † Hartley, Colpitts, multivibrator, and blocking oscillator (and synchroguide and electron-coupled for horizontal oscillators). In vertical chassis, modified Colpitts, blocking oscillator and multivibrator types (the most frequently used in horizontal chassis) are employed, with the blocking oscillator or multivibrator serving as the vertical oscillator, and the synchroguide or multivibrator as the horizontal oscillator. Actually, the oscillator circuits of most vertical chassis resemble each other very closely.

Electron-Coupled Oscillators

The electron-coupled oscillator used as the horizontal oscillator in some horizontal chassis has several unique features; a typical circuit appears in Fig. 1a. It will be noted that if a triode instead of the 6AU6 pentode, were used, the circuit would be a Hartley oscillator. It is known as an electron-coupled oscillator only because a pentode (or tetrode) is used. (Any oscillator which uses a tetrode or pentode as the oscillator tube, and where the screen grid is connected to a B+ source, is known as an electron-coupled oscillator.)

This circuit is equivalent to that of both an oscillator and power ampli-

by LEE SCOTT

fier. That is, the oscillator is a triode (cathode, control grid, and plate) and the power amplifier is a pentode (which includes the screen and suppressor grid elements). Besides the advantage of amplification, the operation of the electron-coupled oscillator is practically independent of load impedance, regardless of how much the latter fluctuates.

Low Load Impedance in Circuit

To obtain this effect, the plate voltage must be very much greater than the screen grid voltage, and the load impedance must be relatively low. This may be noted in the circuit, where the boost voltage is applied to the 6AU6 plate, and B+ (as well as -100 volts) is applied to the screen

grid. It will also be noted that the screen grid is at ac ground potential via a bypass capacitor, C_{513} , to prevent capacitive coupling from the plate, or output portion, to the oscillator section of the tube. Where a bypass capacitor is not used, a neutralizing capacitor is used from screen to plate.

In this circuit, the tank consists of L_{500} and a pair of capacitors, C_{510} and C_{512} . The horizontal oscillator adjustment varies the inherent oscillator frequency by changing the reactance of L_{500} .

Vertical Chassis Oscillator Types

The types of oscillators and tubes found in a number of vertical chassis are detailed in table 1. Here we find that the 12BH7 (dual triode) is used, quite extensively as either the blocking oscillator or multivibrator tube; in some cases the 6CG7, 7AU7, 12AU7, 6AU8, 6AN8, and 6SN7 are used. In all of the models listed, except the Magnavox 250, where the vertical oscillator is a multivibrator, the second half of the multivibrator also serves as the vertical output tube; this eliminates one stage and saves space in the receiver. A typical vertical oscillator circuit is shown in Fig. 1; CBS-Columbia 1600 series chassis. In this instance, the multivibrator circuit is plate-coupled. Fig. 2 illus-

Fig. 1. Electron-coupled oscillator used in G.E. Model 24C101.

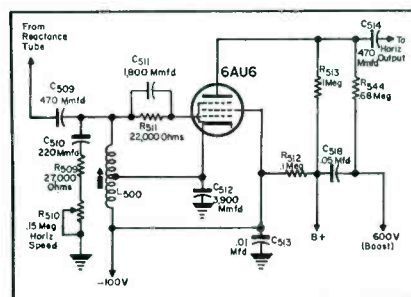

†Dines, Jesse, *B-W and Color-TV Oscillators*, SERVICE, August, September, 1955.

Horizontal and Vertical Oscillators

An Analysis of the Circuitry Employed in Current Receivers

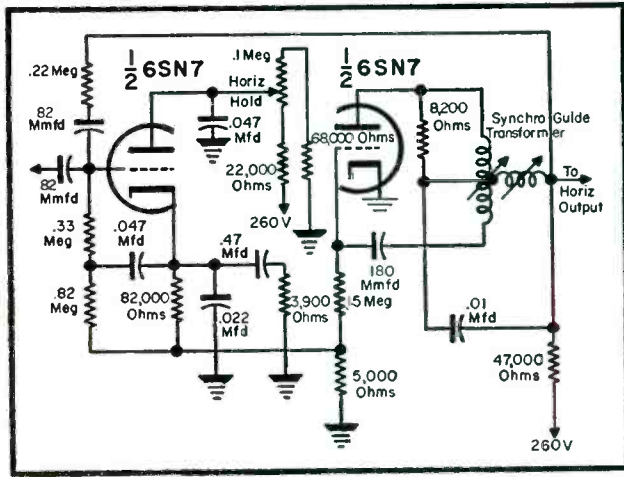

Fig. 3. Horizontal oscillator circuit employed in CBS-Columbia 1603 receiver.

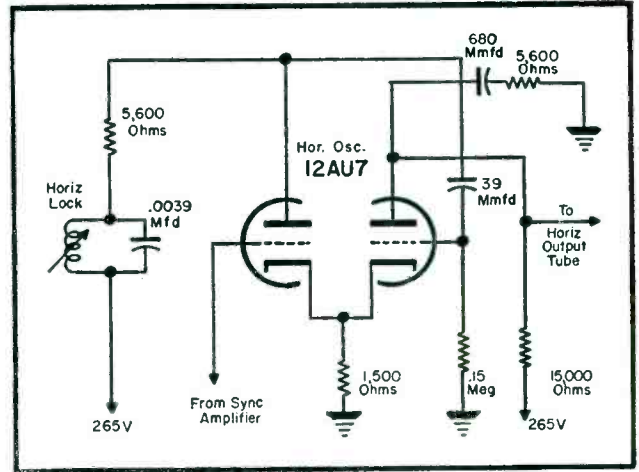

Fig. 4. Admiral chassis (18XP4BZ) horizontal oscillator circuit.

trates a blocking (vertical) oscillator circuit that is used in the Hallicrafter 1850 series. Here, the blocking oscillator tube is one-half of a 12BH7; the other half is used as a vertical output tube. The table reveals that approximately one half of the vertical oscillators are blocking and the remainder are multivibrators.

The listing also discloses that all, but Admiral, Magnavox, and Zenith,

employ either the 6SN7 or the 12AU7 (both dual triodes) synchroguide circuit as a horizontal oscillator. Only Admiral, Magnavox, and Zenith use multivibrator oscillator circuits.

Synchroguide-Circuit Chassis

In the CBS-Columbia 1600 series, which uses a synchroguide circuit, a 6SN7 is employed. One half of this tube is used for *afc* and the other half

as the oscillator; this circuit has been found to insure stability.

Multivibrator Oscillators

Horizontal oscillators serving as multivibrators normally use a 7AU7, 12AU7, or 6SN7. A typical circuit of this type is shown in Fig. 4; for Admiral 18XP4BZ. The 12AU7 is used as a cathode-coupled multivibrator.

Chassis	Vertical Oscillators		Horizontal Oscillators		
	Type	Tube Used	Type	Tube Used	
Admiral	17XP3	Blocking	½ 7AU7	Multivibrator	7AU7
Admiral	18XP4BZ	Blocking	½ 7AU7	Multivibrator	12AU7
CBS-Columbia	1601 to 1608	Multivibrator	12BH7*	Synchroguide	6SN7
Coronado	TV1-9017A, B; 9135B; 9137A, B; 9139A, B	Multivibrator	12BH7*	Synchroguide	12AU7
Crosley	426, 431 to 434, 441 to 443, 445	Blocking	½ 12BH7	Synchroguide	6SN7
Crosley	466 to 469	Blocking	½ 6CG7	Synchroguide	6SN7
Firestone	13-G-165, 166, 167, 183	Multivibrator	12BH7*	Synchroguide	12AU7
Hallicrafters	1600, 1700, 1850 Series	Blocking	½ 12BH7	Synchroguide	6SN7
Magnavox	250 Series	Multivibrator	6SN7	Multivibrator	6SN7
Majestic	125 to 127	Blocking	½ 12BH7	Synchroguide	6SN7
Olympic	14TD30, 31, 52, 53; 17KE65, 66; 17TE37, 38	Multivibrator	12BH7*	Synchroguide	6SN7
Philharmonic	54CM, TM	Blocking	½ 6AN8	Synchroguide	6SN7
Raytheon	17T18, 183; 21T24, 25, 26, 27, 193, 254, 274	Multivibrator	12BH7*	Synchroguide	12AU7
Silvertone	549.16000, .16001, .16002	Blocking	½ 12BH7	Synchroguide	6SN7
Truetone	21T26	Multivibrator	12BH7*	Synchroguide	12AU7
Zenith	16T20; 17T20; 19R21, 22; 19T23; 22T20; 22T21	Multivibrator	6AU8*	Multivibrator	6SN7

*Second half also used as the vertical output tube.

Table 1. Chart detailing vertical and horizontal oscillators (and tubes) used in vertical chassis.

Analysis of Sentinel TV Set Remote Control With Complete Schematic

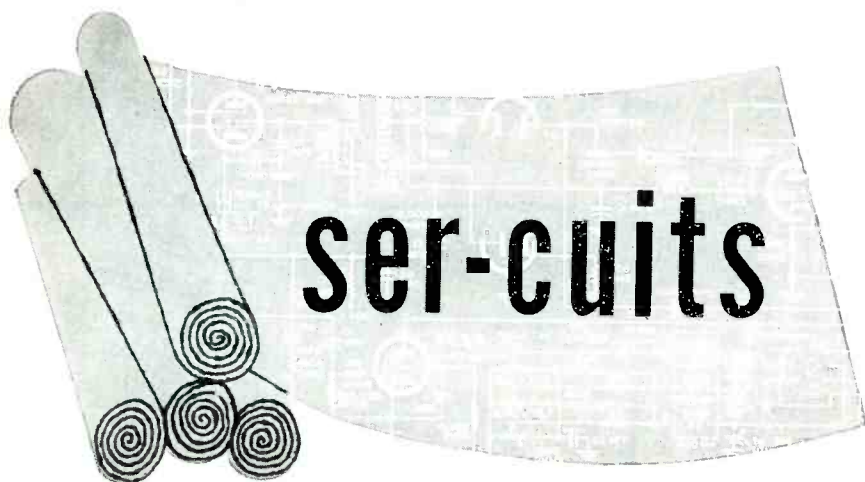

by **ROBERT D. WENGENROTH**

WHILE THE EVOLUTION of simplified circuits for TV receivers has eliminated many controls and reduced the number of tuning operations, video and audio adjustments still must be made. And often such adjustments must be made when one tunes in a new channel. Many times, too, because of propagation peculiarities that obtain on the veryhighs, audio and visual signals shift and tuning must be altered to clear up reception. As a result, it often becomes necessary to make repeated trips to the set to make adjustments. To eliminate this annoyance, remote controls that provide complete control of channel selection, fine tuning, brightness, volume, and power (on-off), as well as selection of either the set's loudspeaker or a speaker in the remote unit, have been designed. The circuitry* of one unit offering such tuning facilities appears in Fig. 1.

The remote unit has four controls plus a slide switch to perform all of the necessary functions. For tuning, there's a 12-position channel selector. The remaining controls are for fine tuning, volume, and off-on-brightness. On the front skirt of the remote is a slide switch which selects either the set's own speaker or the remote-unit speaker, mounted behind the panel to the left of the channel-selector switch.

Power to the receiver is controlled by a relay. Shock hazard is eliminated by operating the remote system from a 24-volt transformer supply. The switch on the brightness control closes the relay circuit; the relay in turn supplies power to the TV set. The 24-volt transformer is energized when-

ever the power switch on the TV set itself is *on*; however, the power drain is negligible when the remote unit is *off*.

The remote's brightness control is a variable resistance in series with the set's brightness control. By adjusting the receiver's brightness control to a position which, without the remote unit, would give too bright a picture (the tap toward the ground or remote unit end), varying the resistance of the remote brightness control provides a full range of picture brightness.

The channel-selector switch operates a 12-position servo system; motor drives the tuner in the receiver by means of a ladder chain. The station-seeking switch stops the motor at the channel position corresponding to the position of the station-selector switch.

The selection of any one of the twelve positions is accomplished with only four interconnecting wires connected to specially-cut rotors on the *channel selector* and *channel-seeking*

switches. These controls are twelve-position single-wafer switches, with both faces active on both switches. Each of the four interconnecting wires always contact either the front or the rear rotor of each switch. Table I details the connections made for each channel at both switches. When all wires contact the same rotor on both switches, the motor stops. In any other position the motor runs. The station-seeking switch always turns clockwise; when it reaches the proper channel the motor stops.

This table reveals why the motor will operate in any position, except the proper channel position. For example, if the station selector is set for channel 11, the brown wire contacts the front rotor, and the orange, yellow and green wires contact the rear wafer. For any position of the station-seeking switch, for which the brown wire contacts the rear rotor (channels 4, 8, 9, 10, 12, and 13), the motor will run because it is connected to the rear rotor of the channel-seeking switch, and the return in the remote unit is connected to the channel-selector switch front rotor. However, in the positions for channels 2, 3, 5, 6, 7, and 11, the front rotor is contacted. In each of these cases, except channel 11, a path will be found from front to rear rotor through the other wires. For example, if the station-seeking switch is in position for channel 2, the green wire also contacts the front rotor at the channel-seeking switch. At the channel-selector switch, the green wire contacts the rear rotor, along with the orange and yellow wires. At the channel-seeking switch these wires contact the rear rotor, continuity through the switches is obtained, and the motor will run. In the channel-11 position, there is no path, and the motor stops.

Fine tuning is accomplished by changing the plate voltage of the local oscillator. Oscillator plate current flowing through the control produces sufficient adjustable voltage drop to provide adequate tuning range, so long as the receiver tuner is reasonable well aligned. The range, however, is less than that of the usual mechanical fine-tuning control.

Audio volume is controlled by shunting the speaker voice coil. A 22-ohm control provides negligible shunting in the maximum output (maximum resistance) position, but

(Continued on page 80)

Chan- nel	Brown	Orange	Yellow	Green
2	Front	Rear	Rear	Front
3	Front	Front	Rear	Rear
4	Rear	Front	Front	Rear
5	Front	Rear	Front	Front
6	Front	Front	Rear	Front
7	Front	Front	Front	Rear
8	Rear	Front	Front	Front
9	Rear	Rear	Front	Front
10	Rear	Rear	Rear	Front
11	Front	Rear	Rear	Rear
12	Rear	Front	Rear	Rear
13	Rear	Rear	Front	Rear

Table 1. Switch connection to the four interunit wires of the channel-selection servo system. Connections made by both switches are identical. These data apply to both station-selector and station-seeking switches.

*Sentinel models 21101, 21121, 21145.

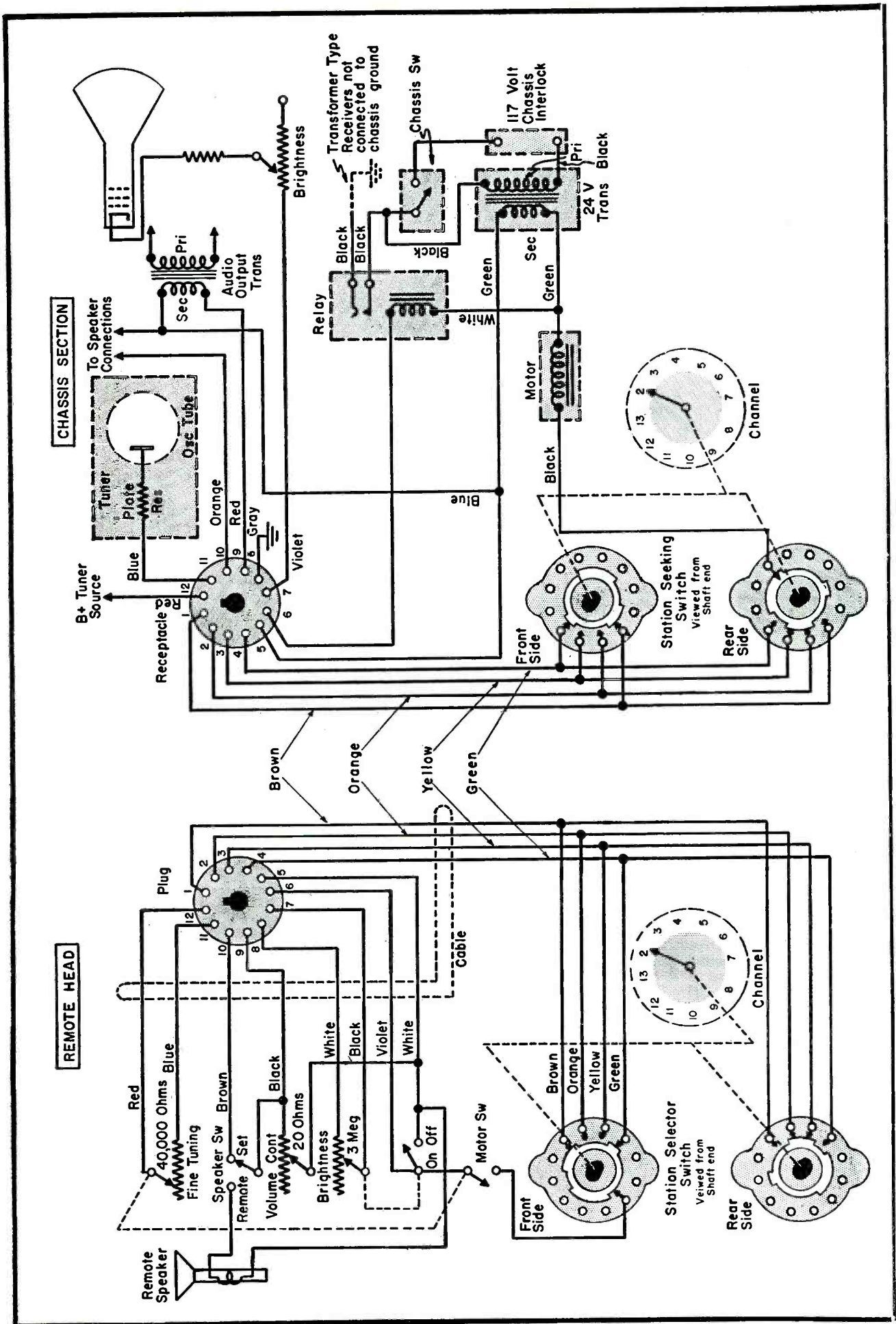

Fig. 1. Circuit of Sentinel remote-control system; models 21101, 21121 and 21145.

Leakage Resistance in Capacitors

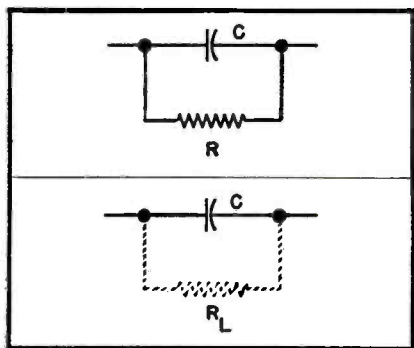

Fig. 1. When leakage resistance in a capacitor is represented conventionally, a resistance is drawn in parallel with the capacitor, as illustrated at top. This is a very primitive representation, which although sometimes is in accordance with physical facts, more often is grossly misleading. Generally, leakage resistance has very many equivalent circuits, and can be better represented in the first analysis by a dashed-line resistance symbol, as shown in bottom drawing.

Nature of Problem . . . Affect on Circuit Operation . . .

How to Locate and Eliminate Defects

by G. S. RYANT

LEAKAGE RESISTANCE in fixed capacitors, causing failures, represents an involved problem. When leakage resistance in a capacitor is illustrated in the conventional manner, a resistance shunting a capacitance is shown. There are cases in which the equivalent circuit of the leaky capacitor describes the physics of the situation, but in most instances, this equivalent circuit is highly inaccurate. For this reason, it has been found preferable to draw a symbol for leakage resistance with a dashed line, as shown in the lower portion of Fig. 1.

Equivalent Circuit Problem

If it were true that leakage resistance can be represented as ordinary resistance, then it follows that when we connect a resistor in parallel with a capacitor, we must expect the same electrical behavior. However, an ohmmeter test reveals that this is not

so, and that our equivalent circuit is too primitive. As shown in Fig. 2, the ohmmeter does not come to its final value, for a given value of leakage resistance, as fast as it does for the same value of resistance in conventional form, such as a composition resistor. Hence, we must establish a more accurate equivalent circuit, as shown in Fig. 3. Here we find several integrating circuits formed by the leakage resistance and the capacitance, whereby the charging time of the capacitor is lengthened. It is acknowledged that this is not an accurate physical representation of the situation, but the equivalent circuit does describe the observed facts more closely than a simple resistance shunting the capacitor.

Direction of Resistance Path

Often a leaky capacitor may measure a higher resistance value in one direction than in the other direction.

Hence, the equivalent circuit must be further elaborated as shown in Fig. 4. This equivalent circuit includes a semi-conducting diode. The diode does not have an extremely high front-to-back ratio in most cases; for example, an apparent front-to-back ratio of 3 to 1 or 5 to 1 may be observed not infrequently.

Furthermore, it has been observed that leaky capacitors sometimes behave as batteries, whereby a source of *dc* potential, such as .25 volt (as measured on a *vtvm*) must be added to the equivalent circuit, as depicted in Fig. 5. In this situation, it may or may not be necessary to include the semi-conductor diode in the equivalent circuit.

Charging Time

But another complication also enters into the equivalent circuitry for leakage resistance; the behavior of

Fig. 2. When a leaky capacitor is checked with an ohmmeter, it normally takes much longer for the pointer to pass a given resistance value on the scale, than when a good capacitor is checked. The graphs here show typical times required for good and leaky capacitors to bring the ohmmeter pointer to the 1,000-megohm point.

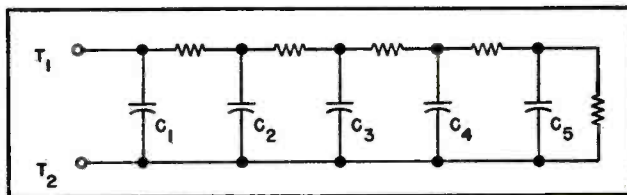
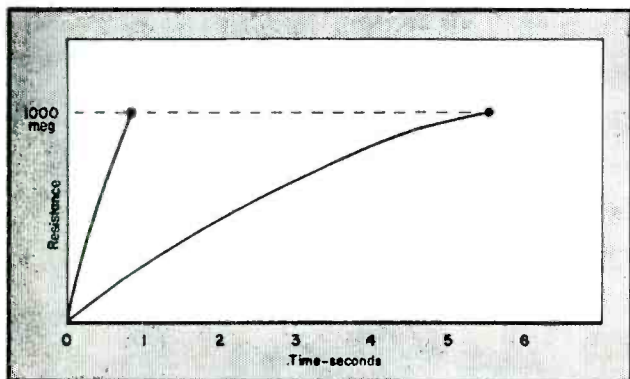

Fig. 3. From the standpoint of charging time of some leaky capacitors, when tested with an ohmmeter, this equivalent circuit can be regarded as more in accord with the observed facts. T_1 and T_2 are the terminals of the leaky capacitor. The nominal value of the capacitor is represented by the sum: $C_1 + C_2 + C_3 + C_4 + C_5$.

†From a field report submitted by Robert G. Middleton, Simpson Electric Company.

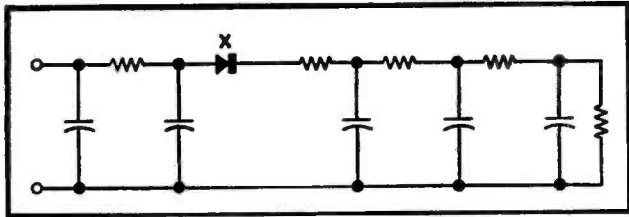

Fig. 4. A leaky capacitor often will be found to measure more resistance in one direction than the other. In this case, the equivalent circuit must be elaborated by addition of a semi-conductor diode; the front-to-back ratio of the equivalent diode (X) is commonly in the order of 3 to 1, or 5 to 1.

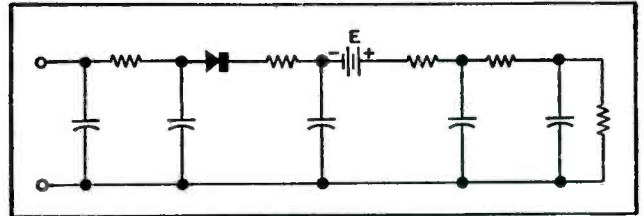

Fig. 5. Leaky capacitors also show a potential difference occasionally at their terminals. In such case, a battery (E) must also be added into the equivalent circuit. The semi-conductor diode may or may not be properly included.

the capacitor for reversed voltage checks with respect to charging time. For example, many leaky capacitors behave in the following way; upon application of +600 volts, the initial leakage current will be quite high, and will then drop off to a very much lower value which remains relatively stable. No further change will be observed in the course of testing unless the test leads are removed and reversed. When -600 volts is applied to the capacitor, the former cycle is repeated; the initial leakage current will be quite high, and will then drop off to a much lower value which remains relatively stable for applied negative voltages. But once again, the cycle will be repeated for applied positive voltages. Hence, it is necessary to introduce the concept of polarization into the equivalent circuit for leakage resistance; this polarization, as shown in Fig. 7, may be conceived conveniently as the formation of microscopic bubbles of gas at one electrode, which serve to increase the value of the leakage resistance. Upon reversing the polarity of the test voltage, the electrode becomes depolarized, and gas bubbles form on the opposite electrode.

In addition, leakage resistance is often unstable, jumping from higher

to lower values, in response to applied voltages, such as pulses. Leakage resistance is also commonly non-linear, as illustrated in Fig. 6.

It has also been found that leakage resistance is subject to sudden breakdown and arcover in some cases, when the capacitor is tested at rated working voltage. In other cases, the application of substantial voltage values causes the leak to clear and disappear. If such tests are made in circuit, the test voltage should be applied in pulse form to avoid overheating of the resistors in the circuit associated with the capacitor.

Pulse Voltages

Fig. 8 illustrates how leakage resistance may sometimes be caused to suddenly take on a new value, by application of a pulse voltage to the capacitor under test. Old timers will readily recall likewise how a poor capacitor would appear to be completely discharged, but after a period of time, show some presence of charge. This equivalent circuit can also be represented by Fig. 3.

These known physical properties of leakage resistance have made it possible to design capacitor-leakage testers which are able to distinguish

between leakage resistance and circuit resistance in a majority of cases. Based upon new concepts, some of which are not entirely simple, a certain amount of knowledge and experience is required for the successful application of such in-circuit capacitor leakage testers.

Circuit Tester Applications

Not one of the least complicating factors which must be taken into account in the design and application of such an instrument is the failure of some small composition resistors to obey Ohm's Law precisely. Such resistors, although not exactly what they are supposed to be, operate satisfactorily in the receiver circuit; but the leakage tester must be designed and utilized with this knowledge in mind.

Another complicating factor is the wide range of pulse currents drawn by circuits ranging from cathode to coupling circuits. In existing testers operating on this principle, low-impedance circuits cause a pointer swing or oscillation, which must be taken into account. The operator should take the average position of the pointer as the indication, when such circuits are under test.

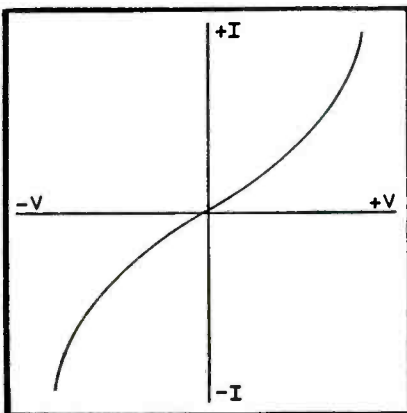

Fig. 6. Leakage resistance may be linear, but is more often non-linear, as shown, with the current increasing faster than the applied voltage.

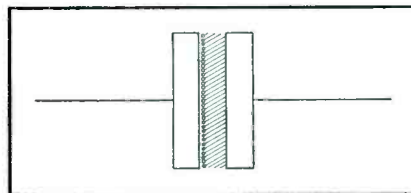

Fig. 7. The high initial currents and small final currents, obtained each time the test leads are reversed to some leaky capacitors, show that the concept of polarization must be introduced into the equivalent circuit for leakage resistance. We may conceive of the formation of microscopic gas bubbles at one electrode in response to the applied polarity of test voltage. It is not suggested that the picture is final physically, but only that it serves a useful purpose in guiding one to a solution.

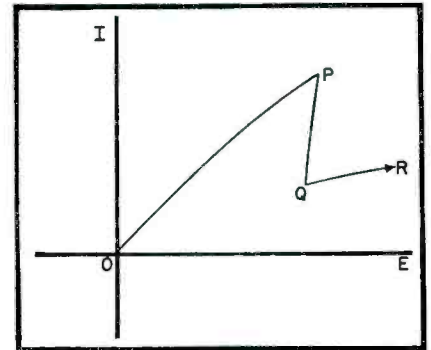
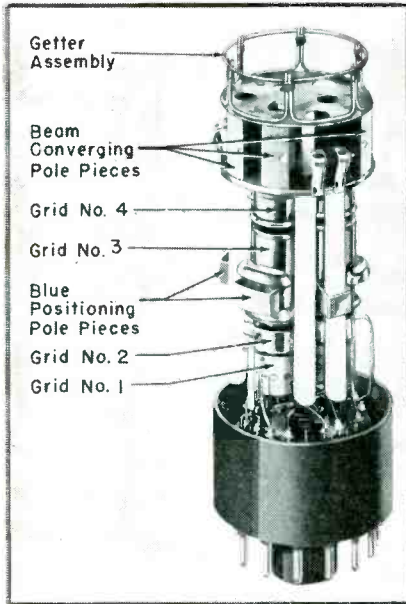

Fig. 8. When leakage resistance is unstable, application of voltage values from O to P produce a smooth characteristic, which then abruptly changes to a new and different characteristic, such as Q-R.

The 21-Inch Tricolor Picture Tube

A Study of the Latest Advances Included in Large-Screen Tubes . . . Circuitry Developments . . . Simplified Tube Installation Techniques and Tests Now Available

by **W. W. LENZ, JR.**, Training Specialist, RCA Service Company



IN THE COLOR system, the picture tube is, of course, a focal component. Its structure not only determines the circuitry that one can use, but the controls that we will have and the installation procedures and adjustments that will be necessary to insure best set performance.

In developing the latest type tricolor tubes, design engineers have included a number of advancements that have made it possible to simplify color chassis, across the board.

To illustrate, the 21AXP22 21-inch color tube, a direct view, metal en-

velope type, utilizing electrostatic focus guns to provide separate electron beams to excite the phosphor dots on the screen, has a rounded faceplate. This tends to equalize the length of beam travel to different parts of the screen, thus simplifying dynamic convergence requirements.

There are three electron guns in the tube, manufactured as a unit, spaced at 120° apart and mounted in the neck of the picture tube. To reduce the amount of static convergence correction which must be applied to the three beams, the three

guns are tilted toward the central axis of the tube so the beams will converge at the shadow mask.

The tube's phosphor dots are printed directly upon the back of the faceplate. Approximately one million phosphor dots .016" diameter are used to provide approximately 357,000 dot trios. The spacing between the centers of adjacent dot trios is .029". The shadow mask has the approximate curvature of the faceplate and contains 357,000 holes or apertures of .010" diameter through which the phosphor dot screen is scanned. To maintain alignment of the shadow mask and phosphor dot screen the expansion of the shadow mask is controlled as it heats. This compensation is accomplished by special design of the mask mounting ring.

In the electron gun assembly each of the electron guns is flanked by a pair of internal magnetic pole pieces. These direct the magnet convergence fields to the area directly in front of the guns and they minimize interaction between guns. A separate internal pole piece, known as the blue-positioning pole piece, is supplied for the blue gun. In all, there are four internal pole pieces in the electron

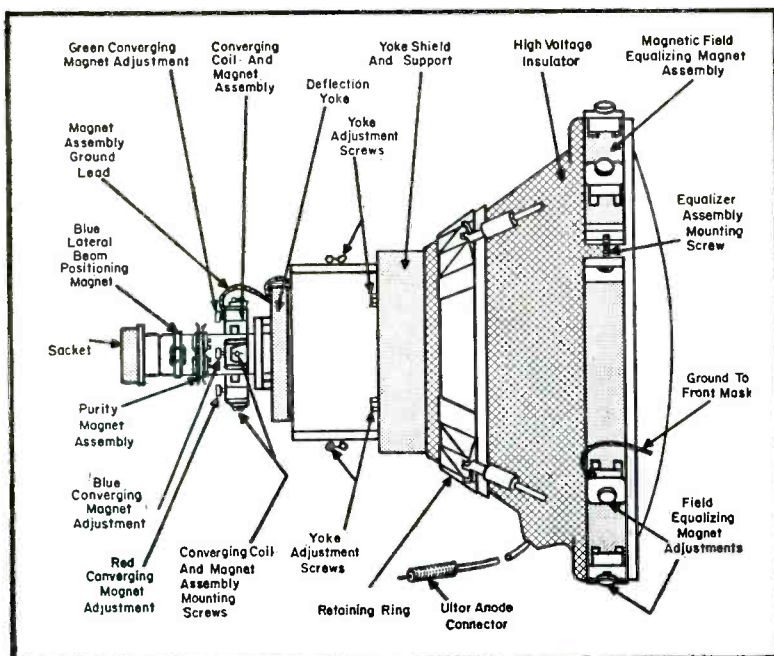

Fig. 1 (above). Electron gun assembly of 21-inch color picture tube.

Fig. 2 (left). The 21-inch color picture-tube (21AXP22) and its associated components. This tube provides a picture area of 256 square inches, 19 1/16" x 15 1/4".

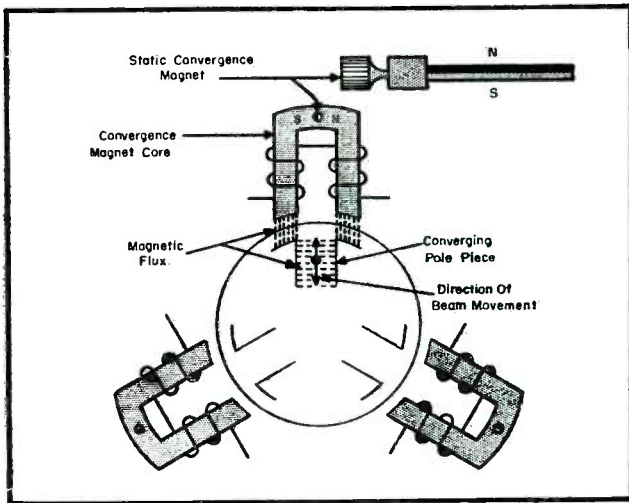

Fig. 3 (right). Magnetic field (color) equalizer assembly.

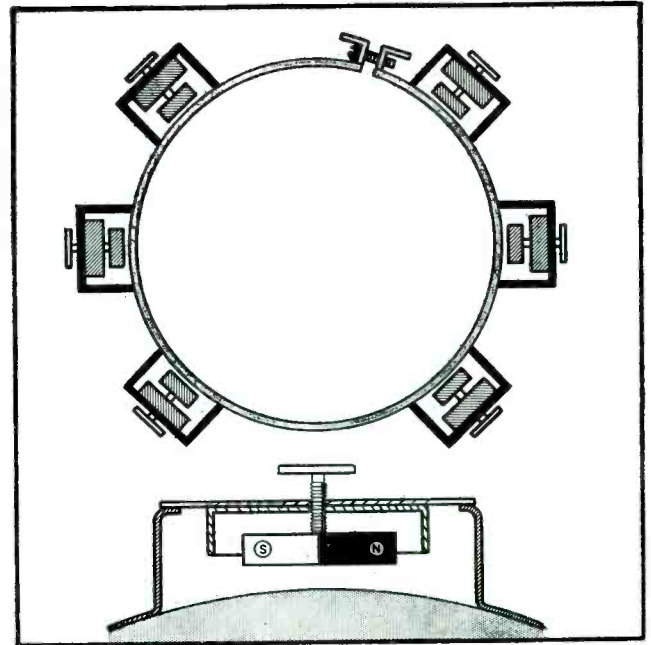

Fig. 4 (above). Convergence magnet mounted over internal pole piece used for proper orientation of convergence assembly.

gun assembly; one for each red and green gun and two for the blue gun.

The gun structure consists of a separate indirectly heated cathode, a grid No. 1 (control electrode), a grid No. 2 (accelerating electrode), a grid No. 3 (focusing electrode), and a grid No. 4, which is connected to the ultor.

There are four components associated with the tube; purifying magnet, magnetic-field equalizer assembly, blue-positioning magnet, and converging-magnet assembly.

Purifying Magnet

The purifying magnet is a permanent magnet similar to centering magnets used on conventional black and white receivers. The correct position for this assembly is directly behind the converging-magnet assembly. The field produced by this magnet affects all three beams equally, and is adjusted for strength and direction which will cause the beams to pass through their centers of deflection. Strength is adjusted by separating the red tabs; direction is adjusted by rotating the entire assembly around the neck of the tube.

Magnetic-Field Equalizer Assembly

The magnetic-field equalizer assembly consists of six permanent magnets mounted around the rim of the tube. The function of the assembly is to allow correction of color contamination around the periphery of the tube, due to extraneous magnetic fields. The strength of each magnet is controlled by the amount it ex-

tends from within the high permeability keeper or housing. The direction of the lines of force is adjusted by rotating the magnet in its holder.

Blue-positioning Magnet

The blue-positioning magnet is positioned on the neck of the tube over the pole piece of the blue gun. This magnet is used, in addition to the permanent magnets of the converging-magnet assembly, for adjusting static convergence.

Converging-Magnet

The convergence assembly consists of three pairs of converging coils and permanent magnets mounted on a common ring. This assembly is positioned on the neck of the tube so that the core of each magnet is di-

rectly over the internal pole pieces of its associated electron gun. To vary the amount of magnetic flux influencing the electron beam, a static convergence magnet is positioned within the converging-magnet core, permitting the electron beam to be moved perpendicular to the lines of force.

Dynamic correction is obtained by the use of the three converging coils on the convergence assembly and dynamic convergence currents obtained from the deflection circuits. These coils are wound on the same cores used with the static convergence magnets. The magnetic field produced by current flowing in the coils adds to or subtracts from the field produced by the static magnets.

The dynamic convergence currents are obtained from the vertical and

(Continued on page 66)

Fig. 5. Vertical and horizontal sweep circuits that provide dynamic convergence currents.

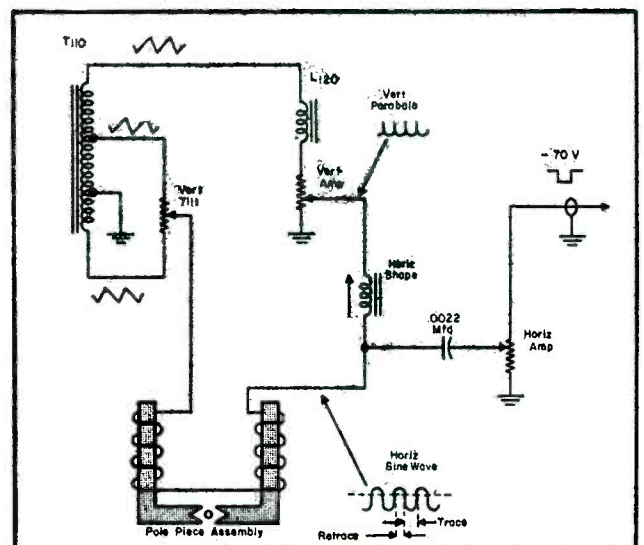

Automatic Chroma Control Circuitry

by W. W. COOK, Training Specialist, RCA Service Company

Operation of Band-Pass Amplifier, Color Killer, Burst Gate and

Phase Detector Which Function As An Automatic Color-Control System

INCLUDED IN the new circuits employed in the current line of color-TV receivers is an automatic chroma control system. Although the *automatic chroma control* is new, its basic theory of operation is similar to both *avc* and *agc* systems in radio and black and white television. As the name implies, *acc* alters the gain of the chrominance circuits. Since the amplitude of the chrominance signal may vary in relation to the luminance signal, this additional circuit is preferred to minimize the number of front panel controls. The *acc* does not replace the *agc* circuit in the color receiver. The *agc* system is still used to control the composite color signal through the *rf* and *if* amplifiers in the receiver. In the current color-TV models, the *acc* bias voltage controls the amplitude of the chrominance signal after it has been separated from the luminance signal.

The ACC System

The *bandpass amplifier*, *color killer*, *burst gate* and *phase detector*, all of which directly tie together and are an integral part of the *acc* system, appear in the schematic on the cover and in Fig. 1.†

The composite color signal is fed to the grid of the bandpass amplifier from the color take-off transformer through an 82-mmfd capacitor (C_{222}). The bandpass-amplifier stage amplifies the color signal and through a transformer it is fed to the demodulator driver stage. Since it is desirable to control automatically the gain of the color signal, the bandpass

[See Front Cover]

amplifier is the most logical stage to form this function. It should be noted at this point that burst, which is part of the composite color signal, is gated to the phase detector transformer by means of a burst gate tube. The gate tube is normally in a cut-off state; however, a flyback pulse, which is coincident with burst time, allows the gate tube to conduct, amplifying only the burst pulse.

Burst Signal Function

The burst signal, which is developed across the secondary of the phase - detector transformer, T_{112} , causes the phase detector to conduct a large negative voltage, developed at point A in the schematic. This negative voltage is developed across two bleeder resistors, R_{218} and R_{217} ; 2.2-megohm and 560,000-ohm units. The *acc* bias voltage is obtained from the junction of these two resistors and is applied to the grid of the bandpass amplifier controlling the gain of this stage.

The ACC Bias Voltage

The amplitude of the negative voltage developed at point A is in direct proportion to the amplitude of the burst signal. As the burst signal increases in amplitude the *acc* bias voltage becomes more negative, de-

creasing the gain of the bandpass amplifier stage. Thus, if the amplitude of the composite chrominance signal should vary in relation to a constant-amplitude luminance signal, in the process of transmission, the *acc* bias voltage will maintain proper color saturation in the color picture on the face of the color picture tube.

Color Killer Action

The color killer and color saturation control also affect the operation of the bandpass-amplifier. The color killer disables the operation of the bandpass-amplifier during black and white transmissions, making sure that no higher video-frequency pulses cause color edges on the black and white picture. The color-saturation control acts very similar to the contrast control; at its maximum counterclockwise position there is no color in an otherwise colored picture. Advancing the control in a clockwise rotation increases the saturation of the color during a color telecast.

B-W Interval Operation

During a b-w telecast there is only a small negative voltage developed at point A, since there is no burst signal across T_{112} . With the absence of this negative voltage, the color-killer tube conducts freely, being controlled only by the killer threshold control. At the end of each horizontal line a horizontal flyback pulse is fed to the grid of the killer tube. This pulse, negative in polarity, is ampli-

†RCA 21CT661.

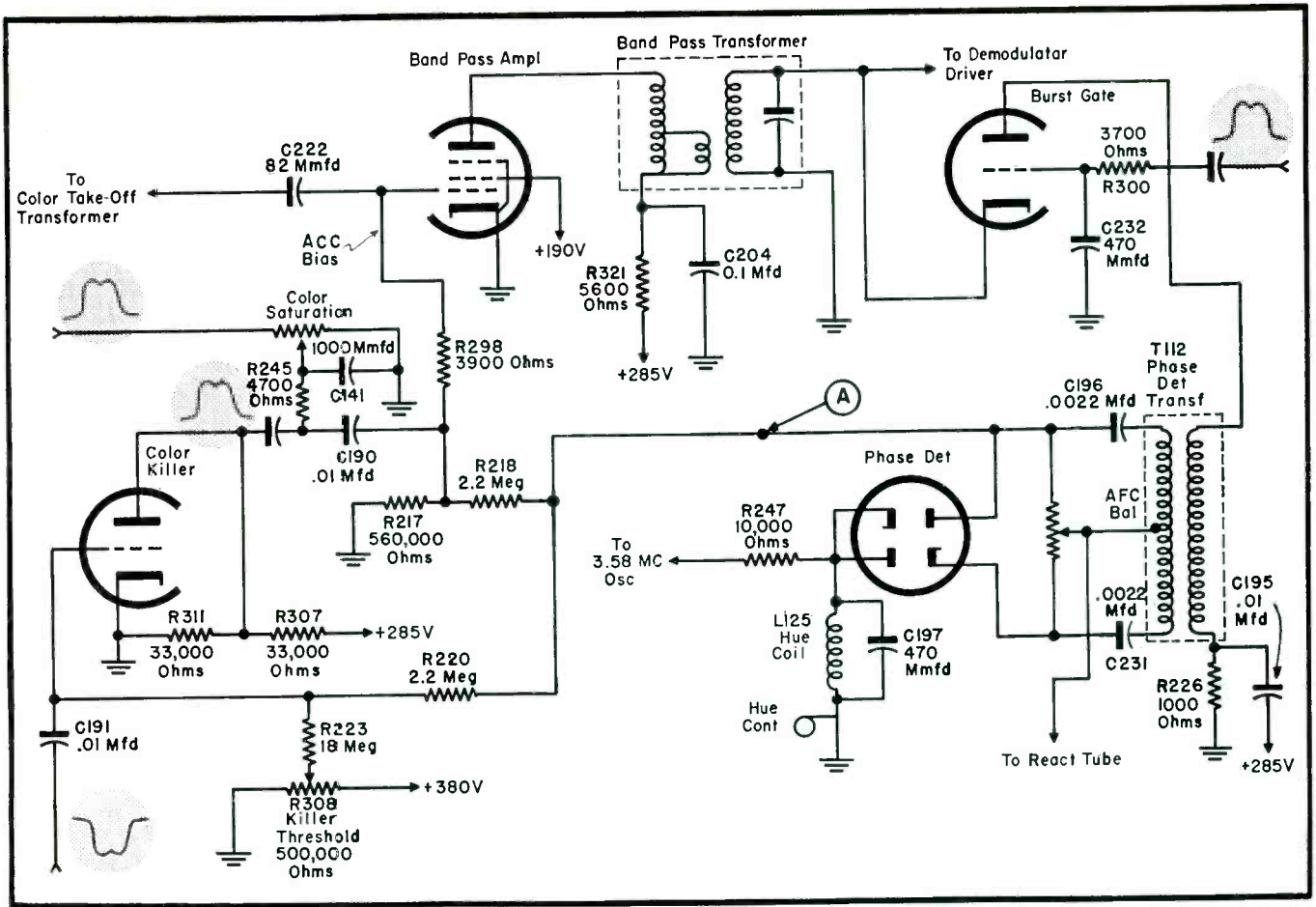

Fig. 1. Schematic of bandpass-amplifier, color killer, burst gate and phase detector which are an integral part of the automatic color control system.

fied and becomes a large positive pulse on the plate. This positive pulse is coupled to the grid of the bandpass-amplifier through a pair of .01-mfd capacitors, C_{145} and C_{150} . The bandpass-amplifier in turn conducts into saturation and draws a large amount of grid current; this grid current charges C_{145} and C_{150} . At the end of the horizontal retrace the flyback pulse no longer appears on the grid of the color killer. As a result the capacitors in the grid circuit discharge, developing a large negative bias at the grid of the bandpass-amplifier. This bias is sufficiently negative to cutoff this stage during the scanning-line interval. At the end of each horizontal line, the action of the flyback pulse recharges the capacitors in the grid circuit, maintaining the bandpass-amplifier in a cutoff state during the scanning-line interval. The significant point of this technique is that the amplifier always conducts during the blanking interval; this is so because the burst information, when transmitted, occurs during this

interval. Thus, when switching to a color program, burst will be amplified and fed on to the phase detector.

Burst Affect on Killer

The killer is inoperative during a color telecast. The large negative voltage developed at point A, due to the presence of burst, prevents the color killer from conducting. This means that capacitors C_{145} and C_{150} will no longer take on a large negative charge, and the bandpass-amplifier will conduct during the line interval allowing the chrominance information to be amplified.

Color Saturation Control

The operation of the color-saturation control involves a rather novel technique. It was stated earlier that the *acc* bias voltage varies in direct proportion with the amplitude of burst. If the amplitude of burst increases, the amplitude of the *acc* bias voltage increases, decreasing the gain

of the bandpass-amplifier. By action of the color-saturation control, the burst signal is amplified by a greater amount than the chrominance signal information. Thus the *acc* voltage increases to the extent that the chrominance signals are amplified in the bandpass-amplifier by a lesser amount. To do this, a positive horizontal flyback pulse is applied across the color control. By turning the color control in a counterclockwise rotation, this positive pulse is applied to the grid of the bandpass-amplifier. Since this pulse occurs during the horizontal blanking interval only, the burst signal is amplified to a greater extent than the chrominance signals. A greater burst pulse is then fed to the phase detector, which in turn develops a larger *acc* bias, decreasing the gain of the bandpass-amplifier. With the color control in its maximum clockwise position, no positive pulse is applied to the grid and the gain of the tube remains constant for both the burst and the chrominance information.

Test Equipment for COLOR-TV Receivers

The Dot-Bar and Color-Bar
With Complete Schematics

by

E. R. KLINGEMAN

Electronic Equipment Specialist

and

S. WLASUK

Manager, Special Products,
Engineering Group

RCA Service Company

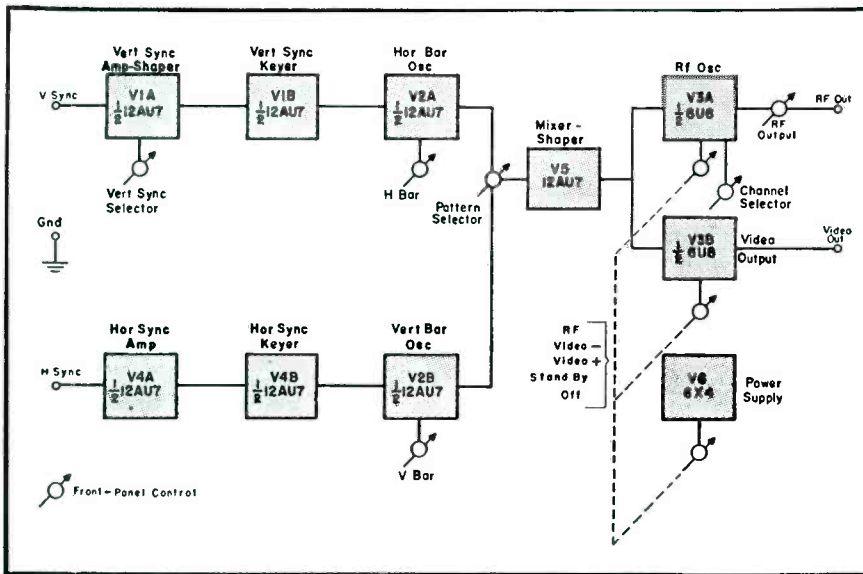

FOR THE SERVICE MAN contemplating the installation and service of color-TV receivers, some additional test equipment is mandatory.

The color-TV receiver must fulfill two requirements; it should produce a black and white picture, free from objectionable color fringing on black and white telecasts; the color-decoding section of the receiver should produce an accurately registered and faithfully reproduced color signal for addition to the luminance signal and eventual reproduction on the picture-tube screen. To fulfill the first requirement a white dot or crosshatch

pattern generator is needed to converge the red, green, and blue rasters of the tricolor picture tube. To fulfill the second, a stable and accurate color bar generator is needed.

For dot-bar service, a generator¹ has been designed to furnish a pattern of dots, crosshatch, horizontal bars, or vertical bars at either video frequency or *rf* output on any channel from 2 through 6, when properly connected to a color-TV receiver. Basically, it consists of two oscillators, one operating between 450 and 900 cps to provide the horizontal bars or rows of dots, and one operating be-

tween 180 and 240 kc to provide the vertical bars or rows of dots.

V-H Sync Terminals

In this generator, the V sync and H sync terminals are coupled loosely to a color-TV receiver. Usual practice is to clip the H sync lead over the insulation of one of the deflection-yoke horizontal coil leads. The V sync lead may be connected to the picture-tube cathode, since the picture tube has vertical blanking applied to it to minimize vertical retrace. These synchronizing signals are amplified and used to lock the dot-bar generator oscillators to the color-TV receiver sweep oscillators. The horizontal and vertical-bar oscillator signals are selected by the pattern-selector switch and passed to the mixer-shaper stage where they are added and passed to *rf* and video-output stages. When it is desired to connect the output of the dot generator to the color receiver antenna terminals, the output selector switch is turned to the *rf* position and the +155-volt bus is connected to G₂ of the *rf* oscillator. When video output of either polarity is desired, the output selector is turned to the video

¹RCA WR-36A.

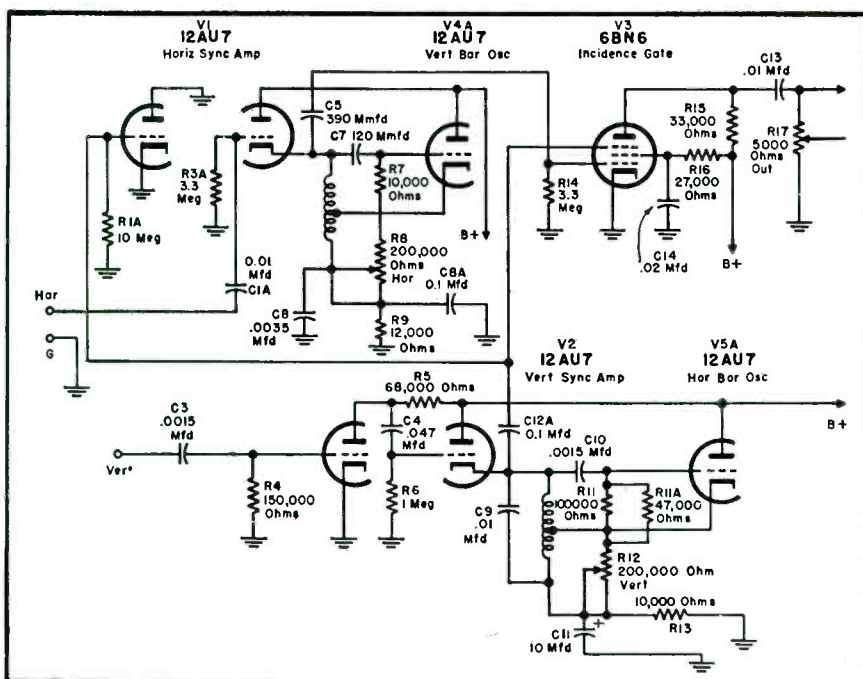
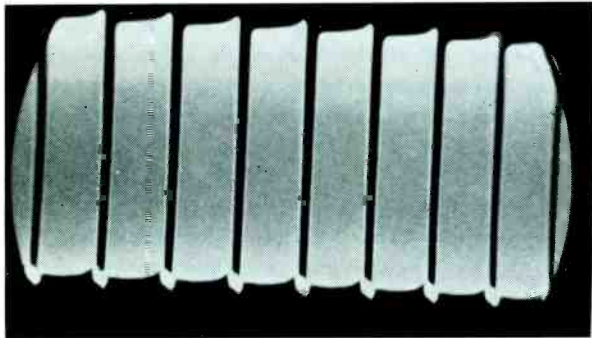

Fig. 1 (above). Block diagram of the dot-bar generator.

Fig. 2 (left). Circuit of simplified dot generator with video-frequency output.

★ A Field Progress Report on COLOR-TV

Instruments: Their Design, Circuitry and Application of Generators: See Page 46



(Above)

Fig. 3. Waveform of crosshatch pattern.

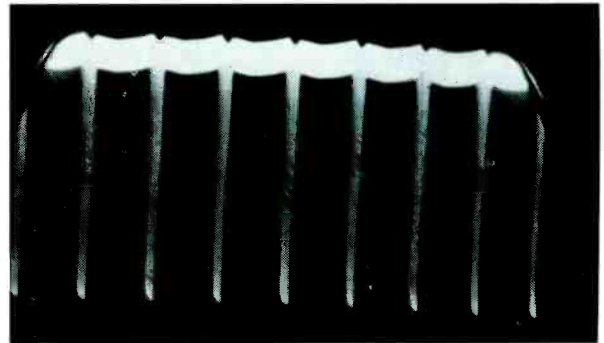

(Above)

Fig. 4. Waveform of dot pattern.

position and the output cable is connected to the input of the luminance video amplifier. This is best done in most receivers by using an adapter under the last luminance video amplifier tube. The adapter is used to break the control-grid connection and substitute the dot-generator output between grid and ground, depending on the circuit arrangement in a particular receiver. In most cases, the edges of the dots secured with a video signal will be sharper than that obtained with the *rf* signal.

A diagram of a simplified dot generator with a video-frequency output is shown in Fig. 1. The functions of the second half of V_1 and V_2 as sync amplifiers is somewhat more apparent than in the complete schematic of the instrument, shown on page 46. The amplified sync signals trigger the horizontal and vertical bar oscillators

and synchronize them with the horizontal and vertical sweep oscillators in the TV receiver. The outputs of the horizontal and vertical bar oscillators are mixed in a gated-beam tube, the vertical bar pulses being fed to G_1 and the horizontal bar pulses to G_2 of the 6BN6. This tube conducts only when both pulses coincide, thus forming dots at the intersections of the horizontal and vertical bars. In the diagram, it will be noted that the mixer consists of two triodes with their plates paralleled, thus permitting a continuous or crosshatch output. This output is clipped by crystal diode (CR_2) at a *dc* level selected by a voltage divider, R_{12} and R_{15} . When dots are desired, the polarity of CR_2 is reversed and the *dc* level is selected by R_{11} and R_{12} . Waveforms of crosshatch and dot patterns are shown in Figs. 3 and 4. These

patterns illustrate how the reversal of the crystal CR_2 clamps either the positive or negative peaks of the bar signals to the average *dc* level.

Color-bar generators designed for service use, must provide all the facilities required for complete checking of the color functions in a receiver, including: (1) accurate check on demodulator phasing adjustments of all major angles (*I*, *Q*, *R-Y*, *B-Y*, *G-Y*); (2) check on matrixing; (3) check on color-sync action for normal and weak color-sync-burst signals; (4) check on registration or *fit* of the luminance and chrominance signals on the picture tube; (5) check on the overall *rf*, *if*, video response for color signals; (6) check on effectiveness of sound *if* rejection in minimizing beat interference between the color subcarrier and the sound carrier at the correct ratio of picture to sound carrier ampli-

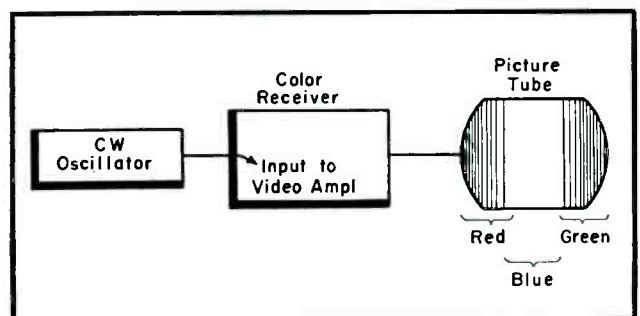
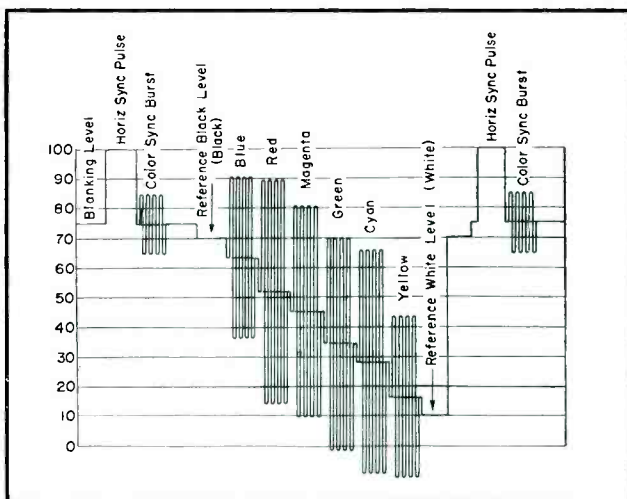
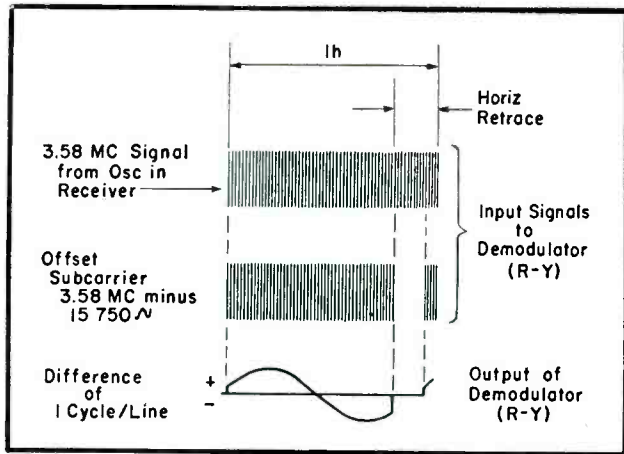

Fig. 5 (left). Waveform pattern produced by conventional type of color-bar generator.

Fig. 6. Typical rainbow pattern that can be produced by applying a cw signal of the correct frequency to the input of the video amplifier in a color set.



(Left)

Fig. 7. With the offset-subcarrier method, as illustrated, there is a difference of one cycle per horizontal scanning line between the offset-subcarrier and the 3.58-mc oscillator in the receiver, resulting in an output signal of one cycle per line from each demodulator.

(Below, left)

Fig. 8. Phase relationship of signals at the picture-tube grids produced by offset-subcarrier of 3.58-mc minus 15,750 cps. These signals produce a rainbow of color on the picture tube. (The signal amplitudes are not drawn to scale.)

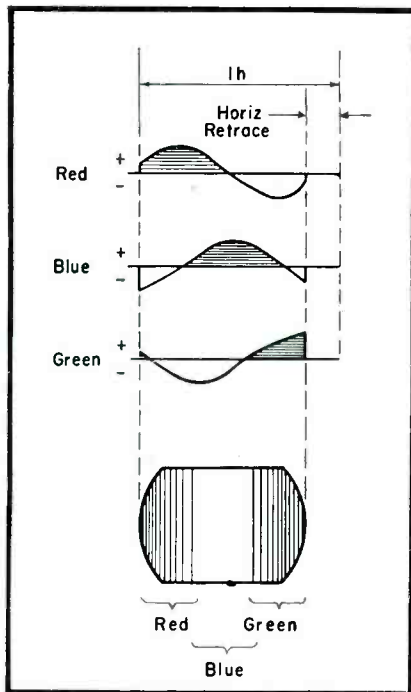

tudes; and (7) a check on non-linear amplitude characteristics that might affect color reproduction.

The conventional type of color-bar generator is designed primarily for use in lab, factories, and broadcast stations, where the factors of size, weight, and cost are relatively unimportant. This point is illustrated in the waveform shown in Fig. 5, a complex affair that highlights the fact that this type of generator is neither simple nor inexpensive, especially if it contains standard *H* and *V* blanking and synchronizing pulse-generating equipment, and also the modulator and *rf* carrier required for testing the over-all operation of color receivers.

The need for a compact, accurate, and foolproof color-bar generator for servicing color receivers, resulted in the development of an entirely different method that served to eliminate

the need for delay lines (or equivalent phase-shifting networks) and their attendant multiple gating circuits. The design employed is unique, since no color signals, as such, are developed in the generator; yet ten bars of different colors can be produced simultaneously on the color picture tube, each bar accurately phased at 30° intervals.

Offset Subcarrier Method Used

The basic principle used in this instrument² may be described as the *offset-subcarrier* method, because the frequency of the subcarrier is offset from the normal value, of approximately 3.58 mc, by an amount equal to the horizontal scanning rate. (For several reasons the black-and-white

(Continued on page 48)

WR-61A.

Fig. 9. Waveform of the offset-subcarrier and horizontal sync pulse in the bar generator. The gated offset-carrier signal used in the bar generator produces bar output signals from the demodulators, but the bar envelope is similar to the one-cycle-per-line output obtained when using an ungated offset-subcarrier, as shown in Fig. 7.

Fig. 10. Bar pattern, as displayed on receiver picture tube, showing order of color bars and their corresponding phase angles and axis relationships.

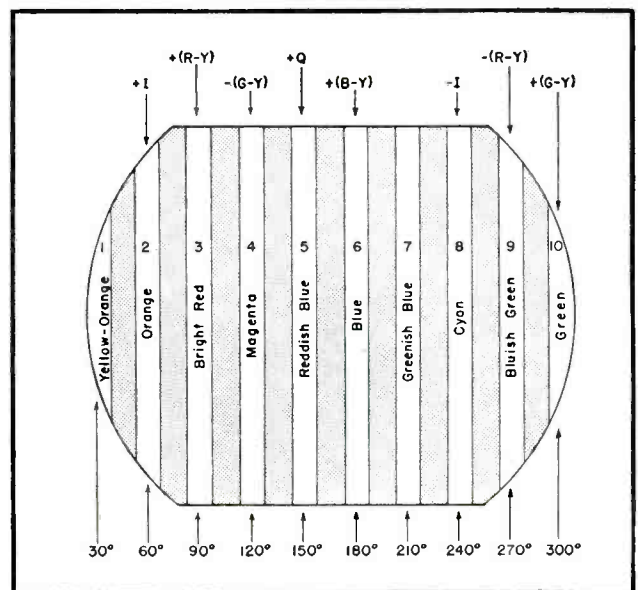
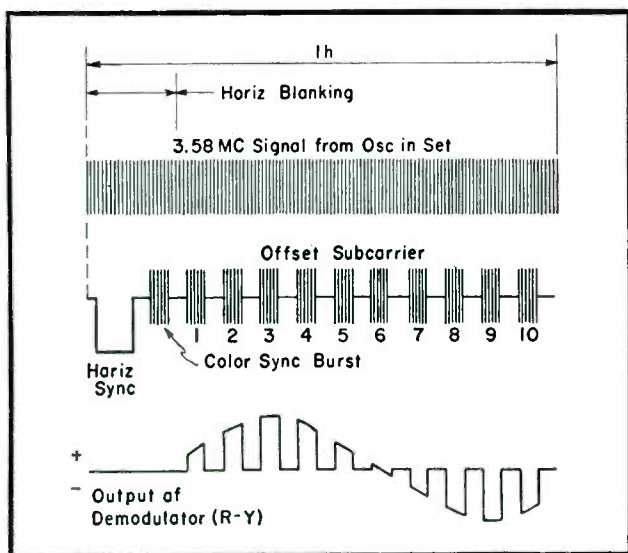

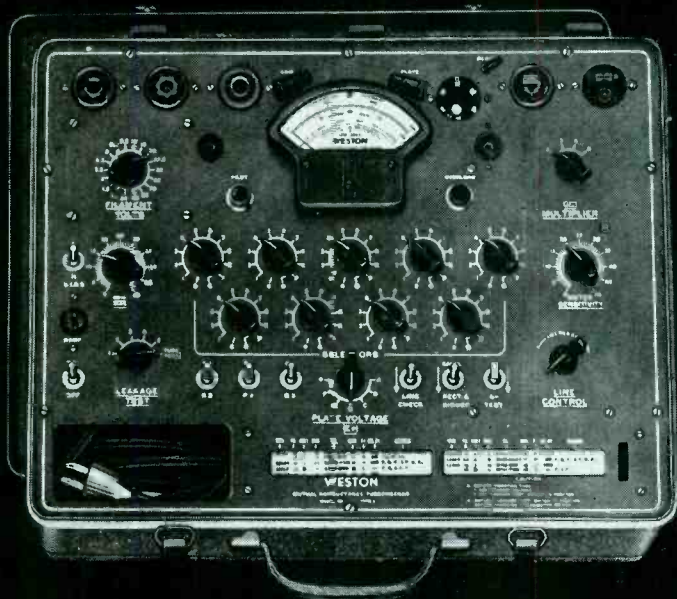

Weston Model 981
Proportional Mutual Conductance Tubechecker

FILTERED D-C POTENTIALS

for accurate
 G_m
measurements

OUTSTANDING FEATURES:

G_m MEASUREMENTS— G_m measurements are made more accurately by using filtered d-c plate, screen grid and control grid potentials. A precision voltage divider network and selector switch allows a proportionate value of signal voltage to be chosen for testing tubes having transconductances up to 30,000 micromhos. Signal voltages of 5.2, 2.6, 1.3, and 0.65 volts peak-to-peak having a frequency of 5000 cycles are provided.

GRID BIAS, SCREEN GRID AND PLATE VOLTAGE: Filtered d-c potentials of 90, 130, and 220 volts are available for plate and screen potentials. A variable filtered d-c voltage in two ranges of 0-5 and 0-20 volts are used to obtain better resolution of Grid Bias settings. *Far greater accuracy is obtainable with filtered d-c potentials than previously possible in portable tubecheckers.*

METER MEASUREMENT OF HIGH LEAKAGE RESISTANCE—Since tube leakage as high as several megohms can cause poor performance in TV Receivers, this tubechecker is designed to provide an accurate meter measurement of leakage resistance as high as 5 megohms between tube elements, thus being particularly useful for TV servicing and TV line production assembly.

TWIN SECTION TUBES—Three toggle switches make it possible to rapidly check and compare the respective sections of twin section tubes at only one setting of the selector switches.

WESTON 980 LINE
TEST EQUIPMENT

THE
980
LINE

PROPORTIONAL
MUTUAL
CONDUCTANCE
TUBECHECKER

SEND COUPON TODAY FOR
COMPLETE DESCRIPTION AND PRICES

Weston Electrical Instrument Corporation
614 Frelinghuysen Avenue
Newark 5, New Jersey

Please send literature on the new 981 Tubechecker.

NAME _____

ADDRESS _____

SE

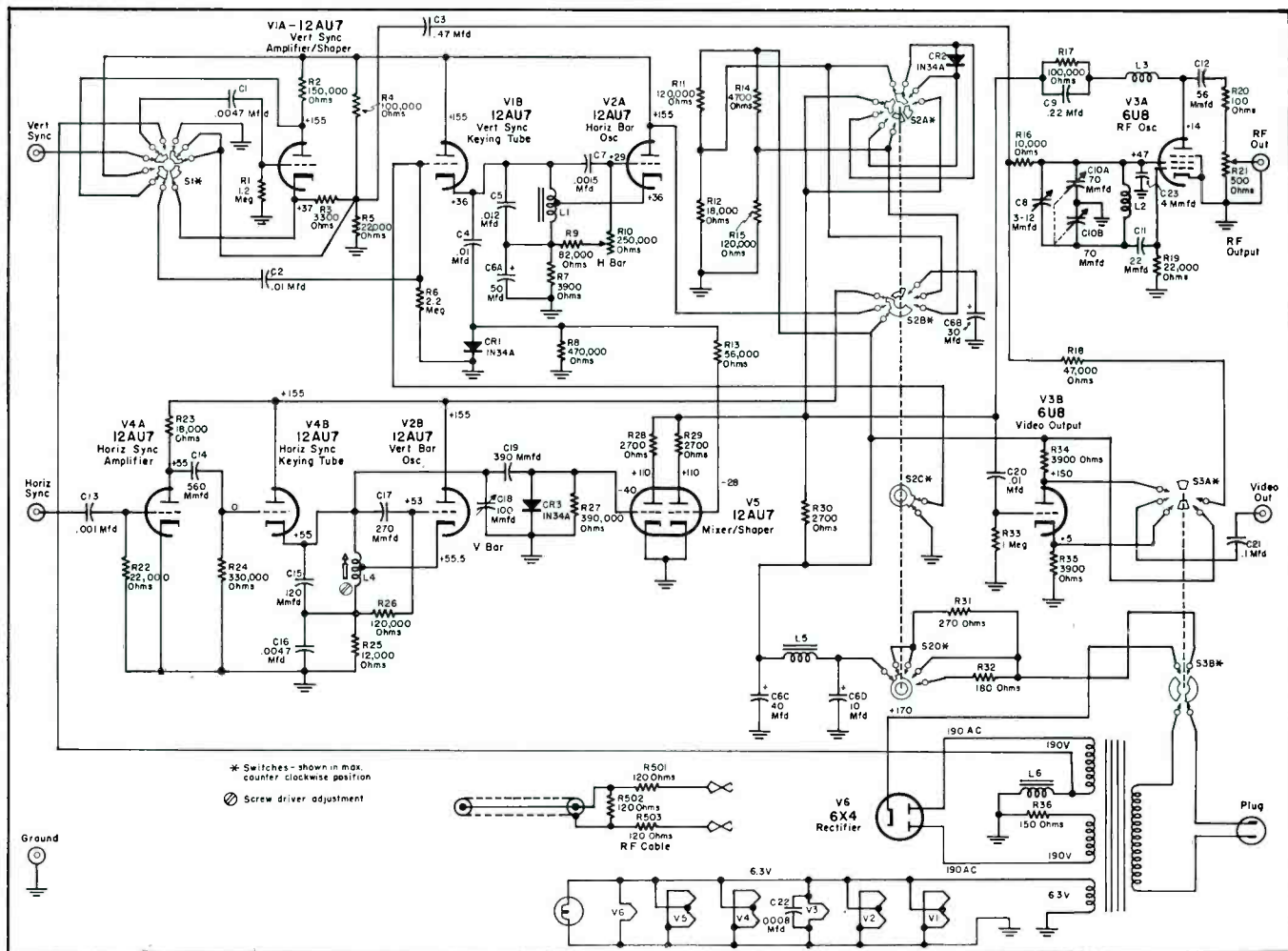

Above: Complete schematic of RCA dot-bar generator; WR-36A. Below: Complete schematic of WR-61A color-bar generator.

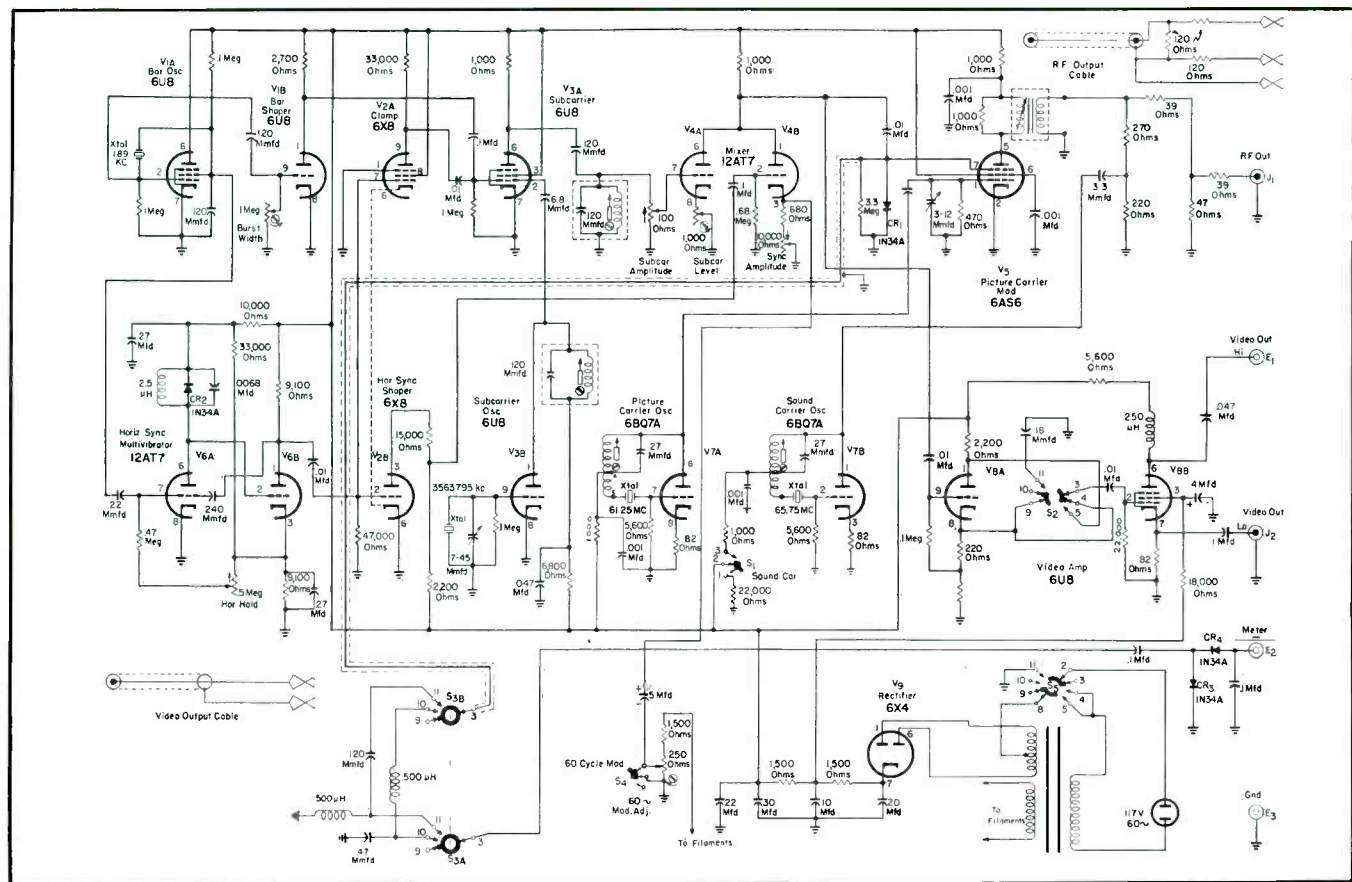

from

DELCO RADIO...

One of the Largest Makers
of High Quality

SPEAKERS

for Home and Auto Radios,
Phonographs and Television

Product of combined Delco Radio and General Motors engineering skills, manufactured in plants devoted exclusively to electronic parts, the Delco speaker line embraces 14 standard models for home and auto radios, phonographs, and television—plus the model 8007, a superior Hi-Fi dual-purpose speaker for replacement in AM, FM, TV and phonograph sets, and for use with custom-built high-fidelity audio systems. It's plain to see that here's the speaker line to fill your needs... products of uniformly fine design and construction, *all* of them competitively priced!

Standard Speaker Features: Designed and built to R.E.T.M.A. standards; cones uniform in response over operating frequency range; fully dustproofed with drawn brass magnet covers and felted cones; Alnico-V magnets; heavily plated metal parts.

Model 8007 Hi-Fi Speaker Features: Size 8"; 50 to 12,500 CPS frequency range; Alnico-V magnet; 10-watt power rating; 4.1 input impedance; $1\frac{3}{16}$ " voice coil.



DELCO RADIO

DIVISION OF GENERAL MOTORS, KOKOMO, INDIANA

A GENERAL MOTORS PRODUCT   A UNITED MOTORS LINE

DISTRIBUTED BY ELECTRONICS DISTRIBUTORS EVERYWHERE

Order these quality products of a volume electronics manufacturer through your UMS Electronic Parts Distributor today.

Small
in size and cost
Big
in performance



**American's NEW
TAPE RECORDER
MICROPHONE**

Here's a new standard for high fidelity convenience . . . for the home or small studio. Attractively styled, and available in matching colors, this sensational new lightweight champ delivers a heavyweight performance throughout the entire tone range. Omni-directional pick-up pattern provides uniform fidelity when more than one performer or participant is being recorded at one time.

Versatility underscores the modern functionalism of this new design. It weighs only 2 ounces, only 3 3/8 x 2 1/4 x 1/4 inches in size . . . can be easily handled and used by standing persons, or it can be rested on a flat surface for conference type pick-up such as conference recording.

Quality in construction means quality in tonal reproduction. The microphone element is shielded, with very low hum pick-up. Model B-203, ceramic type, and Model X-203, crystal type are both available with RCA type or miniature phone plugs.

For high fidelity sound that is reproduced to last, use American tape recorder microphones.



full vision . . .
full sound . . .
where fidelity
speaks for itself!

American
microphone
company

370 South Fair Oaks Ave., Pasadena 1, Cal.

AN ELGIN NATIONAL WATCH
COMPANY AFFILIATE

Color-TV Instruments

(Continued from page 44)

horizontal scanning rated of 15,570 cycles is used in the generator.)

The offset-subcarrier method is based on experimental observation that a rainbow of colors can be produced by simply applying a *cw* signal of 3.58 mc minus 15,570 cycles (or 3.58 mc plus 15,750 cycles) to the video input of a color receiver.

Using a frequency of 3.58 mc minus 15,570 cycles, the rainbow appears as indicated roughly in Fig. 6 (p. 43). (With a frequency of 3.58 mc plus 15,750 cycles, the order of colors is reversed, with green on the left, blue in the center, and red on the right.) Yellow hues are lost because they occur during the horizontal-retrace period.

The frequency of the subcarrier in the color-bar generator is offset on the low-frequency side. The exact frequency is 3.579545 mc minus 15,750 cycles, or 3.563795 mc. This signal has a maximum production tolerance of ± 20 cycles.

When the offset-subcarrier signal is applied to the video amplifier of a color receiver, each of the demodulators in the set receives two different signals as indicated in Fig. 7 (p. 44): (1) a signal of 3.58 mc from the local color oscillator in the receiver, and (2) a signal of 3.58 mc minus 15,750 cycles, from the external oscillator.

Because there is one cycle difference between these two signals in each complete horizontal scanning-line period, each demodulator produces a sine-wave output of one cycle-per-line, or 15,750 cps. (A portion of each cycle is lost due to blanking during flyback time.) The relative phasing of the output signal is different at each demodulator, owing to the difference in phasing of the signals from the local 3.58-mc oscillator at each demodulator.

The signals developed at the grids of the picture tube, and the resultant pattern on the tube, are indicated in Fig. 8 (p. 44). The red signal is positive over the left-hand half of each horizontal scan, with peak amplitude (and maximum red brightness) at the quarter-way point. The blue signal is positive over the center-half of each horizontal scan, with peak amplitude (and maximum blue brightness) at the center. The green signal is positive over the right-hand third of each horizontal scan, with peak amplitude (and maximum green brightness) at the right-hand edge. The areas where red and blue overlap have magenta

hues. The areas where blue and green overlap have cyan hues.

It can be observed in Figs. 8 and 9 that, with the offset-subcarrier method, one complete 360° rotation of color phase is assured for each complete horizontal scanning-line period.

In considering means for identifying different color-phase angles, especially the demodulation angles, it was noted that the R-Y, B-Y, and G-Y angles are located at or very close to multiples of 30° from burst, while the I and Q angles are only 3° off from 30° multiples. Hence, it was evident that identification should be provided at 30° phase intervals referenced to burst phase.

Since, with the offset-subcarrier method, the time for one complete 360° rotation of color phase is the same as for one complete horizontal scanning-line period, the required identification can be provided by

**DON'T
JUST SAY
CAPACITORS**

Ask For
Sprague
By Catalog
Number

Know what you're getting . . .
get exactly what you want.
Don't be vague . . . insist on
Sprague. Use complete radio-
TV service catalog C-610. Write
Sprague Products Company,
61 Marshall Street, North
Adams, Massachusetts.

SPRAGUE[®]
WORLD'S LARGEST
CAPACITOR MANUFACTURER

**don't
stand on your
head!**

let the
MASTER
show you the
easy way . . .
see pg. 78



using a square-wave signal to gate the subcarrier on and off at a rate to produce 12 bursts, or bars, of subcarrier signal in each complete horizontal line period (or in each 360° of color phase rotation). In this way, the bars of subcarrier signal can be accurately spaced at 30° phase intervals. The required gating frequency, for a horizontal scanning rate of 15,750 cycles, is 12 x 15,750 cycles or 189 kc.

Other steps in development included crystal control for the offset-subcarrier oscillator, and the addition of horizontal sync pulses obtained from a multivibrator triggered by every 12th cycle of the 189-kc subcarrier gating signal, which is also of crystal accuracy to insure correct offset. One of the 12 bars of subcarrier signal is blanked out to provide space for the horizontal sync pulse.

As a result of the previously described developments, the offset-subcarrier method was transformed from a lab novelty to a stable and precise method for checking and adjusting demodulator phasing. In addition, the horizontal sync pulses, which pass through the luminance channel in the receiver, provide a luminance reference level for checking matrixing.

Further steps in development included the addition of: (1) controls to adjust the duration of the color bars to produce a standard duration burst of eight cycles; (2) luminance signals at the edges of the color bars to aid in checking the registration or fit (relative time delay) of the luminance and color signals as they appear on the picture tube. (The luminance signals produce a thin dark vertical line on the left-edge of each color bar, and a thin white vertical line on the right-edge of each color bar.) And (3) a 60-cycle luminance signal that produces a horizontal area of increased brightness across the color-bar pattern. This signal provides a check on amplitude distortion in the receiver by showing whether the hue of the color bars change in the light and dark areas. This luminance signal can be switched off. In addition, there were included controls for adjusting the amplitudes of the offset-subcarrier and the horizontal sync pulses, and a rectifier circuit for metering these amplitudes. Front panel control of the subcarrier amplitude (including the bar that acts as the reference color-sync burst) provides a good check on ability of the color sync circuits in the receiver to hold on burst signals of less-than-normal amplitude, a condition en-

(Continued on page 50)



STOP using compromise antennas

NOW THERE'S A
TRAPPER®
FOR EVERY AREA!

SUPERTRAPPER
A dependable fringe and extreme-fringe antenna for reception of channels 2 through 13.
Cat. No. 1890—Single Bay Super Trapper
Cat. No. 1892—Stacking Line peaked for high-band
Cat. No. 1883—Stacking Line peaked for low-band

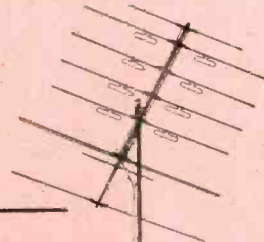

TRAPPER
No. 1 choice of the trade for medium to fringe area reception of channels 2 through 13.
Cat. No. 1880—Single Bay Trapper
Cat. No. 1882—Stacking Line peaked for high-band
Cat. No. 1883—Stacking Line peaked for low-band



New! TRAPPER® ROYAL

A new Taco Trapper design providing greater gain on channels 2 through 6 and high-band channels 8 through 13. Another Taco area-tored antenna, designed to provide better reception in every locality.
Cat. No. 2885—Single Bay Trapper Royal
Cat. No. 2887—Stacking Line peaked for high-band
Cat. No. 2888—Stacking Line peaked for low-band

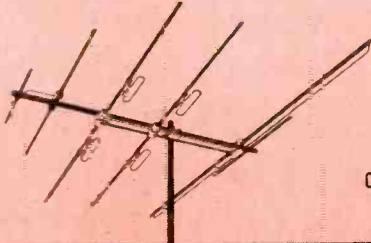

TRAPPER JR.
Streamlined, compact design for channels 2 through 13 in strong to medium signal strength areas. An excellent antenna for attic installations in metropolitan areas.
Cat. No. 1870—Single Bay Trapper Jr.

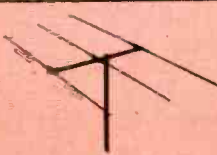

GET COMPLETE DETAILS ON THE TRAPPER BEST SUITED TO YOUR NEEDS FROM YOUR TACO DISTRIBUTOR



TACO TECHNICAL APPLIANCE CORPORATION
SHERBORNE, N. Y.

for servicing **color**

YOU NEED SOMETHING EXTRA

For instruments actually *ahead* of today's circuitry ... ready for the day when color TV becomes as general as today's black-and-white sets ... look at the Hycon line, designed with the electronic serviceman in mind. Accurate enough for critical work in the shop, you'll also find these test instruments rugged, compact, lightweight... just what you need for those money-making house calls.

MODEL 616 COLOR-BAR/DOT GENERATOR

... for adjusting and testing color receivers and transmitting equipment by manufacturer, station or serviceman. Features: Seven output forms of bars, dots, cross-hatch, phase and color-difference signals, including NTSC color bars.

PANEL PRESENTATION SHOWS ACTUAL COLOR AND SEQUENCE OF GENERATOR OUTPUT. \$415⁰⁰



MODEL 614 VTVM

Convenience at unprecedented low cost sums up this rugged, serviceable instrument. Hycon *plus* features include: 21 ranges (28 with peak-to-peak scales); large 6½" meter; 3% accuracy on DC and ohms, 5% on AC; AC frequency response to 250 mc (auxiliary probe extra) AND TEST PROBES STOW INSIDE CASE, READY TO USE. \$87⁵⁰

MODEL 617 3" OSCILLOSCOPE

Designed both for color TV servicing and laboratory requirements. Features high deflection sensitivity (.01 v/in rms); 4.5 mc vertical bandpass, flat within ±1 db; internal 5% calibrating voltage.

Small, lightweight ... but accurate enough for the most exacting work.

SPECIAL FLAT FACE 3" CRT PROVIDES UNDISTORTED TRACE EDGE TO EDGE. \$269⁵⁰



See these latest Hycon money-makers — all in matching, bench-stacking cases — at your local electronic parts jobber.

Hycon

ELECTRONICS, INC.

321 SOUTH ARROYO PARKWAY
PASADENA, CALIFORNIA

A SUBSIDIARY OF HYCON MFG. COMPANY

Color-TV Instruments

(Continued from page 49)

countered in some receiving locations due to multipath reception. Also, a crystal-controlled *rf* oscillator operating at the picture-carrier frequency of channel 3 was provided. This carrier is modulated by the composite video signal. *Rf* output is essential for checking the overall operation of color receivers. (High and low-impedance video outputs were also built in to permit checking of color video monitors, and for troubleshooting the video portion of color receivers.) Finally, an unmodulated crystal-controlled *rf* oscillator, operating at the sound-carrier frequency of channel 3, was supplied. This carrier can be switched on and off to aid in checking beat interference between the offset-subcarrier and the sound carrier. The sound carrier is essential to insure correct adjustment of the fine tuning control when checking a color receiver.

The waveform of the offset-subcarrier and the horizontal sync pulse in the bar generator is shown in Fig. 9 (p. 44). There are 11 bars of offset-subcarrier signal in each horizontal scanning-line period; the 12th bar is removed to accommodate horizontal sync. The bar immediately following horizontal sync functions as the reference color-sync burst. The timing of this burst, with relation to horizontal sync, is within FCC standards. The remaining 10 bars produce output from the demodulators, as shown in Fig. 10 (p. 44).

Earlier, it was mentioned that the first bar of the offset-subcarrier signal, following horizontal sync, acts as the reference color-sync burst. The local 3.58-mc oscillator in the receiver *locks up* on the average phase of this bar, which remains the same from line to line. In receivers that have a phase detector and a reactance-tube-controlled 3.58-mc oscillator, the correction voltage is the same with the off-set subcarrier as it is with the standard color-subcarrier frequency. In receivers that utilize a *ringing* or injection type of 3.579545-mc color-reference source, the pass band for the gated burst is narrow and hence provides an averaging effect of phase, equivalent to the phase at the center of the burst.

One may wonder why the black and white horizontal scanning rate of 15,750 cycles was selected instead of the color rate of 15,734 cycles.

This was done to prevent averaging out (on the picture tube) of beat in-

interference between the subcarrier and the unmodulated sound carrier; the color horizontal scanning rate was chosen to minimize this beat. Unless the beat is visible, the user is unable to determine the correct adjustment for the fine-tuning control when checking or adjusting a receiver. If the beat is visible (not averaged out) one can adjust the fine-tuning control accurately by tuning for minimum-intensity beat.

Vertical sync pulses have been intentionally omitted in the generator to aid in revealing any residual visible hum in the receiver.

Bar Generator Waveforms

The waveform patterns shown in Fig. 11 illustrate the operational characteristics of the instrument.

For example, at the output of an R-Y demodulator (or at the red grid), the third and ninth bars should have maximum amplitude, while the sixth bar (B-Y) which is 90° out of phase, should be zero.

Conversely at the output of a B-Y demodulator (or at the blue grid), the sixth bar should have maximum amplitude, while the third and ninth bars (R-Y) which are 90° out of phase from B-Y, should be at zero.

The method of using the horizontal sync pulses as a luminance reference level, for checking matrixing, is shown in the three lower waveforms of the drawing.

Fig. 11. Idealized representation of waveshapes produced by the bar generator at output of the I, Q, R-Y and B-Y demodulators at the picture-tube grids.

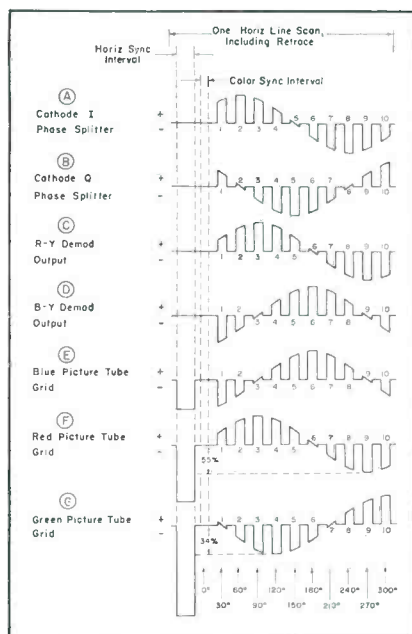



ALL-ALUMINUM Conical ANTENNAS



*Opens as easily
as an
umbrella*

WITH THE NEW AND AMAZING







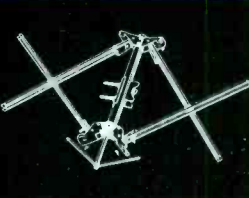
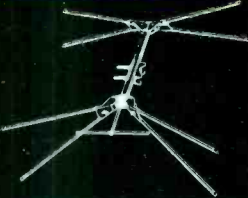

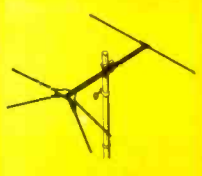
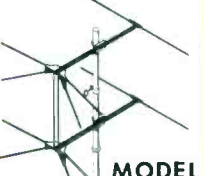

"Presto"

INSTANT MOUNT ASSEMBLY

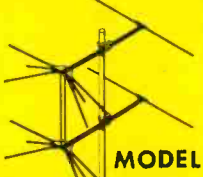
Complete line of 16 full size, completely pre-assembled conical antennas with doweled elements and malded plastic insulator of high impact polystyrene. See new Tenna catalog.

REMOVE FROM BOX • OPEN ELEMENTS • AND PRESTO, IT'S READY!

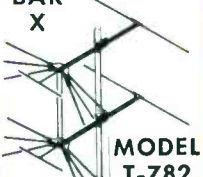
 MODEL T-801 \$417 <small>LIST</small>	 MODEL T-802 \$875 <small>LIST</small>	 MODEL T-811 \$500 <small>LIST</small>	 MODEL T-812 \$1042 <small>LIST</small>
 MODEL T-791 \$444 <small>LIST</small>	 MODEL T-792 \$931 <small>LIST</small>	BAR X  MODEL T-751 \$556 <small>LIST</small>	BAR X  MODEL T-752 \$1153 <small>LIST</small>
BAR X  MODEL T-781 \$556 <small>LIST</small>	BAR X  MODEL T-782 \$1153 <small>LIST</small>	BAR X  MODEL T-851 \$472 <small>LIST</small>	BAR X  MODEL T-852 \$986 <small>LIST</small>

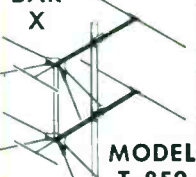
Tenna Manufacturing Co.

7580 GARFIELD BLVD. • CLEVELAND 25, OHIO

Interpreting VOM Measurements

Complete Explanation of Instrument's Design, Operation, Accuracy Considerations and Applications... Use of Shunts and Multipliers . . . AC/DC Measurements . . . Circuitry Variations

by **NORMAN CROWHURST**

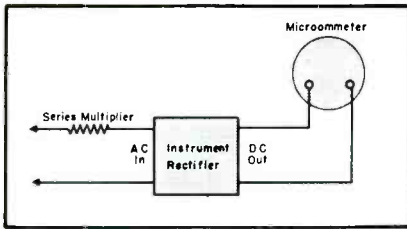

Fig. 1. Basic arrangement of series multiplier and instrument rectifier in making ac measurements.

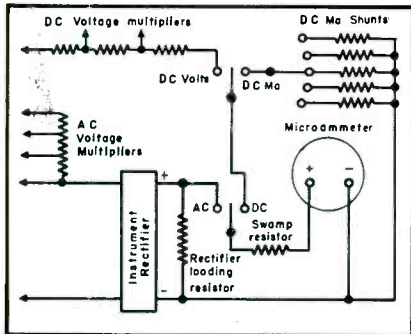

Fig. 2. General arrangement of multi-range instrument for ac and dc measurements, showing position of various shunts and multipliers in circuit, and of the copper swamp and the rectifier-loading resistors.

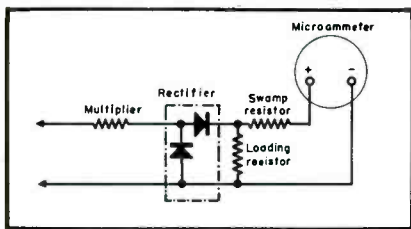

Fig. 3. One arrangement of an instrument rectifier. This has the advantage that one side of both ac input and dc output may be grounded.

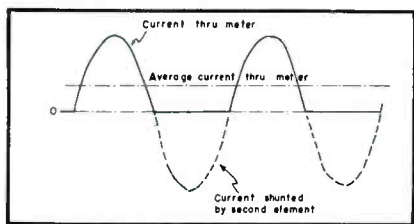
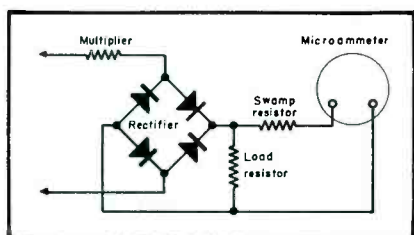

Fig. 4. Waveform of current delivered to microammeter with the circuit of Fig. 3, from a sinusoidal voltage input.



IN PRECEDING INSTRUMENTATION reports, it was noted that no two instruments normally provide exactly the same reading when measuring the same voltage. This condition usually prompts one to wonder just what we can trust. There are, of course, standard instruments which can be used as a reference to obtain greater accuracy than the routine bench-type instruments can provide. However, the cost of such standards usually eliminates their use. Thus the most sensible thing one can do is to use a good instrument and bear in mind its accuracy characteristics.

Some may be wondering why instruments are not made with an accuracy comparable to standard instruments. The answers to this appear in the assorted problems that face an instrument maker.

In the first place, to obtain good initial accuracy, standards are required against which to calibrate the instrument. Where does one find a standard volt or a standard amp, against which to calibrate instruments? All standards used, the standard volt, amp and ohm, are not in a form suitable for application to a direct-reading instrument.

The volt is obtained from a standard cell of which a variety are available, but each of them gives an odd fraction, such as 1.083 volts, for the cell. And other voltages must be standardized against this by some method of comparison, such as the *dc* potentiometer, a device for the measurement of voltage similar to a

bridge for the measurement of resistance.

The standard ampere is defined in terms of the amount of metal that the current will deposit when passed through an electrolyte solution. So to obtain an accurate standard of current, a steady value must be maintained through the solution for an accurately-determined amount of time, to weigh the amount of metal deposited and determine the current value.

The standard of resistance is defined in terms of a column of mercury at a specified temperature and of specified dimension.

From the foregoing, it will be realized that the forms used as international standards for the various units are not practical for every-day measurements. These standards are used for the calibration of special instruments designed to maintain a high degree of accuracy over long periods of time, and which are calibrated so that it is possible to compensate for conditions that can change accuracy.

If one wants to know the value of a resistance accurate to three significant figures, for example 582 ohms correct to the nearest ohm, one should not use an ohmmeter to find this value, but an accurate resistance bridge. Similarly, for accurate measurements of voltage and current, a standard of measurement closer than an average *vom* must be used to find the accurate value. But, for most service requirements, measurements

(Continued on page 54)

Fig. 5 (left). Alternative instrument rectifier arrangement, that provides full-wave rectified current through the microammeter.

Fig. 6 (right). Waveform of current delivered to microammeter with the circuit of Fig. 5, from a sinusoidal voltage input.

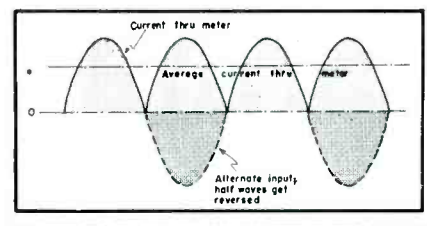

Captures *All* the Picture . . . every tone . . . every detail . . . brilliantly!



A picture of unsurpassed realism—every tone, every detail brilliantly portrayed . . . that's what you see when you view television created by the Tung-Sol Magic Mirror Aluminized Picture Tube.

Because the Magic Mirror brings into play a much wider range of intermediate tones, every detail is caught. The new depth, sharper contrast and lively, life-like sparkle you see make ordinary pictures seem faded and flat.

Hundreds of exacting tests from raw materials to finished tubes—plus a constant vigil of quality control during the entire manufacture—guarantee the uniformly superior performance of the Magic Mirror Aluminized Picture Tube.

When you're replacing picture tubes, make sure you



install this finer Magic Mirror Aluminized Picture Tube. Ask your Tung-Sol supplier for details about the big new promotion program that will make Magic Mirror one of your biggest selling items.

TUNG-SOL ELECTRIC INC., Newark 4, N. J.

Sales Offices: Atlanta, Chicago, Columbus, Culver City, Dallas, Denver, Detroit, Newark, Seattle.



Miniature Lamps



Sealed Beam Headlamps



Signal Flashers



Radio And TV Tubes



Aluminized Picture Tubes



Special Purpose Tubes



Semiconductors

NOW! TEST TUBES IN SECONDS! MAKE NEW PROFITS *in MINUTES!*



on every
service call



B&K NEW PORTABLE
DYNA-QUIK MODEL 500
DYNAMIC MUTUAL CONDUCTANCE TUBE TESTER

ONLY
\$109⁹⁵ NET

Now you can easily cut servicing time—make more on-the-spot tube sales—prevent costly call-backs—and give a better service guarantee! DYNA-QUIK—the new top quality, low cost, portable tester quickly locates all weak and in-operative tubes—and easily does the complete job with laboratory accuracy right in the home! You create greater customer confidence because your customer sees for himself the true tube condition. Easy to operate—in just a few minutes you can quickly check all the tubes in a TV set. You can depend upon DYNA-QUIK because it tests under the dynamic heavily loaded conditions that are the actual operating conditions of the set. At such low cost DYNA-QUIK quickly pays for itself—and continues to make money for you every day!

DYNA-QUIK DOES IT FASTER, EASIER, MORE ACCURATELY

- Makes complete tube test in as little as 12 seconds per tube—faster than any other tester!
- One switch tests everything! No multiple switching—no roll chart.
- Laboratory accuracy right in the home! Large 4½" plastic meter has two scales calibrated 0-6,000 and 0-18,000 micromhos.
- Shows customer true tube condition and life expectancy on "Good-Bad" scale!
- Automatic line compensation! Special bridge continuously monitors line voltage.
- 7-pin and 9-pin straighteners mounted on panel!
- Never Obsolete! New overlay panels with up-to-date markings available from factory, when required.

TESTS 99%

OF ALL TUBES*
in use today for:

**DYNAMIC
MUTUAL CONDUCTANCE
SHORTS
GRID EMISSION
GAS CONTENT
LEAKAGE
LIFE EXPECTANCY**

*Including new 600 mil series tubes.

PORTABLE—CAN BE USED ANYWHERE

Handsome, rugged, luggage style carrying case, covered in durable, black leatherette. Removable slip-hinged cover. Size: 15¼ x 14½ x 5¾ in. For 105-125 volts, 60 cycle, A.C. Net wt. 12 lbs.

SEND FOR BULLETIN 500-S

Made by the makers of
the famous CRT 350



B & K MANUFACTURING CO.
3726 N. SOUTHPORT, CHICAGO 13

VOM Measurements

(Continued from page 52)

to this order of accuracy are quite unnecessary, and a good quality of vom is quite adequate for practically all applications.

Basic Instrument Accuracy Factors

The accuracy of the basic meter, which is simply a microammeter, is determined by the accuracy with which the scale is calibrated. Then, after calibration, there are things that can happen to deteriorate the accuracy.

For instance, if the strength of the control spring, that returns the instrument pointer to zero when a voltage is removed, changes, due to temperature variations or aging of the spring, the accuracy of the instrument will be affected.

Alternatively, if the magnetic field in the air gap of the instrument changes, due to the magnet strength deteriorating with age, the accuracy again will be affected.

If temperature changes have any affect on either the magnetic strength or the torsion of the spring, this will affect the accuracy in a manner dependent on temperature.

Another thing which can affect the accuracy of the instrument is the balance of the movement. A good instrument is balanced in such a manner that gravity does not have any affect. When this is done, the instrument will give the same reading at any position of the scale, whether the meter is laid down or stood up or held in any position. This means that the movement has to be perfectly balanced so that gravity does not pull the pointer one way or the other, and the only controlling force on the pointer is provided by the control springs.

Any form of misuse, such as banging of the pointer against the end stop, by applying a voltage too high for the range to which it is set, may disturb the balance of the instrument. The zero can be reset by means of the zero adjustment on the instrument. But, the accuracy can also be upset because gravity will now exert a partial control, whereas in the original condition it did not.

The basic microammeter around which the multi-range meter is built, is usually specified as having an accuracy of $\pm 2\%$. This means that the reading at any point on the scale will be within $\pm 2\%$ of the current required to give a full scale reading. If the instrument is specified as hav-

ing a *dc* sensitivity of 20,000 ohms per volt, the full scale will be achieved with 50 microamps. And 2% of 50 microamps is 1 microamp. This means that, using a scale calibrated 0-50, the reading is accurate within one microamp at any point on the scale.

Usually instruments of this type have an accuracy much closer than this, in their initial condition. The 2% accuracy tolerance is intended to allow for deviation with aging, as well as for deviation in production calibration. In some instruments, 2% could mean that the instrument may be in error by as much as this when it is new. And this is a legitimate interpretation of the specification. But a quality instrument will hold its accuracy, and to insure that the accuracy held is always within 2% manufacturers endeavor to maintain a much closer tolerance than this during production.

Shunts and Multipliers

So much for the basic microammeter around which the *vom* is built. To establish the *vom*, a battery of shunts and multipliers has to be added. These are resistance wire wound and kept within a tolerance, usually of the order of 1%.

This is an additional 1% to the 2% already allowed for the microammeter. Suppose the error in the microammeter is in one direction, and the error in the resistor is in the opposite direction. For example, if the microammeter reading is 2% high, and the current due to an applied voltage is additionally 1% high, the total error will then be 3% high. This means that the guaranteed accuracy of an instrument specified as $\pm 2\%$ on the basic microammeter will be $\pm 3\%$ on the *dc* range, including voltage and current ranges.

Since the error in current due to the tolerance on the multiplier resistors is a fraction of the current actually passing, and not of the full scale current, we thus find that, at half scale reading, the maximum error would be 2½% of full scale reading.

This tolerance on shunt and multiplier values is designed to take care of not only of errors in production, but also of changes in temperature, since all resistance wires possess a temperature coefficient, which alters the absolute resistance value as the temperature changes. As it is, with the current through the microammeter which causes the reading, and

(Continued on page 78)

Plagued by Call Backs?



Be Right with
OHMITE®

DEPENDABLE REPLACEMENTS

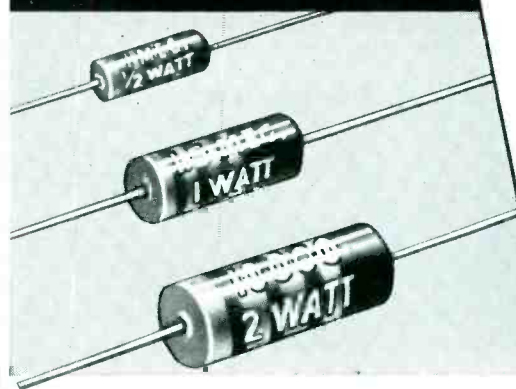

Little Devil.
COMPOSITION RESISTORS

meet all MIL-R-11A requirements... are completely sealed and insulated by molded plastic. Rated at 70C rather than 40C. Available in ½, 1, and 2-watt sizes in all standard RETMA values.

Other Ohmite Products available from your Electronics Parts Distributor...

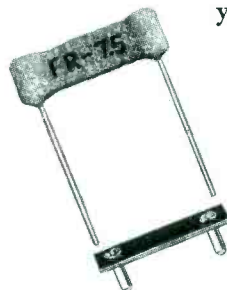

FR-7.5 FUSE RESISTOR
for replacement in all television receivers.



TYPE AB POTENTIOMETERS
Solid molded. Noise-free. Rated at 2-watts.



BROWN DEVIL® RESISTORS
Vitreous enameled, in 5, 10, and 20-watt sizes.

OHMITE®

WRITE FOR STOCK CATALOG

OHMITE MANUFACTURING COMPANY
3642 Howard St., Skokie, Ill.
(Suburb of Chicago)



ANNOUNCING THE

Trio Zephyr Royal

THE FIRST STAGGER-TUNED TELEVISION ANTENNA

Patent No. 2,703,840



*What Hi-Fi brings to Audio
Stagger-tuning
brings to TV Antennas!*



Pre-Assembled—Uses TRIO's famous Insta-Lok Clamps. Sturdy—Rugged—Compact and it's patented too!



MODEL ZR-1
\$34⁹⁵ LIST

The ZEPHYR ROYAL employs three "wing" dipoles, stagger-tuned, to provide even higher and more uniform gain, absolute flat response on all channels 2-13—a necessity for color TV. It is tuned on six pre-determined frequencies in the same way that stagger-tuned circuits are used in I.F. stages in TV receivers.

The ZEPHYR ROYAL is not just an addition to the famous TRIO ZEPHYR, but is a completely new electrical design. Parasitic elements are used ONLY where they contribute to the efficiency of the antenna's electrical design—not just for promotional purposes.

A new phasing method provides increased directivity—and functions equally well on the highs as well as the lows.

The elimination of minor lobes, to an extent never before realized in an all-channel antenna, finally banishes all co-channel interference. All of the gain is packed into one efficient forward lobe.

Try a new TRIO ZEPHYR ROYAL. You'll find that in gain and directivity it's the best all-channel TV antenna ever produced for color or black and white.

America's New Favorite

the Trio Zephyr

The antenna everyone's talking about! The ZEPHYR is a high performance, single lobe antenna, employing two revolutionary "wing" dipoles. Three half waves in phase, combined with an integrated director makes each dipole a uni-directional antenna on the high channels.

The ZEPHYR uses two "wing" dipoles, one resonated on the low ends of channels 2-6, and 7-13, the other on the high end of these channels. These composite dipoles, both driven, together with fully functional parasitic elements, produce the high performance to size ratio never before achieved in antenna design.

There's sharp directivity too, on all channels—comparable to a yagi.

TRIO believes that with the introduction of the ZEPHYR and the ZEPHYR ROYAL, the need for stacked arrays is eliminated.



TRIO® Manufacturing Company
GRIGGSVILLE, ILLINOIS

COPYRIGHT 1955—TRIO MANUFACTURING COMPANY

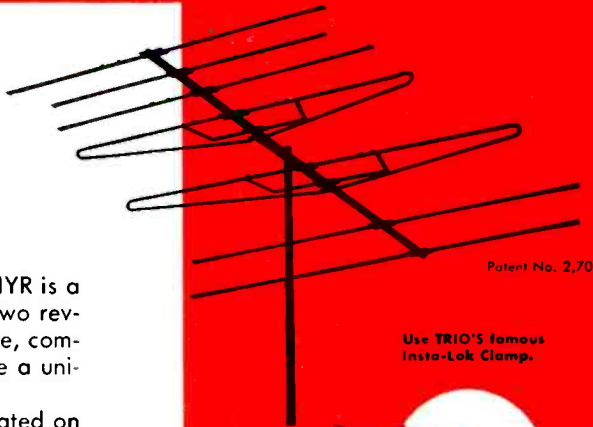

Patent No. 2,703,840

Use TRIO'S famous Insta-Lok Clamp.



It's Efficient!



It's Compact!



It's Patented, too!

MODEL Z-1 \$27⁹⁵ LIST

EXPORT SALES DIV., SCHEEL INTERNATIONAL INC., 4237 N. Lincoln Ave., Chicago, U.S.A. Cable Address: HARSHEEL

BLOOMING is a symptom which presents two principal definitive displays on the picture tube.

The common type of blooming appears in the form of an expansion or a contraction of the raster area whenever the controls are adjusted; usually the brightness or contrast controls have the predominant effect.

In the second type we see a variation in the size of the spot, with defocusing as a secondary symptom.

This type of blooming is caused principally by variations in the high-voltage and sometimes the low-voltage applied to the picture-tube electrodes. The voltages of the second (*hv*) and first anodes, and even the control grid may be sufficiently changed to vary the velocity of the electron beam, which also varies the linear dimensions of any picture. The line structure of a raster may be observed on a blank channel to eliminate the rather rare cases in which the video signal itself causes blooming. A partly gassy picture tube is very likely in such a case.

Poor regulation of the voltage supplies at the tube electrodes are the most common troubles, or direct causes. The exact localization of the actual cause is sometimes difficult, since the entire horizontal sweep circuitry may be responsible for such variation in the *hv* supply. Other variable loads on other sections of the set may vary the low voltage supply, with consequent blooming.

A weak picture tube operated with excessive grid drive can cause higher than normal beam current and a reduction in electrode voltages. This causes a lower velocity beam and therefore an enlarged picture. This condition occurs in spite of the fact that the currents are otherwise operating normally.

Either the low or the high voltages may be monitored at the tube electrodes, starting with either as personal preference indicates. For example, the *hv* at the second anode may be checked first while manipulating the contrast or brightness controls; a 10% variation is allowed.

If the variation is greater, then one must travel backward through the horizontal sweep section towards the horizontal oscillator. The next point to check might be the grid drive to the horizontal output tube, although some use the *hv* rectifier filament; the filament terminal to which the *hv* filter resistor is connected should be the one employed. If the variation is not substantial here, but more than appreciable at the second anode, the filter resistor should be suspected. In replacement, the *hv* type of resistor

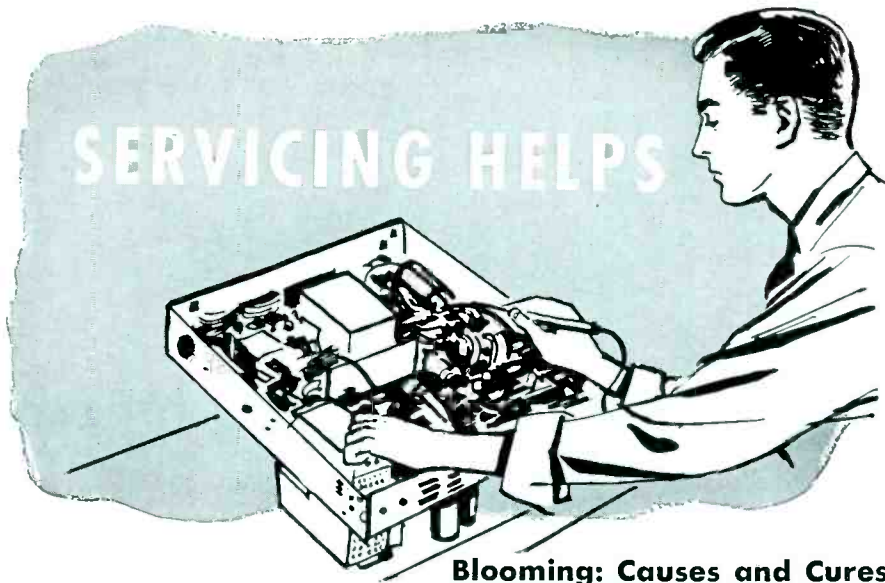

Blooming: Causes and Cures

must be used, or a callback will be very likely.

If the *hv* at the rectifier filament is poorly regulated, then the search must extend backwards to the entire horizontal system. The next step is a test at the horizontal output tube's control grid. One should use a voltmeter with a blocking capacitor. The *ac* input of the voltmeter should be monitored, while the brightness and contrast controls are manipulated. A change that is greater than 10% will be productive of blooming. It will be noted that the *ac* signal here eventually produces the *dc* high voltage for the second anode. If the variation is not excessive, then the trouble lies in the plate circuit of the horizontal output. A gassy vertical oscillator tube (only partly gassy in fact)

can cause a heavy drain on boosted B+. The boosted or bootstrap B+ is a measure of the horizontal output tube's regulation; it should not vary appreciably. If normal B+ is 350 v and the boost is up to 525 v, the variation would be 525 - 350 = 175 volts. To aid further localization in this complicated circuit, a voltmeter on *ac* and a test prod can be used; this unit should be clipped to the insulation of the output lead of the horizontal output tube. The insulation of the prod handle and the lead covering form a capacitance divider with the internal resistance of the meter. One must not move or touch the leads while the set is turned on. The controls should be manipulated

(Continued on page 66)

Fig. 1. Schematic of horizontal sweep system in Emerson 120220D chassis. Any reduction of the ac sweep signal will affect the high voltage; hence the entire horizontal sweep must be regulated. A indicates point at which test prod should be applied. B illustrates point where resistor should be supplemented by another to eliminate cause of blooming. Second resistor serves as a bleeder to ground or B- as necessary.

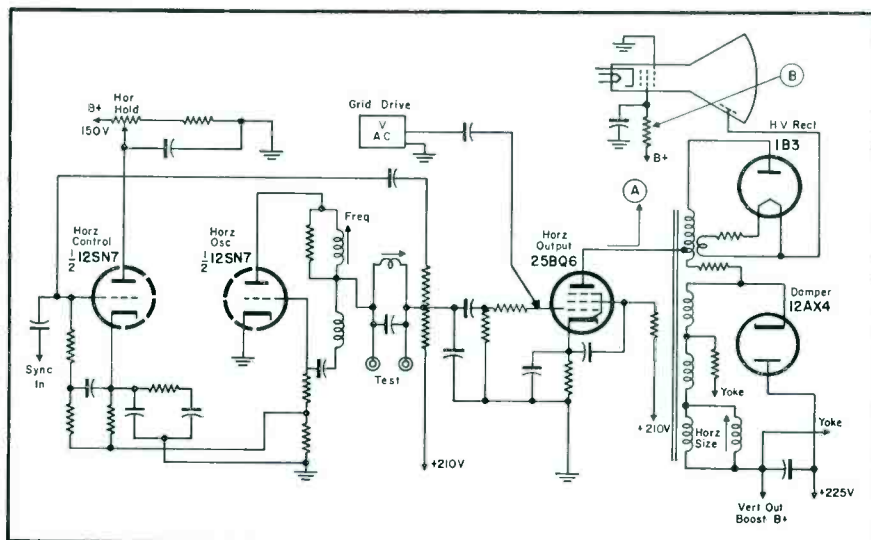

Field and Lab Tests that Are Used to

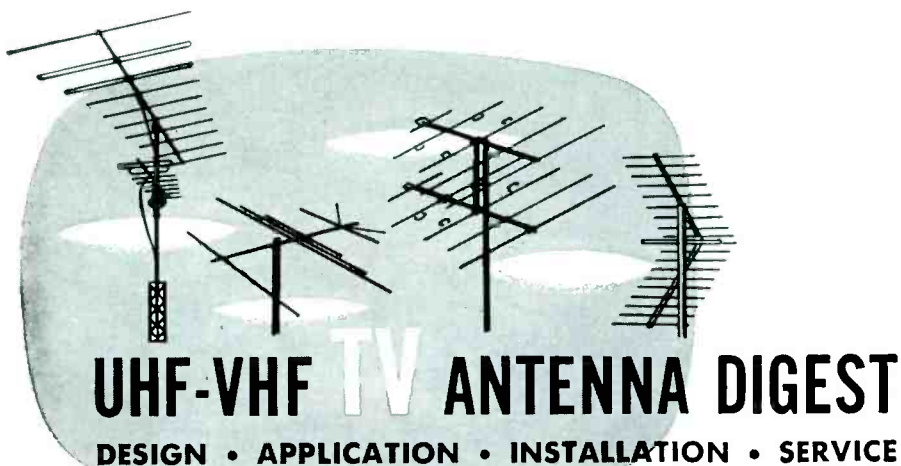

UHF-VHF TV ANTENNA DIGEST

DESIGN • APPLICATION • INSTALLATION • SERVICE

by G. N. CARMICHAEL and J. F. GUERNSEY

Engineering Department, Trio Mfg. Co.

THE TECHNIQUES and physical setup necessary for evaluating antenna performance are by no means simple. Certain standards have been fixed (by RETMA) for such testing in order that quantitative reports on antenna performance may have some meaning.

There are three important characteristics for measuring the performance of a TV antenna; relative gain, directivity, and voltage-standing-wave ratio (*vswr*) or impedance. Each of these is significant in determining the usefulness of a TV antenna for a particular application.

In antenna reports the term *db* occurs frequently, since it represents a comparison between two different voltages or powers. That is, for voltage ratios, *db* gain or loss equals $20 \times \log V_1/V_2$. For power ratios, *db* gain or loss equals $10 \times \log P_1/P_2$. It is not necessary to convert to *db* for a full understanding of antenna performance. However, it is convenient to have the ratio equivalent of some values. A condensed chart of voltage ratios, power ratios and *db* gain appears in table 1.

It is difficult to determine exactly the smallest variation in signal which will be readily apparent on a TV

screen. However, a change of 1 *db* could certainly not be detected even on a weak, snowy signal. A voltage gain of 2 *db* will be indicated on a weak signal by a decrease in the snow and a clearer outline.

Directivity is usually given only for a horizontal variation of the antenna; that is, the variation in signal voltage which is obtained as the antenna is rotated in a horizontal plane. Vertical directivity exhibits the same comparison, as the antenna is rotated from the horizontal through a vertical plane containing the boom of the antenna.

If an antenna is not perfectly matched to the feedline, standing

Channel	A	B	C
2	96.5	3"	1"
3	87.2	3"	1"
4	79.5	3"	1"
5	69.5	3"	1"
6	64.5	3"	1"
7	30.7	1 3/4"	1"
8	29.65	1 3/4"	1"
9	28.65	1 3/4"	1"
10	27.7	1 3/4"	1"
11	26.8	1 3/4"	1"
12	26.0	1 3/4"	1"
13	25.3	1 3/4"	1"

Dimensional data for Fig. 1.

waves will appear along the line. The ratio of maximum to minimum voltage occurring along this line is the *vswr*.

Antenna gain is shown by a comparison of the antenna under test with a series of reference dipoles or folded dipoles. Since we are interested primarily in 300-ohm antennas, the folded dipole, whose impedance is approximately 300 ohms, is used as a reference. Dimensions of such reference dipoles for channels 2 to 13 appear in Fig. 1.

The physical setup for such tests requires a transmitting antenna fed from a stable signal source, a receiving antenna spaced at least 10 wavelengths of the lowest transmitting frequency and at least a full wave above ground. For channels 2 to 13, with 54 mc as the lowest frequency, the transmitting and receiving antennas must be separated by at least 175' and the receiving antenna should be at least 17 1/2' above ground level. The voltage or power delivered by the antenna under test is measured by a field strength or intensity meter, suitably calibrated and matched to the antenna under test with a *vswr* of less than 1.3.

It is also necessary that the receiving antenna be in a homogeneous field. That is, the signal variation should not be more than 2 *db* when the reference dipole is moved within an area extending 1/4 wave in each direction beyond the space occupied by the antenna under test. This is much more difficult to obtain than might be expected. In verifying this, one observes the pattern of a folded dipole mounted 1/4 wave in front of the axis of rotation. If the field is uniform, a symmetrical two-lobed figure-8 pattern will be obtained. In case of a non-uniform field, usually produced by reflections, there will be some distortion of this pattern. For example, in Fig. 2, the solid curve

Figs. 1, 2, 3, 4, 5 and 6. Dimensions for standard reference dipoles appear in Fig. 1. The ideal versus experimental horizontal pattern of dipole is illustrated in Fig. 2. A horizontal directivity pattern is shown in Fig. 3, while Fig. 4 shows a vertical directivity pattern. Fig. 5 illustrates inferior gain due to sharp vertical lobe. Antenna test setup is shown in Fig. 6.

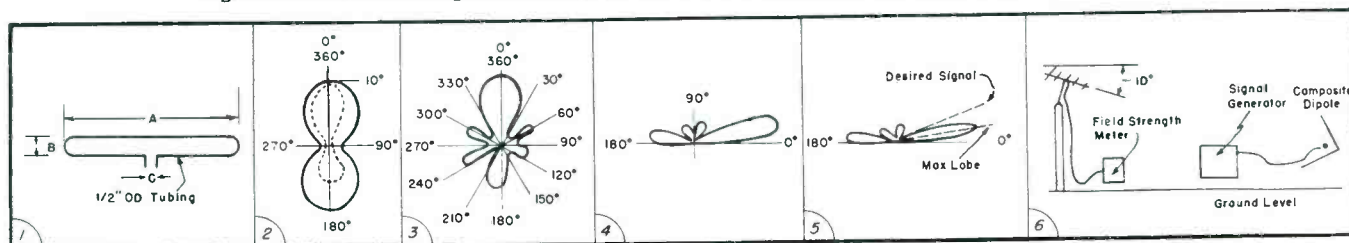

Evaluate TV Antenna Performance

shows the ideal case; the dotted line indicates the curve obtained when reflections are present. One would interpret the results from the dotted curve as indicating a front to back ratio of 2 db; although the antenna, a folded dipole, would obviously show no variation in gain between front and back.

The horizontal directivity of an antenna is important; typical field-results are shown in Fig. 3. This plot shows the relative power as compared with the maximum for a number of positions covering a 360° rotation of the antenna. The maximum was arbitrarily set at 10, and the readings at intermediate points show the relative power gain of the antenna. Readings are made at intervals of 10° from 0° to 360°. The readings must be taken at sufficiently close intervals to insure the inclusion of all lobes showing an amplitude greater than 10% of the maximum.

In addition to the horizontal pattern, the vertical directivity may also be shown; Fig. 4. Again this gives the comparison between signal voltages or power, usually from 0° to 180°.

The *vsur* is indicated either graphically or by a table which shows the frequencies for which these measurements are made. It consists of the ratios of maximum to minimum voltages developed along the feedline. A *vsur* of 1, of course, means a perfect match of the antenna to the feedline.

In each of the foregoing tests, on gain, directivity and *vsur*, sufficiently complete information must be given to cover the frequencies involved in the particular antenna under test. Tests must be made on the center frequency and, other than directivity, on the end frequencies of the channels involved. This means, for example, that in testing an antenna covering channels 2 to 13, it will be necessary to obtain 36 independent readings for gain and *vsur*, and 12 polar patterns for directivity.

It is not possible, even with much care, to duplicate precisely in the laboratory the conditions which exist in a field installation. For example, the setup will not, in general, take into account the varying vertical angles from which the maximum signal is received, especially in a fringe area. This may be a very significant factor. If an antenna has a single, sharp, vertical lobe, as indicated in Fig. 5, it might exhibit poor gain characteristics in an area where terrain or atmospheric conditions produced the maximum field from an angle outside that of the main vertical lobe. This explains, in many cases, why an antenna fails to perform in one particular area on one or more channels. However, except for such special cases, the antenna performance characteristics obtained by the procedures described will represent the expected performance characteristics of the average installation.

A typical setup employed in antenna tests is illustrated in Fig. 6. Here we have a foldover tower 50' high that serves as a mount for the receiving antenna. Although the tower is vertical, the mast for the receiving antenna is tilted approximately 10°. The transmitting antenna consists of a composite dipole with a corner reflector; this reflector consists of two halves, each 10' x 16' of 1" wire mesh, mounted with a 90° aperture, with the entire array tilted approximately 10° above the horizontal. This tilt is necessary so that the plane of the receiving antenna, which is above the level of the transmitting antenna, shall be co-planar with the plane of the transmitting antenna. Selsyn motors are used to provide an accurate direction indicator for the receiving antenna, which is rotated in a plane at an angle of 10° below horizontal. A short 300-ohm transmission line delivers the signal to a field-strength meter. To establish some factor to judge *vsur*, provision is made for continuously varying the length of the lead by an amount equal

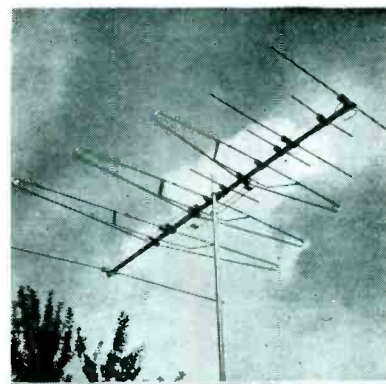

VHF antenna which features stagger-tuning and is said to be tuned to six predetermined frequencies. On the low band, model has three driven elements stagger-tuned to channels 2, 4, and 6, together with two directors and one reflector. Other than the wing dipoles, there are eight parasitic high-band elements. The three wing dipoles add to a total of nine driven elements pretuned to channels 7, 10, 13, driven in phase, together with three integrated directors, providing a total of eleven parasitic and nine active elements stagger-tuned.

to ½ wave of the lowest frequency involved; the length can be adjusted for maximum or minimum. In actual tests, the length of line can be adjusted for maximum signal on each channel, followed by an adjustment for minimum signal. Both values can be recorded; the average of the two is used as a final answer. Such tests have been found to approximate the conditions which may arise in the field. There may be as much as 2 db variations between readings obtained

(Continued on page 79)

Table 1: Ratio equivalents in db

Voltage Ratio	Power Ratio	Db Gain
1.00	1.00	0
1.06	1.12	.5
1.12	1.26	1
1.26	1.58	2
1.41	1.99	3
1.58	2.51	4
1.78	3.16	5
3.16	10.00	10
10.00	100.00	20

Figs. 7, 8, 9, 10 and 11. A lab setup for *vsur* tests is shown in Fig. 7; a *vsur* scope pattern appears in Fig. 8. Gain, horizontal pattern and *vsur* plots of a wing-dipole type antenna appear in Figs. 9, 10 and 11.

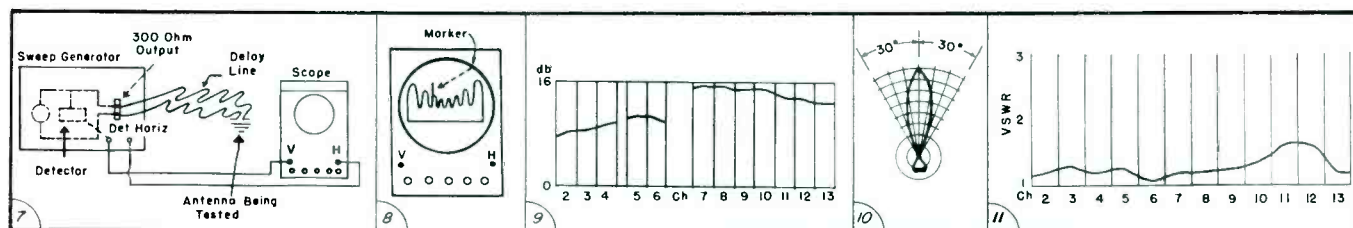

Superior's New Model TV-60

ALLMETER

The most complete all-purpose 20,000 Ohms per Volt Multimeter ever designed!

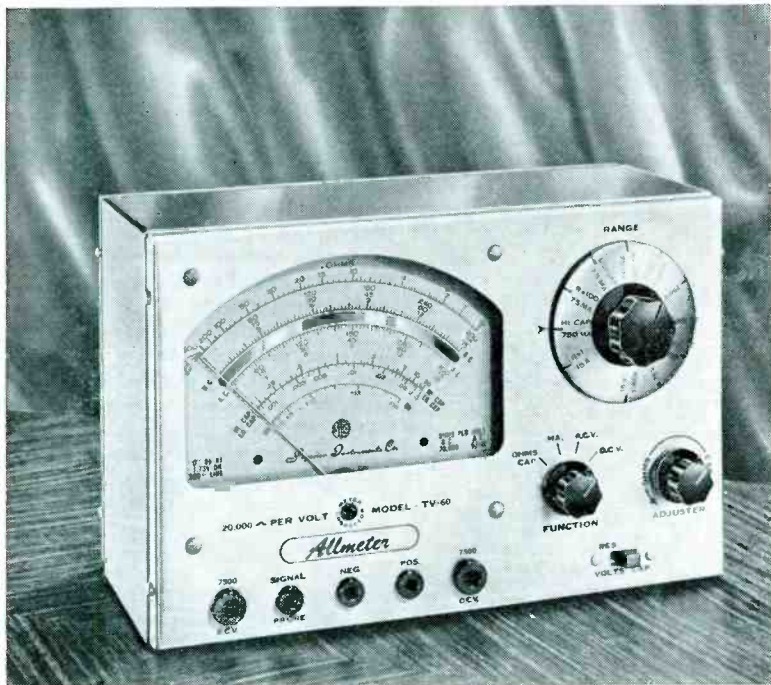

FEATURES

- ✓ Giant recessed 6½ inch 40 Microampere meter with *mirrored* scale assures accuracy and easy-reading. All calibrations are printed in large easy-to-read type. Fractional divisions are easily read with the aid of the mirrored scale.
- ✓ The line cord, used only when making Capacity measurements, need be plugged in only when using that service. It is out of the way, stored in its pliofilm compartment at all other times.
- ✓ A built-in Isolation Transformer automatically isolates the Model TV-60 from the power line when the capacity service is in use.
- ✓ Selected, 1% zero temperature coefficient metalized resistors are used as multipliers assuring *unchanging* accurate readings on all ranges.
- ✓ Use of the latest type of *printed circuit* guarantees maintenance of top quality standard in the production runs of this precise instrument.
- ✓ A new *improved* type of high-voltage probe is used for the measurement of high voltages up to 30,000 Volts. This service will be required when servicing color TV receivers.
- ✓ Simply plug-in the R.F. probe and convert the Model TV-60 into an efficient R.F. SIGNAL TRACER permitting the measurement of stage-gain and cause of trouble in the R.F. and I.F. circuits of A.M., F.M., and TV receivers.
- ✓ Plug in the Audio probe and convert the Model TV-60 into an efficient AUDIO SIGNAL TRACER. Measure the signal levels and comparative efficiency of hearing-aids, public-address systems, the amplifier sections of Radio & TV receivers etc.

- ✓ A sensitive, accurate Volt-Ohm-Milliammeter with *giant* meter and *mirrored* scale.
- ✓ An accurate direct-reading Capacity meter.
- ✓ A Kilovoltmeter.
- ✓ An R. F. Signal Tracer.
- ✓ An Audio Signal Tracer.

SPECIFICATIONS

- 8 D.C. VOLTAGE RANGES: (At a sensitivity of 20,000 Ohms per Volt) 0 to 15/75/150/300/750/1500/7500/30,000 Volts.
- 7 A.C. VOLTAGE RANGES: (At a sensitivity of 5,000 Ohms per Volt) 0 to 15/75/150/300/750/1500/7500 Volts.
- 3 RESISTANCE RANGES: 0 to 2,000/200,000 Ohms, 0-20 Megohms
- 2 CAPACITY RANGES: .00025 Mfd. to .3 Mfd. .05 Mfd. to 30 Mfd.
- 5 D.C. CURRENT RANGES: 0-75 Microamperes, 0 to 7.5/75/750 Milliampere, 0 to 15 Amperes
- 3 DECIBEL RANGES:
 - 6 db to + 18 db
 - + 14 db to + 38 db
 - + 34 db to + 58 db

R. F. SIGNAL TRACER SERVICE:

Enables following the R.F. signal from the antenna to speaker of any radio or TV receiver and using that signal as a basis of measurement to first isolate the faulty stage and finally the component or circuit condition causing the trouble.

AUDIO SIGNAL TRACER SERVICE:

Functions in the same manner as the R.F. Signal Tracing service specified above except that it is used for the location of cause of trouble in all audio and amplifier systems.

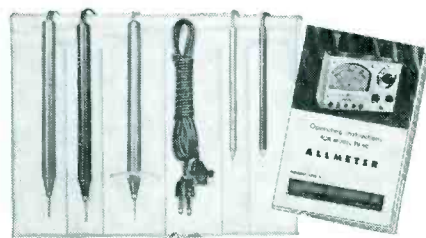

Model TV-60 comes complete with book of instructions, pair of standard test leads; high-voltage probe; detachable line cord; R.F. Signal Tracer Probe and Audio Signal Tracer Probe. Pliofilm bag for all above accessories is also included. Price complete. Nothing else to buy. Only **\$52.50**

SHIPPED ON APPROVAL NO MONEY WITH ORDER — NO C.O.D.

Try it for 10 days before you buy. If completely satisfied then send \$12.50 and pay balance at rate of \$8.00 per month for 5 months. **No Interest or Finance Charges Added!** If not completely satisfied return unit to us, no explanation necessary.

MOSS ELECTRONIC DISTRIBUTING CO., INC.
Dept. D-183, 3849 Tenth Ave., New York 34, N.Y.
Please rush one Model TV-60. I agree to pay \$12.50 within 10 days and to pay \$8.00 per month for 5 months. It is understood there will be no finance, interest or any other charges, provided I send my monthly payments when due. It is further understood that should I fail to make payment when due, the full unpaid balance shall become immediately due and payable.

Name _____
Address _____
City _____ Zone _____ State _____

Superior's New Model TV-12

TRANS-CONDUCTANCE TUBE TESTER

ALSO TESTS TRANSISTORS!



A RADICAL CHANGE IN DESIGN PROCEDURE. Customarily, a new model Tube Tester means a revised model. For usually when a manufacturer designs a "new" model, he actually re-designs the last model made, including new improvements to meet changing requirements, and circuit improvements resulting from experience in producing the last model made. That is the usual practice, but doesn't apply to the new Model TV-12.

Superior Instruments Co. has been designing and producing Tube Testers since 1935. About two years ago, they asked their engineers to select a circuit which would meet the requirements of those technicians who want a top quality Tube Tester. The engineers selected the basic TRANS-CONDUCTANCE circuit employed in the Model TV-12. And then, thanks to the cooperation of a leading switch manufacturer, who designed a special five position lever switch, they were able to improve that basic circuit.

The Model TV-12, therefore, is not a "rehashed" model — it is not a tester which simply tests good tubes "good" and bad tubes "bad." This radically new tester will check tubes under dynamic conditions very closely simulating the manner in which they would function in a receiver or amplifier. It is a tube tester we are proud of. It is a tube tester which we claim will compare favorably with laboratory instruments selling for double the price.

And about Transistors. We doubt that the Transistor will ever wholly replace the Vacuum tube. Unquestionably, however, the present already substantial rate of production and use of Transistors will be very greatly increased in the near future.

The Model TV-12 will test all Transistors produced to date and provision has been made for testing the new Transistor types known to be designed but not yet in production.

SPECIFICATIONS

TESTING TUBES

- TESTS ALL TUBES including 4, 5, 6, 7, Octal, Lock-in, Hearing-Aid, Thyratrons, Miniatures, Sub-Miniatures, Noval, Sub-Minar and Proximity Fuse types.

- Employs improved TRANS-CONDUCTANCE circuit. An in-phase signal is impressed on the input section of a tube and the resultant plate current change is measured. This provides the most suitable method of simulating the manner in which tubes actually operate in Radio & TV receivers, amplifiers and other circuits. Amplification factor, plate resistance and cathode emission are all correlated in one meter reading. Although the Model TV-12 is not calibrated to provide mutual-conductance reading (MHO'S), the Engineer or Technician who needs that information may easily compute it with calibrations we supply.

- NEW IMPROVED ROLL CHART MECHANISM uses a combination of fibre and brass gears to eliminate back-lash and slippage.

- NEW LINE VOLTAGE ADJUSTING SYSTEM. A tapped transformer makes it possible to compensate for line voltage variations to a tolerance of better than 2%.

- SAFETY BUTTON — protects both the tube under test and the instrument meter against damage due to overload or other form of improper switching.

- This model retains the INDIVIDUAL ELEMENT IDENTIFYING SYSTEM developed by Superior in 1945. All elemental switches are numbered according to RMA pin number designations. This procedure enables the operator to instantly identify the particular element being tested.

- NEWLY DESIGNED FIVE POSITION LEVER SWITCH ASSEMBLY. Previously because of switch limitations, the same voltage was applied to the plate and grid. Extra position and unique design of new switch permits application of separate voltages as required for both plate and grid of tube under test, resulting in improved Trans-Conductance circuit.

TESTING TRANSISTORS

Although Transistors may be tested for forward and inverse action with an Ohmmeter, such procedure will not identify an inefficient transistor. Also, if the ohmmeter uses a high-internal battery voltage, the transistor will likely be damaged. A transistor can be safely and adequately tested only under dynamic conditions. The Model TV-12 will test all transistors in that approved manner, and quality is read directly on a special "transistor only" meter scale.

The Model TV-12 will accommodate all transistors including NPN's, PNP's, Photo and Tetrodes, whether made of Germanium or Silicon, either point contact or junction contact types.

Model TV-12 housed in handsome rugged portable cabinet sells for only **\$72.50**

SHIPPED ON APPROVAL NO MONEY WITH ORDER — NO C.O.D.

Try it for 10 days before you buy. If completely satisfied then send \$22.50 and pay balance at rate of \$10 per month for 5 months. **No Interest or Finance Charges Added!** If not completely satisfied return unit to us, no explanation necessary.

MOSS ELECTRONIC DISTRIBUTING CO., INC.
Dept. D-183, 3849 Tenth Ave., New York 34, N.Y.
Please rush one Model TV-12. I agree to pay \$22.50 within 10 days and to pay \$10 per month for 5 months. It is understood there will be no finance, interest or any other charges, provided I send my monthly payments when due. It is further understood that should I fail to make payment when due, the full unpaid balance shall become immediately due and payable.

Name _____
Address _____
City _____ Zone _____ State _____

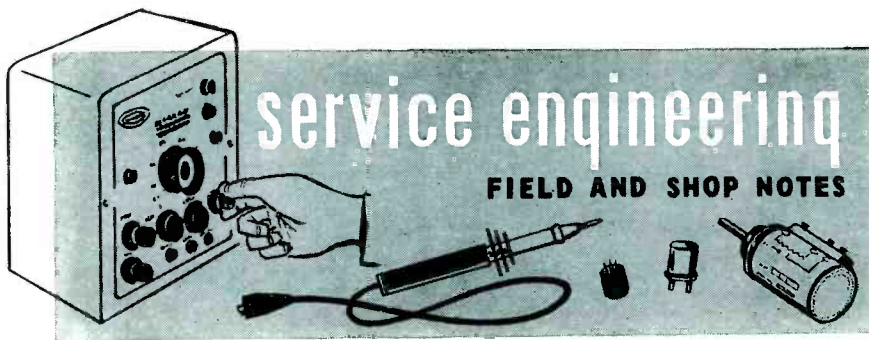

Servicing of 450-Mc

by **GEORGE A. SVITEK**

IT HAS BEEN ESTIMATED that less than 5% of the nation's commercial vehicles are at present equipped with two-way systems. In view of the saturation existing on low and high bands with this relatively small number of users, it is not surprising that the FCC opened up the new band of frequencies from 450 to 470 mc. However, this new band was not an unmixed blessing, for it introduced a parade of problems that had to be solved by equipment and system designers.

The first pressing requirement was the need for increased transmitter stability. On the low band where there are only 50-million parts for a maximum drift of 1.5 kc, a stability of 30 parts-per-million is satisfactory. At 450 mc, however, this represents a large drift of 13.5 kc. System requirements dictate a stability of 5 ppm for 450-mc transmitters. This can only be achieved by the use of heated crystals. The blind faith entrusted these heated crystals in the past indicates that a Service Man must learn their limitations, or spend a great deal of time looking for troubles in the wrong places and drawing wrong conclusions.

A heated crystal is usually ground to have a zero-temperature coefficient at one temperature, perhaps 85° C. If this crystal is operated at some

temperature substantially different from that which it was ground for, the stability will not be as good as that of a regular unheated crystal. Thus, another component enters the stability picture, namely the thermostat. Should the thermostat fail, the transmitter will approach a stability of 60 ppm with large outside temperature variations, rather than the desired 5 ppm. This would be tempered, of course, by heat from the base station itself. Still another consideration, warranting suspicion of transmitter drift, is the fact that it is possible for the temperature of the crystal to rise above 85° C under certain high ambient conditions. This is even more true when the crystal is ground for 65° C. When in doubt, one must measure.

Another problem that faced transmitter designers was the limited power obtainable from ordinary tubes at these frequencies. This problem was solved by recourse to the 2C39A lighthouse triode. This tube has concentric electrodes, however, and it was necessary to house it in a cavity; a power output of 20 watts for mobiles and 30 watts for fixed stations is obtainable from this combination. The application of these cavities has been achieved with no added servicing burdens.

A complete change in component philosophy had to be made at 450 mc. A quarter-wavelength resonant line is approximately 6" long at these frequencies; this makes the use of such lines and cavities practical. On the other hand, the usual lumped constant components can be applied only by careful engineering, and they begin to show peculiar behavior in this frequency band, with capacitors often looking like inductances and vice versa. Thus it is extremely important to replace components only with exact duplicates.

One of the major circuit modifications appearing in both the transmitter and receiver is the grounded-grid amplifier. This type of circuit has the *rf* input isolated from the *rf* output, preventing parasitic oscillation which standard triode-amplifier circuits tend to have at this frequency range.

The receiver must have another mixer to heterodyne the 450-mc signal to a frequency that can be more easily handled. This has resulted in the addition of a third crystal oscillator and a complete multiplier chain in the receiver. The high *if* is 48 mc, which strongly suggests that beyond this point the 450-mc receiver will resemble a low-band receiver.

The frequency-drift problem outlined for the transmitter applies equally to the receiver. With a high *if* of 48 mc, the indicated injection frequency is in the 400-mc range. Thus, there is an indicated stability of 5 ppm for the first oscillator crystal. A heated crystal was found to be unnecessary as a solution. By tightening the tolerance on the receiver crystal to 20 ppm, which can be readily obtained with current knowhow, it has been found possible to obtain a maximum drift of +8 kc. Even this would be unsatisfactory except for the addition of *automatic frequency control*. The *afc* pull-in ratio has been designed to be 8:1; this means that at maximum receiver

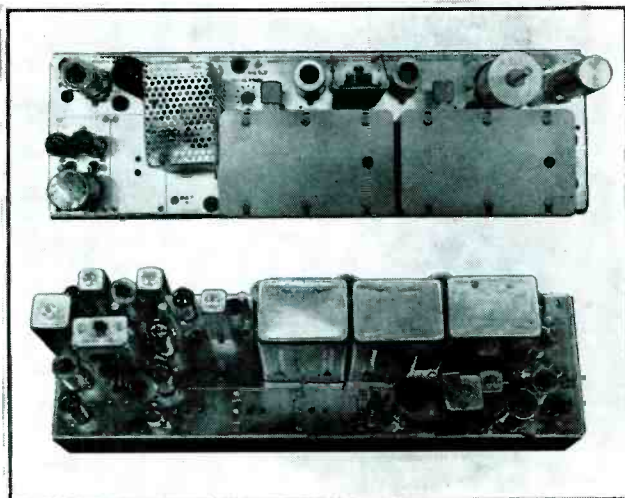

Figs. 1 and 2. Chassis of a 450-470 mc transmitter appears in Fig. 1 (top), while Fig. 2 illustrates receiver chassis for same band.

Communications Gear

Communications Training Counselor,
General Electric Company

crystal drift, the signal behaves as though it were 1 kc off center.

As an installer, the Service Man is interested in the effects of these higher frequencies on the choice of antennas, transmission lines, and connectors. A complete line of station antennas is available, but systems economics¹ usually dictates the choice of high-gain types.² Corner reflectors and yagi types are available for long-range point-to-point service.

Transmission line losses are rather high at 450 mc as the following approximate figures indicate:

RG/8	5.2 db/100'
RG/17	2.5 db/100'
7/8 Copper Coax.		.8 db/100'

More expensive lines which have much lower losses are available, but for practical considerations, the majority of installations use RG/17.

One new fitting used at these frequencies is the BNC connector, which heretofore has been a radar-equipment component. Many Service Men encountering this connector for the first time, fail to read the assembly instructions and as a result troubles develop. Its use is no coincidence, however; it has a much lower *vswr* than either the type N or the *uhf* connectors. At 450 mc the *uhf* connector has a *vswr* of 1.5 and the N is little better; the BNC has a *vswr* of 1.1. A special phono jack used internally in the 2-way equipment has a *vswr* of 1.08, but has been found unsuitable for frequent disconnects. It is very difficult to load a transmitter at 450 mc into a high *vswr*, to say nothing of the loss of output power. At a *vswr* of 2:1, the 450-mc transmitter power output may drop from 30 to 22 watts.

Propagation characteristics of 450 mc waves merit some attention. This band has strong line-of-sight charac-

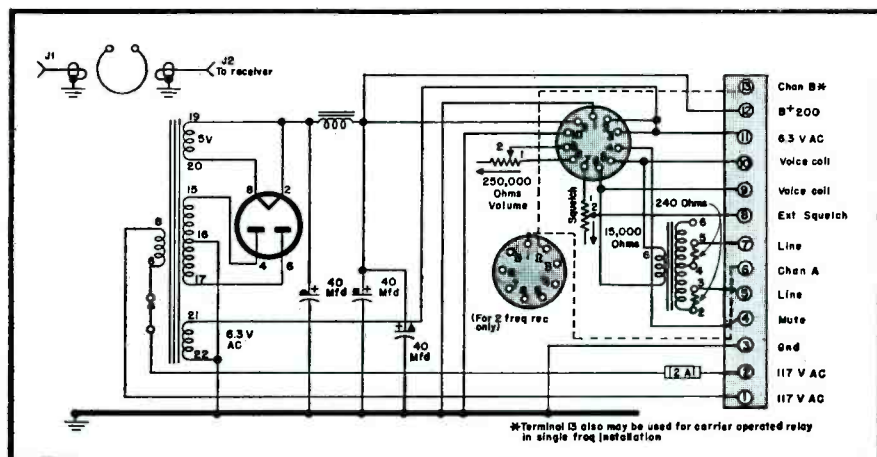

Fig. 2. Diagram of the power supply for the 2-way 450-470 mc receiver.

teristics. Once a mobile unit is *out of sight* of the base station antenna, the signal deteriorates rapidly. Actually, there are four zones of reception with no clear boundary between them. The first zone represents an area of good solid coverage. In the second zone the signal is usually solid, but there will be spots where the background noise comes through. The third area is one in which reception is generally noisy, but readable with occasional strong or dead spots. In the fourth area the signal is very weak, but a standing-wave pattern of field intensity exists. Remembering that a quarter wavelength is about 6", it can be seen that the antenna passes through strong and weak fields very rapidly with a resultant fluttering in the speaker. By parking a car in one of the strong field points, it is possible to carry on perfectly clear conversations which are impossible with the vehicle in motion. The last two zones are of greatest interest to the Service Man. Many receivers, reported out or intermittent in these areas, are actually either in a dead spot or passing through a flutter zone.

Of invaluable aid in calculating system range is a range and signal strength calculator³ which is ideal for flat or slightly hilly terrain. The rule does not take into account the shadow losses due to tall buildings or hills, but these can be obtained from reports on propagation,² should such information be necessary. Shadow losses in a city are often of no sig-

nificance, since there are usually many tall buildings which can reflect the 450-mc signal into the *shadow*. Where this is not true, dead spots can be expected.

An interesting feature of 450-mc equipment is the freedom from industrial and ignition noise. This band, located high in the frequency spectrum, is far above the point where ignition noise has its peak intensity. Thus, while it is possible to design a receiver on low band with a sensitivity of .4 microvolt and of .8 *uv* on 450, the reliable signal sensitivity of the low band is 5 *uv* and at 450 mc it is 1 *uv*, when used in cities.⁴ Thus, 450 mc finds its major application in large cities where it can actually outperform the lower-band equipment. This will perhaps explain why, as a practical matter, RG/17 is more commonly used than air dielectric lines, the latter being, of course, much more difficult to install. Most installations in cities are made in high buildings, with the transmitter being located physically near the antenna. This calls for only a short run of cable which can, therefore, be RG/17.

Thus far, some of the effects of the 450-mc band on the equipment have been analyzed. What has been the effect of this band on the Service Man? In all too many cases, paralysis. A fear of 450-mc equipment has often hit old Service Men to the extent that system performance has suffered. There is little reason for such fear. The equipment has been designed for ease of service.

In the transmitter there are only ten tuning adjustments; five are in the multiplier chain, two in the *pa*, and one in the output cavity. One is the modulation adjustment and there is a trimmer to make minor adjustments

(Continued on page 67)

¹Krahe, L. R., *Minimum Cost Equipment Assemblies*, Communications Engineering; Jan.-Feb., 1954.

²Typical high-gain antennas are the Andrews 4000 and Mark Products C-7455.

³G.E.

⁴Young, Jr., W. Rae, *Comparison of Mobile Radio Transmission at 150, 450, 900, and 3700 Mc*, Bell System Technical Journal; Nov. 1952.

⁵Bullington, Kenneth, *Radio Propagation at Frequencies Above 30 Megacycles*, Proc. IRE; Oct. 1947.

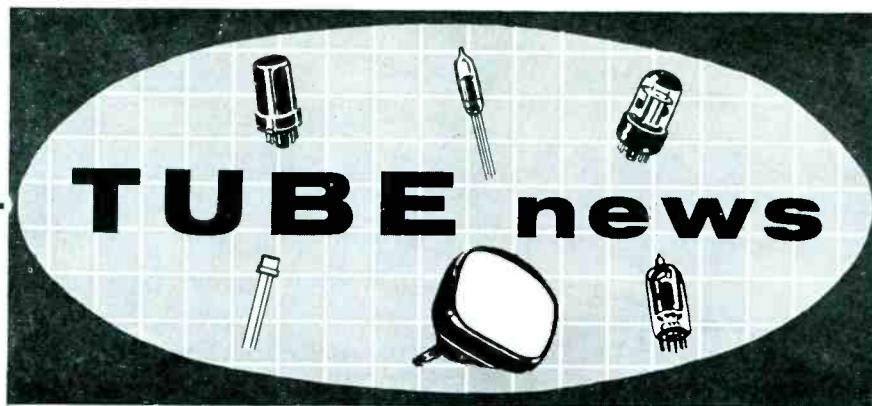

UHF-TV Microminiature Ceramic Tubes . . . TV RF Pentodes . . . Audio Transistors

A NEW CONCEPT in receiving tube design in the form of a *microminiature* ceramic triode for *uhf* has been announced by G.E.

The microminiature triode, a 6BY4, is an all metal-and-ceramic tube about 3/8" long and 5/16" in diameter.

Development work has indicated that production models, which will soon be available, are expected to have a noise factor of approximately 8 db and a power gain of approximately 15 db when operating at 900 mc with a bandwidth of 10 mc.

Although the tube features micro-spacing of elements and a grid of approximately 1000 turns per inch, the microminiature design is said to permit simplified construction and test procedures.

Designers of the triode have disclosed that eventually these tiny tubes will be available in diode and complex multielement types.

The design and manufacture of these ceramic tubes were described as representing a departure from conventional techniques of quantity tube manufacture.

The grid assembly was cited as typical of the new approach, the grid being made from tungsten wire .0003" in diameter, with the wire being wound and brazed to a small

tungsten washer at a pitch of 1000 turns per inch.

UHF Pentodes

FOR UHF TUNERS and *if* amplifiers, two new miniatures, the 3CE5 and 6CE5, have been developed by CBS-Hytron. High - transconductance, sharp-cutoff pentodes, they were designed to meet the narrow limits for grid voltage at plate current cutoff. In TV receiver design, this narrow cutoff range characteristic has been found to permit closer tolerances in the automatic gain control circuit and eliminates the need for tube selection by the set manufacturer. In addition, the signal input capacity can also be increased to an optimum level.

Electrically and mechanically, the tubes resemble the 3CB6 and 6CB6. The 3CE5 has a 600-ma heater for series-string receivers; the 6CE5 is a 6.3 v version.

Junction Power Transistors

Junction power transistors (2N68)¹ offer many possibilities in applications requiring useful audio power output. Although small in size and operating at low *dc* voltage, these transistors are capable of 2.5 watts dissipation in free air and 4 watts when provided with external heat. At -12 v collector potential, a single 2N68 will de-

liver .6 watt output when operated as a class-A amplifier, and a pair in a pushpull class-B will deliver 5 watts. Class-A collector efficiency is 35 per cent, and class-B 75-per cent. Power gain is better than 15 db and frequency response greater than 10 kc.

Transformers must be fabricated especially for the low impedances of the 2N68, although the input unit can be a conventional output transformer designed to operate into a loudspeaker voice coil. The primary impedance of this transformer must be selected either to match a low-impedance line from the preamp or the collector impedance of a transistor preamp. If a medium-power amplifier is used as a preamp, the primary of the transformer must be center-tapped. In addition to having a 100-ohm primary, the output transformer must be able to handle the 100-ma constant collector current of the transistor.

The base bias resistor must be adjusted for a steady collector current of 100 ma. Its median value should be 3000 ohms.

Two 2N68 power transistors in a pushpull class-B stage operated at -12 v *dc* will deliver 5 watts of audio output power with ½ watt drive.

¹Sylvania.

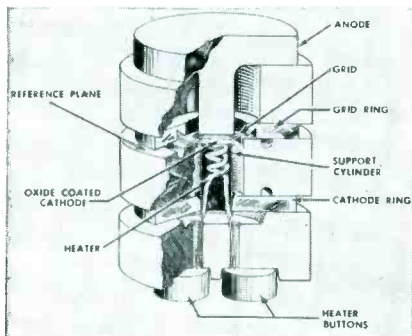

(Left)
Cutaway view of ceramic triode developed for *uhf* TV.

(Right)
Size comparison of the microminiature ceramic and conventional glass and miniature tube types.

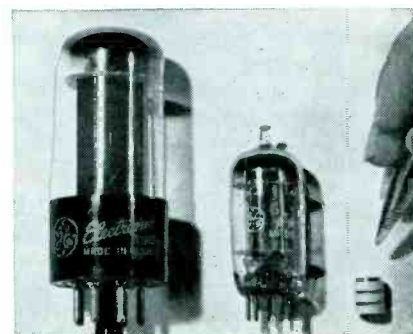

Independent Servicing

(Continued from page 31)

ment as a service station for their equipment. We have such an assignment.²

As a word of caution, one should not try to adjust a transmitter unless he is a licensed man; there are severe penalties for violations.

The service engineer must constantly remember that he is the link between the owners of the equipment and the FCC. The FCC has definite regulations that have to be lived up to, and the service engineer must see that *all* measurements are made to comply with the regulations. Owners will forget or do not want to tie up their equipment for measurements so it is up to the service engineer to see that the measurements are made.

The bulk of all radio-telephone service work must be done in the field; consequently the service engineer's car must be a rolling shop.

He should carry an assortment of components and test gear. We have found that approximately one hundred tubes, spare relays, microphones and cable, vibrators, plugs, and a quantity of small resistors and capacitors are required.

Test gear includes a *vom*, frequency meter, modulation meter, dummy antenna (so as not to upset the system while checking a transmitter) and a wattmeter. Dummy control heads are not a must, but they do help when working on equipment having obscure trouble.

The service engineer will find out very soon that there is no substitute for the *finest* and most *accurately* calibrated signal generators. Also he may elect to buy or build crystal-controlled single frequency generators for high and low *if* alignment.

Many Service Men have been accustomed to checking radio and TV sets by depending on the average volume or picture-tube result. This practice does not hold in two-way work. The squelch, for maximum receiver sensitivity, must open between a tenth and a quarter microvolt; that means *on the nose alignment*. With the proper equipment, there is no guessing; one knows when such precision adjustment has been obtained.

The majority of the radio-telephone service engineers take care of police, fire, taxi cabs and other metropolitan units. They are relatively close to a jobber for some small parts, but as the distance increases, an increased stock of parts must be carried.

The 2-way activity, plus radio and TV installation and repair work, keeps us on our toes throughout the year.

²Shop is an authorized G.E. service station.



for complete protection
in your
circuit...

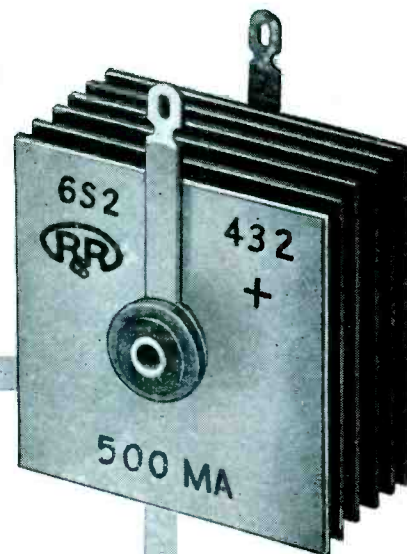

**SELENIUM
RECTIFIERS**
with

"SAFE CENTERS"

The rectifier center is a real trouble zone. That's why all Radio Receptor selenium rectifiers are specially built and tested to eliminate arc-over danger, short circuits and heating at the center contact point. Even assembly pressure, or pressure applied in mounting the rectifier cannot affect its performance.

This "Safe Center" feature of RRco. rectifiers is accomplished by deactivating the area of the plate under the contact washer... An added safety factor that gives protection during mounting and when the rectifier is in use.

No wonder RRco. selenium rectifiers are preferred by leading manufacturers of radios, TV and other electronic equipment. Millions in use under all conditions—including high humidity—give eloquent testimony to their dependable service. Next time you need rectifier replacements demand the bright green RRco. units with "Safe Centers."

For the latest information of the Radio Receptor Rectifier line, write today to Dept. S-2.



Semi-Conductor Division

RADIO RECEPTOR COMPANY, INC.

In Radio and Electronics Since 1922

SALES DEPT.: 251 West 19th Street, New York 11
WAtkins 4-3633 • Factories in Brooklyn, N. Y.

EVERY SERVICEMAN NEEDS THIS VOLTAGE ADJUSTOR

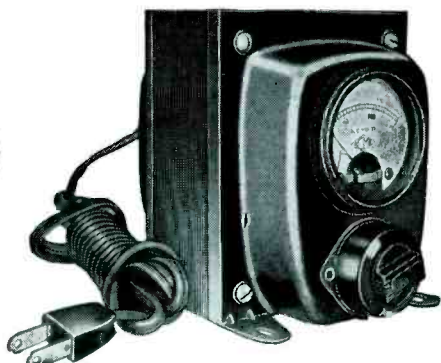

T-8394M MANUAL VOLTAGE ADJUSTOR

Where low voltage is affecting TV reception, the service man can detect the condition at once with a T-8394M Acme Electric Voltage Adjustor. And by a simple demonstration he can sell a Voltage Adjustor to the TV set owner. Sales are easy to make because demonstration while servicing a set quickly convinces its owner that the voltage regulation is essential to good TV reception.

How To Use The T-8394M VOLTAGE ADJUSTOR on Service Calls

With the tap switch set at 115 volts, the meter reading will show incoming line voltage. Thus it can be instantly determined if line voltage is lower than normal required for good TV set performance.

The T-8394M Voltage Adjustor can also be used to reproduce the operating condition about which the customer complains by turning tap switch to the voltage which simulates such condition. For example, customer complains that evening program pictures flicker and shrink. When service man calls next day all operation appears normal — voltage tests out properly. But, by adjusting voltage to 97 volts the condition about which the complaint was made is reproduced. This indicates low voltage condition during evening that can be corrected with a T-8394M Voltage Adjustor.

Not A Gadget — A High Quality Unit You'll Be Proud To Use

The T-8394M Voltage Adjustor can be installed instantly, no tools needed. Just plug into most convenient outlet. Then plug television cord into secondary receptacle on Voltage Adjustor.

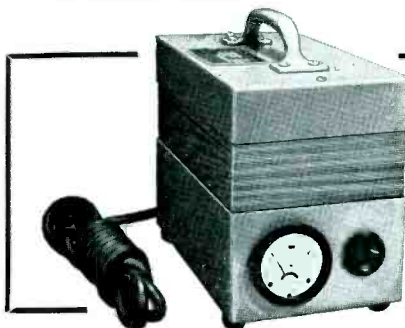

FOR COMPLETELY AUTOMATIC VOLTAGE CONTROL

Regardless of line voltage supply, the Automatic Voltrol corrects voltage fluctuation over a range from 95 to 130 volts. The voltmeter supplied indicates secondary voltage while unit is in operation. A built-in relay automatically disconnects circuit when set is turned off.

Acme Electric
TRANSFORMERS

ACME ELECTRIC CORPORATION
MAIN PLANT: 4711 WATER STREET • CUBA, N. Y.
West Coast Engineering Laboratories:
1375 West Jefferson Boulevard. • Los Angeles, California
In Canada: Acme Electric Corp. Ltd.
50 North Line Road • Toronto, Ontario

Tricolor Picture Tube

(Continued from page 39)

horizontal sweep circuits, as shown in Fig. 5 (p. 39). This schematic illustrates only one of the three-pole piece assemblies, for simplification. A saw-tooth voltage, obtained from a secondary winding on T_{110} , the vertical output transformer, is applied across L_{120} producing a parabola of current through the vertical amplitude control. This parabola is shaped by means of the vertical tilt control which shunts a portion of the secondary winding on T_{110} . By adjusting the vertical amplitude and tilt con-

trols, correct vertical dynamic convergence can be obtained.

Horizontal dynamic convergence correction is obtained from a tuned circuit composed of the horizontal shape control and the .0022-mfd capacitor. This circuit is tuned to 15,750 cps, the horizontal scanning rate for proper horizontal dynamic phase. The circuit is ringed by a high-voltage flyback pulse and a sine wave is produced at the point shown in the circuit diagram. The amplitude of this sine wave is adjustable by the horizontal amplitude control; the usable portion of the sine wave approximates a parabola.

Servicing Helps

(Continued from page 57)

lated as before. This test will monitor the output of the tube itself and its driving circuit.

A similar test may be made at the output of the oscillator, if separated by some waveshaping circuit similar to the type used in the 630 chassis. Here the input to the discharge tube furnishes a satisfactory check point for excessive voltage variation. In this instance we are not particularly interested in the absolute value of the voltages, but the variation; the regulation at the points checked. If the voltage is abnormal, other symptoms will be present, as well as blooming, as guide posts to help localize the trouble.

The first anode or accelerator anodes are commonly fed from low-voltage B+ through resistors. These electrodes (anodes) form part of the electron lens system that focuses the beam and also accelerates it. Blooming is primarily caused by a variation in the relative voltages; hence a variation of the low voltage is just as obnoxious as a variation of the high voltage. To test, one monitors the low voltage supply with a dc voltmeter, while manipulating the controls. The monitor point should be at the tube lead and at the B+ side of any resistor used to isolate the anode. A variable load on some other part of the set may cause a blooming symptom. In one instance, variation of the volume control overdrove a gassy audio output causing blooming along with distorted sound. The sound trouble gave the clue here, as well as the control that was turned to create the condition.

One must not overlook the possibility of a surge-limiting resistor causing trouble in a selenium rectifier circuit. Any series resistance can increase in value, particularly if heavily loaded; a resistor may carry the load without burning up, but its resistance may vary considerably in the process. These cases can be readily found by monitoring the B+ before and after the resistor. It is wise not to be too stingy with the size of the resistor.

Except where caused by abnormalities in the tube face (some of this type blooming is inevitable), blooming that results in defocusing of the spot is caused by improper biasing of the picture-tube grid. One must measure from grid to cathode, and from grid to ground. It will be noted that the brightness control varies this voltage, but that the grid-cathode voltage should always be negative; the grid must be more negative than the cathode.

Service Engineering

(Continued from page 63)

on the transmitter frequency. The tuning process involves nothing more than peaking the multipliers, dipping the *pa*, and peaking the output. Even an output diode is furnished. It is located in the filter cavity and permits peaking the output coupling and the filter cavity itself. All circuits can be tuned with a 0-3 volt, 20,000-ohm voltmeter. Tuning is straightforward with no tricks. The only possible source of difficulty lies in the cathode-current limitation placed on the 2C39. For best tube life, consistent with good transmitter power output, the cathode current must be limited to 115 ma. It is impossible to read cathode current directly, so the grid and plate currents must be read and added. A typical operating point is 90-ma plate current and 25-ma grid current indicated by readings of .9 and 2 volts, respectively, on a 0-3 *vm*.

There are also ten tuning adjustments in the receiver. Five of these are in the receiver multiplier chain where a simple peaking process is carried out. Another involves tuning the first local oscillator for peak and backing it off *ccw* by 30%. The *rf* amplifier, input cavity, and second oscillator plate are also peaking adjustments. Finally, there is a trimmer on the second oscillator to permit adjusting the receiver discriminator reading to zero with an incoming carrier. In short, the 450-mc equipment has been made as easy to adjust as that of the other bands. One should approach it with confidence.

Test equipment, in general, has not kept pace with 2-way design advancements. Transmitter stabilities of 5 *ppm* have outstripped the ability of reasonably priced instruments to measure them. Suitable instruments for measuring receiver sensitivity are also quite expensive. And, an instrument that offers both of these features, with portability, is not available at any price. Most Service Men attack the 450-mc equipment *rf* section problem with a little uncertainty.

Suitable harmonic generator circuitry† has been developed to generate ample harmonics to permit tuning receiver front ends. With experience, this approach will permit reasonable receiver sensitivity.

To measure transmitter frequency one should make an accurate measurement of one transmitter in a single frequency system and net the whole system to that transmitter. In multi-frequency systems correspondingly more measurements will be necessary.

†For use with Lampkin 105B.

NEW!
NEW!
NEW!

Simpson
VARIDOT
WHITE DOT GENERATOR
model 434

VARIABLE DOT
NUMBER AND SIZE

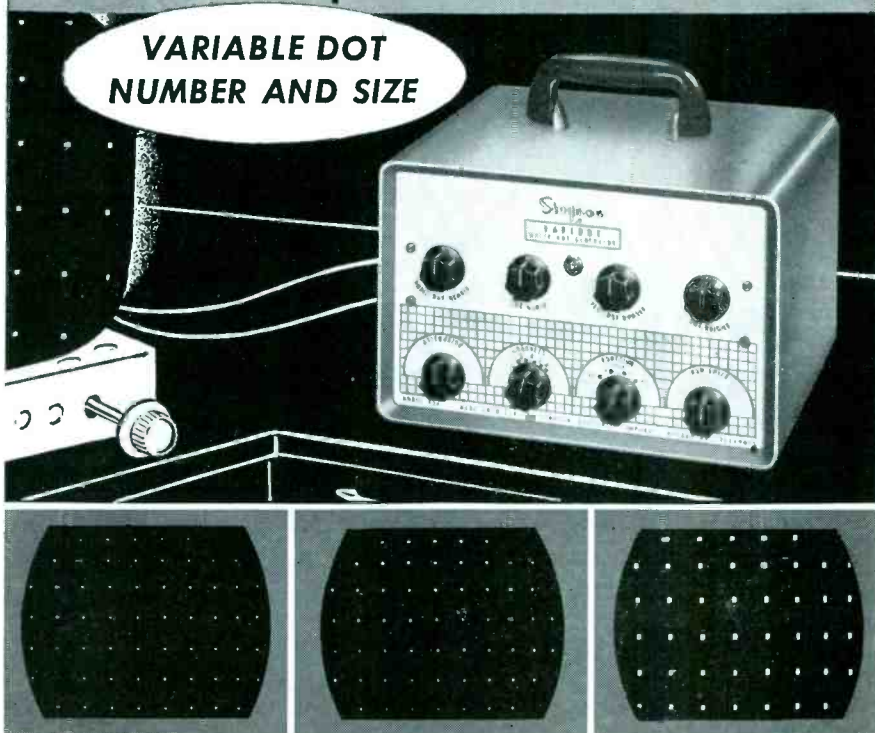

(Actual Photographs)

Provides white dot patterns with VARIABLE dot size (from 1 to 8 scanning lines, with corresponding dot widths), and variable dot number from 6 to 12 horizontal dots, and 6 to 12 vertical dots. Modulated RF output is available, operating on fundamentals from Channel 2 to Channel 6.

THE ONLY WHITE DOT GENERATOR THAT LETS YOU MATCH ANY RECEIVER MANUFACTURERS' RECOMMENDATIONS

You can make convergence adjustments on color-TV receivers faster and better with the new Simpson Varidot. Use for linearity adjustments on both color and black and white.

Vertical and horizontal synchronization assures you of correct aspect ratio . . . ample attenuation . . . 300 ohm RF output.

Adjustable dot size provides a check of receiver transient response. Positive or negative video

output is excellent for accurate and fast checking of transient response of video amplifiers.

Use the new Simpson Varidot for hum checking both color and black and white receivers—a rare feature in test equipment at this price.

Portable: Approx. 11½ lbs.
Housed in Simpson gray case.

Complete with Output Cables and Operating Instructions **\$147.50**

See Your Electronics Parts Distributor, or write

Simpson
ELECTRIC COMPANY

WORLD'S LARGEST MANUFACTURER
OF ELECTRONIC TEST EQUIPMENT
5206 W. Kinzie St., Chicago 44, Illinois
Phone: EStebrook 9-1321
In Canada: Bach-Simpson Ltd., London, Ontario



by MARK VINO

Effect of Room Environment on Reproduction: Installations in Live and Dead Rooms . . . Compensating Factors Through Amplifier Controls . . . Room Resonances . . . Use of Signal Generator to Check Output

THE SUBJECT of room acoustics is something like the weather; we talk about it but seldom do anything about it. Most installations have to be made accepting the room as is, without changes. However, there are measures that can be taken to match the installation to the room for the best results.

A universal characteristic of radiating surfaces is that as the frequency is lowered, the directional pattern of radiation becomes progressively broader. This means that the bass portion of the musical spectrum will be diffused over a larger angle of

radiation than are the higher components of the sound.

One practical result of this characteristic is that if the angle into which the speaker radiates is not restricted by wall and floor surfaces, the low bass will be attenuated relative to the treble. For a given speaker, the weakest bass will be produced when the enclosure is standing out in the middle of the floor, away from the walls. Higher frequency sounds will be concentrated in the area ahead of the speaker, while the bass is thinned out by being spread in all directions. A similar effect is produced by mount-

ing bookshelf enclosures in the middle of the wall, away from the floor or ceiling.

The best cure for this difficulty, of course, is to see to it that the speaker is mounted in such a way as to get a sufficient bite of the air of the room. Setting a floor enclosure against the wall (wherever possible the woofer should be towards the floor, the treble unit higher) reduces the *solid angle of radiation* to 90°. Placing the cabinet in a corner (resting on the floor and touching the walls) cuts the radiation solid angle to 45°. A corner position off the floor brings the solid angle back to 90°. Such measures can make a difference in bass response, particularly in the extreme low range, which is greater than the differences which exist between various makes of speakers.

While corner mounting provides the fullest low bass, it is not necessarily optimum in all cases. A bass-heavy system, for example, can be improved by taking it out of the corner. For a small enclosure, a corner floor position may not be the best from the point of view of the treble; it is usually undesirable to have the treble speaker too close to the floor. In such a case a corner position several feet off the floor often proves best.

Compensation for Speaker Placement

The loss or over-emphasis of bass resulting from imperfect speaker placement for a given system can, to some extent, be compensated in the amplifier. The bass tone control may help, but this control is usually *hinged* at too high a frequency for such an application. Where compensation may only be required below one hundred cycles, the bass tone control usually controls all frequencies below some point between 600 and 1000 cycles.

A much more accurate type of bass compensation for variations in speaker placement is afforded by the damping-factor control, a feature appearing on an increasing number of amplifiers. This control may be thought of fundamentally as a bass control, whose hinge is much lower than the usual tone control. The hinge frequency depends upon the speaker, but may be below 100 cycles.

For speaker positions in which the radiation is into a small solid angle, such as corners or the junction between the floor and the wall, the higher range of damping factor values

(Continued on page 70)

Fig. 1. Absorption coefficients of various materials. The presence of surfaces with high absorption coefficients make the room less live. Note the increase of absorption at higher frequencies. (After Olson)

Material	Frequency, cps					
	128	256	512	1024	2048	4096
Draperies hung straight, cotton fabric, 10 ounces/square yard, in contact with wall:	.04	.05	.11	.18	.30	.44
Draperies, velour, 18 ounces/square yard:	.05	.12	.35	.45	.40	.44
Velour draperies as above, 4" from wall:	.09	.33	.45	.52	.50	.44
.4" carpet on 1/2" felt on concrete:	.11	.14	.37	.43	.27	.27
.4" carpet on concrete:	.09	.08	.21	.26	.27	.37
Concrete, unpainted:	.01	.012	.016	.019	.023	.035
.5" plaster, lime on wood lath on wood studs, rough finish:	.039	.056	.061	.089	.054	.070
.5" plaster, gypsum:	.023	.039	.039	.052	.037	.035
Wood sheeting, pine, .8":	.10	.11	.10	.08	.08	.11

Latest in Audio

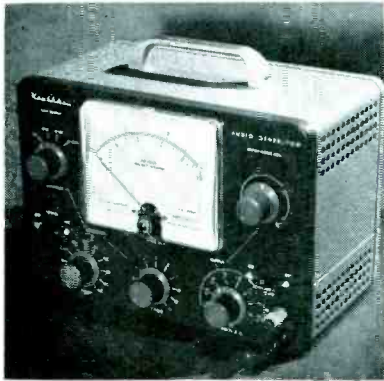

Audio generator which features step-tuning from 10 cps to 100 kc with three rotary switches that provide two significant figures and multiplier. Output monitored on 4 1/2" meter that reads voltage or db. Both variable and step-type attenuation provided. Meter reads zero-to-maximum at each attenuator position. Output (meter) ranges are 0-.003, .01, .03, .1, .3, 1, 3, 10 volts. (Heathkit; Heath Co., Benton Harbor, Mich.)



Three-way speaker system with a dual impedance woofer, reciprocating flare horn speaker and tweeter. Has 700/5000 cps crossover network. Cabinet (37"x28"x19 1/4") available in cherry and blond mahogany. (Decor-Cooustic [with C15W, 4409 and HF-206 speakers]; University Loudspeakers, Inc., 80 S. Kensico Ave., White Plains, N. Y.)



Record accessory bar, designed for counter-top display, which contains anti-static spray, plastic protective record sleeves, a balanced sound kit and record brush. Balanced sound kit features a turntable level designed to help obtain turntable balance and eliminate distortion, groove jumping, tone arm bouncing and excessive record wear. Kit also contains a stylus pressure gauge. Record brush is made of soft camel's hair and can be attached to tone arm. (Walco Products, Inc., 60 Franklin St., East Orange, N. J.)

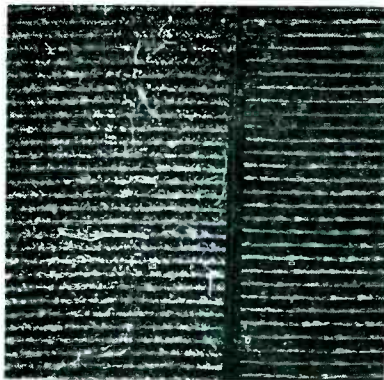

(Left)
Microscopic photos of phono records after several plays, before it has been cleaned with a record-wipe cloth (left), and after it has wiped with special cloth (right) removing dust and lint. (Duotone)



(Right)
Microphone cover, made of impregnated material, designed to afford protection from dirt or dust particles, mist and rain, and permit use of microphone, while covered, with slight loss of highs. (Save-Ur-Mike; S. I. Jacobson Manufacturing Co., 1414 S. Wabash Ave., Chicago 5, Ill.)

Cross-sectional views of phono record and needle illustrating why it is necessary to replace needles. A side view of the small contact area (ball-point fit) of a new needle in groove appears in Fig. 1 a; how the needle rides on side walls is shown in b, and movement of the needle, when it provides good response, because it follows groove curvatures is illustrated in c. Fig. 2 shows problems that occur when needle is slightly worn, but usable. How the wear area reduces sensitivity and the needle begins to sink lower in groove is shown in a and b; the slight loss of high frequencies that result is illustrated in c. Figs. 3 and 4 reveal what happens when needle is so worn that it must be replaced. The view in Fig. 3a shows how the wear flats cause poor response to moving groove walls. Groove damage caused by sharp edges (noise level rises at this point) is shown in b, and noticeable restriction of sound frequency range is illustrated in c. Effects of badly worn needle are shown in Fig. 4; a illustrates how large flats choke groove space, hampering vibration. How a chisel-shape needle cuts groove, ruining record, is shown in b, while c shows distortion caused by bridging of sound curvatures. (Tetrad)

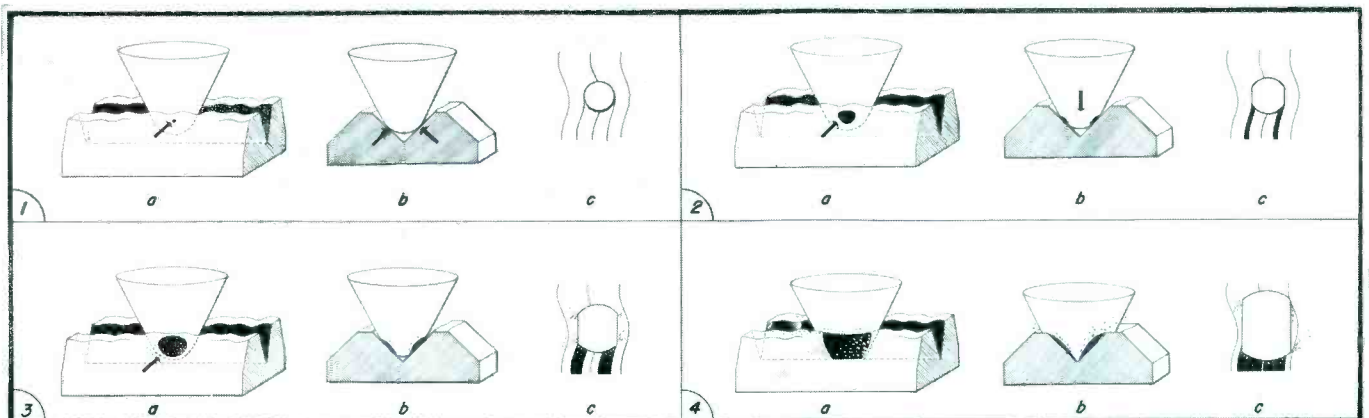

Double the money you



make from each needle



**with fabulous
Shooting Star Deal!**

100% profit—really a deal! For Duotone does all the work! No fuss with returns, no complaints to listen to any longer, for under a full 6 months guarantee any replacements are handled directly from the factory. Reduces your needle business to half the work. But more—you upgrade every sapphire needle sale—double it—make \$2.50 profit instead of \$1.25. A sale, on every call, too, for these Duotone natural sapphires are infinitely superior to original equipment needles.

The Shooting Star Deal #S 19: Free all these: Lucite drawer display case; easy-find catalog that lists all manufacturers' needles with Duotone equivalents; jeweler's screwdriver worth \$1; counter displays; bill stuffers; and the benefit of 2,550,000 national ads. Retail cost—\$152.50; Your cost—\$75.00; Your profit—\$77.50. Over 100%!*

Twice the profit, half the work

DUOTONE
KEYPORT NEW JERSEY

SUPPLIER & MANUFACTURER

Can. Rep., Chas. W. Pointon, Toronto; Exp. Div., Ad Auriamo, Inc., New York, N. Y.

Audio

(Continued from page 68)

is normally appropriate. For positions in which the angle of radiation is large, such as mid-wall or mid-floor, optimum damping-factor values for the same system are appreciably lower, and may be of the order of one. In any case, the best way to determine the proper adjustment is to use program material with heavy bass passages and to set the control at the point where the bass appears to be the most natural; full but not boomy.

Live and Dead Rooms

A live room is one which is very reverberant; a dead room is, of course, the opposite. One can usually tell immediately upon entering a room what its characteristics are, from the way conversation or even footsteps sound. A rough check can also be made by clapping one's hands sharply and noting the time it takes for the echo to die away. Experience with different rooms will indicate how to classify rooms; the longer the reverberation time the livelier the room.

Rugs, drapes, stuffed furniture and other such absorptive surfaces all work to decrease the liveliness of the room, while smooth plaster surfaces and bare floors increase liveliness. The absorption qualities of various materials at different frequencies are detailed in Fig. 1 (p. 68).

If the room's liveliness is just right, the tonal balance of the reproduced music will also be right, assuming an ideal reproducing system. But even with an ideal system, tonal balances can be thrown far off by too live or too dead a room. The surfaces of a dead room tend to absorb the higher frequencies, especially the mid-highs, more than they do the bass, and the sound may appear dull, lacking in treble. On the other hand too live a room may give the sound an over-bright even strident sound, with accentuated treble.

This is what treble tone and tweeter level controls are for, at least as much as they are for anything else. The neutral position for such controls may represent tonal imbalance in particular rooms; too much treble in one room and too little in another. A careful adjustment of the speaker tweeter level control, if such exists, and a careful determination of the setting of the treble tone control that can be considered normal for most program material, may be as important as the more technical aspects of the installation job.

The principles discussed apply equally to demonstration sound rooms as to living rooms. Some demonstration rooms are too live, some too dead. The ideal would probably be to offer an acoustical environment close to that of an acoustically good living room, so that the differences between the sound that the buyer hears at the demonstration and at his own home are minimized.

It is interesting to note that outdoor acoustical environments are similar to those of completely dead rooms; there are practically no reflecting surfaces at all, and speakers made for outdoor work are designed with more relative treble output than indoor speakers.

Treble Dispersion

It has already been pointed out that the higher the frequency of radi-

**DON'T JUST SAY
CAPACITORS**

Ask For Sprague By
Catalog Number

Know what you're getting . . .
get exactly what you want.
Don't be vague . . . insist on
Sprague. Use complete radio-
TV service catalog C-610. Write
Sprague Products Company,
61 Marshall Street, North
Adams, Massachusetts.

SPRAGUE[®]
WORLD'S LARGEST CAPACITOR MANUFACTURER

**stop
knockin'
yourself
out!**

let the
MASTER
make life
easier
for you . . .
see pg. 78



ated sound, the less diffuse the radiation. As we approach the higher treble frequencies, there is a tendency for the sound to confine itself to an increasingly narrow beam, and listeners sitting off-axis from a speaker tend to lose the higher frequency tones.

Many designs have been developed to relieve this characteristic of radiating surfaces, and speakers have dispersion patterns which may vary from good to excellent. There is almost always some narrowing at the upper treble, however, and the speaker must be placed so that it commands the room fairly well. One would not, for example, face the speaker away from the major listening area and into a highly absorptive surface.

There are occasions, however, when treble dispersion is actually improved by placing the speaker so that it does not face the listening area directly. The higher frequencies may be made to bounce off reflecting surfaces and reach the listening area in the desired diffused condition.

Room Resonance

The hand-clapping test referred to will also reveal another room characteristic; the presence or absence of sharp resonances. A sharp resonance (the word *sharp* refers to the shape of the frequency-response peak) will be characterized by an echo which not only perseveres, but has a distinct musical pitch; a tone that can be hummed.

Such resonances reduce the clarity of the sound; the distinctness of the different instrumental voices, and the purity of their tone colors, is impaired. With very bad cases of room resonance listeners will complain about a sensation of ringing about the ears at high volume. The room is, after all, the final transmission channel of the sound reproducing system through which the signal is passed, before it reaches the listener's ears, and a system with smooth frequency response can be made to sound like a system with a peaked and ragged curve, or one with a single strong resonant peak, by the characteristics of the room.

Of all the acoustical conditions that can be found in a room, undesirable resonance is probably the one for which it is hardest to compensate. Deadening the room somewhat by the addition of rugs, drapes or other absorptive surfaces may help, but this

(Continued on page 72)

3 SHURE CRYSTAL PICKUP CARTRIDGES

replace the 192

cartridges you are most likely to encounter in your service work!



-
-
-
-
-

TECHNICAL DATA AND REPLACEMENT CHART IS ENCLOSED.
Lists 192 Crystal Cartridges manufactured by five leading cartridge manufacturers.

Lowest investment for broadest coverage! The RK-54 is beyond all doubt the *most practical* Replacement Kit on the market! Proof? Simply this—you get the broadest coverage at the lowest investment—only \$22.55 list! Think of it—3 Crystal Cartridges replace 192 of those specific Cartridges most likely to be in need of replacement! Two of the Cartridges consistently have been “best sellers” in the Shure line—as established by actual sales to Servicemen! The Cartridges are: Model W22AB, 3-Speed, 2-Needle Cartridge—Model W26B, All-Purpose, Single-Needle Cartridge—Model W78, 78 RPM, Dual-Volt, Dual-Weight Cartridge. Model W78 is the new, versatile Cartridge that replaces 149 other Cartridges! This Cartridge alone will become a sensation overnight! Order a Replacement Kit from your Distributor today—once you have worked with this practical kit you will find that these three Cartridges are dependable replacements—will make your service work faster, easier and more profitable!



TRANSPARENT PLASTIC BOX IS FREE!
This Handy Box is 5" long, 3½" wide, 1¼" deep.

SHURE — The Mark of Quality

Yehudi Menuhin



David Stone

Comments on Diamond Phonograph Needles

"I value my record collection too highly to entrust it to anything but the best stylus. For quality reproduction, record protection, economy, and convenience, the diamond needle is without peer."



Insist on a **BRAND NAME DIAMOND**

PLAY SAFE
PLAY DIAMOND

TETRAD

WORLD'S LARGEST
MANUFACTURERS
OF DIAMOND STYLI

For further information write to: Dept. 5MN 62 St. Mary St., Yonkers, N. Y.

in TV fringe areas...

**DON'T GIVE YOUR
CUSTOMERS
A SNOW JOB!**

install a "De-Snow"
Preamplifier

Here's your key to snow-free all-channel TV reception in hard-to-reach areas! The Jerrold "De-Snow" Preamplifier, mounted at the antenna, amplifies the *signal*—not the snow. 6BQ7A, 6AK5, and 6CB6 tubes in a new cascade circuit provide a whopping 25-db gain with a noise level of only 6 db (approaching the theoretical minimum). So, even with long cable runs, your customer receives the clearest picture attainable from his antenna.

Available in two models—channels 2-6 or 2-13. Flat response for color. See your parts distributor or write Jerrold for illustrated literature.



JERROLD ELECTRONICS CORP.

2220 Chestnut Street • Philadelphia 3, Pa.

JERROLD

Audio

(Continued from page 71)

is a procedure which is normally beyond the authority or power of the person making the sound installation. The only recourse left is to experiment with different room positions for the speaker.

Use of Audio Signal Generator

If the sound seems cleaner, less unnaturally reverberant in one particular position, that position is superior. It is possible to investigate the effect of different mounting positions more rigorously than by a subjective listening test, and without too much trouble; but an audio signal generator is required. The system must be swept through the frequency spectrum and the violence of the frequency peaks noted; that is, the differences in volume between the resonant points and the average sound level observed. The speaker position which yields the most uniform sound over the useful range of frequencies will be the best.¹ It may be that the position giving the smoothest response is not the same as the optimum position, from the point of view of bass response or treble dispersion; in such a case a reasonable compromise must be reached.

The effect of room environment on sound quality has been often overlooked. Careful attention to this factor can result in a very significant improvement to natural musical reproduction.

Changer Repairs‡

AN IMPROPERLY seated or binding automatic shut-off assembly can cause a changer to keep going after the last record has been played. All parts on this assembly should move freely without binding. If bent, it must be straightened or replaced. At all times it should be firmly seated against the motorboard assembly.

A bent or broken shutoff rod must be straightened or replaced, as also must a bent or binding rest position lever.

If the changer shuts off after the last record has dropped, it will usually be found that the shutoff assembly is bent up. It should be bent back down till it is parallel with the motorboard. A bent pressure arm may also be at fault here. It should be bent down

¹The strong psychological peak at about 3500 cps, caused by the Fletcher-Munson effect, must be ignored.

‡From Webcor service notes.

slightly so that it, too, is parallel with the motorboard.

A short or bent upward rest position lever stud can cause the changer to shut off after the last record has dropped. If the stud is short it should be replaced. When bent it should be forced downward slightly until the stud end is stopped by the raised lip on the reject lever.

Another cause for failure of the record to drop could be that the ejector lever roller may be out of the spindle. This necessitates removal and replacement with a new spindle assembly. The ejector lever rising outside the spindle body also calls for a new spindle assembly.

Often two records drop at the same time. This can be due to an enlarged hole in the record, the record gate not being fully down, or a slight wobble in the spindle assembly.

The first step is to check the diameter of the hole in the record. Next, if the record gate is not down as far as possible it should be cleaned, but not lubricated. A wobbly spindle assembly calls for checking of the mounting and set screws to see that they are tight.

A record hitting the tone arm, when it drops, may be caused by extension of the ejector lever beyond the outside diameter of the spindle body or improper adjustment of the tone arm.

If the ejector lever is at fault, the changer should be cycled by hand until the ejector lever is at its furthest point of travel. Then a new record should be passed over the spindle area below the record shelf to see if it binds anywhere. High points on ejector or spindle should be filed or ground off until the record passes freely over the entire length of the spindle.

Failure to cycle, when the record has been played, may be due to any one of six conditions. The first of these is the absence of a finishing trip groove in the record. Service Men should check to be sure the record has an eccentric trip groove in the center. Most old recordings and many home recordings do not have this groove.

Then one should see if the needle jumps out of the record grooves. The trip pressure should be examined here; lateral pressure to trip should not exceed 3 grams. Trip push rod and cam assembly should be checked for binding.

Again, the recording may be defective. The finishing groove on many is too shallow. Changer should be

(Continued on page 74)

Gives your customers brilliant results ...pays off for you!

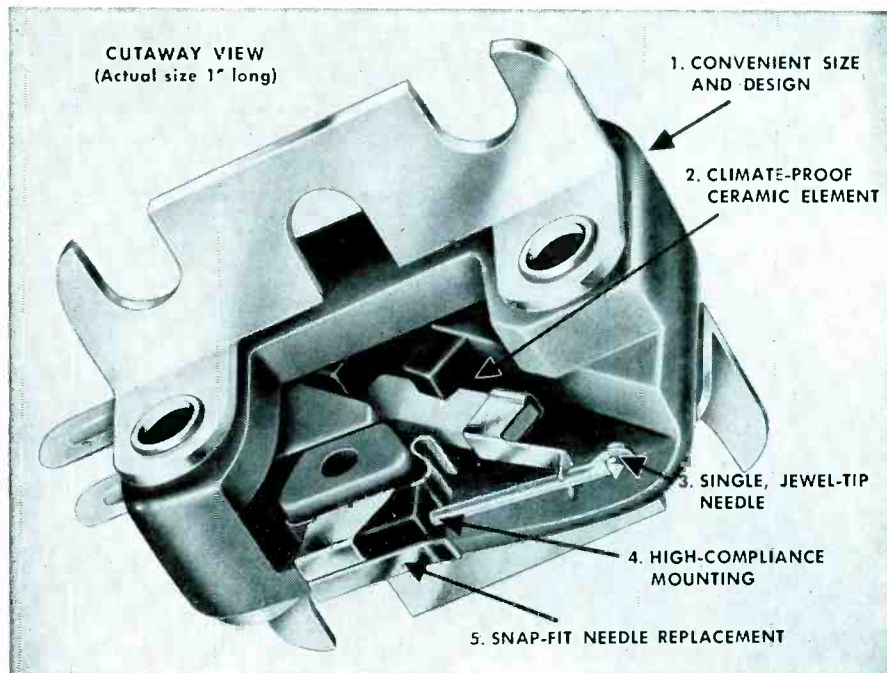

New Sonotone 1P Cartridge

1. Easy to install. Just two models fit most arms now in use. Cartridge is less than 1" long, 8/10" wide with bracket. Time-saving hardware included.
2. Ceramic element gives flat response (see curve) — requires no preamplification or equalization. No deterioration problems as with other

types... virtually immune to hum pickup.

3. Replaceable needle, diamond or sapphire. Models for 33-45 rpm, or 78 rpm.
4. Extreme lateral compliance and low-mass design give superior tracking, low wear.
5. Needles snap in, snap out easily.

Tap the Huge 45 RPM Changer Market!

Install this new Sonotone 1P, and give your customers exciting, true, wide-range response. At one stroke, you make a good sale, cut installation time, avoid problems found with other types of cartridges... and build your reputation for quality work and professional advice. No other cartridge has all the advantages this 1P gives you! With sapphire, \$7.50; with diamond, \$25.00.

RESPONSE 30-15,000 ± 3 DB!

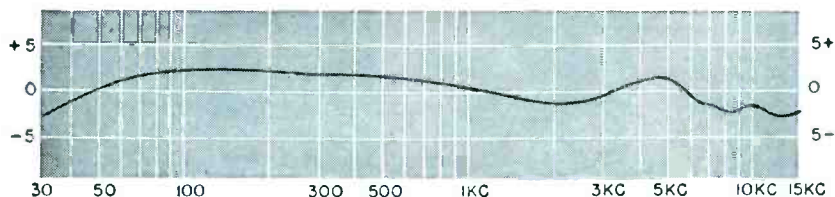

SONOTONE[®] CORPORATION

ELMSFORD, N. Y.

Write Dept. CS-115 for free Phono Modernization Manual

INTERNATIONAL'S

NEW TV RECTIFIER REPLACEMENT BONUS PACK!



FREE! NYLON TV TOOL

With every pack of 4 TV Selenium Replacement Rectifiers...
A PAIR and a SPARE PAIR!

You can't miss with International's New "BONUS PACK"! You'll get the *best* in TV replacement rectifiers. Each BONUS PACK contains a pair for immediate use, and a spare pair for your next job—PLUS a Nylon TV Alignment Tool worth \$1.00—ABSOLUTELY FREE!

SPECIFY INTERNATIONAL RECTIFIERS for long, dependable performance—the Widest Range in the Industry! Best for you... Best for your service customers!



Ask your distributor for details about "Bonus Pack" today!

International Rectifier

1521 East Grand Avenue, El Segundo, California • Oregon 8-6281
IN CANADA: Atlas Radio Corp., 50 Wingold Ave. W., Toronto, Ontario

**WORLD'S LARGEST SUPPLIER
OF INDUSTRIAL METALLIC RECTIFIERS**

Audio

(Continued from page 73)

tested with a record known to be good.

Often the needle point may be damaged or affected by an excessive accumulation of dust, lint, etc. Needle pressure should be tested to see that it does not exceed that recommended for the particular cartridge being used.

A loose eccentric on the turntable hub can be at fault here. It should be restaked or the turntable assembly replaced. A bent down trip pawl lever should also be replaced, or straightened if possible.

If *ac* wiring is hitting on the cam wheel assembly it should be dressed so that it does not interfere with the function of the unit, particularly the cam wheel assembly. Defective rubber on the cam wheel assembly must be replaced.

Changer tripping before the needle reaches the end of the record can be caused by too large a hole in the record or a bad needle.

Improper tracking of the needle on the record is usually due directly to a needle defect. It may be clogged with lint, dirt, etc., bent upward so that it does not engage the record groove or, in many cases, worn out.

Tight pivots can also cause trouble here; vertical friction should not exceed 2 or 3 grams. To adjust, the pivot screw should be loosened slightly and the lock nut retightened.

Turnover type magnetic pickup with replaceable styli. Stylus is said to have high compliance for low tracking force (2-5 grams); vibratory mass is claimed to have been reduced to provide flat response at 30 kc on ordinary vinyl. Termination impedance, 47,000 ohms. Magnetic circuit, including magnetic gap, is encapsulated in plastic. Pickup is supplied with a mounting clip which adapts it to all standard arms, and also acts as bearing for turnover action. (Fluxvalve; Pickering and Co., Inc., 309 Woods Ave., Oceanside, N. Y.)

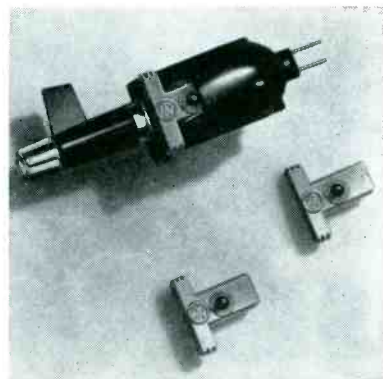

"There's nothing wrong with you, doctor, that a new JENSEN NEEDLE won't fix up."

KENCO KATE SAYS

"NO INSTALLATION PROBLEMS
when you use
KENCO MOUNTS"

KENCO EAVE MOUNTS

Easily mounted on hanging rafters or trim boards of eave. Eliminates need for drilling into brick or masonry walls. Ideal for buildings with extended roofs. Hot dip galvanized.

AVAILABLE IN 3 SIZES:
Model #122...22" Eave Mount
Model #128...28" Eave Mount
Model #148...48" Eave Mount

OTHER KENCO PRODUCTS:
All-Position Mounts; Parapet Mounts; Sky Struts; "Snap-In" Wall Brackets; "Snap-In" Chimney Mounts; Z-Type Chimney Mounts; Lag Screws and Hardware.

For information on the complete Kenco line write Dept. S.

KENWOOD ENGINEERING CO., INC.
Kenilworth, New Jersey

Associations



At recent unity meeting in Indianapolis, Ind., left to right: Max Liebowitz, **NETSDA** and **ARTSNY** prexy; Frank J. Moch, **president of NATESA**; Al Bernsohn, **executive director of NARDA**; and Bert Bergenzer, **president of FRSSAP**.

ESC

OVER ONE-HUNDRED delegates, representing over thirty national, state and local associations attending the second meeting of the Electronic Service Council at Indianapolis, Indiana, recently to discuss unity of independent service groups.

Among those at the session were members of TEA, Texas, FRSSAP, NETSDA, NARDA, NATESA, and a number of unattached locals.

A resolution recommending that the associations affiliate with NATESA was offered. The proposal, it was said, would be presented before the complete memberships of the associations who were at the council meeting, for further consideration.

• • •

TSA, Oklahoma

THE TELEVISION SERVICE ASSOCIATION of Oklahoma, with headquarters in Oklahoma City, was formed recently.

Prexy of the new group is *H. O. Eales*. Other officers include *Floyd E. Banks*, *Ed Cones*, and *Raymond Selby*, vice presidents; *William S. Jones*, secretary-treasurer and *Robert Armstrong*, executive secretary.

The group has been incorporated under the state laws of Oklahoma. An extensive ad program, describing the association's pricing and service practice standards, is now under way, in cooperation with a distributor.

PRSSMA, Pa.

CLINTON WALTER, chief field engineer, RCA Service Co., recently delivered a lecture on color-TV installation and troubleshooting during a meeting of the Philadelphia Radio Service Men's Association which was held at the Franklin Institute Auditorium. Walter employed a 21-inch color set to illustrate field and bench problems and solutions.

TEN YEARS AGO IN SERVICE

FM continued to receive headline attention. Sylvania's sales research director, *Frank Mansfield*, predicted that 10-million wide-band sets would be sold during the next two to three years. The optimistic forecasts prompted associations to plan series of FM circuitry-installation clinics. . . . Postwar FM receivers would, it was said, feature a tuning-dial numbering system in which the first frequency (88.1 mc) was to be designated as 201, the second frequency (88.3 mc) as 202; this practice would continue until 300 had been reached. . . . Crystal-controlled oscillators began to appear in complete lines of AM and FM receivers. . . . American Phenolic Corp. expanded its plastics manufacturing facilities with the addition of a three-story building. . . . Mueller Electric Co. announced a postwar plant expansion program to start with the installation of new plating and finishing facilities. . . . Technical Appliance Corp. consolidated its wartime New York City and Flushing plants at the Flushing, N. Y. location. . . . A *Bonded Electronic Technician Program*, to improve standards of practice among Service Men, was announced by Raytheon Manufacturing Co.

Eastern Air Lines Specifies G-E Speakers for Silver Falcon, Golden Falcon Aircraft



DEPENDABLE G-E SPEAKERS fly with Eastern Air Lines' new Golden Falcon aircraft. G-E proved best in rigid flight tests.



ALOFT, TOP-PERFORMING G-E SPEAKERS provide faithful communications despite high humidity and pressure changes. Eastern specifies G-E speakers for all new craft, all replacements.

One Year Flight Performance Test Proves Value of G-E Moisture-proof Speaker Design

G-E speakers can take plenty of rugged duty—still deliver top performance and dependability. That's why Eastern Air Lines specifies G-E speakers—*all the way!*

FLIGHT TESTS DEMONSTRATE G-E QUALITY. Eastern conducted grueling tests, lasting over a year, among speakers of many makes. Results left no doubt that G-E speakers had earned their wings. Here's what H. W. Mehrling, Chief, Electronics Engineering, for EAL says about the test:

"G-E speakers will be used as a standard item with EAL on all new aircraft and as a replacement unit. Our original reason for specifying the G-E speaker was due to the installation of our P.A. system speakers in the air duct of our Martin Silver Falcon airplanes. The condensation and vapors within this duct caused a complete failure of speakers formerly used. We placed a number of G-E speakers in this aircraft for a service test for approximately one year and at the end of this period no noticeable deterioration had resulted. On the basis of this test we made the decision to specify this speaker for all future use."

A G-E SPEAKER FOR EVERY APPLICATION. There's a famous G-E Quality Line Speaker to fit your every application—all with the same top-quality standards that Eastern found in their flight performance tests. See the G-E Quality Line today, or write to: *General Electric Co., Radio & TV Department, Section R3115, Electronics Park, Syracuse, New York.*

Progress Is Our Most Important Product

GENERAL  ELECTRIC

TAPE Maintenance and Service Tips

TAPE MACHINES often present a number of repair problems that require special techniques, tools and test equipment. To illustrate, to obtain good *hf* response the recording heads must be properly aligned. This involves the use of a *vtvm*, 6500-cycle prerecorded tape, and two Phillips head screw drivers. On one line of recorders (Webcor 2110/130/131-132), the *vtvm*, using the 100-volt scale, is connected to the output receptacle of the recorder. The speed is then set at $7\frac{1}{2}$ *ips* (on dual-speed units) and the tone and volume controls are turned to maximum.

While the tape is being run from left to right, the screw drivers are inserted into adjusting screws. By tightening one screw and loosening the other alternately, the maximum *vtvm* reading can be obtained. (A scope, instead of the *vtvm* can be used to obtain the maximum reading.) This reading represents the proper alignment point. With the tape running from right to left, this same procedure is used to align the right head.

For standardization, every effort is made at the plant to align the head gaps so that they are exactly perpendicular to the tape. This is done by tilting the head for maximum output from a 6000-cps tape, upon which a steady *hf* signal has been recorded using a carefully aligned head. If the reproducing gap is not parallel to the recorder poles, serious *hf* losses and poor erase can result.

Head cover adjustments are also important in tape servicing. In the RCA TR-1 models, the head cover is adjusted for minimum record hum. Before making the adjustment, the volume control must be turned down to minimum, the tape mechanism stopped, and any tape which may be over the head removed. Then the recorder must be placed in the *play-*

back position, and a *vtvm*, or a pair of earphones, connected to the output jack.

To adjust the head cover, the head shield should be rocked back and forth. The shield should be adjusted to the position which gives the least hum indication by pressing its alternate ends. The head must be re-aligned after this adjustment is made. The head cover should never be *dropped* onto the head, since this not only affects the hum adjustment but also the alignment of the head.

The torque sent to the takeup shaft (right-hand reel in RCA models) should be adjusted for 5 to 6 inch-ounces. This can be accomplished by adjusting a knurled split-nut to provide the proper drag. The drag can be measured with a one-pound spring balance attached to the free end of a string, wrapped several times around the hub of a 7" reel mounted on the takeup hub. The *inch-ounces* of torque can be calculated by multiplying the number of ounces of pull (registered on a spring balance) by the distance (in inches) from the center of the takeup shaft to the tangency of the string coming off the reel. This measurement should be made with the recorder *on* and in a running (*forward*) position.

The rewind reel should be adjusted for a tension of 3 or 4 inch-ounces, following the foregoing takeup-reel method. The drag on the rewind wheel should be made with the recorder set to *stop* position, and with no tape on the recorder. The string on the reel should pull the reel in a clockwise direction.

In checking amplifiers in Webcor models, the output selector switch

can be used as a key test point. It should be positioned so that one can monitor a program (while it is being recorded) through the recorder's speaker. Thus, by feeding sound into the recorder through a microphone, or phono pickup, the signal will be fed through the complete amplifier, just as in a public address system.

When making this test, the *record* button must be depressed and the *tape direction* control turned either to the right or left. If the amplifier circuit is operating properly, sound will be heard in the speaker. The volume control must not be turned up too far, lest feedback occur, due to the proximity of the microphone to the speaker; feedback is normal under these conditions.

If no amplifier output is obtained during this test, the output selector switch should be turned to another point on the unit (position 3) to determine whether the signal is present at the output of the phase inverter stage; headphones can be used for this test. If a signal is heard at this stage, then the trouble is in the audio output stage; a 12AT7 phase inverter feeds the 6V6 audio output stage. If the signal is not present at the phase inverter, then you should check with the phones connected to the *record-listen* switch and other terminals to isolate the defective stage; this may be the 12AX7 preamp or compensator stage.

Defects in the head (or pole pieces) mechanism can cause any, or a combination of, the following troubles: poor erasure; unstable tape path in guides; tape skewing, occurring simultaneously with amplitude fluctuations, and in head wear. These troubles may be due to foreign deposits, or nicks or gouges on the head surfaces. It may be necessary to replace the head or pole pieces, or both.

Fig. 1. Schematics illustrating path of signal when recording on tape equipment (a); path of signal in playback (b); and path of bias during record (c). (Webcor)

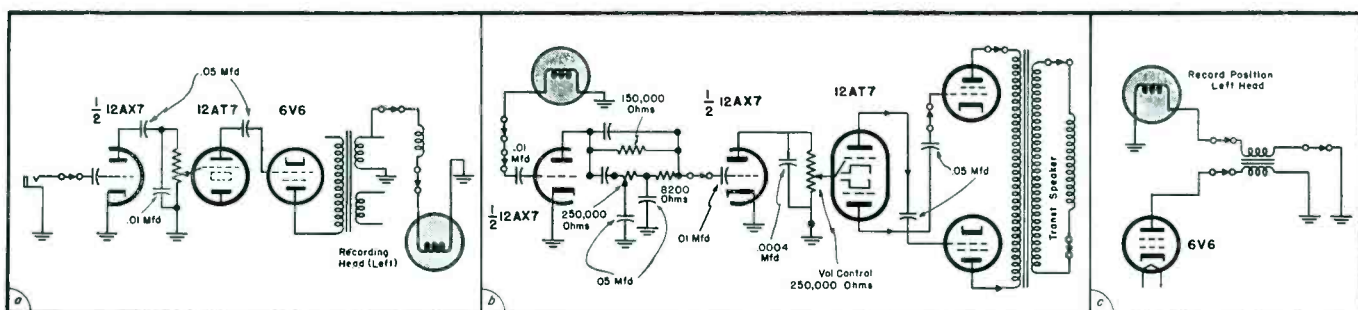

BLACK AND WHITE TV

COLOR TV

TRANSISTOR RADIOS

FM RADIOS

AM RADIOS

AMPLIFIERS AND TUNERS

AUTO RADIOS

RECORD CHANGERS



WHAT'S YOUR SERVICE PROBLEM?

PHOTOFACT HELPS YOU SOLVE IT

FASTER, EASIER, BETTER, MORE PROFITABLY!

**THE WORLD'S
FINEST SERVICE DATA**

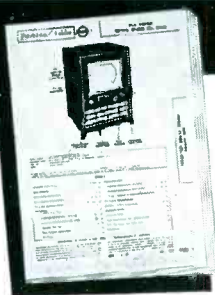

**THESE GREAT FEATURES ARE EXCLUSIVE IN PHOTOFACT—THEY HELP
YOU EARN MORE DAILY, HELP INSURE CUSTOMER SATISFACTION**

PHOTOFACT Service Data is the *only* service information based upon first-hand examination of the actual production-run receivers and equipment. It is authentic, uniform data developed through actual study and analysis by service engineers in the Howard W. Sams Laboratories. PHOTOFACT is the *only* data prepared from the practical point of view of the Service Technician.

Thousands of Service Technicians use PHOTOFACT daily for time-saving, profit-boosting service operations. If you've never used PHOTOFACT, you've never realized your full earning power—you've never given such complete customer satisfaction. So get the proof for yourself. Try PHOTOFACT—use it on any job. Your Parts Distributor has the Folder Sets you need for any of the 17,000 TV and radio receivers, changers, recorders, etc., covered in PHOTOFACT. Once you use this great service, we know you'll want the complete PHOTOFACT Library.

**FREE Send for the PHOTOFACT
CUMULATIVE INDEX
IT'S VALUABLE!**



Send for it! Your guide to virtually any model ever to come into your shop; helps you locate the proper PHOTOFACT Folder you need to solve any service problem on any model. Once you have the make and chassis number, it takes just 60 seconds to find the applicable PHOTOFACT Folder. Send coupon now for your FREE copy of the valuable Cumulative Index to all the PHOTOFACT Folders you need.

FREE

EASY-PAY PLAN TO FIT YOUR BUDGET

Ask your PHOTOFACT Distributor... he'll show you how you can now own the PHOTOFACT Library through a unique Easy-Pay Plan that exactly fits your needs. Pays for itself as you EARN MORE.

FULL SCHEMATIC COVERAGE

1. Famous "Standard Notation" uniform symbols are used in every schematic.
2. The same standard, uniform layout is used for each schematic.
3. Diagrams are clear, large, easy to read, easy to handle.
4. Wave forms are shown right on the TV schematics for quick analysis by 'scope.
5. Voltages appear on the schematics for speedy voltage analysis.
6. Transformer lead color-coding is indicated on the schematic.
7. Transformer winding resistances appear on the schematic.
8. Schematics are keyed to photos and parts lists.

FULL PHOTOGRAPHIC COVERAGE

9. Exclusive photo coverage of all chassis views is provided for each receiver.
10. All parts are numbered and keyed to the schematic and parts lists.
11. Photo coverage provides quicker parts identifications and location.

ALIGNMENT INSTRUCTIONS

12. Complete, detailed alignment data is standard and uniformly presented in all Folders.
13. Alignment frequencies are shown on radio photos adjacent to adjustment number—adjustments are keyed to schematic and photos.

TUBE PLACEMENT CHARTS

14. Top and bottom views are shown. Top view is positioned as chassis would be viewed from back of cabinet.
15. Blank pin or locating key on each tube is shown on placement chart.
16. Tube charts include fuse location for quick service reference.

TUBE FAILURE CHECK CHARTS

17. Shows common trouble symptoms and indicates tubes generally responsible for such troubles.
18. Series filament strings are schematically presented for quick reference.

COMPLETE PARTS LISTS

19. A complete and detailed parts list is given for each receiver.
20. Proper replacement parts are listed, together with installation notes where required.
21. All parts are keyed to the photos and schematics for quick reference.

FIELD SERVICE NOTES

22. Each Folder includes time-saving tips for servicing in the customer's home.
23. Valuable hints are given for quick access to pertinent adjustments.
24. Tips on safety glass removal and cleaning.

TROUBLE-SHOOTING AIDS

25. Includes advice for localizing commonly recurring troubles.
26. Gives useful description of any new or unusual circuits employed in the receiver.
27. Includes hints and advice for each specific chassis.

OUTSTANDING GENERAL FEATURES

28. Each and every PHOTOFACT Folder, regardless of receiver manufacturer, is presented in a standard, uniform layout.
29. PHOTOFACT is a *current* service—you don't have to wait a year or longer for the data you need. PHOTOFACT keeps right up with receiver production.
30. PHOTOFACT gives you complete coverage on TV, Radio, Amplifiers, Tuners, Phonos, Changers.
31. PHOTOFACT maintains an inquiry service bureau for the benefit of its customers.

HOWARD W. SAMS & CO., INC.

Howard W. Sams & Co., Inc., Dept. 5-L5
2201 E. 46th St., Indianapolis 5, Ind.

Send FREE Photofact Cumulative Index.

Name.....

Address.....

City.....Zone...State.....

HELPS YOU EARN MORE DAILY

The MASTER SETS YOU UP!

here's what's in it for you . . .

DOLLAR-WISE PURCHASING
Shop before you buy! Do it right at your own bench through the supermarket pages of the industry-wide MASTER. Compare specs and prices first—then buy and save.

BONANZA BUSINESS Use The MASTER as your "geiger". Strike it rich with every repair. Take The MASTER right into your customer's home and sell direct from its pages. Watch it pay off!

- 100,000 items • Complete descriptions
- Specifications—Prices • 11,000 illustrations • 350 mfrs. • 8 x 11", 6 lbs.

UNITED CATALOG PUBLISHERS, INC.
110 Lafayette St., New York 13

List \$7.50
As low as
\$2.95
from parts distributors

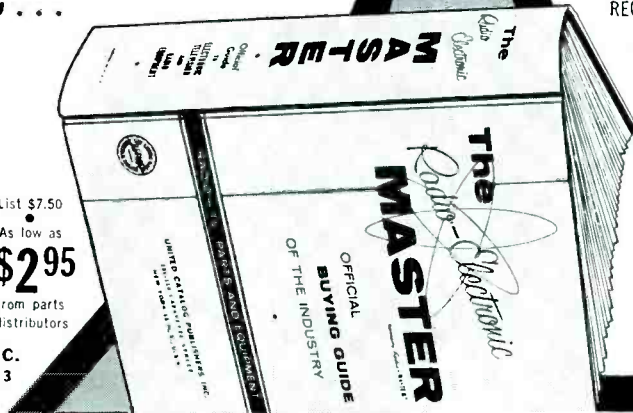

1956 edition

FULLY CATALOGS:

- TUBES — TRANSMITTERS
- TEST EQUIPMENT — COMMUNICATION
- RECEIVERS — RESISTORS — COILS
- ANTENNAS — TRANSFORMERS
- RECORDING & PA SYSTEMS
- CAPACITORS — HARDWARE
- RELAYS — TOOLS, ETC.

1456 pages
OFFICIAL
BUYING GUIDE
OF THE
INDUSTRY

Coming Events

Instrumentation Conference-Exhibit Nov. 28-30
Hotel Biltmore, Atlanta, Georgia

Eighth Annual Southwestern Conference-Show . . . Feb. 9-11, 1956
Municipal Auditorium, Oklahoma City, Okla.

VOM Measurements

(Continued from page 55)

not the voltage across the coil, the change of the coil resistance with temperature creates no problem, in the case of voltage reading.

But, when shunts are used as multipliers for current reading, the change in resistance with the temperature of the coil is different from the change in the shunt resistances with temperature. The coil is wound of copper, while the various shunts, made of resistance metal, do change so much, as temperature varies.

To minimize this error, good instruments employ a resistance, made of resistance metal, in series; designed to swamp the variation in the resistance of the copper coil winding; this serves to minimize the variation in accuracy on current reading, due to temperature changes. Using this method, a quality multi-range instrument can also achieve $\pm 3\%$ accuracy overall on the direct current range.

AC Ranges

Now what about instrument accuracy on ac ranges? All vom's use an instrument rectifier to provide the ac reading. This is a tiny metal-contact rectifier whose function is to reverse alternate half waves of the alternating waveform, and provide a direct current proportional to the original alternating current, to induce instrument deflection. The microammeter will read the average value of the direct current given by the rectifiers.

[To Be Continued]

for service and lab. work

Heathkit PRINTED CIRCUIT OSCILLOSCOPE KIT FOR COLOR TV!

① Check the outstanding engineering design of this modern printed circuit Scope. Designed for color TV work, ideal for critical Laboratory applications. Frequency response essentially flat from 5 cycles to 5 Mc down only $1\frac{1}{2}$ db at 3.58 Mc (TV color burst sync frequency). Down only 5 db at 5 Mc. New sweep generator 20-500,000 cycles, 5 times the range usually offered. Will sync wave form display up to 5 Mc and better. Printed circuit boards stabilize performance specifications and cut assembly time in half. Formerly available only in costly Lab type Scope. Features horizontal trace expansion for observation of pulse detail — retrace blanking amplifier — voltage regulated power supply — 3 step frequency compensated vertical input — low capacity nylon bushings on panel terminals — plus a host of other fine features. Combines peak performance and fine engineering features with low kit cost!



Heathkit TV SWEEP GENERATOR KIT ELECTRONIC SWEEP SYSTEM

② A new Heathkit sweep generator covering all frequencies encountered in TV service work (color or monochrome). FM frequencies too! 4 Mc — 220 Mc on fundamentals, harmonics up to 880 Mc. Smoothly controllable all-electronic sweep system. Nothing mechanical to vibrate or wear out. Crystal controlled 4.5 Mc fixed marker and separate variable marker 19-60 Mc on fundamentals and 57-180 Mc on calibrated harmonics. Plug-in crystal included. Blanking and phasing controls — automatic constant amplitude output circuit — efficient attenuation — maximum RF output well over .1 volt — vastly improved linearity. Easily your best buy in sweep generators.

Heath
COMPANY
A SUBSIDIARY OF DAYSTROM, INC.
BENTON HARBOR 11, MICH.
WRITE FOR FREE CATALOG
... COMPLETE INFORMATION

TV Antennas

(Continued from page 59)

for different lengths of line. The Service Man may be able to provide favored performance on one channel by experimenting with the length of the feedline.

A calibrated signal generator is connected to the transmitting antenna through a 52-ohm coax cable. A constant-voltage transformer furnishes *ac* to both the field-strength meter and the signal generator. In addition, voltage regulated *dc* power supplies are used with the equipment.

To obtain a more accurate value of the *vswr* than can be obtained with the adjustable line, a sweep generator, rectifier and 'scope are used. Fig. 7 (p. 59) shows in block diagram the necessary equipment, and Fig. 8 (p. 59) shows the 'scope response from which the *vswr* can be accurately determined.

To test completely the three characteristics for a channel 2 to 13 *vlf* antenna, it is necessary to record 72 measurements for antenna gain, three for each channel of the antenna under test and three for each channel of the reference dipole. These first 36 readings are made with the adjustable line in a position to give maximum readings. An additional 36 readings are necessary with the line adjusted to give minimum results. For directivity, 36 readings are necessary for each frequency involved. This means that a total of 432 individual readings are necessary to provide full information on the horizontal directivity of the antenna for all channels. For *vswr* one must observe 'scope patterns on 36 different frequencies and translate these into direct voltage ratios.

In other words, the evaluation of the necessary characteristics for a single, all-channel antenna represents many hours of recording data and compiling averages in to the gain, directivity and *vswr* charts which are commonly shown. Typical charts of this type are illustrated in Figs. 9, 10 and 11 (p. 59); the antenna used to obtain these plots also is shown on page 59.

In conclusion, we find that test equipment and techniques provide the best possible quantitative evaluation of antenna performance. It should be noticed, however, that the same tests, on the same antenna, carried out independently by two different laboratories, might produce gains differing by 2 *db* or more. This can arise if conditions in one case are optimum for that channel, and in the other case are not.

C-D's CUB BEST-BAR NONE

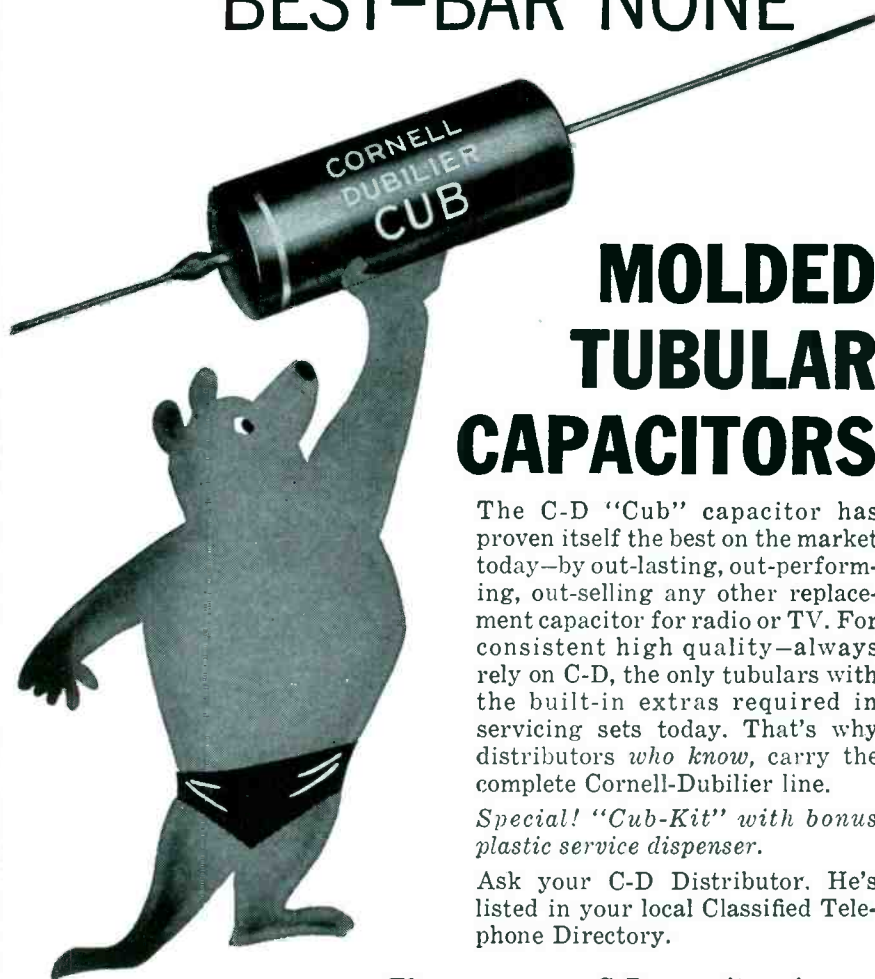

MOLDED TUBULAR CAPACITORS

The C-D "Cub" capacitor has proven itself the best on the market today—by out-lasting, out-performing, out-selling any other replacement capacitor for radio or TV. For consistent high quality—always rely on C-D, the only tubulars with the built-in extras required in servicing sets today. That's why distributors *who know*, carry the complete Cornell-Dubilier line.

Special! "Cub-Kit" with bonus plastic service dispenser.

Ask your C-D Distributor. He's listed in your local Classified Telephone Directory.

There are more C-D capacitors in use today than any other make



CONSISTENTLY DEPENDABLE CORNELL-DUBILIER CAPACITORS

PLANTS IN SOUTH PLAINFIELD, N. J.; NEW BEDFORD, WORCESTER AND CAMBRIDGE, MASS.; PROVIDENCE AND HOPE VALLEY, R. I.; INDIANAPOLIS, IND.; SANFORD AND FUYQUAY SPRINGS, N. C.; SUBSIDIARY: THE RADIART CORPORATION, CLEVELAND, O.

FRINGE-ZONE ANTENNA

Fringe area antenna which utilizes a sleeve dipole principle, said to provide high gain and broad band. Design features short antenna elements in series with a section of simulated three-wire transmission line, in conjunction with a reflector system. Sleeve dipole principle is also claimed to assure close centering of the impedance characteristic. Available in two and four bay models. (Poweray; American Phenolic Corp., Chicago 50,

III.)

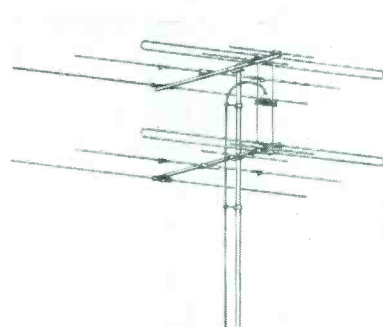

Ser-Cuits

(Continued from page 34)

will reduce the level to near zero, when only contact resistance remains.

The installation of the remote-control unit on receivers equipped with the necessary internal circuits and receptacle is simple; it is only necessary to plug in and adjust the controls. On other chassis, one has to install the tuning motor, relay, and transformer, and break the power, cathode return, audio, and tuner-oscillator supply leads, bringing the necessary leads to the receptacle which should be mounted on the rear of the receiver chassis.

To adjust the receiver and the remote control, both the receiver and

the remote control unit should be turned *on*. Then the remote fine tuning control should be turned to the *manual* position counterclockwise, until a click is heard. The receiver channel selector switch should be set to the highest channel in use in the area, and the receiver fine tuning adjusted for best picture detail; optimum intercarrier receiver tuning. The receiver-brightness control is adjusted to near maximum brightness, and the remote control unit brightness control is adjusted for desired picture brightness. Other receiver controls (contrast, hold) must be adjusted for the best picture. Then the receiver should be checked for operation on all other channels. It should be possible to tune all channels satisfactorily with the remote fine tuning control, leaving the receiver fine tuning control set. If this cannot be done, the individual channel trimmers should be readjusted. The receiver volume control should be set to mid position, and volume adjusted by the remote unit volume control.

To service the receiver without the remote unit, jumpers should be placed between pins 5 and 6 (to actuate the relay), pins 7 and 8 (to complete the brightness circuit), pins 11 and 12 (to apply B+ to the tuner oscillator plate), and pins 9 and 10 (to operate the receiver speaker). The receiver can then be operated and tested in the conventional manner; troubles in the remote unit will be isolated.

Troubles in the remote control unit can be readily located by resistance checks. It should be noted that the controls in the remote unit modify the action of the receiver controls; the receiver controls must be preset to permit the proper range of adjustment at the remote control unit. For example, one person sitting near the receiver may turn down the volume at the receiver; a person at the remote unit may turn the volume up. A short *argument* of this nature will soon put the remote unit control at its *limit*; the Service Man may receive a complaint that *there isn't enough sound*. This danger is inherent in any system with dual controls.

More serious trouble can be expected in the auxiliary equipment in the receiver. The relay contacts will tarnish or carbonize. Carbon tet will clean slightly dirty contacts; carbonized contacts will require polishing with crocus cloth. The motor does not require lubrication in normal operation; however, if the bearings become noisy, a few drops of fine oil may be added to each.

SHOOT TV AND RADIO TROUBLE FAST

NEW! NEW!



Without experience or knowledge, this guaranteed new method of servicing AC/DC radio sets and TV sets, enables you to **DIAGNOSE** troubles as rapidly as an expert. **NO THEORY—NO MATH**—you can locate faults in record-breaking time, regardless of make or model. **"SHOOT TV & RADIO TROUBLE FAST"** is the most valuable servicing aid ever written. Be a radio & TV trouble Diagnostician. Increase present earnings. Open a profitable business.

IT'S ALL IN THIS BOOK

TV section has hundreds of picture, raster & sound troubles. This unique copyrighted method shows you **EXACTLY WHERE** trouble is; plus step-by-step instructions including **RAPID CHECKS**, over 65 of which require **NO INSTRUMENTS!** These include checks for distorted picture, bad tubes, including Pix tube, plus 57 others. **ALL EXPLAINED IN SIMPLE LANGUAGE, PERFORMED WITHOUT INSTRUMENTS. MANY CHECKS USE PICTURE TUBE AS GUIDE.**

AC/DC RADIO SECTION contains alphabetical list of **SYMPTOMS** including almost every possible fault. Each symptom lists possible **CAUSES** & each **CAUSE** is referred to a **FAST RADIO TEST** which pin-points the defective part and gives the appropriate **REMEDY**. H. G. Cisin, the author, is the inventor of the AC/DC midset radio. He licenses RCA, AT&T, etc. He has trained thousands of radio & TV technicians. His years of experience are embodied in this remarkable **NEW BOOK**.

Only \$1.50 postpaid.

Rush This Book

TV TROUBLE TRACERS

H. G. Cisin's **TV TROUBLE TRACERS**—(4 volumes)—Each contains different **COPYRIGHTED** Trouble Indicating Tube Location Guides, covering hundreds of the most popular TV models. Each has over 70 illstr. & tube guides. 40 most common pix troubles illustr.

Vol. 1—Older Models Vol. 3—'53-'54 sets
Vol. 2—'52-'53 sets Vol. 4—'54-'55 sets

EACH VOL. 50¢ postpaid

RUSH Vol. 1; Vol. 2; Vol. 3; Vol. 4.

ANNOUNCING!

H. G. Cisin's Newest Book

"**TV & RADIO TUBE SUBSTITUTION GUIDE**" Gives direct replacement of set and picture tubes. A most valuable service aid!

Only 50¢ postpaid.

Rush This Book

FREE TV & RADIO TUBE SUBSTITUTION GUIDE

with every purchase of \$2 or over

5-day MONEY BACK GUARANTEE

RUSH COUPON NOW!

H. G. CISIN CONSULTING ENGINEER
Amagansett, N. Y. Dept. S-28
Enclosed find.....Rush postpaid books checked above.
Name.....
Address.....
City..... Zone..... State.....

DON'T JUST SAY CAPACITORS

Ask For Sprague By Catalog Number

Know what you're getting... get exactly what you want. Don't be vague... insist on Sprague. Use complete radio-TV service catalog C-610. Write Sprague Products Company, 61 Marshall Street, North Adams, Massachusetts.

SPRAGUE®

WORLD'S LARGEST CAPACITOR MANUFACTURER

Coming Events

Hi-Fi Audio Show
February 8-11, 1956
Los Angeles, Calif.

STATEMENT REQUIRED BY THE ACT OF AUGUST 24, 1912, AS AMENDED BY THE ACTS OF MARCH 3, 1933, AND JULY 2, 1946 (Title 39, United States Code, Section 233) SHOWING THE OWNERSHIP, MANAGEMENT, AND CIRCULATION OF SERVICE, published monthly at New York, N. Y., for October 1, 1955.

1. The names and addresses of the publisher, editor, managing editor, and business managers are:

Publisher: Bryan Davis Publishing Co., Inc., 52 Vanderbilt Ave., N. Y. 17, N. Y.; Editor: Lewis Winner, 245 W. 107th St., N. Y. 17, N. Y.; Managing Editor: None; Business Manager: F. W. Boyd, 494 Martense Ave., Teaneck, N. J.

2. The owner is: (If owned by a corporation, its name and address must be stated and also immediately thereunder the names and addresses of stockholders owning or holding 1 percent or more of total amount of stock. If not owned by a corporation, the names and addresses of the individual owners must be given. If owned by a partnership or other unincorporated firm, its name and address, as well as that of each individual member, must be given.)

Bryan Davis Publishing Co., Inc., 52 Vanderbilt Ave., N. Y. 17, N. Y.; B. S. Davis, Ghent, N. Y.; M. T. Davis, Ghent, N. Y.; J. C. Munn, 2253 Delaware Drive, Cleveland 6, Ohio; F. W. Boyd, 494 Martense Ave., Teaneck, N. J.; Lewis Winner, 245 W. 107th St., New York 25, N. Y.

3. The known bondholders, mortgagees, and other security holders owning or holding 1 percent or more of total amount of bonds, mortgages, or other securities are: (If there are none, so state.)—None.

4. Paragraphs 2 and 3 include, in cases where the stockholder or security holder appears upon the books of the company as trustee or in any other fiduciary relation, the name of the person or corporation for whom such trustee is acting; also the statements in the two paragraphs show the affiant's full knowledge and belief as to the circumstances and conditions under which stockholders and security holders who do not appear upon the books of the company as trustees, hold stock and securities in a capacity other than that of a bona fide owner.

(Signed) F. W. BOYD, Business Manager
Sworn to and subscribed before me this 27th day of September 1955.

(Seal) Nathan Jelling, Notary Public

Instruments

LaSALLE PICTURE TUBE TESTER

A 5AHP4 universal miniature aluminized picture tube, *Pic-Testube*, that serves to compare performance with large tubes in TV sets has been announced by LaSalle Tube Manufacturing Co., Inc., 155 E. Grand Ave., Chicago, Ill.

Features automatic focus; eliminates ion trap and focus coil. Tube comes in carrying case.

LEITCH AUTOMATIC VTVM

An automatic range-switching *vtvm*, *Meter-Matic*, featuring an 8½" meter, has been introduced by Leitch Engineering Corp., Manchester, N. H.

Each set of calibrations is said to be complete without need of adding zero multipliers. *Ac* and *dc* voltage measurements from .1 to 1500 v. In measuring resistance, automatic reading is claimed to be possible from .5 ohm to 1 billion ohms in six ranges. Instrument protected from burnout or damage up to 2000 v; on resistance readings up to 300 v. Single set of probes serves all functions.

B&K CATHODE REJUVENATOR TESTER

A portable cathode-rejuvenator tester, model 400, for checking and correcting T picture tube troubles without removing tube from set, has been introduced by B&K Manufacturing Co., 3726 N. Southport Ave., Chicago 13, Ill.

Unit is said to find and repair interelement shorts and open circuits, stop leakage, reactivate picture tube cathode and restore emission. A check for gas content is also included.

EICO WIDE BAND 'SCOPE

A wide-band 5-inch 'scope, 460 (kit or factory wired, designed for checks of 3.58-mc sync burst and oscillator signals in color-TV sets, has been developed by Electronic Instrument Co., Inc., 84 Withers St., Brooklyn 11, N. Y.

Response is said to flat from *dc* to 4.5 mc; usable to above 5 mc. Pre-set TV vertical and horizontal sweep positions are incorporated. Has push-pull vertical amplifier. Offers choice of direct (*dc*) or capacitive (*ac*) coupling. Sweep frequencies are from 10 cps to 100 kc; lower sweep frequencies with external capacitor.

SEL-SON PICTURE TUBE TESTER

A picture tube tester, *Substituter*, for determining whether trouble is in TV tube or chassis without removing tube, yoke, focus arrangement or ion trap from set, has been introduced by the Sel-Son Electronic Tube Corp., Darby, Pa.

Necessary extensions for high voltage connection, tube socket and yoke supply are included. Yoke supply extension has four specially-designed leads with insulation piercing clips.

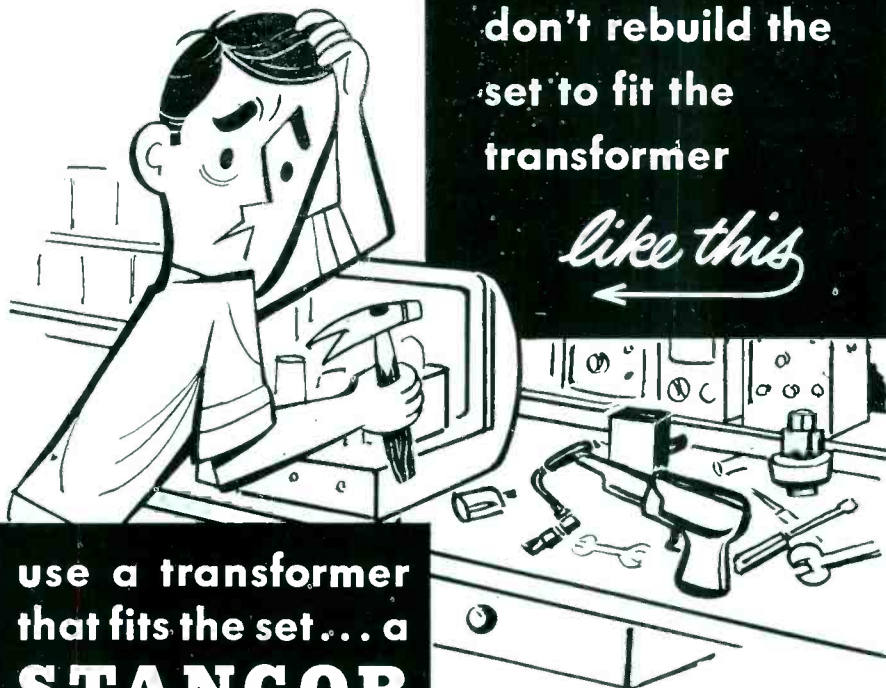

don't rebuild the set to fit the transformer

like this

use a transformer that fits the set... a
STANCOR
verified
exact replacement
TRANSFORMER

FREE STANCOR TV Transformer Catalog and Replacement Guide listing replacement data on virtually all TV sets in use today, with hundreds of **VERIFIED** exact replacement applications.

EXPORT SALES:
Roburn Agencies, Inc.
431 Greenwich Street
New York 13, N. Y.



**CHICAGO STANDARD
TRANSFORMER CORPORATION**

3588 Elston Avenue • Chicago 18, Illinois

When you install a STANCOR exact replacement TV transformer, all you'll need is a soldering iron and a screwdriver, and perhaps a wire cutter... because STANCOR transformers are **VERIFIED** exact replacements... designed from the original manufacturers specifications and tested by actual installation and operation in the recommended chassis.

EMC TUBE TESTER-REJUVENATOR

A tube tester-rejuvenator, model 209 (kit or factory wired), for checking all types of vacuum tubes and repairing b-w picture tubes, has been announced by Electronic Measurements Corp., 280 Lafayette St., New York 12, N. Y.

Tubes are tested through use of standard, total emission method. Unit is said to detect shorts, leakages, continuity and opens occurring between any two tube elements. With addition of EMC model CRA picture tube adaptor, rejuvenation and repair of all b-w picture tubes is claimed to be possible. Comes in an oak or metal case.

SENCO FILAMENT CHECKER

A pocket-sized automatic filament checker, model FC4, for testing octal, loctal, 7- and 9-pin miniatures and picture tubes, has been announced by Service Instruments Co., 171 Official Rd., Addison Industrial District, Addison, Ill.

By inserting standard test leads in pins 1 and 12 of picture tube socket, unit can be used to check continuity and as a neon voltage indicator. Neon light glows when a TV line cord is connected to indicate that unit is on; stops glowing when a good tube is inserted.

Mr. Electronic Service Technician

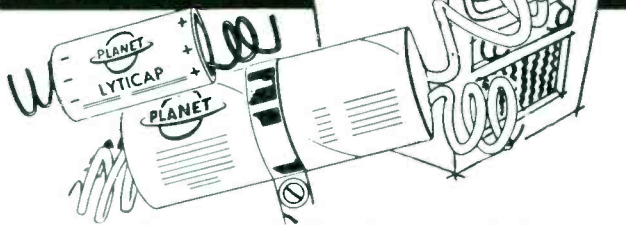

You have seen and will continue to see, in the chassis of TOP-NAME Radio and TV sets, an increasing number of Planet electrolytic capacitors — conspicuous because of their shiny red cardboard jackets. They are in those quality sets because components engineers have proven for themselves that PLANET condensers are "ENGINEERED FOR QUALITY".

You can take advantage of their findings by purchasing from your distributor Planet universal replacement types of the same high standard of quality. Ask for PLANET by name.

Write now for "ENGINEERED FOR QUALITY" latest FREE catalog. **GUARANTEED FOR ONE YEAR**

PLANET PLANET SALES CORPORATION
225 BELLEVILLE AVENUE
BLOOMFIELD, N. J.

FIRST and FOREMOST! the original and unmatched

CapaciTester

The pioneer instrument for checking coupling condenser leakage in the circuit!

TeleTest anticipated your demand for a unit that would check leaky coupling condensers, under load, without removal from the circuit. With the remarkable and unparalleled CapaciTester, you not only can check any coupling condenser without clipping or unsoldering leads, but you can test for leakage between any points where it may occur! AND, with the added Wien bridge, you can measure capacities from 10 mmf. to 50 mfd.



Model CT-355

1-YEAR FACTORY SERVICE GUARANTEE

only \$44⁹⁵

- Tests all coupling condensers for leakage, regardless of type or capacity.... IN THE CIRCUIT
- Will not damage condensers
- No calibration adjustments required
- Positive indication of relative leakage amount present



See your local jobber, or write TODAY:
31-01 Linden Place, Dept. 511, Flushing 54, N. Y.

WRITE FOR THIS.

FREE

LIFETIME
HI-FIDELITY
Sales Kit

DEALER SALES KIT MAKE BIG HI-FI PROFITS

Sell the finest HI-FI Units for custom building or in BEAUTIFUL CABINETS... Sell BELOW REGULAR WHOLESALE PRICES with full dealer mark-up and with price protection.

TRANSVISION Hi-Fi Equipment is SOLD THRU SELECTED DISTRIBUTORS

TRANSVISION, INC., NEW ROCHELLE, N. Y.
In Canada: 1338 Queen St. W., Toronto 3, Ont.

TRANSVISION, INC., New Rochelle, N. Y. S-11
Rush FREE Dealer SALES KIT on HI-FI and name of nearest distributor.

Name _____
Address _____
City _____ State _____

(Right)

Gerald Macheak, owner, Macheak Radio and TV, Cedar Falls, Ia. (second from left) and truckload of Winegard Pixie antennas he purchased from Gifford Brown Co., Winegard distributor in Cedar Rapids. Macheak is promoting antenna installations over radio and in newspapers. Looking over lineup of antennas, left to right: John Winegard, president of Winegard Co., Macheak, and Howard Secor, manager of the Gifford Brown Distributing Co.

(Right, below)

Ray R. Simpson being congratulated on his fiftieth year in the electrical instruments industry by Wallace E. Carroll, president of Simpson Electric Co. An oil portrait, a gift from company and its sales rep, was presented to Simpson during celebration.

TV PROGRAM FOR TUBES



Garry Moore, now sponsored by CBS-Hytron on TV, to promote the sale of radio and television tubes.

TRUCKLOAD OF ANTENNAS FOR SERVICE SHOP

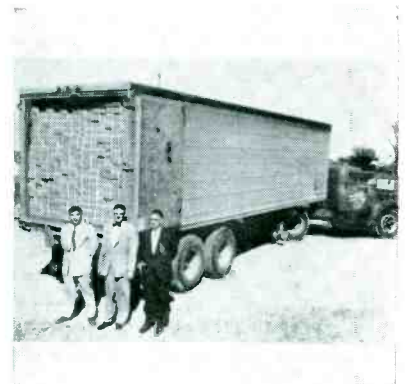

FIFTY-YEAR CELEBRATION



SAM SCHLUSSEL has been named to a new post, sales manager of antennas and accessories, at Channel Master Corp., Ellenville, N. Y.



Sam Schluszel



Joseph Solari

JOSEPH SOLARI, formerly vice president in charge of sales for Jefferson Electric Co., has joined Federal Telephone and Radio Co., 100 Kingsland Rd., Clifton, N. J., as general sales manager of the components division. . . . J. E. VAN WAGENEN, formerly sales manager of semiconductor products, is now selenium product line manager.

PETER MALER has been appointed sales promotion manager of Astron Corp., 255 Grant Ave., East Newark, N. J.

WALTER NACHTIGALL, formerly with Peck Advertising Agency, has been appointed advertising and sales manager of Fanon Electric Co., Inc., Jamaica, N. Y.

RICHARD SCANLON has been named production manager of Todd-Tran Corp., Mt. Vernon, N. Y. . . . RICHARD CORN has been appointed chief engineer.

Personnel

HAL BECKER has joined Shappe-Wilkes, Inc., 215 Fourth Ave., New York 3, N. Y., as a principal.

WILLIAM J. BAKROW has been named public relations manager of CBS-Hytron, Danvers, Mass. . . . WILLIAM W. POSEY has become east central district sales manager of CBS-Hytron.

EDWARD E. WINEBLATT has been named general manager of Radio Merchandise Sales, Inc., 2016 Bronxdale Ave., New York 62, N. Y.



Edward E. Wineblatt



Eugene Duffner

EUGENE DUFFNER has been appointed district sales manager for Florida by Channel Master Corp., Ellenville, N. Y. . . . EARL PRUITT was named district sales manager for Indiana and Illinois.

HOWARD W. SAMS has been elected chairman of the board of Howard W. Sams and Co., Inc., Indianapolis, Ind. . . . J. A. MILLING is now president.

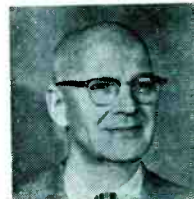

H. W. Sams



J. A. Milling

HAROLD J. McCORMICK is now manager of advertising and sales promotion of the radio and television department of General Electric Co., Electronics Park, Syracuse 1, N. Y.

FITZROY KENNEDY has been named chairman of the board of the Spencer-Kennedy Laboratories, Inc., Cambridge, Mass. . . . DONALD SPENCER has been elected president. . . . GEORGE W. W. BREWSTER is now chairman of the executive committee.

A. H. HARDWICK, manager of the New York IRC sales office, has been elected a vice president of International Resistance Co., 401 N. Broad St., Philadelphia 8, Pa.

Circuit Diagrams In This Issue

	Page
CBS-Columbia (Model 1603) Vertical Oscillator	32
Halicrafters (Model 1850) Vertical Oscillator	32
CBS-Columbia (Model 1603) Horizontal Oscillator	33
Admiral (Model 18XP4B2) Horizontal Oscillator	33
G.E. (Model 24C01) Electron-Coupled Oscillator	32
Sentinel Remote Control; Models 21101, 21121, 21145	35
Leaky Capacitor Evaluation Circuit	36
Color-TV Vertical/Horizontal Sweep Circuits (RCA)	39
Color-TV Automatic Chroma Control; RCA (Cover)	41
Color-TV Dot-Bar Generator; RCA	42
Color-TV Simplified Dot Generator Schematic; RCA	42
Color-TV Dot-Bar Generator; RCA WR-36A	46
Color-TV Color-Bar Generator; RCA WR-61A	46
Multi-Range AC/DC Test Instrument Circuitry	52
Metallic Rectifier Circuit for Test Instrument	52
Bridge Rectifier Circuit for Test Set	52
Emerson 1202200 Horizontal Sweep	57
Power Supply for 2-Way 450-Mc Receiver (G.E.)	63
Tape Recording-Playback Signal Path Schematics (Webcor)	76

WHEN YOU CHANGE YOUR ADDRESS

Be sure to notify the Subscription Department of SERVICE at 52 Vanderbilt Avenue, New York 17, N. Y., giving the old as well as the new address, and do this at least four weeks in advance. The Post Office Department does not forward magazines unless you pay additional postage, and we cannot duplicate copies mailed to the old address. We ask your cooperation.



Yes, they're SUPEREAMERS!

Just what you've wanted!

- **SUPER size!**
... ream 1/8" to 3/8"
- **SUPER tough** ...
rust resistant

CHROME FINISH!

No. 38 fixed in full-size XCELITE handle \$2.15
List, less your discount

No. 99-38 to fit the big 99-1 handle in your versatile 99PR nut driver-screwdriver kit (there's a pocket to hold it!) \$1.85
List, less your discount

ASK YOUR JOBBER TODAY!

XCELITE, INCORPORATED

Dept. V
Orchard Park
New York

For Originality
LOOK TO XCELITE



KESTER



Absolutely non-corrosive and non-conductive, KESTER "RESIN-FIVE" CORE SOLDER contains an activated type of resin that gives you that fast, positive action on all your jobs . . . including the most difficult.



KESTER SOLDER COMPANY
4848 Wrightwood Avenue • Chicago 39, Illinois
Newark 5, New Jersey • Brantford, Canada

SOLDER

SUPPORT the
UNITED COMMUNITY CAMPAIGNS

Components

ERIE DISC CERAMICONS

Temperature-stable disc ceramic capacitors, *II-A*, said to provide a maximum capacity change of 3% over temperature range from +10° to +85° C, have been developed by Erie Resistor Corp., 644 W. 12th St., Erie, Pa.

Units are available in capacitance values from 150 mmfd to 4250 mmfd, with tolerances of ±10% and ±20%. Diameters range from 5/16" to 3/4". Maximum thickness on all units is 5/32". Available with 22 and 20 gauge wire leads or spade leads for insertion in printed circuit boards. Further details in bulletin 449.

• • •

CLAROSTAT POWER RHEOSTATS WITH POWER SWITCH

Power rheostats which incorporate a switch for multi-circuit applications, 25GS and 50GS, have been announced by Clarostat Manufacturing Co., Inc., Dover, N. H.

Units are encased modified to accommodate power switches of *spst*, *spdt*, or *dpst* construction.

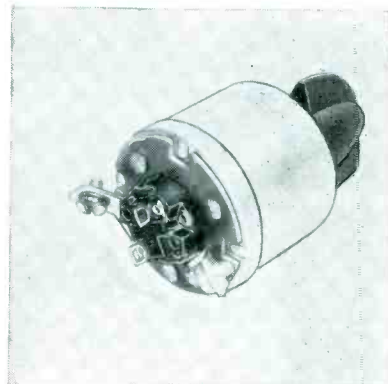

• • •

INTERNATIONAL DUAL-PURPOSE SELENIUM RECTIFIERS

Small, dual-purpose selenium rectifiers 60-9150 (basically voltage doubler stacks), for doubler (one unit) or single-phase full-wave bridge (two units) applications have been developed by International Rectifier Corp., 1521 E. Grand Ave., El Segundo, Cal.

Two units connected in a single-phase full-wave bridge circuit will deliver approximately 180 *vdc* at .10 *amp* for an *rms* voltage input of 230 *v*. As a voltage doubler the unit will deliver 50 *ma* connected to a maximum *ac* input of 175 *v rms*. With sufficient capacitance an output of 350 *vdc* can be obtained. Size is 21/32" x 1 1/16" x 1 1/4". Can be used to operate remote TV tuners in hospitals, homes and offices where hum is objectionable, due to normal operations of *ac* relays.

A NEW PRODUCT

by the makers of the famous "NO NOISE" Volume Control and Contact Restorer

NO-NOISE TUNER-TONIC

NO NOISE
Volume Control and Contact Restorer with *PERMA-FILM*
Cleans, lubricates, protects . . . not a carbon-tet solution. Still available in the new 6 oz. spray can.

Net to servicemen \$2.25
2 Oz. Bottle

Net to servicemen \$1.00
Also available in 8 oz. bottles and quart cans.

Nearest distributor or write direct today.

with *PERMA-FILM*

Cleans, lubricates, restores all tuners including water type. Won't change or affect capacitors, inductance or resistance, nor harm insulations or precious metals, nor attack plastics. For television, radio and FM. Eliminates all noise, oxidation and dirt indefinitely.

Non-toxic, non-inflammable insures trouble-free performance. 6 oz. Aerosol Can. Net to servicemen.

\$3.25

Extra economical because a small amount does the job!



ELECTRONIC CHEMICAL Corp.

813 Communipaw Avenue Jersey City 4, N. J.



NEW Bench-Field SELENIUM TESTER Tools . . .

MODEL
SEL-1

65 MA
600 MA

ONLY
\$12.95
NET



The SEL-1 Selenium tester is supplied complete with all operating instructions. Operates on any 115V A.C. line.

SELENIUM TESTER MODEL SEL-1

The EBY selenium tester Model SEL-1 is a compact instrument designed to furnish tests for most Radio and Television types of rectifiers. The SEL-1 tester affords quality tests on all types of rectifiers from 65 ma. to 600 ma. under actual operating loads. Rectifiers tested with this instrument are tested at their specified current rating. The tester incorporates a variable current supply for all types of rectifiers. A neon type indicator is used to ascertain the quality of all types of rectifiers.

WRITE — DEPT. S-11-S

EBY SALES CO. of N.Y.

130 LAFAYETTE STREET
NEW YORK CITY 13, N. Y.



AMPLIFIERS for Public Address

Backed by the
world's greatest
performance
record for
power at
low cost!



3 Popular Sizes

10, 15 and 30-watt power output. Available with phonograph top or as a complete portable ready-to-use system including microphone, speaker and case. Engineered for top performance and easy operation. A model for every need.



Send for **FREE** New Catalog!



PRECISION ELECTRONICS, INC.
9101-S King Ave., Franklin Park, Ill.

Name _____

Address _____

City _____ Zone _____ State _____

106-55

G-C INSPECTION MIRROR

A shockproof inspection mirror, 5090-P, for use in high-voltage areas of TV chassis, has been announced by General Cement Manufacturing Co., 400 S. Wyman St., Rockford, Ill.

Mirror features all plastic construction for use in live circuits.

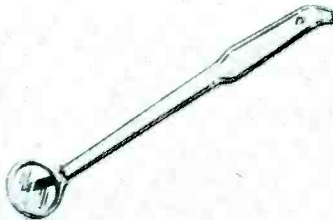

AMALITE EJECTION GRIP NUT DRIVER

An ejection grip nut driver for radio and TV work, has been announced by Amalite, Inc., 1884 Pitkin Ave., Brooklyn 12, N. Y.

An internally tapered socket takes care of size variations in nuts, bolts and screws. Driver available in sizes from 3/8" through 1/2". Also available is a plastic roll kit containing 3/16", 1/4", 5/16", 11/32", 3/8" and 7/16" drivers.

WEN HEAVY-DUTY SOLDERING GUN

A 200-watt heavy-duty soldering gun, model 288, with silver-plated tip and connectors, has been introduced by Wen Products, Inc., 5804 Northwest Highway, Chicago 31, Ill.

Features of the unit include an extra-rigid tip, heavy-gauge steel nose and built-in spotlight. Working heat is said to be obtained in less than 5 seconds.

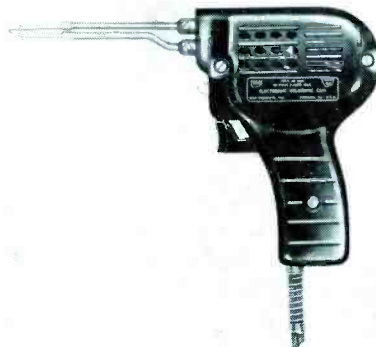

RCA SERVICE PARTS • FACTORY-TAILORED TO SAVE YOU TIME AND MONEY

take
Knobs
for
example

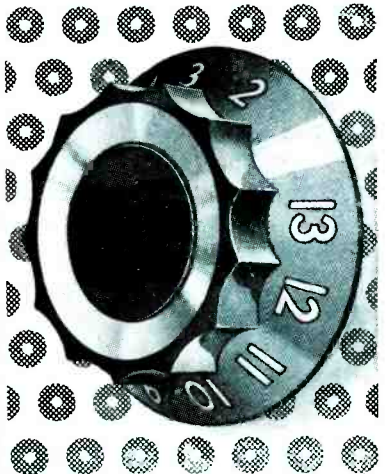

RCA Knobs for RCA home instruments give your service jobs that satisfying touch of perfection. True to the design and function of the original parts, RCA replacement knobs help you build customer confidence quickly. Your customer knows the job's done right because it looks right, at a glance.

So, keep your servicing "on-the-go" profitably. Insist on RCA Knobs. There's an exact RCA replacement knob for virtually every RCA Victor TV Receiver, Radio, and Phonograph in use today. And remember: RCA Service Parts are the only genuine replacement parts for all RCA equipment . . . factory-tailored to save you time and money by fitting right, installing fast.



**RADIO CORPORATION
of AMERICA**

SERVICE PARTS HARRISON, N. J.

SERVICE, NOVEMBER, 1955 • 85

1st with all prices

Pricing Digest answers a need long-felt by Servicemen—List or resale prices for every replacement part or component at your fingertips.

Over 200 pages, covers more than 60,000 items

Compiled like a telephone book (1) alphabetical by Manufacturer (2) Alphabetical by Product Category (3) Numerical by Part Number. Price and identify any replacement item in seconds—as easy as 1-2-3.

9 1/2" long by 3 1/2" wide . . . convenient for counter, pocket, tool box or tube caddy.

1st in savings

Time and money savings—no wasted effort—no calls to your distributor to check prices. No undercharges—no overcharges when you price your tubes and parts from the Official Pricing Digest. PRICE \$2.50 PER COPY—will pay for itself many times over by giving you CORRECT PRICES where and when you need them. Publication dates are October, January, April and July. Completely revised prices will be current on each publication date.

Available exclusively thru your parts distributor.

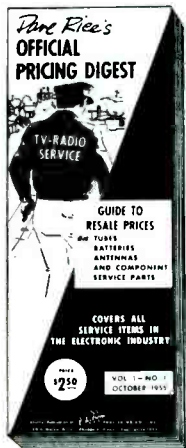

Dave Rice's OFFICIAL TV-RADIO SERVICE ORDER BOOK

Best Service Order Book because it's the only form providing for all types of service on TV-Radio, Phono or Hi-Fi equipment. Best service order book because it's the only form providing separate listings for tubes, parts and components, plus space for picture tube and serial number. Best service order book because it's the only form clearly separating labor and parts and allowing all state and local taxes to be added.

Best Service order book because its handy size is 5 1/2" wide by 8 1/2" long. Each book contains 50 orders (in triplicate). Original white bond, duplicate yellow, triplicate pink. Numbered consecutively in sets. Two sets of carbons bound into each book. The only form packaged in dustproof boxes of ten—keeps stock clean until you need it.

Sold by parts distributors at 75c per book or \$6.50 per box of 10.

Electronic Publishing Co., Inc.
180 North Wacker Drive
Chicago 6, Illinois

News

RCA PICTURE-TUBE PROMOTION CAMPAIGN UNDER WAY

The introduction of RCA's *Silverama* aluminized TV picture tubes is being supported by a promotion campaign utilizing magazine, radio, TV and trade advertising, and point-of-sale material.

Program also includes a \$12,000 contest for most effective window displays in eight RCA sales regions. Best display from each region will be selected by a panel of judges and awarded a \$1000 U. S. Savings Bonds.

REINER ELECTRONICS EXPANDING

An additional building is under construction for Radio City Products-Reiner Electronics in Easton, Pa. Building will be used for finishing operations in its metal working division.

CBS-HYTRON SETS UP SALES CORP

The CBS-Hytron Sales Corp. has been formed for the promotion and sale of CBS tubes and semiconductors in the distributor market. Change, it is said, will not affect present handling of products sold to distributors, but serve to afford concentrated attention upon nationwide distributor sales.

KRYLON MOVES TO NEW QUARTERS

Plant and executive offices of Krylon, Inc., have been moved to Norristown, Pa., from Philadelphia.

Company manufactures protective coatings for electronic applications.

N. Y. TRANSFORMER ACQUIRES TARTAK

New York Transformer Co., Inc., Alpha, N. J., has acquired Tartak Electronics, 2979 Ontario St., Burbank, Cal., as its west coast subsidiary. Company name will be changed to NYT Electronics.

Officers of the organization are: L. Burzycki, president; R. L. Hyder, assistant to the president and sales manager, and A. A. Tallis, chief engineer.

CROWN CONTROLS CELEBRATES TENTH ANNIVERSARY

The tenth anniversary of the Crown Controls Co., New Bremen, O., was celebrated recently.

Company, which now employs 160, is headed by James Dicke, son of the co-founder Carl Dicke. Thomas Shelby is sales manager.

AMERICAN RELAY MERGES WITH OHMITE

Ohmite Manufacturing Co. will hereafter manufacture Amrecon relays previously made by American Relay and Controls, Inc., formerly a subsidiary of Ohmite. The relays will be known as Ohmite Amrecon relays, and will continue to be produced at the Ohmite plant, 3601 Howard Street, Skokie, Ill.

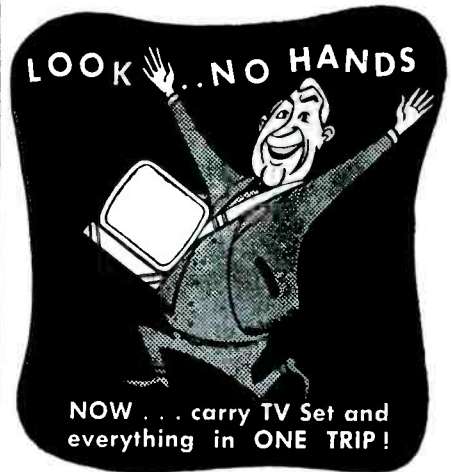

TV HAMMOCK

Save time . . . Save trips . . . carry TV set safely with both hands free. Heavy durable harness webbing with adjustable strap. 24x24 inches.

Deluxe Model 24.....List Price \$4.95
Economy Model 18.....List Price 2.95

SAVE-UR-MIKE COVER

Special impregnated white celanese cover. Fits and protects all microphones. Keeps out mist, rain, dust and mike can be used covered with only slight loss of highs.....List Price \$1.25



See your dealer or write for complete details and where to buy.

S. I. Jacobson Mfg. Co.

1414 S. Wabash Ave. • Chicago 5, Ill.

USED AND RECOMMENDED BY SERVICEMEN AND TECHNICIANS WHO UNDERSTAND TV CIRCUITRY

a professional instrument designed for testing a T.V. ABOVE and BELOW chassis!

THE VIDEO PROBE METER!

Saves TWO HOURS PER DAY when used in shop for under chassis work.



With the attachable pick-up loop, (where sufficient signal is available) the Probe Meter can detect and indicate radiation of signal thru I.F. and video amp tubes. (Simply slide loop over tube being tested.) Where internally shielded tubes are encountered, remove tube and insert probe tip into grid pin of socket.

Model V-1 indicates gain per stage



List Price \$31.50

Can accurately trace and indicate the following T.V. circuits,—(from tuner to pix tube) R.F., I.F., Det., Video, Sync, local osc., Hz. osc., Hz. Drive, audio output, sound I.F. (Signal tracing radios.)

EXCELLENT FOR TRACING AND COMPARING COLOR T.V. CIRCUITS

ADDITIONAL FEATURES

Voltmeter, 0-500V. D.C., 20,000 Ohms/volt

Fully Guaranteed

If your dealer cannot supply you, order direct. Full purchase price refunded if not satisfied.

DEALERS AND REPS.: INQUIRIES WILL RECEIVE IMMEDIATE ATTENTION

Research Inventions & Manufacturing Co.
617 F St., N. W., Washington 1, D. C.

ADVERTISERS IN SERVICE
NOVEMBER, 1955

	Page
Acme Electric Corp.	66
Alliance Mfg. Co.	21
American Microphone Co.	48
American Phenolic Corp.	10
American Television & Radio Co.	88
Astron Corp.	9
B & K Mfg. Co.	54
Bussmann Mfg. Co.	12
CBS-Hytron (Div. Columbia Broadcasting System)	24
Channel Master Corp.	4, 5
Chicago Standard Transformer Corp.	81
H. G. Cisin	80
Clarostat Mfg. Co., Inc.	3
Columbia Wire & Supply Co.	87
Cornell-Dubilier Electric Corp., Inside Front Cover,	79
Crown Controls Co., Inc.	16
Delco Radio Div. General Motors Corp.	47
Duotone Co.	70
Eby Sales Co. of N. Y.	85
Electro Products Laboratories	2
Electronic Chemical Corp.	84
Electronic Publishing Co., Inc.	86
Federal Telephone & Radio Corp.	17
General Cement Mfg. Co.	14
General Electric	18, 19, 75
Guide Lamp Div. General Motors Corp.	11
The Heath Co.	78
Hycon Electronics, Inc.	50
International Rectifier Corp.	74
JFD Mfg. Co. Inc.	8
S. I. Jacobson Mfg. Co.	86
Jensen Industries, Inc.	74
Jerrold Electronics Corp.	72
Kenwood Engineering Co.	74
Kester Solder Co.	84
P. R. Mallory & Co., Inc. Inside Back Cover	
Moss Electronic Dist. Co., Inc.	60, 61
Ohmite Mfg. Co.	55
Planet Sales Corp.	82
Precision Apparatus Co., Inc.	30
Precision Electronics	85
Pyramid Electric Co.	29
The Radiart Corp. Inside Front Cover,	79
RCA Service Co.	6
Radio Corporation of America, 15, 85, Back Cover	
Radio Receptor Co., Inc.	86
Research Inventions & Mfg. Co.	65
Rohn Mfg. Co.	7
Howard W. Sams & Co., Inc.	77
Seco Mfg. Co.	88
Shure Brothers, Inc.	71
Simpson Electric Co.	67
Snyder Mfg. Co.	13
Sonotone Corp.	73
Sprague Products Co.	48, 70, 80
Sylvania Electric Products, Inc.	1
Technical Appliance Corp.	49
Teletest Instrument Corp.	82
Tenna Mfg. Co.	51
Tetrad Corp.	72
Transvision, Inc.	82
Trio Mfg. Co.	56
Tung-Sol Electric Inc.	53
United Catalog Publishers, Inc.	48, 70, 78
United Motors Service Div. General Motors Corp.	22, 23
The Ward Products Corp. Div. of the Gabriel Co.	26
Welco Mfg. Co.	25
Wen Products, Inc.	20
Weston Electrical Instrument Corp.	45
Xcelite, Inc.	83

Catalogs-Bulletins

RECOTON CORP., 52-35 Barnett Ave., Long Island City 4, N. Y., has released a 21-page replacement needle reference guide which includes a needle-type replacement chart, a listing of cartridges and proper needle replacements by manufacturer, index of phonos specifying manufacturer and model number, and a complete catalog of needles, cartridges, recording tape, recording blanks and phono accessories manufactured by the company.

ELECTRO-VOICE, INC., Buchanan, Mich., has published a 32-page illustrated catalog, 120, covering professional TV and broadcast microphones, with detailed information on applications, features and specifications of each model.

OHMITE MANUFACTURING CO., 3680 Howard St., Skokie, Ill., has issued a 2-page bulletin, 147, with specifications and features of axial-lead wire-wound vitreous-enameled resistors in 5 and 10 w ratings.

RADIO CORPORATION OF AMERICA, Tube Division, Harrison, N. J., has released a 336-page (revised) edition of receiving tube manual RC-17, which includes a 26-page supplement listing 51 new types, a section on electron tube theory, tube characteristics and applications, a chart listing characteristics of 64 b-w and color-TV picture tubes, and 22 commonly-encountered circuit diagrams. Priced at 60 cents per copy.

ALLIED RADIO CORP., 100 N. Western Ave., Chicago 80, Ill., has published a 324-page illustrated catalog, 150, covering hi-fi components and systems; TV chassis, boosters, rotators and converters; table model and portable phonos; professional and home recording equipment; pu amplifiers and systems; vhf radio and radiotelephone equipment; tools, hardware and a complete listing of all electronic components.

INTERNATIONAL RESISTANCE CO., 401 N. Broad St., Philadelphia 8, Pa., has issued a resistor engineering guide covering the company's complete line of resistors and special products. Includes data on rated wattage, standard tolerances, temperature rise, temperature coefficient, maximum operating temperature, ohmic values and dimensions.

B&K MANUFACTURING CO., 3726 N. Southport Ave., Chicago 13, Ill., has published bulletin 500, covering model-500 portable tube tester, explaining its functions and use.

WESTON ELECTRICAL INSTRUMENT CORP., 614 Frelinghuysen Ave., Newark 5, N. J., has issued a 15-page illustrated catalog, R36A, covering ac clamp ammeters and voltmeters, tube analyzers, scopes, tube checkers, tom, vtvm, sweep generators and pocket size testers.

Guaranteed for 15 and 25 Years...

All Columbia 300 ohm PERMALINE TV TRANSMISSION LINE is backed by a written guarantee of 15 and 25 years (150 mil - 15 years; 80 mil - 25 years)

Extensive research on Permaline insulation has shown that it will far outlast any other type of television transmission line in average use today. This is based on reports of one of the largest testing laboratories in the country (name upon request). Servicemen are rapidly learning that even though Columbia Permaline insulation is more durable, it strips easier due to the high molecular weight of Polyethylene... simplifies service jobs.

Available from leading jobbers

Columbia WIRE & SUPPLY CO.
2850 Irving Park Road, Chicago 18, Ill.

Another "Columbia" First...

AMERICAN TELEVISION & RADIO CO. ST. PAUL, MINN.

introduces the
new

ATR TV

*Full Door Console
Receiving Sets*

UNSURPASSED
IN BEAUTY

UNEQUALLED
IN PERFORMANCE

UNMATCHED IN
QUALITY
CONSTRUCTION

exclusive
profitable
dealer
franchises
now available



*designed
with the
Serviceman
in mind
... easy to
get at*



WRITE TODAY FOR COLORFUL
BROCHURE SHOWING THE
NEW LINE OF ATR TV SETS

ALSO MANUFACTURERS OF DC-AC INVERTERS,
"A" BATTERY ELIMINATORS, AUTO RADIO VIBRATORS

ATR AMERICAN TELEVISION & RADIO CO.
Quality Products Since 1931
SAINT PAUL 1, MINNESOTA-U.S.A.

JOTS and FLASHES

THE INCREASING use of printed wiring boards for radio and TV has caused widespread expansion of *pc* production facilities. General Electric has announced that they expect to make between five and six-million individual boards during 1956 in their newly-acquired 100,000-square foot plant in Auburn, N. Y. . . . The Chicagoland Chapter of *The Repts* recently sponsored its third color TV symposium for manufacturers, distributors and associated personnel. . . . An optical lens that affords the precise location of the triangular color phosphor dots on the face of tri-color picture tubes is now being used by RCA. The lens permits projected light to follow a path that coincides exactly with the path that will be followed by the electron beams in the finished tube; the dots are printed on the face plate at the exact points where they will be struck by electrons moving through the holes in the shadow mask. . . . Entron Inc., Bladensburg, Md., and Electroline TV Equipment, Inc., of Montreal, supplied four adjacent-channel signals from Montreal and U.S. on one cable to more than 220 TV receivers at the recent All-Canada Electrical Show. . . . CBS-Hytron plans to build a 55,000-square-foot brick masonry warehouse on Manheim Road in Melrose Park, Chicago, for on-the-spot handling of radio and TV receiving tubes, picture tubes, diodes, and transistors. Completion is scheduled for early spring. . . . Karlson Associates, Inc., are now located on 1610 Neck Road, Brooklyn 29, New York. . . . Allen S. Johnson, formerly with Webster-Chicago Corp., Chicago, has joined the Electronics Division of Thompson Products, Inc., Cleveland, O., as assistant to the division manager, William M. Jones. . . . David Hafler has formed a new audio organization, Dyna Co., headquartered in Philadelphia at 5142 Master St., Phila. 31, Pa. . . . Les A. Thayer, sales manager of the merchandise division of Belden, recently celebrated his twenty-fifth year with the company. Thayer is a past president of the Electronic Parts and Equipment Manufacturers Association, and served as treasurer and member of the board of directors of the Electronic Parts and Equipment Shows, Inc. . . . Robert B. Sampson has been appointed manager of market research for the RCA Tube Division, Harrison, N. J. . . . Joseph B. Bannon has been promoted to general sales manager of the RCA Victor Television Division. . . . Anthony S. Katona has been named manager of Jerrold-Southwest, Inc., Dallas, Tex., a subsidiary of Jerrold Electronics Corp. . . . J. E. Hall has been named purchasing agent of Capehart-Farnsworth Co., Fort Wayne, Ind.

INTRODUCING
YOUR NEW
**PROFIT
MAKER**

SAVE
SERVICE
TIME
SELL
MORE
TUBES

MODEL GCT-5
SECO
GRID CIRCUIT
TUBE TESTER

\$29.95 Slightly higher West

Now quickly and accurately detect "positive grid" conditions in amplifier tubes used in circuits employing a high value of grid return resistance. EXCLUSIVE!



**"HARD TO FIND"
TV TUBE FAULTS
LOCATED FAST!**

- Poor picture contrast
- Grainy picture
- Twisting, bending or pulling of the picture
- AGC, RF, IF and Sync. Group tube faults
- Vertical jitter or bounce
- Sync. Buzz in the sound
- Any or all symptoms caused by sync. pulse compression.

Stop guessing and substitution checking, test and sell tubes with conviction on the first call, avoid embarrassing and costly callbacks.

Filament Selector Switch accommodates all the latest tubes for TV and INDUSTRIAL uses.

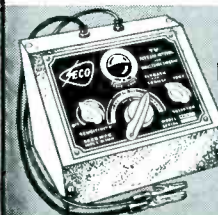

Another Seco Exclusive!
**FLY BACK INTERVAL
& INDUCTANCE
ANALYZER**

Checks horizontal circuits without disconnecting!

For specialized applications to meet your specific need, contact:



SECO MFG. CO.
5015 Penn. Ave. So.
Minneapolis, Minn.

P. R. MALLORY & CO. INC.
MALLORY
APPROVED PRECISION PRODUCTS

P. R. MALLORY & CO. INC.
MALLORY
APPROVED PRECISION PRODUCTS

P. R. MALLORY & CO. INC.
MALLORY
APPROVED PRECISION PROD

Exact Duplicate DUAL CONTROLS available TWO ways

DO you prefer ready-to-use dual controls? Or would you like a small stock of control sections, switches and shafts that you can assemble quickly for the combination you need?

Either way, with Mallory, you can be sure of duplicating the exact electrical characteristics of the controls in practically any popular TV set.

Either way, with Mallory, you can equal or exceed the performance of the original equipment control. You can count on accurate resistance values, smooth tapers, quiet operation and long life.

Either way, with Mallory, you can be sure the job is right the first time... without profit-cutting "come backs."

Either way, your Mallory distributor has what you need. Call him today!

Exact duplicate, ready-to-use, dual control... factory-made with all the resistance values, tapers, taps, switches and shaft lengths needed for most of the popular TV sets.

Exact duplicate, dual control kits. With a small stock of factory-assembled control sections, you can make 10,000 different combinations. No soldering or special tools required. Assembly takes less than five minutes.

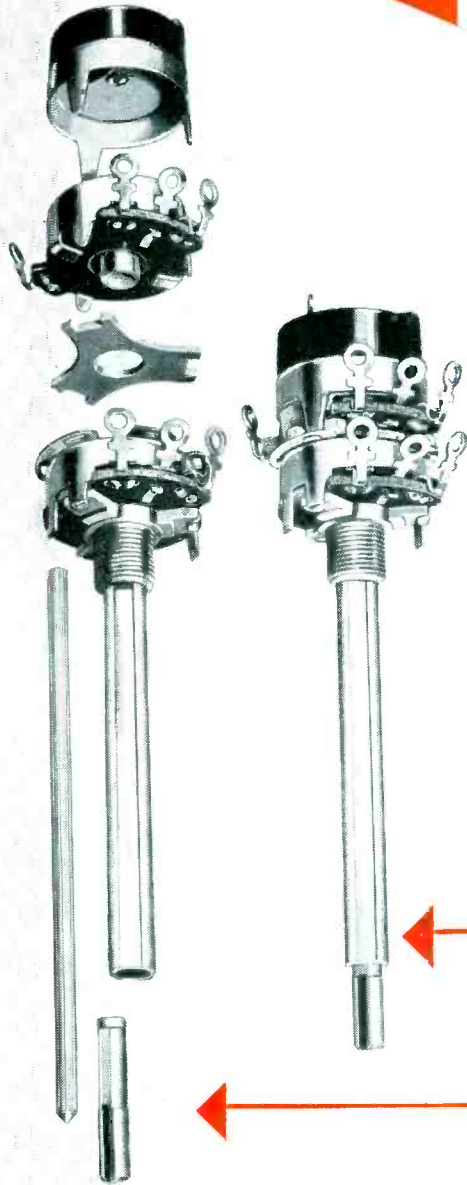

APPROVED PRECISION

APPROVED PRECISION

P. R. MALLORY & CO. INC.
MALLORY

CAPACITORS • CONTROLS • VIBRATORS • SWITCHES • RESISTORS
RECTIFIERS • POWER SUPPLIES • FILTERS • MERCURY BATTERIES
APPROVED PRECISION PRODUCTS

P. R. MALLORY & CO. Inc., INDIANAPOLIS 6, INDIANA

HOW YOU CAN BUILD NEW BUSINESS AND BIGGER PROFITS WITH RCA

Silverama

SUPER-ALUMINIZED PICTURE TUBES!

Take an active part in RCA's powerful sales promotion and advertising campaigns in your neighborhood now!

RCA's campaigns to introduce "SILVERAMA" are the most dynamic sales stimulators in picture tube history. Make your store "sales headquarters" for RCA "SILVERAMA" in your own neighborhood. Join successful hands with RCA and your RCA Tube Distributor. Use these *sell-powered* advertising and sales promotion materials to increase your business, prestige, and profits . . . now!



Window Display Kit, Streamers, and Hanger...dramatic, eye-catching traffic stoppers! These tell your neighbors *your store* is "Hq" for the great new "SILVERAMA" Picture Tube! See your RCA Distributor for full details on the "SILVERAMA" Window Display Contest!

SALES PROMOTION

Merchandising Booklet . . . the top secrets of "putting on a good front" window display are revealed to you. Shows you how to "stop them . . . so you can sell them!"



Direct Mail Piece . . . handy self-mailer or envelope stuffer. Ties your name and shop in with RCA "SILVERAMA" national advertising campaigns!

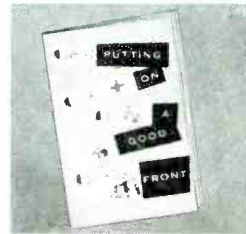

ADVERTISING

National Magazines . . . "Advertised in Life" . . . and in TV Guide! Important, consistent, big ads in these top magazines tell your customers about the wonders of RCA "SILVERAMA." Be ready for the demand. Contact your RCA distributor!



Local Newspapers . . . ad mats available to your distributor will feature names and addresses of service-dealers handling RCA "SILVERAMA". Be sure *your name* is on the list. Contact your RCA Tube Distributor!

Radio and TV . . . "Milton Berle" and "Martha Raye" coast-to-coast TV Shows, and network radio programs such as "Monitor", and "Fibber McGee and Molly" will bring the RCA "SILVERAMA" story right into your customers' homes . . . send them to your shop. Be ready. Contact your RCA Tube Distributor!

There's more, too! And your RCA TUBE DISTRIBUTOR has the complete story. Cash in on the new, dynamic RCA "SILVERAMA" campaign. SEE YOUR RCA TUBE DISTRIBUTOR NOW!



RADIO CORPORATION of AMERICA

TUBE DIVISION

HARRISON, N. J.