

# SERVICE

VOL. 23

THE TECHNICAL JOURNAL OF THE TELEVISION-RADIO TRADE

JANUARY  
1954

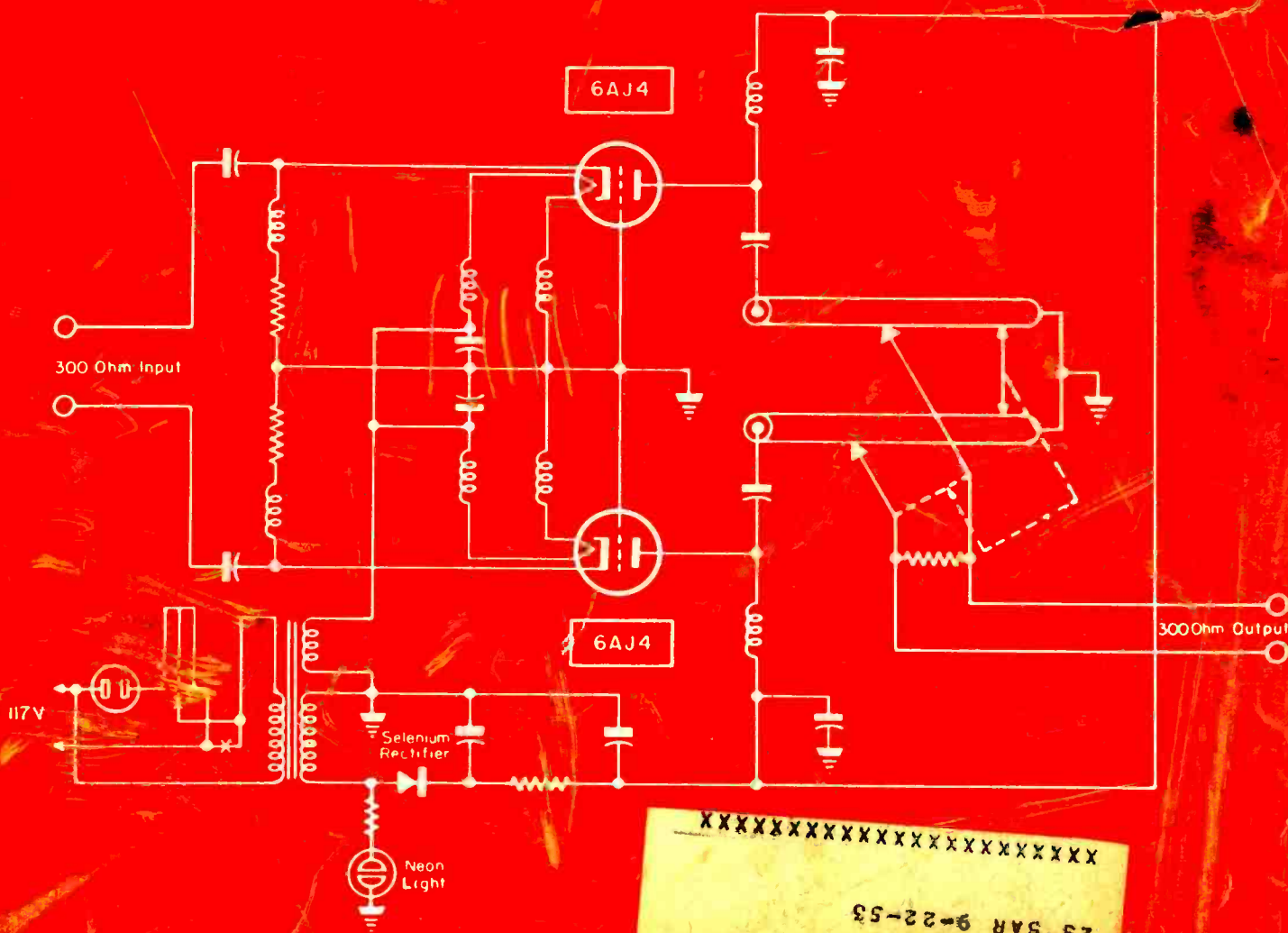

UFR booster with grounded-grid triodes in push-pull circuit.  
[See circuit analysis, this issue]

XXXXXXXXXXXXXXXXXXXXXXXXXXXX  
 25 BAR 9-22-53  
 NEW JERSEY  
 POMPTON LAKES,  
 RUSSELL TURSE  
 10-55

-the MOST popular!

# C • D • R

## R O T O R S

built to last

dependable

powerful

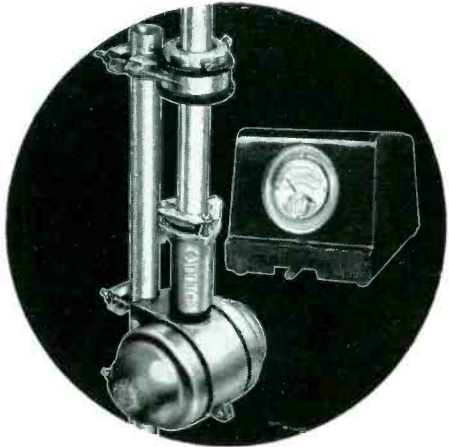

**TR-12** ... a special combination value consisting of complete rotor including thrust bearing ... handsome modern design cabinet with meter control dial ..... \$47.95

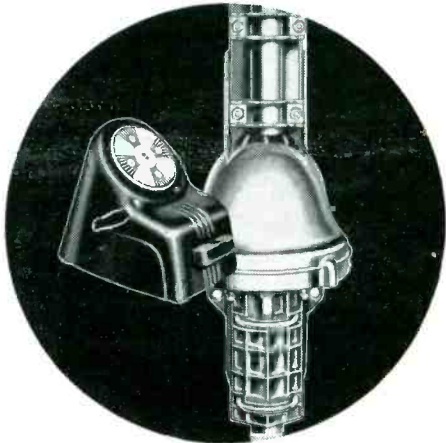

**TR-2** ... the HEAVY DUTY rotor especially suited for special TV antenna installations. Complete rotor with "compass control" cabinet having illuminated "perfect pattern" dial ..... \$49.95

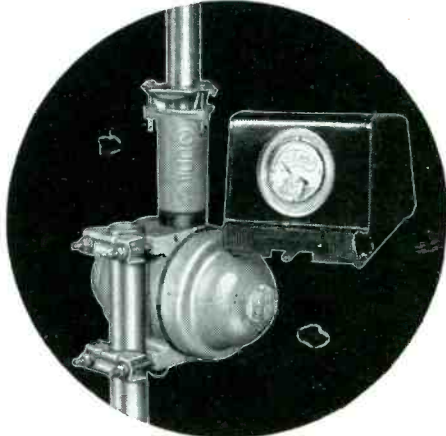

**TR-11** ... the same as the TR-12 without the thrust bearing, complete with meter control dial cabinet ..... \$44.95

ONE OF THE WORLD'S LARGEST ELECTRONICS MANUFACTURERS SINCE 1912

 **CORNELL-DUBILIER**  
SOUTH PLAINFIELD, N. J.

 **THE RADIART CORP.**  
CLEVELAND 13, OHIO

sees all...

tells all...



# TEL-OHMIKE®

## capacitor-resistor analyzer

"Better than a crystal ball" . . . that's what TV and radio service technicians everywhere are saying about the sensational Sprague TO-4 Tel-Ohmike Capacitor-Resistor Analyzer. It *sees all, tells all* with its resistance and capacitance bridges using magic eye balancing . . . direct meter readings of leakage current and insulation resistance . . . power factor measurement . . . continuously adjustable test voltage for checking electrolytics at exact rated voltage . . . push-button range selection.

Tel-Ohmike's many other *plus* features in-

clude: capacitor measurements up to 2000 mf., with an exclusive special low range of 1 mmf. to 100 mmf.; resistance readings from 2.5 ohms to 25 megohms; and automatic capacitor discharge upon release of all push-buttons for greater safety.

This handsome laboratory-type instrument is sturdy, reliable and a cinch to use—and it's priced right!

See it in operation at your Sprague distributor's TODAY . . . or write for descriptive circular M-499 to:

ONLY  
**\$73<sup>50</sup>**

### SPRAGUE PRODUCTS COMPANY

61 Marshall Street • North Adams, Massachusetts

don't be vague . . . ask for

# SPRAGUE

ACCEPT NO SUBSTITUTES! There is a Sprague distributor in every sales area in the U.S. Write for name of nearest source of supply today.

WORLD'S LARGEST CAPACITOR MANUFACTURER

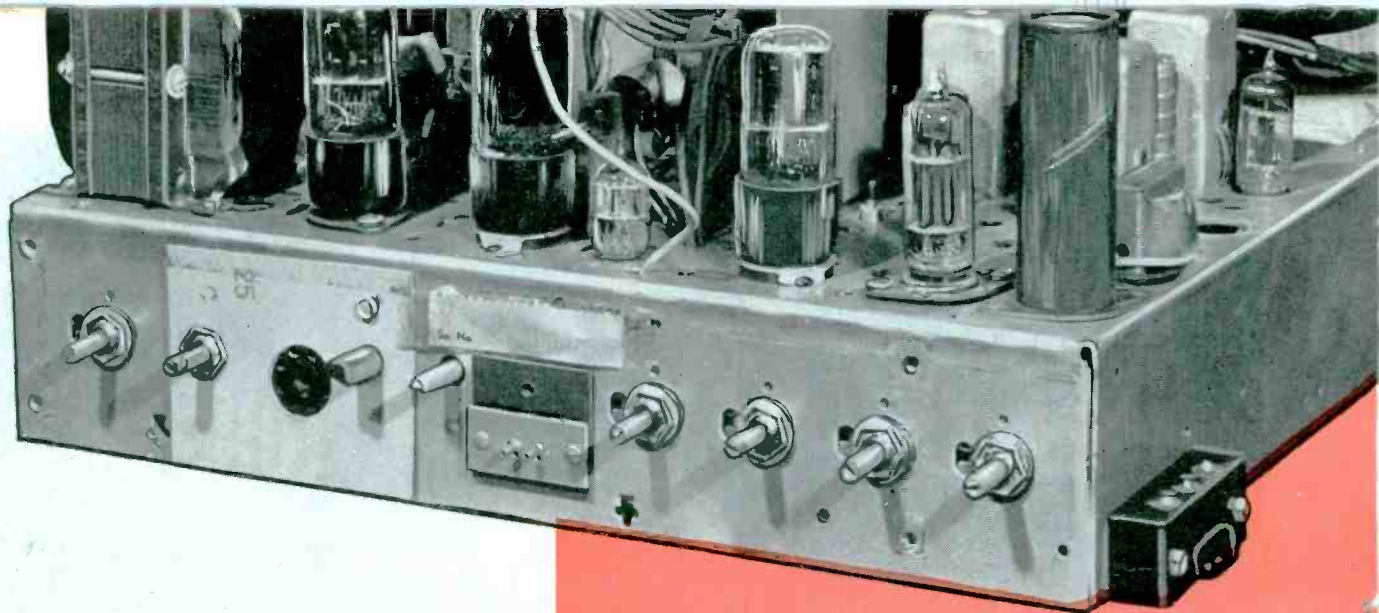

# precision

*tools for precision servicing*  
*... G-C Alignment Tools*

**G-C Alignment Tools**—more than 60 of them—are precision engineered for faster, more effective TV servicing . . . and service developed to be sure they're what you need.

Besides those alignment tools you see here, G-C has many others . . . part of the more than 3,000 G-C service items designed specifically for better service work. Remember, too, that there are a dozen G-C Alignment Tool Kits . . . matched instrument sets to meet most service requirements and priced surprisingly low for top quality tools!



YOUR COPY of the big, new illustrated G-C Catalog No. 156. It's free . . . at your favorite jobber or write direct.



**GENERAL CEMENT MFG. CO.**

901 Taylor Street

Rockford, Illinois



**G-C NEW TV "X-57 PLASTIC LONG SLIM" SCREWDRIVER**  
 Rugged, 100% insulated.  
 No. 8989 18 $\frac{1}{4}$ " long List \$2.00



**G-C NEW NYLON TV LONG-REACH ALIGNER**  
 Replaceable Nylon Tip.  
 No. 8607 12 $\frac{3}{4}$ " long List \$1.80



**G-C TV CORE ALIGNER**  
 For sets using stud type cores.  
 No. 8271 List \$0.90



**G-C TV I.F. OSCILLATOR ALIGNER**  
 Fits all makes of sets.  
 No. 8272 List \$1.20



**G-C TV LONG-REACH ALIGNER**  
 For hard-to-reach iron cores.  
 No. 8274 List \$1.20



**G-C TV DUPLEX ALIGNER**  
 All-purpose, extra-strong.  
 No. 8276 List \$0.80



**G-C NEW ZENITH TV WRENCH & ALIGNER**  
 Specially made for Zenith TV.  
 No. 8282 List \$0.55



**G-C TV 2-in-1 LONG-REACH DUPLEX ALIGNER**  
 For No. 4 and No. 6 studs.  
 No. 8721 9" long List \$1.25



**G-C NEW RCA-ZENITH ALIGNER**  
 Aligns strips, etc on Zenith, RCA.  
 No. 9050 List \$0.30



**G-C NEW RCA-ZENITH "SHORTY" ALIGNER**  
 For those tight spaces; only 2" long  
 No. 9051 List \$0.75

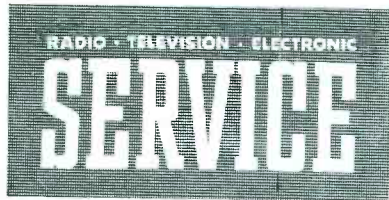

**LEWIS WINNER**  
Editor

**B. BLOCK**  
**F. WALEN**  
Assistant Editors

Including SERVICE—A Monthly Digest of Radio and Allied Maintenance: RADIO MERCHANDISING and TELEVISION MERCHANDISING. Registered U. S. Patent Office.

Association News	60
Audio Installation and Service (Miniature Input Mixers). By Kenneth Stewart and Paul Edwards	38
Better Audio from Radio and TV for the Hard-of-Hearing. By Donald Phillips	22
Color TV (NTSC Signal Chart Analysis). By W. Kay Brownes	30
Color TV Picture Tubes (Analysis of 3-Gun and 1-Gun Types). By W. L. Roberts	26
Ser-Cuits (Continuously Tunable UHF Converter). By M. W. Percy	28
Service Engineering (Electronic Computers). By Thomas K. Beamer	29
Service . . . The National Scene	19
Servicing Helps (TV Tuner Repairs). By T. L. Gilford	34
Servicing Hi-Fi Audio (Checks for Speakers, Preamp Problems). By Mark Vino	33
Ten Years Ago	61
Troubleshooting 60-Cycle Buzz in TV (Step-by-Step Trace Guide). By Clark R. Alisen	24
Tube News (Surface-Barrier Transistors). By E. A. Teverson	31
TV Antenna Digest (Broad-Band Yagis). By Ralph G. Peters	36
UHF TV Booster (Cover). By Wyn Martin	40
Views and News. By Lewis Winner	17

**AUDIO INSTALLATION AND SERVICE**

Capacitive Hi-Fi System	45
Intermodulation Effects and Reproduction	46
Miniature 2-Input Audio Mixers	38

**CIRCUITS**

Basic Electronic Computer Block Diagram	29
Bogen Continuously-Tunable UHF Converter	28
Color TV Dynamic Convergence and Focusing Circuits	27
Color TV Video Chain for Shadow-Mask Tube	27
Colpitts Oscillators for UHF	51
Equalizer Modified to Provide Three Bass-Turnover Points	33
E-V 3400 UHF Booster (Cover)	41
Feedback/Grounded-Speaker Circuitry	23
Flip-Flop Oscillator for Computers	29
FM Treble Deemphasis Network	33
Looker Point in Mixer Grid	34
Miniature 2-Input Audio Mixer	38
60-Cycle Buzz Check Points in TV Chassis	25
Standard Cascode/Pentode Tuner Connection to Split-Sound IF Chassis	63
Sweep-Generator Input Matching Circuit	34
Ungrounded Headset Circuit	23

**COVER**

UHF TV Booster (E-V 3400)	40
---------------------------	----

**SERVICING HELPS**

Adapting Cascode or Pentode Tuners to Split-Sound Chassis	63
TV Tuner Repair	34

**Index to Advertisers**

	79
--	----

**Manufacturers**

Catalogs and Bulletins	59
Jots and Flashes	73
News	67, 73, 78
New Parts . . . Tools . . . Instruments	64
On Book Row	53
Personnel	44
Rep Talk	47
TV Parts . . . Antennas . . . Accessories	68



Entire Contents Copyright 1954, Bryan Davis Publishing Co., Inc.  5  
Published monthly by Bryan Davis Publishing Co., Inc.

52 Vanderbilt Avenue, New York 17, N. Y. Telephone Murray Hill 4-0170

Bryan S. Davis, Pres. Paul S. Weil, Vice-President F. Walen, Sec. A. Goebel, Cir. Prom. Mgr.  
Mid-West Representative: Stuart J. Osten, 333 N. Michigan Ave., Chicago 1, Ill. Telephone: DEarborn 2-3507  
East-Central Representative: James C. Munn, 2253 Delaware Dr., Cleveland 6, Ohio. Telephone: ERview 1-1726  
Pacific Coast Representative: Brand & Brand, 1052 W. Sixth St., Los Angeles 17, Calif. Telephone: MADison 6-1371  
Metropolitan District Manager: Donald C. Weil, 52 Vanderbilt Ave., New York 17, N. Y.

Entered as second-class matter June 14, 1932, at the Post Office at New York, N. Y., under the Act of March 3, 1879. Subscription price: \$2.00 per year in the United States of America and Canada; 25 cents per copy. \$3.00 per year in foreign countries; 35 cents per copy.

**NOW!**  
**TEST SERVICE**  
**12v. AUTO RADIOS**



**New DC Power Supply**  
**Model C-12**

0-16 Volts from 0-8 Amperes Continuous Output. Up to 12 Amperes Intermittently



Knob selects 6 or 12 v.  
No Connection Needed  
**Only 3% Ripple at full load!**

Completely variable output, makes it possible to test equipment under any voltage input condition. Provides filtered adjustable DC voltage for testing and servicing 12 volt and 6 volt auto radios from AC lines. Operates electronic equipment used on trucks, tanks and other mobile units; low voltage devices. Utilizes Superior Powerstat Voltage Control (Model 10) for extremely fine voltage adjustments.

See Your Nearest Parts Jobbers!  
Write for **FREE BULLETIN!**

MODEL BJ	6 Volts, 1-12.5 Amps. 5% Ripple
MODEL B	6 Volts, 1-20 Amps. 3% Ripple
MODEL N	0-28 Volts, 1-15 Amps. 8% Ripple
MODEL NF	0-28 Volts, 1-15 Amps. 1% Ripple

**ELECTRO PRODUCTS LABORATORIES**  
4501-Sc No. Ravenswood Ave., Chicago 40, Ill.  
CANADA: Atlas Radio Corp., Ltd., Toronto, Ont.



Arthur Godfrey, famous CBS-TV star

# GET BETTER THAN NEW-SET PERFORMANCE

## WITH CBS-HYTRON MIRROR-BACK SCREEN

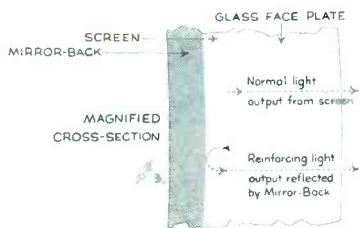

Mirror-Back (aluminized) screen mirrors all the light output to the viewer. Offers: Brighter pictures. Greater contrast. Better resolution. Reduced strain on other components. Full effective anode potential. Prevention of cross-burns. And longer life. For greater customer satisfaction . . . more profit, replace with original CBS-Hytron Mirror-Back tubes. Many types now available.

## WITH CBS-HYTRON BLUE-WHITE SCREEN



Ever notice how a shirt laundered with bluing appears whiter? With the CBS-Hytron Blue-White screen, whites are whiter; blacks, blacker. Expanded gray scale gives noticeably sharper pictures in fringe areas. No wonder CBS-Hytron's original Blue-White screen has become the universally preferred standard. Your customers, too, will prefer Blue-White screens.

## WITH CBS-HYTRON SMALL-SPOT GUN

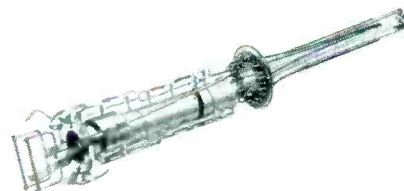

Smaller the spot produced by electron beam, sharper the picture. New lens focusing system of CBS-Hytron Small-Spot Gun reduces spot size 30 per cent. Prove it. Replace with a new CBS-Hytron Small-Spot tube. See, yourself, the superior resolution. Profit more. Combine all three: CBS-Hytron Mirror-Back . . . Blue-White Screen . . . Small-Spot Gun. Get and give that better-than-new-set thrill!

## LOOK TO CBS-HYTRON FOR COLOR, TOO!

New CBS-Colortron stresses simplicity. Offers many advantages: Simpler construction. Fool-proof assembly. Lower cost. Lighter weight. Adaptability to mass production in large sizes. Improved contrast. Simplified focusing . . . circuitry . . . adjustment. Resistance to overload. Greater stability. All stemming from unique spherical mask and face plate. You'll appreciate these advantages when you start servicing color TV.

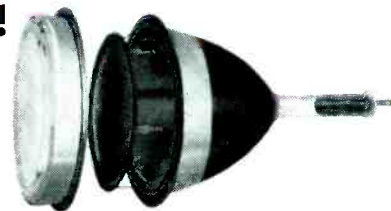

### FREE CATALOG . . . CBS-HYTRON BUSINESS BUILDERS



Describes all CBS-Hytron Business Builders to date: Certified Quality Service tags, streamers, decals, illuminated and flange signs, clocks, postal cards, and ad mats. The famous CBS-Hytron service tools. Technical literature. Price lists. Special offers. Get your Business Builders Catalog, PA-37, today . . . from your distributor, or direct.

### NEW . . . FREE CBS-COLORTRON DATA

For a look into the future, get complete advance data on the new, revolutionary CBS-Colortron: Construction . . . operation . . . application . . . installation and adjustment . . . electrical and mechanical data. FREE . . . from your CBS-Hytron distributor . . . or direct.



Manufacturers of Receiving Tubes Since 1921

CBS-HYTRON Main Office: Danvers, Mass.

A Division of Columbia Broadcasting System, Inc.

A member of the CBS family: CBS Radio • CBS Television  
Columbia Records, Inc. • CBS Laboratories • CBS-Columbia • and CBS-Hytron

RECEIVING • TRANSMITTING • SPECIAL-PURPOSE • TV PICTURE TUBES • GERMANIUM DIODES AND TRANSISTORS

# RCP VTVM

## Model 655

### READS PEAK-TO-PEAK VOLTAGES DIRECTLY

#### ACCURATE MEASUREMENT OF COMPLEX WAVESHAPES

##### SINE WAVE

RMS or Peak-To-Peak... Useful and Necessary—Read Directly With Model 655

##### PEAKED SAWTOOTH WAVE

TV Horizontal Signal... Peak-To-Peak Reading Required—Easily Done Directly with the Model 655.

##### PULSE WAVE

TV Horizontal Deflection... Peak-To-Peak Measurements Needed—Read It Directly on the Scale—Model 655.

##### COMPOSITE VIDEO WAVE

Video Amplifier... Peak-To-Peak Measurements A Must—Do It Directly With The Model 655.



*Quickly... Accurately*

**DO-ALL Model 655.**

**ONLY \$59.50**

... gives a true reading measurement of complex and sinusoidal voltages with necessary peak-to-peak or RMS value read directly, for the analysis of waveforms in video, sync and deflection circuits.

Now TV efficiency is given greater effectiveness because sets can be serviced as the manufacturers say—the peak-to-peak way. The combination of this P. to P. meter and service notes to match, take the guesswork out of service and speed up your service operation.

Versatility of measurement, built into each Model 655, serves a variety of industrial applications in the service of vibrator power supplies, AC generators and all equipment utilizing any type of waveform or DC.

Match the Model 655 with any peak-to-peak VTVM—You will find that comparable performance can only be found

in much higher priced instruments. Of high impedance design, the Model 655 makes use of an electronic balanced push-pull circuit and peak-to-peak rectification. The result is an absence of circuit loading, waveform error or frequency distortion.

This handsome looking unit has a brushed aluminum panel, etched for durability and uses an attractive clear plastic meter. Comes complete with our new "RCP SOLDERLESS TEST LEADS" for operation on 105 to 125 V AC.

#### FOR TELEVISION SERVICE AND INDUSTRIAL MAINTENANCE

- PEAK-TO-PEAK AC measurements of from .2 V to 4200 V on 7 ranges.
- AC RMS measurements of .1 V to 1500 V on 7 ranges.
- DC measurements of from .02 V to 1500 V on 7 ranges.
- RESISTANCE measurements of from .2 ohms to 1000 Megohms on 7 ranges.

Remember You can do more with a "DO-ALL"

See your local parts distributor or write for Catalog S-1

**RADIO CITY PRODUCTS CO., INC.**

152 WEST 25th STREET • NEW YORK 1, N. Y.



THIS BOOK HELPS YOU

# Make Increased Profits

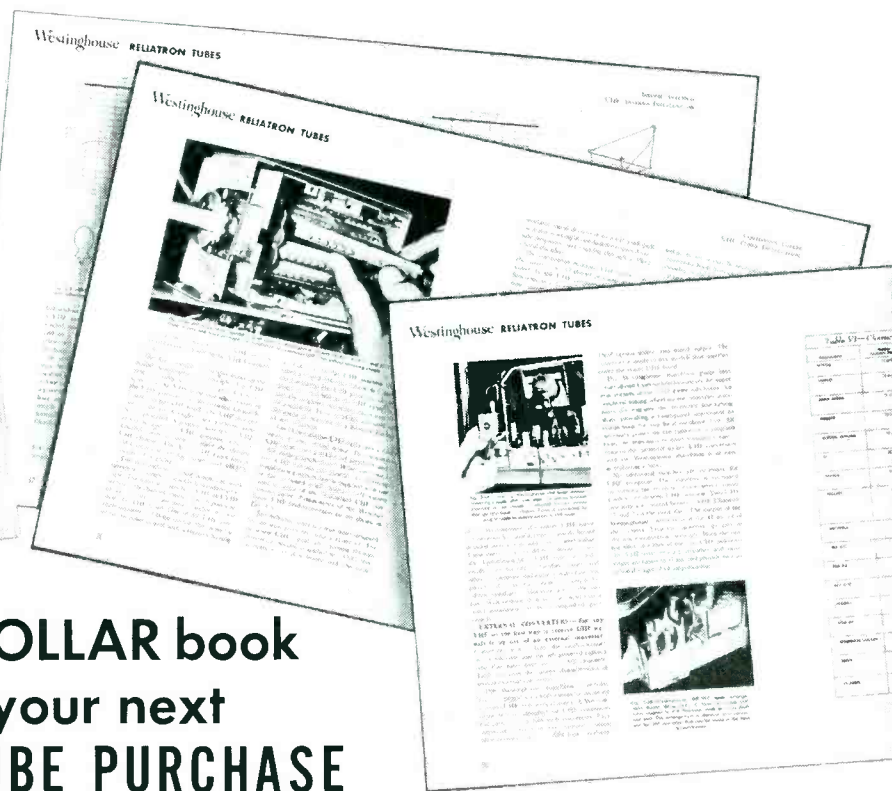
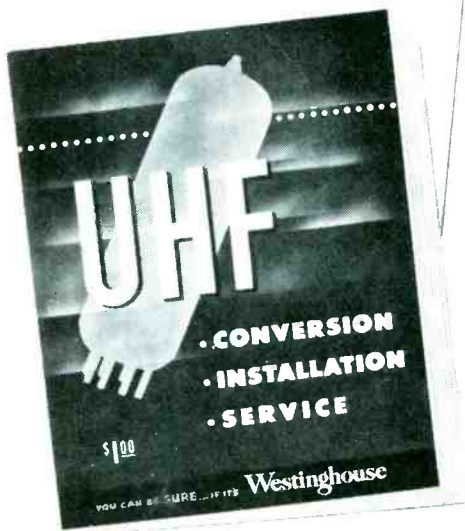

Get this ONE DOLLAR book  
**FREE** with your next  
 25-TUBE PURCHASE

This newest, most helpful book on UHF conversions is yours free when you buy 25 RELIATRON receiving tubes or one picture tube from your Westinghouse Distributor.

This vital handbook covers conversion data, tuners and converters, antenna installations, channel frequency charts, station coverage, and many other necessary, conveniently arranged facts you will need.

There's a gold mine in UHF conversions. And this book will help you make the most out of

the biggest profit opportunity since television came alive.

Get this dollar value for no extra charge with your next order of 25 tubes! For your nearest Westinghouse Distributor, see the list of all Distributors of Westinghouse RELIATRON Tubes on the opposite page.

*Act Now for*  
**UHF PROFITS**

See Westinghouse Tube Listings in 1954 Photofact Folders.

ET 95046

**YOU CAN BE SURE...IF IT'S**  
**Westinghouse**

**RELIATRON TUBES**  
 T M

WESTINGHOUSE ELECTRIC CORPORATION, ELECTRONIC TUBE DIVISION, ELMIRA, N. Y.



# Get the Newest, Finest UHF Conversion Handbook

from one of these Westinghouse Tube Distributors  
**FREE** with your next 25-tube order

## ALABAMA

Birmingham — James W. Clary Co.  
Birmingham — Moore-Handley Hardware Co.  
Mobile — Moore-Handley Hardware Co.

## ARKANSAS

Little Rock — Southern Radio Supply

## CONNECTICUT

Bridgeport — Hatry of Bridgeport  
Danbury — Pilgrim Electronics Co.  
Hartford — Hatry of Hartford  
New Haven — Hatry of New Haven  
Stamford — Hatry of Stamford  
Waterbury — Hatry of Waterbury

## DELAWARE

Wilmington — D & M Radio Sales & Service Co.

## DISTRICT OF COLUMBIA

Washington — Electronic Wholesalers, Inc.  
— Silberne Radio & Electronics Co.

## FLORIDA

Jacksonville — Bay Co.  
— Thurow Distributors Inc.  
Miami — Herman Radio Supply Co.  
— Thurow Distributors Inc.  
Orlando — Thurow Distributors Inc.  
Pensacola — Grice Radio & Electronics Supplies  
St. Petersburg — Thurow Distributors Inc.  
Tallahassee — Thurow Distributors Inc.  
Tampa — Thurow Distributors Inc.  
West Palm Beach — Thurow Distributors, Inc.

## GEORGIA

Atlanta — Herndon-Thomas Electronics  
— Specialty Distributing Co.  
— Yancey Co., Inc.  
Albany — Specialty Distributing Co.  
Augusta — Specialty Distributing Co.  
Macon — Specialty Distributing Co.  
Savannah — Specialty Distributing Co.  
— Yancey Co., Inc.

## ILLINOIS

Alton — Radonics Alton, Inc.  
Chicago — Broadwin Radio & TV, Inc.  
— Chauncey's, Inc.  
— Clayton Radio Parts  
— Irving Joseph, Inc.  
— J. G. Bowman & Co.  
— Radio Parts Co.  
— Walker-Jimieson, Inc.  
Danville — Bud Electronic Supply Co.  
Elgin — Elgin Electronic Supply  
Joliet — Joliet Radio Supply  
Kankakee — Radio Doctors Supply House  
Oak Park — Melvin Electronics, Inc.  
Peoria — Warren Radio Co.  
Rockford — Superior Radio Co.  
Rock Island — Tri-City Radio Supply, Inc.

## INDIANA

Angola — Shaw Engineering Co.  
Columbus — H. A. Williams & Co.—Radio Parts  
Evansville — Hutch and Son  
Ft. Wayne — Wall Distributing Co.  
— Warren Radio Co.  
Hammond — Broadwin Television & Radio,  
Inc. of Indiana  
Indianapolis — Graham Electronics Co. Inc.  
— Meunier Radio Supply Co.  
— Warren Radio Co.  
Marion — Mobile Radio Supply Co.  
Terre Haute — Archer & Evinger  
Valparaiso — Jess Bowman & Assoc.

## IOWA

Cedar Rapids — Gifford-Brown, Inc.  
Council Bluffs — World Radio Laboratories  
Davenport — Tri-City Radio Supply  
Des Moines — Gifford-Brown, Inc.  
— Radio Trade Supply Co.

## KANSAS

Pittsburg — Pittsburg Radio Supply  
Topeka — Overton Electric  
Wichita — Radio Supply Co.

## KENTUCKY

Lexington — Lex-Tronics  
Louisville — Peerless Electronic Equipment Co.  
— Universal Radio Supply Co.  
Paducah — Warren Radio Co.

## LOUISIANA

Baton Rouge — 'Ole Miss Supply  
New Orleans — Atlas Radio Supply  
— Crescent Radio & Supply Inc.  
— 'Ole Miss Supply  
— Pelican Radio Supply  
Sulphur — General Electronic & Engineering  
Service Corp.

## MAINE

Hallowell — Powell Radio Supply

## MARYLAND

Baltimore — Wholesale Radio Parts Co. Inc.

## MASSACHUSETTS

Boston — Commercial Radio Corp.  
— Gerber Radio Supply Co.  
— Lincoln Electronic Supply Corp.  
— Radio Wire Television, Inc.  
Lynn — Essex Electrical Supply Co. Inc.  
Natick — Willett Radio Supply  
New Bedford — E. A. Ross & Co.  
Springfield — Regent Sales, Inc.

## MICHIGAN

Battle Creek — Electronic Supply Corp.  
Benton Harbor — Benton Electronic Supply  
Co., Inc.  
Detroit — Glendale Electronic Supply  
Flint — Lifsey Distributing Company  
Grand Rapids — Radio Parts, Inc.  
— Wholesale Radio Co.  
Highland Park — Hi-Park Distributor  
Jackson — Matteson Electronics, Inc.  
Muskegon — Bell Lourim Electronics, Inc.  
Pontiac — Electronic Supply Co.

## MINNESOTA

Duluth — Lew Bonn Co.  
Minneapolis — Electronic Center, Inc.  
— Lew Bonn Co.  
St. Paul — Lew Bonn Co.

## MISSOURI

Kansas City — Manhattan Radio Supply  
— Radiolab  
St. Louis — Van Sickle Radio Co.  
— Radonics Co.

## NEW JERSEY

Hackensack — American Distributing Co.  
Hillside — Sherwood Distributors, Inc.  
Jersey City — Hallmark Electronics Corp.  
Manville — Masters TV Supply Co.  
Newark — Emerson-New Jersey, Inc.  
— Radio Wire Television, Inc. of N.J.  
— Variety Electric Co., Inc.  
North Bergen — American Distributing Co.  
Paterson — Jersey Electronic Distributing Co.  
Perth Amboy — Bennett's Radio Supply  
Teterboro — Van Dusen Aircraft Supplies  
Trenton — Allied Electrical Appliance Parts, Inc.

## NEW YORK

Albany — Air Waves Electronic-Radio Dist. Co.  
Binghamton — Stack Electronic Supply Co.  
Brooklyn — Ace Electronics  
— Bay Electronic Distributors  
— Benray Electronics Corp.  
— Hygrade Electronics, Inc.  
Buffalo — Buffalo Electric Co. Inc.  
— Radio Electric Products, Inc.  
Elmira — Le Valley McLeod, Inc.  
Fredonia — Barker-Higbee, Inc.  
Ithaca — Stallman of Ithaca, Inc.  
Mineola — Emerson-Long Island, Inc.  
Monticello — Fleisher Distributors, Inc.  
Newburgh — Chief Electronics, Inc.  
New Rochelle — Transvision, Inc.  
New York City — Barry Electronic Corp.  
— Bay Electronic Distributors  
— Emerson-New York, Inc.  
— House of Electronics  
— Magic-View Television Corp.  
— Midway Radio &  
— Television Corp.  
— Milo Radio & Electronics Corp.  
— Radio Wire Television, Inc.  
— Sanford Electronics Corp.  
Patchogue — South Bay Radio Distributors  
Poughkeepsie — Chief Electronics, Inc.  
Rochester — Maseline Radio & Electronic  
Equipment, Inc.  
Rome — Rome Electronic Supply  
Staten Island — B & D Distributing Co.  
Syracuse — Karl-Williams Co., Inc.  
Troy — Troy Electronics Distributing  
Utica — Electronic Laboratories & Supply Co.  
White Plains — Emerson Radio Westchester, Inc.

## NORTH CAROLINA

Charlotte — Dixie Radio Supply Co.  
— Westinghouse Electric Supply Co.  
Greensboro — Westinghouse Electric Supply Co.  
Hickory — Victor Radio TV Supply Co.  
Raleigh — Raleigh-Allied Electronics, Inc.  
— Westinghouse Electric Supply Co.

Salisbury — Leonard Electronics of  
Salisbury, Inc.

## OHIO

Akron — Sun Radio Co.  
Canton — Burroughs Radio, Inc.  
Cincinnati — Halub & Hogg  
— Mytronic Co.  
— Radio TV & Refrigeration  
Supply, Inc.  
Cleveland — Radio Electronic Parts Corp.  
Columbus — Buckeye Electronics  
— Electronic Supply Corp.  
— Whitehead Radio Co.  
Dayton — Allied Supply Co., Inc.  
— Stotts-Friedman Co.  
Lima — Allied Supply Co., Inc.  
Mansfield — Burroughs Radio Inc.  
Marion — Servex Distributing Co.  
Toledo — Lifetime Electronics  
— Warren Radio Co.  
Warren — Radio Specialties  
Youngstown — Radio Parts Co.

## OKLAHOMA

Oklahoma City — Dulaney's  
— Electronic Supply Co.  
Tulsa — S & S Radio Supply

## PENNSYLVANIA

Allentown — Radio-Television Supplies  
Braddock — Marks Parts Co.  
Erie — B & D Wholesale Distributing Co.  
Harrisburg — Harrisburg Radio Laboratory  
Supply  
Hazleton — Moyer Electronic Supply Co., Inc.  
New Brighton — Television Parts Co.  
Philadelphia — Allied Elec. Appliance Parts, Inc.  
— Alma Radio Co.  
— Barnett Bros. Radio Co.  
— Herbach & Rademan Co.  
Pittsburgh — Cameradio Co.  
— Radio Parts Co. Inc.  
— Tydings Co.  
Scranton — General Radio & Refrigeration Co.  
— Penn Electrical Engineering Co.  
Wilkes-Barre — General Radio & Electronic Co.  
York — York Radio & Refrigeration Parts

## RHODE ISLAND

Providence — Television Accessory House

## SOUTH CAROLINA

Columbia — Dixie Radio Supply Co.  
— Westinghouse Electric Supply Co.  
Florence — Dixie Radio Supply Co.  
Greenville — Dixie Radio Supply Co.  
— Westinghouse Electric Supply Co.  
Spartanburg — McElhanney Co., Inc.

## TENNESSEE

Chattanooga — Mills & Lupton Supply Co.  
— Specialty Distributing Co.  
Kingsport — Chemcity Radio & Electric Co.  
Knoxville — Chemcity Radio & Electric Co.  
Memphis — Electronic Supply, Inc.  
— McGregor's, Inc.  
— W & W Distributing Co.  
Nashville — Currey's Wholesale Distributors  
— Electra Distributing Co.  
— Moore-Handley Hardware Co., Inc.

## TEXAS

Amarillo — Dulaney's Co., Inc.  
Beaumont — Covington Distributing Corp.  
Corpus Christi — Hayes Radio Supply Co.  
Dallas — Adleta Co.  
— Crabtree's Wholesale Radio Co.  
Denison — Denison Radio Supply  
Ft. Worth — Sutton's Wholesale Electronics  
Houston — Angie Radio & Supply Co.  
— Electro-Mechanical Products Co.  
— Hall, Inc.  
Midland — Henderson-Hoff  
San Antonio — Mission Radio, Inc.  
— Modern Radio Supply  
Tyler — Radio Service Supply Co.

## VIRGINIA

Bristol — Bristol Radio Supply Corp.  
Fredericksburg — J & J Appliance Co.  
Lynchburg — Eastern Electric Co.  
Newport News — Noland Co., Inc.  
Norfolk — Radio Parts Distributing Co.  
Richmond — Meridan Electronic Equipment Co.  
Roanoke — Leonard Electronics of  
Roanoke, Inc.  
Winchester — Leonard Electronics of  
Winchester, Inc.

## WEST VIRGINIA

Bluefield — Superior-Sterling Co.  
Huntington — TV Supply Co.

## WISCONSIN

Madison — Superior Radio Co. of Madison  
Milwaukee — Electronic Expeditors Co.  
— Marsh Radio Supply Co.  
Racine — Superior Radio Co.  
Wausau — Electronics, Inc.

The above listing was closed as of November  
10, 1953. Watch for new Westinghouse Dis-  
tributor Appointments in your area.

ET-95046

# THIS ANTENNA OUT-PERFORMS:

this ... this ... this ... or this

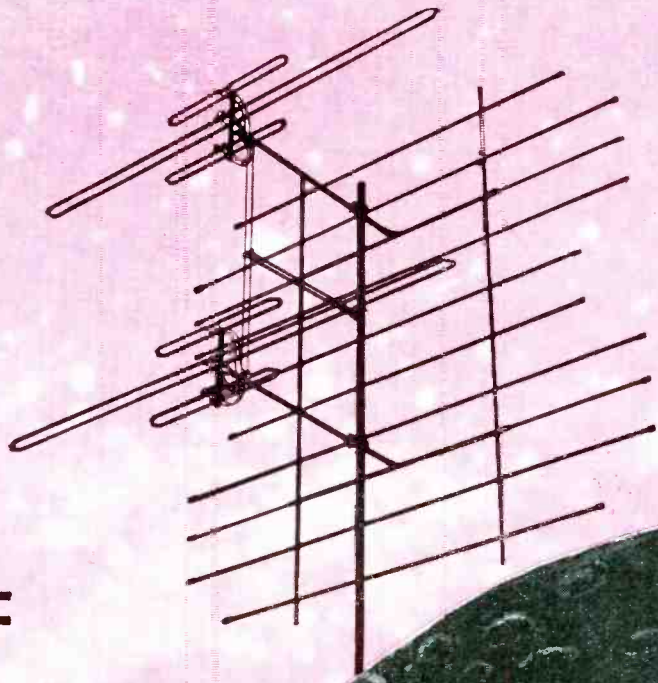
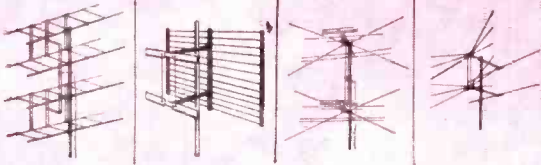

# the AMAZING VHF CHAMPION\*

a NEW KIND of Antenna  
that out-performs every all-channel  
VHF antenna ever made — —  
and many Yagis, too!

America's servicemen have spoken! In only 3 months, they've made the CHAMPION the nation's top-selling VHF antenna! It's the highest gain all-channel VHF antenna ever developed, and its performance has now been proven by over 50,000 outstanding installations.

Only the CHAMPION has the unique new "Tri-Pole", a triple-powered dipole system in which the Low Band dipole also functions as three dipoles tied together, in phase, on the High Band.

Folded dipoles throughout give close to 300 ohms impedance across entire band. Lightweight, all-aluminum construction. Available in one, two, or four-bays.

**CHANNEL  
MASTER  
CONQUERS  
SPACE!**

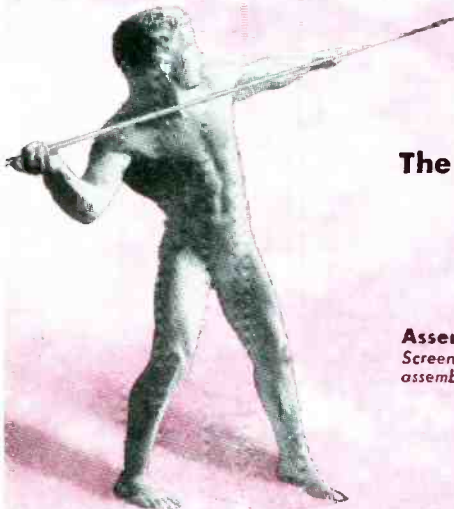

## The stacked CHAMPION provides:

- 11-13 DB High Band gain
- 6½-7½ DB Low Band gain

Assembles faster than a five-element Yagi.  
Screen "Pops-Up" instantly. "Tri-Pole"  
assembly just snaps into place.

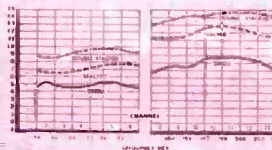

horizontal polar pattern (relative voltage)

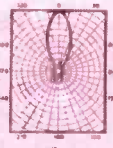

**CHANNEL MASTER CORP.**  
EALENVILLE, N. Y.



model no.		list price
325	single bay	\$20.83
325-2	two bay	42.36
325-4	four bay	88.87
Separate Stacking Harnesses:		
325-3	2 bay harnesses	\$2.00
325-5	4 bay harnesses	4.15

\*Pat. Pend.

# 3 great, new UHF antennas

by **CHANNEL MASTER**

## STACKED TWIN CORNER REFLECTOR model no. 406-2

The most powerful UHF fringe area installation you can make today!

- Broad Band coverage — yet out-performs most stacked Yagis.
- Covers every UHF channel, not just segments of the band.
- New impedance-matching, two-stage stacking system.

Another original Channel Master development!

Model No.	Description	List Price
406	Twin Corner Reflector	\$18.06
406-2	2-Bay Twin Corner Reflector. Stacking harness furnished free.	36.10
406-3	Stacking harness only, furnished separately.	2.08

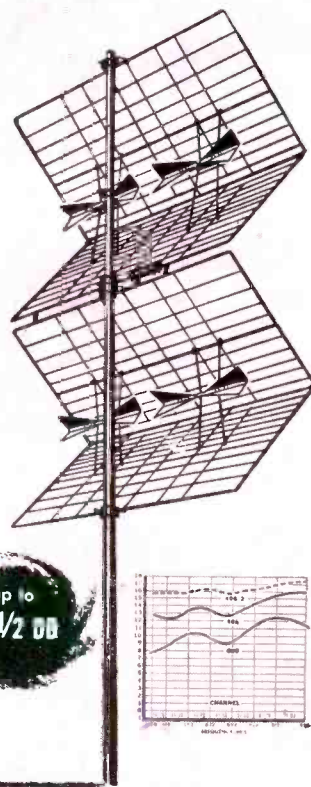

*powerful  
new  
antennas  
span  
vast  
distances*

## the first UHF CORNER REFLECTOR with optional "2-way" mounting!

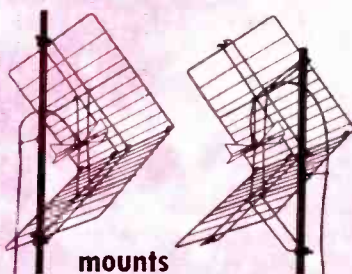

mounts

this way . . . or this way

model no. 409

Only CHANNEL MASTER'S CORNER REFLECTOR can be adapted to any kind of UHF installation — with or without VHF — at no extra cost. Every antenna contains all necessary hardware and braces for BOTH popular types of mounting. Sharp directivity and unusually high gain across entire UHF band.

only  
\$903  
list

**Installs instantly!** Original Channel Master assembly feature: Screen swings open like a book — dipole assembly snaps into place.

## "SWEET 16" The World's First 16-Element UHF Yagi!

- Custom-designed for your particular area.
- Super-power! Sensational fringe area reception.
- Delta-Weld design. Elements WELDED to crossarm. Delta-matched dipole gives uniform impedance.
- Wide band coverage, up to 21 channels.
- Average gain: 13 DB single  
16 DB stacked

model no. 420

\$ 8 20 list

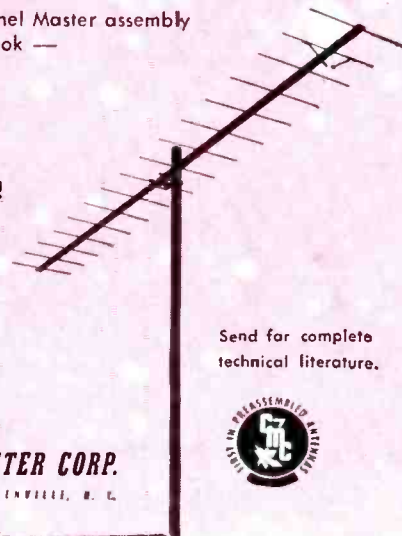

Send for complete technical literature.

**CHANNEL MASTER CORP.**  
GREENVILLE, N. C.



You can't do without...

# SYLVANIA'S SEE-WELL TOOL KIT

A NEW, TIME-SAVING TOOL-SENSATION!



Flash-light handle for interchangeable tips.

Tough, compact styrene case with clip lock.

**YOUR 3 MOST NEEDED TOOLS IN 1 KIT—MAGNETIC PHILLIPS AND FLATHEAD SCREWDRIVERS, NYLON ALIGNMENT TOOL—PLUS POWERFUL FLASHLIGHT!**

Break-resistant lucite spotlights work.

Stainless steel handle with built-in flash-light. Uses 2 pencil light batteries of any size (not included in kit).

Magnetized tempered steel Phillips screwdriver head embedded in clear lucite shaft.

Nylon, non-conductive alignment tool on lucite rod, to reach and see what you're doing.

Flat screwdriver, magnetized tempered steel, clear lucite shaft for tight fitting handle.

This **\$795** VALUE for only 15 Sylvania Premium Tokens.

NO MORE FUMBLING inside dark radio and TV cabinets. At the flick of a switch, a bright light automatically focuses right at the spot you're seeking. Saves your time . . . improves your work.

3 Handy Tools in 1. Magnetized Phillips and Flathead screwdrivers, nylon alignment tool—all 3 built into break-resistant lucite shafts perfectly fitted to flashlight handle.

Without doubt, this SEE-WELL Tool Kit is one of the slickest, quickest service tools ever built!

See your Sylvania Distributor Today! He has this remarkable tool kit for you now—you need only 15 Sylvania Premium Tokens. The time to get this valuable Sylvania See-Well Tool Kit is NOW—so don't delay, order high quality Sylvania tubes TODAY.

Remember, you get 1 token with every 25 Sylvania Receiving Tubes or every Sylvania TV Picture Tube you buy.

# SYLVANIA

Sylvania Electric Products Inc., Dept. 4R-4001, 1740 Broadway, New York 19, N. Y.

In Canada: Sylvania Electric (Canada) Ltd. University Tower Bldg., St. Catherine Street, Montreal, P. Q.

LIGHTING • RADIO • ELECTRONICS • TELEVISION

10 • SERVICE, JANUARY, 1954

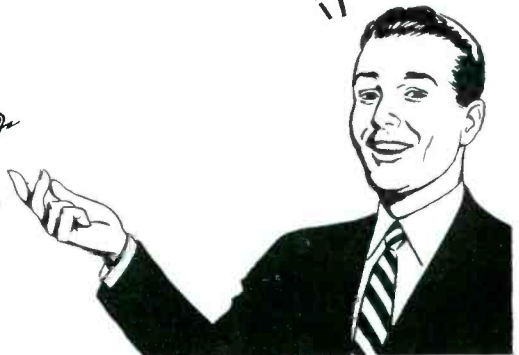

A **Leader** First

No Drift, No Coast



# Only Superotor<sup>®</sup> HAS Double Lock Stop

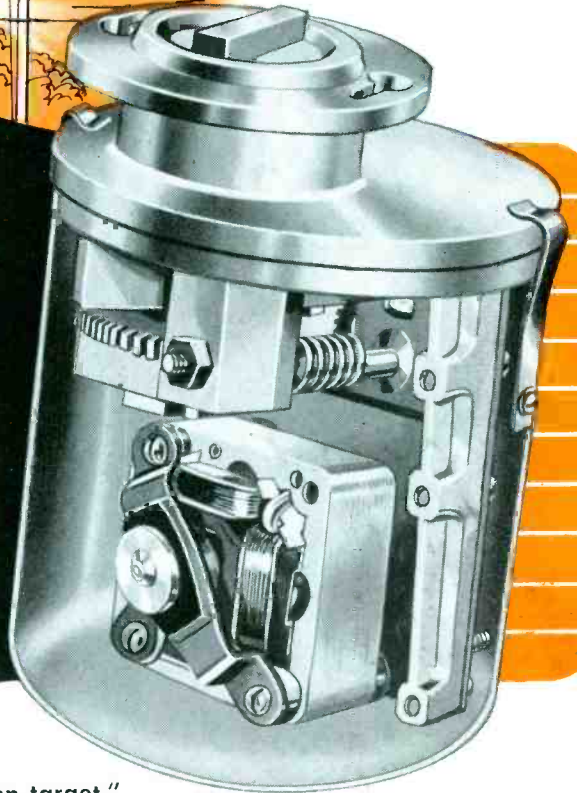

At last! — an antenna rotator that really stays "on target." With Superotor there's no jumping up to make adjustments, because it locks in place **two** ways, instead of one. First, a motor brake eliminates "coasting"; second, a worm gear lock prevents "drifting." This exclusive double lock also permits rotation in increments of **less than 1/2-degree**, enabling razor-sharp tuning for top UHF reception!

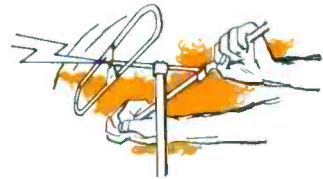

Compare All The Features, And You'll Join The Big Switch To Superotor



• Quick Detachable Drive Unit

A **Leader** First

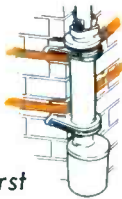

• Built-in Chimney Mount

A **Leader** First



• Steel-Reinforced Construction

A **Leader** First



• VP\* Tuning Accurate — Precise Simple

A **Leader** First



2925 EAST 55TH STREET  
CLEVELAND 27, OHIO

Patent Applied for Copyright

LEADING THE WAY TO BETTER PRODUCTS

For  
Your Exact  
Fuse Needs  
there's  
A BUSS  
FUSE

BUSS is the one source for any fuse you need: — standard type, dual-element (slow blowing), renewable and one-time types . . . in sizes from 1/500 ampere up.

BUSS Fuses can be relied upon for dependable electrical protection, elimination of needless blows, and top quality in every detail because — EVERY BUSS and FUSETRON FUSE USED IN THE ELECTRONIC TRADE IS ELECTRONICALLY TESTED. The sensitive testing device rejects any fuse that is not correctly calibrated, properly constructed and right in all physical dimensions.

That's why manufacturers and service organizations for over 38 years have turned to BUSS for their fuse needs — no matter how exacting.

And a customer instantly recognizes quality when he sees BUSS Fuses. Millions of fuses for home, farm, commercial and industrial use have established BUSS as the known brand — sales are easier and never a "come back" on your service.

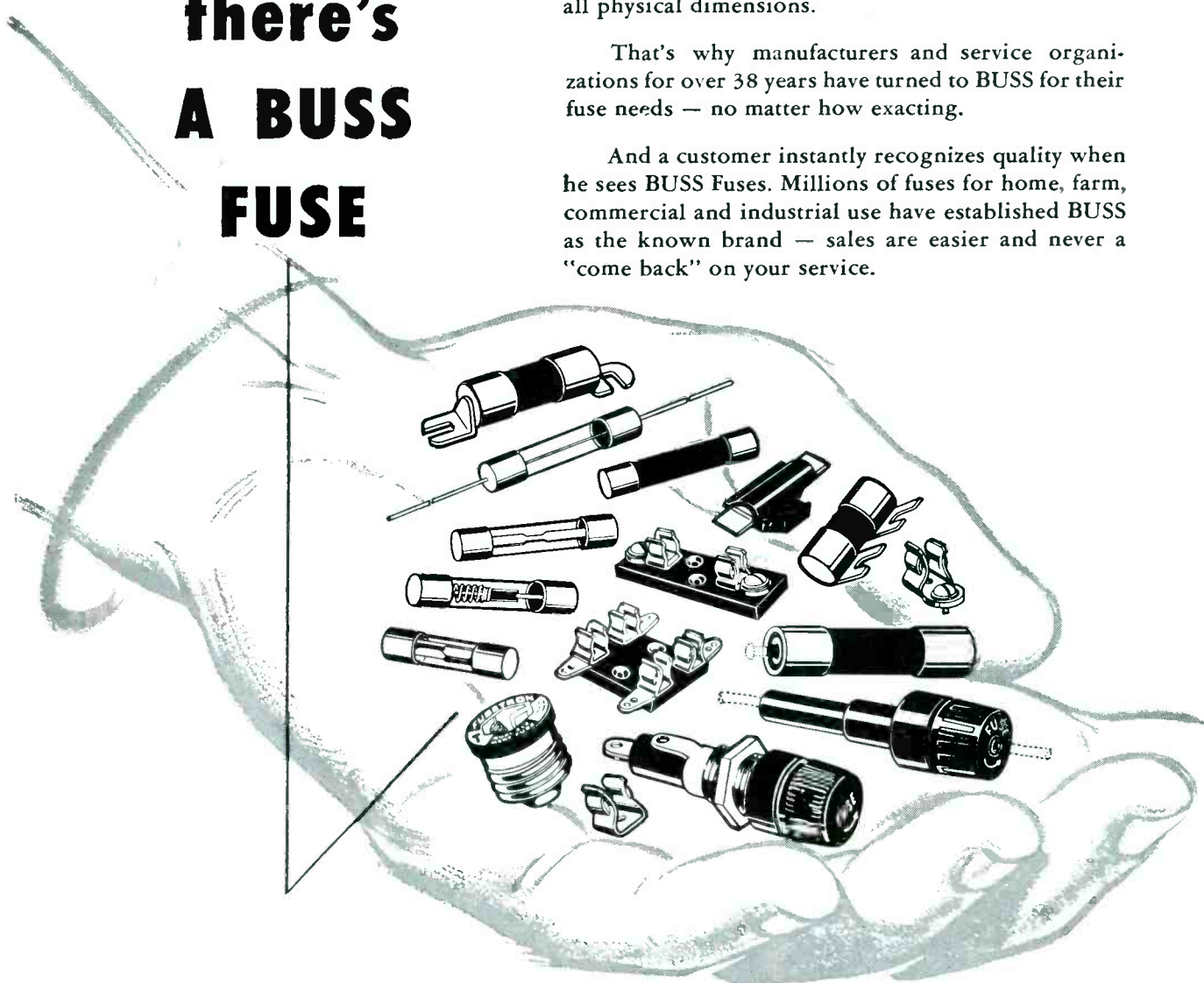

For  
Full  
Information  
Mail  
this  
Coupon

BUSSMANN Mfg. Co. (Division of McGraw Electric Co.)  
University at Jefferson, St. Louis 7, Mo.

Please send me bulletin SFB containing facts on  
BUSS small dimension fuses and fuse holders.

Name \_\_\_\_\_

Title \_\_\_\_\_

Company \_\_\_\_\_

Address \_\_\_\_\_

City & Zone \_\_\_\_\_ State \_\_\_\_\_ S-154

# GENERAL INSTRUMENT\*

**all channel UHF converter**

(FORMERLY THE SILVERLINE)



**tops in  
performance  
across  
the  
nation**

**R**eports from all areas of the country prove that the General Instrument all channel UHF Converter is first in side by side tests. *Now . . .* the General Instrument converter is available in *Light Sand*, as well as mahogany, to match modern cabinets.

**For the finest UHF convert-  
er plus eye-appeal—choose  
General Instrument**

*\*Jobbers: Some choice territories still remain open. Write for details.*

**General Instrument & Appliance**

CORPORATION

Subsidiary of GENERAL INSTRUMENT CORPORATION • 829 Newark Avenue • Elizabeth 3, N. J.

©NTI

This is to certify that

Frank's Radio

has  
**BOND**  
and the

**EXTRA**  
The Daily News  
**RAYTHEON BONDED PROGRAM  
ENTERS TENTH YEAR**

**RAYTHEON PROGRAM CONTINUES TO BE  
SERVICE DEALERS' MOST EFFECTIVE SALES AID**

1. GUARANTEE FOR NINE REPLACEMENT DATE
2. Use only
3. Not el
4. Test



COMPANY  
By ROY TECHRESTER, President  
No. \_\_\_\_\_ A

It was way back in 1945 that Raytheon, the first tube manufacturer to recognize the Service Dealers' need for help in combating public mistrust, provided that help through the *Raytheon Bonded Electronic Technician Program*.

For the past nine years this Raytheon support has helped many thousands of Service Dealers gain customer confidence and good will — substantially in-

crease their volume and profit.

Today, with the addition of television, the Raytheon Bond is more important than ever. And today, as always, if you can qualify for it, your status as a Raytheon Bonded Electronic Technician *costs you not one cent*. It is *Raytheon's* investment in *your* future.

If you're interested in making more money, ask your Raytheon Tube Distributor to tell you about the Raytheon Bonded Program. He'll be pleased to tell you how this powerful sales stimulator can help you.



**RAYTHEON MANUFACTURING COMPANY**

Receiving Tube Division  
Newton, Mass., Chicago, Ill., Atlanta, Ga., Los Angeles, Cal.

*Excellence in Electronics*

RAYTHEON MAKES ALL THESE: RELIABLE SUBMINIATURE AND MINIATURE TUBES • SEMICONDUCTOR DIODES AND TRANSISTORS • NUCLEONIC TUBES • MICROWAVE TUBES • RECEIVING AND PICTURE TUBES



RADIO · TELEVISION · ELECTRONIC  
**SERVICE**

**Bustling Days Ahead**

BLESSED with an industry that is constantly steeped in exciting developments, and always surging forward, Service Men once more can look forward to a pace-setting year splashed with dynamic events that will offer a sterling opportunity to display the completeness of their knowledge, and their aptness in applying their know-how. There'll be many occasions, when those in the shop and in the field, too, will face a driving challenge to their skill and ingenuity. And those who meet the rugged tests will surely find a rich reward for their resourcefulness.

Color\* will be a real proving ground for ability. For here there'll be a rash of problems to solve at the onset. Since actually the first runs of commercial receivers will be truly pilot models, subject to many field quirks, Service Men will be obliged to solve many odd difficulties such as color fringing, crosstalk, drifting, phase shifting, and, of course, the familiar assortment of b-w troubles that might obtain.

At present, plans call for the shipment of the three-gun tubes separately, so that they'll have to be installed in the home. One will have to exercise quite a bit of dexterity in these installations. In a typical assignment, it will be necessary to place an insulating ring over the high-voltage anode, and then a heavy metal shield over the tube. In mounting the tube in the cabinet, painstaking care will be required to assure accurate positioning of the three guns. After the tube is in place, one will have to perform many tasks, such as alignment of a special yoke for gun focusing, locating a purity coil on the neck of the tube and adjustment of convergence magnets.

According to present plans, no color test patterns will be televised, and thus it will be necessary to create artificial color signals. For such test-pattern work, several types of generators will be available. Some will be known as color signal simulators, and others will be cross-hatch, color-dot, or color-bar generators.

Convergence adjustments on three-gun tube models will be a particularly delicate operation. To illustrate, if convergence is faulty, color fringing will appear on the b-w pictures. Such color

fringing will be viewed as a double or triple image in the primary colors.

Receivers are also expected to feature color killers, which will eliminate color on b-w operation. If the circuits with this feature are defective, queer effects such as color splashing will appear.

Ghosts, smears, flutters, shimmers, and particularly snow, all somewhat tolerable in b-w operation, will be impossible to live with in color. As in b-w sets, inadequate antenna gain or faulty orientation of antennas will be found to be the basic problem here for most of these faults.

While practically all of the initial color sets will use 15-inch three-gun tubes which will provide an 11½-inch picture, some sets might appear with single-gun 21 and 22-inch round or rectangular tubes offering 17 and 18-inch pictures. In the single-gun tube receivers, convergence, fringing or signal drift will not be too serious, but unless the tubes are well shielded, severe radiation will occur, and in addition, defocusing and pin-cushioning might prevail because of yoke and focus-coil difficulties. Also, because of the coarse-line structure of the tube the reproduction of the reds and yellows might annoy some.

Of course, one should also remember that many b-w set owners will be content to wait until color gets a firmer foothold before they buy. During this trial era, b-w viewers will be more anxious than ever to keep their holdover sets in tip-top form; a tailor-made job for Service Men.

There'll be many challenging opportunities elsewhere, too. In communities, beyond the normal reception range of existing TV stations, which also lack a population density necessary to make the market attractive to prospective broadcasters, reception will continue to be provided by either community-TV systems, which are growing in popularity (over 240 have been installed), or either of two new types of retelecasters—satellites or boosters. Both of these new mediums will introduce lively markets for installation, service and maintenance, too. Satellite stations are actually low-power TV transmitters, but they employ no camera or other studio facilities, and instead derive their program material by retransmitting on a separate channel signals of selected TV broadcast sta-

tions. Booster stations intercept the signals of a mother station, amplify them, and retransmit the signals on the channel on which they were received. In both cases, the slave transmitters are of the unattended type, and will require service and maintenance, which can be performed by Service Men. To minimize interference, low power will be used by either satellite or booster, and thus receivers will normally require an outdoor antenna and the usual care in its installation to insure maximum pickup. Proponents of the retransmitting idea have told the Commission that there are thousands of communities who can readily use these new retransmitting services.

The recent competitive trends in marketing hi-fi have altered old concepts for selling custom-packaged component systems, and jobbers are now displaying a greater spirit of cooperation. And there are indications that the willingness to work with Service Men will grow. It has been found that Service Men can more readily survey a customer's needs, and certainly perform an installation and follow up service calls with striking efficiency. Many jobbers have already, or are in the process of including audio demonstration rooms or salons, openingly inviting Service Men to bring their customers to such studios to help consummate a sale. And hi-fi, heretofore believed to be only limited to the classics, has begun to have its effect on the jazz and pop market, too. Bands, singers and instrumental groups have begun to apply the acoustical advantages of wide-band recording. As a result, there has been a tremendous upsurge of public interest, and prospects for installations have skyrocketed. But, only Service Men can engineer hi-fi systems so that they provide the brilliant reproduction the consumer is looking for and the manufacturer loudly claims it is possible to obtain from his equipment.

With color all set to make its glamorous appearance, b-w TV replacement<sup>2</sup> and installation needs still a roaring factor, and the requirements of the rest of the active radio-audio-electronic family as urgent as ever, Service Men truly face a whirling, busy period, which should sprinkle the ledgers of '54 with gilded entries. —L. W.

<sup>2</sup> See *National Scene*, this issue.

\*For an additional report on color-set design, see *National Scene*, page 20, this issue.

# WARD

# TELE-VANES

*styled for*

**NEW BEAUTY on the housetops**

**INCREASED SALES of TV antennas**

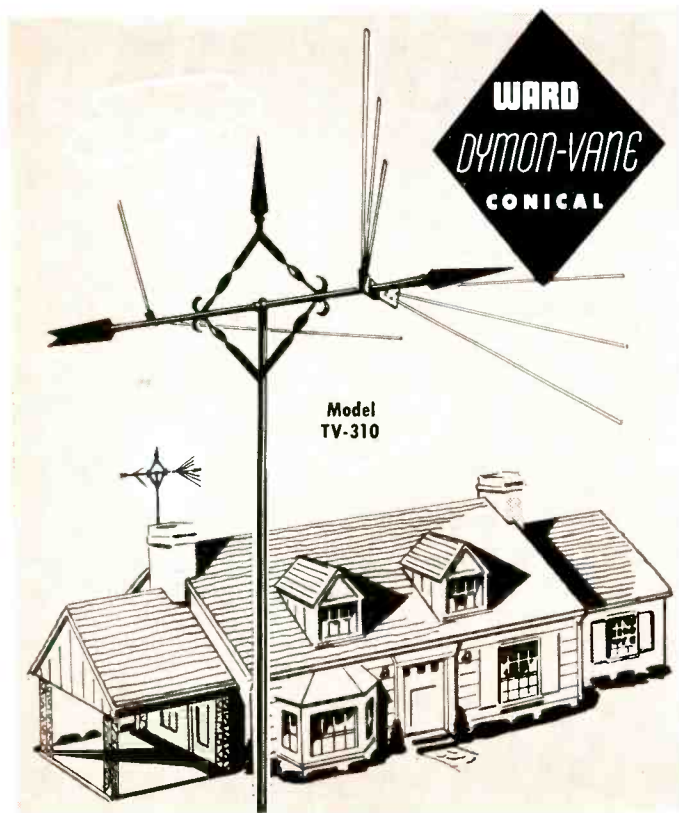

Sell the antennas that are "selling" for you. Ward is promoting their new line of Tele-vane

| The American Home  
 | Architectural Forum  
 | Better Homes and Gardens  
 | Business Week  
 | House Beautiful

Write today for the giant Tele-vane Sales Kit that gives you the complete schedule plus many, many more selling aids. Tie-in with this gigantic selling

Antennas right to the consumer with national advertisements in:

| Popular Mechanics Magazine  
 | Popular Science Monthly  
 | Time  
 | House and Garden Book of Building  
 | Newsweek

campaign for the newest, most revolutionary idea in TV antennas yet.

# THE WARD PRODUCTS CORP.

DIVISION OF THE GABRIEL COMPANY

1148 Euclid Avenue, Cleveland 15, Ohio

In Canada: Atlas Radio Co., Ltd., Toronto, Ont.



# SERVICE... *The National Scene*

STRIDENT PROGRESS TO CONTINUE IN '54, INDUSTRY EXPERTS PREDICT--The next 12 months will sizzle with activity, the heads of practically all set, tube and part makers have declared in their annual forecasts. They have based these predictions on the following bright prospects: From 200 to 250 more TV stations should begin telecasting during the next 12 months; this would bring the total number of active TV stations to well over 600. . . . Color sets will begin to roll off the lines in substantial quantities. . . . Hi-fi, disc-tape recording, home and auto radio interest will continue to grow, and there'll be a mounting need for commercial pa, two-way and industrial electronic gear.

ENTHUSIASM for station expansion is certainly well founded, with the FCC files bulging with over 800 applications still to be processed. A year ago it was believed that no more than 75 new stations would go on the air; to date, there are about 360 stations in operation, with about one-third operating on vhf, and the remainder on the ultra-highs.

ACCORDING to most guesstimates, over five million b-w chassis are expected to be made in '54, and from 100,000-150,000 color sets will probably be produced, too. There'll also be a continued strong demand for home, portable and auto sets, with a production of well over 10-million chassis scheduled to be made. This is a slight reduction over the entire '53 output; but percentage-wise more small portables, auto and clock radios will probably be made.

AN ESTIMATED \$60-million worth of communications equipment will be sold in '54, including two-way and microwave apparatus. . . . Tube sales (covering all types) in '54, it has been predicted, will reach at least \$700-million. . . . According to present schedules, 21-inch picture tubes will be used in about 70% of all the b-w receivers that will be made during the year; 17 inchers will account for 20%, and 24 and 27-inch models will make up the remaining 10%.

ALMOST one out of every seven TV sets in use today, and there are over 27-million now in operation, is expected to require a new picture tube in '54. This high replacement tube figure, it has been noted, represents a normal development with so many chassis growing older. Specifically, over four-million picture tubes should be replaced during the next 12 months, topping the '53 requirement by about 50%. . . . Incidentally, color picture tubes will take up about 2% of the industry's total picture-tube output during the year.

RADIO LISTENING will continue to be an extremely important factor in the home and on the road, and families will be just as anxious as ever to keep their sets in operation. At the beginning of the year, there were 110-million radio sets distributed throughout the country: 44,800,000 radio-equipped homes with 75-million sets; 26,200,000 auto radios, and 9-million receivers were in public places. And, through the year another 13,500,000 sets were bought for home and car use. It has been reported that there are now five-million homes out of 48-million families which have at least three radio sets. According to a network survey, over 41-million families, or about 92% of the nation's radio families, listen in for an average of more than three hours a day. Commenting on this continuing interest in radio, one FCC Commissioner said that apparently TV has not displaced the demand for radios in the home; it has merely divided the living-room set into three parts, in most instances, and moved one to the bedroom, one to the kitchen, and one to the children's bedroom or recreation room.

UPPER NEW YORK STATE ASSOCIATION PROTESTS JOBBER-DISCOUNT PRACTICES--In a sharp note, sent out by the Radio and TV Service Association of Western New York (Buffalo), jobbers were asked to protect Service Men against retail purchasing at the wholesale level. A motion passed by the group, and distributed to parts jobbers and set distributors in the area, asked the merchants to display prominently a sign that would state that wholesale discounts will be given only to those individuals or organizations that hold sales tax exemption certificates, which, of course, are held only by those who operate shops. The only exception to this ruling would be hams who present an operating license as certification of their activity. According to the association's prexy, jobbers were asked to reply to this request, either by phone or letter. The association declared that it proposed to supply, at its own expense, signs with the tax-exemption discount information.

# SERVICE... The National Scene

COLOR-SET OPERATION-DESIGN FACTORS DEFINED IN OFFICIAL NTSC APPROVAL--In its report and order approving compatible color, the FCC included pages of basic data on set design and operation that will probably be found in all future color manuals and textbooks. In a commentary on the inherent complexity of color signal specs, it was noted that the color tube and its attendant circuitry is very complicated and of intricate design, and will impose a substantially greater burden in instruction, servicing and maintenance. Finer adjustments of the tuner control will be required; to illustrate, by moving this control too far in either direction, a considerable change in the color balance of the picture will obtain. Color sets will also have a chroma control which determines the saturation of color; at one extreme position colors will be fully saturated, while at the other end colors will be washed out. Many models will also have controls for hue, convergence and color hold.

IN THE REPORT from Washington, it was said that the tricolor picture tube, the involved convergence circuitry, and special deflection yoke and hv supply, will require particular attention in manufacture and servicing, too.

INTERFERENCE, as noted earlier in these columns, remains as a key problem; color chassis are more vulnerable to interference which falls in the region of the subcarrier. Such interference to the receiver could originate from the additional sideband energy radiated by a color transmitter on the upper adjacent channel, or it could be caused by some other source--the receivers themselves. Receiver manufacturers will have to take every precaution to prevent such radiation by making full use of shielding, traps, and other known control methods.

IN INSTALLING AND SERVICING color sets, Service Men will also have to be concerned with such factors as the brightness component. Since the eye is most sensitive to green, less sensitive to red, and least sensitive to blue, brightness is obtained by mixing signals in that order of proportion. Specifically, the values of the mixture are: 59% green, 30% red and 11% blue. Such a mixture produces shades of gray in pictures on b-w sets. However, in the color system, this mixture accomplishes the primary objective of transmitting with the correct intensity the brightness signal which is one of the two components of the color picture image.

THE CHROMA component will also be of particular concern to Service Men. When a composite color signal is received on a color set, the chroma component must be separated by special filters before it can be processed. This chroma signal is removed from the composite signal at about the third video amplifier, and then fed through a 1.8 to 4.3-mc bandpass filter. This filters out the video carrier frequency and lf components, leaving the color subcarrier and sidebands along with the hf components of the luminance signal. Actually, the modulations of the two-color difference signals on the subcarrier remain independent only when the modulated waves each consist of like upper and lower sidebands. . . . The output of these filters is fed to a chroma demodulator which recovers the original color-difference signals. And, the two color-difference signals which result are fed into a matrixing unit from which is recovered the third color-difference signal, or green minus brightness. In the case of the three-gun tube, the three-color-minus-brightness signals are routed to the three respective electron beams of the color tube, where they are combined with the brightness signal. The result is that we have color minus brightness, plus brightness, which equals color. That is, the original primary color is restored and projected on the viewing tube.

BBB TELLS CONSUMER ABOUT COLOR--In one of the most enlightening booklets ever published, the National Better Business Bureau has presented an extremely forthright report on the status of color today. Defined are compatibility, availability of chassis, problems of conversion, picture-tube sizes, and the relative complexities of receivers. Answers are sincere, and in reply to questions that are expected to puzzle many consumers. Here, truly, is an extremely useful addition to the library of every service shop. Congratulations to those in the BBB for their vision in preparing and releasing this highly instructive booklet at this time.--L.W.

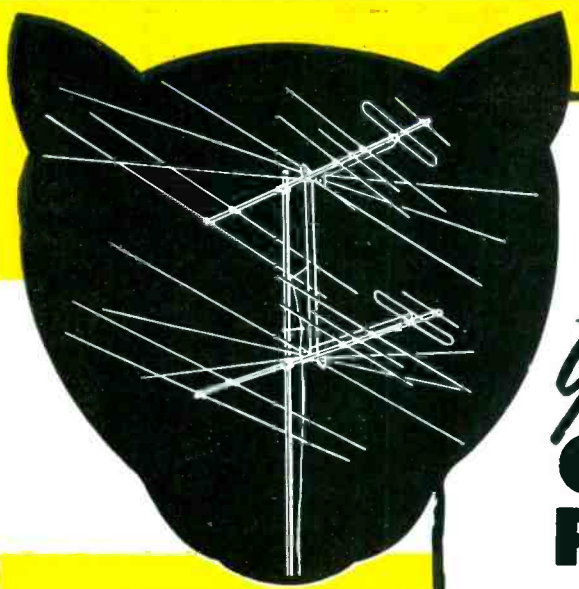

"BIG JOE" all channel VHF antenna  
BJ-10 single bay; BJ-20 stacked

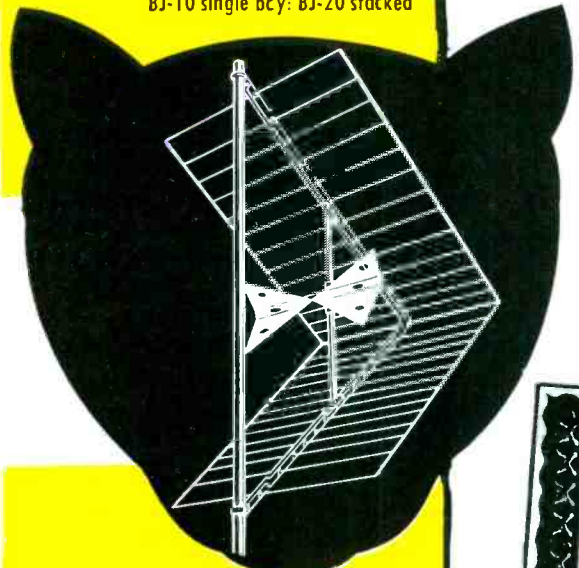

UHF Ultra Cor-Tenna, Model 706  
(Available stacked as Model 706-2)

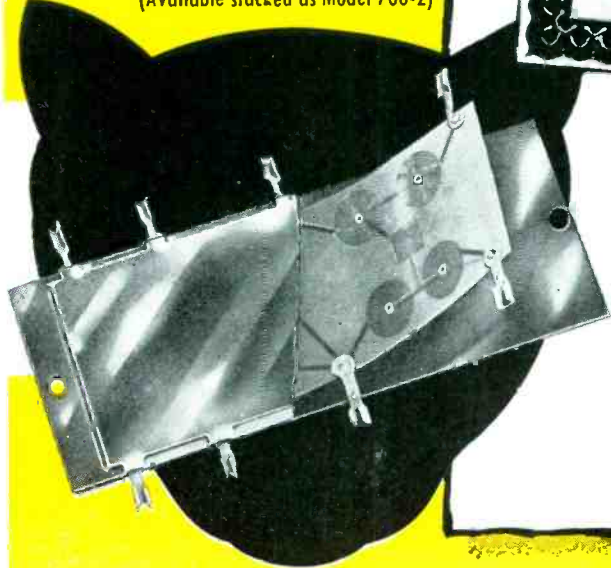

Model UV-3 Trip e-tie cross-over filter

# TESCON . . .

## You are Guaranteed OUTSTANDING PERFORMANCE

by

TESCON'S unique and exclusive engineering . . . rugged construction, spectacular reception, easy "snap-in" assembly, split-second installation, strongest signal . . . features that make these the most outstanding antenna values at any price! Regardless of the antenna requirement, there is a TESCON model available that will do the perfect job, with the highest gain. Leaders in the TESCON line are the "BIG JOE"—the first antenna to cover all VHF channels with tremendous db gain—and the Ultra Cor-Tenna—one of the most powerful UHF corner reflector antennas known with a gain of up to 14.8db!

**Guarantee**

Tescon guarantees that the snap-in construction of all grouping, completely pre-assembled Tescon Rucke-Tennas will positively lock all elements in place and will mechanically outlast the antenna's electronic life. Snap-in construction of Tescon's antennas eliminates the necessity of tightening wing nuts, screws, nuts or bolts. This Guarantee, naturally, is predicated on the fact that the entire installation is also of sound mechanical construction, and is not void if hurricanes, lightning or other Acts of God cause mechanical destruction.

This is your protection against limitations. Don't take less than the best—insist on TESCON.

*Elliot March*  
Vice President  
In Charge of Sales & Engineering

Write TESCON today for literature on the complete line of antennas and mounts for UHF, VHF and UHF-VHF.

# TESCON

TV PRODUCTS COMPANY  
SPRINGFIELD GARDENS 13 NEW YORK



©NTI

# Better Audio From Radio and TV For the Hard-of-Hearing



by DONALD PHILLIPS

**TV and Radio AF and Power Circuits Can Be Altered for Headphone Use to Provide Improved Sound Reproduction and Insure Safety, Too**

Above, left: Multiple listening unit that can be used with hearing aid or headset; both speaker and headset or hearing aid can be operated with this device in circuit. As a safety feature item has a line-isolation transformer. (Philco)

MANY, who use hearing aids, have found that these devices do not provide completely satisfactory audio performance from radio and TV chassis. It has been noted that these persons do not hear the programs as clearly as they can hear *directly* the voices of others.

One reason for the inferiority of sound reproduction from a TV or radio receiver through the hearing aid has been attributed<sup>1</sup> to the fact that the audio signal must pass through two amplifier systems before it reaches the hearer. Inferior reproduction has also been found to be due to reverberation of the sound waves in the room, since the receiver is placed at a greater distance from the hearing aid than in normal conversation.

#### Headphones Instead of Hearing Aids

Whether or not the theories offered for the inferiority of sound reproduction are correct or sufficient, there is no doubt that hard-of-hearing persons often prefer to listen to audio by means of a pair of headphones plugged into the audio-output circuit of the receiver. It has been found that a tone control is very desirable to help accommodate the user's particular type of hearing loss.

#### The Safety Factor

Service Men who are asked to install earphones and tone controls actually shoulder a heavy responsibility. In the event of trouble which could

result in a fatal shock to the user, the Service Man would first be accused. And there is more than one problem to the shock difficulty.

It might be supposed that if one terminal of the circuit to the earphone were grounded, the user would be safe from any shock due to trouble in the TV or radio receiver. With certain technical exceptions, this supposition is true. On the other hand, if the user should be wearing the grounded earphone, and reach for an electric switch in a faulty lamp, the trouble in the appliance could cause fatal shock. Again, the chassis of some TV receivers are *hot* when the power plug is inserted in the power outlet in one direction; contact of the user with a control shaft or faulty knob of the receiver could again result in fatal shock.

Chiefly for these reasons, various authorities maintain that the earphone should not be connected to ground in any manner, and that insulation, tested to withstand 2,000 volts, should be provided between earphone and the receiver output circuit.

#### Careful Inspection of Receiver Circuit

The output transformer in the radio or TV receiver may or may not have a chassis-grounded secondary. In some cases the secondary drives the voice coil of the speaker only, but in other instances the secondary also supplies a

feedback voltage to the audio-amplifier circuit. Accordingly, whether the chassis of the receiver is connected to the power line or not, other considerations may prevent *floating* the secondary of the output transformer, to provide safety to the earphone user.

Circuit considerations do not end here. The secondary of the output transformer may be ungrounded in certain types of receivers, but may still be unsuitable for the intended application because of insufficient insulation between primary and secondary. Unless the output transformer can withstand a 2,000-volt test on a *dc* megger,\* it should not be considered safe for the application, in the view of established authority on this subject. Since the entire future of the installing Service Man may be at stake in case of a faulty job, too much attention cannot be given to safety considerations and to the background of experience which has been accumulated on the subject.

#### Circuit Considerations

In Fig. 1 appears an arrangement for an *ac/dc* chassis, in which one side of the earphone circuit is grounded. Far from providing protection to the user, the grounded earphone circuit can instead provide a shock circuit (between X and Y). Wet, frayed, or burned cords, cracked insulation or otherwise damaged phones and switches can provide the shock contact to the earphone user. Hence, it is clear that

<sup>1</sup>Wireless and Electrical Trader; May 23, 1953.

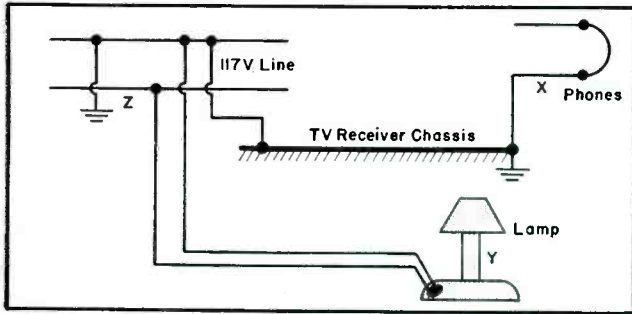

Fig. 1. Although one side of the earphone link is grounded in this circuit, the user could receive the full 117-volt line potential between points X and Y, in case line Z should come into contact with the metal structure of the lamp. Such contact often occurs in practice, due to frayed cords; contact can also result from damaged sockets or switches. The user may make contact at X due to frayed or burned insulation, wet insulation, or breakdowns in the earphone structure.

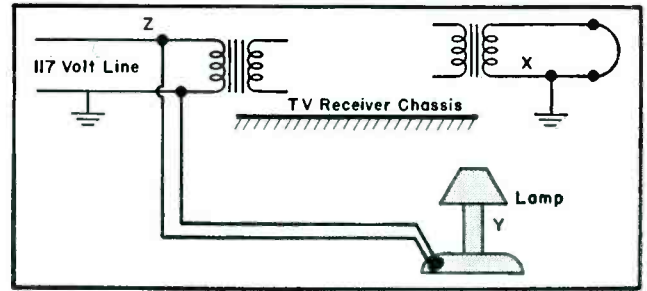

Fig. 2. The same possibility of shock to the earphone user noted in Fig. 1 also exists in a grounded-earphone circuit used with an ac receiver. This danger obtains because one side of the 117-volt power line is externally grounded. If line Z should make contact with the metal structure of the lamp, the listener can receive the full 117 volts between X and Y. Grounded earphone circuits are dangerous for use with any receiver.

grounded earphone circuits are a source of danger to the user.

Service Men must be careful to distinguish between the danger of shock from a hot ac/dc chassis, as contrasted with the danger of shock from a grounded earphone circuit to an electrical appliance. Fig. 2 illustrates an ac receiver of the transformer-coupled variety in which the TV chassis is floating. The earphone circuit is grounded to a water pipe for safety, but it is clear that the ungrounded chassis affords no protection over the arrangement shown in Fig. 1. The earphone user can still receive a shock between the earphone circuit and the lamp (or other appliance) in case of wet cords, frayed or burnt insulation, or other faults.

The danger to the user in such arrangements lies in the fact that one side of the power line is externally grounded by the power company. The shock which can be obtained from the earphones in the circuit of Fig. 2 is thus to be clearly distinguished from the shocks which can be received from hot chassis due to broken knobs, tampering by fix-it-yourself addicts, or similar misfortunes.

In Fig. 3 we have an output circuit for a receiver, in which neither side of the speaker is grounded. Hence, this

is a suitable arrangement for providing a floating earphone circuit, provided of course that the output transformer and its associated speaker circuit is not leaky or subject to breakdown from transient surges. If the speaker and secondary of the output transformer can withstand a 2,000-volt megger test to chassis, the primary requirement is met. Nevertheless, the added margin of safety provided by a separate output transformer for the earphone circuit is too strong to be disregarded.

As an illustration of the wide variations in speaker circuitry which are encountered, Fig. 4 shows a speaker circuit which is grounded on one side, and returned to a feedback loop on the other side. It is sometimes found that the speaker circuit includes hum-bucking arrangements, as shown in Fig. 5 (p. 76). In most of these arrangements, it is possible to provide a ground to the secondary of the output transformer, as shown in Fig. 6 (p. 76), if one is not provided by the receiver manufacturer.

The secondary of the output transformer should always be grounded, when a separate earphone transformer

is used, as shown in Fig. 6, to provide a margin of safety to the earphone user against leaking of B+ voltage from primary to secondary of the output transformer; leakage resistance, R, as indicated in Fig. 6, is clearly a separate source of shock to the user of an ungrounded earphone circuit. However, the combination of a grounded secondary in the output-transformer circuit, plus the installation of a separate earphone transformer rated at 2,000-v insulation between primary and secondary, insures the user against shock either from receiver faults, or from switching hot chassis on and off, or touching faulty electrical appliances.

Since Service Men will encounter speaker circuits in ac/dc receivers in which one side of the speaker line may not be grounded, it is important to provide for this situation. In such cases, two earphone transformers must be used in cascade, with the secondary of the first earphone transformer grounded, and the secondary of the second earphone transformer ungrounded. This provides the same safety factors to the earphone user as the arrangement shown in Fig. 6 (p. 76).

Volume control is a necessity, of course, and the basic arrangement

(Continued on page 76)

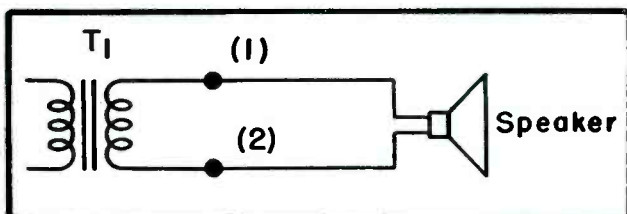

Fig. 3. If the earphones are connected between 1 and 2 in this arrangement, the first requirement of an ungrounded earphone circuit is met. Nevertheless, Service Men must ask whether the output transformer T<sub>1</sub>, which is supplied with the receiver, may be safe, and whether the associated speaker circuit may likewise be safe. A test with a 2,000-volt megger between either 1 or 2 and chassis should be passed before this basic arrangement is utilized. A separate output transformer provides a margin of safety which cannot be disregarded.

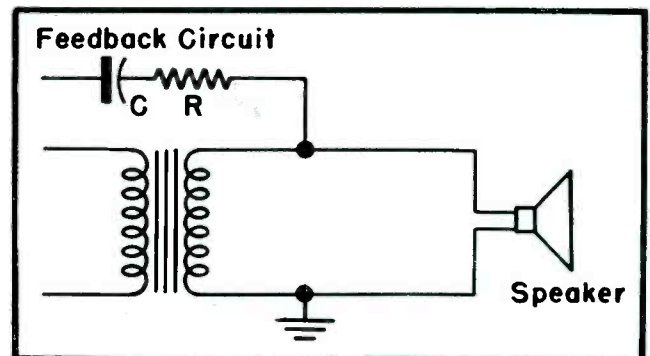

Fig. 4. Some receivers utilize a feedback circuit, in addition to grounding one side of the speaker circuit. It is the incidence of such unexpected arrangements that calls for the careful inspection of the circuit diagram before starting an earphone installation job.

Buzz can be localized by turning controls on a TV set and supplementing these tests with specific component and wiring checks. In probing for buzz, the following step-by-step procedure has been found very effective.

1: The receiver should be switched to an inactive channel. If the receiver continues to buzz, an *untunable* distortion voltage is present; a typical untunable buzz pulse is shown in Fig. 1, below.

2: If the buzz ceases when the receiver is switched to an inactive channel, *tunable* (sync) buzz is present. A typical tunable buzz pulse is shown in Fig. 2. In case of tunable buzz, suggestions offered in step 21+ (p. 48) should be followed; in case of untunable buzz, step 3 is in order.

3: The vertical-hold control should be turned, listening to the pitch of the buzz. If the buzz changes in pitch, it can be concluded that the source of the buzz is in the vertical-sweep or vertical-oscillator circuit.

4: The volume control can now be turned and another listening test made, this time on the intensity of the buzz. If the intensity of the buzz does not change, sweep voltage is entering the audio circuits at a point past the volume control. And if the intensity of the buzz is changed by a setting of the volume control, then the sweep voltage is entering the audio circuits at a point prior to the volume control.

5: Volume control should be replaced if noisy, or if an ohmmeter check shows too high a resistance value; a defective volume control can pick up stray fields.

6: One should also check grounding of outer braid on shielded volume-control lead and lead dress. Even a shielded volume-control lead occasionally picks up buzz when dressed too close to the vertical-sweep circuits.

Fig. 1. When a 'scope is applied at the output of the audio amplifier, an untunable buzz pulse, as shown here, will appear. A good 'scope is more sensitive than the ear, and it may not be possible to bring the pulse to invisibility on the 'scope screen.

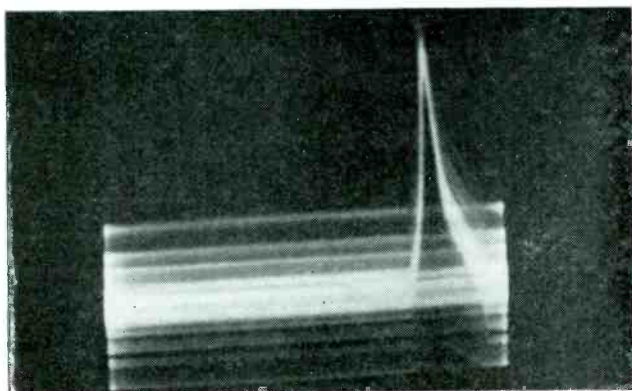

# Troubleshooting

## 60-Cycle Buzz in TV

by CLARK R. ALISEN

### Step-by-Step Trace Guide

7: If untunable buzz persists, the first audio amplifier tube should be removed to determine whether buzz ceases; if buzz continues, the vertical-sweep voltage is entering the audio amplifier between the driver and output stage.

8: If the speaker has been replaced, one should check to see whether a hum-bucking coil is present, and correctly connected. A high hum level, simulating buzz, can enter at the speaker, if the hum-bucking terminals have been inadvertently reversed.

9: To distinguish between hum and soft buzz, the vertical-output tube should be removed to see whether the buzz stops. In some cases it may also be necessary to check the vertical-oscillator tube.

10: Buzz may be entering audio circuits through the *B* supply line. Here one should check the line with a 'scope to see whether it is *hot* or *cold*. If *hot*, decoupling capacitors in the audio and vertical-sweep circuits should be checked.

11: If the *B* supply line is not at fault, grounding of the vertical-output transformer core to chassis should be checked.

12: Arcing turns may develop in vertical-output transformer, developing excessive stray field. A substitution test should be made in case of doubt.

13: Shielding of audio-input stage should be checked; a metal-type tube should be used, or a shield provided for a glass-type tube.

14: Lead dress in the vertical-sweep circuit should be checked; output leads close to chassis should be dressed.

15: If the pitch of the buzz remains constant as the vertical-hold control is turned, it will be usually found that buzz voltage is entering via the *B+* line.

16: Line filter should be checked to make certain that the power line is not operating as an antenna. (Bypass capacitors should be shunted from each side of the line to chassis.)

(Continued on page 48)

Fig. 2. Here we have a typical tunable buzz pulse as it appears on a 'scope. The tunable buzz pulse is derived from the video signal, while an untunable buzz pulse is derived from the vertical-sweep voltage.

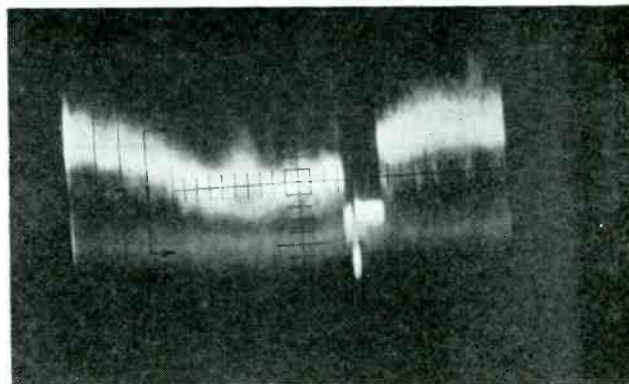



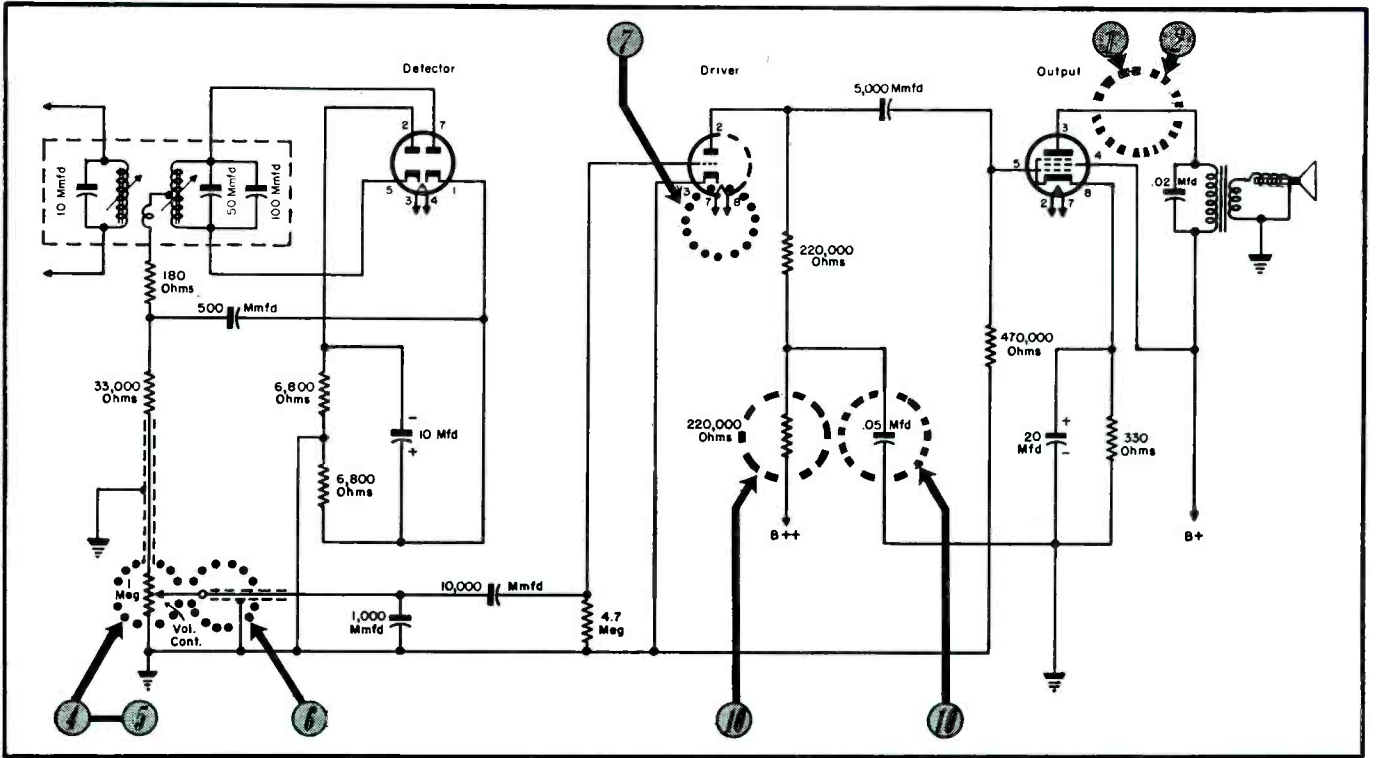

(Above)

Fig. 3. Check points for 60-cycle buzz: See detailed probe procedure at left.

(Below)

Fig. 4. Circuit illustrating where 60-cycle buzz may appear: See analysis with corresponding numerical references at left.

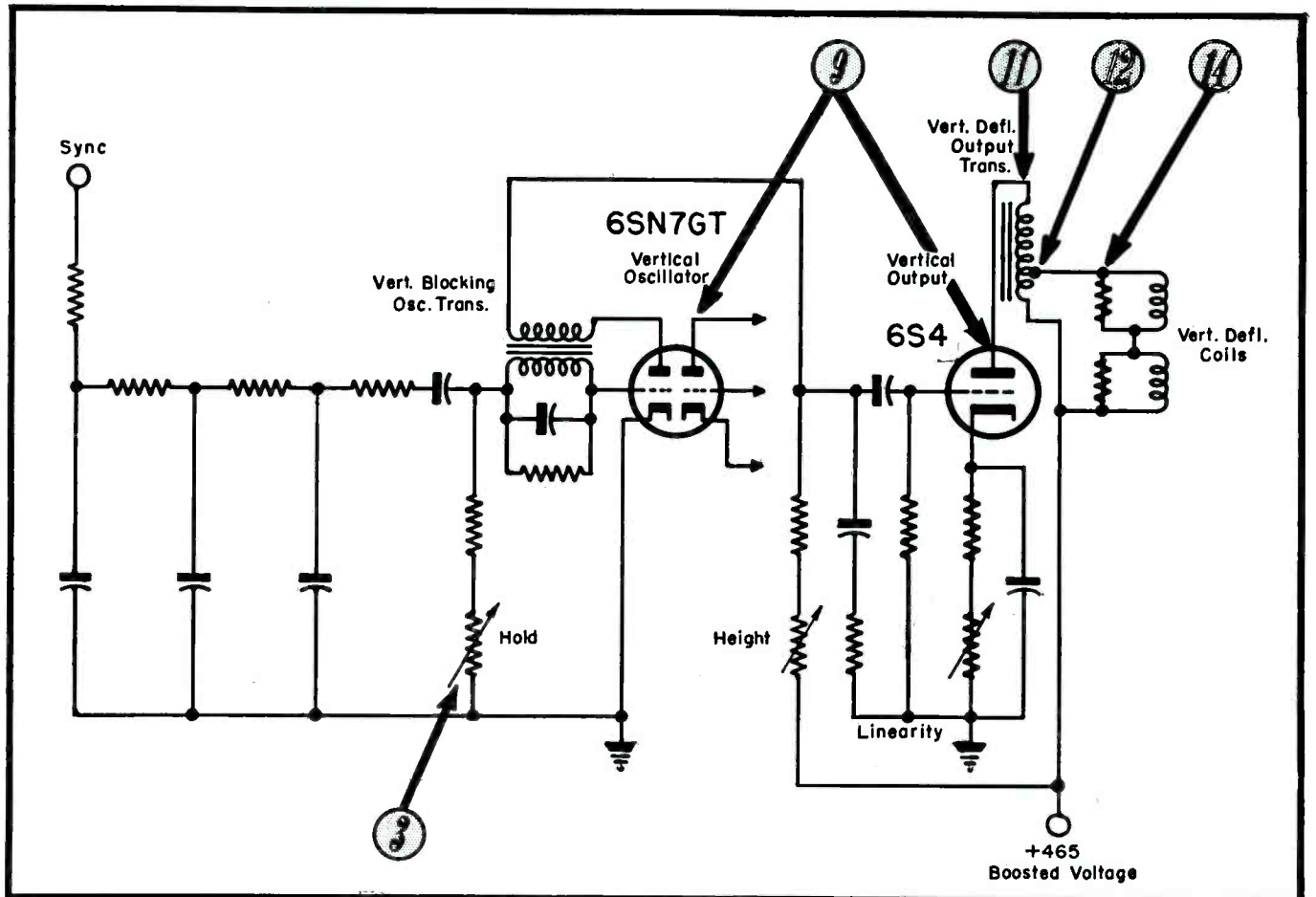
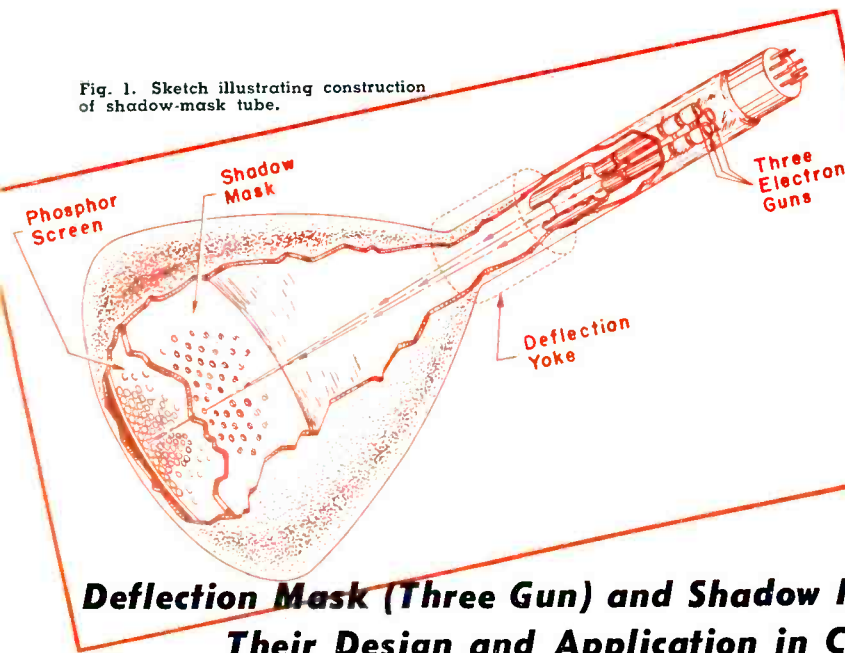

Fig. 1. Sketch illustrating construction of shadow-mask tube.



# COLOR TV Picture Tubes

by **W. L. ROBERTS**  
Westinghouse Research Laboratories

## Deflection Mask (Three Gun) and Shadow Mask (Single Gun) Picture Tubes: Their Design and Application in Compatible Color Chassis

IN ITS EFFORTS to develop the best practical tricolor picture tube, industry has undoubtedly spent far more money than upon all the other aspects of color TV. This intensive research and development program has not been without success, for several successful direct viewing tubes have been demonstrated\*. Among these are the deflection mask type where variation in color can be produced by deflecting the beam near the screen and the other is the shadow mask type utilizing three electron guns, each gun being capable of exciting phosphor dots on the screen of the color tube only.

The possible use in home receivers

of three small projection picture tubes, one with a red, one with a green and one with a blue phosphor screen should not be ruled out. Such a color receiver has already been demonstrated. In it, the images of the three screens are optically superimposed on a ground glass screen. Such sets have two inherent problems. The first lies in the fact that exact registration or superposition of the three images is somewhat difficult. Moreover, the screen usually has directional qualities and must be viewed from a direction almost normal to it to see a picture of desired brightness. Their chief advantage lies in their ability to produce

large size pictures and hence it seems probable that they will find more use in hotels, clubs and other public places rather than the home.

### The Shadow Mask Tube

The shadow mask tube is an extremely interesting type. Outwardly, it resembles a conventional black-and-white picture tube, except for its greater length from gun to screen and the larger diameter neck of the tube. Inwardly, however, it is a real triumph of engineering skill. The gun assembly consists of three accurately aligned electron guns located 120° apart around the tube axis, arranged so that at the center of the screen the convergence angle (or angle between each beam and the axis of the tube) is about 2°.

### Mask Construction

Located just behind the screen of the tube is the shadow mask, a thin perforated sheet of metal or glass with a large number (approximately 200,000) of uniformly distributed holes, with center-to-center spacings of approximately .03" and diameter of .012". On the screen in front of each hole are three dots of phosphor each emitting a primary color when excited by the electron beam. These dots are so arranged that when a particular gun produces a beam, only those phosphor dots of the color associated with that gun are excited. The other dots are screened from the beam by the shadow mask. To produce white light, all three guns are switched on to pro-

Fig. 2. Geometrical arrangement of beams, shadow mask and phosphor dots in shadow-mask tube.

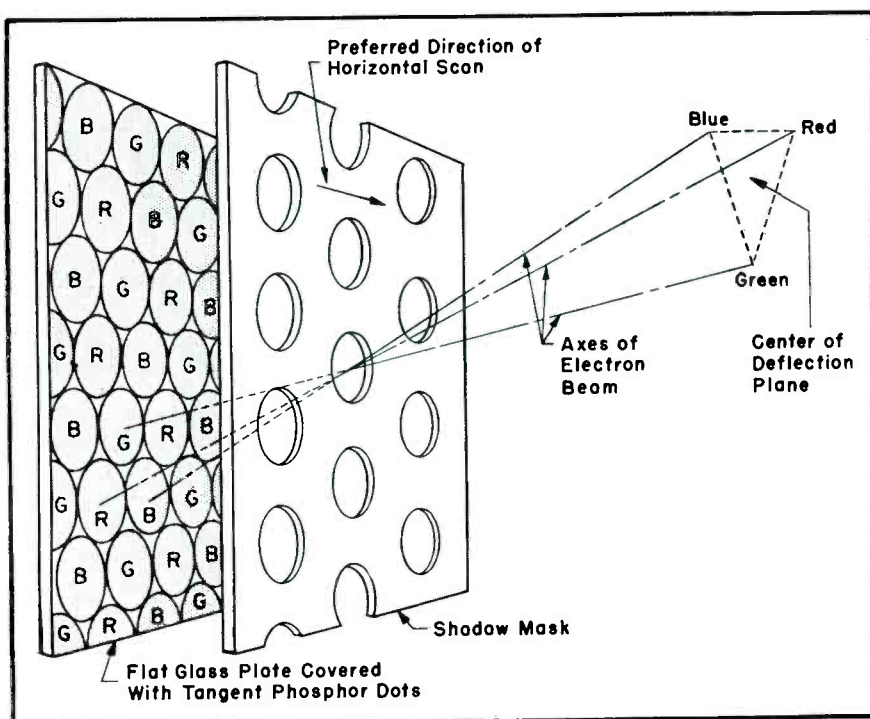

\*Tube News, SERVICE; November, 1953.

duce equal light output from all the phosphor dots.

### Dynamic Convergence

Essentially, the three-gun shadow mask color tube may be visualized as three picture tubes built into one envelope; the three pictures produced by each gun must be exactly registered or superimposed on one or the other. This is facilitated to a great extent by the proximity of the guns to each other, by the use of a common-deflecting system for the three beams and by using small deflecting angles. However, to insure convergence of the three beams at the same point irrespective of their deflection, a system of dynamic convergence is used. This system utilizes a magnetic (or an electrostatic) convergence lens on the neck of the gun, and the focal length of the lens is changed with the angle of deflection of the beams. This is accomplished by modifying the vertical and horizontal scanning waveforms and applying them to the dynamic convergence coil located on the neck of the tube to the rear of the main deflection yoke. To enable the three beams to produce well-focused spots for all deflection angles, dynamic focusing must also be used. The circuit utilized in the early experimental models of the Westinghouse color TV receivers is shown in block schematic form in Fig. 4. Parabolic waveforms are first derived from the cathode circuits of the horizontal and vertical output tubes. After shaping and phasing, these waveforms are combined in series by means of transformers to form the dynamic convergence and focus waveforms which are applied to the tube.

Because of the use of three guns and a corresponding larger neck of 2"

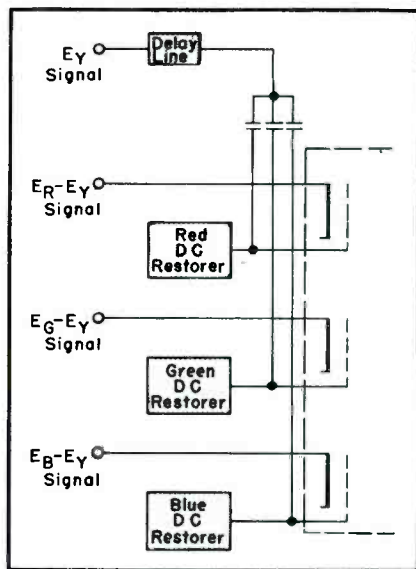

Fig. 5. Diagram illustrating application of video signals to the shadow-mask tube.

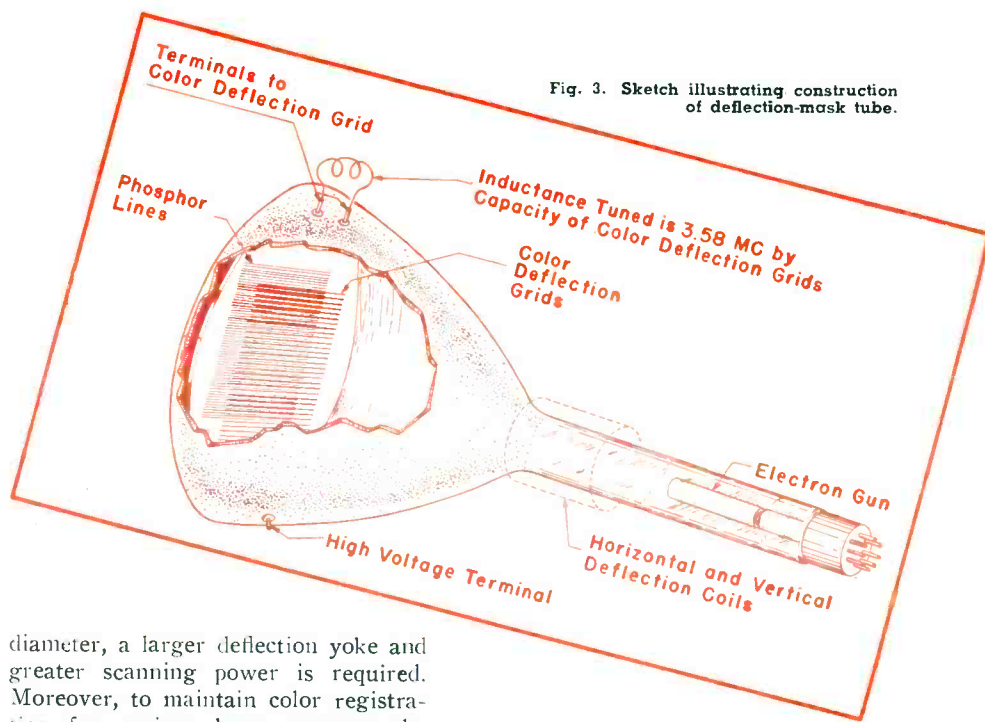

Fig. 3. Sketch illustrating construction of deflection-mask tube.

diameter, a larger deflection yoke and greater scanning power is required. Moreover, to maintain color registration for various beam currents the high-voltage supply of the picture tube must be well regulated at approximately 20 kv and has to be capable of supplying a current of about 300 microamperes.

### The Efficiency of the Tube

At first, it would appear that by using three typical electron guns with a total beam current of the order of 1 ma there would be no difficulty in obtaining bright pictures. However, only about 10% of the electrons get through the holes in the shadow mask, so that the number of electrons reaching the screen is only 30% of what would be obtained in a single gun black-and-white tube that requires no mask. By

increasing the screen voltage, pictures of adequate brightness are obtained.

### Application of Color Signals to the Shadow Mask Tube<sup>1</sup>

In using this tube, it is customary to put the wideband,  $E_v$ , or luminance signal on all three control grids and the lower frequency ( $E_R-E_Y$ ), ( $E_G-E_Y$ ) and the ( $E_R-E_Y$ ) signals on to the appropriate cathodes. As far as the lower frequency components of the video signals are concerned, the resultant grid voltages of the guns with respect to their cathodes are  $E_R$ ,  $E_G$  and  $E_R$ , respectively. This is due to the fact that if the signals are correctly phased, they are effectively added in the cathode-grid circuits. This is il-

(Continued on page 74)

<sup>1</sup>Geist, J. C., *Compatible Color Servicing Problems*, SERVICE; August, September, 1953.

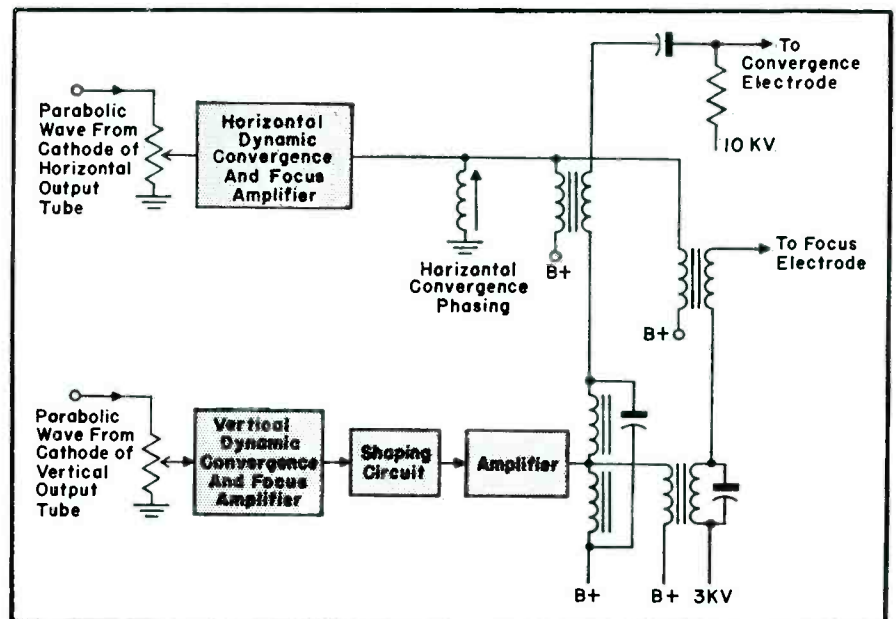

Fig. 4. Dynamic convergence and focusing circuits for use with the shadow-mask picture tube.

When *uhf* first came on the scene, most converters were basically similar in their tuning and tube layouts. With the advent of a new family of tubes that could be used in ultrahigh oscillators and *if* amplifiers, and the allied development of new techniques for tuning, many novel circuitry designs began to appear.

An illustration of this new era in design appears in the circuit shown in Fig. 1; a continuously tunable converter<sup>1</sup> which uses a quarter wavelength shorted-transmission line as the tuning element.

**Tube Complement**

The tube complement in this model consists of a 6T4 (or a 6AF4) as the local oscillator, a 6BK7A (or a 6BZ7) connected as a low-noise *if* amplifier and a special low-noise germanium diode.<sup>2</sup> Power is furnished by a selenium rectifier.

There are two sections in the unit; a pre-selector and an oscillator designed for proper tracking.

The design of the input circuit is such that the antenna is matched properly to the pre-selector. This results in a low-input standing-wave-ratio, which allows maximum power transfer from the antenna to the converter. The possibility of ghosts originating from reflections in the lines is also reduced by the match.

The impedance match is achieved by means of a network consisting of two 470,000-ohm resistors, three

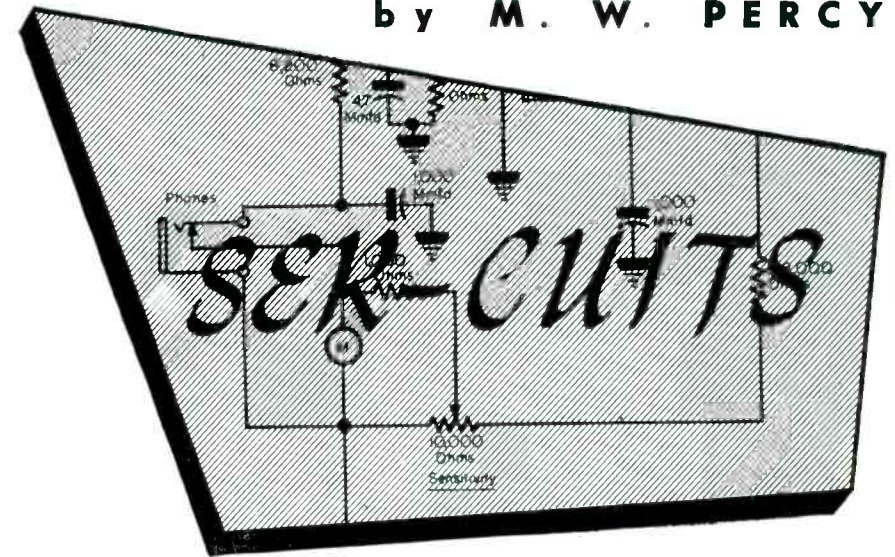

### ***Analysis of Continuously-Tunable UHF Converter Using 1/4-Wavelength Shorted Line for Tuning***

1-mmfd capacitors, *C*<sub>624</sub>, and a *formed buss*. The capacitors and the formed buss are adjustable to provide the proper input balance.

The oscillator is a modified Colpitts. The tuning unit furnishes the resonant circuit. The capacitor divider consists of the grid-to-cathode and plate-to-cathode capacities in the tube: *C*<sub>625</sub> is an adjustable oscillator control. The

10-mmfd feed-through acts as a *dc* blocking unit and also as part of the plate-to-cathode capacity. The *U*<sub>407</sub> coils serve as *rf* chokes. In the plate circuit *U*<sub>407</sub> and the 1000-mmfd capacitor represent the *rf* decoupling network. The coil in the cathode circuit provides the *dc* path for the tube's plate current. A 10,000-ohm resistor is

*(Continued on page 50)*

Fig. 1. Schematic of continuously-tunable uhf converter.

<sup>1</sup>Bogen UCT-1.

<sup>2</sup>Gahagan, Inc.

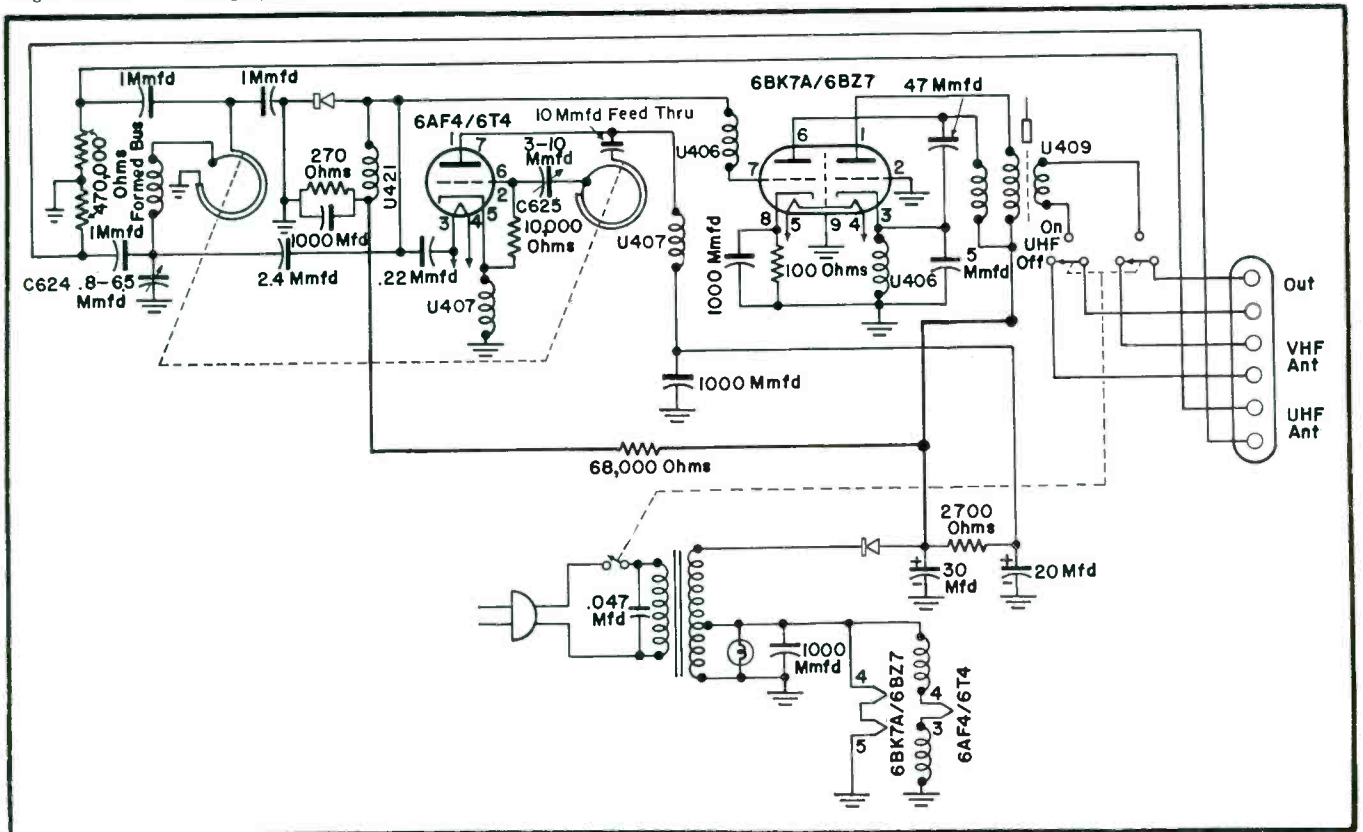

# Simplified Explanation of Electronic Computers and Their Circuitry\*

## Service Engineering field and shop notes

by THOMAS K. BEAMER

MODERN ELECTRONIC computers are gigantic multi-tube monsters using as many as 18,000 tubes and capable of adding and subtracting as many as 1900 eleven-digit numbers per second. However, when analyzed, any computer will be found to be composed of various combinations of basic circuits or, as they are sometimes called, elementary potential digital computing components (*epdcc*). (An *epdcc* represents a circuit which may assume any one of a number of predetermined stable states, and in the process of changing its state can bring about a change in the state of other components or *epdcc*'s.)

Computer circuits utilize pulse techniques and circuits which are surprisingly similar to those used in radar systems, but have the advantage of requiring few circuits that operate at high radio frequencies; this also simplifies troubleshooting. With the increasing use of electronic computers in modern commerce and industry, one should begin now to acquire at least a friendly acquaintanceship with these *super brains*.

### Basic Computer

An extremely simplified block diagram of a typical computer system is shown in Fig. 1. The computer itself is one part of a system consisting of an input, a memory, a central computer, and an output. The function of the input circuits is to receive information pertaining to a problem, and to convert that information into a predetermined series of coded pulses which are capable of energizing the *epdcc*'s. In order that a problem may be entered into the input system while the computer itself is solving an entirely different problem, it is desirable to store the input information for long periods of time. Therefore, a flexible computing system is used to record the coded pulses on some long-term storage device such as punched cards or *magnetic tape*. The memory circuits are designed to store both the coded pulses from the input system and the results of the computer calculations which must be held until a later stage in the solution of the problem. The output system converts the coded pulses into words and figures.

For the most part, computing circuits do not utilize tubes operating on the central portion of the  $E_c-I_p$

curve, but rather employ the two stable states of a vacuum tube: cutoff and saturation. Hence, no errors are introduced into the computation by changes in tube parameters with age. By far the most common type of *epdcc* in use is the Eccles-Jordan multivibrator, or, as it is more familiarly known, the *flip-flop*. The flip-flop circuit utilizes two tubes, one of which is conducting heavily (saturated), and by its action holds the second tube at cutoff. A trigger pulse of the correct amplitude and polarity will reverse the condition of the circuit, so that the first tube is held at cutoff by the second tube, which conducts heavily.

### Counting-type Computers

The basis of any type of counting device, whether it is mechanical, electrical, or electronic, is a mechanism which is capable of assuming any one of a discrete number of stable conditions. The popular, pocket-type adding machine exemplifies a mechanical counting mechanism which fulfills this condition. This mechanism consists of a series of identical number wheels each of which has 10 gear teeth on the outer periphery so that the wheel can be positioned in any one of 10 stable states. Each state, of course, represents a decimal digit. When the wheel on the extreme right has passed through all ten positions, a cam engages a gear tooth on the second

\*Based on data prepared by Warren Kitter, Philco Corp.

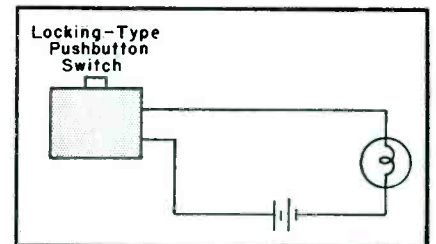

Fig. 2. Simple counting circuit which indicates whether button has been pushed an odd or even number of times.

wheel and advances that wheel one position. The adding process that takes place in this device, assuming that 8 and 6 are to be added together, is: The number 8 advances the wheel eight steps; then the number 6 advances the wheel six additional steps, carrying the first wheel four digits beyond position 10. The result of the addition of 8 and 6 is 4, with a carry-over of 1. Therefore, the first wheel indicates the additive value of 4, while the second wheel indicates the carry value, or a total of 14. This process

(Continued on page 52)

Fig. 3. Basic decision (flip-flop) oscillator circuit.

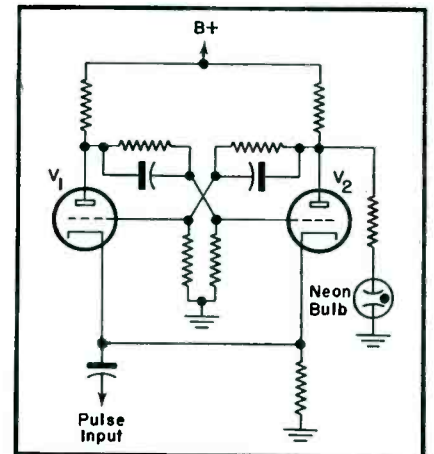
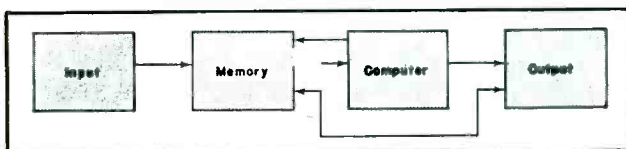

Fig. 1. Block diagram of typical basic computer.



# TELEVISION

## How NTSC Color Signals are Applied at Transmitter and Translated at Receiver

by W. KAY BROWNES

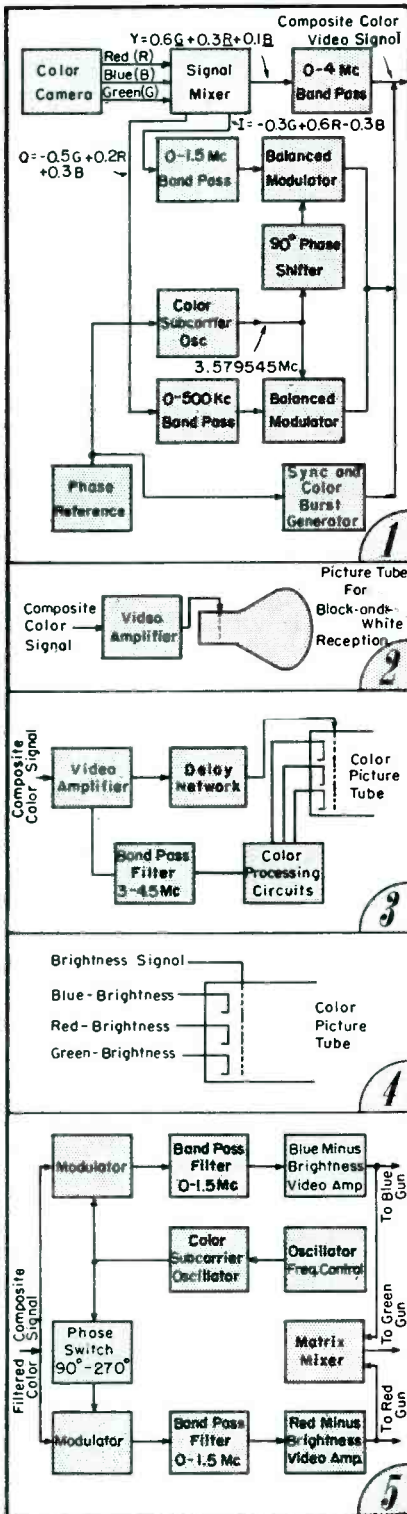

(1)

THE COLOR CAMERA at the transmitter uses color filters to obtain the red, blue and the green portions of the image separately. The *brightness* signal is obtained by mixing the red, green, and blue portions of the image in the right amounts. The signal mixer also develops the red color-difference signal, and the blue color-difference signal, as explained in the block diagrams. Of course, proper amounts of signals must be used in this subtractive process; these are indicated in the accompanying diagram. The balanced modulator is used to suppress the color subcarrier, as explained<sup>1</sup>, and to pass the color sidebands. The 90° phase shifter permits the two color subcarrier components to be modulated individually; one by the blue color signal, and the other by the red color signal. To SUMMARIZE: (1) The color subcarrier has two components, which are 90° out of phase with each others. (2) These two components are separately modulated. (3) One component is modulated by the blue color-difference signal. (4) The other component is modulated by the red color-difference signal. (5) The green portion of the image is not transmitted as such, but is developed at the receiver by a suitable combination of the transmitted information.

(2)

THE SIGNAL radiated by a color TV transmitter is termed a composite color signal. When the composite color signal is applied to the grid of the picture tube in a conventional monochrome receiver, a black and white picture is obtained.

(3)

WHEN THE COMPOSITE color signal is utilized by a color TV receiver, the output from the video amplifier is applied to the grids of the color picture tube through a delay network, to permit the color signals to arrive at the cathodes of the picture tube through color-processing circuits at the same instant of time. That is, there is a transit time of the signals through the various circuits, and it is necessary that the video signals be impressed simultaneously on cathodes and grids. A bandpass filter is utilized between the video amplifier and the color processing circuits to remove all monochrome signals except those which are necessarily interleaved with the color signal.

(4)

THE COLOR PROCESSING circuits apply a blue-minus-brightness signal to one cathode of the color picture tube, a red-minus-brightness signal to the second cathode of the picture tube, and a green-minus-brightness signal to the third cathode of the picture tube. The brightness signal is added to the color signal via the grids of the picture tube.

(5)

SYNCHRONOUS DETECTION is the process of separating out the various color signals from the composite color signal. Synchronous detection is accomplished by supplying a carrier frequency which is in phase with the component of the color subcarrier which is to be demodulated. Thus, the color subcarrier is applied directly to one modulator, but through a phase-shifting circuit to the other modulator. Thus, blue information and red information are recovered. The 90°-270° phase switch is an electronic device which is required because color phase alternation is used at the transmitter. Color phase alternation reduces distortion, and will be reviewed in a subsequent color-reception analysis.

<sup>1</sup>Color TV, SERVICE; October, November, December, 1953.

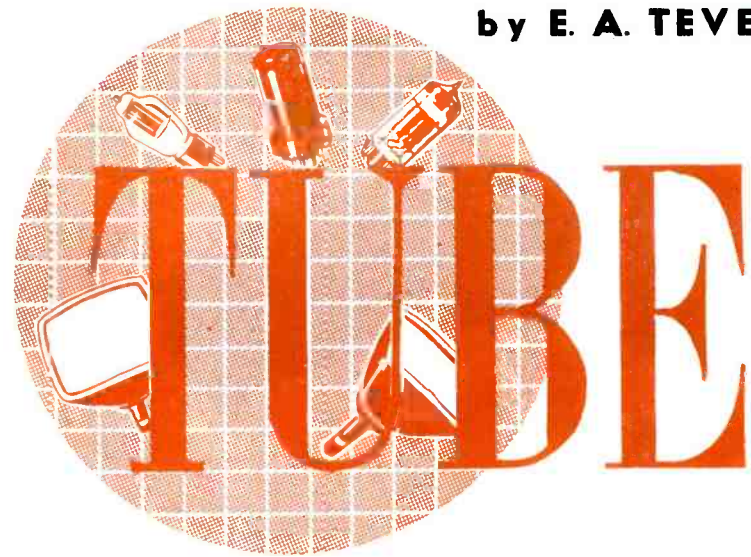

# Tube

## News

### Surface-Barrier Transistor Construction and Circuit Applications

TRANSISTORS, because of their low-power consumption characteristics, have made it possible to extend the uses of many circuits and allied systems, heretofore restricted by the higher power requirements of vacuum tubes.

To illustrate, the point-contact transistors, which normally require a collector-supply power of 25 mw or more from a power source of 10 volts, when operating at *hf*, have been employed as *hf* oscillators and amplifiers at frequencies running up to over 100 mc. The junction tetrode types have been successfully used as amplifiers above 50 mc and as oscillators at frequencies above 100 mc. These transistors require but a 15 volt+ source; here the total power-supply requirement is about 50 mw.

Now there has been developed another type of transistor which for some applications requires a total power-supply drain of slightly over 2 mw, with a maximum collector-supply voltage of 3 volts. This new item, known as a surface-barrier transistor,<sup>1</sup> is capable of operating above 50 mc and with a gain bandwidth product approaching the 60 mc of the 6AK5. The production of this transistor is based on the discovery that broad-area, metal-to-semiconductor contacts, when properly prepared using a metal such as indium or zinc, can produce excellent rectification characteristics and have good hole injection on *n-type* germanium.

These units are fabricated by a novel electrochemical jet process. Two axially aligned glass nozzles squirt jets of a metal salt solution at opposite sides of a germanium wafer .003" thick. During the first part of the

cycle the germanium operates as the anode for electrolytic etching; the solution is maintained at a negative potential by an electrode sealed into the jets.

The electrolytic etching process machines a pair of opposing pits in the germanium wafer. When the thickness of the semiconductor between the pits has been reduced to .0002", one-tenth the diameter of a human

hair, the polarities of the solution and the germanium are reversed, causing the metal ions to plate out of the solution onto the germanium. The electroplated metal contacts are the emitter and the collector of the final transistor. The entire process is carried out at room temperature; no heating or forming is required. The completed transistor is mounted on a glass stem (Continued on page 49)

(Below)

Geometry of the recently-developed surface-barrier transistor.

[All surface-barrier transistor illustrations, courtesy Philco.]

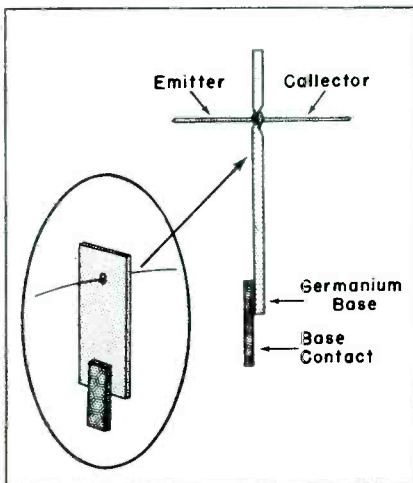

Philco.

(Right)

Surface-barrier transistor cutaway view showing detail of the active elements including the emitter, collector and germanium base. Transistor is shown mounted on the glass stem and hermetically sealed in a metal container. Finished transistor is approximately 2/10" in diameter and 4/10" long.

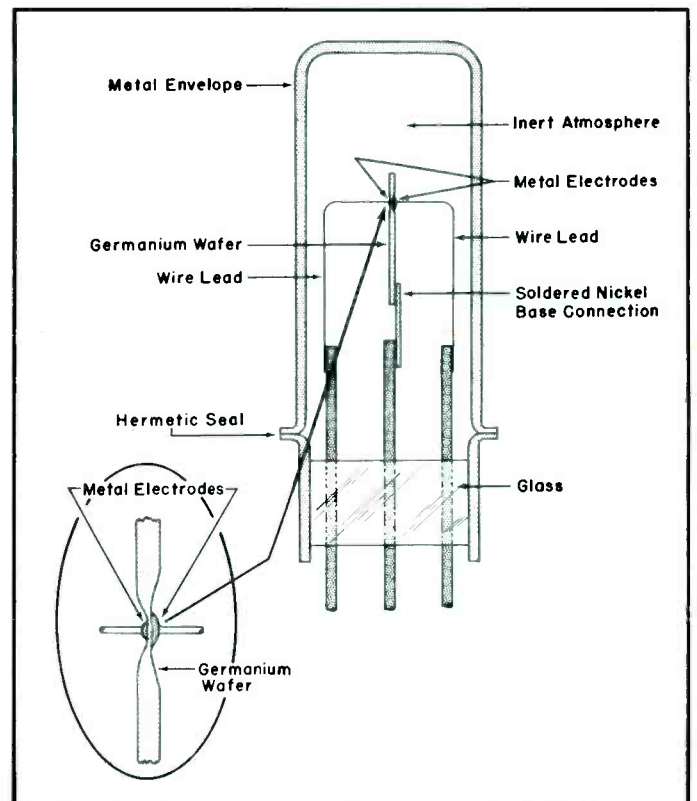

# NEW

BARRIER DISC INSULATOR

BARRIER DISC INSULATOR

BARRIER DISC INSULATOR

## WALSCO

### *Imperial*

INTRODUCING the greatest advance in Conical antennas ... it's the *all-new* WALSCO *Imperial*. Featuring a new "barrier disc" insulator with 2 inches of air space between the terminals to prevent shorts. Soot deposits, dirt, moisture, salt, etc., cannot affect this insulator. The WALSCO *Imperial* will therefore maintain *lasting* high gain performance *anywhere*, regardless of weather conditions. Contact surfaces and terminals will never rust or oxidize. Front end hardware is *stainless steel* to prevent corrosion losses *permanently*.

Front end elements are pre-assembled to holding plates which are fastened to the insulator with one wing nut. Less than 2 minutes to assemble.

## MOST REVOLUTIONARY CONICAL ANTENNA

## IN 4 YEARS

*Guaranteed lasting high gain on all VHF channels*

*3 year unconditional guarantee!*

WALSCO

ELECTRONICS CORPORATION

3602 Crenshaw Blvd., Los Angeles 16, Calif.



# Servicing HI-FI AUDIO

by MARK VINO

## Minimizing Tunable and Mixer Hum . . . Checking Speaker Defects . . . Artificial Aging of Speaker Suspensions . . . Remedies for Fixed Equalizer and Preamp-Equalizer Circuit Difficulties

THE INSTALLATION of additional signal input jacks and selector switches can involve the danger of hum pickup from chassis currents. The physical point for ground returns on the chassis or bus bar should be determined experimentally, from the point of view of minimum hum, rather than chosen at random. It may be necessary to insulate the signal jack from the chassis and to run a ground wire to some other chassis location for a low hum level. It may also help to ground the metal frame of a record changer, or to reverse the power plug for the changer motor.

Modulation or tunable hum results from the mixing of hum voltages with the *rf* signal carrier, either AM or FM, and is recognizable by the fact that it appears only when stations are tuned in. This effect may take place due to an interaction between the line and the antenna circuit, or to coupling in the mixer stage of a superhet receiver. The former is corrected by line bypass capacitors, usually of .05-mfd capacitance, and by earthing of the chassis. Mixer hum is treated by taking all of the hum precautions in the mixer stage that one would take in a low-level audio stage, especially with regard to heater-induced hum.

### Speaker Trouble

The best method of checking for defects in a speaker is temporary substitution of a test speaker, and comparison of the performance of the two by ear. However, there are certain precautions which must be observed with this procedure. If the test speaker has a more limited frequency range than the original, defects in the original system associated with frequency extremes may not show up in the test. Thus high-frequency amplifier distortion or oscillation, which the original speaker reproduces perfectly, may be attenuated or absent in the output of the test unit.

A speaker can be checked manually for rubbing of the voice coil in the gap, a fault that causes rattling and

Fig. 1. Bass boost equalizer employed in G.E. preamp.

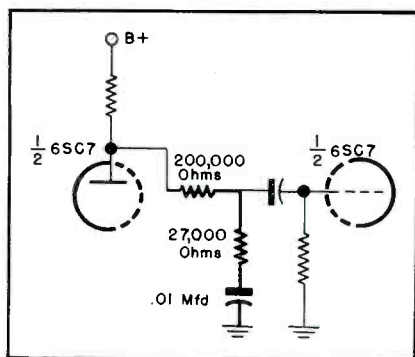

high distortion levels. The cone should be moved gently with the fingers, applying the force near the apex and taking care to press evenly around the entire surface. Rubbing will be heard as a scratching noise, or felt by the fingers as a rough, intermittent vibration. With a perfect speaker the motion will be entirely smooth.

A variable-frequency audio-signal generator, or a glide-tone test record, is very valuable in checking for a defective speaker. (It is assumed that the amplifier feeding the speaker has already been eliminated as a possible source of trouble.) Tone signals varying from about 50 to 10,000 cycles or higher should be fed to the speaker. This test is almost valueless as a frequency response check, because of room resonances and non-uniform hearing sensitivity, but it will reveal speaker defects that only appear at certain frequencies.

An elusive, intermittent rattle or buzz in a sound system, for example, can be pinned down to definite, continuous speaker distortion at one particular frequency or set of frequen-

Fig. 2. In a appears an FM treble deemphasis network. A frequency response curve of deemphasis network, and final receiver output, is shown in b.

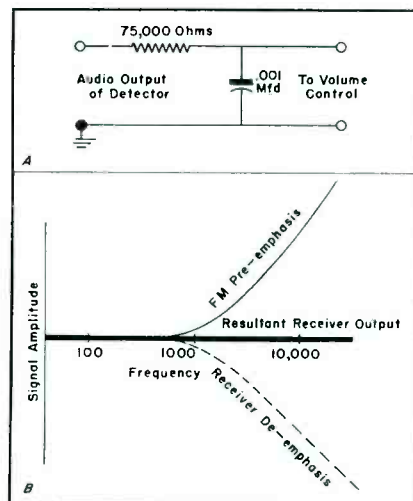

cies, at which the pure test tone becomes rough or broken up. It must be remembered that rattling or boominess in the bass may be caused by mechanical or acoustical resonances of the speaker enclosure, rather than by defects in the speaker itself.

Occasionally it may be necessary to have a cone and voice coil replaced due to mechanical damage. Whenever possible it is advisable to secure exact replacements for high-quality speakers. High-fidelity speakers often use cones of special construction, edge-wound aluminum voice coils, etc., for which the standard speaker replacement parts cannot be properly substituted. The latter are fine for ordinary commercial speakers, but were not meant for high-fidelity applications.

### Artificial Aging of Speaker Suspensions

When a cone has just been replaced its suspensions will probably be stiffer than the old suspensions. This raises the resonant frequency of the speaker and causes low frequency response to suffer. Some speaker manufacturers artificially age their new speakers prior to shipping them out to avoid this effect.

The suspensions of a newly repaired speaker can be loosened up quite a bit by a simple method which may, how-

(Continued on page 55)

Fig. 3. Modification of equalizer of Fig. 1 to provide three bass-turnover points. The approximate turnover frequencies are: position 1, 600 cycles; position 2, 400 cycles; and position 3, 300 cycles.

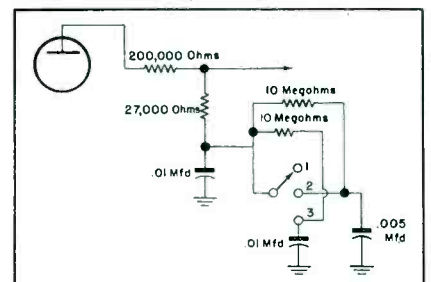

by T. L. GILFORD

# Servicing Helps

## TV Tuner Repairs...Adapting Cascode or Pentode Tuners to Split-Sound Systems...

BASICALLY THERE are three types of tuners used in TV chassis. All have *rf*, mixer and oscillator sections.

The drum tuner or the turret type is probably the most popular of the tuners. On the drum are channel-selector coils. Contacts on the drum and the stationary contacts are silver plated to assure the least resistance. And often this silver plating will tarnish just as household silver will; thus a resistance between contacts occurs. Also dust and dirt usually work their way into the tuner; the results are weak and showy pictures or flashes in the picture which can be aggravated by a slight movement of the selector knob. A soft lintless cloth can be used to clean this tarnish from the contacts. As an aid, a contact cleaner can be absorbed in the cloth to speed up the cleaning process. A very light film of tuner lubricant will insure smoother movement or slide of the contacts. The contacts should not be touched after cleaning and lubricating since the acid oils from the skin will return the tarnish effects.

The stationary contacts provide spring tension and these may be a little weak. They should all be repositioned so that they all engage at the same time.

A slight application of dustless grease to the end bearings and detent

is desirable for friction-free rotation.

The next type of tuner employed in TV front ends is the wafer type which utilizes flat rotating silver contacts sandwiched between two sections for each rotating contact.

These tuners also require tarnish and dirt cleaning. A pipe cleaner saturated with a combination cleaner and lubricant can do a good job of cleaning. Particular attention should be paid to the oscillator section. If the individual wafers are separated by spacers with long screws holding them in position, they must be tightened for a snug fit. In general, on all types of tuners, all mounting screws and nuts must be tightened. In some cases the screws and nuts provide grounds for circuits, and loose contact with the tuner chassis can give trouble.

The detent should be lubricated with dustless lubricant.

### Continuous Tuner

The third basic type is the continuous tuner. These may use either rotating coils or air capacitors for selecting tuned circuits. Both depend upon good contact either to the coils or proper grounding of the rotator with the air capacitor. Again a combination lubricant and cleaner is recommended. It should be used spar-

ingly so that the dirt and dust will not be washed into hard-to-get-at places.

The end bearings should be lubricated with a *tuner* lubricant. The dustless grease may not provide positive grounding.

Some set manufacturers use a gear train from the channel selector knob to the tuner proper. Slight oiling of the bearings and a little dustless grease will insure easier rotation.

After the tuner is cleaned and lubricated, and defective tubes and parts have been replaced, a final check should be made by a voltage reading at the mixer grid. Better tuners provide such a test point and it is frequently called the *looker point*.

With or without a signal being received and the channel selector turned to a low frequency channel, a negative voltage will be recorded. By tuning to the higher channels a similar negative reading will appear. This check should be made because some local oscillator tubes will not eject enough voltage to the grid of the mixer to provide proper bias of this stage. This is especially true at *uhf*. With low bias the conversion efficiency falls off and a weak picture will obtain. A new tube that has been carefully checked should be substituted.

### Alignment

The last step in *rf* mixer and oscillator repair and adjustment involves alignment.

In tuner alignment, the circuits involved are the input to the *rf* amplifier, possibly the output and the mixer grid. The mixer output can be accounted for in the video *if* alignment at 25 to 45 mc.

The output impedance of the sweep generator required for alignment must match that of the antenna terminals of the receiver. Since most generators use a low impedance output of 75 ohms unbalanced and the majority of receivers use a 300-ohm balanced input, a matching unit is required. Three carbon 1/2-watt resistors can be used here (Figs. 2 and 3). Lead lengths should not exceed 1" for maximum stability.

Incidentally, the vertical input to the 'scope is connected to the *looker point*. A high-frequency probe is not necessary for detection here, since the mixer

(Continued on page 63)

Fig. 1. Looker-point location in mixer-grid circuit.

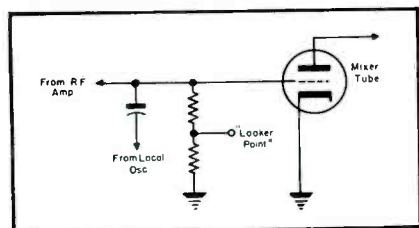

Fig. 2. Layout of alignment matching unit, shown in the Fig. 3 schematic.

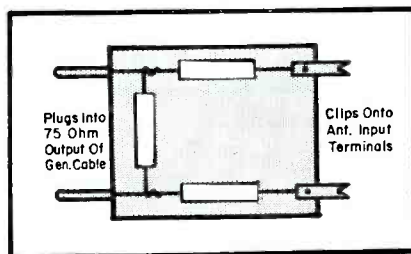
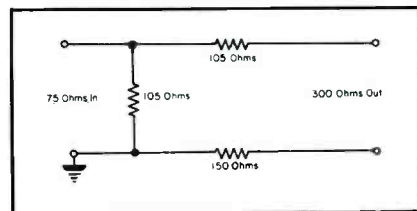
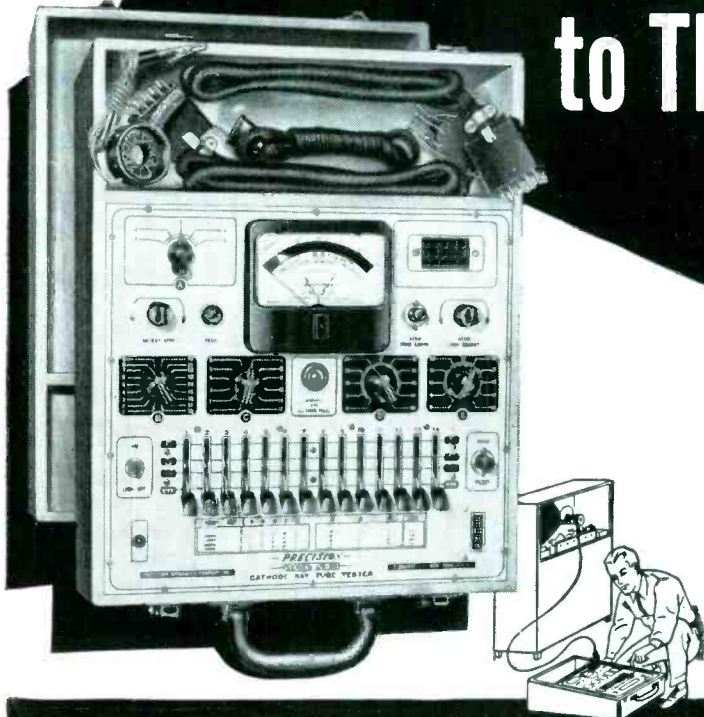

Fig. 3. Circuitry of matching unit connected to sweep generator in tuner alignment.



# It takes a CR TUBE TESTER to TEST a CR TUBE...



...because CR tubes are electrically and physically different from all other types of electron tubes! Some of the more obvious differences include:

- PICTURE PRODUCING BEAM CURRENT
- EXTREMELY LOW ANODE CURRENTS
- DIFFERENT, MULTIPLE OPERATING VOLTAGES
- HIGH LEAKAGE and SHORT CHECK LIMITS
- MORE and DIFFERENT TUBE ELEMENTS
- ELECTROSTATIC FOCUS ELEMENT
- ELECTROSTATIC DEFLECTION PLATES
- ELECTROMAGNETICALLY FOCUSED GUN
- ELECTROMAGNETICALLY DEFLECTED BEAM
- ETC., ETC., ETC.

YES, IT TAKES A CR TUBE TESTER TO TEST A CR TUBE...  
AND THE **PRECISION CR-30**  
WAS SPECIALLY DEVELOPED FOR THIS VERY IMPORTANT PURPOSE!

**TESTS ALL TV PICTURE TUBES**      Magnetic & Electrostatic  
**...FOR BEAM CURRENT INTENSITY (Proportionate Picture Brightness)**      Oscilloscope & Industrial Types

## Stop Guess-Checking with CABLE ADAPTERS!

- Receiving tube checkers were made for testing receiving tubes and NO CABLE ADAPTER can adapt them to do the job of the CR-30.
- CABLE ADAPTERS only check for filament continuity, a degree of inter-element short and a so-called emission test.
- CABLE ADAPTERS do not test for the all-important, picture producing beam current.

You can't afford to guess when you test the most expensive component of a TV set.  
Be sure with PRECISION Model CR-30!

IT IS THE ELECTRON BEAM (and NOT total cathode emission) which traces the pictures on the face of the CR tube.

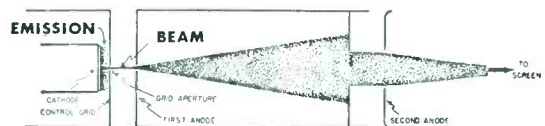

Cathode emission can be high, and yet Beam Current (and picture brightness) unacceptably low. The CR-30 will reject such tubes because it is a Beam Current tester. Conversely, cathode emission can be low and yet Beam Current (and picture brightness) perfectly acceptable. The CR-30 will pass such tubes because it is a Beam Current Tester.

The CR-30 incorporates additional special test facilities necessary for overall performance evaluation of the CR tube as will permit positive answer to the question "Is it the Picture Tube or the TV Set?" And the CR-30 gives the answer in but a fraction of the time required to test the other 2 dozen or so tubes in the set.

**SERIES CR-30:** In hardwood, tapered, portable case, with hinged, removable cover. 17¼" x 13¾" x 6¾". Complete with standard picture tube cable, universal CR tube test cable and detailed instruction manual. Shipping weight: 22 lbs.  
**NET PRICE \$104.75**



**PRECISION APPARATUS COMPANY, INC.**

92-27 HORACE HARDING BLVD., ELMHURST 13, N. Y.

Export Division: 458 Broadway, New York 13, U.S.A. • Cables—Morhanex  
In Canada: Atlas Radio Corp., Ltd., 560 King Street, W., Toronto 2B

# Broad-Band VHF Compound Yagis: Design Features and Applications †

by RALPH G. PETERS

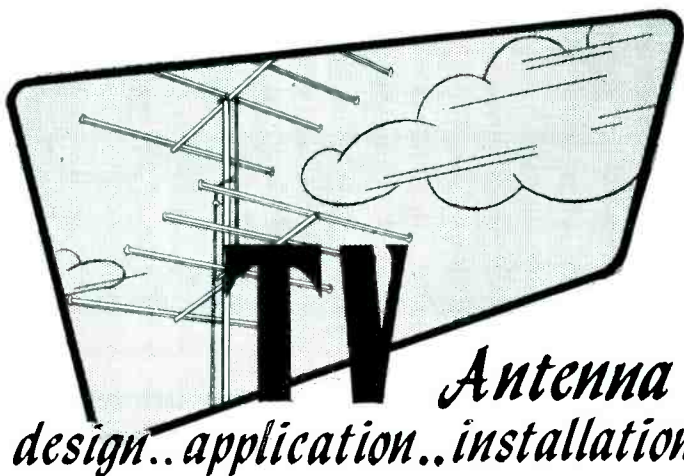

## Antenna Digest design.. application.. installation.. service

Yagis, originally developed for single-channel operation, have now undergone several interesting phases of design permitting them to be used for broad-band applications.

In one such re-design, a compound type<sup>1</sup> was evolved, with electrical inter-coupling and an improved low-loss frequency segregation network.

In Fig. 1, the general configuration of a nine-element mono-planer yagi is shown. The five elements of the forward section have been cut to cover channels 7-13. At the rear are four wider elements responsive to the channels 2-6. Analyzing the basic element layout, we find that the reflector (1) at the rear has been cut for channel 2, so that it contributes a high front-to-back ratio for the low channel section. In front are two *T* matched main radiators (2 and 3) cut for the audio-carrier of channels 2 and 5, respectively. This double-driven radiator section has been phase-linked by a transposed 300 ohm coupling line, which in turn is connected to the network. A director (element 4) cut for the audio-

carrier of channel 6 also serves as the low channel director. In addition, this element has a dual function of serving as a reflector for the low end of the high channel spectrum. In the high channel section, a reflector (element 5) is resonant to channel 7 and was introduced as the control element for establishing correct impedance matching. A pair of double-driven main radiator elements (6 and 7) were introduced to drive the high or forward section to provide broad-band coverage. Both of these elements are *delta*-matched; 6 being cut for the video-carrier of channel 7, and 7 resonant to the audio-carrier of channel 12. In addition, the former radiator (6) also acts as a reflector for the high end of the spectrum, or channels 10-13. Coverage for the lower end of the high channel band (i.e. channels 7-9) has

been gained through dual use of 7 as a director. Elements 8 and 9 were cut for emphasis as directors for channel 13; however, they also serve as directors for the channels 7 through 13.

As noted, both pairs of driven elements were coupled together with a short length of 300-ohm line transposed for proper phasing and impedance match. The forward driven element of the low and high channel section was then connected to respective inputs of a frequency-segregation network featuring a printed circuit type of high-low net. It is enclosed in a weatherproof plastic case homogeneously bonded and neoprene rubber sealed at the terminals. Standoff type of terminal posts were also included to prevent signal attenuation due to leakage during operation in rainy weather.

For outlying fringe areas, two of these yagis may be stacked, over and under, as shown in Fig. 2 (p. 70). It will be noted that tubular stacking bars are employed to shunt both antennas in parallel. When antennas are superposed upon a common mast, a spacing of 84" results from the use of the 3/8" bars to assure reinforcement, fore and

(Continued on page 70)

†From notes prepared by L. F. B. Carini, Assistant Chief Engineer, La-Pointe Electronics, Inc.

Fig. 1. Nine-element mono-planer yagi.  
(Courtesy Vee-D-X)

<sup>1</sup>Vee-D-Xtra Special.

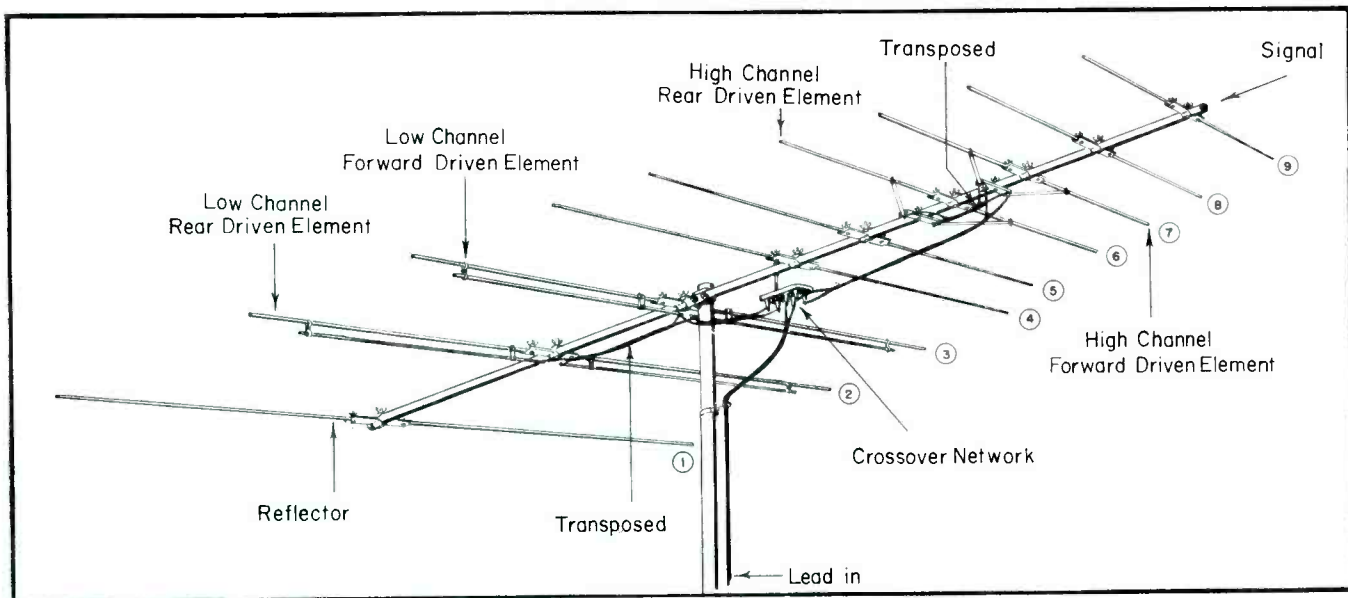

Dealers Sell

# BAKER TOWERS

*because they're...*

- SOLD QUICKER
- INSTALLED FASTER
- BUILT BETTER

## OUTSTANDING ADVANTAGES

Specially engineered telescoping mast designed for economical, quick, simple, installation of tower 40 feet over roof. Exclusive telescoping mast joint is simple and strong. Safety catch holds 10 foot mast sections extended and firmly in place during erection—installer has hands free. Eliminates cumbersome tip-ups—and high climbing. Electricweld for strength and rigidity.

Tower fits any pitch roof. All steel parts heavily galvanized for long life. Designed to withstand 80 mile wind. Major assembly done at factory. Folded compact flat for easy shipment and storage.

## EASY TO INSTALL

*As easy as one, two, three*

- 1) Simply bolt the base level on roof and clamp readied mast in tower.
- 2) Extend top 10' mast section until it stops automatically and is held temporarily by safety catch. Then lock in position. Extend middle section in the same manner.
- 3) This done, just raise the complete mast, clamp in position, and the tower is up!

No tip up, no trip up. No other tower is so easy to install.

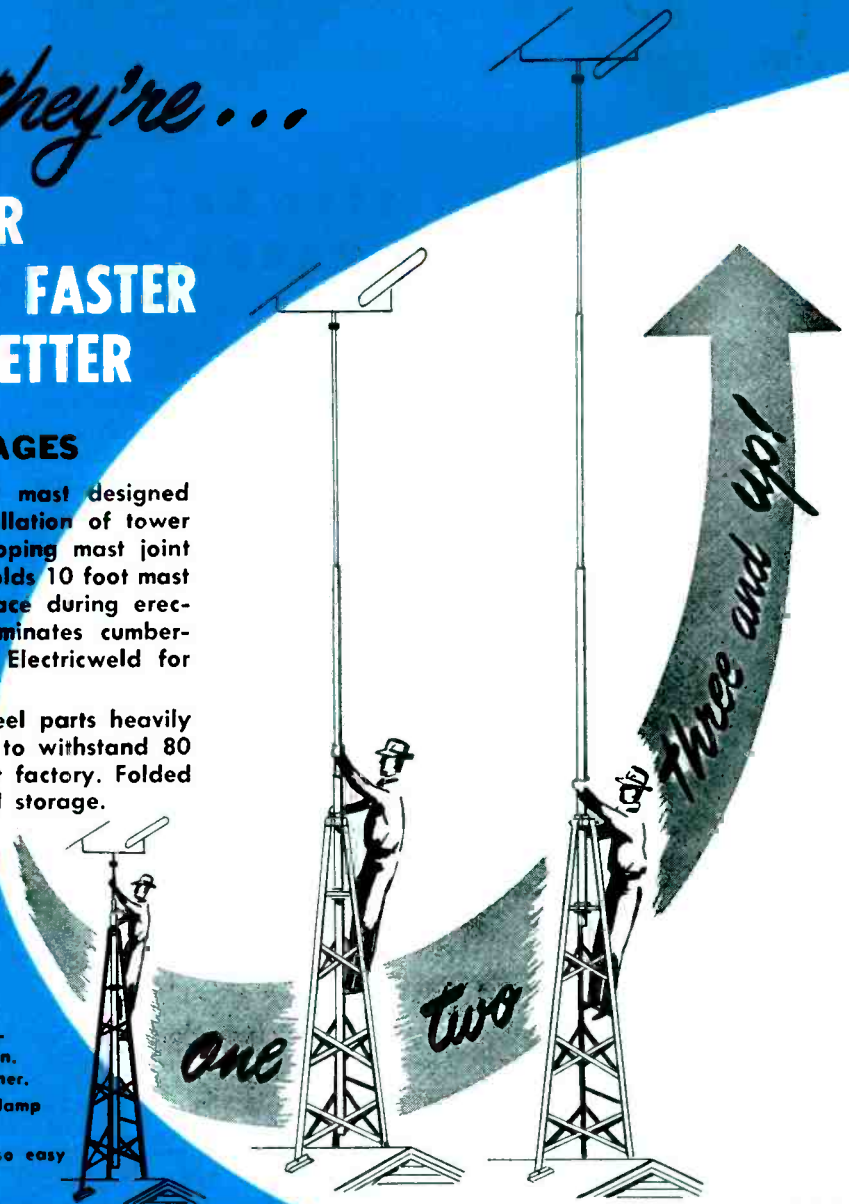

- |                          |  |
|--------------------------|--|
| <b>RETAIL LIST PRICE</b> | • BAKER OFFERS THE DEALER              |
| Model 40 TK              | • • 10' fitted end masts.              |
| Complete 40 ft.          | • • 20' telescoping masts.             |
| Installation \$54.60     | • • 30' telescoping masts.             |
| Shipping weight 80 lbs.  | • • Roof mounts to fit any pitch roof. |

**BAKER MFG. COMPANY**  
DEPT. D  
EVANSVILLE, WISCONSIN

Please send me information on the Baker 40 TK Tower and other Baker tower products . . . . .

Please have a Baker Tower representative call on me as soon as possible . . . . .

Name \_\_\_\_\_ Company \_\_\_\_\_  
Address \_\_\_\_\_  
City \_\_\_\_\_ Zone \_\_\_\_\_ State \_\_\_\_\_

**BAKER MFG. COMPANY**  
EVANSVILLE, WISCONSIN

# Miniature 2-Input Audio Mixers † ...Capacitive Hi-Fi System...Intermodulation\*



by **KENNETH STEWART**  
and **PAUL EDWARDS**



Miniature 2-input audio mixer which accommodates two high-impedance inputs. Model at left has phone jack inputs with a phone plug output fitting standard jacks. At right is another type with microphone connector inputs and output mating with standard microphone connectors. (Mini-Mix; Switchcraft)

EARLY DESIGNS of wire, tape or disc recorders and audio amplifiers provided for a multiplicity of *inputs*.

For example, some of the early equipment featured jack inputs for microphones and separate jack inputs for radio attachment devices or phono pickups. In these instances, either a mixer circuit inside the recorder or a switching circuit was necessary. Usually a switch to pick the proper input was provided, but if an inexperienced operator failed to set the switch for the input in use, the program material wanted in a recording might be lost.

A more recent trend in the design of recorders, whether tape, wire or disc, has been to provide only one audio *input*. This step was taken to overcome the *fear complex* that it was felt would obtain in using such equipment with a multiplicity of *inputs*. In general, the new design provides a single receptable *input* that serves as a *microphone input* or *radio attachment* or *phono input*. The change has simplified operation and reduced the

period required to train or learn one how to operate a recorder to a minimum.

Often, many desire to record more than one signal simultaneously. For example, one might want to record an orator with background music, thus requiring two independently controlled inputs. Several sound sources could be fed into a single input by using commercially available *Y* connectors, etc. However, this has not been found to be too practical, because one normally wants to vary the relative loudness of the two signals.

This requirement led to the development of a miniature, 2-input audio mixer.<sup>1</sup>

Basically the unit, included in a metal housing about  $2\frac{1}{16}$ " x  $1\frac{1}{8}$ " x  $1\frac{1}{16}$ ", has 2 *inputs* at one end and a single *output* at the other end. This housing encloses the necessary con-

nectors and resistance network. The design utilizes a miniature chassis to which are mounted two *mixing controls* (volume controls), assembled into the housing, so that only a portion of the control knob extends through rectangular slots, in direct line with their respective inputs.<sup>2</sup>

Isolating resistors have been included to reduce to a minimum the signal loss of one input, while varying the intensity of the other signal. The volume controls used are the *hearing aid* type with a 1-megohm resistance; therefore quiet control of the low-level (high-impedance) circuits is afforded. The metal enclosure provides an effective shield for the jacks (or connectors), resistors, and volume controls; the very design necessarily reduces lead lengths and their enclosure in the shield eliminates any stray signal

(Continued on page 46)

<sup>1</sup>Mini-Mix (Pat. Pending); Switchcraft, Inc.

<sup>2</sup>Currently models are available with jack inputs and plug output, or regular connector inputs and output.

†From notes prepared by Wilfred L. Larson, president and general manager, Switchcraft, Inc.

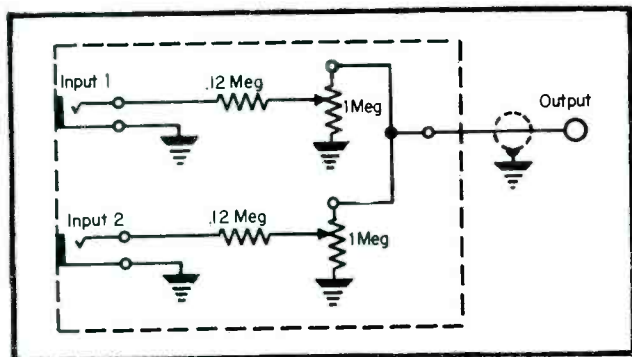

(Above)

Circuitry of miniature 2-input audio mixer.

Record-changer connections and switching in Motorola chassis 53F2, using capacitive af system; see p. 46.

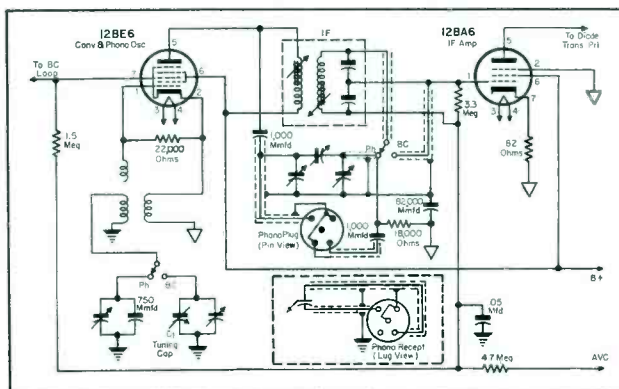



YAGI



DELTA MATCH

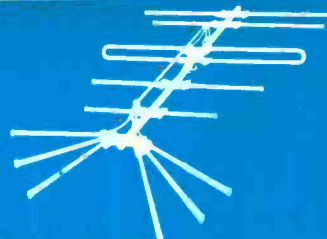

CON-YAGI COMBINATION

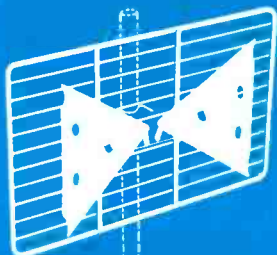

UHF

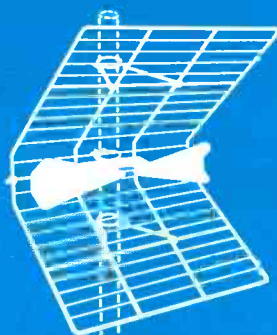

UHF

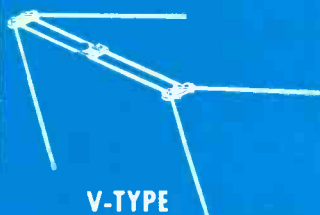

V-TYPE



\*BELLEVUE TV MASTS



INDOORS

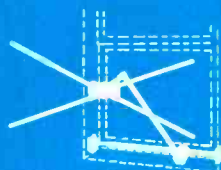

WINDOW

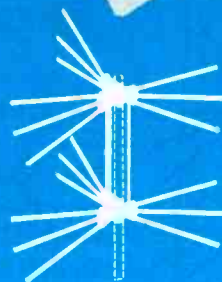

Directronic



LINE-UP



SNAP-UP

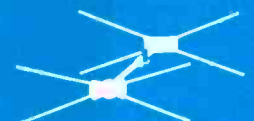

CONICAL

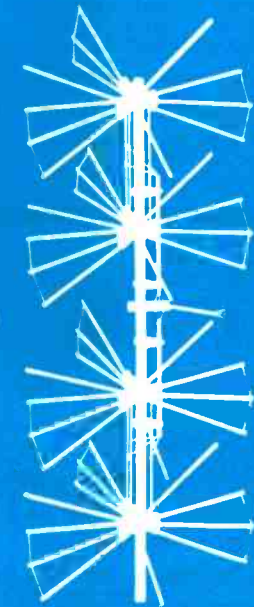

Directronic

**Snyder**  
PHILADELPHIA

**The Only**

**Complete**

**TV ANTENNA**

**LINE**

**SNYDER MFG. CO.**

**ANTENN-GINEERS<sup>®</sup>**  
**PHILADELPHIA, U.S.A.**

\*BELLEVUE TUBE MILL, INC., PHILADELPHIA, A *Snyder* AFFILIATE  
 SNYDER ANTENN-GINEERS LTD., TORONTO, CANADA, A *Snyder* AFFILIATE  
 WORLD EXPORT: ROBURN AGENCIES, INC., NEW YORK 7, N.Y.

**MANUFACTURERS ..... START TO FINISH**

*“ . . . helping to keep  
the business cycle  
on an even keel . . . ”*



**HARRY B. HIGGINS**  
President, Pittsburgh Plate Glass Company

*“The employees of Pittsburgh Plate Glass Company since 1946, have purchased \$9,488,510 in United States Savings Bonds through the Payroll Savings Plan. This accumulation of assets will be of inestimable value in helping to keep the business cycle on an even keel by maintaining purchasing power for the future.”*

Payroll Savings—the plan that protects—pays the employer triple benefits:

- it makes a good employee a better one—a serious saver with a definite plan for personal security.
- as enrollment on the plan goes to 60%, 70% employee participation, productivity increases, absenteeism decreases and accident records go down.
- and as Mr. Higgins points out, the systematic purchase of Defense Bonds through the Payroll Savings Plan is building a tremendous reserve of purchasing power.

Let's point up the third employer benefit with a few figures:

- On September 30, 1951, individuals held Series E Bonds totaling \$34.6 Billion—more than \$4.6 greater than on V-J Day.
- ✓ During the five calendar years (1946-1950) Defense Bonds sales provided:

—Cash to retire \$3 Billion A-D Savings Bonds (maturing Series).

—Cash to meet \$24 Billion redemptions of E, F and G Bonds.

—\$6 Billion (after providing cash for the payments enumerated above) that the U.S. Treasury could use to pay off bank-held debt.

And the figures are getting better every day—between January 1, 1951 and November 1, 1951, 1,200,000 employed men and women joined the Payroll Savings Plan.

If the employee participation on your Payroll Savings Plan is less than 60%, phone, wire or write to Savings Bond Division, U.S. Treasury Department, Suite 700, Washington Building, Washington, D.C. Your State Director will be glad to show you how you can participate in the triple benefits of the Payroll Savings Plan.

*The U.S. Government does not pay for this advertising. The Treasury Department thanks, for their patriotic donation, the Advertising Council and*

**SERVICE**





# Rep Talk

G. S. MARSHALL Co., 40 S. Los Robles Ave., Pasadena, Calif., recently held its second annual technical show at the Los Angeles Statler Hotel; more than a score of factories were represented. Among those present at the manufacturers' booths were: *Frank Braugh*, chief engineer of Helipot Corp., South Pasadena, Calif.; *C. B. Dewey*, vice president of Reeves Instrument Corp., New York; *Ed Sawyer*, general manager of Crescent Engineering and Research, South Pasadena, and *Andrew Kay*, president of Non-Linear Systems, Inc., Del Mar, Calif. . . . *Roy J. Magnuson*, head of the by-laws committee of The Reps, reported that the annual election of officers of the Chicagoland chapter will take place at the May meeting instead of the December meeting. . . . *Becht Associates* have moved from 5707 W. Lake St. to 1155 Waukegan Rd., Glenview, Ill. . . . *Ken Bluzat* is now located at 2842 N. Cicero Ave., Chicago, Ill. . . . *Ray C. Hitchcock* has moved to 160 E. Grand Ave., Chicago, Ill. . . . *Al J. Rissi*, newly elected vice president of the Los Angeles chapter, has moved to new quarters at 2724 S. Peck Rd., Monrovia, Calif. . . . *F. X. Brennan Co.*, is now located at larger quarters at 180 Glenridge Ave., Montclair, N. J. . . . *Ben Joseph* has moved to 521 Fifth Ave., New York, N. Y. . . . *George Davis* has been elected president of the Los Angeles chapter of The Reps. *Frank A. Emmett* was elected secretary-treasurer. . . . *George G. Scarborough* is now president of the Mid-Lantic chapter. Others elected were: *John J. Mahoney*, vice president; *David G. Quinlan*, secretary; and *Ken Randall*, treasurer. . . . The Missouri Valley Chapter has changed its name to the *Heart of America Chapter*. *Clyde H. Schryver* was elected president of the group. *Fred Somers, Jr.* was named vice president. . . . *I. N. Drucker* has joined the Wilson Sales Agency, 2750 W. North Ave., Chicago 47, Ill., and will call on the distributor and jobber accounts. . . . *John B. Tubergen Co.*, Los Angeles, Calif., will handle replacement sales for tubes and tube parts to jobbers for Allen B. DuMont Labs., Inc., in southern California and Arizona. *Jack Carter* and *Robert L. Bray* have become associates in the firm. . . . *George Davis Sales Co.*, Los Angeles, Calif., has been named rep for Vaco Products Co. in southern California, Arizona, and Las Vegas, Nev. . . . *R. Gordon Dougherty*, formerly a field rep for the Regency division of I.D.F.A., has become a principal in the firm of Hagerty-Scott Co., 10116 Puritan Ave., Detroit 38, Mich. He will headquarter at 2339½ S. Cedar St., Lansing, Mich. . . . *Martin Vogt*, Royal Oak, Mich., has been appointed rep for the Mark Simpson Manufacturing Co., in Michigan.

F. G. Dougherty

Martin Vogt



you're always sure with

**BLUE-POINT\***

**MOLDED PLASTIC CAPACITORS because . . .**

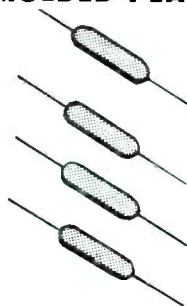

**Bonded Blue Point Seal—  
locks out humidity**

**85° C Operation**

**No Soldering Damage**

**Highest Insulation Resistance**

Patent Pending

Trade Mark

**AND FOR THE DRY ELECTROLYTICS YOU NEED . . .**



Superior Astron SM† will do the job better, meeting the most exacting demands for heat and moisture resistance and low leakage.

Ask your jobber for Astron — the best capacitor made. For the name of your nearest Astron jobber, write today to Dept. S.

**ASTRON CORPORATION**

255 Grant Avenue, East Newark, New Jersey  
Manufacturers of a complete line of capacitors and filters  
for every television, radio, and electronic application.  
In Canada: Charles W. Pointon, 6 Alcona Avenue, Toronto 10, Ont.

† Safety Margin

## EVERY SERVICEMAN NEEDS THIS VOLTAGE ADJUSTOR

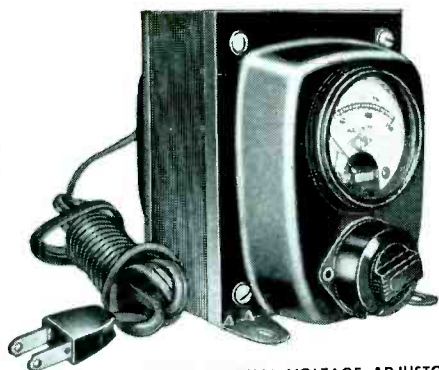

T-8394M MANUAL VOLTAGE ADJUSTOR

Where low voltage is affecting TV reception, the service man can detect the condition at once with a T-8394M Acme Electric Voltage Adjustor. And by a simple demonstration he can sell a Voltage Adjustor to the TV set owner. Sales are easy to make because demonstration while servicing a set quickly convinces its owner that the voltage regulation is essential to good TV reception.

### How To Use The T-8394M VOLTAGE ADJUSTOR on Service Calls

With the tap switch set at 115 volts, the meter reading will show incoming line voltage. Thus it can be instantly determined if line voltage is lower than normal required for good TV set performance.

The T-8394M Voltage Adjustor can also be used to reproduce the operating condition about which the customer complains by turning tap switch to the voltage which simulates such condition. For example, customer complains that evening program pictures flicker and shrink. When service man calls next day all operation appears normal — voltage tests out properly. But, by adjusting voltage to 97 volts the condition about which the complaint was made is reproduced. This indicates low voltage condition during evening that can be corrected with a T-8394M Voltage Adjustor.

### Not A Gadget — A High Quality Unit You'll Be Proud To Use

The T-8394M Voltage Adjustor can be installed instantly, no tools needed. Just plug into most convenient outlet. Then plug television cord into secondary receptacle on Voltage Adjustor.

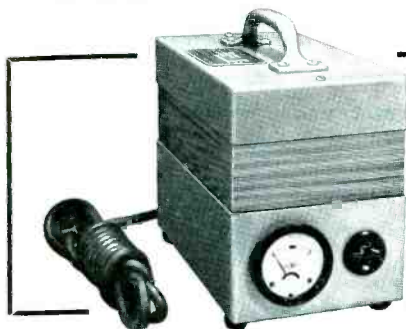

### FOR COMPLETELY AUTOMATIC VOLTAGE CONTROL

Regardless of line voltage supply, the Automatic Voltrol corrects voltage fluctuation over a range from 95 to 130 volts. The voltmeter supplied indicates secondary voltage while unit is in operation. A built-in relay automatically disconnects circuit when set is turned off.

**Acme Electric**  
TRANSFORMERS

### ACME ELECTRIC CORPORATION

MAIN PLANT: 471 WATER STREET • CUBA, N. Y.  
West Coast Engineering Laboratories:  
1375 West Jefferson Boulevard • Los Angeles, California  
In Canada: Acme Electric Corp. Ltd.  
50 North Line Road • Toronto, Ontario

## Audio

(Continued from page 38)

pickup. The direct connection of the entire shielded mixer to a recorder is, of course, especially important in high-impedance input circuits.

This device has no external cables and can be placed in the accessory compartment of a recorder, when the instrument is not in use.

### Capacitive Hi-Fi System

IN CONVENTIONAL *af* systems only the audio stages of the receiver are used

for amplification. This approach makes it necessary to use a cartridge with a high signal output.

### New Approach

Recently, there has been developed a method<sup>3</sup> which makes it possible to use the entire receiver for *af*. In this system, the local oscillator of the receiver is switched to a fixed frequency of 455 kc, which is fed through the entire *if* system, demodulated at the second detector, and amplified through the audio amplifier. A cart-

<sup>3</sup>Motorola; Patented.

ridge with a small mass acts as a variable capacitor, which varies the amplitude of the carrier as it passes through the first *if* transformer.

To amplitude modulate the 455 kc carrier, the first *if* transformer, designed with a low mutual inductance, is operated at a point somewhat below critical coupling. With this low value of mutual inductance, capacitance between the primary and secondary windings has an appreciable effect upon the overall coupling. Actually, a small value of fixed capacitance is switched across the high end of the primary winding and the high end of the secondary winding. The value of this capacitance has been adjusted just above the point where the component of current transferred by the fixed capacitance cancels out the component of current transferred by the mutual inductance between the two windings. This has been done to take advantage of the linear portion of the response curve of the *if* transformer. The cartridge, connected in parallel with this value of fixed capacitance, provides a small amount of variable capacitance. Near the null point of operation, a small change in capacitance will produce a relatively large change in carrier. The spacing of the fixed plate and a movable plate in the cartridge can be adjusted. It has been found, so as to realize nearly 90% modulation; however, in actual practice, modulation percentages in the order of 5% or 10% are all that is necessary because of the strong carrier available.

The cartridge is connected directly across the *if* transformer. The needle or movable plate is connected to the grid of the first *if* amplifier tube and the fixed plate is connected through a large value isolating capacitor to the plate of the mixer tube. The action of the cartridge is such that it varies the coupling between the primary and the secondary of the first *if* transformer. This results in amplitude modulation of the carrier. This carrier is then amplified through the *if* amplifier, demodulated at the second detector and amplified through the audio amplifier as in a conventional radio circuit.

### Intermodulation Effects and Reproduction\*

THERE IS A special variety of intermodulation effect that occurs in amplifiers which employ power drive for the output tubes. The trouble is not intermodulation, in the accepted

(Continued on page 62)

\*From an exclusive report prepared for SERVICE by Norman Crowhurst, audio consultant.



# THE *American* IDEA

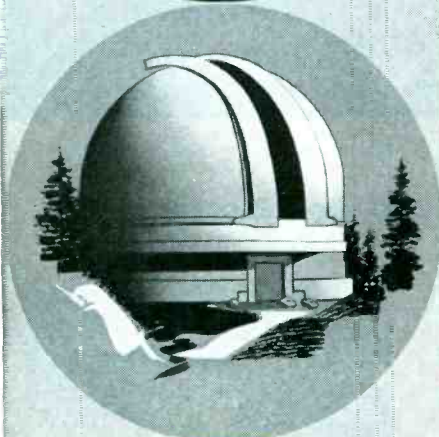

"To find great things  
the better way" . . . Out of the  
vision of Dr. George Ellery Hale came  
the great "American Idea" that resulted  
in the creation of the "Glass Giant of  
Palomar"—world's largest telescope—to  
gather new light from the farthest  
stars for the searching eye of science.

With us, the "American Idea" is, by  
directed effort and applied know-how,  
to continue to lead in bringing  
you electronic products  
of the highest quality.

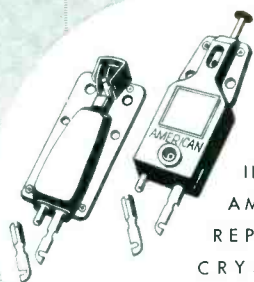

INSIST ON  
AMERICAN  
REPLACEMENT  
CRYSTAL  
CARTRIDGES

Look for 1948 marking on



*American* microphone co.

370 South Fair Oaks Ave. • Pasadena, 1, Calif.

## 60-Cycle Buzz in TV

(Continued from page 24)

17: If a hum-bucking metal band is used around transformer core, one should check for a broken solder joint in band.

18: Power transformer should be checked for overheating; this can be caused by excessive power-supply drain, or by shorted turns in the power transformer. Overloading of transformer increases the intensity of the stray field, which is occasionally a source of trouble not only in the sound, but also in the picture.

19: To run down overload trouble, a wattmeter check should be made of the power-line load, and the behavior of the meter watched as the receiver is switched on from a cold start. An immediate overload indicates shorted turns in the transformer; a delayed overload indicates that the trouble is beyond the rectifier tube.

20: One must make sure that the ratio-detector shield is well grounded. If required, one should spot solder.

21: Channel-selector should again be switched to an inactive channel; if receiver stops buzzing, the interference is of the *tunable* variety; the channel-selector should be turned back to the active channel.

22: To determine the location of the trouble, one should listen to the buzz level while turning the receiver controls, as follows:

23: The brightness control should be turned throughout its range; if the buzz stops at the dark-screen position, the high-voltage circuit is the source of the buzz.

24: One should check for a defective volume control; this can be the point of entry of the high-voltage field.

25: Dress of the second-anode lead of the picture tube should be checked, keeping it away from the ratio-detector and audio tube.

26: Now the hair-pin grounding springs to the outer coating of the picture tube should be checked.

27: If the receiver is of the type which utilizes a limiter, electrode voltages on limiter tube should be checked.

28: One should also check for a leaky coupling capacitor in the grid circuit of 4.5-mc driver circuit.

29: It is also important to check for an open high-voltage filter capacitor. A substitution test is usually quickest and easiest.

30: An imperfectly grounded high-voltage cage might be the trouble and thus should be checked.

SERVICE MEN  
KNOW THERE IS  
JUST ONE

# EVER-QUIET



Since 1949

the Original Volume Control  
& Contact Restorer

EVER-QUIET is a free-flowing liquid  
that leaves no powder residue.

- Does Not Arc or Affect Inductance, Capacitance or Resistance.
- Harmless to Metals, Insulation and other Fine Finishes.
- Contains No Carbon "Tet," Gums or other Adhesive Chemicals.

2-Ounce Bottle with Handy Dispenser—Only 59¢ Reg. U.S. Pat. Off.

EVER-QUIET is made by the  
manufacturers of  
HUSH—The TV-Tuner Cleaner that  
Sprays On.

EVER-KLEER—The TV Tube Cleaner  
in the Plastic Spray Bottle.

All products liability protected by one of  
America's largest underwriters.

Ask your local distributor for EVER-QUIET  
or write:

**CHEMICAL ELECTRONIC  
ENGINEERING, INC.**

283 Main St. Matawan, N. J.

Preferred for  
Original Equipment  
Proven for  
Replacement

O  
X  
F  
O  
R  
D



**Speakers**

Available from leading jobbers!

**OXFORD ELECTRIC CORP.**

3911 S. Michigan Ave., Chicago 15, Ill.

EXPORT: ROBURN AGENCIES, N.Y.C., N.Y.

In Canada: Atlas Radio Corp., Ltd., Toronto

## Tube News

(Continued from page 31)

and hermetically sealed into a metal can.

The steps of establishing the base region geometry and of positioning the emitter and collector barriers are completely independent in the *sbt* fabrication process. This is contrasted with the alloy process by which the majority of commercially available *pnp* junction transistors are made. In this process, the forming of the *pn* junctions within the crystal and the establishment of the final transistor junction-to-junction spacing takes place simultaneously.

The mechanical precision of the *sbt* process is claimed to be about 50 times better than that of the alloying process. This makes possible the 50-mc operation of the *sbt* compared with 1 mc for the *pnp* junction transistor.

### Applications

Typical *sbt*'s operate at 1.5 to 3 volts with .5 to 1 ma of collector current. The ability to perform at 50 mc on 1 to 2 mw per stage will make it possible to design *vhf* communications receivers with a total power drain on the order of 10 mw, capable of operating for several months on 2 flashlight cells.

The junction transistor performs well in audio circuits such as hearing aids. But the *sbt* extends the useful operating range of low-power-drain transistor circuits to *vlf* and wideband video applications.

well in audio circuits such as hearing video amplifiers with 5-mc bandwidths and tuned amplifiers at 30 mc. In such applications, it has been found possible to achieve gains of 15 db or more. It has also been found possible to use the *sbt*'s in oscillators at 70 mc. A 9-mc bandwidth 28-db gain video amplifier has also been constructed with the surface-barrier units. The *sbt*'s have also found use in multi-vibrator and flip-flop circuits.

### References

Angell, J. B., and Keiper, F. P., Philco, *Circuit Applications of Surface Barrier Transistors*; IRE Proceedings, December, 1953.

### CORRECTION

THE ANNUAL Electronics Parts Show, which will be held at the Conrad Hilton Hotel, May 17-20, 1954, will be co-sponsored by five associations: RETMA, SMC (Eastern Division), AEPGM, WCFMA and NEDA. Serving on the fourteen-man board of directors are seven representatives of NEDA.

# Stop scouting around for hard-to-find Can-Type Electrolytics!



## Your Sangamo Jobber can supply all your "twist-tab" needs

Whether you need a hard-to-find capacitor for an obsolete set, or the latest size for any 1953 model, you can make just *one* stop for all electrolytic replacements—your Sangamo Jobber. He carries the most complete line of twist-tabs in the industry . . . and he has them IN STOCK!

Sangamo Type PL Electrolytics are used as original equipment by all major manufacturers—they are *exact* replacements—they assure long life and dependable performance at 85° C and under conditions of high surge voltages and extreme ripple currents.

Make your Sangamo Distributor your "headquarters" for all your capacitor needs. He can help you because he stocks . . .

Sangamo . . . still the most complete line in the industry



## SANGAMO ELECTRIC COMPANY

MARION, ILLINOIS

SC54-1

SERVICE, JANUARY, 1954 • 49

You name the  
speed . . .

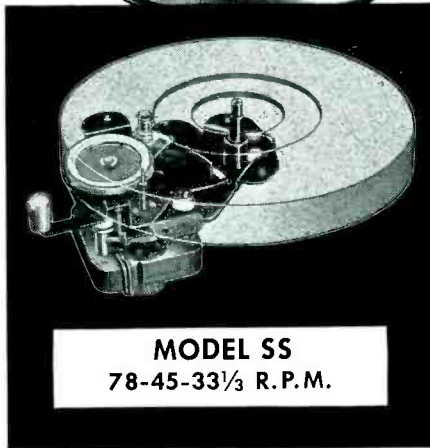
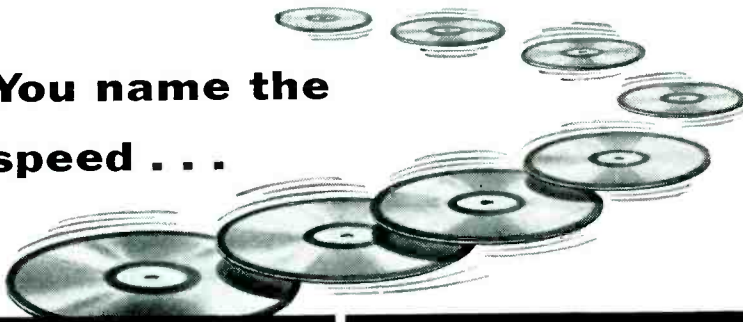

**MODEL SS**  
78-45-33 $\frac{1}{3}$  R.P.M.



**MODEL DSS**  
78-45-33 $\frac{1}{3}$  R.P.M.

## G. I. has the phonomotor

Single speed . . . two speeds . . . or three speeds . . . there's no limitation on combination or type when you choose from General Industries' broad line of phonomotors.

For example, shown above are two of General Industries' newest three-speed developments: Model SS, an extremely compact design with 2-pole motor; and Model DSS, with 4-pole motor and heavy-duty construction features for high fidelity reproduction. Both models incorporate the General Industries' unique, stepped-shaft drive principle which assures accurate reproduction and trouble-free long life. Both contain an "OFF" position in which the idler wheel is released from contact with the turntable rim. "OFF" position on Model DSS also cuts off current to motor.

For complete information, specifications, dimensions, and quantity-price quotations on these, or other phonomotors in the famous Smooth Power line, write us *today*.

**THE GENERAL INDUSTRIES CO.**  
DEPARTMENT MF • ELYRIA, OHIO



### Ser-Cuits

(Continued from page 28)

the grid leak which supplies oscillator bias.

Optimum performance can be obtained from a germanium crystal (used here as a mixer diode) when it is properly biased. The bias for this mixer is developed by a voltage divider consisting of 270-ohm and 68,000-ohm resistors from B+ to ground. This arrangement provides a .25 *v* bias on the crystal in the forward direction.

$U_{421}$  is the *if* load for the crystal. Sufficient stray capacity exists across this coil to bypass the *rf* to ground. Coupling to the mixer from the pre-

selector is accomplished by a 2.4-mmfd capacitor. And oscillator injection is achieved by means of a .22-mmfd capacitor connected to the filament of the 6T4. This method of coupling has been found to result in least loading of the oscillator and at the same time provides ample oscillator injection current. The value of the coupling capacitor was chosen to limit the crystal current to approximately .5-1.5 ma. It has been found that higher crystal currents deteriorate the crystal noise figure.

The 6BK7A *if* amplifier is connected in a shunt-cascade circuit. The cascade amplifier is inherently a high-gain, low-noise amplifier. The output of the *if* stage is centered at 82 mc

and is sufficiently broad to cover channels 5 and 6.

The input to the grounded cathode section consists of  $U_{406}$  coupled to  $U_{421}$ . This coupling was designed to match the crystal impedance to the input to the 6BK7A for best gain and noise figure. The output of the first triode is fed to the cathode of the grounded grid section by the 47-nmfd capacitor. A resonant network, consisting of  $U_{406}$ , in parallel with a 5-mmfd capacitor and the stray capacities, serves as the plate load of the first section. A 1- $\mu$ h choke supplies plate voltage to the first triode. The output of the grounded grid section is fed to  $U_{408}$ . The secondary of this transformer has been designed to operate into 300-ohm antenna terminals.

### Servicing the Converter

In all TV work and especially in the *uhf* band, the condition of the antenna and leadin wire is critical. Corrosion and dust accumulation on the antenna and leadin result in attenuation of the signal. Therefore, before attempting to service a converter, an examination of the antenna system is imperative. Faulty antenna installation or orientation can result in weak (snowy) pictures, sound distortion, poor definition or ghosts.

Actually, the major part of service work on this unit will revolve about the replacement of defective tubes and mixer diodes. Replacement tubes must be of the same type as those used originally in the unit.

Since the diode is biased, it is important to note the crystal polarity. (The negative or minus side is the one with the black band.) To test the crystal, a *vrom* should be placed between the positive end and the chassis. With the oscillator tube removed, the meter should read approximately .25 volt positive. With the oscillator tube replaced in its socket, the meter should read from .5 to 1.5 *v* over the tuning range. A reading outside these limits usually indicates a defective crystal.

Occasionally one will find a noisy or intermittent tuner, usually caused by dust inside the tuning unit. When this is the cause, the tuner dust cover should be removed; with the use of a soft brush, the tuning elements should be cleaned with carbon-tet or a good silver cleaner. After cleaning, the tuned lines and the shorting bar should be lubricated with a high grade lubricant.<sup>3</sup>

$C_{024}$  and  $C_{025}$  are factory-aligned high-end adjustments and one should not try to readjust them. The correct settings do not vary with time and so need no further touch-ups.

<sup>3</sup>Such as the sulphur-free lubricants made by Gulf Oil, Cities Service, etc.

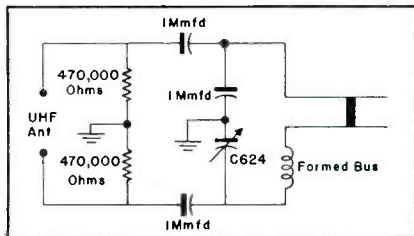

Fig. 2. Input network for the converter.

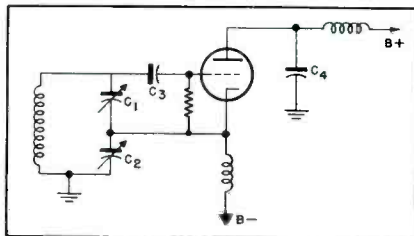
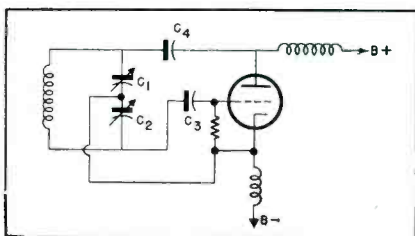

Fig. 3.

Fig. 4.



Figs. 3, 4, 5 and 6 (top and below): Successive modification stages made in Colpitts oscillator used for uhf converter. Circuit in Fig. 3 is a standard Colpitts, while the circuit shown in Fig. 4 represents a re-drawn version. A modified schematic appears in Fig. 5; in this form circuit is an ultra-audion. The final step appears in Fig. 6, with the coil replaced by a shorted line; tube capacities are not shown.

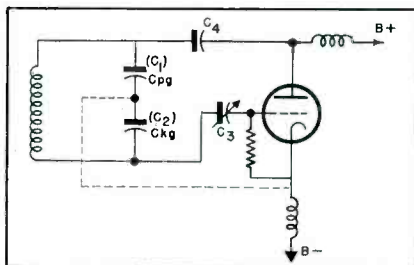
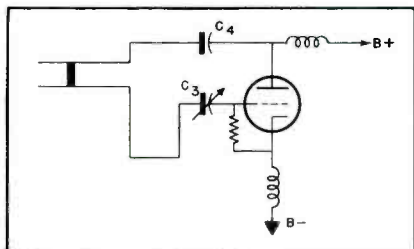

Fig. 5.

Fig. 6.



#### Credits

Data in this analysis are based on a report prepared exclusively for SERVICE by Oscar Levine and Leonard Lieberman.

WHY TIE UP TIME  
AND MONEY WITH  
DOZENS OF CARTRIDGES?

JUST TWO

# TITONE CERAMIC CARTRIDGES

will replace OVER 90% of  
present-day phono installations!

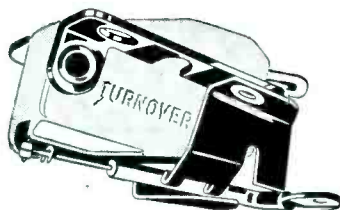

For the CUSTOMER, TITONE will

1. Not only replace his present crystal, but improve the performance of the system with thrilling new TITONE SOUND.

For the JOBBER and DEALER,  
TITONE will

1. Reduce inventory
2. Increase sales

And TITONE makes REPLACEMENT  
easy through its

1. Small Size
2. Universal Bracket
3. Accessory Hardware

TITONE Ceramic Cartridges are unaffected by temperature and humidity. They do not deteriorate on the shelf or in equipment, as crystals do.

The ceramic principle is an original discovery and development of the Sonotone laboratories. The demand for TITONE is growing daily. More and more quality-conscious manufacturers are specifying TITONE for original equipment. The same high quality is available to you in every TITONE CERAMIC PICKUP CARTRIDGE.

#### Other SONOTONE Products:

Sonotone Hearing Aids • Sub-miniature vacuum tubes • Cathode ray electron guns for television tubes • Nickel cadmium storage batteries for the armed services.

ELECTRONIC APPLICATIONS DIVISION

## SONOTONE CORPORATION

Elmsford, New York

# NO ROTORMOTOR - YET

## ALL DIRECTION UHF-VHF RECEPTION

**53** CLAIMS GRANTED IN  
**5** U. S. PATENTS

- #2,585,670
- #2,609,503
- #2,625,655
- #2,644,091
- #2,661,423

OTHERS PENDING

UP TO

**10** TIMES MORE POWERFUL  
THAN ALL OTHER ANTENNAS

*Solves Your Problem in Your Area*

Yes, we said YOUR area. With the FCC allocating over 2,000 new TV Stations covering 12 VHF and 70 UHF channels, your area is due to change and you will require an antenna able to receive both UHF and VHF channels from all directions. All Channel Antenna Corp. has just the antenna to fill your needs and money back guaranteed to positively bring you at your location, clearer, sharper, pictures than any combination of present day antennas using expensive rotor motors, boosters, etc. With a flick of the 9 position electronic beam selector switch, any station in any area is instantly brought in on any TV set clearer and sharper.

9 POSITION  
ELECTRONIC  
ORIENTATION  
SWITCH

The 9 position selector switch electronically rotates the antenna in a stationary position.

**NEW POLYMICALENE**  
4 CONDUCTOR TRANSMISSION LINE

- Low Loss External Air Dielectric
- Matched Impedance
- Eliminates End Sealing
- Eliminates Condensation
- Up to 50% Less Loss Than Tubular When Wet
- Easily Spiraled
- No Breaking or Shorting
- Patents Pending - T. M. Reg.

While antenna reception is guaranteed as specified, perfect pictures have been consistently received from 2 to 3 times these distances.

**ALL CHANNEL ANTENNA CORP.,**

70-07 Queens Blvd., Woodside 77, N. Y. Hickory 6-2304

the compilation of shell trajectories. High-speed electronic computers are ideally suited for these operations.

The simplest type of counting circuit which consists of a locking push switch, a lamp, and a battery connected in series, is shown in Fig. 2 (p. 29). This elementary circuit is an odd-even type of counter, indicating by one of the two stable conditions of the lamp whether the push switch has been pushed an odd or an even number of times. Relay circuits have been devised which can perform counting functions, and entire computers have been based upon relay operations. However, the shortest time in which an ordinary relay can operate is about 5000 microseconds. In contrast to this, electronic counting circuits composed of flip-flop, or decision, oscillators can produce the same result in less than one microsecond. This means an increase in operating speed of 5000 to 1.

The basic flip-flop circuit is shown in Fig. 3 (p. 29). In this circuit, it is assumed that component values have been selected so that  $V_2$  conducts a trifle more current than  $V_1$  at the instant plate voltage is applied to both tubes. This extra conduction causes a lowering of the plate voltage of  $V_2$ , and the voltage drop is passed on to the grid of  $V_1$  by means of the coupling capacitor and resistor network. The lowering of the grid potential of  $V_1$  causes a decrease in plate current and a resultant increase in plate voltage, which is fed back to the grid of  $V_2$ , further increasing its plate current. The condition of instability continues until  $V_2$  is conducting heavily at plate-current saturation, while  $V_1$  is held at cutoff because of the large voltage developed across the common-cathode resistor (by virtue of the heavy current flow through  $V_2$ ). This condition is reached practically instantaneously. The neon bulb connected from the plate of  $V_2$  to ground lights only when the tube is cutoff (or during the period of highest plate potential). This bulb provides a visual indication of the condition of the circuit. If the circuit components are chosen so that the positive voltage applied to both cathodes is sufficiently higher than the grid potential of the nonconducting

### Service Engineering

(Continued from page 29)

can be expanded to handle sizeable sums by incorporating additional number wheels. This is similar to the process used in the addition of numbers by electronic computers.

The type of adding machine described has limited usage in the scientific and commercial fields because of the time required to feed information into it, and also because of the relative slowness of each individual operation. These characteristics render this type of machine

practically valueless (even when electrified and developed into a calculating device) when large amounts of raw data must be handled, such as in the analysis of a census or survey or in

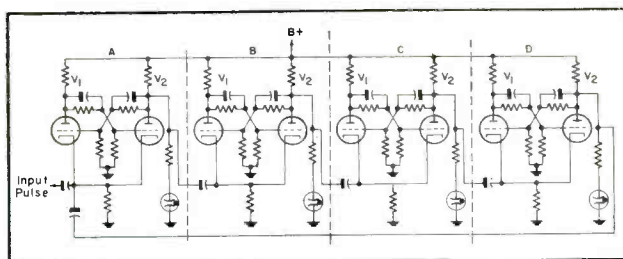

Fig. 4. Radix-2 counter, capable of counting to 15 and resetting to zero.



tube, the circuit remains fixed in a stable condition with  $V_2$  conducting heavily; the unlit neon bulb indicates the fact that  $V_2$  is operating at saturation. If a negative pulse of correct amplitude is applied to the pulse-input lead connected to the common cathodes, it can have no effect in  $V_2$ , which is already at saturation. However,  $V_1$  is driven into conduction and its plate voltage drops. This reduction in plate voltage is applied to the grid of  $V_2$ , thus tending to lower conduction in  $V_2$ , with the resultant rise of  $V_2$ 's plate voltage causing still more conduction in  $V_1$ . This action continues very rapidly until  $V_1$  is operating at saturation and  $V_2$  is operating at cut-off, by virtue of the bias conditions produced by the current flowing through  $V_1$ . At this point, the neon lamp lights because of the rise in voltage at the plate of  $V_2$ . A series of negative pulses applied to the input lead will cause the circuit to alternate between its two stable states, while the neon bulb will indicate whether the total number of applied impulses has been odd or even. This type of circuit is known as a *modulo-2* counter, since 2 is the standard of measurement in determining odd or even.

If several modulo-2 counters are connected in cascade, the system is known as a *radix-2* counter. Fig. 4 illustrates a radix-2 counter which is capable of counting up to 15 and then resetting to repeat the cycle. The four flip-flop circuits, labeled *A*, *B*, *C*, and *D*, are identical. The plate lead of tube  $V_2$  in one stage is connected to the cathode input lead of the flip-flop circuit in the next stage. In all the flip-flops, the circuit constants are such that when the circuit is first energized,  $V_2$  conducts first. Hence,  $V_2$  always goes to plate-current saturation,  $V_1$  is driven to cutoff, and none of the neon lamps is lit when the circuit is first energized.

#### Radix-2 Counter Operation

How the radix-2 circuit counts can be easily understood by following the operation when a series of negative pulses is applied to the common cathode lead of counter *A*. When the first negative pulse is applied, it causes  $V_1$ , which is at cutoff, to conduct, driving  $V_2$  to cut off. Since the plate-voltage pulse applied to counter *B* is in a positive direction, there is no change in state of counter *B* or any of the following counters. The neon bulb in counter *A* is now lit, indicating that a binary pulse has been stored in it. If the order of the lamps is transposed from left to right, the lamps now indicate binary number 0001 (or numer-

(Continued on page 54)



## R. H. SCHNEBERGER

NATIONAL  
SERVICE  
MANAGER

OF

*Crosley*

SAYS...

"... we are glad to see the wide distribution of our information in Rider's Radio-TV-PA Manuals, Tek-Files, TV MANUFACTURERS' RECEIVER TROUBLE CURES Series, UHF PRACTICES AND PRINCIPLES, etc. We keep all of this information in our technical library. When we hold our monthly service classes the distributors, dealers and independent service men who use these manuals and books comment on their accuracy and reliability.

"For the past 20 odd years we have observed that people in the Radio-TV Servicing Industry have always considered Rider servicing data, both Manuals and Tek-Files, to be an "encyclopedia" of our industry. We are glad to see such technical literature disseminated to the servicing fraternity."

available *Now* -  
TV 12 and Radio Manual 23

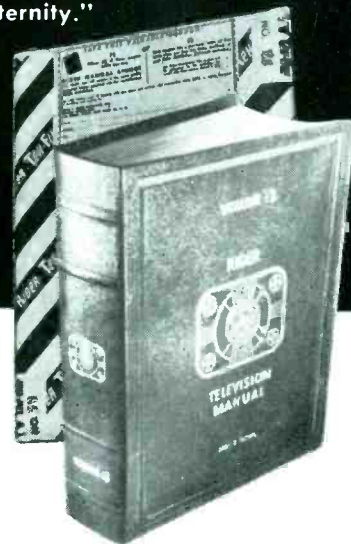

### MR. SERVICE SHOP OWNER:

Your integrity, reputation . . .  
the "good will" you establish  
. . . can only be built or  
maintained by servicing your  
customers with the best!

And now TEK-FILE... ONLY \$1.50 per pack

Dependable replacement parts listings  
beginning with TV 10 and TEK-FILE pack 57

For easier radio servicing... use Rider's 22 AM-FM Radio Manuals

**JOHN F. RIDER**

PUBLISHER, INC.  
480 Canal Street, New York 13, N. Y.

In Canada,  
Mr. Charles W. Pointon  
1920 Gerrard Street, East  
Toronto, Ontario

Export Agent:  
Roburn Agencies, Inc.  
39 Warren Street  
New York 7, New York

West Coast Office:  
4216-20 W. Jefferson Blvd.  
Los Angeles, California

Cable Address:  
Roburnage N. Y.

# Make your Math EASY!

See the  
NEW

## ELEMENTS of MATHEMATICS For RADIO & TELEVISION

by Bernhard Fischer & H. V. Jacobs

If you've ever hesitated to use a time-saving equation because you were not quite sure how to set it up; or had moments of doubt about decimals or percentages; or wanted a quick check on your figuring—THIS IS THE BOOK FOR YOU. It makes crystal clear each step in the reasoning and each procedure in the arithmetic, geometry, and algebra needed by radio and TV technicians. You'll see how the simple, basic calculations are used in the more complex problems. You'll find it EASY to work out frequency resolutions, voltage drops, inductive reactances, decibels and the many other radio and TV problems in which accurate use of math is essential. Hundreds of sample problems, with answers, give you thorough practice. Ready in February \$6.60 (probable)

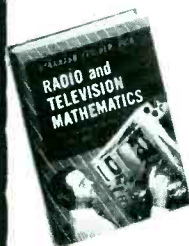
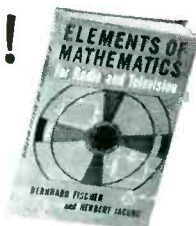

and the famous  
Handbook of Problems  
and Solutions—

## RADIO & TV MATHEMATICS

by Bernhard Fischer

"A book for the place of honor beside its natural partner the slide rule," says *Radio-Electronics*. Step-by-step solutions for 409 problems in radio, TV, and industrial electronics. Whatever YOUR problem—whether it is to correct the power factor of a motor, find the impedance and length of a matching stub between antenna and transmission line, or any of hundreds of other problems—here is the clear, exact solution. \$6.75

### Special Notice

Save time and trouble; get better results. Use Mandl's TV SERVICE COURSE MANUAL in your shop training. Here are clear what-to-do and what-to-observe instructions, with report sheets, for 46 practical problems in TV servicing. Ready in February. Write for a sample copy.

### SEE THEM ON APPROVAL

The Macmillan Co., 60 Fifth Ave., New York 11

Please send me copies of the books checked below. I will either remit the full price plus small delivery charge or return the books in 10 days. (Save: Send check or money order and we pay delivery charge)

- Elements of Mathematics for Radio & TV \$6.60 (prob.)  
 Radio & TV Mathematics \$6.75

Signed .....

Address .....

This offer good only within continental limits of U.S.A.

(Continued from page 53)  
ical value 1). When the second negative pulse is applied to the pulse input line, the state of counter *A* is again reversed, causing the lamp to go out. Inasmuch as the plate voltage of  $V_2$  in counter *A* has dropped, a negative pulse is transmitted to counter *B*, creating the condition necessary for a reversal of this flip-flop circuit, and the neon lamp lights as the circuit reverses. The conditions of the lamps in the four counters are now as follows: counter *D* out, counter *C* out, counter *B* lit, and counter *A* out. This set of lamp conditions indicates binary number 0010, or numerical value 2. The third negative pulse again lights the counter *A* lamp but has no effect on subsequent counters, indicating binary number 0011, or numerical 3. The fourth negative pulse puts out the lamps in counters *A* and *B*, but lights the lamp in counter *C*, indicating binary number 0100, or numerical 4. As other negative pulses are applied the radix-2 counter continues to count until it reaches binary number 1111, or 15. At this point all the lamps are lit; the next negative pulse causes a reversal of the states of all counters (the negative pulse being passed from one counter to the next), so that all lamps go out and the circuit is returned to its starting, or zero, condition. Counting to higher numbers is possible by adding additional modulo-2 counters. Each additional counter increases the counting range by a power of 2. In a long string of modulo-2 counters, the highest limit of counting is equal to  $2^n - 1$ , where *n* is equal to the number of counters in the radix. If it is designed to count in the decimal system, decades of four modulo-2 counters (previously connected so that the 10th pulse restores the circuit to 0000) may be employed. Each decade equals 10, and feeds the 10th, or carry, pulse into the next decade.

### CHARLES H. BUNCH

CHARLES H. BUNCH, chairman of the board and treasurer of Acme Electric Corp., Cuba, N. Y., died recently at a Los Angeles hospital. He was 61.

Bunch started his engineering career with the Electric Products Co., Cleveland, O., and in 1917 became one of the founders of Acme Electric. He was a member of the AIEE, member of the IES and other professional and engineering organizations.



Charles H. Bunch

# South River

## NEWS

**NOW! Banding Kits NEW!**  
for EXTRA LARGE CHIMNEYS

**KIT XL "ST":** (Consists of)  
2—18' x 3/4" STAINLESS STEEL STRAPS with eyebolts attached  
2—Eyebolts Unattached  
4—Nuts to Fit Eyebolts  
2—KWIK KLIP Strapping Fasteners

Also available, KIT XL "G", same as above with 18' GALVANIZED STRAPS.

Universal—may be used with any chimney antenna mount.

In Can.: A. T. R. Armstrong Co., Toronto

**SOUTH RIVER METAL PRODUCTS CO., INC.**  
SOUTH RIVER, N. J.

PIONEER AND OUTSTANDING PRODUCER OF FINEST LINE OF ANTENNA MOUNTS

## The Dollar You Make is Yours ONLY if There are NO CALL BACKS

### RMC DISCAPS

Insure Your Service Profits by Using the 1000 V.D.C.W. Ceramic Capacitors That TV Manufacturers Depend On.

NOW, RMC DISCAPS are supplied in handy, reusable molded plastic boxes. Contents and ratings can be determined at a glance. You'll find dozens of uses for the box in your tool kit.

Remember, you can install 1000 V.D.C.W. DISCAPS at no extra cost and end your call back problems.

**RADIO MATERIALS CORP.**  
Factories at Chicago, Ill., and Attica, Ind.

For the name of your nearest RMC jobber contact:

**JOBBERS SALES COMPANY**  
NATIONAL DISTRIBUTORS FOR RMC DISCAPS  
146 BROADWAY PATERSON 1, NEW JERSEY

## Servicing Hi-Fi Audio

(Continued from page 33)

ever, prove very tiring on the nerves. The speaker terminals are connected directly to a low-voltage *ac* source; a 6.3-volt filament winding is usually appropriate for the kind of speakers used for home reproduction. The speaker is then reproducing a high-power, 60-cycle signal, and since the voice coil excursion increases inversely with frequency, the suspensions are being given a hard workout. The speaker should be allowed to continue to reproduce the 60-cycle signal for about 12 hours, with possibly a few breaks to guard against overheating of the voice coil. There will be no danger of damage if the speaker has at least ten watts steady power capability.

There remains the problem of the very loud and very annoying 60-cycle hum. (The speaker can be muffled with pillows and put away in a closet or cellar for the duration of the treatment.) This procedure should *never* be applied to industrial horn-type speakers, or to tweeters or mid-range speakers of any type. It applies only to units capable of reproducing very low notes at high power.

### Repair of the Speaker Cone

Minor tears and even holes in the speaker cone can be repaired with little or no loss of quality. Such repairs *must not be made haphazardly*, though, because the physical action of the cone is an important element of audio reproduction. Above the bass region the cone does not vibrate as a unit, but *breaks up* and forms standing waves in the various modes and configurations.

One common mistake made by laymen is to repair torn cones with a type of glue or tape that becomes stiff after drying. Scotch tape and mucilage are good examples of mending material *not* to use. Special speaker cement may be purchased, and speaker patch material, sold in convenient sizes, can be used with good effect. The compliant patch does not get stiff, so that it provides minimum interference with the normal modes of cone flexure. The patch has the further advantage that it does not tend to draw or shrink the cone; a process which may create off-center warping and introduce the danger of fubbing.

In general, speakers used exclusively as woofers can better afford to have patch material than units covering both bass and treble, because cone breakup

(Continued on page 55)

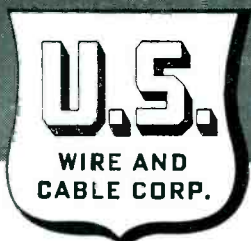

**U.S.**  
WIRE AND  
CABLE CORP.

# "Rotaxial" Cables

for

## COMMUNITY TV SYSTEMS



Several of the largest and most successful  
Community TV Antenna Systems  
in the country, specify  
**U. S. Cables.**

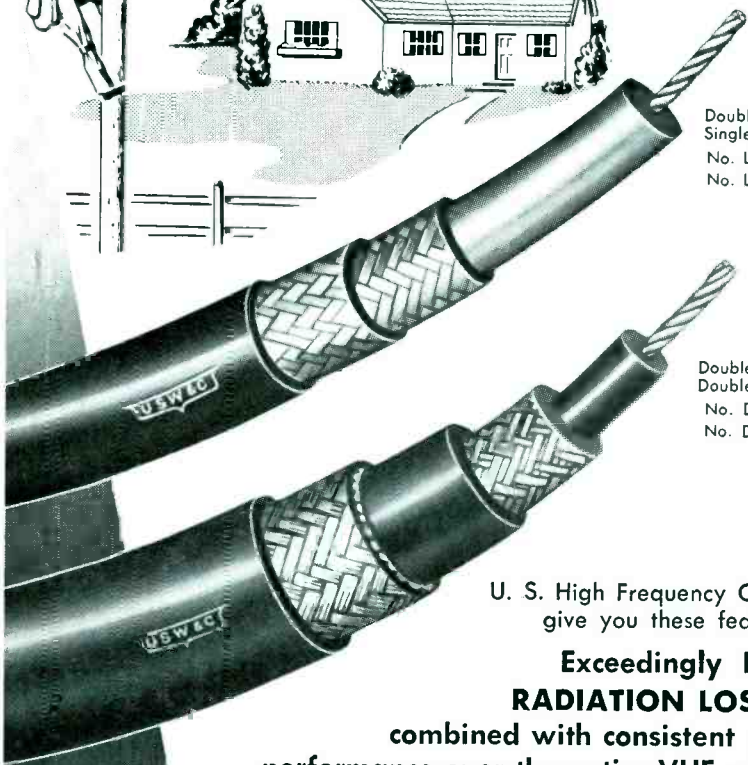

Double Braid,  
Single Jacket  
No. LR 590C  
No. LR 110C

Double Braid,  
Double Jacket  
No. DSDJ-59  
No. DSDJ-11

U. S. High Frequency Cables  
give you these features:

**Exceedingly LOW  
RADIATION LOSSES,**  
combined with consistent peak  
performance over the entire VHF range.

**LONG LIFE** and maximum efficiency,  
regardless of weather conditions,  
are inherent in these cables.

*New Catalog:* Write for your copy today.

### UNITED STATES WIRE & CABLE CORP.

PROGRESS AND MONROE STREETS • UNION, NEW JERSEY

Representatives in Principal Cities





## UHF CONVERTER VHF BOOSTER

The **ONLY** Combination Unit



# SUTTON

### ONE UNIT DOES THE WORK OF TWO

Make more happy customers in 1954 with the new Sutton Converter-Booster. Here's the one unit that gives you *both* UHF Converter and VHF Booster in one attractive, compact cabinet that is designed to blend beautifully with any TV set. It has proved outstandingly satisfactory in *all* present UHF operating areas. Gives *any* TV set *all* UHF channels and *all* VHF channels remain open. Takes an easy five minutes to install and your customers like the neater installation, easier operation and better performance.

MANUFACTURED BY

**SUTTON ELECTRONIC COMPANY, LEXINGTON, KENTUCKY**

(Continued from page 55)

is not as much involved in the woofer performance. All patches should be applied with the edges pressed firmly to the cone. A loose edge can form a small resonant system of its own which buzzes audibly whenever it is stimulated in the right frequency band.

#### Tone Control and Equalization

In the servicing of commercial AM, FM or TV receivers the audio stages are generally considered the least complicated. When the initial diagnosis

of a faulty receiver localizes the trouble in the audio section rather than in converter, detector, or sweep circuits, the Service Man usually looks forward to a relatively simple and rapid repair job.

The circuits of high-fidelity sound systems, however, are a different matter. The audio field has developed specialized circuit designs of its own, and the intelligent servicing of modern audio amplifiers requires a knowledge of these special circuits.

Audio amplifiers are rated as having an essentially *flat* frequency response

within given limits, which means that they are able to amplify signals of different frequencies in a uniform manner. Certain circuits, however, are expressly designed for the purpose of creating non-uniform response to signals of different frequency. Such circuits may be categorized into three types: the fixed equalizer circuit, which introduces a constant frequency discrimination in compensation for known conditions; the variable tone-control circuit, which enables the operator of the system to adjust the relative bass and treble response of the amplifier; and the automatically-variable circuit, such as is used in a loudness control, where the operation of a control is determined by the position of the volume control slider.

#### Fixed Equalizers

The most universally-used fixed equalizer is the FM deemphasis network. Although this network is found in the FM tuner, it is inserted after the detector and may be considered a part of the audio circuits. Figure 2 (p. 33) illustrates an FM deemphasis network, with typical component values, and the curve of treble attenuation that it produces. This treble attenuation is in compensation for the treble preemphasis required by the FCC of all FM broadcast stations, and the final frequency response curve of the tuner output signal is essentially flat.

Different values for the resistor and capacitor of the deemphasis network will be found in different receivers, but the correct time constant of the two is always the same; that is, the product of the resistance, in ohms, and the capacitance, in microfarads, will always be equal to the standard 75 microseconds.

If the shunt capacitor should open up, effect would be a constant-treble boost, following the curve of the treble preemphasis in the received FM signal. This treble boost would tend to produce a shrill tone, with unnatural emphasis of the higher musical overtones and of the *s* sounds in speech. It should be clear that replacement components for the deemphasis network must have exactly the same value as the original; the capacitor cannot be treated as a bypass unit, whose replacement does not have a critical value so long as its capacitance is at least as large as that of the original.

#### Phono Preamp Equalizers

The signal output of a magnetic pickup has been doctored, relative to

frequency distribution, in much the same way as the FM signal. Treble preemphasis and bass pre-attenuation are both applied, although the characteristics of this doctoring have unfortunately not been standardized.

The *rc* or resistance-capacitance network is almost universally used to equalize the pickup signal fed to the main amplifier. The equalization network of the G.E. preamp, providing compensatory bass boost for recording characteristics, is illustrated in Fig. 1 (p. 33). A 6,800-ohm resistor across the preamp input terminals (and therefore directly across the pickup itself) introduces treble droop by virtue of the effect of resistive loading on the magnetic pickup.

Here, too, as in the FM deemphasis network, all replacement components must be of a value carefully matched to the original. Furthermore, these circuit components are in an extremely sensitive part of the amplifier, and only the very highest quality resistors and capacitors should be used; an initial saving of a few pennies may be paid for with costly future trouble. Small defects in replacement parts, that would have no significance in ordinary low-gain circuits, may create annoying intermittent noise in the phono preamp.

The preamp circuit illustrated in Fig. 1 provides a single transition frequency or turnover point for its bass boost, but many records use a lower turnover frequency. The signal from such records may be approximately compensated by using the tone controls of the main amplifier to introduce a certain amount of bass attenuation, or a simple variable-turnover circuit may be added, requiring only a switch plus a capacitor and 10-megohm click-suppressing resistor for each added position. Fig. 3 (p. 33) illustrates the addition of such a circuit to the G.E. preamp equalizer, providing three turnover frequencies that can be selected for the most natural sounding bass of the record being played.

#### Correction

THE CIRCUIT appearing in the *Vino* paper on audio maintenance in the Dec. 1953 issue of *SERVICE* should have been presented as shown below, with B+ applied through a dropping resistor.

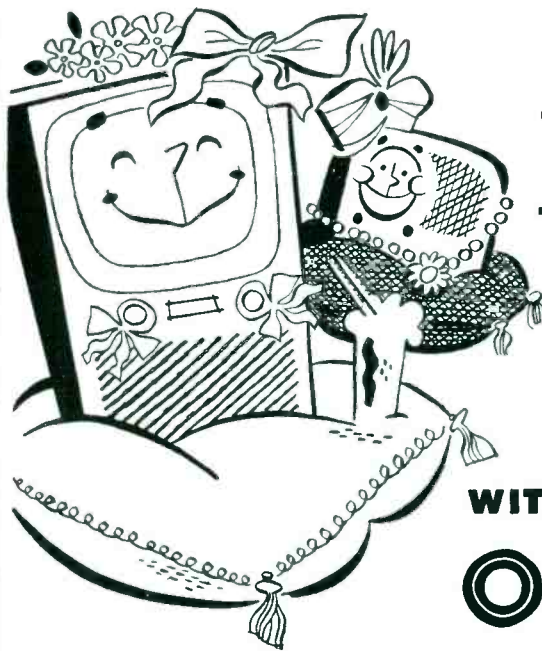
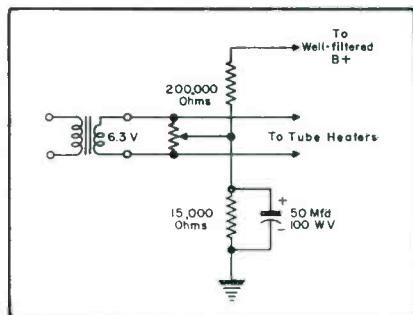

# PAMPER YOUR TV AND RADIO SETS WITH DEPENDABLE OHMITE® REPLACEMENTS

## Little Devil® COMPOSITION RESISTORS



Tiny, yes... but what dependability, ruggedness, and stability! And they provide an *extra* margin of safety—being rated at 70C rather than 40C. Completely sealed and insulated by molded plastic, they meet all JAN-R-11 requirements... are available in 1/2, 1, and 2-watt sizes in all RTMA values.

## TYPE AB NOISE-FREE POTENTIOMETERS

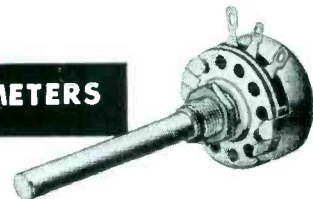

Because the resistance material in these units is solid-molded—not sprayed or painted on—continued use has practically no effect on the resistance. Often, the noise-level *decreases* with use... and they provide exceptionally long, trouble-free service. Rated at 2 watts, with a good safety factor.

## BROWN DEVIL® AND DIVIDOHM® RESISTORS

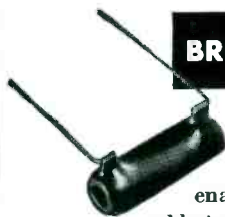

BROWN DEVIL fixed resistors and DIVIDOHM adjustable resistors are favorite vitreous-enameled units! DIVIDOHM resistors are available in 10 to 200-watt sizes; BROWN DEVILS in 5, 10, and 20-watt sizes.

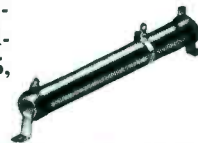

WRITE FOR  
STOCK  
CATALOG

OHMITE MFG. CO.

3642 Howard St.  
Skokie, Illinois  
(Suburb of Chicago)



Be Right With...

# OHMITE

RHEOSTATS • RESISTORS • TAP SWITCHES

## SERVICE MEN HAVE NO WORRIES



Tung-Sol works harder to make Tung-Sol tubes better. That pays off in fewer service call-backs.

# TUNG-SOL®

dependable

## PICTURE TUBES

TUNG-SOL ELECTRIC INC., Newark 4, N. J. Sales Offices: Atlanta, Chicago, Columbus, Culver City (Los Angeles), Dallas, Denver, Detroit, Newark, Seattle.

## On Book Row

NBC HANDBOOK OF PRONUNCIATION. . . . By JAMES F. BENDER: A dictionary of more than 15,000 hard-to-pronounce words of the English language which might be encountered by service personnel involved in *pa* work or broadcasting. Features *three-way approach*: word is spelled; then respelled to show pronunciation; and finally, printed in phonetics. Entries include names of places, names of people, words in the news, musical terms, and thousands of common everyday words.—372 pages (Second Edition), priced at \$4.50; Thomas Y. Crowell Co., 432 Fourth Ave., New York 16, N. Y.

\* \* \*

HIGH FIDELITY TECHNIQUES. . . . By JOHN H. NEWITT: In this treatment of *hi-fi*, a practical working knowledge from which to evaluate, install, and maintain equipment is provided. Amplifiers, tuners, preamps, phono cartridges and arms, tape recorders, loudspeakers, baffles and crossover networks are described, and their design and performance analyzed, with charts and schematics showing examples of typical circuits, construction practices and installations. Design data and dimensions for constructing infinite baffle, reflex, horn, labyrinth, or other speaker cabinets, are also included. Also available are details on volume expanders, noise suppressors, resonant and nonresonant tone controls, and binaural or stereophonic audio systems.—512 pages, 6" x 9", priced at \$7.50; Rinehart Books, Inc., 232 Madison Ave., New York 16, N. Y.

\* \* \*

RCA REFERENCE BOOK. . . . 1954 EDITION: New edition of this standard reference book, with data on over 20 subjects. Includes information on receiving tube characteristics (charts); picture tube characteristics (charts); semiconductor devices; interchangeability directory of tubes for communications and industry; battery characteristics (chart) and interchangeability guide; battery socket and terminal, and replacement guide; deflection components; speakers; TV components; test equipment and lightning arresters. Also offered are notes on alignment and the use of test patterns. Book also includes a diary and color maps.—120 text pages, plus diary and maps, 3 1/4" x 5 1/4", priced at \$1.00; Radio Corp. of America, Tube Dept., Harrison, N. J.

\* \* \*

HOW TO TROUBLESHOOT A TV RECEIVER. . . . By J. RICHARD JOHNSON: Described in this text are the mental and physical processes involved in troubleshooting TV receivers. Presented are step-by-step troubleshooting procedures, and an interpretation of circuit symbols. Analyzed are the antenna system, *rf* tuner, video *if* and detector sections, video amplifier sections, picture tube, deflection and sync circuits, high and low-voltage power supplies. Book includes a chapter on the setting up of a service shop, detailing the kinds of tools and test equipment required for field as well as shop-servicing activities. Also tabulates the kinds of tubes and types of components which should be kept in inventory.—128 pages, 5 1/2" x 8 1/2", paper bound, priced at \$1.80; John H. Rider, Publisher, Inc., 480 Canal St., New York 13, N. Y.

\* \* \*

BASIC RADIO MANUAL: A 248-page syllabus outlining a 36-lesson course on basic radio, with a practical shop project section demonstrating theories in action. Can be used as a text for the student and instructor. Presented in two sections: the first is theory; the second projects.—8 1/2" x 11", priced at \$5.00; Howard W. Sams and Co., Inc., 2201 E. 46th St., Indianapolis 5, Ind.

# Catalogs and Bulletins

FEDERAL TELEPHONE AND RADIO Co., 100 Kingsland Rd., Clifton, N. J., has published the second edition of their *Selenium Rectifier Handbook*. An 80-page book, it covers selenium rectifier designs and power supply circuits for phonos, audio amplifiers, mobile radios, photocell amplifiers, intercom systems and other *dc* power supply requirements. Features servicing information, and troubleshooting tables with proper procedures to be followed in checking rectifiers under varying circuit conditions. Priced at \$.50.

\* \* \*

HEATH Co., Benton Harbor, Mich., has released a 40-page '54 catalog, which describes test equipment, amplifiers and receivers in kit form. Items covered include *ac vtvm*, antenna impedance meter, *af* generators, oscillator and wattmeter, bar generator and capacitor checker.

\* \* \*

ADMIRAL CORP., 3800 Cortland St., Chicago 47, Ill., has issued a 16-page catalog, describing a line of antennas and accessories. Included are all-channel antennas, indoor types, yagis, transmission line and groundwire, mounting hardware, masts and towers, and tables and bases.

\* \* \*

GENERAL INSTRUMENT Co., F. W. Sickles Division, Chicopee, Mass., has released a 12-page catalog, *AT-53*, detailing specifications and data on air dielectric trimmers.

\* \* \*

ELECTRONIC INSTRUMENTS Co., INC., 84 Withers St., Brooklyn 11, N. Y., has issued a 12-page catalog, describing a line of 30 kits and 33 factory-wired instruments. Features, specifications and applications of each instrument are offered.

\* \* \*

TELEX, INC., Dept. KP, Telex Park, St. Paul, Minn., has prepared a catalog sheet on the *Twinset*, a twin-magnetic receiver, weighing 1.6 ounces. Sheet lists specifications and explains professional, business and technical uses.

\* \* \*

AUDIO-MASTER CORP., 17 E 45th St., New York 17, N. Y., has released a catalog describing a line of audio equipment, ranging from a small phono to a transcription player combination with *pa* system.

\* \* \*

PLASTIC CAPACITORS, INC., 2511 W. Moffat St., Chicago 47, Ill., has issued a catalog, describing a line of plastic-film capacitors, as well as hermetically-sealed power packs.

\* \* \*

PRECISION EQUIPMENT Co., 3702 N. Milwaukee Ave., Chicago 41, Ill., has released a 24-page catalog, detailing steel and aluminum equipment, including shelving, folding tables, cabinets, bins and lockers. Other equipment described include ladders, storage and maintenance gear, rotating bins, utility trucks, work benches and instruments.

\* \* \*

AMERICAN MICROPHONE Co., 370 S. Fair Oaks Ave., Pasadena 1, Calif., has prepared a catalog sheet describing hand-held dynamic and carbon microphones for use in mobile radio, paging and intercom systems.

\* \* \*

UNITED CATALOG PUBLISHERS, INC., 106-110 Lafayette St., New York 13, N. Y., has issued the 18th edition of their *Radio's Master* buying guide with 1,370 catalog pages. Descriptions, specifications and prices are accompanied by better than 8,000 product illustrations. Organized in 18 sections. More than 85,000 items are cataloged. A few of the products cataloged include: tubes, test equipment, tools, service aids, TV and audio components, antennas and accessories, recording and PA systems, and *hi-fi* equipment. Priced at \$6.50.

## ...WHEN CUSTOMERS HAVE NO COMPLAINTS



Tung-Sol never lets up on keeping quality up. That's why customers make fewer complaints about Tung-Sol tubes.

# TUNG-SOL<sup>®</sup>

dependable  
**RECEIVING TUBES**

TUNG-SOL makes All-Glass Sealed Beam Lamps, Miniature Lamps, Signal Flashers, Picture Tubes, Radio, TV and Special Purpose Electron Tubes and Semiconductor Products.

SERVICE, JANUARY, 1954 • 59

# NEW! only from

# TELEMATIC

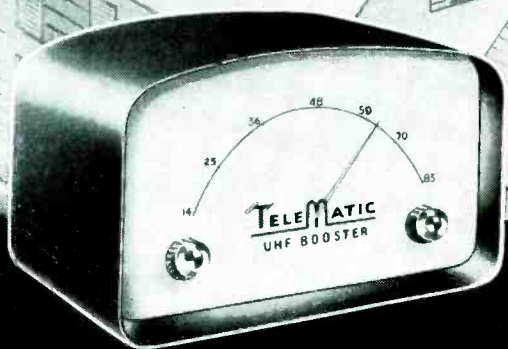

## U. H. F. BOOSTER

### Increases Radius of Good U. H. F. Reception

### Improves Performance In Many Locations

This need is accentuated at U.H.F. because of the low levels of transmitter power, poor propagation properties at U.H.F. and high noise figures of present day converters and receivers.

The noise figure of the Telematic BOOSTER averages approximately 10 DB lower than most converters, an improvement of 10 to 1.

The gain of the Telematic BOOSTER is 14 DB, which is more than sufficient to minimize the noise figure of the converter. The complete absence of sliding contacts eliminates tuning noise.

The band width of 10-15 M.C. is wide enough for full reproduction of both picture detail and sound, yet narrow enough to offer excellent selectivity.

**TELEMATIC**  
INDUSTRIES INCORPORATED

Write for complete catalog.

3 Joralemon Street  
Brooklyn 1, New York

Available Through Parts Distributors From Coast To Coast.

## ASSOCIATIONS



### LITRTG, Long Island, N. Y.

AT THE ANNUAL election of officers of the Long Island Television and Radio Technicians Guild *Henry Wawryck* was elected prexy. Others now on the officer roster include *Arthur Cyr*, vice prexy; *John Wheaton*, treasurer; *Murray Barlowe*, corresponding secretary; *Al. Weil*, recording secretary and *Earl Horton*, sergeant-at-arms. Trustees were added to the executive board for the first time; *Jack Buck*, three years; *Dick Bishop*, two years, and *Bill Allen* and *Ralph Milne*, one year each. The election was followed by the first in a series of color lectures by *Murray Barlowe*, who was affiliated with CBS during development of the sequential color system, and who has since followed color TV's program closely. The meeting also featured the announcement of the formation of two special committees: one (consisting of *Arnold Corbyons* and *Bob Bloom*) to develop a form of diploma to be awarded to all members who attend six or more of the color lectures, and another (with *Jack Buck* and *Earl Horton*) to handle publicity.

### TRT, Kansas City

FLOYD G. CONKRIGHT, Lee Wholesale Co., and *F. W. Ragan*, Jenkins Music Co., have been elected to the executive committee of Television and Radio Technicians, Kansas City, Mo., for three-year terms.

*David Doss*, general manager of Hoffman Sales Corp., spoke to the group at a recent meeting on Hoffman's expansion to the middle west and east coast, and explained what this expansion would mean to the electronics industry in the Kansas City area. Doss reported that the north Kansas City plant would start with the production of radios, and then expand its facilities to include TV receivers by about May. He predicted that about 1000 TV sets a day would eventually be produced.

### ARTSNY, New York, N. Y.

A NEW SLATE of officers has been elected by members of the Associated Radio-Television Servicemen of New York.

*Phil Goldfarb* is the new prexy. *Arthur Rhine* was reelected executive secretary, and *George Kimmel*, treasurer. *Edward Eisen* was named chairman of the business chapter, and *Jacob Allen*, recording secretary. *Herman Bruck* now is financial secretary, and *Kingsley Sherwood* was selected as the corresponding secretary. *John Wagonny* is sergeant-at-arms.

Six were named to the board of directors of the business chapter: *Max Liebowitz*, *Jack Spegal*, *Karl Mertel*, *Peter LaPresta*, *Harold Kanfield*, and *Stephen Pokal*.

On the technical chapter, *Joseph Wilin* was named chairman; *Jacob Allen*, recording secretary; *Martin Boxer*, corresponding secretary; *Harry Tenler*, financial secretary; and *Ben Cohen*, sergeant-at-arms. Eight were named to the board of directors of this chapter: *Robert T. Olson*; *Warren Metz*; *Henry Levine*; *Henry Kaye*; *Harry Ozer*; *Harold Levenson*; *Sidney Perlin*; and *Jerry Maccherone*.

*Max Liebowitz*, who served for seven terms as prexy of the association, was elected permanent chairman of the board of the entire group.

### CTID, Rockford, Ill.

ROY W. PEARSON has been reelected president of the Certified Television Installation Dealers, Rockford, Ill., and *C. T. Van Ausdall* was renamed secretary.

New officers include *Harry Harris*, vice president, and *Ray Dean*, treasurer.





At presentation of NATESA's Friends of Service Management Award to G.E., Schenectady, the fifth award received by the company for its public relations program in behalf of TV service: Bertram L. Lewis, left, Rochester, N. Y., NATESA eastern vice-president; John T. Thompson, center, manager of replacement tube sales for the G.E. tube department; Frank J. Moch, right, Chicago, president of NATESA. Previous awards to G.E. came from NATESA, Associated Radio and Television Service Dealers, Inc., Columbus, Ohio; Federation of Radio Servicemen's Associations of Pennsylvania, and the Radio Technicians Guild of Boston.

#### TISA, Chicago

FRANK J. MOCH, NATESA prexy, has been reelected head of the national association's Chicago affiliate, Television Installation Service Association of Illinois.

Other TISA officers reelected include: *John Cecich*, first vice-president; *Jerome Man*, treasurer, and *Rubin Saxner*, secretary.

*Ralph Friedman* has succeeded *Sidney Terman*, as second vice president, and *Russ Havill* is now sergeant-at-arms, succeeding *Fred H. Levine*.

*Milton Stone* now heads a training committee; *George Hingson*, fraudulent practices, and *Leonard March*, advertising.

It was also announced at the election that *Moch* presented NATESA awards to RCA and G.E., in Camden and Schenectady. At the Camden ceremonies the award was presented to *Charles M. Odorizzi*, executive vice prexy of RCA, by *Moch* and *Harold Rhodes*, awards chairman.

Other RCA officials attending the ceremony were *E. C. Cahill*, president of RCA Service Co.; *Dan Creato*, vice-president; *D. H. Kunsman*, vice president in charge of consumer products service; *R. M. Baggs*, general sales manager, and *J. W. Zaun*, quality division manager.

#### TEN YEARS AGO

BOND GEDDES, executive vice-president and general manager of RMA, reported that there would be no civilian production of receivers in 1944. . . . The WPR set up a program calling for the production of at least 4½ million hard-to-get tubes during the first quarter of '44; 12SA7, 12SQ7, 12SK7, 50L6, 35Z5, 35L6, 1H5, 1A7 and 80. Tubes were to be marked MR for maintenance, repair, and operating supply purposes. . . . The job that Service Men did on overseas assignments in '43 was reviewed by *W. L. Jones*, RCA Service Co. vice president and general manager. . . . On the front cover a wide-range of meter with a keying amplifier and square-wave generator providing coverage of ten linear ranges from 50 to 50,000 cycles (RCA 306-A), was presented. . . . *Meyer Eisenberg*, Plaza Radio Shop, Brooklyn, N. Y., won a \$25 war bond from the Proctor Electric Co. for an electric-cord repair suggestion. . . . *Orrin E. Dunlap, Jr.*, was appointed director of advertising and publicity by Radio Corp. of America. . . . *American Radio Hardware Co.* opened a new factory in Mt. Vernon, N. Y. . . . *C. L. Pugh*, formerly jobber sales manager of Stancor, organized his own rep firm in the Middle West. . . . *David Gross* was named sales director of the materials test division of DuMont. *Samuel H. Cuff* was appointed sales promotion manager for TV. . . . *William C. Speed* was named vice president in charge of manufacturing of Reeves Sound Labs. . . . *William J. Massey* was appointed general lamp sales manager by Westinghouse, Bloomfield, N. J. . . . Army-Navy E Award winners: *Erie Resistor Corp.*, Erie, Pa.; *Bell Sound Systems, Inc.*, Columbus, Ohio, and *Sylvania's Williamsport, Pa.*, plant. . . . JFD published a 100-page manual on fabric belts and ballasts. . . . *Al Ghirardi* described 'scopes and their applications in a 4-page feature report. Instruments detailed were Hickok's RFO-4, Dayrad's 65, RAC's 155C327A and various models made by DuMont.

Modernize  
20 MILLION  
TV SETS!

Wipe out the  
Retrace Line!



MODEL  
CR-59

with the

TELEMATIC

Retrace Eraser

- JIFFY INSTALLATION
- EXTRA PROFITS ON SERVICE CALLS

Elimination of annoying retrace lines that interfere with TV reception is accomplished by the RETRACE ERASER.

This plug-in electronic network, model CR-59, permits the set owner to turn up the brightness and contrast controls and enjoy optimum TV reception without the interference of annoying lines.

Write for complete catalog.  
3 Joralemon Street  
Brooklyn 1, New York

TELEMATIC  
INDUSTRIES INCORPORATED

It's no contest—

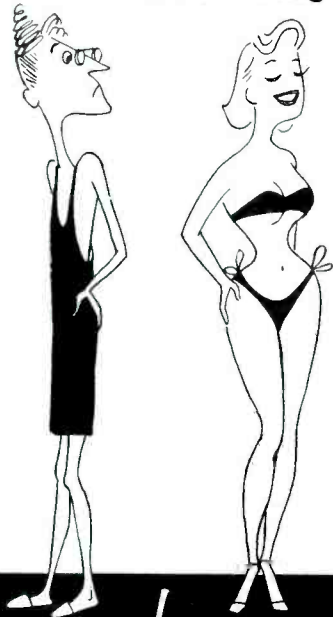

**AEROVOX**  
is best!



Take the jack-of-all-trades — Type PRS "Dandeeds." Exceptional choice of voltages, capacities, combinations, means the right fit for any electrolytic replacement need. Higher voltage listings, together with 85° C rating, meet the extra-severe-service conditions in today's radio and TV sets. For stay-put jobs that spell lasting profits for you: it's no contest—Aerovox is BEST.

GET THE FACTS!

Ask your Aerovox distributor for these handy "Dandeeds." Ask for latest catalog—or write us.



**AEROVOX CORPORATION**

NEW BEDFORD, MASS.

See your Aerovox distributor!

In Canada: AEROVOX CANADA LTD., Hamilton, Ont.

## Audio

(Continued from page 46)

sense, but it has a similar effect on the reproduction. Stages of this type require a drive stage giving a low source impedance, so the onset of grid current does not produce waveform distortion. If the source impedance is too high, this can produce regular intermodulation distortion, as well as a rather objectionable form of harmonic distortion. But because a satisfactory drive stage has low source impedance, these amplifiers sometimes run into parasitic oscillation at *rf*. Sometimes, though, the circuit does not have high enough *Q* to generate continuous oscillations, merely showing a very high peak in response well above the audio range, verging on oscillation. When this happens, cessation of the grid current can excite a damped train of oscillations at the resonant (*rf*) frequency. The resultant output waveform for a single sinusoidal input appears in Fig. 1. As the *rf* component of this wave is inaudible, its presence would not be detected in this case. But when another waveform is superimposed on the one exciting the parasitic, the grid current varies the damping on the *rf* with the waveform of the secondary *af* signal; thus this secondary waveform effectively modulates the *rf* damped train. This results in the absorption of energy from the modulating waveform, so that during these periods its amplitude is reduced. The resultant sound is very similar to intermodulation, except that it will become evident quite suddenly as level rises, because it does not show up at all, until grid current commences.

### Break Through

Often reproduction sounds as if it is being forced through some barrier, and it only succeeds in doing so in spurts; generally these spurts are considerably distorted. Sometimes only the very loudest passages succeed in breaking through, leaving silence between, and sometimes almost all the signal gets through, but it gives the same general impression. This form of

Fig. 1. Example of waveform produced by parasitic *rf* oscillation excited by grid-current pulses. Dotted lines indicate point where grid current starts and finishes.

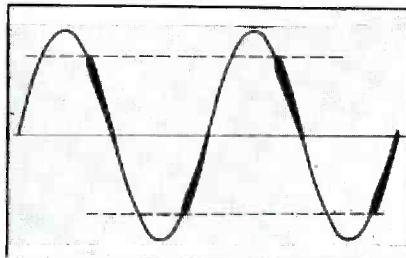

## The COMPLETE line



Paging & Talk-Back Speakers

for EVERY



## Public Address need!



WRITE NOW for FREE Catalog 553



**ATLAS SOUND CORP.**

1442 39th St., Brooklyn 18, N. Y.  
In Canada: Atlas Radio Corp., Ltd., Toronto, Ont.

**STOP VOLUME CONTROL NOISE!**

**"NO NOISE"**

NEW 6 OZ. SPRAY CAN

Net to Servicemen **\$2.25**



CONTAINS THE AMAZING NEW **PERMA-FILM**

- ★ **CLEANS!** ... dirt and oxidation immediately on contact.
- ★ **LUBRICATES!** ... One drop eliminates scratch, hum & noise.
- ★ **PROTECTS!** ... Assures continued top performance.

Perfect Contact Restorer—cleans & restores volume controls, band switches, push button assemblies, electrical contacts. **NO NOISE** is not a carbon tet solution.



2 oz. bottle Net to Servicemen **\$1.00**

**"NO NOISE"**

Available in 8 ounce bottles and quart cans

Nearest distributor ... or write **ELECTRONIC CHEMICAL CORP.**  
813 Communipaw Ave., Jersey City 4, N. J.

distortion is due to parasitic *rf* oscillation, which loads the amplifier, or some stage of it, up to maximum level, so that the normal audio signal cannot get through. However, a high-amplitude audio signal injected with the *rf* will push the combined grid potential much more positive momentarily and damp down the *rf* level, so that the oscillation has to build up again to a saturation point. During this build-up interval, some of the *af* signal will become amplified, until the *rf* again blocks the channel.

When this trouble occurs, the amplifier will be found unusually quiet in the absence of signal, hum and tube hiss being undetectable, even by crawling into the loudspeaker. This is so, because the blocking action stops the spurious forms of signal, as well as the regular program signal.

## Servicing Helps

(Continued from page 34)

and first detector provide a rectified signal.

With this arrangement alignment can be performed in the cabinet or on a non-metallic bench top.

In checking for stability one can touch the chassis near the tuner or slide the hand along the sweep output cable and observe if the shape of the curve changes.

To offset the *agc* developed from the sweep signal, the first *vif* tube should be pulled out of its socket. Then proper bias can be applied to the *rf* and mixer tubes.

The sweep generator and bias should be adjusted until there isn't a change in the curve shape with a decrease in sweep input or an increase of the bias. This will prevent overloading the stages which could result in limiting or clipping of the response curve.

### Tuner Replacements

WHEN TUNERS are to be replaced with cascode and pentode types,\* chassis should be checked to be sure that they use intercarrier or that the sound take-off is not within the tuner circuit (at mixer output).

For those systems which previously required the use of a 21.25-mc *if* sound take-off coil connected to the tuner converter plate circuit, a coil<sup>1</sup> has been developed; this can be mounted on the TV chassis and connected as shown in Fig. 4. Where more audio output is required, an alternate method can be

\*Standard Coil TV-2232 (cascode) and TV-1532 (pentode). <sup>1</sup>Part XM-752.

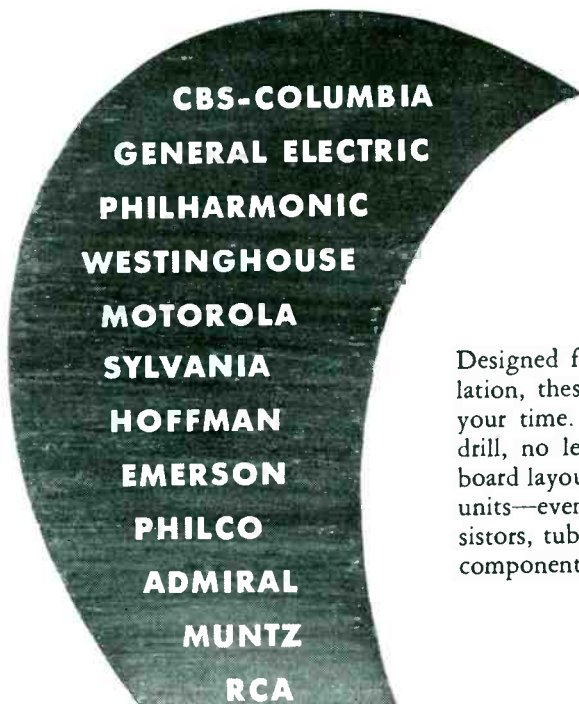

Designed for quick, simple installation, these Stancor flybacks save your time. There are no holes to drill, no leads to splice. Terminal board layouts duplicate the original units—even include choke coils, resistors, tube sockets and any other components that are on the original.

**STANCOR HAS EXACT REPLACEMENT FLYBACKS FOR ALL THESE TV MANUFACTURERS' SETS...and others will be available soon**



Stancor TV replacements are listed in Sams' Photofact Index, Counterfacts, Rider Manuals and Tek-Files

**CHICAGO STANDARD TRANSFORMER CORPORATION**  
3588 ELSTON AVE., CHICAGO 18, ILL.

EXPORT SALES: Roburn Agencies, Inc.  
39 Warren Street • New York 7, New York

employed, as illustrated in Fig. 5 below.

Some TV sets may not have enough sound rejection built into the *if* system and will require more trapping than the sound take-off coil will pro-

vide. In these sets an additional trap at sound-*if* frequency should be included in the *if* system.

### Credits

<sup>1</sup>From notes submitted by M. Martynec.

Figs. 4 and 5. Circuits illustrating application of Standard cascode and pentode tuners to split-sound *if*-system chains. Method of adaptation, shown in Fig. 5 can be used where more audio output is required. C = gimmick or capacitor approximately 2 to 4 mmfd.

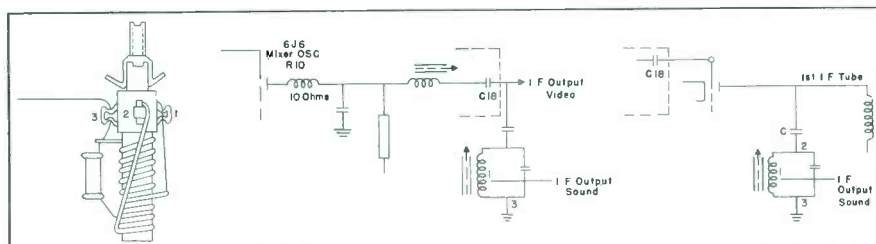



I've switched to  
**ERIE SWITCHES**  
*They're in the BAG!*

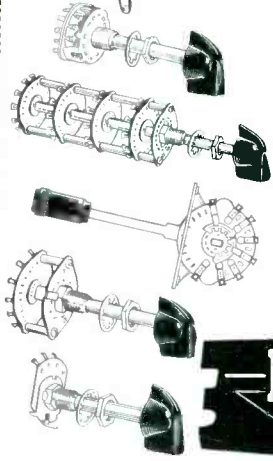

The new, full line of ERIE rotary selector and lever switches includes twenty-five item numbers. They are made in four styles, in single or multiple sections, shorting and non-shorting types. ERIE switches meet existing R.E.T.M.A. requirements. For protection against the corrosion of heavy silver plated contacts, each switch is sealed in a durable plastic bag and then boxed for convenient stocking.

*Descriptive literature is available at your distributors, or write Dept. A for your copy.*

*ERIE components are stocked by leading electronic distributors everywhere.*

**ERIE** RESISTOR CORP. ELECTRONICS DISTRIBUTOR DIVISION  
**ERIE RESISTOR CORPORATION**  
Main Office: ERIE, PA.  
Factories: ERIE, PA. • LONDON, ENGLAND • TORONTO, CANADA

Answer the Call . . .  
**JOIN the RED CROSS**  
**and SERVE!**

VIDAIRE • VIDAIRE • VIDAIRE • VIDAIRE • VIDAIRE

*Lines out!*

**Vidaire**

**ELIM-A-TRACE**  
VERTICAL RETRACE LINE  
ELIMINATOR

- Eliminates annoying vertical retrace lines in the picture when the brightness control is turned up.
- Makes the picture viewable on weak picture tubes.
- In fringe areas, the picture may be viewed without strain.
- The chassis or picture tube is not removed from the cabinet.
- No cutting or splicing of leads.
- Installed in the TV set in minutes.

VIDAIRE • VIDAIRE • VIDAIRE • VIDAIRE • VIDAIRE

**FREE BOOKLET CATALOG**

VIDAIRE ELECTRONICS 6 E. 39th ST., N.Y. 16, N. Y.

Please Send FREE Copy

Latest catalog

"TV INTERFERENCE AND ITS REMEDIES"

NAME \_\_\_\_\_

ADDRESS \_\_\_\_\_

CITY \_\_\_\_\_ STATE \_\_\_\_\_

AT YOUR DISTRIBUTOR

**Vidaire**

ELECTRONICS MFG. CO., LYNBROOK, N. Y.

NAT'L SALES OFFICE:  
6 E. 39TH ST., NEW YORK 16, N. Y. LE 2-7372

VIDAIRE • VIDAIRE • VIDAIRE • VIDAIRE • VIDAIRE • VIDAIRE

# Tools . . . Instruments Parts . . .

## INSULINE TEST LEADS

A pair of lucite handle test leads, 304, for use with standard voltmeters, multi-meters, *vtoms* and similar measuring instruments, has been introduced by the Insuline Corporation of America, 3602—35th Ave., Long Island City 1, N. Y.

Handles are 5" long and  $\frac{3}{8}$ " in diameter. Ends are fitted with small threaded chucks which take phono-needle test tips. Needles can be inserted with either the blunt or the sharp points outward.

Handles are colored red and black, respectively, and carry 45" lengths of kinkless, flexible leads with molded right-angle phone tip plugs.

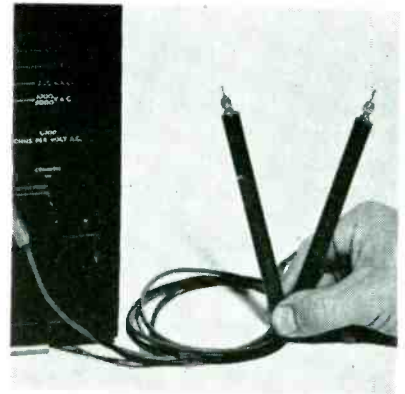

Insuline Test Leads

## CENTURY SERVICE CASE

An all-steel carrying case, designed for radio and TV Service Men, has been introduced by Century Display Manufacturing Co., Chicago, Ill.

Featuring six plastic-clear boxes for small parts, a seven partition removable metal tray, four partitioned bins on one side, two extra large on the other, case is 21" x 12" x 7 $\frac{1}{2}$ ". Includes a full-length hinge, cylinder lock with two keys and metal handle.

Century Display Service Case



### XCELITE REAMER

A super-hard reamer, 99-71, that reams from  $\frac{1}{8}$ " to  $\frac{5}{16}$ " in wood, sheet metal, and plastic, has been announced by Xcelite, Inc., Orchard Park, New York. Available with detachable handle.

### C-D MOTOR STARTING CAPACITOR

A motor-starting electrolytic capacitor, EXWCB, featuring a compact case design that is said to mount securely on the motor frame and blend into its contour, has been developed by Cornell-Dubilier Electric Corp., South Plainfield, N. J. Entire unit is less than four inches long.

Unit is made of black molded bakelite, and two parts comprise the assembly: the body and cap. Latter is fastened to the body by two self-tapping screws, providing accessibility to the capacitor terminals. Container is hermetically sealed by means of a steel spider-ring which presses against a rubber bakelite washer; rubber lining of washer in turn presses against the inner ledge of the container.

Also provided with a tempered steel mounting clip, shaped to conform to the curvature of the motor frame, to which it may be fastened by means of two round head machine screws. Opening in the bottom of the case cap permits connecting wires to pass from capacitor terminals into the motor housing. Case cap is removable for testing at the terminals without the necessity of unclipping the case from the mounting or motor frame.

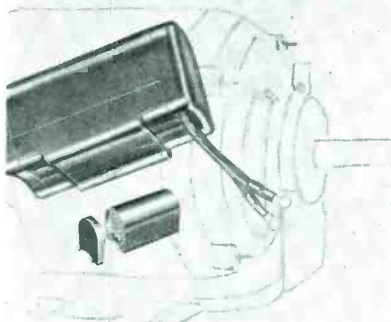

C-D Motor Starter Capacitor

### TARZIAN SELENIUM PLUG-INS

Selenium rectifiers fitted with polarized lugs, for mounting in a socket, have been developed by Sarkes Tarzian, Inc., Rectifier Division, 415 N. College Ave., Bloomington, Ind.

Plus lug has a 90 degree twist for polarization. Socket placement determines the rectifier size. Rectifier lugs snap into place and won't fall out.

Sockets are being made by the Cinch Manufacturing Company, Chicago.

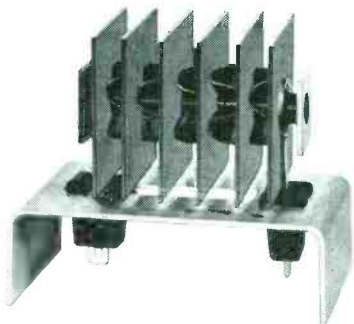

### HOLUB TEST LIGHT AND FUSE PULLER

A test-light and fuse puller combination, that is said to eliminate the danger of inserting or removing cartridge fuses by hand; prevent the bending of clips through improper removal, and can be used for handling live electrical parts up to 600 v ac-dc, has been introduced by Holub Industries, Inc., Sycamore, Ill.

Made of red plastic, jaws are shaped to hold cartridge fuses up to 100 a-size; inside of jaws are serrated. Handles are formed to fit the fingers and corrugated to prevent slipping. Two 24" leads are furnished with each tool. One lead has a 4" plastic handle prod, and the other a spring clip. Test light is of the neon type with a resistor.

# V-M HIGH FIDELITY 936HF RECORD CHANGER

## Leads in Features that help you profit!

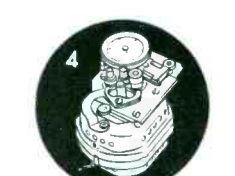
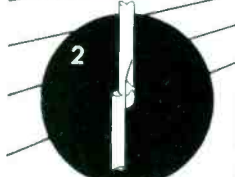
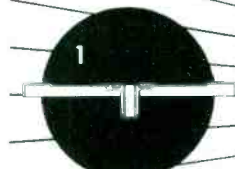
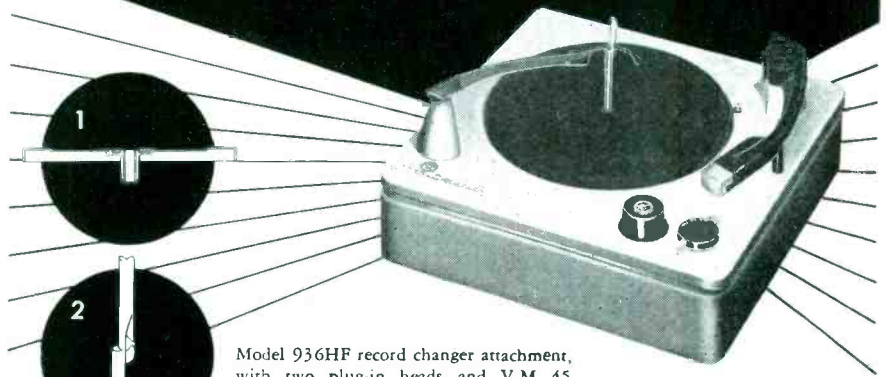

Model 936HF record changer attachment, with two plug-in heads and V-M 45 Spindle, list ..... **\$69<sup>95</sup>\***.

Model 935HF, less metal pan, list ..... **\$59<sup>95</sup>\***.

*\*Slightly higher in the west.*

The custom-engineered 936HF means hi-fi sales and satisfied customers to you. It is the first record changer specifically designed to meet the highest standards of discriminating high fidelity enthusiasts.

### V-M PORTABLE high fidelity P-A SYSTEM

Ideal for record dealers, schools, wherever easy portability and powerful, hi-fi sound reproduction are desired! Includes V-M tri-o-matic 960 changer, V-M 160 slide-out 8-watt amplifier and Jensen 10" speaker, all in two matched cases.

Model 960 changer, list **\$64<sup>50</sup>\***.

Model 160 amplifier and speaker, list **\$66<sup>50</sup>\***.



Made by V-M Corporation, world's largest manufacturer of phonographs and record changers exclusively.

THE VOICE  OF MUSIC

### MAIL COUPON FOR FULL DETAILS

V-M Corporation, Benton Harbor 5, Michigan

Tell me more about the V-M 936HF , and the V-M high fidelity P-A package .

Name \_\_\_\_\_  
 Firm \_\_\_\_\_  
 Address \_\_\_\_\_  
 City \_\_\_\_\_, State \_\_\_\_\_

MANY MORE DELUXE FEATURES

### UTICA CUSHION THROAT PLIERS

A safety-idea for pliers, *cushion throat*, which it is said acts as a third hand to hold the short end of the wire during and after cutting, has been developed by Utica Drop Forge and Tool Corp., Utica, N.Y.

The *cushion* is rubbery red *Plastisol*, bonded in the throat beside the pliers' cutting edges. As the pliers close, the pliers' grips the short end of the wire tightly, holding as the cut is made. Generally, pliers must be opened to release the cut wire end. It is claimed that cuts can be made inside a chassis without danger of the snips of wire falling into the set. On *live* work, this helps prevent short circuits. While cutting springs, the safety feature keeps wire from flying.

# NEW! 3-WAY SNAP-OUT SERVICE FORMS

FOR • RADIO • TV • APPLIANCE SERVICE

- No carbon changing
- Write only once
- Hard 3rd copy
- Simple to route
- Easy to imprint
- Numbered claim check
- Convenient 4"x 7" size
- Pix tube release
- Promissory note
- Parts and performance guarantee
- Numbered in red
- Low in price

**#120 RADIO-TV-APPLIANCE SERVICE ORDER**  
100 Individual Triplicate Sets . . . \$2.95

See it at your TV Parts Distributor or write for sample

**#712 COST & RESALE SLIDE RULE...\$1.00**



Simple to use. Figure selling prices, profit percentages, trade-ins, etc., in seconds. Increase sales, increase profits by figuring the prices that you can sell at profitably.

## OELRICH PUBLICATIONS

4135 NORTH LAWLER AVENUE

CHICAGO 41, ILLINOIS

Our line of stock forms and business aids include—TV Service Call Books, Cash Sales Books, Collection-Aider, Service Contract Books, Guarantee Books, Business Sign Kits, TV Service Reports, Radio & TV Job Ticket Books, Master Service Card File System, Radio Work Sheet, Radio-TV Service Pricer, TV Call Router Book.

See Them at Your Radio-TV Parts Distributor Now!

**FREE!** Catalog RS on request.

### CARTER VOLTAGE CHANGERS

An addition to a line of power supplies, *Change-A-Volt Dynamotor*, that is said to make it possible to operate 6-volt two-way radio equipment from 12-volt systems without any rewiring or modifications, has been introduced by the Carter Motor Co., 2644 N. Maplewood Ave., Dept. 17, Chicago 47, Ill. Unit is supplied complete with starting relay and switch, 12-v fuse block, and wiring to convert directly a 12-v battery to a 6-v radio supply.

For transmitters up to 30 watts output, model B615V is available. It delivers 15 a continuously for receive and 45 a for transmit. It is also available in 24, 28, 32, 48 and 64-v inputs to change directly to 6 or 12 volt. Unit can also serve as a battery equalizer when operating low-voltage equipment on several cells of a higher-voltage battery system.

\* \* \*

### IRC MOLDED BORON-CARBON RESISTORS

A film-type, 1/2-watt resistor, that incorporates the advantages of a fully insulated unit, has been developed by the International Resistor Co., 401 N. Broad St., Philadelphia 8, Pa.

Resistors are said to be suited for applications where unmolded boron or deposited carbon units cannot be used due to the risk of mechanical damage to their coating, insulation breakdown, or high moisture change. Available from 100 ohms to .51 megohm.

\* \* \*

### CLAROSTAT HV HIGH-RESISTANCE CONTROL

A high-voltage, high-resistance, composition-element control, *series 51*, to control voltage for electrostatic-focus TV picture tubes, and for use too with three-gun color TV tubes, and photoelectric circuits, has been announced by the Clarostat Manufacturing Co., Inc., Dover, N. H.

Housed in low-loss phenolic case with a phenolic disk back that separates the terminals for maximum insulation, control is said to withstand 10,000 volts dc breakdown test between terminals and mounting bushing. It measures 2" in diameter by 5/8" deep. Available in resistance values from 5000 ohms to 50 megohms linear, and rated 1 watt. Tapers available to meet requirements. Tolerances of plus/minus, 20% to 1 megohm, 30% above 1 megohm.

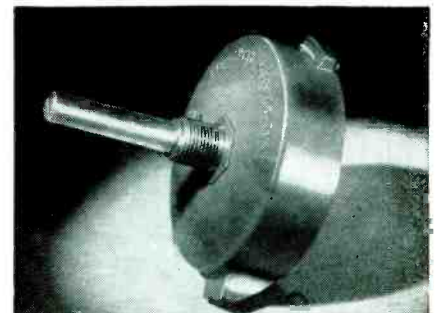

\* \* \*

### NEXT MONTH

THE CONCLUDING installment of the *Geist* series of articles on *systematic servicing* will appear in the February issue of SERVICE.

**NEW MULTIMETER KIT \$26.50**

**SIGNAL TRACER KIT \$23.50**

**NEW SCOPE KIT \$59.50**

**CONDENSER CHECKER KIT \$19.50**

**VACUUM TUBE VOLTMETER KIT \$24.50**

**TUBE CHECKER KIT \$29.50**

**SIGNAL GEN. KIT \$19.50**

**GRID DIP METER KIT \$19.50**

**Heathkit TEST EQUIPMENT**

BUILD YOUR OWN — INCREASE KNOWLEDGE — SAVE MONEY — BUY DIRECT FROM MANUFACTURER . . . Top quality instruments in kit form featuring latest design and circuit developments. Completely detailed step-by-step construction manual — clear pictorials — complete schematics. All sheet metal work punched, formed and finished. Low kit prices include tubes, chassis, cabinet and all necessary constructional components.

Kits for the school — service shop — industrial laboratory — hobbyist, etc.

Write for free catalog for further information.

**HEATH COMPANY BENTON HARBOR 11, MICHIGAN**

THE SYMBOL  
OF QUALITY

in TRANSFORMERS



QUALITY

*you can see!*

"Beauty is only skin deep," but the distinctive appearance of Triad Transformers is an outward evidence of inner quality, more than simply good looks.

Brilliant design, fine materials, precision manufacturing techniques and skilled craftsmanship contribute to the end result, which looks like—and is—the finest transformer made.

Triad Transformers are sold by principal jobbers in leading cities.

Write for Catalogs TR-53L & TV-53L.



4055 Redwood Ave., Venice, California



REP REAPPOINTMENT



Dick Morris (left), general sales manager of Snyder Manufacturing Company, Philadelphia, at recent renewal rep signing contract session with Maury Mifelman, Mifelman Associates, Los Angeles.

CAPACITOR AD-PLANNING SESSION



J. K. Poff, Pyramid jobber sales manager (right), discussing ad and promotion campaign for Pyramid capacitors with Burton Browne, head of the Chicago agency now handling the account.

TV TUNER REPLACEMENT PARTS KIT

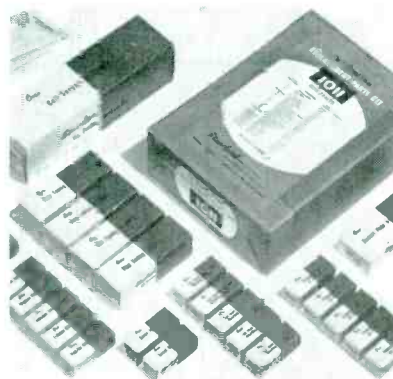

Tuner replacement parts kit developed by Standard Coil Products Co., Inc. Included are 104 of the most-called for parts servicing TV-200, TV-1500, TV-2000 and TV-2200 series Standard tuners. Majority of parts are individually boxed.

*Announcing*

AN  
ADDITION TO  
THE

*PHALO* *Tran*

FAMILY OF  
TRANSMISSION  
LEADS

• • •

**300 Ohm  
Tubular Twin  
Transmission Lead**

(Produced under Amphenol  
License No. 2,543,696)



Full Technical Data on Request

PHALO PLASTICS CORPORATION  
25-3 Foster St., Worcester, Mass.

**Insulated Wires, Cables  
and Cord Set Assemblies**





### FEDERAL UNIVERSAL SELENIUM RECTIFIERS

A universal line of selenium rectifiers, designed for replacement in any radio or TV receiver now equipped with this component, has been introduced by the Federal Telephone and Radio Co., 100 Kingsland Rd., Clifton, N. J.

Universal rectifiers are of eyelet construction and equipped with mounting hardware for simplified installation into the radio of TV chassis. Code numbers and ratings of selenium rectifiers available are: 1236A, rated at 300 ma; 1238A, rated at 350 ma; 1241A, rated at 400 ma; and 1237A, rated at 500 ma.

\* \* \*

### RCP FLYBACK AND YOKE TESTER

An instrument, 123 Flybacker, for testing the condition of flyback transformers and yokes in horizontal output circuits, has been developed by Radio City Products Co., 152 W. 25th St., New York, N. Y.

Tester detects a single shorted turn or a number of shorted turns in both the flyback and yoke, and also shows up circuited windings. To use the instrument, the flyback plate caps are removed, switches set, and leads applied to the component; results are read on a good-bad scale.

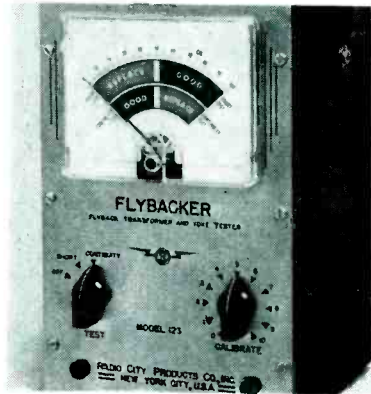

RCP Flyback/Yoke Tester

\* \* \*

### TECH-MASTER 70-CHANNEL UHF SELECTOR

A uhf selector, TV101-U, designed for 630-type TV receivers, as well as Tech-Master receivers, models 2430, 2431P, 2430-9, 1930 and C-30, is now available from Tech-Master Products, 443 Broadway, New York 13, N. Y.

Selector fits into the front recess of the 630-type chassis, and is said to require no cabinet alterations. Three high-Q resonators are said to provide high gain sensitivity; cascode if stage is completely shielded.

Tube complement: 6AG4 oscillator, 6BQ7 if and 1N82 crystal diode-mixer.

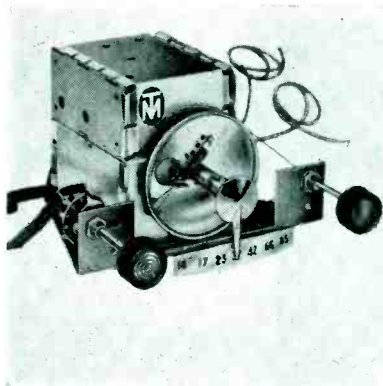

# Come Again

## Radio - Electronic Men!



Just as you have been coming since 1945 to the IRE National Convention and Radio Engineering Show—coming by the thousands, 35,642 in '53—so come again to see and hear all that is new in the engineering advances of your industry.

▲ **Fifty-four in '54!**—243 scientific and engineering papers will be presented, skillfully grouped by related interests into 54 technical sessions. More than half these sessions are organized by IRE Professional Groups, thus making the IRE National a federation of 21 conferences in one. The whole provides a practical summary of radio-electronic progress.

▲ **600 Exhibitors "spotlight the new!"** A mile and a half of exhibits line the avenues of this show, intriguingly named for the elements of radio—such as "Instruments," "Components," "Airborne," "Radar," "Transistor," "Audio," "Microwave," etc., filling the four acres of the great Kingsbridge Armory to capacity. An expanding radio industry shows why it is growing by proving how engineering research pays out in new products. The exhibits themselves are an education, condensed to one place—reviewed in four days.

▲ **Kingsbridge is the solution!** Only the combined facilities of the Waldorf-Astoria Hotel, plus the three great halls in the Kingsbridge Armory, seating 906, 720 and 500 respectively, are able to keep pace with the increased technical papers program of the IRE Convention. The show had to move because the U. S. Treasury took over Grand Central Palace. The immense Kingsbridge Armory, connected to the very satisfactory Lexington Avenue Hotel area by direct express subway, serves well to expand the already outgrown exhibit facilities of the Palace and provide

space for 200 new firms to exhibit, as well as seat greater audiences at the high-interest sessions. In addition to the subways, free busses leave the Waldorf every ten minutes in which you may travel in the congenial company of fellow engineers, direct to Kingsbridge.

### ▲ Admission by registration only!

Registration serves for the four day period. It is \$1 for IRE members, \$3 for non-members, covering sessions and exhibits. Social events priced separately.

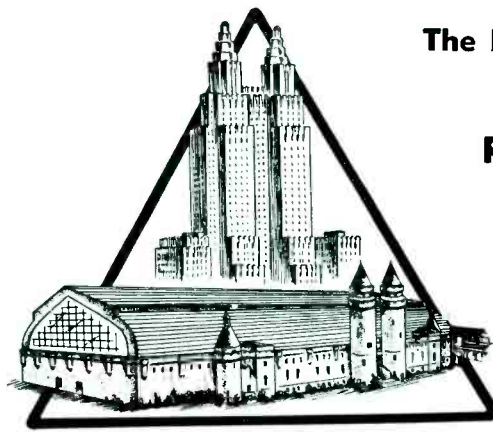

Waldorf-Astoria and Kingsbridge Armory

## The IRE National Convention and Radio Engineering Show

March 22 - 25, 1954

THE INSTITUTE OF  
RADIO ENGINEERS

1 East 79th Street, New York City

### STANCOR EXACT SYLVANIA REPLACEMENT FLYBACKS

Exact replacement flybacks, A-8227, A-8228, A-8229, that it is said covers almost 90% of all Sylvania production up to 1953, have been announced by Chicago Standard Transformer Corp., Standard Division, Addison and Elston, Chicago 18, Ill.

Supplied as coil and core for installation to the original brackets which are a permanent part of the chassis. New filament leads are packed with each transformer.

Bulletin 478 lists over 170 Sylvania models and chassis using these transformers.

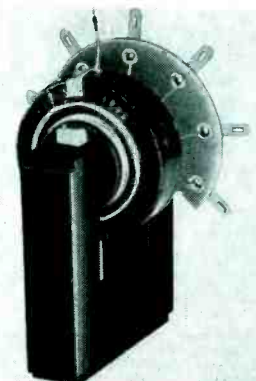

# TV Antenna Digest

(Continued from page 36)



## C-D's new Cub

outlasts other  
molded tubulars  
in humidity tests!



- Government humidity tests show C-D's to be 3 to 6 times better!
- A better all-around tubular designed specifically for radio and TV service replacement needs!
- Compare its new sleek looks!
- -- and be sure to ask about the new "Cub-Kit".

This time try C-D's NEW CUB! For your nearest C-D distributor see the Yellow Pages of your Telephone Directory. Write for catalog to Dept. S14, Cornell-Dubilier Electric Corporation, South Plainfield, New Jersey.

CONSISTENTLY DEPENDABLE

# CORNELL-DUBILIER CAPACITORS



There are more C-D capacitors in use today than any other make.

PLANTS IN: SO. PLAINFIELD, N. J.; NEW BEDFORD, WORCESTER AND CAMBRIDGE, MASS.; PROVIDENCE AND HOPE VALLEY, R. I.; INDIANAPOLIS, IND.; SANFORD AND FOUQUAY SPRINGS, N. C. SUBSIDIARY: RADIART CORP., CLEVELAND, OHIO

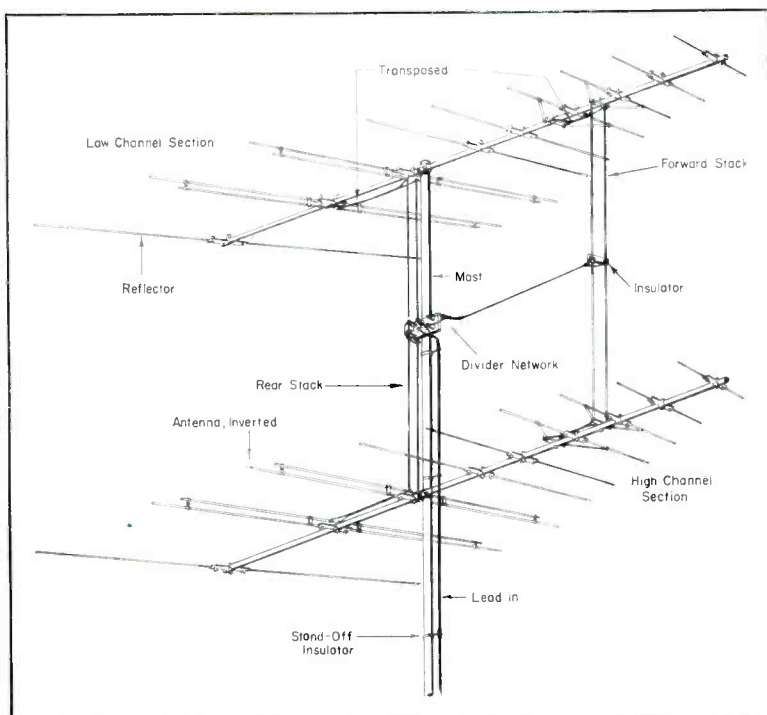

Fig. 2. Stacked yagi system. (Courtesy Vee-D-X)

aft. in supporting the booms in a coplanar position. A spacing insulator, placed on the stackers midway between the antennas, serves as a terminal block for attachment of the interconnecting harness to the network. The output of the network is terminated for 300-ohm impedance to accommodate the standard types of transmission lines.

Fig. 3 illustrates the forward horizontal directivity of the yagi. One of the interesting properties of this compound yagi, it is reported, is that the pattern configuration for both single and stacked bays is said to remain essentially the same.

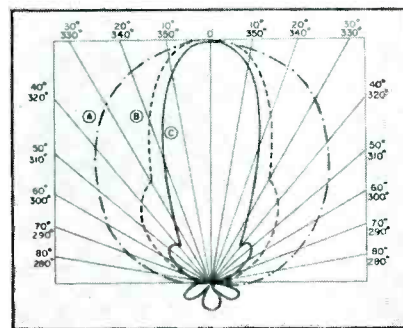
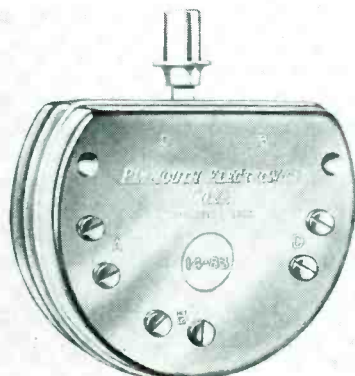
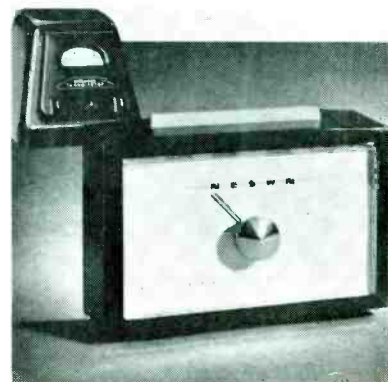

Fig. 3. Horizontal radiation pattern of yagi: A = channel 2; B = channel 7 and C = channel 11.

Transfer switch for vhf/uhf featuring a water component with widely separated contacts said to assure positive make-break characteristics. Switch case uses low-carbon compound called mesonetic plastic. (Plymouth Electronics Corp., 50 Kingsbury St., Worcester 10, Mass.)



Old and new: At left, old pyramid-style rotator, in contrast to new rectangular shape model below. New model provides control bar across the top. Pressing on one end of the tilt bar turns rotor one way. Pressing on the other end of the bar turns rotor in opposite direction. Selects and shows the actual direction to which antenna is pointed (Model T-10; Alliance).





**QUIETROLE**  
 TRADE MARK REG. U.S. PAT. OFF.  
**ELIMINATES NOISE**  
**THE SAFE\*CLEAN WAY!**

**"The ORIGINAL  
 NON-INFLAMMABLE  
 NON-CONDUCTIVE  
 LUBRICANT CLEANER"**

Available in  
 2 oz., 4 oz., 8 oz.



QUIETROLE . . . the original and most reliable lubricant cleaner quiets noisy television and radio controls, switches\* and other moving parts. Why take less . . . avoid imitations . . . order QUIETROLE, developed after years of research.

**NO GUM! NO GOO!  
 NO GRIME!**

Carried by recognized jobbers . . . everywhere!

\*Unequaled for TV front end switches. Contains no "thinner".



manufactured by  
**QUIETROLE  
 COMPANY**  
 Spartanburg, South Carolina

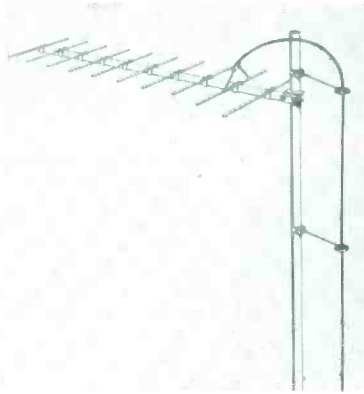

(Above)

A 10-element uhf yagi that is said to be plated with 24-carat gold. Yagi is custom-made for each location, and designed for either single channel or broad band (15 channels or more) bandwidth. (Walsco.)

(Below)

Conical vhf antenna which utilizes barrier-discs and 2" of air space between terminals. Insulator containing barrier-discs is said to prevent shorts. Front end hardware is stainless steel. (Walsco.)

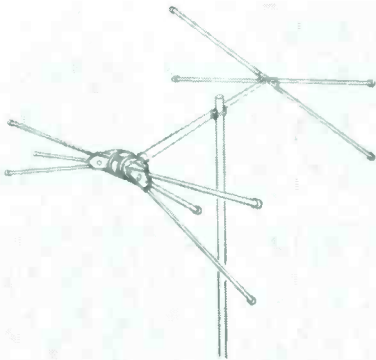

(Below)

Single-wire transmission line for uhf which consists of an impedance-matching unit at each end called launchers, which match 300-ohm balanced line connection at the antenna to single wire which carries the signal to TV set. Near the TV set, a second launcher matches the single wire to a short length of 300-ohm twin line attached to the receiver. Losses of the line are said to be one db per 100' in the uhf band. The launchers each introduce 1/2 db loss. Kit is available; consists of two launchers, 150' of wire, and two standoff brackets. (G-Line and GL kit; David Bogen Co., Inc., 29 Ninth Ave., N. Y. 14.)

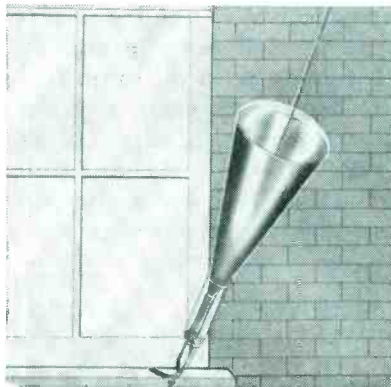

There are more C-D capacitors in use today than any other make.

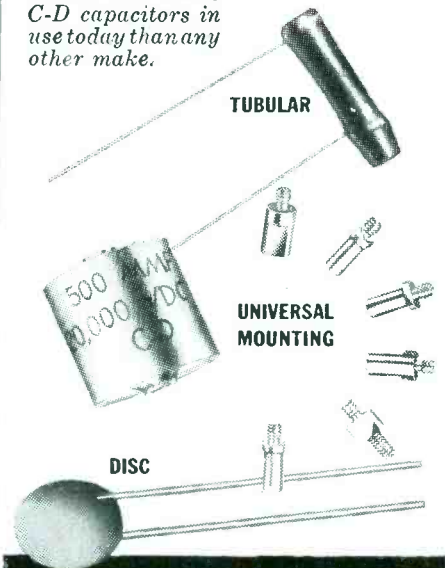

**There's a C-D ceramic with the "Million Dollar Body" for every requirement**

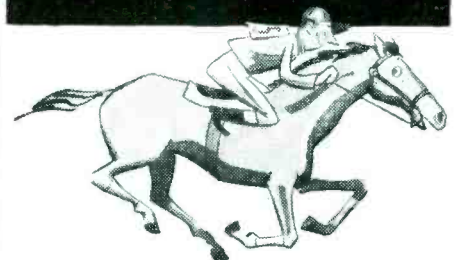

**Every one a winner**

A line of the most popular, fast-moving sizes, in both general purposes and temperature compensating types. Ask your C-D jobber about them today! He's listed in your local Classified Telephone Directory. For catalog write to Dept. S14A, Cornell-Dubilier Electric Corp., South Plainfield, New Jersey

CONSISTENTLY DEPENDABLE  
**CORNELL-DUBILIER**  
 CAPACITORS



PLANTS IN SO. PLAINFIELD, N. J.; NEW BEDFORD, WORCESTER AND CAMBRIDGE, MASS.; PROVIDENCE AND HOPE VALLEY, R. I.; INDIANAPOLIS, IND.; SANFORD AND FLOUAT SPRINGS, N. C. SUBSIDIARY: RADIART CORP., CLEVELAND, OHIO

# KESTER



Since the most important single step in Radio-Television Servicing is soldering . . . it's just plain good sense to use the best — KESTER SOLDER . . . Key Name in Solder for More Than 50 Years.



KESTER SOLDER COMPANY  
6348 Wrightwood Avenue • Chicago 39, Illinois  
Newark 5, New Jersey • Brantford, Canada

# SOLDER

YOU CAN MAKE

## MONEY

### Repairing Small Electrical Appliances

The Electra-Craft Appliance Co., New York's largest distributor of replacement parts for small electrical appliances, has developed a plan to assist Radio and T-V repair shops to take on the repair of small electrical appliances in an orderly and profitable manner. Details of this plan may be obtained by filling in and mailing the attached coupon.

#### ELECTRA-CRAFT APPLIANCE CO.

361 West 42nd St., New York 36, N. Y.

Gentlemen: Please send me details of your plan to equip Radio and T.V. repair shops to take on the repair of small appliances. I understand this entails no obligation on my part.

NAME .....

ADDRESS .....

Years in business.  No. of mechanics employed.

## RADELCO

### INDOOR ANTENNA

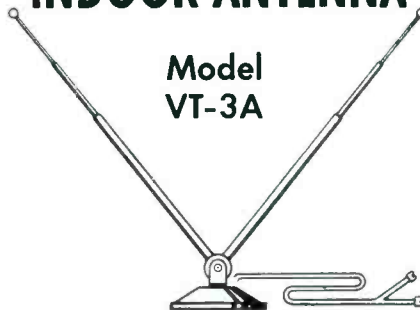

Model  
VT-3A

... A high quality antenna, attractively designed and finished in mahogany lacquer to harmonize with all room furnishings. Three section, brass tubing masts with lustrous plate finish extend to 45" for fine reception. Heavily weighted base. Lead and terminals included. A real value!

ORDER FROM YOUR  
NEAREST PARTS JOBBER

LIST PRICE  
**\$3.45**

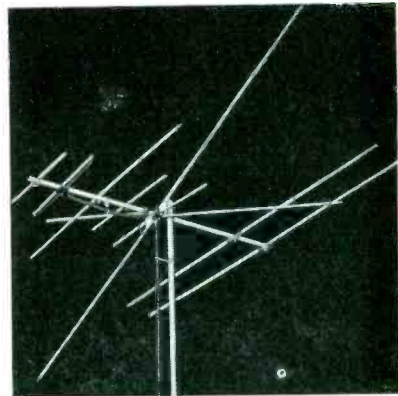

(Above)

Conical yagi antenna for vhf. Has 5 elements on low channels, and 4 on the highs. Low channel section consists of a conical driven element using vari-con adjustable head, plus dual reflectors and a director. High channel section uses two separate driven elements and a director for each. One driven element and director operates across channels 7-8-9, the other pair being most effective across channels 10 to 13. Entire array is fed with a single 300-ohm line. (Model 88; Falcon Electronics Co., Quincy, Ill.)

(Below)

Automatic signal equalizer designed for locations where signals from low-frequency channels cause overloading and the high-frequency channels are not strong enough to tolerate any attenuation. (Model AT-25; Tele-Matic Industries, Inc., 1 Joralemon St., Brooklyn, N. Y.)



(Below)

Ultrahigh 12-element yagi designed for deep-fringe reception of single channels. Model also said to pick up adjacent channels due to mean-frequency pick-up. Yagis are one-piece, welded and plated with Bronzidite. (Model UHF812; JFD Manufacturing Co., Inc., 6101 Sixteenth Ave., Brooklyn 4, N. Y.)

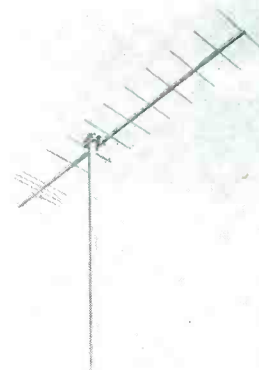



you're on **easy street**  
with **PHOTOFACT**  
**FIELD SERVICE HINTS & TROUBLE-SHOOTING AIDS**

VERTICAL

EXCLUSIVE Trouble-Shooting Aids—in each and every PHOTOFACT TV Folder—applicable to the particular receiver covered by the Folder. Describes trouble symptoms—tells where to look for them; explains new or unusual circuits used in the receiver. Specific, invaluable time-saving help!

NOW—included in each and every PHOTOFACT TV Folder! Invaluable time-saving guide and reference for adjustments and services you can perform on the specific receiver in the customer's home—right down to safety-glass cleaning tips. Helps eliminate costly chassis-hauling back to shop...

**22** other exclusive features consistently in every PHOTOFACT Folder—the world's best data for faster, more profitable servicing...

**NOW! GET THE PROOF FOR YOURSELF!**

**FREE** We'll send you a Free Photofact TV Folder—just ask us for it!

Learn for yourself how PHOTOFACT pays for itself by earning bigger profits for you! We'll send you the proof—a FREE specimen PHOTOFACT TV Folder that shows all the features found consistently and exclusively ONLY in PHOTOFACT. Send for your FREE specimen TV Folder now. Examine it. Compare it. You'll see why PHOTOFACT belongs in your shop! And you'll want to ask your parts distributor about the pay-as-you-earn-plan. Only \$25 down brings you the entire PHOTOFACT Library. Write for FREE specimen TV Folder—learn now how to earn more!

HOWARD W. SAMS & CO., INC.  
2207 E. 46th St., Indianapolis 5, Ind.

**HOWARD W. SAMS & CO., INC.**



**FINNEY WINS MISREPRESENTATION COURT DECISION**

A court judgement for damages and a permanent injunction against a Canton, Ohio, service company, that had been selling another-type antenna as a genuine Finco, has been obtained by the Finney Company, 4612 St. Clair Ave., Cleveland 3, Ohio.

Decision of the Court stated that . . . "The defendant has engaged in unfair competition by passing off unto its customers . . . as *Finco* antenna . . . other antennas of similar appearance which were not genuine *Finco* antennas . . . and which were not products of the Finco Co. . . and a final and permanent order, restraining defendant from further unfair competition, is granted."

After the decision was rendered, Finney, in a newspaper ad, reproduced a paragraph from the court decision and warned the Canton public against the possibility of being victimized in the future by the few and isolated service companies who engage in unscrupulous substitution practices.

Commenting on the decision, M. L. Finneburgh, Finney vice prexy, stated that . . . "If the electronics industry and, especially, antenna manufacturers are ever to achieve recognition as an honored and stable part of American industry, they must mature and aspire to standards of ethics, integrity, and dignity followed in other industries. Deception, substitution, and misrepresentation must be stopped."

\* \* \*

**S/C RECEIVES GUIDE-A-TUBE PATENT**

Patent 2,659,061, for a low-loss plastic wafer designed to guide miniature tubes into their respective sockets, has been issued to *Frank D. Mirabella* and *Nicholas Zanzano* of S/C Laboratories, Inc., 37 George St., Newark, N. J.

Wafer is slipped over the tube pins and the tube then inserted into the socket.

\* \* \*

**TV ANTENNA ENGINEERS MEET**



TV antenna engineering staff of JFD during a recent field test, left to right: *Sai Gambardella*, chief machine design engineer; *Hal Bloomberg*, assistant chief antenna development engineer; *Douglas H. Carpenter*, chief antenna development engineer; *Simon Holzman*, formerly with Federal Radio and Eng. Corp., who has joined JFD as a field engineer; *Jack Goodman*, chief production engineer of electronics division, and *Arne Benson*, chief mechanical development engineer.

**INTERNATIONAL RECTIFIER CORPORATION**  
EL SEGUNDO CALIFORNIA

**DIRECT REPLACEMENT**

**RADIO & TV Selenium Rectifiers**

**UNIVERSAL MOUNTING**

**WIDER RANGE**

**NOW AVAILABLE AT YOUR FAVORITE JOBBER**

*Write for Bulletin JRP-1*

**INTERNATIONAL RECTIFIER CORPORATION**

1521 E. Grand Ave., El Segundo, Calif. - Phone: ORegon 8-6281  
CHICAGO 205 W. Wacker Drive - Phone: Franklin 2-3889  
NEW YORK 501 Madison Avenue - Phone: Plaza 5-8665



**NEW! 1954 TV CONSULTANT  
TV Serviceman's Silent Partner**



New, easy-to-use way to solve toughest TV troubles. UHF sect. includes conversions, installations and servicing. Modern alignment methods shown by pictures, diagrams and simple directions, tell exactly what to do and how to do it. Practical pointers on use of all TV Test Instruments. Over 300 pix, raster and sound symptoms. Detailed directions tell where and how to find faulty parts. Over 135 **RAPID CHECKS**, many using pix tube as trouble locator. 125 illustr. of scope wave forms, diagrams, station patterns, show various defects—take mystery out of TV servicing. **NO THEORY — NO MATH — NO FORMULAS** — just practical service info. covering all types of TV sets.

Only.....\$2

**NEW! 1954 TV TUBE LOCATOR  
All Pix Tubes Listed!**

Money-making Time Saver tells which tubes to replace to cure every type of tube trouble. Over 135 such TV troubles listed with clear charts for quickly locating the faulty tubes. Copyrighted **TROUBLE INDICATING TUBE LOCATION GUIDES** for over 3000 most popular models from Admiral to Zenith plus **PIX TUBES** used in each model! 1947 to 1953 models. A storehouse of valuable TV servicing info. priced very low for large volume sales.



Only.....\$1

**NEW! Trouble Shooting PIX  
GUIDE incl. TV TERMS Explained**



Sec't. 1 is a fully illustrated **GUIDE** to oft-recurring pix faults. Causes and cures explained. Copyrighted Trouble Indicating illustrated chart tells where troubles start in typical TV set—illustrations show resulting faulty TV pictures. Sec't. 2 explains hundreds of TV terms in non-technical language. **SPEEDS UP TV SERVICING—HELPS YOU DO A BETTER JOB FASTER!**

Only.....\$1

**NEW! TV TROUBLE TRACER  
Vol's 1 & 2 Now Ready!**

70 Common TV troubles traced to source and cured. Copyrighted trouble indicating tube location guides covering over 1200 most popular TV models—many models different from those shown in TV TUBE LOCATOR. Each contains over 70 illustrations and tube location guides. Forty most common picture troubles illustrated, with symptoms described, causes given and remedies prescribed.



Vol. 1 Only 50¢  
Vol. 2 Only 50¢

**H. G. CISIN, Publisher**

Order from your Jobber today, or if not stocked, write to  
**Harry G. Cisin, Dept. S-18  
Amagansett, New York**

Enclosed find \$..... Send

- TV Consultant  Locator
- TV Pix Guide  TV Tracer Vol. 1
- TV Tracer Vol. 2

Name .....

Address .....

City .. Zone .. State ..

**Color TV Picture Tubes**

(Continued from page 27)

illustrated by Fig. 5, which also shows how the *dc* restorers are connected from the common  $E_V$  signal to the respective color difference signals. Thus, the signals appearing across each restorer correspond to the primary colors, namely  $E_R$ ,  $E_G$  and  $E_B$ . Because the higher-frequency components are not cancelled, high black-and-white definition is provided by the  $E_V$  signal.

Since the luminance signal applied to the control grids passes through a 0-4 mc filter, and the color difference signals have been obtained through circuits with smaller bandwidths, color difference signals experience a slightly longer delay than the luminance signal in reaching the picture tube. To compensate for this, the luminance signal is applied to the tube by means of a 1-microsecond delay line having a bandwidth of 4 mc.

**The Deflection Mask Tube**

The single-gun direct viewing tri-color picture tube using a deflection mask also resembles an ordinary black-and-white tube except in screen structure. On the screen of the tube, the phosphor is deposited in the form of strips, each phosphor strip emitting a primary color. To the rear of the screen is a beam deflecting structure consisting of two intermeshed wire grids. If no potential difference exists between these grids, the electron beam passes through them essentially undeflected to impinge on a phosphor strip emitting green light. However, if one grid is positive with respect to the other, the beam is deflected as it passes the wires and as a result excites, let us say, the red phosphor. If the polarity of the voltage existing between the two grids is reversed, then the beam excites the blue phosphor. If the deflection grids are operated at potentials lower than the final screen, then a focusing effect can be produced at the screen.

Since the grids to the rear of the screen in the deflection mask tube are solely for deflection and not for masking purpose, the beam is used with high efficiency.

**Circuit Arrangement with the  
Deflection Mask Tube**

In the three-gun shadow-mask tube, information relating to the three primary colors is presented simultaneously. (However, the tube could be used with field, line or dot sequential operating only one gun at a time.)

The deflection-mask tube, on the other hand, utilizing only a single gun

must present its colors sequentially to conform to field, line or dot sequential systems. When used with the NTSC compatible system with a 60-cps field rate, it is not feasible to use the tube with field-sequential switching because the flicker would be highly objectionable. Line sequential operation of the tube is relatively easy to perform, but an objectionable effect known as *line crawl* would be observed. In this effect, colored lines appear to move systematically across the face of the tube.

When used dot sequentially, the capacity between the two sets of deflecting grids becomes very important because for this type of operation, a color-switching frequency of 2-10 mc must be used. At these frequencies, the inter-grid capacity presents a very small impedance and the reactive power to drive the grids is large. A sine wave switching signal must be used; green dots occur twice as regularly as the red and blue dots but they are of only about half the duration.

A 3.58-mc signal (synchronized with the local color subcarrier oscillator) is used for this dot switching. The use of such a frequency has certain advantages, the primary one being that it provides a dot interlace in the presentation of the color information

Fig. 6. Diagram illustrating application of video signals to the deflection-mask tube

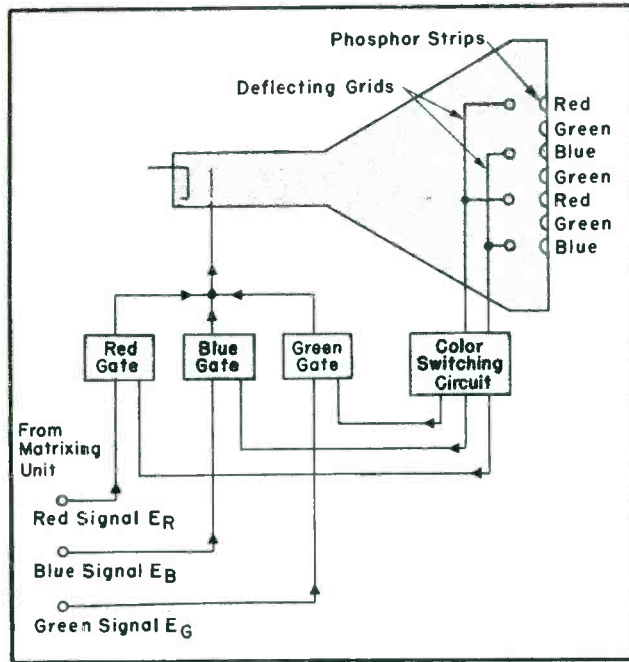

since the color subcarrier is synchronized to the line frequency. Moreover, since the color subcarrier is present on the luminance signal, the use of this frequency eliminates beating effects.

#### Gating Pulse

In the deflection mask tube, color signals are always fed to the grid of the tube through gating tubes. Fig. 6 illustrates the required circuit arrangement, showing the use of three gates, one for each signal corresponding to a primary color. The gating pulses fed to these gates must be synchronized to the color switching signals applied to the deflection grids. Thus for example, when no potential difference exists between the color switching grids and the beam falls on the green phosphor, the green gate is opened, allowing the  $E_G$  signal to be applied to the control grid. Similarly, when a deflecting potential is applied to the

grids to deflect the beam on to the red phosphor, the gate in the  $E_R$  signal circuit is opened up.

#### Future Developments

In the not-too-distant future it is highly probable that many other color picture tubes will be demonstrated. Scores of patents have been issued on such tubes but the technical difficulties of developing and fabricating these tubes have hindered their introduction. However, there is good reason to hope that modern technology will expedite their development. So far it is only possible to speculate on the nature of future tubes. It seems almost certain that they will feature only one gun; will not require dynamic focusing or convergence; will require only low power color switching circuits; will exhibit no color contamination but present a really bright picture and probably most important of all, be low in cost.

Now Available

# MUNTZ

## Flyback Replacements

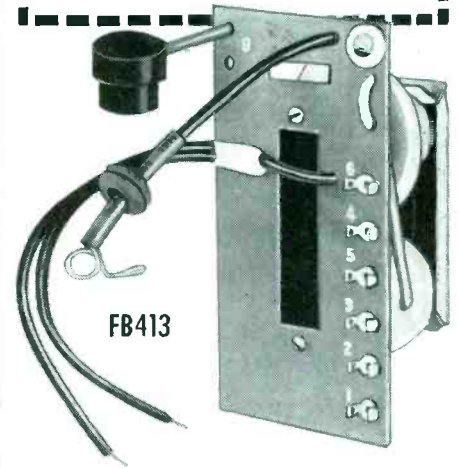

FB413

**HALLDORSON FB413**—A new exact replacement for Muntz TO-0031 Flyback used in hundreds of thousands of Muntz TV sets during 1951, 1952 and 1953.

DEALER'S NET, \$5.97

**HALLDORSON FB403**—An exact replacement for Muntz TO-0024 used in earlier Muntz TV sets.

DEALER'S NET, \$6.30

NOW, AT LOWEST PRICES, you get complete flyback coverage for all popular Muntz TV Sets. Write for descriptive Bulletin 115 showing models and chassis.

**PREMIER TV RADIO SUPPLY**  
Division of CONTINENTAL CORPORATION  
3239 West North Avenue, Chicago 47, Ill.  
DEPARTMENT 505 ARmitage 6-5550

### RADAR TYPE TV ANTENNA

For UHF and VHF RECEIVES ALL CHANNELS

212 miles reception recorded, 125 miles common. This unbeatable antenna has been reinforced to withstand 150 mile winds.

Satisfaction guaranteed or your money back. Less Mast, List Price.....\$49.95

Your Cost.....\$19.95

5 ft. ALUMINUM MAST heavy gauge 1/4" diam. with interlocking end. Slip two sections together for a ten-footer. 5 sections = 25ft.

Each section.....\$1.25

Write for our BARGAIN FLYER No. 55

### UHF Antenna Kit

Includes everything you need.

- 1.) UHF bow tie antenna with reflector.
- 2.) 3 mast sections.
- 3.) Jumbo 300 ohm tubular transmission line
- 4.) Sealer cap for UHF transmission line.
- 5.) Universal mast base.
- 6.) 50 ft. top quality guy wire.
- 7.) 3 screw eye anchors for guy wire.
- 8.) Guy wire ring.
- 9.) 3 stand off insulators for 300 ohm transmission line.
- 10.) 2 mast stand off insulators for 300 ohm transmission line.
- 11.) Illustrated instructions for quick, easy assembly.

All in one carton for only \$7.65  
Double bay array complete as above plus 5 mast sections and matching device for proper stacking \$11.77

### TV Antennas

10 Element conical... rugged throughout. Only \$3.95

Double bay array.....\$7.75

4 Bay array, with harness and stacking bars.....\$14.95  
6 Element Conical. Only.....\$2.95

## HALLDORSON REPLACEMENTS

are now being listed in PHOTOFACTS and COUNTER FACTS

HALLDORSON TRANSFORMER CO.  
4500 Ravenswood Avenue  
Chicago 40, Illinois

**Haldorson**  
QUALITY Transformers SINCE 1913

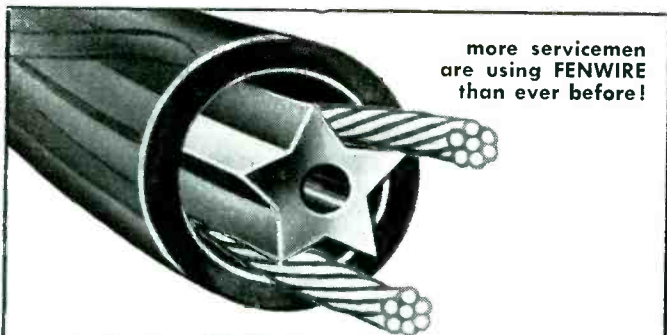

more servicemen  
are using FENWIRE  
than ever before!

# FENWIRE

## twisttube

**300-OHM ROUND TRANPOSED  
SEMI-AIRSPACED TUBULAR LINE**

The only transposed transmission line specifically developed to reduce interference pickup. 7/28 AWG conductors semi-air spaced and transposed around a hollow star-shaped former.

Sold Through  
Jobbers Only



Write Dept. SV-1 for complete FENWIRE line.

**FENTON COMPANY**

15 MOORE ST. • NEW YORK 4, N. Y.

U. S. and British Patents Pending

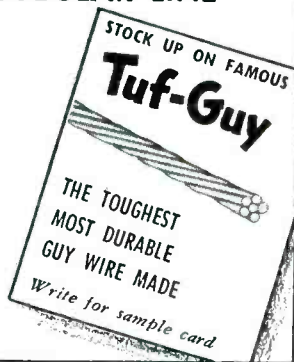

## WHEN YOU CHANGE YOUR ADDRESS

Be sure to notify the Subscription Department of SERVICE at 52 Vanderbilt Avenue, New York 17, N. Y., giving the old as well as the new address, and do this at least four weeks in advance. The Post Office Department does not forward magazines unless you pay additional postage, and we cannot duplicate copies mailed to the old address. We ask your cooperation.

## Coming Events

**1954 Pacific Coast Audio Fair: Feb. 4-6**  
Alexandria Hotel, Los Angeles, Cal.

**Radio Engineering Show: Mar. 22-25**  
Waldorf-Astoria Hotel and Kingsbridge Armory, New York City.

**1954 Electronics Parts Show: May 17-20**  
Conrad Hilton Hotel, Chicago, Ill.

## Better Audio

(Continued from page 23)

shown in Fig. 7 has been found to be preferred, because it lessens the change of impedance across the earphone transformer as the volume level is changed. Impedance changes often lead to puzzling distortions, and certainly if a low-impedance volume control is used with a high-impedance pair of earphones, as shown in Fig. 7, practically constant loading can be maintained across the earphone transformer. Treble and bass boost tone-control circuits are often desirable, in addition to the volume control.

It should be noted that when an

impedance  $Z_1$  is shunted across another impedance  $Z_2$ , the resultant impedance is equal to  $Z_1 Z_2 / (Z_1 + Z_2)$ . In the simple case in which  $Z_1 = Z_2$ , the resultant is  $1/2 Z_1$ . This is a consideration of central importance, because the output transformer in a receiver is designed to reflect the speaker impedance back into the plate circuit of the output tube as an increased value

Fig. 5 (left). The secondary of the output transformer is sometimes associated with a hum-bucking coil as well as the voice coil. The likelihood of the secondary withstanding a 2000 volt megger test to chassis is considerably lessened in an arrangement of this type.

which constitutes a low-distortion plate load. When the earphone transformer is shunted across the secondary of the output transformer, the effective plate load presented to the output tube is lowered. The simplest way to avoid distortion due to impedance lowering is to utilize an earphone transformer, which reflects the impedance of the volume control back

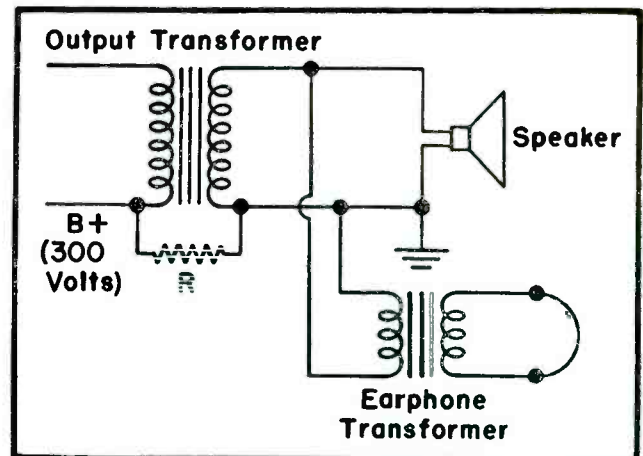
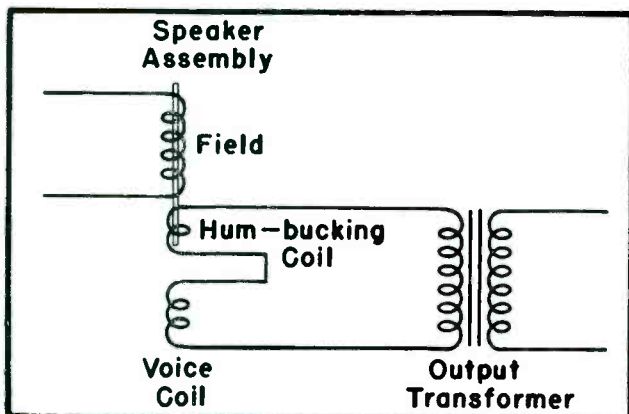

Fig. 6. A preferred basic arrangement for connecting earphones into receiver circuit. When the secondary of the output transformer in the receiver is grounded, the secondary cannot receive B+ voltage, in the event of leakage between primary and secondary. By use of a separate earphone transformer, the earphone circuit is ungrounded, affording safety to the user in switching lamps off and on, as well as in switching a hot chassis receiver off and on. The dotted resistance R indicates a B+ leakage path which can inject plate-supply voltage into the speaker circuit.



New and Popular

**Mueller**

PRODUCTS

COMPLETELY INSULATED



Alligator Clip.  
New No. 62  
Insulator Covers  
Mueller 60 Series  
Alligator Clips.

NEEDLE CLIP

Pierces insulation—  
makes quick contact  
anywhere along insu-  
lated wire. No. 50-C.



WEE-PEE-WEE  
CLIP

A small slim-nosed clip  
for miniaturized cir-  
cuits. Phosphor bronze  
No. 88.



STAND-OFF INSULATOR

The most  
versatile!  
Grips masts,  
guy wires  
or gutters.  
No. 135.



Send for Free Samples and Catalog 810

**Mueller Electric Co.**

1565 E. 31st STREET CLEVELAND 14, OHIO

**Masco**  
**CASCADIAN**



**Sensational New All-Channel  
TV BOOSTER**

TV Service Dealers and Distributors  
All Over the Country Hail Field-Test Results...  
Agree—"Most Exciting Booster in Years"...

- CASCADIAN'S special adaptation of Cascode Circuit provides excellent NOISE FREE reception with new style TV front ends
- Gives better picture than previously possible with older style receivers
- Handsome metal cabinet, two-tone brown and tan

- Good snow-free picture in fringe areas now possible
- Average gain of 56 times on all channels (35 db.)
- Automatically switched on and off by the TV set
- Single knob control

Send For Catalog TVB 353



MARK SIMPSON MANUFACTURING CO., Inc.  
32-28 49th Street, Long Island City 3, N. Y.

into the secondary of the output transformer, with a value at least five times that of the speaker impedance. The speaker impedance is commonly assumed to be equal to 1.3 times the *dc* resistance of the voice coil; Fig. 8.

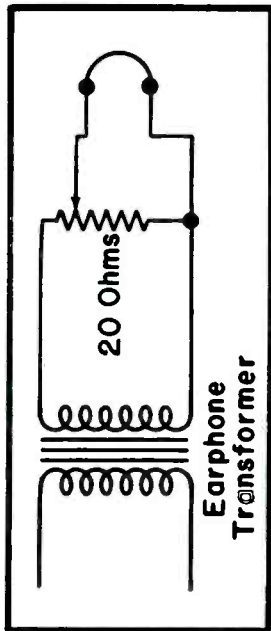
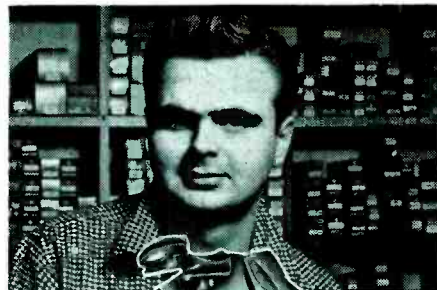
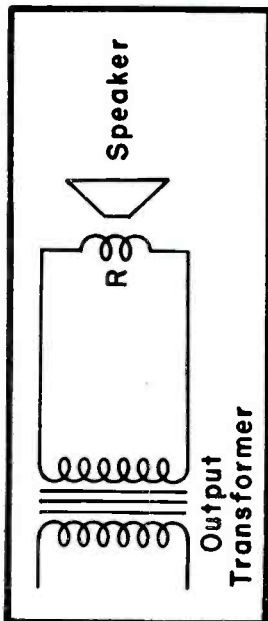

Fig. 7. Volume control in the earphone circuit arranged as a bleeder across the transformer secondary to minimize impedance change across circuit as the volume level is varied. Use of high-impedance earphones further minimizes undesirable impedance changes.

Fig. 8. The ac impedance of the speaker is roughly equal to 1.3 times the *dc* resistance, *R*, of the voice coil. The turns ratio of the output transformer steps up this impedance (reflects the impedance) to the primary winding with a value which provides a low-distortion plate load for the output tube. Tube manufacturers publish recommended plate load values in tube manuals. One should note that when the winding of another transformer is shunted across the secondary of the output transformer, the effective plate load for the output tube is lowered; the incorrect plate-load impedance can result in noticeable distortion. Suitable arrangements can be used to maintain proper plate-load impedance.



**"Webcor  
Diskchangers  
are easiest  
to install"** ...says  
*Al Zeller, Wigdahl Electric,  
Chicago, Illinois*

More and more servicemen are choosing Webcor for swift, trouble-free record-changer installations.

Even INEXPERIENCED servicemen can follow the *actual size* drawing and simple instructions. And to make your job *even easier*, Webcor offers a mounting board with the *inside already cut out to fit*. You just trim the outside to size and screw down the board. Each mounting board has **PREDRILLED HOLES** for quick, sure changer mounting. Average installation by experienced servicemen is under 15 minutes. Call your Webcor distributor today!



Webcor Hi-Fi 3-speed changers are world famous for quality. With Webcor you have:

Webcor template  
**FREE**



Webcor Mounting  
Board \$2.50

- A choice of **TWO** different sizes
  - A choice of **THREE** different colors
  - A choice of **TWO** pickups (magnetic or ceramic)
- PLUS... exclusive Velocity Trip, Step Drive, powerful motor super-thick Flocking, Balanced Tone Arm. From \$49.50.

A Webcor Diskchanger is the heart of every High-Fidelity installation.

**Webcor®**  
Webcor is the trade name of Webster Chicago Corp.  
Chicago 39, Illinois



Money Back Guarantee  
(Cost of Mfse. Only) \$5  
Min. Order F.B.N.Y.C.  
Add Shpg. Charges or  
25% Dep. Tubes Gtd.  
via R-Exp. only. Prices  
Subject to Change.  
Phone Rector 2-6245

### REBUILT TV PICTURE TUBES

Standard One Year Guarantee  
Duds must be shipped in advance prepaid.  
We then ship new tubes from our stock.  
All types available.



**F.O.E. N. Y. C.** \$1.00 PER INCH  
Add 10¢ per inch for metal or Electrostatic Types

### NEW "LENK" 180 WATT SOLDERING GUN



No other gun offers all these features at any price. 115 VAC 180 Watt, perfect balance, lightweight 28 oz., melts solder 3 1/2 seconds. swivel 180° tip, heavy duty transformer, positive trigger-easy action. balanced Luger pistol feel. "TAB" Special \$7.45

### TUBES

90 DAY "TAB" GUARANTEED	
OB3 .96	6AX4 .74
OC3 .92	6BA6 .54
OD3 .92	6BA7 1.09
IB3 .80	6BC7 1.23
IR5 .59	6BE6 .54
IU4 .52	6BG6 1.58
IU5 .54	6BH6 .63
IU2A .98	6BT9 .96
SU4G .55	6BK7 1.58
5Y3 .43	6BL7 1.19
6AC7 .80	6BN6 1.19
6AF4 1.29	6BQ6 1.20
6AG5 .71	6BQ7 1.65
6AL5 .48	6BZ7 1.49
6AN5 2.90	6BT6 .54
6AQ5 .32	6BC6 .59
6AQ6 .81	6CD6 1.69
6AT6 .54	6J6 .58
6AU6 .56	6K6 .54
6AV6 .49	6L6G 1.08
6AW6 1.09	6SA7 .66
5S7 .64	6SH7 .61
6SK7 .58	6SK7 .56
6SL7 .64	6SL7 .64
6SN7 .68	6SN7 .68
6SQ7 .62	6SQ7 .62
6SR5 .54	6SR5 .54
6S7G .80	6S7G .80
6S7H .63	6S7H .63
6S7J .54	6S7J .54
6S7K .66	6S7K .66
6S7L .62	6S7L .62
6S7N .68	6S7N .68
6S7Q .54	6S7Q .54
6S7R .98	6S7R .98
35W4 .49	35W4 .49
35Z5 .54	35Z5 .54
50B5 .54	50B5 .54
50L6 .62	50L6 .62
80 .58	80 .58

### SPECIAL — SPECIAL — SPECIAL

You Pick Them, Lots of 10 at 39c each  
(Cracked base or broken key electrically perfect.  
TESTED & 90 DAY GUARANTEED.

SU4G-6SN7-25L6GT-25BQ6  
5Y3GT-6K6GT-12SA7GT-6H6  
6V6-6BQ6-6W4-12SQ7

### TELEVISION ANTENNA

VEE CONICAL, all channel, for fringe areas...\$8.95  
FOLDED DIPOLE Hi & low antennas, all channel...\$4.95  
TV CONICAL ANTENNA All Channel, Sturdy...\$3.95  
DOUBLE-V Ant. All Channel, Sturdy Cons. w/Mtg.  
Clamps & 100 ft. TwineX...\$4.49  
WINDOW CONICAL ANT. All Channel...\$3.95  
5 FOOT Interlocking Mast Sections, Heavy Duty,  
rustproof...2 for \$1.49; 10 for \$7  
ANTENNA COMBINATION, SPECIAL-TV ANTENNA,  
2 POLES, 100 FT. TWINE X, & MTG. ACCS. \$5.69

### TV TWINE X & COAX CABLE

300 Ohm TwineX, Heavy Duty 65 mil  
all copper TV lead in.  
Per ft. 2¢; 100 feet...\$1.39  
1000 foot reel...\$11.95  
RG59 73 ohm TV Coax Cable MPGRD  
to rigid UHF specs, per ft. 5¢ 100 ft...\$ 4.50  
SPECIAL 500 feet...\$22.00

### REPAIR KIT #873

All the tools needed for on-the-spot repair job. Includes (4) interchangeable screw driver blades and handle, electrician's pliers, adjustable wrench, long-nose pliers and wrap-around case. Tempered tool steel...\$2.69  
Model 3701 6 screw drivers from 12" down, all tempered tool steel, magnetized, hammer-proof amber handles. Special...96¢  
My Buddy 8 pcs. kit (5) interchangeable screw driver blades and handle. 3 ft. steel tape rule, diagonal cutter and case. "TAB" SPECIAL...\$1.79



### YOU PICK THEM 39c ea. WHILE THEY LAST

ELECTROLYTIC CONDENSERS	
20MFD/25VDC	2X15MFD/350VDC
20MFD/450VDC	2X20MFD/25V. 30MFD/450V
25MFD/300VDC	40MFD/250V. 20MFD/25V
50MFD/350VDC	3X100MFD/35VDC
100MFD/25VDC	30/15/10MFD/250VDC

ALL SIZES & TYPES NEW STOCK

### DRILL KIT

2001K workshop, 55 pcs. set. A must for the SERVICEMAN. Includes 3/4" 200J drill, w/Jacobs chuck, drill bits & accessories for grinding, polishing, buffing, sanding, Paint Stirrer and many other uses. 55 pieces in all. Special...\$19.25



### KITS AND COMPONENTS

Oil Condensers Assorted	5 for \$1.25
Electrolytics Assorted	5 for 1.25
Silver & Mica Condensers	15 for 1.25
Volume Controls, Popular Values	5 for 1.25
Resistors, 1/2 & 1W	100 for 1.25
Sockets, Assorted 8, 7, 5, 4P	12 for 1.25
Knobs, Assorted w/Insert	10 for 1.25

"TAB" Special \$1.00 EACH Lots of 5

Dept. 15  
111 Liberty St.  
New York 6, N. Y., U. S. A.  
Rector 2-6245

### SPRAGUE CAPACITOR GUIDE AND PLASTIC PACKAGE

A capacitor replacement guide, C-452, designed to hang on the wall, has been prepared by the Sprague Products Co., 61 Marshall St., North Adams, Mass.

Featuring flip-type pages, guide lists all Sprague capacitors and provides data on capacitance, *wvdc*, diameter and length, catalog number and price.

A replacement line of ceramic capacitors, furnished in clear molded Plasti-Pak polystyrene boxes, has also been announced.

Rigid reuseable containers have a hinged lid and a snap lock. Also available for printed circuit units, with labels showing complete circuit diagram and application notes.



### RCA DEVELOPS COLOR TV TRAINING PROGRAM

A training and educational program, designed to provide complete information on the theory and practice of installation and service for color TV receiving equipment, before the first commercial color sets reach the public, has been announced by the RCA Service Co.

The program is divided into four major elements. One is a series of two-day technical clinics to be held in 65 key cities across the country, starting early in February. Clinics will be conducted by technical specialists of RCA Service using textbooks, test equipment, and other instructional materials developed especially for the clinics by the company. Service dealers and Service Men in each city will be invited to attend.

RCA Service has also prepared a textbook, *Practical Color Television for the Service Industry*, illustrated by photographs in four colors, which graphically depicts service techniques for color TV receiver installation and maintenance.

Copies of the book will be available to Service Men completing the clinics. It will also be made available either through RCA parts and tube distributors or directly from the RCA Service Co., Camden, N. J., at \$2.00 per copy.

### FEDERAL OPENS REGIONAL WAREHOUSES

A regional program of warehouse facilities for the distributor market, with the opening of a New England outlet at 292 Main St., Cambridge, Mass., has been announced by the Federal Electric Corp., Clifton, N. J.

Outlets will facilitate the flow of selenium rectifiers, coax cable, TV lead-in, picture tubes and germanium diodes, manufactured by FTR. Orders on the warehouse are being handled through *Abbett and Hustis*, 1105 Commonwealth Ave., Boston, Mass. Warehousing facilities are already in operation on the west coast and in the southwest.

## THE NEW TV DYNATRACER

**\$4.95**  
Ppd.  
or C.O.D.  
+ Chgs.

- Traces TV Signals and Voltages
- Locates Defective Components
- Requires No Additional Equipment

This sensationally new piece of test equipment is ideal for troubleshooting television sets in the home or in the shop. The "DYNATRACER" will outperform more expensive testers and should pay for itself on first repair.

A Must For Every TV Technician

**SPECIFICATIONS:** The "DYNATRACER" is a self-powered quality test instrument designed to trace TV signals through any Video, Sound, Sync, AFC, Horizontal or Vertical Sweep Circuit—will isolate trouble to a stage or component.

**ADDED FEATURE:** The "DYNATRACER" will also trace voltages (50/500 V. AC/DC) and instantly locate open, shorted, intermittent or leaky (up to 20 megohms) condensers, resistors, coils, transformers, etc.

Instruction and Trouble-Shooting Book Enclosed  
**10-DAY MONEY-BACK GUARANTEE**  
Cut out ad, attach name and address, with \$5 bill, check or money order, and mail to

## Century ELECTRONICS CO.

8509 21st Ave., Dept. 304, Brooklyn 14, N. Y.

### ALL-CHANNEL APPOINTS BING CROSBY ENTERPRISES COAST DISTRIBUTOR

Bing Crosby Enterprises, Inc., has been appointed exclusive west coast distributor to handle the line of motorless all-direction antennas produced by the All Channel Antenna Corp., 70-07 Queens Blvd., Woodside, N. Y.

Bing Crosby Enterprises has established dealer franchises.

### SYLVANIA REVISED PICTURE-TUBE COMPARISON WALL CHART

A new version of the *TV Picture Tube Comparison Chart*, has been announced by Sylvania.

Over 160 different picture tube types are listed on the chart. Added informational features in this new chart include info trap listings and base diagrams. Face, body, focus, deflection angles, basings, and length in inches on all tubes are also included. Can be obtained free from Sylvania advertising distribution department, 1100 Main St., Buffalo, N. Y.

### PROFIT-SHARING AWARD



Harry Resnick (left), president of Channel Master Corp., presenting check for \$332,531.43 to the trustee of the company's employee profit-sharing retirement fund. The amount, 15% of the year's earnings up to September 30, '53, of the 574 participants employed, was said to be the maximum contribution permitted by law. Contributions to the fund, based solely on Channel Master's profits, consist of 10% of the first \$125,000 of net profits and all profits above that, up to the maximum limit.

## JOTS AND FLASHES

COLOR TV chassis will not only employ a host of new components, but special types of tubes, too. G.E. has already announced the development of a miniature triple diode, coded 6BJ7, whose primary application is as the *dc restorer* for the three signal channels of color receivers. The electrical characteristics of each section of the 6BJ7 are similar to those of each section of the 6AL5 twin triode. . . . *Ludwig Arnson*, 70-year-old prexy of Radio Receptor Co., Inc., was honored recently by the VWOA on the 50th anniversary of his key-clicking of the first distress call by wireless from S.S. Kroonland. . . . *Dick O. Klein*, vice president and general manager of Raytheon Distributors, Inc., has been appointed director of marketing for the TV and radio division of the Raytheon Manufacturing Co. . . . *Don G. Mitchell*, chairman of the board of Sylvania Electric Products, Inc., has been named Commerce & Industry chairman for the 1954 campaign for members and funds of the New York Chapter, American Red Cross. . . . *Dr. Allen B. Du Mont* was recently selected for the *Hall of Fame in Distribution* by the Boston Conference on Distribution. The citation was made for distinguished contribution to the advancement of distribution through TV in the last quarter century. (The Boston Conference is a permanent group sponsored by the Boston Chamber of Commerce in cooperation with leading Massachusetts universities and colleges.) . . . Five RCA Fellowship awards by RCA to young scientists and graduate engineering students for the 1953-1954 college year were announced recently by *Dr. C. B. Jolliffe*, vice president

and technical director of RCA. The fellowship grants, which range from \$1,800 to \$2,700, went to *Harold S. Rothman*, *Robert C. Miller*, *William Y. Stevens*, *Peter H. Lord*, and *Robert A. Kudlich*. . . . A community TV system has been installed in Vancouver, by *Spencer-Kennedy Lab's* licensee in western Canada, Research Industries, Ltd., for Tru Vu Television Ltd. The system will be expanded to service eventually 100,000 sets. In full operation, channel 2 from Vancouver, channels 4, 5, and 7 from Seattle, channel 12 from Bellingham, and channels 11 and 13 from Tacoma, and a closed loop channel will be distributed. To date, 30,000' of K-14, 50,000' of RG-11/U, and 25,000' of RG-59/U cable have been installed in the initial section of the city. The longest run from the antenna will be 14 miles and total area to be served will be 20 by 8 miles. At present, 2,500 dwelling units are being serviced. . . . *Webster-Chicago Corp.* will establish a branch assembly plant at New Ulm, Minn., early in '54, it was reported recently by *R. F. Blash*, president. . . . Electro Products Labs have expanded production area at their plant, 4501 North Ravenswood Ave., Chicago, adding 30 per cent more floor space. . . . *Bob Middleton*, formerly with RCA and Precision Apparatus, has joined the sales-engineering division of Simpson Electric Company, Chicago. In his new position, Middleton will conduct lectures for Service Men throughout the country. A novel twist will be an open invitation to all who attend the meetings to bring their *can't-fix-it* repair problems to the sponsoring jobber the following morning. Bob will personally tackle each repair problem with Simpson test equipment.

## ADVERTISERS IN SERVICE, JANUARY, 1954

Acme Electric Corp.	46	Mueller Electric Co.	77
Admiral Corp.	80	Oelrich Publications	66
Aerovox Corp.	62	Ohmite Manufacturing Co.	57
All Channel Antenna Corp.	52	Oxford Electric Corp.	48
American Microphone Co.	48	Phalo Plastics Corp.	67
American Phenolic Corp.	40, 41	Precision Apparatus Co., Inc.	35
Astron Corp.	43	Premier-TV Radio Supply	75
Atlas Sound Corp.	62	Quietrol Co.	71
Baker Manufacturing Co.	37	Rad-El-Co Manufacturing Co.	72
Blonder-Tongue Labs., Inc.	45	The Radiart Corp.	Inside Front Cover
Bussmann Manufacturing Co.	14	Radio City Products Co., Inc.	5
CBS-Hytron (Div. Columbia Broadcast- ing System)	4	Radio Corporation of America	Back Cover
Century Electronics Co.	78	Radio Materials Corp.	54
Channel Master Corp.	8-9	Raytheon Manufacturing Co.	16
Chemical Electronic Engineering Co.	48	John F. Rider Publisher, Inc.	53
Chicago Standard Transformer Corp.	63	Howard W. Sams & Co., Inc.	73
H. G. Cisin	74	Sangamo Electric Co.	74
Cornell-Dubilier Electric Corp.	70, 71	Mark Simpson Mfg. Co., Inc.	77
Allen B. Du Mont Laboratories, Inc.	12	Snyder Manufacturing Co.	39
Electra-Craft Co.	72	Sonotone Corp.	51
Electronic Chemical Corp.	62	South River Metal Products Co., Inc.	54
Electro Products Laboratories	3	Sprague Products Co.	1
Erie Resistor Corp.	64	Sutton Electric Co.	56
Fenton Co.	76	Sylvania Electric Products, Inc.	10
General Cement Manufacturing Co.	2	TAB	78
The General Industries Co.	50	T.V. Products Co., Inc.	21
General Instrument & Appliance Corp.	15	Telematic, Inc.	60, 61
Haldorson Transformer Co.	75	Telrex, Inc.	13
The Heath Co.	66	Triad Transformer Corp.	67
Hickok Electrical Instrument Co.	74	Tung-Sol Electric, Inc.	58, 59
Industrial Television, Inc.	79	U. S. Treasury Dept.	42
The Institute of Radio Engineers	69	United States Wire & Cable Co.	55
International Rectifier Co.	73	V-M Corporation	65
JFD Manufacturing Co., Inc.	47	Vidaire Electronics Manufacturing Co.	64
Kester Solder Co.	72	Walsco Electronics Corp.	32
Leader Electronics, Inc.	11	The Ward Products Corp.	18
The Macmillan Co.	54	Webster-Chicago Corporation	77
P. R. Mallory & Co., Inc.	Inside Back Cover	Wen Products, Inc.	44
		Westinghouse Electric Corp.—Electronic Tube Div.	6, 7
		Windsor Electronic Tube Co.	68

FOR CLEAREST,  
STEADIEST RECEPTION

# Boost UHF Before Conversion



133-A

UHF AutoBooster

List Price \$49.95

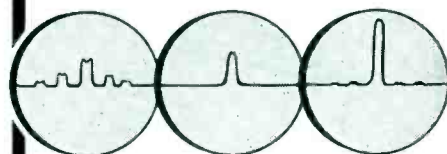

Typical  
Receiver-  
Converter  
Response

UHF  
AutoBooster  
Response

Combined  
Receiver-  
Converter-  
AutoBooster  
Response

Now you can boost the power of the *desired* signal, and tune out *interfering* signals—with the new ITI 133-A UHF AutoBooster.

This great new booster increases station power nearly *ten times*. Even under the most unfavorable conditions, the 133-A provides *clear, steady, interference-free* pictures. It's the ideal working companion for all UHF and UHF-VHF systems. In *fringe* areas, it provides a lower noise figure, eliminating snow, and a high gain which compensates for strip or converter losses. In *primary* areas, it affords increased selectivity, eliminating interference, and a grounded grid RF which suppresses oscillator radiation. It is tunable over the entire UHF range. Write for technical data sheet today.



INDUSTRIAL  
TELEVISION, INC.

369 Lexington Avenue Clifton, New Jersey

# Admiral

**ALL-CHANNEL**

# UHF

**ANTENNAS**

**HIGH GAIN**

**LOW COST**

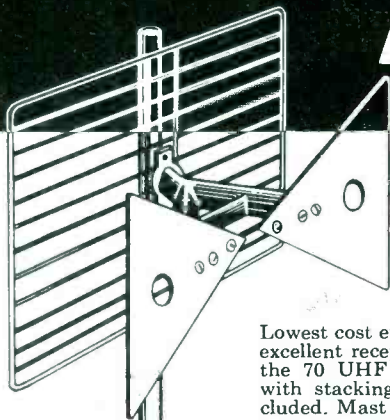

## Admiral BOW TIE

Lowest cost ever for a quality UHF antenna. Gets excellent reception in good signal areas on any of the 70 UHF channels. Each antenna furnished with stacking bar. Mast mounting brackets included. Mast not included.

No. AN65A—Deluxe—Shipped completely assembled. Suggested list price..... **\$5.95**

No. AN65B—Standard—Similar to above, smaller reflector screen. Shipped knocked-down. Sug. list price.. **\$3.95**

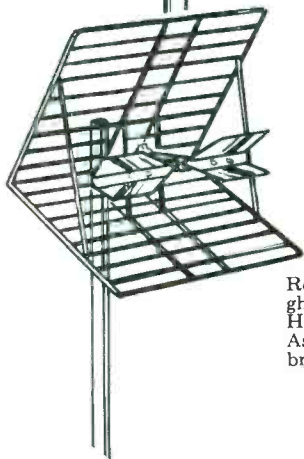

## Admiral CORNER REFLECTOR

Recommended for troublesome locations where ghosts, reflections and interference are encountered. High gain, 14db. Front to back ratio 15 to 1. Assembled, ready to put up. Mast mounting bracket included. Mast not included.

No. AN56A—One bracket mounting. Suggested list price..... **\$11.25**

No. AN56B—Same as above, front mounting. Suggested list price..... **\$11.25**

## INDOOR UHF ANTENNAS

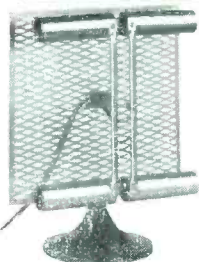

### Admiral Super

Recommended for troublesome locations. Exceptionally high gain... over 7 db... excellent ghost suppression. Only 12 inches wide. Weighted and felt padded base.

### Admiral Target

Smartly styled in rose-gold colored anodized aluminum with mahogany phenolic base. Stands only 10 inches high. Base is weighted and felt padded... can be placed on top of receiver... picks up all UHF channels.

No. 94A10-6—Complete with lead-in. Suggested list price... **\$12.95**



No. 94A10-7—Complete with lead-in. Suggested list price... **\$4.95**

You'll make an *extra profit* on every installation using these high gain UHF antennas. Ask your Admiral distributor about the *extra large discounts* from the list prices quoted here.

You'll be giving your customer extra value, too! All these antennas are finest quality... made with aircraft aluminum antenna elements and vibration-proof reflectors. "A-frame" insulators provide plenty of free air space around elements. The units have high mechanical strength and low resistance. They are *double* plated for extra resistance to weathering... first zinc plated, then dipped in zinc dichromate which gives them a beautiful gold finish. These antennas can be easily fastened to existing masts and towers. Order by part number from your Admiral distributor.

Ask your Admiral distributor for  
**FREE CATALOG**  
with complete line of Admiral  
TV antennas and accessories

**Admiral Corporation**  
Accessories and Equipment Division,  
Chicago 47, Illinois

Depend on Mallory  
for  
Approved Precision Quality

The sales leader—  
proved in every UHF area



## Now... The MALLORY CONVERTER Packs ALL Features in Half the Size!

The new Model 88 has these important Sales Advantages  
originated by Mallory:

**Less than half as large** . . . measuring only 7 $\frac{5}{8}$ " wide x 5 $\frac{9}{16}$ " high x 4 $\frac{5}{8}$ " deep . . . yet full Mallory quality.

**It has linear tracking.** Tuning is easier, more exact than ever. No bunching of channels.

**The Preselector** in the new 88 protects against image interference, oscillator radiation and interference at the IF frequency. It insures better selectivity.

**The Mallory 88 Converter** adds *all* UHF channels to *any* TV set without sacrificing a single VHF channel.

**Design refinements** and precision quality of the 88 assure high quality picture definition and easy tuning.

**The customer has nothing more to buy**, no adjustments to make for additional new channels . . . even if he moves to another area.

**Installation is easy.** It only takes a few minutes to connect the antenna and power leads from the Converter to the set. It can be done right in the customer's home.

**ASK YOUR MALLORY DISTRIBUTOR** for complete details of the new, handsome, compact Model 88 Converter. It can be your answer to bigger profits . . . just as all Mallory Converters have been for dealers in areas where UHF is already on the air.

P. R. MALLORY & CO. INC.  
**MALLORY**

CAPACITORS • CONTROLS • VIBRATORS • SWITCHES • RESISTORS  
RECTIFIERS • POWER SUPPLIES • FILTERS • MERCURY BATTERIES  
**APPROVED PRECISION PRODUCTS**

**P. R. MALLORY & CO., Inc., INDIANAPOLIS 6, INDIANA**

# Now... only \$149<sup>50</sup> Suggested User Price the popular RCA WO-88A

featuring . . .

- ✓ Voltage-Measuring Facilities
- ✓ "Plus" and "Minus" Sync
- ✓ High-Input Resistance
- ✓ Low-Input Capacitance

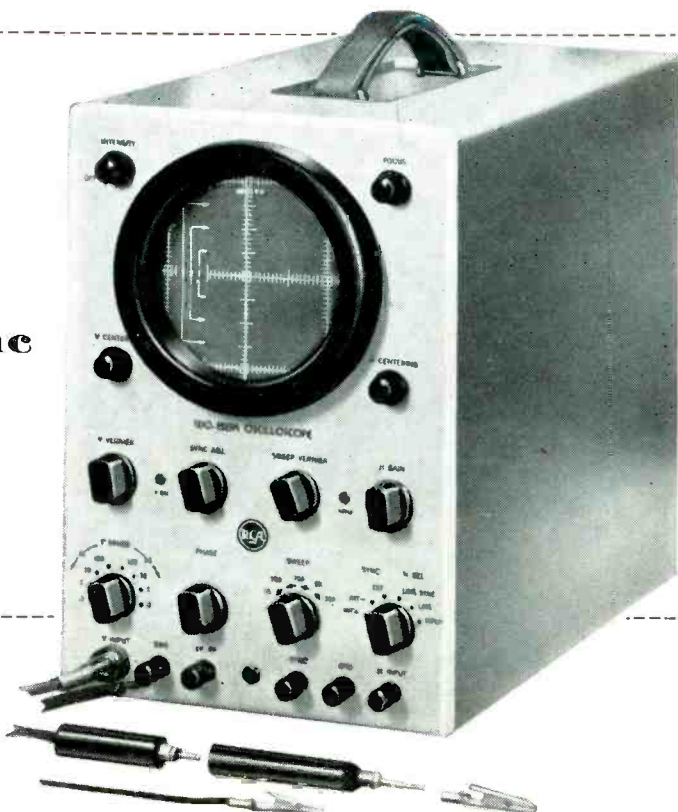

Check these "extra" features

- Direct-coupled vertical amplifier
- 5" Cathode-ray tube with magnetic shield
- 60-cycle sweep with wide-angle phasing control
- Frequency-compensated attenuators
- "Voltmeter-type" vertical attenuator
- "Voltmeter-scale" type graph screen
- 1-volt peak-to-peak calibrating voltage
- "Scope is completely stable—even at maximum sensitivity of 25 millivolt-per-inch
- Quick "recovery" time, freedom from line "bounce"
- Completely shielded input cable eliminates hum and noise pickup

Specifications—

- Deflection Sensitivity: (vertical amplifier) 25 rms millivolts or better per inch.
- Vertical-Amplifier Frequency Response: Flat from dc to 100 Kc; within -3 db at 500 Kc; within -10 db at 1 Mc.
- Input Resistance and Capacitance: 10 megohms and 9.5 uuf with WG-216B Low-Capacitance Probe.
- Sweep-Circuit Frequency (four ranges): 15 cps to 30 Kc.
- Square-Wave Response: Negligible tilt and overshoot.
- Average Rise Time (Vert. Amp.): 0.5 microsec.
- Power Supply: 105-125 volts, 50-60 cycles.
- Size 13½" high, 9" wide, 16½" deep. Weight only 25 lbs. (net).

The WO-88A has built-in voltage calibrating facilities which permit simultaneous waveshape display and peak-to-peak voltage measurements. Frequently, the shape of the TV waveform under observation will be correct but its amplitude will be low and, consequently, cause improper operation. Therefore, a TV 'scope is complete only if it can measure the peak-to-peak voltage of the displayed waveform. Check this feature on the "88"!

On the WO-88A, sync polarity may be reversed instantly by simply clicking a front-panel switch. This feature is important because TV pulses may be either positive or negative, depending upon where the 'scope is connected. To avoid waveshape "jitter" or distortion, use a 'scope which will "lock in" readily on all types of TV waveforms. Check this feature on the "88"!

When you use the low-capacitance probe supplied with the WO-88A, the over-all input resistance is raised to 10

megohms! Because many TV circuits are extremely sensitive to resistive loading, normal circuit operation may be seriously disrupted by loading of the average 'scope. With the low-capacitance probe, however, loading problems are minimized. Check this feature on the "88"!

In addition, the low-capacitance probe supplied with the WO-88A decreases the over-all input capacitance to less than 10 uuf! Excessive capacitance loading can cause the horizontal oscillator to change frequency or stop oscillating. When the WO-88A is connected, the low over-all input capacitance leaves receiver operation essentially unaffected. Check this feature on the "88"!

Get full details today from your RCA Distributor or clip coupon and mail to:

RCA Commercial Engineering  
 Section A-44-W, Harrison, N. J.  
 Please send me your new folder on the RCA  
 WO-88A Oscilloscope.

NAME \_\_\_\_\_

ADDRESS \_\_\_\_\_

CITY \_\_\_\_\_ STATE \_\_\_\_\_ ZONE \_\_\_\_\_



**RADIO CORPORATION of AMERICA**  
 TEST EQUIPMENT

HARRISON, N. J.