

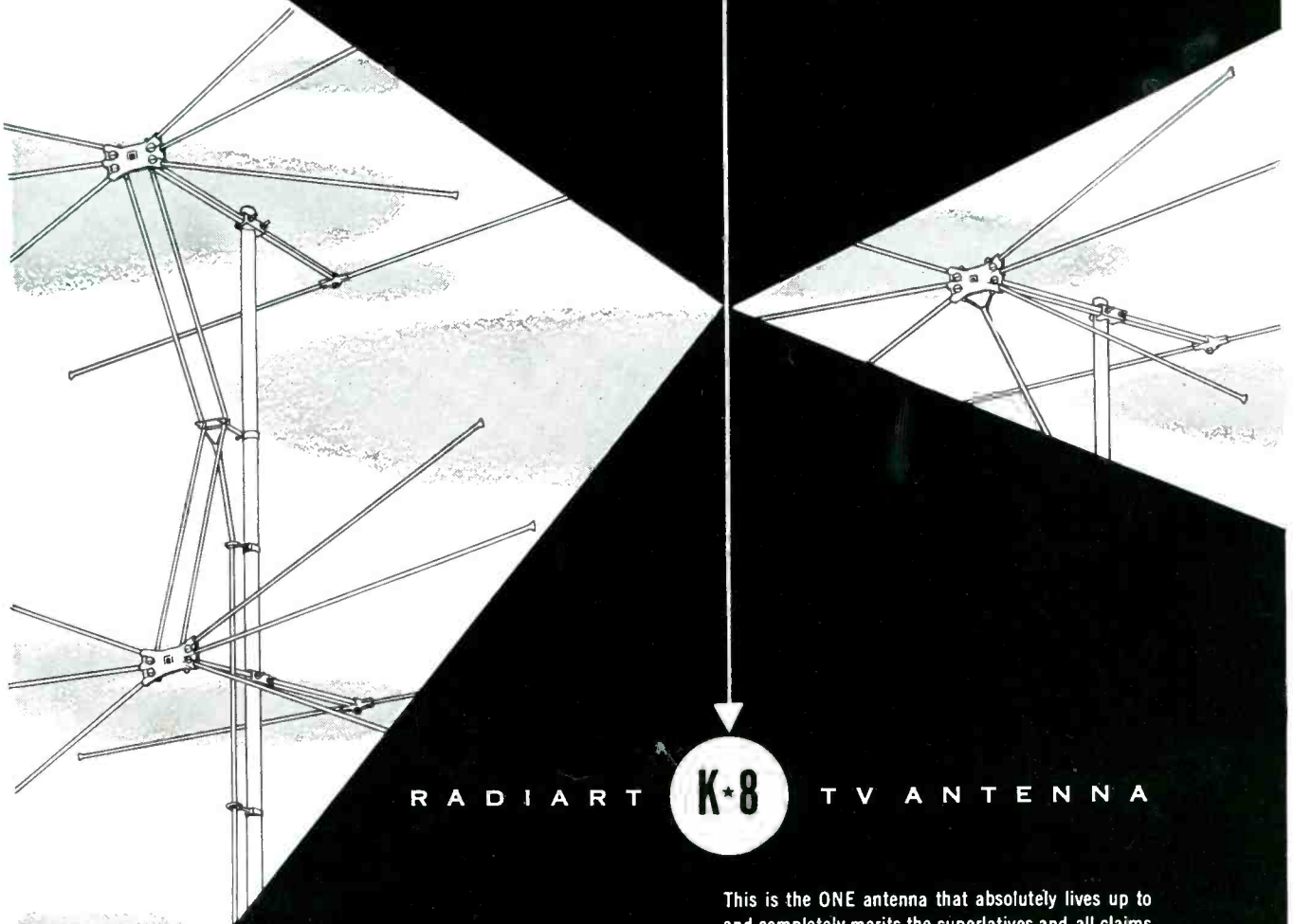

ONLY FOR THOSE WHO WANT THE BEST



RADIART **K-8** TV ANTENNA

This is the ONE antenna that absolutely lives up to and completely merits the superlatives and all claims made for other type antennas! Here's why:

- Field tested for two years — proving its ability to get all VHF channels exceedingly well.
- Superior construction throughout featuring 1/2" seamless aluminum elements.
- Exclusive, patented, quick-rig, cam action locking device for positive speedy assembly.
- Extra heavy moulded plastic insulators with precision machined brackets as well as costly die cast fixtures.
- Double stacked array eliminates fringe area reception problems.



THE **RADIART** CORP.  
CLEVELAND 13, OHIO

VIBRATORS • TV ANTENNAS • AUTO AERIALS • ROTORS • POWER SUPPLIES

# NO. 1 CHOICE

of **ALL** Fixed Composition Resistors by almost

# 3 to 1\*

*\*Not Claims! Not Predictions! But Plain Facts! Unbiased, authoritative, independent surveys (made regularly since 1930) show IRC BT RESISTORS to be the Service Technicians' choice by a continually increasing margin. Today, BT RESISTORS are preferred over the total of all other brands combined!*

**Ask for IRC BT's...  
Most Service Technicians Do!**

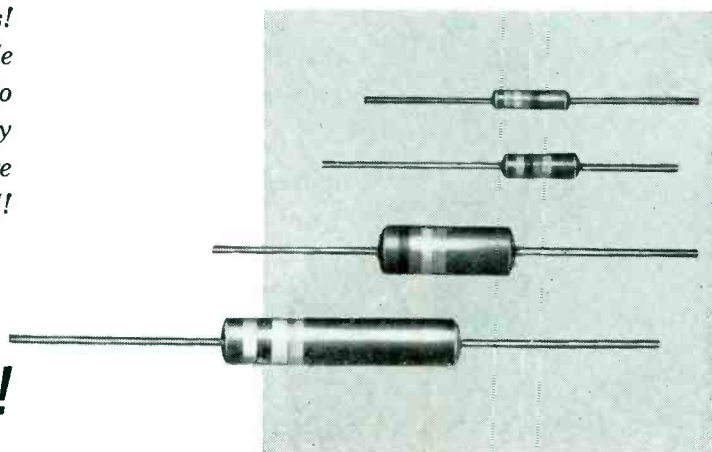

## INTERNATIONAL RESISTANCE COMPANY

413A N. Broad Street, Philadelphia 8, Pa.

Wherever the Circuit Says ~~~~

In Canada: International Resistance Co., Ltd., Toronto, Licensee

SERVICE, DECEMBER, 1953 • 1

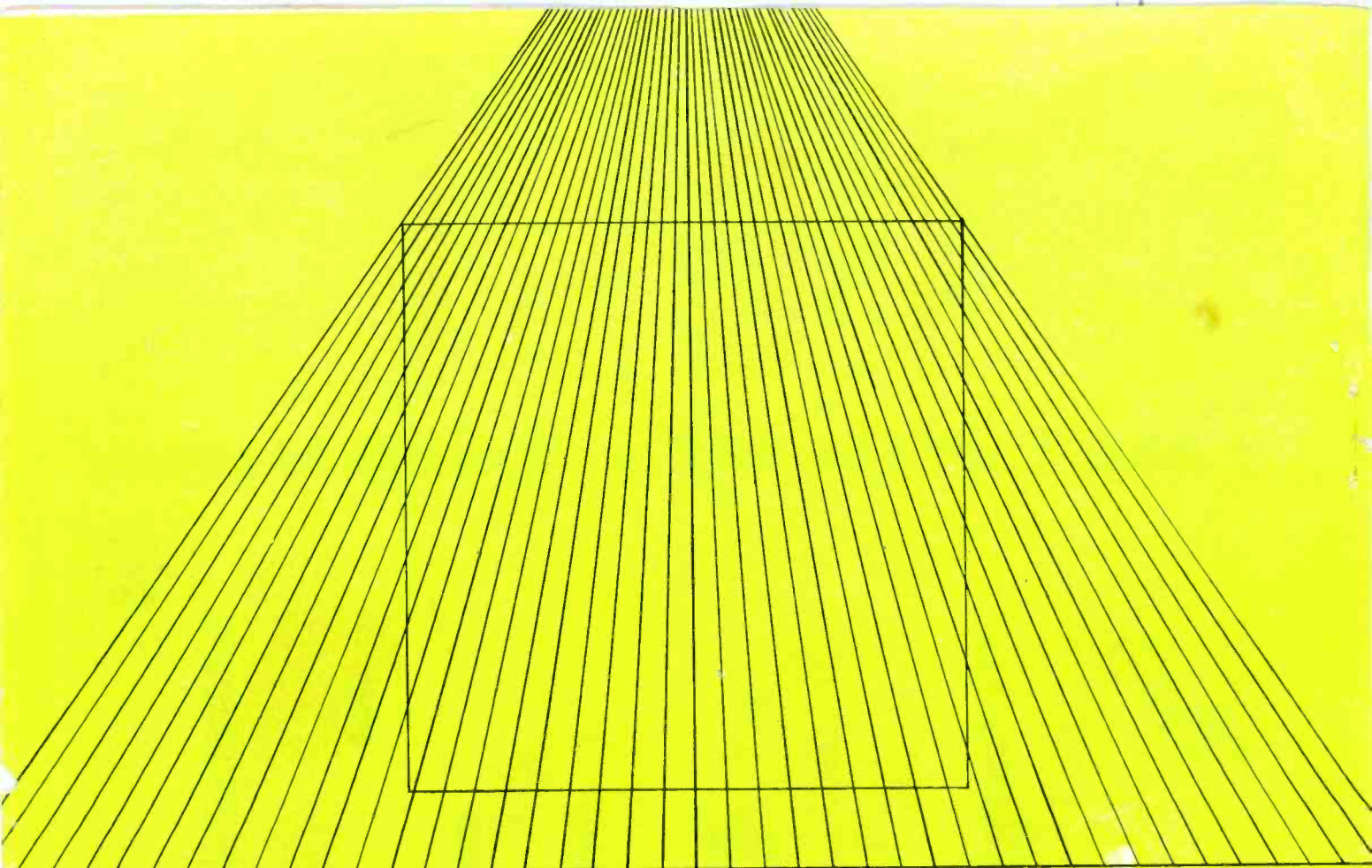

# THINGS ARE **NOT** AS THEY SEEM...

This *is* a perfect square.  
It is an optical illusion that the sides bend.



3 amps fuse will not blow at 3 amps.

Fuses are not rated by the current at which they blow. Fuses are rated by the maximum current they should carry indefinitely.

Each type of fuse blows according to the requirements of the equipment it was designed to protect.

Littelfuse has cooperated with NEC, Underwriters, Armed Forces MIL Specs Committees in establishing the characteristics of the various fuse types.

*Littelfuse holds more design patents on fuses than all other manufacturers combined.*



3 AG "SLO-BLO"



3 AB



8 AG U/L



1 AG



4 AG ANTI-VIBRATION

# LITTELFUSE

DES PLAINES, ILLINOIS

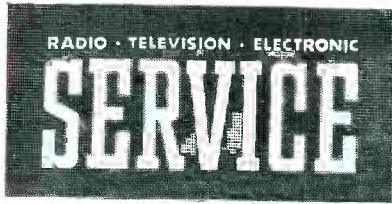

**LEWIS WINNER**  
Editor

**B. BLOCK**  
**F. WALEN**  
Assistant Editors

Including SERVICE—A Monthly Digest of Radio and Allied Maintenance: RADIO MERCHANDISING, and TELEVISION MERCHANDISING. Registered U. S. Patent Office.

Annual Index to SERVICE (January-December, 1953).....	47
Association News.....	56
Audio Installation and Service (Locating Distortion... Review of New AF Gear). By Kenneth Stewart and Paul Edwards.....	52
Color TV (A Simplified Analysis of the NTSC System). By W. Kay Brownes.....	44
Maintenance of Audio Systems (Hum... Causes and Cures). By Mark Vino.....	34
Ser-Cuits (Electronic Remote TV Tuner). By M. W. Percy.....	28
Service Engineering (HF Motor-Generator System Operation-Servicing). By Thomas K. Beamer.....	46
Service... The National Scene.....	21
Servicing Helps. By T. L. Gilford.....	49
Sweep-Circuit Troubleshooting (Chart Analysis). By Clark R. Alisen.....	38
Tape Recorder Report 3 (Solenoid-Operated Push-Button Models). By D. S. Cevans Ten Years Ago.....	30
The Systematic Servicing Approach. By J. C. Geist.....	57
Tube News (UHF Miniature Tube-Socket Application Survey). By E. A. Teverson.....	43
TV Antenna Digest (1-Man Orientor... New Product Report). By Ralph G. Peters.....	54
2-Speaker Phono With 2-Cubic Foot Enclosure (Cover). By Wyn Martin.....	50
Views and News. By Lewis Winner.....	26
	25

**AUDIO INSTALLATION AND SERVICE**

Locating Distortion: Harshness Problems.....	52
Dithery Reproduction.....	52

**CIRCUITS**

Amplified AGC Circuit; Simplified Schematic.....	29
Ampro Models 755/766 Push-Button Tape Recorders.....	31
Arvin TE Chassis Modification to Prevent 6BN6 Radiation.....	49
Heater-to-Cathode Emission Control Circuit.....	35
Heater-Induced Hum Balance System.....	35
HF Motor-Generator Circuitry.....	46
Hum Measurement With Calibrated 'Scope.....	35
Kelton Cambridge 2-Speaker Hi-Fi Phono (Cover).....	26
Keyed AGC Circuit; Simplified Schematic.....	29
Radio Craftsmen Chassis Sweep Circuits.....	39
Rectified AGC Circuit; Simplified Schematic.....	29
Rectified AGC Circuit With Separate Diode.....	29
Regency RT-700 Remote TV Tuner.....	29
Sweep Circuits (Ram).....	39
TV Antenna Orientation Setup.....	50

**COVER**

2-Speaker Phono With 2-Cubic Foot Enclosure (Kelton Cambridge).....	26
---	----

**SERVICING HELPS**

Area Selector Switching.....	49
Electrostatic Picture-Tube Focus Control.....	49
Inverter Unbalance Problems... Cures.....	49
Picture-Tube Pulling Caused by Hash; Cures.....	49
VIVM Scale Conversion.....	49

**Index to Advertisers**

	79
--	----

**Manufacturers**

Catalogs and Bulletins.....	40
Jots and Flashes.....	79
News.....	58
New Parts... Tools... Instruments.....	62
On Book Row.....	60
Personnel.....	65
Rep Talk.....	41
TV Parts... Antennas... Accessories.....	61



Entire Contents Copyright 1953, Bryan Davis Publishing Co., Inc.  5  
Published monthly by Bryan Davis Publishing Co., Inc.

52 Vanderbilt Avenue, New York 17, N. Y. Telephone MUrray Hill 4-0170

Bryan S. Davis, Pres. Paul S. Weil, Vice-President F. Walen, Sec. A. Goebel, Cir. Prom. Mgr.  
Mid-West Representative: Stuart J. Osten, 333 N. Michigan Ave., Chicago 1, Ill. Telephone: DEarborn 2-3507  
East-Central Representative: James C. Munn, 2253 Delaware Dr., Cleveland 6, Ohio. Telephone: ERview 1-1726  
Pacific Coast Representative: Brand & Brand, 1052 W. Sixth St., Los Angeles 17, Calif. Telephone: MAdison 6-1371  
Metropolitan District Manager: Donald C. Weil, 52 Vanderbilt Ave., New York 17, N. Y.

Entered as second-class matter June 14, 1932, at the Post Office at New York, N. Y., under the Act of March 3, 1879. Subscription price: \$2.00 per year in the United States of America and Canada; 25 cents per copy. \$3.00 per year in foreign countries; 35 cents per copy.

**THE NEW**



Only \$1395\*  
8 x 15 x 21 in.  
Available.

**MOST COMPLETE,  
VERSATILE**

A proud new "tube caddy"—  
to save even more time and  
money for the TV serviceman.  
**PAYS FOR ITSELF.**  
Carries up to 262 tubes. A  
complete tool and tube kit—  
helps technician to give efficient  
service that builds confidence.  
Ruggedly built with

*Craftsmanship  
in Cabinets*



\*Net to Service dealer.  
Other tube caddies  
from \$7.75 to \$14.95.  
Write for FREE FOLD-  
ER. Sold only thru  
Parts Jobbers. Slightly  
higher West of Rockies.



# FALCON

# Introduces -

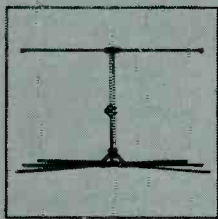

Channels 2-13, peaked for low channels (2 thru 6)

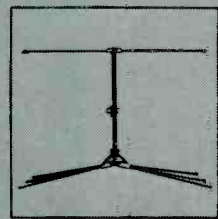

Channels 2-13, normal position, peaked for all VHF channels (2 thru 13)

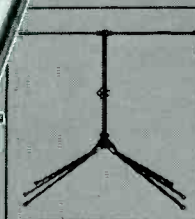

Channels 2-13, peaked for high channels (7 thru 13)

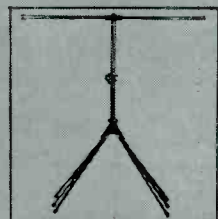

Channels 2-83, peaked for UHF channels

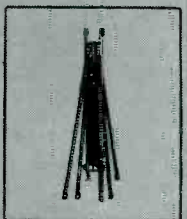

Falcon "VARI-CON" folded for packing

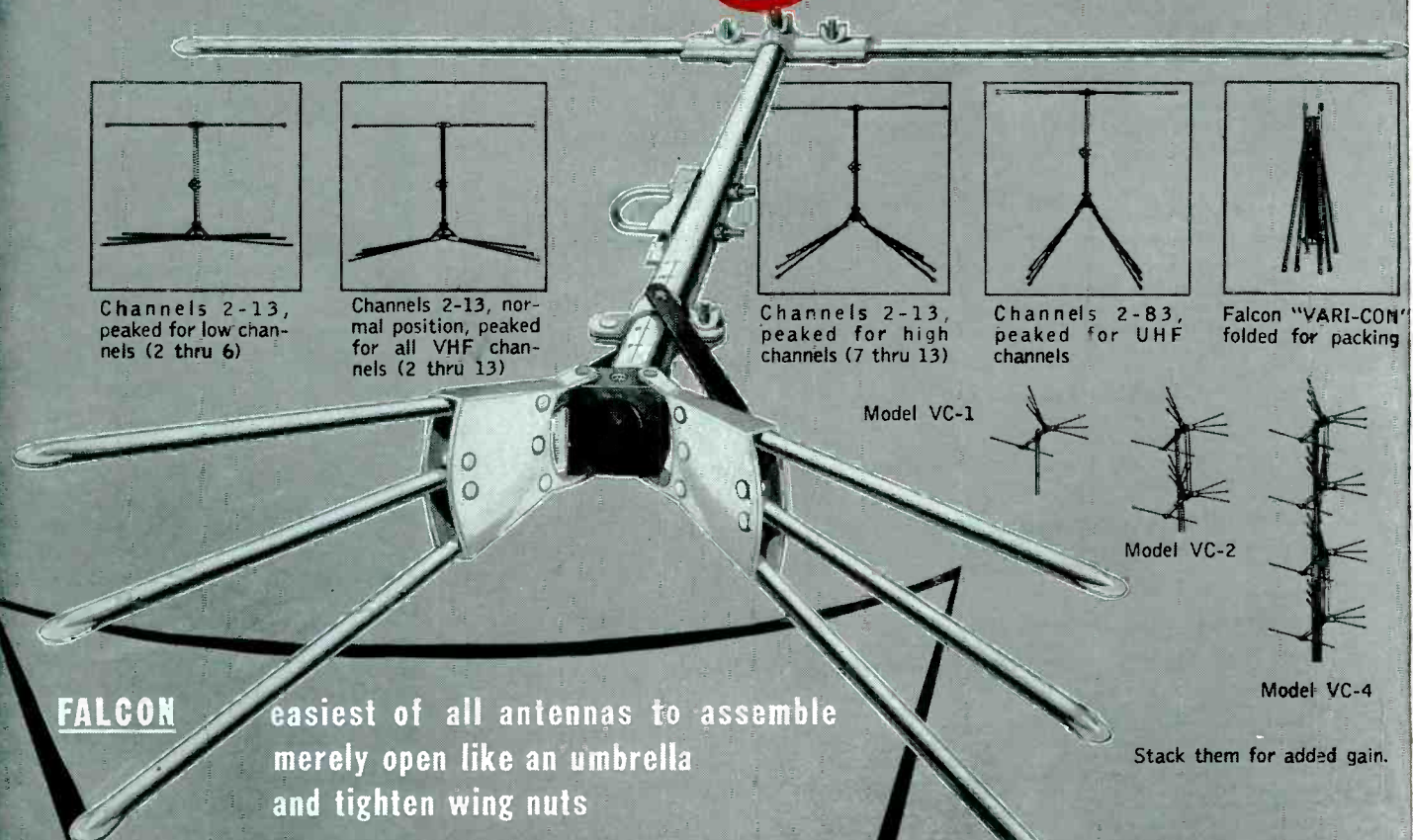

## FALCON

easiest of all antennas to assemble merely open like an umbrella and tighten wing nuts

There is NO ASSEMBLY problem with a FALCON "VARI-CON". It takes longer to explain the operation than to accomplish it! Your FALCON "VARI-CON" comes folded into one compact unit. You need only swing the reflector into position and tighten the wing nuts. Move the sliding sleeve to the calibrated channel setting you desire and tighten. The butterfly springs snap the elements into position and lock them securely. The FALCON "VARI-CON" is ready to install, ready to provide peak performance. Changing the channel peaking of the "VARI-CON" is just as simple and easy as making the original setting. No tools are needed for either operation.

Model VC-1



Model VC-2



Model VC-4

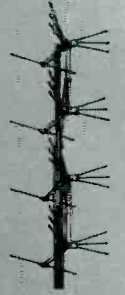

Stack them for added gain.

## THE HEART OF THE "VARI-CON"

Above is a view of the new mechanism which enables anyone to adjust the peaking of the FALCON "VARI-CON" to any range of channels desired. The sliding sleeve, on the calibrated boom, automatically fans out the elements to their correct position.

A simple, trouble-proof, snap-action spring in the

butterfly keeps the elements solidly in place. The insulated hinge assembly is extremely strong, durable and weather-resistant and has an extra long leakage path. Weight has been kept to a minimum, strength at a maximum in order to assure long life and freedom from wind and weather damage. A heavily plated mast clamp is supplied.

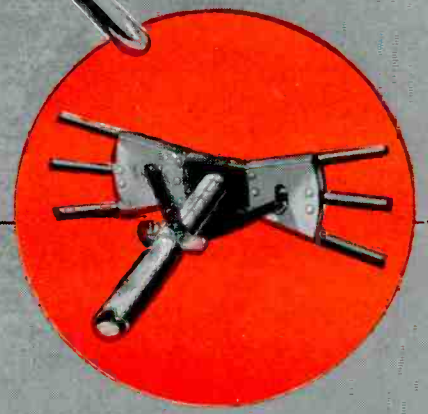

Calibrated sleeve for quick peaking of antenna.

# the "VARI-CON"

(The conical that's variable)

*Provides all Channel Performance...*

**Yet can be Peaked for Increased Gain on any Channel Range**

The FALCON "VARI-CON" was designed for today, tomorrow and years to come. Its unusual construction permits setting the "VARI-CON" for all-channel performance peaked to provide the additional gain needed on special channels. In addition, the variable patterns obtainable are of great value in ghost elimination.

There is no guess work; no tedious assembly; no field strength equipment needed to peak the "VARI-CON" for high-gain, sharp pattern performance in your area. It's as simple and easy as opening an umbrella. Here's all you do: Unpack the "VARI-CON"—Slide the adjusting sleeve to the calibrated marking on the boom for the best reception of channels in your area — Fan out the reflector elements — Tighten the locking wing nuts. The "VARI-CON" is

automatically peaked WHERE YOU WANT IT and ready to install. It is the only conical that enables you to provide a custom-made installation resulting in higher gain and increased customer satisfaction.

The NEW FALCON "VARI-CON" is ruggedly constructed. Heavy-duty heads will not crack or break. The steel spring snap-action butterfly assemblies are unbreakable. Full length, 48 inch, elements are used. One of the most capable engineering staffs in the industry has worked out every last detail of this truly remarkable TV antenna. To the high gain all-channel performance and excellent line match of the conical, FALCON engineers have added the "plus" feature — adjustable, calibrated channel range peaking!

## FALCON

The new "VARI-CON" is one of the most significant additions to antenna design. Watch for the other new FALCON antennas which will be announced in the near future! Each will represent the most advanced, most efficient antenna design of its type.

**WRITE FOR ILLUSTRATED FOLDER AND PRICES**

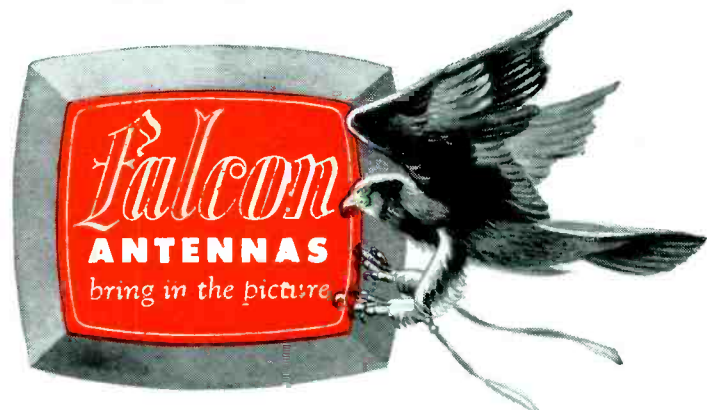

**FALCON ELECTRONICS COMPANY • 2003 CEDAR ST. • QUINCY, ILLINOIS**



## NATIONAL ADVERTISING TO BACK NEW FALCON "VARI-CON"

To stimulate sales on all levels, FALCON is conducting one of the most aggressive advertising campaigns in the industry. Full two-page color spreads are appearing regularly in many of the nation's top trade and consumer publications.

5 ft. and 10 ft. self-coupling

**immediate  
delivery  
from your  
Admiral  
distributor**

# MASTS

*Television*

# MASTS

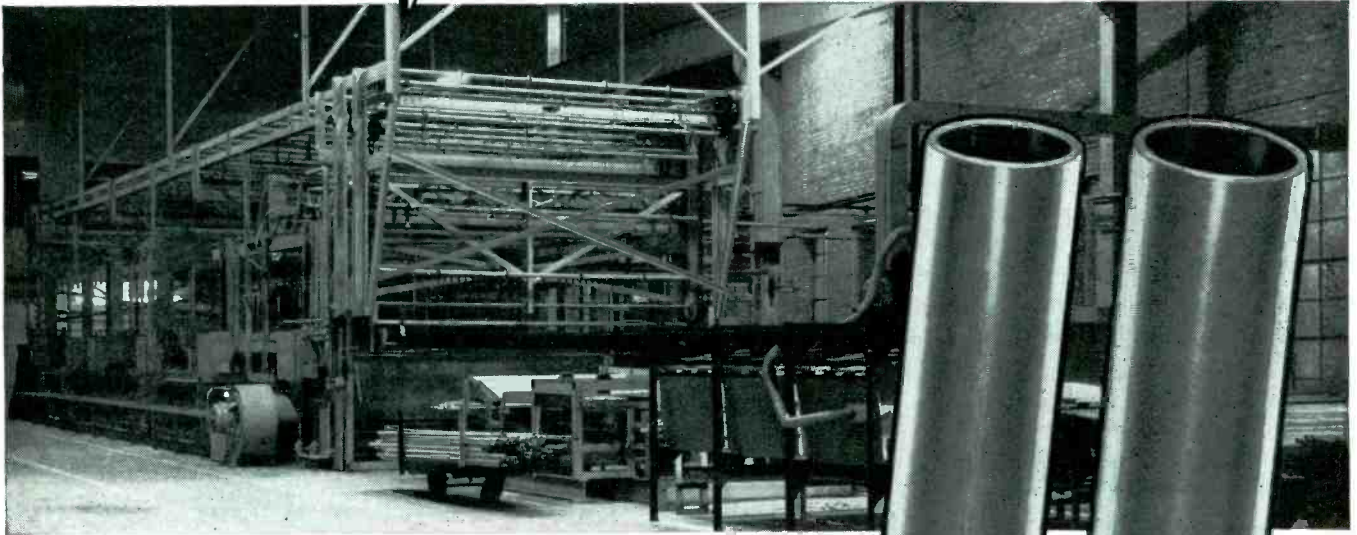

The greatly increased need for outside antennas in new station areas has just about soaked up the supply of masts. Now Admiral is ready to help you meet the demand with these new 5 and 10 foot masts . . . available at once from your Admiral Distributor.

Admiral's huge production brings you these masts at the industry's lowest prices. Finest quality, too . . . made of cold-rolled seamless steel tubing, heavily electrogalvanized for utmost rust resistance. Both 5 and 10 foot masts are available with one end flared to take extensions . . . eliminates the need for separate mast couplers. Order from your Admiral Distributor by part number:

	20 gauge	18 gauge	16 gauge
5 ft. plain end	M 40		
5 ft. flared end	M 40A		
10 ft. plain end	M 41	M 42	M 43
10 ft. flared end	M 41A	M 42A	M 43A

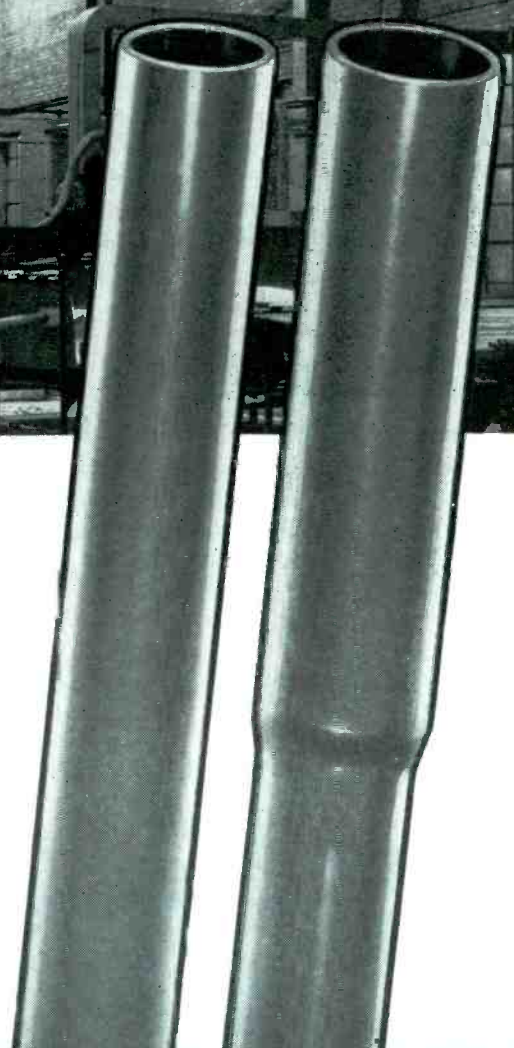

**Admiral Corporation**, Accessories and Equipment Division, Chicago 47, Ill.

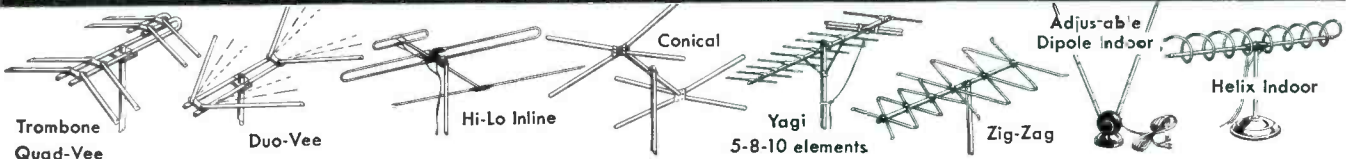

**A COMPLETE LINE OF ADMIRAL TV ANTENNAS . . . NOW AVAILABLE FROM YOUR ADMIRAL DISTRIBUTOR**





Again,  
**TTA**    does it!

**HIGH-GAIN**

Cat. No.

3015 ( — )

Price **\$6.75**

ea. list

**ALL-ALUMINUM**

**ALL-WELDED**

The  
**TTA**   

**UHF GRID YAGI**

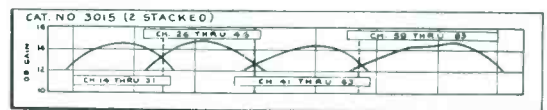
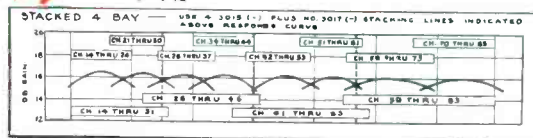

A new high in UHF antenna design — with new and better performance  
 — the antenna you have looked for!

All welded!—perfect mechanical and electrical union between all elements—  
 no chance for corrosion between—grid reflector for maximum back door rejection.

Extra-high gain—yagi performance improved through  
 use of Grid Reflector.

Packed two per carton with stacking lines for dual stacking.  
 Use as single antenna or as stacked array for extra gain.

**GET COMPLETE DETAILS FROM YOUR JOBBER, OR WRITE . . .**

**TECHNICAL APPLIANCE CORPORATION, SHERBURNE, NEW YORK**

In Canada: Hockbusch Electronics, Inc., Toronto 4, Ont.

PLUS — Four stack installation  
 by addition of full-wave stacking  
 lines for the ultimate in  
 UHF gain and "pin-point"  
 directivity.

Cat. No. 3017 ( — )

Price

**\$1.25** ea. list

**BLACK  
BEAUTY®**

**dry-assembly  
phenolic-molded**

# TV TUBULARS

**The Standard By Which Others Are Judged**

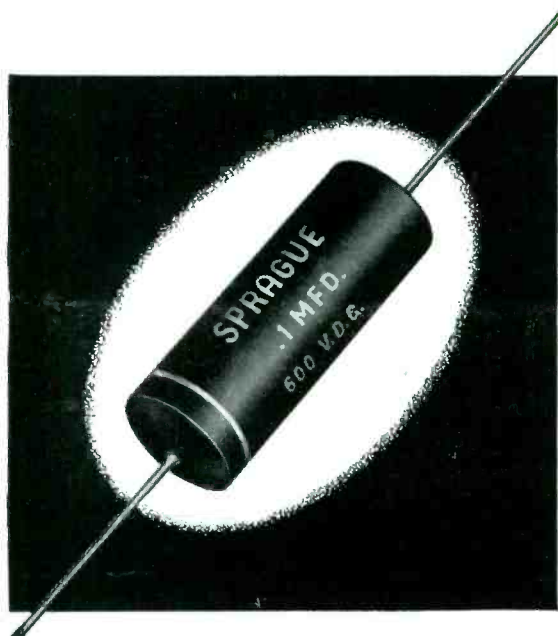

**ACCEPT NO SUBSTITUTES**

There is a Sprague Distributor in every sales area in the United States. Write for the name of your nearest source of supply today.

**L**OOK at the critical points in any TV set. That's where you'll find Sprague Black Beauty Telecaps. Over 250 million of these molded tubular capacitors have been made since 1947 and demands are still increasing . . . thanks to their unprecedented failure-free record.

Sprague's unique patented design and "dry assembly" processing make these *the first* tubulars made just like more expensive metal-encased oil capacitors. Every Black Beauty Telecap from 200 to 12,500 volts is molded *dry* in non-flammable phenolic. After molding it is impregnated thru an eyelet under high vacuum; the lead is then inserted and the capacitor solder sealed.

Don't be vague—insist on Sprague Black Beauty Telecaps for your TV and radio service needs! You can depend on *extra high insulation resistance; minimum capacitance change with temperature variations; and absence of drift with repeated heating and cooling.* Avoid being misled—there are no others just-as-good!

Write today for complete Sprague television and radio service catalog C-609 to . . .

**SPRAGUE PRODUCTS COMPANY**

(Distributors' Division of the Sprague Electric Co.)  
61 Marshall Street • North Adams, Mass.

**DON'T BE VAGUE . . .**

**ASK FOR**

# SPRAGUE

**WORLD'S LARGEST CAPACITOR MANUFACTURER**

# NEW Certified Quality Service Business Builders SIGNS...POSTALS ...AD MATS

GET THIS CATALOG

**TIE IN** even stronger with your *Certified Quality Service* campaign in LIFE and POST. Tell your customer again and again. *You* offer him the quality service and fair charges that spell C...Q...S. Win his confidence and you win his business. Along with your CQS tags and displays, use your new CQS illuminated indoor sign . . . flange sign . . . postals . . . and ad mats. You'll be proud of them. They are modern, dignified, economical . . . and their CQS message sells *hard*. See them at your CBS-Hytron distributor's. Or write for CQS-10 catalog. But act now!



### NEED MORE CQS TAGS?

With your 3-line imprint, they are priced low: 250 for \$2.25, 500 for \$3.50, 1000 for \$6.00. Order from your distributor . . . or direct.

## 4 MORE CQS Sales Aids

IDENTIFY YOU AS A...  
*Certified*  
QUALITY SERVICE DEALER

**NEW CQS ILLUMINATED INDOOR SIGN**  
Wraps your potent *Certified Quality Service* message into a dignified display. Brilliant . . . colorful . . . fluorescent sign (25" by 10 by 3 1/2 inches) pulls customers to you. Hang it (comes equipped with chains and hooks) or stand it in window . . . on counter . . . on shelf. Comes ready to plug into ac socket, with economical 30-watt fluorescent tube. Makes ideal night light and 24-hour salesman. Identify yourself. Get your CQS illuminated indoor sign up right away. Only \$9.45, F.O.B. continental U. S. A.; or see your CBS-Hytron distributor.

**RADIO...TELEVISION**  
*Certified*  
QUALITY SERVICE  
We Certify Quality Parts and Service . . . Fair Charges  
TUBES

**NEW CQS METAL FLANGE SIGN**  
Proudly, boldly . . . *Certified Quality Service* is seen by millions in campaign. Big, sturdy 12 inches, with complete in weatherproof mount. This smart sign outdoors or indoors. Only \$1.75 each. U. S. A.; or see your distributor.

**NEW CQS POSTAL CARDS**  
NEW CQS AD MATS

CQS-10 PA-11

CQS-10 Catalog also features  
3 direct-mail postals . . . 9 ad mats.

**60-DAY OFFER!**

## 10 SOCKET LOCATORS with 20 miniature tubes

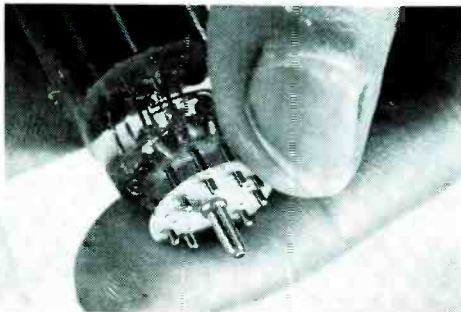
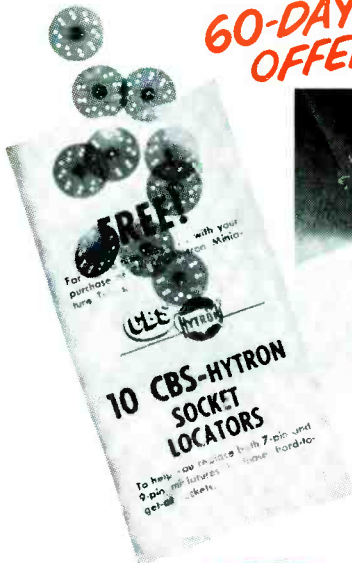

During January and February. Order 20 CBS-Hytron miniature tubes. Your distributor will *give* you this package of 10 new CBS-Hytron Socket Locators. With them, plugging miniatures into hard-to-locate sockets is easy. Socket Locator slips over pins of tube (7-pin or 9-pin). Key of Locator finds socket . . . guides tube into it, quickly. Save time and temper . . . take advantage of this limited offer. See your CBS-Hytron distributor.

### NEW...FREE CBS-HYTRON CRYSTAL DIODE MANUAL

Complete, down-to-earth, 8-page manual on crystal diodes. Three parts: 1. Advantages and construction. 2. Complete data, 38 types. 3. Selection and application. Profusely illustrated. Ten basic circuits. Gives you *all* the crystal-diode information you have been seeking. FREE . . . from your CBS-Hytron distributor . . . or write direct.

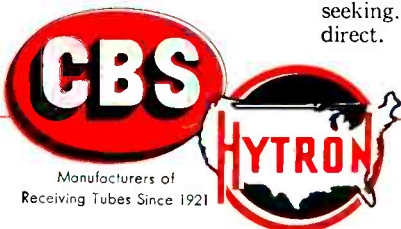
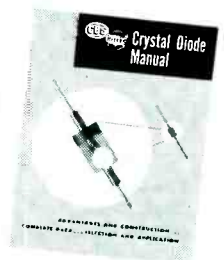

**CBS-HYTRON** Main Office: Danvers, Massachusetts

A Division of Columbia Broadcasting System, Inc.

A member of the CBS family . . . CBS Radio • CBS Television  
Columbia Records, Inc. • CBS Laboratories • CBS-Columbia • and CBS-Hytron

RECEIVING . . . TRANSMITTING . . . SPECIAL-PURPOSE AND TV PICTURE TUBES • GERMANIUM DIODES AND TRANSISTORS

SERVICE, DECEMBER, 1953 • 9

**have  
confidence**

**... THAT YOUR  
FRINGE AREA INSTALLATIONS  
ARE TOPS!**

**Suggest and Use  
the remarkable new Double CO-Lateral**

**FINCO 400-A**

**ALL CHANNEL**

**FINCO IS A NAME  
YOUR CUSTOMERS  
KNOW BECAUSE OF  
THIS POWERFUL  
NATIONAL ADVERTISING  
PROGRAM!**

**UHF and VHF**

**EXCELLENT RECEPTION  
120 to 150 MILES  
FROM STATIONS**

**FARM MAGAZINES** **RADIO** **LOCAL NEWSPAPERS** **TELEVISION** **LIFE**

**FINCO is acknowledged as the  
First and Foremost fringe area antenna**

"Fringe area buyers more and more ask for the FINCO by name. Let them know you handle the best — advertise the low cost way with Finco co-op mats — tie-in with a business-getting national advertising program — watch your sales soar! Get the complete story from your jobber or write direct".

**The FINNEY Company**

Dept. S-212, 4612 St. Clair Ave., Cleveland 3, Ohio

**The Finney Co.**

Dept. S-212  
4612 St. Clair Ave.  
Cleveland 3, Ohio

**RUSH**

- information on the new 400-A and UHF Conversion Kit No. 12.
- FREE LIFE merchandising display material.
- Co-op newspaper ad mat brochure.

YOUR NAME .....

COMPANY NAME .....

ADDRESS .....

CITY ..... ZONE ..... STATE .....

YOUR JOBBER .....

# IMPACT IN UHF

## FINCO

series 500

GREAT UHF ANTENNAS

Engineered To Give  
**HIGHEST GAIN** and  
**NARROWEST PATTERNS**  
 to solve difficult "GHOST"  
 problems in the FRINGE  
 AREA AND IN CLOSE  
 TO THE STATION

# IMPACT

Through Advertising

LOCAL NEWSPAPERS

LIFE

FARM MAGAZINES

RADIO

TELEVISION

**FINCO** IS A NAME  
 YOUR CUSTOMERS  
 KNOW BECAUSE OF  
 THIS POWERFUL  
 NATIONAL ADVERTISING  
 PROGRAM!

**THE  
 FINNEY COMPANY**

Dept. S-312 - 4612 St. Clair Ave., Cleveland 3, Ohio

This great series once again reaffirms Finco leadership! Model 502 is a 2-bay unit of the collateral\* type with a "snap-out" screen for instantaneous installation. Model 504 is the 4-bay version; highly effective in super fringe areas where ultra high gain is consistently required. Both models feature high front to back ratio and excellent impedance match to 300 OHM line for low signal fringe areas. Completely preassembled — corrosion proof aluminum throughout (including screen) — one antenna, one transmission line!

Both Units available in 3 models which peak on channel ranges shown below and maintain high gain on balance of frequencies:

#502A — channels 14-32

#502B — channels 29-55

#502C — channels 53-83

#504A — channels 14-32

#504B — channels 29-55

#504C — channels 53-83

Patent No. 2,566,2E7

\*Reg. U.S. Pat. Off.

**BACK THE LINE THAT BACKS YOU!**

# ALLIANCE

**New, Restyled Models + \$500,000 Ad Campaign**



**IMPROVED ROTATOR UNIT**  
 —Speed increased to 2 rpm.  
 Magnetic anti-drift brake.  
 Smoother synchronization  
 with control units.

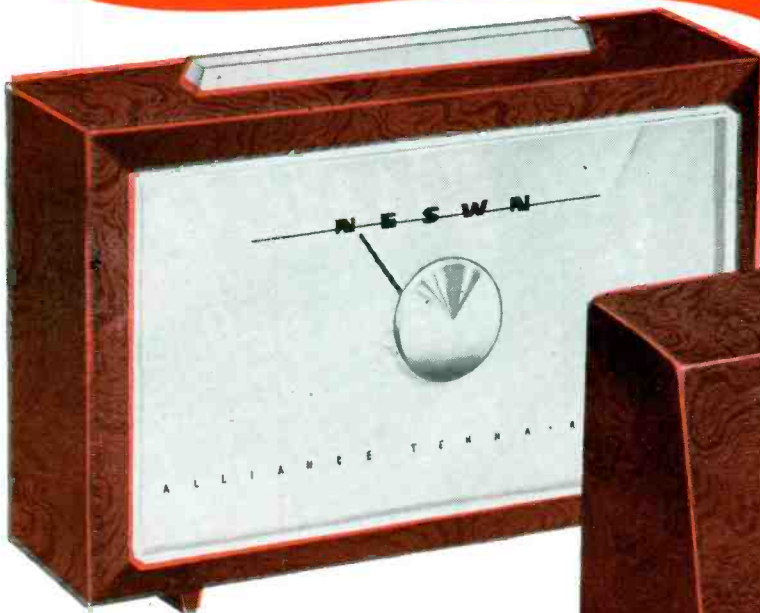

**MODEL T-10**, finger-tip electrically controlled Alliance Tenna-Rotor with direction indicator dial. Extremely accurate. Modern styling by Reinecke & Associates . . . . . \$44.95



**MODEL U-83**, the only fully automatic antenna rotator on the market. Just "set it — forget it!" — this new model automatic Alliance Tenna-Rotor. Reinecke-designed . . \$44.95

## Here's how Alliance pre-sells for you!—

**1** New styling sells on sight! Style's the thing, and Alliance has it! More eye-appeal, more buy-appeal in these smart, new Alliance Tenna-Rotors and the Alliance TV Converter! Boost your sales, boost your profits with Alliance — the line that backs you!

**2** \$500,000 ad campaign sends sales your way! Alliance keeps spring promises!

TV Spots—eye-compelling "home" demonstrations—more than 16 million viewers on more than 100 stations—*this is our fifth straight year of TV advertising!*



**ALLIANCE TV CONVERTER**  
 adds all new UHF channels. Advertised on TV! The quality converter built to last! . . . . . \$42.50

**LIFE**  
**Magazine**

— full-page ad in this top consumer magazine! Newspapers—dominant, sales-making ads in key markets! Point-Of-Sale Displays—full-color, on-the-spot reminders!

**OVER ONE AND ONE-QUARTER MILLION ALLIANCE TENNA-ROTORS NOW IN USE!**

**ALLIANCE MANUFACTURING CO., ALLIANCE, OHIO**

The Quality of Your Service  
can be no better than the  
Quality of the Parts You Handle

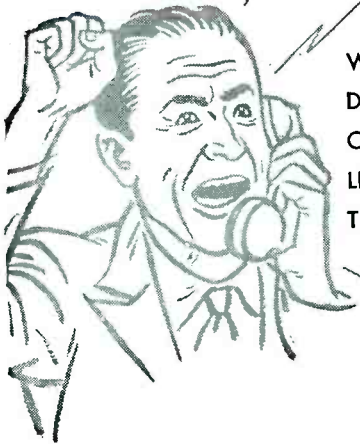

WHEN POOR QUALITY OR FAULTY  
DESIGN OF A COMPONENT PART  
CAUSES TROUBLE—YOU ARE MORE  
LIKELY TO GET THE BLAME THAN  
THE MAKER OF THE PART.

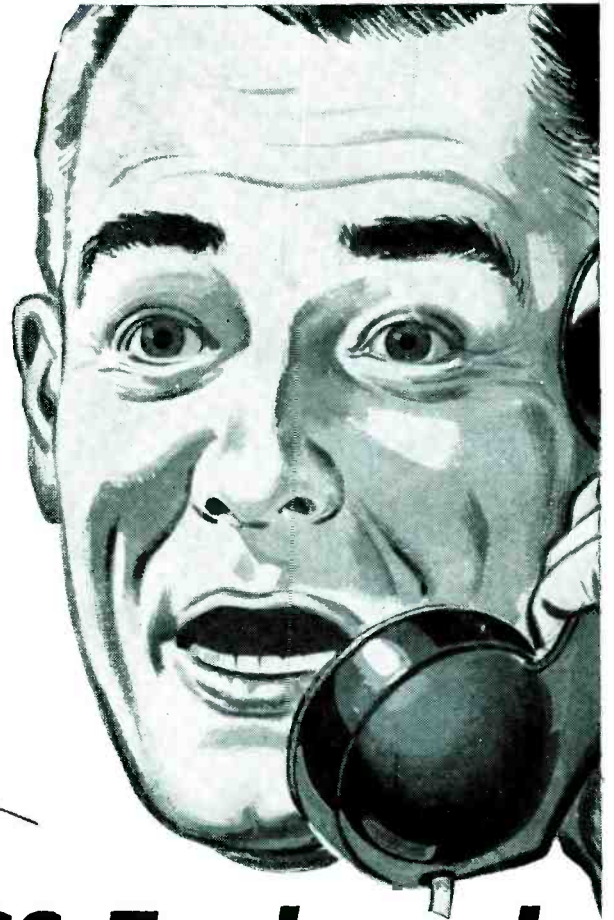

# In Fuses the **BUSS** Trademark represents unquestioned High Quality!

Why take a chance with your goodwill, reputation and profits when BUSS and FUSETRON Fuses are available?

To maintain highest quality *every BUSS and FUSETRON fuse used by the electronic industries is electronically tested.* A sensitive testing device rejects any fuse that is not correctly calibrated, properly constructed and right in all physical dimensions.

BUSS quality means dependable electrical protection under all service conditions and — BUSS quality means fuses that blow to protect — never needlessly.

That's why for over 38 years it has just been good business for distributors and service organizations to handle only BUSS Fuses — the KNOWN brand.

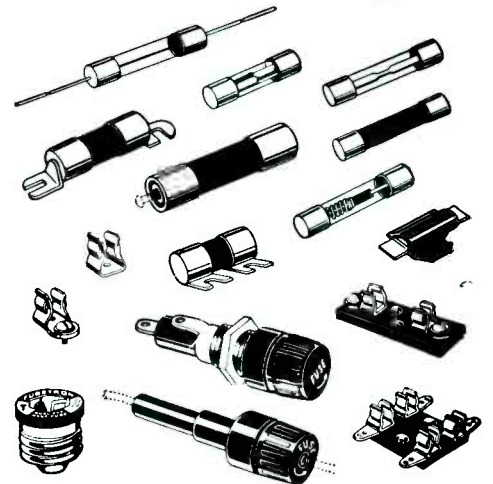

FOR MORE INFORMATION *Mail this coupon*

BUSSMANN Mfg. Co. (Division of McGraw Electric Co.)  
University at Jefferson, St. Louis 7, Mo.

Please send me bulletin SFB containing facts on  
BUSS small dimension fuses and fuse holders.

Name \_\_\_\_\_

Title \_\_\_\_\_

Company \_\_\_\_\_

Address \_\_\_\_\_

City & Zone \_\_\_\_\_ State \_\_\_\_\_ S-1253

*“ . . . helping to keep  
the business cycle  
on an even keel . . . ”*



**HARRY B. HIGGINS**  
President, Pittsburgh Plate Glass Company

*“The employees of Pittsburgh Plate Glass Company since 1946, have purchased \$9,488,510 in United States Savings Bonds through the Payroll Savings Plan. This accumulation of assets will be of inestimable value in helping to keep the business cycle on an even keel by maintaining purchasing power for the future.”*

Payroll Savings—the plan that protects—pays the employer triple benefits:

- it makes a good employee a better one—a serious saver with a definite plan for personal security.
- as enrollment on the plan goes to 60%, 70% employee participation, productivity increases, absenteeism decreases and accident records go down.
- and as Mr. Higgins points out, the systematic purchase of Defense Bonds through the Payroll Savings Plan is building a tremendous reserve of purchasing power.

Let's point up the third employer benefit with a few figures:

- On September 30, 1951, individuals held Series E Bonds totaling \$34.6 Billion—more than \$4.6 greater than on V-J Day.
- During the five calendar years (1946-1950) Defense Bonds sales provided:

—Cash to retire \$3 Billion A-D Savings Bonds (maturing Series).

—Cash to meet \$24 Billion redemptions of E, F and G Bonds.

—\$6 Billion (after providing cash for the payments enumerated above) that the U.S. Treasury could use to pay off bank-held debt.

And the figures are getting better every day—between January 1, 1951 and November 1, 1951, 1,200,000 employed men and women joined the Payroll Savings Plan.

If the employee participation on your Payroll Savings Plan is less than 60%, phone, wire or write to Savings Bond Division, U.S. Treasury Department, Suite 700, Washington Building, Washington, D.C. Your State Director will be glad to show you how you can participate in the triple benefits of the Payroll Savings Plan.

*The U.S. Government does not pay for this advertising. The Treasury Department thanks, for their patriotic donation, the Advertising Council and*

**SERVICE**





CUSTOMERS EVERYWHERE KNOW  
 SYLVANIA TUBES JUST  
 CAN'T BE BEAT FOR QUALITY!



## WHY SYLVANIA PRODUCTS MEAN BETTER BUSINESS!

**Y**OU'RE really on board the *better-profit* special when you feature Sylvania Picture Tubes and Receiving Tubes.

Your customers know Sylvania as a pioneer in the development of fine radio and television products. From the very beginning, the name Sylvania has stood for the highest possible quality. And, as the industry has progressed and expanded, Sylvania has taken great care to maintain its recognized leadership.

*Now, due to advanced manufacturing techniques and precision testing methods, Sylvania tubes can point to outstanding records, both in long life and fine performance. Today 7 of the 10 leading set manufacturers use Sylvania Picture Tubes and Receiving Tubes.*

So, if you want *recognized quality* working on your side . . . *sell Sylvania!* Call your local Sylvania Distributor for the latest fall prices and money-making promotion offers, or write to: Sylvania Electric Products Inc., Dept. 3R-2412, 1740 Broadway, New York 19, N. Y.

# SYLVANIA



LIGHTING • RADIO • ELECTRONICS • TELEVISION

**Television keeps telling  
 about Sylvania quality**



Sylvania's popular nation-wide television show "Beat the Clock" continues to tell millions of your customers week after week, all through the year, about the unbeatable quality of Sylvania products.

In Canada: Sylvania Electric (Canada) Ltd.  
 University Tower Bldg., St. Catherine Street, Montreal, P. Q.

SERVICE, DECEMBER, 1953 • 15

# THIS ANTENNA OUT-PERFORMS:

this ... this ... this ... or this

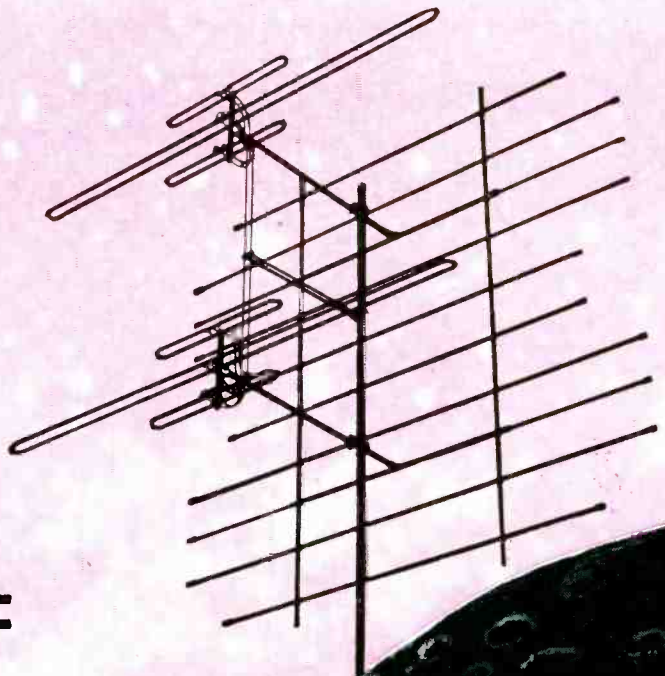
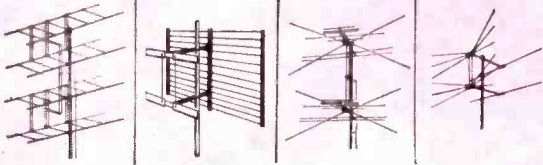

# the AMAZING VHF CHAMPION\*

a NEW KIND of Antenna  
that out-performs every all-channel  
VHF antenna ever made — —  
and many Yagis, too!

America's servicemen have spoken! In only 2 months, they've made the CHAMPION the nation's top-selling VHF antenna! It's the highest gain all-channel VHF antenna ever developed, and its performance has now been proven by over 30,000 outstanding installations.

Only the CHAMPION has the unique new "Tri-Pole", a triple-powered dipole system in which the Low Band dipole also functions as three dipoles tied together, in phase, on the High Band.

Folded dipoles throughout give close to 300 ohms impedance across entire band. Lightweight, all-aluminum construction. Available in one, two, or four-bays.

## CHANNEL MASTER CONQUERS SPACE!

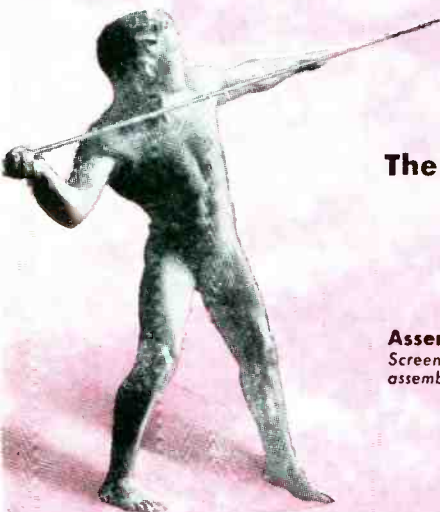

### The stacked CHAMPION provides:

- 11-13 DB High Band gain
- 6½-7½ DB Low Band gain

Assembles faster than a five-element Yagi.  
Screen "Pops-Up" instantly. "Tri-Pole"  
assembly just snaps into place.

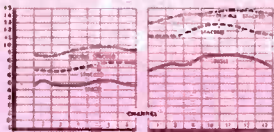

horizontal polar pattern (relative voltage)



**CHANNEL MASTER CORP.**  
ELLENVILLE, N. Y.



model no.		list price
325	single bay	\$20.83
325-2	two bay	42.36
325-4	four bay	88.89
Separate Stacking Harnesses		
325-3	2 bay harnesses	\$2.08
325-5	4 bay harnesses	4.15

\*Pat. Pend.

**3** great, new **UHF** antennas

by **CHANNEL MASTER**

**STACKED TWIN  
CORNER REFLECTOR** model no. 406-2

The most powerful UHF fringe area installation you can make today!

- Broad Band coverage — yet out-performs most stacked Yagis.
- Covers every UHF channel, not just segments of the band.
- New impedance-matching, two-stage stacking system.

Another original Channel Master development!

Model No.	Description	List Price
406	Twin Corner Reflector	\$18.05
406-2	2-Bay Twin Corner Reflector. Stacking harness furnished free.	36.10
405-3	Stacking harness only, furnished separately.	2.08

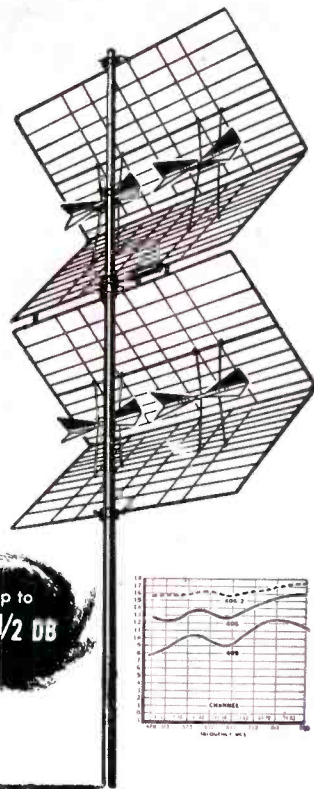

*powerful  
new  
antennas  
span  
vast  
distances*

the first UHF  
**CORNER REFLECTOR**  
with optional "2-way" mounting!

model no. 409

Only CHANNEL MASTER'S CORNER REFLECTOR can be adapted to any kind of UHF installation — with or without VHF — at no extra cost. Every antenna contains all necessary hardware and braces for BOTH popular types of mounting. Sharp directivity and unusually high gain across entire UHF band.

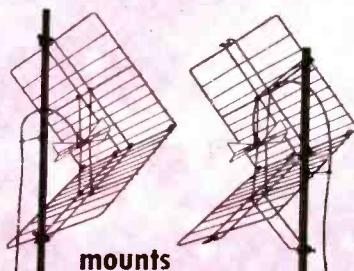

mounts

this way . . . or this way

only  
\$903  
list

**Installs instantly!** Original Channel Master assembly feature: Screen swings open like a book — dipole assembly snaps into place.

**"SWEET 16"** The World's First 16-Element UHF Yagi!

- Custom-designed for your particular area.
- Super-power! Sensational fringe area reception.
- Delta-Weld design. Elements WELDED to crossarm. Delta-matched dipole gives uniform impedance.
- Wide band coverage, up to 21 channels.
- Average gain: 13 DB single  
16 DB stacked

model no. 420

\$ 8<sup>20</sup> list



Send for complete technical literature.

**CHANNEL MASTER CORP.**  
ELLSVILLE, N. C.



# MERIT

## HOLLYWOOD, HOLLYWOOD and CHICAGO!

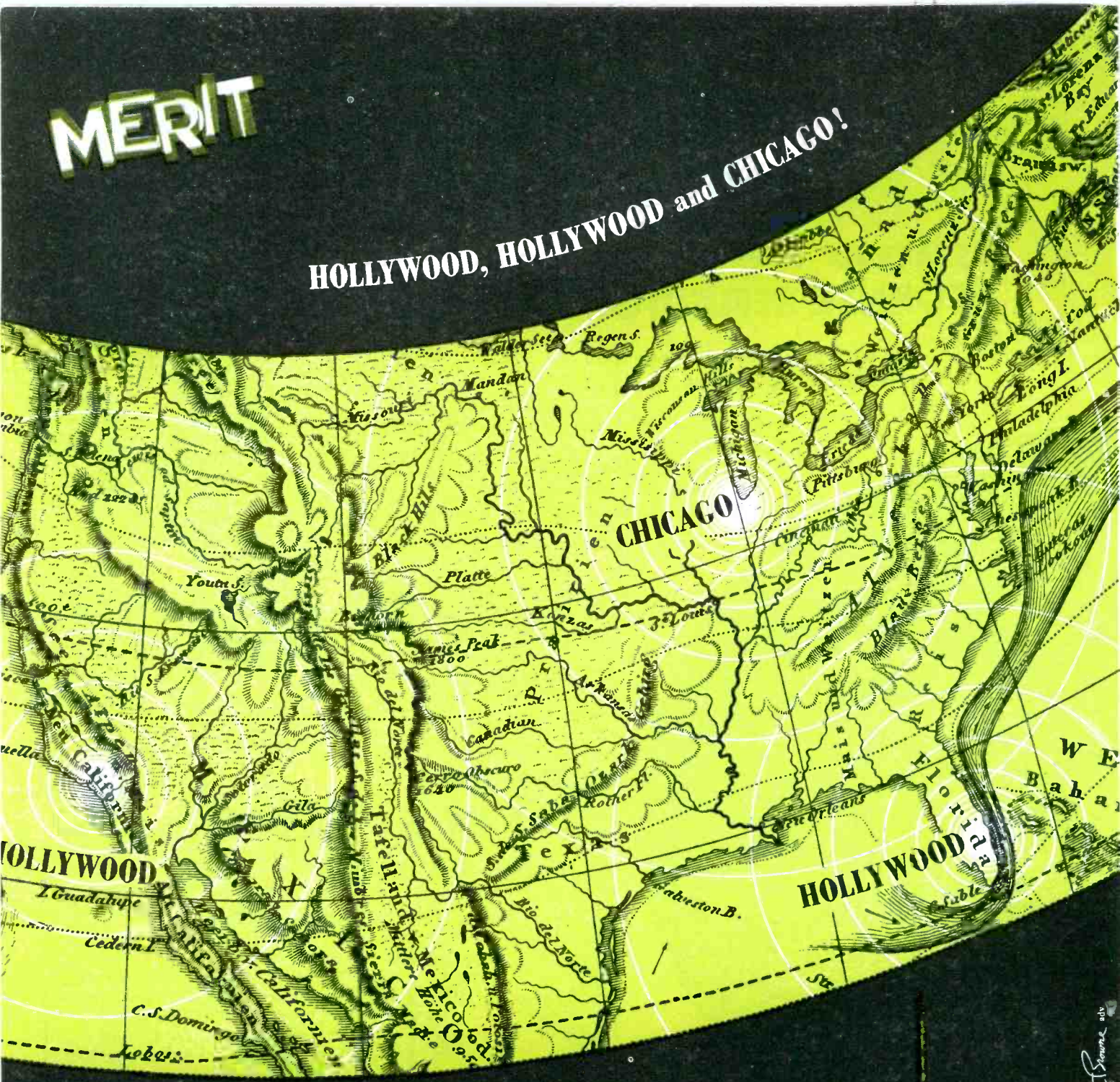

East coast, West coast or the middle of the country, Merit's plants are where you need them ... for, Merit is the only independent coil and transformer manufacturer devoted exclusively to the serviceman's TV problems.

Take advantage of MERIT'S faster service.

Find Merit's complete line, Tape Marked,\* listed in John Rider's Tek-File and Howard Sam's Photofacts and Counter Facts to help you.

And! Be sure to get Merit's latest complete Replacement Guide.

Forty pages of replacement data and schematics, including IF-RF coils, an exclusive Merit feature.

\*originated by Merit

### MERIT COIL AND TRANSFORMER CORPORATION

4425 North Clark Street  
Chicago 40, Illinois • LO. 1-6311

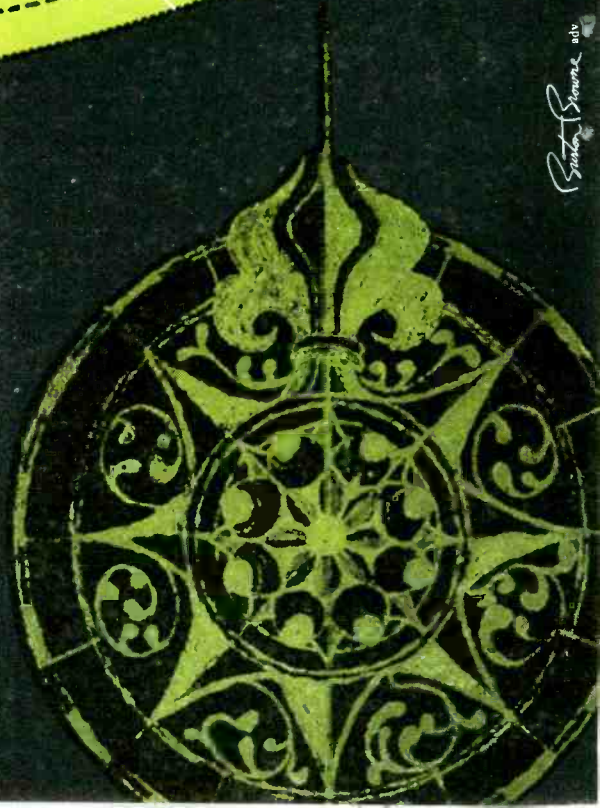

*Robert S. ...*

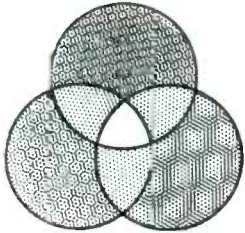

# "Color Television"

A special issue containing

## ▲ 15 N.T.S.C. Monographs

The National Television Systems Committee has authorized IRE to publish its long awaited Monographs in the January 1954 special Color Television issue of "Proceedings of the I·R·E" — thus giving them industry-wide distribution for the first time in print.

## ▲ 25 additional Color TV articles —

will also appear in this issue, which brings the reader up-to-the-minute on the developments of Color Television. Copies of the first Color Television issue are still available and combined with this second Color Television issue will form a complete bibliography of major historical importance. Also included in the January issue will be a complete listing of the N.T.S.C. system specifications as submitted to the F.C.C.; and field test reports on the system's performance.

## ▲ in "Proceedings of the I·R·E" January '54

Available to non-members for \$3.00. Extra copies to I R E members are \$1.25. All members get one copy free!

*Another  
History  
Making  
Issue!*



IRE is an organization of 33,312 member-engineers. There are no company memberships. Operating continuously since 1913, its sections meet in 78 cities. 21 specialized Professional Groups widen the scope of its member-services and 40 technical committees help the industry.

## "Proceedings of the I·R·E"

Published by

**THE INSTITUTE OF RADIO ENGINEERS**

1 East 79th Street, New York 21, N. Y.



**WARD'S**

new

# TOWER-JACK

**fast and easy**

no tower

less man-power...

**needed to erect  
telescopic masts with**

Now, WARD'S TOWER-JACK makes erecting Telescopic Masts a one man job. Just mount the antenna on the top section — and then raise it away. Each section is held firmly until secured with pin and guy-wires. WARD'S TOWER-JACK is then attached to the next succeeding sections until the mast is fully extended.

The TOWER-JACK is easy to use  
... easy to carry from job to job.

Handles any two-to-five section mast from 1½" to 2¼" in diameter. Greatest time and money saver for telescopic mast erections ever devised . . . Order your WARD TOWER-JACK today. Model TJ-1.

**THE WARD PRODUCTS CORP.**  
DIVISION OF THE GABRIEL COMPANY

1148 Euclid Ave., Cleveland, Ohio. • In Canada: Atlas Radio Co., Ltd., Toronto, Ont.



# SERVICE... *The National Scene*

INITIAL '54 COLOR SETS EXPECTED TO BE 36-TUBE MODELS--Color receivers, now being developed for the early '54 market, will, in the main, use 36 tubes, and round, all-glass picture tubes. Some will employ 15-inch diameter types, providing a 11½-inch wide picture, and others plan to use larger sizes. . . . About twice as many components as are used in b-w sets will appear in these chassis. In one model, described as a typical production type, there'll be about 7 resistors and 6 capacitors to each tube circuit. . . . Chassis will be heavily shielded to prevent interference, and will use quite an assortment of new components. Around the face of the tricolor picture tube in one series, a field neutralizing coil will be used to eliminate color distortion, which might obtain as the receiver is moved about and comes within the influence of magnetic fields, found to be present everywhere. Receivers will also use luminance delay lines, which, in some instances, might be up to 2 feet in length.

MOST OF THE CIRCUITRY employed in the first color sets will follow a basic pattern. Any variations, which will appear, will be particularly in the picture-tube section, where either of four different types of color tubes might be used.\*

JANUARY WILL PROBABLY SEE the official unveiling of many pilot color models. These will be exhibited at trade shows, and will be used only for demonstration purposes. One manufacturer has already announced that he'll have 100 receivers set up for dealer viewings at a meeting in Chicago. The investment in these models, it has been reported, will be around \$200,000.

IN MANY AREAS, particularly the saturation zones, the advent of color has begun to retard new-set installations, but rocket interest in maintenance and servicing. Old set owners are asking the boys to check their antennas and keep their sets in top form, until the color models arrive for judgment. . . . Because of color, it has been guesstimated that black and white set production in '54 will be about 20% below the '53 level, or around 5,000,000 chassis. It is also expected that about 100,000 color receivers will be made for the '54 market.

NOT ONLY is there lively interest in tricolor receiver design, but many unusual allied projects, such as video tape recording. It has been found possible to reproduce color signals, using high-frequency recording heads, on ½-inch magnetic tape. In the process, five parallel channels are recorded on a single tape; for each of the primary color signals (red, green and blue), for the sync signal (to control the deflection of the electron beam in the picture tube), and for sound. In reproduction, the tape supplies the tricolor signals directly to the three guns of the picture tube, and the sync and sound signals to their respective circuits. The tape is operated at a speed of 30 feet-per-second. Problems overcome in this new application include the elimination of interchannel bleed on the tape, and frequency shifting. . . . The system can also be used for black-and-white recording and playback; in this instance, ¼-inch wide tape is used, and the tape carries two recorded channels, one for the video and sync signals, and one for sound. The use of tape for visual recording, which has been dubbed electronic photography, is not expected to be commercially practical until 1955.

ANTENNA INSTALLATION SAFETY CODES UNDER STUDY IN NEBRASKA AND IDAHO--In Lincoln, Neb., and Idaho Falls, Idaho, the city fathers are exploring the adoption of ordinances which will control the installation of TV antennas. Proposed in Lincoln is a rule which would require at least three guy wires for the first 20 feet of a roof-installed antenna. To minimize danger of lightning, grounding would be imperative, according to this code. In addition, bases of wooden poles, that might be used as antenna mounts, would have to be treated to prevent rotting. . . . In Idaho Falls, it has been proposed that TV towers should be no higher than 20 feet above a building, and TV installers should be required to post a \$10,000 bond and obtain a permit to operate. . . . In Pocatello, Idaho, a revision of the city's TV antenna code is now being reviewed. The ordinance, which now requires building permits for all roof-top antennas, limited in height to 40', may be rewritten to void the need for permits for antennas that are but 10' high or less.

\*RCA, CBS-Hytron, Rauland, Lawrence.

# SERVICE... *The National Scene*

NEED FOR UHF CONVERTER-ANTENNA AND ROTATOR COMBINATIONS BOOMING--Many cities, who have had to be content with reception from one or two local vhf stations, have, with the arrival of uhf, become roaring centers of uhf installation-servicing activity. To illustrate, two uhf stations went on the air recently in Milwaukee, supplementing the single station which had been on the air for more than 5 years. When the ultrahigh stations began operating, it was found necessary to use rotators, because the transmitter towers of both stations were widely separated; new antennas to pick up the uhf signals; and converters to change the high band to a low band so that the standard vhf receivers could be used promptly. In addition, in many instances, because of low uhf-station power, it was necessary to use converter-boosters to provide satisfactory reception.

FOUR ASSOCIATIONS TO CO-SPONSOR PARTS SHOW IN MAY, '54--The Radio-Electronic-Television Manufacturers Association; Sales Manager's Club, Eastern Division; Association of Electronic Parts and Equipment Manufacturers, and the West Coast Equipment Manufacturers Association, will co-sponsor the annual electronic parts show, which will be held at the Conrad Hilton Hotel in Chicago, May 17-20, 1954.

AUDIO FIESTA SCHEDULED FOR L. A.--At the Hotel Alexandria, in Los Angeles, Calif., on February 4, 5 and 6, 1954, the Audio Engineering Society will sponsor the second Pacific Coast Audio Fair. The convention will feature technical-paper sessions, and three floors of exhibits.

PHILADELPHIA BROADCASTER TO PROMOTE SERVICING IN DAILY PROGRAMS--WFIL in Philadelphia, Pa., will soon activate a novel series of daily broadcasts in cooperation with local service associations and their memberships. . . . Daily, listeners will be told that a service shop's investment in test equipment alone is usually more than \$3000. Using this equipment, the announcement will say, the Service Man is able to diagnose a set's troubles accurately, and repair it in the least time, and at a reasonable cost. In another announcement, set owners will be told not to use . . . "snap judgment when you need TV or radio service. By now it is a proved fact that reliable electronic service requires high technical skill, efficient business management, costly, modern test equipment, and sound financial backing. These features are easily recognized . . . in the service shop . . . that has been long established in your community, and is known for its good reputation, and membership in one of the associations cooperating with the Council of Radio and TV Service Associations." . . . "Don't let a tinkerer fool with your radio or TV set", serves as the introduction to another announcement. Tampering with a TV set, listeners will be told, is not only dangerous, but can easily become an expensive practice. Continuing, the announcement points out that . . . "Only service personnel can probe safely for faults, and make repairs to your valuable radio or TV set. . . . For your protection and assurance of good TV and radio service, the Council of RTSA advises you to call a member of your local service association." . . . In New York, the alliance between NBC and ARTSNY has proved so effective that the TV-radio programs originally planned for one month will now be continued indefinitely. In a memo to ye editor, the manager of the radio and TV stations now carrying the association messages declared that . . . "we consider the radio and TV Service Man one of our most vital allies, because it is through him that our audience is assured of the best radio and TV enjoyment."

ORCHIDS TO SERVICE--In a recent letter to ye editor, J. G. Russell Jr., Pittsburgh, Pa., wrote that SERVICE is . . . "Far ahead others. . . . We are independent Service Men . . . and your magazine has been of great help to us on many problems we have encountered." . . . And, J. K. Litton, of High Point, N. C., declared that SERVICE is the only magazine . . . now giving . . . real, down-to-earth service information on tape recorders; particularly important today because of the increased use of these recorders in homes and offices. . . . Our grateful thanks, gentlemen, for these sparkling appraisals.--L. W.



With double  
lock stop...

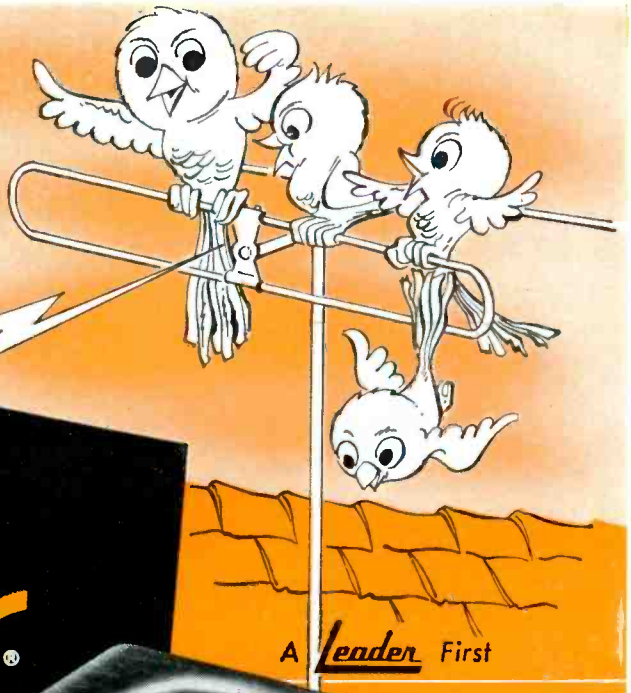

# Only Superotor<sup>®</sup>

OFFERS  
VP Tuning



A *Leader* First

VP means Vernier Precision — sharpest tuning ever possible with any antenna rotator! With the exclusive double lock stop, and "telegraph key" fingertip action, Superotor can be rotated in increments of less than 1/2-degree, permitting highly critical orientation of antenna which automatically locks in position. In addition, Superotor's advanced design permits reading the antenna position without moving the antenna!



Compare All The Features, And You'll Join The Big Switch To Superotor



A  
*Leader*  
First



A  
*Leader*  
First

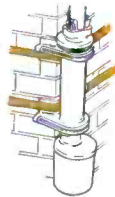

A  
*Leader*  
First

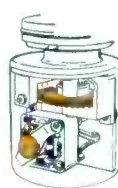

A  
*Leader*  
First



● Quick Detachable Drive Unit

● Built-in Chimney Mount

● Double Lock Stop Prevents Drift & Coast

● Steel-Reinforced Construction



2925 EAST 55TH STREET • CLEVELAND 27, OHIO

LEADING THE WAY TO BETTER PRODUCTS

# It takes the WORLD'S Newest PICTURE TUBE PLANT...

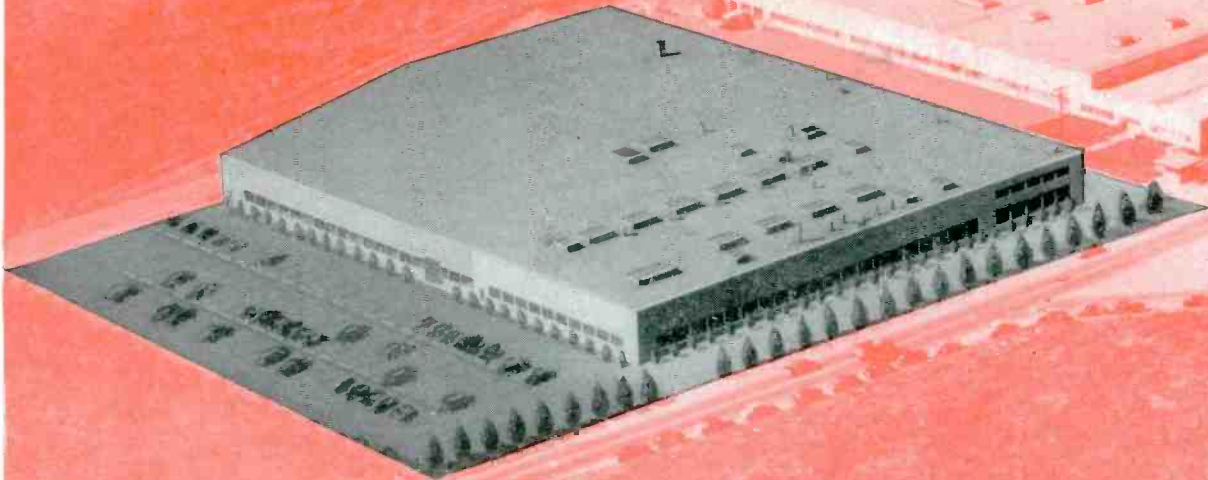

Equipped with the WORLD'S  
LARGEST SETTLING MACHINE...



A BAKE OVEN  
as Big as They Come...

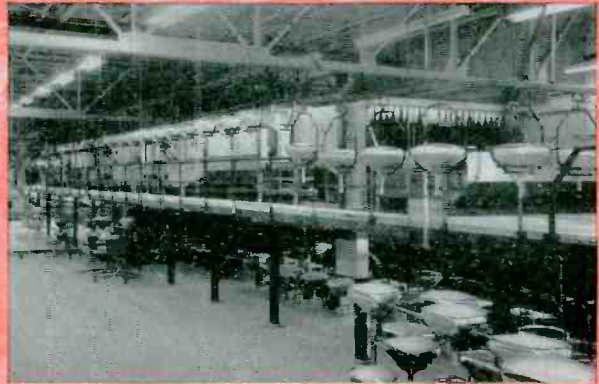

And the WORLD'S LARGEST  
EXHAUST MACHINE...



to make the WORLD'S Finest  
TELEVISION PICTURE TUBES...

RAYTHEON  PICTURE TUBES

The only way to make large screen (21", 24" and 27") TV Picture Tubes of unsurpassed quality is to make them with equipment especially designed to handle and produce them. That's why Raytheon built and has in operation this miracle of a picture tube plant, which houses the world's finest, largest and most advanced equipment and methods for making large size Picture Tubes. This magnificent new plant is one more indication of Raytheon's dedication to a single ideal — to continue to supply you with the finest quality Television and Radio Tubes the world has ever known.



*Excellence in Electronics*

RAYTHEON MANUFACTURING COMPANY

Receiving Tube Division  
Newton, Mass., Chicago, Ill., Atlanta, Ga., Los Angeles, Cal.

RAYTHEON MAKES ALL THESE:

RECEIVING AND PICTURE TUBES • RELIABLE SUBMINIATURE AND MINIATURE TUBES • GERMANIUM DIODES AND TRANSISTORS • NUCLEONIC TUBES • MICROWAVE TUBES

RADIO • TELEVISION • ELECTRONIC  
**SERVICE**

### The Folly of Bait Advertising

THE PHILOSOPHY that service should and can be sold, now solidly accepted as one of the basic tenets modern shops must adopt if they are to succeed, recently has been receiving sorrowful treatment. For, to the embarrassment and dismay of those who have striven so hard to prove that it is possible to hold to high standards in selling, the country has become dotted with miscreants who think that they can outsmart the public with deceptive promotion. Completely by-passing the frantic pleas of many who have lived through several earlier eras where similar waves of fallacious selling obtained, they have seen fit to do it their way and invite disaster.

In Washington, the Federal Trade Commission has received numerous complaints, and has initiated searching investigations. Some shops have already received warnings that their advertising is in violation of section 5 of the FTC act, which prohibits unfair and deceptive acts in commerce. In New England, a state legislature has become so alarmed at this barrage of mischievous copy that they have decided to adopt an amendment to the general laws, which carries a fine for violators. Specifically, the measure declares that any person who offers for sale merchandise, commodities or *service* by making, publishing, disseminating, circulating or placing before the public, within the Commonwealth, in a newspaper or other publication, or in the form of a book, notice, handbill, poster, bill, circular, pamphlet or letter, or in any other way, an advertisement describing the said merchandise, commodities or *service*, as part of a plan or *scheme* with the intent not to sell said merchandise, commodities or *service*, so advertised at the price stated, or with the intent not to sell said merchandise, commodities or *service* so advertised, shall be punished by a fine of not less than \$10 nor more than \$500.

The advertisements that irked the state officials and prompted them to act, were those which offered home TV service, including the service call, all adjustments, and even the tubes

needed, for the ridiculously low prices of between \$5 and \$8. Other advertisers, even bolder, announced city-wide, round-the-clock service, including calls on Sunday, for but \$2.

How one can possibly afford to guarantee the replacement of all the tubes needed (except the picture tube, fortunately), and in addition make all the necessary repairs and adjustments for the low prices quoted, is a mystery. Even operating on the law of averages, these rates cannot be justified. Investigators have found that in practically every instance the shops who used this form of advertising have done so with a deliberate intent to *bait* the customer. And once the call has been made, the set owner receives the customary extensive list of reasons why their chassis cannot be repaired for the advertised price. Normally, this exasperating report is not issued until after the Service Man has taken the chassis out of the housing, and the poor customer is at the mercy of the repairman.

Most of those who advertise in this vicious way seldom include their address, but instead use a central telephone exchange, so that it is impossible to direct a complaint properly.

And to rattle the situation further, some of these bait specialists have even tied up with shoddy merchants advertising such miracles as combination TV antenna and table lamps that guarantee excellent reception . . . "without having to rotate the antenna for *uhf* or *vhf* stations." In one such advertisement, the ingenious development was described as a . . . "non-directional, TV antenna, that provides eye-easing light." (?) Another entrepreneur advertised a . . . foolproof guaranteed *uhf* converter . . . so easy to install that only about five minutes of time were required. The unit illustrated, though, was not only one that required special mounting and careful matching, but alignment as well. And, all this could be done in five minutes. Naturally, the price of the entire oper-

ation was a bargain. In fact, in this instance, it was below \$20.

Successful Service Men who are proud of their work and very zealous of their reputation, of course, just rebel at these conniving practices. They found a long time ago that it is best to be ethical. There is nothing to be gained through the bait act, and the usual follow-through with haphazard repairs and part skimping, or doctoring up a repair job so that it will last just long enough to collect a bill. The ethical practitioner has also found that it is suicidal to make a promise that knowingly will never be kept, a common practice among bait operators. The so-called smart operators are only slowly, but surely putting themselves out of business.

It has often been said that selling of service is just as important as the selling of any commodity. And it must be done honestly and sincerely. As most Service Men have found, the majority of folks who are in need of repairs will gladly spend the necessary dollars, if they feel secure that the job will be done properly, and if they are approached in the right manner. Service Men have found that it is wise to explain, and explain carefully, what the cost of repairs will add up to, and why such repairs were necessary. Vague explanations only arouse suspicions, and often lead to a lost customer.

Those who conduct themselves in their business in a straight-forward manner always win the complete confidence of their customers. This is a credo that has been adopted wisely by all associations, and found to be a key to success.

Misleading or untruthful advertising, and the making of unreasonable promises or statements, can only eventually sour everyone, and lead to one inescapable result—an empty shop.

Bait advertising is foolhardy and treacherous. It should be shunned forever; that's a sterling resolution to make for the new year!—L. W.

# 2-Speaker Phono With 2-Cubic-Foot Enclosure †

by WYN MARTIN

[See Front Cover]

THE PROBLEM OF DEVELOPING and producing a wide-range phono is by no means a simple one. Aside from the acoustical and electrical factors involved, there is the cabinetry design which must be attractive and have universal eye appeal. The question of size is of prime importance and presents almost insurmountable acoustical difficulties if size is to be kept within reason. In an effort to solve this acoustical problem, and provide good low-frequency response from a small chamber, a novel enclosure system has been evolved.<sup>1</sup> In a space of two cubic feet it has been found possible to include a two-speaker system utilizing 6" and 8" specially-developed models, one for frequencies from 50 to 200 cps and one for the 200 to 12,000-cps range. The upper register speaker was enclosed in a conventional closed box lined with absorptive material. The free air resonance of the 6" diam-

eter speaker is 185 cps; by enclosing it in its chamber it was possible to raise the resonant frequency to 200 cps. Below this frequency the response drops off at a 12-db per octave rate. Since the speaker was to be used for *hf* only, it was possible to employ a stiff, shallow cone with a very light diaphragm and a light voice coil.

The 8" *lf* speaker was also mounted in a closed box, but here the similarity to a conventional system ended. The front of the speaker was loaded with a closed cavity which opens to the air through an array of small holes. The resulting frequency response from this system was found to be flat from 50 to 200 cps with a 12-db per octave decrease at each end.

### Response and Acoustical-System Analogy

Common *if* cans in radios and tuners are the electrical equivalent of an

acoustical system and it is common knowledge that the response of these units can be tailored by adjusting the resistance, *lc* ratio, coupling etc. The principal gain from using this type of system is the suppression of harmonic distortion. In the system developed, for example, if a 100-cps tone is used to drive the speaker and enough power is used to overdrive the speaker with a resulting production of distortion, the system will respond only to the fundamental and the 300, 500 cps, etc., distortion products are effectively suppressed. The sound that reaches the ear of the listener will be found to be pure 100-cps sound. At the very low end of the scale, one will find that the majority of the distortion produced by overdriving the system is suppressed and only the third harmonic content remains. Actually, to take full advantage of the system, a special loudspeaker is necessary. There is no way to circumvent the natural law that energy must be conserved and to obtain a good low frequency response down to 50 cps, a large volume of air must be moved. Either a conventional 15" loudspeaker with a normal excursion, or a smaller speaker with a large excursion is possible. The 8" model used in the low section of this system was found to provide a large excursion to move the air, and a free air resonance of 50 cps.

### Amplifier Design Factors

Since the phono model with this 2-speaker system was to be used in the home, it was determined that a ten-watt amplifier was necessary to produce the required loudness. A frequency range was chosen, not by conventional procedure which dictates flat response from 2 cps to 100,000 cps or better, but by limitations in response of other elements in both this system and in the recording industry as a whole. Actually there is no valid argument for a low-frequency range below 30 cps. Those who point to the 16-cps response of the organ must realize that there are *very* few organs in the country which include a 64-foot pipe or even 32-foot pipes to provide such low notes. As far as recorded music is concerned, a lower-end response below 35 cps is a hindrance both to the maker and the user since table rumble becomes a problem. Couple this with the fact that speakers in general, and

Fig. 1. Circuit of amplifier developed for the two-speaker system; see cover.

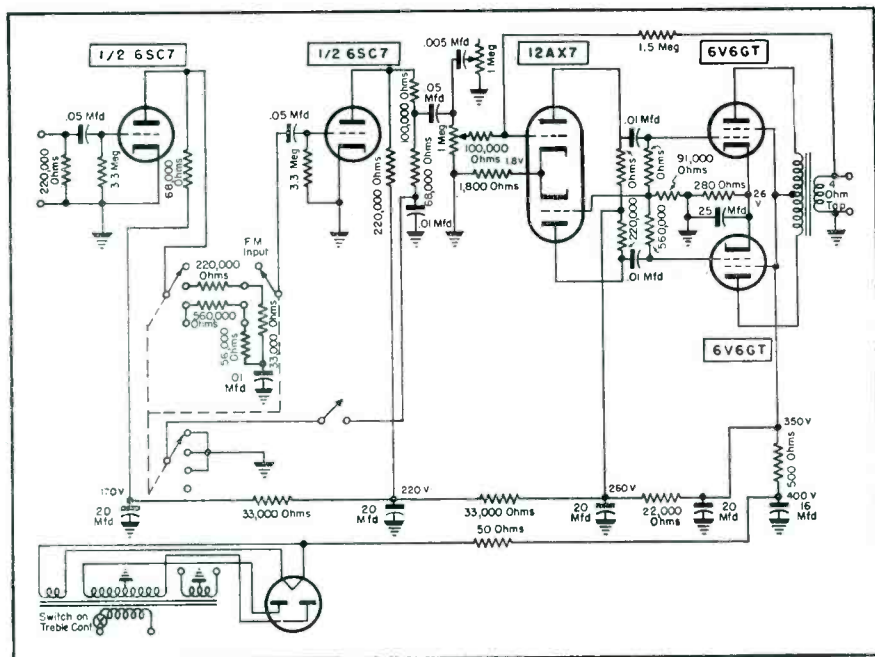

†From a report prepared exclusively for SERVICE by Henry C. Lang, chief engineer, The Kelton Company.

<sup>1</sup>Patented; used in Kelton Cambridge.

<sup>2</sup>The two speakers were developed by Peter D. DeJong, chief engineer of Carboneau Industries, in cooperation with the Kelton research and development department.

Fig. 2. Sectional view of Kelton speaker-enclosure model, which is acoustically identical to that used in packaged phono model. The small size and multi-braced construction make it possible to use 1/2" plywood, thus lightening the weight of the cabinet.

this includes costly models, do not reproduce well below 40 cps, the response of an amplifier said to go down to 2 cps becomes an academic question. There is considerable merit in extending the range of an amplifier above the normal hearing range to introduce as little transient or phase distortion as possible. That the range should extend to 100,000 cps is a moot point, since neither the source material nor the final reproducer reaches much beyond 13 to 15 kc. In view of the foregoing, it was decided to develop an amplifier whose range would be 30 to 20,000 cps. This range was to include the entire amplifier including the pre-amp. Hum and noise level for inaudibility in living-room use was to be down at least 55 db, and total distortion was to be less than 2% at full rated output. The preamp section, it was felt, should include equalization curves for the three major recording characteristics (Columbia, London, and RCA) and a variable treble control. The variable treble, both boost and roll off, is necessary to compensate for variations in the high-frequency response of living rooms which can be considerable. The low-end response of average-sized rooms, on the other hand, is not subject to the variations found at the high frequencies, since very few materials absorb sound at the lower frequencies. The inclusion of a bass control knob is then merely a concession to the musical tastes of the customer, not to the dictates of good reproduction.

The most important single item in an amplifier is the output transformer. If inverse feedback is to be used, the output transformer must have good frequency and phase characteristics. It is also necessary to have a heavy duty transformer if good low-frequency reproduction is to follow. Inverse feedback in an amplifier will extend the frequency response and decrease distortion in the original pass band, but the distortion in the extended range will be high. Before accepting a transformer more than twenty output transformers were tested.

In Fig. 3 appears the frequency response for the amplifier section alone, with the equalization response on the (Continued on page 64)

Fig. 3 (center, right). Frequency response of the amplifier section from FM input (load=3.5 ohms), with the equalization response in the upper section of the plot. A, B, and C represent reproduction from RCA, Columbia and London recordings, respectively.

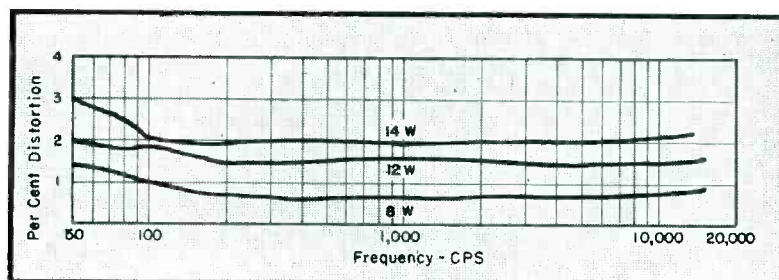
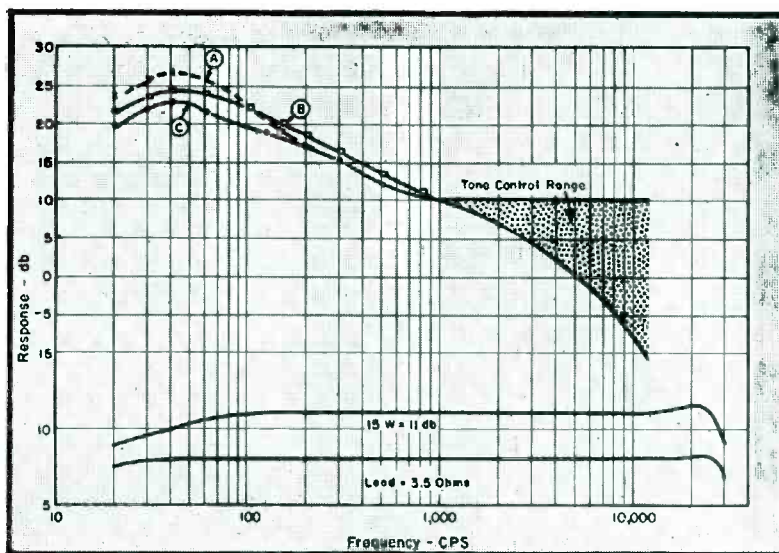
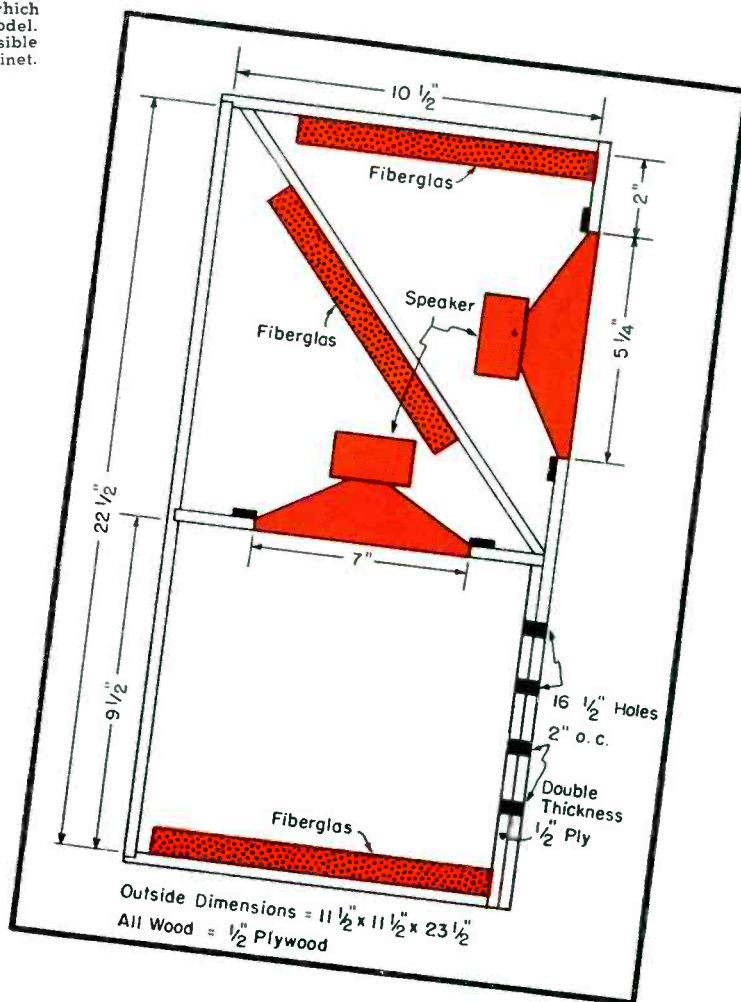

(Right) Fig. 4. Distortion curves at various power levels.

REMOTE TUNING has always been an extremely attractive design feature. In the early days, it was very popular, and recently, it has once more become quite a factor in audio systems, and especially TV.

The renewed interest in the remote control of television chassis has accelerated development of special tuners for that purpose, an interesting example of which is illustrated in Fig. 1.\*

With this equipment, viewers can select the channel, adjust fine tuning, and set the volume and contrast levels without approaching the receiver.

The unit is unique in that no mechanical action takes place in the receiver. There are no solenoids or latching mechanisms required for its operation. The controlling action is completely electronic via a single-shielded lead.

A self-contained, half-wave power supply powers a cascode tuner, and a selenium rectifier supplies voltage to a contrast control circuit. By making simple wiring changes, the output polarity of the selenium supply can be reversed so that the tuner can be used with receivers requiring contrast bias voltages of opposite polarity.

#### Installation

The first step in the installation of a tuner of this type is the selection of the proper unit for the receiver. Two models are available<sup>2</sup>; they differ only in their output *if* frequency.

The type of *agc* circuit used in the receiver determines the connection of the contrast bias line. It is then necessary to determine what type of *agc* circuit is employed in the receiver to which the remote is to be attached. The three basic *agc* circuits which have been and are being used (simple rectified, keyed and amplified) are shown in Figs. 2 through 5.

There are many variations of each of these types of circuits. The Service Man must determine the basic type of circuit since this will determine the installation procedure to be used.

#### AGC-Type Circuits

The simple rectified *agc* circuit utilizes the rectified video signal as the source for *agc* voltage. A filter network is used to smooth out the video signal resulting in a *dc* voltage whose amplitude is proportional to signal strength.

The circuit in Fig. 3 is similar to that of Fig. 2, except that it employs a separate diode for rectifying the *if*

## Electronic Remote TV-Tuner Circuitry Analysis

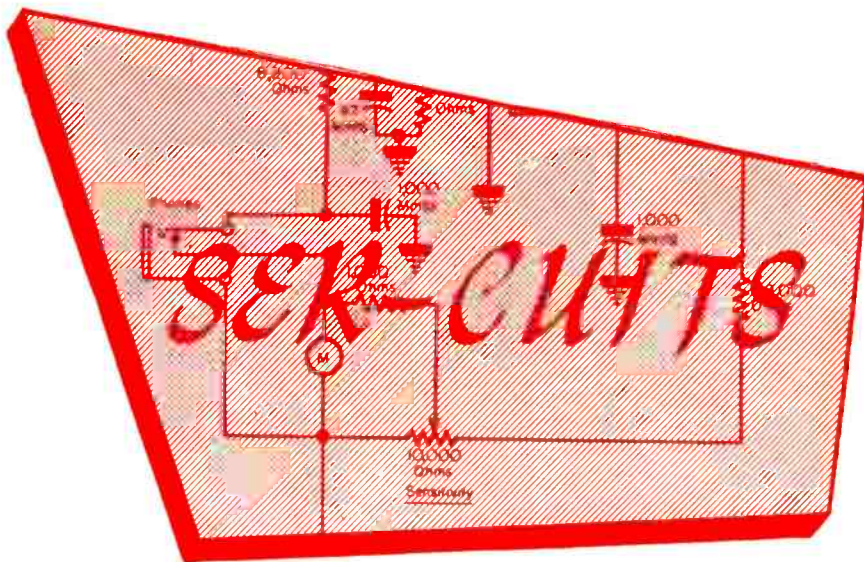

by M. W. PERCY

signal to provide a source for the *agc* voltage.

In the keyed *agc* circuit *agc* voltage is developed by means of a sampling process of the amplitude of the sync pulse. Operation of the circuit relies on the conduction of the *agc* tube only during the sync pulse time. This is accomplished by applying a positive pulse to the plate of the *agc* tube during sync pulse time. This pulse is provided by the horizontal output circuit. A positive-going video signal is then applied to the grid; the degree to which the tube conducts is governed by the amplitude of the sync pulse. Thus, the *agc* voltage developed is proportional to the signal strength.

This type of *agc* circuit can be identified by the presence of a horizontal pulse on the plate of the stage and a video signal on the grid.

The horizontal pulse for this circuit is generated by means of a winding on the horizontal output transformer or the width coil. A video signal is applied to the grid from the video amplifier or sync separator.

In the amplified-*agc* circuit shown in Fig. 5, a *dc* amplifier is employed to develop the voltage for controlling the gain of the receiver. A *dc* voltage, proportional to the signal strength, is applied to the stage to control its conduction. Normally, the cathode is returned to a *B-* point while the plate load is returned to ground. Thus, conduction of the tube produces a

minus voltage on the plate. This voltage is filtered and utilized as an *agc* voltage.

To identify this circuit, the *dc* path should be checked; you will note that the *dc* path of the *agc* line is returned to the plate, while *dc* voltages only are present on all elements of the stage.

The varying bias for the control of the *agc* amplifier stage here is obtained from a cathode-follower stage normally referred to as an *agc* rectifier. The filter capacitors in the cathode circuit maintain the cathode voltage at a level governed by the amplitude of the signal being applied to the grid. As the signal level changes, the conduction of the *agc* amplifier is varied, resulting in a change in *agc* level.

This keyed *agc* circuit requires a positive voltage output from the remote unit. The remote unit, as supplied, is wired for negative output, but the required positive voltage can be obtained by transforming a lead on the coarse-bias adjustment pot.

Most receivers employ a voltage-divider network to obtain the proper voltage at the cathode of the amplified *agc* tube. In many cases, an *agc* control is included in the divider network to provide some adjustment of the *agc* operation. To prevent the disruption of the normal operation of this circuit, it is necessary to have a return point which is more negative than the voltage present on the cathode. Thus, the

(Continued on page 66)

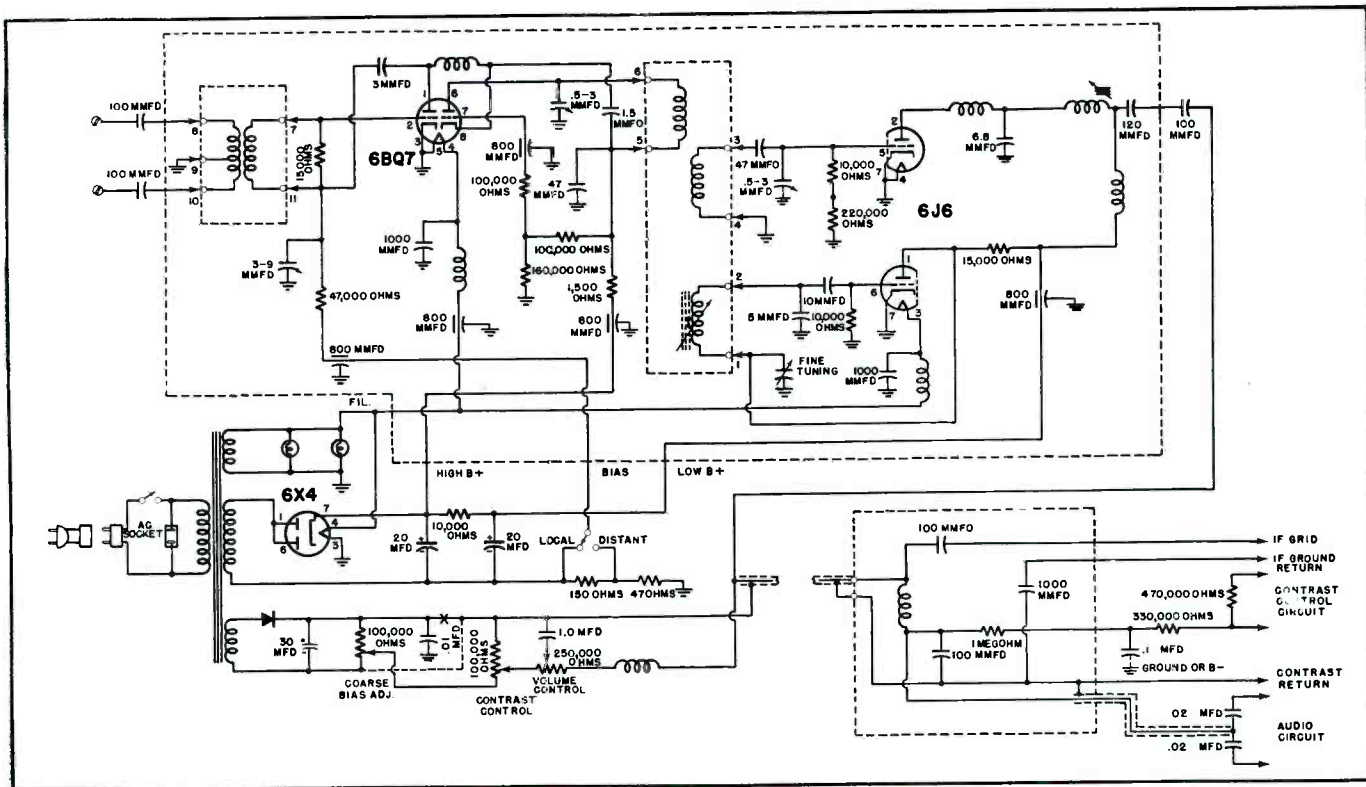

Fig. 1. Schematic of Regency RT-700 remote tuner.

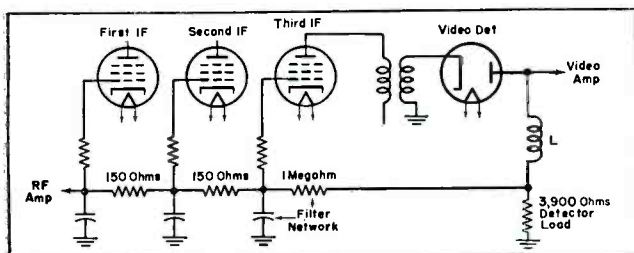

Fig. 2. Simplified rectified agc circuit.

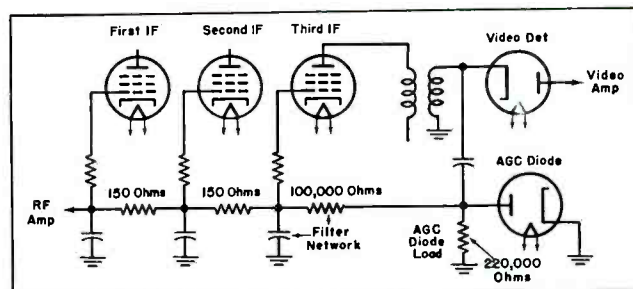
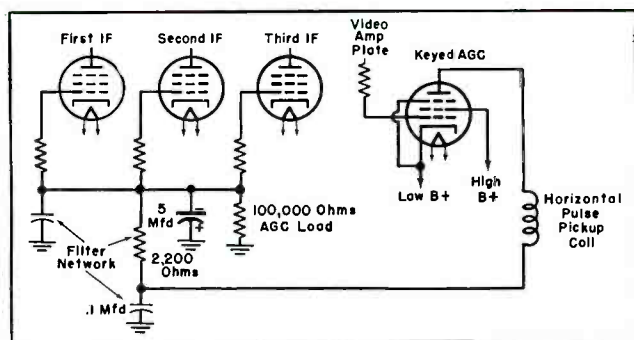

Fig. 3. Simplified rectified agc circuit employing a separate diode for rectifying the if signal to provide a source for the agc voltage.

Fig. 4. Keyed agc circuit utilizing sampling process of the amplitude of the sync pulse to develop agc voltage.



\*Regency model RT-700 series. <sup>2</sup>RT-700-21 (21-mc) and RT-700-41 (41 mc).

Fig. 5. Amplified agc circuit employing a dc amplifier to develop the voltage for controlling the gain of the receiver.

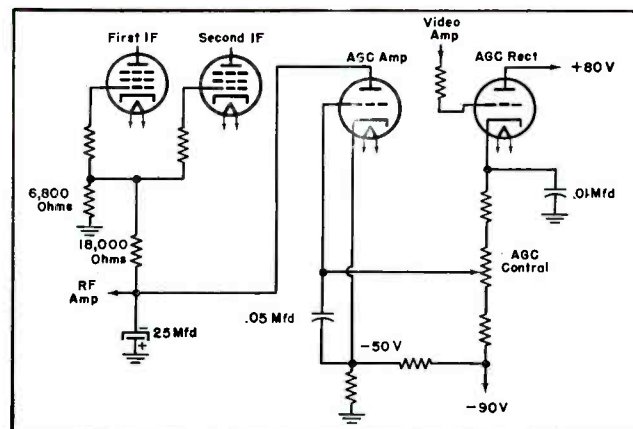

# TAPE RECORDER Report 3:

## 7½/3¾ Solenoid-Operated Push-Button Models

by D. S. CEVANS

**Design . . . Operation . . . Installation . . . Service\***

IN OUR PREVIOUS REVIEWS of tape recorders, dual-track types in singular two-speed or separate models for either speed, with mechanical switch controls, were described. In this report is offered an analysis of another type of dual-track model (for either speed) featuring electromechanical or solenoid-actuated push buttons.<sup>1</sup>

The two models are alike in basic design, the differences being that one is designed for a tape velocity of 3¾ ips and the amplifier is equalized for that tape characteristic, whereas the other is designed for a velocity of 7½ ips and is equalized accordingly.

Through a mechanical interlock, a *stop* switch prevents actuating other switches until the recorder has been stopped. A separate mechanical lock is provided for the *record* switch to prevent accidental erasure. Switch decks, in general, perform two functions: one, signal or bias switching, and two, switching of solenoid circuits. A considerable amount of electrical interlock is used.

A separate oscillator tube (6C4) is used. Bias frequency is 48 kc, ±10 kc.

A conventional 4-stage amplifier is used; 3 stages are used for recording. Fixed equalization is employed for recording and adjustable equalization is used on playback.

Filament supply is by means of a transformer, but the plate supply is obtained from an additional winding in the motor. This winding is protected against burnout by means of a fuse (¾ A) mounted within the motor housing. The amplifier power supply has a voltage doubler using a pair of selenium rectifiers. The *dc* power for solenoid operation is obtained from a half-wave selenium rectifier, directly connected to the power line.

The erase head operates from 6.3

volts. Saturation (erasure) and demagnetization are achieved by pulling the tape through a tapered gap in the core of an erase magnet. The head can be rotated slightly for lateral positioning of gap with respect to tape passage and can be raised or lowered for track coverage.

The record-play head can be rotated for tangency and tilted for azimuth adjustment.

### Tape Drive Mechanism

In the primary drive, the pulley and driver unit is mounted on the shaft of the drive motor and drives the flywheel and capstan assembly by means of a drive belt. The motor is controlled by a switch on the volume control.

In the takeup drive, the takeup belt drives the takeup pulley, which in turn drives a takeup spindle through a takeup clutch (located between the spindle cup and takeup pulley). When any key except *stop* is depressed, a brake solenoid is energized, thereby releasing a takeup brake and a feed spindle brake. When *record* or *play* is depressed a forward solenoid is partially energized, thereby pulling downward on the takeup spindle and causing the spindle to be driven through the takeup clutch. When the *fast forward* key is depressed the forward solenoid is fully energized, thereby pulling downward on the takeup spindle with sufficient force to lock virtually the spindle clutch, producing a direct drive between takeup pulley and takeup spindle.

When either the *record*, *fast forward* or *play* key is depressed, the brake is released and the feed spindle is driven by the tape. Rotation of the spindle drives a counter by means of a belt. When the *rewind* key is depressed a rewind solenoid is energized, thereby swinging the feed spindle toward the

motor shaft, causing the drum to come in contact with a tire on the rewind driver. The rewind driver is driven through a clutch disk located between the driver and the flywheel drive pulley.

A pinch roller is mounted on a pinch roller arm which is pivoted on an eccentric stud. When either the *play* or *record* key is depressed a pinch solenoid is energized, thereby swinging the pinch roller over against a capstan. The head pad is pivoted on the pinch roller arm so that, when the pinch roller presses the tape against the capstan, the head pad presses the tape against the head.

### Mechanical Adjustments

Proper operation of brakes is essential to good tape handling. Improper adjustment can be expected to lead to either tape spilling or tape breakage; therefore, it is essential that brake adjustments be made carefully, and in the sequence, manner and specific amounts.

(1) The rewind brake adjusting screw must be loosened enough to prevent the ear on the actuating arm from moving the arm upon which the brake roller is mounted, even through the brake solenoid plunger is pushed in as far as it will go.

(2) With the brake solenoid plunger pressed in as far as possible (apply pressure to end of plunger; not to operating bar) the operating bar stop screw should be adjusted to ¼" clearance between the end of the screw and the stop stud.

(3) With the plunger depressed, as indicated, the rewind brake adjusting screw should now be adjusted to produce a clearance of .020"-.025" between the brake roller and the spindle drum.

(4) The brake solenoid plunger should then be released and the takeup

\*From notes prepared by the Service Division, Ampco.

<sup>1</sup>Ampco models 755 and 756.





# THE "TELCO TEN"

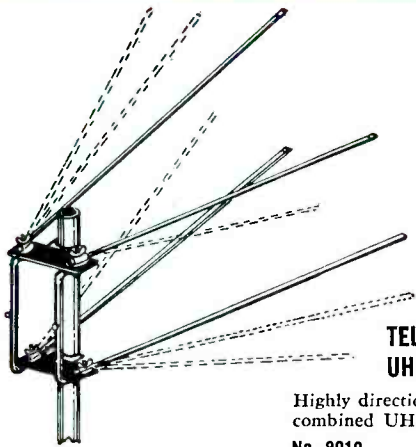

**NEW!**  
TELCO "DOUBLE V"  
UHF-VHF ANTENNA

Highly directional...adjustable for  
combined UHF-VHF 50°-70°-90°.  
No. 9010 List \$6.95

... the "T" formation line—T for Top Quality  
and T for Ten Antenna Styles. Insist on TELCO  
... the best TV antennas for the greatest "show"  
on earth.



## WISHBONE

... exclusive with TELCO, is a free  
air insulator that prevents shorting  
out under any condition ... found  
only on TELCO UHF Antennas.

**FREE CATALOG**—illustrates all TELCO  
products. Available at your jobber or  
write direct today!



**TELEVISION HARDWARE MFG. CO.**  
DIVISION OF GENERAL CEMENT MFG. CO.  
901 Taylor Street Rockford, Illinois

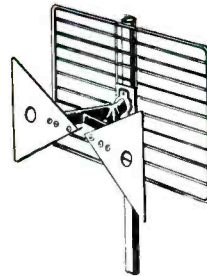

TELCO UHF "GOLDEN GRID" SUPER  
DELUXE BUTTERFLY ANTENNA  
No. 8965 List \$5.95



TELCO UHF "GOLDEN GRID" STANDARD  
BUTTERFLY ANTENNA  
No. 9001 List \$3.95

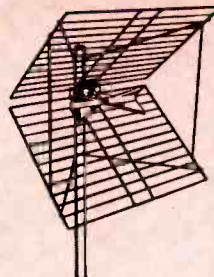

TELCO UHF "GOLDEN GRID" DELUXE  
CORNER REFLECTOR ANTENNA  
No. 8984 List \$11.25

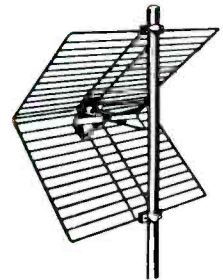

TELCO UHF "GOLDEN GRID" STANDARD  
CORNER REFLECTOR ANTENNA  
No. 9002 List \$11.25

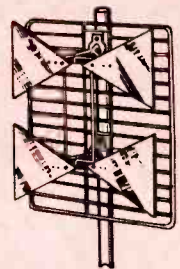

TELCO UHF "GOLDEN GRID" 2-STACK  
DOUBLE TIE ANTENNA  
No. 9004 List \$7.50 less mast

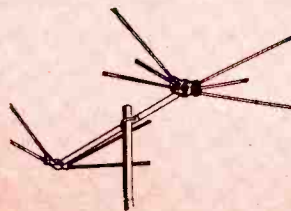

TELCO VHF CONICAL ANTENNA  
No. 8700 List \$9.25

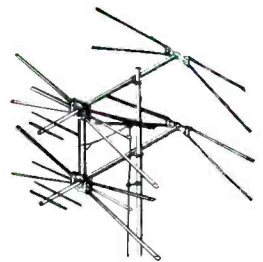

TELCO VHF SUPER CONICAL ANTENNA  
No. 8902 List \$19.85

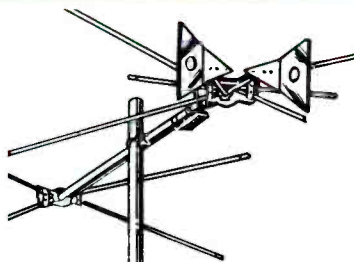

TELCO UHF-VHF UNIVERSAL CONICAL  
ANTENNA  
No. 8981 List \$16.25

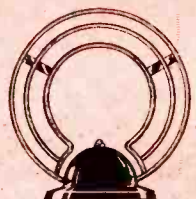

TELCO UHF-VHF "GOLDEN HALO" IN-  
DOOR ANTENNA  
No. 9000 List \$4.95

here is the  
new →

**VEE-D-X**

# mighty match

FOR CONNECTING SEPARATE  
UHF AND VHF ANTENNAS  
TO A SINGLE TRANSMISSION LINE.

With entirely new patented\* circuits and new construction, the MM-40 and its companion (MM-40-A) are by far the finest, most efficient isolation filters for combining separate UHF and VHF antennas for single line installation. The MM-40 in new yellow weather-resistant case is quickly and easily mounted on antenna mast. The MM-40-A is used at converter or TV set that has separate UHF and VHF terminals.

## FACTS ABOUT THE NEW MIGHTY MATCH

- New improved patented\* printed circuits
- Amazingly *LOW* insertion loss
- Weather-resistant case
- New larger terminals for easy line connections
- No critical lengths of connecting lines
- Loss preventative stand off.

VEE-D-X was first to introduce the isolation filter (Mighty Match). Every Mighty Match is fully protected under\*A.A.K. Pats. 2,422,458; 2,282,292; 2,611,086. The new models greatly minimize insertion loss, and are the result of constant research and engineering. Accept no substitute—insist on Mighty Match.

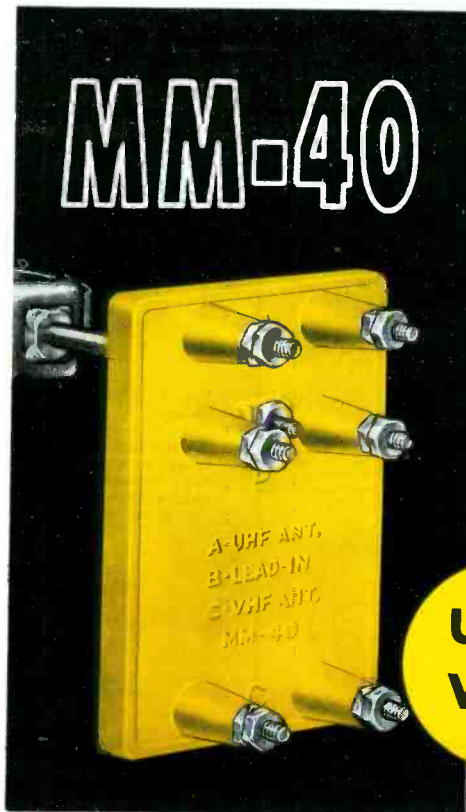

**UHF  
VHF**

...and its companion

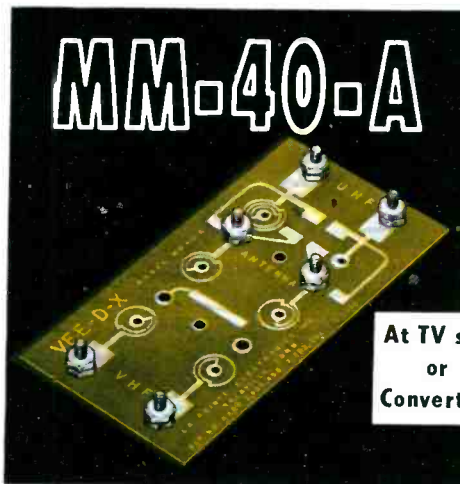

At TV set  
or  
Converter

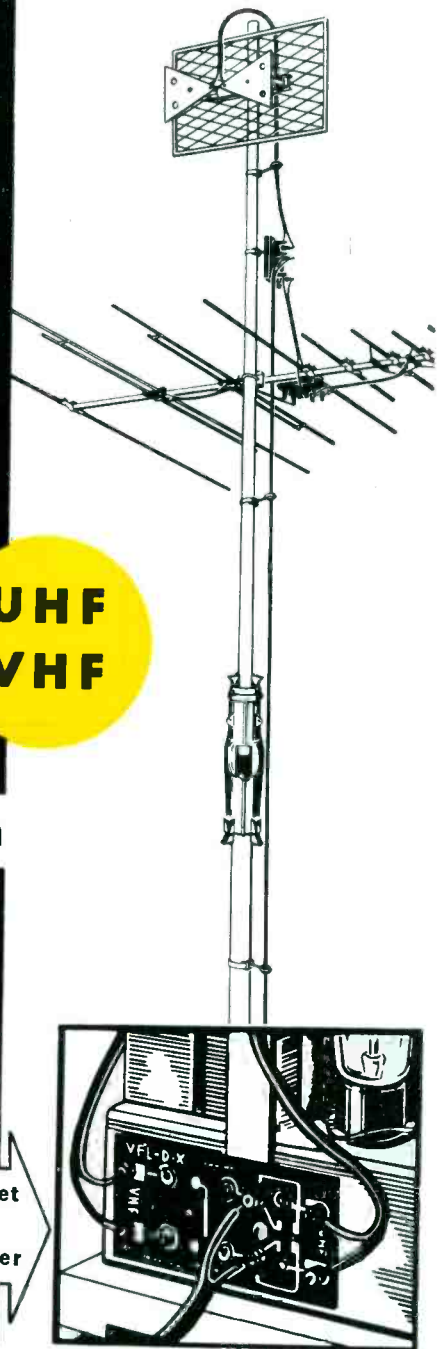

SEVEN MODEL VARIATIONS FIT EVERY TYPE OF INSTALLATION.

also the new

**VHF MM-25**

Permits the use of single transmission line between separate high and low channel VHF antennas mounted on the same mast. Saves 300 ohm transmission line. Saves installation time and money. Saves extra accessory cost. This new model MM-25 replaces the older model MM-20. With new improved circuits and case construction, it is far more efficient. New raised terminals permit easier, faster line connections. Has weather-resistant green case.

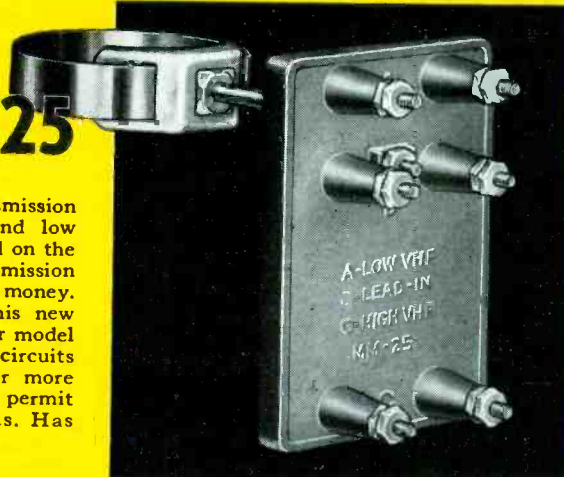

**NEW!**  
Printed Circuits  
and amazingly low insertion  
loss make Mighty Match  
by far the finest, most  
efficient crossover  
network.



**LaPointe** ELECTRONICS INC.  
ROCKVILLE, CONNECTICUT

# Maintenance of

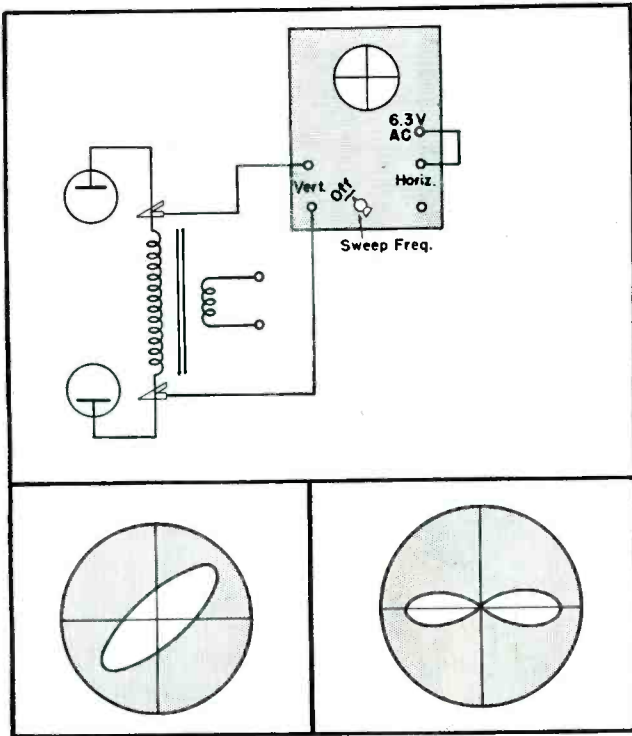

Fig. 1. Checking frequency of the hum. The open pattern at the left indicates pure 60-cycle hum, while the figure-8 pattern shows that the hum is pure 120 cycle.

THE HUM PROBLEM in most commercial receivers does not usually involve anything more complicated than the replacement of filters. But modern audio amplifiers designed for low-output magnetic pickups have so much more gain, and the associated speaker system is likely to have so much better response at the fundamental 60 cycles of the *ac* line, that a whole new set of hum sources must be taken into consideration.

It would be a mistake to assume that all hum originates in the amplifier or preamp. Not only may one of the other components be at fault, but the trouble may arise from an interaction between two units, neither one of which is defective.

The first step in hum tracing must therefore be localization of the source within the complete reproducing system. All input units to the amplifier, including the preamp if it is separate, should be disconnected and turned off. If this operation causes the hum to disappear the trouble has clearly not originated in the amplifier itself, and each of the input units should be turned on and reconnected in turn to determine which is responsible.

Hum tracing in the amplifier proper also starts out with localization. Hum level can be checked with all tubes except the rectifier and output tubes removed. (The hum is liable to be somewhat greater than that of the complete amplifier in perfect condition, as the feedback loop has been effectively opened.) The amplifier should be worked on in its almost tubeless condition until the hum level

is satisfactory. The phase inverter should then be inserted, and the same procedure followed; then each of the voltage amplifier tubes should be replaced in turn, always working back from high level to low level. In this way various sources of hum can be checked and cleared up independently.

The foregoing procedure is especially important when working on an amplifier or sound system whose hum level has gradually built up, over months of use, to an unacceptable value. In such a case it is quite possible that the hum is being introduced from several independently operating sources, and without systematized localization the work may turn into confused and ineffective puttering.

It is very useful, when working on hum, to use a visual indicator in addition to or instead of an audible one. Not only can the annoyance of the constant noise in the speaker be eliminated, but visual indication is more accurate, and furnishes information on the frequency components of the hum that can only be guessed at from the sound itself. A 'scope connected across the output transformer's voice coil terminals will reveal gross hum, but for a more sensitive measurement the 'scope should be connected across the whole of the output transformer primary; that is, between the plates of the two output tubes. The 'scope may also be used to check between plate and ground of a particular voltage amplifier stage.

With the 'scope sweep-frequency selector switch turned to zero, or off, and a 60-cycle comparison signal

(available from the 'scope) injected at the horizontal input terminals, 120-cycle hum applied to the vertical input will produce some sort of figure-eight pattern on the screen, while 60-cycle hum will produce a closed circle or ellipse without crossed lines. These patterns are illustrated in Fig. 1. The figure-eight points to ripple from the full-wave power supply, while the open ellipse eliminates such ripple and indicates one of the less obvious hum sources.

It is possible to make a fairly accurate measurement of final hum level with the 'scope, using the setup shown in Fig. 2. The 'scope pattern can be approximately translated into an *rms* voltage reading from a knowledge of the vertical 'scope sensitivity, normally rated in the number of *rms* volts required to produce a one inch peak-to-peak deflection. The method of calculating both the output hum power and the *db* hum rating relative to amplifier power has been described earlier.<sup>1</sup>

## Sources of Hum

There are five major categories of hum source: (1) B—supply ripple, (2) pickup from electromagnetic or electrostatic *ac* fields, (3) pickup from tube heaters, (4) *ac* currents flowing in the chassis or signal cable shields, (5) *ac* modulation of an *rf* carrier (tunable hum).

The first of these is the most common, and all Service Men are familiar with it. The only feature peculiar to multi-stage, high-quality audio amplifiers is the fact that as many as three or four additional resistance-capacitance filter sections may be used after the main filter section, and there are that many more filter capacitors to check. The best method of testing is to bridge temporarily the suspected filter with a test capacitor and to observe the result, if any, on the hum.

The second source of hum, involving inductive or capacitive pickup from an *ac* field by some point along the signal channel, is far more significant in high-gain systems than in ordinary radios. Hum fields created by adjoining components or chassis are a matter of original design and layout, and were discussed previously.<sup>2</sup> Hum

<sup>1</sup>Vino, Mark, *Audio Equipment Test and Measurement, SERVICE*; July, 1953.

# AUDIO SYSTEMS

## General Causes and Sources of Hum

by MARK VINO

pickup due to defects that develop after use is often associated with broken or frayed connections to cable shields, corroded connections between component shields and chassis, or service replacements of defective *ac* carrying components with a physical layout changed from the original. Replacement of a metal tube by an equivalent glass type can also result in greater pickup from hum fields.

When testing to determine whether hum is being coupled from a given point, a test shield should be inserted between the suspected source and the point of entry into the signal channel, grounding out the shield by heavy pressure against the chassis. It must be remembered that iron is required to shield against both types of *ac* fields; aluminum or copper will only shield against capacitive pickup.

Replacement *ac* wiring must be twisted for hum field cancellation, and the original layout and lead dress followed carefully. Another source of hum field is the earth itself, to which one side of the power line is connected. The amplifier can be protected against this type of hum pickup by solid electrical grounding of the chassis to a cold-water pipe, and subsequent testing of plug polarity for least hum.

Hum pickup from *ac* fields will be predominantly 60 cycles if the field is directly associated with the line, or 120 cycles if the field is associated with a component (such as a choke) in the unfiltered output of the *B* power supply.

Hum from tube heaters is a problem that is especially significant in low-level preamps. Certain tubes, such as the 12AY7, 1620, 5879, and the new Z729<sup>3</sup> have been specifically designed for low noise and hum. Individual tubes vary as to hum level, and the insertion of a particular tube which operates perfectly in a high level stage may cause a bad case of hum in a preamp.

Fortunately it is comparatively simple to determine whether hum is due to coupling from the tube heater. A conclusive test can be made by dis-

Fig. 2. Method of measuring hum at the output of an amplifier, with calibrated 'scope. The hum power is equal to  $E^2/R$ , where  $E$  is the voltage appearing on the 'scope, and  $R$  is the plate-to-plate rated impedance of the transformer, properly loaded as shown.

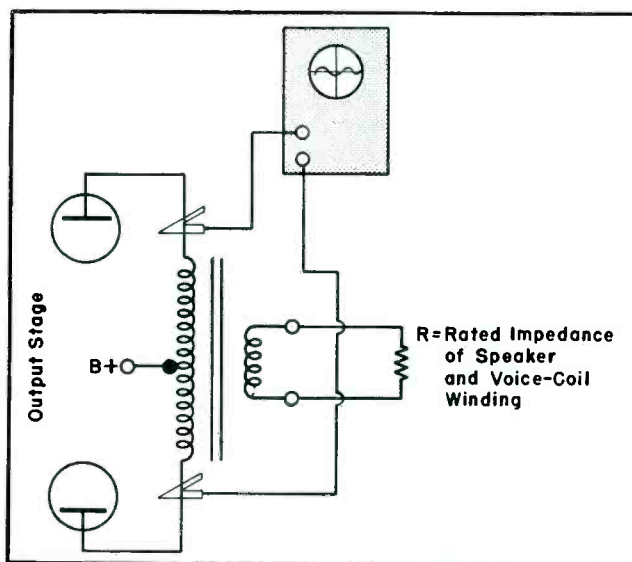

connecting the heater leads of the stage being tested and observing or listening to the effect on the amplifier hum output. If the heater has been the source of trouble the hum will disappear instantaneously the moment that the heater circuit is opened. If, however, the heater has not been to blame, the hum will disappear only gradually with the cooling of the cathode. If there is any doubt in the matter, or if other sources of hum make it difficult to determine the effect of opening the heater circuit, a 6-volt battery can be substituted for the heater leads, and the new hum level compared with what it was originally. Heater-induced hum will always be 60 cycles in frequency.

The installation of a preamp which draws its power from its associated low-gain amplifier can result in heater hum if the design of the amplifier heater circuit is not adequate for low-level stages. An effective hum-cancelling heater circuit that can be added to almost any amplifier is illustrated in Fig. 3. When the original

Fig. 3. Method of balancing a heater-induced hum. The potentiometer, which may be between 50 and 100 ohms, must be adjusted for minimum hum.

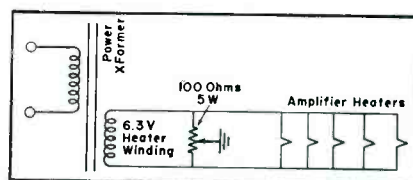

<sup>3</sup>British type tube.

circuit has one side grounded this ground must first be removed.

Another circuit for reducing heater hum is illustrated in Fig. 4. Here the circuit of Fig. 3 has been combined with a voltage divider arrangement that applies a positive *dc* voltage to the heaters, making the cathode negative with respect to the heater and preventing heater-to-cathode emission.

The fourth source of hum is probably the most subtle and difficult to trace. Minute voltage drops are formed along the chassis, due to the flow of alternating current in a return path or to induction from an alternating field. These voltage drops can be introduced into the signal channel at low-level points and amplified into an appreciable hum. Although chassis currents are in general a design rather than a service problem there is one rule that must be strictly followed in all repair work on audio stages; the grid resistor and cathode resistor must always be grounded at the same point, and a good, clean, solid joint must be made.

[Next Month: Speaker Troubles and Cures]

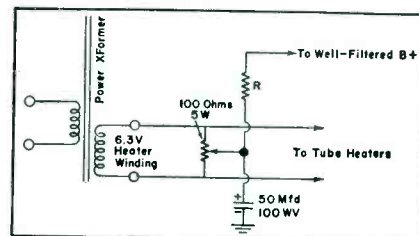

Fig. 4. Method of preventing heater-to-cathode emission by application of positive voltage to heater. The cathode is thus negative with respect to the heater and will not permit emission.  $R$  is of such value that between 15 and 40 volts *dc* is applied to the potentiometer.

<sup>2</sup>Vino, Mark, *Interconnection of Audio Components*, SERVICE; August, 1952.



**LADIES GENTLEMEN!**

*with your kind permission . . .*

**Regency**

**PRESENTS**

**THE**

**'FABULOUS FIVE'**

**QUINTUPLET UHF CONVERTER**

This fall, a huge promotional program is directing thousands of customers to Regency!

Stand-out advertising in **LIFE**, **HOUSE BEAUTIFUL**, **HOUSE AND GARDEN**, **ATLANTIC MONTHLY**, **SATURDAY**

**REVIEW**, **HARPER'S** and **Nation-wide TELEVISION** will effectively sell your customers on Regency. Take advantage of it! Fifty million

customers will see it! Make sure you can offer them the only converter ever made that utilizes any of 5 VHF channels in converting to UHF! Don't take chances!

Other converters work on only 2 channels! Insure your customers against image interference, obsolescence . . . sell them **REGENCY'S**

fabulous, profit-fetching Quintuplet Converter! . . . at \$49.95 list there's extra profit for you!

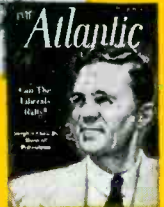

**Regency**

Division of I. D. E. A., Inc., Makers of VHF Boosters, FM Boosters, UHF Converters, Professional High Fidelity Equipment and Television Remote Control.

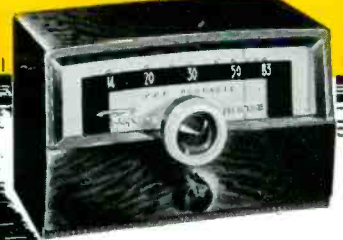

# Decide on DuMont

on the basis of...



Microscopic look at the cathode surface reveals soft, even texture, necessary for efficient tube performance

*Product Superiority*

*not too wet, not too dry—  
not too light or heavy...*

THE CATHODE plays an important role as source of electron energy in the picture tube. Moisture content and texture of the cathode coating must meet rigid standards to insure maximum picture tube life.

At Du Mont, exclusive processes are used for applying the cathode substance. The soft even texture achieved (see illustration) packs the effective emitting area (in circle) with extra electron power.

The resulting brighter performance over maximum tube life tells you why Du Mont is the right replacement for any set.



\*Trade-mark

REPLACEMENT SALES, CATHODE-RAY TUBE DIVISION • ALLEN B. DUMONT LABORATORIES, INC., CLIFTON, N.J.

# Sweep-Circuit Troubleshooting

by **CLARK R. ALISEN**

Condition	Cause	Control Method
Ringling in raster, accompanied by waviness of scanning lines. (11)	Crosstalk of vertical winding with horizontal winding in yoke.	Value of capacitor across <i>hot</i> half of horizontal deflection coil should be adjusted. Trimmer should be connected from ground to junction of horizontal coils, and value adjusted as required: <b>See schematic at right; circle 1.</b>
Ringling in raster; no waviness in scanning lines. (12)	Amplitude modulation of electron beam, or velocity modulation.	A .1-mfd capacitor should be connected from grid (or video signal electrode) of pix tube to ground. If ringling disappears, cause is amplitude beam modulation; if ringling continues, cause is velocity modulation: <b>See schematic at right; circle 2.</b>
Foldover in picture at left or right-hand edge. (13)	Excessive retrace time.	One should check for excessive stray capacitance of sweep and high-voltage leads to chassis. Transformer or yoke may also be defective: <b>See schematic at right; circle 3.</b>
Squegging in receiver. (14)	Positive feedback between sync and sweep circuits.	Here it is necessary to check for open common bypass capacitors, for <i>ac</i> voltages arriving with <i>dc</i> supply voltages, and resistors and capacitors in sync feedback circuit for changed values: <b>See schematic at right; circle 4.</b>
Horizontal sweep circuit efficiency is low. Width subnormal. (15)	Horizontal-output tube is not being cut off during flyback.	One should check for stray coupling between grid lead of horizontal-output tube and sweep-circuit leads. Feedback peaking circuit should also be checked: <b>See schematic at right; circle 5.</b>
Horizontal sweep width inadequate. (16)	Insufficient deflection voltage to yoke.	Line voltage should be checked. The <i>dc</i> supply voltage to horizontal oscillator and screen of horizontal-output tube should be increased. Value of high-voltage filter resistor should be increased: <b>See drive waveform and schematic at right; circle 6.</b>
Width coil overheats. (17)	Slug is located too far out of winding.	Width coil should be removed completely: <b>See schematic at right; circle 7.</b>
High-voltage subnormal; filter components okeh. (18)	Kickback pulse is partially bypassed.	Lead dress of high-voltage wires should be checked and kept well clear of metal surfaces: <b>See schematic at right; circle 8.</b>
White lines at right-hand side of screen. (Vertical lines.) (19)	Parasitic oscillation of horizontal-output tubes.	Tubes should be selected or parasitic-suppression resistor installed in grid, screen-grid, and plate lead of horizontal-output tube: <b>See schematic at right; circle 9.</b>
White lines in left-hand region of screen. (Vertical lines.) (110)	Core saturation of horizontal-output transformer.	Proper air gap in core should be used and drive to grid of horizontal-output tube should be advanced as required to obtain desired width: <b>See schematic at right; circle 10.</b>
'Scope display shows current is ringling in sweep circuit. (111)	Insufficient damping.	Damping tube should be selected. Value of resistor shunting damper tube should be decreased and horizontal drive adjusted: <b>See voltage waveform and schematic at right; circle 11.</b>
Horizontal sweep is non-linear. (112)	Incorrect shape of driving wave to grid of horizontal-output tube.	Values of booster capacitors should be changed slightly up and down. Values of capacitors and resistors in grid, cathode, and screen circuit of horizontal-output tube should also be changed slightly: <b>See schematic at right; circle 12.</b>
Ringling, foldover, and excessive non-linearity in picture. (113)	Open input booster capacitor.	Capacitor should be checked for open; appreciable leakage or a short will produce a dark screen: <b>See schematic at right; circle 13.</b>
Dim picture, blooms when brightness control is turned up. (114)	High-voltage filter resistor has increased excessively in value.	Value of resistor should be checked on high-voltage megohmmeter: <b>See schematic at right; circle 14.</b>

Right—Figs. 1, 2 and 3, top, center, bottom: Schematics of typical sweep circuits. [Courtesy Ram (top and center) and Radio Craftsmen (bottom).]



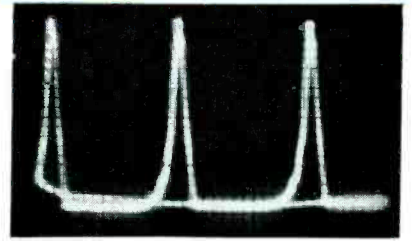
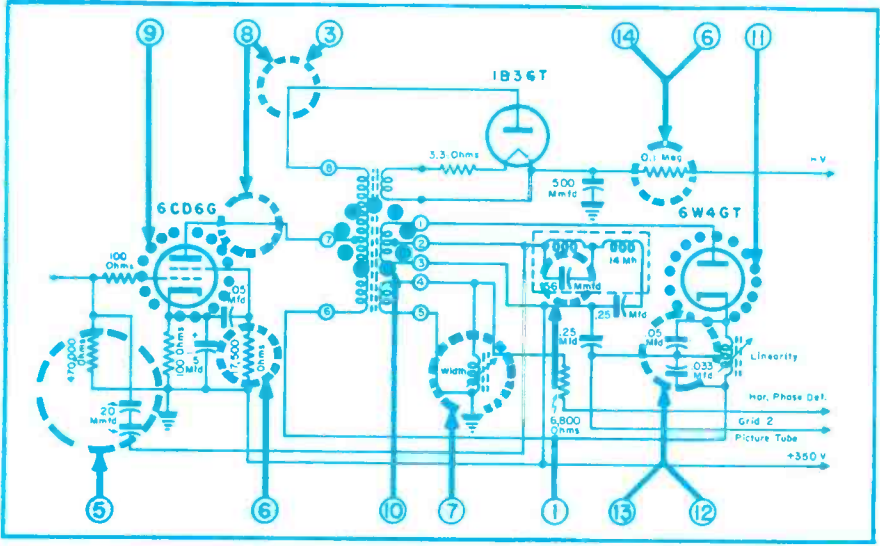
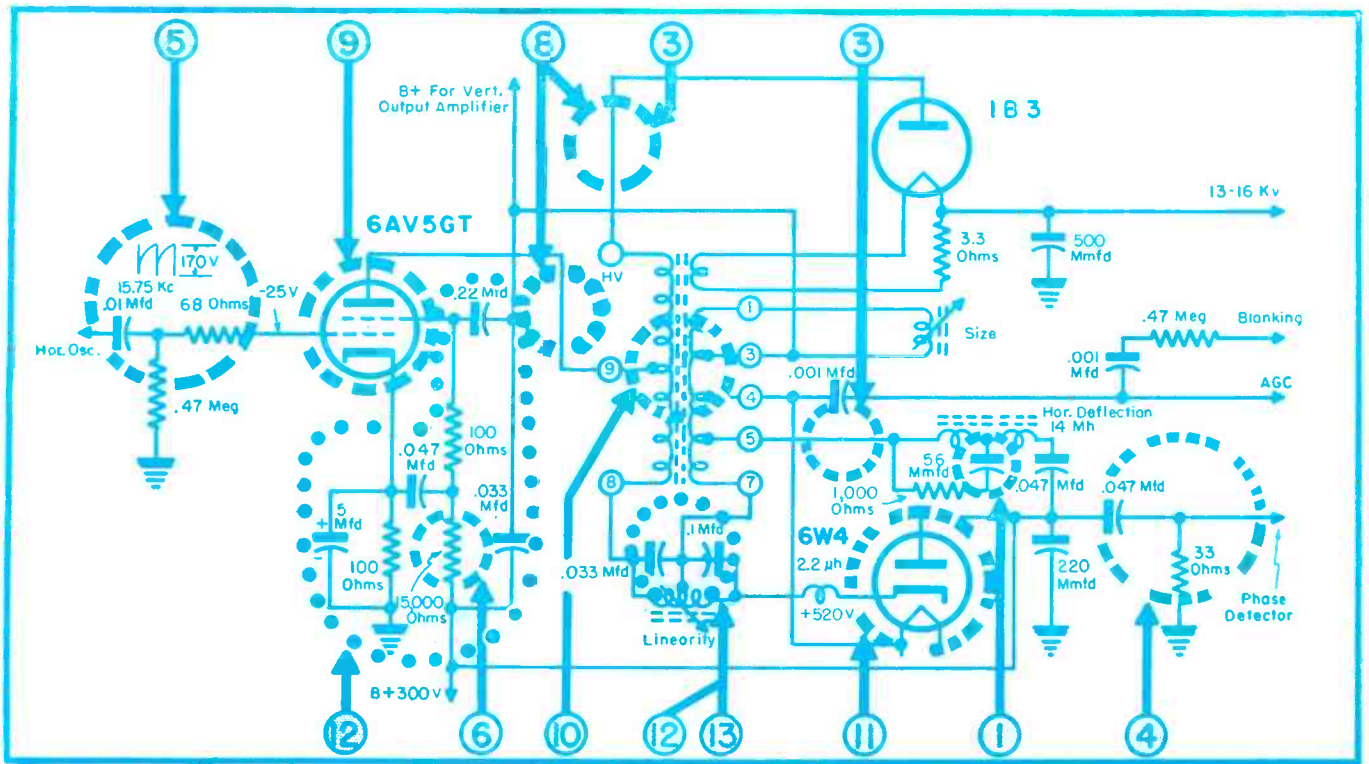

(Below)

Drive waveform to grid of horizontal-output tube, with peak-to-peak voltage and peaking-pulse width specifications. If overdrive is required to obtain adequate picture width, a circuit fault is present which must be corrected; overdrive shortens tube life and leads to circuit breakdowns.

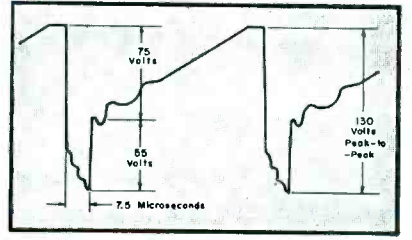

Top right: Voltage waveform across horizontal-deflection coils. A subnormal peak-to-peak voltage develops a narrow picture.

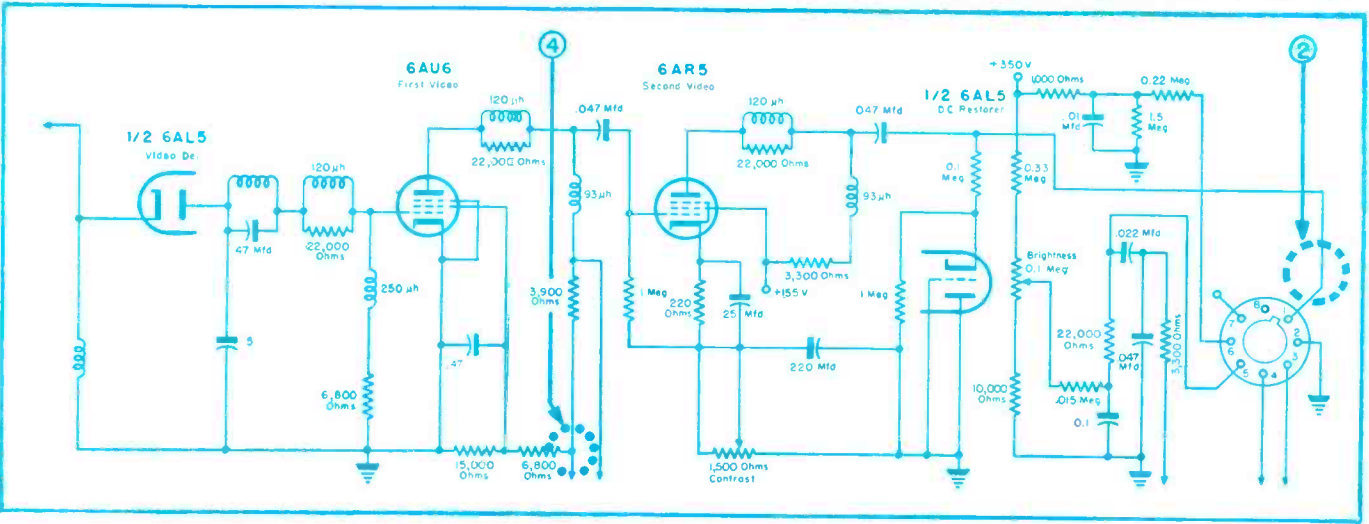

# LAST CHANCE!

Time is running out on this very special introductory offer. After January 1, 1954, Sangamo will accept no more orders from jobbers for these kits. Be sure to get yours while they are still available.



this  
Sangamo  
**Telechief**  
SPECIAL  
INTRODUCTORY  
OFFER  
will soon  
be withdrawn.  
**See your jobber today!**

Only  
**\$24.00**  
Slightly higher in Canada

Here's a deal you can't afford to miss. You get a basic balanced inventory of fast-moving "Telechiefs"—assortment based on national popularity—PLUS a heavy gauge steel chest with two extra drawers for small parts—PLUS your choice of 100 attractive folders to promote your business. You get all this for only \$24.00—the dealer net price of the capacitors alone. (They list at \$40.00.)

Get acquainted with the Telechief today—join the thousands of alert servicemen who have already taken advantage of this big bargain in premium molded paper tubular capacitors.



You can have 100 of any of these business-building folders without extra cost—a sample of each is enclosed in the kit.



*Those who know... choose Sangamo*

8C43-17A

**SANGAMO ELECTRIC CO. MARION ILLINOIS**

SNYDER MANUFACTURING Co., Philadelphia 40, Pa., has issued its '54 catalog describing its line of TV antennas and accessories. . . . BELLEVUE TUBE MILL, INC., P. O. Box 4465, Philadelphia 40, Pa., a Snyder affiliate, has also released a catalog on TV electro-welded antenna masts, and butt and lock seam tubing.



TUNG-SOL ELECTRIC, INC., Newark 4, N. J., has published the 19th edition of their *Tube Characteristics Manual*, which is available through their tube distributors. First 166 pages contain technical information on receiving and picture tubes. A special 20-page section contains basic marketing information to aid Service Men plan a local promotion program.



## CATALOGS, BULLETINS ETC.



ADMIRAL CORP., Advertising Dept., 3800 Cortland St., Chicago 47, Ill., has prepared a 12-page booklet, *What You Should Know About High Fidelity*, which describes characteristics of tuners, amplifiers, record changers and speaker systems. Available for 10c.

\* \* \*

CBS-HYTRON, Danvers, Mass., has released a brochure of handy tools for Service Men. Described are a soldering aid, test adapter, tube lifter, probing tweezer, tube puller, miniature pin straighteners, pick-up stick and tube tapper.

\* \* \*

STANDARD ELECTRICAL PRODUCTS Co., 2240 E. Third St., Dayton, Ohio, has issued an 18-page catalog describing a line of variable transformers for auto, isolated, and built-in and bench applications. Terminal and tap arrangements as well as circuit diagrams are included along with an index of specifications and applications of single phase and three-phase transformers.

\* \* \*

VACO PRODUCTS Co., 317 E. Ontario St., Chicago 11, Ill., has made available a folder describing assorted screwdriver kits, using single handle and from five to sixteen interchangeable blades.

\* \* \*

SYLVANIA ELECTRIC PRODUCTS, INC., 1740 Broadway, New York 19, N. Y., has released a 40-page booklet, *How You Can Be Sure of Television Picture Tube Quality*, for distribution to consumers.

\* \* \*

CORNELL-DUBILIER ELECTRIC CORP., South Plainfield, N. J., has released a 36-page catalog, *200-D*, listing replacement capacitors, with data for 134 types, including specifications, diagrams and prices.

\* \* \*

HEATH Co., Benton Harbor, Mich., has prepared an 8-page *Modification Flyer*, detailing a number of modification kits available for earlier model instruments. Modification kits included are for push-pull 'scope, battery eliminator, grid dip meter, *ac vurm*, and tube checker.

\* \* \*

LAPOINTE ELECTRONICS, INC., Rockville, Conn., has released a 20-page catalog, *54*, describing its line of TV antennas, rotators, isolation filters, and boosters and accessories. Appearing, too, are performance gain charts for antennas.

\* \* \*

AEROVOX CORP., New Bedford, Mass., has prepared a bulletin, *Aerovox RF Noise Suppression Filters*, describing seven filter types, and including dimensions and drawings, electrical factors, and attenuation curves.

\* \* \*

G. AND H. WOOD PRODUCTS Co., 75 N. 11th St., Brooklyn 11, N. Y., has made available a pocket-size catalog, *High Fidelity Cabinets of Character*, containing specifications and data on choice of woods and finishes for custom-styled cabinets.

\* \* \*

HERMAN H. SMITH, INC., 2326 Nostrand Ave., Brooklyn 10, N. Y., has released a 20-page catalog, *53-A*, describing electronic components and TV accessories.

# Rep Talk

THE REPS national membership has reached an all-time high of 622, according to *George Peitt*, national treasurer, 549 W. Washington St., Chicago, Ill. . . . *Harry L. Lewis*, formerly with the capacitor division of G. E. and with the components engineering section of Bendix Radio, has joined the sales staff of S. W. Simberkoff, 68 Hudson St., Hoboken, N. J. . . . *Saffro and Gettleman Co.*, Chicago, Ill.; *Walter J. Brauer and Associates*, Cleveland, O.; *William J. Purdy*, San Francisco, Calif.; *Jack Berman*, Los Angeles, Calif.; *Tim Coakley*, Boston, Mass.; *Burt C. Porter Co.*, Seattle, Wash.; *Harold Blumenstein*, Philadelphia, Pa.; *Fred Kantor*, New York, N. Y.; *Paul Hayden*, East Point, Ga., and *Anile and Smith*, Dallas, Tex., have been named reps for G. and H. Wood Products. . . . *Delzell-Maynard Sales Co.*, 3409 Oaklawn Ave., Dallas, Tex., has been appointed rep for Tech-Master Products Co., in Texas, Oklahoma, Arkansas and Louisiana. . . . *Arthur L. Ehlers Co.*, 49 Central Ave., Cincinnati 2, O., have been named rep for the Hindle Transformer Co., Inc., in southern Ohio, Indiana and Kentucky. . . . *Arnold-Vore Associates*, 1321 Rosedale Ave., Chicago, Ill. (Illinois, Wisconsin, Minnesota, North and South Dakota); *Robert E. Clemenson Co.*, 210 W. 8th St., Kansas City, Mo. (Missouri, Kansas, Iowa and Nebraska); *Sam Karns Co.*, 36 Oak Ave., Tuckahoe, N. Y. (metropolitan New York City and northern New Jersey), and *Edward F. Aymond Co.*, 4308 Maple Ave., Dallas, Tex. (Arkansas, Louisiana, Oklahoma and Texas), have been appointed reps for Commercial Products, antenna mounting equipment and parts manufacturer. . . . *Clark R. Gibb*, 312 16th Ave., S.E., Minneapolis 14, Minn., has been named rep for Atlas Sound Corp., in Minnesota, western Wisconsin and North and South Dakota. . . . *J. Alan Biggs and Co.* have closed their New York office. All activities will be continued from its headquarters in Doylestown, Pa. (P. O. Box 450). . . . *Howard M. Saul and Associates* have moved their offices to 5015-6 San Vicente Blvd., Los Angeles 19, Calif. . . . *Robert S. MacArthur* has been named sales rep for John F. Rider Publisher, Inc., in Connecticut, Maine, Massachusetts, New Hampshire, Rhode Island and Vermont. . . . *Burt C. Porter Co.*, 4310 Roosevelt Way, Seattle, Wash., are now reps for Ram Electronics Sales Co., in Washington, Oregon, Idaho and Montana. . . . *Conrad R. Strassner Co.*, 1865 North Western Ave., Los Angeles 27, Calif., has been appointed rep for Plastic Capacitors, Inc., in California, Nevada, Arizona and New Mexico. . . . *Arthur Z. Adelman* has joined Leon L. Adelman Co., 25 Chittenden Ave., New York 33, N. Y., as field rep in hi-fi sound equipment. . . . *William A. Dietrich*, formerly a Westinghouse field engineer, is now on the staff of Lowry Dietrich Co., 1404 Swantek St., Pittsburgh 4, Pa.

W. A. Dietrich

A. Z. Adelman



**B-T  
LABS**

# Ultravertex

THE ALL CHANNEL UHF CONVERTER  
THAT OFFERS YOU *Everything*



PRICE  
PERFORMANCE  
SALES APPEAL  
EXCLUSIVE FEATURES  
and GREATER  
PROFIT MARGIN

**Make Your Own  
Point By Point  
Comparison:**

- ✓ LIST PRICE IS ONLY \$39<sup>95</sup>
- ✓ High Gain with Lowest Noise Factor
- ✓ Makes ANY TV Set a Modern 82 Channel Receiver
- ✓ Rapid Dual-Speed Tuning Controls
- ✓ Has No Power-Switch—'On-Off' Automatically Controlled by TV Set
- ✓ Rugged Construction, Attractive Styling, and Rubber Protective Feet
- ✓ Exclusively Designed 3-Section B-T UHF-tuner
- ✓ Better Discounts for Greater Profits.



## Supported By Hard Hitting Sales Promotion

- ✓ National Advertising in Consumer, Dealer, and Service Publications.
- ✓ Cooperative Newspaper Advertising
- ✓ FREE Attention-Getting Sales Displays for Dealers
- ✓ Catalog Sheets, Service Data, other Sales Aids

It's *Ultra* POWERFUL . . . It's *Ultra* DEPENDABLE

For complete details, write to Dept. O.M.-8

**B-T  
LABS**

**BLONDER-TONGUE LABORATORIES**  
WESTFIELD, N. J.

Manufacturers of TELEVISION AMPLIFIERS, UHF CONVERTERS,  
MIXERS, DISTRIBUTION UNITS and TV ACCESSORIES

you're ready for

# COLOR TELEVISION

with an AMPHENOL **→INLINE\***

Color television is fast becoming a reality! Sets are expected to be available the first part of next year and stations are purchasing the necessary transmitting equipment. Initial costs, unfortunately, will be high but as improvements in design and production are achieved the price of color television will become within everyone's reach.

The consumer is concerned with the problems presented by television in color. He has read reports on prices and availability; all have been conflicting. He knows, however, that his set will have to be replaced or converted. What he does not know is that if he has an AMPHENOL INLINE\*, there will be no extra expense in antenna or installation! AMPHENOL engineers provided for color in the original design of the INLINE\*.

Every dealer, distributor and installer will want to acquaint their customers with this reassuring information. The color television market is potentially tremendous. It certainly will prove of benefit if the consumer can be reassured on one part of the cost of conversion to color.

The fact that AMPHENOL INLINES are able to receive color television so well reflects favorably upon the engineering ability of AMPHENOL. For in ordinary black and white television the same level-gain design has proved valuable. Set owners know, now, that their AMPHENOL INLINE\* is providing them with the best black and white picture their sets can deliver.

\*Reissue U.S. Pat. No. 23,273

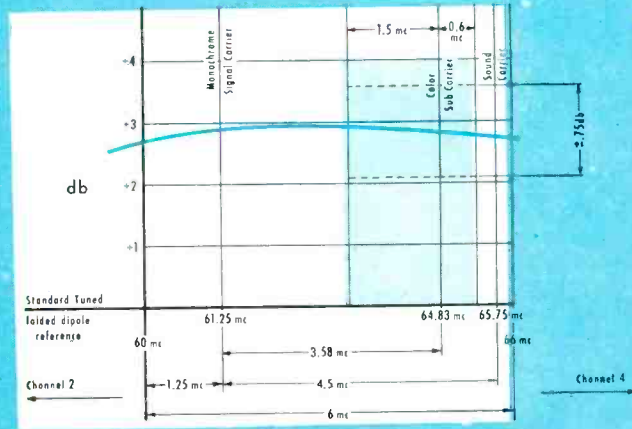

CHANNEL 3

## Antenna Electrical Requirements for COLOR TELEVISION

Information now available on color television has made it clear that the receiving antenna must have these characteristics:

- 1 Antenna gain must be flat, no gain or loss greater than one db, within 1.5 mc below and 0.6 mc above the color sub-carrier\* (a width of 2.1 mc).
- 2 Antenna gain must be held down across the FM frequencies. Rejection of FM signals is much more important in color than in black and white television.

\*Channel frequency widths are at present divided between the monochrome amplitude modulation picture carrier and the frequency modulation sound carrier. The addition of the color sub-carrier is made at 3.58 mc above the monochrome carrier.

The AMPHENOL INLINE\* fully meets the two conditions listed above. Besides being engineered to reject FM signals, from 88 mc to 108 mc, the INLINE provides very level gain across all channels, particularly over the color sub-carrier. Typical of the INLINE's performance on all channels is the gain chart† illustrated above for channel 3.  
†Measured in accordance with proposed RETMA standards.

AMERICAN PHENOLIC CORPORATION  
chicago 50, illinois



## **Use of Service Teams for Home Calls... Dispatching Procedures . . . Basic Differences Between Radio and TV Chassis, and Servicing Problems Involved**

**by J. C. GEIST**

# The Systematic Servicing Approach

IN COMMUNICATION RECEIVERS which operate in the *vhf* range and at very low signal levels, sensitivity measurement with a signal generator with an accurately-calibrated output control has become recognized as essential for effective servicing. This test provides a simple positive check on receiver performance which must be kept near design peak to provide full-system coverage. Furthermore, it has been found that little reliance can be placed on tube tester measurements on tubes used in the *rf* and *if* stages of these receivers. TV receivers operating in the *vhf* and *uhf* ranges, at relatively low signal levels (particularly in fringe areas), would seem to have more in common with *vhf* communication receivers, than with low-frequency broadcast receivers. In spite of this similarity, the advantage of sensitivity measurements has not been generally recognized; an understandable situation since TV servicing has been so largely an extension of broadcast radio servicing.

It is recommended that consideration be given to including some form of sensitivity measurement in the routine maintenance procedures. Measurement with a signal generator, incorporating an accurately-calibrated output control, has been found to be the only way to get a positive check on whether or not the receiver is near enough peak performance for satisfactory operation in fringe areas. In strong-signal areas less precise measurements may prove satisfactory. It is risky to attempt to use the attenuated output from an antenna as a standard signal even in a constant-signal area, since dampness and long-time antenna deterioration would provide misleading results. In strong-signal areas it has been found that good results can be obtained by observing the output of the video detector

on a 'scope and substituting each *rf* and *if* tube, one at a time, with a new tube. In this procedure any new tube that produces greater than a 15% increase in the detector output could be left in the receiver as a replacement.

### **Integrated Test Setup**

Just as in the production operation, to make these procedures successful it is necessary to provide an efficient arrangement of working area, efficient storage and handling facilities, plus adequately designed and properly located tools and test equipment.<sup>1</sup> The problem of handling-equipment and storage facilities is worthy of special mention since these items seem to be so universally neglected in the small service shops. Since TV receivers are inherently heavy and cumbersome to handle it seems only logical to provide adequate facilities to make this part of the operation easier and more efficient. A little study of a typical service operation will show that set handling accounts for an appreciable percentage of the total time involved. The setup referred to<sup>1</sup> suggests an integrated test-equipment and handling dolly arrangement in which a dolly is used for both set movement and as a working-bench area, thus reducing the overall set handling required.

In such an arrangement the ideal storage area would be rows of benches of the same height as the dollies so that receivers could be slid from the bench to the dolly and back with the minimum of actual lifting being required. In any case chassis should be kept off of the floor. Not only is set handling from the floor a back-breaking job, but there is also again the matter of customer relations to be taken into account. Consider the impression on the customer who walks

<sup>1</sup>Geist, J. C., *One-Man TV Shop Tool-Test Setup*, SERVICE; February, 1953.

through the plush front show room to the service department only to find his expensive television chassis along with numerous others scattered about the floor collecting dust, floor dirt, and cigarette ashes.

### **Small-Large Shop Procedures**

In a small shop each Service Man would carry out all of the procedures. In a larger shop it would be more efficient to have apprentice-type Service Men carry out the handling and maintenance procedures, and have experienced personnel do the more technical repair work and test procedures. In any case, the key to successful operation is the establishment of a written list of procedures, assignment of these procedures to appropriate personnel as a required part of their job, and the training of these personnel to carry out the procedures in an efficient manner. Proper application of these techniques will result in more thorough work at less cost and with greater customer satisfaction.

### **Home Service Calls**

The application of systematic service procedures to home service calls requires special consideration. It is generally recognized that normally home service is limited to tube and fuse replacement, picture and channel-frequency adjustments, and antenna-system maintenance. It does not make a good impression on set owners to work on the underside of the chassis in the middle of the living room floor. It is, however, possible to establish a routine procedure for limited servicing that can be done in the home, which will result in a much higher order of performance than can be obtained from hit-or-miss tube replacement.

Before listing detailed routine procedures let us consider some of the complications involved in home service calls. It has become standard practice in some shops to separate receiver repair and antenna work. In some cases this has resulted in inefficiency since two or even more calls might be necessary to repair a single difficulty. Another complication has appeared with the introduction of the larger screen sets; usually chassis cannot be safely handled by one man and two men must be sent along to bring a

(Continued on page 67)

# COLOR TV

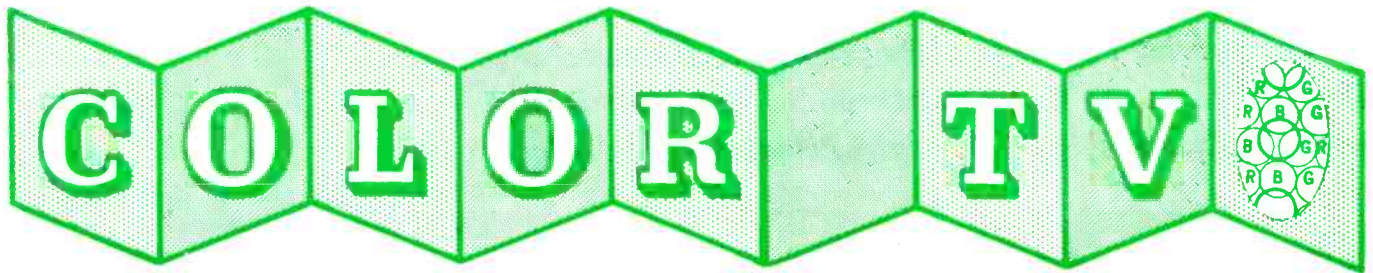

## A Simplified Analysis of the NTSC System

by W. KAY BROWNES

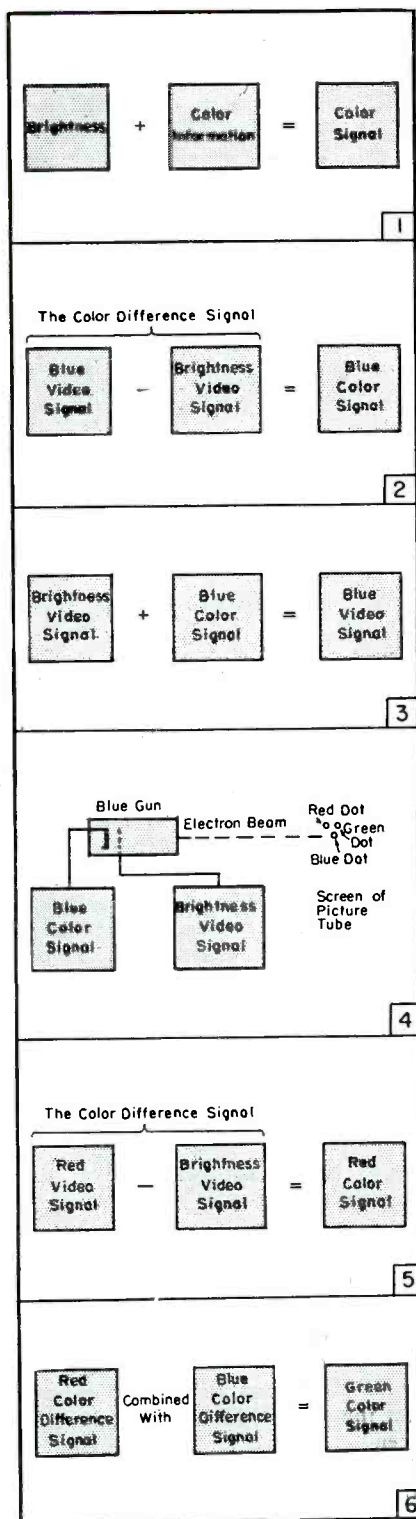

(1)

THE COLOR SIGNAL consists of two principal parts; *brightness and color information*. This is because the resonance of the *violet* sense organ of the eye does not change to another light frequency when the light intensity is changed. From another point of view, the resonance curves of the sense organs of the eye, shown in (1) at left, do not change in shape as the amount of light is varied. Hence, color television can transmit a color signal in terms of its brightness and its relative amounts of red, green, and violet.

(2)

THE BLUE COLOR signal is modulated upon the color subcarrier. The blue color signal is obtained at the transmitter by subtracting the brightness video signal from the blue video signal; the signal is provided by a camera tube which responds to the blue portion of the image. The brightness signal is the black-and-white portion of the image, or, the intensity or the total color composition of the image.

(3)

AT THE RECEIVER, the process is reversed. The brightness signal will be added to the blue color signal to obtain the blue video signal; the brightness signal will be applied to the grid of the picture tube, and the blue color signal will be applied to the cathode of the picture tube. The result is to add the two signals.

(4)

HERE IS what happens at the receiver in the color picture tube. The picture tube has three guns: blue, red, and green. The blue color signal is applied to the blue gun only. The brightness signal is applied to all three guns. In the case of the blue gun, a blue video signal is developed; the electron beam from the blue gun can hit only the blue dot on the screen of the picture tube. The blue color is excited at the required point in the image, and with correct saturation.

TO SUMMARIZE: (1) The *color subcarrier*, which is transmitted in the gaps between the groups of the black-and-white signal, has two components which have the same frequency, but which are 90° out of phase. (2) The *blue color signal* is modulated upon one of these subcarrier components.

(5)

THE OTHER SUBCARRIER component is modulated by the *red* color difference signal.

(6)

THE GREEN COLOR signal is not transmitted as such, because it can be obtained at the receiver from a suitable combination of red and blue signals, as shown.

[Next Month: Analysis of Color Cameras and Color-Processing Circuits]

DISCOVER WHAT **GOLD**

AND 2 INCHES OF AIR

DO FOR

**2**

NEW

**WALSCO ANTENNAS**

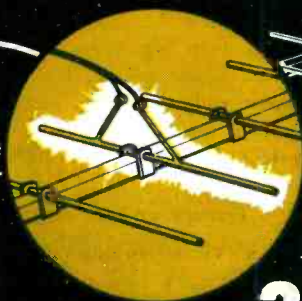

AMAZING  
**3 YEAR**  
GUARANTEE

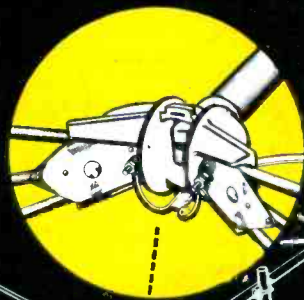

● **NEW WALSCO GOLD DIPOLE YAGI (UHF)**

No less than *24 kt. gold* plating on the receiving dipole of this great, new, 10 element Yagi. Why *gold*? Because *gold* resists corrosion better than any other metal... and *gold* is an excellent conductor. Like the most powerful *radar* antennas, the *Walsco Gold Dipole Yagi* guarantees *permanent* high gain in any location, under all weather conditions. It's custom-made for each location. The *only* Yagi that carries a *3 year* unconditional guarantee! And it costs no more than conventional Yagis.

● **NEW WALSCO IMPERIAL CONICAL (VHF)**

Here's the first radical improvement in Conicals. A new insulator which utilizes "barrier discs" and *2 inches of air space* between the terminals prevents "shorts." Soot deposits, dirt, moisture, salt, etc., *cannot* affect the insulator. This great, new *Conical* will therefore maintain high gain performance under any and all weather conditions. Front-end hardware is *stainless steel* to prevent corrosion losses permanently. Takes only *2 minutes* to assemble because there's no loose hardware. Nothing compares to the *Walsco Conical* at any price... and it's backed by the *only 3 year* unconditional guarantee!

Write for complete information

**WALSCO ELECTRONICS CORPORATION**

3602 Crenshaw Boulevard, Los Angeles 16, California

ALMOST ALL PLANTS and labs engaged in the development of electronic equipment for airborne applications employ motor generator sets as sources of high-frequency power. In most instances, these generators supply electrical power in the region of 400 cps, required for the operation and testing of equipment designed for operation on aircraft where *hf* power is utilized.

Because the size and weight of electric motors and power supply units for electronic equipment can be drastically reduced, *hf* power is used. Furthermore, filtering of the output of a rectifier operated from a *hf ac* source is relatively easy and the filter can be small.

Several types of motor generator sets are used. Some deliver single phase power; some furnish three-phase power on a three-wire *delta* or four-wire *wye* basis. Where it is desirable that the output frequency be maintained at exactly 400 cycles per second, a synchronous motor is used for driving the generator. Where some variation in frequency is allowable, an induction motor is used; in this case the output frequency may vary from approximately 4 or 5 cycles when the generator is fully loaded to 4 to 8 cycles when the generator load is zero.

In some operations it is necessary that the output frequency be adjustable. A mechanical variable speed transmission is sometimes used between the motor and generator. Where more precise adjustment is necessary, a variable speed *dc* motor is used for driving the generator.

Where a *dc* motor is used and *dc* is not available from the power mains, *dc* may be furnished by an *ac-to-dc* motor generator set or a rectifier-power supply.

When an *ac-to-dc* motor generator set is used for driving the *dc* motor of the *hf* generator, speed control is provided by adjustment of the field current of the *dc* generator. This varies the *dc* output of the generator, which is the voltage applied to the armature of the *dc* motor.

To maintain the speed of the *dc-to-ac* motor generator at any set value, a speed regulator is required. This is generally one which employs magnetic amplifiers,<sup>1</sup> although there are regulators available which employ tubes. The magnetic amplifier is preferred because it requires no warm-up time, has no tubes to burn out, and uses no moving or wearing parts.

The output voltage of the *hf* generator is varied by adjustment of the field current directly or indirectly by

# Service Engineering

## field and shop notes

### High-Frequency Motor-Generator System Operation and Servicing †

by THOMAS K. BEAMER

varying the field current of the exciter generator used for energizing the field of the *hf* generator. Maintenance of constant-output voltage is accomplished by use of a voltage regulator which may be of the carbon pile or finger type, or a magnetic amplifier or an electronic device. The voltage regulator automatically adjusts the generator field current to maintain constant output voltage, compensating for load changes or variations in generator speed.

#### HF Generator Types

There are several types of high frequency generators. Some employ a stationary field and a rotating armature with power take-off through slip rings and brushes. Others employ a rotating field with power take-off from the stator windings. Slip rings provide electrical contact with the rotating field.

Still another type of *hf* generator is the inductor alternator which does not require rotating windings or brushes. However, the inductor alternator is larger and heavier, and because slip

rings require so little maintenance, the advantages of an inductor alternator are not significant except in certain mobile applications where it is difficult to gain access to the brushes for maintenance.

One of the prime requisites of a *hf* generator is that it should produce sine-wave output. This means that the output voltage should contain only a small amount of harmonics. A three-phase generator inherently has a lower harmonic content than a single-phase generator. Through very careful design, there are *hf* generators being produced which have a total harmonic content as low as one or two per cent. Because strong harmonics can cause erroneous tests or even damage the equipment being tested, the need for sine-wave output is obvious. Sometimes it is necessary to use external filters to reduce harmonics adequately.

#### Generator Servicing

Field servicing of motor generator sets can be easy and profitable. An

(Continued on page 68)

Circuitry of *hf* motor-generator system.

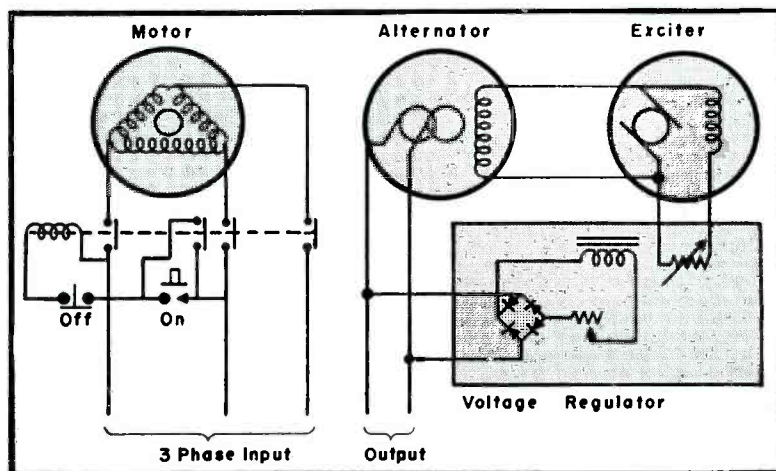

†From notes prepared by Leo G. Sands.

<sup>1</sup>Cataldo, J. T., *Magnetic Amplifier Rectifiers*, SERVICE; May, 1953.



# NEW JFD "3-in-one" LIGHTNING ARRESTER

No. AT110 with hardware for wall or window sill mounting, \$1.50, list.

No. AT110S with stainless steel strap for pipe mounting, \$1.75 list.

Both feature the patented JFD strain-relief lips which prevent contact washers from ripping the lead-in wires apart!

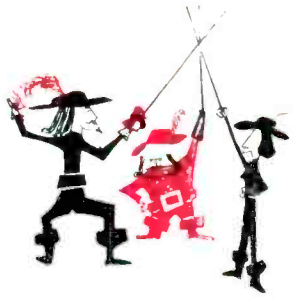

lip →

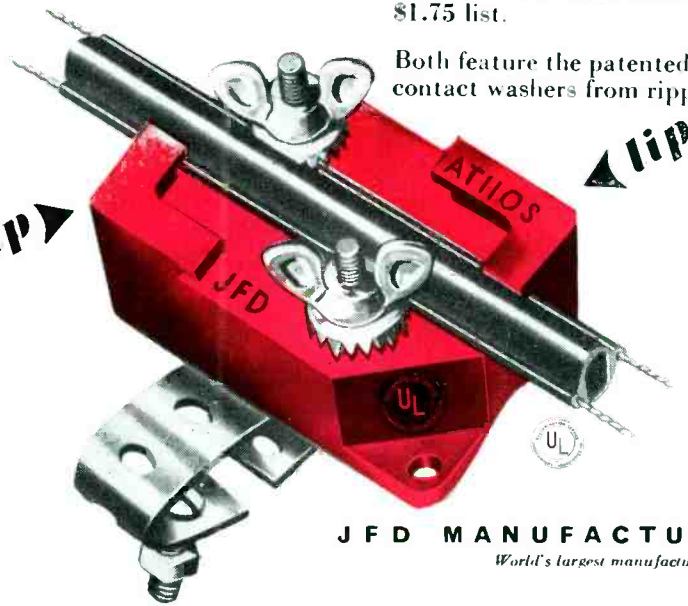

← lip

one for all... all for one

1. for UHF or VHF tubular twin lead
2. for VHF flat twin lead
3. for VHF or UHF open wire



JFD MANUFACTURING COMPANY, INC.

World's largest manufacturer of antennas and accessories; Brooklyn 4, New York

## Annual Index

### ANTENNAS

Adjustable End-Fire Conicals.....	Mar.
Antenna Mounting Techniques on 2-Way FM Installations.....	Sept.
Antennas for the Ultrahighs and VHF/UHF Pickup.....	Feb.
Auto-Radio Antenna-Ground Installation.....	Nov.
Auto-Radio Antenna Trimmer Adjustments.....	Nov.
Community-TV Antennas, Allied Equipment Used on Tower, Poles and in Subscribers' Homes.....	Mar.
Community-TV at Barre, Vermont; Gene Clark.....	Aug.
Community-TV Equipment.....	Apr.
Community-TV Zoning, Right-of-Way Access and Telephone/Power Company Requirements.....	Mar.
Continuous-Tuned UHF Booster (Cover); Wyn Martin.....	Nov.
Continuous-Tuning Coax-Cavity UHF Tuners, and UHF Antennas.....	Mar.
Designing and Testing Auto-Radio Antennas; C. D. Wymer.....	Feb.
Diamond-Grid Element Dipole Antennas.....	Mar.
Equipment Used and Results Obtained During UHF Field Tests in Portland, Atlantic City, York and South Bend.....	July
Evolution of Top-Mounting Antennas.....	Feb.
First Veryhigh/Ultrahigh Community TV Installation.....	Mar.
Installing 25-50 Mc 1/4-Wave Antennas.....	Apr.
Low and High-Band Transmission Lines and Antennas and Their Installation.....	July
Measurement Techniques Required to Check Auto-Radio Antenna Performance on the Road.....	Feb.
Measuring TV Antenna Characteristics; Donald Phillips.....	Jan.
New UHF Developments (Bow-Ties Feed Filters... Attenuators).....	Apr.
1-Man Antenna Orientor.....	Dec.
Parallel-Wire Transmission Line UHF Converter; R. A. Morris.....	Jan.
Pictorial Report on VHF/UHF Antennas, Converters, Boosters and Hardware.....	Aug.
Portland UHF Reception Survey.....	Jan.
Regency RT-700 Remote TV Tuner.....	Dec.
Remote Control Multiposition Switches.....	May
Report on 850-Mc Reception Tests.....	June
Sharpening Masonry Drills.....	July
Single-Channel UHF Converters.....	Mar.
Standoffs and Standing-Wave-Ratios.....	Sept.
Steele VHF/UHF Community TV (Part I); Mark L. Houtz.....	Mar.
Steele, Pa., VHF/UHF Community TV (Part II); Mark Houtz.....	Apr.
3-Channel Community-TV System, Using Horn Antenna and Chain Amplifiers, Installed Atop 1300' Site.....	Sept.
TV Antenna Digest; Ralph G. Peters.....	Jan.-Dec.
TV Antenna Remote Switching.....	May

### JANUARY-DECEMBER, 1953

UHF Area Survey in Easton-Allentown-Bethlehem, Penna.....	Oct.
UHF Parabolic Antenna Design.....	Aug.
UHF Signal Surveys; Donald Phillips.....	July
UHF Signal Survey Report (Part II); Donald Phillips.....	Aug.
UHF Tubular Line Sealing.....	July
UHF/VHF Antenna Installation; Henry R. Hesse.....	July
UHF/VHF Lead-Antenna Couplers.....	Mar.
UHF/VHF Lightning-Arrester Design Notes.....	Nov.
VHF and UHF Antenna Evaluation: Gain, Radiation Pattern and VSWR.....	Jan.
Wavetrap Applications.....	Aug.

### AUDIO INSTALLATION

Acoustic Lens Enclosures.....	July
Action of Conical Dome Speakers.....	Nov.
Amplifier in Mobile PA System, With PC Units, Drawing Less Than 9 Amperes.....	Oct.
Architect-Builder Audio-System Specification Data.....	Jan.
A Report on Dual-Track 2-Speed Tape Recorder-Playback Equipment; D. S. Cevans.....	Oct.
At the Audio Fairs.....	Oct.
Audio Installation and Service.....	Jan.-Dec.
Auto Radios With PC Audio-Coupling Assemblies.....	June
Capacitive Pickups.....	Sept.
Constant-Amplitude Oscillator System.....	Jan.
Control Amplifiers.....	Apr.
Crossover Network for Two Speakers.....	Jan.
Crystal-Element Components.....	June
Design, Operation and Servicing of Current Tape Recorder Equipment (Part I).....	Oct.
Dual Track Tape Recorder/Playback Models for 7 1/2" and 3 1/4" Speeds; D. S. Cevans.....	Nov.
Engineering Small Hall Audio Systems; Donald Phillips.....	June
Features of Push-Button Tape Recorders, Remote Preamps and Amps.....	Aug.
FM IF Amplifier.....	Jan.
45 Record-Changer Tripping Adjustments.....	June
Heater-Induced Hum Balance System.....	Dec.
Highlights of Mikes, Home Tape Recorders, 3-Speed Changers, Amps and Tri-Speaker Phonos.....	Sept.
Hum Measurement with Calibrated 'Scope.....	Dec.
Hum or Noisy Amplifier Remedies for 45s.....	May
Keiton Cambridge 2-Speaker Phono (Cover).....	Dec.
Locating Distortion: Harshness and Dithery Reproduction Cures.....	Dec.
Locating Distortion in Amplifiers (Knocking).....	Nov.
Magnetic Tape HF Biasing.....	Feb.

Magnetic Tape Hum Reduction.....	Feb.
Magnetic Tape Pulling Mechanisms.....	Feb.
Magnetic Tape Recorder Servicing.....	Feb.
Maintenance of Audio Systems; Mark V. Dec. Merchandising Audio (Part II); Lawrence J. Epstein.....	Jan.
Miniaturized Mobile PA System Using Printed-Circuit Units; Jack Darr.....	Oct.
New Standards for Tape and Disc Systems.....	June
Phonos With Built-In Stroboscope.....	Aug.
Phono-TV Switch Operation.....	Feb.
Pitch in Audio Design.....	Sept.
Portable and AC/DC Clock Radios (Cover); Wyn Martin.....	July
Preamp Equalizers.....	Apr.
Record Changer Turntable Replacement.....	June
Service Man's Role in the Hi-Fi Market.....	Jan.
Small Shop Sound Systems; Jack Darr.....	June
Solenoid-Operated Push-Button Tape Recorder; D. S. Cevans.....	Dec.
Sound Augmentation Techniques, Through Use of Carefully-Selected and Properly-Installed Amplifier, Speaker Assemblies and Feeds, to Insure Uniform Coverage.....	June
Speaker Enclosures.....	Apr.
Stroboscope 3-Speed Changers.....	July
Tape Equipment Report—Part 2: Analysis of Circuitry Used in Playback and Recording Amplifier.....	Nov.
Tape Recorder Report 3; D. S. Cevans.....	Dec.
Testing and Measuring Audio Equipment; Mark V. Dec. Tracking Down Amplifier Troubles at the Input End.....	Sept.
Troubleshooting Hum in Audio Amplifiers.....	Oct.
Ultra-Linear Williamson Circuit Amplifier (Cover); Wyn Martin.....	June
Variable Speaker Crossovers.....	Apr.
Veryhigh Frequency Drivers.....	May

### AUTO RADIO

Antenna Mounting Techniques on 2-Way FM Installations.....	Sept.
Auto-Radio Antenna-Ground Installation.....	Nov.
Auto-Radio Antenna Trimmer Adjustments.....	Nov.
Auto-Radio '53 Pontiac Output Transformer Installation.....	Nov.
Auto Radio Fuse Characteristics.....	Feb.
Auto-Radio Relays in Signal Seeker Chassis.....	Nov.
Auto-Radio 12-V Buffer Capacitor Replacement.....	Nov.
Cable Routing Practices in Trucks.....	Aug.
Designing and Testing Auto-Radio Antennas; C. D. Wymer.....	Feb.
Evolution of Top Mounting Auto-Radio Antennas.....	Feb.
Measurement Techniques Required to Check Auto-Radio Antenna Performance on the Road.....	Feb.

(Continued on page 72)

AN ALL-CHANNEL UHF

# CONVERTER



MODEL NO. RC-53  
Patent Pending

only

\$

# 19.95

*Regency*

Div. I. D. E. A., Inc.  
7900 Pendelton Pike  
Indianapolis 26, Indiana  
Telephone: Cherry 2466

*Patent Pending*

# Electrostatic Picture Tube Focus Control...Curing 6BN6 Radiation . . . TV Area-Selector-Switch Applications . . . Inverter Unbalance . . . VTVM Scale Conversions

by T. L. GILFORD



THE QUALITY of the picture on any TV receiver is to a large degree determined by the sharpness of focus of the electron beam. Just as in photography, a picture with good black and white contrast can be ruined by poor focus.

On the self-focusing or electrostatic tube models, like the Stewart-Warner 9300 series, there is no external focus control of any type. However, the focus of the tube is very much affected by the setting of the ion trap. This device controls the path of the electron beam prior to its deflection over the face of the tube and there is only *one* correct setting for it. It should be adjusted for maximum brightness. Within this range of maximum brightness there is only one point of optimum focus.

To obtain this point of best focus, the brightness level should be adjusted to normal with the brightness control and the tuner set off channel. The line structure of the raster should be observed on the screen while making slight adjustments of the ion trap. One will find that there is one point at which the scanning lines appear most sharp. In obtaining this point of best focus, one should be sure that brightness is not reduced.

In the event that good sharp focus cannot be obtained even after careful ion trap adjustment, it is suggested that the ion trap be reversed. To do this it should be slid off of the tube, turned over and slipped back on. The magnet should be placed diametrically opposite its original position. By careful readjustment, it should now be possible to obtain good, sharp focus.<sup>1</sup>

## 6BN6 Radiation

UNDER CERTAIN signal conditions there may be interference in the picture

caused by radiation from the 6BN6 circuit in Arvin chassis TE 358, TE 358-I -2; TE 359; TE 363, TE 363-I -2; and TE 364.

To check for this type of interference the 6BN6 should be removed from set. If this interference disappears the following changes should be made (Fig. 1):

(1) The ground side of  $C_{100}$  should be removed from lug A and moved to lug B. (2) The blue and yellow leads should be removed from pin 1 of the 6BN6 socket and a series peaking coil,  $L_{102}$ , added between these leads and pin 1: 40 to 200  $\mu$ h choke. (3) Then a 4700 mmfd capacitor ( $C_{113}$ ) should be added from pin 4 of the 6BN6 socket to lug B. (4) A ground lead should now be made from pin 1 of  $T_{101}$  as short as possible by soldering it directly to the chassis. (5) A grounded shield should now be added to the 6BN6. This will primarily affect *uhf* channels.

## Area Selector Switches

TO REDUCE the possibility of picture overloading in strong signal areas, in-

<sup>1</sup>From Stewart-Warner service notes, submitted by R. W. Felber, service manager.

Fig. 1. Circuitry revisions which should be made in Arvin TE chassis, if 6BN6 radiation appears.

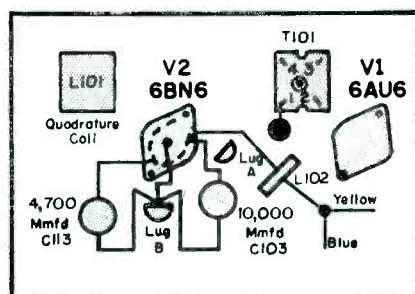

dicated by extreme contrast, an *area selector switch* has been added to Travler TV chassis.<sup>2</sup> This, it is said, will permit adjustment of receiver to any particular receiving condition involving local or fringe area reception.

The unit is a single pole, single throw, rotary wafer switch, located on the rear apron of the chassis.

When this switch is in the local position, the delay bias is disabled. When in the fringe position, the delay bias is in the circuit.

## Picture Pulling Often Caused by Hash

IT HAS BEEN FOUND that picture pulling will be occasionally caused by dressing a heater lead too close to the grid terminal of a video-amplifier stage. In such cases, it will be found that the picture pulling is being caused by relatively high-frequency *hash* voltages on the heater lines, and that the picture pulling can be cured by better by-passing of the heater line to chassis.

## Inverter Unbalance

OCCASIONALLY one notes that the waveform on the 'scope changes slightly in shape when the pattern reversal switch is used. This situation usually arises from high-frequency unbalance in the phase-inverter circuit. Within the frequency response range for which the 'scope is intended in such cases, the waveform variation will be so slight as to be practically unnoticeable.

## VTVM Scale Conversion

IT IS SOMETIMES supposed that all that is necessary to convert an *rms vtvm*

(Continued on page 68)

<sup>2</sup>Effective October; part No. TV-SW-16.

# Circuitry and Operation of One-Man Antenna-Orientation Device\* . . . New

by RALPH G. PETERS

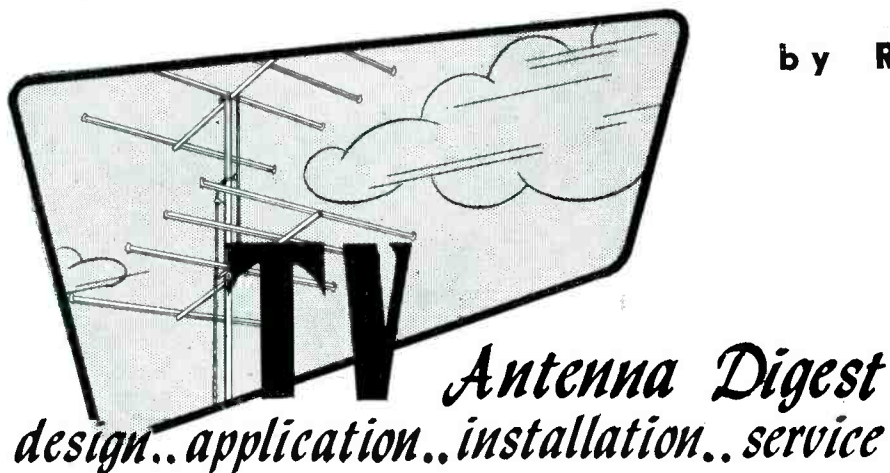

THE PROPER ORIENTATION of an antenna is certainly one of the most important operations in an installation. For only when the antenna is correctly adjusted for direction, and height, too, can it serve as an effective pickup medium. In the past, the job of turning the antenna, and moving it up or down, has been a tedious one requiring at least two or more men and usually an involved signaling system.

With the development of orientation devices, the task has not only been simplified, but greater accuracy has been assured. To illustrate, with the equipment<sup>1</sup> shown in Fig. 1, which can be used in conjunction with a rectifier type *ac* voltmeter, installers are provided with a relative strength reading of the signal. Thus, a report on just what is occurring at the TV set can be carried back instantly to the rooftop.

Two units, comprising this device, shown schematically in Fig. 2, provide isolation networks which allow a transmission line to carry the signal from the antenna to the TV set and simultaneously carry the video signal

back to the meter without interaction between the two signals.

### Principle of Operation

By proper choice of capacity in  $C_1$ ,  $C_2$ ,  $C_3$ , and  $C_4$ , the reactance of the capacitors at the signal frequency will be very low and offer practically no attenuation to the signal. At much lower video frequencies, the reactance of the capacitors is sufficiently high to prevent the video signal from appearing at the antenna or set input, but will pass the *uhf/vhf* signal along the transmission line.

The chokes  $L_1$ ,  $L_2$ ,  $L_3$ , and  $L_4$  serve a similar purpose. Here, the proper choice of inductance introduces a low reactance at video frequencies and very high reactance at the signal frequencies. They will therefore isolate the metering circuit and prevent the signal frequency from appearing on the meter and, more important, prevent the metering circuit from loading the line.

Because the metering circuit is isolated from the transmission circuit, it

represents, for all practical purposes, an additional pair of wires which can be used for a variety of purposes that may suggest themselves to the installer.

Any frequency from *dc* to about 5 mc can be fed over the transmission line, while it is feeding a signal to the TV set, without either signal appearing on the other. Installers can connect the metering circuit at the set end to the output of the video amplifier by inserting a test prod into the picture tube socket and connecting an alligator clip terminal to ground. At the antenna end of the transmission line a rectifier type *ac* voltmeter, range 0-50 *v*, will record the video signal as received by the set. If desired, the metering circuit can be used simply as another pair of lines and telephones can be connected up to permit a viewer at the television set to transmit instructions to the installer on the roof as he moves the antenna about.

In using this equipment, the first step involves the usual installation of the transmission line from antenna position to set position, but without making connections to either. Step number two consists of the connection of one of the coupler units to the TV set and to the transmission line. Since both units are identical and interchangeable, it does not matter which one is used at the set and which is used at the antenna. To connect the set unit, it is first necessary to determine where, on that particular set, the source of video signal may be obtained. In most cases this will be either the grid or cathode of the picture tube socket. A special lead with a pin con-

(Continued on page 70)

\*From a report prepared for SERVICE by Wallace E. St. Vrain, chief engineer, Mosley Electronics, Inc.

Fig. 1. Units comprising TV antenna orientation device. Features knurled thumb-screws to facilitate connections. (Mosley)

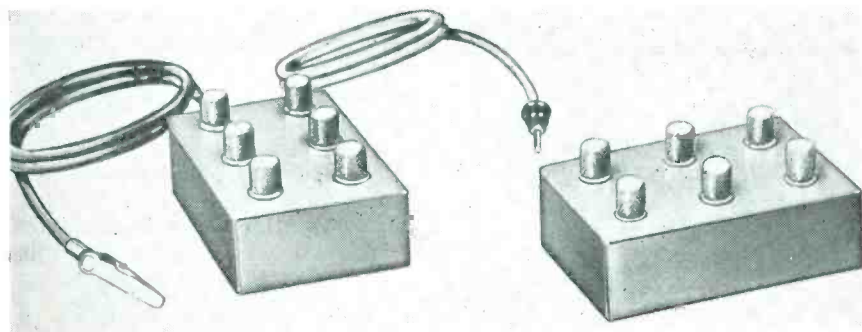

<sup>1</sup>Mosley Orientor.

Fig. 2. Circuit of units, connected together for antenna orientation, illustrating how isolation between *uhf/vhf* signal and returning video signal is achieved. Meter (may be rectifier type 0-50 *v ac* voltmeter, or practically any portable *vom*) indicates relative video signal strength as antenna is moved.

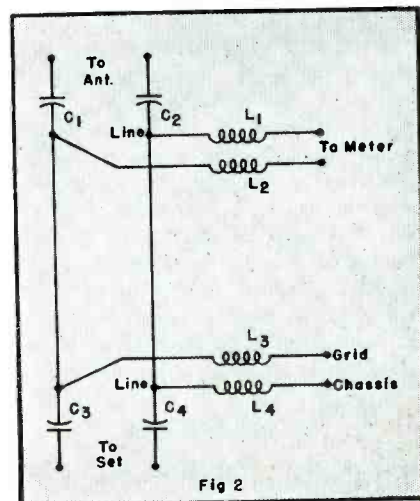

# UHF/VHF Lightning Arresters . . . UHF/VHF Antennas . . . UHF Converters

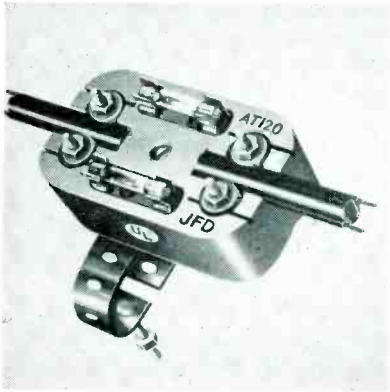

Lightning arrester and static discharger, which includes both an internal resistor network and two replaceable fuses. The resistor network, it is said, will bypass all regular picture-smearing static charges to ground, as well as lightning charges. However, strong lightning charges that normally would destroy an arrester before reaching ground, will merely blow the two replaceable fuses. Will secure oval, tubular, flat ribbon and open-wire twin-leads. Contact is made electrically at four points. (Model AT120; Lightning Sentry (Patented); JFD Manufacturing Co., Inc., 6101 Sixteenth Ave., Brooklyn 4, N. Y.)

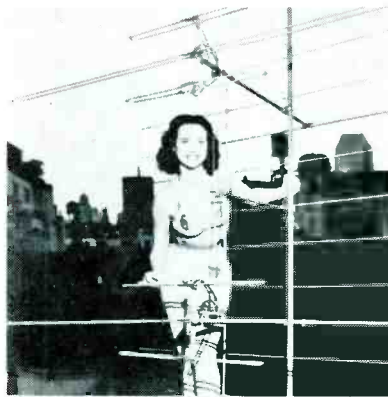

(Above)

All-channel vhf antenna. (Champion; Channel Master Corp., Ellenville, N. Y.)

(Below)

Single bay all-channel uhf corner antenna. Features factory pre-assembly. (Model 706; TV Products Co., Springfield Gardens 13, New York.)

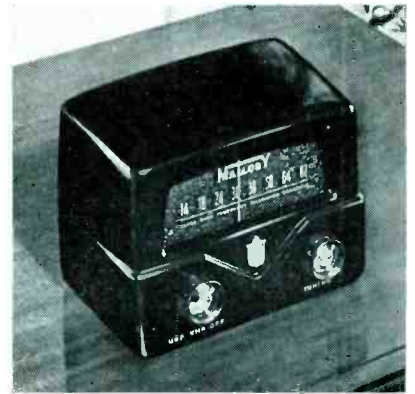

All-channel uhf converter, said to be 50% smaller than previous model. A single knob tunes all the uhf channels in a total of  $7\frac{1}{2}$  turns. A second knob switches from uhf to vhf and also turns both the converter and TV set on and off. Uses a 6AF4 or 6T4 oscillator tube; 6CB6 if amplifier; selenium power supply rectifier; and 1N72 uhf diode detector. The if is 82 mc. Oscillator is said to stabilize in one minute when used with intercarrier receivers; stabilizes in 3 to 5 minutes when used with split-carrier receivers. (Model 88; P. R. Mallory & Co., Inc., Distributor Division, 3029 E. Washington St., Indianapolis 6, Ind.)

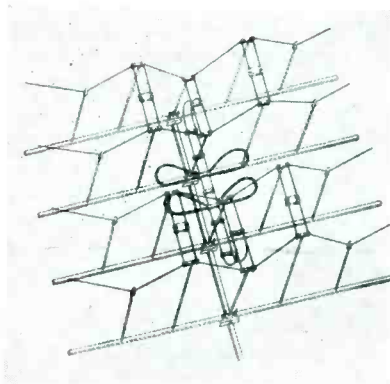

Broadband colinear array that features four 104" reflector bars which are said to raise the gain on the low channels. (Super Fretaray; Fretco, Inc., 406 N. Craig St., Pittsburgh, Pa.)

Traveling wave antenna designed for fringe area uhf television reception and medium range vhf reception. The antenna is non-resonant at frequencies above 250 mc. Elements are designed to move slightly in gusty winds to relieve strain on the mast. (TW-30; Metal Products Corp., 807 NW. 20th St., Miami 37, Fla.)

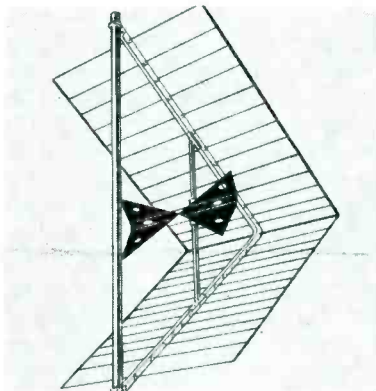

(Below)

Lightning arrester designed to carry tubular, small oval, large oval, open line, 300 ohm and Anaconda lines. Contact is made by teeth which bite into the insulation. Enclosed in plastic molded housing, readily adaptable for indoor or outdoor installation on walls, windows, masts or pipes. (Models 4000 and 4005 with stainless steel strap for pipe mountings; iE Manufacturing, 325 N. Hoyne St., Chicago, Ill.)

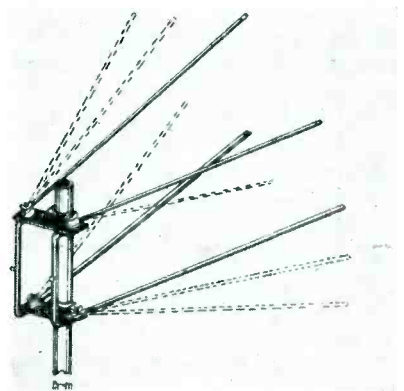

Stack-type antenna for both uhf and vhf in primary and secondary signal areas; can be adjusted to 50°, 70° and 90° for either band or for combined bands. (Double V—No. 9010; Television Hardware Manufacturing Co., Rockford, Ill.)

Indoor rhombic design antenna. Made of aluminum with matching 300-ohm lead-in wire. Has a tuning slide and rotates 90° on each side of the vertical. It is 27" high and 24" wide. (Ultra-Tenna; Ultra-sonic Corp., 61 Rogers St., Cambridge, Mass.)

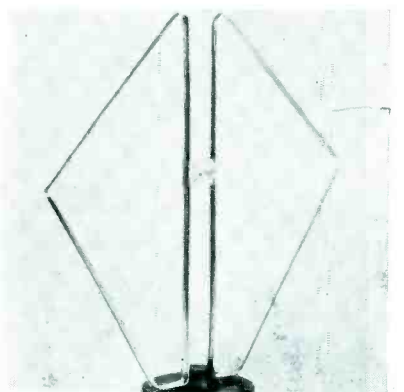
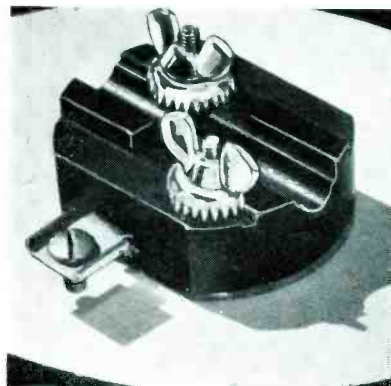
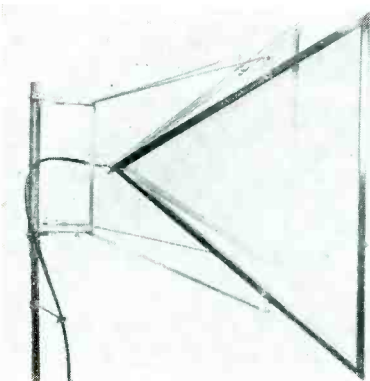

## Locating Distortion\*: Harshness Troubles . . .

### Dithery Type of Reproduction . . .



by **KENNETH STEWART**  
and **PAUL EDWARDS**

THE GENERAL EFFECT of an undue amount of second or third harmonic in reproduction is harshness. There will be intermodulation products in abundance as well, but the general harshness of all the sound is likely to be sufficiently pronounced to drown out intermodulation effects, except in passages that show up intermodulation specifically. Where the effect is not sufficiently pronounced to be identified as harsh, the reproduction of music tends to sound sharp; speech may even appear to be improved by this distortion.

Now to locate its cause; the most obvious is over-biasing. This can be due to cathode-bias resistors with too high a value. A high-value resistor

*\*From an exclusive report prepared for SERVICE by Norman Crowhurst, British audio consultant.*

Wide-angle trumpet multi-speaker announce system installed at key subway and surface-line stations in New York City. (Cobrellex-2 and model SA-30 driver unit with built-in line matching transformer; University Loudspeakers.)



here is a somewhat unusual fault, but where an electrolytic is used, an open-circuit resistor will produce the same effect. The voltage rises until the leakage of the capacitor provides a path for the total emission current. This, of course, shortens the life of the capacitor, and when this fault is located the bypass capacitor, as well as the open resistor, must be replaced.

The wrong plate load is another possible cause. In this case the defect is more likely to occur in triode circuits. This is illustrated in Fig. 1 *a* and *b* for both *rc* and transformer coupling. In each case *A* is the plate supply voltage and *B* the normal bias point. In *rc* coupling *AB* is the drop in the plate coupling resistor; in transformer coupling it is the drop in the

Professional boom stand which is claimed to feature a safety air-lock cushion built into the vertical section to prevent accidental or sudden slippage. Gyromatic swivel joint is also provided at microphone end of the boom. Base is equipped with ball-bearing swivel casters. Boom length is 72". (Model BS-36W; Atlas Sound Corp., 1451 - 39th St., Brooklyn 18, N. Y.)



primary resistance. *CD* represents the normal dynamic load line. In *RC* coupling, it is due to the added effect of the following grid resistor, coupled in by the coupling capacitor; in transformer coupling, it is due to the load connected to the secondary winding. In either case, a reduced dynamic load impedance, *EF*, steepens the line and the curve spacing along the load line becomes convergent, denoting curvature. The curves close up toward the bottom end of the load line and open out toward the top.

In *rc* coupling, use of too low a grid resistor value causes this defect. This is one reason why too low a grid resistor cannot be used to minimize the effect of capacitor leakage referred to earlier.

In transformer coupling, where the output circuit is involved, it may be the use of a 2- or 3-ohm unit on a circuit designed to take a 15-ohm unit. Or, particularly in the case of an interstage transformer, shorted turns inside the transformer can have similar effect. If the turns shorted are in the primary, the transformer will show more than its rated stepup, if they are in the secondary the stepup will be reduced. But shorted turns can cause this trouble before enough of them are shorted to show up in a ratio test, unless the test is of a precision type. Even then the ratio test would not be conclusive, for the production tolerance on turns ratio may be greater than the effective alteration made by shorted turns. The simplest check is to substitute a transformer known to be good.

#### Dithery Reproduction

Since the advent of intermodulation consciousness, dithery reproduction has

*(Continued on page 71)*

Turnover needle cartridge, in which cartridge remains stationary, but double-tipped needle is rotated in switching for narrow and wide groove record operation. Cartridge employs ceramic element. Output is listed at one volt. Minimum needle pressure requirement is six grams. No preamp or equalizer is required, it is said. (Model GCD; Astatic Corp., Conneaut, Ohio.)



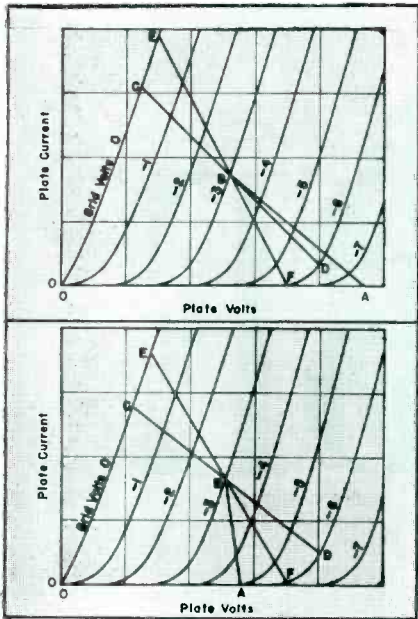
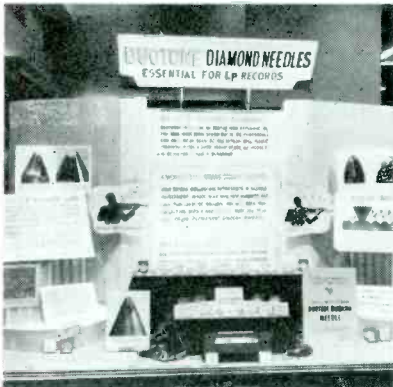
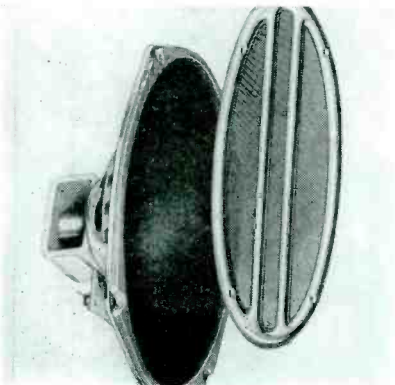

Fig. 1 a and b. Plots illustrating how too low a plate load causes curvature distortion with triodes, whether the stages are RC or transformer coupled. In a (top) curves are for a resistance-capacitance coupling case. In (b) bottom, we have a transformer coupled illustration.



Window display of Lyon and Healy, Chicago, devoted to the promotion of diamond needles.

Rear seat auto extension speaker baffle kit, available with or without speaker, in chrome as well as in grey, light blue or light bronze. Includes a 6" x 9" oval speaker with 2.15-ounce magnet. Kit also includes 3-way switch, knob, dial plate, stamped metal baffle plate with metal screening, 15' of cable, and instructions for mounting. (Model R7-K; Lowell Manufacturing Co., 3030 Laclede Station Road, St. Louis, Mo.)



Here's a bigger value than ever!

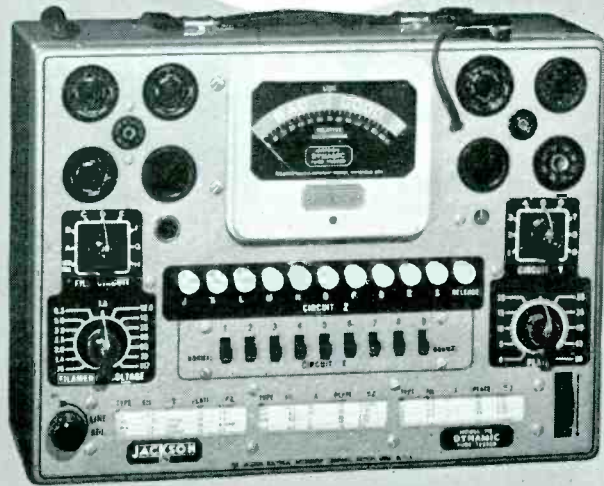

## JACKSON CHALLENGER DYNAMIC® Model 715 Tube Tester

New in design and performance. Latest Jackson patented switching circuits.

Modern in every detail of construction, appearance, operation.

Complete with every valuable feature, including provision for CRT testing.

In this improved instrument you get separate voltage to each tube element . . . higher plate voltages . . . spare circuits with switch and socket positions for future use . . . simplified operation . . . large, easy-to-read meter . . . complete shorts and leaks tests . . . provision for testing over 700 types of tubes . . . built-in roll chart.

Finished in gray Ham-R Tex with ivory knobs, push buttons, and meter cover. Net weight, 11 lbs.

**Dealer net price, only \$79.50**

Ask your electronics distributor for information, or write us.

**JACKSON**

JACKSON ELECTRICAL INSTRUMENT CO.  
DAYTON 2, OHIO

"SERVICE ENGINEERED" TEST EQUIPMENT

IN CANADA: THE CANADIAN MARCONI CO.

# Follow this path to faster, more profitable repair service

If you're like thousands of other busy Service Engineers, you can't afford to sacrifice profit time — hunting for repair parts. That's why it pays to have your Centralab controls on hand when you need 'em — in one of these 3 handy Blue Shaft Control kits. Assortments contain *exact* replacement values you use every day, in plain or switch types, for popular radio and TV sets!

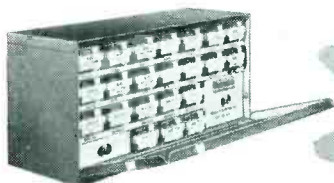

**Kit deal B-A**  
contains 22 controls (8 types) in 1/2 and 1 megohm. All units C<sub>2</sub> audio taper. Standard full-length fluted mill and split-knur shafts.



**Kit deal B-B**  
newest, revised. Has 22 controls (15 C<sub>2</sub> types, —1000 ohms to 5 megs) plus 4 Fastatch® type KB line switches.



**Handy Plastic-Paks**  
of 12 controls each in 10 fast moving assortments. You pay for parts only — no charge for metal or plastic containers.

And remember . . . switches are factory-attached and tested for immediate installation. Your Centralab distributor has plenty of Blue Shafts on hand to keep kits well-stocked. Order kits from him NOW. \*Trademark

## Centralab

CENTRALAB  
A Division of Globe-Union Inc.  
908-L E. Keefe Ave., Milwaukee 1, Wis.  
Please send me Catalog 28 with complete details on Centralab Radio-TV control kits.

Name \_\_\_\_\_  
Firm \_\_\_\_\_  
Address \_\_\_\_\_  
City \_\_\_\_\_ Zone \_\_\_\_\_ State \_\_\_\_\_

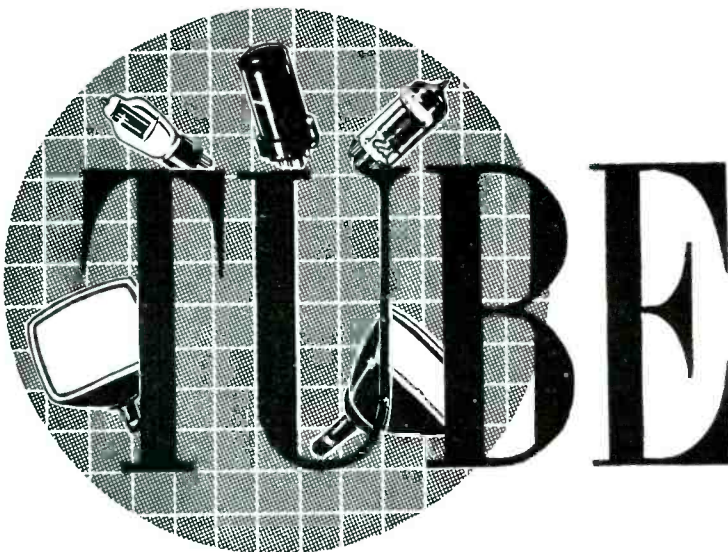

## News — by E. A. TEVERSON

SPECIAL *uhf* sockets for seven- and nine-pin miniature tubes are often used in *uhf* television tuners and converters. These sockets have been designed to make contact with the tube base pins in a region very close to the glass button, usually within 1/16" from the bottom of the seated tube. Because these sockets, compared with the conventional miniature types, provide appreciable reduction in lead lengths and lead inductances, they can be used to advantage on the ultrahighs for such applications as *rf* amplifiers and mixers, which must operate satisfactorily up to 890 mc and oscillators, which may be required to operate at frequencies as much as 40 mc higher.

The use of such sockets, however, has been found to present some disadvantages along with advantages.

In preparing the design specs for

Medium-mu twin-triode miniature (GL-6386) designed primarily for use in remote-cutoff cascode applications. The tube, it is said, can minimize cross modulation which can occur in the first stage of a receiver when a strong signal is close to the frequency of the desired signal. Designed for applications as a cascode *rf* and *if* amplifier, or mixer, in circuits to which it is desired to apply automatic-gain-control. (G. E.)

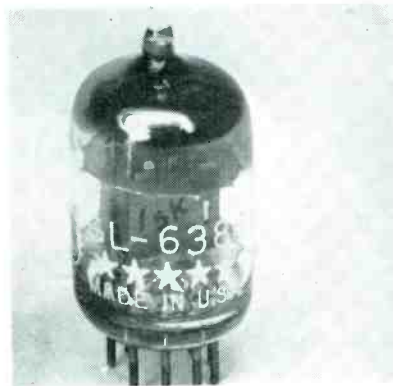

these tubes, it was noted<sup>1</sup> that the socket design should be such that circuit wiring should not impress lateral strain through the socket contacts on the base pins. And the point of bearing of the contacts on the base pins should not be closer than 1/8" from the bottom of a seated tube.

Because the region of contact between the special *uhf* socket and the tube base pins is so close to the glass button, the pressure of the socket contacts on the pins can place additional lateral strain on the glass and cause cracks in the tube base. In addition to glass strain, poor *rf* contact may obtain. Because of the heat used in the tube-manufacturing process to seal the tube base pins into the glass button

More Money Spent

TO FIGHT POLIO

in '53  
THAN EVER BEFORE

Join the  
**MARCH  
OF  
DIMES**

IT  
WILL  
TAKE  
MORE  
IN '54!

January 2 to 31



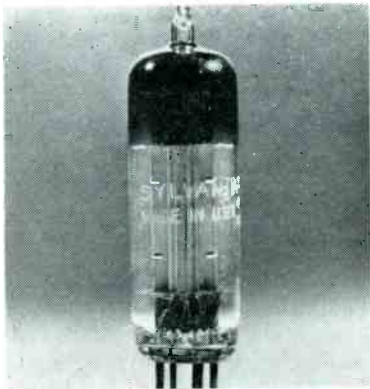

Gated beam discriminator which, it is claimed, performs function of limiter, discriminator and audio amplifier. (Sylvania.)

stem, the base pins may exhibit discolorations, which appear as stem burns, close to the stem of the tube, but in the area which makes contact with the special *uhf* sockets. When these discolorations are due to actual burning-off of the silver plating on the base pins, it may be difficult to obtain satisfactory high-frequency contact.

In view of the foregoing problems, it has been found that the use of special *uhf* sockets must be restricted to those applications in which good *uhf* performance is the paramount consideration. When they are used, wiring plugs<sup>2</sup> are usually inserted in each socket, before it is wired, to minimize the possibility of lateral strain which could be transmitted through the socket contacts and cause glass breakage.\*

#### New Tube Developments

IN TV CHASSIS, there are *strain areas* where tubes are subjected to severe  
(Continued on page 69)

\*Based on copyrighted application notes prepared by the tube department of RCA.

<sup>1</sup>Specifications published in general section of the *RCA Tube Handbook, HB3*.

<sup>2</sup>Similar to those manufactured by *Star Expansion Products Co., New York*.

Twin-pin straightener for 7-pin and 9-pin tubes, back to back, now available. Straighteners have steel dies, pin-circle holes individually drilled to close tolerances, and an absence of guide posts, thus permitting final touch of sidewise straightening. (Hytron.)



Standardize on

## WEBSTER ELECTRIC Featheride<sup>®</sup> REPLACEMENT CARTRIDGES

When you stock these five models of Featheride Replacement Cartridges, you can handle virtually *all replacement needs*—regardless of make of record player or changer—quickly, easily, profitably, and with a minimum inventory investment.

Mail the coupon for free copy of our handy new Replacement Chart YF-2, showing how you can most profitably fill your replacement needs.

these 5 models are all you need!

Model WS • A versatile unit capable of replacing the majority of 78 RPM Cartridges in the field.

Model AX • A complete unit for three-speed application, furnished with a removable twist mechanism.

Model BX • Designed primarily for RCA Automatic record changers and Columbia players. Unusually high fidelity.

Model CX • May be used with a three-mil needle for 78 RPM or two-mil needle for three-speed application.

Model FX • A two-needle twist cartridge, delivering high or low output.

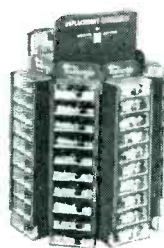

### THIS NEW DISPENSER WILL INCREASE YOUR SALES

• This attractive Featheride Replacement Cartridge Dispenser on your counter or wall will boost your sales and profits. It comes with a basic stock of 10 each of the 5 models shown above—each cartridge packaged with all needed fittings, instructions and data, all in individual transparent plastic box. Replacement chart included in back of dispenser.

Send coupon for details of our Special Dispenser Offer, whereby you save \$10 if you order promptly.

**WEBSTER ELECTRIC**  
RACINE WISCONSIN

"Where Quality is a Responsibility and Fair Dealing an Obligation"  
WEBSTER ELECTRIC COMPANY, RACINE, WISCONSIN • EST. 1909

Webster Electric Co., Dept. S-12, Racine, Wisconsin

Send me, without obligation, the items checked below:

Free Featheride Replacement Chart YF-2

Details of Special Dispenser Offer, whereby we can save \$10.00

Ordered by \_\_\_\_\_

Company \_\_\_\_\_

Address \_\_\_\_\_

City \_\_\_\_\_

Zone \_\_\_\_\_

State \_\_\_\_\_

FOR A LIMITED TIME ONLY

# REPAIRMEN SERVICEMEN

TV  
RADIO  
HOME REPAIRS  
APPLIANCES



CRAFTSMAN  
QUALITY

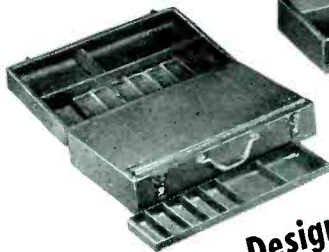

"At Last a Case Designed for You"

- PRACTICAL, EASY TO CARRY
- PROFESSIONAL APPEARANCE
- BIG SIZE 21" x 12" x 7 1/2"
- ALL STEEL CONSTRUCTION

Look at these features! Six plastic-clear boxes for small parts . . . A seven partition removable metal tray . . . Four partitioned bins on one side, two extra large on the other. Heavy gauge metal throughout, with full length hinge, cylinder lock with two keys, two heavy suitcase type catches and metal handle.

ALL THIS FOR

\$13<sup>95</sup>  
PREPAID

No C.O.D. Orders. Send Check or Money Order to:

HARDWARE DEPT.

(STOCK NO. S-399)

SEARS, ROEBUCK AND CO.

403 S. STATE STREET • CHICAGO 5, ILLINOIS

# ASSOCIATIONS



## CRTSA, Philadelphia

THE NEWLY-FORMED Council of Radio and Television Service Associations of Philadelphia, which includes the Philadelphia Radio Service Men's Association, the Television Contractor's Association, Northeast Television Service Dealers Association and the Television Service Dealers' Association of Philadelphia, will co-sponsor next Spring a convention featuring an educational display of TV equipment, supported by a series of seminar talks.

Among those on the committee preparing the program are *Sam Brenner*, PRSMA prexy, *Lou Smith*, TSDA prexy, and *Dave Krantz*, industry liaison chairman for TSDA and the state federation.

Color will be a highlight subject at the meeting supported by operational exhibits.

*Ye editor* will serve as moderator at one of the sessions.

## ARTSNY, New York

MAX LIEBOWITZ, prexy of the Associated Radio-Television Service Men of New York, was honored recently at a testimonial dinner in New York for his outstanding service as headman of the association during the past seven years.

Present were members of the technical and business chapters. Among those who paid tribute to Liebowitz at the dinner were *Arthur Rhine*, executive secretary; *Henry Levine*, member of the board of directors; *O. Capitelli*, chairman of the technical chapter; *Phil Goldfarb*, chairman of the business chapter; *Joseph Forman*, counsel for the group; *John F. Rider* and *ye editor*.

In appreciation, the association gave Max a gift certificate.

## TSA, Detroit, Michigan

H. H. MARIEN, JR., has been named executive director of the Television Service Association of Michigan. He will be responsible for the publication of the monthly *TSA News* and handle business projects of the association.

Marien will headquarter at 2237 Dime Building, Detroit.

At present, there are over 40 active members and over 30 known as associate servicing members and associate members. In the latter group are distributors, schools, and one of the local radio stations.

## TRAA, Fort Wayne

THE RECENTLY organized TV-Radio-Appliance Association,



Max Liebowitz, ARTSNY president, who was honored at a testimonial dinner recently in New York City.



E. R. Klingman, technical specialist of the RCA Service Company, discussing the color TV dynamic demonstrator at the recent NATESA conference in Chicago.

Ind., in Fort Wayne, Ind., have prepared a comprehensive application questionnaire for applicants.

Prospective members, who must send along \$40 with the completed form, are asked to note if they operate their business on a full time basis, and display suitable signs, whether or not they employ qualified Service Men and qualified antenna installers, and whether the owner or any of the officers of the company are personally qualified to install or service TV receivers. Other information sought includes the name of the insurance company and agent with which liability insurance is carried, and if TV installation and repair work is a feature of the organization. In addition, applicants are asked to give their State store license number, and declare if they will abide by the various codes established by the association.

Harold Spangler is president of the group.

#### TEN YEARS AGO

Radiovision to prevent collisions on highways and railroads, on sealanes, and on the airways of the world, was described as a forthcoming vital factor in industry by David Sarnoff, RCA proxy, before the American Association for the Advancement of Science. . . . Feature articles covered an analysis of grid-bias circuits by Alfred A. Ghirardi and the application of special photocontrols by S. J. Murcek. . . . A station allocator, with magnetic-core inductances that afford push-button selection of eight adjustable frequencies from 405 to 1700 kc (RCA 171) appeared on front cover. Ken Barcaw, jobber sales manager of Radiart, became a flyer in the Civil Air Patrol. . . . David T. Siemel, founder and president of Ohmite Manufacturing Co., was elected to the board of trustees of Illinois Institute of Technology. . . . John Meek, president of John Meek Industries, announced that the jobber would be retained for distribution in postwar merchandising plans. . . . S. K. Macdonald was named chairman of the MidAtlantic chapter of The Reps. Roy Bengt was named chairman of the membership committee. . . . R. T. Perron was elected chairman of the New England chapter. . . . P. A. Emmet was elected a member of the Los Angeles chapter. . . . J. Moanire of the MidAtlantic chapter joined the Armed Forces. . . . P. Leo Granier was named radio service manager of Stromberg-Carlson. . . . Lucius E. Packard was placed in charge of the Chicago office of General Radio. . . . Lester Via was appointed to the engineering department of John Meek Industries to undertake special crystal research. . . . J. W. Whiteside was appointed buyer in the tube division of G.E.'s electronic department. Frank W. Warner was named chief engineer of the plastic division. . . . Robert C. Berner joined Emerson Radio as assistant to president Ben Abrams. . . . Ted Pockrandt was appointed supervisor of production for Universal Microphone.

One of the truckloads of uhf converters and rotators delivered recently to Alliance distributors in Milwaukee, when new uhf stations WCAN-TV and WOKY-TV went on the air. Occasion sparked additional extensive promotional drive in newspapers and over stations, and campaign of endorsement approvals from leading players of the Milwaukee Braves.



# ATR

## "A" BATTERY ELIMINATORS

*Makes it easy to . . .*

for Demonstrating and Testing Auto Radios

**6 VOLT OR 12 VOLT!**

6 or 12 volt D. C. combination output available by means of simple toggle switching arrangement, properly safeguarded to prevent accidental switching.

New Models . . . Designed for testing D. C. Electrical Apparatus on Regular A. C. lines. Equipped with Full-Wave Dry Disc Type Rectifier, Assuring Noise-less, Interference-Free Operation and Extreme Long Life and Reliability.

TYPE	INPUT A. C. Volts 60 Cycles	D. C. OUTPUT			SHIPPING WEIGHT	USER PRICE
		VOLTS	AMPERES Cont.	AMPERES Int.		
610-ELIC	110 volts	6	10	20	22 lbs.	\$29.70
610C-ELIC	110	6	10	20	22	33.50
		12	6	12		
620C-ELIQ	110	6	20	40	33	46.95
		12	10	20		

\$29<sup>70</sup>

and up  
User Price

See your jobber or write factory ✓ NEW MODELS ✓ NEW DESIGNS ✓ NEW LITERATURE



"A" Battery Eliminators, DC-AC Inverters, Auto Radio Vibrators

## ATR AMERICAN TELEVISION & RADIO CO.

Quality Products Since 1931  
SAINT PAUL 1, MINNESOTA—U. S. A.

**FREE! NEW '54 EDITION**

**SIMPLIFIES TV ANTENNA INSTALLATIONS AND SALES**

**INCLUDES LATEST UHF/VHF DATA & EXCLUSIVE "ANTENNA SELECTOR"**

Completely revised by TV authorities Matt Mandl and Ed Noll, this essential pocket size manual includes the exclusive "Antenna Selector", Directronic Antennas, Dimension Guide, Channel Frequencies, Proper Feed Methods, Helpful Hints... everything about every type of TV antenna.

**FREE To TV Servicemen, Service Dealers, Dealers, Distributors, Hams, Salesmen, Manufacturers**

Publication Price \$1. Yours free if you write at once.

**-MAIL THIS COUPON TODAY-**

**SNYDER MFG. CO., Dept. A**  
22nd & Ontario Sts., Phila. 40, Pa.  
Please send free copy of TV 'TENNA TIPS

Name \_\_\_\_\_  
Address \_\_\_\_\_  
City \_\_\_\_\_ Zone \_\_\_\_\_ State \_\_\_\_\_

# NEWS

## SYLVANIA PICTURE-TUBE PLANT EXPANSION

Construction of a 200,000 square-foot plant extension, to be used for the manufacture of 24" and 27" TV picture tubes, and for pilot-line production of color tubes, is nearing completion at the Seneca Falls, N. Y., plant of Sylvania Electric Products Inc. Expansion will bring total manufacturing space, devoted exclusively to TV picture tubes, to 687,000 square feet.

In the new addition, 82,000 square feet of the addition has been earmarked for color screen work, production of color TV tubes, equipment development, and storage.

\* \* \*

## OELRICH SERVICE CARD KIT

A service-card business-sign kit, 800, that contains 25 messages printed on heavy 5" x 10" wood grain finish cards, all dealing with specific dealer needs and problems, has been introduced by Oelrich Publications, 4135 North Lawler Ave., Chicago 41, Ill. For fastening, a sheet of sticky tacks is included in each kit.

\* \* \*

## AEROVOX CERAMIC CAPACITOR DISPENSER CABINET

A dispenser cabinet, *Ceramic Center*, for selection of ceramic capacitors, has been announced by Aerovox Corp., New Bedford, Mass.

Rack displays some 700 window cartons, each containing five pieces of a given type and value. Cartons are on inclined channeled shelves to accommodate either the individual cartons or the ten carton display sleeve. Dispenser also has drawers for slug type or *cartwheel* capacitors, and again for plate assemblies.

A unique packaging arrangement, for *Hi-Q* plate assemblies, has also been introduced by Aerovox. Plate assemblies are packaged in a transparent plastic envelope; envelope is stapled to a 3" x 5" tab index card which carries the circuit diagram, constants and other application data. In addition, reverse side of index card provides replacement data with manufacturer's name and part numbers.

\* \* \*

## NEW TUBE SIGN



Irving Joseph, 5959 W. Fullerton Ave., Chicago, dusting off his new electric sign, the first in the country to be installed in cooperation with the electronic tube division of Westinghouse Electric Corp. Looking on is R. E. Warner of Westinghouse's Chicago office.



"Thank Heaven . . . we can leave now. Here comes the JENSEN NEEDLE."

## NOW GIVE BETTER . FASTER SERVICE

INVEST in KAY INSTRUMENTS THAT SAVE YOU TIME AND INCREASE YOUR PROFITS



Calibrated MEGA-SWEEP 50 kc to 950 mc range Sweep width at least 30 mc



MEGALIGNER—a calibrated variable frequency IF marker-pip generator



MEGA-MARKER SR. crystal controlled, 12-channel TV RF sound carrier generator



DUAL MEGA-MARKER Sr.—same as Mega-Marker Sr. with RF picture carrier generator added

Consult this latest 64-page catalog FREE



Write . . .

**KAY ELECTRIC CO.**

12 MAPLE AVE.

PINE BROOK, N. J.

**SUPEREX ELECTRONICS TAKES OVER RAYBURNE**

Superex Electronics Corp., 23 Ather-ton St., Yonkers, N. Y., headed by *Daniel Schulman* and *Marvin Buchalter*, is now operating Rayburne Corp. (for-merly Grayburne) also of Yonkers, and will market the combined lines of elec-tronic components and equipment under the Superex Electronic Corp. name.

**SUPERIOR IN NEW PLANT**

Completion of a manufacturing plant, which adds over 15,000 square feet to existing facilities, has been announced by Superior Insulated Wire Co., Haver-straw, N. Y. Plant, located at Route 9W, West Haverstraw, will feature production of transmission lines and insulated wires.

**ORRADIO INDEXING TAPE REELS**

An identification tab, *Reel-Tab*, de-signed to replace makeshift scraps of paper and China crayon markings that are used for labelling sound tape reels, is now available from Orradio Industries, Inc. (*Nat Welch*), T-120 Marvyn Rd., Opelika, Ala. Tab fits beneath the edges of any type of 7" plastic or metal reel, whether the reel is full, half full, or empty.

**PENTRON EXPANDS MANUFACTURING FACILITIES**

Additional manufacturing space has been leased at 2355 South Indiana Ave., and 2441 South Michigan Ave., for as-sembly operations of the Pentron Corp., Chicago, Ill.

**SPRAGUE T-C RULE**

A capacitor temperature-coefficient slide rule, *C-753*, that is said to speed and simplify ceramic capacitor installation problems, is now available for 15c, from Sprague Products Co., 61 Marshall St., North Adams, Mass.

Values of stock *N750* and *NPO*-type ceramic capacitors, connected in parallel to equal a capacitor of intermediate tem-perature coefficient of the required capaci-tance, can be found.

Back of the rule features a key to ceramic capacitor color codes. Color bands and dots and their positions on each capacitor type are indicated for tempera-ture coefficient, capacitance, tolerance and voltage.

**B-T TV CALCULATOR**

A *TV Calculator*, that contains a scale for conversion of db to voltage gain, charts and diagrams describing various strengths of attenuator pads, a channel-mc scale, and a table to compute TV transmission line losses at *vhf* and *uhf* channel frequencies, is available from Blonder-Tongue Laboratories, Inc., 526-536 North Ave., Westfield, N. J.

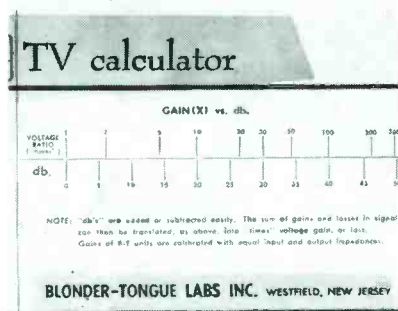

# QUAM

the Quality line

**When you specify Quam products you are assured of components that are carefully checked and tested for top performance and dependability . . . delivered when you need them . . . at the right price!**

**manufacturers of**

**QUAM Adjust-a-Cone<sup>®</sup> Speakers** for television, radio, high fidelity, public address, out-door use, replacement and many other applications.

**QUAM Focalizer Units** for TV picture tube focusing . . . use Alnico V permanent magnets . . . eliminate troubles inher-ent to wire-wound focusing devices.

**QUAM Ion Traps** for any size or type of TV picture tube.

**QUAM Tru-Match Output Transformers**, designed to get the best performance from your speaker.

**QUAM-NICHOLS CO.**  
Marquette Road and Prairie Avenue  
Chicago 37, Illinois.

**RETMA JOBBER RELATIONS COMMITTEE SET UP**

A RETMA jobber relations committee has been announced by *J. A. Milling*, chairman of the group.

Those named to the committee include: *Harry A. Ehle*, IRC; *Ed. A. Freed*, F. W. Sickles Div., General Instrument Corp.; *William J. Halligan, Jr.*, Halli-crafters; *Charles Hansen*, Jensen Manu-facturing; *Edw. T. Herbig*, E. F. John-son; *Jack D. Hughes*, Littlefuse; *Harry Kalke*, Sprague Electric; *Roy S. Laird*, Ohmite; *Matt Little*, Quam-Nichols; *Tore Lundhal*, TACO; *Richard W. Mitchell*, I.D.E.A., Inc.; *Robert A. Mueller*, Centralab; *Robert Reigel*, Stancor; *Web. F. Soules*, E-V; *Robert Svoboda*, Amphenol; *Earl Templeton*, P. R. Mallory; *Les A. Thayer*, Belden; and *N. A. Triplett*, Triplett.

**FLASHLIGHT/BATTERY DISPLAY**

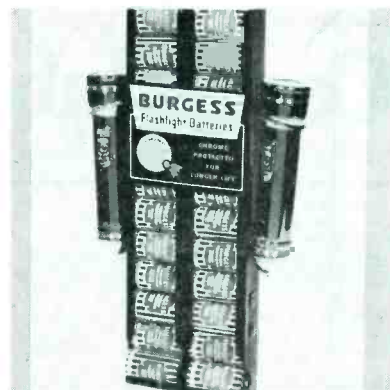

Wall vender which displays 24 chrome-protected Burgess batteries and new Burgess bullet-end flashlights.

# NEW! 4 P.E.C.\* KITS

Right now there are 100,000,000 radio and TV sets — 4 or more years old — in everyday use. These sets do not have P.E.C.'s. You'll save service time and parts investment — have greater confidence in your service jobs if you replace old-style components with P.E.C.'s. Centralab P.E.C. kits are your best supply source!



## PCK-18

18 P.E.C. units. Replace 42 old-style resistors and 52 old-style capacitors.  
Net - - - \$9.00

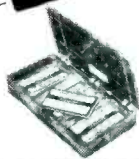

## PCK-110

110 P.E.C. units. Replace 255 old-style resistors and 52 old-style capacitors.  
Net - - - \$55.80



## PCK-220

220 P.E.C. units. Replace 525 old-style resistors and 620 old-style capacitors.  
Net - - - \$115.80  
All prices subject to change without notice



## PCK-45

45 P.E.C. units. Replace 106 old-style resistors and 133 old-style capacitors.  
Net - - - \$24.00

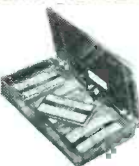

This P.E.C. Guide No. 2 (included with each kit) tells you how and when to use P.E.C.'s. Shows cross indexing — schematics — tells you how to test P.E.C.'s. Get complete details from your CRI distributor or use coupon below.

# Centralab

\*Trademark — Printed Electronic Circuits

CENTRALAB  
A Division of Globe-Union Inc.  
908-L E. Keefe Ave., Milwaukee 1, Wis.  
Please send name of distributor stocking P.E.C. Kits, also additional technical data.

Name \_\_\_\_\_  
Firm \_\_\_\_\_  
Address \_\_\_\_\_  
City \_\_\_\_\_ Zone \_\_\_\_\_ State \_\_\_\_\_

## On Book Row

TV MANUAL 12: Latest edition, with unabridged factory-authorized TV servicing information on receivers manufactured during the period of March through August '53. Various production runs and chassis are covered; modified schematics and original pilot-run circuits are included, as well as chassis views, voltages, resistance readings, alignment procedures, troubleshooting waveforms and manufacturers' parts lists and values. Cumulative index, embracing all twelve TV volumes released so far, is included. —2600 pages with binder, priced at \$24.00; John F. Rider, Publisher, Inc., 480 Canal St., New York 13, N. Y.

TRANSISTORS AND THEIR APPLICATIONS IN TELEVISION-RADIO-ELECTRONICS . . . BY LOUIS E. GARNER, JR.: A simplified discussion of transistors and their practical application in radio, TV and electronics. Chapters include: Understanding transistor action; amplifier, oscillator and special transistor circuits; transistor components; care and servicing. —100 pages, paper bound, priced at \$1.50; Coyne Electrical School, Distributed by Howard W. Sams and Co., Inc., 2201 E. 46th St., Indianapolis 5, Ind.

TV RECEIVER DESIGN II, FLYWHEEL SYNCHRONIZATION OF SAW-TOOTH GENERATORS . . . BY P. A. NEETSON: Second in series of receiver design texts providing an analysis of the flywheel action of resonant circuits, a study of automatic phase control and of practical flywheel circuits for TV receivers. —170 pages, priced at \$4.50; Philips Technical Library, Distributed by Elsevier Press, Inc., 402 Lovett Blvd., Houston 6, Texas.

PRINCIPLES OF COLOR PHOTOGRAPHY . . . BY RALPH M. EVANS, W. T. HANSON, JR., AND W. LYLE BREWER: A comprehensive volume covering the development of basic theory, as well as the physical features of the color photographic processes and the resulting effects of the picture on the observer. Some of the chapters included are: response of the eye to light in simple fields; systems of color specification and measurement; visual processes and color photography; responses of light in complex fields; color photographic systems; color sensitometry and analyses of color-sensitometric characteristics. —709 pages, priced at \$11.00; John Wiley and Sons, Inc., 440 Fourth Ave., New York 16, N. Y.

ULTRA HIGH FREQUENCY PROPAGATION . . . BY HENRY R. REED AND CARL M. RUSSELL: A valuable text with information on the most recent developments in the field of ultrahigh propagation. The system approach is emphasized, with much of the material devoted to an examination of dynamic system performance characteristics which are present in almost all *uhf* fields. Book provides a fuller understanding of the relative meaning of such critical factors as reflection, divergence, diffraction, turbulence and directivity. It also demonstrates the application of *uhf* propagation in devices such as radar, TV, automobiles, trains and missiles; shows the way to an approach to ideal installation practice, pointing up problems of maintenance. —562 pages, priced at \$9.50; John Wiley and Sons, Inc., 440 Fourth Ave., New York 16, N. Y.

# RADELCO

## LIGHTNING ARRESTOR

MODEL R-116

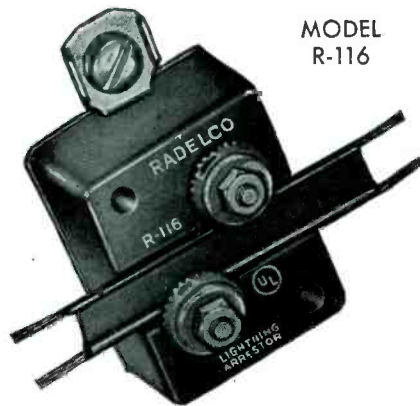

IT'S THE LOWEST PRICE UNDERWRITERS' LISTED ARRESTOR ON THE MARKET

ORDER FROM YOUR NEAREST PARTS JOBBER

LIST PRICE  
**90¢**

# CORNISH Wires

have been identified with **QUALITY** since the swaddling days of Radio. The era of Television finds them, more than ever, the **Serviceman's Friend.**

## GLUTTONS for PUNISHMENT

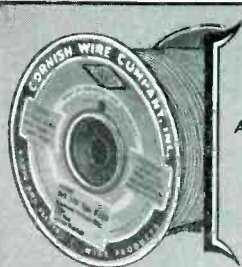

Preferred for their Absolute Uniformity. Superior Qualities and Ultimate Economy

**CORNISH WIRE COMPANY, INC.**  
50 Church Street, New York 7, N. Y.

# TV Parts... Accessories

## TELE-MATIC RETRACE ERASER

A retrace plug-in eraser, CR-59, that is said to eliminate retrace lines that interfere with TV reception, has been introduced by Tele-Matic Industries, Inc., 1 Joralemon St., Brooklyn, N. Y.

Unit is installed by plugging it into the back of the picture tube and connecting one lead to yoke.



Tele-Matic Retrace Eraser.

\*\*\*

## G-C TV ALIGNMENT TOOL

A plastic TV-set alignment tool, X-57 Long Slim, that is  $\frac{1}{8}$ " in diameter and available in 7", 12" and 16" blade lengths, has been introduced by the General Cement Manufacturing Co., 904 Taylor St., Rockford, Ill.

Tool is said to feature a super-tough tip.

\*\*\*

## TRIPLETT UHF MARKER/SIGNAL GENERATOR

A uhf marker and signal generator, 3436, has been introduced by The Triplett Electrical Instrument Co., Bluffton, Ohio.

Instrument provides all fundamentals on channels 14-83 (470-900 mc), scale marked in both frequency and channels; rf output average .3 volt; output impedance 150 and 300 ohms; piston-type attenuator; voltage-regulated power supply; adjustable modulation of rf signal at approximately 1000 cycles, and 0-20 volt audio output at panel. Can also be used as horizontal bar generator.

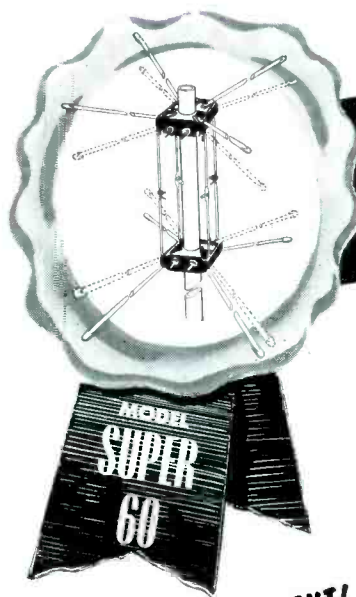
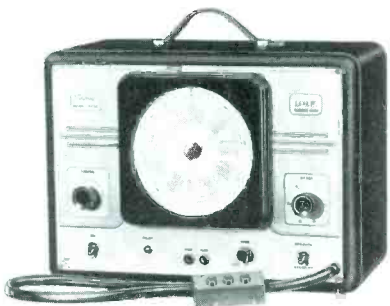

# GUARANTEED PERFORMANCE

**MONEY BACK GUARANTEED TO RECEIVE All UHF and All VHF STATIONS IN All DIRECTIONS FOR 60 MILES WITHOUT A ROTORMOTOR OF ANY KIND!**

**SO NEW! SO DIFFERENT!  
IT'S PATENTED!**

# 2,585,670  
# 2,609,503  
# 2,625,655  
# 2,644,091

OTHERS PENDING

**NEW POLYMICALENE 4 CONDUCTOR TRANSMISSION LINE**

- Low Loss External - Air Dielectric
- Matched Impedance
- Eliminates End Sealing
- Eliminates Condensation
- Up to 50% Less Loss Than Tubular When Wet
- Easily Spiraled
- No Breaking or Shorting
- Patents Pending - T. M. Reg.

**Money Back Guarantee IN EVERY AREA**

**IN ALL LOCATIONS WITH STATIONS IN ALL DIRECTIONS**

The new All Channel Model Super 60 is guaranteed to bring in, immediately on installation, every UHF and every VHF station within 60 miles in any direction, giving clearer and sharper pictures than any antenna or combination of antennas with or without rotor motors.

If, immediately on installation, it fails to do this, we agree to refund to the jobber to whom we sold and shipped it, his full purchase price.

## WORLD'S MOST POWERFUL UHF-VHF TELEVISION ANTENNA

While antenna reception is guaranteed for 60 miles, perfect pictures have been consistently received as far as 160 miles from stations.

## All NEW DESIGN FOR '54

- LOW-LOSS SWITCH
- LOW-LOSS PHENOLIC INSULATORS
- USES NEW 4-CONDUCTOR MATCHED IMPEDANCE LINE
- ONLY 10 INCH SPACING BETWEEN ANTENNA BAYS

The 9 position selector switch electronically rotates the antenna in a stationary position



LIST PRICE  
**\$36.75**  
SEE YOUR LOCAL JOBBER.

**PRICE INCLUDES**  
Complete stacked array • 4 stacking bars • 9 position switch • Switch-to-set coupler • 2 - 7 1/2" stand offs • Individually boxed in available carton

## ALL CHANNEL ANTENNA CORP.

70-07 Queens Blvd., Woodside 77, N. Y. Hickory 6-2304

## MILLER PICTURE-TUBE CHECKER/RESTORER

A picture tube restorer/checker, Re-Katho, using the beam-current principle, that checks magnetic as well as electrostatically-deflected picture tubes, and also is said to restore tubes, has been developed by the Miller Television Co., 2840 Naomi, Burbank, Calif.

Has a microamp meter for current readings. Checks electron gun for open or shorted elements. By increasing the operating temperature of the picture tube cathode and by application of various dc potentials, unit sets up a forced current flow which is said to result in a high rate of formation of barium coating on the surface of the cathode.

Right: Miller Picture-Tube Checker/Restorer



# ARGYLE®

again revolutionizes  
TV installation  
business... one look  
shows you  
how

The Argyle Mast Type Universal Standoff combined with the new Argyle Mast-Lok clamp permits the best installation possible. Is stronger, more versatile—clamps will not slip or loosen...entire installation is done in a few seconds.

a must  
for UHF...

you need it  
for VHF too!

1 PAT. APPLIED FOR

Now—Argyle introduces Mast-Lok...the clamp used in conjunction with the Universal Mast Type Standoff! Available at no difference in price.

The strongest, quickest, and most positive method of securing standoffs to the mast... heavy duty steel with a re-intorced cantilever clamp.

- **Improves Reception**... rigid engineering and lab tests prove that the New Argyle Universal Standoff tends to substantially reduce coupled-in effects and related evils in the line.
- **Big Time Saver**... you can actually save 75% of your installation time.
- **No Threading**—use any type of wire at all... Flat, Tubular, Open, Rotor—When ordering MAST-LOK with Argyle Universal Standoffs\*—add letters MC after model number of standoff... Separately model AMC-12.



## ARGYLE ELECTRONICS CO.

8 West 18th Street, New York 11, N. Y. • CH 2-2093

## ATLAS PROJECTORS



9 models to  
choose from for  
EVERY application

The performance-proved ATLAS Double Re-entrant ('DR') design combines compactness with unequalled high efficiency and uniform response in a rugged, stormproof, demountable construction. The larger size horns are excellent for greatest efficiency and low-frequency response. Where space and cost limits exist, the smaller horns are recommended. For complete details on 'DR' Projectors and the famous ATLAS line of Public Address and Microphone Stand equipment...

WRITE NOW for FREE Catalog 553



# ATLAS SOUND CORP.

1442 39th St., Brooklyn 18, N. Y.  
In Canada: Atlas Radio Corp., Ltd., Toronto, Ont.

# STOP

Volume  
Control  
Noise!



# "NO NOISE"

Contains the  
amazing new

## PERMA-FILM

- ★ **CLEANS!**  
Gets rid of dirt and oxidation immediately on contact.
  - ★ **LUBRICATES!**  
One drop eliminates scratch, hum and noise.
  - ★ **PROTECTS!**  
NEW Perma-Film assures continued top performance.
- The PERFECT Contact Restorer**  
Cleans and restores volume controls, band switches, push button assemblies, electrical contacts.
- **NOT A CARBON TET SOLUTION**  
NO NOISE is a scientific formula especially compounded for contacts!

Available in 8 oz. bottle, quart cans and 6 oz. spray can. 2 oz. Bottle Not to Serve Ice men.....

Nearest Distributor—Or Order Direct

## ELECTRONIC CHEMICAL CORP.

813 Communipaw Ave., Jersey City 4, N. J.

**\$1.00**

# Tools . . . Instruments Parts . . .

## PRECISE CAPACITY-DECADE KIT

A capacity-decade box, 478, that offers four decades from 100 mmfd to 1.111 mfd (100-mmfd steps), is now available from Precise Development Corp., 999 Long Beach Rd., Oceanside, L. I., N. Y.

Unit is pocket-size (3¾" x 6¼" x 2") in a bakelite case. It is claimed to have 1% accuracy. Available in kit or wired form.

\* \* \*

## C-D METAL-CASED CAPACITORS AND KIT

A series of capacitors, impregnated with *Fixfil*, which it is said prevents softening, cracking or leaking, are now available from the Cornell-Dubilier Electric Corp., South Plainfield, N. J.

Impregnant, which is a specially developed *solid* that is thermosetting in nature, is claimed to permit operation at full-rated voltage over the temperature range of -55° C to +130° C without derating at any temperature.

Available in both metal-container, in ratings up to 1 mfd. 400 vdc, and tubular metal-cased styles.

An assortment of 76 *Cub* capacitors, available in a compartment-type, clear plastic, hinged-cover case (size 11" x 6¼" x 1⅞"), has also been announced.

Kit assortment contains: 6—.001; 6—.002; 6—.003; 6—.005; 6—.0068; 10—.01; 6—.02; 5—.03; 6—.047; 10—.05, and 10—.10 mfd capacitors.

All the above capacitors are rated at 600 vdcw.

\* \* \*

## HALLDORSON FLYBACK FOR MUNTZ MODELS

A flyback transformer, *FB413*, for replacement of the Muntz TO-0031 used in '51, '52 and '53 models, is now available from Halldorson Transformer Co., 4500 Ravenswood Ave., Chicago 40, Ill.

For earlier models, *FB403* can be used for Muntz TO-0024 flyback.

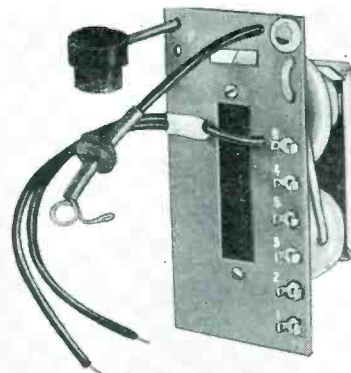



**WESTON PROPORTIONAL MUTUAL-CONDUCTANCE TV TUBE CHECKER**

A tube checker of the proportional-mutual-conductance type, 981 Type 2, has been announced by the Weston Electrical Instrument Corp., 614 Frelinghuysen Ave., Newark 5, N. J.

Tube checker provides for measurement of proportional mutual conductances, emission characteristics of rectifiers and diodes, and the firing potential limits of voltage regulators and low-power thyratrons. Features meter measurement of leakage resistance, as high as 5 megohms, between the tube elements, and measures transconductance up to 24,000 micromhos, a selector switch providing the following ranges: 3000/6000/-12000/24000 micromhos. Sockets are provided for all conventional type tube bases as well as acorn, and 7 and 8 pin subminiatures.

Instrument provides 19 filament voltage settings from .65 to 115, and give plate voltages from 20 to 177, with a 45-v source to facilitate testing of subminiature type tubes. Overall voltage variations are corrected by a line control adjustment. Signal voltages of 3.2/1.6/.8/.4 are provided at a frequency of 5 kc. For testing voltage regulator tubes a selenium rectifier supply furnishes 200 v dc, for a maximum dc current of 65 ma. A roll chart is included.

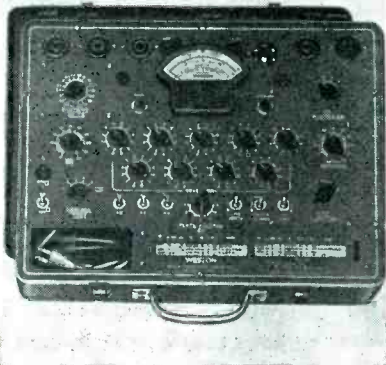

Weston TV Tube checker.

**TAL BENDER TUBING BENDER**

A tool, TT-57, which can be used to bend tubing, especially hard and soft copper in the sizes of 5/8" and 3/8" od, has been developed by Tal Bender, Inc., Milwaukee 2, Wisconsin.

Tool is made from a light-weight metal, and has the two bending sizes in one. Two pipe handles are available so that they may be secured in each of the two parts of the bending section.

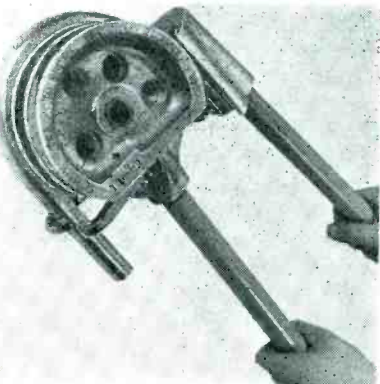

**PROFIT-WISE TV DEALERS**

**DON'T—Send 2 Men To Do A 1 Man Installation Job!**

**DON'T—Risk Costly Equipment On A Roof-top!**

**DO—Send 1 Man, A Pocket Meter\* and**

**The NEW MOSLEY "ORIENTOR"**

**for FAST, ACCURATE ORIENTATION OF ANY UHF/VHF TELEVISION ANTENNA**

If TV antenna orientation is a problem in your area, here is a piece of equipment that pays for itself every day it is used. It's the new MOSLEY "ORIENTOR"—a simple-to-use, compact and low cost device that enables the installer on the roof to know, instantly and unerringly, just what is occurring in the TV set.

**HERE'S HOW THE "ORIENTOR" SAVES TIME AND MONEY...**

- ✓ Permits ONE MAN To Do The Job Formerly Requiring Two!
- ✓ Makes Possible Use Of Low Cost, Portable VOM\* To Read Relative Video Signal Strength!
- ✓ Eliminates Need For Extra Wires From Set To Roof!
- ✓ Use To Determine Best Lateral, Vertical and Directional Orientation Of Antenna!
- ✓ Aids In Determining If Transmission Line Is Functioning Properly!

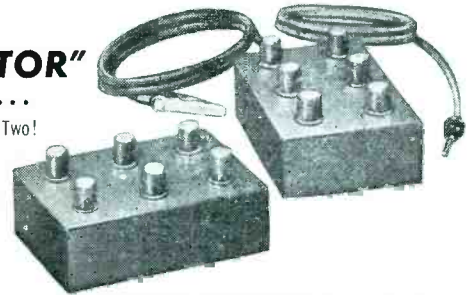

Try it on your next installation job. You'll quickly see why the MOSLEY "ORIENTOR" has been termed "The TV Installers' Handiest Tool Since The Step-ladder...!"

THE NEW MOSLEY "ORIENTOR", includes dual isolation network units, ready-to-use leads for connecting unit to set without removing chassis and complete instructions.

Catalog 903, Dealer Net, just \$7.50  
Descriptive Folder, Form 903, Sent Upon Request.

**The NEW MOSLEY "ORIENTOR"**

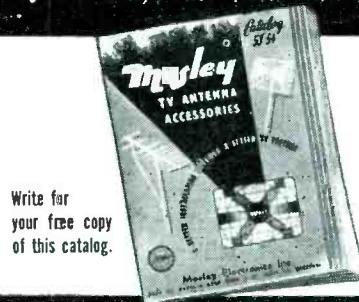

Write for your free copy of this catalog.

**Mosley Electronics, Inc.**

8622 St. Charles Rock Road St. Louis 14, Missouri



**ROCKFORD WIRE STRIPPER**

A wire stripper, *Whis Wire*, with interchangeable cutters for stripping 12 to 24-gauge solid or stranded wire, or 300-ohm twin leadin, has been introduced by the Rockford Wire Stripper Co., 2323 23rd Ave., Rockford, Ill.

Unit has a lock-open feature that holds the jaws open automatically; jaws are released with touch of lower handle. Tool has steel cutters that can be replaced by removing two screws. Four extrusions, two for each blade, hold cutters in alignment.



Right: Rockford Wire Stripper.

# RIDER TEK-FILE\*

**NOW...  
ONLY \$1.50  
PER PACK!**

## packaged tv service information

(Schematics on all production runs. Voltage data. Waveforms. Alignment. Chassis views. Installation. Chassis removal, etc.)

## factory- authorized

## factory- approved

for easy TV  
servicing...

tailor-made  
for more than  
3000  
receiver models.

**NOW ONLY  
\$1.50 per pack**

(at your jobbers)

Try a pack. If you're not satisfied,  
return the pack within 7 days and  
your money will be refunded.

\*Dependable TV replacement  
parts listings starting  
with pack 57

## JOHN F. RIDER

Publisher, Inc.  
480 Canal Street  
New York 13, N. Y.

## 2-Speaker Phono

(Continued from page 27)

upper section of the graph. Distortion curves at various power levels are shown in Fig. 4 (p. 27). The distortion, plotted in the usual manner, shows the typical rapid increase in distortion at the overload point of feedback amplifiers. The gain of the pre-amp, however, has been held down enough so that overload rarely occurs, using a reluctance cartridge.<sup>3</sup>

No special circuits were used to produce the results shown in the response figures. The feedback was taken to the grid of the input tube rather than the cathode, so that the cathode resistor of the phase inverter could be common to the two tubes. In this way, a good deal of balance could be obtained to minimize tube selection for good performance and simplify production-line assembly. For treble boost, the cartridge was terminated with a very high resistance; this was found to permit all of the preemphasis used in recording to be passed through the amplifier. It was possible to obtain a standard roll-off without sacrificing gain. Standard circuitry was used in the bass boost circuit with a boost of 6 db at 60 cps, tapering off to level at 200 cps. This boost is controlled with a shorting switch, but the switch can be replaced with a 1-megohm potentiometer for continuous control. The amplifier has a power rating of well over ten watts of continuous power handling capacity, and distortion of over 2 or 3 per cent is not reached until the fifteen-watt point.

### Test Procedures

The problems of production of high-quality reproducing equipment can be overwhelming unless rigorous test procedures are followed in every stage of production. Thus the amplifier line is checked with a setup which tests power output over the complete frequency range, distortion, hum level, sensitivity, equalization and tone-control characteristics. This section is so equipped that less than five minutes per amplifier is necessary to complete a test. Amplifiers not passing the minimum requirements are sent to a repair department. Loudspeakers are tested before mounting to weed out units with defective voice coils, rattles, and limited power handling capacity. They are again tested when mounted, but before the cabinet back is put in place to eliminate internal rattles in the en-

<sup>3</sup>G.E.

<sup>4</sup>Collaro. <sup>5</sup>Cook 10LP; London LD-1011.

<sup>6</sup>G-R

## TEST PICTURE TUBES

in a jiffy

- ACCURATE
- INEXPENSIVE
- POCKET SIZE

Test picture tube without removing it or chassis from cabinet.

## KINE-TEST



- ELIMINATES GUESSWORK
- TESTS ALL STANDARD TUBES
- SIMULTANEOUSLY CHECKS:

FIRST ANODE VOLTAGE VIDEO SIGNAL  
FILAMENT VOLTAGE BIAS VOLTAGE

Sold only through VIDAIRE distributors

Write for Catalog A

## Vidaire Electronics Mfg. Co.

Mfrs. of TV color equipment, TV amplifiers,  
Electronic Devices



Factory: Lynbrook, L. I., N. Y.  
Nat'l. Sales Office: 6 E. 39 St.  
N. Y. 16, N. Y. - LE 2-7372

## CARBON-TET

Finest Cleaner for Electrical Parts



1. Quickly removes oil, grease, tar and other soils from electrical parts!
2. Safe, Won't burn! Won't explode!
3. Won't harm finest surface or finish!
4. Dries instantly—no odor or residue!
5. Economical for cleaning sliding contacts, condenser plates and chassis. Also as a wash for carbon deposits.

In gal. cans, qt. cans, 8-oz. bottles.  
Order from your jobber.

## THE KERDEN CHEMICAL CO.

5717 WALWORTH AVENUE • CLEVELAND 2, OHIO

closure. After the back is secured, the speaker-enclosure combination is given a frequency-response test to be sure that the unit is within the  $\pm 5$  db tolerance over the 50 to 10,000 cps range. The record changers<sup>4</sup> are subjected to mechanical tests for speed, cycling, etc. When the unit is completely assembled, the final tests include a sweep frequency record<sup>5</sup> check and a one-hour running test. To test adequately the units, a test setup including an anechoic (dead room) chamber, a flat-response microphone, a beat-frequency oscillator,<sup>6</sup> and a sound level recorder is used.

# PERSONNEL



EDWARD W. ALLEN, JR., has been appointed manager of publicity and publications for Allen B. DuMont Laboratories, Inc. Allen will be responsible for corporate and divisional publicity activities, except the DuMont Television network, and will also supervise company publications.

\* \* \*

WILLIAM C. BROWN, manager of the magnetron research and development labs, has been named an assistant vice president of the Raytheon Manufacturing Co., Waltham, Mass. . . . WILLIAM W. GARSTANG has been appointed assistant vice president in charge of manufacturing for the TV and radio division.



William W. Garstang



P. S. Christaldi

DR. P. S. CHRISTALDI has been named manager of the instrument division of Allen B. DuMont Labs, succeeding RUDOLF FELDT, who has resigned.

\* \* \*

LAWRENCE S. THEES, formerly general sales manager, has been named to the newly-created post of general commercial manager of the tube department of RCA Victor, RCA, Harrison, New Jersey. . . . D. Y. SMITH, formerly manager of sales operations, is now general marketing manager. . . . KENNETH G. BUCKLIN has been named manager of the new receiving tube and transistor marketing division. . . . MICHAEL J. CARROLL is now manager of the cathode-ray and power-tube marketing division. . . . HARRY B. WILSON has become manager of the electronic components marketing division.



L. S. Thees



D. Y. Smith

\* \* \*

LYNN EATON has been appointed vice president in charge of sales of the National Co., Inc., Malden, Mass. . . . C. G. BARKER, former vice president in charge of sales for Magnecord, Inc., is now distribution manager at National.



Lynn Eaton



C. G. Barker

MARVIN L. BRUCKNER has been named sales coordinator of the Oxford Electric Corp., Chicago, Ill. . . . JACK HARVEY, formerly sales coordinator, is now assisting Hugo Sundberg, vice president, covering manufacturing accounts in and around Chicago.

\* \* \*

HOWARD J. GREENLEY is now ad manager of The Hickok Electrical Instrument Co., Cleveland, Ohio.

\* \* \*

RONALD W. ARGENTA has been appointed art director and assistant ad manager of LaPointe Electronics, Inc., Rockville, Conn.

\* \* \*

CHARLES G. WEKES has joined the sales staff of the Tung-Sol Sales Corp., Newark, N. J.

DICK MORRIS has been named sales manager of Bellevue Tube Mill, Inc., an affiliate of Snyder Manufacturing Co., Philadelphia, Pa.

\* \* \*

DR. ALFRED N. GOLDSMITH has been awarded the *Founders Award* by the Institute of Radio Engineers.



A. N. Goldsmith

The  
TARZIAN  
TUNER  
is known  
for its  
perfection

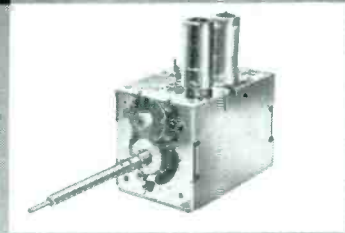

Yes, perfection in design . . . craftsmanship . . .  
and perfection in performance.

That's why you'll find most manufacturers of the best known receivers  
today are placing their confidence in the Tarzian Tuner.

Leading manufacturers are specifying the Tarzian Tuner to be used  
in the sets they make because they can be sure of customer  
satisfaction with the trouble-free Tarzian Tuner.

You just can't beat the Tarzian Tuner for selectivity,  
stability and reception . . . especially in fringe areas.

And, the Tarzian approach to UHF is recognized  
as the sensible . . . all-channel . . . approach. Remember, Tarzian  
was first with UHF engineered into a VHF Tuner.



**SARKES TARZIAN, Inc.**

**Tuner Division • Bloomington, Indiana**

# Windsor TUBES

RADIO & TV RECEIVING

TESTED and  
GUARANTEED  
for **PEAK**  
PERFORMANCE

**TO MERIT YOUR CONFIDENCE**—to insure your satisfaction—Every tube we ship has been tested in a radio or TV set for **PEAK PERFORMANCE**. Each tube is attractively packaged in individual carton—and, **EACH WINDSOR Tube you buy carries the full RTMA GUARANTEE!**

## REPEAT BUSINESS

is our best Testimonial! Many thousands of dealers and servicemen throughout the nation continue to re-order WINDSOR Tubes month after month! Such overwhelming endorsement merits YOUR confidence too!



Type	Each	Type	Each	Type	Each	Type	Each	Type	Each
1A7GT	\$.67	1U4	.61	6AT6	.42	6E5	.72	6X4	.37
1B3GT	.69	1U5	.51	6AU5GT	.85	6F5GT	.54	6X5GT	.36
1C6	1.06	1X2A	.74	6AU6	.47	6J5GT	.44	6Y6G	.64
1E7GT	1.09	2A7	.74	6AV6	.41	6J6	.68	7A4/XXL	.57
1H5GT	.51	2X2	1.41	6AX4	.72	6J7	.70	7A5	.70
1H6	.93	3LF4	.76	6B8G	.93	6K6GT	.45	7A6	.57
1J6	.93	3Q4	.66	6BA6	.50	6K7	.70	7A7	.58
1L4	.63	3Q5GT	.72	6BA7	.66	6L6G	.88	7A8	.56
1L6	.66	3S4	.61	6BC5	.58	6L6GA	.88	7AD7	1.05
1LA4	.32	3V4	.62	6BD5GT	.98	6Q7GT	.55	7AF7	.63
1LA6	.80	5R4GY	1.00	6BD6	.54	6S4	.51	7AG7	.65
1LB4	.32	5U4G	.44	6BE6	.51	6S8GT	.75	7AH7	.55
1LC5	.80	5V4G	.83	6BF5	.66	6SA7GT	.57	7AJ7	.70
1LC6	.80	5Y3G	.37	6BF6	.43	6SC7	.63	7B4	.54
1LD5	.80	5Y3GT	.32	6BG6G	1.47	6SD7	.55	7B5	.51
1LE3	.80	5Y4G	.43	6BH6	.63	6SF5GT	.66	7B6	.52
1LG5	.80	6A8GT	.68	6BJ6	.53	6SH7GT	.52	7B7	.58
1LH4	.80	6AB4	.51	6BK5	.76	6SJ7GT	.52	7C4	1.05
1LN5	.80	6AC5GT	.82	6BK7	.97	6SK7GT	.55	7C5	.56
1NSGT	.63	6AG5	.59	6BL7GT	.94	6SL7GT	.68	7C6	.50
1P5	.76	6AH4	.68	6BN6	.98	6SN7GT	.59	7C7	.58
1Q5	.72	6AK5	1.05	6BQ6GT	.98	6SQ7GT	.46	7E5	.85
1R4	.85	6AL5	.44	6BZ7	.92	6T8	.85	7E6	.65
1R5	.62	6AQ5	.51	6B7	1.09	6U8	.86	7E7	.85
1S4	.67	6AQ6	.47	6C4	.41	6V3	1.09	7F7	.69
1S5	.52	6AQ7	.75	6CB6	.58	6VG6T	.5	7F8	.97
1T4	.62	6AR5	.42	6CD6G	2.04	6W4GT	.50	7G7	.85
1T5GT	.78	6AS5	.55	6D6	.63	6W6GT	.63	7H7	.85
								7J7	.85
								7K7	.85
								7L7	.85
								7N7	.62
								7Q7	.62
								7R7	.70
								7S7	.90
								7V7	.92
								7X6	.62
								7Y4	.45
								7Z4	.50
								12AT6	.53
								12AT7	.75
								12AU6	.47
								12AU7	.58
								12AV6	.41
								12AV7	.87
								12AX4	.72
								12AX7	.67
								12AY7	2.15
								117Z3	.43
								19BG6G	1.53
								19T8	.87
								25BQ6GT	.98
								25L6GT	.53
								25W4GT	.53
								25Z6GT	.46
								35A5	.55
								35B5	.53
								35C5	.53
								35L6GT	.52
								35W4	.33
								35Z5GT	.33
								50A5	.55
								50B5	.52
								50C5	.52
								50L6GT	.52

## FREE! WINDSOR TUBE CADDY

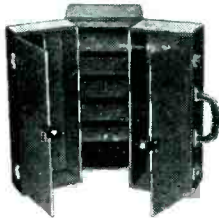

The most practical Service-Aid ever designed for the radio and tv repairman. This ideal television carry-all now offered free with every purchase of \$160.00 or accumulated purchases totalling \$160.00 within 90 days. (You get caddy credit memo with each purchase.)

Windsor Tube Caddy may also be purchased outright for **\$14.95**

Don't Miss This Sensational Offer!

- Carries approximately 125 tubes including meters and tools.
- 16 3/4 inches long x 8 1/4 inches wide x 1 3/4 inches high.
- Weighs only nine pounds.
- Ruggedly constructed with heavy leatherette covering, strong plastic handle, nickel plated hardware, and reinforced with metal clamps.

**WRITE FOR** Additional Tube Types and Prices. We also stock Special Purpose and Transmitting tubes at similar savings!

25% DEPOSIT with Order. All Merchandise F.O.B. New York City. For orders less than \$10, add \$1 handling cost. Deduct 2% if full remittance accompanies order. All merchandise subject to prior sale and price change without notice. Dept. S-53.

**Windsor ELECTRONIC TUBE CO.**  
1515-S SHEEPSHEAD BAY ROAD, BROOKLYN 35, N. Y.

## Ser-Cuits

(Continued from page 28)

connection of the contrast return line is made to the B-line in the receiver. This will usually be the most minus point in the power supply.

This connection also serves as the return line for the volume control circuit; it is therefore necessary that this point be adequately bypassed (10 mfd or larger) to provide proper volume control action. Most receivers employ a filter capacitor between the B-line and ground. However, in the event

that no such bypass capacitor is present, one must be added for remote operation. (Note: Should little or no control of the volume be experienced from the remote position while making an operational check, probably this return point is not properly bypassed.)

### Amplified AGC Voltage Output

This type of *agc* circuit also requires a positive voltage output from the remote unit, and since the remote units are supplied for negative output, the polarities must be reversed.

## Tape Recorder Report

(Continued from page 31)

ter. The locking screw should then be tightened.

The counter and takeup belts can be lifted off of the pulleys and replaced. Should it be necessary to replace the drive belt, the takeup belt should be removed, and the four screws located at the ends of the recording mechanism assembly removed and lifted off the assembly. A new belt can then be installed and the assembly replaced.

### Electrical Tests and Adjustments

To check bias current the shield of the recording head cable must be disconnected at the terminal strip directly behind the head. A non-inductive resistor (not over 10 ohms) should be inserted between the cable shield and the terminal and a *vtvm* connected across the resistor; lead length should be kept as short as possible. The record key should now be depressed. The voltage across the resistor should indicate a bias current of .6-.8 milli-ampere.

To test record current, the same setup employed in the bias check can be used. The 6C4 oscillator tube should be removed and an audio oscillator connected to the mike jack. The oscillator should be set to 1,000 *cps* and the recorder *volume* control adjusted so that the level indicator eye just closes; one must be sure to keep the output of the oscillator low enough so that the recorder volume control is advanced more than half-way. This will avoid overloading of the input section of the 12AX7. The voltage across the resistor should indicate a record current of .06-.08 milliamperere.

### Head Orientation and Azimuth

For this check, the recorder head assembly should be removed and the head retaining nut (located on the threaded bushing through which the head cable passes) loosened enough so that the head can be rotated slightly on the mounting bracket. The head assembly should be installed and the recorder threaded with a 1-mil azimuth tape. An output meter should be connected across the speaker. The *play* key should be depressed and a rough azimuth adjustment made by rotating the adjusting nut. The record head should then be rotated to obtain maximum output. The head assembly should now be removed and the head adjusting nut tightened. The head should then be replaced and the adjust-

ing nut rotated to obtain maximum output. Warning: Watch out for a false peak. Due to the short wavelength it is possible to obtain a low peak when the ends of the head gap are displaced from a position normal to the line of tape travel by  $\frac{1}{2}$  wavelength.

To position the erase head so that the tape passes through the center of the gap, the retaining screw should be loosened and the head swung sideways to the proper position. The retaining screw should then be tightened. To locate the head vertically, the retaining nut should be loosened and the head raised or lowered so that the top surface of the pole pieces is even with the top edge of the tape.

Switch contacts can be cleaned with alcohol or carbon-tet, and lubricated with vaseline.

A light film of *Lubriplate* should be applied to all pivots. Apply 2 drops of clock oil to each capstan shaft bearing. The motor bearings are equipped with wicks which should be oiled once a year or every 500 hours of operation, whichever occurs first. Clock oil or light machine oil (pure mineral oil only) should be used. Felt clutch disks can be cleaned with carbon-tet, dried and then saturated with a mixture of 50% alcohol and 50% carbon-tet. After lubricating the recorder, the capstan, belts, pinch roller, feed spindle drum and rewind driver should be wiped with a cloth dampened with carbon-tet to remove any oil which might have seeped onto these parts.

## Systematic Servicing

(Continued from page 43)

receiver back to the shop. These complications can be overcome by setting up all home service calls for a two-man team with proper training and properly equipped to perform antenna maintenance, as well as receiver repair and adjustment; and these teams should follow a routine procedure on each call to utilize their time in an efficient manner.

Recently, a typical incident, illustrating the type of costly inefficient home service operation, that can be avoided by two-man team systematic servicing, occurred. A chassis, in a home service call, showed a tendency toward loss of sync. Replacement of two tubes apparently corrected the condition. However, within a week it was necessary to return because of bad horizontal pulling. After replacement of several more tubes it was decided that the receiver would have to undergo thorough shop tests to determine the origin of the trouble. After a complete overhaul the receiver

was returned, reportedly in perfect working order, only to once again fail with the same annoying pulling. It was then decided to look at the antenna, which was not visible from the front entrance. It was found that the mast had slipped, so that although the antenna was pointed in about the right direction and providing a fairly strong signal, it was tilted about 45° from its proper horizontal position. As a result it was providing one of those freak reception conditions which cause horizontal pulling even in a properly-operating receiver. It was then necessary to make still another

# Only C-D gives you the built-in extras

No other line puts so much engineering, so many heavy duty construction features, and so much experience into every capacitor.

Whether it's an electrolytic, a ceramic, a paper or a mica, you know you're getting field-proved performance when you ask for C-D. Why take less?

Don't accept substitutes on the basis that they even "look-alike". It's what's inside that counts. Insist on C-D's.

Order a supply today from your C-D jobber! His name is in the Yellow Pages of the Classified Telephone Directory. For catalog write to Dept. S-123, Cornell-Dubilier Electric Corporation, South Plainfield, New Jersey.

CONSISTENTLY DEPENDABLE

# CORNELL-DUBILIER CAPACITORS



There are more C-D capacitors in use today than any other make.

PLANTS IN SO. PLAINFIELD, N. J.; NEW BEDFORD, WORCESTER AND CAMBRIDGE, MASS.; PROVIDENCE AND HOPE VALLEY, R. I.; INDIANAPOLIS, IND.; SANFORD AND FLOUAY SPRINGS, N. C. SUBSIDIARY: RADIART CORP., CLEVELAND, OHIO



CUB



CERAMIC



MICA

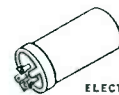

ELECTROLYTIC

call with a helper to repair the antenna installation and restore satisfactory reception. Obviously this little fiasco was costly to the customer and unprofitable to the service shop.

[In January: Routine Home Service-Call Procedures]

\* \* \*

## PLASTOID TRANSMISSION LINE

A twin-wire leadin, *Foamline*, that it is said eliminates dampness, and thus line loss, has been introduced by the Plastoid Corp., 42-61 24th St., Long Island City, N. Y.

Constructed of tiny, foamlike air cells that protect the wire leads. Air dielectric principle is also maintained in the line.

# The First Practical, Understandable Book About TRANSISTORS

distributed by  
**HOWARD W. SAMS & CO., INC.**

NEW COYNE PUBLICATION

## "TRANSISTORS AND THEIR APPLICATIONS IN TELEVISION-RADIO-ELECTRONICS"

by Louis E. Garner, Jr.

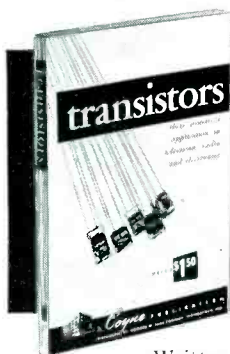

The "inside story" of Transistors for Servicemen, Engineers, Amateurs and Experimenters

Written by an authority on the subject. Explains in easy-to-understand language the theory and practical applications of Transistors. Clears up common misconceptions; clarifies Transistor circuitry, installation, testing techniques, theory and servicing. An important book for everyone in Electronics.

### CONTENTS

**Chapt. 1:** History of Transistor development and its implications for the electronic industry. **Chapt. 2:** Non-mathematical explanation of how Transistors work; description of basic types. **Chapt. 3:** Physical and electrical properties of transistors. **Chapt. 4:** Transistor amplifier circuits. **Chapt. 5:** Transistor oscillator circuits. **Chapt. 6:** Special Transistor circuits (D.C. amp., R.F. det., Clippers, Phase Inverters, etc.). **Chapt. 7:** Transistor Components (sub-miniature parts and power supplies). **Chapt. 8:** Care and servicing of Transistors. **Chapt. 9:** Practical Transistor circuits (experimental circuits with parts values; audio and r.f. circuits). **Chapt. 10:** Reference data; commercially available Transistors and their characteristics, etc.

Have ALL the latest information on Transistors in this authoritative, low cost book—it's a "must" for your library.

100 PAGES. 5½ x 8½" \$1.50  
ORDER CTB-7. Only....

ORDER TODAY

**HOWARD W. SAMS & CO., INC.**

Order from your Parts Jobber today, or write direct to Howard W. Sams & Co., Inc. 2207 East 46th St., Indianapolis 5, Ind.

My (check) (money order) for \$..... enclosed. Send..... copy(ies) of "Transistors" (CTB-7) at \$1.50 per copy.

Name.....

Address.....

City..... Zone..... State.....

## Service Engineering

(Continued from page 46)

ohmmeter can be used for checking continuity of field coils, armature windings and regulator components.

The electrical power engineer uses different terms and schematic symbols than those with which the electronic Service Man is familiar. Generally, however, electric power circuitry is very simple.

Where an induction motor is used as the driving motor for a *hf* generator, a magnetic or even a manual across-the-line starter is used. The latter is simply a husky relay which connects the motor input leads to the *ac* line. A coil pulls the contacts closed when a push-button is operated and a contact in the starter assembly keeps the coil energized until opened by the *stop* button or an overload or under-voltage protective device.

Magnetic or thermal circuit breakers are generally used in lieu of fuses to protect the power line or the generator output in case of an overload.

Failure of a motor generator to start can be generally traced to one or more of the following faults: (1) Absence of line power; (2) faulty power contacts in starter; (3) open fuses in circuit breaker; (4) open coil in starter; (5) poor contact in push-button; and (6) defective motor.

If the motor generator runs, but no output or very low output is delivered by the generator, one of the following conditions might be present: (1) Open fuses in output circuit breaker; (2) defective voltage regulator; (3) open field coil in exciter; (4) open field coil in *hf* generator; (5) brushes not contacting armature in exciter; (6) brushes not contacting armature in generator; (7) defective exciter armature; and (8) open generator armature.

By studying the schematic diagram and checking continuity of all circuits, with the machine shut down, or by measuring the voltage across the various circuits with the machine running, the faulty condition or conditions can be diagnosed in short order.

## Servicing Helps

(Continued from page 49)

into a peak-to-peak *v<sub>rms</sub>* is to multiply the *rms* scale by 2.83. This is in general not true. In the first place, conversion from *rms* to peak-to-peak voltage can be made by multiplying by 2.83 *only if the waveform under test is a sine wave*. Since this is only true

THE SERVICE MAN'S CHOICE!

New Improved  
**EVER-KLEER**



TV Tube and Glass Cleaner

Now in the handy  
PLASTIC SPRAY BOTTLE!

- Eliminates grime & carbon from TV tubes.
- Prevents fogging. Has no affinity for dust.
- Leaves a microscopic film of protective wax that lasts indefinitely.
- EVER-KLEER's quality is so high that it can be used on the most delicate optical lenses.

3¾ Ounce EVER-KLEER Refillable Plastic Spray Bottle. Only 98c

8 Ounce Refill Bottle. Only 69c

3¾ Ounce EVER-KLEER Refillable Plastic Spray Bottle plus 8 oz. Refill Bottle. Only \$1.50

Reg. U. S. Pat. Off.

EVER-KLEER is made by the manufacturers of HUSH—The TV-Tuner Cleaner that Sprays On. EVER-QUIET—The Original Volume Control & Contact Restorer.

All products liability protected by one of America's largest underwriters. Ask your local distributor for EVER-KLEER or write:

**CHEMICAL ELECTRONIC ENGINEERING, INC.**

283 Main Street Matawan, N. J.

# RADELCO

## INDOOR ANTENNA

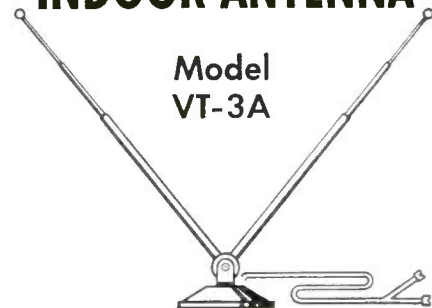

Model  
VT-3A

... A high quality antenna, attractively designed and finished in mahogany lacquer to harmonize with all room furnishings. Three section, brass tubing masts with lustrous plate finish extend to 45" for fine reception. Heavily weighted base. Lead and terminals included. A real value!

ORDER FROM YOUR NEAREST PARTS JOBBER

LIST PRICE  
**\$3.45**

**THE SYMBOL  
OF QUALITY**

in **TRANSFORMERS**

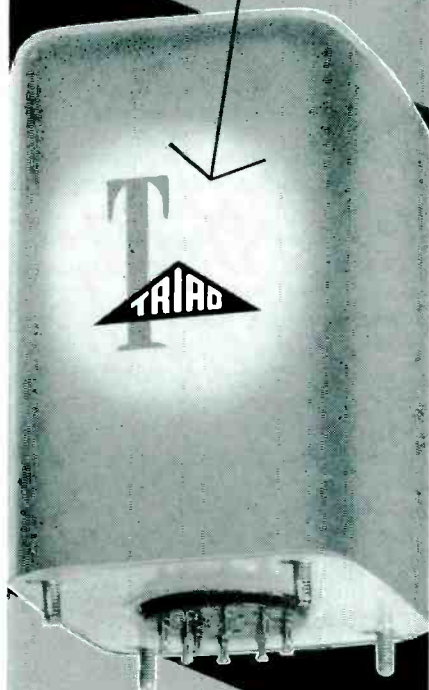

**QUALITY**

*you can see!*

"Beauty is only skin deep,"  
but the distinctive appearance  
of Triad Transformers is an  
outward evidence of inner quality,  
more than simply good looks.

Brilliant design, fine materials,  
precision manufacturing techniques  
and skilled craftsmanship contribute  
to the end result, which looks like—  
and is—the finest transformer made.

Triad Transformers are sold by  
principal jobbers in leading cities.

Write for Catalogs TR-53L & TY-53L.



4055 Redwood Ave., Venice, California



of sine waves, it is obviously untrue  
of non-sinusoidal waves.

Furthermore, non-sinusoidal waves  
usually have vertical dissymmetry  
(positive-peak voltage is not equal to  
the negative-peak voltage), and hence  
the conversion from *rms* to peak-to-  
peak voltage cannot be made at all  
*unless a full-wave input circuit is pro-  
vided in the *v<sub>rms</sub>**. A so-called vol-  
tage-doubler circuit is usually utilized  
for this purpose. Hence, if a *v<sub>rms</sub>*  
does not make full provision for  
measurement of peak-to-peak voltages,  
it is in general impossible to arrive at  
the peak-to-peak voltage of a signal  
upon the basis of an *rms* scale indi-  
cation.

### Tube News

*(Continued from page 55)*

use punishment. Involved are the low-  
and high-voltage rectifiers, horizontal  
and vertical deflection amplifiers, and  
the damper diode. Larger screen sets  
aggravate the problem.

In an effort to alleviate the problem,  
one tube maker has begun to develop  
a line of *CTS-Rated* tubes<sup>3</sup>.

So far, there are two such tubes:  
The 5AW4, which replaces the 5U4G;  
and a 6CU6, which replaces the  
6BQ6GT.

The 6CU6 is said to offer wide  
margins of safety for plate dissipation,  
plate current, high-voltage insulation  
and high-line protection.

The 5AW4 is a full-wave, high-  
vacuum rectifier designed for use as  
a low-voltage rectifier in TV receivers.

In addition, it is said, the tube has  
oversize radiating fins, a transmitting-  
tube type filament hook and a spring  
suspension to prevent sagging and  
permit mounting in any position.

A new tube type, a gated-beam dis-  
criminator (6BN6)<sup>4</sup> which it is said  
performs the function of limiter, dis-  
criminator, and audio amplifier, has  
also been announced.

The tube, a T-5½ miniature, offers  
a sharply focused electron beam; thus,  
it is noted, the first control grid has a  
step-shaped control characteristic, the  
plate current rising abruptly from zero,  
the sharply defined maximum as the  
grid voltage changes from negative to  
positive.

The second control grid has similar  
properties, controlling plate current  
from a cutoff condition at negative  
bias up to a slightly positive condition.  
Beyond this point it loses control of  
the plate current which is limited to a  
level defined by the first control grid  
and the electron beam.

<sup>3</sup>CBS-Hytron Continuous TV Service types.  
<sup>4</sup>Sylvania.



**gives  
BETTER  
UHF**

**RECEPTION**

**"ANACONDA"**

finest UHF Foam  
Polyethylene  
transmission line

- ▶ NO MOISTURE PROBLEMS!
- ▶ NO TERMINATION PROBLEMS!
- ▶ EXTREMELY LIGHTWEIGHT!
- ▶ LOW ATTENUATION!



**THIS**

**NOT THIS**



Has all channel reception for both  
UHF and VHF

We have a UL approved universal type "Lightning Arrestor" for use with all Anaconda UHF lines & other types of flat or round TV wires. A stripper for easy installation is also available.

Write for Samples and New  
Descriptive Literature

Sold through recognized jobbers only!

"National distributors and warehouse  
for ANACONDA denshath television  
and radio wires and cables"

**Columbia**  
**WIRE & SUPPLY CO.**  
2850 Irving Park Road • Chicago 18, Ill.



**New 1954 TV CONSULTANT  
TV Serviceman's Silent Partner**



New, easy-to-use way to solve toughest TV troubles. UHF sect. includes conversions, installations and servicing. Modern alignment methods shown by pictures, diagrams and simple directions, tell exactly what to do and how to do it. Practical pointers on use of all TV Test Instruments. Over 300 pix, raster and sound symptoms. Detailed directions tell where and how to find faulty parts. Over 135 RAPID CHECKS, many using pix tube as trouble locator. 125 illustr. of scope wave forms, diagrams, station patterns, show various defects—take mystery out of TV servicing. **NO THEORY—NO MATH—NO FORMULAS**—just practical service info. covering all types of TV sets. **Only...\$2**

**NEW! Trouble Shooting PIX GUIDE  
incl. TV TERMS Explained**

Sect. 1 is a fully illustrated GUIDE to oft-recurring pix faults. Causes and cures explained. Copyrighted Trouble Indicating illustrated chart tells where troubles start in typical TV set — illustrations show resulting faulty TV pictures. Sect. 2 explains hundreds of TV terms in non-technical language. SPEEDS UP TV SERVICING — HELPS YOU DO A BETTER JOB FASTER! **Only...\$1**

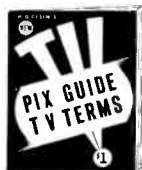

**NEW! TV TUBE LOCATOR**

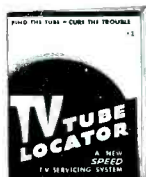

Money-making Time Saver tells which tubes to replace to cure every type of tube trouble. Over 135 such TV troubles listed with clear charts for quickly locating the faulty tubes. Copyrighted TROUBLE INDICATING TUBE LOCATION GUIDES for over 3000 most popular models from Admiral to Zenith, 1947 to 1953 models. A storehouse of valuable TV servicing info. priced very low for large volume sales. **Only...\$1**

**NEW! TV TROUBLE TRACER**

70 Common TV troubles traced to source and cured. Copyrighted trouble indicating tube location guides covering over 500 most popular TV models. Many models different from those shown in TV TUBE LOCATOR. Contains over 70 illustrations and tube location guides. Forty most common picture troubles illustrated, with symptoms described, causes given and remedies prescribed. **Only...50¢**



**H. G. CISIN, PUBLISHER**

Order from your Jobber today, or if not stocked, write to

Harry G. Cisin, Dept. S-17  
200 Clinton St., Brooklyn 1, N. Y.

Enclosed find \$ \_\_\_\_\_ Send

- TV Consultant     TV Locator  
 TV Pix Guide     TV Tracer

NAME \_\_\_\_\_

ADDRESS \_\_\_\_\_

CITY \_\_\_\_\_ ZONE \_\_\_\_\_ STATE \_\_\_\_\_

**TV Antenna Digest**

(Continued from page 50)

nector is supplied to facilitate plugging into this socket position. The other end of this lead is connected to the unit terminal marked *grid*. The lead with an alligator clip is connected to unit terminal marked *chassis*, and the clip itself used to connect to the chassis for a ground.

In the next step the two terminals marked *set input* are connected to the antenna terminal strip on back of the set with a short piece of 300-ohm transmission line. Then the transmission line going to the antenna is connected to the middle terminals of the coupler unit. In the final procedure, at the set, the TV chassis is turned on, the desired channel selected and the brightness control opened about half way.

At the antenna position, the installer first connects the middle two terminals of the unit, he has carried with him, to the transmission line going to the set. An additional short piece of line is then connected from the unit terminals marked *ant* to the antenna itself. Either a rectifier type *ac* voltmeter or a portable *vom* is then connected to the unit terminals marked *meter*. The antenna can now be oriented for maximum signal.

The varying video signal will cause the meter reading to fluctuate, but as

the antenna is moved about and rotated the position at which the best picture will be obtained will be indicated by a maximum upward deflection of the meter needle.

When the optimum antenna position has been determined, the transmission line must be disconnected from the unit terminals and connected to their usual terminals on the antenna. At the set, the other unit should be disconnected and the transmission line attached to the set terminal strip.

**Tests and Measurements**

In tests and measurements, with particular emphasis on line loading and insertion loss, it was found that maximum insertion loss occurred at channel 2 and was 2 db. On most channels, the measured insertion loss was zero.

To assure that isolation was complete on the metering circuit, the meter terminals were short-circuited at both units and the attenuation measured. The maximum loss with metering terminals shorted occurred at channel 4 and a mounted to 3 db. With a high impedance, as offered by the metering circuits, the line loading was found to be negligible.

In every case, it is highly desirable to provide an external ground to the chassis before the installer goes to the roof to make the connections there. The device should not be used for installation of transformerless type TV sets since no provision for grounding can usually be made.

Stand-off insulator free of metal on both sides, top and bottom. Stand-off can be screwed into a surface, or the insulator can be left wide open and it will stay that way because part of the insulator is anchored on the stand-off which serves as a hinge. Can be used for oval, tubular, flat ribbon or open wire leads, with special gripper notches for each type. Note: in the illustration, the notch midway from the bottom, is for flat ribbon or an open-wire insulator. Cam type open notch of the insulator slips into the stand-off frame, locking with added pressure from a raised nub between the two fingers of the insulator. (Pat; JFD)

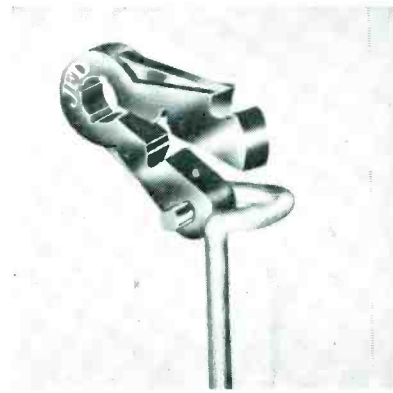
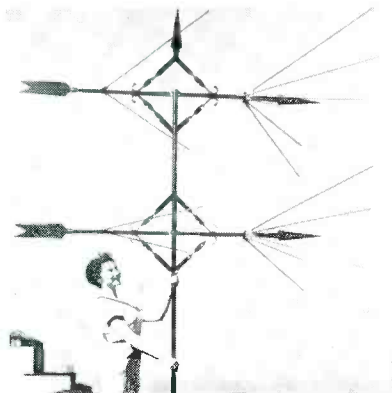



**DO MORE with  
RCP TV "DO-ALL"**

for **UHF**  
and **VHF**

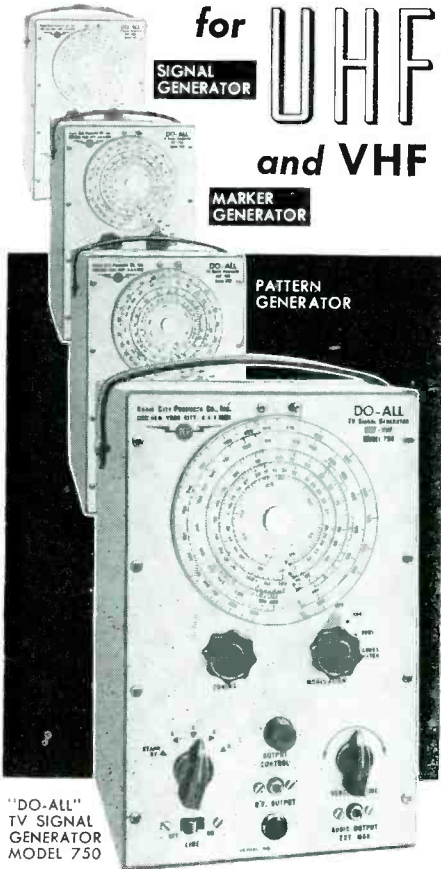

"DO-ALL"  
TV SIGNAL  
GENERATOR  
MODEL 750

**ONE**

**RCP "DO-ALL"  
SIGNAL GENERATOR**

for all **THREE**

- SIGNAL GENERATOR
- MARKER GENERATOR
- PATTERN GENERATOR

Designed for portable or bench use, the 750 reflects the finest in construction and appearance. It is handsomely finished in an attractive brushed aluminum panel with a steel carrying case.

- Inductuner insures accuracy of within 1/2 of 1% over the entire range of 9 Mc to 900 Mc.
- All VHF frequencies are on fundamentals.
- RF's and IF's are clearly calibrated on a large etched aluminum dial.
- Steady horizontal bars, vertical bars and cross-hatch pattern individually produced on all channels.

**PRICE \$79.50**

MODEL 740A—Same as Model 750 described above, less Calibrated UHF scale. Perfect for VHF areas.

**\$69.50**

See Model 750 and Model 740A At Your Local Parts Distributor

Write For Complete RCP Catalog S-12

**RADIO CITY PRODUCTS CO., INC.**  
152 WEST 25th STREET  NEW YORK 1, N. Y.

## Audio

(Continued from page 52)

become more apparent. Its presence indicates that high amplitude low frequencies have a modulating effect upon smaller amplitude highs, causing the latter to *dither* in the presence of a loud low note. While spurious tones may be the academic method of detecting intermodulation, this *dithery* effect is probably the simplest practical check. A program of organ music provides as good a test as any for this purpose, particularly when really low tones are struck and accompanied by the high ones.

Intermodulation is due to tube curvature. However, it would be as well to see that the program source is clear of intermodulation. In the case of a record, this can be done by using an amplifier known to be good, or in the case of a radio program, another receiver can be used. Phono pickups, except the better types, and to a lesser extent loudspeakers, are more often guilty of intermodulation than amplifiers, and should be suspected.

But there is another cause of *dithery* reproduction, not often realized; the drying up of electrolytic smoothing capacitors (even though hum may not be evident as a result). Actually, this is a form of intermodulation, but the modulating frequency is not as low from the program signal, but the supply ripple frequency. Often, a push-pull output stage is fed from a partially-smoothed point in the supply filter. Because of push-pull balancing, the hum cancels in the output. But the plate voltage, fluctuating at ripple frequency, modulates the push-pull signal amplified from the grids, producing a *dithery* effect.

The difference between these two defects is fairly easy to detect, once this principle is understood. Intermodulation of the highs by the lows in the *af* signal is proportional to the amplitude of the lows; no lows, no intermodulation. High amplitude lows produces a considerable *dithery* effect. But the modulation by ripple on the supply to a push-pull stage depends only on the ripple amplitude, which will not vary appreciably with signal amplitude; consequently all signals, loud and soft, and whether lows are present or not, will sound *dithery*. This difference is manifest when speech and music are compared. Speech is relatively free of low frequency components, and intermodulation distortion is not readily evident. But music, especially with high-level lows, shows it up well. On the other hand, ripple modulation is quite as evident on speech as on music.

**You  
can  
build  
a  
reputation  
on  
Tung-Sol.<sup>®</sup>  
Quality**



**TUNG-SOL makes**  
All-Glass Sealed Beam Lamps,  
Miniature Lamps,  
Signal Flashers,  
Picture Tubes, Radio, TV,  
Special Purpose Electron Tubes,  
Semiconductor Products.



**TUNG-SOL ELECTRIC INC.**  
Newark 4, New Jersey

Sales Offices: Atlanta, Chicago, Columbus, Culver City (Los Angeles), Dallas, Denver, Detroit, Newark, Seattle

# Index

(Continued from page 47)

Miniatures and Subminiature Tubes for 12-V Auto-Radios . . . Oct.  
 Pickup and Heavy Truck 2-Way FM Installation (Part II); Jack Darr . . . Sept.  
 Positioning of 2-Way FM Equipment to Expedite Service and Maintenance . . . Aug.  
 Power Supply Line Routes . . . Control Head Installation . . . Engine Noise Elimination . . . Sept.  
 6-V Auto Radio With PC Audio Coupler (Tructone 4C11) . . . June  
 12-Volt Auto-Radio Design Features . . . May  
 12-Volt Beam-Power Amplifiers for Auto Sets . . . Feb.  
 2-Way FM Installation in Pickup and Heavy Trucks; Jack Darr . . . Aug.

## CHARTS AND TABLES

Channels, Frequencies, Picture and Sound Carriers, and Oscillator Frequencies for Standard IF and Channels 5-6 Conversion . . . Mar.  
 Chart Analysis of Buzz . . . Saturation . . . Hum Bars . . . Grain . . . Smear . . . Trailing Reversal . . . Oct.  
 Chart Analysis of Picture Tear . . . Hammer-Head Distortion . . . Interlace Pairing . . . Squegging . . . Nov.  
 Chart-Circuit Analysis of Operational Characteristics of IF Amplifiers Employed in Most TV Receivers . . . Sept.  
 Color TV (A Simplified Analysis of the NTSC System); W. Kay Brownes . . . Dec.  
 Curve-Distortion, Neck Shadow, Horizontal Linearity Troubleshooting Chart . . . Aug.  
 Picture Tube Faults, Checks and Cures; J. C. Geist . . . May  
 Picture Tube Circuit Faults, Checks and Cures; J. C. Geist . . . Sept.  
 Streamlined Analysis of Circuitry and Components Required to Insure Top Results from Mixer and RF Amplifier . . . Aug.  
 Sweep-Circuit Troubleshooting (Chart Analysis); Clark R. Alisen . . . Dec.  
 Sync-Circuit Performance (Chart-Analysis); Clark R. Alisen . . . Nov.  
 Tables Detailing TV Symptoms and Troubleshooting Procedures . . . May  
 TV Chassis IF Performance Factors; Clark R. Alisen . . . Sept.  
 TV Front End Performance Factors; Clark R. Alisen . . . Aug.  
 TVI Causes . . . Effects . . . Solutions . . . Sept.  
 Video Amplifier Performance Factors; Clark R. Alisen . . . Oct.  
 Video Response Factors: Due to Peaking-Coil, Load-Resistor and Damping-Resistor Changes . . . Oct.

## CIRCUITS

AC/DC Receiver Output Stages with Trouble Areas . . . Mar.  
 Admiral 19 Schematic Revised to Prevent Fuse Failure . . . July  
 Admiral 22 Chassis Modified to Shield Horizontal Lock Coil . . . July  
 AM Detector-Load Circuit 10-Kc Filter . . . Nov.  
 Amplified AGC Circuit . . . Dec.  
 Ampco Models 755/756 Push-Button Tape Recorder . . . Dec.  
 Arvin 657T Electric-Clock Circuitry . . . July  
 Arvin 6000/FE 319, 330, 331, 332 Symptom-Change Chassis Layout . . . Feb.  
 Audio Selector Switch Circuit . . . Sept.  
 Auto-Antenna Apparent-Capacity and RF-Resistance Measurement . . . Feb.  
 Auto-Antenna Effective Antenna Height-Measurement . . . Feb.  
 Auto-Antenna Field-Strength Measurement Setup . . . Feb.  
 Balancing or Screening Input Leads at Line Impedance to Eliminate Hum Pickup . . . Oct.  
 Barker and Williamson Model 600 Dip Meter (Cover) . . . Apr.  
 Brociner A100 and A100P Pre-Amp-Equalizer . . . Apr.  
 Brociner CA-2 Control Amplifier . . . Apr.  
 Brociner UL-1 Ultra-Linear Williamson Amplifier (Cover) . . . June  
 Calibrated Voltage Divider . . . May  
 Capelhart-Farnsworth CX-37 Horizontal Phase Detector . . . Apr.  
 Capelhart-Farnsworth Horizontal AFC in CX-37 . . . Apr.  
 Cascade VHF Circuit With Pair of 6AN4s . . . Aug.  
 Channel Interference (Fidco and Sound) Trap . . . Aug.  
 Coax-Line 6AN4 RF Amplifier for UHF . . . Aug.  
 Collins Audio FM IF Amplifier . . . Jan.  
 Color Set Video Section . . . Sept.  
 Color Sync Channel . . . Sept.  
 Color TV Pix Tube Basing . . . Nov.  
 Color TV Receiving Setup During FCC Tests . . . Nov.  
 Colpitts Oscillator Illustrating Inter-electrode Capacitances . . . Feb.  
 Columbia 800 Modification to Remove Vertical Shading . . . Sept.

**NEW MULTIMETER KIT**  
\$26.50

**SIGNAL TRACER KIT**  
\$23.50

**NEW SCOPE KIT**  
\$59.50

**CONDENSER CHECKER KIT**  
\$19.50

**VACUUM TUBE VOLTMETER KIT**  
\$24.50

**TUBE CHECKER KIT**  
\$29.50

**SIGNAL GEN. KIT**  
\$19.50

**GRID DIP METER KIT**  
\$19.50

**Heathkit TEST EQUIPMENT**

BUILD YOUR OWN — INCREASE KNOWLEDGE — SAVE MONEY — BUY DIRECT FROM MANUFACTURER . . . Top quality instruments in kit form featuring latest design and circuit developments. Completely detailed step-by-step construction manual — clear pictorials — complete schematics. All sheet metal work punched, formed and finished. Low kit prices include tubes, chassis, cabinet and all necessary constructional components.

Kits for the school — service shop — industrial laboratory — hobbyist, etc.

Write for free catalog for further information.

**HEATH COMPANY**  
BENTON HARBOR 11,  
MICHIGAN

## Coming Event

**Radio Engineering Show . . .**  
**Kingsbridge Armory, Bronx, N.Y.C.**  
**March 22, 23, 24 and 25, 1954**

**Brand New Set Mfr's SURPLUS**

**TUBES**

**STANDARD BRAND WARRANTY**

Bulk Packed in Original Mfr's Nested Cartons or Individually Boxed  
 Every tube meter and chassis tested for top quality . . . **BRANDED**

1B3GT . . . 54	6AK5 . . . 79	6BQ7 . . . 79	6T8 . . . 64	12SN7GT . . . 49
11A . . . 50	6AL5 . . . 37	6BQ6GT . . . 79	6V6GT . . . 41	12N07 . . . 41
1R5 . . . 49	6AQ5 . . . 41	6BK7 . . . 71	6W4GT . . . 41	19B6G . . . 1.19
1S4 . . . 55	6AG5 . . . 49	6C4 . . . 31	6W6GT . . . 31	19T8 . . . 64
1S5 . . . 41	6AT6 . . . 34	6C5 . . . 44	6X5GT . . . 34	25BQ6GT . . . 82
1T4 . . . 49	6AU6 . . . 37	6CB6 . . . 45	12AT6 . . . 34	25L6GT . . . 41
1U4 . . . 49	6AV6 . . . 34	6CD6G . . . 1.11	12AT7 . . . 60	35B5 . . . 49
1U5 . . . 41	6B4G . . . 82	6HE . . . 41	12AU6 . . . 37	35C5 . . . 49
1X2A . . . 55	6B5 . . . 55	6J5GT . . . 37	12AU7 . . . 49	35L6GT . . . 45
3Q5GT . . . 58	6BA6 . . . 36	6J6 . . . 51	12BA6 . . . 41	35W4 . . . 32
3S4 . . . 49	6BC5 . . . 49	6J7 . . . 19	12BE6 . . . 41	35Z5 . . . 36
3V4 . . . 49	6BE6 . . . 41	6K6GT . . . 37	12BH7 . . . 56	50B5 . . . 49
5U4G . . . 37	6BG6G . . . 1.19	6NA7 . . . 44	12C8 . . . 19	50C5 . . . 49
5Y3GT . . . 34	6BH6 . . . 49	6SK7 . . . 44	12SA7 . . . 49	50C5 . . . 49
6AC7 . . . 71	6BJ6 . . . 49	6SN7GT . . . 49	12SA7 . . . 49	50L6GT . . . 45
6AH6 . . . 64	6BL7GT . . . 79	6SQ7 . . . 44	12SK7 . . . 49	

More than 400 types in stock. Include all your needs when ordering.

Orders less than \$10.00—add \$1.00 service charge. Terms: 25% with order, balance C. O. D. Please include postage. All prices subject to change without notice. F.O.B. New York City. Mail order division.

**TRANSAMERICA ELECTRONICS CORP.**  
 120 LIBERTY ST., NEW YORK 6, N. Y. • COrtlandt 7-4307

# TV Voltage Trouble?

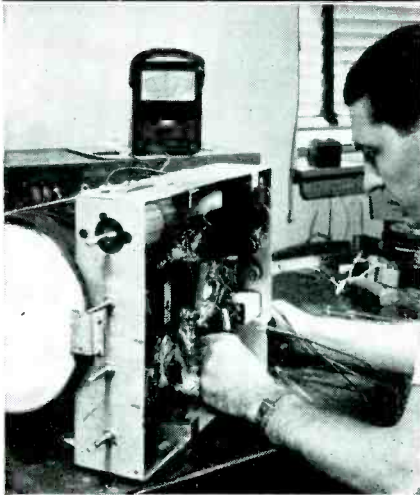

## TeleVolt AUTOMATICALLY corrects fluctuating line voltage

Low voltage causes poor television reception. If your customers' line voltage is bad, supply the television manufacturers' specified voltage by plugging in a SOLA TeleVolt Constant Voltage Transformer between the set and wall outlet. It will also protect costly components against damaging high voltage surges. The TeleVolt is a patented voltage regulator that automatically stabilizes voltage within  $\pm 3\%$  with line fluctuations as great as  $\pm 15\%$ ; it is not a voltage booster.

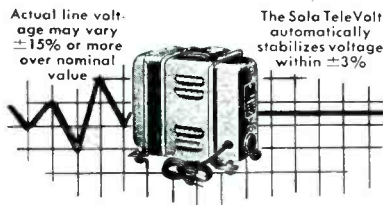

Write today for Bulletin AD-CV-175  
or see your electronic distributor

**SOLA Tele Volt**  
Automatic Constant Voltage  
TRANSFORMERS

**SOLA ELECTRIC CO.**  
4633 W. 16th St. Chicago 50, Ill.

Community-TV Chain Amplifier for 12 Channels	Aug.
Community TV High-Band Preamp.	Apr.
Community TV Isolation Unit	Apr.
Community TV System for Channels 2, 8 and 43	Mar.
Compatible Color Receiver Block Diagram	Aug.
Connecticut Tel. (Model 10) VHF/UHF Signal Generator (Cover)	Aug.
Coupling Capacitors in Audio Amps.	Nov.
Crescent 903/907 Tape Recorder and Playback Amplifier	Nov.
Crystal-Diode Connection Diagrams	Mar.
Crystal Pickup Compensator Circuit	Jan.
Crystal Probe to Develop Video-Audio Response Curve	Mar.
DC Voltage Divider	Sept.
Deflection-Type Photoelectric Recorder	Aug.
Diode in Clipper Circuit	May
Diode-Triode Booster-Damper Circuit	Aug.
Dividing Networks: Inductance-Capacitance/Resistance-Capacitance	Feb.
Dual-Channel Amplifier to Drive Hearing Aids and Broadcast Loop	June
Dual-Track Tape-Amplifier System	Nov.
DuMont Cascode Front-End	Aug.
Effects of Circuit Elements (Basically a Resistance) on Impedance	Sept.
Effects of Various Loadings on Impedance of a Crystal Mike or Pickup	Sept.
Electrolytic Capacitor Re-former	Sept.
Electronic Timer Schematic	Oct.
Emerson 731D Phono-TV Switching	Feb.
Emerson 120169-F TV Chassis Revised to Eliminate Popping in Audio	May
Emerson U/V Chassis Front End	July
Filament Circuitry for Hum Reduction	May
Filter Circuit for Ringing	Feb.
Filter Used in 'Scope Modernization	Mar.
FM Receiver Temperature-Compensated Oscillator	Nov.
Front-End Basic Circuitry	Aug.
Full Coverage U/V Tuners	Apr.
Galvanic Selenium Rectifier Tester (Cover)	Jan.
G.E. Control Unit for 2-Way Amplifier	Oct.
G.E. 103 UHF Translator	Jan.
G.E. 835 Video-Audio Section Modified for Monitoring	Oct.
G.E. Stratopower Chassis; Fourth Run	Nov.
Granco CTV (Cover)	May
Grounded-Grid VHF Amplifier With 6AN4	Aug.
Hallcrafters Photo-Etch Clock-Radio Chassis	Jan.
Hallcrafters TS-64	Jan.
Harmonic Crystal Multiplier	Jan.
Heater-to-Cathode Emission Control Circuit	Dec.
Heater Induced Hum Balance System	Dec.
HF Motor-Generator Circuitry	Dec.
High-Pass Filter for 300-Ohm TV Input	Sept.
Hoffman 182 Chassis Modified Audio Output for Two Speakers	Jan.
Hoffman 403 Push-Pull Hi-Fi 24" Chassis	Oct.
Hoffman TV Cascode Tuner With 41-Mc IF	Feb.
Horizontal and Vertical Sync System; Relation to Other Circuits	Nov.
Horizontal Deflection and HV Circuit for Big Picture Tubes	Oct.
Horizontal Deflection Circuit for Replacement Transformers (Cover)	Mar.
Horizontal Deflection Circuit for Truetone H-O-F Replacement	Mar.
Horizontal Deflection Circuit, Modified, Showing Check Points	Mar.
Hum Measurement with Calibrated 'Scope	Dec.
Horizontal Reframing Circuit	May
Hot-Cathode Phase Inverter	Apr.
How a Beam Is Formed in a Picture Tube	Sept.
IF Amplifier Signal-Trace Arrangement	Apr.
IF Amplifier Using Tertiary Winding to Feed Screen Voltage	Mar.
Input Filter (Regency Converter)	Jan.
Intermittent Test Arrangements for RF, AF, IF Signal Generators	Oct.
IT 133A UHF AutoBooster (Cover)	Nov.
Jack Box With Compensating Resistor and Volume Control	June
Jerrold 704 Field-Strength Meter	May
Junction-Transistor Circuitry	June
Junction-Transistor Circuitry Operation	Apr.
Junction-Transistor Oscillator	Feb.
Keyed AGC Circuitry	Feb.
Keyed AGC Test System	Feb.
Low-Level Test Setup Incorporating Audio Amplifier	Apr.
Magnavox CT-358 27-Inch Picture-Tube Receiver	Mar.
Magnavox 700-359 Continuous UHF Tuner	Mar.
Magnetic Pickup Preamp Hookup	Jan.
Magnetic Recording AC-Bias/Erase Circuit	Feb.
Magnetic Recording DC-Bias/Erase Circuit	Feb.
Magnetic Recording 25-Kc-Oscillator	Feb.
McIntosh 50-W-2/20-W-2 Amplifier Power Supplies	May
McIntosh 50-W-2/20-W-2 Amplifiers	May
Medium-Mu 6BQ7A Twin-Triode Circuit	Oct.
Meissner 9-1160 10-Watt Preamp/Amplifier	Mar.
Minimizing Hum Through Use of Twin-Screened Lead	Oct.
Mobile Transmitter-Receiver Primary Power	Apr.

(Continued on page 74)

530K Multimeter Kit \$12.90  
Wired \$14.90  
1000 ohms/volt

425K 5" Scope  
Kit \$44.95  
Wired \$79.95

## YOU BUILD **EICO** KITS IN ONE EVENING- but they last a lifetime... and you save **50%!**

221E VTVM Kit \$5.95  
Wired \$9.95

565K Multimeter Kit \$24.95  
Wired \$29.95  
20,000 ohms/volt

**25 Kits and 27 Instruments —  
the Industry's most complete  
line of MATCHED  
TEST INSTRUMENTS!**

320K Sig. Gen.  
Kit \$19.95. Wired \$29.95

360K Sweep Gen.  
Kit \$34.95. Wired \$49.95

1000K Battery Elim.  
Kit \$25.95. Wired \$34.95

**Laboratory  
Precision  
at Lowest Cost**

25K Tube Tester  
Kit \$34.95  
Wired \$49.95

1952 **EICO** INSTRUMENTS & KITS  
ELECTRONIC INSTRUMENT CO., Inc.  
84 Withers Street, Brooklyn 11, N. Y.

Prices 5% higher on West Coast. Rec. U.S. Pat. Off.

# KESTER

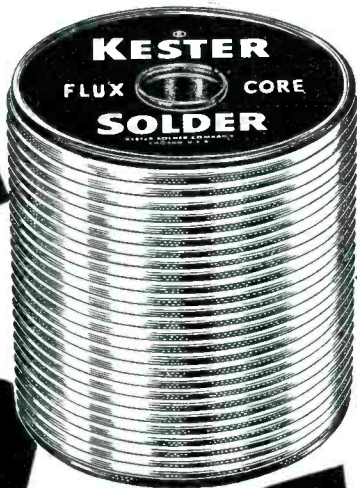
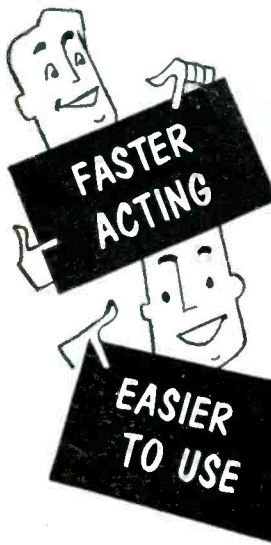

Since the most important single step in Radio-Television Servicing is soldering . . . it's just plain good sense to use the best — KESTER SOLDER . . . Key Name in Solder for More Than 50 Years.

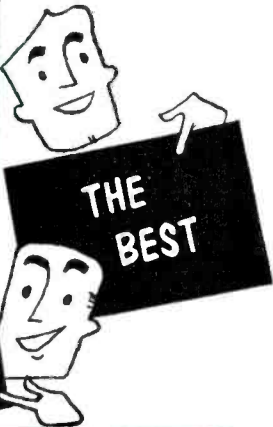

**KESTER SOLDER COMPANY**  
4244 Wrightwood Avenue • Chicago 39, Illinois  
Newark 5, New Jersey • Brantford, Canada

# SOLDER

## Index

(Continued from page 73)

Modified Sentinel Video Amp Grid-Control Which Prevents Crystal Detector Failures.	Jan.
Motorola 53LC (Cover)	July
Motorola 412 Auto Chassis (12-V)	May
Motorola Transformerless TV Power Supply	Oct.
Motorola TS-501B-02 Picture-Tube Circuit Modified to Protect Focus Pot.	Feb.
Motorola TS-602	Sept.
Motorola UHF Tuner	Apr.
MRT-3B Taxicab Transmitter-Receiver for 152-162 Mc Band	Sept.
Multiple-Speaker Setups	Feb.
Muntz TV Chassis	Sept.
NBS Constant-Amplifier Oscillator	Jan.
Negative Feedback Audio System	Sept.
Oscillator Using Pentagrids	Apr.
Peaking Coil Circuitry	Apr.
Pentode Second Detector-First AF Stage with Trimmer-Capacitor Tweet Filter	Mar.
Phase Inverter With Dual Cathode-Follower Output	Apr.
Phase Shifter Networks	Oct.
Phase-Split Amplifier Circuitry	Apr.
Philco 52-T1610	May
Philco Turret-Type Input With 6AG5 RF	Aug.
Photoell and Amplifier Used in Gas-Fired Boiler-Control System	Nov.
Photoelectric Recorder Electronic Circuitry	Aug.
Photoelectric Recorder Pipe-Line/Cloth Quality Test Setups	May
Point-Contact/Junction Transistors Amplifiers	Sept.
Point-Contact Transistor Circuitry	June
Point-Contact Transistor Circuitry Operation	Apr.
Power Supply Elements in 'Scope Voltage Calibrator	May
Precision Apparatus Resistive-Isolating Probe Hookup	Sept.
Printed-Circuit Audio Amplifier	Oct.
Printed-Circuit Component TV IF Amplifier	June
Push-Pull Output DC Balance Check Setup	Oct.
Push-Pull Output Signal Balance Check With Phones	Oct.
Push-Pull Output Signal Balance Probe Setup	Oct.
Quarter-Wave Open-Ended Stub	Sept.
Radio Craftsmen Sweep Circuits	Dec.
Radion FSM 5000 (Cover)	Sept.
Ram Sweep Circuits	Dec.
RCA CMV-3E1 30-50 Mc Two-Way FM	June
RCA KRK-12 UHF/VHF Tuner	May
RCA KRK-22 VHF Tuner	May
RCA WO-56A 7-Inch 'Scope Vertical Amplifier	Feb.
Reactive TV Circuit and Resulting Current/Voltage Waveforms	May
Rectified AGC Circuit	Dec.
Rectified AGC Circuit With Separate Diode	Dec.
Regency RT-700 Remote TV Tuner	Dec.
Regency UHF Converter	Jan.
Retrace Blanking Amplifier	Apr.
Revised Video IF in Sentinel Chassis Which Halts Picture Tearing and Rolling	Jan.
'Scope Amplifier Gain Stage	Apr.
'Scope Amplifier With Gain of 10-100	Apr.
'Scope Amplifier With VTVM	Apr.
'Scope Voltage Calibrator With Voltage Regulator	May
Screen Booth System Circuitry	Apr.
Selenium Rectifier Forward Test Circuit	Jan.
Selenium Rectifier Output Voltage Tester	Jan.
Selenium Rectifier Reverse Test Circuit	Jan.
Sentinel 401 Video-Sound Circuit Altered for Cueing	Oct.
Sentinel Models 454, 456 and 457 Circuit Changes to Improve Contrast Range and Better Control of Vertical Size	June
Service Instrument Voltage Booster	Apr.
Simplified Schematic of Common DC Restorer	Oct.
Single-Stage Response Crystal-Probe Test Setup	Oct.
Southwestern C-3 Resistance Meter	Feb.
Speaker-Field-Coil Circuitry	Aug.
Speaker Phasing Check System	June
Stewart-Warner 9300 IF Amp With Adjacent-Channel Sound Trap	Sept.
Stopping-Resistor Connections in Push-Pull Paralleled Output Stage To Prevent Parasitic Oscillations	Oct.
Stromberg-Carlson AR-425 Power Amplifier	Feb.
Stromberg-Carlson AR-425 Preamp-Remote Control (Cover)	Feb.
Stromberg-Carlson Dual-Target Tuning-Eye Schematic for Picture-Tube V Checks	June
Stub With 300-Ohm Twin Lead	Sept.
Sutco UHF/VHF Converter-Booster Model 21-A	Apr.
Switch-Tuned UHF-VHF Indoor Antenna	Oct.
Sylvania 1-508-1 Altered Ratio Detector to Eliminate Harmonic Interference	Feb.
Sylvania 1-508-1/1-508-2 Modified for Noise-Gate Action	Feb.
Sync System; Relation to Allied Circuitry	Nov.
10-Watt 6/12-Volt Mobile Audio Amplifier (G.E., Cover)	Oct.
Test-Record Frequency-Response Layout	June

## HICKOK

### Model 650

**COMPOSITE VIDEO GENERATOR**

- Quickly localizes and identifies trouble in any section of a TV receiver.
- Does in minutes many TV jobs that normally take hours by usual methods.
- Write for technical details . . .

**THE HICKOK ELECTRICAL INSTRUMENT CO.**  
1021 DUPONT AVE., CLEVELAND 8, OHIO

## RADIO'S MASTER

### NEW! 1954 EDITION

- 1370 pages
- Over 85,000 items
- Over 8,000 illus.
- Completely indexed

**FASTER EASIER more PROFITABLE operation**

**GET INTO THE MASTER HABIT!**

**\$1.95** at your parts distributor. Publisher's price \$6.50

Have complete access to the many thousands of products vital to your daily sales and service operations. In the customer's home, across the counter or on the bench, you'll value the Master's thoroughly complete descriptions, specs, illustrations and prices . . . all systematically organized in 18 big sections for instant reference. Increase your sales . . . sell directly from the Master. Facilitate your stock problem . . . use the Master for jiffy comparison of all electronic products. The Master is the only Official Buying Guide for the TV-Radio-Electronics industry. It contains unabridged catalog data direct from the manufacturers. For buying and selling—the Master gives you all the needed facts in a single volume. Over 100,000 in active daily use. Get into the Master habit. Order your copy today!

Just a few of the products included: Tubes — Test Equipment — Tools — Transformers — Capacitors — Resistors — Relays — Coils — Antennas — Recording & PA Systems — Hardware — Transmitters — Receivers — Kits — Wire — Cable . . . and thousands of allied products!

Eliminate Incomplete Small Catalogs and Loose Literature

**UNITED CATALOG PUB., INC.**  
110 LAFAYETTE ST., NEW YORK 19, N. Y.

**INTERNATIONAL  
RECTIFIER  
CORPORATION**

EL SEGUNDO  
CALIFORNIA

**RADIO & TV**

*Selenium Rectifiers*

**Top Performance  
Requires  
RELIABLE  
REPLACEMENT  
RECTIFIERS**

**AVAILABLE  
AT YOUR  
FAVORITE JOBBER**

**DIRECT REPLACEMENT  
UNIVERSAL MOUNTING  
WIDER RANGE**

*Ask for Bulletin JRP-1*

**INTERNATIONAL RECTIFIER  
CORPORATION**

1521 E. Grand Ave., El Segundo, Calif - Phone: ORegon 8-6281  
CHICAGO: 205 W. Wacker Drive - Phone: Franklin 2-3889  
NEW YORK: 501 Madison Avenue - Phone: Plaza 5-8665

Test-Record Intermodulation-Distortion Percentage Setup	July
Tetrode-Transistor Circuitry	Sept.
Thyratron Firing Circuit	May
Timing Oscillator	May
Transistorized Audio Amplifier	Apr.
Triode Amplifier 'Scope Injection Circuitry	May
Triode-Connected 6W6GT Vertical-Deflection Schematic	Oct.
Truetone 4C11 6-V Auto Radio With PC Audio Coupler	June
Truetone 2D1089B Horizontal Deflection Circuit	Mar.
Tunable Signal-Tracing Probe	Feb.
Turret Tuners Equipped With UHF and VHF Strips	Apr.
TV AGC Filter Circuit	Sept.
TV Antenna Orientation	Dec.
TV Chassis Filament Choke Circuitry	Mar.
TV Power-Supply System	Oct.
TV Receiver Matching Test Setup	Apr.
TV Tuner Using 6BK7A as RF Amplifier in Cascode Circuit	Jan.
Tweeter-Woofer Relative-Phase Measurement	Aug.
2-Speaker Phono With 2-Cubic Foot Enclosure (Cover); Wyn Martin	Dec.
Two-Way Field-Strength Meter Setup	Sept.
Two-Way Taxi-Set Bench Test Jig	Sept.
Two-Way Test Meter	Sept.
Typical U/V Tuner of Future	Apr.
UHF Balun Construction	Apr.
UHF Booster and VHF-UHF Coupler	Nov.
UHF Portion of Portable Field-Strength Meter (Simplified Schematic)	Sept.
UHF (6AF4) Grounded-Grid Amplifier	Feb.
UHF Test Alignment System	May
UHF/VHF Filter-Type Crossover Network	Nov.
UHF/VHF Lightning Arrester Circuitry	Nov.
UHF/VHF Strip Assemblies	Aug.
UHF/VHF Tuners Using 6AN4 and 6T4	Aug.
Unknown Speaker-Impedance Measurement System	Aug.
Variable IF-Bandwidth Circuitry	Nov.
Vertical-Horizontal Retrace-Blanking Circuit	Oct.
Video Amp Adjustment and Sweep Setup	Mar.
Video Amplifier Addition for Picture Polarity	Oct.
Video Amplifier Schematic	Oct.
Video Detector/Video Amp/DC Restorer Circuitry	Oct.
Video Detector Working Into Class A Amplifier	Oct.
Video Section of Compatible Color Transmitter	Aug.
Voltage Regulator Circuit	May
Volume-Control Circuitry	Feb.
Wavetrap Installation	Nov.
Westinghouse FM Detector/AF Output Using 6BN6 and 6BK5	May
Wilcox-Gay 3A01 2/4-Watt Tape Amplifier	Oct.
Z-Axis Input Circuit	Apr.
Zenith K Chassis VHF/UHF Tuner With Selector in VHF Position	Aug.
Zenith K Chassis VHF/UHF Tuner With Selector in UHF Position	Aug.
Zenith K Chassis Input With UHF Strips Installed	Aug.
Zenith K Chassis Input With VHF Strips in Place	Aug.

**COLOR TELEVISION**

Analysis of Restorer Systems That May Be Used in Color-TV Chassis to Provide Faithful Reproduction of Brightness Levels	Oct.
Black-White Reception From Color TV	Nov.
Color Reception From Color Chassis	Nov.
Color TV (A Simplified Analysis of the NTSC System); W. Kay Brownes	Dec.
Color Tube HV Requirements	Nov.
Color TV Tube News; E. A. Teverson	Nov.
Compatible-Color Receiver Operation	Sept.
Compatible Color-Set Servicing Problems Ahead; W. K. Brownes	Sept.
On-The-Scene Review of FCC Tests of Color-TV Comparable System	Nov.
Phosphor-Dot-Screen/Aperture-Mask Color Tube Report	Nov.
Preview of Problems Ahead in Compatible Color-Set Servicing; W. Kay Brownes	Aug.
Report on What Can Be Expected to Be Involved in the Installation and Servicing of Color Chassis, Which Will Follow NTSC Standards	Aug.
Simplified Explanation of Compatible Color Operation	Nov.
The NTSC Color TV Demonstration Before the FCC; Donald Phillips	Nov.
Troubleshooting Techniques and Equipment Necessary in Color-Set Servicing	Sept.
TV Color Reception (Simplified Explanation); W. Kay Brownes	Nov.
What Happened to the DC Restorer: Will It Return With Color?; J. C. Geist	Oct.

(Continued on page 76)

# ATTENUATOR SWITCH eliminates "cut and try" methods for better TV reception

A twist of the dial on this Centrallab TV Attenuator Switch instantly shows proper amount of attenuation for best reception. You know how important this is in multi-station areas!

Four different H-pads are mounted in the attractive metal case. You simply hook up the 300-ohm antenna twin-lead, and dial finds correct setting. Then, unhook leads and install proper H-pad. Simple as that. And it's accomplished in a few minutes.

If customers want permanent selective attenuation installation, a handy mounting bracket does the trick. And it's another sale for you!

Yes, time saved by Centrallab TV Attenuator on one job is profit time for another job. That's why you'll want to contact your distributor for full details.

## Centrallab

CENTRALLAB,  
A Division of Globe-Union Inc.  
908-L E. Keefe Ave., Milwaukee 1, Wis.  
Please send additional technical data on  
Centrallab's TV Attenuator and H-pads.

Name.....  
Firm.....  
Address.....  
City..... Zone..... State.....

Replace with



SELETRON RECTIFIERS



and  
be  
safe!

No arc-over, short circuits or excessive heating when you replace with SELETRON. Proof? Millions are giving top performance as original equipment in many famous make radio and TV sets right now!

See H. W. Sam's Red Book Supplement listing SELETRON selenium rectifier replacements. Write us for the name of our nearest jobber.



Seleton and Germanium Division  
**RADIO RECEPTOR COMPANY, INC.**  
Since 1922 in Radio & Electronics  
Sales Dept.: 251 West 19th Street, New York 11  
Factories in Brooklyn, N.Y.

## YOUR OWN BUSINESS

Chance of a Lifetime

New Jersey Chain now being organized to sell TV, Radio and Electronic parts and accessories direct to the consumer. Several successful stores already operating. New stores and franchises available. An unprecedented, sound opportunity for you to own your own business in a major city supported by aggressive, forceful advertising and group buying power. Capital required: \$4,000.00 to \$7,500.00, depending on size of city selected. Write for appointment only.

**PARTS UNLIMITED**

11B HILL STREET, NEWARK 2, NEW JERSEY

## WHEN YOU CHANGE YOUR ADDRESS

Be sure to notify the Subscription Department of SERVICE at 52 Vanderbilt Avenue, New York 17, N. Y., giving the old as well as the new address, and do this at least four weeks in advance. The Post Office Department does not forward magazines unless you pay additional postage, and we cannot duplicate copies mailed to the old address. We ask your cooperation.

## Index

(Continued from page 75)

### FM

- Adding Components to Old System (FM Tuners) for Hi-Fi Results.....Sept.
- Addition of FM Systems for Hi-Fi Results.....Aug.
- Adjustments for Weak, Distorted or Noisy FM Signals.....Nov.
- Antenna Mounting Techniques on 2-Way FM Installations.....Sept.
- Cable Routing Practices in Trucks.....Aug.
- Correcting FM Tuner Drift.....Nov.
- FM IF Amplifier.....Jan.
- FM/TV Amplifier Tubes.....Feb.
- Improving FM/AF System in Westinghouse Chassis.....May
- Pickup and Heavy Truck 2-Way FM Installation (Part II); Jack Darr.....Sept.
- Positioning of 2-Way FM Equipment to Expedite Service and Maintenance.....Aug.
- Power Supply Line Routes.....Control Head Installation.....Engine Noise Elimination in 2-Way FM Installations.....Sept.
- Reactive Distortion in FM Detector De-emphasis Networks.....Jan.
- 2-Way FM Installation in Pickup and Heavy Trucks; Jack Darr.....Aug.

### HI-FI

- Adding Components to Old System (FM Tuners and 3-Speed Players) for Hi-Fi Results.....Sept.
- Adjustments for Weak, Distorted or Noisy FM Signals.....Nov.
- Audio Conversions for Hi-Fi Results; Mark Vano.....Aug.
- Audio Equipment Test and Measurement (Part II); Mark Vano.....July
- Audio System Maintenance: Hi-Fi Tuners; Mark Vano.....Nov.
- Bass-Reflex Cabinet Tuning Setup.....Mar.
- Correcting FM Tuner Drift.....Nov.
- Cost and Performance Considerations in Hi-Fi Audio Conversions.....Sept.
- Critical Listening Test Techniques.....June
- Crystal and Magnetic Pickup Compensators.....Jan.
- Crystal, Magnetic and Capacitive Pickup, Tone Arm and Needle Characteristics.....Apr.
- Determining Frequency Response with Test Records.....June
- Diagnosing Troubles in Hi-Fi Record Players.....Oct.

- Distortion Problems in Loudspeakers.....Feb.
- Distortion Tests.....June
- Evaluating Efficiency of Baffles, and Open and Closed Enclosures for Mounting Speakers.....Mar.
- Hi-Fi Audio Products.....June
- Hi-Fi Package Designs.....Mar.
- Hi-Fi Phono Chassis.....July
- Hi-Fi Results Via Audio Conversions (Part II); Mark Vano.....Sept.
- Hi-Fi 20-50-Watt Amplifiers.....May
- Horn Properties.....Mar.
- Improvement of Amplifier.....Addition of FM Systems and 3-Speed Player for Hi-Fi Results.....Aug.
- Inverse or Negative Feedback Application.....Sept.
- Loudspeaker Construction Requirements.....Feb.
- Loudspeakers for Hi-Fi; Mark Vano.....Feb.
- Loudspeaker Mounting Precautions.....Mar.
- Loudspeaker Power Capabilities.....Feb.
- Maintenance of Audio Systems; Mark Vano.....Dec.
- Measurement of Hum.....July
- Measuring Effectiveness of Bass-Reflex Cabinets.....Mar.
- Mounting the Loudspeaker; Mark Vano.....Mar.
- Mount Locations for Loudspeakers.....Mar.
- Multiple Hi-Fi Speaker Uses.....Feb.
- Pickup Compensators and Preamps; Mark Vano.....Jan.
- Pickups, Needles and Tone Arms; Mark Vano.....Apr.
- Preamp-Remote 25-Watt Amplifier Control (Cover); Wyn Martin.....Feb.
- Preamps for Magnetic and Capacitive or FM Pickups.....Jan.
- Provocative Hi-Fi.....Mar.
- Record Player Recommended Installation Adjustment Techniques.....May
- Record Players; Mark Vano.....May
- Replacing Output Transformers.....Sept.
- Selecting Record Players by Checking Motor RPM, Extent of Rumble, and Tone Arm Design and Operation.....May
- Service Man's Role in the Hi-Fi Market.....Jan.
- Servicing Hi-Fi Audio Amplifiers Through Tube and Push-Pull Balance Checks.....Oct.
- Speaker Enclosure Structures.....Mar.
- Speaker Frequency Response/Directional Characteristics Study.....Feb.
- 10-Kc Whistle-Filter Installations.....Nov.
- Testing and Measuring Audio Equipment; Mark Vano.....June
- Testing for Distortion.....June
- The Hi-Fi Market; C. K. Sterling.....June
- The Maintenance of Hi-Fi Audio Systems; Mark Vano.....Oct.
- Tracing and Curing Hi-Fi Amplifier Oscillation.....Oct.

- Tracking Force, Tip Radius, Stylus Material, Shaft and Replacement Problem Data.....Apr.
- Transient Response Testing.....June
- Treble Preemphasis and Methods to Suppress Surface Noise on Records.....Jan.
- Tuner Alignment.....Nov.
- 24-Inch TV Chassis Featuring Push-Pull Hi-Fi Audio.....Oct.
- 2-Speaker Phono With 2-Color Foot Enclosure (Cover); Wyn Martin.....Dec.
- Use of Temperature-Coefficient Capacitors.....Nov.
- Woofer-Tweeter Networks.....Feb.

### SERVICING HELPS

- AGC Threshold-Control Adjustments.....Jan.
- Aligning Syncroguide Transformers.....Sept.
- Area-Selecting Switching.....Dec.
- Auto-Radio Antenna-Ground Installation.....Nov.
- Auto-Radio Antenna Trimmer Adjustments.....Nov.
- Auto-Radio '53 Pontiac Output Transformer Installation.....Nov.
- Auto-Radio Relays in Signal Seeker Chassis.....Nov.
- Auto-Radio 12-V Buffer Capacitor Replacement.....Nov.
- Buzz Analysis.....Oct.
- Carrier Amplification Technique Adopted to Simplify Troubleshooting and Predict Problem-Areas.....Oct.
- Checking Flatness of Sweep-Generator Video Output.....Nov.
- Checking Video Amplifiers.....Nov.
- Contrast-Control Modifications.....June
- Correcting Line-Voltage Variations.....Apr.
- Crystal Demodulator Probe Applications.....Oct.
- Curbing Picture Shift at Maximum Contrast.....Jan.
- Cures for Horizontal Jitter and Unstable Sync in Fringe Areas.....Jan.
- Decreasing Minimum Brightness Levels.....June
- Dual-Target Tuning Eyes for Picture-Tube Voltage Checks.....June
- Easing Frozen Yokes.....May
- Electrostatic Picture-Tube Focus Control.....Dec.
- Eliminating Horizontal Ripple.....July
- Germanium Crystal Servicing Notes.....Feb.
- Halting Picture Tearing and Rolling on Strong Signals.....Jan.
- Horizontal AFC Adjustment Procedures.....Mar.
- Horizontal Reframing.....May
- Hum Distortion in Square-Wave Check.....Nov.
- HV Breakdown and Corona Cures.....Jan.
- Improving FM/AF System in Westinghouse Chassis.....May
- Improving Horizontal Linearity of Scope Sweep.....Dec.

Improving Horizontal Stability	June
Improving Stability with Filament Chokes	Mar.
Installation of Adjacent Channel Sound Traps	Sept.
Intermittent Fault Location in Electronic Equipment; <i>Sidney Wald</i>	Oct.
Lack of Flatness in Sweep-Generator Output	Nov.
Large-Picture Tube Corona Problem Solutions	Feb.
Line-Frequency Inaccuracy	Nov.
Locating Distortion in Amplifiers ( <i>Knocking</i> )	Nov.
Marker-Generator Calibration	Oct.
Odd Loss-of-Sensitivity Troubles in Broadcast Receivers	Mar.
Picture-Tube Pulling Caused by Hash; Cures	Dec.
Positioning of UHF Mixer Crystals	June
Preventing Fuse Failure in TV Chassis	July
Preventing Inverter Unbalance	Dec.
Preventing Premature Crystal-Detector Failures	Jan.
Removing Black Horizontal Streaks Over Picture When Tuned to Channel 6	May
Removing Cause of Repeated Fuse Failures in TV Sets	May
Removing Static on VTVM Face Plates	Nov.
Removing Tweet on UHF	Nov.
Replacing 6BQ7A or 6BZ7 with 6BQ7 in Tuners	May
Safety-Glass Pix-Tube Precautions	Nov.
Signal Generator Waveform Tests	Sept.
6BK7/6BQ7 Interchangeability in Cascade Tuners	Jan.
6U8 Replacements	Mar.
Slow Recovery Time in 'Scope	Nov.
Stopping Picture Smear in 24-Inch Models	Jan.
Supply Voltage Harmonic Problems in 'Scope Work	Oct.
Those Weak Chassis Complaints; <i>Jack Darr</i>	Mar.
Tracing and Curing Troubles in 3-Way Portables and Old-Battery Models Using External Antenna and Coils	Apr.
Troubleshooting With Resistive Isolating and Low-Capacity Probes	Sept.
Tube Check Suggestions	Nov.
TV Chassis Hum Cures	Apr.
UHF Oscillator Servicing	Feb.
UHF Strip Servicing	Aug.
Variations of 1B3GT HV Rectifiers	Mar.
Vertical Crosstalk Cures	Sept.
Vertical-Horizontal Sync Stabilization	Feb.
Video IF Alignment	Mar.
VTVM Scale Conversion	Dec.
Weak Chassis Complaints ( <i>Part II</i> ); <i>Jack Darr</i>	Apr.
Width-Coil Adjustment	Mar.

## SERVICE ENGINEERING

Additional Horizontal and Vertical Input Installation, in Scopes for Industrial Applications	Apr.
Aluminum Drilling, Boring, Reaming and Bending	May
Communications and Electronic Applications of 'Scope with New Inputs	May
Carrier Amplification Technique Adopted to Simplify Troubleshooting and Predict Problem-Areas	Oct.
Dust-Proofing Techniques	Mar.
Dynamotor Relay Checker	Mar.
Electronic Timer Operation, Maintenance and Servicing	Oct.
High Frequency Motor Generators— Installation and Servicing	Dec.
Increasing Frequency Response in 'Scope	Apr.
Installing 25-50 Mc 1/4-Wave Antennas	Apr.
Installation and Maintenance Notes on Photoelectric Control System Used for Gas-Fired Boilers	Nov.
Instrument Developments	Mar.
Integrated Fixed-Mobile Facilities, Featuring use of 20-Watt AC Amp, 6-V 10-Watt DC Amp ( <i>For Truck</i> ) and Combination 20-25 Watt Unit Which Can Operate from 6-V DC or off the 110-V Line	June
Intermittent Fault Location in Electronic Equipment; <i>Sidney Wald</i>	Oct.
Magnetic Amplifier Rectifiers; <i>J. T. Cataldo</i>	May
Miniatures and Subminiature Tubes for Mobile and Aircraft Receivers	Oct.
Mobile Dynamotor Relay Life Checks	Apr.
Modernizing a 'Scope for Service Engineering	Mar.
Modifying 'Scope for Field Service Engineering Applications ( <i>Part I</i> ); <i>Ronald L. Ives</i>	Mar.
Photoelectric Recorder Applications	May
Photoelectric Recorder Circuitry and Operation	Aug.
Receiver Noise Reduction Suggestions	Mar.
Reducing Hum in 'Scope Work	May
'Scope Improvements for Service Engineering ( <i>Part II</i> ); <i>Ronald L. Ives</i>	Apr.
'Scope Modifications ( <i>Part IV</i> ); <i>Ronald L. Ives</i>	June
'Scope Retrace Blanking Provisions	Apr.
Screen Booths for VHF and UHF Testing and Measurements	Apr.
Selenium Rectifiers Developed to Improve Efficiency of Tubeless Power Amplifiers	May

Service Engineering 'Scope Improvements ( <i>Part III</i> ); <i>Ronald L. Ives</i>	May
Servicing 2-Way 152-162 Mc Taxicab Radios	Sept.
Small Shop Sound Systems; <i>Jack Darr</i>	June
10-Watt 6/12-Volt Mobile Audio Amplifier; <i>G. H. Floyd</i>	Oct.
Tubes Used in Mobile Gear and Methods Available for Test	Mar.
Two-Way FM System Design	June
Two-Way Installation Hints	Oct.

## TELEVISION

A Chassis Merchandising Plan for TV Service Men; <i>C. K. Sterling</i>	Mar.
Adjustable End-Fire Array Conicals	Mar.
Amplified AGC Circuit	Dec.
AGC Threshold-Control Adjustments	Jan.
Aligning Syncguide Transformers	Sept.
Amplified AGC-Sync Clipper Noise-Gate Analysis	Sept.
Birdies	Mar.
Buzz Analysis	Oct.
Calibrator Featuring DC Supply for Diode Bias and Voltage Regulator	May
Cascade Amplifiers Using Miniature Heater-Cathode Double Triodes With Internal Shields	Jan.
Cascade RF Tuner Design Features	Feb.
Causes of Dot Size Variation from Generator	Nov.
Chart Analysis of Buzz Saturation Hum Bars Grain Smear Trailing Reversal	Oct.
Chart Analysis of Picture Tear Hammer-Head Distortion Interlace Pairing Squegging	Nov.
Chart-Circuit Analysis of Operational Characteristics of IF Amplifiers Employed in Most TV Receivers	Sept.
Checking for HF Voltage Feeds	Mar.
Checking Harmonics in 'Scope Sweep	May
Checking Video Amplifiers	Nov.
Color TV ( <i>A Simplified Analysis of the NTSC System</i> ); <i>W. K. Brotnes</i>	Dec.
Community-TV Antennas; Allied Equipment Used on Tower, Poles and in Subscribers' Homes	Mar.
Community TV At Barre, Vermont; <i>Gene Clark</i>	Aug.
Community-TV Equipment	Apr.
Community-TV Zoning, Right-of-Way Access and Telephone/Power Company Requirements	Mar.
Contrast-Control Modifications	June
Crystal Polarity Considerations	Apr.
Crystal Probe Circuits	Apr.

**PROFIT**  
with no after effects  
when you sell the  
**Golden Wand** line

UHF VHF FM

MODEL NO. TG-62

\$5<sup>95</sup>  
LIST

Eliminate refunds on returned merchandise! That is exactly what you do when you sell the Golden Wand line. Golden Wand antennas are guaranteed for customer satisfaction. Order this popular seller now! Heavy-weight, walnut mahogany felted base. Admiralty brass dipoles finished in sparkling gold. Polystyrene insulators that match the base and gold finish hardware. 3-section, velvet smooth telescopic action, free from dripping oil. Brass will not rust.

SEND TODAY! for our price catalog.

**PEERLESS PRODUCTS INDUSTRIES**  
816 N. Pulaski Rd., Chicago 51, Illinois

*Servicemen*  
+ YOU =

*This should interest you*

### Reconing is Preferred...

WHEN exact replacement speakers are not available, reconing immediately solves mounting problems.

WHEN greater profits for you and greater savings for customers are desired.

WHEN you want quality and fidelity of performance.

**Prove this to yourself!**

Write to us for location of Reconing Station in your area.

**WALDOM**  
**ELECTRONICS INC.**

909 N. Larrabee Street  
Chicago 10, Illinois



Money Back Guarantee  
(Cost of Mds. Only) \$5  
Min. Order FOB N.Y.C.  
Add Shpg. Charges or  
25% Dep. Tubes Gtd.  
via R-Exp. only. Prices  
Subject to Change. Ph.  
Rector 2-6245.

**SPECIAL — SPECIAL — SPECIAL**  
You Pick Them, Lots of 10 at 39c each

Cracked base or broken key electrically perfect.  
TESTED & 90 DAY GUARANTEED.  
5U4G-6SN7-25L6GT-25BQ6  
5Y3GT-6K6GT-12SA7GT-6H6  
6V6-6BQ6-6W4-12SG7



**TUBES**

**90 DAY "TAB" GUARANTEED**

0B3	.98	8AX4	.74	6SG7	.64	12BA6	.59
0C3	.92	6BA6	.54	6SH7	.61	12BA7	.94
0D3	.92	6BA7	1.00	6S17	.58	12BD6	.59
1B3	.80	6B07	1.23	6SK7	.56	12BE6	.59
1R5	.59	4BE6	.54	6SL7	.56	12B17	1.29
1U4	.52	6BG6	1.58	6SN7	.68	12B77	1.35
1U5	.54	6BH6	.63	6SQ7	.62	12SA7	.86
1X2A	.98	6B16	.69	6T8	.96	12SF5	.51
5U4G	.55	6BK7	1.58	6U8	.99	12SG7	.80
5Y3	.43	6BL7	1.19	6V6	.59	12SH7	.63
6AC7	.80	6BN6	1.20	6W4	.49	12SL7	.62
6AF4	1.23	6B08	1.20	6X5	.54	12SK7	.66
6AG5	.71	6BQ7	1.65	12AL5	.54	12SN7	.68
6AL5	.48	6BZ7	1.49	12AT6	.54	12SQ7	.54
6AN5	2.90	6C4	.52	12AT7	.89	25BQ6	.98
6AQ5	.52	6BC6	.59	12A16	.72	35W4	.49
6AQ6	.81	6CD6	1.69	12A17	.69	35Z5	.54
6AT6	.54	616	.51	12A18	.52	50B5	.54
6A8U	.56	6K6	1.08	12A19	1.49	6L6	.62
6AV6	.49	616G	.68				
6AW6	1.09	6SA7					

**NEW "LENK" 180 WATT SOLDERING GUN**



No other gun offers all these features at any price. 115 VAC 180 Watt, perfect balance, lightweight 28 oz., melts solder 3 1/2 seconds, swivel 180° tip, heavy duty transformer, positive trigger-easy action, balanced Luger pistol feel. "TAB" Special \$7.45

**SPEEDWAY ELECTRIC DRILL — 1/2" Model 200J**



HI-torque (Powerful UL apprd. 2408 RPM/115 VOLT/AC/DC Motor. Jacobs Chuck & key. Self-aligning—oilless—Ball thrust bearings. Plus 9 drills in case. Here in a workhorse drill, priced Right plus 9 drill bits. Model 400J 1/2" Electric drill 425 RPM with JACOBS GEARED CHUCK & KEY & 9 DRILLS...\$29.95

**REBUILT TV PICTURE TUBES**



Standard One Year Guarantee  
Duds must be shipped in advance prepaid. We then ship new tubes from our stock. All types available.  
**F.O.B. N. Y. C. \$1.00 PER INCH**  
Add 10¢ per inch for metal or Electrostatic Types

**KITS AND COMPONENTS**

Oil Condensers Assorted	5 for \$1.25
Electrolytics Assorted	5 for 1.25
Silver & Mica Condensers	15 for 1.25
Controls, Popular Values	5 for 1.25
Resistors, 1/2 & 1W	100 for 1.25
Vitreous W W Resistors	8 for 1.25
Sockets, Assorted 8, 7, 5, 4P	12 for 1.25
Iron Core Slug & Screw	50 for 1.25
Knobs, Ass'd. w/Insert.	10 for 1.25

**"TAB" YOU PICK 'EM \$1.00**

Special Lots of 5

**TELEVISION ANTENNA**

VEE CONICAL, all channel, for fringe areas...\$8.95  
FOLDED DIPOLE (li & low antennas, all channel...\$4.95  
TV CONICAL ANTENNA All Channel, Sturdy...\$3.95  
DOUBLE-V Ant. All Channel, Sturdy Cons. w/Mtg Clamps & 100 ft. Twine...\$4.49  
WINDOW CONICAL ANT. All Channel...\$3.95  
5 FOOT Interlocking Mast Sections, Hwy Duty, Rust-proof...\$1.49; 10 for \$7  
ANTENNA COMBINATION SPECIAL—TV ANTENNA, 2 POLES, 100 FT. TWINE, & MTG. ACCS...\$5.69

**TV TWINE & COAX CABLE**

300 Ohm Twine, Heavy duty 65 mil all copper TV lead in. per ft. 2¢; 100 feet...\$1.39  
1000 foot reel...\$11.95  
RG59U 73 ohm TV Coax Cable MFGRD to rigid UHF specs. per ft. 5¢; 100 feet \$4.50  
SPECIAL 500 feet...\$22.00

**PRECISION OILER OR CARBON TET DISPENSER**



Designed for applications requiring pin point oiling, or when using carbon tet for quieting & cleaning radio & TV controls. Precision made needle point. Attractive fountain pen design.  
"TAB" SPECIAL...89¢; 6 for \$5.00

**YOU PICK THEM 39c ea**

**WHILE THEY LAST**

**ELECTROLYTIC CONDENSERS**

20MFD/25VDC	2X15MFD/350VDC
20MFD/450VDC	2X20MFD/25V, 30MFD/450V
25MFD/300VDC	40MFD/250V, 30MFD/25V
50MFD/350VDC	3X100MFD/35VDC
100MFD/25VDC	30/15/10MFD/250VDC

ALL SIZES & TYPES NEW STOCK

**"TAB"**

Dept. 125  
111 Liberty St.  
New York 6, N. Y., U. S. A.  
Rector 2-6245

**Index**

(Continued from page 77)

Curbing Picture Shift at Maximum Contrast ..... Jan.  
Cures for Horizontal Jitter and Unstable Sync in Fringe Areas ..... Jan.  
Curve Distortion ..... Aug.  
Dampner Output-Waveforms ..... Oct.  
Decreasing Minimum Brightness Levels ..... June  
Design Features of Tubes for TV Chassis and 'Scope Applications ..... Sept.  
Determining If 'Scope is Operating Properly ..... Mar.  
Determining the Characteristics of Vertical Sync and Buzz Pulses ..... Feb.  
Diamond-Grid Element Dipole Antennas ..... Mar.  
Differentiator and Integrator Circuitry ..... Nov.  
Dual-Target Tuning Eyes for Picture-Tube Voltage Checks ..... June  
Electronic Remote TV Tuner, *M. W. Percy* Dec.  
Eliminating Horizontal Ripple ..... July  
Eliminating Ringing in Rasters ..... Feb.  
Easing Frozen Yokes ..... May  
Feedback in IF Amp ..... Nov.  
First Veryhigh/Ultrahigh Community-TV Installation ..... Mar.  
Fixed-Mobile Bench Rack Design for TV Servicing ..... Feb.  
FM/TV Amplifier Tubes ..... Feb.  
Germanium and Silicon Diodes as Rectifiers, Detectors and Frequency Converters ..... Mar.  
Germanium Crystal Servicing Notes ..... Feb.  
G.E. Stratopower Chassis: Fourth Run Model Analysis (with Production Changes) ..... Nov.  
Halting Picture Tearing and Rolling on Strong Signals ..... Jan.  
Horizontal AFC Adjustment Procedures ..... Mar.  
Horizontal AFC System Operation ..... Apr.  
Horizontal Bending Causes ..... Mar.  
Horizontal Deflection and HV Circuits for 27-Inch Picture Tubes ..... Oct.  
Horizontal Frequency Dampner Diodes ..... Jan.  
Horizontal Linearity Troubleshooting ..... Aug.  
Horizontal-Pulling Differences (Picture Pulling, Horizontal-AFC Pulling and Raster Bending) ..... Mar.  
Horizontal Pulling in TV Receivers; *J. C. Geist* ..... Mar.  
Horizontal Reframing ..... May  
Horizontal Sawtooth Characteristics ..... Oct.  
Hum Modulation Affects: Bending Raster Edges ..... Mar.  
HV Breakdowns and Corona Cures ..... Jan.  
Improving Horizontal Stability ..... June  
Improving Reproduced Waveforms ..... Apr.  
Improving Stability with Filament Chokes ..... Mar.  
Installation of Adjacent-Channel Sound Traps ..... Sept.  
Installation of Replacement Horizontal-Output Transformers (Cover); *Wyn Martin* ..... Mar.  
Internal Magnetic Focus Picture Tubes ..... May  
Interpretation of Waveforms ..... June  
Keyed AGC Circuitry ..... Dec.  
Large-Picture Tube Corona Problem Solutions ..... Feb.  
Locating Grid-Current Flow Which Can Cause Response Curve Distortion ..... Mar.  
Locating Points of Takeoff ..... Jan.  
Low-Capacitance Probes for IF Signal Tracing ..... Apr.  
Meaning of DB in Alignment ..... Apr.  
Measuring TV Antenna Characteristics; *Donald Phillips* ..... Jan.  
Miniature High-Perveance Double Triodes for Vertical Deflection ..... Jan.  
Miniature Output Stage Power Pentodes ..... Jan.  
Mirror-Image Distortion ..... Apr.  
Modification in Video and Audio Sections of Standard TV Chassis To Provide Effective Video Monitoring Unit for New VHF and UHF Broadcasters ..... Oct.  
Neck Shadow ..... Aug.  
1-Man Antenna Orientor ..... Dec.  
One-Man TV Shop Tool-Test Setup; *J. C. Geist* ..... Feb.  
Oscillation Problems and Cures ..... Jan.  
Overpeaked IF Amplifier Effects ..... Jan.  
PC TV IF Amplifier ..... June  
Peak-to-Peak Voltage Value Measurement Cyclogram ..... Hum Effects on Calibrating Voltage Patterns ..... Sept.  
Picture Tearing Causes ..... Nov.  
Picture Tube Circuit Faults, Checks and Cures (Tabulated Troubleshooting Guide); *J. C. Geist* ..... Sept.  
Picture Tubes Faults, Checks and Cures; *J. C. Geist* ..... May  
Picture-Tube Fundamentals; *Paul M. Reinhardt* ..... Sept.  
Poor Regulation and Picture Pulling ..... May  
Preventing Fuse Failure in TV Chassis ..... July  
Preventing Premature Crystal-Detector Failures ..... Jan.  
Preventive Maintenance Plan, Designed to Eliminate Callbacks and Increase General Efficiency of Service Operation ..... Nov.  
Probes for Video-Amplifier Adjustment ..... Apr.  
Radio Craftsmen Sweep Circuits ..... Dec.  
Ram Sweep Circuits ..... Dec.  
Reading Difficult TV Schematics; *Cyrus Glickstein* ..... Jan.

**\$495**  
Ppd. or C.O.D. + Chgs.

**THE NEW TV DYNATRACER**

- Traces TV Signals and Voltages
- Locates Defective Components
- Requires No Additional Equipment

This sensationally new piece of test equipment is ideal for trouble-shooting television sets in the home or in the shop. The "DYNATRACER" will outperform more expensive testers and should pay for itself on first repair.

A Must For Every TV Technician

**SPECIFICATIONS:** The "DYNA-TRACER" is a self-powered quality test instrument designed to trace TV signals through any Video, Sound, Sync, AFC, Horizontal or Vertical Sweep Circuit—will isolate trouble to a stage or component.

**ADDED FEATURE:** The "DYNATRACER" will also trace voltages (50/500 V. AC/DC) and instantly locate open, shorted, intermittent or leaky (up to 20 megohms) condensers, resistors, coils, transformers, etc.

**Instruction and Trouble-Shooting Book Enclosed**  
**10-DAY MONEY-BACK GUARANTEE**  
Cut out, attach name and address, with \$5 bill, check or money order, and mail to

**Century ELECTRONICS CO.**  
8509 21st Ave., Dept. 304, Brooklyn 14, N. Y.

Reason for Use of Ion Traps ..... Focusing Techniques ..... Analysis of Faceplates ..... Characteristics of Metal-Backed or Aluminized Tubes ..... Sept.  
Rectified AGC Circuit ..... Dec.  
Rectified AGC Circuit With Separate Diode ..... Dec.  
Removing Black Horizontal Streaks Over Picture When Tuned to Channel 6 ..... May  
Removing Cause of Repeated Fuse Failures in TV Sets ..... May  
Replacing 6BQ7A or 6BZ7 with 6BQ7 in Tuners ..... May  
Residual Voltage Pattern Types ..... Mar.  
Response-Curve Peaking and Its Relation to Picture Distortion ..... Jan.  
RF Unit Design for UHF/VHF Chassis; *C. K. Sterling* ..... May  
Safety-Glass Pix-Tube Precautions ..... Nov.  
'Scope Pattern Relationship to Receiver Troubles ..... June  
'Scope Voltage-Calibrator Operation; *Donald Phillips* ..... May  
Screen Booths for VHF and UHF Testing and Measurements ..... Apr.  
Service Men Can Convert TV Sets For Station Monitoring and Cueing; *John B. Ledbetter* ..... Oct.  
Sharp Cutoff Video Pentodes ..... Jan.  
Signal Tracing Probes ..... Apr.  
6BK7/6BQ7 Interchangeability in Cascade Tuners ..... Jan.  
6U8 Replacements ..... Mar.  
Spiral-Wound Tuned-Line VHF/UHF Signal Generator (Cover); *Wyn Martin* Aug.  
Standoffs and Standing-Wave-Ratios ..... Sept.  
Steelton VHF/UHF Community TV; *Mark L. Houtz* ..... Mar.  
Steelton Pa., VHF/UHF Community TV (Part II); *Mark Houtz* ..... Apr.  
Stocking Up for UHF Service; *Harold Schulman* ..... Apr.  
Stopping Picture Smear in 24-Inch Models Jan.  
Streamlined Analysis of Circuitry and Components Required to Insure Top Results from Mixer and RF Amplifier ..... Aug.  
Sweep-Circuit Troubleshooting Chart; *Clark R. Alisen* ..... Dec.  
Sync-Circuit Performance (Chart-Analysis); *Clark R. Alisen* ..... Nov.  
Systematic Servicing (Preventive Maintenance Plan); *J. C. Geist* ..... Nov.  
Tables Detailing TV Symptoms and Troubleshooting Procedures ..... May  
Tabulated Data on Possible Faults and Corrections Prepared to Facilitate Troubleshooting ..... Sept.  
Tests for Line to Antenna or Receiver Matching ..... Apr.  
The Systematic Service Approach; *J. C. Geist* ..... Dec.  
3 Channel Community-TV System, Using Horn Antenna and Chain Amplifiers, Installed Atop 1300' Site ..... Sept.  
Tin-Foil Slide Effects on Leadin ..... Jan.  
Tracing Motorboating in TV IF Stages ..... Jan.  
Troubleshooting Keyed AGC Circuits ..... Feb.  
Tube Check Suggestions ..... Nov.  
Tuners Which Permit 16-Channel Coverage ..... May  
TV and Its Impact on Tube Progress ..... May  
TV and Radio Chassis Protection; *J. C. Lebens* ..... Feb.  
TV Antenna Remote Switching ..... May  
TV Chassis Fuse Characteristics ..... Feb.  
TV Chassis Hum Cures ..... Apr.  
TV Chassis IF Performance Factors (Streamlined Table); *Clark R. Alisen* Sept.  
[Next Month: Index Data on Test Equipment, Tube News and UHF TV]



## JOTS AND FLASHES

OVER TWO-THIRDS of a TV Service Man's work is done in the home, according to a survey recently completed by the tube department of G. E. In contrast, between 80% and 90% of the typical radio Service Man's work is done in the shop. General Service Men, it was found, do about half of their work in the shop and half in the home. . . . Transistors are now being used in TV production test equipment at the Long Island City plant of CBS. The transistors have been included in high-gain, low-level voltage amplifiers, together with *uhf* signal generators and auxiliary equipment for checking of band-pass measurements of *uhf* converter units. Use of transistors in test equipment, it was announced, allows testing at low voltage levels, closer to those at which the converter normally operates, than ever before. With this advanced technique, it has been possible to minimize hum and vibration. . . . *Thomas T. Goldsmith, Jr., Irving G. Rosenberg, and C. Edwin Williams* have been elected vice presidents of Allen B. Du Mont Labs, for research, tubes and government, and instruments and transmitters, respectively. . . . Over 1,000 Service Men are reported to have attended the Raytheon *Service Saver* meetings in Springfield, Mass.; Manchester, N. H.; and Boston, Mass., recently. . . . Unit and master shipping

cartons for Burgess portable radio batteries will carry NEDA numbers as well as their own, hereafter. Copies of the NEDA Battery Index are available from National Electronic Distributors Association, 228 North LaSalle St., Chicago 1, Ill. . . . *William R. Hewlett*, vice president of Hewlett-Packard Co., Palo Alto, Calif., has been elected president of the IRE. He succeeds *Dr. James W. McRae*, president of the Sandia Corp. and vice president of Western Electric. . . . The *Vladimir K. Zworykin* TV prize award for '54 has been awarded by the IRE to *Alda V. Bedford*, RCA Labs for his contributions to the principle of mixed highs and its application to color television. . . . A 15" x 16½" chart that shows the rating in power output versus frequency for power tubes in typical operation has been issued by Amperex Electronic Corp., Hicksville, L. I., N. Y. Chart also includes the FCC frequency allocations and associated applications correlated with tube performance. . . . Four more participants in the *Photofact* services have been announced by Howard W. Sams and Co., Indianapolis, Ind. Companies added include: *Sylvania Electric Products, Inc.* (crystal diodes in addition to receiving and picture tubes); *Westinghouse Electric Corp.* (receiving and picture tubes); *Haldorson Transformer Co.* and *Thordarson-Meissner*.

## ADVERTISERS IN SERVICE, DECEMBER, 1953

Admiral Corp.	6	P. R. Mallory & Co., Inc.	Inside Back Cover
All Channel Antenna Corp.	61	Merit Coil & Transformer Corp.	18
Alliance Mfg. Co.	12	Mosley Electronics	63
American Phenolic Corp.	42	Parts Unlimited	76
American Television & Radio Co.	57	Peerless Products Industries	77
Argos Products Co., Inc.	3	Quam-Nichols Co.	59
Argyle Electronics Co.	62	Rad-EI-Co. Mfg. Co.	60, 68
Atlas Sound Corp.	62	The Radiart Corp.	Inside Front Cover
Blonder-Tongue Labs., Inc.	41	Radio City Products Corp.	71
Bussmann Mfg. Co.	13	Radio Corporation of America	Back Cover
CBS-Hytron (Div. Columbia Broadcasting System)	9	Radio Receptor Co., Inc.	76
Centralab Div. Globe-Union, Inc.	54, 60, 75	Raytheon Manufacturing Co.	24
Century Electronics Co.	78	Regency Division I.D.E.A., Inc.	36, 48
Channel Master Corp.	16, 17	John F. Rider Publisher, Inc.	64
Chemical Electronic Engineering Co.	68	Howard W. Sams & Co., Inc.	68
H. G. Cisin	70	Sangamo Electric Co., Inc.	40
Columbia Wire & Supply Co.	69	Sears, Roebuck & Co.	56
Cornell-Dubilier Electric Corp.	67	Snyder Manufacturing Co.	58
Cornish Wire Co., Inc.	60	Sofa Electric Co.	73
Allen B. DuMont Laboratories, Inc.	37	South River Metal Products Co., Inc.	80
Electronic Chemical Corp.	62	Sprague Products Co.	8
Electronic Instrument Co., Inc.	73	Sylvania Electric Products, Inc.	15
Falcon Electronics Co.	4, 5	TAB	78
The Finney Co.	10, 11	Sarkes Tarzian, Inc., Tuner Division	65
The Heath Co.	72	Technical Appliance Corp.	7
Hickok Electrical Instrument Co.	74	Television Hardware Mfg. Co.	32
Industrial Television, Inc.	79	Transamerica Electronics Corp.	72
The Institute of Radio Engineers	19	Triad Transformer Mfg. Co.	69
International Rectifier Co.	75	Tung-Sol Electric, Inc.	71
International Resistance Co.	1	U. S. Treasury Department	14
JFD Mfg. Co., Inc.	47	United Catalog Publishers	74
Jackson Electrical Instrument Co.	53	Vidaire Electronics Mfg. Co.	64
Jensen Industries, Inc.	58	Waldom Electronics, Inc.	77
Kay Electric Co.	58	Walsco Electronics Corp.	45
Kerden Chemical Co.	64	The Ward Products Corp. Div. The Gabriel Co.	20
Kester Solder Co.	74	Webster Electric	55
LaPointe Electronics, Inc.	33	Windsor Electronic Tube Co.	66
Leader Electronics, Inc.	23		
Littelfuse, Inc.	2		

FOR CLEAREST,  
STEADIEST RECEPTION

# Boost UHF Before Conversion

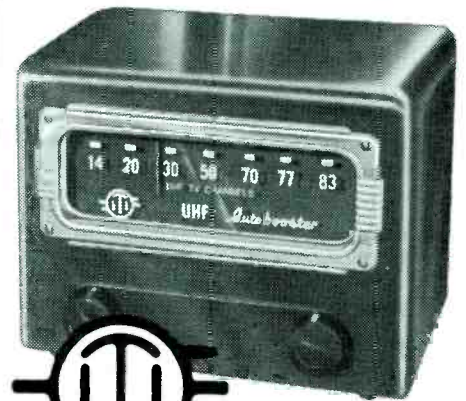

133-A

**UHF AutoBooster**

List Price \$49.95

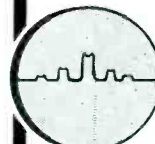

Typical  
Receiver-  
Converter  
Response

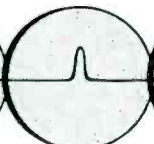

UHF  
AutoBooster  
Response

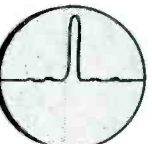

Combined  
Receiver-  
Converter-  
AutoBooster  
Response

Now you can boost the power of the desired signal, and tune out interfering signals—with the new ITI 133-A UHF AutoBooster.

This great new booster increases station power nearly ten times. Even under the most unfavorable conditions, the 133-A provides clear, steady, interference-free pictures. It's the ideal working companion for all UHF and UHF-VHF systems. In fringe areas, it provides a lower noise figure, eliminating snow, and a high gain which compensates for strip or converter losses. In primary areas, it affords increased selectivity, eliminating interference, and a grounded grid RF which suppresses oscillator radiation. It is tunable over the entire UHF range. Write for technical data sheet today.



**INDUSTRIAL  
TELEVISION, INC.**

369 Lexington Avenue Clifton, New Jersey

# NEW

## Model RM-15 ROOF MOUNT

AGAIN South River has the serviceman in mind! With the new South River Roof Mount Model RM-15 his job is a quick, easy, efficient operation. A unique "walk-up drop-lock" feature permits ONE MAN roof-mounting for single mast installations. This mount allows fast, simple installation from a horizontal position. After the antenna and mast are "walked-up" to the vertical position, the mast holder DROPS into a special notch and LOCKS securely. The serviceman is then free to guy the mast.

Made of heavy-gauge metal, heavily plated for rust resistance and embossed at all critical points for extra strength and rigidity, the 5 1/2" long mast socket accommodates masts measuring up to 1 1/2" O. D.

The mast is secured in the mounting socket with 2 rugged hex screws, eliminating the danger of the installation vibrating loose. Two "in line" holes in mounting base permit bolting directly into heavy roof cross member.

FROM

# South River

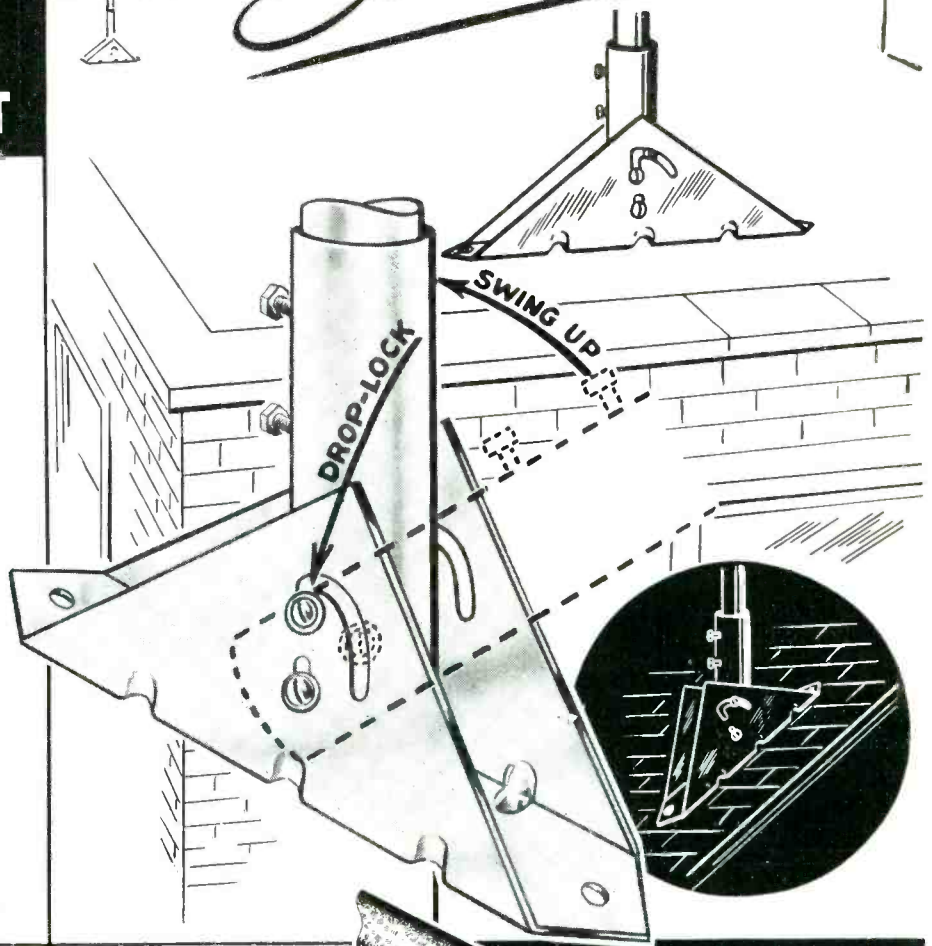

### Rust-Proof

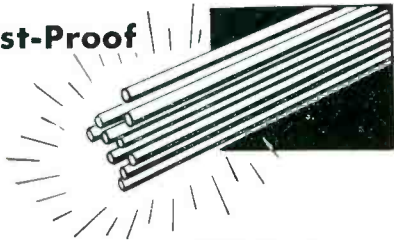

### ALUMINUM TUBING

Only South River is able to offer the industry this super-strength product extruded especially for us. The new aluminum tubing is fabricated of 63S-T6, a special structural alloy designed for maximum strength. Aluminum itself is bright and non-rusting, affording a lasting finish. Made with a .054 wall by 1 1/4" dia., in 10' lengths, the tubing is supplied 25 to a bundle.

### Stronger, Tight-Twist GUY WIRE

Do the best installation job... use South River's new hot-dip galvanized guy wire, carefully drawn with a tighter, stronger twist for extra durability under stress—providing tensile strength up to 70,000 lbs. per square inch. Produced in either 18 gauge or GENUINE 20 gauge, both available in either 4 or 6 strands, this vital product comes to you in 1,000' lengths on metal spool, or in continuous loops of 50' and 100' lengths.



### Exclusive STEEL TUBING

### Hot-Dip Galvanized Inside and Outside!

South River presents another FIRST in the industry... 18 gauge steel tubing, hot-dip galvanized INSIDE AND OUTSIDE... affording maximum utility and long life because of complete, all-over protection. It greatly increases the resistance of steel to the extreme atmospheric corrosion of shore and industrial areas. Hot-dip galvanizing is the only experience-proven rust resistant finish known. The tubing is available in 5' and 10' lengths, 10 to a bundle, is 1-1/4" dia., and is supplied with either plain or swaged end for mast extension.

South River's INSIDE AND OUTSIDE hot-dip galvanized steel tubing is another step forward in combating rust and corrosion. Your use of this product will prove that you keep abreast of important, new developments, for increased customer satisfaction.

*South River*  
METAL PRODUCTS CO., INC., South River, New Jersey

Write for  
Complete Catalog

PIONEER MANUFACTURER AND OUTSTANDING PRODUCER OF THE FINEST LINE OF ANTENNA MOUNTINGS

In Canada—A.T.R. Armstrong Co., Toronto

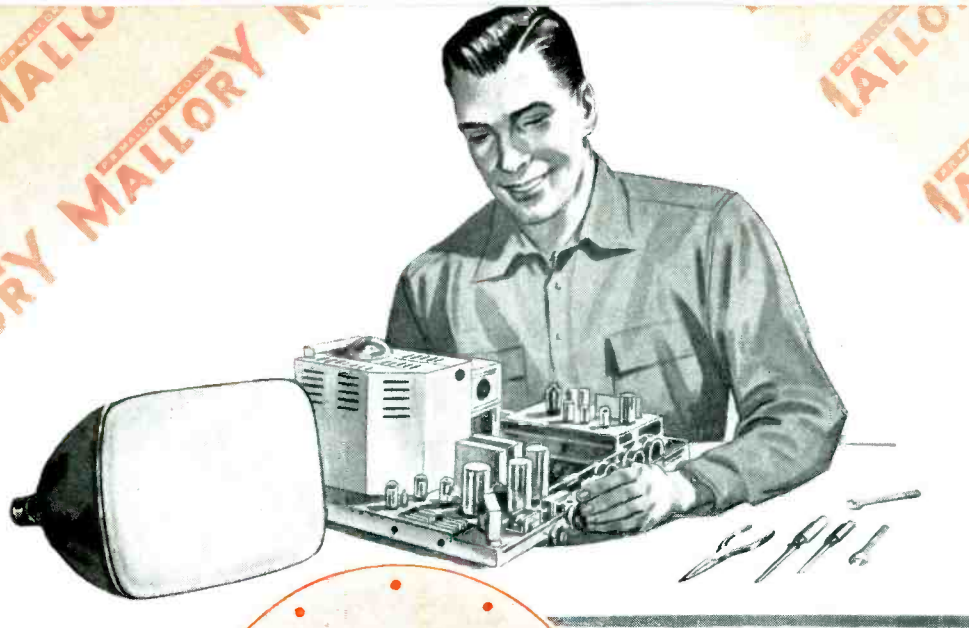

# The Time YOU SAVE ...is ALL PROFIT!

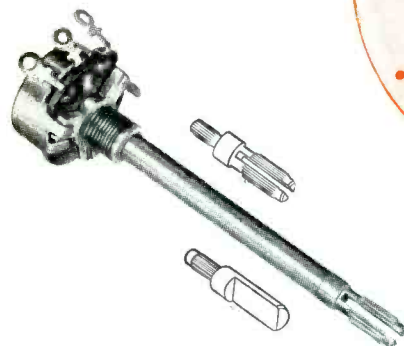

## Mallory Dual Control Kits

Three kits of controls and switches, selected to meet varying requirements in different parts of the country, will serve 50 different models of radio and television sets. You pay only for the controls and switches; attractive 3-drawer metal cabinet is free of extra cost. Get details from your Mallory Distributor.

Every job is in a hurry around a busy service shop . . . and minutes saved add up to more work done and greater profits, to say nothing about satisfied customers.

When you use Mallory Midgetrols®, you'll find them fast and easy to install in any TV or radio set.

*Round tubular shafts* can be cut accurately and quickly . . . fit split-knurled or flatted-type knobs.

*AC switches* can be attached instantly without disassembling the control.

*Unique design* simplifies inventory problems . . . makes them quickly available from your distributor.

Midgetrols are engineered to match the electrical characteristics of the original equipment of any TV or radio set. They will give equal, and often better, performance than the original control . . . your assurance of precision quality on every job.

*This will save time, too.* Ask your Mallory Distributor for a copy of the Mallory Control Guide. It is a complete cross reference between set manufacturers' part numbers and the equivalent Mallory control.

P. R. MALLORY & CO., INC.  
**MALLORY**

CAPACITORS • CONTROLS • VIBRATORS • SWITCHES • RESISTORS  
RECTIFIERS • POWER SUPPLIES • FILTERS • MERCURY BATTERIES  
**APPROVED PRECISION PRODUCTS**

**P. R. MALLORY & CO., Inc., INDIANAPOLIS 6, INDIANA**

*Depend on Mallory  
for  
Approved Precision Quality*

# Let's face it...

... the best tube you can buy  
is your best buy

When it comes to anything so important in radio and television servicing as a receiving tube, *performance* means much more than *price*.

After all, when you purchase a receiving tube, you are not buying just glass and metal. Your reputation and your profit depend on the *performance* that tube will provide!

If you try to cut corners by buying "seconds" . . . or by using "just any tube brand," you may be in for trouble. Unnecessary callbacks alone can eat up all your profit. That's why we think you'll be interested in these two facts about RCA Receiving Tubes . . .

**First Fact:** There is no such thing as a "second" RCA Receiving Tube that can find its way to market. If an RCA Tube fails to pass its final test, it is not only rejected . . . *it is broken up, dumped into a "meat chopper" and ground up into so much hash.*

**Second Fact:** The quality of RCA Receiving Tubes is continually being "upgraded." For instance, when television came, you asked for an improved 6SN7-GT. As a result, RCA's 6SN7-GT is a far better tube than the 6SN7-GT of yesterday. You see, we guard our reputation as zealously as you guard yours.

**So let's face it . . .** you just can't afford to buy anything less than the best in receiving tubes—and that's RCA.



To be sure you're getting unused, factory-fresh RCA Tubes, buy them only in the familiar red, white and black RCA Tube cartons through your authorized RCA Tube Distributor.



**RADIO CORPORATION of AMERICA**  
ELECTRON TUBES

HARRISON, N. J.