

RADIO • TELEVISION • ELECTRONIC

SERVICE

JANUARY
1953

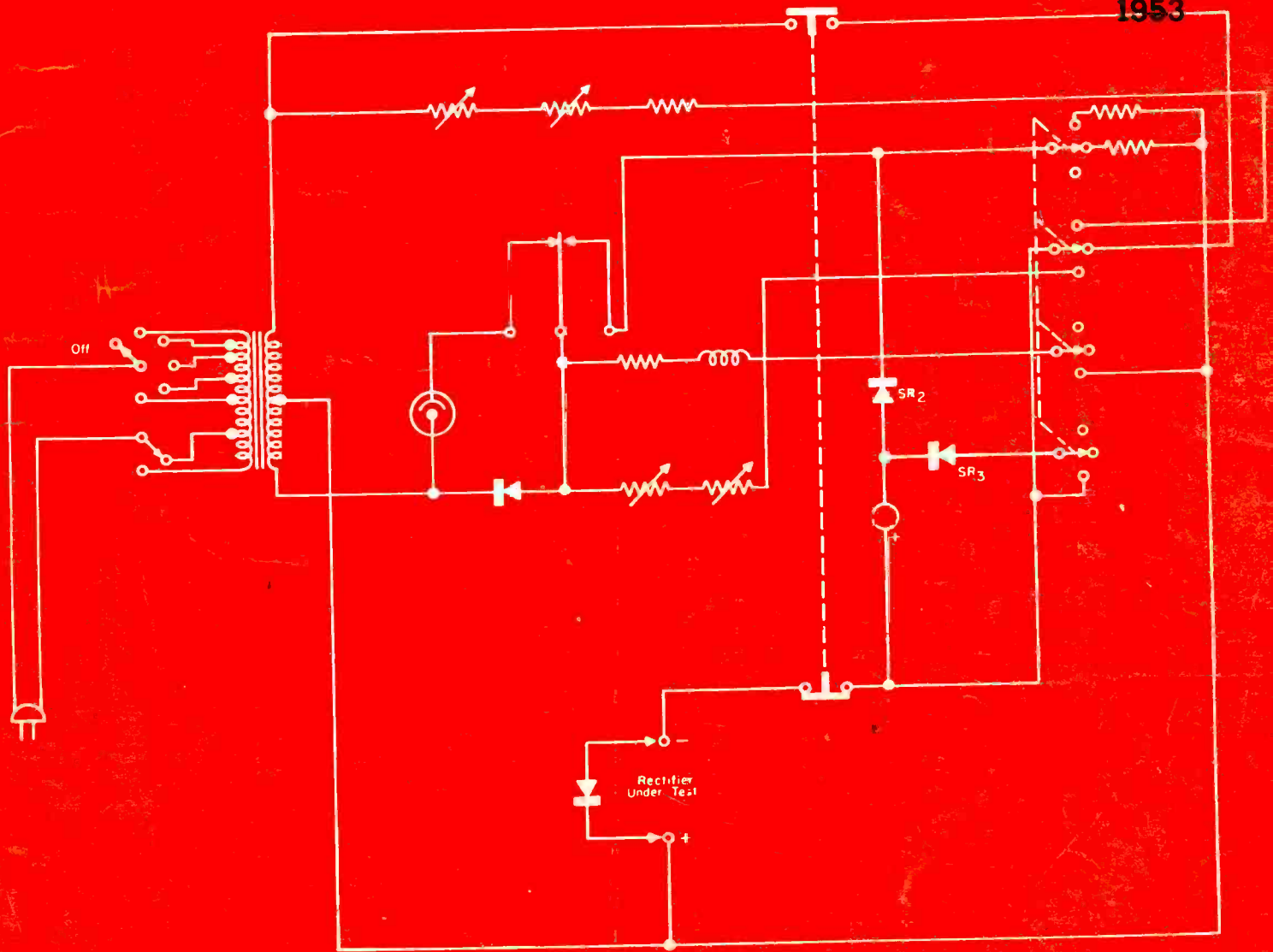

Selenium rectifier tester which provides for checking of forward resistance, reverse leakage current, open, and shorts.

[see page 3]

THE TECHNICAL JOURNAL OF THE RADIO TRADE

www.americanradiohistory.com

In a Class
by Itself



the
CDR Rotor

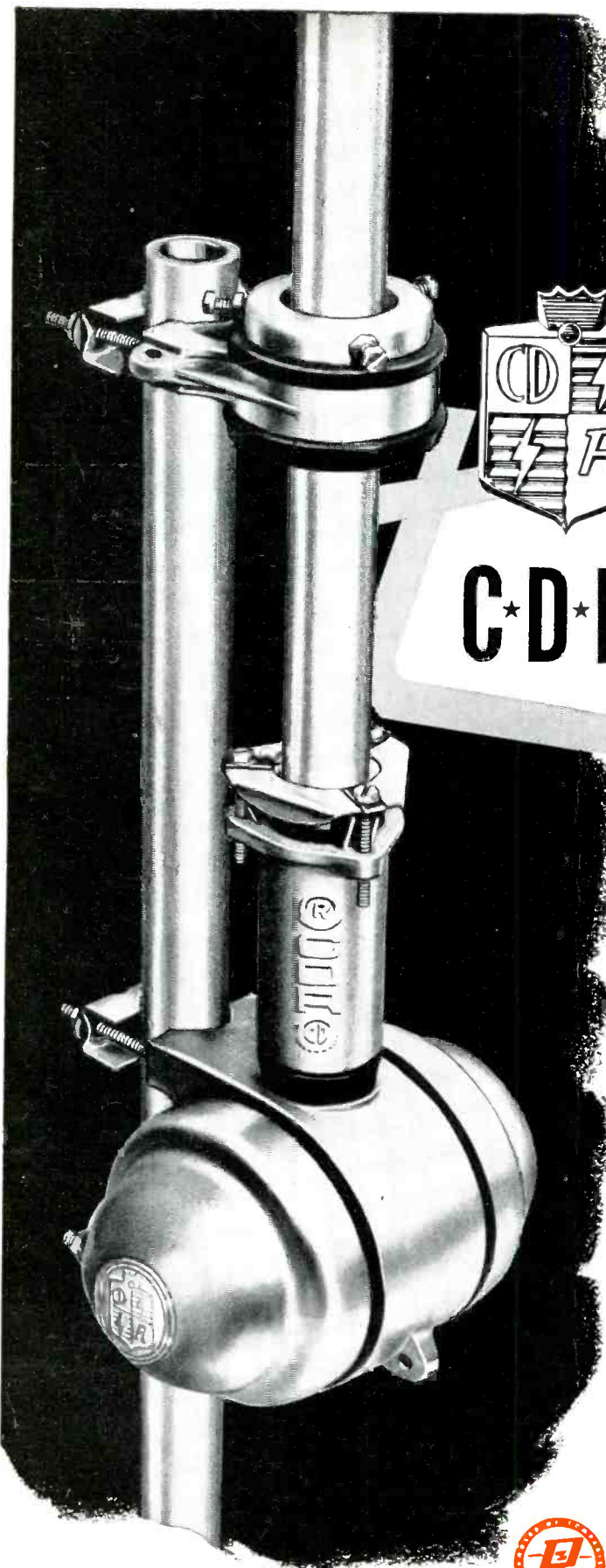

Speedy Installation ... the servicemen's dream come true! No loose parts to assemble...no kits with loose washers, nuts and bolts... quick mounting antenna mast collet plus four wire cable hookups!

Dependable ... experience has proven that once a CDR ROTOR is up ... it's THERE TO STAY! No costly call-backs! Completely weather-sealed and streamlined ... it's the outstanding value in the field!

Powerful ... sturdy in design to support and TURN ANY TV ANTENNA array ... never a worry about the CDR rotor working! Locking instantly it will not drift! Instantly reversible ... makes a complete revolution in 45 seconds!

MODEL TR-12 A special combination value consisting of complete rotor including thrust bearing ... handsome modern design plastic cabinet with meter control dial, only \$47.95



MODEL TA-6 Thrust bearing accessory, separately \$4.95

MODEL TR-11 Same as TR-12 without thrust bearing... \$44.95

THE **RADIART** CORPORATION
CLEVELAND 13, OHIO



CORNELL-DUBILIER
SOUTH PLAINFIELD, NEW JERSEY

**ASTRON
SERVES UP**

SATISFACTION

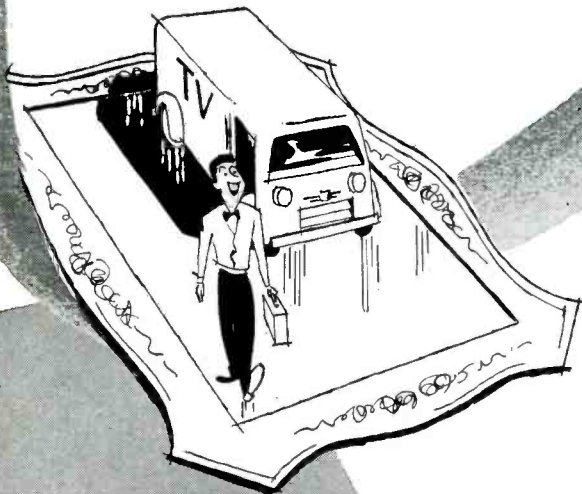

ASTRON

C O R P O R A T I O N

255 Grant Avenue • E. Newark, N.J.

on *Every* Service Call

When you replace with Astron Capacitors you are equaling or bettering original equipment—add to this:

- The service your customer expects
- The exact performance characteristics you demand
- Reduced call-backs everyone demands

And you have a few of the reasons why Astron Capacitors help “serve up satisfaction” to your customers. Alert jobbers are stocking Astron Capacitors—make sure you talk to your supplier today—or write to us for the name of the Astron Distributor nearest you. Send for catalog AC-3.

DEPEND ON . . . INSIST ON . . . **ASTRON**

SERVICE, JANUARY, 1953 • 1

JFD UHF Corner Reflector No. UHF400

JFD UHF Ultra V-Beam No. UHF500

JFD UHF YAGIS No. UHF300 Series for Channels 14 to 83

JFD UHF "Double-Vee" No. UHF100

JFD UHF "Route-Flector" No. UHF600

JFD UHF Rhombic No. UHF 200

JFD wins again!

Be ready for UHF in any location with the first complete antenna line of its kind. Start today to build more profits and customer confidence with new JFD UHF antennas. Write for bulletins 172-6 for full details.



JFD MFG. CO.

BROOKLYN 4, N. Y.
BENSONHURST 6-9200

world's largest manufacturer of
tv antennas and accessories



LEWIS WINNER Editor

B. BLOCK F. WALEN Assistant Editors

Registered U. S. Patent Office Including Radio Merchandising and Television Merchandising

Association News 60
Audio Installation and Service (Architect-Builder Audio System Specs). Kenneth Stewart 42
Measuring TV Antenna Characteristics. By Donald Phillips 28
Merchandising Audio. By L. J. Epstein 54
In the Field (Scope . . . FM Detector . . . Takeoff . . . TV Antenna Problems and Answers) 70
Parallel-Wire Transmission-Line UHF Converter. By R. A. Morris 18
Pickup Compensators and Preamps. By Mark Vino 20
Reading Difficult TV Schematics. By Cyrus Glickstein 45
Selenium Rectifier Tester (Cover). By Earl Steiker and Oscar Nelson, Jr. 22
Ser-Cuits (PC AC Clock and AC-DC Chassis . . . UHF Tuners). By M. W. Percy 50
Service . . . The National Scene 35
Servicing Helps (TV Chassis Case Histories). By M. A. Marwell 39
Ten Years Ago 58
Tube News (Cascode Amplifier Tubes). By L. M. Allen 24
TV Antenna Digest (On-the-Scene Report of Portland UHF). By Ralph G. Peters 30
UHF Crystal Diode Troubleshooting. By Henry R. Hesse 78
Views and News. By Lewis Winner 17

AUDIO INSTALLATION AND SERVICE

Architect-Builder Audio-System Specification Data 42
FM IF Amplifier 42
Network for Two Speakers 42

CIRCUITS

Collins Audio FM IF Amplifier 42
Crystal Pickup Compensator Circuit 21
Galvanic Selenium Rectifier Tester (Cover) 22
G.E. 103 UHF Translator 51
Hallicrafters Foto-Etch Clock-Radio Chassis 50
Hallicrafters TS-64 45
Hoffman 182 Chassis Modified Audio Output 42
Magnetic Pickup Preamp Hookup 21
Modified Sentinel Video Amp Grid-Control Which Prevents Crystal Detector Failures 39
NBS Constant-Amplifier Oscillator 51
Regency UHF Converter 18
Revised Video IF in Sentinel Chassis Which Halts Picture Tearing and Rolling 39
Selenium Rectifier Forward Test Circuit 56
Selenium Rectifier Output Voltage Tester 22
Selenium Rectifier Reverse Test Circuit 57
TV Tuner Using 6BK7A as RF Amplifier in Cascode Circuit 24

COVER

Selenium Rectifier Tester (Galvanic) 22

SERVICING HELPS

AGC Threshold-Control Adjustments 63
Curbing Picture Shift at Maximum Contrast 39
Cures for Horizontal Jitter and Unstable Sync in Fringe Areas 39
Halting Picture Tearing and Rolling on Strong Signals 39
HV Breakdown and Corona Cures 62
Preventing Premature Crystal-Detector Failures 39
6BK7/6BQ7 Interchangeability in Cascode Tuners 63
Stopping Picture Smear in 24-Inch Models 62

Index to Advertisers

Manufacturers

Catalogs and Bulletins 58
Jobs and Flashes 80
News 66
New Parts . . . Tools . . . Instruments 69
Rep Talk 59
TV Parts . . . Antennas . . . Accessories 76



Entire contents Copyright 1953, Bryan Davis Publishing Co., Inc.

Published monthly by Bryan Davis Publishing Co., Inc.

52 Vanderbilt Avenue, New York 17, N. Y. Telephone Murray Hill 4-0170

Bryan S. Davis, Pres. Paul S. Weil, Vice-President F. Walen, Sec. A. Goebel, Cir. Prom. Mar. Mid-West Representative: Stuart J. Osten, 333 N. Michigan Ave., Chicago 1, Ill. Telephone: DEarborn 2-3507 East-Central Representative: James C. Munn, 2253 Delaware Dr., Cleveland 6, Ohio. Telephone: ERievview 1-1726 Pacific Coast Representative: Brand & Brand, 1052 W. Sixth St., Los Angeles 14, Calif. Telephone: MIchigan 1732 Metropolitan District Manager: Donald C. Weil, 52 Vanderbilt Ave., New York 17, N. Y.

Entered as second-class matter June 14, 1932 at the Post Office at New York, N. Y., under the Act of March 3, 1879. Subscription price: \$2.00 per year in the United States of America and Canada; 25 cents per copy. \$3.00 per year in foreign countries; 35 cents per copy.

specified by top radio manufacturers for SERVICING AUTO RADIOS



Electro MODEL "B" FILTERED DC POWER SUPPLY Patent 2,599,748

because

- 1 Withstands High Overloads, gives rugged life-long service.
2 Cooler Operation—selenium rectifier application and conduction cooling dissipate over 3 times the heat.
3 EPL Patent Doubles Rectifier Power Rating.
4 Lowest Cost Per Ampere Output.
5 Operates 2 Auto Radios with push-button solenoids at same time.

output

1 to 20 amperes continuous duty. 35 amperes at peak rating.

other uses

Tests phone circuits, relays, instruments, low voltage devices. Charges batteries. Electroplating.

watch for

New 12 Volt DC Power Supply, Model C-12.

See Your Jobber or Send Coupon to ELECTRO PRODUCTS LABORATORIES 4501-5b N. Ravenswood Ave., Chicago 40, Ill. Canada: Atlas Radio Corp., Ltd., Toronto, Ont.

Send FREE bulletin on "B." Send Folder on Complete Line. Name Street City State

**Build Your Service-
Sales Future on a Firm
Foundation with . . .**

PRECISION
TEST EQUIPMENT
Standard of Accuracy

**... These 5 Matched "PRECISION"
Instruments provide a Complete
MODERN SERVICE LABORATORY for
TV-FM-AM at only moderate cost.**

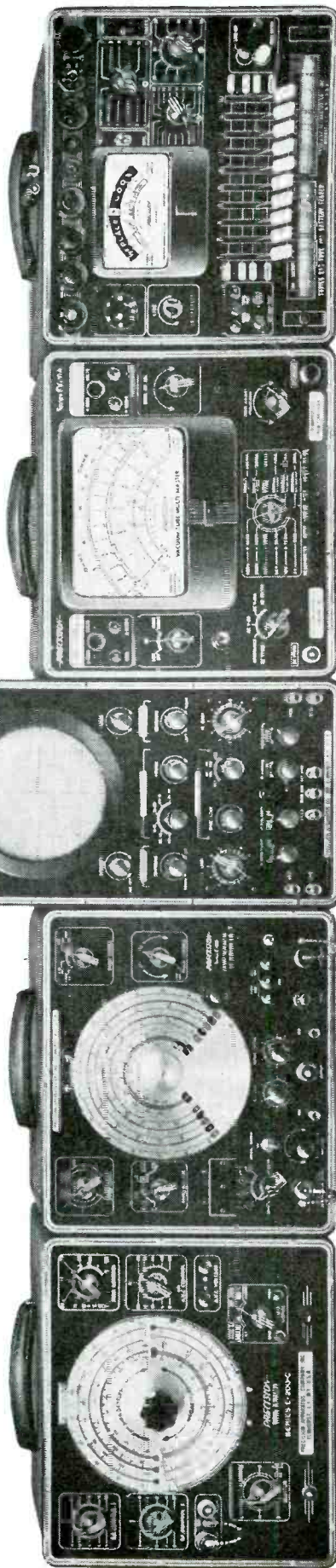

SERIES E-200-C

SIGNAL and MARKING GENERATOR
for A.M., F.M., and TV alignment.

Exceptional Accuracy and Stability • 1000 pt. vernier calibrating scale • 0-100% Modulation • A.V.C. — A.G.C. substitution-override network • Direct reading 88KC to 120 MC • Complete with Coaxial output cable and technical manual • In matched, heavy gauge steel case 10 1/2 x 12 x 6".

Net Price: \$73.25

SERIES E-400

SWEEP SIGNAL GENERATOR
Direct Reading from 2 to 480 MC.

Narrow and Wide Band Sweep for F.M. and TV, 0-1MC and 0-15MC • 1500 pt. vernier calibrating scale • Multiple Crystal Marker • 8 tubes including V.R. and rectifier • RG/62U Coaxial Terminated Output cable • Complete with 2 crystals • In matched copper-plated case 10 1/2 x 12 x 6".

Net Price: \$135.75

SERIES ES-500A

**High Sensitivity, Wide Range
5" C.R. OSCILLOGRAPH**

Push-Pull "V" and "H" amplifiers • 1 MC Band Width • High impedance, compensated "V" input Step Attenuator • Z axis modulation • 12 tubes incl. V.R. and 2 rect. • Light Shield and Mark • Heavy Steel Case, 8 1/4 x 14 1/4 x 18".

Net Price: \$173.70

SERIES EV-10A

True Zero-Center VTVM—MEG OHMMETER
with large 7" meter.

58 ranges to 6000 Volts, 2000 Megs, ±700B, 12 Amps • Direct Reading R.F., VTVM scales via optional RF-10A High Freq. probe • Voltage Regulated bridge type circuit • Constant 13 1/2 Megs input resistance to 600 V, 133 1/2 Megs at 6000V • Complete with test cables • In matched steel cabinet 10 1/2 x 12 x 6".

Net Price: \$97.20

SERIES 612

**Modern Free-point TUBE TESTER, and
dynamic A-B-C Battery Tester.**

Incorporates RTMA recommended circuit principles • 10 lever free-point element selection • Built-in roller chart • Dug, short-check sensitivity • Noise, Ballast and Pilot Tests • Free replacement tube test data chart service • Complete, ready to operate • In matched heavy gauge steel cabinet 10 1/2 x 12 x 6".

Net Price: \$72.75

BUY PERFORMANCE — NOT SPECIFICATIONS!

PRECISION PERFORMANCE, ACCURACY, WORKMANSHIP and VALUE have been setting a world-wide standard of comparison for over 20 years.

Every **PRECISION** instrument is guaranteed for one full year against mechanical or electrical defects.

OTHER MATCHED COMBINATIONS

The instruments shown above illustrate one of many possible **MATCHED COMBINATIONS** of **PRECISION** Test Equipment for the modern TV-FM-AM service bench. Each combination provides a selected, basic and efficient Laboratory at moderate cost.

SERIES TV-4—Super-High Voltage Safety Test Probe.

Extends range of Series EV-10A (above) to 60 KV direct reading, with full safety to operator and equipment. Multiplier cartridges also available to match most VTVM's and 20,000 ohms per volt test sets.

Series TV-4: — Complete, for use with EV-10A.

Net Price: \$14.75



PRECISION APPARATUS CO., INC.

92-27 Horace Harding Boulevard, Elmhurst 6, New York
Export Division: 458 Broadway, New York 13, U.S.A. • Cables—Morhanc
In Canada: Atlas Radio Corp., Ltd., 560 King Street, W., Toronto 2D

TV • AM • FM • TV • AM • FM • TV

PRECISION Performance-Engineered Instruments are on display at leading radio parts and equipment distributors.

TV • AM • FM • TV • AM • FM • TV

Convenient PRECISION Purchase Terms can be arranged with your favorite authorized Precision Distributor.

Let's forget the "glittering generalities" about quality.

Let's Check 4 specific ways **CBS-HYTRON** cuts your call-backs



1. BY MAKING CBS-HYTRON TV ORIGINALS BEST.

Longest experience with production . . . with applications . . . with improvements . . . all count. CBS-Hytron-built 1AX2, 1X2A, 6BQ6GT, 12A4, 12B4, 12BH7, 12BY7, 12BZ7, 25BQ6GT, 16RP4, etc. are more trouble-free. Prove it to yourself.



2. BY ENDLESSLY IMPROVING STANDARD TV TYPES.

Close co-operation with leading set makers alerts CBS-Hytron daily to needed betterments. Take one of endless examples: the CBS-Hytron 6CB6. You will find its clear, non-carbonized bulb eliminates undesirable loading effects at vhf.



3. BY APPLYING "RELIABLE" TUBE TECHNIQUES.

CBS-Hytron 6AL5 is typical. Experience with the military 6AL5 family (JAN 6AL5, 6097/CT, 5726) is passed on to you. You profit by a commercial CBS-Hytron 6AL5 made truly reliable.

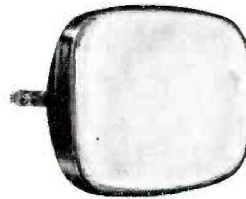

4. BY MATCHING EACH TUBE TO THE SET.

Daily, CBS-Hytron analyzes leading TV chassis. Dynamic socket-by-socket checks, plus continuous field experience, pay off. Give you CBS-Hytron matched-to-the-set performance . . . with the accent on trustworthy replacements.

Take advantage of CBS-Hytron extras like these. Keep your customers happy. Guarantee yourself against profit-slicing call-backs. Demand dependable CBS-Hytron tubes.



NOW...TEST THE EASY TOPSIDE WAY!

Wish you could test a chassis topside? Without first pulling and wrestling with the heavy chassis? Without disturbing wiring and parts by digging underneath for buried sockets? How much faster, easier, safer you could work! New CBS-Hytron Test Adapter does the trick. Just replace a 7-pin miniature tube with the Test Adapter. Plug tube into Test Adapter. Presto, all socket connections are topside . . . within instant reach of your test prod or clip. Just one job pays for this new CBS-Hytron Test Adapter. Get yours today!

\$1.45 net



HERE'S HOW! With the CBS-Hytron Test Adapter, you quickly measure voltage, resistance, gain. You inject and trace signals . . . monitor intermittents. You check oscillating stages. Or the effect of adding a bypass condenser or shunt resistor.

With several CBS-Hytron Test Adapters you make stage-by-stage circuit checks . . . fast. You do all this dynamic testing the e-a-s-y way . . . topside. With no ill effects at a-f frequencies. And only slight capacitance and inductance effects at much higher frequencies.

You will like: The positive contact of the low-resistance, silver-plated base pins and test points. The plainly marked pin connections. The easy insertion and tight grip. CBS-Hytron Test Adapter is another designed-by-and-for-you "must" you must have. See your CBS-Hytron jobber today.



DANVERS, MASSACHUSETTS

SERVICE, JANUARY, 1953 • 5

from
Admiral
ALL-CHANNEL
ANTENNAS
 for high gain
 on both . . .

VHF
UHF



**Admiral Trombone
 Quad-Vee
 VHF-UHF Antenna
 No. AN2**

Designed for fringe areas. Stacking kit available for extreme fringe areas.

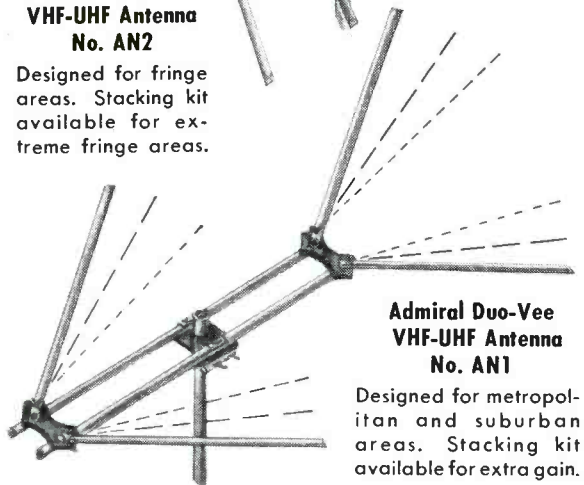

**Admiral Duo-Vee
 VHF-UHF Antenna
 No. AN1**

Designed for metropolitan and suburban areas. Stacking kit available for extra gain.

See your Admiral distributor for Antenna masts and tower equipment. Mounting hardware and accessories. Tubular steel TV tables.

Admiral Corporation

Accessory and Equipment Division
 Chicago 47, Illinois

These two new antennas will help you sell TV sets now . . . especially if you expect new stations or channel changes in your area. Elements are adjustable to three positions . . . (1) VHF only, (2) VHF-UHF and (3) UHF only. Thus the same antenna may be installed to deliver high gain on any currently operating station . . . and will give top performance on all new stations, either VHF or UHF.

Admiral antennas are built to minimize call-backs. Sharp directivity reduces ghosts and interference. Seamless aluminum elements, doweled for sturdiness. Completely preassembled for quick, easy installation . . . no lost parts. See these and other Admiral Antennas when you visit your Admiral distributor.

**A COMPLETE LINE OF ADMIRAL TV ANTENNAS . . .
 NOW AVAILABLE FROM YOUR ADMIRAL DISTRIBUTOR**

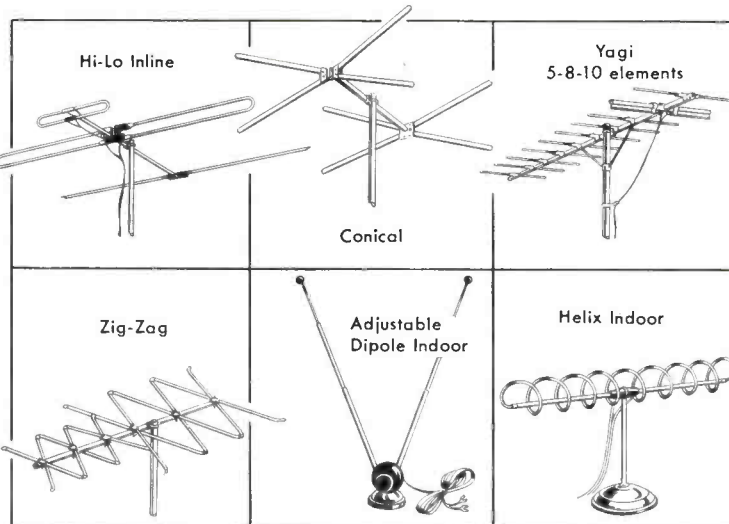

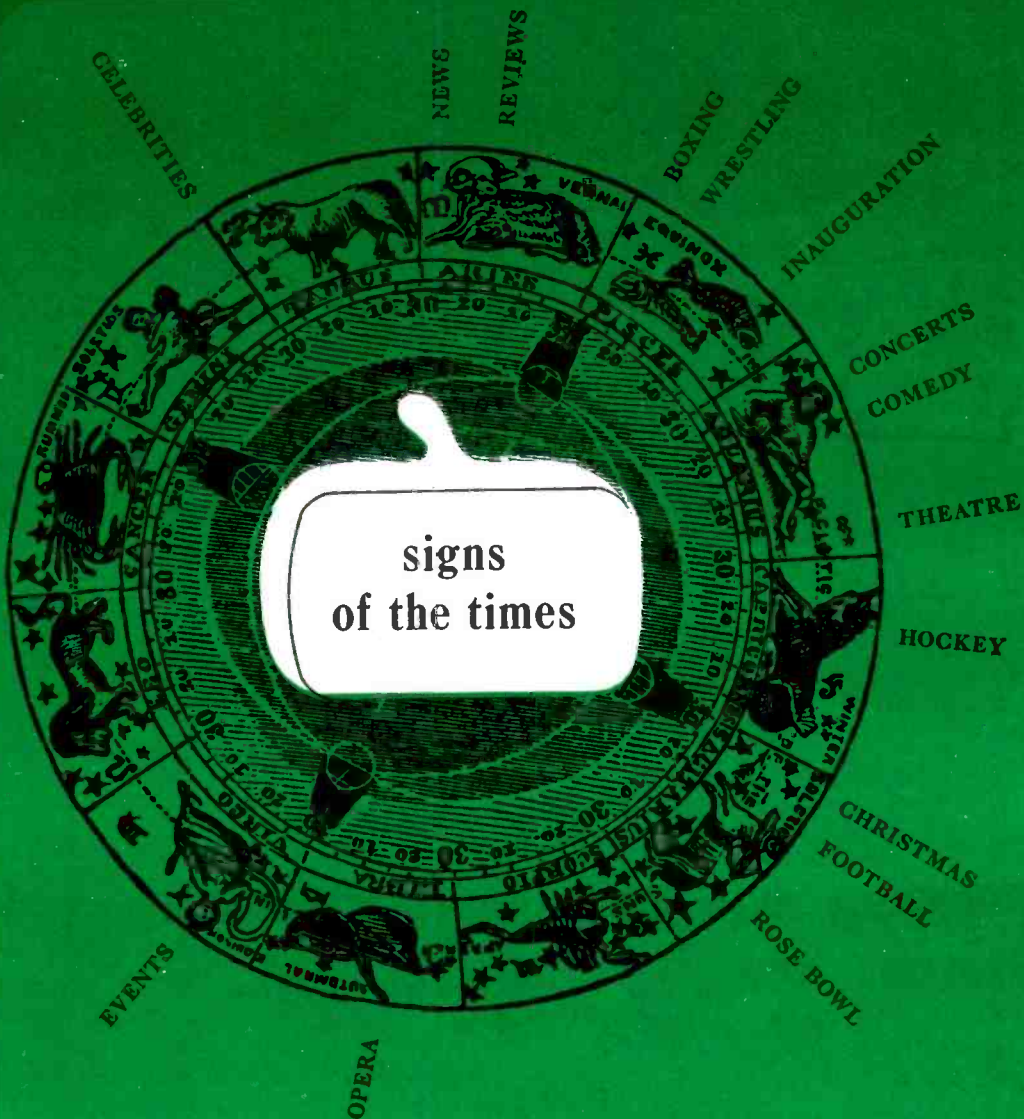

burton brown advertising

signs
of the times

The stars show quality ascendant in the TV set owner's mind. Follow your stars—give the set owner the best picture-tube replacement—Rauland. Your Rauland jobber anticipates your need today with a complete stock. The Rauland Corporation, 4245 N. Knox Avenue, Chicago 41, Illinois. MUlberry 5-5000.

RAULAND

PERFECTION THROUGH RESEARCH



**Let it
pour**

**Install an
RCA Weather-Resistant
Lightning Arrester
and forget it**

THE RESISTANCE ELEMENTS in RCA Lightning Arresters are made of a remarkable, new *conductive rubber* that is *noncorrosive and impervious* to moisture . . . to provide *lasting* protection to TV and FM installations. Cap covers contacts. Losses are negligible even under extremely tough weather conditions.

Just mount, unscrew cap, insert transmission line in slot, and replace cap. It's as easy as that. Type 214X1 for indoors, type 215X1 for outdoors. *Both are listed by Underwriter Laboratories, Inc.*

**See Your RCA Parts Distributor for
"the best lightning arrester to come down the line."**



RADIO CORPORATION of AMERICA
ELECTRONIC COMPONENTS

HARRISON, N. J.

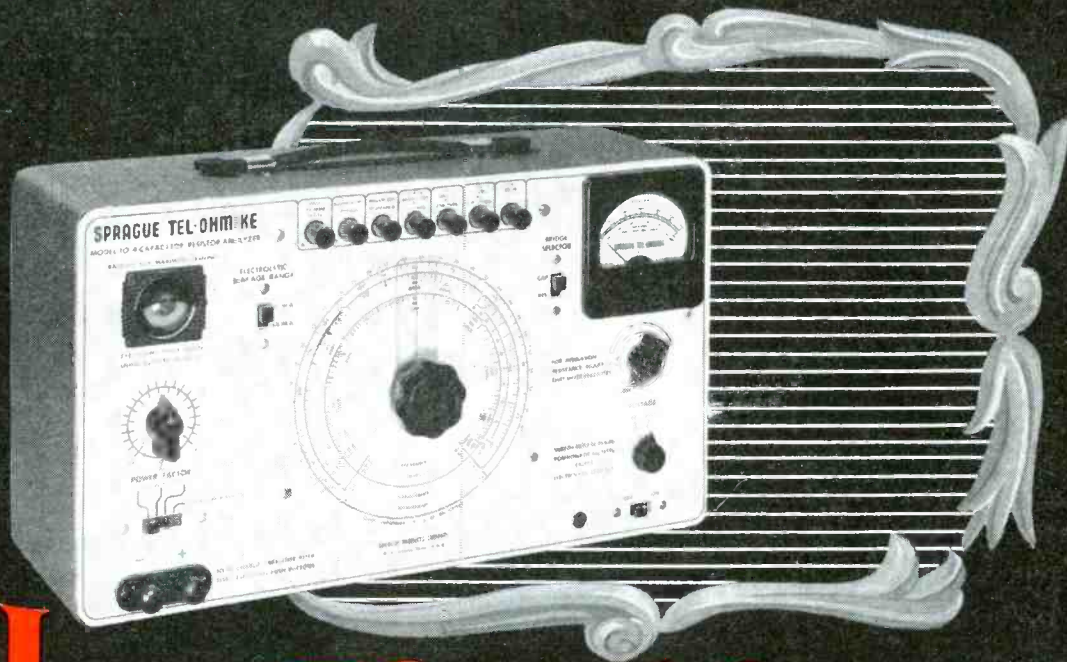

Here's The New

Model TO-4 **TEL-OHMIKE**[®] CAPACITOR-RESISTOR ANALYZER

- You'll be proud to have this completely new instrument on your service bench!
- The result of a nationwide survey of radio and television technicians makes the new TO-4 Tel-Ohmike meet your capacitor test needs to a capital "T". Trim and trustworthy, it has instant push-button range selection, magic-eye bridge balancing, safety discharge feature, direct meter readings of leakage current and insulation resistance, and a continuously adjustable test voltage for checking electrolytics at exact rated voltages.
- Two especially valuable features are the provision of a special low capacitance circuit for checking small ceramics and "gimmick" capacitors down to 1 mmf (in addition to a top capacitance range of 2000 mf) and the simplified insulation resistance circuit with a top reading of 20,000 megohms.
- See a demonstration of this new instrument at your distributor without delay!
- And the price of this new improved Tel-Ohmike is still the same Only **\$73.50** NET.



Write for full descriptive bulletin today

SPRAGUE PRODUCTS COMPANY

(Distributors' Division of Sprague Electric Co.)

61 MARSHALL STREET, NORTH ADAMS, MASS.

ANOTHER NEW DEVELOPMENT BY THE WORLD'S LARGEST CAPACITOR MANUFACTURER

For accurate
flexible and
quick tube
testing at
low cost...
model 3413-A

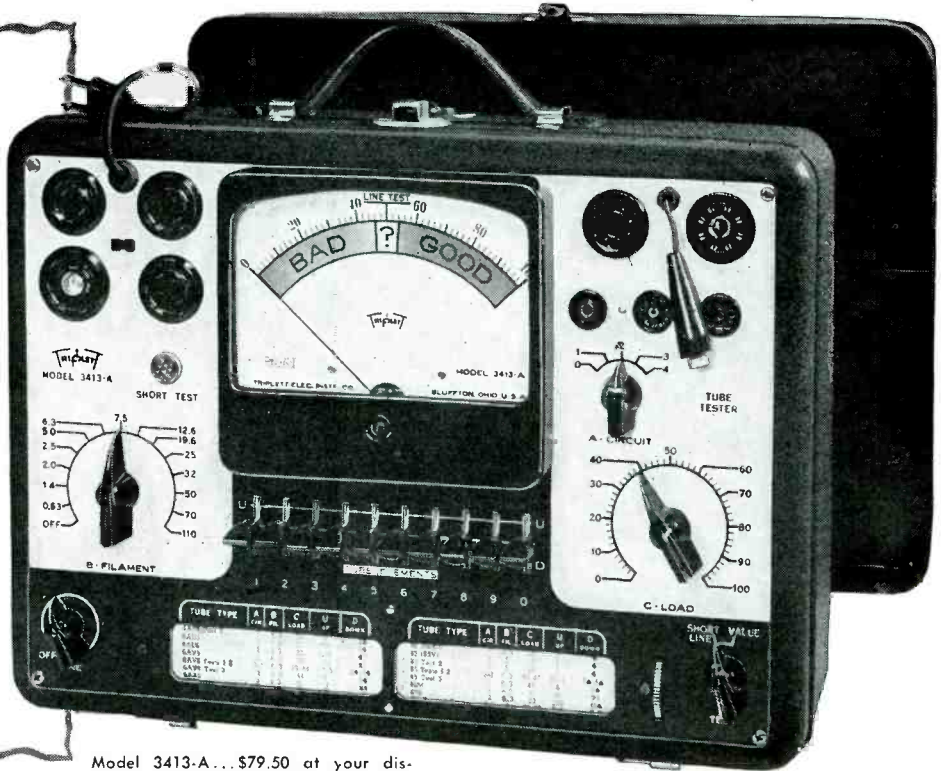

Model 3413-A... \$79.50 at your distributor. (Price subject to change.) BV Adapter, \$7.90 Add'l.

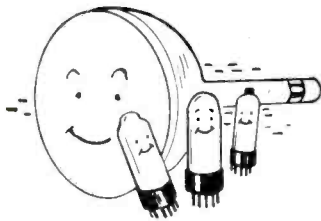

1. YOU CAN TEST MORE TYPES of tubes, also appliances for shorts and open circuits.

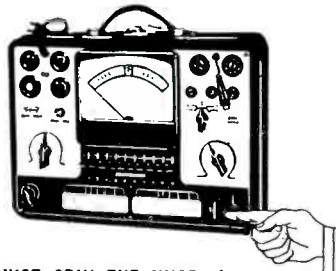

2. JUST SPIN THE KNOB—for correct, last-minute data, on the speed roll chart. Lists 700 tubes.

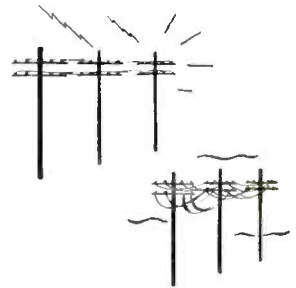

3. YOU CAN COMPENSATE for line voltage—just throw snap-action switch.

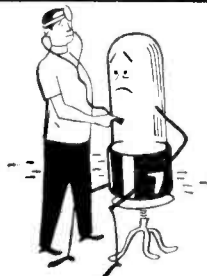

4. YOU CAN TEST EACH ELEMENT in each tube—by a simple flip of the switch.



5. YOU CAN TEST THE NEW TUBES—including those with low cathode current.



6. YOU GET NEW TUBE DATA—immediately, while it is still news. No waiting.

Nearly Half a Century of Service to the Service Man

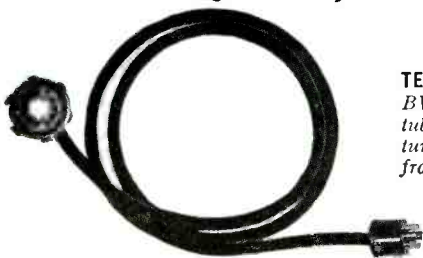

TESTS PICTURE TUBES, TOO! With this BV Adapter, Model 3413-A tests every tube in a TV receiver, including the Picture Tube—without even removing tube from receiver or carton! Saves time!

FOR THE MAN WHO TAKES PRIDE IN HIS WORK

Triplet

TRIPLET ELECTRICAL INSTRUMENT CO., BLUFFTON, OHIO, U. S. A.

Extra profits for servicemen!

NOW you can add UHF to the thousands of VHF Super Fans presently installed in your area, with Channel Master's exclusive new Ultra Dapter, Model No. 414. In 5 minutes you can convert any Super Fan into an all-channel VHF-UHF antenna. See your distributor for details.

VHF *and* UHF

Now! Get all 82 channels
with the
new

CHANNEL MASTER ULTRA FAN

Single Bay
model no. 413

Stacked
model no. 4132

Write for literature on Channel Master's new complete line of UHF antennas including such models as these:



Ultra Bow
Model No. 401

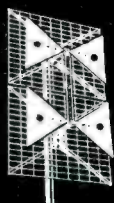

Ultra Bow with
screen reflector
Model No. 403

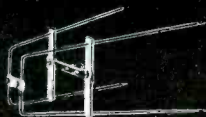

Ultra Vee
Model No. 404



**Today's most sensitive
ALL-VU* antennas!**

*All VHF, All UHF

Featuring:

- **2 great antennas in 1** —
A genuine, high gain Super Fan on VHF, and an all-channel Triangular Dipole and reflector for peak UHF reception.
- **Electronic inter-action filter** —
Automatically isolates VHF and UHF bands, eliminates inter-action. Ultra Fan operates with only a *single* transmission line to TV set.
- **"Free space" terminals** —
Channel Master's exclusive UHF "free space" terminals prevent accumulation of dirt and moisture which gradually reduce picture quality in ordinary UHF installations.
- **Famous Channel Master engineering** —
The Ultra Fan is an *integrated* VHF-UHF antenna that give uniformly high gain over *all* TV channels, from 2 through 83.

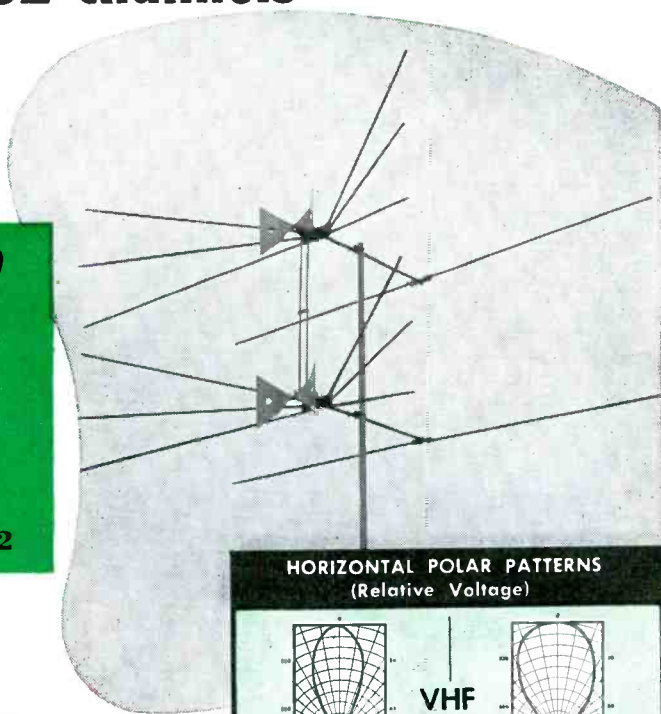

**HORIZONTAL POLAR PATTERNS
(Relative Voltage)**



VHF

Channel 2

Channel 10

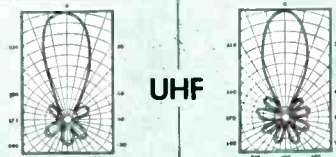

UHF

Channel 60

Channel 77

GAIN CURVES

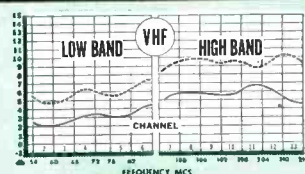

VHF

LOW BAND

HIGH BAND

CHANNEL

FREQUENCY MC/S

UHF

CHANNEL

FREQUENCY MC/S

— Single Bay
- - - Stacked

MEMBER



CHANNEL MASTER CORP. ELLENVILLE, N. Y.

SYLVANIA PICTURE TUBES

Lasted Longer than others tested!

"IT'S A TRUE
BLUE-RIBBON
TUBE"

BEST IN
OVER-ALL
POINT
QUALITY!

SYLVANIA
OUTLASTED
ALL TUBES
TESTED

TESTS CONDUCTED
BY U.S. TESTING
COMPANY

RADIO TUBES; TELEVISION PICTURE TUBES; ELECTRONIC
PRODUCTS; ELECTRONIC TEST EQUIPMENT; FLUORESCENT
TUBES, FIXTURES, SIGN TUBING, WIRING DEVICES; LIGHT
BULBS; PHOTOLAMPS; TELEVISION SETS

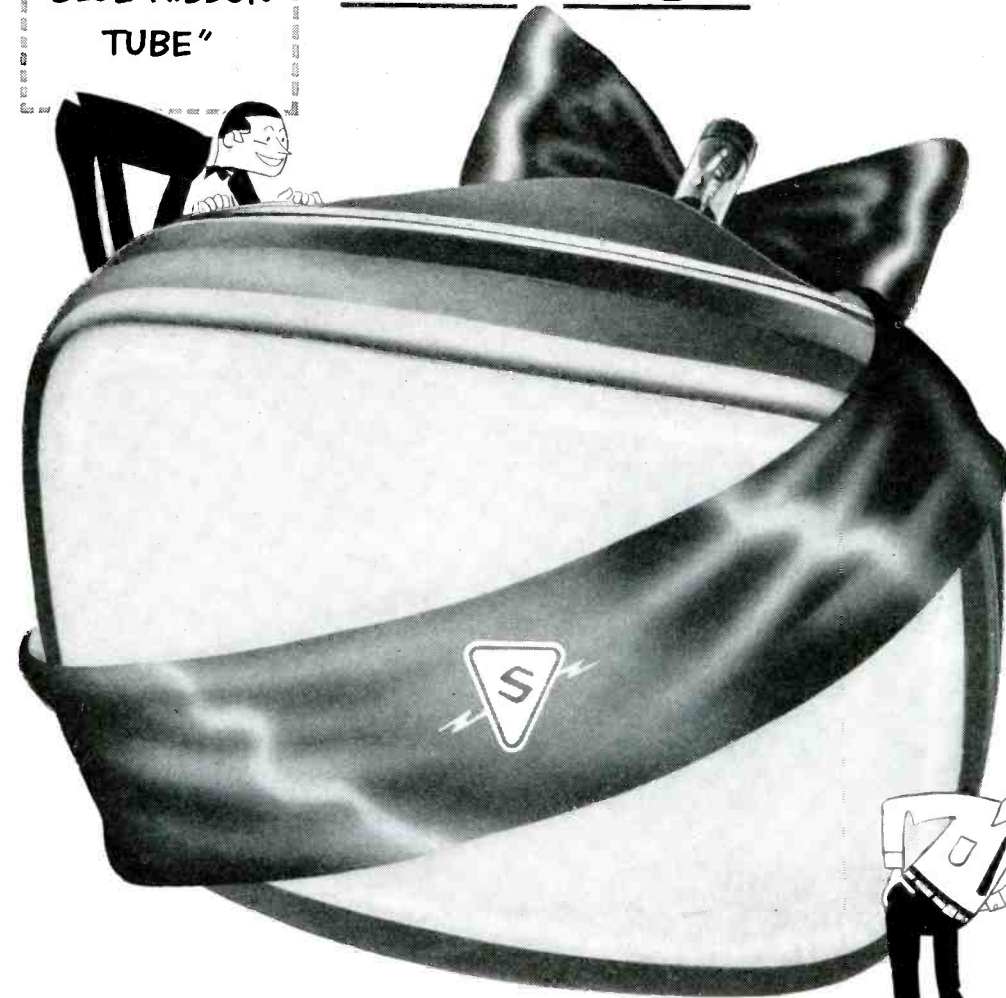

Only Sylvania tubes showed **NO FAILURES** after 1400 hours . . . at accelerated voltages

Exhaustive tests conducted under the supervision of an outside impartial laboratory, the United States Testing Company, showed Sylvania Picture Tubes lasted longer than any others tested.

These tests included the picture tubes of nine leading manufacturers. All tubes were placed in identical test racks and tested under identical accelerated voltages. At the end of 1400 hours, only the Sylvania

Picture Tubes showed *no failures*.

These tests definitely establish the outstanding dependability of Sylvania Picture Tubes. They prove that these tubes will best uphold your reputation for fine performance in the sets you manufacture, sell or service. Send today for complete details about Sylvania Picture Tubes. Sylvania Electric Products Inc., Dept. 3R-2401, 1740 Broadway, New York 19, New York.

SYLVANIA

ACCURACY, DEPENDABILITY, ALL-WEATHER OPERATION

MAKE ALLIANCE TENNA-ROTOR VITAL KEY IN RAILROAD TV!

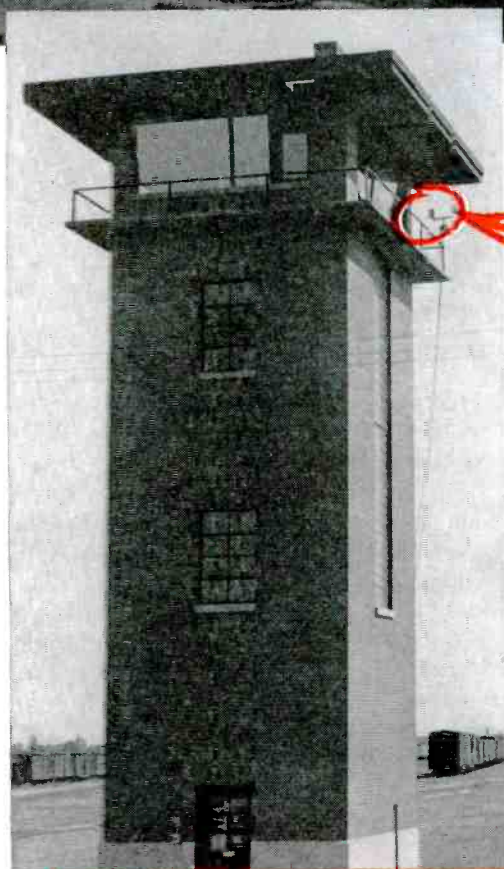
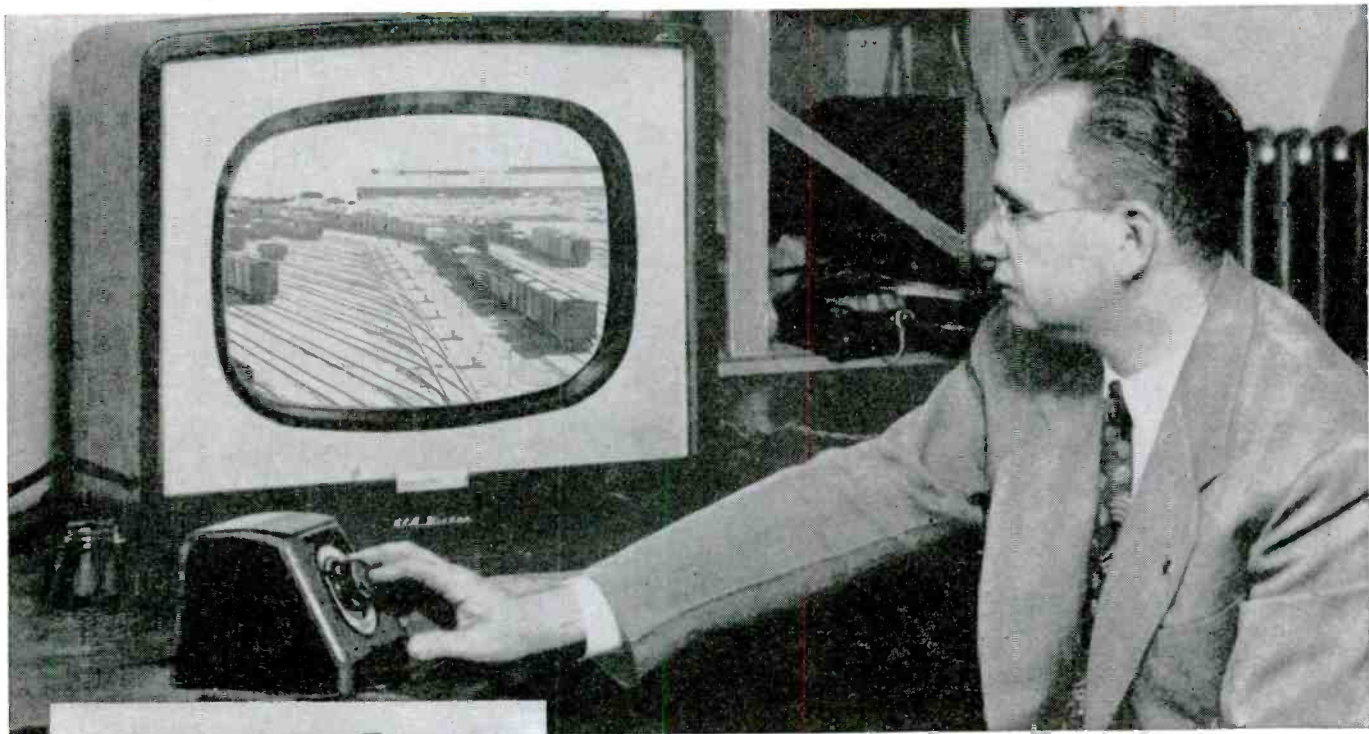

Yardmaster now "watches" cars from desk as **ALLIANCE TENNA-ROTOR** turns TV camera!

Alliance TENNA-ROTOR is "working on the railroad!"

Railroad yardmasters in the Baltimore & Ohio Chicago yards now speed their work. They use *television* to direct freight cars over the maze of switches and tracks. Small TV cameras mounted on Alliance TENNA-ROTORS rotate to scan any section of the yard. Yardmasters operate the TENNA-ROTOR control and observe the yard movements on the TV monitor screen, right at their desks!

Hundreds of thousands of TV viewers rely on TENNA-ROTOR's accuracy

New UHF stations are highly directional! Channels are changing on many stations . . . this makes many 'stay-put', single channel antennas obsolete! For accurate "on-the-beam" reception . . . UHF and VHF, Alliance Tenna-Rotor is the number one TV accessory!

Advertised on 60 TV stations. It pays to push the line that's pre-sold!



ALLIANCE MANUFACTURING CO. • ALLIANCE, OHIO

...sold the MOST because it's seen the MOST!

alliance
TENNA • ROTOR

TELEVISION ANTENNA ROTATOR

*“... opportunity
is freely given...”*

PAUL M. HAHN

President, The American Tobacco Co.

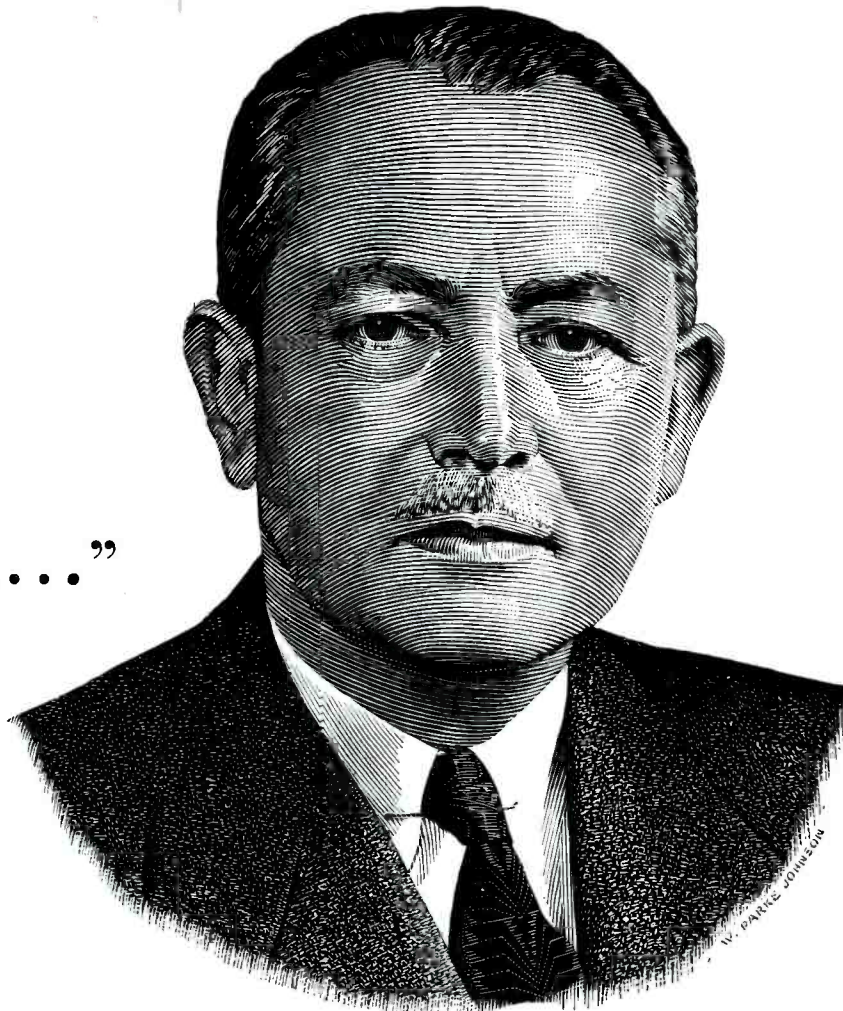

“Our nation has grown great largely because opportunity is freely given. Only very few people actually make their own ‘breaks.’ Today, millions of Americans are providing for their personal financial security and at the same time helping in the building of our national defenses. The opportunity to do so is given by business management which affords employees the means of practicing systematic thrift through the Payroll Savings Plan for the purchase of U. S. Defense Bonds.”

Nearly seven million employees of industry are “providing for their personal security and at the same time helping in the building of our national defenses.”

- they are the men and women who availed themselves of the opportunity referred to by Mr. Hahn—the opportunity to enroll in the Payroll Savings Plan for the systematic purchase of U.S. Defense Bonds.
- they represent a high percentage of their companies’ employees—in plant after plant, the averages are climbing to 60%, 70%, 80%—even higher.
- their investment in Defense Bonds—and America—add up to \$140 million per month.
- they constitute a large block of the men and women who on December 31, 1951, held Series E Bonds

amounting to \$34,727,000,000—\$4.8 billions more than the cash value of Series E’s outstanding in August, 1945.

Not far from you is a State Director of the Savings Bond Division. He will be glad to tell you how easy it is to give your employees a Payroll Savings Plan. Or, if you already offer the Plan to your people, he will show you how to conduct a simple person-to-person canvass of your plant—a canvass intended to do only one thing—to put a Payroll Savings Application Blank in the hands of every man and woman on your payroll. Your employees will do the rest.

Phone or write to Savings Bond Division, U.S. Treasury Department, Suite 700, Washington Building, Washington, D. C.

The U. S. Government does not pay for this advertising. The Treasury Department thanks, for their patriotic donation, the Advertising Council and

SERVICE



PRESTIGE of the **BUSS** Name and
PROTECTION of BUSS **FUSES** means
PROFIT For You

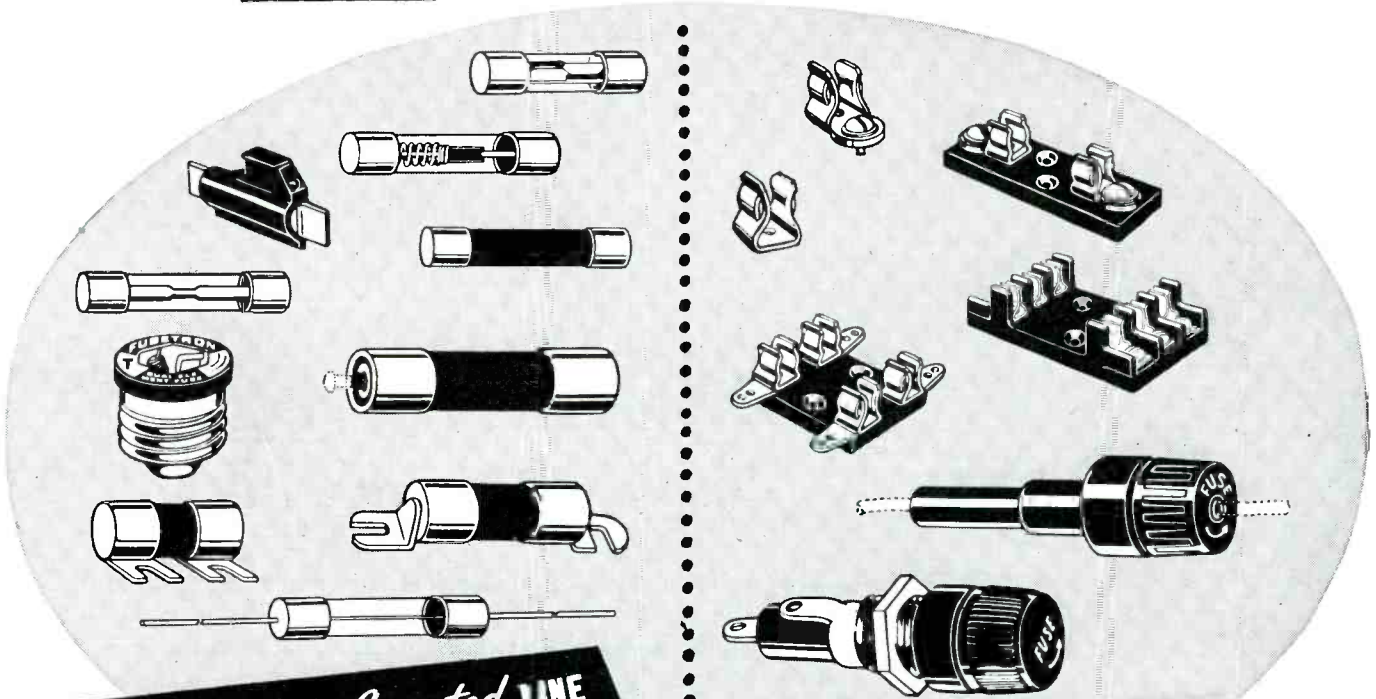

THE Customer Accepted LINE
 for: TELEVISION
 RADIO
 RADAR
 INSTRUMENTS
 CONTROLS
 AVIONICS

*.. Plus a complete
 line of fuse clips,
 blocks and holders*

For more than a third of a century BUSS has lead in the research, design and development of fuses for electrical protection. To maintain this standard of unquestioned high quality, each and every BUSS fuse for the electronic field is tested in a highly sensitive electronic device that rejects any fuse that is not correctly calibrated — properly constructed — and right in all physical dimensions.

The complete BUSS line makes it easy and economical for you to select the fuse that is right for any requirement. Choose from Dual-Element (Fusetron slow blowing fuses), Renewable, and One-Time types which are available in all standard sizes, and many special sizes and designs.

BUSSMANN Mfg. CO., Division McGraw Electric Company
 University at Jefferson, St. Louis 7, Missouri

The BUSS Trade-Mark Helps Insure Your Profits and Goodwill

You'll never be bothered with irritating, profit-consuming kicks and comebacks—because BUSS is the **Known** line, and people won't blame their troubles on fuses you furnished them. Thus the BUSS Trade-Mark protects your profits and goodwill.

You're Invited

TO MAIL THIS
 HANDY COUPON TODAY!

BUSSMANN Mfg. Co. (Division of McGraw Electric Co.)
 University at Jefferson, St. Louis 7, Mo.
 Please send me bulletin SFB giving the facts on
 BUSS small dimension fuses and fuse holders.
 Name..... Title.....
 Company.....
 Address.....
 City & Zone..... State..... S-153

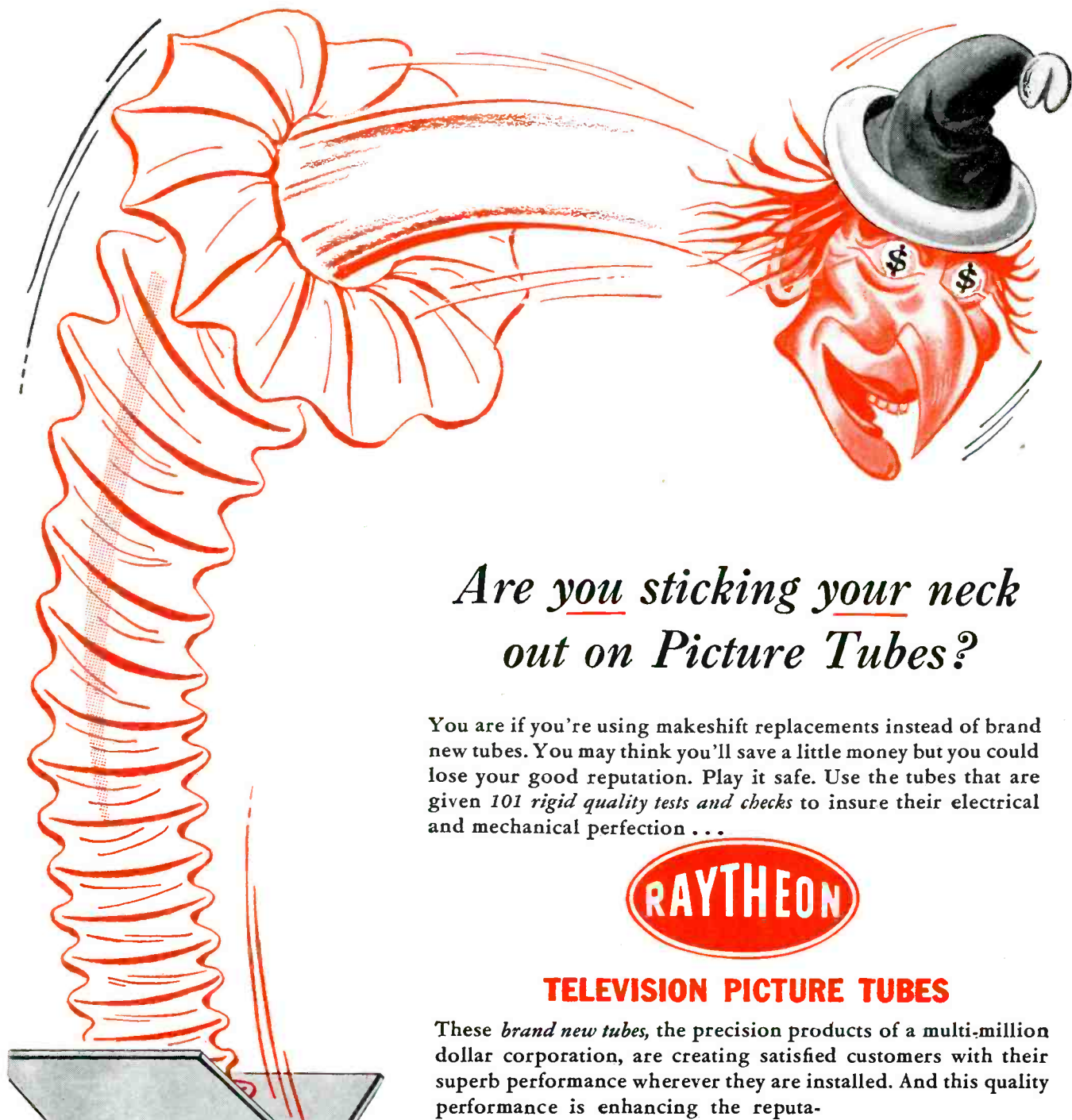

Are you sticking your neck out on Picture Tubes?

You are if you're using makeshift replacements instead of brand new tubes. You may think you'll save a little money but you could lose your good reputation. Play it safe. Use the tubes that are given 101 rigid quality tests and checks to insure their electrical and mechanical perfection . . .



TELEVISION PICTURE TUBES

These *brand new tubes*, the precision products of a multi-million dollar corporation, are creating satisfied customers with their superb performance wherever they are installed. And this quality performance is enhancing the reputation of the Service Technicians who install them. Protect your future with RAYTHEON TV PICTURE TUBES.



Use RAYTHEON TELEVISION PICTURE TUBES
They're Right for Sight . . . and Right for You . . . and Always New!



RAYTHEON MANUFACTURING COMPANY

Receiving Tube Division
Newton, Mass., Chicago, Ill., Atlanta, Ga., Los Angeles, Calif.

Excellence in Electronics

RAYTHEON MAKES ALL THESE:
RECEIVING AND PICTURE TUBES • RELIABLE SUBMINIATURE AND MINIATURE TUBES • GERMANIUM DIODES AND TRANSISTORS • NUCLEONIC TUBES • MICROWAVE TUBES



The Guarantee Tussle

IN SERVICING, especially since the advent of TV, Service Men have been plagued by the ever-provocative issue of *guarantees*.

Now, the rash, oleaginous promises of too many in servicing, and even industry, have become so frequent that associations and better-business groups have decided to enter the scene and wage war.

Believing that there are an army of earnest and honest operators who are anxious to pitch in and serve in the cause, the BBBs have asked Service Men for their assistance. Questionnaires have been submitted asking for forthright answers to the knotty problem. It is heartening to report that many replies have been received and with enlightening information. In one review of the situation, a Service Man* declared that the confusing state of guarantees could be ironed out by engaging in a bold public-relations program, carrying messages to Service Men, the consumer, and even set manufacturers. The theme of the program, it was said, should be that no guarantee is stronger than the intent behind it, and based solely on the sincerity of those involved.

Commenting on the type of supporting statements that should appear to describe the insurance value of a valid guarantee, this operator noted that ads and bulletins should stress the fact that only well-trained, skilled Service Men are able to repair chassis, in a reasonable time, and are thus entitled to an equitable payment for material and their effort. The public should not demand free labor within 90 days or longer following a repair job, and will not, if they are convinced that such a request is completely unreasonable.

The report then referred to a very vital point, the complexity of the TV chassis, which contain more circuits, components, wires and controls, than any of the standard household appliances, such as vacuum cleaners, sewing machines, toasters, or even the midget radio; thus more knowledge and experience is absolutely essential.

Unfortunately, it was noted, too many sets have been sold on the premise that they are absolutely trouble free, and if manufactured correctly,

will never break down. Recently some chassis makers have revised their philosophy and begun to follow the practice of automobile manufacturers, who bluntly advertise the fact that efficient repair facilities are available at convenient locations, acknowledging that their cars do require attention, with occasional replacement of worn parts. It was suggested that all TV manufacturers should subscribe to this type of thinking and indicate that if their equipment eventually requires attention, and possibly repair and part replacement, a capable Service Man should be called in.

Stressed, too, should be the fact that even though parts and tubes might carry a long-term guarantee and new parts are available at no charge, servicing is still required, for the defective parts or tubes must be removed and replaced by a trained man who is certainly entitled to compensation for his labor.

Set owners would not become so disturbed about repair expenses, if they adopted a budget plan, it was pointed out, setting up a fund as a reserve for repair and replacement; perhaps based on 25 per cent per annum of the cost of the receiver. Thus, the owner of a \$200 receiver would put aside \$1 a week and set up a base kitty of \$20. The owner of a \$250 console could bank \$25 in a TV budget envelope, and then set aside \$1.25 each succeeding week.

Newspapers could also be very helpful in this campaign, it was indicated, by careful advertising solicitation and presentation. The dailies should print only TV repair ads that contain bonafide addresses, and non-evasive and complete specifications of what services are offered in return for the advertised amount. As an example, if a service-call charge is noted as \$5.95, the advertiser should state that this covers a half-hour labor charge at home, and time over the first 30 minutes will be charged at a \$5.00-an-hour rate. It should also be clearly stated that part replacements involve an additional charge.

Congratulations to the BBBs and cooperating Service Men on this crusade, which it is hoped will rout the irresponsible and their brash claims, and bring a justifiable soundness to the term *guarantee*.

Phono Designers—Please Help**

WITH THE INTEREST in ultra-fidelity galloping along, more and more have become very conscious of all of the special elements that are required to provide this improved reproduction. Of particular concern has been the *needle*, that tiny item so vital to the successful operation of the hi-fi chain.

Unfortunately, in too many systems the installation of the needle has been a monumental job, instead of a simple task. At one time, pickup cartridges were designed around the needle. Since the advent of hi-fi, and with the intention of improving quality, the procedure has been reversed, with the cartridge being designed first and the needle assembly following. In many instances, this has resulted in the oddest assortment of needle shapes and methods of replacement, with a weird variety of positioning springs, secreted set screws and complex mounts holding assemblies in place. Service Men have found it impossible to insert new needles in most of these jig-saw assemblies.

It must be admitted that the technique of designing the cartridge first, with the needle assembly following along, has resulted in a definite improvement in response, as long as the needle remained in good condition. But, since no needle has a permanent life, it must be eventually replaced. Not even the stouthearted diamonds last forever. Eventually, even the most durable of all substances succumb to the attritious attack of the spinning groove.

While it may be impossible to return ever to a single uniform needle design, it should be possible to limit the variety of designs and standardize on methods of removal and replacement. Perhaps pickup and phono-system designers should form a committee to set standards for phono-needle shanks, and also evaluate the problems which may develop after the equipment has been installed. Immediately, phono manufacturers can help remedy the condition by supplying well-prepared instructions, detailing exactly how to replace the needle, and also advising honestly how long the needle in the cartridge will really last.

Service Men will be forever indebted to phono designers, if they will make it a pleasure, instead of a chore to replace those precious needles.—L. W.

*Arthur E. Rhine.

**With apologies to E. J. Marcus of Tetrad.

Parallel-Wire Transmission

Circuitry Features of Continuous 70-Channel Unit Which Employs Input Filter to Reduce Image and Spurious Response, Curb Oscillator Radiation of Converter, and Serves to Provide Decoupling Isolation From Antenna Line at VHF Frequencies

IN DESIGNING CONVERTERS for *uhf* application, there are several approaches that can be followed. On several occasions, many of these have been discussed in SERVICE.*

In Fig. 1 appears the circuit of one type, recently developed, which features the use of two sets of parallel-wire transmission lines as tuning elements. To gain compactness, as well as to simplify the slider and tuner drive mechanism, the lines are circularly shaped. Tuning is accomplished by using silver-plated sliders, and is continuous via a dial drive shaft covering 70 channels in 340° of rotation, permitting use of a direct dial scale. Included in the tuner are two stages of *if* amplification.

In the tuning mechanism, which provides tuning of both circuits simultaneously, anti-backlash drive and

speed reduction are obtained by using a spring-loaded dial cord around a molded bakelite ring to which the preselector and oscillator sliders are attached.

The circuitry of this converter is quite simple. The overall *rf* circuit consists of a balanced high-pass input filter, preselector transmission line tuning section and a crystal mixer.

The input filter has been designed to reduce image response, reduce spurious responses, especially high powered *vhf*-TV or FM broadcast stations; and reduce oscillator radiation of the converter itself.

There is still another function of the filter which can be quite useful,

and that is decoupling-isolation of the *uhf* converter from the antenna transmission line at *vhf* frequencies. This is particularly applicable when combination *vhf-uhf* antennas are being used.

It is perhaps interesting to compare the electrical and physical appearance of the filter since this points up strikingly the change from conventional circuitry wrought at *uhf*. The electrical diagram of the filter is shown in Fig. 2 and its actual physical appearance is illustrated in Fig. 3. The filter capacitances are represented by C and $2C$, while L represents the inductance. The unique feature of the filter, in its physical form, is that no conventional capacitors are used nor are there any soldered joints.

Capacitance is obtained by the proximity effects of the wires; that is, by placing them close to one another. To form the smaller capacitance C (Fig. 2), leads from each inductance are brought together and held by small wire staples. For the larger $2C$, one circuit lead and one inductance lead are similarly held by metal staples. The dielectric between the conductors,

¹An application for a patent, which covers the mechanical configuration, has been filed.

*Martin, Wyn, *UHF Continuously-Tuned Oscillator*; May, 1952. Martin, Wyn, *UHF Selectors*; Nov., 1952. Hesse, Henry R., *UHF TV Converter*; Sept. 1952. Percy, M. W., *Ser-Cuits*; May and June, 1952.

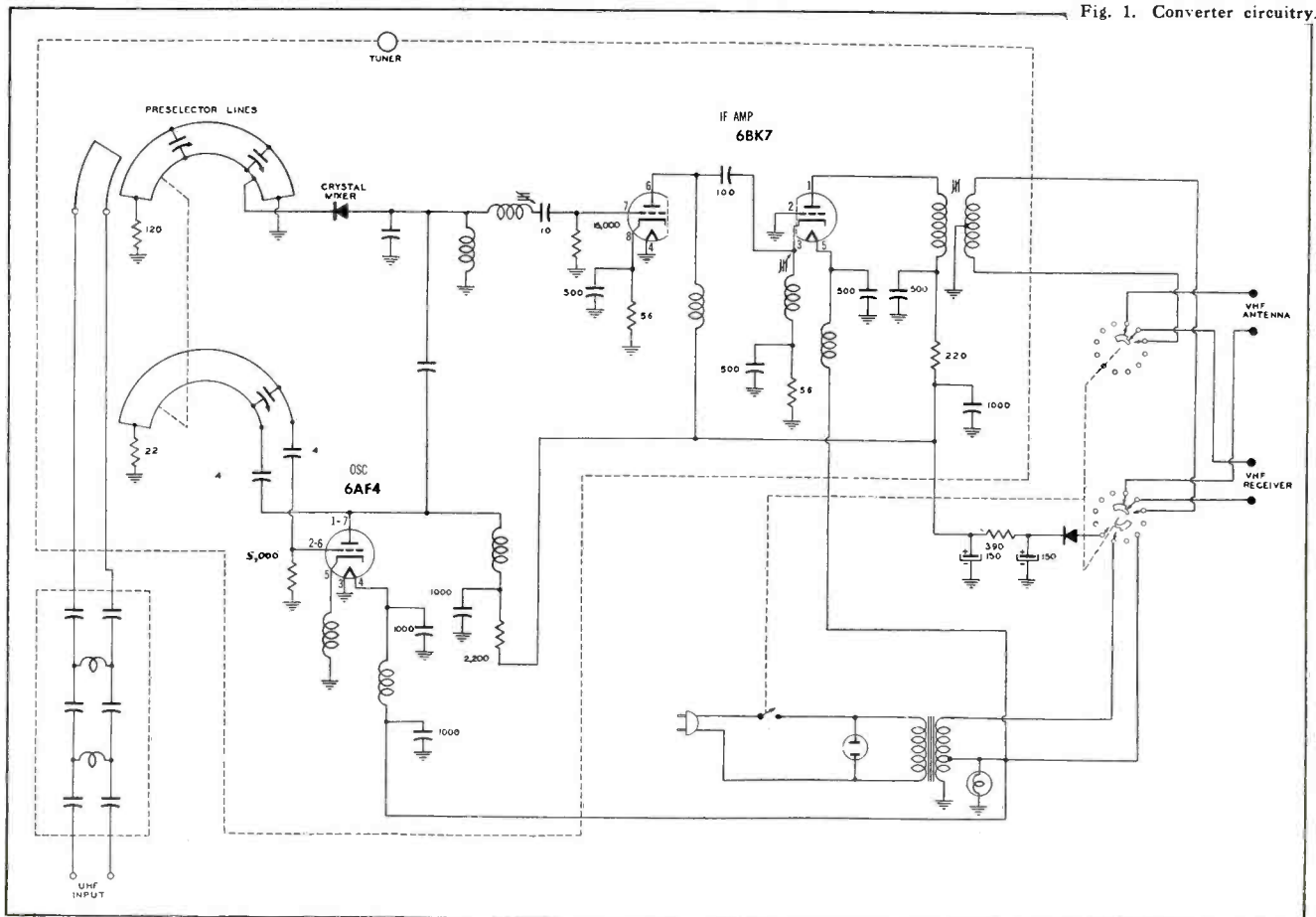

Fig. 1. Converter circuitry.

Line UHF CONVERTER

by R. A. MORRIS, Chief Engineer, I.D.E.A., Inc.

for both capacitances, is provided by the wire insulation.¹

The capacitance value, C , is on the order of 1 mmfd and the inductance value is .06 μh . The impedance of this double T , constant K , high-pass filter is 300 ohms and the cut-off frequency is 400 mc (approx.). The selection of this value of cutoff frequency, rather than one closer to 470 mc, the lower limit of the uhf band, was made to avoid excessive loss in the neighborhood of 470 mc. Signals passing through this filter suffer an average loss of about 3 db. Below 400 mc the attenuation rises rapidly reaching a value of 28 db at 250 mc. Losses in excess of 30 db are obtained in the $v hf$ and FM bands. These attenuations are directly addable to the inherent attenuation in the non-passband of the tuner.

Following the filter is the preselector, which uses a half-wave transmission line with the input coupling loop positioned at one end and the crystal mixer at the other. A movable shorting bar determines the active electrical length of the line, and over the entire uhf 470 to 890-mc band, it covers a distance of 4".

The oscillator circuit is of the ultra-audion variety using a 6AF4. The tuning circuit here is a quarter-wave transmission line which is capacity-loaded at its open end. Addition of this capacity tends to shorten the required length of the line.

Both the oscillator and preselector lines are made of $\frac{1}{4}$ " wide curved parallel strips of silver-plated brass. Tuning by means of a parallel line of adjustable electrical length has been found to provide a large frequency range, simplicity of tuning, and uniformity of tuning, which facilitates tracking and flexibility of design.

It will be noted that whereas the rf preselector circuit employs a half-wave length of line, the oscillator uses a quarter-wave length. This is so, because the local oscillator tunes from 275 to 710 mc, while the rf preselector covers the 470 to 890 mc range. It will also be noted that the local oscillator frequencies are not exactly half of the uhf frequencies; this unusual condition is taken care of by adding a capacitor across the open end of the quarter-wave line. This serves to shorten the line so that each shorting bar will travel over the same distance.

Since the shorting bars of both lines are ganged to the same tuning shaft,

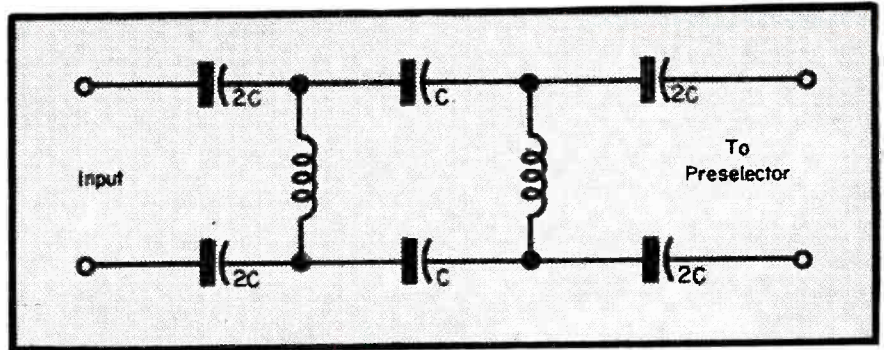

Fig. 2. Electrical schematic of input filter.

adjustments must be provided to insure proper tracking. This is accomplished by using two trimmers on the preselector lines. One trimmer is used for adjustment at the hf end and another trimmer is for adjustment at the lf end. On the oscillator tuner line there is a small trimmer across the open end of the line; this establishes the frequency at the low end of the range.

High stability is available in the local oscillator. The warm-up drift of the local oscillator at the hf end of the band has been found to be approximately +200 kc and at the low end of the band it is approximately -200 kc. The frequency stabilizes after about five minutes of operation. The maximum deviation due to line voltage drift is approximately 70 kc throughout the range of 95 to 125 volts line change.

The output of the crystal mixer is fed to a two-stage intermediate amplifier. A 6BK7 double triode is used. The amplifier tuned circuits are adjusted to $v hf$ channel 10. Actually, any of the $v hf$ channels 8, 9, 10, 11, or 12 can be chosen, permitting a choice of the channel which is most free of undesirable interference.

The power gain of the intermediate amplifier at 200 mc measured as the

ratio of power at the 300-ohm input to the power into the grid of the input stage has been found to be 21 db. The bandwidth of the intermediate amplifier has been found to be adequate to allow for mistuning and drift, and prevent appreciable amplitude distortion. The overall bandwidth is approximately 7 mc and is reduced as much as possible to obtain maximum gain and provide maximum attenuation to spurious $v hf$ signals.

Not only can this unit be used as a complete uhf device, but as a tuner installed on a $v hf$ chassis proper with the tuner working into the high $v hf$ channels. This is particularly true for receivers using a 25-mc if . In these instances spurious responses can be overcome by switching the $v hf$ tuner to channels 8, 9, 10, 11, or 12, whichever is free of undesirable response, and adjusting the if output trimmer control on the rear of the tuner accordingly.

In another application of this unit, the uhf tuner would have a 40-mc if output frequency and would couple directly into a 40-mc if amplifier system. In this case, two preselector stages will be used in the uhf tuner. Finally, this uhf tuner can be combined with a compatible $v hf$ tuner serving as a compact and complete tuning unit.

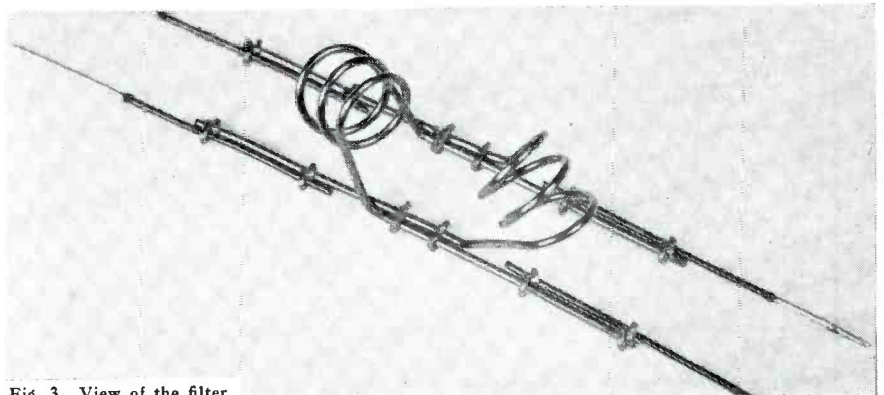

Fig. 3. View of the filter.

Comprehensive Analysis of Vital Audio Components Detailing Electronic and Physical Features of Crystal and Magnetic Pickup Compensators . . . Preamps for Magnetic and Capacitive or FM Pickups . . . Treble Preemphasis and Methods Now Available to Suppress Surface Noise on Records

PICKUP COMPENSATORS

IN THE EARLY DAYS of acoustical recording the artists played or bellowed into large horns which led directly to the recording diaphragm, and the cutting head was expected to do as well as it could with the undoctored original sound. This procedure is, of course, no longer followed today; the signal that is fed to the magnetic recording head is electrical rather than acoustical, and has been changed according to a definite plan, so that the relative intensities of the original bass and treble frequencies are radically altered. If the disc were played back

through a *flat* (uniform frequency response) system the results would be thin in the bass and screechy in the treble. It is necessary, therefore, that the record playback system restore the original frequency distribution to the recorded signal.

This restoration is performed by the frequency discriminating characteristics of the pickup or of the circuit into which the pickup works. It is this circuit which is called the pickup or record compensator. Actually it compensates simultaneously for both the record and the pickup, and its design

depends upon the frequency characteristics of each.

Recording Characteristics

The groove *excursion* or displacement required for the recording of a signal of given amplitude is not constant at all times, but increases as the frequency of the signal is lowered. Bass notes will therefore be recorded by relatively wide groove modulations, while treble notes of the same power will be confined to a much narrower area of excursion.

If this natural effect is not checked the width of the groove modulations at very low frequencies will be extremely great. In such a case either the spacing of the grooves must be made very wide, so that the small number of grooves-per-inch is unsatisfactory from the point of view of playing time, or over-cutting from one groove to another will take place.

The modern solution¹ to this problem is illustrated in Fig. 1. Bass attenuation is introduced into the recording itself, below a given frequency called the *turnover* point, and is compensated for in playback. In this way a signal of given power will create groove modulations of the same width at all frequencies below turnover. The rate of attenuation required to accomplish this purpose is 6 db per octave, and this rate is standard in commercial records of all makes. Unfortunately, however, no standard turnover frequency has been adopted by the record industry, and values ranging from 250 to 750 cycles have been used. European recording companies have in general used the lower values.

It is clear that, no matter what turnover frequency is used, the reproduced

Fig. 1a. How groove modulations (for the same signal amplitude) increase as the frequency is lowered; *constant velocity* recording. The effect of bass attenuation, producing *constant amplitude* recording below the turnover frequency, is shown in *b*. Bass attenuation (6 db per octave) required for *b*, as illustrated in *c*.

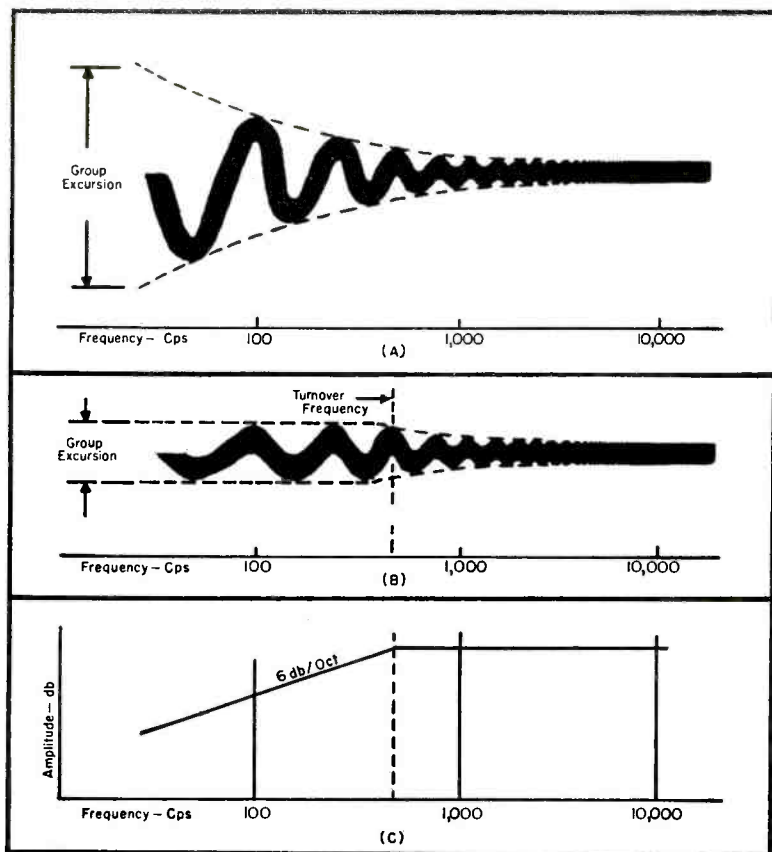

¹This was not a serious consideration in earlier recording, because the bass regions could only be recorded with greatly diminished amplitude anyway.

Fig. 2. Graph of the *af* spectrum as it is recorded. This curve is known as the recording characteristic.

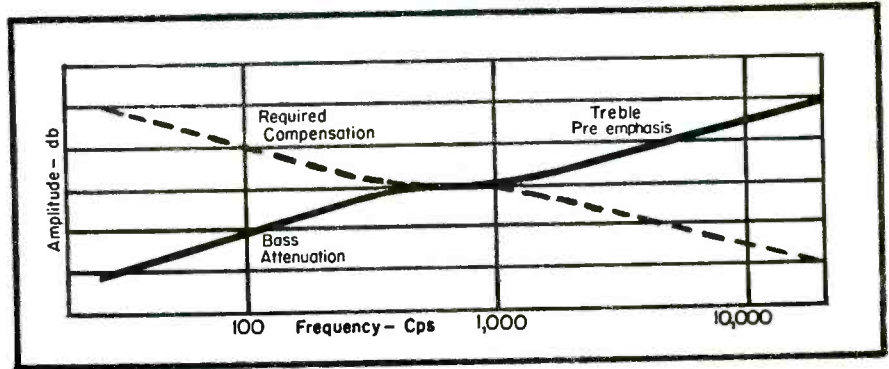

and **PREAMPS**

sound will be very tinny unless the bass attenuation is equalized during playback.

Treble Preemphasis

Random irregularities in the record groove create well-known source of irritation, surface scratch. This noise has two adverse effects; it is an extremely annoying sound to listen to, and in addition the high-frequency signals (whose groove excursion is very small, sometimes comparable to the dimensions of the groove irregularities) may be *masked* so as to become inaudible, or *lost in the mud*.

Modern recording has adopted a technique to reduce surface noise, which is directly analogous to the treble preemphasis employed in FM broadcasting. The high frequencies are boosted in the recording, so that the ratio of treble signal-groove deviation to that of the random irregularities is increased. Playback equipment must therefore provide treble *deemphasis*, as in an FM receiver. This makes the music sound natural again, and in addition cuts the surface noise appreciably.

As in the case of bass turnover, the record companies have not reached agreement on the best treble preemphasis curve to use. To illustrate, on Columbia 78 and 33 $\frac{1}{3}$ records, treble

by **MARK VINO**

preemphasis begins at 1,590 cps, and the rate of treble boost is 6 db per octave. RCA uses 1,000 cps as a treble preemphasis base for their 78s, while the rate of treble boost is 2 $\frac{1}{2}$ db per octave. In contrast, the FFR Decca records (78 and 33 $\frac{1}{3}$) have a treble preemphasis base of 3,000 cps; rate of treble boost is 3 and 6 db per octave, respectively.

A graph of the complete frequency spectrum as it is recorded, including bass attenuation and treble preemphasis appears in Fig. 2. The particular curve used to doctor the recorded signal is called the *recording characteristic*.

Crystal Pickup Compensators

The frequency response or playback curve of a phono should be the mirror image of the recording characteristic, as illustrated by the dotted line of Fig. 2. The crystal phono pickup has a natural frequency response which resembles this required playback curve, and crystal pickups are therefore often used with a minimum of compensation. There is invariably some compensation, however, as the grid resistor

across which the crystal is connected acts as a compensating circuit element. The lower the value of this resistor the less will be the bass response of the pickup. There is an optimum value normally recommended by the manufacturer which should always be used. This is usually between $\frac{1}{2}$ and 1 megohm.

More elaborate crystal pickup compensators may be purchased² or constructed with a few simple parts, and in most cases these greatly increase the fidelity of reproduction. A typical circuit design is shown in Fig. 4. Proper values for particular pickups are generally obtainable from the cartridge manufacturer. These values are usually chosen to effect a compromise between the various recording characteristics in use by record companies, and additional frequency adjustments may be introduced by use of the phono's tone controls.

Magnetic Pickup Compensators

The frequency response of modern magnetic pickups, unlike that of crystals, is uniform over the frequency band. Bass boost to balance the bass attenuation in recording, and treble droop to compensate for preemphasis, must therefore be introduced by the circuits following the pickup. Treble
(Continued on page 48)

Fig. 3. Preamplifier for magnetic pickup. (Courtesy G.E.)

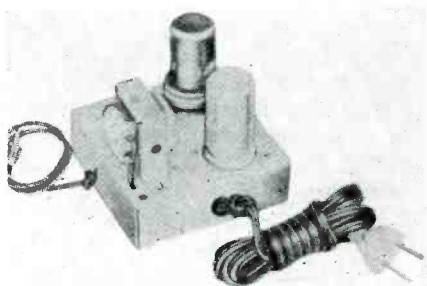

²For use in conjunction with a particular cartridge or series of cartridges.

Fig. 4. Typical circuit for crystal pickup compensator. Values for *R* usually range from .25 to 2 megohms; for *C*, 50 to 200 mmfd.

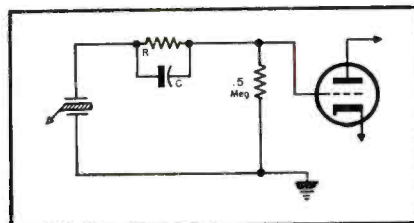
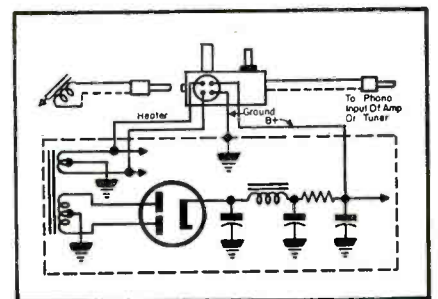

Fig. 5. How to connect a preamp for magnetic pickups.



SELENIUM Rectifier TESTER

by **EARL STEIKER** and **OSCAR NELSON, Jr.**

Gen. Manager, Rectifier Div.

Senior Design Engineer

Galvanic Products Corporation

HIGH-VOLTAGE miniature selenium rectifiers, introduced early in '46, have since found widespread use in all types of radio and TV sets, because of their many advantages. In addition, shortages of scarce materials, whose use they can eliminate, have now greatly increased the popularity of these rectifiers.

While proving quite satisfactory to chassis manufacturers, these disc rectifiers have been quite a problem to Service Men, due not only to the difficulty in testing them properly, but to the high cost of building homemade equipment necessary to provide an adequate test. In addition, there has been confusion as to what actually constitutes a good test for these rectifiers, and what limits should be used on this test.

General Methods of Test

Two methods have been generally used to test miniature selenium rectifiers; the ohmmeter test and the substitution test. Both of these have been found to be inadequate and a source of

[See Front Cover]

serious confusion or damage. While the ohmmeter test does provide a fair indication of forward conductivity, it is not too practical when used to measure the reverse characteristics of the rectifier, because it does not apply the proper peak inverse voltage to the rectifier. Many rectifiers, which apparently are all right at the lower voltage, will pass excessive reverse leakage current or break down completely at the higher voltage. Excess reverse leakage can damage electrolytics or cause the stack to burn out in a very short time.

Substitution Method Problems

The substitution technique can lead to trouble because there is not always a positive indication that the rectifier being replaced is at fault rather than some other component, and because the replacement rectifier may be faulty. This can cause damage to a number of good rectifiers, series resistors, and

electrolytics before the trouble is located.

Deforming Requirement

Both of these tests have also been found to be ineffective, because they do not account for the *deforming* characteristics of selenium rectifiers. Often, rectifiers that have been on the shelf will decrease in reverse resistance and draw excessive reverse leakage current when the voltage is first applied. This excessive reverse current can damage the electrolytic or the rectifier itself and can also cause low *B* voltage. However, if voltage of the proper peak value is applied to these rectifiers for a short time before they are installed, many of them will *reform*; that is, their reverse resistance will increase until they pass less than the maximum allowable leakage current. Incidentally, this reverse leakage current is peculiar to dry metallic rectifiers and does not exist in vacuum tubes. When the current is excessive, it can cause the rectifier to overheat, causing it to age rapidly or burn out. Excessive leakage current can also, as has been mentioned, cause low output voltage or damage the electrolytics.

Other Suggested Tests

Recently, two other tests have been suggested. One of these, the output voltage test, is shown in Fig. 1. This means of checking has been found to be inadequate, too. One important difficulty has appeared in the electrolytic setup; since these capacitors age with time, there will appear variations in output voltage, other than those for which the rectifier is responsible. Also, rather intricate protective equipment has been found to be necessary to protect all of the components should a dead short-circuited stack be placed on test. This protective equipment would be quite important if the tester was also to be used as an electroforming device.

The other recommended tests are illustrated in Figs. 2 and 3 (p. 56-57).

(Continued on page 56)

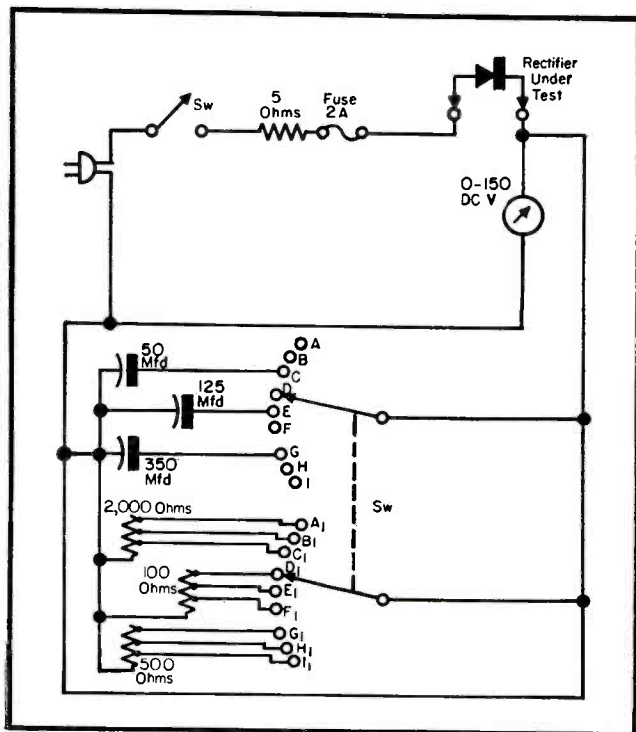
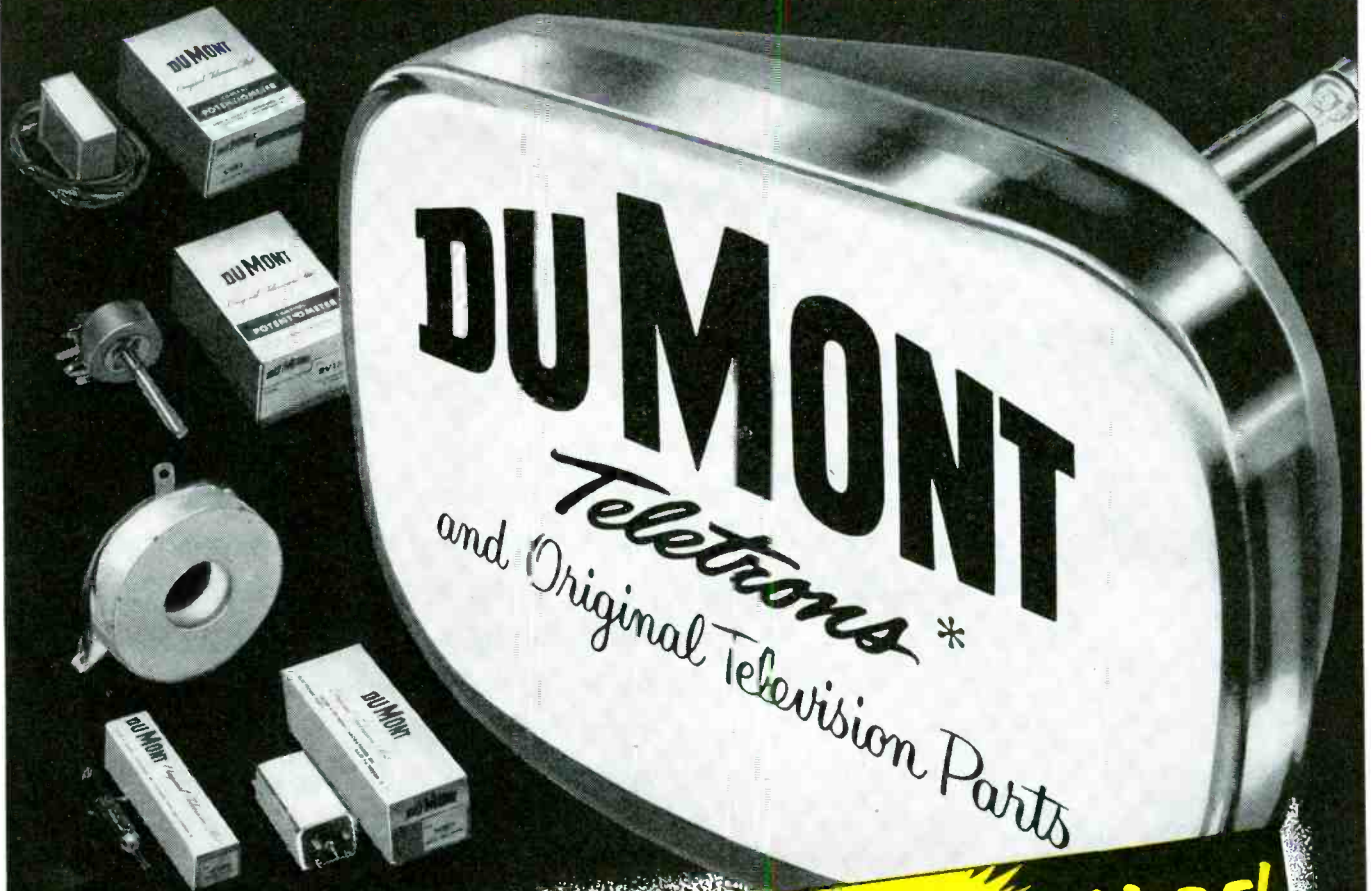

Fig. 1. Output voltage tester for selenium rectifiers.

DO IT RIGHT- DO IT WITH DUMONT



FREE! YOUR COPY OF **DUMONT Service News** **HERE!**



at your jobber!

THE SERVICE NEWS, authoritative publication of Du Mont Teleset Service Control, gives you each month service techniques as they are tested ... production changes as they happen!

With the *right information*, minutes may save hours of trouble-shooting. With the *right parts*, repair is simplified ... service is better ... customer satisfaction builds confidence and reputation.

Both are at your local Du Mont Distributor. Look for the Du Mont SERVICE NEWS on your next call ... and insist on ORIGINAL TELEVISION PARTS.

*TRADE MARK

REPLACEMENT SALES, CATHODE-RAY TUBE DIVISION, ALLEN B. DU MONT LABORATORIES, INC., CLIFTON, N. J.

SERVICE, JANUARY, 1953 • 23

TUBE

News

by L. M. ALLEN

Test adapter designed to bring all socket connections topside, and permit measurement of voltage, resistance, gain or trace signals and monitor intermittents. (Courtesy Hytron)



To MEET THE DEMAND FOR more and more gain from TV chassis, it has been necessary to develop a host of new circuits and new tubes, too. One of the most popular of the circuits designed for high-gain service has been the cascode amplifier, discussed on several occasions in this journal.¹ Recently, there appeared a tube designed especially for this unusual circuit, a 6BK7A* which is a heater-cathode type double triode of miniature construction, featuring an extremely high transconductance and a high ratio of transconductance to plate current. The problem of interstage coupling has been solved by locating an internal shield between the two sections of the tube.

In Fig. 1 appears a cascode amplifier circuit** in which this tube is used, with a series arrangement which provides a more remote-cut-off characteristic for *agc* action, requires fewer circuit components and is said to result in lower effective interstage capacitance. The series cascode also provides slight advantages in noise and gain performance. On the other hand, the series arrangement necessitates using the grounded-grid stage at an elevated heater-cathode voltage; and, for the same plate voltage on each triode, a higher plate-supply voltage is required.

The problem of biasing the grounded-grid stage can be solved either by operating this section with a grid-leak

Circuitry of Cascode Amplifiers Using Miniature Heater-Cathode Double Triodes With Internal Shields...Other TV Tube Developments: Miniature High-Perveance Double Triodes for Vertical Deflection...Horizontal Frequency Damper Diodes . . . Sharp Cutoff Video Pentodes . . . Miniature Output Stage Power Pentodes

resistor between grid and cathode, or by connecting the grid to a fixed voltage from a voltage divider connected between the plate-supply voltage and ground.

It should be noted that cathode bias is not used on the grounded-cathode section, because this stage is connected to the *agc* line, and the grid effectively

sees a high impedance for *dc*. As a result of the contact-potential characteristics of the 6BK7A, a bias of .5 to 1.0 volt is developed across this source impedance. The contact-potential bias of the grounded-cathode section effectively determines the bias on the other section that is required for optimum *dc* voltage division between the two series

TV tuner using 6BK7A as *rf* amplifier in cascode circuit. (Courtesy Raytheon)

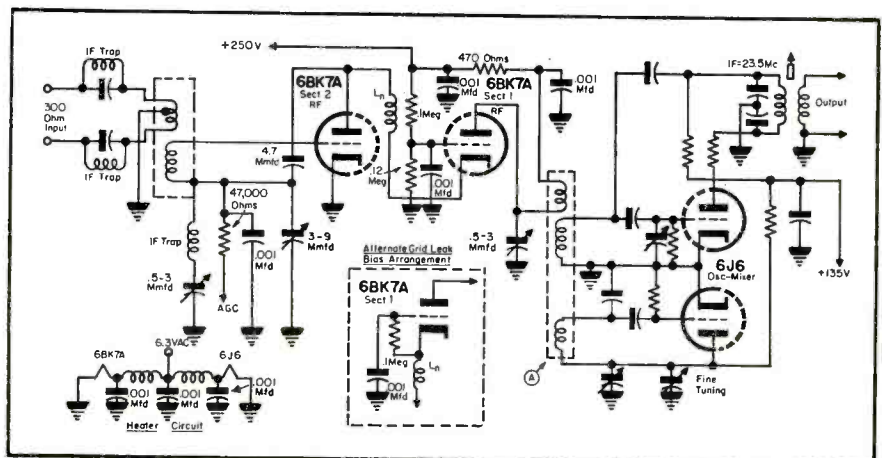

¹Menarik, Bernard A., *Cascode Tuner Conversion*, and Percy, M. W., *Capehart CX-36*; SERVICE; September, 1952.

*Raytheon. For use in *vlf* cascode circuits at frequencies below approximately 300 mc.

**Based on Raytheon tube application data.

W

hen was the last time

you were knocked

on your



It won't happen again with the

MERIT



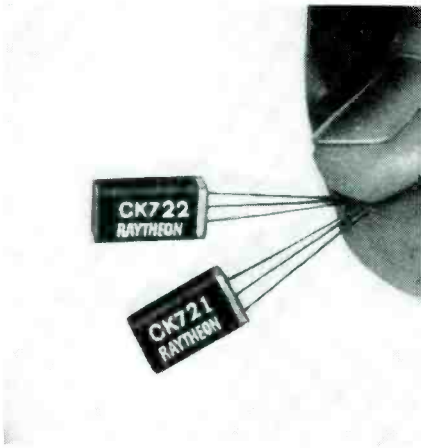

Junction transistor now being produced in quantities for military and commercial applications. (Types CK721 and CK722; Raytheon.)

sections. Any increase in bias on the grounded-cathode section such as would result by adding a cathode-bias resistor, would necessitate increasing the bias on the grounded-grid stage to maintain voltage balance, and this action would result in reduced plate current and transconductance.

It is also important to keep the effect of the cathode lead inductance of the grounded-cathode stage to a minimum. The cathode, therefore, must be connected directly to ground with the shortest possible lead. Similarly, special care must be taken in grounding the grid of the grounded-grid stage. The shortest possible lead lengths and a low-inductance capacitance should be employed.

Optimum performance of a cascode amplifier requires that interstage capacitance shunting effects be kept to a minimum. Unavoidable capacitance shunting exists in the form of stray wiring capacitance and heater-cathode capacitance of the grounded-grid stage. This capacitance loading is very severe; particularly on the high channels. To compensate for this undesired shunting, an inductance, L_n , has been added between the sections and a capacitor, C_n , connected from the plate of the grounded-cathode section to the ground side of the input transformer. These two components effectively combine with the heater-cathode capacitance of the grounded-grid stage to form a tuned π network. The values of inductance and capacitance must be selected so that the response of the network is peaked at the high TV channels.

The interstage impedance is limited by the input impedance of the grounded-grid stage and is approximately equal to the reciprocal of the transconductance of the grounded-grid

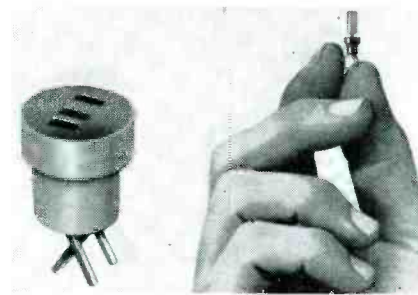

Transistor socket molded of Mycalex 410, a glass-bonded mica insulation said to have low dielectric loss, immunity to high temperature and humidity exposure, combined with maximum mechanical strength.

stage. This low impedance shorts the interstage network and as a result the frequency response of the network is very broad. If the network is peaked at the center of the high channels, improved performance will result on all of the high channels. As a result of the interstage network, the difference in performance between the low and high channels is kept to a minimum. The low interstage impedance also contributes to the high stability characteristics of the cascode amplifier.

The capacitor, C_n , also serves as a feedback network to correct for interstage degeneration and increases the effective input impedance of the first stage. The value of this capacitor has a very marked effect on the gain of the cascode amplifier. For the circuit shown, a value of 4.7 mmfd is recommended for C_n as a compromise between degree of performance and uniformity of performance.

The frequency response of the input transformer is affected by the input impedance of the grounded-cathode section. Because the input impedance increases with decreasing frequency, the response of the input transformer becomes narrower on the lower channels. As a limit, the bandwidth of the input circuit must not become less than that of the *if* amplifier. If necessary, a resistor in the order of 15,000 ohms can be connected directly across the transformer secondary on the low channels to minimize the effects of variations in input impedance from

Tube tester designed for production testing of electrostatic picture tubes: Checking of breakdown, stray emission, astigmatism, spot or raster cutoff, spot examination, line width, deflection factor or sensitivity, leakages, angle between traces, deflection plate cutoff and base alignment, etc. (Type 2166; Du Mont.)

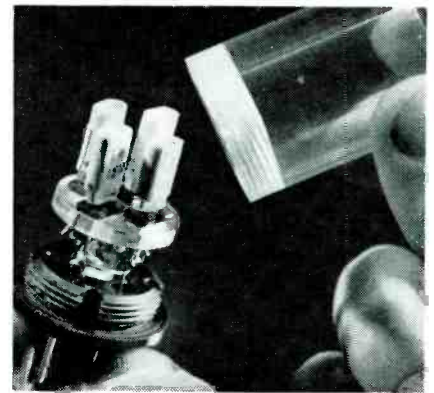
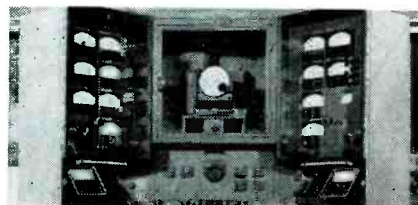

Complete experimental audio amplifier stage in which four junction transistors, mounted on a small plug-in base, perform the combined functions of two or more electron tubes, an output transformer and other components. Operating off a small low-voltage battery, this transformerless and tubeless audio amplifier developed at the David Sarnoff Research Center of RCA at Princeton, N. J., can provide sufficient amplification to operate a loudspeaker.

tube to tube, with only a slight sacrifice in performance.

Other TV Tube Developments

Also announced recently for TV applications is a miniature, high permeance, double triode, vertical deflection amplifier; 12BH7 \ddagger .

The unit consists of two completely independent medium- μ triodes in a T-6 $\frac{1}{2}$ envelope. One section may be used as the sawtooth generator while the other section serves as the vertical deflection amplifier. Both sections are designed to withstand the high pulse voltages normally encountered in vertical amplifier service. For certain applications where the plate supply voltage must be kept low, parallel connection of the two sections may be used. The heater of the 12BH7 is designed to operate from either 6.3 or 12.6 volts.

Two new diodes \ddagger for use in horizontal frequency damper circuits have also been produced; 6AX4GT and 12AX4GT. They are half-wave, indirectly heated diodes contained in T-9 envelopes, designed to withstand the extremely high voltage pulses of line frequency between cathode and both heater and plate elements, normally encountered in direct drive circuits.

The tubes are identical except for heater characteristics. The 6AX4GT requires 6.3 volts at 1.2 amperes, and the heater of the 12AX4GT requires 12.6 volts at 600 milliamperes.

A new television pentode, the 12BY7 \ddagger , is now in production, too.

This is a high transconductance, sharp cutoff video pentode, featuring a

(Continued on page 57)

\ddagger Sylvania.

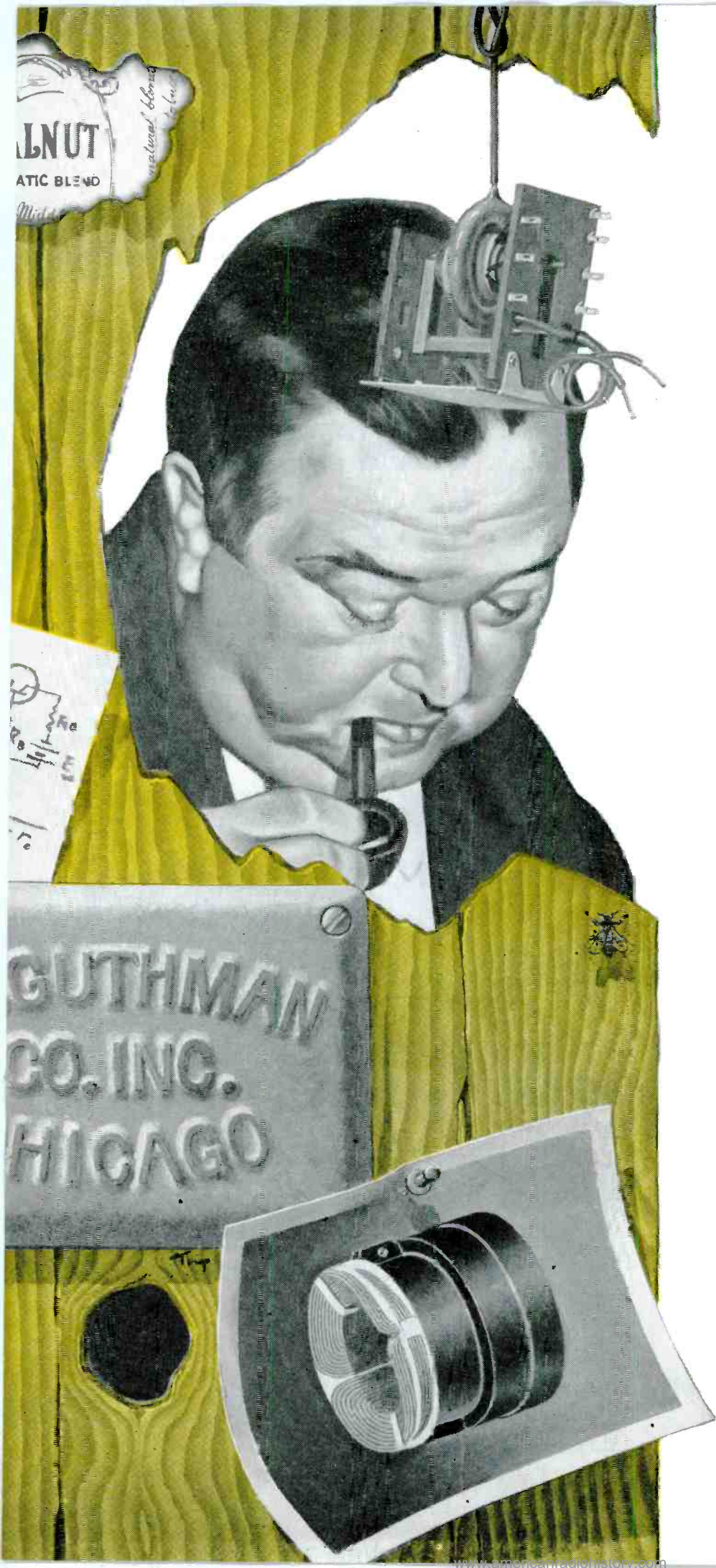

"In Arizona, my ranch is well beyond the fringe area — TV reception seemed out of reach, but I found that

with a *Regency* Booster I got an excellent picture."

Edwin I. Guthman
President
Edwin I. Guthman & Co., Inc.
Chicago, Illinois and Attica, Indiana



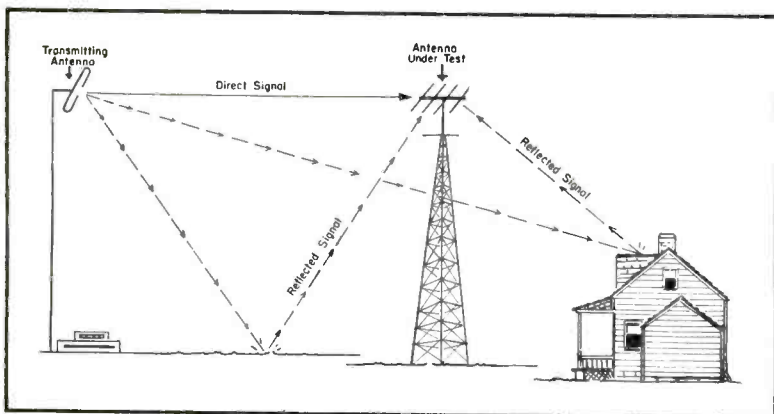

Fig. 1. Method used in past to measure antenna characteristics; faults common in antenna test sites are illustrated here.

Measuring TV ANTENNA

ACCURATE, RELIABLE measuring techniques are an absolute necessity in the design of TV antennas. The demand for more and more gain for fringe areas, and the increased complexity of *uhf* receiving problems makes adequate test facilities even more important.

There are three indications of antenna merit. The first is the antenna's gain. It is the measure of an antenna's ability to gather signals arriving from a given direction and deliver them to the receiver. The second is the an-

tenna's radiation pattern, which indicates the ability of the antenna to discriminate against unwanted signals arriving from other directions. Another characteristic of antennas is the voltage standing-wave-ratio, which measures an antenna's usefulness in delivering power to a load of given impedance level.

The theory of measuring both antenna gains and antenna patterns is simple and straightforward. To measure gain, one connects the antenna under test to its proper transmission

line and measures the power available to a matched load at the transmission line terminals. One then substitutes for the antenna under test a standard antenna, (usually the standard is a matched half-wave dipole) and measures the power available at the transmission line terminals. The ratio of these two powers is the gain of the antenna. This ratio is usually expressed in decibels (*db*).

To measure the pattern of an antenna, the antenna is connected to a power measuring device and the power

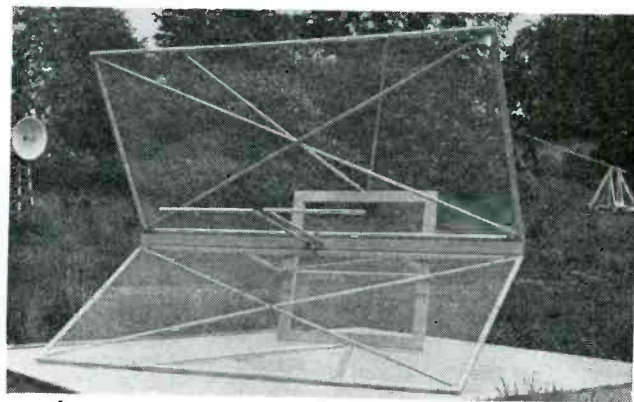
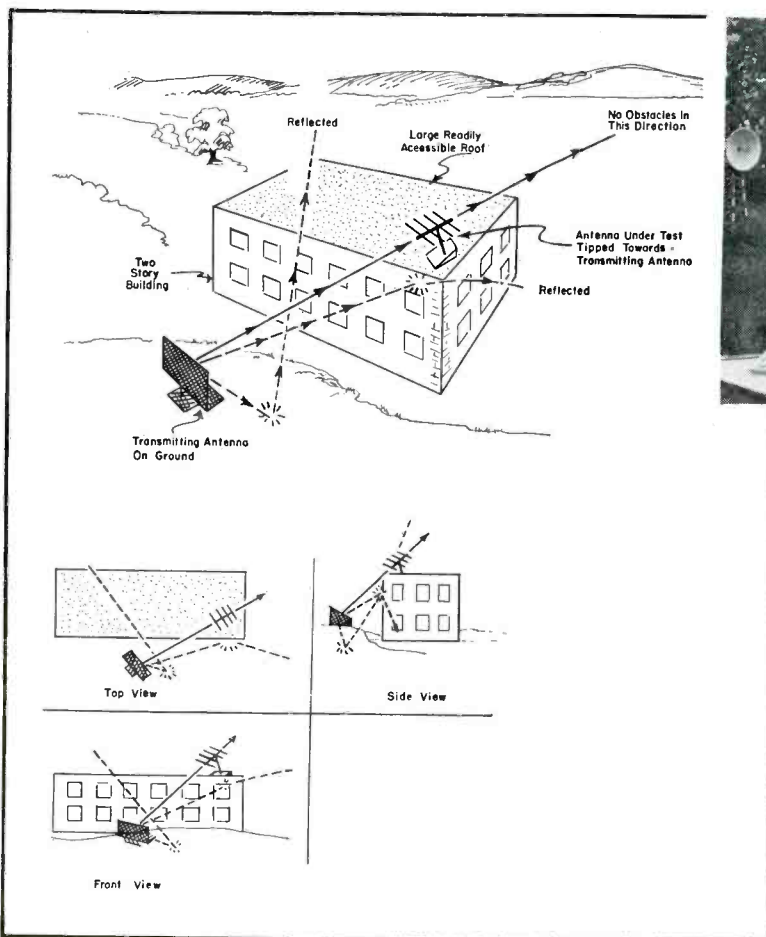

Fig. 2 (left). Layout for antenna tests which has been found to eliminate the problems shown in Fig. 1.

Fig. 3 (above). Corner reflector type of antenna with interchangeable dipoles (*vhf*) used for transmitting during tests.

Fig. 4 (right, top). Polar recorder and associated controls used to plot radiation pattern.

**A Report on the Lab and Field Facilities
Employed to Evaluate VHF and UHF
Antenna Merit Involving Gain, Radiation
Pattern and VSWR**



Characteristics †

by **DONALD PHILLIPS**

received by the antenna is recorded as the antenna is turned past a distant transmitter. The plot of power received against angle of arrival of the signals is the pattern of the antenna.

In practice there are many complications to this straightforward theory.

High-frequency radio energy travels in straight lines and when it strikes an obstacle it bounces, again traveling in straight lines away from the obstacle. From a small obstacle the energy scatters in all directions. From an extended obstacle it usually travels only in those directions, so that the angle of incidence equals the angle of reflection. A site for measuring antenna characteristics must be entirely free of obstacles which can produce reflections. This is an exceedingly difficult requirement since the earth itself is such an obstacle.

A common method of measuring antenna characteristics is to place a transmitting antenna and the antenna under test on towers, as illustrated in Fig. 1. It will be noted that radiation can arrive at the antenna under test from many directions, and, consequently, the power measured at the antenna terminals may not be a reliable indication of the antenna's ability to receive only from the direction of the transmitting antenna.

It is possible, by using a highly directive transmitting antenna and by carefully choosing the height and loca-

(Continued on page 61)

**Based on field test procedure data prepared by the lab staff of Gabriel Laboratories, research center for Ward Products, with lab facilities in Needham, Mass., about 15 miles from Boston, and additional test site at Natick, Mass.*

(Right)

Fig. 6. Loss in the gain of an antenna to a specified mismatch at the input.

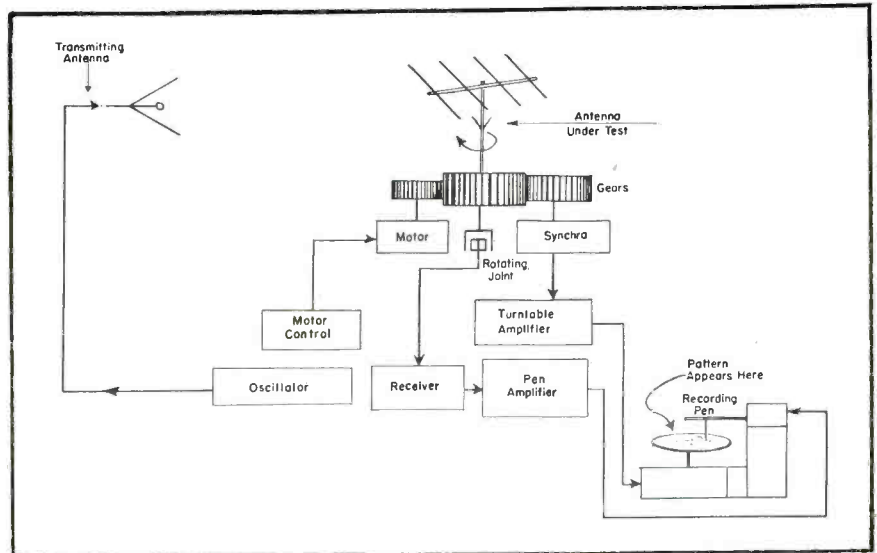
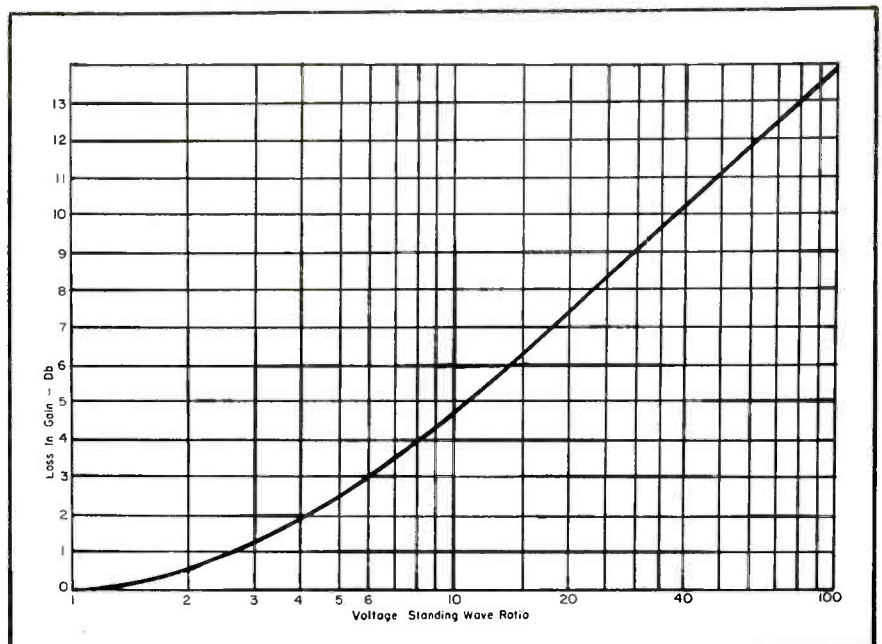
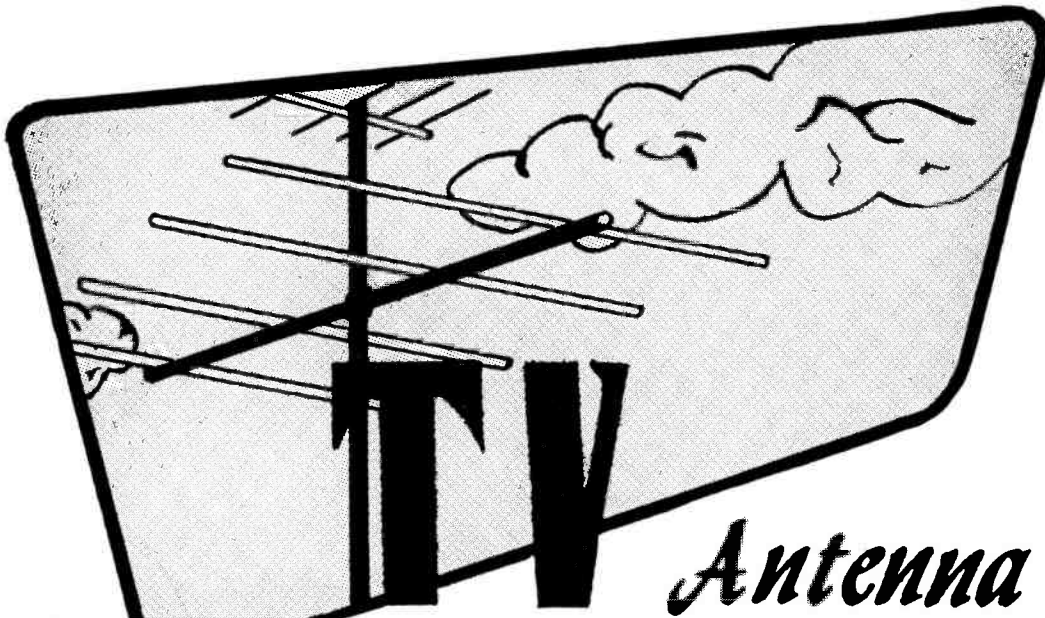

Fig. 5. Block diagram of complete system designed for pattern measurements.





Antenna Digest

design.. application.. installation.. service

by RALPH G. PETERS

THE INTRODUCTION of commercial *uhf* in Portland, Oregon, provided an unusual opportunity to evaluate on a broad scale, the problems and possibilities of the ultrahighs, and probe the types of antennas and accessories that are necessary to insure reliable performance.

Portland has five shadow areas where it has been found difficult to receive sufficient signal strength for suitable pictures. For the most, these areas are so hilly that the signals have been found to vary considerably with elevation. Because at these higher *uhf* frequencies there is less refraction to bend the wave, it is difficult to receive adequate signal strength in the depths of these hills unless it is due to a reflected condition. Should a signal be found on the *ground floor* of these hills, it might well come from any direction, even opposite to that direction of the transmitter.

However, hills alone are not the only gathering place for reflections or low signal strength. In relatively clear areas, trees can splatter the signal causing reflections as well as absorbing the signal strength. Any area, while it may represent flat terrain, if behind an obstacle and is located in the shadow cast by that obstacle can suffer from insufficient signal strength, too. But, with careful choice of antenna, and a thorough probe of both roof and height, it has been possible

‡Based on a field report prepared by Lee Allen of Amphenol.

On-the-Scene Survey ‡ of UHF Reception in Portland, With Analysis of Results Obtained With Assorted Antennas, Leads and Accessories

to satisfy most installation requirements.

It is generally known that most antennas originally designed for *vhf* will receive *uhf*, too, *after a fashion*. They operate at *uhf* strictly on harmonics and as such have omnidirectional, multi-lobed patterns that intercept from all directions. This does not, of course, contribute to satisfactory *uhf* reception.

One type of 2-83 mc antenna found quite effective has been the *V*. While

A 75-300 ohm matching transformer. Precision impedance match at 75 and 300 ohm screw terminals said to provide a means of eliminating standing waves and line reflections in individual installations, as well as master TV systems. Providing a 2 times increase in signal voltage and signal-to-noise ratio, when transforming from 75 to 300 ohm level, this unit has been designed for installation at the terminals of many types of antennas that feed into 300 ohm, or open wire lines. This application is said to be necessary in the case of stacked arrays and multi-element yagis where the impedance of the antenna is often 75 ohms or less. (Model MT-1; Blonder-Tongue Labs.)

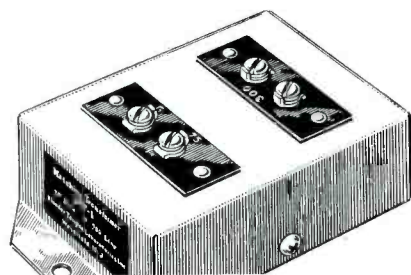

their gains are usually limited and their patterns wide at *vhf*, they have been considered sufficient for major area *vhf* installations. At *uhf*, their gains rise rapidly offering gains of 7 to 12 db at *uhf* frequencies. The forward lobe at the ultrahighs has been found to be extremely sharp and thus is decidedly useful for rejection of reflections.

One should carefully consider the use of a multi-channel *vhf-uhf* antenna and make certain that its characteristics are favorable to the channels assigned to his area, plus the fact that the signals from both *vhf* and *uhf* transmitters will be reflection free and adequate in strength where this antenna type is to be installed.

Another type available is the *bow tie* antenna, one of the simplest of broadbanded *uhf* antennas. It covers all channels, 14 through 83, with its wide, bidirectional, figure-eight reception pattern that intercepts as well off the back, as it does from the front. With moderate signal gain, up to 4 db, it has been found to be good for major signal area installations where reflections are at a minimum. When reflections are bothersome or additional signal strength is needed, the use of a reflector with the *bow tie* will elim-

HICKOK

Choice of the Experts

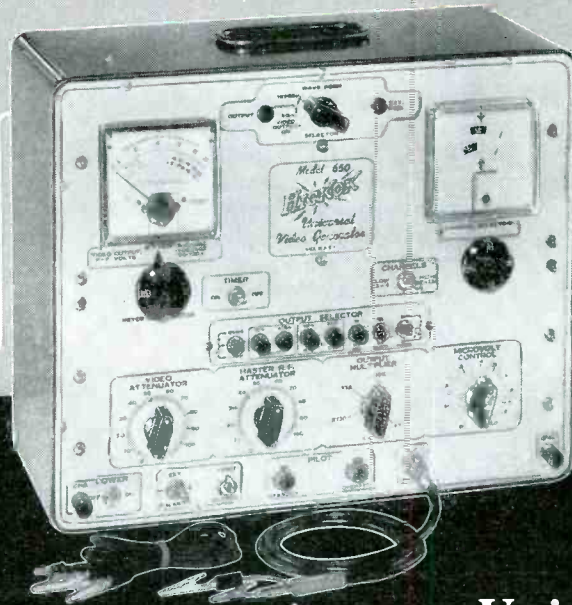

**Model
650**

**Universal Video
Generator**

Hickok, through 42 years of uninterrupted quality production has pioneered and developed numerous well-known electrical and electronic equipments now recognized as standards for the industry.

The newest Hickok contribution is the Model 650 Universal Video Generator. It accurately and rapidly localizes trouble in any stage of a TV receiver. It's use accomplishes in minutes tasks that normally take hours.

THE HICKOK ELECTRICAL INSTRUMENT COMPANY

10514 Dupont Avenue • Cleveland 8, Ohio

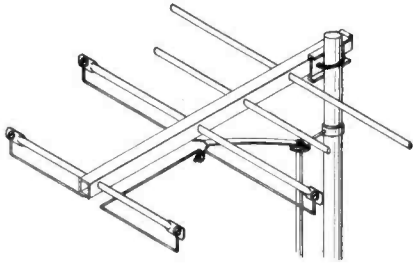

A multi-element beam *uhf* duplex yagi, which is said to have high gain and excellent directivity over the entire *uhf* band. (Model 300; Telrex.)

inate back pickup and provide approximately another 2 to 4 db gain. As in *vlf*, stacking antennas at *uhf* will further increase your signal gain. In Portland, practically all the *bow ties* use reflectors.

The *corner reflector* represents another *uhf* type that offers interesting possibilities. A high gain broadband antenna, it has but a single forward lobe with signal gains from approximately 6 db at the lower *uhf* channels to 12 db at the higher channels. Its unidirectional pattern rejects reflections approaching from the sides or back and its increased gain permits installation in fringe or *shadow* areas. It is one of the larger types and normally more costly.

The Rhombic

Still another type is the rhombic with signal gains of 2 to 8 db, and a narrow main lobe. Only 10° to 25° wide at half power point, it is like the beam of a searchlight pointing the way to reflection-free reception. When the problem is reflections, the *rhombic* might be the answer.

The familiar *yagi*, which won wide acclaim at *uhf* because of its tremendous gain over a narrow bandwidth, limited to one or two channels, at *uhf* has a bandwidth which extends from five channels at the low end to about ten channels at the high end. Its peak gain of about 10 db for a six-element array which drops only about 3 db over that bandwidth has been found to make it an ideal antenna for deep fringe applications, or wherever the narrow single forward lobe selectivity is necessary. These, physically, will most likely be available in the five to eight-element types.

In Portland, in some areas, it was found that the problem of signal strength was not as acute as reflections. While in others, such as shadow or hilly areas, it was found necessary to fight for every ounce of signal all the way. In these areas, movement of the antenna in any direction, up, down, or sideways could have considerable effect, good or bad, upon the sig-

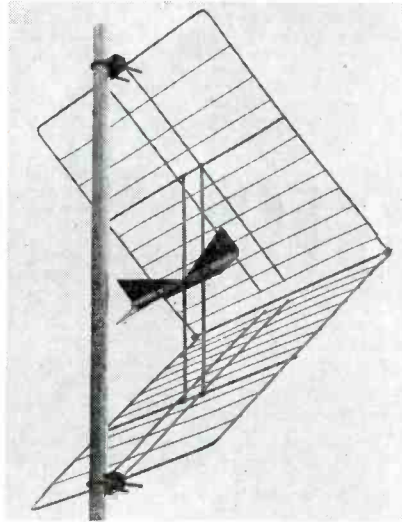

UHF corner reflector with antenna mounted behind the mast. Reflecting screen is said to be held rigid by two separate U-bolt assemblies which are welded to the extreme ends of the screen. Antenna has free space terminals to prevent the accumulation of dirt and moisture at the feed points. (Model 405; Channel Master.)

nal. Tipping the antenna, upwards or downwards, didn't seem to have much effect. However, polarization was found to be very important. The moment an antenna is rotated from its horizontal position toward vertical, with every degree additional signal is lost until at vertical, all is lost.

When mismatching of impedances occur, with resultant standing waves, and the signal is inadequate, the standard *vlf* metal ringed type stand-off insulators were found to be very critical of placement in transmission line support. If one is not careful under these conditions, the limited signal being received can be lost entirely by placing the standoffs along the transmission line at the wrong points. Of course, standing waves can also develop double images on a TV screen just like reflected signals. It is very important, therefore, at *uhf* that impedances be matched.

Vhf lightning arresters, likewise, were found to be contributors to signal

Jay Saphier, of Brach Manufacturing Corp. (right), Seymour Wiedenbaum (left) of National Radio Distributors, and Sol Verter (center) with recently developed *uhf* corner reflector with bow-tie elements. The open-mesh construction is said to present the least possible wind load. Both reflector sections and the antenna element are supported so that they cannot change positions with vibration. Antenna is claimed to have a high front-to-back ratio, with a gain of 8 to 12 db over the *uhf* band. (Radar-Tenna model 479.)

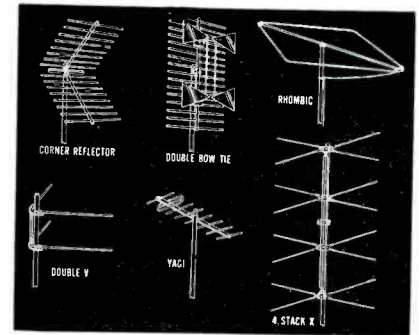
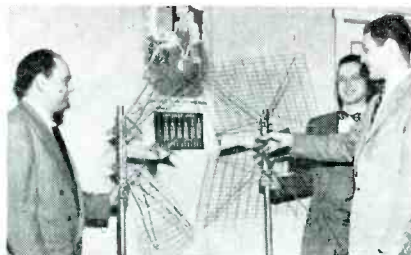

Kit with all necessary parts to enable assembly of six complete *uhf* antennas. By experimenting with the six basic *uhf* designs, the user can determine by actual test, it is said, the antenna best suited to *uhf* reception in his area. (Miller Television Co., 2840 North Naomi Ave., Burbank, Calif.)

loss. In many installations it was observed that the lightning arrester was affixed to the house beneath the transmission line, but the line was not connected into its circuit because of its effect upon the picture. Lightning arresters and standoff insulators designed for *uhf* applications are now on their way from various manufacturers, and these necessary components will be welcome, particularly for these critical installations.

Unquestionably, the leader in popularity as far as transmission lines were concerned in Portland, was the tubular 300-ohm line. Portland has a rainy season and the ability of tubular at *uhf* frequencies to conserve three times the signal as that of the popular flat ribbon type in wet weather is indeed appreciated. Open wire line, while it doesn't enjoy the acceptance of tubular, is being used extensively, too. However, there is rebellion on the part of some Service Men to the mechanical and physical problems often involved in its handling and installation.

It has been indicated that the major signal range of Portland's *uhf* station is approximately 20 miles, with fringe or secondary reception possible up to 30 to 40 miles. Salem, Oregon, 43 airline miles south of Portland, was found to represent an ideal reception condition because it is flat between it and Portland. At this point it has been found possible to receive signals of 350 to 600 microvolt intensity at 20' heights above most roofs. The results were particularly impressive, because the station presently is only operating on one-fifth of its ultimate power.

While one should be conservative in *uhf* optimism, because we have really experienced only the low end of the band's performance, Channel 27, it is difficult to withhold one's elation. It is possible that the higher *uhf* channels will increase the problems, but as in the past Service Men will rise to the occasion and come through with practical solutions.

For faithful tone reproduction . . . high fidelity at low volume level — use Centralab's Compentrol

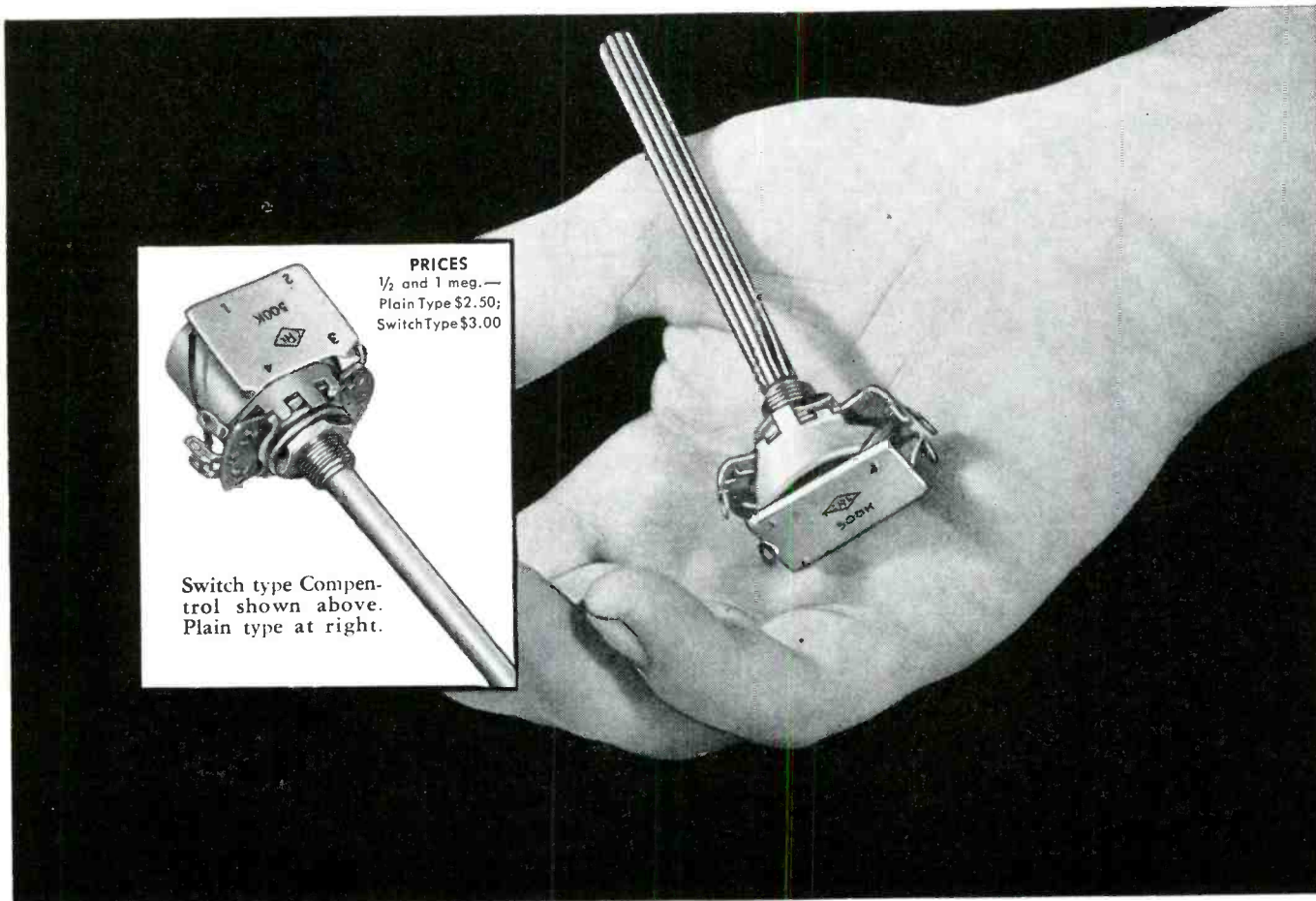

PRICES
 1/2 and 1 meg.—
 Plain Type \$2.50;
 Switch Type \$3.00

Switch type Compentrol shown above. Plain type at right.

Centralab components are safest for guaranteed servicing

YOU can stake your service reputation on the Centralab Compentrol. That's because this combination volume control and Printed Electronic Circuit faithfully reproduces the high-pitched tones of the operatic soprano — or the deep bass notes of the boogie woogie beat . . . when volume is set at low level.

In fact, Compentrol was especially developed to better reproduce the apparent bass and treble response of radios, audio amplifiers, phonograph combinations and television sets. Use it as a business builder as well as for replacement service. It actually improves original performance! What's more, its low price will fit any pocketbook.

Because of its design CRL's Compentrol needs *no additional amplification*. There is no insertion loss when you use Compentrol.

The Centralab Compentrol is furnished in 1/2 or 1 meg. — plain or switch types. Switch is SPST, and an insulated switch shield is furnished for a-c shielding. Most amplifiers use a plain type. For complete details, ask your Centralab distributor, or use the coupon.

Make your Centralab distributor headquarters for exact electronic replacements

Centralab

A Division of Globe-Union Inc.
 Milwaukee 1, Wisconsin

In Canada, 635 Queen Street East, Toronto, Ontario

The Centralab Compentrol is only one of the more than 470 *new* items listed in Centralab's new Catalog 28. Get your copy of this 32-page index to the latest developments in the fast-changing electronic field, plus a 16-page booklet telling the whole Compentrol story. See your distributor or use the coupon.



CENTRALAB, A Division of Globe-Union Inc.
 908 E. Keefe Ave., Milwaukee 1, Wis.

Please send me my copy of the new Compentrol Booklet as well as Centralab Catalog 28 at once and without charge.

Name.....Position.....
 Company.....
 Address.....
 City.....State.....



Having an antenna nightmare?

Are you bothered and bewildered by all the claims and counter-claims that are being tossed at you regarding antenna performance and construction?

Then choose the TESCO line because only TESCO gives you *all* of these outstanding features:

- ✓ Amazingly powerful reception delivers strongest possible signal to receiver
- ✓ Rugged, all-aluminum antennas.
- ✓ Exclusive pre-assembled Rocketenna construction
- ✓ No loose hardware.
- ✓ Lifetime factory warranty

**Remember! Don't take less than the best!
Don't take less than a TESCO!**

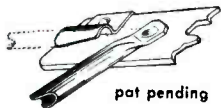
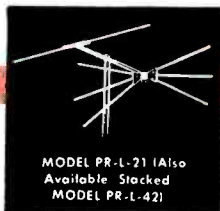

All Rocketenna elements feature this Exclusive Time-Saving design

ROCKETENNAS

by **TESCO**

T-V PRODUCTS CO. 152 SANDFORD ST. • B'KLYN, N. Y.



SERVICE... *The National Scene*

1953 VIEWED AS RECORD-SHATTERING YEAR BY EXPERTS--Unparalleled expansion will prevail not only in TV, but in radio and allied fields, during the new year, according to management and engineering heads, association chairmen, and trade specialists. Their optimism is based on many sound facts. For instance, with between 100 to 150 new TV stations expected to go on the air during the new year, approximately 5-million additional families will be brought within the TV service range. . . . Not only is it expected that new TV receivers will be installed in the new market areas, but that replacements and second sets will be required in communities where stations have been operating. . . . In addition, new stations opening in fringe areas should cause a strong upward swing in such vital markets as Detroit, Cleveland, Chicago, and other cities which have had TV since early postwar years. . . . Because of this huge anticipated receiver requirement, the picture-tube industry will be asked to produce more than 8-million tubes, of which 2 million will be for replacement. It is expected that the 21-inch rectangulars will be the most popular, and the 17 inchers will run second. Liberal quantities of receivers with 24-, 27- and 30-inch picture tubes will also be produced. . . . With 20-million viewers in American homes, the replacement-parts market will assume greater importance during the next 12 months. Servicing of these receivers will require more replacement components than ever before in the 6-year postwar history of the industry. . . . It is estimated that nearly 4½-million TV sets, now in use, have screens smaller than 16", and will probably require replacement or conversion this year. . . . Radio-set production will also continue firm in '53, with about 9-million sets coming off the line. . . . The servicing of communications equipment will also become an extremely dominant factor during the year, in view of the increased use of two-way equipment not only among police and fire departments, but pipelines, taxicabs, lumber-camps, trucking concerns, farmers and ranchers, strip mines, doctors, ambulances, newspapers, motion picture companies and others. . . . According to one industry association prexy, within another five years 50-million TV sets should be in operation, and the replacement markets alone thereafter, will require production almost as great as at present.

OUTSTANDING VARIETY OF PARTS NOW BEING MADE--To meet the growing requirements of today's radio-TV servicing industry, and the initial equipment needs of labs, schools and others, manufacturers are now obliged to produce an unusually wide assortment of components. According to one supplier engaged in manufacturing capacitors, whereas a few years ago their line consisted of a few hundred different numbers, today, over 4,500 different types are being processed, with approximately over 900 different electrolytics, 300 tubulars, 1,200 oil-filled, 300 metallized-papers, 400 micas and 200 ceramic types coming off the line to take care of all needs. Thanks to robust factory stocks, permitting fast delivery cycles, distributors can draw on these inventories at any time for their customers. . . . This expanding and still-expanding selection of components represents a dominant achievement in the parts industry, which will play a significant role in servicing during '53*.

UHF TELECASTING SPREADS TO EAST AND MIDDLE WEST--At long last, ultrahigh broadcasting has begun to spread its wings eastward. . . . Two cities roared a welcome to uhf shortly before New Year's Day--York, Pa., and Atlantic City, N. J. In the former instance, WSBA-TV went on the air on channel 43, and in the latter case, WFPG-TV began telecasting on channel 46. . . . As this column was being written, WSBT-TV (channel 34) in South Bend, Ind., began testing, and WBRE-TV (channel 28), Wilkes Barre, Pa., pulled its on-the-air-switch, too. . . . It is expected that WFMJ-TV (channel 73) and WKBN-TV (channel 27) in Youngstown, Ohio, will also be on the air as this issue comes off the press.

*With apologies to Charles Golenpaul of Aerovox.

SERVICE... *The National Scene*

TV BUILDING PERMITS STILL POURING OUT OF WASHINGTON--Over 165 have now received authorization to construct TV stations. Among those who have received grants recently are: Community Telecasting Service, Bangor, Maine (channel 5), which represents the first station in that state; WONN-TV, Lakeland, Fla. (16); Thames Broadcasting, New London, Conn. (26); Harrisburg Broadcasters, Harrisburg, Pa. (71), the second station authorized in that city, WHP-TV (55) receiving the first grant; Gable Broadcasting, Altoona, Pa. (10); KCNA-TV, Tucson, Ariz. (9); WIRK-TV, West Palm Beach, Fla. (21), and WEEX-TV, Easton, Pa. (57).

16-CHANNEL VHF/UHF ROTARY TUNER INCLUDED IN ALL-CHANNEL CHASSIS--A rotary-type tuner receiver, providing selection of any combination of vhf and uhf stations up to a total of 16, will soon be available. As shipped, 12 of the 16 inserts for which the tuner has been designed will be pretuned for 12 vhf channels. Inserts pretuned at the factory for any specified uhf channels will be supplied by the manufacturer for insertion in the remaining four spaces. Should more than four ultrahigh channels be required in any area, inserts tuned for the additional channels can be substituted for an equal number of vhf inserts in the tuner. . . . New tuner is based on operation of the fundamental of the oscillator frequency, rather than the harmonic. . . . An analysis of the circuitry used in this receiver will appear soon in SERVICE.

CBS URGES EARLY SETTLEMENT OF COLOR DISPUTE--In a plea to bring color to the public at the earliest possible moment, CBS declared in a special statement that it . . . "genuinely hopes that the industry committees in groups now working on . . . a compatible system, will be successful in their efforts, and will press forward to obtain approval of its standards in 1953." According to Columbia . . . "The manufacturing industry, broadcasters, and the FCC, owe the public the obligation of promptly considering whether it still remains true, as CBS believes . . . that the present field-sequential system is the only practical, workable and inexpensive color system, or whether this approved system is to be replaced by a compatible system which must be equally practical, workable and inexpensive. All elements in the industry and in the government should strive promptly to resolve this question, so that all can go forward in vigorous efforts under whichever system prevails."

TRANSISTORS NOW ON PRODUCTION LINE--Substantial quantities of transistors are now being processed not only for the military, but the commercial world. As a result, many extremely active developmental projects are now underway. Some efforts have already been quite productive. In one instance, hearing aids, featuring pea-sized transistors in amplifier circuits, have been evolved. . . . During the next few months many similar transistorized devices will probably appear, and at this writing, it seems as if the transistor may soon become a factor in complete amplifiers and radio sets. According to the headman of the TV division of one leading eastern manufacturer, transistors might even appear in production model TV chassis in about a year or so.

MULTIPLE ANTENNA BUSINESS BOOMS ON PACIFIC COAST--The installation of master-antenna systems in apartment developments has become a roaring project in California. One servicing organization in San Diego has received a contract for the installation of a 420' antenna tower to feed 552 apartments in 12 apartment buildings. In another assignment, an antenna is being installed to pipe signals to 1,200 apartments.

SERVICE APPLAUSE CONTINUES--Reports Johnny Sky of Portland, Oregon, in a letter to ye editor . . . "You certainly have a wonderful magazine!" . . . A. W. Gotcher, also of Portland, notes that of the six radio and electronic publications he subscribes to, SERVICE is . . . "the only one devoted entirely to service. . . . I enjoy the audio articles, your coverage of recent uhf developments, and the Ser-Cuits department. I want to thank you for all the excellent articles, which are, in my opinion, getting better all the time." . . . It is gratifying to learn, gentlemen, that SERVICE serves you so well.--L. W.



IMPS are TOPS!



IMPS ARE REALLY RUGGED!

The tough thermo-setting plastic will take an astounding amount of abuse —yet IMPS will still look and perform like new!

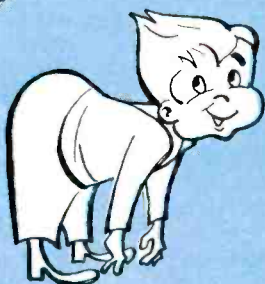

IMP LEADS CAN BEND AND BEND!

Tinned leads that are really securely anchored—you'll be amazed at how much punishment they'll take without breaking!

IMPS WON'T FREEZE OR MELT!
They'll operate faithfully in temperatures ranging from -40°C. to $+100^{\circ}\text{C.}$ (212°F.)—and that's the boiling point of water!



IMPS ARE MOISTURE-PROOF!

No moisture can get through the varnished plastic case, or even through the lead anchor points.

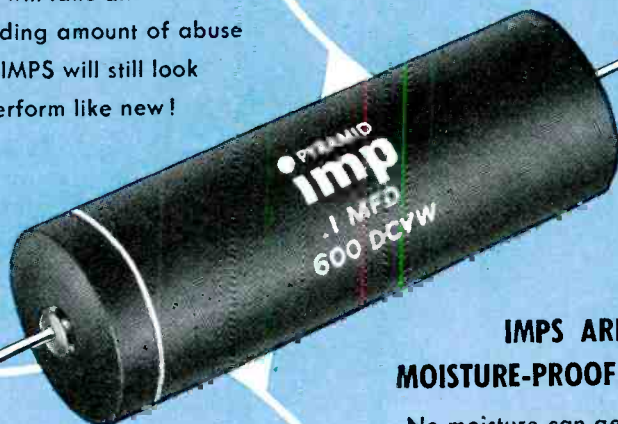

All over the country service-engineers are praising the newest and finest molded tubular paper capacitor—the Pyramid IMP!

IMPS are available in all popular ratings in 200, 400 and 600 volt ranges. See your local distributor.

For free, attractive catalog on IMPS, write Dept. S2

PYRAMID ELECTRIC COMPANY

1445 HUDSON BOULEVARD • NORTH BERGEN, NEW JERSEY

THE Webcor® "HF" DISKCHANGER

belongs in every High-Fidelity installation



Model 126 HF

PUSH-OFF CHANGING—universally acclaimed as the most gentle method known. Makes records last longer.

HIGHLY FINISHED SPINDLE—special design of "step" and satin-smooth shank save wear on record center hole.

ELECTROSTATIC FLOCKING—exclusive Webcor process forms thick, resilient record cushion—prevents record slip.

STONE ARM REST—prevents injury to Balanced Tone Arm when in "rest" position. Spring latch immobilizes tone arm when transporting unit.

BALANCED TONE ARM—provides feather-light needle ride and optimum tracking. Available equipped with crystal or G.E. Triple Play Cartridge—or for plug in of magnetic cartridges.

SPEED SELECTOR—conveniently located. Immediate, positive speed selection. In "off" position, the drive wheel is retracted to prevent flat spot causing "wow."

EXTRA-HEAVY TURNTABLE—mounted on ball bearings. Extra weight and precise balancing allow it to act as fly-wheel for motor. Makes for constant, accurate speeds.

TWO-TIER MAINPLATE—made of 18-gauge steel. Will not warp or throw parts out of alignment. Spring mounted to absorb unwanted vibrations.

4 POLE—SHADED POLE MOTOR—for smooth power. Eliminates "hum," "wow" and "rumble"—delivers accurate, constant speeds.

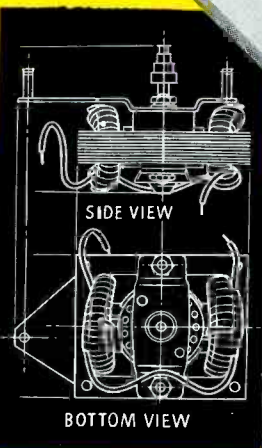

STEP-DRIVE COUPLING—for accurate transfer of speeds from motor to turntable. Has fewer working parts.

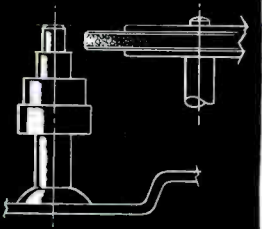

VELOCITY TRIP—eliminates damaging lateral needle pressure in record grooves. Tone arm moved by record—not by mechanical drives.

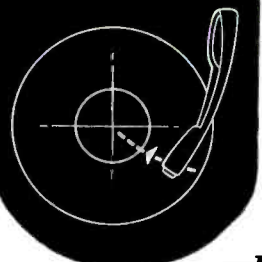

Webcor's mechanical excellence and design superiority make it the ultimate in automatic record changing for custom, high-fidelity installations. The powerful 4 pole—shaded pole motor is statically and dynamically balanced for positive, accurate speeds—and to eliminate "hum," "wow" and "rumble." The ball-bearing mounted, extra-heavy turntable changes speeds smoothly and accurately by means of the new "step-drive" coupling.

This Webcor precision means the utmost in convenient listening pleasure—up to four hours of uninterrupted music—then, automatic shut-off. It means your precious records will sound better and last longer on a Webcor "HF" Diskchanger.*

**Available mounted on beautiful base pan for plug into phono-jack of radio, television, or amplifier.*

all music sounds better on a

Webcor®



8103

WEBCOR PRODUCTS ARE MANUFACTURED BY WEBSTER-CHICAGO, CHICAGO 39, ILLINOIS

© W/C-1952

Servicing Helps

Preventing Premature Crystal Detector Failure...Halting Picture Tearing and Rolling on Strong Signals...Cures for Horizontal Jitter and Unstable Sync in Fringe Areas, Picture Shift at Maximum Contrast and HV Breakdown and Corona . . . AGC Threshold Control Adjustment

by M. A. MARWELL

EXCESSIVE SOUND BARS in a picture, that are not due to fine tuner misadjustment, normally indicate that the crystal is about to fail. Ultimately, complete failure will result in weak picture and loss of sync.

In Sentinel chassis,* this condition is caused by a momentary surge current in the control grid circuit of the 6AH6 video amplifier tube due to internal shorting of the screen grid to the control grid damaging the 1N60 crystal detector.

To remedy a 270-ohm $\frac{1}{2}$ -watt resistor (R_{85}) should be added between the .1-mfd capacitor (C_{24}) and the control grid (pin 1) of the 6AH6 video amplifier, if this resistor is not already in the set. (This change has been incorporated in all but the early production chassis.)

Picture Tearing and Rolling on Strong Signals

Picture tearing and rolling on strong signals, when not caused by locality adjuster switch on Sentinel sets,* being in the wrong position, or on weak or medium position in a strong signal location, may be caused by overloading of the 6CB6 third *if* amplifier due to low plate voltage of

this tube, preventing it from properly handling strong signals.

Necessary Changes

In initial production, the screen and plate were tied together to the 150-volt line. If a chassis is encountered in which the plate is tied to the 150-volt line and the picture tears or rolls on strong signals, the following changes should be made to tie the plate of the third video *if* tube to the 265-volt line:

- (1) Change the 6CB6 82-ohm cathode resistor, R_{26} , to 220 ohms, $\frac{1}{2}$ watt.
- (2) Remove the jumper wire that runs from the screen, pin 6, of the 6CB6 to terminal 1 of the fourth video *if* transformer. This will leave the screen of the third video *if* tube connected to the 150-volt line through a 1,000-ohm resistor.
- (3) Add a 1,000-ohm $\frac{1}{2}$ -watt resistor between terminal 1 of the fourth video *if* transformer and the 265-volt line.
- (4) Add a .001-mfd 500-volt capacitor between terminal 1 of the fourth

*Models 454, 455, 456 and 457.

video *if* transformer and chassis ground.

Hoffman Field Service Notes

Horizontal Jitter in Fringe Areas. . . Chassis 200, 201, 202: When horizontal jitter in fringe areas is reported in these chassis, the value of the capacitor connected between pin 4 of the horizontal multivibrator and ground should be increased from .01 to .05 mfd. A 20-per cent 400-v capacitor may be used.

Unstable Sync in Fringe Areas. . . Chassis 196, 196M, 196T: Some of these chassis have exhibited unstable sync in fringe areas. To remedy this situation, the $\frac{1}{2}$ -watt 1-megohm resistor that is wired across pins 1 and 6 of the *agc* keyer tube socket (front, left-hand socket when viewing chassis from the bottom rear position) should be clipped from the chassis. This change has been incorporated in production runs on all receivers produced after J243241.

Picture Shift at Maximum Contrast. . . Chassis 210, 210M, 211, 212, 212M and 213: This condition can be remedied by increasing the value of R_{304} , a 47-ohm $\frac{1}{2}$ -watt resistor to a 150-ohm, $\frac{1}{2}$ -watt resistor. A connection should

(Continued on page 62)

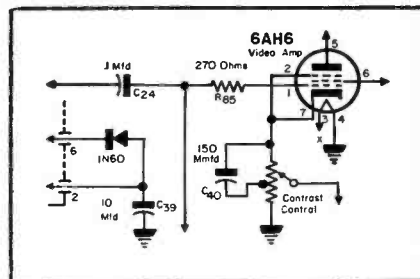

Fig. 1. Modifications in control-grid circuit of video amplifier tube in Sentinel chassis which serve to prevent premature crystal detector failure.

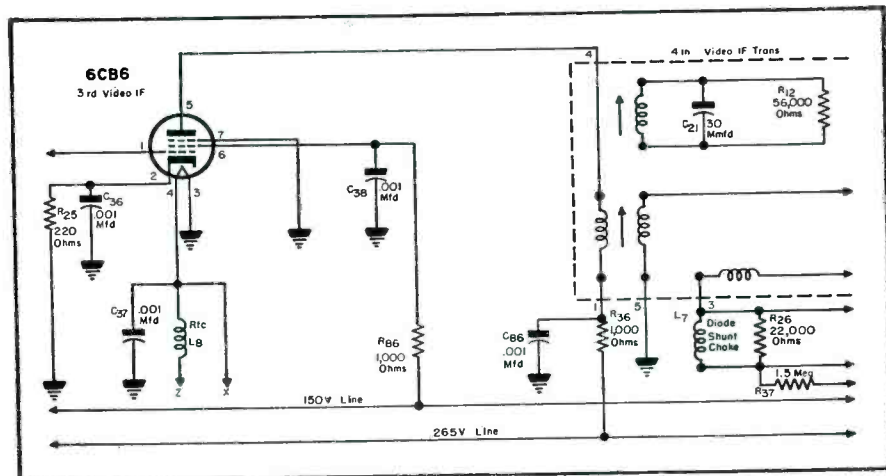

Fig. 2 (right). Revised circuit of third video *if* amplifier in Sentinel receivers which halts picture tearing and rolling on strong signals.

New master of the



THE **NEPCO** LINE

National Electric Products

Radio and Television Department
Pittsburgh, Pa.

elements



The NEPCO Line—television's *new* "Master of the Elements"—now meets the pressing demand for *better* electronic equipment. This complete line of *quality* TV Antennas, Mounting Accessories and Wire represents more built-in ruggedness than any now known—proves that *only the best meets the test of time!*

See the Nepco Line today. Examine its radically *new* design and construction. Prove to yourself that there's nothing finer on the market today—that it's the best by far at any price. Backed by the world's largest producer of electrical "rough-in" materials, the Nepco Line carries National Electric's guarantee of quality, engineering and research. You can specify and install it with *complete* confidence of *long-life* installations and customer satisfaction. Write for details now.

THE **NEPCO** LINE

Regency

UHF

CONVERTER

RC-600

\$49.95 list

no matter how
you look at it...

the only choice is
the Regency converter

... the quarter
million dollar converter

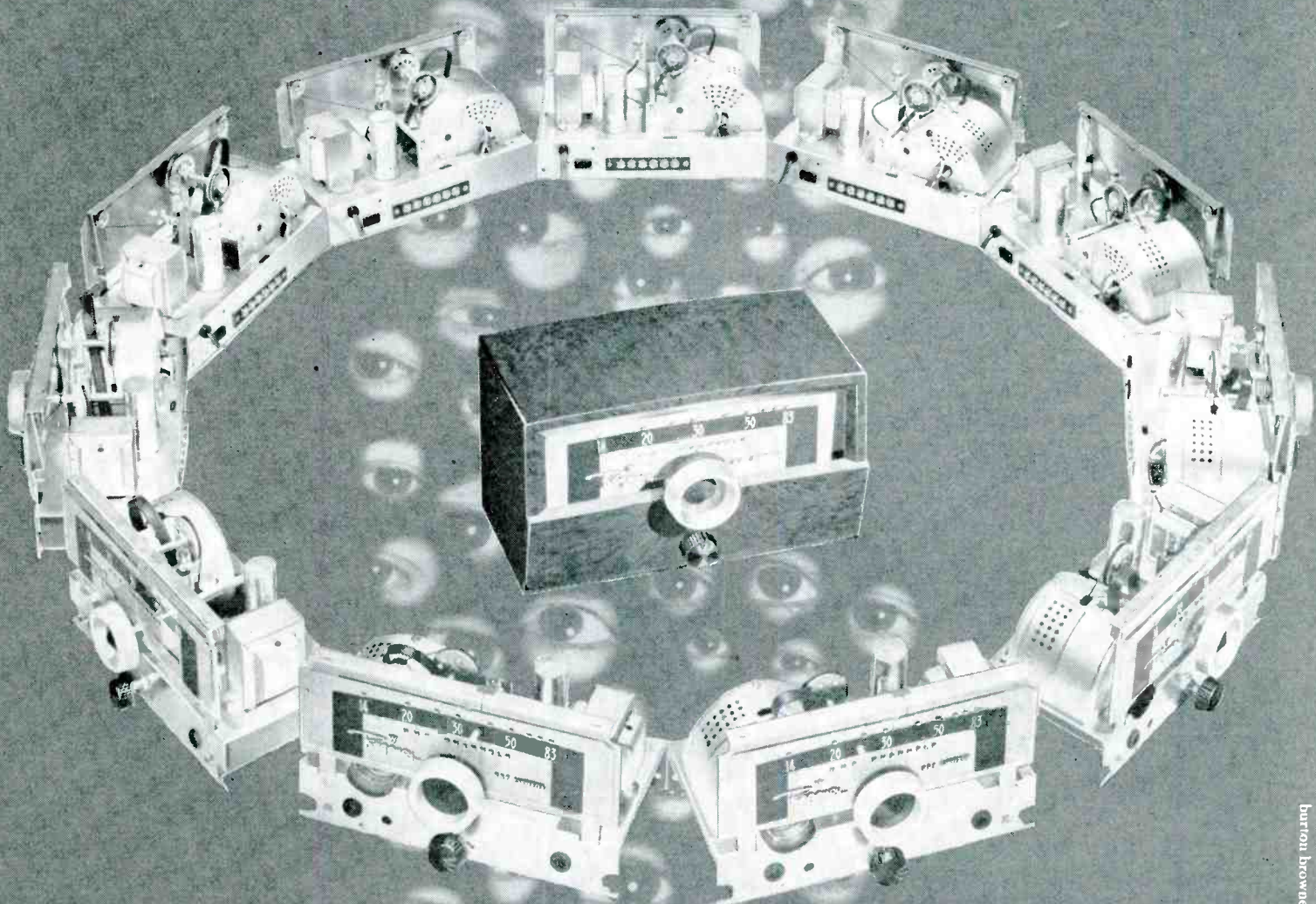

teamed together for Better TV Picture Quality

AMPHENOL
—INLINE*
 ANTENNA

AMPHENOL
 TUBULAR
 TWIN-LEAD

The combination of the famous Amphenol Inline Antenna with the extremely low-loss Amphenol Tubular Twin-Lead permits any TV set to present the best picture it possibly can.

In addition to a strong forward reception lobe, the Inline has uniform gain over the entire range of VHF channels—less variation than the 3 decibel change which causes “fuzziness.” The Inline is also available in stacked array for those fringe or trouble areas which require additional signal strength.

The Amphenol Tubular Twin-Lead provides very low-loss and constant impedance. The tubular construction minimizes the effect of moisture and dirt deposits on the concentrated field of energy and ends weather interference. Because of these characteristics, Amphenol Tubular Twin-Lead has been recommended by leading TV manufacturers and authorities for any installation where UHF is, or will be available.



This illustration clearly shows that the concentrated field of energy between the two conductors, which are 7 strands of #28 copper weld wire, is contained by the tubular construction. This important field of energy is unaffected by any exterior conditions.

Your free copy of this book is available from your Authorized Amphenol Distributor. It contains complete factual and test data on the factors which determine Better TV Picture Quality.

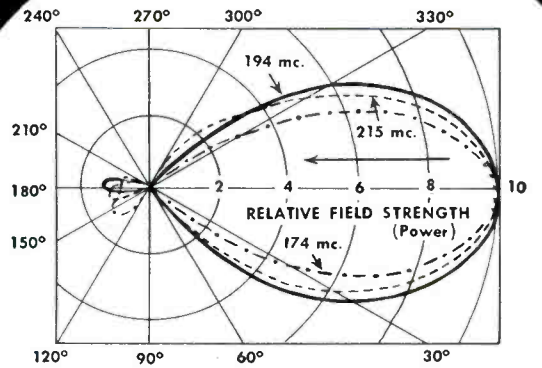

consider the evidence.

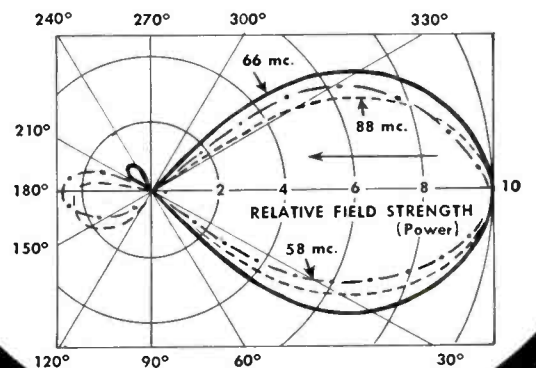

The test patterns on both high and low bands reveal the Amphenol Inline Antenna's superior uni-directional reception lobe. This single forward lobe intercepts the TV signal at its maximum available strength. It also rejects unwanted reflected signals or side interference that cause “ghosts” and unsteady pictures.

No other broadbanded antenna can present as favorable a reception pattern on all the VHF channels as does the Amphenol Inline Antenna.

Reading Difficult TV Schematics

by CYRUS GLICKSTEIN

MOST SERVICE MEN realize that in deciphering a TV schematic, one cannot simply follow a connecting wire by eye alone. The complexity of most schematics makes this almost impossible. To determine where a connecting line goes, it is good practice—in fact, almost essential—to follow carefully with a pencil, pen or tool, each line to its destination, including the detours or side-roads through terminals and plugs. An example of the need for this procedure is illustrated in Fig. 1; the partial schematic of the Hallicrafter T-64 chassis.

Points which may help one travel through a plug and jack without getting lost are:

(a) When following a wire into a plug, the pin number on the plug should be noted; the correspondingly numbered pin should be found on the jack or socket and tracing of the wire continued to its destination.

(b) Some schematics often show a plug and a corresponding socket without numbers on the pins as indicated

Part II . . . Tracing Complex Connections Through Plugs . . . Deciphering Complicated Diagrams Through Use of Arrowheads to Indicate Current Flow

in plug 6, socket 4 in Fig. 1. Schematics are generally drawn so that the plug and jack (socket) terminals with the same relative position connect with each other. If in doubt, one can pencil in a keyway in the same position at the bottom of the plug and of the socket, and count around on the plug (or socket) until the pin is reached which connects to the wire being traced. In the next step, one should count around to the pin with the same number on the corresponding socket (or plug) to find the pin through which the connection is continuing.

(c) It is important to make certain that the connection is being traced through the correct male and female

connections. In most schematics, the plug and corresponding socket are drawn close to each other. In some, however, they are separated. Usually, the plug and jack have the same numerical designation; viz., P501 goes to J501. In some cases, different numbers are used; P601 may go to J401. When there is any question as to which plug and jack go together, it is necessary to check the numerical designations of all plugs and jacks and note the number of terminals on the plug and jack under question as compared to those on the other plugs and jacks on the diagram. The plug and jack which go together obviously must have the same

(Continued on page 46)

Fig. 1. Partial schematic of Hallicrafters model T-64, illustrating plugs and sockets through which interconnections are made.

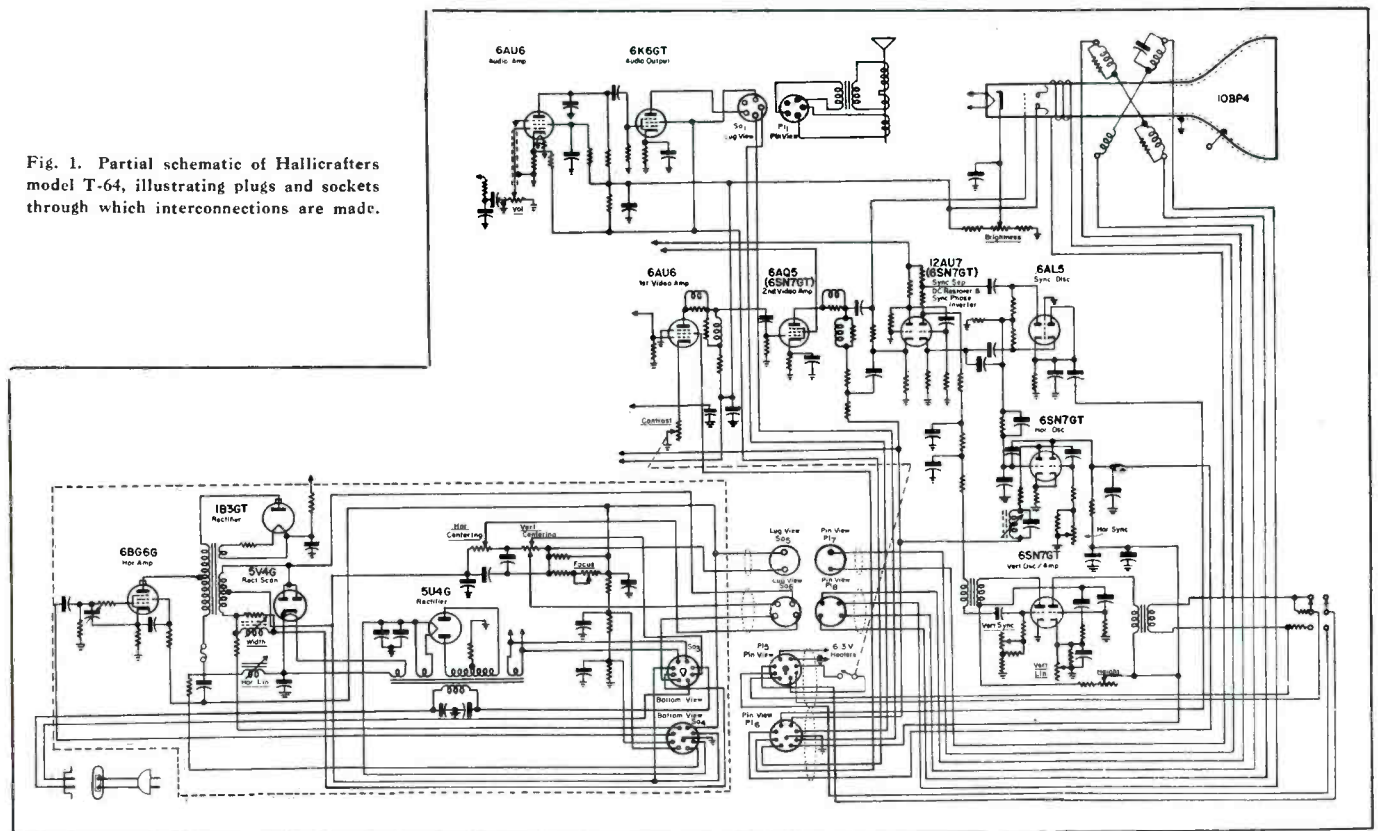

THEY'RE
ASKING
FOR
IT!



BEST REASON YOU SHOULD STOCK



THE TURNER BOOSTER

- New and beautiful!
- Cascode circuit!
- Continuous tuning!
- Brighter, sharper picture!
- Minimizes noise and snow!
- Simple to install!
- List price \$57.50.

Proof of the Turner Booster's popular appeal to TV set owners piles up every day from dealers all over the country. "They're asking for it!" say the dealers, "Double our order for the Model TV-2." Get your share of the profitable Turner Booster sales that are pyramiding from coast to coast. Order this finest of all TV boosters now!



THE TURNER COMPANY, Cedar Rapids, Iowa

EXPORT: Ad. Auriema, Inc.
89 Broad Street,
New York 4, N. Y.

IN CANADA: Canadian
Marconi Co., Toronto, Ont.,
and Branches.

How to Read Schematics

(Continued from page 45)

number of and the same physical arrangement of terminals.

Unfamiliar Circuits

In reading schematics, unfamiliar circuits often present a problem. To cut down the time lost due to this, Service Men must keep abreast of current developments and new circuits. Most have little trouble in following the path of the signals through the signal circuits, and through the front end, the video and audio strips. There is usually little trouble, too, in following sync signals through the sync stages until they are applied to the sweep generators. Circuits which may give even experienced Service Men some trouble include unusual arrangements of the low-voltage supply. In some models, stages are connected in series-parallel to form voltage dividers across the $B+$ supply. These circuit variations were analyzed in a previous discussion.*

Confusing Diagrams

Probably the greatest cause of confusion, next to switches, are diagrams with many criss-crossing connections. When the number of connecting lines is multiplied, the schematic becomes harder to follow.

In deciphering such diagrams, arrows should be inserted on the lines to show the direction of current flow. Current flows from a lower to a higher potential to a maximum $B+$ point in

*Glickstein, Cyrus, *TV Troubleshooting by Voltage Measurements, SERVICE*; September and October, 1952.

(Below)

Fig. 3. Types of symbols used in recent schematics released by DuMont. Large symbol with extra line around represents voltage source. Small symbols without surrounding line show circuit points connected to source.

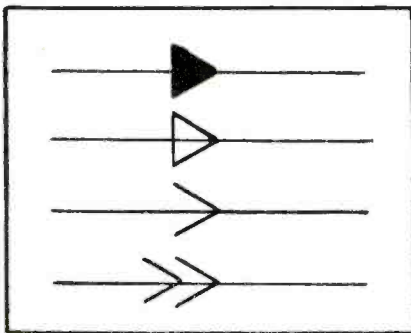

(Above)

Fig. 2. Assortment of arrowheads which can be used to indicate current flow in more than one bus.

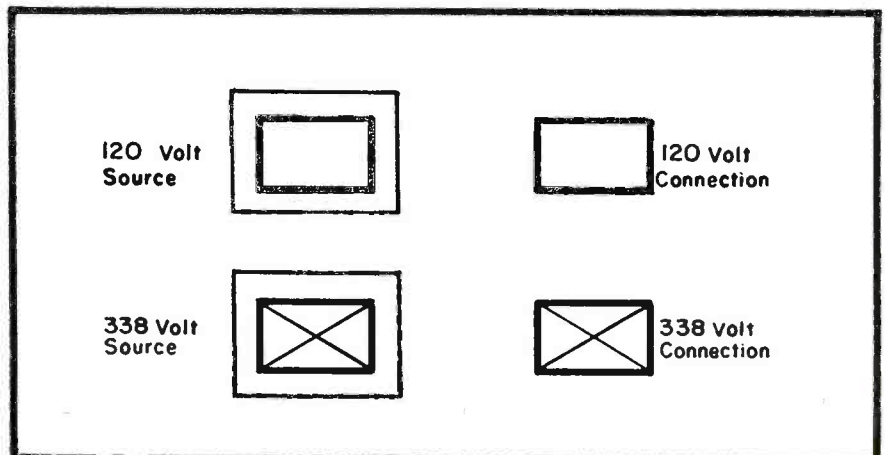

the power supply. To make tracing even easier, the arrowheads can be numbered in sequence. Arrowheads can be added to the diagram to indicate the flow of current through a $B+$ bus to the $+250$ v point in the low voltage supply. Where there is more than one key circuit to trace out, different arrowheads can be used. Some of the different types of arrowheads which can be used are illustrated in Fig. 2.

Power supply connections can be quite involved. It may be necessary to trace the connections from the plate of a given stage all over the schematic before getting back to the $B+$ supply point. Sometimes this results in following wires that lead to blind alleys. It is then necessary to return to the last junction and taking another turn, very much like in the maze puzzles children play with, until the correct path is found. However, it is usually simpler, both in maze puzzles and in this kind of diagram, to start at the end and work back. It is easier to start at the $B+$ output of the power supply and to follow the $B+$ distribution line back to the various stages.

In recent schematics, some have tried to eliminate some of the confusion caused by the maze of interconnecting lines. These lines have been omitted and keyed symbols used to show which circuit points are connected to which power supply points. Each power supply point of a given potential in the diagram has a symbol drawn next to it, but with an extra line surrounding the symbol. Other points in the diagram which are connected to the power supply point do not have connecting lines, but instead have a smaller symbol of the same kind, without the surrounding line. Two examples are shown in Fig. 3. Use of this method minimizes the number of connecting lines.

SMALL BATTERY CAMPAIGN AIDS



Window streamer and combination counter card and battery display stand, designed to promote alkaline dry-cell B (RCA VS216) and redesigned A_6 (RCA VS236), which are said to provide up to ten times more playing hours than conventional battery combinations previously employed in most small personal type portable radios. Counter card, a two-color self-supporting type, measures 17" high and 14" wide.

UHF-VHF Signal Testing is QUICK, EASY with...

**THE NEW
HEAVY DUTY**

Alprodco EREC-TOWER

TEST SIGNALS UP TO 80 FT. ▶

EREC-TOWER—and only EREC-TOWER—goes up a full 80 feet. You test signal strength anywhere along the way up... determine just exactly how high the permanent antenna must be!

ERECT PERMANENT TV TOWERS ▶

Use the EREC-TOWER as a gin pole to raise permanent antenna towers. With an EREC-TOWER, for example, two men can erect a 100-foot Alprodco Tower in less than two hours. You save time, money, labor on every job!

DEMONSTRATE TV SETS ▶

EREC-TOWER helps you demonstrate sets quickly, anywhere. Here's the ideal way to show razor-sharp pictures to your fringe area prospects... right in their own homes. EREC-TOWER is a real sales closer!

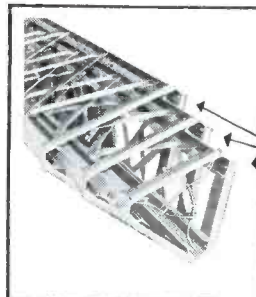

BETTER BUILT

EREC-TOWER is constructed of lifetime aircraft aluminum. Each leg and track (see opposite illustration) is extruded in one solid 24-foot length... will not buckle, crack, stick or rust.

**HEAVY EXTRUDED
ONE-PIECE ALUMINUM
TRACKS**

FREE! WRITE TODAY for full information and literature on the Alprodco EREC-TOWER as well as Alprodco Aluminum TV-FM-AM Towers.

Alprodco, Inc.

305 E. MAIN ST., KEMPTON, INDIANA
MINERAL WELLS, TEXAS • DUBLIN, GEORGIA

Dealer
Net Price
(For Tower)
\$233.50

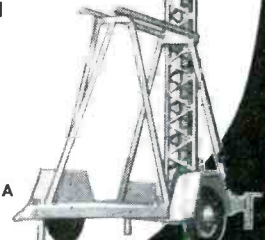

at Last!

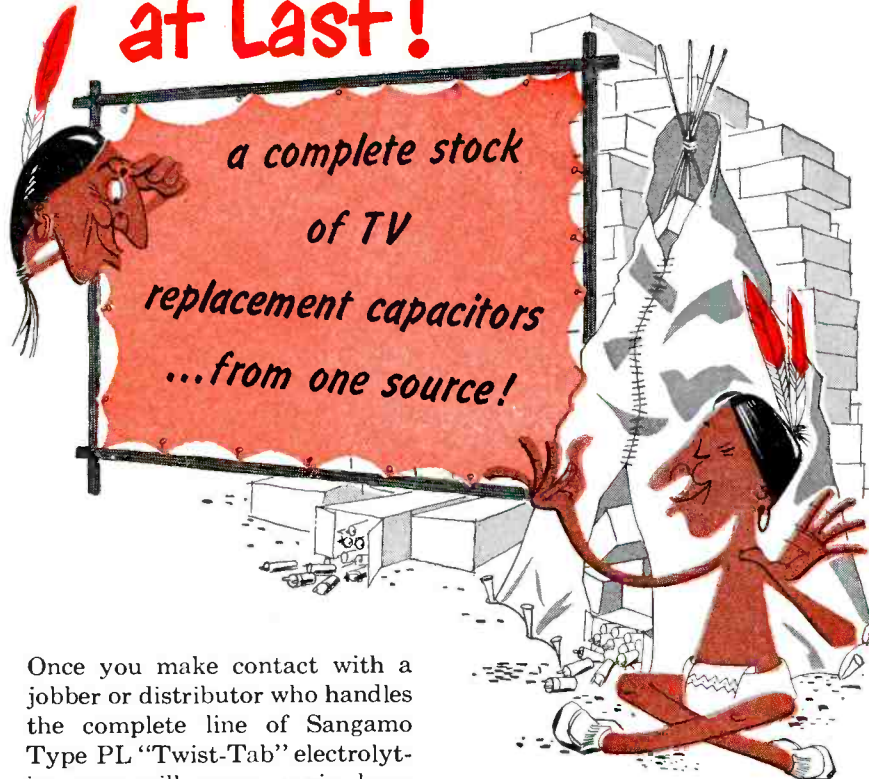

Once you make contact with a jobber or distributor who handles the complete line of Sangamo Type PL "Twist-Tab" electrolytics, you will never again have to "shop around" for odd sizes or capacities. Why? ... because the Sangamo line is the most complete in the industry.

Used by all leading manufacturers of TV sets, Sangamo Type PL "Twist-Tab" electrolytics are exact replacements. They assure long life and dependable performance at 85° C and under conditions of high surge voltages and extreme ripple currents often found in TV applications.



Ask your distributor for a copy of the Sangamo TV Replacement Catalog. It's easy to use and helps you choose the right replacement every time.

Deal with your Sangamo "Headquarters."

Those who know ... choose Sangamo



SANGAMO ELECTRIC CO. MARION ILLINOIS

Pickup Compensators

(Continued from page 21)

cut may not be included in the circuits immediately ahead of the pickup, since the main treble tone control can be used for this function. Bass boost, however, is always introduced in these early stages, so that any hum generated in low-level stages will not be boosted along with the signal bass frequencies. Simpler compensator circuits for magnetic pickups use a compromise bass turnover frequency of about 500 cps, while some record compensators provide a multi-position

switch which brings into play the proper circuit for equalizing both the bass and the treble of various types of records.

The *dc* resistance into which the magnetic pickup works has the opposite effect from the resistive load of a crystal; it introduces treble losses instead of bass losses. This effect can be used for equalizing treble preemphasis. When separate magnetic cartridges are employed for standard and *lp* records, a measure of variable equalization may be introduced by decreasing the load resistance for the *lp* cartridge. A small resistor of about 5,000 ohms is wired directly across the *lp*

cartridge terminals. Since the treble preemphasis of 78 records is in general less than that of the microgrooves, the added resistor automatically corrects the equalization when cartridges are changed.

Preamplifiers for Magnetic Pickups

Although it is possible to buy variable record compensators (for magnetic pickups) by themselves, this compensation is usually incorporated in the circuit of an electronic preamp, most commonly a dual triode stage with the two sections connected in cascade. A preamp is required because the output of the magnetic pickup is inadequate to drive the ordinary audio amplifier. Crystal pickups have signal outputs ranging from about 1/2 to several volts, while magnetic pickups have much smaller outputs, in the range between 10 and 100 millivolts. This disadvantage of magnetic pickups is offset by their high quality.

Preamps are rated in much the same way as amplifiers, except that many of the standards to which the power output stage must conform do not apply. The preamp should have a low hum level (at least 60 db below output) low harmonic distortion (preferably less than 1%), and accurate frequency compensation.

Some preamps contain their own power supply, while others furnish leads for tapping power from an amplifier or tuner (Fig. 5, p. 21). The amount of power used is very small (.3 amp heater current, and 2 or 3 mils plate current), so that overload of the supply from which power is borrowed is not a danger. There is one extremely important consideration relative to this power supply, however; *hum*. Although the preamp contains its own *B+* filter sections no supply point which is not very well filtered should ever be used. Occasionally even the selection of a physical point at which to connect the ground lead may be a factor in keeping hum low. The heater supply should be carefully selected also, and heater circuits which merely ground one side, rather than grounding the center tap of the filament winding or of a bridging resistor, should be avoided. The best type of heater circuit to connect to is one in which the heater winding is grounded through the center tap of a hum balancing potentiometer.

In general, it will be found that power is best borrowed from audio stages, whether on the tuner or amplifier, because purely *rf* chassis' do not require as careful hum precautions in their design. Where the preamp has its own independent power supply

the relative polarity of its line plug, and the extent of electrical bonding between the preamp and other chassis', may affect the hum level. The phono preamp is potentially the greatest single source of hum in the entire radio-phono assembly.

The preamp should be located physically near the pickup so that the pickup lead can be short, to avoid high frequency losses and opportunities for hum pickup by the lead.

Many modern audio amplifiers, and tuners with audio stages, include a preamp stage for magnetic pickups. Care must be taken to avoid connecting crystal pickups through such preamp stages, or excessive gain and boomy reproduction will result. Similarly, if the output of a preamp is accidentally connected through a crystal compensating network the treble frequencies will be unduly boosted.

Available also is the capacitive or FM pickup, designed to frequency modulate a supersonic carrier signal created by the circuit to which it is connected. It, therefore, requires a special type of preamp containing its own oscillator.

Some years ago scratch suppression was attempted by the use of resonant filters which attenuated a certain band of frequencies in the mid-high range. Today, it is recognized that surface noise covers the entire audio spectrum but becomes more apparent as the frequency goes up, and the above method has been abandoned. Present-day methods of combatting record surface noise (especially from older shellac records) include:

(1) General treble attenuation by the tone control.

(2) Sharp treble cut-off at selected predetermined frequencies. This method is made available in some record compensators, and is superior to turning down the treble control, as it leaves a maximum frequency range for the recorded signal, while eliminating the worst of the high frequency noise and distortion.

(3) Volume expansion (increasing amplifier gain for loud signals, relative to the gain for weak signals). Although this feature is introduced primarily to increase the dynamic range of the music, it also has an apparent scratch reducing effect, since it allows the music to be played at a lower average intensity level.

(4) Dynamic suppression of record noise. The *Scott* system of noise suppression, which is included in several makes of amplifiers and in the *Dyna* preamp, automatically controls a variable treble cut-off according to the frequency content of the signal.

THE PLUS VALUE ANTENNA

for perfect

ULTRA VISION TV!



Rytel

DOUBLE "O"
UHF ANTENNA

UHF stations are springing up all across the country. Demand is terrific. Start right with a performance antenna that can't give you "customer headaches."

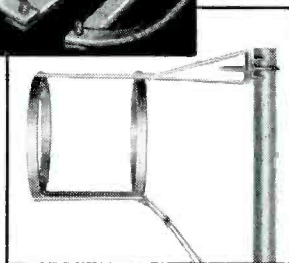

SIMPLICITY . . . NO ELECTRICAL OR MECHANICAL BREAKDOWNS

The facts: high signal-to-noise ratio. Here is why. The Double-O antenna has high directivity along horizontal planes, acts like a wall in blocking noise from vertical sources and cancels out at the feed point all noise and multipath reflections. In addition, 2-circle antennas fed 90° out of phase with a gain of 3.8 db, plus 1 db gain over a single dipole in each of two circles, give an overall gain in forward direction of 5.8 db. Result . . . low noise, high gain . . . Perfect Vision.

PLUS ECONOMY . . . simple, tough aluminum construction means low price, no maintenance, long life.

PLUS RUGGED CONSTRUCTION . . . simplicity of design avoids fragile, expensive insulators, no chance of electrical or mechanical breakdown. Supported at current node (ground potential).

PLUS APPEARANCE . . . no more monstrosities on the roof . . . just simple, attractive . . . perfect Double-O.

PLUS INSTALLATION . . . no more "servicemen's nightmares" . . . Double-O is a serviceman's dream . . . comes completely assembled, just a "U" clamp to tighten, no "adjustments."

It's the **DOUBLE-O** for **PERFECT ULTRA VISION** . . . **ACT NOW**
AND BE READY WITH A UHF ANTENNA THAT
NEEDS TO BE SOLD JUST ONCE.

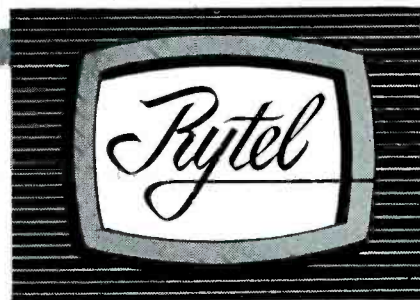

RYTEL ELECTRONICS MFG. CO.
9820 Irwin Avenue • Inglewood, California

Also connector clips, impedance matches, tube reacti ators, tube-pullers, etc. Over 800 Rytel distributors in the United States. Write for further information.

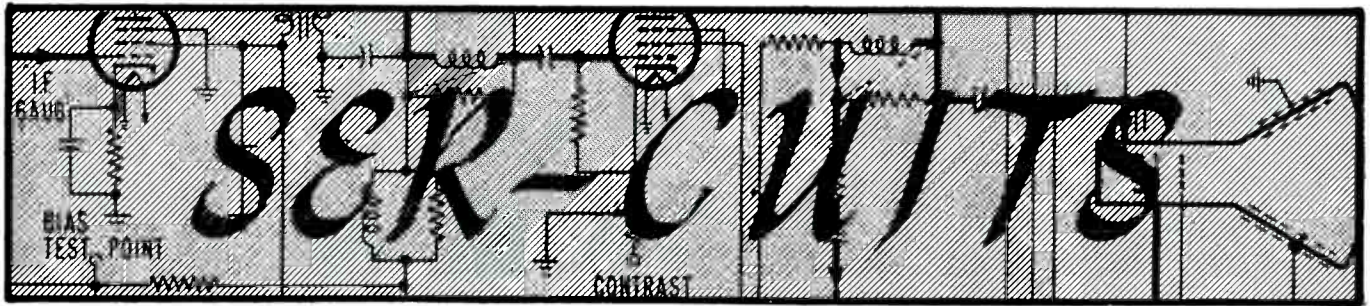

by M. W. PERCY

Review of Circuits Used in Printed-Circuit AC-Clock and AC-DC Table Models . . . UHF 3-Channel Translators . . . Constant-Amplitude Oscillator System

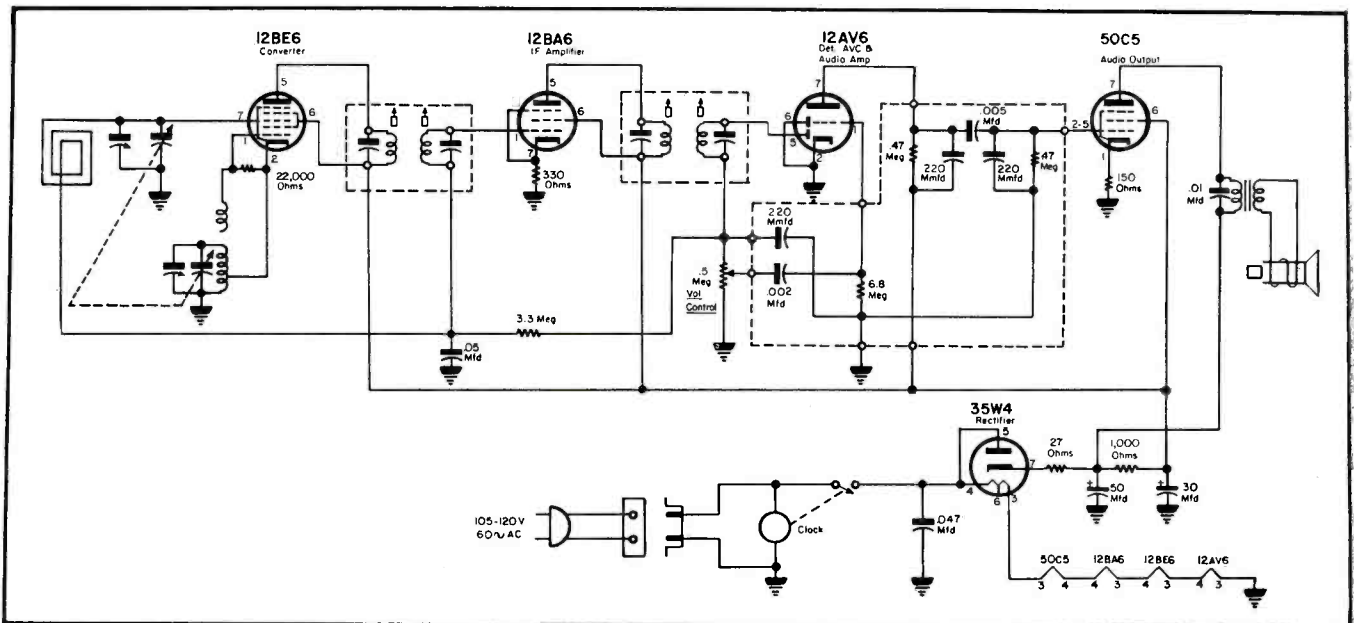

Fig. 1. Hallierafsters *foto-etch* chassis circuit, featuring provision for a clock.

PRINTED CIRCUITRY, described on several occasions in Service,¹ has now been adopted as a production technique by several manufacturers for table models.

In Fig. 1 appears the circuit of one such set utilizing a *foto-etch* chassis for a clock radio.

In this method, the base of the chassis is formed by laminating a sheet of Formica and copper under high heat and pressure until a perfect bond is achieved.

The copper side of the sheet is then covered with an emulsion. A negative of the circuit is laid on the emulsion, an exposure made and the base is then developed like a photographic plate. Next, the sheet is given an acid dip, which washes away the unwanted copper, leaving only the lines of the circuit.

Small holes for the tube sockets and the leads of small component parts

such as capacitors and resistors are then automatically punched in the base and the parts manually mounted

¹September and October, 1952.

Fig. 2. View of Hallierafsters *pc* clock-radio chassis.

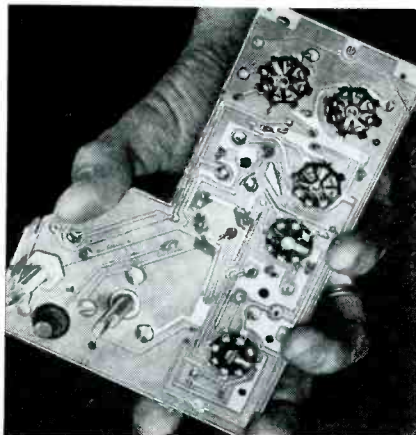

in position. The sheet is then dipped into a non-corrosive cleaning solution which is followed by a single dip into a solder pot which solders all connections in one operation.

The clock radios have a standard broadcast receiving band, a *wake-up* switch connected to the radio, and built-in antenna.

As indicated earlier, in servicing these chassis one must avoid carelessness in making solder joint connections. If one is careless and splatters solder around over the bottom of the chassis plate, some short circuits will occur between the wiring that's photo-etched on the chassis base. Some Service Men may become apprehensive about *pc* sets, fearing that they cannot replace components in this type of receiver in the manner that they're normally accustomed to when servicing wired chassis. There is no need to be so concerned, since conventional

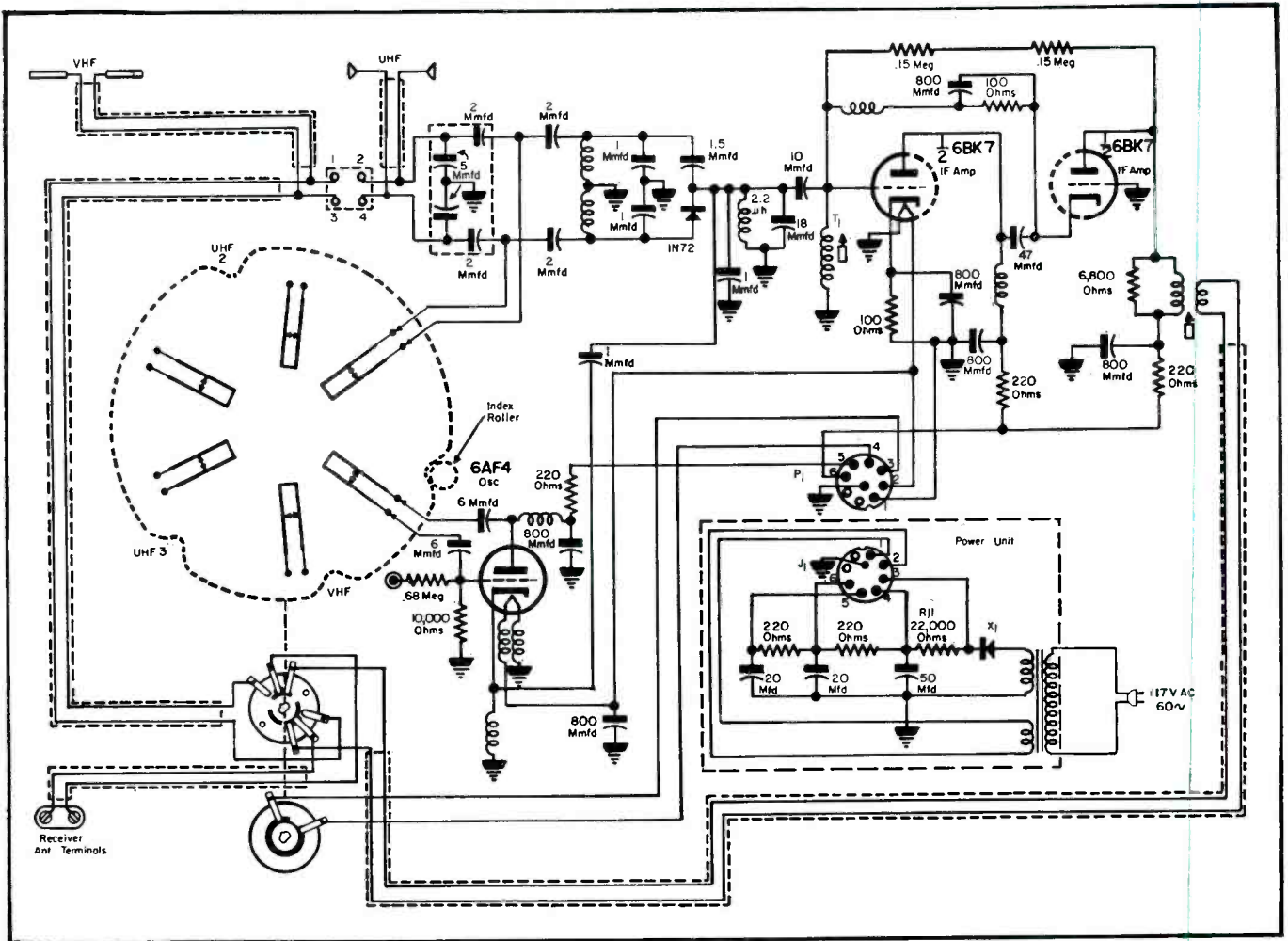

Fig. 3. Circuit of G.E. 103 *uhf* translator which provides for three-channel pickup. In the first, second and third *uhf* switch positions, the output transformer T_1 is connected to receiver transformer, and the *vhf* antenna is disconnected. In the fourth position, or *vhf* contact, the output transformer is disconnected, and R_{11} (22,000 ohms) is switched in to drop $B+$; the *vhf* antenna is connected to the receiver antenna.

components such as tube sockets, if transformers, resistors and capacitors are used and readily removable and replaceable. The Hallicrafters' *pc* chassis only uses the photo-etch process to provide wiring connections between sockets and components.

According to Hallicrafters there are available a replacement supply of photo-etched chassis plates should any replacement ever be needed.

The model illustrated is an *ac* type. Available too, from another source¹ is an *ac-dc* model, using the same tube lineup, but without a clock in the circuit. In making voltage readings or resistance measurements, test leads with needle point prods should be used to avoid possibility of shorts between sections of the printed circuit wiring.

UHF Translators

To permit reception of three *uhf* channels on *vhf* receivers, there has been developed a detent switch-type unit (G. E. 103; Fig. 3), which can

be installed inside of the TV cabinet.

As shipped from the factory, unit has its output stage tuned to channel 5, to which the TV receiver must be tuned. However, output stage can be

realigned for channel 6 operation, should 5 be active.

The Service Man must individually adjust each of the three *uhf* positions
(Continued on page 52)

Fig. 4. Circuit diagram of NBS constant-amplifier oscillator. The unit utilizes one-half of a 12AT7 twin triode as an oscillator and the other half as a clamper tube. A 6AL5-diode rectifier across the output of the oscillator supplies the input voltage to the clamper tube. The constant-amplitude oscillator is a source of *rf* voltage that has been found to remain reasonably constant irrespective of changes in tube parameters, supply or heater voltage, or load impedance.

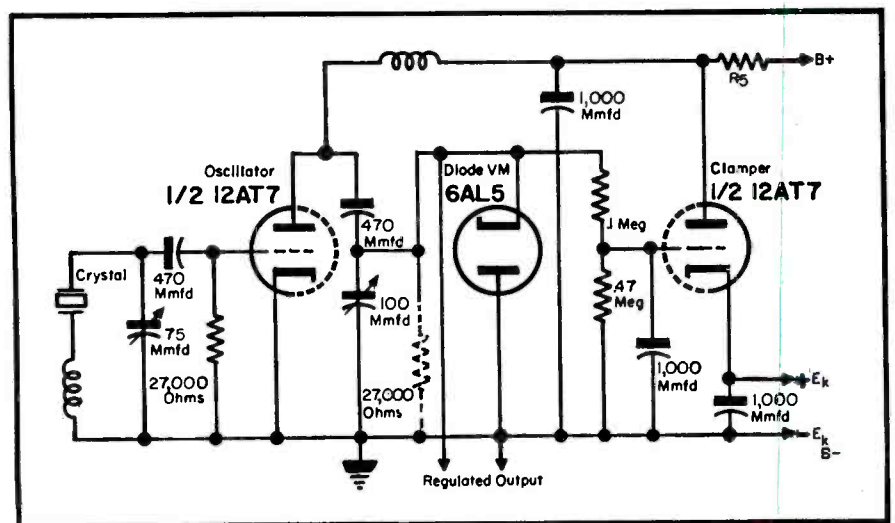

¹Admiral 5C3 chassis.

Thousands depend on PHOTOFACT! THEY TELL YOU WHY

Unsolicited letters tell what the world's finest TV and Radio Data means to Service Technicians



Alexander Cuomo
193 Columbia St.
Brooklyn, N. Y.

"Just to let you know that your PHOTOFACT diagrams are a lifesaver to me and many other Radio and TV men. I congratulate you and your entire staff that worked hard to make it possible for us to read your diagrams in a simple manner. Thank you."



C. S. Pruett
Pruett's Radio Shop
450 N. 7th St.
Dade City, Fla.

"I have all of your PHOTOFACT Folders, and I think they are the most useful thing in my shop. They really save time and money."



Fred Hale
719 E. 10th St.
Brooklyn, N. Y.

"Let me say that I like the way you put out PHOTOFACT Folders. It is worth \$1.50 for one circuit alone because you do a thorough job."

NOW! GET THE PROOF FOR YOURSELF!

FREE

We'll send you a Free Photofact Folder on any receiver listed in "PF Index & Technical Digest."

Learn for yourself—at our expense—how PHOTOFACT pays for itself by earning bigger profits for you! Select any Folder from the PF Index (if you haven't an index, get a copy from your distributor). When you write us for your Free Folder, be sure to state Photofact Set and Folder Number as shown in the Index. Get your Free Folder now. Examine, use, compare—see why you can't afford to be without PHOTOFACT!

HOWARD W. SAMS & CO., INC.
2207 E. 46th St., Indianapolis 5, Ind.

HOWARD W. SAMS & CO., INC.

Ser-Cuits

(Continued from page 51)

for operation on the local active *uhf* channels. The tuning ranges of the three *uhf* positions are all identical and cover the entire *uhf* spectrum.

Constant-Amplitude Oscillator

In electronic equipment such as exciters, signal generators, and high-quality communication receivers, the adjustable-frequency oscillators must be stabilized against changes arising from possible variations in circuit components. Automatic volume control systems have been modified to provide the stabilization, but it has been found that they have proved ineffective for class-C oscillators because of the self-biasing feature associated with this class of operation. Fixed-level clipper circuits have also been utilized but the output waveform has normally contained strong, undesirable harmonic components.

To overcome these objections, a constant-amplitude oscillator has been developed. The circuit evolved at the Bureau of Standards[†], and shown in Fig. 4 (p. 51), has been found to maintain the apparent grid-plate gain of the oscillator reasonably steady. The input and output capacitances have been held practically constant, and the clipping of the output waveform reduced to very low levels. The moderate amount of clipping that does occur is said to be due only to the diode detector across the oscillator output.

The oscillator was originally designed as a fixed-frequency local oscillator in a gain-stable receiver. It utilizes both sides of a 12AT7 twin-triode as the oscillator and clamper tube, respectively, and a 6AL5 diode detector. The grid tank circuit is composed of a fifth overtone crystal (30 mc), a frequency-shifting trimmer, and a crystal-peaking coil. A coil in the plate circuit of the oscillator section of the 12AT7 serves to resonate at the crystal frequency.

The clamper tube is initially biased in the region of plate cutoff. The oscillator output, after rectification by the diode, is applied as a positive voltage to the grid of the control tube, the other half of the 12AT7. When the oscillator output voltage reaches a sufficiently high level, the clamper begins to draw plate current and causes a reduction of plate voltage. Because the oscillator is connected to the same plate-dropping resistor, it too suffers a reduction of plate supply. Thus, the tendency of the clamper, as the oscillator output voltage increases, is to

[†]Designed by N. C. Hekimian.

FASTER STURDIER

Lower Installed Cost

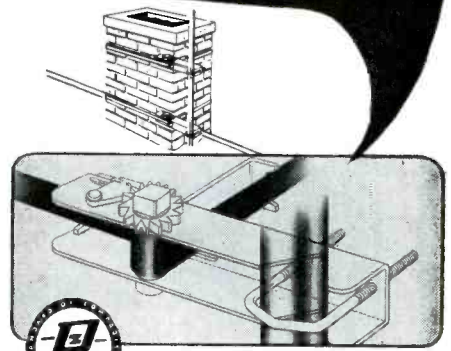

SPEE-DEE

CHIMNEY MOUNT

Model AK 85 The fastest-installed chimney mount ever devised for TV antennas! Rugged in design—simple to install. Simply thread strapping through ratchet, around chimney and back through ratchet—wind up ratchet tight—and the job's done! Heavy gauge, zinc-plated steel with large "U" bolt for up to 1 3/4" O.D. mast and full length galvanized steel strapping.

THE **RADIART CORPORATION**
CLEVELAND 13, OHIO

VEE GOT IT!

Check these tube prices against your last purchase order. We're positive you can't beat these prices for branded tubes, fully guaranteed and individually boxed.

OZ4A	.68	6AV6	.41	6W4	.49
1B3	.68	6BA6	.48	6X4	.39
1R5	.61	6BC5	.56	6X5	.38
1S5	.52	6BC6	1.40	12AT7	.73
1T4	.61	6BE6	.49	12AU6	.48
1U4	.60	6BQ6	.90	12AU7	.57
1X2	.68	6CA	.40	12BA6	.48
3Q4	.65	6CB6	.56	12BE6	.48
3Q5	.70	6CD6	1.79	12SA7	.57
3S4	.60	6J5	.40	12SK7	.55
5U4	.45	6J6	.71	12SN7	.57
5Y3	.35	6K6	.48	12SQ7	.47
6AC7	.80	6S4	.51	19BG6	1.44
6AG5	.56	6SA7	.57	25BQ6	.90
6AK5	1.15	6SK7	.55	25L6	.50
6AL5	.45	6SQ7	.47	35W4	.34
6AQ5	.51	6SN7	.57	35Z5	.40
6AT6	.41	6T8	.83	50B5	.53
6AU6	.45	6V6	.51	50L6	.53

Jobber Inquiries Invited

All prices F.O.B., N. Y. Min. order \$5.00. C.O.D.'s. of course. 25% deposit with order. Prepaid shipments if check in full with order.

VEE Dept. S
Box 134,

Queens Village 29, N. Y.



Fig. 5. Installing G.E. translator in TV chassis.

maintain the final output voltage at a relatively fixed level.

The bias for the clamper tube is usually obtained from a low impedance source of constant potential. In the test model of the constant-amplitude oscillator, bias voltage was obtained from batteries with internal resistances of about 5 ohms. Normally, the bias voltage is adjusted so that the control tube is always slightly conductive at the minimum level of oscillator voltage anticipated. Hence, positive control action is available at all times. Under these conditions, the best regulating characteristics are obtained with the largest plate-dropping resistor that still permits the desired plate voltages. A plate-dropping resistance of 40,000 ohms was found to give satisfactory operating conditions.

An experimental investigation of the effect of different plate-loading resistances on the oscillator output voltage revealed that a resistance of 10,000 ohms permitted a 12-volt variation for a change in plate supply from 200 to 350 volts. A plate-load resistance of 40,000 ohms, however, restricted the output variation to 1.5 volts with the same change in plate supply. In both of these instances the bias supply voltage was held at 18. It was noted that output voltage is determined largely by the bias voltage with the plate-loading resistor adjusted for satisfactory regulation.

Improved clamping may be obtained by employing a voltage-multiplier type of rectifier to drive the clamper tube. Thus, a greater ratio of *dc* control bias to *rf* output can be obtained, resulting in better regulation. Also, if a power amplifier replaced the clamper portion of the 12AT7, its greater plate-current capabilities will result in more positive control action. Further, if the clipper diode is fed from the final output of the oscillator-buffer circuits with more gain included between the oscillator and the rectifier-control circuit, the sensitivity to small changes in output will increase and improved stability will result.

to the

ELECTRICAL

ENGINEER

or

PHYSICIST

with experience in

RADAR

or

ELECTRONICS

Hughes Research and Development Laboratories, one of the nation's leading electronics organizations, are now creating a number of new openings in an important phase of their operations.

Here is what one of these positions offers you:

THE COMPANY

Hughes Research and Development Laboratories, located in Southern California, are presently engaged in the development and production of advanced radar systems, electronic computers and guided missiles.

THE NEW OPENINGS

The positions are for men who will serve as technical advisers to government agencies and companies purchasing Hughes equipment—also as technical consultants with engineers of other companies working on associated equipment. Your specific job would be essentially to help insure successful operation of Hughes equipment in the field.

THE TRAINING

On joining our organization, you will work in the Laboratories for several months to become thoroughly familiar with the equipment which you will later help users to understand and properly employ. If you have already had radar or electronics experience, you will find this knowledge helpful in your new work.

WHERE YOU WORK

After your period of training—at full pay—you may (1) remain with the Laboratories in Southern California in an instructive or administrative capacity, (2) become the Hughes representative at a company where our equipment is being installed, or (3) be the

Hughes representative at a military base in this country or overseas (single men only). Compensation is made for traveling and moving household effects, and married men keep their families with them at all times.

YOUR FUTURE

In one of these positions you will gain all-around experience that will increase your value to our organization as it further expands in the field of electronics. The next few years are certain to see large-scale commercial employment of electronic systems. Your training in and familiarity with the most advanced electronic techniques now will qualify you for even more important future positions.

How to apply:

HUGHES

RESEARCH AND DEVELOPMENT LABORATORIES

*Engineering Personnel Department
Culver City,
Los Angeles County, California*

If you are under thirty-five years of age, and if you have an E.E. or Physics degree, write to the Laboratories, giving resumé of your experience.

Assurance is required that relocation of the applicant will not cause disruption of an urgent military project.



Speakers

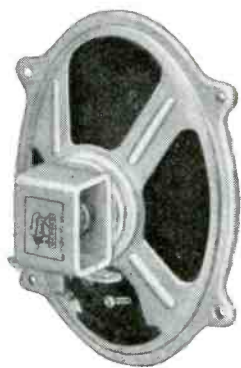

There is an application for every Oxford Speaker . . . and an Oxford Speaker for every application.

OXFORD ELECTRIC CORPORATION

3911 S. Michigan Ave.
Chicago 15, Illinois
EXPORT: ROBURN AGENCIES
NEW YORK CITY



Preferred for
original equipment
... Proven for
replacement!

Merchandising Audio

By L. J. EPSTEIN

University Loudspeakers, Inc.

Part II..The Service Man's Role in the Hi-Fi Market

UNLESS ONE is looking for an excuse to stay out of the *hi fi* picture, the Service Man's position in the distribution network is as strong and indispensable as ever. It is important to remember that the Service Man who is invited into the homes to service radios, TV, appliances, etc., represents the one group who know at first hand the individual's needs, tastes, and financial capabilities. In most cases you are Mr. Music to the buying public in your neighborhood and you have their confidence. This adds up to a highly encouraging position which should at least entice a fair share of prospects if you set the stage a little and do a reasonable amount of promotion.

It was noted that a Service Man's position was not only strong, but indispensable. That happens to be true, for the most part. While quite a good deal of *hi fi* sales are being made to the experimenter and hobbyist (similar to the interest and activity displayed in the radio amateur field), the great bulk of complete system sales, which incidentally account for the major share, go to the out and out *music lover* who is interested in the result and not the cause. No one package is going to satisfy these *golden ears*. Not only do these people require *service* but more often as not want the system installed in a special way or place. And that's just where you come in—*service*; that's you. You can *survey* a prospect's requirements, *engineer* the system which consultation with both the customer and your jobber indicates will be most suited to his needs, make the installation and provide him with future maintenance as may be required from time to time.

Despite recent competitive trends in marketing *hi-fi* equipment, Service Men will find that jobbers can be used to considerable advantage in establishing one's self. First, your plans should be discussed with the jobber in detail, and every effort made to con-

Ask the Man who Knows



JOHN MILLER

Here is the Miller UHF Antenna Kit enabling you to make your own UHF tests. 6 complete UHF antennas with the six basic designs known today. Available immediately. Priced reasonably. Manufactured by the West's pioneer producer of television antennas.

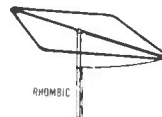

RHOMBIC



CORNER REFLECTOR



DOUBLE BOW TIE

Write for the Miller S-1 UHF Antenna Kit today.

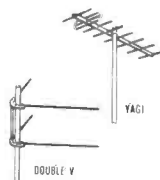

YAGI

DOUBLE V

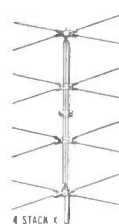

4 STACK K



MEMBER ANTENNA MANUFACTURERS ASSOCIATION

Miller
TELEVISION CO.

2840 NAOMI • BURBANK, CALIF.

BRIGHTEN YOUR SALES PICTURE With The New KINE-LITE

Picture Tube Pat. Pending
Brightener & Rejuvenator

Only VIDAIRE'S Kine-Lite operates on ANY cathode ray picture tube of 10" and larger, including electrostatic focus.



VIDAIRE'S Kine-Lite brings new brightness to TV picture tubes having low emission—permanent installation—can be re-used—simple instructions with each unit.

- ★ Renews brilliance and contrast of picture
- ★ Prolongs life of old picture tubes
- ★ Easy to install ★ No soldering necessary
- ★ For all standard tubes using duo-decal bases
- ★ No limit to tube size—10" to 30"
- ★ Standard Warranty ★ Two connecting plugs
- ★ Compact, attractive package
- ★ QUICK SELLER — EXCEPTIONAL PROFITS

Sold only through VIDAIRE distributors
Write for Catalog C

Vidaire Electronics Mfg. Co.



Mfrs. of TV color equipment,
phono & TV amplifiers
6 E. 39th St., N. Y. 16, N. Y.
LEXington 2-7372

vince him that you are serious about it. You will find that he will begin to turn over to you for follow up, leads that have come his way, often from the manufacturers of *hi-fi* equipment who receive hundreds of letters from individuals who write directly. Certainly the last thing a jobber wants is the burden of surveying the customer's needs, nor has he any inclination to do an installation or follow up service calls. In fact, he barely has time to check on leads and welcomes the opportunity to turn them over to reliable and loyal Service Shops.

Many jobbers today already have or are in the process of setting up audio demonstration rooms or *salons*. It has been found that most jobbers openly invite Service Men to bring their customers to such studios, use their facilities and the guidance of their sound specialists, and offer protection in consummating the sale. Access to such facilities is a worthy and valuable asset which you should attempt to exploit, and which can be easily accomplished by merely an *understanding* with your jobber. This has been accomplished in many places in the country to the extent where even the *I can get it wholesale* customers find it possible to work equitably with the Service Men.

Working with a jobber makes it possible not only to start in the *hi-fi* business, but *remain in it profitably*. By having available to you the lines and stock of your jobber, your own investment in components and parts is reduced to a simple working and turn-over level.

Having established the existence of three major markets and discussed the problems therein, let us examine the merchandising of audio from the point of view of application. Obviously, a *market* is simply descriptive of the *place* in which audio is to be used while the application describes the *function* of audio. An excellent chart listing *basic* uses for audio, showing the relation of place and function, appeared in the initial installment last month.

Though it is possible to evolve a chart in even greater detail (one need only to refer to a dictionary and list every conceivable application starting with *A bby* and ending with *Z oo*), the chart offered is a practical, workable one in which ten functions transgress the specific applications to result in thousands of opportunities for the alert Audio Man. When one realizes that all this can be accomplished with virtually the same pieces of equipment, the great potential which exists in the audio business becomes apparent, and extremely stimulating.

Use either one...

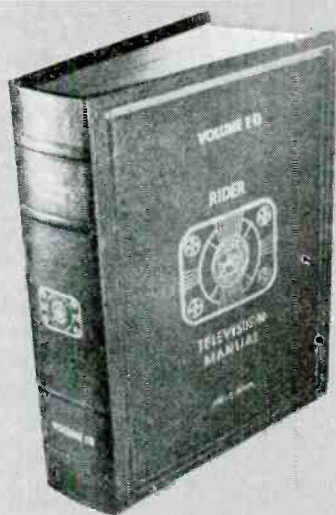

BOTH make your TV servicing fast, easy, more profitable!

All Rider TV servicing information is produced to make your TV service work easier! Making it easier makes it faster and more profitable. Why is Rider information easier to use? Because it is the only source for official, complete, factory-authorized data. Exactly as issued by the receiver manufacturer... with all of his production changes and trouble cures — organized into indexed, easy-to-follow style. When you repair a set with Rider servicing data, you have everything you must know to do a fast, accurate diagnosis and make a permanent repair. RIDER TV SERVICING DATA COMES IN TWO FORMS, MANUALS... The TV Manual has 10 Volumes covering more than 4,650 models of TV receivers. Each volume has over 2,000 (8 1/2 x 11") pages of servicing data with an index that covers the contents of all volumes. The Manual form is ideal for shop use and as a permanent reference.

TEK-FILE... is Rider's same, complete, official TV service information in packaged form. The only difference is that each TEK-FILE pack covers a few receiver brands where, each Manual covers all of them. With TEK-FILES, you buy only what you need. You'll find the models you want listed in the FREE, up-to-date TEK-FILE INDEXES at your jobber's. There are now 69 TEK-FILE Packs covering over 2,500 TV models. NEW FEATURE ADDED! Beginning with TV Manual Vol. 10 and TEK-FILE Pack 57, you'll find a feature that can't be beat — a listing of dependable replacement parts by brand names! All listed parts check against the physical and electrical requirements of the receiver's original parts. DON'T BE SWITCHED! Remember, Rider Manuals and TEK-FILES are the only source for complete, factory-authorized servicing data. If your jobber doesn't have Rider Manuals, write to us... we'll tell you where to get them. If he doesn't have TEK-FILES, write to us... we'll fill your order directly. (Please include jobber's name!). Prove to yourself that Rider Servicing Data really makes servicing easy! Try one Rider TV TEK-FILE pack at our risk! For the next receiver you repair... if you don't agree that it makes your servicing easier than anything you've ever used, RETURN THE PACK TO US WITHIN SEVEN DAYS AND WE'LL SEND YOU A FULL REFUND! Act now... you have absolutely nothing to lose!

For Easier Radio Servicing... Use Rider's 22 AM-FM Manuals!

JOHN F. RIDER

PUBLISHER, INC.
480 Canal Street, New York 13, N. Y.

Export Agent: Roburn Agencies, Inc. 39 Warren Street, New York 7, New York Cable Address: Roburnage, N. Y.
West Coast Office 4216-20 W. Jefferson Blvd. Los Angeles, California

meet 85%
of your
replacement
needs with
these TRIAD
Television
Components

There are 23 Triad Television Replacement items listed below. They will take care of 85% of your service needs. Always keep a supply on hand. They eliminate excessive inventories, speed servicing and simplify reordering. Your Triad jobber carries them in stock. Call him today.



Y-12

DEFLECTION YOKES:

Y-11 Y-19
Y-12 Y-20
Y-17



TYPE P

**HORIZONTAL OUTPUTS:
(Flybacks)**

D-1 D-15
D-11 DA-20
D-14



CASE Y

**VERTICAL BLOCKING
OSCILLATORS:**

A-97X A-97Y
A-97K



CASE X

FILTER CHOKES:

C-11X C-21X
C-13X C-23X
C-17X

VERTICAL OUTPUTS:

A-99X A-103X
A-101U A-107X
A-102X

Write for Catalogs TR-52C and TV-52C



4055 Redwood Ave., Venice, California

Selenium Rectifier Tester

(Continued from page 22)

Two operations are involved and, if used properly, a good indication of the quality of the rectifier will obtain. This test method, or some slight variation of it, is used as a production test by most of the manufacturers of selenium rectifiers. The forward test measures the non-linear conducting resistance of the rectifier at the operating voltage by the *E-I* method. This test is important, as excessive forward (conducting) resistance can cause low output voltage, ripple and resulting hum, and overheating of the rectifier, causing it to age (further increase in forward resistance) or burn out.

The reverse test measures reverse leakage current (current which flows through the rectifier in the blocking direction) at the rated *PIV* of the stack. Excess reverse leakage will definitely cause the stack to overheat and thus age quickly or burn out. It can also cause a low output voltage or, if the leakage is extremely high, cause damage to the electrolytic.

Although these two tests give an adequate check, they are not often used by Service Men, because the equipment is expensive and also offers various technical problems, such as the difficulty of building protection against shorted stacks into the circuit. Also, if the two circuits are combined into one, the forward test would read good upscale and the reverse test would read good downscale, necessitating a pair of opposing meter scales which could lead to confusion. (The reverse circuit could be used for electroforming.)

Practical Tester Requirements

From the foregoing, it is apparent that a practical and economical tester would have to provide a positive rapid indication of short-circuited and open rectifier stacks; a definite indication of excessive forward resistance and excessive reverse current; an electroforming circuit; scale readings in the same direction for both forward and

¹Galvanic Selester.

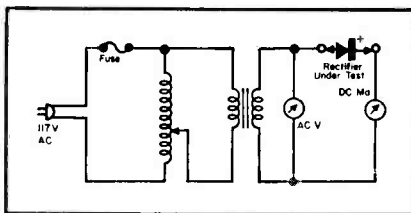

Fig. 2. Forward test which measures non-linear conducting resistance of rectifier at operating voltage by *E-I* method.

**INSURANCE
against KICKBACKS
because of
NOISY
CONTROLS**



in 3 sizes
2 oz., 4 oz., 8 oz.

Your guarantee for quieting noisy television and radio controls, switches and other moving parts is QUIETROLE . . . the original, quality lubricant-cleaner. There is no substitute for "real insurance" to satisfy your customers.

Carried by recognized jobbers . . . everywhere.
manufactured by



**QUIETROLE
COMPANY**
Spartanburg, South Carolina

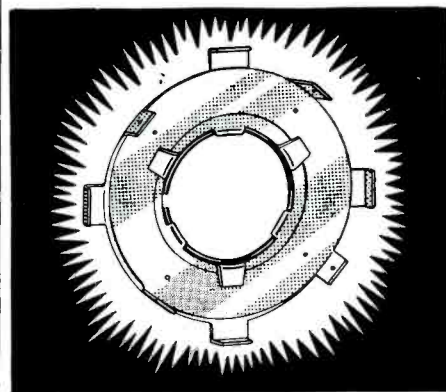

CENTER TV PICTURES

IN 3 SECONDS

with the

PERFECTION

Beama Juster

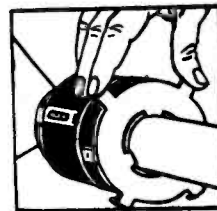

1. Snap BeamaJuster on back cover of tube yoke. (Fits any standard yoke and any size tube.)
2. Rotate BeamaJuster as shown here for approximate centering of picture.
3. Make final adjustment by sliding outer plate of BeamaJuster vertically or horizontally.

Order today from your supplier!

PERFECTION ELECTRIC COMPANY
2635 South Wabash Ave., Chicago 16, Illinois
Makers of Perfection Speakers, Ion Traps and
B. O. (Barkhausen Oscillation) Eliminators.

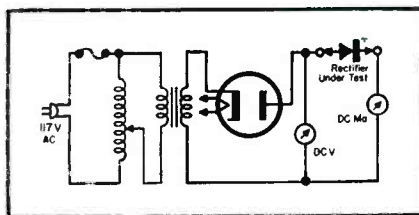

Fig. 3. Reverse test which measures reverse leakage current at rated PIV of stack.

reverse test; positive protection for the meter and other components when shorted stacks are tested; indication that a stack is electroforming, and protection for the meter when the reverse leakage current is high during electroforming; whenever possible, the ability to test the rectifier in the set without unsoldering any wires; and portability.

To meet these specifications, the tester¹ diagramed on the cover was developed.

In this instrument the problem of a single scale has been solved by a change in the forward circuit, which makes it possible to measure the forward resistance as a function of the voltage across the rectifier with the rated current flowing through it, rather than by measuring it as a function of the forward current with a fixed voltage across the stack.

Protection Circuit

Protection against short-circuited stacks has been provided by means of a special relay circuit, which connects the meter in the circuit only when the reverse current will read on scale. The meter is also protected against excessive forming currents by a rectifier plate acting as a parallel non-linear resistance. This causes considerable cramping at the high end of the scale so that no matter how high the reverse current is when a stack is forming, the needle will still be on scale. This provision allows the reverse circuit to be used as an electroforming circuit; and the user is always aware of the forming progress, since the drop in reverse current can be continuously observed.

When the tester is used to test all rectifiers in half-wave circuits, no connections need be broken; the stack can be tested as it is connected in the set by turning the switch to *off* and removing any one tube. In the case of doubler circuits, however, the units can be tested by unsoldering two of the three wires involved.

Tube News

(Continued from page 26)

miniature T-6½ construction, and said to be capable of furnishing large

#1 IN PORTLAND!



RADELCO UHF ANTENNA

MODEL US-102 DOUBLE STACK

Completely preassembled. Matches 300 ohm line. Durably constructed of finest materials. Shipped as shown above, less mast.

LOW
LIST
PRICE **\$5.45**

For remote fringe areas. Model US-104 Quad Stack with Jumper Bars. List Price \$12.25.

**PROVIDED 100% RECEPTION
IN BOTH PICTURE AND SOUND
IN PORTLAND PROVING GROUND**

★ Think of it . . . hundreds and hundreds of Radelco U.H.F. Antenna installations in Portland . . . and not a single, solitary complaint. The Portland Proving Ground was quick to prove that Radelco engineers know how to design and make antennas for Ultra High Frequencies. The Radelco Model US-102 antenna is a high gain job. Gain increases with increasing frequency . . . this means that the antenna compensates for the decreasing wave length at the high frequency end of the band. It is a tried, tested and proved antenna . . . proved to outperform them all. Better get Radelco, because you can't get a better U.H.F. antenna!

RADELCO
MANUFACTURING CO.

**7580 GARFIELD BLVD.
CLEVELAND 25, OHIO**



output voltages across low values of load resistance and supply voltage. Has separate suppressor grid connection. The heater may be operated from either 6.3 or 12.6 volts.

A nine-pin miniature power pentode (6CL6) for use in the video output stage has been added to another tube line.²

Video Circuit, Voltage Gain

Using this tube it is said to be possible to obtain a voltage gain of from

²G. E.

40 to 45 in wide-band video circuits. The tube features high transconductance, low capacitances, and high output current capability.

Peak-to-Peak Output

The tube is claimed to provide a high plate current at low plate voltages and able to supply enough peak-to-peak output voltage to drive large picture tubes with high efficiency and low amplitude distortion. It is capable of supplying 132 volts peak-to-peak output across a load resistor of 3,900 ohms.

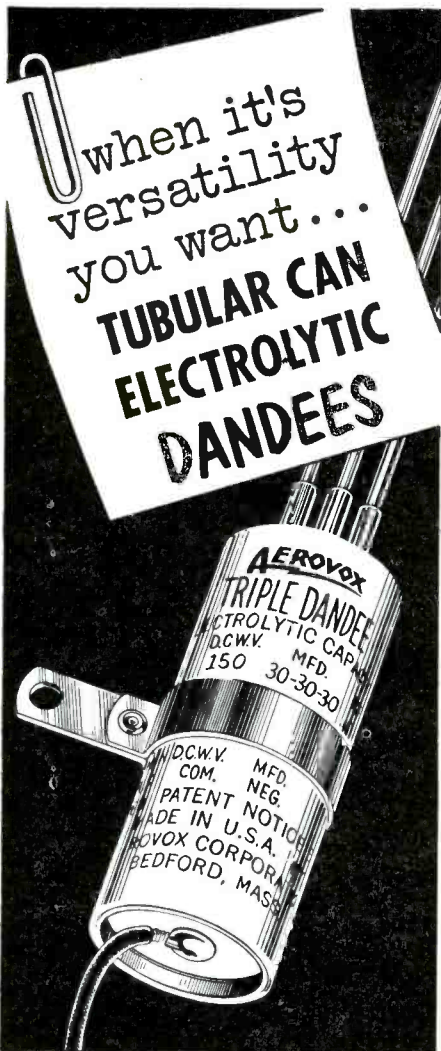

So compact they fit anywhere. So many listings (over ten dozen) that you can meet any capacitance, voltage and combination requirement. Yes, singles, duals, triples and quads.

Multiple-section units have stranded wire leads and safety sleeves. Hi-purity aluminum construction minimizes corrosion. Vented for excessive gas pressures.

If ever there was a Jack-of-all-trades electrolytic, this is it—Aerovox Type PRS Dandee.

Ask your Aerovox distributor for Aerovox Dandees. Ask for latest catalog—or write us.



FOR RADIO-ELECTRONIC & INDUSTRIAL APPLICATIONS
AEROVOX CORPORATION
NEW BEDFORD, MASS., U.S.A.

In Canada: AEROVOX CANADA LTD., Hamilton, Ont.
Export: 41 E. 42nd St., New York 17, N. Y.

CATALOGS..BULLETINS

RCA Victor, Tube Department, Harrison, N. J., is now distributing the '53 edition of its pocket reference and calendar notebook. Pocket book contains technical information on picture tubes, receiving and transmitting tubes, electronic components, test equipment, batteries and miniature lamps. Includes 16-page color maps, 58-page diary, and TV troubleshooting data.

* * *

JFD Manufacturing Co., Inc., 6101 16th Ave., Brooklyn 4, N. Y., has published a 36-page catalog, *TV Almanac*, No. 450, describing in detail indoor and outdoor antennas, lightning arresters, boosters, couplers, wave traps, ballasts, mounts, screw eyes, tools, phono switches, and accessories.

* * *

Jensen Industries, Inc., 329 S. Wood St., Chicago 12, Ill., has released a brochure, *Your Favorite Phonograph Records' Best Friends*, discussing advantages of diamond-pointed needles, and offering helpful hints and facts on records, cartridges, etc.

* * *

Blonder-Tongue Laboratories, Inc., 526 North Ave., Westfield, N. J., has issued an installation manual, *The B-T Unit System for Better TV*, providing technical data on all types of master TV systems. Included are layout of a master system, type of transmission line to use, location and installation of various units, and methods available for the elimination of ghosts and other interference.

* * *

Ram Electronics Sales Co., Irvington-on-Hudson, N. Y., has published the '53 edition of *TV Replacement Manual*, with over 6,200 listings covering manufacturer's name, chassis and model numbers and corresponding Ram part numbers. Manual, with 32 pages, also features schematics of typical circuit applications. Priced at \$1.00.

* * *

Brach Manufacturing Corp., 200 Central Ave., Newark, N. J., has released a booklet, *How to Select UHF-TV Antennas*, that outlines the major differences between *vhf* and *uhf*, and solutions to problems that may arise. Detailed also are *uhf* multiple installation systems.

* * *

John F. Rider Publisher, Inc., 480 Canal St., New York 13, N. Y., has released *TV Manual Vol. 10* which features three separate sections: manufacturer's servicing information; replacement parts listings; and production changes, trouble cures and servicing hints. Book contains equivalent of 2,350 pages, priced at \$24.00.

TEN YEARS AGO

SERVICE MEN were declared essential to the support of the war effort, according to a bulletin issued by the War Manpower Commission, and were eligible for occupational deferment until a replacement could be trained. Class 2A was assigned to those deferred. . . . A two-sided record player with two high-impedance pickups with a reversible motor for the turntable and another motor for cycling. *RCA RP-151* was the cover feature. . . . Loop circuitry, 1.5-volt set conversion, speaker phasing and portable developments, were highlighted in a discussion on design trends. . . . Army-Navy E awards were presented to Meissner, Stromberg-Carlson and DeJur-Amsco. . . . American Institute of Electrical Engineering Edison medal for '42 was awarded to Major Edwin H. Armstrong. . . . Ellis Travers was appointed director of advertising and public relations at Crosley. . . . Leslie J. Woods was named vice president of National Union. . . . Roger M. Wise was appointed director of engineering at Sylvania. . . . Thoms W. Bullock was named assistant sales manager, in charge of lamp sales, of Ken-Rad.

NEW *Mueller* CLIPS

The Only Complete Line
A Clip for Every Purpose



Copper
Alligator
Clips



WEE-PEE-WEE
Phosphor-Bronze Clip

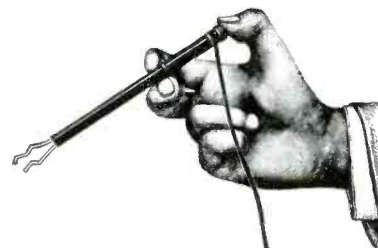

THE SNAPPER—For "Deep-Sea" Tests

Mueller clips are offered in a great variety of types and sizes—insulated and uninsulated.

SEND FOR SAMPLES & CATALOG 810
CLIP SPECIALISTS SINCE 1908

Mueller Electric Co.

1565 E. 31st St., Cleveland 14, Ohio

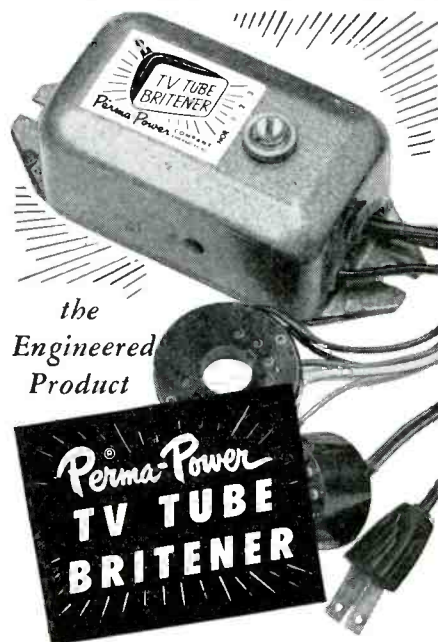

extends useful life
of older TV tubes!

manufactured by
Perma-Power COMPANY

Chicago 25, Illinois

Manufacturers of Electronic Equipment Since 1928

Rep Talk

THE REPRESENTATIVES of Electronic Products Manufacturers, Inc., has become the official title of this national organization. A meeting of the group's board of governors was held recently at the Hotel Congress in Chicago. Members of the board now include: *R. W. Farris* (Missouri Valley), *B. C. Landis* (New York), *David N. Marshank* (Los Angeles), *William E. McFadden* (Buckeye), *M. K. Smith* (Dixie), and *W. S. Trinkle* (Mid-Lantic). . . . Twenty-three more (thirteen seniors and ten associates) have been admitted to the Rep's membership; total membership is 574, with New York chapter's 81 members the largest single unit. . . . Seniors elected to the New York chapter are: *Al Gary*, 1961 Broadway, New York 23; *Carrol S. Banfield* and *Richard Gentry, RSA Co.*, 68 Hudson St., Hoboken, N. J.; *Hy Bloom*, 8 W. 18th St., New York 11; *Jerry Greenberg*, 1902 Avenue L, Brooklyn 30; *Harry Miller*, 1180 Raymond Blvd., Newark 2, N. J.; *Robert A. Stang*, 79 Storer Ave., Pelham, N. Y.; and *William W. Weiss*, 509 Fifth Ave., New York 17. . . . Senior members elected to the Chicagoland chapter include: *Harry Monson*, 919 N. Michigan Ave., Chicago 11; *William M. Lins*, 7115 N. Mobile Ave., Chicago 31; and *Dayton L. Warner*, 15423 Honore Ave., Harvey, Ill. Associates include: *William K. Fawcett*, Ridley Associates, 1551 N. Austin Blvd., Chicago 51; *Roy J. Bouda*, William E. Burgoyne, 7001 N. Clark St., Chicago 26; *A. A. Sroka*, Roy J. Magnuson associate, 4258 W. Irving Park, Chicago 41; and *Robert Engstrom*, Harry W. Gebhard associate, 5129 W. Devon Ave., Chicago 30. . . . Seniors elected to Mid-Lantic chapter were: *George A. Shelps*, 9 Chelsea Lane, Allentown, Pa., and *Paul Williamson*, 720 Rittenhouse, Philadelphia 44, Pa. Associates elected were: *William G. Bauer, Jr.*, and *Charles W. Janton, Jr.*, associated with Wilmer S. Trinkle, 2 Roberts Block, Glenside, Pa.; *Tom Cox*, R.S. 1, Green Lane, Pa.; *Horace C. Johnson*, associated with Andrew A. Foley, 640 Federal St., Camden, N. J.; *Arthur J. Stobhart*, associated with L. D. Lowery, 50 E. Wynnewood Rd., Wynnewood, Pa.; and *W. H. Watt*, 225 S. 69th St., Upper Darby, Pa. . . . *Percival Ridley* has been elected president of the Chicagoland chapter. Other officers elected included *Roy J. Magnuson*, vice president, *Roger Clark*, treasurer, and *Karl Engle*, secretary. . . . *Ralph T. Sullivan* has moved his offices to 1551 N. Austin Blvd., Chicago 51, Ill. *Bruce Matson* has joined the firm as an associate. . . . *George S. Gordes*, formerly connected with Fafnir Bearing Co., has become a member of the sales staff of Henry Lavin Associates, Box 196, Meriden, Conn. . . . *Adolph L. Gross Associates, Inc.*, 45 W. 45th St., New York, N. Y., have been named reps for General Hi-Fi Speaker Co. in metropolitan New York. *Robert Hertzberg* has resigned as vice president of the company. . . . *Lee Naylor* has been named rep for Channel Master Corp., in the northwest territory. . . . *Nat Louis*, 1867 Kapiolain Blvd., Honolulu, T. H., is now a rep for Don Good, Inc., in the Hawaiian Islands. . . . *William J. Doyle*, vice president in charge of sales of The Astatic Corp., has resigned his position, and will become a rep in the Chicago area.

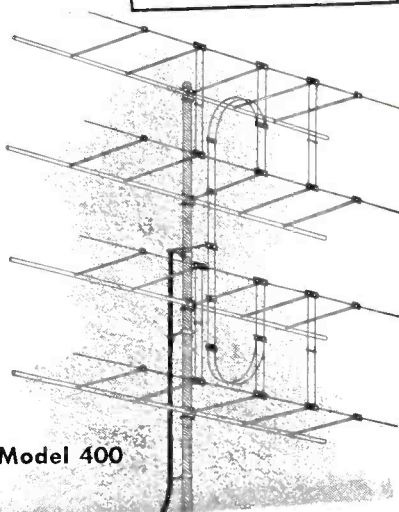

Model 400

Features . . .

- Clear pictures up to 120 miles and more from station!
- 12 driven elements on high band!
- 8 driven elements on low band!
- High gain—low noise!
- One antenna—one transmission line!
- Total weight only 8 lbs.!

..Preamsembled for easy-fast-simple installation!

the Sensational
TV ANTENNA
 THAT WINS
 FRIENDS
 AND MAKES
MORE SATISFIED
CUSTOMERS!

Here's the key to more and more installations in fringe areas—the new FINCO 20-in-1 Antenna that provides the best reception over 100 miles from stations. Your customers will say "you are a magician" when they compare FINCO reception with any other antenna. You can build yourself an outstanding reputation by recommending the FINCO 20-in-1 because every satisfied customer tells and sells another. Get your share of the profitable sales that are just waiting to be made in areas where good reception has never been available before by getting acquainted with the FINCO 20-in-1 today. See your Jobber.

The Finney Company
 4612 ST. CLAIR
 CLEVELAND 3, OHIO

On the dias at the recent annual stag dinner party of the Reps at the Woodstock Hotel, New York City, left to right: Joe Sprung, Jules Bressler, James Pickett, Wally Shulan. Standing, left to right: Sam Shaw, John Kopple, Dan Bittan, Leo Freed, Bob Breuer and Bill Gold.





a Gem

a Gem IN PERFORMANCE

- (a) Long Life
- (b) Good Regulation
- (c) High Efficiency

a Gem FOR VERSATILITY

- (a) Wide Range of Power Outputs
- (b) Temperatures of -55°C to $+100^{\circ}\text{C}$
- (c) Impervious to all Humidity
- (d) Impervious to Salt Atmosphere

a Gem IN COMPACTNESS

- (a) Various sizes and shapes
- (b) Light Weight for any Power Output
- (c) "Tailor-made" for Individual Requirements

Write Janet for your free copy of the booklet on Sarkes Tarzian Embedded Selenium Rectifiers



Sarkes Tarzian INC.

RECTIFIER DIVISION

Dept. R-1, 415 North College Ave., Bloomington, Ind.

60 • SERVICE, JANUARY, 1953

Associations

ARTSNY

THE ASSOCIATION OF RADIO and Television Servicemen of New York has altered its setup and established two chapters within the group, devoted to the business and technical aspects of the profession, with elected officers and board members for each chapter.

Under the new arrangement, *Max Liebowitz* will serve as prexy and executive director, while *Sid T. Perlín* will be treasurer. Business chapter officers include: *Phil Goldfarb*, vice president; *Arthur Rhine*, corresponding secretary; *Jerry Macheronne*, recording secretary; *John Lacey*, financial secretary; *Jack Ornstein*, business director; and *Lew Gioia*, sergeant-at-arms. Members of the business board of directors include: *Jack Katz*, *Arthur Kummel*, *Peter Cusimano*, *Edward Eisen* and *Kingsley Sherwood*. Technical chapter officers are: *O. Capitelli*, vice president; *Harold Levinson*, corresponding secretary; *Jacob Allen*, recording secretary; *Joe Guarnieri*, financial secretary; *Lou Benz*, technical director; and *Sid Cornfield*, sergeant-at-arms. Members of the technical board of directors include: *Harry Temler*, *Harry Oxer*, *John Wagony*, *Ted Caumont* and *Henry Levine*.

The technical chapter will hold meetings on the first and third Thursdays of the month, and the business chapter will hold meetings on the second and fourth Thursdays. All officers and members of the board of directors of both chapters will have their own executive meetings once a month.

it's the Nut
that counts!

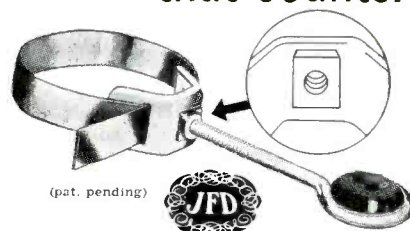

Nut universal STAND-OFF INSULATOR

greatest improvement in screw-eyes since TV began!

6 full, machined threads provide "bulldog" grip, anchor the screw-eye for good! No stripping of any screw-eye, no slipping of strap! Reinforced "arch-bridge" construction prevents bending or buckling of clamp no matter how much the stand-off is tightened. Ultra-low loss polyethylene insert and sturdy electro-galvanized steel strap for universal mounting on any mast up to $2\frac{1}{2}$ " od. Available for both single and dual lead-ins in $3\frac{1}{2}$ ", $5\frac{1}{2}$ ", $7\frac{1}{2}$ " and 12" sizes.

Write for Form No. 149 and Free Nut Stand-off Sample today!

JFD Mfg. Co.
Brooklyn 4,
Bensonhurst 6-9200



world's largest manufacturer of TV antennas & accessories

**\$1,500,000 in
IRON LUNGS in '52**

Join the
**MARCH
OF
DIMES**
JANUARY 2 TO 31

STANDARD BRANDS **TUBES** INDIVIDUALLY BOXED

STANDARD WARRANTY **NEW LOW PRICES** BRAND NEW!!

0Z4 \$.54	5Y3G \$.39	6BA6 \$.54	6F6GT \$.54	6W4GT \$.54	12SQ7GT . . . \$.63
1B3GT87	6AB461	6BA776	6H657	6W6GT65	19BG6G . . . 1.75
1L465	6AC798	6BC565	6J5GT54	6X449	19T887
1R565	6AG564	6BE657	6J676	6X5GT43	25AV5GT . . 1.05
1S476	6AG7 1.05	6BF569	6K6GT54	12AT647	25BQ6GT . . 1.08
1S564	6AH6 1.05	6BG6 1.69	6L6GA 1.05	12AT776	25L6GT54
1T464	6AK594	6BH672	6SA7GT61	12AU654	25Z6GT49
1U469	6AL554	6BJ661	6SC776	12AU765	35B561
1U561	6AQ554	6BL798	6SF558	12AV788	35C561
1X2A79	6AQ649	6BN672	6SH765	12BA654	35L6GT61
3Q475	6AR554	6BQ6 1.08	6SJ754	12BE658	35W441
3Q5GT72	6AS562	6BQ7 1.08	6SL7GT64	12BH782	35Z5GT39
3S465	6AT646	6C449	6SN7GT73	12SA7GT62	50B561
3V465	6AU654	6C557	6SQ7GT49	12SG761	50C561
5T4 1.31	6AV5GT . . 1.05	6CB665	6SR749	12SH749	50L6GT59
5U4G54	6AV646	6CD6G . . . 1.82	6T887	12SK7GT63	117Z354
5V4G98	6B4G98	6E576	6V6GT57	12SN7GT73	

Many other types equally low priced—include all your tube needs with your order.

One of the largest stocks in the country!
Min. Order \$10.00. Terms: 25% with order, balance C.O.D.
All prices subject to change without notice, F.O.B. New York City. Mail order division.

Television Materials Corp.

120 LIBERTY ST., NEW YORK 6, N.Y. • COlltlandt 7-4307

Antenna Measurement

(Continued from page 29)

tion of the towers to eliminate all these effects. Without careful planning, however, a range of this type can become very cumbersome and inflexible. In Fig. 2 (p. 28) appears a range layout found to provide complete control of test. By placing the transmitting antenna on the ground and the receiving antenna on the roof of the lab, harmful reflections have been entirely eliminated. Reflections from the ground and from the building bounce up into the air away from the antenna under test. There are no objects directly behind the antenna to cause reflection. All radiation arriving at the antenna under test arrives from one direction only.

The transmitting antenna used in this instance is a corner reflector type with interchangeable dipoles. A photo of this antenna with the *vhf* dipole in place is shown in Fig. 3 (p. 28). The corner has considerable gain, which makes it possible to use a precision low-power laboratory signal generator, and also eliminates interference to TV sets operating in the vicinity of the lab.¹

Antenna gains can be measured on this system by substitution of a standard antenna. The accessibility of the test site makes this process very rapid.

Auxiliary equipment is available for recording automatically antenna patterns. This consists of a precision rotator which is electrically coupled to a polar recorder. As the antenna is rotated, a turntable turns in complete synchronism with it. After turning on the signal generator and tuning the receiver, a single control causes the antenna to rotate and the recorder to plot its radiation pattern.

With the automatic recorder a complete set of radiation patterns of an antenna at all frequencies of interest throughout the *vhf* and *uhf* bands can be taken quickly and accurately.

The Meaning of Voltage Standing-Wave-Ratio

As indicated earlier *vswr* is a particularly important factor in antenna design. If energy is introduced into a transmission line of a given characteristic impedance, it will flow to the end where a certain part enters the termination (antenna, receiver, or

¹A military type APR-4 receiver has been tested and found adaptable for use in the system. . . . The input circuit of the receiver which is normally 50 ohms unbalanced must be modified so that it is very accurately 300 ohms balanced, and the output circuit must be modified to remove certain non-linearities which were not important in the military applications. With these two modifications the receiver has been found to meet all the requirements for a detector in the system; viz., it presents a matched load, its output is linear, it rejects unwanted frequencies, it is sensitive, and it is easily and rapidly tuned.

Announcing THE FERALOY

Extra Long Life-Tip

**LASTS 20
TIMES AS
LONG**



**50c
LIST**

Same size as standard tip of the Wen Soldering Gun but specially coated to protect against corrosion and silver plated to insure continuous good electrical contact and heat transfer. It stays tinned indefinitely, never requires dressing, is more rigid, retains full tip contact area. Where soldering is constant and tip life is important, (as in factory production or bench work) this Feraloy tip is terrific. One plant reports standard tips had to be changed every half hour—Wen Feraloys every two weeks.

by **WEN**

MAKERS OF

THE BETTER ELECTRIC SOLDERING GUN

The 250 Watt electric soldering gun that's Underwriter's approved. Its excellent design and construction prevent overheating, so **NO DUTY CYCLE**; can be used almost constantly. Operates on 120 Volt AC, 60 cycle. Handles all soldering requirements 50 to 250 Watts. Retail \$12.95 Fully guaranteed.



EXPORT AGENTS, SCHEEL INTERNATIONAL, INC. • CHICAGO 18, ILL.

WEN PRODUCTS, INC.

5806 NORTHWEST HIGHWAY • CHICAGO 31, ILL.

other transmission line) and a certain part is reflected. The reflected wave combines with the original wave to produce a standing wave on the line. The ratio of the maximum voltage to

the minimum voltage is the voltage standing-wave-ratio or *vswr*. Only if the impedance of the termination equals the characteristic impedance of

(Continued on page 62)

Fig. 7. View of slotted line and balun used to measure *vswr*.

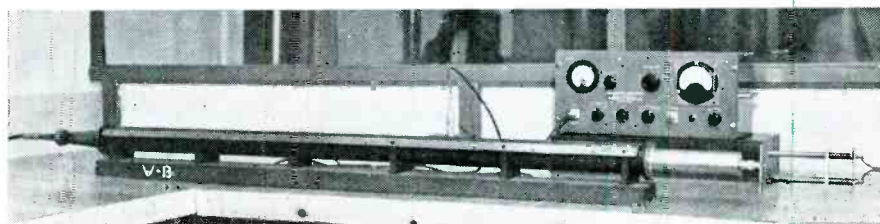

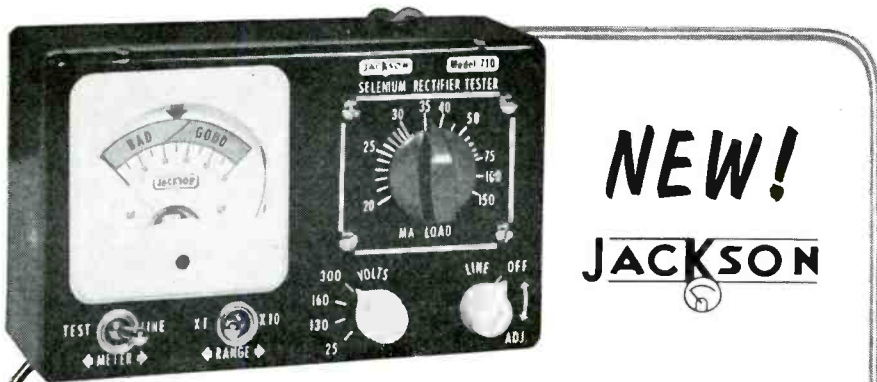

NEW!
JACKSON

SELENIUM RECTIFIER TESTER

- Tests all types 20 to 650 ma - 25 to 300 VAC.
- Gives positive indication - GOOD or BAD - on 3" meter. Shows voltage drop across rectifier under load.
- Novel system gives correct setting, even if rectifier rating is unknown.
- Small, compact - 7" x 3 1/4" x 4 1/4". Has permanent, "loss-proof" color-coded test leads.
- Operates on 110-125 VAC. "Line Adjust" for accurate testing.
- Model 710 Dealer Net Price only \$29.50. See it at your distributor's.

"SERVICE-ENGINEERED" TEST EQUIPMENT

JACKSON

ELECTRICAL INSTRUMENT CO.
DAYTON 2, OHIO

IN CANADA:
CANADIAN MARCONI CO.

Antenna Measurement

(Continued from page 61)

the line will there be no reflected energy. When an antenna intercepts energy it reradiates part of it and delivers the rest to the transmission line. The *vswr* of the antenna when used as a transmitter is simply related to the loss of signal caused by reradiation when used as a receiver. Only when the antenna impedance is the same as the transmission line impedance is reradiation a minimum. The loss incurred by having an antenna with varying degrees of mismatch is illustrated in the graph of Fig. 6 p. 29).

The method of measuring gain described previously takes this loss into account. Nevertheless, for design purposes it is useful to know the *vswr* of an antenna.

A slotted line and balun for measuring *vswr*'s is shown in Fig. 7 (p. 61). The combination of balun and antenna produces exactly the same mismatch in the 75-ohm coax line as the antenna alone produces in 300-ohm twinlead. This scheme is used because of the many difficulties in *vswr* measurements on open lines.

Servicing Helps

(Continued from page 39)

be run from the top, not ground, of this 150-ohm resistor to the fringe position of the maximum performing selector switch on the rear of the set, so that when in a fringe position maximum contrast can still be obtained.

High Voltage Breakdown and Corona... Chassis 200, 201: To reduce tendency to breakdown or corona, the 1B3 filament winding should be moved as far from the *hv* winding as possible. The lead that goes from the 1B3 filament to the picture tube anode connection should be attached to pin 2 instead of pin 7, and all sharp points of solder on the socket lugs should be removed. All 1B3 socket lugs should be bent toward the center of the socket, and the lug on the electrolytic capacitor located under the 1B3 bent down as far as possible. All sharp points should be removed from the flyback transformer lugs. The 1B3 socket, transformer lugs, and top of the damper-tube socket, should be sprayed with a plastic spray.

Stopping Pix Smear in 24-Inch Models: In Hoffman sets (chassis 187 series), if the red deflection yoke lead is dressed too close to the picture tube cathode lead, the

BUILD YOUR OWN
Heathkit
TEST EQUIPMENT

Heathkits are completely engineered instruments supplied unassembled. Every kit goes together smoothly and easily. All drilling, punching, and painting has already been done for you. All parts are furnished and are of highest quality.

Detailed construction manual shows clearly where each wire and part goes and tells exactly how to build the kit. Write for free catalog.

AUDIO GEN. KIT
\$29.50

R. F. SIGNAL GEN. KIT
\$19.50

5" SCOPE KIT
\$43.50

SIGNAL TRACER KIT
\$22.50

T.V. ALIGN. GEN. KIT
\$39.50

BATTERY ELIMINATOR KIT
\$24.50

VACUUM TUBE VOLTMETER KIT
\$24.50

HEATH COMPANY
BENTON HARBOR 11,
MICHIGAN

IMPEDANCE BRIDGE KIT
\$69.50

TUBE CHECKER KIT
\$29.50

EXPORT AGENT
ROCKE INTERNATIONAL CORP.
13 East 40th Street
NEW YORK CITY (16)

GRID DIP METER KIT
\$19.50

CONDENSER CHECKER KIT
\$19.50

yellow lead connected to the picture tube socket, horizontal voltage pulses will be coupled to the picture tube cathode, causing the picture tube to draw grid current on the negative portion of the voltage pulse. There is also the possibility of the horizontal pulse reaching the sync circuits via the picture tube cathode lead and *rc* circuit between this lead and the first sync separator. If the coupling is severe enough a *Christmas tree* condition is apt to occur. To remedy, the yellow cathode lead and red yoke should be dressed lead away from one another, taking care not to dress the red yoke too near the 6BL7GT.

6BK7/6BQ7 Interchangeability in Cascode Tuner: In Hoffman service manuals, it has been noted that either the 6BK7 or 6BQ7 can be used in the *rf* stage, but that the two types are not directly interchangeable. Substitution of the same tube type was recommended. However, should necessity require that one type be substituted for the other the tuner alignment should be checked and corrected if necessary, since the interelectrode capacities of the two types differ enough to affect the tuned circuits in the tuner.

RCA TV Service Hints

AGC Threshold Control Adjustment: The *agc* control on RCA chassis** is adjusted at the factory to provide maximum possible gain without clipping sync for all signals above the receiver threshold up to 25,000 microvolts. The adjustment of this control should not be touched in the field unless it is definitely known to be incorrect. If the control is misadjusted so as to increase the receiver gain, it may overload when a strong signal is received, or when a weak signal temporarily increases in strength due to unusual propagation conditions. On the other hand, if the receiver gain is lowered by the *agc* control, the sync noise immunity is reduced.

To reduce the prominence of snow on weak signals it is important that the picture control not be operated at its maximum clockwise position. Such an adjustment will provide a higher contrast picture but at the same time may produce an apparent poorer signal-to-noise ratio, due to the fact that an excessive amount of signal on the picture-tube grid causes the snow to bloom or defocus, thus causing the flake particle to become larger and more prominent than normal. At the

**Models 17T150/1/3/4/5/160/162/163/172/172K/173/173K/174/174K and 21T159/165/176/177/178/179

Fidelity

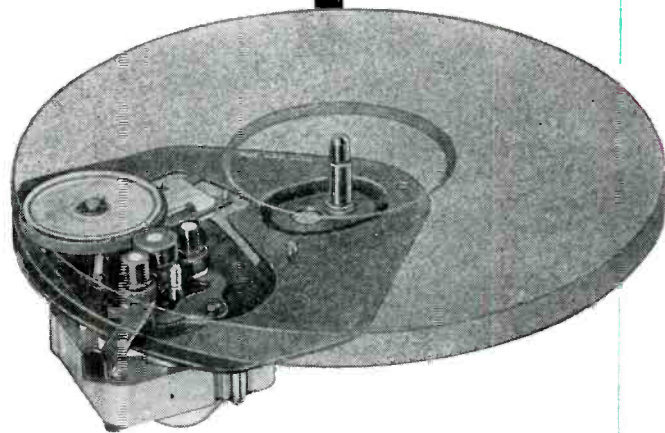

BEGINS HERE . . .

with General Industries' Phonomotors

The fidelity reputation of your record players, phono-combinations, and portables begins at the phonomotor. Be sure it's a good reputation that stays good . . . protected by General Industries' *Smooth Power Phonomotors*.

Complete data and specifications on the entire line of *Smooth Power Phonomotors* will be sent promptly on your request.



THE GENERAL INDUSTRIES CO.
DEPARTMENT MF • ELYRIA, OHIO

same time it is equally important that the receiver be focused to obtain the appearance of the least amount of snow in the picture. To do this, the receiver should be focused by the method described in the service data. As a final adjustment, the focus control should be adjusted for the appearance of minimum snow in the picture.

Conditions for AGC Adjustment

Only under two conditions can it be considered permissible to adjust the *agc* control. In an area where the signal is so weak that the snow prac-

tically obscures the picture after having taken all the foregoing precautions, then the *agc* control may be adjusted to give the best signal-to-noise ratio. It should be recognized, however, that trouble from loss of sync noise immunity might be experienced.

Adjustment for Strong Signal

The other condition which would justify adjustment of the *agc* control is where a signal of over 25,000 microvolts is received. Under this condition the *agc* control should be adjusted until the receiver no longer overloads.

Mr. Electronic Service Technician

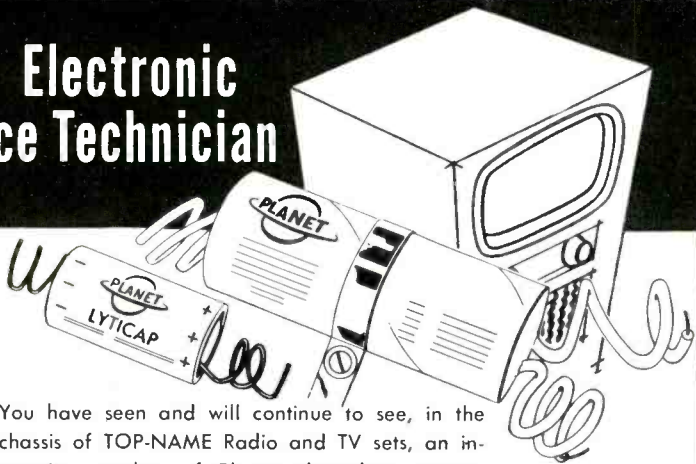

You have seen and will continue to see, in the chassis of TOP-NAME Radio and TV sets, an increasing number of Planet electrolytic capacitors — conspicuous because of their shiny red cardboard jackets. They are in those quality sets because components engineers have proven for themselves that PLANET condensers are "ENGINEERED FOR QUALITY".

You can take advantage of their findings by purchasing from your distributor Planet universal replacement types of the same high standard of quality. Ask for PLANET by name.

1 year
service
guarantee



"ENGINEERED FOR QUALITY"

Write now for
latest FREE catalog
206-A

PLANET MANUFACTURING CORPORATION

225 BELLEVILLE AVENUE
BLOOMFIELD, N. J.

Audio

(Continued from page 42)

frequency-control circuit designed to prevent drift on the FM band and correct for normal errors in tuning. A switch is provided to disconnect the *afc* circuit. Oscillator radiation does not exceed 50 microvolts per meter measured at 100' and meeting RTMA specification REC-129-C. The input circuit to the FM section of the tuner provides for a 72 to 300-ohm input for use with a dipole antenna.

AM Receiver Requirements

On the AM band, a signal of 5 microvolts provides not less than .25-volt output. The AM section of the tuner includes a tuned *rf* stage and a two-stage *if* system. An efficient automatic gain-control circuit is incorporated to minimize the effects of fading and prevent overloading on strong signals. A 10-kc filter is also provided to prevent inter-station whistle; the frequency response of the AM section is within ± 3 db from 20 to 7,500 cps. Temperature-compensating capacitors and coils are used to minimize drift. High-impedance antenna terminals are available for short antennas and separate low-impedance terminals provide for a low-impedance loop or a flat-top antenna with coax leadin.

Hi-Fi Amplifier Specs†

Reviewing hi-fi amplifier requirements, the spec data note that the unit should be complete with a power supply on a single cold-rolled steel chassis. The specific amplifier³ referred to, in this instance, was described as having a frequency response flat within ± 1 db from 20 to 20,000 cps; power output 10 watts at less than 1 per cent harmonic content; hum level 70 db below rated output; intermodulation distortion less than 1.3 per cent at 6 watts as measured on the usual intermodulation output meter and a damping factor 10 to 1.

Direct Radiator Speakers

Reporting on loudspeaker characteristics, and covering direct radiator types consisting of separate high and low-frequency *pm* mechanisms, the specs note that these units should be mounted coaxially together. Referring to the type⁴ they produce, it is noted that the response is 30-14,000 cps,

†Vino, Mark, *Picking Out the Right Amplifier*, SERVICE; December, 1952.

³Stromberg-Carlson AR-410.

⁴Stromberg-Carlson RF-471.

33 1/3% More Storage Space in Same Area

With Equipto SHELVEING

Especially designed for
the Electronic Industry

• Economical • Light Weight, High Capacity • Shelves Instantly Adjustable.

Don't waste valuable space with useless oversized shelving. The new 8" deep Equipto shelving specifically designed for electronics trade can be used as a regular instantly adjustable shelf or inverted to use the turned up shelf edge for extra protection to keep valuable items from falling to floor. The 8" depth is made expressly for the narrow lineup of merchandise necessary in this field. Holds 150 lbs. without reinforcements. Can be reinforced to hold up to 1200 lbs. on each shelf.



TYPICAL ASSEMBLY

Use end to end as shown or back to back for maximum storage in small space. Shelves may be adjusted on any one unit on 1/2" centers without adjusting shelves on any other unit.

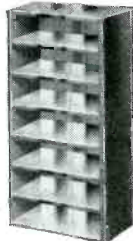

No. 565-A
Closed Type Shelving 8" x 3' x 7" high. Single or starting unit; equipped with backs and sides. Ideal for dope storage.

No. 893-8
Open Type Shelving 8" x 3' x 7"



Even if items tip over—the risk of falling to floor is greatly reduced when shelves are used with flange turned up. The turned up flange is used as a stop. Also saves 1" of space at shelf flanges.



View of typical 8" deep shelf showing flange down.

The fast, labor saving shelf clip used to make all shelves instantly adjustable on 1/2" center.

View of typical 8" deep shelf inverted showing flange up.

Sway Braces available as needed, included in price.

OTHER STYLES AND SIZES AVAILABLE

Equipto Division of Aurora Equipment Co.
790 Prairie • Aurora, Illinois
Phone: Aurora 9231

Write for
FREE
Catalog

40
YEAR

Containers for replacement cartridges which feature a floating suspension to prevent cartridge from touching the case at any point, thus insuring the cartridge reaching its destination in perfect condition. Container also has a hinged top with a purse-type clasp. Model number and list price of cartridge appear on each end of the package. (Webster Electric Co.)

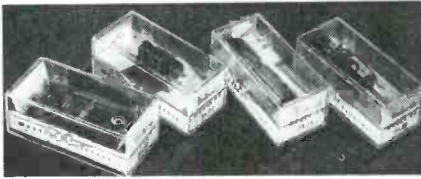

power-handling capacity 32 watts, angle of coverage 100° throughout the entire range, and impedance of the speaker system approximately 8 ohms at 400 cps. The low-frequency cone in this instance is heavy-weight ribbed and moulded fibre 12" in diameter with a 1½" diameter voice coil, while the hf unit is 3½" equipped with a 2" cone and ¾" voice coil. Describing mounting, it is said that the speaker should be mounted on a 14" square baffleboard 1" thick, drilled with 12 clearance holes for No. 8 flathead wood screws for fastening in a cabinet.

Exponential Acoustical Labyrinth

The architects' and engineers' specifications also describe the requirements of an exponential acoustical labyrinth to provide an acoustically correct speaker enclosure for 12" and 15" coax speakers. The finished size, it is said, should be 35⅞" high, 23¼" wide and 18" deep, and provide direct forward exposure of the front of the coax speaker and acoustical loading of the back of the low-frequency cone by means of a 5' exponential air column folded on itself.

While the data in these specs refer to items produced by this manufacturer, it will be found that many of the general details will hold for equipment made by others. Thus, this information can serve as an example of typical specs which Service Men either might have to read or prepare. Exceptions will usually prevail in the speaker and enclosure required; the requirements will usually vary with the range wanted, area available and built-in or external housing demands.

Basic 10-watt amplifier for average hi-fi home system. Distortion at 10 watts said to be 1% harmonic and 2% intermodulation; frequency response at 3 watts ± .5 db, 20 to 50,000 cps; frequency response at 10 watts, ± 1 db 30 to 20,000 cps. (Model 100BA; Precision Electronics, 9101 King Ave., Franklin Park, Ill.)

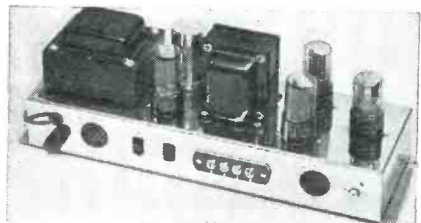

KNOWS HIS BUSINESS

Yes, this Service Man knows his business—knows that he must be sure replacement transformers will perform superbly and reflect favorably his reputation as a highly skilled service technician.

He doesn't gamble with mediocre transformers, he installs the choice of leading set manufacturers—Utah. Don't hazard your reputation with unproven parts, specify "Utah" Transformers and be sure of a job well done.

POWER TRANSFORMERS • VERTICAL OUTPUT TRANSFORMERS • FILTER CHOKES
VERTICAL BLOCKING OSCILLATORS • AUDIO OUTPUTS

Free WRITE TODAY FOR Complete TRANSFORMER INFORMATION, UTAH TRANSFORMER DIVISION, CATALOG T-100

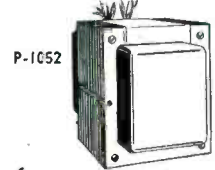
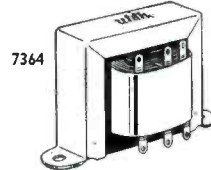
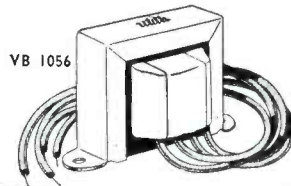

Speakers . . . Transformers

Export Dept. Rocke International Corporation, N. Y. C.

RADIO PRODUCTS CO., INC.

HUNTINGTON, INDIANA

A WHOLLY OWNED SUBSIDIARY OF NEWPORT STEEL CORPORATION

Tiniest and biggest: Marty Thurnblad, grandson of Thomas A. White, Jensen president and general manager, with tiny experimental 2" sub-miniature speaker. On the left is giant 18" model used for commercial sound.



Turn-over pickup which is said to have an output of 30 millivolts at 10 cm per second, and can be mounted in any type arm. (Model 260; Pickering and Co.)

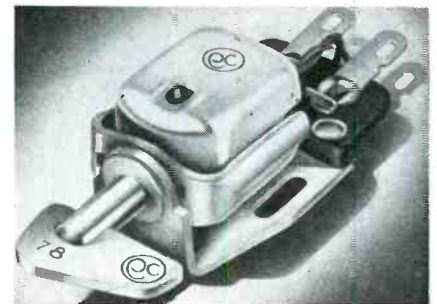

KESTER

Since the most important single step in Radio-Television Servicing is soldering . . . it's just plain good sense to use the best — KESTER SOLDER . . . Key Name in Solder for More Than 50 Years.

KESTER SOLDER COMPANY
4248 Wrightwood Avenue • Chicago 39, Illinois
Newark 5, New Jersey • Brantford, Canada

SOLDER

NEWS

SID HARMAN NOW EXECUTIVE V-P OF HARMAN-KARDON

Sidney Harman has resigned as vice president and general manager of David Bogen, Inc., and acquired a half interest in Kardon Manufacturing Corp., 52 W. Houston St., N. Y., which will hereafter be known as Harman-Kardon, Inc. Harman will be executive vice president and *Bernard Kardon*, who established the predecessor company three years ago, has become president of the new firm.



Sid Harman

H. C. Stacey

WEBSTER ELECTRIC APPOINTS STACEY SALES MANAGER

Howard C. Stacey, formerly assistant sales manager, has become sales manager of the sound sales division of Webster Electric, 1900 Clark St., Racine, Wis.

* * *

BERNARD L. CAHN ELECTED INSULINE V-P

Bernard L. Cahn, formerly general sales manager, has been elected vice president of the Insuline Corporation of America, 3602 35th Ave., Long Island City, N. Y.



B. L. Cahn

O. E. Bishop

MALLORY PROMOTIONS

O. E. Bishop has been promoted to manager of sales operations, distributor division, of the P. R. Mallory and Co., Inc., 3029 E. Washington St., Indianapolis, Ind. In his new position, Bishop will assist *J. E. Templeton* in coordinating field sales activities.

Dan Mischler, formerly a distributor rep, will replace Bishop as sales service manager.

* * *

VAN AUKEN JOINS MARK SIMPSON

John A. Van Auken has been appointed general manager of Mark Simpson Manufacturing Co., Inc., Long Island City, N. Y.

* * *

FEIR AND FELTMAN JOIN DUMONT

Sol D. Feir has been named district sales manager for Manhattan by the New York factory distributor, Allen B. Du Mont Laboratories, Inc.

John Feltman has been named assistant manufacturing manager of the picture tube division.

Double talk that makes cents! **University**
Paging and Talk-Back Speakers

—designed to meet any paging requirement. The exceptional conversion efficiency and sensitivity, resulting from the many exclusive fabricating techniques embodied in all University products, not only permit these speakers to be successfully employed as high output microphones for remote "talk-back" . . . but enable more distance to be covered, provide double duty service.

MODEL MIL—Available in 8 or 45 ohms. Flange mounted, or swivel bracket models as shown. Small, compact, sturdy — ideal where every ounce of sound must be squeezed out of limited available power.

MODEL IB8 — For those tough ones — where space is limited, noise level is high, noise level is high. Does a real he-man job with remarkable intelligibility, needs only moderate power input. Rated 12 watts, 8 ohms.

COBREFLEX-2 — New wide angle trumpet, takes any University heavy duty driver unit. Rugged die-cast aluminum construction with "U" type swivel mounting bracket. Reduces number of speakers needed to cover wide areas.

WRITE FOR TECHNILOG — combination technical and product catalog, a valuable reference. Address Desk A6.

Numerous other models available for every commercial, industrial and high fidelity application.

UNIVERSITY LOUDSPEAKERS • INC
80 SO. KENSICO AVE., WHITE PLAINS, NEW YORK

AEROVOX ELECTS GOLENPAUL AND MARSHALL V-Ps

Charles Golenpaul, formerly distributor sales manager, has been elected vice president, distributor sales, of the Aerovox Corp., New Bedford, Mass. Frank Marshall, formerly director of sales, manufacturers division, has also been promoted to vice president, manufacturers sales.

MILLER EXPANDING

An addition of 2,000 square feet at the rear of their plant, has been announced by Miller Television Co., 2840 N. Naomi Ave., Burbank, Calif.



WIKE APPOINTED UTAH SALES MANAGER

Gainus Wike has been named general sales manager of Utah Radio Products Co., Inc., 1123 East Franklin Street, Huntington, Ind.

Wike succeeds Fred Tower, who has been promoted to division manager and vice president of the Caswell-Runyan division of Utah.

C-D ANTENNA ROTOR WINDOW STREAMERS AND ENVELOPE STUFFERS

Free window streamers and envelope stuffers promoting antenna rotors are now available through jobbers from the Cornell-Dubilier Electric Corp., South Plainfield, N. J.

Streamer is 10 1/2" x 28", printed yellow, red and black.

KUNZ ELECTED SANGAMO V-P

H. Laurence Kunz, general manager of the capacitor division of the Sangamo Electric Co., Marion, Ill., has been elected vice president.

Kunz started his career with Sangamo in '26, and for a number of years served as assistant general sales manager, being appointed capacitor division s-m in '45.

William W. Taylor has been appointed sales manager of Sangamo's capacitor division, succeeding John G. Twist, who resigned.

Bruce E. Vinkemulder has been named sales promotion manager of the division. Vinkemulder, who was formerly distributor sales manager, is succeeded by A. E. McCluskey.



H. L. Kunz



W. W. Taylor

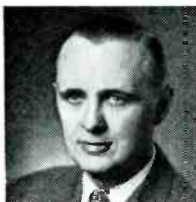

B. E. Vinkemulder



A. E. McCluskey

Now

A SELENIUM RECTIFIER TESTER

The ONLY instrument ever designed to provide The Four Essential Tests for Selenium Rectifiers used in radio and TV receivers:

- 1 Opens
- 2 Shorts
- 3 Forward Conductivity
- 4 Reverse Leakage

Never before has this been possible with a single, popular-priced instrument!

New GALVANIC



SPECIFICATIONS AND FEATURES:

- Eliminates the totally inadequate substitution and ohmmeter tests which frequently cause damage to other expensive components.
- Checks rectifiers in half-wave circuits without unsoldering leads.
- No guesswork . . . simple one-directional scale provides immediate positive reading of both forward and reverse.
- Non-obsolescent . . . will test all presently-made radio and TV power supply selenium rectifiers, and any that may be made in the future.
- Large, easy-reading 4 1/2" D'Arsonval-type rect. meter.
- Power requirements: 117 volts, 60 cycles AC.
- Dimensions: 5 1/2" x 4" x 10".
- Shipping weight: approximately 6 lbs.



Model 100-A Selester, complete with 3 ft. test leads, insulated alligator clips, 6 ft. line cord, detailed instruction manual. \$39.95 net



Ask your local Radio Parts Distributor for a Demonstration of the Selester, or write directly to factory for detailed literature.

GALVANIC PRODUCTS CORPORATION

110 East Hawthorne Avenue Valley Stream, N. Y.

NEW BUILDING FOR ALLIED RADIO

A building, said to cost \$2,000,000, is now under construction for Allied Radio Corp., Chicago.

Allied's new site, with a total floor area of 150,000 square feet, will be in almost the exact geographical center of the city on Western Ave. and Washington Blvd.

According to Allied, its \$2,500,000 inventory for 19,000 items, will be substantially increased within a few years, to cover perhaps up to 25,000 items.



JFD CONSTRUCTS NEW PLANT

A 140,000-square-foot plant, expanding factory space to a total of more than 200,000 square feet, has been announced by JFD Manufacturing Co., Inc., 6101 16th Ave., Brooklyn 4, N. Y.

The company has also purchased a 32,000-square-foot area which temporarily will be used as a stop-off point for incoming trucks and as a parking space for JFD employees.

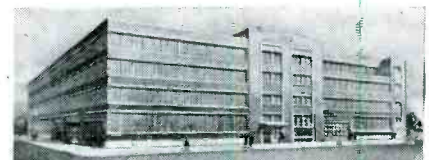

VHF THE RAY-SCOPE
SUPER DELUXE VHF UHF

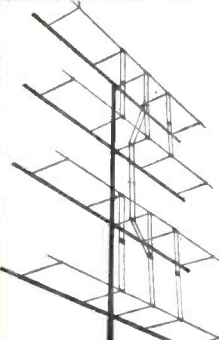

Here is the perfection of antennas, limited but never duplicated. Unsurpassed gain in weak signal areas. Excellent coverage on VHF and UHF channels. . . . All aluminum construction. Completely preassembled. The finest materials and workmanship are incorporated in what we believe to be the BEST antenna on the market.

Suggested list price \$55.00

VHF The RAY-SCOPE '400'
DELUXE CONICAL



The famous RAY-SCOPE "400," our fastest selling conical. A quickrig antenna of unusual design. . . . just flip out AIL elements and tighten wingnuts. Solid aluminum castings throughout. Lifetime construction. Exceptional high gain offering crystal-clear reception on all channels. Ideal for fringe areas. Order today and compare. Suggested list price \$20.50

UHF The RAY-SCOPE UHF 14-83
DELUXE ALL-CHANNEL RHOMBIC



A tried—tested and proven UHF Rhombic to cover ANY UHF channel in your area. Extremely high gain on every channel and covers the entire UHF spectrum from 450 to 900 megacycles. All aluminum construction. Light in weight. Completely pre-assembled. Electronically designed assuring complete satisfaction.

Suggested list price \$13.25

UHF THE TWIN-BOW TIE
DELUXE-CHANNELS 14-83

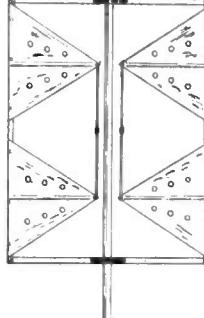

A Unique Antenna covering the entire UHF band. Showing increasing gain in the upper frequencies. Free space terminals. Made entirely of aluminum. Easy installation . . . just clamp on to mast and connect lead wires.

Suggested list price \$9.95

DEALERS • REPS • JOBBERS
TERRITORIES AVAILABLE
WRITE TODAY—DEPT. S

DI-CO TV & PLASTIC CO. INC.
MILFORD CONNECTICUT

The ORIGINAL Universal High Voltage TV Filter Ceramicons



By ERIE . . .

the solution for *all* your high voltage TV filter replacement problems

This package contains six (6) Style 413 Erie Universal High Voltage TV Filter Ceramicons and an assortment of 14 adapter terminals.

Carry one of these handy package assortments with you on all your TV service calls. You are assured of having, at all times, the CORRECT RE-

PLACEMENT UNIT for any receiver rated at 20 KV or lower.

If your requirements are for all of one combination of terminals, the Style 413 may also be obtained in handy plastic kits of ten HV Ceramicon bodies. Adapter terminals are supplied in packets of five each of a type.

Order through your jobber.

ERIE
RESISTOR CORP.

ERIE RESISTOR CORPORATION . . . ELECTRONICS DIVISION
Main Offices: ERIE, PA.
Sales Offices: Cliffside, N. J. • Philadelphia, Pa. • Buffalo, N. Y. • Chicago, Ill. • Detroit, Mich. • Cincinnati, Ohio • Los Angeles, Calif.
Factories: ERIE, PA. • LONDON, ENGLAND • TORONTO, CANADA

SPRAGUE CAPACITOR MANUAL
Sprague Products Co., 61 Marshall St., North Adams, Mass., has issued a 44-page edition, *TV Replacement Capacitor Manual*, that lists capacitor replacements for 2,460 receivers of 78 manufacturers. Also included is a printed circuit guide which shows replacement recommendations for the units used by 46 TV manufacturers. On the back cover appears color code information on capacitors which appeared in former Sprague *Tell U How* wall chart. Copies are available free from Sprague distributors, or by sending 10c to cover handling and postage to Sprague.



CISIN TV CONSULTANT BOOK
A modernized expanded analysis of the Cisin rapid TV troubleshooting method has been published in a 70-page book, *TV Consultant*, by Harry G. Cisin, 200 Clinton St., Brooklyn 2, N. Y.

Featured are 213 picture and 76 raster troubles and sound troubles, which are keyed or classified to a specific part of the TV set. Book contains four sections: rapid TV troubleshooting method; rapid TV alignment method; installation and servicing of *uhf* units; and rapid checks (over 100). TV alignment section is an entirely new section, with the methods developed in the shop under actual working conditions. Priced at \$2.00.

TV ANTENNA GUIDE



Pocket-size book on TV antenna installations with chapters on *uhf* antennas, indoor directronic TV antenna system, and Yagis. Other subjects in the book include antenna dimension guide, channel frequencies, and proper feed methods for stacked arrays. Book was prepared by Edward M. Noll, Matthew Mandl and Edgar Daily. Listing at \$1.00 a copy, copies may be obtained *without charge* by writing directly to Dick Morris, Snyder Manufacturing Company, Philadelphia 40, Pa.

STANCOR NEWS BULLETIN

NEW STANCOR TRANSFORMERS



A-4747—Input transformer for single button mtc. or low imp. line to single grid. Pri.: 70 ohms; sec. 1,300,000 ohms. Turns ratio, 1:137. Ideal for mobile transmitter use.



A-3335—Output transformer for P-P plates to V.C. An economical unit used with 6V6's and inverse feedback. 10,000 to 6-8/3, 2-4 ohms. Max. pri. DC, 40 ma., 10 watts.



P-6468—Filament transformer for a pair of Elmac 4-250A's where CT is operated near ground potential. Sec. 5.0V. CT, 30 amps., RMS insul. 2500V.



P-6410—Electrostatically shielded isolation transformer designed for servicing small receivers, amplifiers and test equipment, 50-60 cycle. Conservatively rated at 50 watts.

Ask your Stancor distributor for Bulletin 450R for additional information on these and other new Stancor transformers.

NEW TELEVISION REPLACEMENT TRANSFORMERS



A-8125—Vertical blocking oscillator. Used in over 600 models by 21 manufacturers. Turns ratio, 1:4.2; height 1 3/4", mounting centers 1 3/4".

P-8170—Power transformer, used in 48 models by Andrea, Bendix, Kaye Halbert, and Magnavox. Plate supply 380-0-380 AC volts, 220 DCMA. Rect. fil. 5V. at 3 amps., other filaments, 6.3 at 1.2, 6.3 at 5.0 and 6.3 at 7.0.



P-8171—Power transformer replacement for Air King part A10109. Plate supply 375-0-375 AC volts, 225 DCMA, rect. fil. 5V. at 3 amps. Other filaments 6.3 at 2.0 and 6.3 at 9.0.

See Bulletin 451 on these new Stancor TV replacements.

STANCOR CR TUBE BOOSTER



A CR tube rejuvenator with many extra features suggested by the Stancor Serviceman Advisory Board. A compact unit that requires no soldering and no connecting to the AC line. It has extra "long" 13" leads between the booster and its connector. Can be installed anywhere in the set. Auto-switch type, with a bl- of two degrees of brilliancy. Supplied complete with bracket and screws for chassis or cabinet mounting. **P-8192...\$2.94 Dealer's net**

FREE!

The new Stancor Simplified Television Transformer Replacement Guide, the most complete and the most concise ever published. Covers over 4400 TV models and chassis. All replacements are listed by manufacturers' original part number for instantaneous reference. Available from your distributor or from Stancor directly.

Stancor transformers are listed in Howard W. Sams Photofact Folders and in John Rider's "ek-Files"

STANDARD TRANSFORMER CORPORATION
3588 ELSTON AVENUE, CHICAGO 18, ILLINOIS

SPRAGUE CAPACITOR-RESISTOR ANALYZER

A capacitor-resistor analyzer, model TO-4 *Tel-Ohmike*, has been introduced by Sprague Products Co., 61 Marshall St., North Adams, Mass.

Instrument includes pushbutton range selection, capacitance ranges from 1 mmfd to 20,000 mfd, resistance measurement range of from 2 1/2 ohms to 25 meg-ohms at line frequency, direct meter reading of insulation resistance up to 20,000 megohms for checking all types of electrostatic capacitors, direct leakage current readings of electrolytics at rated *dc* working voltage, and a three-range power factor measurement of electrolytics. All capacitors are automatically discharged for safety after test by simply releasing the range selector pushbuttons. A *magic eye* tube is used to simplify Wien bridge balance on capacitance and resistance measurements.

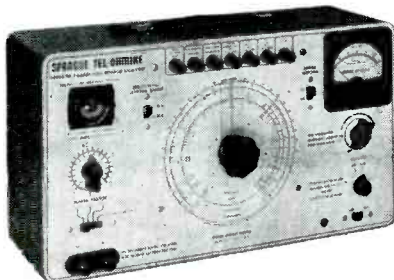

[Additional new part news on page 74 and 75]

Tools . . . Instruments Parts . . .

ASTRON CAPACITOR STORAGE KIT

A plastic-metal capacitor storage kit, *Jiffy-Kit*, that stores bypass and coupling capacitors in clear plastic drawers, with identification labels, all housed in steel, is now available from the Astron Corp., E. Newark, N. J.

Capacitor kit features type AM, a molded paper tubular unit said to be highly resistant to humidity and designed for continuous operation at 85°C. Kit contains 113 capacitors representing 26 different values claimed to be the most frequently replaced by Service Men.

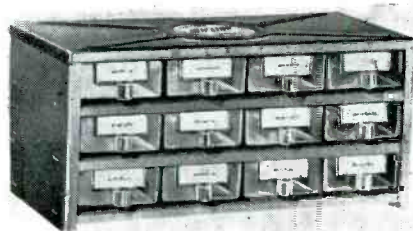

JCT POWER SUPPLIES

Two power supplies, *Mini-Pak*, that employ a selenium rectifier for a source of instant power, and designed to plug into a standard *ac* female receptacle, has been developed by Jersey City Technical Lab, 880 Bergen Ave., Jersey City 6, N. J.

Model R is said to provide 108 volts regulated low ripple *dc* with an OB2 voltage regulator tube, maintaining constant voltage output with load variations up to 15 ma, or lightly loaded with input variations from 100 to 130 volts *ac*. Model P, a voltage doubler, 10 watt power source, of low ripple *dc*, is claimed to provide no load voltage output of 330 volts; at 50 ma maximum constant duty current output is said to be 200 volts. For intermittent use, the current may up to 65 ma.

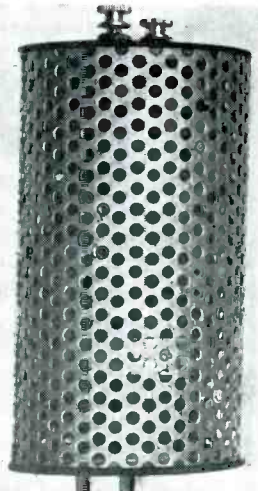

In The Field[‡]

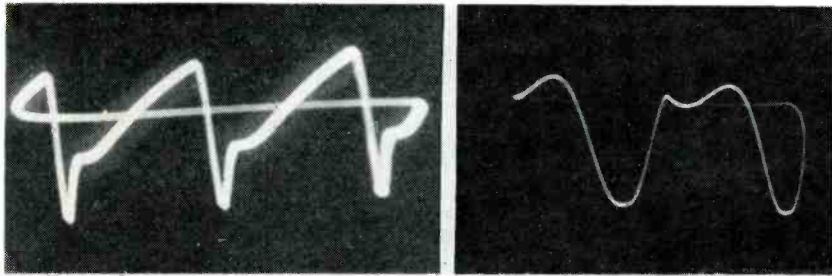

Fig. 1. A thick trace on the 'scope screen is less desirable to work with than a thin trace. A thin trace can be obtained by using sufficient accelerating voltage in the *crt* so that the intensity control does not have to be advanced to the defocusing point; furthermore, the relative *dc* voltages on the other electrodes of the *crt* must be correct in order to obtain good focusing.

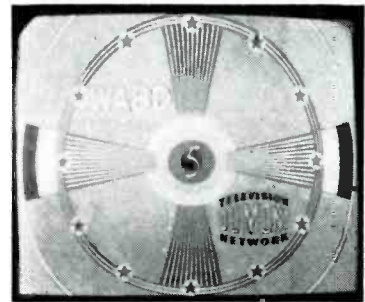

Fig. 2. Peaking of the *rf* or *if* amplifier at the high picture-frequency end (near the sound end) results in excessive contrast of high-frequency picture elements as illustrated in this test pattern reproduction; the vertical wedges appear darker than the horizontal wedges.

Tracing Motorboating in TV IF Stages . . . Locating Points of Takeoff . . . Oscillation Problems and Cures . . . Response-Curve Peaking and its Relation to Picture Distortion . . . Tin-Foil Slide Effects on Leadin . . . Overpeaked IF Amplifier Effects . . . Reactive Distortion in FM Detector Deemphasis Networks

WHAT IS MEANT by the statement that response-curve peaking causes picture distortion?

Probably everyone is familiar with the technique of peaking up the receiver signal circuits in the vicinity of the picture carrier to obtain more contrast and less snow, when a very weak signal is to be received. This is a form of picture distortion (often deemed desirable) which produces abnormal *lf* response and subnormal *hf* response. The opposite type of peaking produces abnormal *hf* response and subnormal *lf* response, as shown in Fig. 2. Such high-video peaking is deemed desirable by a sizable proportion of the viewing audience.

How CAN an open bypass capacitor in an *if* amp produce *lf* motorboating?

An open bypass capacitor (plate-screen or grid bypass) in the *if* amplifier does not always cause *hf* oscillation in the receiver. In some cases, the resulting *hf* feedback is insufficient to cause *if* oscillation, but the *if* response curve becomes distorted and the picture quality usually suffers. In addition, a very low-frequency feedback circuit may be established through the power supply, causing the receiver to motorboat at a very slow rate; the picture remains satisfactory for 15 to 30 seconds, and then slowly fades from the screen, disappears for another 15 to 30 seconds, whereupon the cycle repeats itself continuously.

CAN INSUFFICIENT horizontal width be caused by parasitic oscillation in the horizontal-output tube?

Parasitic oscillation in the horizontal-output circuit, involving the heater line, can cause subnormal picture width. Bypassing of the heater line to chassis at the socket terminal of the horizontal tube should eliminate the parasitic oscillation.

WHEN RECEIVER take off occurs, could it be caused by open decoupling or open common bypass capacitors?

When a receiver *takes off* or oscillates within sync, sweep, or other circuits, the trouble is usually caused by open decoupling, or open common bypass capacitors. A 'scope can be applied across the suspected capacitors to determine whether they are *hot* or *cold*. However, in many receivers bypassing is incomplete under normal conditions. Hence, it may be necessary to check the capacitors by substitution. If a normally operating receiver of the same type is available, a comparison check can be made across corresponding capacitors in the two receivers by means of a 'scope.

[‡]Based on questions posed during meetings conducted by R. G. Middleton, senior engineer at Precision Apparatus Co., Inc., and author of *TV Troubleshooting and Repair Guide Book*, published by John F. Rider.

WHEN TESTING an interlocking booster and horizontal-oscillator circuit, should an auxiliary power supply be used?

Since the horizontal oscillator plate is occasionally supplied with *B+* voltage from the booster circuit, it may be difficult to decide whether low plate voltage at the horizontal oscillator is due to sweep-circuit trouble, or to horizontal-oscillator circuit trouble. To test this type of system, an auxiliary power supply can be used to provide normal *B+* voltage to the plate of the horizontal oscillator. A 'scope check of operating waveforms will then show whether the horizontal oscillator is at fault or whether the sweep circuit is defective.

IN SWEEP ALIGNMENT of the FM detector, is the deemphasis network a source of reactive distortion?

Reactive distortion in the *S*-curve display when sweep-aligning an FM detector causes the *S* curve on the forward trace to appear higher than the *S* curve on the return trace. This reactive distortion is often caused by connection of the 'scope at the output of the deemphasis network, instead of at the input of the deemphasis network. It is also preferable to connect the 'scope at the input of the network, because the markers are then stronger; the deemphasis network is a low-pass filter which reduces the size of a beat marker.

(Continued on page 72)



NOW!
A
**T.V. TEST
PATTERN**

**WHENEVER
You NEED one**

use
MODEL CB-101

**UTL PATTERN
GENERATOR**

SIMPLE • EFFICIENT • ACCURATE
for a **STEADY NON-SHIFTING**
VERTICAL or HORIZONTAL
TEST PATTERN

HERE'S WHY YOU'LL LIKE IT...

- ★ Makes horizontal and vertical linearity, width, height and centering tests.
- ★ Checks relative gain of video stages; isolates defects in video amplifier.
- ★ Tests performance of kinescope directly.
- ★ Checks overall image reproduction when used to modulate TV signal generator.
- ★ Uses sync impulse of receiver to insure steady line or bar pattern.
- ★ No removal of chassis necessary; special leads connect to tube pins.

— Ask your distributor about it.

Send for free folder No. 35

TESTS VIDEO AMPLIFIER
LINEARITY and PICTURE
TUBE PERFORMANCE

MODULATES YOUR T.V.
SIGNAL GENERATOR
FOR OVER-ALL TEST
OF T.V. RECEIVER

\$29.50
COMPLETE WITH
SHIELDED
LEADS

UNITED TECHNICAL LABORATORIES

Engineers

MORRISTOWN, N. J.

Manufacturers

**A HOT Little BOOSTER
for HOT Front Ends**



\$24.95

LIST

VIDEON JR. won't oscillate with
the hot front ends of new sets!

PERFORMANCEWISE—It's tops

PRICEWISE—It's right . . . and as
for customer satisfaction, you cut costly
call backs when you install a **VIDEON JR.**

Write For Descriptive Folder And Name
Of Your Distributor

Watch for it—
The new **VIDEON**
UHF Converter

ELECTRONIC CORPORATION

222 East Ohio Street · Indianapolis, Indiana

Compare...
**prove EMC
superiority**

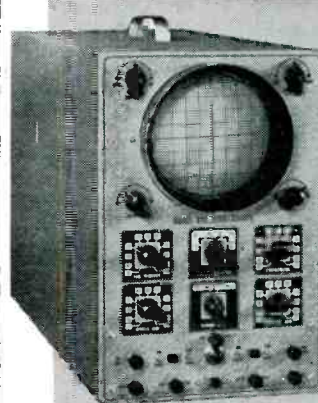

model 600

EMC MODEL 600 SCOPE features
the use of a 5U1 new 5 inch
scope tube. The 2-stage, push
pull, vertical amplifier has a sen-
sitivity of .02 volts per inch and
can be used up to 5 megacycles.
A two step attenuator input is
available. Synchronization is
available on either positive or
negative phase of input voltage
through the vertical amplifier or
from an external source. A multi-
vibrator type of sweep from 15
cycles to 75 kilocycles is incor-
porated. Direct connections to
scope plate available.

MODEL 600 (completely wired and tested)..... **\$99.50**

**model 106
VACUUM TUBE VOLTMETER**

Check these features
SPECIFICATIONS

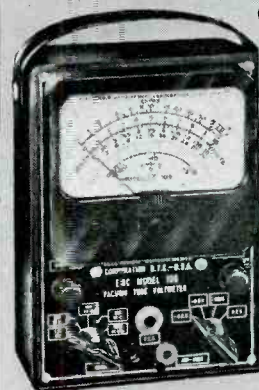

All functions completely electronic
— meter cannot burn out.

DC VOLTAGE: Input resistance
16.5 megs or 1 2/3 megohms per
volt. Ranges 0 to 1.5, 10, 100,
300, 1000 up to 30,000 volts
(with accessory probe).

AC VOLTAGE: Input resistance 2
megohms. Ranges 0 to 1.5, 10, 100,
300, 1000. Frequency response
flat from: 25-100,000 cycles.

OHMS: 1000 — 10,000 — 100,000
— 10 megohms, 1000 megohms.

COMPACT, portable bakelite case
measures 4 1/4 x 5 1/4 x 2 3/8"

MODEL 106 (complete with 1 meg isolating probe)	\$35.90
IN KIT FORM	23.90
MODEL HVP, 30,000 Volt Probe for Model 106	8.75
MODEL RFP, High Frequency Probe (useful to 200 megacycles)	6.95

— See them at your Jobbers —

EMC

Write Dept. S-1
for free com-
plete catalogue
of these and
other instru-
ments.

ELECTRONIC MEASUREMENTS CORPORATION
280 LAFAYETTE STREET • NEW YORK 12, N. Y.

EXPORT DEPARTMENT 136 LIBERTY STREET, N.Y.C. 6, N.Y.

Scala OSCILLOGRAPH PROBES

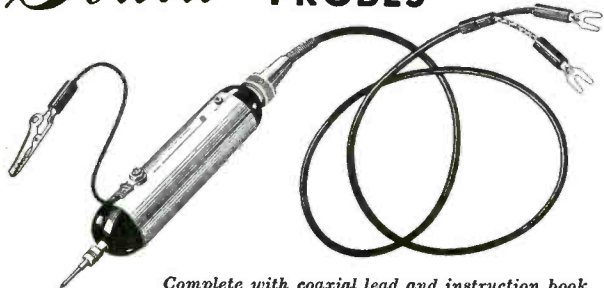

Complete with coaxial lead and instruction book.

A NEW TOOL TO MAKE TV SERVICING Easier, Faster, More Accurate AND MORE PROFITABLE

No probes made anywhere do the job of SCALA oscillograph probes so efficiently, so easily. Use with your present scope . . . low cost will be paid ten times over in a month. Check your local distributor or write factory and specify model number:

BZ-1 SIGNAL TRACING PROBE . . . locates dead I.F. stages, marks ratio detector curve, calibrates marker generator, adjusts video amplifiers, checks output of sweep generator, views response of single I.F. stage, traces buzz pulse in sound I.F. strip. Can be used with V.T.V.M. Contains demodulator of low-capacitance, high-impedance design, useful to 225 MC.

BZ-2 LOW CAPACITY PROBE . . . makes it possible to trace video, sync or sweep waveforms through high-impedance circuits without causing waveform distortion due to circuit loading. Cuts the effective input capacitance of scope by a factor of 10 and gives an attenuation of 10 to 1.

BZ-3 100:1 VOLTAGE DIVIDER PROBE . . . is very useful in trouble-shooting horizontal sweep circuits. It may be applied directly to plate of horizontal output tube or at the plate of the damper tube to check the operation waveforms and to measure their peak to peak voltages without impairing the wave shape or incurring danger to the oscillograph.

SCALA RADIO CO., 2814 - 19th St., San Francisco 10, Cal.

...the nation's HOTTEST antenna line!

CLEARBEAM

BURBANK CALIFORNIA

WHEN YOU CHANGE YOUR ADDRESS

Be sure to notify the Subscription Department of SERVICE at 52 Vanderbilt Avenue, New York 17, N. Y., giving the old as well as the new address, and do this at least four weeks in advance. The Post Office Department does not forward magazines unless you pay additional postage, and we cannot duplicate copies mailed to the old address. We ask your cooperation.

WHY DOES SLIDING a piece of tinfoil along the leadin produce better picture contrast in fringe areas?

The tinfoil produces in-phase reflection of *lf* picture voltages (when properly located), as is obvious from Fig. 3. The in-phase reflection recovers video voltage which would normally be lost by mismatch to the *rf* tuner. DOES THE Zero-Volt reference provided by sweep generator permit measurement of wideband circuit bandwidth?

When a circuit, such as an *rf* transformer, is being sweep-aligned, often the sweep width of the sweep generator is insufficient to display completely the response curve on the 'scope screen. In this case, the location of the half-voltage points on the response curve can be quite difficult to locate, particularly if the circuit has a very wide-band response. The half-voltage points must be known to determine the bandwidth of the circuit. However, the half-voltage points can be very easily determined in this instance if the sweep generator is capable of providing a zero-volt reference line. Although the lower portion of the response-curve skirts are not present in the display, the half-voltage point is given by the level half way between the zero-volt reference line and the peak of the response curve.

In the Field

(Continued from page 70)

WILL SLIGHT fluctuations in picture brightness be caused by intermittent high-voltage filter capacitors?

Tests with a high-voltage capacitance-divider probe and 'scope will usually show that slight intermittent fluctuations in picture brightness are caused by a fluctuating voltage across the high-voltage filter capacitor. This is due to an intermittent condition in the capacitor, which must be replaced.

CAN AN open damping resistor across *if* coil cause receiver oscillation?

Carbon resistors occasionally become defective in use, either developing greatly increased resistance, or opening up completely. The condition may be intermittent. Such a resistor across *if* coils can be responsible for *take-off* in the *if* amplifier circuit. If a resistor is suspected, it should be checked by substitution, since the surge of current from an ohmmeter may temporarily heal an intermittent resistor and lead to false conclusions.

Fig. 3. Traces illustrating effect of sliding a piece of tinfoil along the leadin, with a weak signal present. To prepare these patterns, a small sweep-frequency voltage was mixed with the incoming TV signal at the antenna terminals of the receiver, to show the effect on both the picture signal and on the response curve when the tinfoil was moved along the line. The picture-carrier station marker appears at the top of the response curve. In reproduction at left the tinfoil was placed at a position for the weakest picture; the peak-to-peak voltage of the picture signal is comparatively small. View at right shows result when tinfoil was placed to provide the best contrast in the picture; the peak-to-peak voltage of the picture signal is comparatively large, reducing the gain of the *if* amplifier, which in turn reduces the height of the response curve. It will be noted that the shape of the response curve changed slightly, and the picture-carrier marker remained at the peak of the curve.

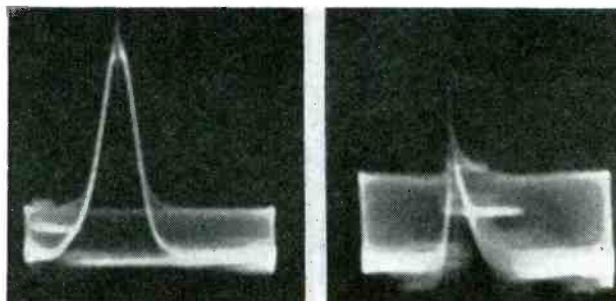

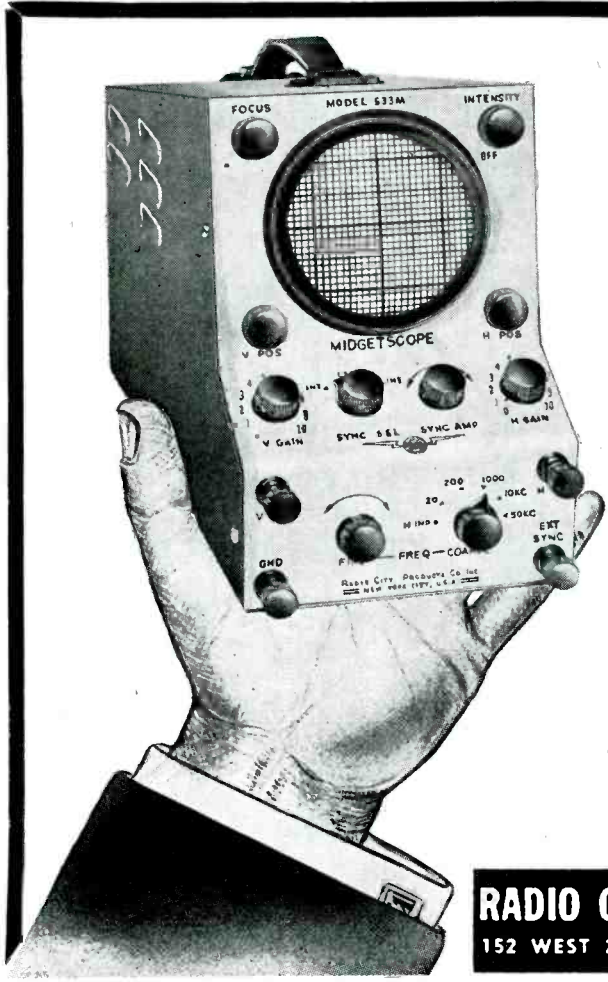

RCP leads the field again ... with the finest ... MIDGETSCOPE

MODEL 533M
WEIGHS ONLY 9 LBS.!

SIZE: 11 3/4" x 7 3/4" x 5 1/8"

THE MIGHTY MIDGET—Here is a truly miniaturized professional oscilloscope for convenience of operation without loss of performance. A new concept in electronic oscilloscopes.

CHECK THIS PERFORMANCE!
SENSITIVITY: Vertical—20 millivolts (.020 volts for 1" rms deflection on CRT face.) Horizontal—.6 volts.

FREQUENCY RESPONSE: 2 db from 20 cycles to 180 kilocycles. Excellent Transient Response.

PUSH-PULL DEFLECTION: For undistorted Response—Eliminates Parallax. Full Vertical and Horizontal Expansion of Trace.

INPUT IMPEDANCE: Vertical—.5 megohms shunted by 70 MMF. Horizontal—.5 megohms shunted by 70 MMF.

TUBE COMPLEMENT: 12AT7, 12AU7, 12AX7, 6J6, 11Z6, 3MP1, CRT.

In metal case with leather handle—Etched panel
—Smart brushed aluminum face—Fuse protected
—for 105-125 volt, 60 cycle AC operation.

MODEL 533M—**\$99.50**
Complete, ready to operate. **NET**

Write for the new colorful, fully illustrated RCP catalog to Dept. SM-1

RADIO CITY PRODUCTS CO., INC.

152 WEST 25th ST • NEW YORK 1, N. Y.



WOULD SECTIONAL ISOLATION be the best approach to localize a *take-off* circuit?

Yes. When a receiver *takes off*, the best troubleshooting procedure usually consists of providing separate *B+* voltages to the individual receiver sections, such as the sync horizontal-oscillator, sweep circuit, etc., since in many cases the oscillation is caused by feedback through some branch of the common plate-power supply. Provision of separate *B-* voltages from *B-* batteries or from line-operated power supplies will serve to stop the oscillation in such cases, and indicate the receiver sections which are faulty. In some cases the feedback takes place from one section to another, as from the sweep section to the sync section. However, in other cases oscillation can arise within a section, as when the sync amplifier is not properly neutralized in certain receivers.

WILL YOU SHOW the effect on the picture of over-peaking the *if* amplifier in the receiver?

The visible effect of over-peaking varies considerably, depending upon the amount of misalignment which exists. However, the screen pattern shown in Fig. 4 is typical of what may be expected.

How DOES ONE go about locating an oscillating *if* stage?

An oscillating *if* stage can be located by connecting a clip-lead across the first *if* coil, and noting whether a change in reading is obtained on a *dc vtrm* connected across the picture-detector load resistor. If no change in indication is noted, the clip lead should be disconnected from across the first *if* coil, and connected across the second *if* coil, again noting whether a change in reading occurs on the *vtrm*. This test should be continued until a large drop is noted in the scale indication, which thereby localizes the oscillating stage.

Fig. 4. Complete picture break-up caused by excessive peaking of the *if* amplifier.

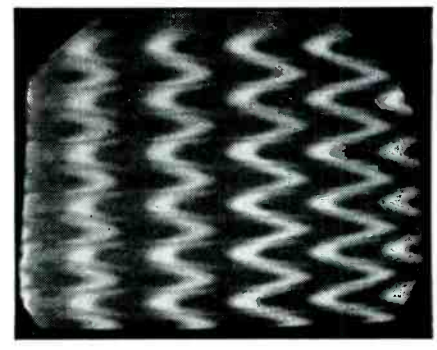

WHEN THE COILS in an *if* amplifier are peaked at 34.8 and 36.9 mc, for example, should the *humps* in the response curve appear at these frequencies also?

Usually no. Often, only one hump may appear, as shown in Fig. 5, due to circuit tolerances. And, even if the tolerances are close, and a double-humped curve is obtained, the peaks of the humps will appear *within* the peaking frequencies of the individual circuits, as illustrated.

Fig. 5. Variations in shape of the *if* response curve, due primarily to variations in *Gm* of the individual *if* tubes, and also to other circuit tolerances. The knee frequencies of the response curve are not the peaking frequencies of the *if* coupling coils. (Bandwidth measured between half-voltage points.)

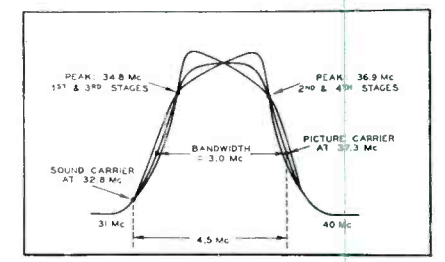

The **Bogen** TWIN

2-Station Wireless Communo-Phone



The TWIN is: A 2 station intercommunicating system which requires no wiring or installation. It uses the regular power line as the transmission medium.

The TWIN is Flexible: Stations can be added at any time for a common call system. Two and sometimes 3 separate systems can be set-up on one circuit.

The TWIN is Quiet: Built in adjustable noise suppresser can be set at installation for optimum performance. The station is quiet when idle.

The TWIN is Safe: It is Underwriters' Laboratories Listed—Extremely important for equipment of this type.

The TWIN Works for YOU: It is an ideal package sale to consumers for use as baby sitter, office intercom, etc. It gives your industrial salesman a door opener he needs to excite the interest of new and old accounts.

LIST PRICE \$95.00

Write for complete details — address Desk V-1



DAVID BOGEN CO., INC.

29 NINTH AVE., NEW YORK 14, N. Y.

A Quarter Century of Electronic Equipment Specialization

JANUARY 28 —
Closing date for the
FEBRUARY MID-WINTER
BUYING ISSUE
Rush your space reservation!

Join the
Fight Polio
MARCH OF DIMES
JANUARY 2 TO 31

The finest all-channel antenna ever made!

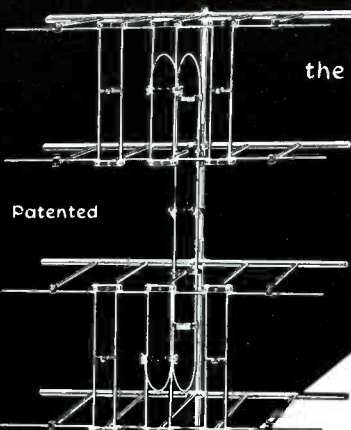

the **SKYLINE**

- ★ 28 fewer element connections
- ★ 8 integral elements VS. 40
- ★ Pre-assembled ★ Quick rigtime
- ★ Extra heavy—all aluminum
- ★ Amazing reception up to 150 mi.

The Skyline foldable colinear antenna possesses higher gain with respect to signal strength because the *elements are integral!*

No loss of signal strength through a multiplicity of mechanical connections.

Only the Skyline continues to maintain high gain with respect to signal strength over an *indefinite period of time.*

The Skyline colinear antenna, with its new engineering developments, is fast replacing *all other types* in fringe areas.



HIGH BAND PATTERN

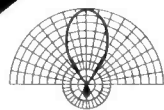

LOW BAND PATTERN

Request further information from your local dealer

SKYLINE MFQ. CO. 1458C3 E. 17 St., Cleveland 14, Ohio

Tools. Instruments. Parts

(Continued from page 69)

S/C TUBE GUIDER

A plastic wafer, *Guide-A-Tube*, that slips over the pins of miniature tubes before inserting them into their sockets, has been introduced by S/C Laboratories, Inc., 37 George St., Newark 5, N. J.

This method is said to prevent forcing, turning or twisting the pins of the tubes, and also acts as a cushion against microphonics.

* * *

ARROW GUN TACKER

A gun tacker, *T-50*, that shoots patented wedge-pointed steel wire staples, up to 9/16" long, has been announced by Arrow Fastener Co., Inc., 1 Junius St., Brooklyn 12, N. Y.

Tacker may be used for tacking built-in antennas in cabinets; attaching speaker grill cloths; tacking cable harnesses into position; attaching small parts envelopes and technical data to or within completed or repaired assemblies; and securing wires and cables on servicing and installation jobs.

Holds 125 staples.



* * *

ELECTRONIC MEASUREMENTS 'SCOPE

A 5" 'scope, *model 600*, that features the use of a 5VP1, has been announced by Electronic Measurement Corp., 280 Lafayette St., New York 12, N. Y.

Vertical amplifier can be used up to 5 mc. Available are a two-step attenuator input, synchronization on either positive or negative phase of input voltage through the vertical amplifier or from an external source, and a multivibrator type of sweep from 15 cycles to 75 kc.

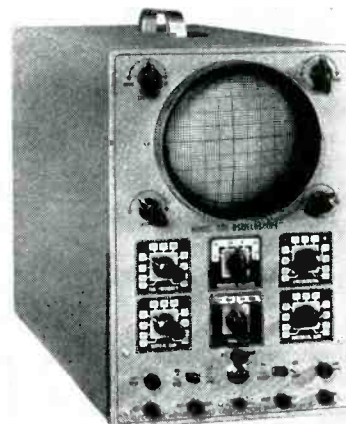

FOR Better
TV PERFORMANCE

B-T Antenna Accessories

Every Service-Technician knows that you can't just hook up a TV set to an antenna and expect that it will always work the way you would want it to. There are too many 'ifs', 'ands', and 'buts' that enter into the picture. That's why Blonder-Tongue Laboratories has devoted its facilities to the creation of accessories designed to assist the Serviceman in meeting these problems.

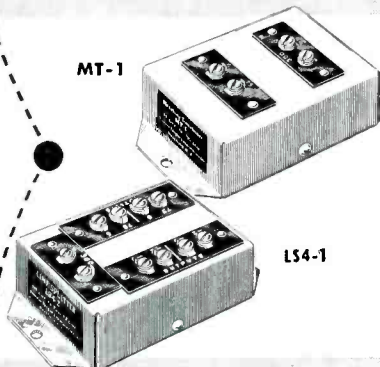

The B-T MATCHING TRANSFORMER permits precise impedance match between 75-ohm unbalanced (co-axial) transmission lines and 300-ohm balanced lines. It eliminates reflections, standing waves, and power loss due to improper impedance matching.

MT-1 List Price.....\$6.50

The B-T LINE SPLITTERS provide the lowest cost means for dividing a transmission line to feed branch lines, or to distribute signals to several TV sets or distribution units in multiple dwellings or community installations. Each Line Splitter supplies up to four impedance-coupled branch lines from one input, with flat response over all channels.

LS4-1 Feeds 4 75-ohm lines from 1 75-ohm line.
LS4-2 Feeds 4 75-ohm lines from 1 300-ohm line.
LS4-3 Feeds 4 300-ohm lines from 1 75-ohm line.
LS4-4 Feeds 4 300-ohm lines from 1 300-ohm line.

List Price, each.....\$7.50

Other B-T ANTENNA ACCESSORIES include: Line Loss Equalizer, Attenuator, Remote Control, and Weather-Proof Housing for B-T Units.

Sold at Leading Distributors

Complete literature available describing the B-T Unit System for Easy-to-install Master Systems and Community Installations, B-T Boosters, and B-T Antenna Accessories.

Write for Catalog FA8

**B-T
LABS**

**BLONDER-TONGUE
LABORATORIES, INC.**
WESTFIELD, NEW JERSEY

BROWNING FM MODULATION MONITOR

A frequency modulation monitor, MD-33, designed to check the modulation swing of FM transmitters operating in the special service bands from 25 to 174 mc, has been announced by Browning Laboratories, Inc., 750 Main Street, Winchester, Mass. Continuous coverage is accomplished in two bands without the use of plug-in units.

Modulation swing is indicated directly on a 4" panel meter with a 20-kc full-scale linear calibration. A dual-range flasher circuit permits checking overmodulation by the shortest of voice peaks at either of two pre-set amounts of swing.



* * *

PILOT FM-AM TUNER

A 9-tube FM-AM radio tuner, Pilot-tuner AF-821, intended for use as the central control head of a hi-fi music system, has been announced by the Pilot Radio Corporation, Long Island City, N. Y. Incorporates a two-stage preamplifier with adjustable equalization for various makes of reluctance phonograph cartridges, separate input connections for phono and TV operation, extended range bass and treble controls, a temperature compensated oscillator for drift-free FM reception, and *afc* at the option of the user. Tuner can be left in the open on a shelf or table, or mounted in a single large rectangular opening in the front of a cabinet.

Overall dimensions are 14 $\frac{1}{4}$ " by 7 $\frac{1}{4}$ " by 8 $\frac{1}{2}$ ".

* * *

IRC FOUR-WATT RESISTORS

Power resistors, PW4, rated at four watts, have been introduced by International Resistance Co., 401 North Broad St., Philadelphia 8, Pa.

Insulated with an inorganic core material molded in a high temperature plastic, unit, it is claimed, will not support combustion. Wire element is wound on glass fibre core with axial leads 1 $\frac{1}{2}$ " long, .036" diameter. Body dimensions: 1 $\frac{3}{4}$ " long by 21/64" diameter. Available from 1 to 8200 ohms in $\pm 5\%$ and $\pm 10\%$ tolerance.

Resistors are recommended for TV circuits requiring 2 to 3 watts actual dissipation at high ambient temperature, resistance element of resistance-capacitance filter in auto receiving sets where operation is at high ambient temperature, and all other circuits where a stable resistor is required, with wattage dissipation of 4 watts and less.

* * *

HELLER CABLE FASTENING GUN

A hand-held automatic fastening gun for cables has been developed by the Heller Co., 2153 E. Superior Ave., Cleveland 14, O.

Gun drives extra-size band with leg lengths varying from $\frac{3}{8}$ " to $\frac{1}{2}$ ".



Industrial
Television Inc.

TECHNI-TOPICS

By LEN MAZEL

Multiple Installations in Fringe Areas Using the AutoCoupler and AutoBooster

The ITI *AutoCoupler* is an exceptionally well-made unit which permits driving more than one set with a single antenna. The Coupler has low losses, but even the ITI *AutoCoupler* does cause some attenuation. In fringe areas, special arrangements must be used involving the use of one or more *AutoBoosters* depending upon the signal strength.

An IT-90AB Cascode *AutoBooster* can be inserted in the lead-in from the antenna, boosting the signal before it gets to the *AutoCoupler*. Splitting into two separate paths—as many as four paths are possible if an IT-118A *AutoCoupler* is used instead of an IT-117A *AutoCoupler*—the signal proceeds toward the receivers. It can be further amplified by an economical IT-102A Super *AutoBooster* located at the input of each receiver.

An unfortunate condition that sometimes exists is interaction. Interaction is occasionally caused by the local oscillator of an offending TV set acting as a transmitter and sending a signal back along the lead-in to the other set.

The IT-102A Super *AutoBooster*, if put in the lead-in of the offending receiver, should cure this trouble by providing effective isolation. An *AutoBooster* strongly amplifies a signal going in the design direction, but stops any signal attempting to go through it in the reverse direction.

Just as the *AutoCoupler* is a must for multi-set operation in the show room or home, the ITI Tenna-Clip is an absolute essential for the service and repair shop. The Tenna-Clip permits instantaneous attachment of wires to terminals. Clipping it on takes no more time than to snap one's fingers.

The wise technician will put one of his Tenna-Clips on the receiver end of his antenna lead-in. With that lead-in suspended near his shop ceiling but dangling free to the service bench, he can quickly transfer his antenna input from one set to another on the bench.

For additional copies of this and earlier issues of *Techni-Topics*, catalog sheets on all ITI products and free sample Tenna-Clip, write on your letterhead, to Industrial Television, Inc.

Industrial Television, Inc.

369 LEXINGTON AVENUE CLIFTON, N. J.

GRegory 3-0900



North
East
West or
South

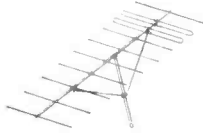

no matter where you look --
the best antennas are

TANCO *
TECHNICAL APPLIANCE CORPORATION
SHERBURNE, N. Y.

TV Receiver
Sensitivity
Measurements
made Simple
with

The New Portable
"SensiMeter" *

... a "must" in fringe areas

- * Takes the guesswork out of TV service
- * Checks receiver from antenna terminals to picture tube
- * Microvolt scale is divided into 3 sections as a guide for the servicemen
- * Sensitivity testing is accepted by servicemen as the best method of determining the cause of bad pictures



Net
\$129.50

*Pat. Applied For

Approved by leading television manufacturers!

Consult your jobber or write for further information.

SI

SERVICE INSTRUMENTS COMPANY

422 South Dearborn Street, Chicago 5, Illinois

TV Parts . . . Accessories

TRANVISION PICTURE TUBE TESTER-REACTIVATOR-SPARKER AND TV RECEIVER KITS

A picture-tube test and repair unit, *Tester-Reactivator-Sparker*, that is self-powered, has been developed by Transvision, Inc., Dept. DG-3, New Rochelle, N. Y.

As a tester, instrument measures cathode emission, locates shorts between elements, high resistance shorts or leakage up to 3 megohms, and indicates whether the tube has lost or is losing its vacuum. As a reactivator, unit is said to rejuvenate dim tubes; reactivation can be done in the customer's home without removing the picture tube from the TV set.

As a sparker, unit sparks out electrical leakage.

Six TV kits for home assembly, *A-4* series, that feature *afc, agc*, choice of several tuners, optional remote control, retrace-elimination, ready addition of *uhf* channel strips without converters, optional power of 60, 50 and 25 cycles, have also been announced.

Kit, when completed, comprises 25 tubes with 6" x 9" pm speaker.



HAMMARLUND VHF-UHF CAPACITOR

A *vhf-uhf* variable capacitor, *vu*, designed for use in tuned circuits that operate at frequencies from 50 to 500 mc, has been introduced by the Hammarlund Manufacturing Co., 460 W. 34th St., New York 1, N. Y.

Capacitor design is said to place two capacitor sections in series and eliminate the need for contacts to the rotor. Rotor is isolated by the use of pyrex glass ball bearings.

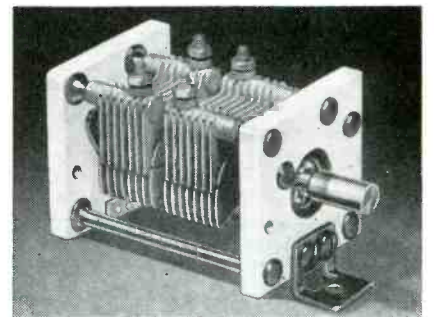

"Quick-Service" Capacitor Kits



in handy,
clear plastic cases!

You pay only for the capacitors. The case costs you nothing!

Six basic kits to service over 85% of all twist-prong replacement needs. Case can be used to store screws, small parts — even fishing tackle. See your Cornell-Dubilier jobber today for details. Cornell-Dubilier Electric Corporation, South Plainfield, N. J.

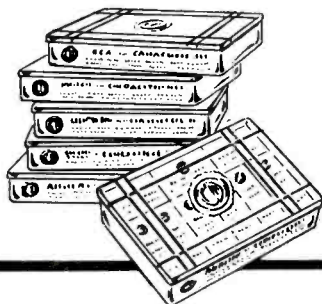

A Service of

CORNELL-DUBILIER

World's Largest Manufacturer of Capacitors

PLANTS IN SO. PLAINFIELD, N. J., NEW BEDFORD, WORCESTER AND CAMBRIDGE, MASS., PROVIDENCE, R. I., INDIANAPOLIS, IND., FLOUQUAY SPRINGS, N. C., SUBSIDIARY: RADIART CORP., CLEVELAND, OHIO

WALSCO TV CONSOLE ROLLER-COASTER

A caster assembly for television sets, *TV Rolabout*, that is said to fit almost any console, has been announced by the Walter L. Schott Co., 3225 Exposition Place, Los Angeles 14, Calif.

Rolabout has 4 ball bearing casters mounted on a heavy steel cross brace which is attached to the base of cabinet.

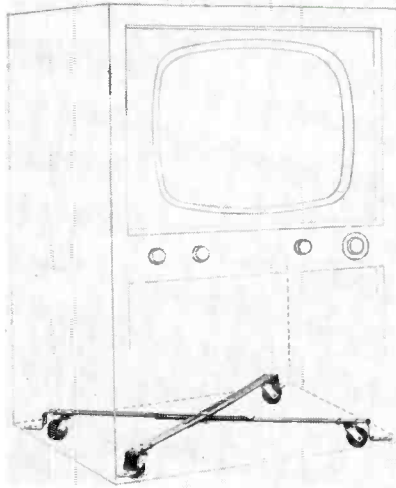

* * *

G-C HV TV TEST PROBE

A tester for checking *hv* TV circuits, 8836, has been introduced by General Cement Manufacturing Co., 919 Taylor Ave., Rockford, Ill.

Measuring about 7" in length, servicing tool is said to provide margin of safety in testing by glowing when in contact with high voltage. Shows points of high voltage to eliminate dangerous shocks.

* * *

RADIO APPARATUS LINE VOLTAGE BOOSTER

A booster, *V-15*, that is claimed to provide full rated performance from any 110-volt electrical device requiring between 500 and 1,500 watts, has been introduced by the Radio Apparatus Corp., 55 N. New Jersey St., Indianapolis 4.

Meter reads actual line voltage and load voltage; switch increases 5 volts-per-step, and is said to raise 85 volts to 120 volts with 1,250-watt load.

* * *

EBCO CRT DYNAMIC ANALYZER

An instrument, *Dynamic Analyzer*, that can be attached to a *vwm* to convert it into a picture-tube tester, has been introduced by Electronic Beam Corp., 923 Old Nepperhan Ave., Yonkers 3, N. Y.

Analyzer is claimed to check all socket voltages of a TV set while in operation, check emission of the picture tube, and opens and shorted elements, and leakage.

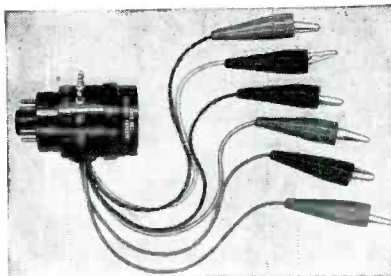

Wanna Trade?

As a subscriber to the CORNELL-DUBILIER monthly magazine "THE CAPACITOR" you can use its famous "TRADING POST" section to run an advertisement to SELL — SWAP — or BUY all sorts of equipment and services helpful to you in your business.

NO CHARGE FOR THE AD!

NO CHARGE FOR THE SUBSCRIPTION!

"THE CAPACITOR" comes prepaid direct to your home every month — 12 times a year, 16 to 24 pages, including a complete full length technical or constructional article.

A Service of

CORNELL-DUBILIER

World's Largest Manufacturer of Capacitors

FREE EVERY MONTH
Just fill in the coupon below — and mail it today.
Our new subscription list limited so — get your request in now!

CORNELL-DUBILIER ELECTRIC CORPORATION
DEPT. 518, SOUTH PLAINFIELD, N. J.

Yes Sir! Put me down for a free subscription to Cornell-Dubilier's "THE CAPACITOR".

NAME _____

ADDRESS _____

CITY _____ ZONE _____ STATE _____

MY BUSINESS IS _____

MY JOBBER IS _____

for dependable sound,
INDUSTRY relies on
ATLAS



DR Double-Reentrant Projectors



Paging & Talk-Back Speakers



ALNICO-V-PLUS Driver Units



Dual Speakers



FULL-GRIP, VELVET-ACTION Mike Stands

ATLAS SOUND CORP.
 44 1/2 -39th Street, Brooklyn 18, N. Y.
 In Canada: Atlas Radio Corp., Ltd., Toronto, Ont.

UHF Crystal Diode Troubleshooting

by **HENRY R. HESSE**

Senior Engineer, TV Receiver Division
 Allen B. DuMont Labs

Part II . . . Checking Current of Crystals . . . Resistance Reading Interpretation . . . How To Replace Crystals

DEPENDABLE QUALITY:

The latest electro-acoustic research and engineering—and over 20 years of manufacturing know-how—are behind every ATLAS product.

DEPENDABLE SERVICE:

Coast-to-coast and around the world today—in every Industrial, Marine, Railroad, Military, Educational, Civic, U.S. and Foreign Government application—under every kind of climate and noise condition—ATLAS sound equipment is famous for highest efficiency and durability. That's the proof of ATLAS performance dependability.

DEPENDABLE DELIVERY:

Yes, ATLAS gives our Government highest priority. And yes, we too feel the pinch of material shortages. But our customers will continue to get our usual dependable delivery—because we believe in equitable and dependable distribution to all ATLAS users.

DEPENDABLE PROFITS:

Completeness of line, excellence of product, dependable delivery, right prices—that's the ATLAS combination that means high, steady Industrial Sound profits for You!

JUDGE for yourself, COMPARE ATLAS at your local Jobber today. See why ATLAS is the preferred line for utmost dependability. Write NOW for FREE latest Catalog 551.

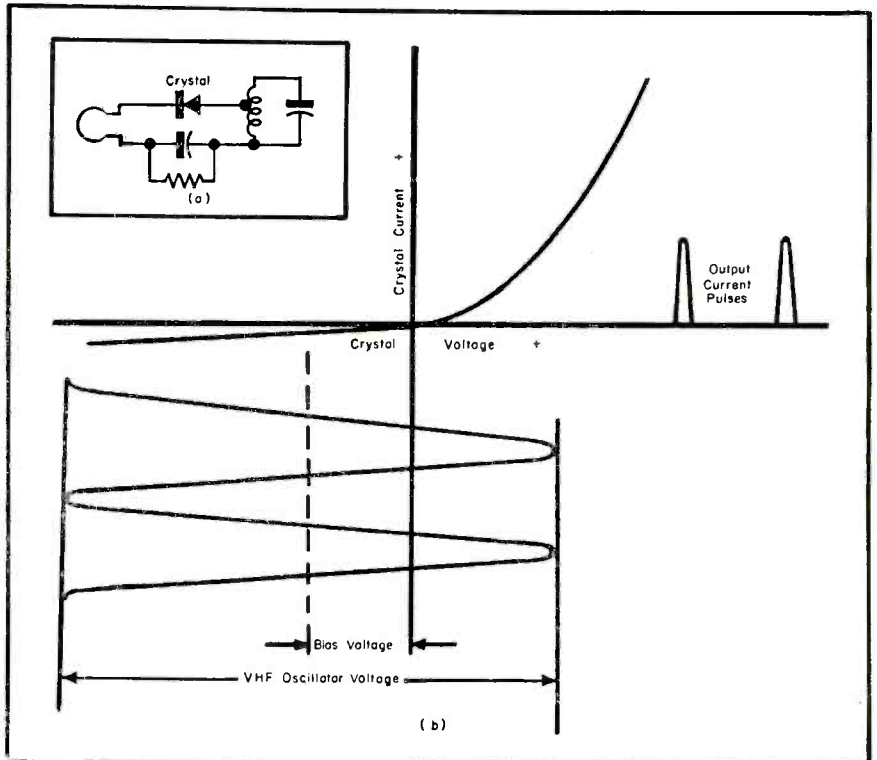

Fig. 1. Circuit and plot illustrating operation of a harmonic crystal multiplier, as employed in some tuners to multiply frequency of vhf oscillator.

IN TROUBLESHOOTING CRYSTAL diodes in ultrahigh circuits, measurement of the dc crystal current is a particularly

important, offering a check on the coupling and tuning, too.

A lack of any crystal current indication would disclose either a burned-out crystal or a defective oscillator tube. A check of the voltage developed across the oscillator grid leak would disclose whether the oscillator was functioning and its relative strength.

Ohmmeter Tests

Crystals can be tested with an ohmmeter. Two resistance readings should be taken; one will indicate the crystal's forward resistance which should read between 50 and 500 ohms, and the other of the back

SPEAKERS NEED REPAIRING

RECONE WITH A WALDOM CONE

A Waldom Cone for the Finest Tone

Quicker, less expensive speaker servicing means greater profits. Speed up your speaker repair jobs . . . **FREE Waldom 24-page Replacement Cone Manual** . . . covers 750 different TV, FM and AM receivers.

WRITE FOR YOUR FREE COPY TODAY. THERE IS NO OBLIGATION

WALDOM ELECTRONICS INC., 911 N. LARRABEE ST., CHICAGO 10, ILLINOIS

South River

★★ NEWS ★★

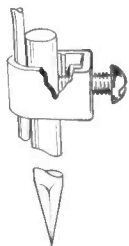

GROUND ROD

Model GND
4' - 6' - 8'

Made of tough, high strength steel and furnished with either copper or hot-dip galvanized finish. The extended aluminum wire clamp provides a simple means of attaching all sizes of ground lead wire up to 1/4" O.D.

South River Antenna Mounting Accessories are carried by leading TV Parts Jobbers from coast to coast.

Write for your copy of our new 1953 catalog.

SOUTH RIVER METAL PRODUCTS CO., INC.
SOUTH RIVER, N. J.

PIONEER AND OUTSTANDING PRODUCER OF FINEST LINE OF ANTENNA MOUNTS

NO ballyhoo — YOU be the SOLE JUDGE!



IMPROVED CECO RESTORER

HUSHES... RESTORES all controls and contacts SAFELY with just one application

\$1.00 list Full 2-oz. bottle

CECO RESTORER—safely cleans, lubricates, restores and silences all contacts and controls. A special hydrocarbon colloidal suspension of a highly refined vegetable gum, its great hyper-capillary action forces it into the inaccessible places—where it cleans instantly and forms a durable, non-greasy, hard-bonded lubricating surface. Does not affect inductance, capacitance, resistance. Non-reactive to heat, cold, oil, corrosives. Proved safe even for all critical UHF circuits!

SPECIAL! Present this ad to your jobber when you buy the regular 2-oz. bottle, and you'll get an additional 2-oz. bottle for only 10¢. If you're not 100% delighted with CECO performance, return the unused 2-oz. bottle to your jobber for immediate full refund. Only proven CECO RESTORER makes this money-back guarantee!



CHEMICAL ELECTRONICS CORP.
P.O. Box 127, Irvington, N. Y.
Modern Chemistry for Better Electronics

resistance obtained by reversing the crystal where the resistance should be above 10,000 ohms. One should not use an ohmmeter with a battery voltage greater than 1.5 volts, to prevent burnout of the crystal during measurements. A burned-out crystal will be indicated by either a low or high resistance in both directions.

Crystal Replacement

Replacement of crystals is quite simple since they can be either clipped or soldered into the circuit. Recognition of some soldered-in crystals is difficult because of their similarity in appearance to carbon resistors. Crystals can be identified by the printed crystal schematic symbol and the absence of the resistor color bands; also crystals are usually located close to the local oscillator tube. In soldering crystals, to prevent crystal damage due to the heat of the soldering iron, the crystal lead should be held in the jaws of a long-nosed pliers, holding the lead as close as possible to the body of the crystal. The long-nosed pliers should always be used to hold the crystal lead between the point of soldering and the body of the crystal to act as a heat dissipator, thus preventing overheating and possible damage to the crystal. The clip-in crystals have an advantage in that they may be checked as easily as tubes by the substitution method. In addition, the clip-in crystals cannot be damaged by the soldering operation.

RTMA Exhibit at AVA Convention



A. Coumont, RTMA service coordinator; Eugene D. Fink, Chief of Bureau of Vocational Curriculum, Development and Industrial Teacher Training, University of the State of New York and A. C. W. Saunders, director of Saunders Radio and Electronic Schools, Inc., Boston, Mass., in both of RTMA service committee, at the annual convention of the American Vocational Association in Boston. The exhibit, under the direction of a subcommittee consisting of E. W. Merriam, Sylvania, F. B. Ostman, Capehart-Farnsworth, and J. A. Milling, Howard W. Sams, demonstrated a test bench for rapid TV chassis troubleshooting and displayed TV technicians servicing and training aids including charts, pamphlets, manuals and a trainer chassis. The purpose of the exhibit was to announce RTMA's offer of supplementary teaching aids for the training of radio and television technicians. A brochure explaining details of this offer was distributed and discussed with administrators, supervisors, teacher trainers and teachers in vocational and industrial arts education.

FREE



NEW '53 EDITION
COMPLETELY REVISED
INCLUDES { DIRECTRONIC UHF DATA

SIMPLIFIES ALL TV ANTENNA PROBLEMS

NEEDED BY ALL IN TV

Outstanding authorities have completely revised this pocket size reference manual... packed it with clear, concise data on Directronics, UHF, all antenna types. A mine of information on many vital subjects including Feed Methods, Channel Frequencies, Helpful Hints, Do's and Don'ts, Dimension Guide, Etc.

LEARN ABOUT THE GREAT NEW TV LINE FOR '53
Snyder DIRECTRONIC · UHF · YAGI

PUBLICATION PRICE \$1. YOURS WITHOUT OBLIGATION IF YOU WRITE AT ONCE

MAIL THIS COUPON TODAY—
SNYDER MFG. CO.

Dept. A BOX #4465, Phila. 40, Pa.
Please send free copy of TV TENNA TIPS

Name _____

Address _____

City _____ Zone _____ State _____

Mention local jobber or dealer

ATR

AUTO RADIO VIBRATORS
have Ceramic Stack Spacers



A COMPLETE LINE OF VIBRATORS . . .

Designed for Use in Standard Vibrator-Operated Auto Radio Receivers. Built with Precision Construction, featuring Ceramic Stack Spacers for Longer Lasting Life. Backed by more than 20 years of experience in Vibrator Design, Development, and Manufacturing.

ATR
 NEW MODELS
 NEW DESIGNS
 NEW LITERATURE

"A" Battery Eliminators, DC-AC Inverters
 Auto Radio Vibrators

See your jobber or write factory

AMERICAN TELEVISION & RADIO CO.
Quality Products Since 1931
 SAINT PAUL 1, MINNESOTA-U.S.A.

JOTS AND FLASHES

THE HUGE QUANTITIES of parts required for TV chassis was strikingly revealed recently in a report from a midwestern set manufacturer, which disclosed that over \$400,000 worth of components are consumed each working day to meet their production schedule of receivers. . . .

Robert F. Halligan has been promoted to assistant operations manager of the Hallicrafters Co. . . . The second annual report by the self-employed, covering '52 earned net income for Social Security purposes, is due between January 1 and March 15, 1953. The amount of tax for '52 is still 2 1/4 per cent of net earnings from \$400 up to \$3,600 a year. Social Security report is made on the combined scheduled C and Ca which is filed with the Form 1040. Service Men are cautioned to make these returns in duplicate, retaining a copy for future reference. . . .

Edgar M. Villchur, a SERVICE contributor, will present a course, *The Reproduction of Sound*, at New York University, Division of General Education, Washington Square. Course, which will cover the theory of sound, plus installation procedures, will start Wednesday, February 4, 7-9:45 P.M. . . . To insure service for Zenith's Hawaiian TV customers, a TV service school and clinic has been introduced by the manufacturer's distributor. . . . G. E., it is said, will double its production of germanium diodes next year. Each of the 6.5-million TV sets expected to be built by industry next year will incorporate as many as three of the tiny devices, it was noted. . . .

Ralph Aasen has been appointed chief engineer and *G. Leonard Werner* director of sales engineering of Mark Simpson Manufacturing Co., Inc. . . . *M. Robert Wilson* has been appointed vice president in charge of sales for the Hallicrafters Co. . . . The Audio Fair in Chicago will be combined with the '53 International Sight and Sound Exposition to be held at the Palmer House, Sept. 1, 2 and 3. . . .

Prestoseal Manufacturing Corp. is now located at 37-27 33rd St., Long Island City, N. Y. . . . The David Bogen Co., Inc., has moved to new quarters at 29 Ninth Ave., New York 14, N. Y. . . .

Ralph Glover, product manager of Jensen Manufacturing Co., has become a member of the RTMA high-fidelity committee. . . . New address of the administrative and home offices of National Union Radio Corp. is Jacksonville Rd., Hatboro, Pa. . . . The American Phenolic Corp. and Cornish Wire Co. have signed a licensing agreement permitting Cornish to manufacture, package and sell tubular twin-lead under Amphenol's Krueger patent 2,543,696. . . . RCA, Harrison, N. J., Sarkes Tarzian, Inc., Bloomington, Ind., and J. W. Miller Company, Los Angeles, have become participants in the Photofact services of Howard W. Sams and Co., Inc.; RCA will participate in behalf of transformer components; Sarkes Tarzian for selenium rectifiers and Miller for coils. . . . *Sidney Pariser*, president of Radio Merchandise Sales, was recently honored by his firm for his 25-year record of achievement in the radio and TV parts industry.



Sidney Pariser

ADVERTISERS IN SERVICE JANUARY, 1953

Admiral Corporation	6
Aerovox Corporation	58
Alliance Mfg. Co.	13
Alproco Inc.	47
American Phenolic Corporation	44
American Television & Radio Co.	80
Astron Corporation	1
Atlas Sound Corporation	78
Blonder-Tongue Labs., Inc.	75
David Bogen Co.	74
Bussmann Mfg. Co.	15
Channel Master Corporation	11
Centralab Div. Globe-Union, Inc.	33
Chemical Electronics Corp.	79
Clear Beam TV Antennas	72
Cornell-Dubilier Electric Corp.	77
Di-Co TV & Plastic Co., Inc.	68
Allen B. DuMont Laboratories, Inc.	23
Electro Products Laboratories, Inc.	3
Electronic Measurements Corporation	71
Equipto Div. Aurora Equipment Co.	64
Erie Resistor Corporation	68
The Finney Co.	59
Galvanic Products Corp.	67
The General Industries Co.	63
Heath Company	62
Hickok Electrical Instrument Co.	31
Hytron Radio & Electronics Co.	5
Hughes Research & Development Labs.	53
Industrial Television, Inc.	75
JFD Manufacturing Co., Inc.	2, 60
Jackson Electrical Instrument Co.	62
Kester Solder Co.	66
P. R. Mallory & Co., Inc. Inside Back Cover	
Merit Coil & Transformer Corp.	25
Miller Television Co.	54
Mueller Electric Co.	58
National Electronic Products Corporation	40-41
Oxford Electric Corp.	54
Perfection Electric Co.	56
Perma-Power Co.	58
Planet Mfg. Corp.	64
Precision Apparatus Co., Inc.	4
Pyramid Electric Co.	37
Quietrole Co.	56
Rad-El-Co Manufacturing Co.	57
The Radiart Corporation	
Radio City Products Co., Inc. Inside Front Cover	52
Radio Corporation of America	73
The Rauland Corporation	8, Back Cover
Raytheon Manufacturing Co.	7
Regency Div. I.D.E.A., Inc.	16
John F. Rider Publisher, Inc.	27, 43
Rytel Electronics Mfg. Co.	55
Howard W. Sams & Co., Inc.	49
Sangamo Electric Co.	52
Scala Radio Co.	48
Service Instruments Co.	72
Skyline Manufacturing Co.	76
Snyder Mfg. Co.	74
South River Metal Products Co., Inc.	75
Sprague Products Co.	79
Standard Transformer Corporation	9
Sylvania Electric Products, Inc.	69
T.V. Products Co., Inc.	12
Sarkes Tarzian, Inc., Rectifier Division	34
Technical Appliance Corporation	60
Television Materials Corp.	76
Triad Transformer Manufacturing Co.	60
Triplett Electrical Instrument Co.	56
Turner Co.	10
U. S. Treasury Department	46
United Technical Laboratories	14
University Loudspeakers, Inc.	71
Utah Radio Products Co., Inc.	66
Vidaire Electronics Mfg. Co.	65
Videon Electronic Corporation	54
Viking Electronics	71
Waldom Electronics, Inc.	52
Webster-Chicago Corporation	78
Wen Products, Inc.	38
	61

Depend on Mallory
for
Approved Precision Quality



Get More Jobs Done In A Day

There's no profit in sets waiting to be repaired. Profits depend on turning out more jobs . . . and cutting down on time wasting call-backs.

Midgetrols® are designed for fast, easy installation in any set, TV or radio.

Round tubular shafts can be cut accurately and quickly . . . fit split-knurl or flatted-type knobs.

AC switches can be attached instantly without disassembling the control.

Their unique design simplifies inventory problems . . . always available from your Mallory Distributor.

Midgetrols are engineered to duplicate the precise characteristics of original equipment. They will give equal . . . and often better performance and life than the original control.

Save time . . . find extra minutes to turn out more finished jobs . . . be sure of dependable, precision quality for all your TV and radio repairs . . . ask for Mallory Midgetrols the next time you call your distributor.

Another time saver. Get your copy of the Mallory Control Guide. It is a complete cross reference between set manufacturers' part numbers and the equivalent Mallory control.

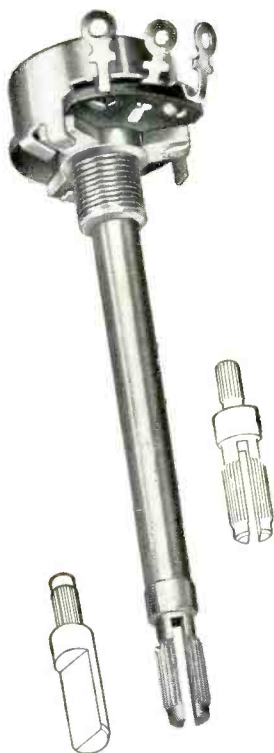

P. R. MALLORY & CO. INC.
MALLORY

CAPACITORS • CONTROLS • VIBRATORS • SWITCHES • RESISTORS
• RECTIFIERS • VIBRAPACK* POWER SUPPLIES • FILTERS
*Reg. U.S. Pat. Off.
APPROVED PRECISION PRODUCTS

P. R. MALLORY & CO. Inc., INDIANAPOLIS 6, INDIANA

The gun that looked 100% "perfect" ... got better "fired a shot"

It's not the gun that counts, it's the shot. The shot that counts is the shot that is true to the mark. The shot that is true to the mark is the shot that is true to the mark. The shot that is true to the mark is the shot that is true to the mark.

RCA RADIO CORPORATION of AMERICA
ELECTRON TUBES

How we "shady characters" before they can damage your business

It's not the microscope that counts, it's the character. The character that counts is the character that is true to the mark. The character that is true to the mark is the character that is true to the mark. The character that is true to the mark is the character that is true to the mark.

RCA RADIO CORPORATION of AMERICA
ELECTRON TUBES

The guinea pig that "runs a fever" no bring you better picture tubes

It's not the guinea pig that counts, it's the fever. The fever that counts is the fever that is true to the mark. The fever that is true to the mark is the fever that is true to the mark. The fever that is true to the mark is the fever that is true to the mark.

RCA RADIO CORPORATION of AMERICA
ELECTRON TUBES

99% pure phosphor... yet we throw it away

It's not the phosphor that counts, it's the throw. The throw that counts is the throw that is true to the mark. The throw that is true to the mark is the throw that is true to the mark. The throw that is true to the mark is the throw that is true to the mark.

RCA RADIO CORPORATION of AMERICA
ELECTRON TUBES

The evidence is clear...

RCA safeguards your reputation... with tubes of unequalled quality

In RCA Tubes and Kinescopes the difference is top-quality control

RCA RADIO CORPORATION of AMERICA
ELECTRON TUBES
HARRISON, N. J.
TMK. 13

A DOUBLE-TAKE to safeguard your reputation

It's not the double-take that counts, it's the safeguard. The safeguard that counts is the safeguard that is true to the mark. The safeguard that is true to the mark is the safeguard that is true to the mark. The safeguard that is true to the mark is the safeguard that is true to the mark.

RCA RADIO CORPORATION of AMERICA
ELECTRON TUBES

The Torture Chamber that tests the strength of RCA Picture Tubes

It's not the torture chamber that counts, it's the strength. The strength that counts is the strength that is true to the mark. The strength that is true to the mark is the strength that is true to the mark. The strength that is true to the mark is the strength that is true to the mark.

RCA RADIO CORPORATION of AMERICA
ELECTRON TUBES

How we get that's just right for RCA picture-tube success

It's not the just right that counts, it's the success. The success that counts is the success that is true to the mark. The success that is true to the mark is the success that is true to the mark. The success that is true to the mark is the success that is true to the mark.

RCA RADIO CORPORATION of AMERICA
ELECTRON TUBES

Quality control by feedback ... the secret of RCA tube performance

It's not the quality control that counts, it's the secret. The secret that counts is the secret that is true to the mark. The secret that is true to the mark is the secret that is true to the mark. The secret that is true to the mark is the secret that is true to the mark.

RCA RADIO CORPORATION of AMERICA
ELECTRON TUBES

The Million-Dollar Test Equipment ... that pays off in better picture tubes

It's not the million-dollar test equipment that counts, it's the better picture tubes. The better picture tubes that counts is the better picture tubes that is true to the mark. The better picture tubes that is true to the mark is the better picture tubes that is true to the mark. The better picture tubes that is true to the mark is the better picture tubes that is true to the mark.

RCA RADIO CORPORATION of AMERICA
ELECTRON TUBES

Take a look at quality being born

It's not the quality being born that counts, it's the look. The look that counts is the look that is true to the mark. The look that is true to the mark is the look that is true to the mark. The look that is true to the mark is the look that is true to the mark.

RCA RADIO CORPORATION of AMERICA
ELECTRON TUBES