

SERVICE

MARCH 1952

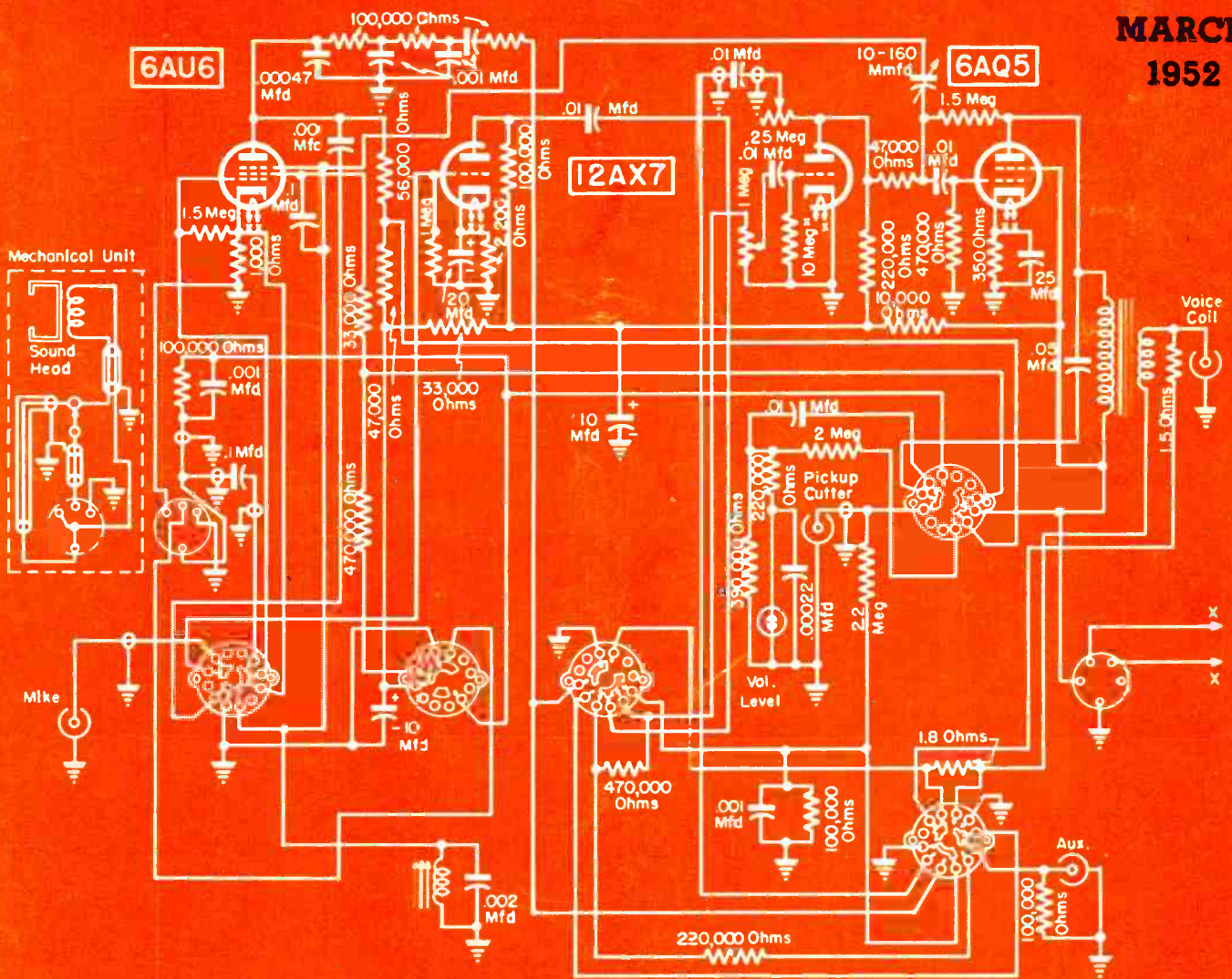

Amplifier circuit for tape-disc recording assembly.

[See page 2]

— there's something missing here



but the RADIART ANTENNA LINE has EVERYTHING

From conicals to yagis . . . from indoor "rabbit-ears" to hi-los and strate-lines — RADIART has everything **good** to be had in antennas! There's nothing missing in your antenna "picture" when you handle RADIART because there is a type and model for every need . . . quality engineered for peak performance . . . and made to outlast them all! GET RADIART — because it means you've got the best!

AND . . . don't forget our quality antenna accessories . . . like the "hottest" lightning arrestor on the market . . . the "SPEE-DEE" chimney mount . . . and our famous TELE-ROTORS!

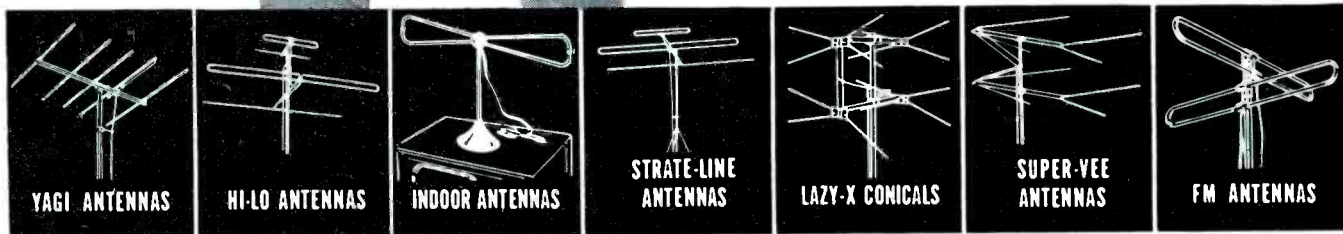

SUBSIDIARY OF



THE **RADIART** CORPORATION CLEVELAND 13, OHIO

VIBRATORS • AUTO AERIALS • TV ANTENNAS • ROTATORS • POWER SUPPLIES



HOW TO PLEASE **1,000,000** MUSIC LOVERS

**WQXR Depends on G-E Pickups and Styli to
Capture Full Brilliance of Recorded Music**

Rated tops by professional users like WQXR, the radio station of The New York Times, G-E audio equipment is at a peak of popularity with lovers of good music. The same superb cartridges and styli employed in WQXR studios are available for installation in home phonographs or sound systems—at prices your customers will appreciate.

Highest sales in G.E.'s history are being chalked up today by this outstanding line of high fidelity speakers, tone arms and pre-amplifiers. Don't miss your share of a fast-growing market that's currently rated in the millions! Call your General Electric distributor for full information.

**Ask Us for This New Free
Phono Accessories Folder**

Complete line-up of G-E audio equipment is listed here. Write:
*General Electric Company,
Section 332, Electronics Park,
Syracuse, New York.*



GENERAL  ELECTRIC



"Services & Tests Auto Radios Best"

SAY RADIO MANUFACTURERS*



Leading Manufacturers Say . . .

"It's the only one to withstand continuous high overloads, so we specify the Model "B" for servicing." Exclusive application of selenium rectifiers, aided by conduction cooling, doubles rectifier power rating, dissipates over 3 times the heat with lowest cost per ampere output. 1 to 20 amperes continuous duty with peak instantaneous rating of 35 amperes. Operates 2 auto radios with push-button solenoids simultaneously. Net \$49.80.

Other Uses . . . Operates many low power 2-way mobile radios, phone circuits, relays, instruments, low voltage devices. Battery charging and electroplating.

*Names on request.

Low Cost Model "BJ" POWER SUPPLY
6 Volts DC, 1 to 12.5 Amps. Net \$37.50

See Your Jobber Today!

**GET NEW
FREE CATALOG
ON
BATTERY ELIMINATORS**

ELECTRO PRODUCTS LABORATORIES
4501-Sb RAVENSWOOD AVE., CHICAGO 40, ILL.

Name
Firm
Street
City State

In Canada: Atlas Radio Corp., Ltd., Toronto

Vol. 21, No. 3

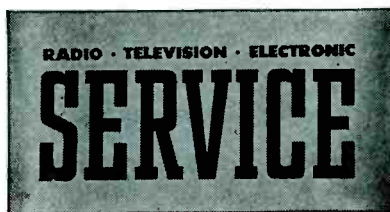

March, 1952

LEWIS WINNER
Editor

F. WALEN
Assistant Editor

Registered U. S. Patent Office
Including Radio Merchandising and Television Merchandising

Audio Installation and Service (Magnetic Tape System Tests). By Kenneth Stewart	26
Association News	50
Business Aids (COD Charges and Collections)	69
Fast-Acting AGC Systems. By Charles E. Bowers	42
FM Servicing-Alignment. By Rudolf F. Graf	32
Hi-Lo Output 78-RPM Replacement Cartridges. By J. G. Haskell	22
Improving Signal-Generator Performance. By Ronald L. Ives	24
Selenium Rectifiers	51
Ser-Cuits (24-Inch Chassis With 45.75 IF). By M. W. Percy	34
Service . . . The National Scene	17
Servicing Helps. By M. A. Marwell	40
Speeding Up TV Troubleshooting. By Cyrus Glickstein	46
Tape-Disc Recorder Amplifier System (Cover). By Wyn Martin	38
Ten Years Ago in Associations	50
The Stratford, Conn. UHF TV Tests. By Russell J. Hall	20
Tube News (UHF Tubes). By L. M. Allen	28
Views and News. By Lewis Winner	15

AUDIO INSTALLATION AND SERVICE

Bias Recording Current and Gain, and Distortion Checks in Magnetic Tape Units	26
Binaural Systems	61
Tape Recorder Service Aids	59

CIRCUITS

Ampro 731 Magnetic Tape Recorder	26
G.E. 24C101 TV Chassis	35
General Industries 250 Tape-Disc Recorder Amplifier (Cover)	38
Improved AF Modulation Circuits	25
Keyed AGC Amplifier	44
Keyed AGC Circuit With Single Video Stage	42
Keyed AGC Circuit With 6AC7 Video Amplifier	44
Keyed AGC System Circuitry	44
Motorola TS-52 Focus Circuit	46
RCA 15E Three-Speed Record Demonstrator	27
Reverse Tape-Recorder Playback-Head Circuit	27
Reverse Tape-Recorder Recording-Head Circuit	24
Signal Generator Circuitry	24
Signal Generator Power Supply	24
Signal Generator Power Supply Modified to Minimize Hum and Raise Output Voltage	46
Test Circuits	46
Video Amplifier With Two Video Stages	42

COVER

Tape-Disc Recorder Amplifier	38
------------------------------	----

SERVICING HELPS

Eliminating Washout in Philco Colorado Tuner	40
Improving Sync on Emerson Chassis	40
Installation of Dust Seals on Sylvania Chassis	40
Picture Centering	64
Stromberg-Carlson Receiver Notes	64

Index to Advertisers

Manufacturers	
Jots and Flashes	80
News	70
New Parts . . . Tools . . . Instruments	78
Rep Talk	68
TV Parts . . . Antennas . . . Accessories	73



Entire contents Copyright 1952, Bryan Davis Publishing Co., Inc.

Published monthly by Bryan Davis Publishing Co., Inc.

52 Vanderbilt Avenue, New York 17, N. Y.

Telephone MURray Hill 4-0170

Bryan S. Davis, Pres. Paul S. Weil, Vice-Pres. Gen. Mgr. F. Walen, Sec. A. Goebel, Cir. Mgr.
Mid-West Representative: Stuart J. Osten, 332 N. Michigan Ave., Chicago 1, Ill. Telephone: DEarborn 2-3507
East-Central Representative: James C. Munn, 2253 Delaware Dr., Cleveland 6, Ohio. Telephone: ERview 1-1726
Pacific Coast Representative: Brand & Brand, 1052 W. Sixth St., Los Angeles 14, Calif. Tel.: Michigan 1732
Suite 1204, Russ Building, San Francisco 4, Calif. Telephone: SUTter 1-2251

Entered as second-class matter June 14, 1932, at the Post Office at New York, N. Y., under the Act of March 3, 1879. Subscription price: \$2.00 per year in the United States of America and Canada; 25 cents per copy. \$3.00 per year in foreign countries; 35 cents per copy.

*Greatest in demand
Greatest in service*

Insist on **N**ational **V**ideo **C**orp.

TELEVISION REPLACEMENT TUBES

Demand the N.V.C. trade mark on every picture tube.



over
1,000,000

Television Tubes Already Produced

In more than a million sets you will find a National Video Corporation tube in active service — every one delivering a clearer, brighter, better picture. Designed to meet the service man's exacting requirements and interchangeable in every standard set.

Be sure to install a N.V.C. Television Tube to eliminate call-backs and waste of time and dollars. See your local distributor — say, "N.V.C.", the next time you buy replacement tubes.

Write for name of Distributor nearest you
3019 West 47th Street, Chicago, Ill.

Three plants with over 17 acres of coordinated machinery and personnel, producing the world's finest television picture and receiving tubes.



National Video Corporation

3019 W. 47th St.
Chicago

Grays Lake
Illinois

NAVIDICO
901 W. Huron St. Chicago

Industrials

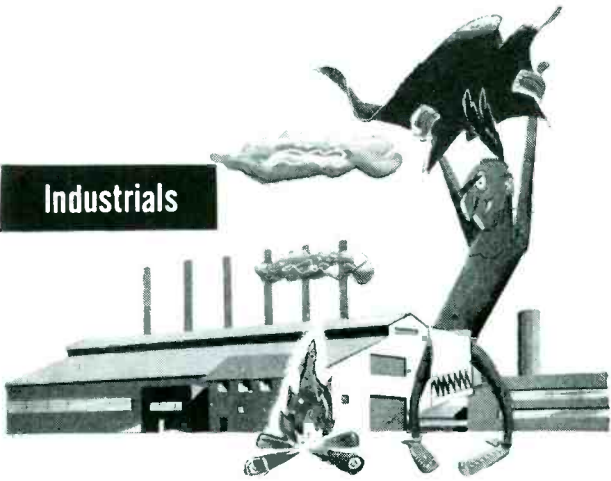

Communications

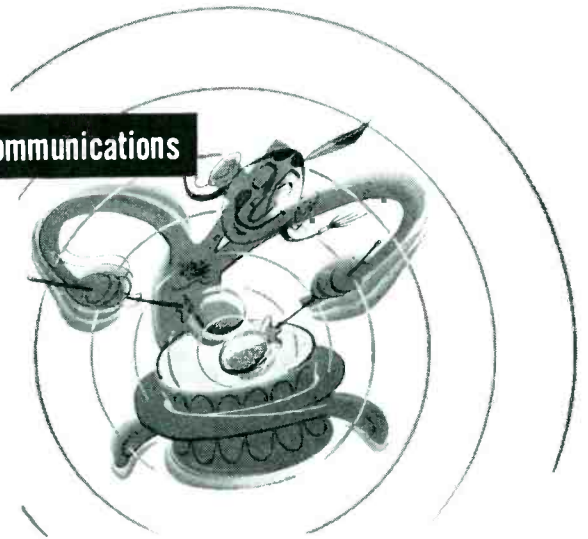

SANGAMO *Capacitors*



papers



micas



buttons



electrolytics



All approved for Armed
Services applications

Those who know...choose Sangamo
for every radio and
electronic application

SANGAMO Capacitors have been the choice of discriminating users for a quarter of a century. Radio servicemen, amateurs, electronic engineers, the Armed Services—all testify to the design, construction, honesty of characteristics, and conservativeness of ratings of Sangamo capacitors.

Television



Armed Services



**SANGAMO
ELECTRIC COMPANY**

MARION, ILLINOIS

IN CANADA

SANGAMO COMPANY LIMITED, LEASIDE, ONTARIO



* DF603

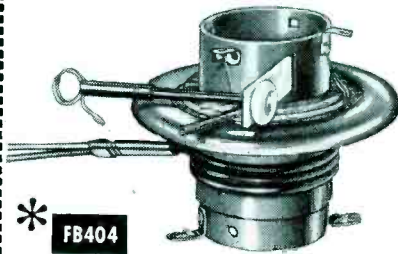

* FB404

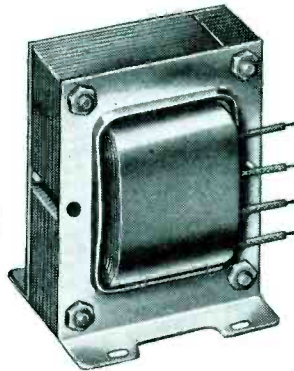
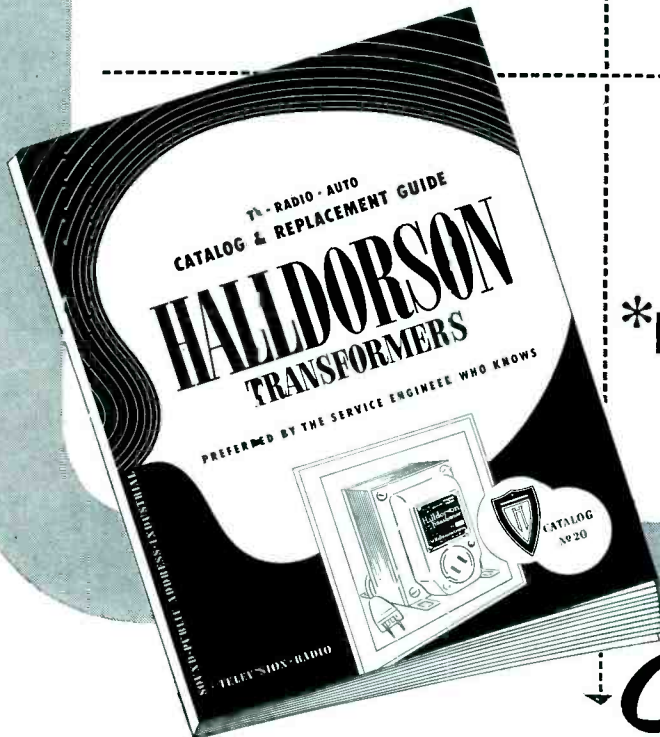

* Z1805

Completely New!

Transformer Catalog and TV Replacement Guide

Direct-Drive Components for Replacement in over Seventy Popular RCA, Emerson, and Capehart TV Models

- * **DF603** 70° cosine ferrite-core deflection yoke. Horizontal scanning coil, 30 MH. Vertical scanning coil, 3.5 MH. List price \$10.75
- * **FB404** High-voltage air-core flyback transformer to work with DF603 deflection yoke. List price \$7.00
- * **Z1805** Vertical output transformer to match vertical scanning coil of DF603 yoke. Turns ratio, 44:1. List price \$5.20

Halldorson's new catalog will become your constant companion. It has the components you need, well classified for easy selection.

This highly active line has been super-charged with 114 new items. Special attention is given to TV replacements. A self-contained guide section quickly tells you where they are used.

Here's extra value, too. Halldorson prices actually have been reduced, but Halldorson quality is even better than ever.

Don't be without this new catalog another minute. Pick up your free copy at your Halldorson distributor today—or write direct.

THE HALLDORSON COMPANY, DEPT. 523-S
4500 N. RAVENSWOOD AVENUE
CHICAGO 40, ILLINOIS



Halldorson
QUALITY *Transformers* SINCE 1913

New 1952 HEATHKITS

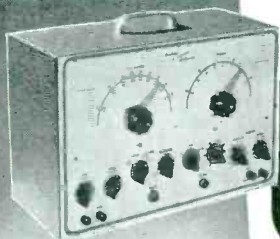

Heathkit TELEVISION GEN. KIT \$39.50



Heathkit ELECTRONIC SWITCH KIT \$19.50

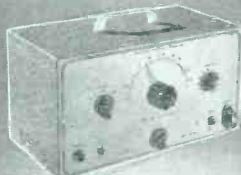

Heathkit AUDIO GEN. KIT \$34.50



Heathkit CONDENSER CHECKER KIT \$19.50

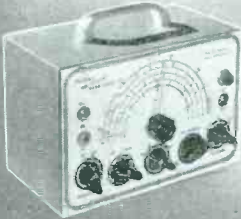

Heathkit R. F. SIGNAL GEN. KIT \$19.50



Heathkit A.C. VOLTMETER KIT \$29.50



Heathkit SQUARE WAVE GEN. KIT \$29.50



Heathkit INTERMODULATION ANALYZER KIT \$39.50



Heathkit AUDIO FREQ. METER KIT \$34.50

Heathkit 5" OSCILLOSCOPE KIT

- New "spot shape" control for spot adjustment — to give really sharp focusing.
- A total of ten tubes including CR tube and five miniatures.
- Cascaded vertical amplifiers followed by phase splitter and balanced push-pull deflection amplifiers.
- Greatly reduced retrace time.
- Step attenuated — frequency compensated — cathode follower vertical input.
- Low impedance vertical gain control for minimum distortion.
- New mounting of phase splitter and deflection amplifier tubes near CR tube base.
- Greatly simplified wiring layout.
- Increased frequency response — useful to 5 MC.
- Tremendous sensitivity .03 RMS per inch Vertical .6V RMS per inch Hor.
- Dual control in vernier sweep frequency circuit — smoother acting.
- Positive or negative peak internal synchronization.
- Multivibrator type Wide Range Sweep Generator.

A brand new 1952 Heathkit Oscilloscope Kit with a multitude of outstanding features and really excellent performance. A scope you'll truly like and certainly want to own.

The kit is complete with all parts including all tubes, power transformer, punched and formed chassis, etc. Detailed instruction manual makes assembly simple and clear — contains step-by-step instructions, pictorials, diagrams, schematic, circuit description and uses of scope. A truly outstanding value.

MODEL 0-7
SHIPPING WT. 24 LBS.

\$43.50



Heathkit VACUUM TUBE VOLTMETER KIT

- New styling — formd case for beauty.
- New truly compact size — Cabinet 4 1/8" deep x 4-1/16" wide x 7 3/8" high.
- Quality Simpson 200 microamp meter.
- New ohms battery holding clamp and spring clip — assurance of good electrical contact.
- Highest quality precision resistors in multiplier circuit.
- Calibrates on both AC and DC for maximum accuracy.
- Terrific coverage — Reads from 1/2V to 1000V AC, 1/2V to 1000V DC, and .1 to over 1 billion ohms resistance.
- Large, clearly marked meter scales indicate ohms, AC Volts, DC Volts, and DB — has zero set mark for FM alignment.
- New styling presents attractive and professional appearance.

The 1952 Model Heathkit Vacuum Tube Voltmeter! Newly designed cabinet combines style and beauty with compactness. Greatly reduced size to occupy a minimum of space on your work-bench. Covers a tremendous range of measurements and is easy to use. Uses only quality components including 1% precision resistors in multiplier circuit for greatest accuracy, Simpson 200 microamp meter with easy to read scales for fast and sure readings.

All parts come right with kit, and complete instruction manual makes assembly a cinch.

MODEL V-5
SHIPPING WT. 5 LBS.

\$24.50



YOU SAVE BY ORDERING DIRECT FROM MANUFACTURER

EXPOSURE
ROCKE INTERNATIONAL CORP.
13 E. 46 ST.
NEW YORK CITY (10)
C-111-B-148-N.Y.

The **HEATH COMPANY**

... BENTON HARBOR 11, MICHIGAN

PHONO NEEDLE REPLACEMENT IS

Buried Treasure...

ARE YOU GETTING YOUR SHARE?



Jensen NEEDLES

Mean extra profit on every service call!

HERE'S YOUR MARKET!

In the last two years, over 10 million phonographs have been manufactured in all three speeds. And today there are over 21 million turntables in use. Here's real "buried treasure"—replacing needles on all these phonographs *right now and at least once a year!*

GO AFTER THIS MARKET! Every phonograph owner . . . every record collector . . . should be told that needles must be changed at least once a year to save valuable and expensive records. You can do this on your regular TV or radio service calls if you take along a kit of Jensen Replacement Needles.

REPLACEMENT IS EASY! Average Jensen Needle replacement time is one minute. And Jensen's own JENSELECTOR quickly gives you exact needle replacement number for any record player without knowing model or cartridge number.



JENSEN—The Oldest Name in Sound Engineering

Jensen INDUSTRIES, INC.
331 South Wood St., Chicago 12, Ill.

Canadian Branch: Duplate Canada Ltd.
50 St. Clair Ave. West, Toronto 5, Canada
Export Sales: Scheel International, Inc.,
4237 Lincoln Ave., Chicago 18, Ill.
Cable: Harsheel

anybody can make claims... we back them up!



GUARANTEED PERFORMANCE OR YOUR MONEY BACK!

Yes, your money back if this booster does not give you as fine a picture as any booster on the market!

- (1) New, balanced input and output circuits for greatest gain. (2) Built-in power transformer (not AC-DC) with long-life selenium rectifier. (3) Utilizes finest turret tuner ever designed. (4) Fine tuning control. (5) Smart metal cabinet finished in wear-resisting mahogany enamel. (6) Pilot light illuminates selected channel.

TVB-2BX television booster \$39.95 list

See your nearest National distributor



Your dollar buys
more "instrument"
... in our Model



630

by **R. L. Triplett**
PRESIDENT

Because we build every major part of our instruments the quality is carefully controlled. For example, we know we have more torque driving our pointers because we designed and built the complete instrument. We know we have sustained dependence in the shafts and switch contacts of our test equipment for the same reason. Cycle tests for switches exceed several times the rigid requirements of the armed forces.

There is another important value to you. Because we make our own components we eliminate the profit another manufacturer would make in selling them to us. And this "profit" is passed on to you.

Consider these features of Model 630 V.O.M., for example—

One Hand Operation—One switch with large recessed knob has a single position setting for each reading. Leaves one hand free. Eliminates switching errors, trouble, saves time.

Ranges—AC-DC Volts: 3-12-60-300-1200-6000 (AC, 5000 Ohms/Volt; DC, 20,000 Ohms/Volt). 60 Micro-Amps. 1.2, 12, & 120 Mil Amps. DB scales at 1.73V on 500 Ohm line, 0-66 DB output.

Highest Ohm Reading—To 100 Meg. in steps of 1000-10,000-100,000 Ohms—100 Megohms.

Yes, with us it's a matter of personal pride to make "Triplett" stand for better construction and more service for your test equipment dollar.

R. L. Triplett

PRESIDENT

TRIPLETT ELECTRICAL INSTRUMENT CO.
Bluffton, Ohio

630
Model

Volt-Ohm-Mil-Ammeter

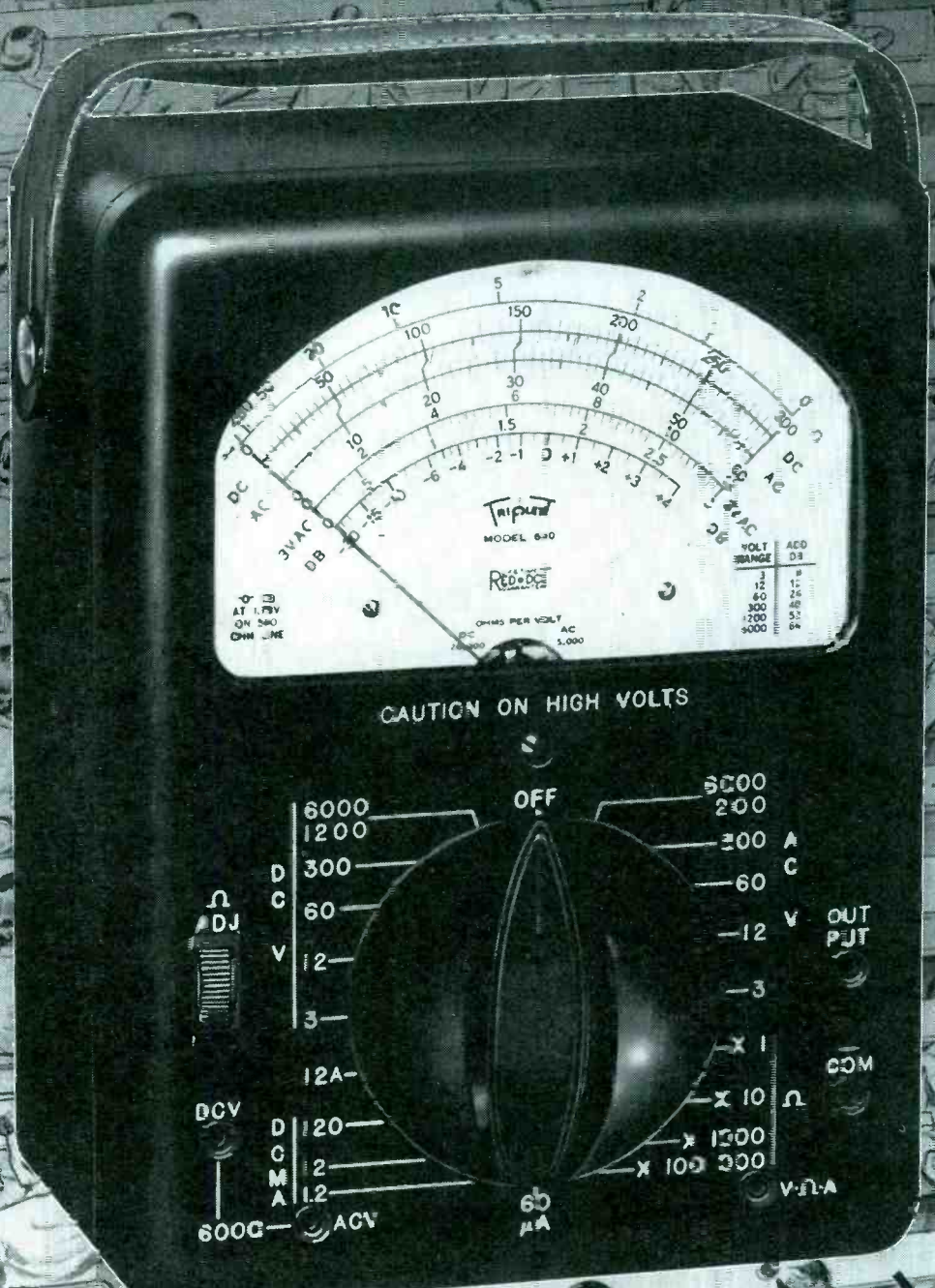

For service, accuracy, highest dependability, buy

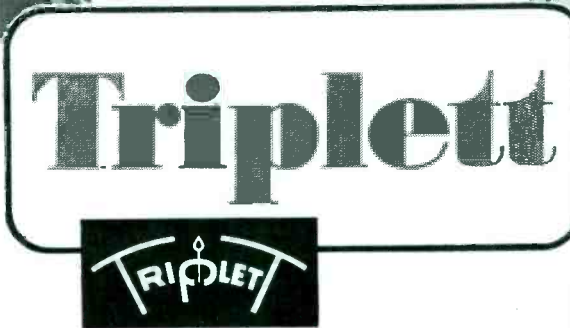

SAVE TUBES— WITH G.E.'S NEW



TUBESAVER

Says Al Mirus of Mirus TV Service Shop (left), 6579 Glenway Ave., Cincinnati, O.: "Our G-E Tubesavers do just what the name says. That's why we have one at every bench. A Tubesaver holds up to 52 tubes in their proper sequence, gripping the tubes so tightly they can't fall out. Built-in pin-straighteners help, too. The best and most practical device we've seen!"

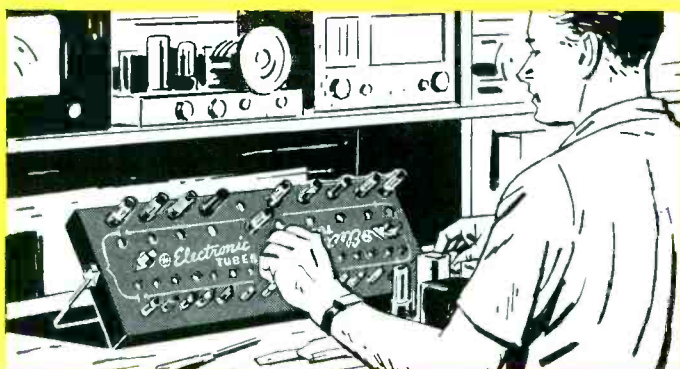

← **NO MORE WORRY ABOUT PUTTING TUBES BACK IN THE WRONG SOCKETS!...** The systematic layout of the G-E Tubesaver keeps tubes in their exact order. Moreover, they stay that way because rubber inserts keep them from dropping out—even if you tip the Tubesaver sharply! With its convenient handle design, the Tubesaver can be laid flat on the bench, angled, or hung on the wall nearby.

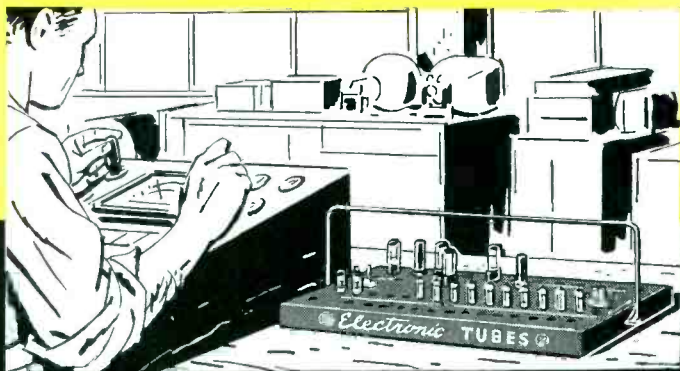

NOW YOU CAN TEST TUBES FAST AND ACCURATELY!... Place tubes in the inner holes of the G-E Tubesaver. Test them one-by-one. Put the good tubes in the outer set of holes, and return rejects to the inner set. Interruptions are no handicap—the Tubesaver keeps tubes correctly arranged till you resume work. In their proper order you now show the full tube complement of the receiver —

← which tubes are usable, which not!

**SEE YOUR G-E
TUBE DISTRIBUTOR
FOR FULL DETAILS!**

SAVE TIME- SERVICE AIDS!

PICTURE-TUBE CARRIER

Here's a practical aid that enables you to carry a cartoned picture tube safely and easily with one hand, leaving the other free for service equipment. Heavy canvas straps—quickly adjusted—hold the tube carton firmly. Rounded leather grip fits snugly in the hand. Blue and yellow colors are attractive. Save extra steps with this new convenience!

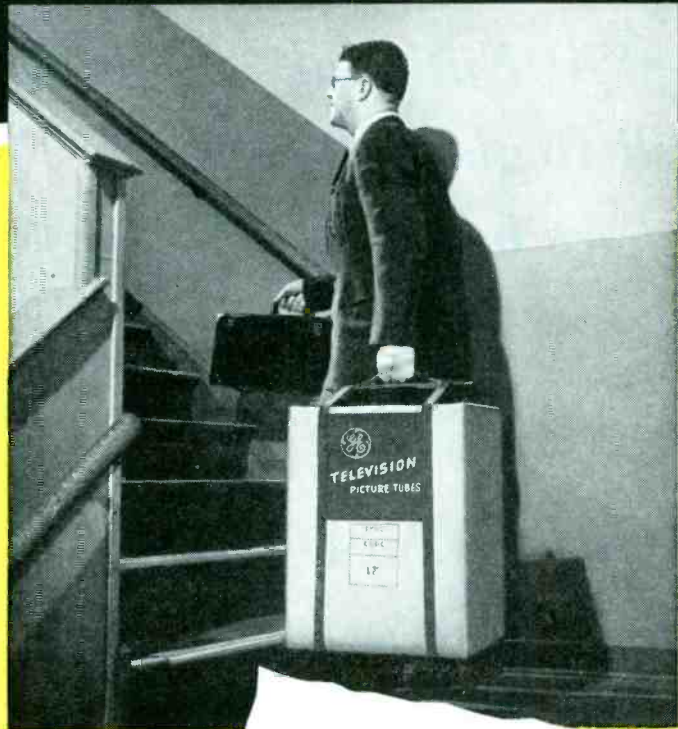

DROP-CLOTH

Use this handy G-E drop-cloth to cover fine rugs or cabinets. It's durably woven, with a soft texture that won't harm the most delicate surface. A plastic top coating takes hard wear, resists hot solder, can be wiped clean in a jiffy. Customers will appreciate your protecting their furnishings from dust, grime, and stray particles of metal!

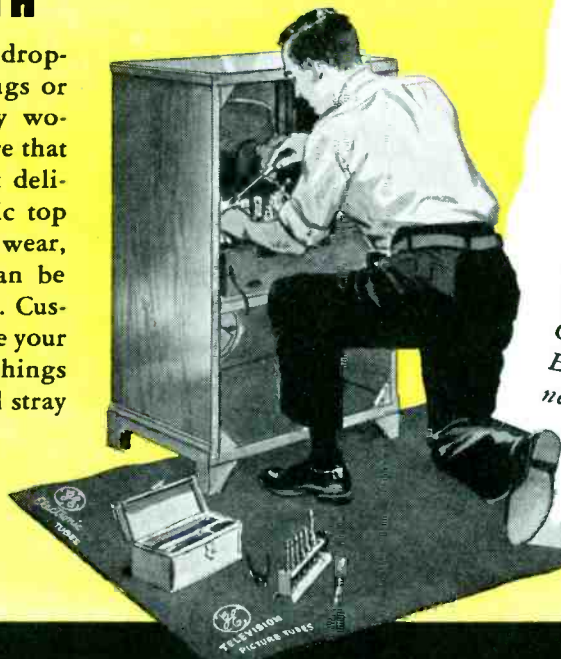

MAKE MORE CALLS PER DAY

... with these G-E-tube service aids! They cut time and costs, build customer goodwill. Your General Electric tube distributor will be glad to help you obtain them. Phone or write him today! General Electric Company, Electronics Division, Schenectady 5, New York.

161-1A1

You can put your confidence in—

GENERAL  ELECTRIC

*“At National
Cash Register
we believe . . .”*



STANLEY C. ALLYN

President, National Cash Register Company

“At National Cash Register we believe a thrifty employee is a better employee and a better citizen. By providing the Payroll Savings Plan for U. S. Defense Bonds we help our employees practice the thrift habit and build up a backlog of savings for their future security. By buying Bonds they become shareholders in their country.”

The employee who joins the Payroll Savings Plan becomes a man with an objective—a young fellow who realizes that the systematic purchase of Defense Bonds is a sure way to the down payment on a home . . . a father who wants to provide for Junior’s college education . . . an older man, with an eye to retirement and personal security.

The man with an objective is a better employee. He knows that a day lost from work is just that much out of his take-home savings. He doesn’t take chances—wants to stay off the accident list. He has a new realization that better work on his part will lead to advancement—and a larger monthly allotment for Defense Bonds.

The man with an objective is a better citizen, holds his head a little higher. He is buying a growing share in

America . . . helping to combat inflation . . . making a real contribution to the defense effort.

These employee and employer benefits of the Payroll Savings Plan are reflected in the records of thousands of companies. Figures show that as employee participation in a Payroll Savings Plan grows to 60%, 70% or higher, absenteeism decreases, the “Lost Time Accidents” curve goes down and production goes up.

If 60% or more of your employees are not Men With Objectives, do something about it. Phone, wire or write to Savings Bond Division, U. S. Treasury Department, Suite 700, Washington Building, Washington, D. C., and your State Director, Treasury Department, will show you how to install a Payroll Savings Plan, or how to build an existing Plan.

During 1951, over 1,500,000 employed men and women joined the Payroll Savings Plan.

The U.S. Government does not pay for this advertising. The Treasury Department thanks, for their patriotic donation, the Advertising Council and

S E R V I C E





A Compact, Versatile, Portable
Circuit-Testing Laboratory for
TV — FM — AM
The New
PRECISION
SERIES EV-20
VTVM and Multi-Range Test Set

Net Selling Price ... **\$68²⁵**

A Modern, Portable VTVM—Megohmmeter.
TRUE ZERO-CENTER on ALL VTVM ranges
PLUS Direct Peak Reading High Frequency Scales
ALSO, complete, standard 1000 ohms per volt functions
48 RANGES TO

1200 Volts*, 2000 Megohms, 12 Amperes, +63DB

* D.C.—VTVM ranges to 12,000 and 30,000 Volts when
used with Series TV Super-High Voltage Test Probe.

Range Specifications

- ★ SIX ALL-ZERO CENTER VTVM RANGES: —13½ Megs. Constant Input Resistance. ±3, ±12, ±30, ±120, ±300, ±1200 volts. Direct Reading to ±12 KV and ±30 KV with Series TV Super-High Voltage Test Probe
- ★ SIX SELF-CONTAINED OHMMETER-MEGOHM-METER RANGES: 0-2000 - 200,000 ohms. 0-2-20-200-2000 Megohms.
- ★ FOUR DIRECT READING HIGH FREQUENCY VTVM RANGES: 0-3-12-30-120 volts. (When used with RF-10A High Frequency Vacuum Tube Probe, Net Price \$14.40. No crystal rectifiers employed.)
- ★ SIX AC-DC AND OUTPUT VOLTAGE RANGES at 1000 ohms/volt. 0-3-12-30-120-300-1200 volts.
- ★ EIGHT D.C. CURRENT RANGES: 0-300 microamps. 0-1-2-3-12-30-120-1200 milliamps. 0-12 Amperes.
- ★ SIX DECIBEL RANGES from —20 to +63DB. Calibrated for 600 ohm, 1 mw., zero DB reference level.

IMPORTANT FEATURES

- ★ VOLTAGE REGULATED—BRIDGE CIRCUIT.
- ★ DIRECT READING. ALL ZERO-CENTER VTVM —indicates BOTH Polarity and Magnitude without switching or test lead reversal.
- ★ MASTER RANGE AND FUNCTION SELECTORS eliminate frequent and inefficient shifting of test leads.
- ★ SHIELDED CONNECTORS for both D.C.—VTVM and RF—VTVM. Permits simultaneous and non-interfering connection of both Circuit Isolating Test Probe and optional H.F. Vacuum Tube Probe Series RF—10A.
- ★ HI-FREQ. VOLTAGE SCALES—Direct Peak Reading.
- ★ DUAL-BALANCED ELECTRONIC BRIDGE OHMMETER—MEGOHMMETER uses two 1.5 volt flashlight cells easily replaced at rear of cabinet.
- ★ 1000 OHMS/VOLT MULTI-RANGE FUNCTIONS permit simple AC-DC voltage, DB and current measurements free of power line requirement.
- ★ 4½" RECTANGULAR METER—200 microamperes, ±2%. Double-Sapphired, D'Arsonval construction.
- ★ 1% Film type. Metallized and Wire-Wound resistors for all shunts and multipliers.
- ★ Heavy gauge, round-cornered, louvred steel case with plastic handle. Etched, anodized, aluminum panel.

NET SELLING PRICE \$68²⁵

Complete with coaxial Circuit Isolating Test Probe, Shielded Ohmmeter Test Cable, Standard #227 Super-Flex Test Leads, Ohmmeter battery and full operating instructions.

Case dimensions—10½" x 6¼" x 5"

Shipping Weight: 11 pounds.

CODE:—Party



Also ask to see the "Precision" Series EV-10A, DeLuxe VTVM—Megohmmeter with extra-large 7" meter. 59 self-contained ranges to 6000 volts and 70 DB. Series EV-10A, affords to the discriminating instrument purchaser, and equipment-conscious service-laboratory, the ultimate in visibility and performance.

EV-10A-P
(Closed portable)—\$97.25
EV-10A-MCP (Illustrated)
(Open Lab. Type)—\$94.50

See complete EV-10A specifications on page 4 of latest "Precision" catalog, available at leading radio equipment distributors or write directly to factory for full details.

PRECISION APPARATUS CO., INC.

92-27 Horace Harding Boulevard, Elmhurst 7, New York
Export Division: 458 Broadway, New York, U.S.A. • Cables—Marhanex

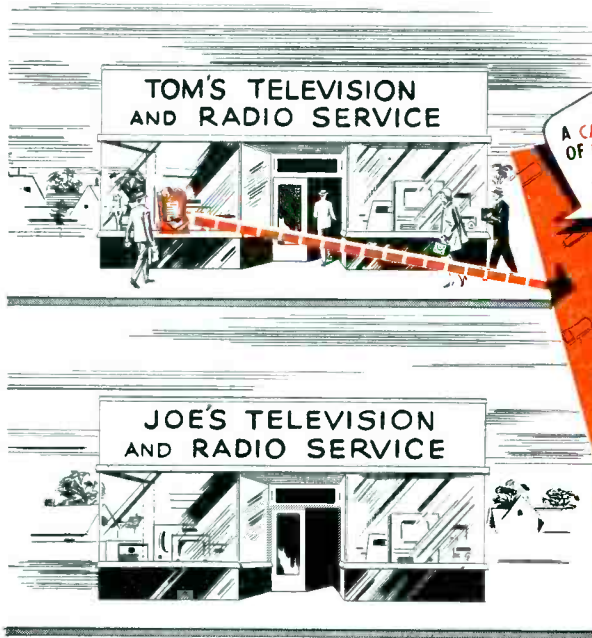

A CASH BOND OF PROTECTION
for You!

To Guarantee Efficient Dependable Television and Radio Repair Work

THIS REPAIR SHOP IS BONDDED...

- 1 Guarantee all radio and television repair work for 90 days.
- 2 Use only parts of recognized quality.
- 3 Charge not over established prices for parts.
- 4 Test customers' tubes as accurately as possible.
- 5 Keep labor charges at a reasonable level.
- 6 Perform only such work as is necessary.
- 7 Maintain proper equipment for good repair work.
- 8 Maintain high quality service.

RAYTHEON
Bonded
ELECTRONIC TECHNICIANS

Right... for Sound and Sight

"Here's why Tom gets my service business!"



Today's wary customers want to know *how you do business* as well as *how capable a technician you are*. That's why thousands of Radio and Television Service Dealers across the nation are discovering that, all other things being equal, their status as RAYTHEON Bonded Electronic Technicians tips the scales in their favor.

If you don't know how this exclusive Raytheon Bonded Program builds customer confidence and good will by cash-protecting your radio and television service 90-day guarantee, *at no cost to you*, you'd better get in touch with your Raytheon Tube Distributor. He'll be happy to tell you whether you can qualify for this important sales aid.



RIGHT... FOR SOUND AND SIGHT



RAYTHEON MANUFACTURING COMPANY

Receiving Tube Division

Newton, Mass., Chicago, Ill., Atlanta, Ga., Los Angeles, Calif.

RECEIVING AND PICTURE TUBES • RELIABLE SUBMINIATURE AND MINIATURE TUBES • GERMANIUM DIODES AND TRANSISTORS • RADIAC TUBES • MICROWAVE TUBES

Excellence in Electronics

RADIO • TELEVISION • ELECTRONIC
SERVICE

Musical Engineering Enters Audio Scene

AUDIO, which has streaked to striking popularity during the past few years, acquiring an evergrowing audience of enthusiasts, has also captured the interest of many outstanding scientists who have continually sought to effect improvements. One of the most active of these specialists, Dr. Harry F. Olson, who has contributed a stream of major developments, proclaimed a short while ago that audio has become so dominant a factor that it merited a thorough probe. A few weeks ago the results of such an investigation appeared in a book, entitled *Musical Engineering*, which will undoubtedly become a bible in industry.

Doc has analyzed each aspect of sound production, pickup and reproduction, from a physical, scientific and practical standpoint. *Musical engineering*, it was indicated, explains the properties of sound waves, and describes the various performance characteristics of musical instruments and the human voice, such as timbre, directional patterns, volume and frequency range, growth, decay and duration. Each of these problems were surveyed in relation to their reproduction in theatres, studios or living rooms.

Here is a text which everyone engaged in design, servicing, installation and selling will find extremely informative and helpful.

Booming New Market Areas

NEW BUSINESS OPPORTUNITIES in model communities now under construction, described in these columns a few months ago as racing ahead, have during the past few weeks become truly a roaring feature. In many communities throughout the country where industry expansion is at a peak, unparalleled possibilities have loomed.

In the critical defense area of Buck county, for instance, there is now under construction a complete city of 16,000 homes with provision for a

half-mile long shopping center, parking space for 5000 cars, and shop facilities for over 350 firms. It is expected that nearly a million dollars will be spent in this area for radio and TV receivers and accessories.

Many Service Men have begun to capitalize on the advantages offered in these new communities. In Long Island, for instance, where a town of 15,000 was established a short time ago, over a million dollars has been spent for chassis and allied gear, including installation and servicing.

Service Men appear to have before them more opportunities than ever before to build successful servicing businesses.

The Rebuilt Pix-Tube Dilemma

WHEN MONTHS AGO it appeared as if picture tubes would be scarce, many decided that the problem could be readily solved by rebuilding. A few introduced an effective service, but too many had and still have distorted views on the subject of rebuilding, and the results have been quite disastrous.

Not only have the flash rebuilders produced unsatisfactory tubes, but they have used every deceptive means to sell, often labeling the rebuild as a new item and fully guaranteed. The problem has become so acute that the Federal Trade Commission has included a set of strict rules in their new proposed trade-practice policy which would make it unlawful to identify rebuild as a new item. When the ruling becomes official, it will become imperative to indicate that the tube has been reconditioned, repaired or rebuilt, and it will become illegal to obliterate the original manufacturer's name and trademark from the product. It is expected that shipping cartons will also be identified properly, and the selling price will reflect the fact that the tube is a repaired item.

No one condemns the practice of repairing a tube, provided no attempt is made to assure a user that such a tube will provide the same maximum results as a thoroughly new tube that has

never seen service before. Several factors have been found to contribute to the difficulty of assuring perfect results with a rebuild. In the main, screen defects have been the cause of most picture-tube trouble. Usually, rebuilders will leave the original screen intact and simply replace the gun, reneck, and reprocess. The loss of light transmission in the glass faceplate has been found to be another acute problem. Even when a rebuild might reneck, rescreen, reexhaust and reprocess, the tube might not provide the same results as a new one because of the definite loss of light transmission in the glass faceplate, prompted by prior use. While the initial results might be satisfactory, it will be necessary to create a stronger beam current for the equivalent brightness of a new tube, and the cathode of the rebuild will have to work harder, with a resultant loss in tube life.

It is obvious, therefore, that tube rebuilding is quite a complex problem, and certainly not within the sphere of operations of a service shop or even a small tube plant who might not have the facilities for uniformly processing the tube and controlling their quality, or providing suitable glass inspection to prevent implosion, or adequate baking to outgas the tube.

If it does become necessary to provide a rebuilt tube because of type unavailability, the consumer should be told that the tube has been repaired and as such cannot provide the maximum efficiency which the tube was able to offer in its brand-new stage.

The Service Man's Responsibilities

Service Men can play a key role in keeping the public posted on what should be generally expected from a rebuilt picture tube, and how to identify a rebuild. It's an important assignment which no Service Man should shirk. Mr. and Mrs. Consumer will be extremely grateful for this valuable counsel.—L. W.

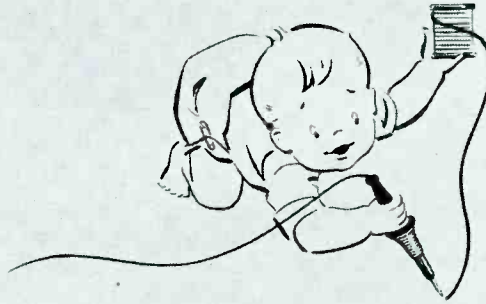

SO SIMPLE...

KESTER "RESIN-FIVE" CORE SOLDER

SO SIMPLE... to give good service



- Non-corrosive and non-conductive... in diameters of $\frac{3}{32}$ ", $\frac{1}{16}$ " and smaller.

KESTER'S "Resin-Five" Core Solder has long enjoyed the greatest popularity as the best solder for all electronic work, radio and TV. That's because it was originally developed to save you time and money... the right combination of tin and lead — flux, too — to simplify and speed up your work. And it's true also of Kester's companion product, Plastic Rosin-Core Solder. Choose either one... and you have the best!

Your Jobber has Kester. Tell him you want "Resin-Five" or "Plastic Rosin"... both genuine Kester Solders. You'll be glad you did!

KESTER SOLDER COMPANY
4248 Wrightwood Ave., Chicago 39
Newark 5, New Jersey • Brantford, Canada

**KESTER
SOLDER**

SERVICE... The National Scene

DEMAND FOR EIGHT TO ELEVEN-MILLION TV ANTENNAS PREDICTED--This year should see a market for from 8-11 million TV antennas, according to members of the Antenna Manufacturers Industry Advisory Committee, who met recently in Washington with NPA to discuss antenna material requirements. It was estimated that this quantity of antennas would be needed to accommodate the 4 to 5-million sets installed before '50, and the new receivers that are being installed and will probably be sold before the year is over. The growing popularity of fringe TV, where two to five-bay antennas are required, was also cited as another factor in setting the anticipated demand. . . . Discussing the material needs, committee members pointed out that industry had displayed extreme ingenuity in finding alternates for scarce aluminum and copper, the substitutes including wood masts and cross bars (silver painted or incorporating a conductive element), plastics, fiber-glas rods and steel. Many extremely effective designs have been involved using these alternate materials, it was said.

INDUSTRY RECEIVES SELENIUM ALLOCATION INCREASE--Operation of selenium rectifier plants, many of which were on the verge of a virtual shutdown a few weeks ago because of a short supply of the precious metal, has now been assured by an allocation of about 25,000 pounds, which will permit continuing production. In commenting on this allocation, NPA reported that the increased amount was made possible by reducing producer's stocks and including the third of production held back in February to build up inventories. It was also disclosed that a source of supply has been developed in recent months from selenium received from defective and scrap rectifier plates. It was said, too, that reclaimed selenium from this source, reportedly of good quality, is being imported by rectifier manufacturers in this country. Refined selenium is also being received from Canada, industry members disclosed. April supplies of selenium for the rectifier industry may be increased by about 6500 pounds of commercial grade, made available for refinement to a high purity grade. It was hoped that it would be possible to continue supplying rectifier manufacturers with sufficient quantities of the rare element selenium (obtained as a by-product of copper smelting and refining), so that rectifier manufacture will be able to produce cells on an equitable basis.

TRADE PRACTICE RULES APPROVED BY INDUSTRY ASSOCIATIONS--The stern FTC trade practice rules, detailing procedures which all will be obliged to follow in advertising and selling, under consideration for nearly a year, have now been generally approved by RTMA, NARDA and NEDA, and should become a government-approved procedure very soon. Many stringent regulations will have to be followed when these rules go into effect. For instance, manufacturers will be obliged to avoid any deceptive description of the size of the actual viewable picture. In detailing the number of tubes used in any type of receiving equipment, it will be necessary, according to the new regulations, to avoid and prevent any misleading references to the number, through the inclusion of ballast tubes or rectifiers. It will not be possible for advertisements to state that any AM receiver can bring in foreign or domestic stations with sharp, clear or distinct reception, or with ease, simplicity or regularity, unless such claims can be completely supported. Other problems covered by the new regulations include the proper identification of converters or adapters, truthful representation of the capabilities of indoor and outdoor antennas, as well as the reproducing properties of TV receivers, particularly for color or black and white.

SERVICE...The National Scene

RTMA DENOUNCES TV HOME-REPAIR BOOK ADS--The roaring TV fix-it-yourself book advertisements, appearing in the general press and popular magazines, have been sharply criticized by the Radio-Television Manufacturers Association's service committee. According to Albert Coumont, who heads the service committee for the association, most of these texts have . . . "inconsequential technical value." He noted that the ads contained . . . "misleading and untrue statements . . . belittling the need for specialized skills in servicing TV receivers, as well as the implications that Service Men were incompetent and fraudulent." Coumont urged members of RTMA's service committee to issue strong protests against these advertisements, and enlist the help of local BBBs, manufacturers and service groups to aid in the drive.

BARGAIN RATES SCORED BY CAPITOL SERVICE MEN--A driving campaign to combat the misleading \$1.98-2.98 service call advertisements now appearing in newspapers in Washington, D. C., has been initiated by a group of Service Men. Several firms have contributed to a general fund for the drive which may take the form of newspaper copy. The Service Men report that these bargain-price operators use the low-service charge as bait, and actually charge excessive fees for routine repairs. This worthy move merits the praise of everyone in the servicing industry.

NETSDA REELECTS LIEBOWITZ PREXY--Max Liebowitz, president of the Associated Radio-Television Servicemen of New York, has been reelected president of the National Electronic Technicians and Service Dealers Associations. Other officers elected for '52 include: Roger Haines, vice president; Richard G. Devaney, recording secretary; David VanNest, corresponding secretary; T. L. Clarkson, treasurer; and John Wheaton, sergeant-at-arms.

ULTRAHIGH TUNERS NOW ON PRODUCTION LINE--In anticipation of the freeze lift and the allocation of channels for the new ultrahigh band, many accessory and receiver manufacturers have set up production lines for tuners, converters, and even front ends. One setmaker in Chicago has announced that his uhf tuners are now in volume production, and that they will be installed at the factory as optional equipment on new receivers for \$29.95, and will also be available for field installation for a total cost of \$39.95, allowing a \$10 charge for installation. Within the next few weeks, it is expected that most manufacturers will announce their plans for factory and field installations.

SETMAKER TO ROUTE DISTRIBUTOR CHASSIS SERVICING TO SERVICE MEN--Within the next few weeks, one of the largest receiver manufacturers will discontinue his distributor servicing department and direct all calls to local Service Men. In explaining this plan, the set producer said that it has been found that independent Service Men can render a highly effective service, which will not only be completely acceptable to consumers, but conducive to an improved relationship with the factory. It was pointed out that the distributor should not maintain service facilities which would be in competition with independent Service Men. To support this move, this manufacturer also announced that it will supply Service Men with continued educational training, technical information, and shop and clinic assistance. It was also indicated that dealers will receive the names of independent service shops who are in a position to handle the dealer's service requirements in an efficient and capable manner. Several other manufacturers have indicated that they might follow this same course, a move which all Service Men will applaud loudly.--L. W.

Rauland—the Original

LOW FOCUS VOLTAGE ELECTROSTATIC TUBE

**Perfected in Rauland Electronics Laboratories,
this tube that gives edge-to-edge sharpness of focus
without coils and magnets is proved and ready
as the materials pinch becomes painful**

BETTER in all ways! Gives better over-all focus—hair-line sharpness from edge-to-edge—with NO critical materials for focusing . . . and **STAYS SHARP** under considerable variation in line voltages.

REQUIRES NO re-engineering of present television chassis . . . NO added high voltage focus circuit . . . NO added receiver tubes . . . NO additional components except an inexpensive potentiometer or resistor.

FOCUSES by using D.C. voltage already available in the receiver.

ELIMINATES focusing coils and magnets . . . saves critically scarce copper and cobalt.

• • •

This new Rauland development is now available in substantial quantities in 17 and 20 inch rectangular tubes. For further information, address . . .

THE RAULAND CORPORATION



Perfection Through Research

4245 N. KNOX AVENUE • CHICAGO 41, ILLINOIS



The Stratford, Conn.

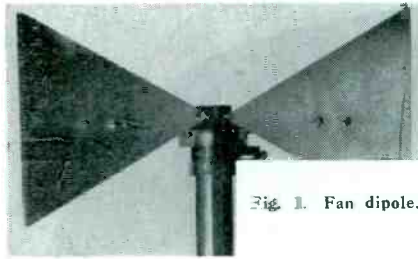

Fig. 1. Fan dipole.

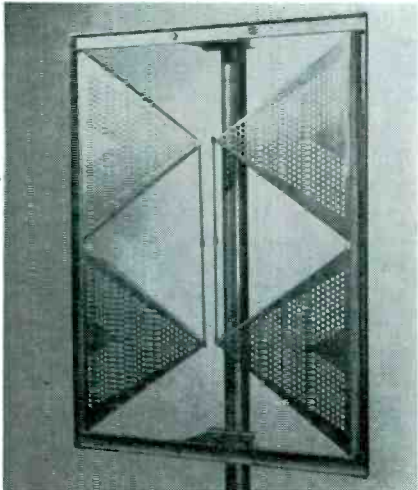

Fig. 2. Two-stacked fan dipole.

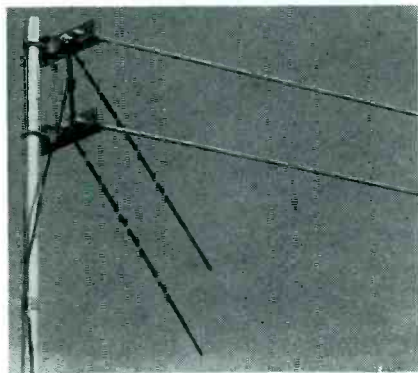

Fig. 3. Stacked V antenna.

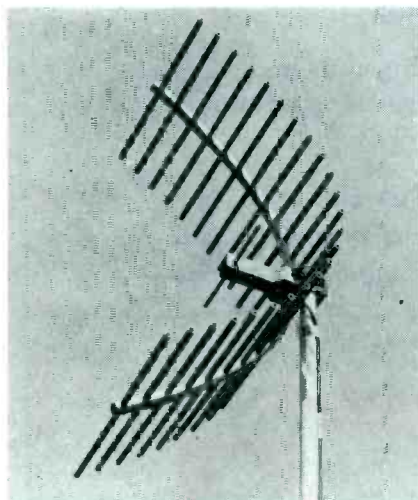

Fig. 4. Parabolic reflector type of antenna used at *uhf*.

THE RAPID GROWTH of the television industry, during the past few years, has created a need for additional channels. To meet that need, the FCC has proposed the allocation of spectrum space in the *uhf* region for over 2,000 stations throughout the country on channels 14 to 83, covering the 470 to 890-mc band.

It has been found that the existing 108 *vhf* stations can provide television for only 60 per cent of the nation's population, with a limited number of stations in any one given area. Therefore, the proposed *uhf* allocations are necessary to the industry and to the public if the full TV potential of the country is to be realized.

A great deal of thought and planning has been devoted to *upstairs television* by the FCC and industry, and both are continuing their work to make sure that manufacturers, broadcasters, and Service Men will be prepared for *uhf* operation.

Long before the FCC proposal to allocate channels in the *uhf* region for commercial television, an extensive *uhf* test and experimental program was initiated. These studies began in July, '46, when experimental transmissions and tests were conducted in New York at 288, 510, and 910 mc. In September, '48, equipment was made available and tested in Washington, D. C., at 504-510 mc.

After the Washington tests, the *uhf* project was moved to Stratford, near Bridgeport, Conn. Tests were made at this location at 530 mc, and are continuing at 850 mc.

Development of UHF

The Stratford station, KC2XAK, was set up to operate on 529 to 535 mc with an effective radiated power of 13.9 kw. The transmitting antenna was placed 250 feet above the ground. Because this station was intended to represent a typical broadcast operation, such as might be located in the future in many American cities, its planning, construction, and operation were patterned to conform to the routine established for commercial *vhf* stations.

The format featured relaying of program material to the Stratford station via a 2000-mc relay link from WNBT, in New York City. Consistent transmitter operation has been maintained on this program material for approximately 340 hours per month, throughout the year.

With these *uhf* facilities, extensive field tests were undertaken to check

transmitting and receiver antenna characteristics, receiver installation problems, effects of terrain and foliage, effects of weather, ground propagation, *uhf* receiver converters, transmission lines, and many other factors.

UHF Antennas

To date, numerous antennas with commercial possibilities in *uhf* have been designed and tested.† There has been selected a group of antennas that will handle many of the special requirements of *uhf* reception. Here, as in *vhf*, antenna problems must be weighed carefully. Such things as gain, directivity, installation time, wind and ice loading, cost and other factors must be considered.

Since wavelengths in the *uhf* band are much shorter than those in the currently operating *vhf* channels, antenna types which were previously deemed impractical warranted reconsideration. Such types as the rhombic, stacked rhombic, parabolic, helix, corner reflector, fan dipole and endfire broadside antennas, heretofore considered only by the dyed-in-the-wool television DX enthusiasts, were found to have very evident UHF possibilities. Familiar antennas such as the half-wave dipole, V type, and yagi have also been considered.

Specific Antenna Types

Indoor antennas of the built-in and cabinet-top types have proved to be generally less satisfactory for fringe area use than outdoor antennas. A person moving or standing near the indoor antenna may cause a serious momentary effect on the picture quality. Venetian blinds, awnings, and similar objects also affect the signal received with indoor antennas. Thus, the tests revolved about the relative advantages of several types of outdoor antennas.

The Fan Dipole

One of the antennas tested was the fan dipole whose characteristics are similar to a *uhf* half-wave dipole, with almost unity gain and a nearly bidirectional *figure eight* directivity pattern. It was found to be light in

†Designs and checks by RCA engineers in conjunction with RCA Service Co.

*In the antennas analyses, all standards of comparison, such as maximum usable range, were based on the power output and antenna height of the Stratford experimental station. These are considerably lower than the maximum allowable power and antenna height specified by the FCC.

UHF TV TESTS

by **RUSSELL J. HALL**

RCA Service Company, Inc.

Resume of Results of Studies Undertaken to Check Receiver Antenna Characteristics, Installation Problems, Effects of Terrain, Foliage and Weather, Ground Propagation, Converters, and Transmission Lines.

weight, easy to construct and offered an orderly appearance desirable for roof installation. Its limited gain and directivity, however, was found to restrict its use to strong, relatively ghost-free signal areas within a short distance of the transmitter.

Two-Stacked Fan Dipole

The double fan antenna was also tried. It naturally, has a greater usable range than the single fan. There has been completed production design work on a single metal stamping for this type of antenna which shows definite possibilities. This antenna is low in initial cost, easy to install, and compact in design, and has higher gain and better directivity, than the single fan.

The Stacked V

Also studied was a stacked V antenna. This type was found to have a gain of 5.7 db over a reference tuned dipole at 500 mc. This antenna was also found to be comparatively low in cost, less critical as to placement and orientation than those previously described, and with a considerably greater range. Although more costly from an installation viewpoint, it has shown good possibilities as a combination *uhf-uhf* antenna. Each element of the antenna is two full wavelengths up to 500 mc and resonant as a half-

Types	Impedance	Losses (db/100')	
		200 mc	500 mc
Flat twin	280	1.6	2.5
Tubular twin ..	280	1.5	2.5
Twinex (braid shield)	220	4.5	7.2
Twinex (foil shield)	220	3.75	6.2
RG59/U coax ..	75	5.6	9.3

Fig. 5
Recapitulation of characteristics of five types of leadins.

wave dipole cut for the low end of the *uhf* band.

Considerable experimenting has been done with rhombic antennas, usually two or more wavelengths to a side. The rhombic exhibited good directivity and gain, a very sharp horizontal directivity pattern, and proved efficient in eliminating ghosts. It was found more costly to build and install than some other types tested, however, and less attractive in appearance.

The Parabolic Reflector Antenna

The parabolic antenna proved to have the highest gain (7.5 db over a resonant dipole) with a very sharp vertical directivity pattern. The horizontal directivity is very broad, and for this reason the antenna is not the best for eliminating ghosts. In some instances the parabolic antenna has been out-performed by a stacked V with a larger aperture. The principle of this antenna is good, although it is heavy and cumbersome to install.

In the modified form illustrated, this antenna has been applied to excellent advantage, inexpensively and efficiently.

The Corner Reflector Antenna

The corner reflector antenna, also studied, was found to have characteristics very similar to the parabolic reflector, with a slightly lower gain of 6.5 db. This antenna was found to be a little easier and less expensive to manufacture than the parabolic; problems of wind and ice loading, weight, and similar factors have been overcome to a great extent. Service range is excellent, and it is likely to be one of the first types put into commercial service.

The Helix Antenna

The helical antenna was considered during the tests because of its excel-

(Continued on page 53)

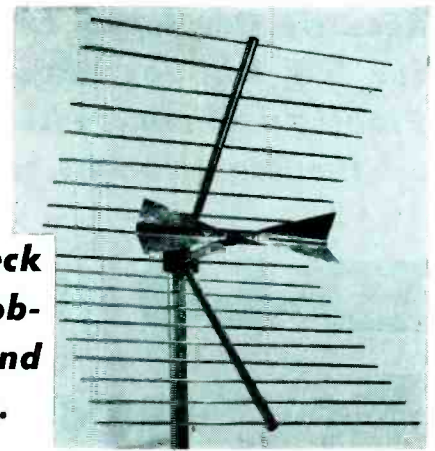

Fig. 6. Corner reflector antenna.

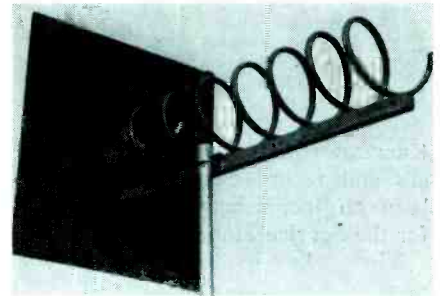

Fig. 7. Helix type of antenna tested at *uhf*.



Fig. 8. A six-element yagi probed during the *uhf* tests.

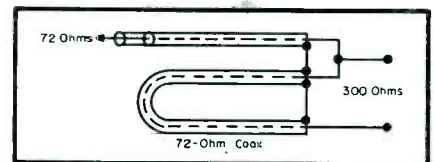

Fig. 9. Circuit of balun, used as a matching section, which performs dual function of matching 300-ohm to 72-ohm impedance and unbalanced coax line to balanced antenna.

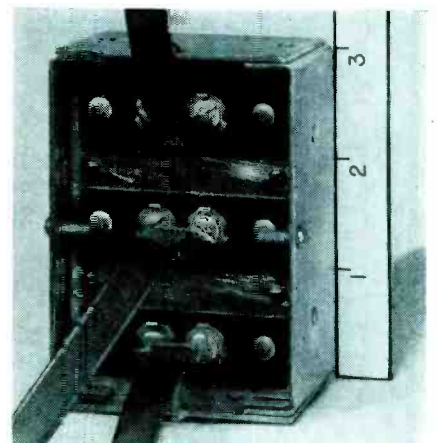

Fig. 10. A crossover network, which can be used for separate *uhf* and *vhf* antennas; center terminals connect to converter or receiver.

Recently Developed Two-Output Universal Cartridges for 78 Phonos, Found to Minimize Inventory Problems, Eliminate Repeat Calls and Efficiently Meet the Requirements of Most Reproducer Systems.

HI-LO OUTPUT 78 RPM Replacement Cartridges

by **J. G. HASKELL**

Webster Electric Company

KEEPING THE OWNERS of record players and record changers happy has been an increasingly perplexing job for the Service Man in recent years.

Time takes its toll and more and more of the older phono sets are calling for repair work. Introduction of the various new types of multi-speed players has added a further element of confusion in the servicing field, just at a time when Service Men are swamped with the demands of the still newer and rapidly expanding TV service problem.

Then, of course, there is the manpower problem. The days when Service Men could pick up a likely looking high school graduate and develop him into a valuable repair assistant are gone, at least for the time being.

Uncle Sam gets the first crack at him. So it is that Service Men are face to face with these repair problems with a definite dearth of experienced help.

As all of us realize, the crystal cartridge in a record player or record changer should be replaced periodically.

It has been found that the average life of a crystal cartridge is from three to five years. Its performance is affected by extreme variations in temperature and its life expectancy is shortened by exposure to extremely humid or extremely dry atmospheres which prevail in certain sections of the country.

The greatest demand for the replacement of these crystal cartridges comes from the owners of the older 78

rpm changers. This is because the greater part of the 33 $\frac{1}{3}$ and the 45 changers in service have not been in service long enough to require many cartridge replacements.

While there is much pressure today on owners to replace the one-speed 78 changers with the newer, all-speed players, there still remains an estimated 10,000,000 owners of the older sets. Many of these have built up highly-prized libraries of 78 records and are well satisfied with their present machines and willing to pay for their repair.

This brings us to the reason why manufacturers of replacement crystal cartridges are so concerned with the replacement problem and what they are doing in the way of developing new cartridges to enable the Service Man to profit from the enormous market for replacement of cartridges in the 78 changers.

The greatest deterrent to profits in this field, of course, has been the necessity of replacing an inoperative cartridge with one of the same manufacture and with the exact model number of the original cartridge. Service Men could not be expected to carry some 200 or more different types of cartridges with him. Accordingly, it was often necessary to make two calls for a small dollar unit sale. Often, hours were spent hunting for the exact model cartridge for a particular job.

A study of the problem revealed that the large over-all volume of replacements involved only two categories: high output and low output with standard RTMA $\frac{1}{2}$ " mounting. While there are still some special cartridges which must be replaced exactly,

Possible output connections for a dual-output replacement cartridge.

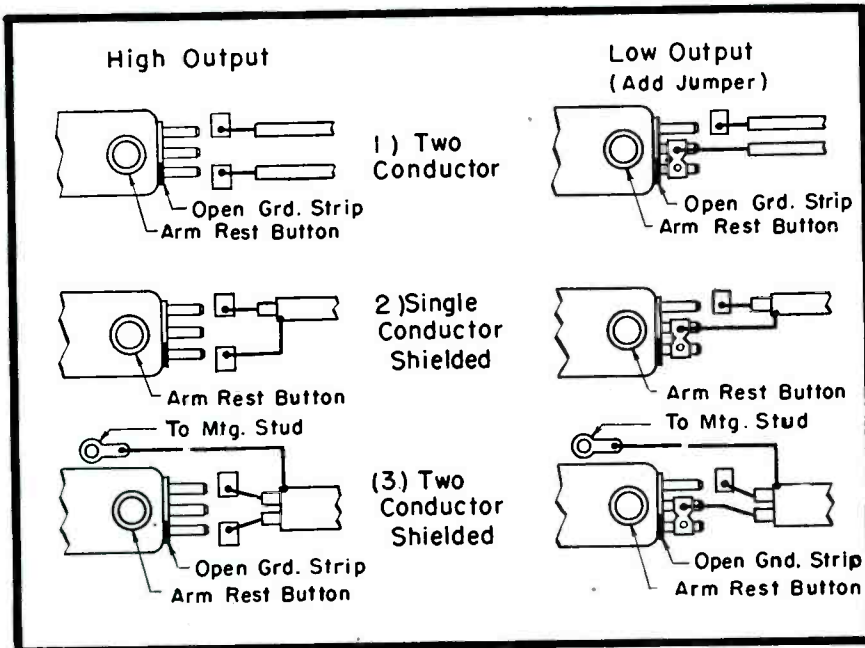

(Continued on page 58)

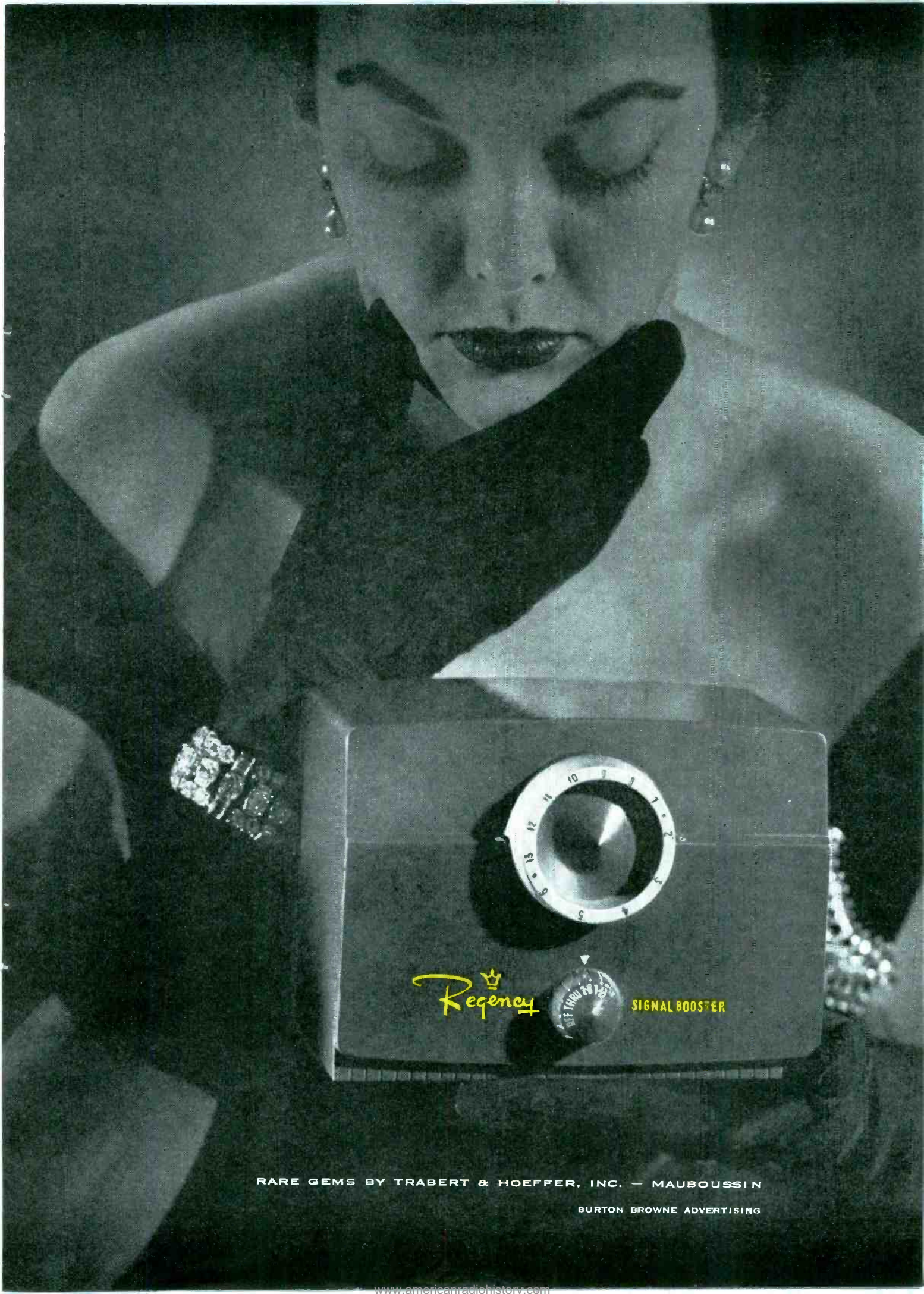

RARE GEMS BY TRABERT & HOEFFER, INC. — MAUBOUSSIN

BURTON BROWNE ADVERTISING

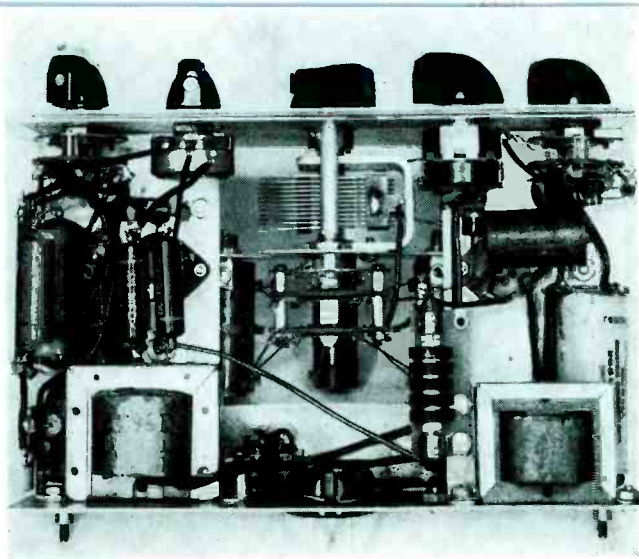
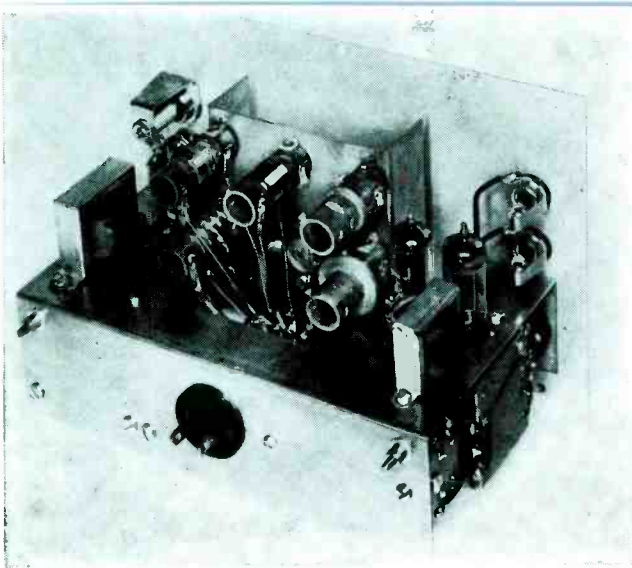

Improving SIGNAL-

MANY OF THE SMALLER signal generators which normally are two-tube affairs, with a Colpitts *af* oscillator modulating a Hartley *rf* oscillator, and usually equipped with a range switch and multiple tank coils, perform quite well insofar as the *rf* output and calibration are concerned, but are unsatisfactory in their overall performance; usually the deficiencies involve hum, poor regulation, low percentage of modulation, asymmetrical modulation, *rf* riders on the *af* output, and shift of the *rf* frequency when the modulation is switched on and off.

Typical Generator Circuit

A typical circuit of such a small signal generator, less switching arrangements appears in Fig. 1. It will be seen that the device comprises a perfectly workable *rf* oscillator, which is plate modulated by a reasonably good *af* oscillator, and a power supply, which is usually under-filtered. Many

generators of this general type have only 15-25 per cent modulation.

Power Supply Difficulties

Most power supplies for small signal generators consist of a half-wave rectifier, followed by a pi-section *rc* filter; Fig. 2*a*. Replacement of the resistor by a choke having a higher reactance at 60 cycles and a lower ohmic value will automatically reduce hum and raise output voltage. This change is shown in *b*. To compute the inductance, the following formula, for the reactance of a choke, can be used: $X_L = 2\pi fL$. For the choke to cause a reduction in ripple, its inductance, in henries, must exceed the resistance it replaces divided by 377. Thus, a choke of from 8 to 15 henries, with a carrying capacity of 20 or more milliamperes[‡] will usually be adequate.

[‡]Such as Thordarson T20C53 or Stancor C1003 or C1708.

Fig. 2. In *a* appears a typical power supply, a half-wave unit, used in a signal generator. To reduce hum and raise output voltage, a choke having a higher reactance at 60 cps and lower ohmic value, can be used as shown in *b*.

Modulation System Improvement

Improvement of the modulation system is somewhat more difficult, as there just isn't enough *af* power in the output of the *af* oscillator to plate modulate the *rf* oscillator to a reasonably high percentage. Grid modulation would be an easy solution for the low frequency ranges of the oscillator, but this introduces so much capacity to ground that the higher frequency ranges of the signal generator would be impaired by its use.

Three Solutions

Three related workable solutions to this problem are shown in Fig. 3. All require an additional *af* stage, but all will give clean modulation up to 80 per cent, and distorted modulation to higher values.

The Modulator Circuit

The complete modulator circuit consists of an *af* oscillator, an amplifier, and a coupling device. This, with choke

Fig. 1. Circuit of a typical signal generator. Switching arrangements are not shown.

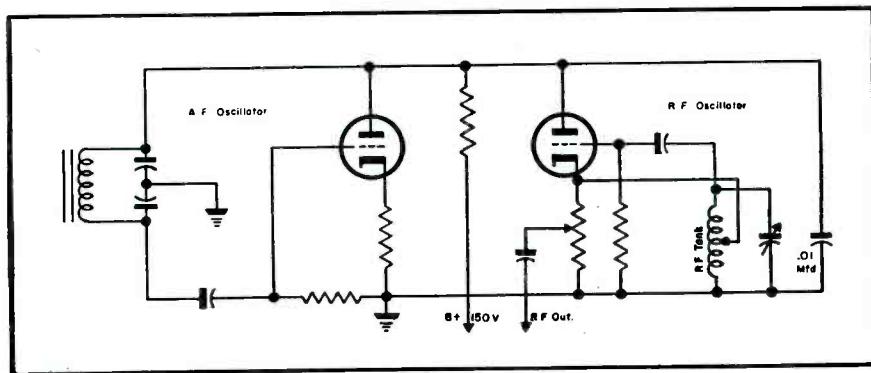
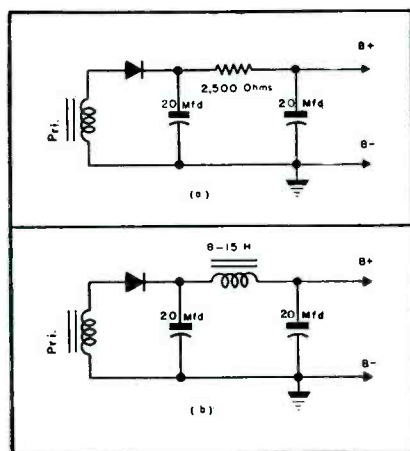

Left: Top and bottom views of modified signal generator. Top view shows added pentode and filter choke. In the underside view appears the added *af* and *rf* chokes. It will be noted that the additions have not complicated the chassis layout. To remove the nuisance of a dangling cord, provision has also been made for an *ac* male plug at the rear of chassis.

Circuitry Alterations Included in Typical Signal Generator Serves to Minimize Hum, Increase Output Voltage and Improve the Modulation System So That It Can Be Varied from 0 to About 80 Per Cent At Will With Clean Waveforms. Overmodulation Can Also Be Produced If Desired.

GENERATOR Performance

by RONALD L. IVES

coupling to the *rf* oscillator, is shown in *a*. The coupling choke should have a minimum value of about 5 henries, and a carrying capacity of about 15 milliamperes. Many small filter chokes perform well in this position, but a few of the cheaper *ac-dc* chokes have a peculiar flyback characteristic which often messes up the *af* waveform.

Coupling Devices

Coupling to the *rf* oscillator is from the plate of the *af* amplifier to the plate of the *rf* oscillator through an *rf* choke, which keeps *rf* out of the *af* system.

Alternative Outputs

Alternative output devices include a tapped choke, which may be the primary of a push-pull output transformer (Fig. 3*b*), and a small stepup transformer (Fig. 3*c*). Both of these outputs give an appreciable voltage stepup, so that undistorted modulation closely approaching 100 per cent is possible at medium settings of the *af* volume control, and extreme overmodulation can be produced at will, by turning up the volume control. Choke coupling is not only the simplest

and cheapest method, but is entirely adequate for most service and experimental work.

former of adequate capacity is substituted.

Modified Generator Features

Pentode AF Stage Problems

Addition of a pentode *af* amplifier stage places an additional load on the power supply of the signal generator amounting to .15 ampere at 6.3 volts (filament) and about 15 ma at 150 volts (plate and screen). Unless the power transformer in the original signal generator will carry this added load, there is little point in making these improvements, unless a trans-

When modified, the signal generator will produce all the *rf* output that it did originally, or a little more, with less hum. It will be found that modulation can now be varied from 0 to about 80 per cent at will, with clean waveforms, and overmodulation can be produced if desired. *AF* output, at oscillator frequency, can be produced at any power level desired from zero to about 1 watt, the load having no effect on the frequency.

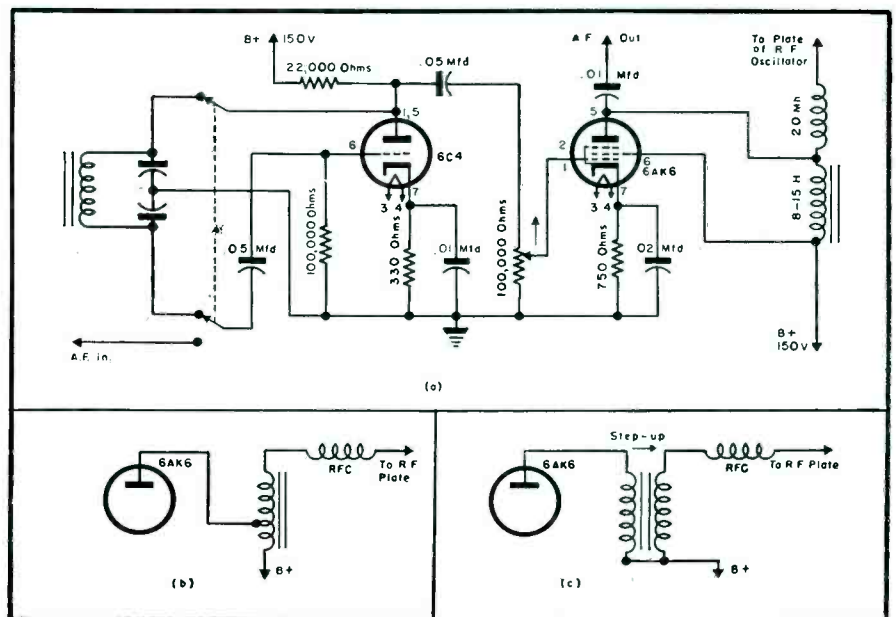

Fig. 3. Improved *af* modulation circuits. In *a* appears a complete modulator circuit which has an *af* oscillator, amplifier and a coupling device. System using choke coupling to the *rf* oscillator is shown here. In *b* and *c* appear alternative output devices which include a tapped choke and small stepup transformer.

AUDIO installation and service

Phono-Tape-Wire-PA-Amplifiers-Speakers

by KENNETH STEWART

Bias-Recording Current and Gain, and Distortion Checks in Magnetic Tape Equipment . . . Design Features of Tape-Phono Units . . . Tape Recorder Service Hints . . . Binaural Systems.

IN TESTING the operation of magnetic tape equipment, there are several unusual checks that must be made.

As an example, it is particularly important to check bias current. To illustrate, in the Ampro 731 tape unit (Fig. 1), this can be done by disconnecting the grounded lead from the recording head at a *play-record* switch, and switch to *record* position. Then a *dc* microammeter should be inserted and a check for current made if current exceeds 1 microampere; the .003-mfd capacitor in the plate circuit of the 6AQ5 should be replaced. The bias

current should then be measured by inserting a 20 ohm non-inductive (or carbon) resistor between the recording head lead and the switch terminal from which it was disconnected and a vtvm connected across the resistor. The bias current will produce .015 volt \pm 10%. Voltages are also subject to the same tolerance as the specific resistor being used in the test circuit. If the current is not within the limits specified, the oscillator and associated resistors and capacitors must be checked. If component values are correct, then plate and grid leads of the 6AQ5

should be pushed together to reduce current or separated to increase current.

Recording current should also be checked. Either lead from the oscillator coil must be disconnected to stop the oscillator. An audio oscillator should be connected to the input jack. The *play-record* switch should then be placed in the *mic* position and the *volume-control* should then be set to the maximum clockwise position; the audio oscillator for 400 cps and the output adjusted so that the neon flashes faintly; *not a sustained glow*. A vtvm and a 20-ohm resistor, when connected as previously described, will indicate .001-.002 volt (plus or minus tolerance on resistor). The waveform, when viewed on a scope connected across a 3-ohm resistor in the record-listen switch circuit will be free from distortion. If the current is not correct, it will be necessary to change the neons, supplied as a matched and aged set, and recheck. If current is low the oscillator level should be increased to produce proper current and waveform checked. If wave is free from distortion, all resistors and capacitors in the neon lamp circuits should be checked. If the wave is distorted, the indicator lamp can be assumed to be correct and recording head or associated supply network is at fault.

Gain and distortion checks are also important. In this instance, the recording-head circuit should be restored to normal, leaving the oscillator circuit open. The output of an audio oscillator should be loaded with a non-inductive resistor of the proper value and the ground terminal of the oscillator output connected to the amplifier

Fig. 1. Magnetic tape recorder and playback unit circuitry; Ampro model 731.

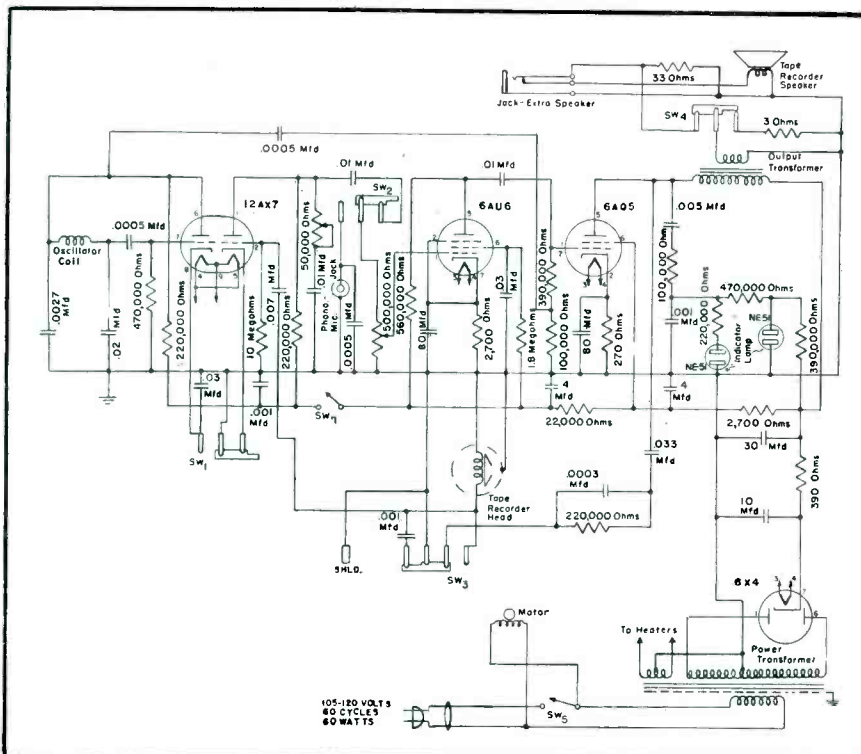

Simplified playback head circuit of Revere tape recorder. A coil is used for both recording and playing back. A .003-mfd capacitor, shunting, resonates the coil to intensify the higher audio frequencies.

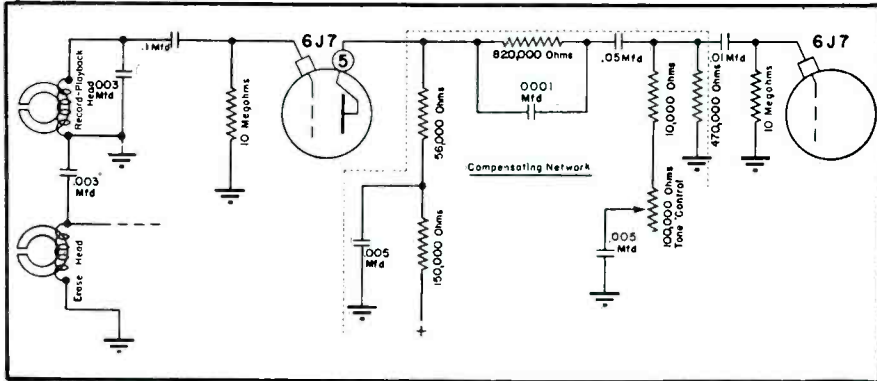

chassis. A 20,000-ohm carbon resistor should be connected between the *hot* terminal on the oscillator output and the ungrounded lead from the recording head; resistor and connecting lead should be shielded and shield should be grounded. The volume control should be turned to maximum clockwise position and *play-record* control to *play* position. The *motor* switch should then be turned *on*. Oscillator should be adjusted to 400 cps and .01 volt; measured across oscillator load resistor. An output meter connected across the speaker terminals should read 2 to 3.5 volts and the output wave form should be free from visible distortion. If distortion is present or output is low, the tubes should be checked, substituting one at a time; then starting at the output stage, the waveform at each plate and grid should be checked to locate the stage in which the distortion is occurring.

Adjustment of the erase head is extremely important, since an accurate adjustment will insure complete removal of all recorded material and leave the tape in a demagnetized state. The adjustment can be made by a harmonic distortion method, which requires an audio frequency oscillator producing 400 cps, free from second harmonic distortion or equipped with filter to attenuate 800 cps harmonic by at least 75 db; matching transformer or network to couple oscillator to input of recorder, and a distortion meter (harmonic).

The audio oscillator should be checked with the distortion meter to be sure that the 400 cps tone is free from harmonic distortion. Use a filter if necessary. The oscillator should be matched to the input of the recorder. The distortion meter should be connected to the output of the recorder, using the procedure recommended by the manufacturer for connecting to a 3.75-ohm source.

The recorder should then be turned on, switch placed in phono-radio posi-

tion and the volume control adjusted to produce a faint flash from the recording lamp. The output of the recorder should be checked to be sure that the level being used produces negligible harmonic distortion. If the output is distorted, the amplifier should be serviced before attempting to adjust the erase head.

The recorder should now be threaded with brown oxide tape and about 5' of tape recorded. The tape should be rewound, switch turned to *play* position and the harmonic distortion measured. The screw which holds the magnet guard in place should be loosened and the guard moved about .005" in either direction. The recording and playback operation should be repeated and again the distortion measured. If the distortion has decreased, the guard should be moved in the same direction and the

Recording head circuit of Revere tape recorder. When the recorder is in *record* position, coil is energized with a 25-kc erase signal. Frequency compensation occurs during playback only.

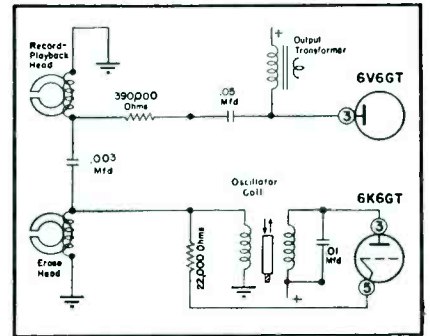

test repeated until a position which produces minimum distortion has been located. As the point of minimum distortion is approached, the guard should be moved approximately .001" per step; this can be accomplished by only loosening the retaining screw slightly and tapping the guard with a light tool.

If a considerable number of recorders are to be serviced, the process can be speeded up by placing a second recorder (known to be in good condition) alongside of the one being adjusted and using it as a continuous playback unit to monitor a loop of tape upon which a recording is being made continuously by the unit being adjusted. Slack should be left in the tape as it passes between the two recorders. This produces an additional

(Continued on page 59)

Circuit of RCA model 15E record demonstrator, which features an automatic 45 rpm player with a 14-record capacity mount, and a manual player for 33 1/3 or 78 records up to 12-inch type. A 6SQ7 is the *af* amp; another 6SQ7 is a phase inverter; a pair of 6V6GTs are in the output and a 5Y3GT is the rectifier.

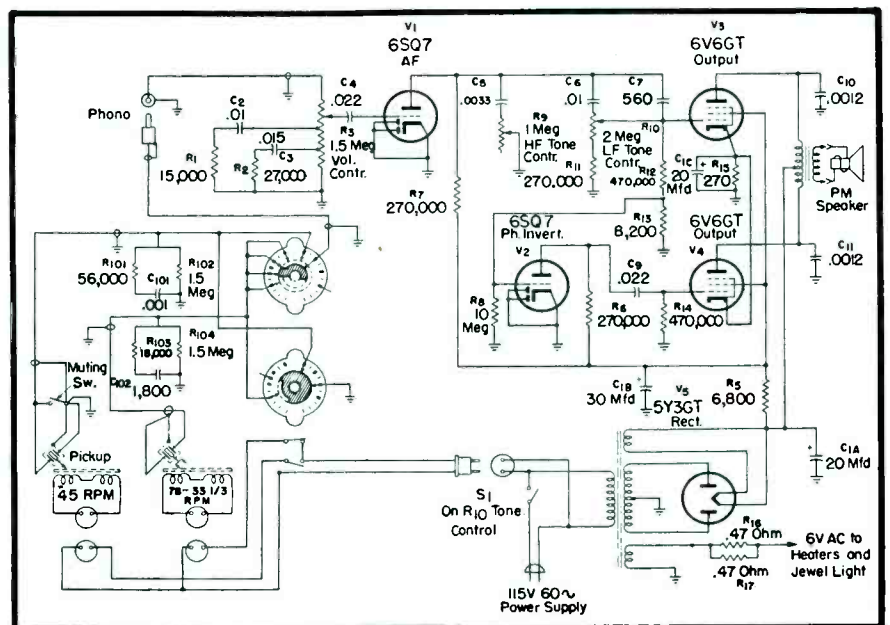

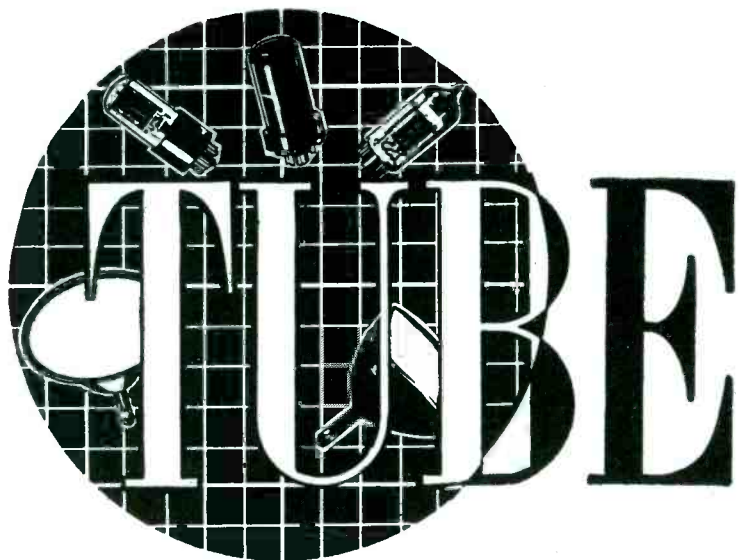

TUBE

News

by L. M. ALLEN

Ultrahigh Tube Design and Application* . . . Sound TV Tubes . . . Picture Tube Production Techniques . . . Cylindrical Face Picture Tubes . . . Electro-Magnetic-LV Electrostatic-Automatic Focus Type Picture Tubes...Transistors.

THE ULTRAHIGH REGION, which has begun to interest everyone, has become a particularly popular favorite among tube researchers. As a result there have appeared many unusual projects.

In designing tubes for these frequencies, it has been necessary to consider, first, the maximum frequency at which conventional tubes will operate. This is determined by three groups of phenomena:

(1) Effects of the finite electron transit time. These effects manifest themselves at frequencies where the duration of one cycle is no longer great in comparison with the time required by an electron to traverse the clearance between the cathode and the anode. At such frequencies the mutual conductance decreases, the input circuit is damped and the signal-to-noise ratio diminishes.

(2) Undesired couplings, caused by the capacitances, the self-inductances and the mutual inductances of the electrodes and their connections.

(3) Losses which, in general, increase with the frequency and which may be distinguished as dielectric losses in the glass, and dissipative losses in the electrode connections and in the electrodes themselves. At *uhf* the latter losses are predominant.

Transit Time

It has been found that the most obvious modification is to reduce the clearance between the electrodes, thus shortening the transit time. Especially important is the spacing between cathode and grid, where the electron velocity is low, and the time for the electrons to traverse this space is therefore relatively high.

By bringing cathode and grid closer

together, their capacity is however increased; but since the mutual conductance is also increased, it has been found that the net result can be an improvement of the tube's properties at high frequencies.

Coupling Effects and Losses

Studies have shown that a reduction can be obtained by shortening the

(Continued on page 30)

Two views of developmental transistor unveiled recently. The transistor performs many of the functions of a tube and can substitute for it in many applications. Because of its minute size and low-power requirements, the transistor is expected to point the way to a wide range of miniaturized electronic products. At right is a transistor in an advanced stage of construction. At left is the finished transistor, with its components embedded in a protective casing of plastic. *(Courtesy RCA)*

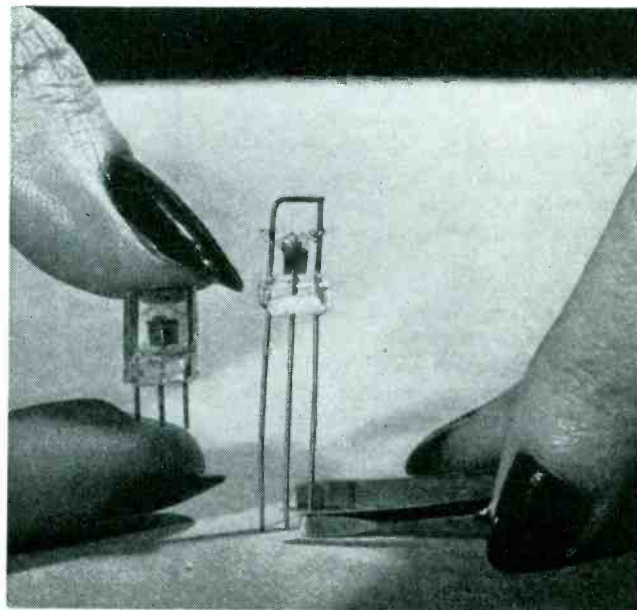

*Based on notes supplied by Amperex.

The 7" TV scope for professionals

RCA WO-56A

DUAL CONTROLS FOR "COARSE" AND "FINE" ADJUSTMENTS

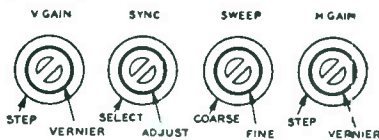

No hunting or fumbling for controls when adjusting Vertical Amplifier Gain, Sweep Frequency, Sync Injection, and Horizontal Amplifier Gain.



NEW!

The WO-56A has a special circuit for automatic control of synchronization over a wide range of input-signal levels.

Supplied with direct probe, low-capacitance probe, and ground cable.

FEATURING—

- Giant RCA 7JP1 cathode ray tube.
- Direct-coupled, 3-stage, push-pull, vertical and horizontal amplifiers.
- Frequency-compensated and voltage-calibrated attenuators on both amplifiers.
- A set of matched probes and cables.
- Panel source of 3 volts peak-to-peak calibrating voltage.
- Identical vertical and horizontal amplifiers with equal phase-shift characteristics.
- Retractable light shield for maximum visibility.
- New filter-type graph screen with finely ruled calibrations.
- Magnetic shield enclosing CR tube to minimize hum-pickup from internal and external fields.

SPECIFICATIONS—

- Vertical Deflection Sensitivity: 10.6 rms millivolts per inch.
- Frequency Response: Flat within -2 db from dc to 500 kc; within -6 db at 1 Mc; useful response beyond 2 Mc.
- Input Capacitance: Less than 10 uuf with WG 216A Low-Capacitance Probe.
- Square-Wave Response: Zero tilt and overshoot using dc input position. Less than 2% tilt and overshoot using ac input position.
- Linear Sweep: 3 to 30,000 cps with fast retrace.
- Trace Expansion: 3 times screen diameter with corresponding centering control range.
- Power Supply: 105-125 volts 50/60 cycles; power consumption 65 watts.
- Size 13 3/4" h, 9" w, 16 3/4" d. Weight only 31 pounds (approx.).

ADVANCED SWEEP FACILITIES—

- Preset fixed sweep positions for vertical and horizontal television waveforms.
- Positive and negative syncing for easy lock-in of upright or inverted pulse waveforms.
- 60-cycle phase-controlled sweep and synchronizing.

Built for laboratory, factory, or shop use, the WO-56A combines the advantages of high-sensitivity and wide-frequency range in a *very small* instrument with a *large* cathode-ray tube.

Designed with the user in mind, this new scope can be depended upon to provide sharp, bright, large, and accurate pictures of minute voltage waveforms over the entire useful surface of the 7JP1 screen.

The amplifier selector switches are provided with both "AC" and "DC" positions so that measurements can be made with or without the effects of any dc component.

Square-wave reproduction is excellent, whether the application is low-frequency TV sweep-alignment or observation of high-frequency steep-fronted sync and deflection voltage waveforms:

A special sync-limiter circuit automatically maintains proper synchronization of the sweep oscillator over a

wide range of input-signal levels without the need for manual adjustment of the sync-vernier control.

The excellent linearity and fast retrace of the sweep or time base are functions of the Potter-type oscillator. Undistorted reproduction of the sawtooth waveform is assured by use of a horizontal amplifier with a wide-band characteristic. The preset sweep positions provide rapid switching between vertical and horizontal TV waveforms.

Truly, the WO-56A is a most useful and practical instrument for everyday work in the fields of television, radio, ultra-sonics, audio, and a wide array of industrial applications.

For details, see your **RCA Distributor**, or write RCA, Commercial Engineering, Section CX56, Harrison, N. J.



RADIO CORPORATION of AMERICA
TEST EQUIPMENT
HARRISON, N. J.

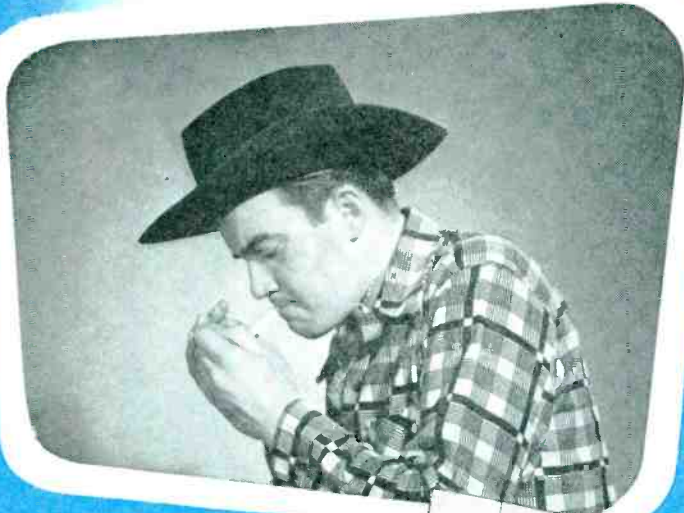
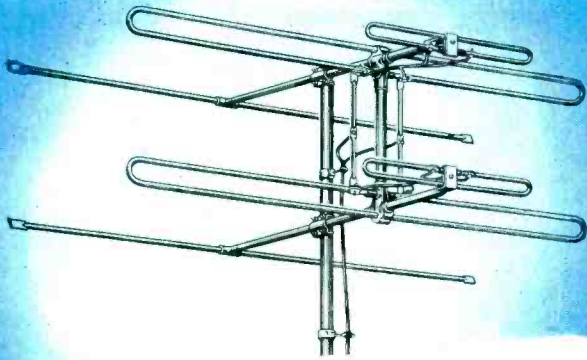

AMPHENOL

this 
Book



... contains information never before available in a concise, readable form. It presents a complete discussion of the factors and conditions which affect television reception and the reasons for good TV pictures. The one single factor which contributes the most to Better TV Picture Quality is the television antenna. The best and most expensive TV set can present a picture no better than that received by the antenna.

This book gives a detailed discussion, complete with illustrations and graphs, of the various types of antennas, their characteristics and performance under given conditions. In addition, the book contains information on the problem of coordinating the antenna with the location.

Your Authorized Amphenol Distributor has a free copy of this book waiting for you — ask for yours today!

AMERICAN PHENOLIC CORPORATION

1830 SOUTH 54th AVENUE • CHICAGO 50, ILLINOIS

AMPHENOL

Tube News

(Continued from page 28)

length of the connections between the electrodes and the exterior contacts. In one series of tubes designed in Holland, which will soon be available in this country, the electrode system has been mounted on a flat glass bottom with moulded-in connecting pins; thus very short distances between the electrodes and the external circuit are possible in this way.

Chrome iron connecting pins, as well as nickel connectors between the pins and the electrodes, are covered with a layer of silver or copper, reducing their resistance at a frequency of 300 mc by a factor of about 10.

Another member of this tube family features a different structure, with the concentric electrode system replaced by plane, parallel electrodes. This form is said to allow very close spacing required for extremely short transit times.

Anode and grid connecting pins have been replaced by copper discs, fused into, and protruding beyond, the wall of the glass bulb. The outer parts of these discs have been shaped in a special way, so that the tube can be inserted in coax line circuits.

This tube, a disc-seal triode, was developed for application in receivers and small transmitting installations. In receivers the tube can be used as a high-frequency amplifier and local oscillator, and in transmitters, as a self-excited, controlled and impulse modulated transmitting tube.

The tube is mainly intended for use in coax line circuits. When the tube is used as an oscillator in a coax line circuit, the output power with an anode input of 10 watts is about 2.8 watts at 1000 mc and about 0.5 watt at 3000 mc. The grid of this tube is composed of stretched wires so that buckling due to heating is avoided; the result is that the frequency drift is very small. Moreover, the grid, and the disc to which it has been attached, function as a screening between the anode and the cathode, so that the coupling between the input and output circuits is very small.

Cooling of the anode is achieved mainly by thermal conduction to the line circuit.

G. E. Uhf Tube

An ultrahigh *rf* amplifier, announced by G.E. during the recent IRE national convention, was also noted as featuring unusual design and serving as a complement to the 6AF4, an oscillator tube for *uhf* tuners, introduced a few months ago.

Sound TV Tubes

From G.E. has also come a new tube, 6BK5, which it is said, in conjunction with a 6BN6 in the sound circuit of TV receivers will result in the elimination of two tubes.

The 6BK5 is a power output pentode, while the 6BN6 is a combination limiter and discriminator. Used together, it is claimed that they eliminate use of a first audio amplifier tube and a limiter tube; the 6BK5 is specifically designed for use with the 6BN6.

When operated with 250 volts on the plate and screen, the 6BK5 can deliver 3.5 watts at seven per cent distortion. The grid driving voltage required for full audio output is said to be only five volts peak. The tube has a plate dissipation of nine watts.

Picture Tube Production*

One of the most important steps in the manufacture of picture tubes is the process of making the screening solution for the faceplate.

The first step in preparing the screening solution is to purify the water used. At the G.E. tube plant, this is done by running ordinary tap water through a series of tanks containing ion-exchange resin. The water is then mineral-free as it emerges from the tanks.

The mineral-free water is then run through a series of filters to remove sedimentary particles. Sample tests of the pure water are made daily.

Following this purifying process, the water is piped into insulated stainless-steel storage tanks and subsequently piped down to the screening room and mixed with other ingredients to form the screening solution.

Preparation of the ingredients used to make the screening solution is made in the lab and then piped down to the screening room to be mixed with phosphor powder and de-ionized water to form the screening solution.

It has been found that the process of mixing these ingredients together must be exact, since the inclusion of too much of one or too little of another will result in a poor screen.

Cylindrical Face Picture Tubes

To eliminate annoying specular reflection, there has been developed a 17" rectangular, all-glass picture tube incorporating a cylindrically shaped face plate.**

In addition to this feature, the tube is magnetically focussed and deflected, and, also, has a single ion-trap gun design, neutral density face plate for better contrast, and external conductive coating for increased anode supply filtration and radiation shielding.

In another picture-tube development, there have appeared tubes† which provide for three methods of focus: Standard electromagnetic focus used with a focus coil, low voltage electrostatic focus, and automatic focus.

The only difference in the external appearance of two of these tubes is that the electromagnetic focus tube has a 5-pin base, whereas the low voltage, electrostatic focus tube has a 6-pin base.

Tube may be used as a standard magnetic focus tube by utilizing the regular focus coil and making no connection to the 6 base pin. By utilizing this method, the low voltage, electrostatic focus tube can be used as a standard electromagnetic tube.

In the event that there is no focus voltage supply, the 6 base pin can be connected to the chassis for ground.

*From notes prepared by G.E.

**Hytron 17 QP4. †Sheldon Electric.

Just Published

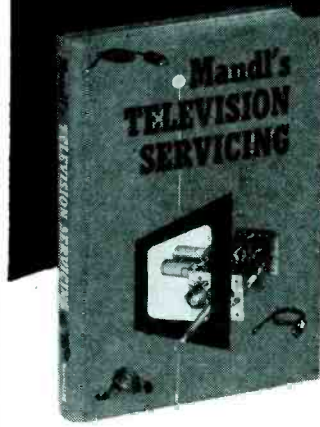

EXACTLY what you want in servicing instruction

- detailed, illustrated trouble-shooting procedures
- for every flaw or failure you're likely to encounter in any TV receiver
- completely and clearly indexed for quick reference

Whatever the trouble, in picture or sound, you'll be able to put your finger on it quickly and accurately with the aid of this book. More important, you'll KNOW HOW TO FIX IT, without guesswork or trial and error, and with full assurance that the trouble is REALLY CORRECTED.

A complete master index, in clear, convenient tabular form, lists over 100 trouble symptoms—all the various hums, sound distortions, streaks and bars on picture, focus defects and all others that you're likely to find—with the probable causes of each and the page on which full servicing instruction for that particular fault is given.

You won't have to thumb through batches of manufacturers' notes, never sure that you have the right directions for the latest improvements or changes. Here are the instructions you need for correcting trouble in each circuit in any set, and the CLEAR UNDERSTANDING of each circuit you need in order to BE SURE that the adjustments you make will achieve the desired results.

300 illus.
A handy 421-page,
fact-packed guide

You'll find

Handy lists of troubles that may occur in each section of the TV receiver and the exact procedures for correcting each.

Large clear block diagrams of typical commercial circuits for tuners, focus control systems, R-F voltage supply, sync separator systems and all other basic TV receiver circuits.

New original photographs showing actual symptoms of trouble on TV screens to aid identification.

Full explanation of unusual, hard-to-find troubles and how to fix them, as well as all ordinary defects.

Complete instruction on the use of testing equipment, and oscilloscope patterns to facilitate the checking of test results.

Ways of improving overall performance; how to improve gain, reduce ghost reception, minimize interference.

Special servicing instruction for color TV and for VHF and UHF receivers.

Are these top-ranking aids on your working reference shelf?

and much more

Fischer's RADIO & TV MATHEMATICS

"An extremely useful reference," wrote *Radio News* about this unique book. Here are step-by-step solutions, showing what formulas to use and what numerical values to substitute, for HUNDREDS of typical radio and TV servicing, construction, and operational problems, arranged under radio topics for quick reference.

Noll & Mandl's TELEVISION & FM ANTENNA GUIDE

A basic course on antenna theory combined with a complete handbook on antennas and their installation. Shows how to pick the right antenna for the site, determine the best position for it, install transmission line for maximum efficiency and all other practical details for getting the most out of the antenna system.

Noll's TV FOR RADIOMEN

Explains very clearly and fully all basic principles of television reception, the essentials of TV transmission, and the construction and operation of each part of modern TV receiving systems; and gives step-by-step instruction in installation, adjustment, alignment, and basic trouble-shooting procedures. A basic book for anyone in television servicing, noted for clarity and completeness. Here are all the fundamental why's and how's by a man known throughout the country as a leading authority on the technical aspects of television.

See them ON APPROVAL

Look them over. If you're not entirely satisfied you may return the books without further obligation.

The Macmillan Co., 60 Fifth Ave., New York 11

S

<input type="checkbox"/> Mandl's TV Servicing	\$5.50	Please send me the books checked at left. I will either remit in full or return the books in 10 days.
<input type="checkbox"/> TV for Radiomen	\$7.75	
<input type="checkbox"/> Radio & TV Math.	\$6.75	
<input type="checkbox"/> TV & FM Antenna Guide	\$6.25	
		Signed
		Address

FM Servicing-Alignment

by RUDOLF F. GRAF*

Part II . . . Ratio-Detector 'Scope Alignment

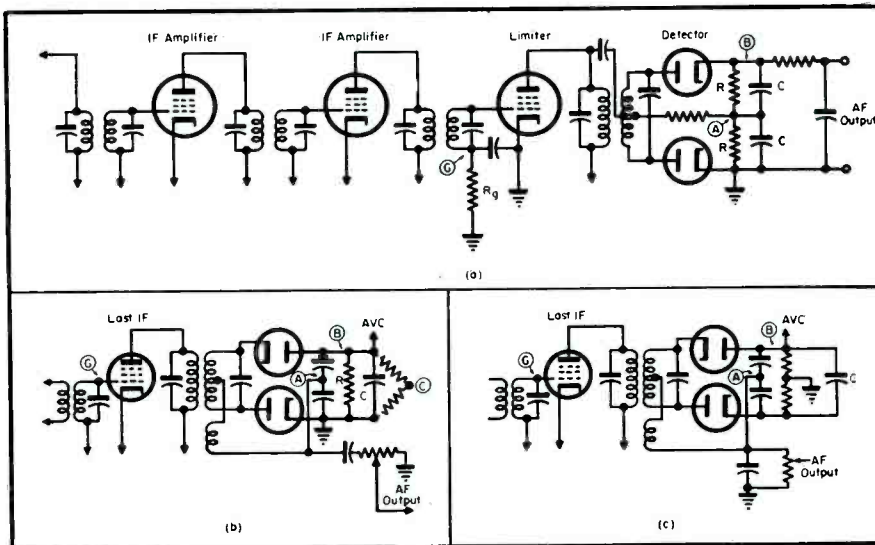
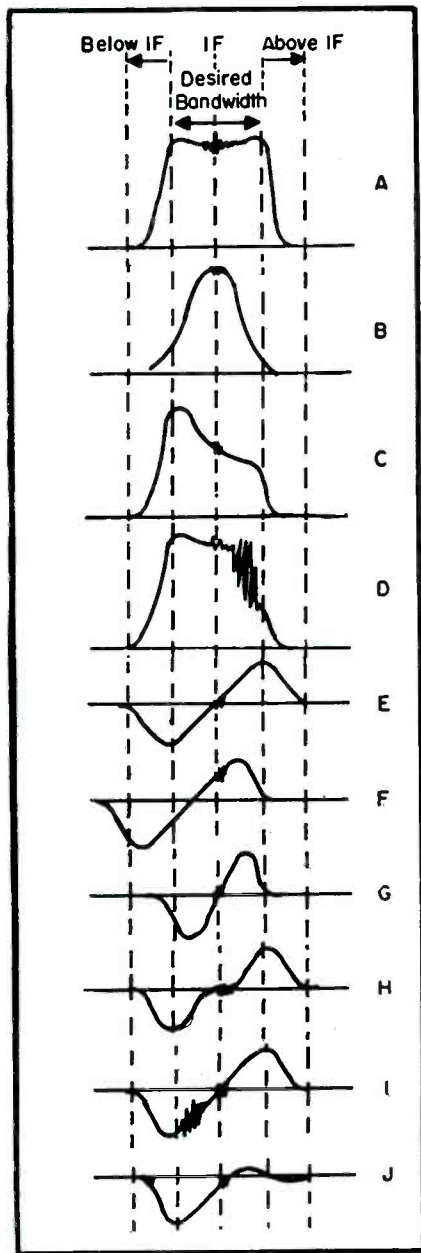

Fig. 1. FM detector circuits and test points. In *A* appears a discriminator type of FM detector, while in *B* and *C* appear unbalanced and balanced ratio detectors, respectively.

ANALYZING THE ALIGNMENT of the *if* stages, in the initial installment¹, it was indicated that the vertical input lead should be connected to the limiter grid (point *G* in the circuitry) and the sweep generator leads should be connected to the grid of the mixer grid. All of the *if* transformers should be aligned to obtain the desired *if* response curve. It is important to be sure to keep the input signal to the mixer grid as small as possible; otherwise the limiter will be driven beyond saturation and the curve will flatten out. The overall bandwidth of the *if* stages can be checked at a glance, by changing the marker frequency over the complete response curve. The overall alignment of the circuit can be checked by leaving the generator con-

nected at the mixer grid and moving the 'scope's vertical input terminals back to point *B*. Then the *S* curve can be observed. If necessary the alignment can now be touched up slightly to straighten out any irregularities.

Ratio-Detector 'Scope Alignment: In receivers employing ratio detectors it is usually best to align the detector first and then turn to the *if* stages. The following alignment procedure holds equally true for balanced or unbalanced ratio detectors:

The vertical input lead should be connected from the 'scope to point *A*, through a 10,000-ohm isolating resistor and the sweep-generator output with the marker signal connected to the grid of the last *if* stage. This is point *G* in Fig. 1*b* and *c*. Now, the primary and the secondary of the transformer can be adjusted for proper symmetry and linearity, as before. Next, the sweep signal should be moved to the mixer grid and the 'scope input leads connected through the isolating resistor to point *B*. The electrolytic, *C*, connected from point *B* to ground, must be temporarily disconnected when the 'scope is at point *B*; otherwise there will be no pattern on the screen. All *if* stages should be aligned for a symmetrical response curve, similar to the one shown in Fig. 2*a*. After the *if* stages are aligned, the electrolytic should be reconnected.

When servicing the FM receiver, there are a number of symptoms that

(Continued on page 77)

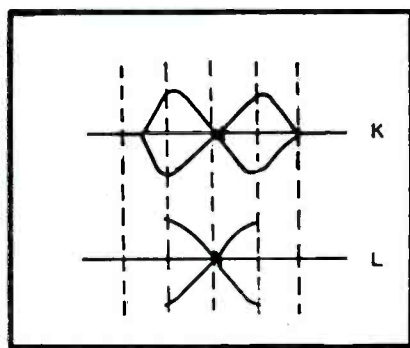

Fig. 2, left. Quick reference charts for *S* curves and *if* response curves. Above: *A* = proper response curve at the limiter grid. It will be noted that the curve is almost flat over the entire bandwidth. *B* = response curve which is too narrow at the limiter grid. It is, therefore, necessary to realign *if* stages to obtain greater bandwidth. *C* = unsymmetrical *if* response curve at the limiter grid. The *if* stages must be realigned for greater symmetry. *D* = response curve at the limiter grid showing oscillating condition in the *if* or *rf* stages. In this instance, it is necessary to check the bypass capacitors, grounds, shielding, tubes, *avc* and decoupling filters. *E* = proper *S* curve at FM detector output. *F* = detuned *S* curve. Here it is necessary to readjust the primary and secondary and check tuned circuits. *G* = *S* curve which is too narrow, which causes the sound to become distorted. The cause may be similar to that indicated in *B*. *H* = non-linear *S* curve, where it is necessary to readjust the secondary. *I* = an *S* curve showing oscillations. In this instance, the checks suggested in step *D* should be followed. *J* = *S* curve showing low emission of one of the diode tubes. This may also be due to a shorted turn in half of the secondary. May also be caused by the troubles indicated in step *C*. *K* = butterfly response curve obtained when 'scope sweep frequency is one-half that of sweep generator. *L* = same as *K*, but with reduced sweep generator width.

*Formerly, Instructor, Gotham Radio Institute.

¹SERVICE; February, 1952.

“When we think of V-R tubes, we think of **CBS-HYTRON**”

**TUBES ARE KNOWN
BY THE COMPANY THEY KEEP**

It's automatic with scores of top-flight manufacturers. They turn to CBS-Hytron for the miniature OA2, OB2 and standard OC3, OD3.

That's only natural. They know CBS-Hytron has the know-how... know-how gained from making over 15,000,000 voltage regulators. They know CBS-Hytron supplies these apparently simple tubes to either JAN or commercial specifications. (In fact, CBS-Hytron's factory tests of VR tubes are much tougher than JAN.) And they know CBS-Hytron... top producer of VR tubes... can be depended upon for prompt delivery.

Follow the leaders yourself. Buy the best. Order your gaseous voltage regulators from CBS-Hytron.

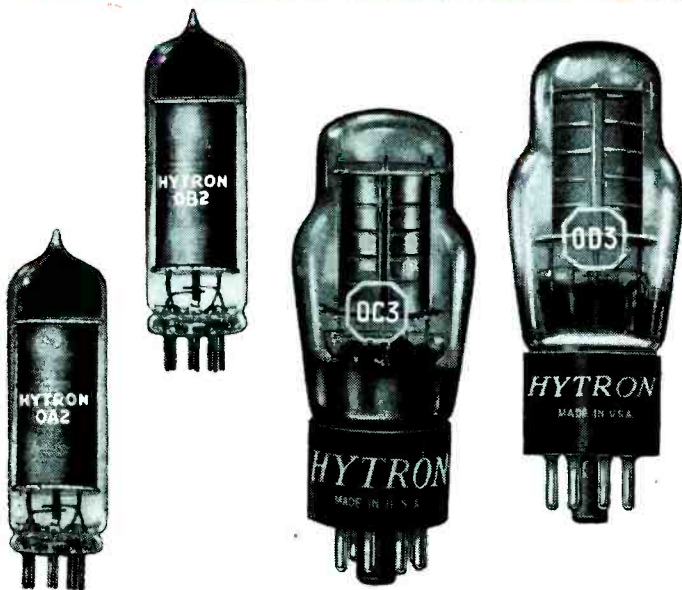

Write for Complete Free Data on
CBS-HYTRON voltage-regulator tubes.



MAIN OFFICE: Salem, Massachusetts

Reads like the blue book of electronics...

this list of famous companies who from long experience buy the best in voltage-regulator tubes... CBS-Hytron.

Admiral Corporation • Airborne Instruments Lab., Inc. • Aircraft Armaments, Inc. • Aircraft Radio Corp. • Airesearch Mfg. Co. • Applied Physics Corp. • Applied Research Laboratories • Arma Corporation A.R.F. Products, Inc. • Atomic Instrument Co. • Audio Products Corp. • Ballantine Laboratories, Inc. • Arnold O. Beckman, Inc. • Bell Aircraft Corp. • Bell Telephone Laboratories, Inc. • Bellaire Electronics, Inc. • Bendix Aviation Corp. • Berkeley Scientific Corp. • Bill Jack Scientific Instrument Co. • Bright Radio Laboratories • The Brinnell Co. • Browning Laboratories, Inc. • J. H. Bunnell & Co. • Cambridge Instrument Co., Inc. • The Allen D. Cardwell Mfg. Corp. • CBS-Columbia, Inc. • CBS Television • Collins Radio Co. • Connecticut Telephone & Electric Corp. • Consolidated Vultee Aircraft Corp. • Cornell-Dubilier Electric Corp. • Crosley Division, Avco Mfg. Corp. • DDD Manufacturing Co. • Douglas Aircraft Co., Inc. • Allen B. DuMont Laboratories, Inc. • Edo Corporation • Eicor, Inc. • Electro-Physical Laboratories, Inc. • Electrotech Corp. • El-Tronics, Inc. • Fada Radio and Electric Co., Inc. • Fairchild Guided Missiles Div., Fairchild Engine and Airplane Corp. • Federal Manufacturing and Engineering Corp. • Federal Telecommunication Laboratories, Inc. • Federal Telephone and Radio Corp. • Ford Instrument Co., Div. of Sperry Corp. • Gaveco Laboratories, Inc. • General Communication Co. • General Precision Laboratory, Inc. • General Radio Co. • Gilfillan Bros., Inc. • Gonset Company • The Gray Mfg. Co. • The Hallcrafters Co. • The Hammarlund Mfg. Co., Inc. • Harvey-Wells Electronics, Inc. • Hazeltine Electronics Corp. • Hewlett-Packard Co. • Hickok Electrical Instrument Co. • Hoffman Radio Corp. • Hubbell & Miller Co. • Industrial Control Co. • Industrial Development Engineering Associates, Inc. • Jack & Heintz, Inc. • Jackson Electrical Instrument Co. • Kepco Laboratories, Inc. • Lavoie Laboratories, Inc. • Lear, Incorporated • Lewyt Corporation • Link Radio Corp. • Loral Electronics Corp. • Lyman Electronic Corp. • Lyseo Mfg. Co., Inc. • P. R. Mallory & Co., Inc. • The Glenn L. Martin Co. • The W. L. Maxson Corp. • McDonnell Aircraft Corp. • McElroy Manufacturing Corp. • Melpar, Inc. • Midwest Engineering Development Co., Inc. • Minshall-Estey Organ, Inc. • Motorola, Inc. • National Company, Inc. • National Electrical Machine Shops, Inc. • National Research Corp. • National Research Council, Canada • New London Instrument Co. • Nuclear Measurements Corp. • Nutone, Inc. • Photobell Co. • Pilot Radio Corp. • Portable Electric Tools, Inc. • Precision Apparatus Co., Inc. • Press Wireless Mfg. Co., Inc. • Radiation, Inc. • Radio Development & Research Corp. • Radio Engineering Laboratories, Inc. • Rauland-Borg Corp. • Raymond Rosen Engineering Products, Inc. • Raytheon Mfg. Co. • Reed Research, Inc. • Sanborn Company • Sangamo Electric Co. • Schuttig & Company, Inc. • Sentinel Radio Corp. • Servomechanisms, Inc. • Setchell Carlson, Inc. • Shalleross Mfg. Co. • F. W. Sickles Div., General Instrument Corp. • Sierra Electronic Corp. • A. F. Smuckler & Co., Inc. • Sonar Radio Corp. • Spencer-Kennedy Laboratories, Inc. • The Stamford Electronics Co. • Fred Stein Laboratories • The Superior Electric Co. • The Technical Materiel Corp. • Telechrome, Inc. • Tel-Instrument Co., Inc. • Times Facsimile Corp. • Tracerlab, Inc. • Trad Television Corp. • Transducer Corp. • United Scientific Laboratories, Inc. • Varo Mfg. Co., Inc. • Wells-Gardner & Co. • Western Electric Co. • Western Sound & Electric Labs., Inc. • Westinghouse Electric Corp. • Weston Electrical Instrument Corp. • Weston Laboratories • Wilcox Electric Co., Inc. • Witeco Mfg. Co.

In addition to many other prominent manufacturers, the U. S. Army, Navy, Air Force, Coast Guard, AEC, CAA, FCC, National Bureau of Standards, government development laboratories and other government agencies, well-known research laboratories and universities, foreign countries, and the nation's leading electronic parts distributors.

SERVICE, MARCH, 1952 • 33

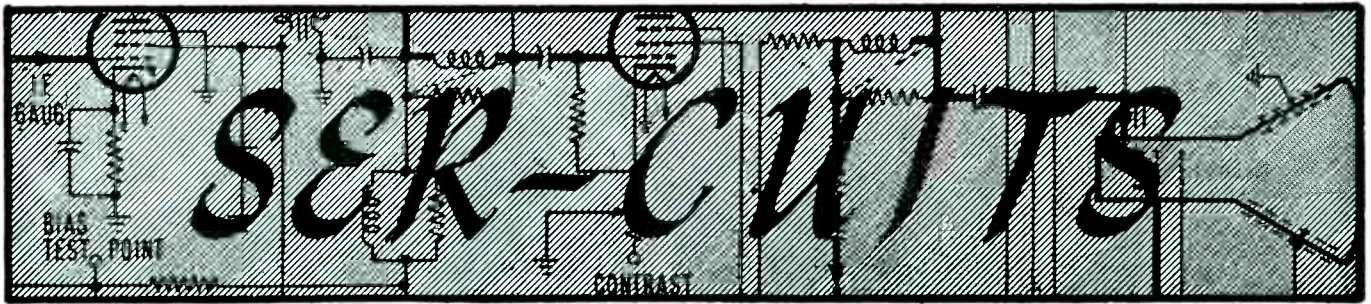

by M W. P E R C Y

Analysis of 24-Inch G. E. Chassis: The 45.75/41.25 IF System . . . Video Amplifier . . . Keyed AGC . . . Sync System . . . Vertical Sweep and Retrace Blanking . . . AFC . . . Audio Circuit.

DURING THE LAST FEW MONTHS it has been noted that the newer line of chassis are featuring many extremely unusual circuitry developments devised to provide higher gain, improved hold and better pictures.

In Fig. 1 appears an excellent example of a circuit with the foregoing features. Specifically this model, a G. E. 24C101, has a two-stage *rf* amplifier, keyed *agc*, automatic horizontal frequency control, advanced type of inter-carrier sound system, an *if* interference trap at input, provision for *uhf* converter connection and a 24-inch round picture tube.

IF System Analysis

This receiver incorporates four video *if* amplifiers which are followed by a crystal diode and associated video amplifier. First two stages are conventional pentode amplifiers whose bandwidth is relatively broad, passing both the video and audio carrier *if* frequencies. Their high-*if* frequency cutoff is determined by a pair of 47.25-mc absorption traps. The plate circuit of the second stage passes the two *if* frequencies and their associated sidebands to the grid of the third video *if* amplifier as well as to the sound takeoff amplifier.

Sound takeoff amplifier is also a fairly broad stage and is similar to a conventional video *if* amplifier in this respect. Its response is relatively broad compared to the bandwidths normally encountered in audio *if* stages. At this point the signal is still a composite one, containing both *if* carrier frequencies, audio and video, whose

relative amplitude ratio is determined by the tuning of an output tank circuit, L_{212} , and to some extent by the pass band characteristics of preceding tank circuits. The output of this stage drives a crystal diode wherein mixing and detection take place, the resultant of which is a 4.5-mc sound *if* signal. From this point to the audio system, the signal passes through a conventional FM *if* system, consisting of an amplifier, limiter and ratio detector.

Now that the audio portion of the transmission has been obtained, it is necessary to dispense with the audio *if* carrier frequency; 41.25 mc. This is accomplished in the next two (third and fourth) video *if* amplifiers by means of absorption traps L_{207} and L_{208} . These two stages may be aligned in such a manner that their response, together with the response of the preceding stages, will have a wide bandwidth characteristic. The video *if* signal is passed to a crystal diode, Y_{200} , in a detector-can assembly.

The video amplifier circuit employs a pentode-type tube whose output is coupled through a capacitor to the picture-tube cathode. The screen voltage of the video amp is varied by the contrast control.

Since there is a *dc* connection between the *agc* keyer tube grid and the video amplifier plate, a variation in the amplifier screen voltage will affect the *agc* keyer tube bias.

Keyed AGC‡

The keyed *agc* system in this chassis differs from other systems in that the

agc keyer tube, V_{117} , is made to conduct only for a short duration of a keying pulse supplied at the horizontal sweep frequency of 15,750 cps. Since the tube does not conduct between pulses, its susceptibility to noise is reduced in proportion to its shortened conduction time which is said to result in an improvement of approximately six to one.

The keyer tube, a 6AU6 pentode, is biased beyond cutoff except during the application of the positive sync pulses of the signal to the grid.

The plate of the keyer tube is essentially at ground potential as far as *dc* voltage is concerned. Plate current flows when positive-going keying pulses obtained from a winding on the width control are applied to the plate. The plate current develops the *agc* bias across a 150,000-ohm resistor.

Since the plate current of the 6AU6 is independent of plate voltage, the keying pulse amplitude has negligible effect in establishing the *agc* bias. This is controlled entirely by the peak amplitude of the signal applied to the grid circuit of the component. Therefore, the video signal is applied with its *dc* component, by taking it off the plate of the video amplifier, V_{108} .

If the station signal increases suddenly, the positive sync pulse amplitude at the grid of the keyer tube also increases and the decrease in bias causes a greater current, resulting in an increased *agc* bias which biases the tubes of the video *if* amplifier so that the gain is reduced. The opposite action takes place when the signal de-

(Continued on page 62)

‡See article by Charles Bowers; this issue.

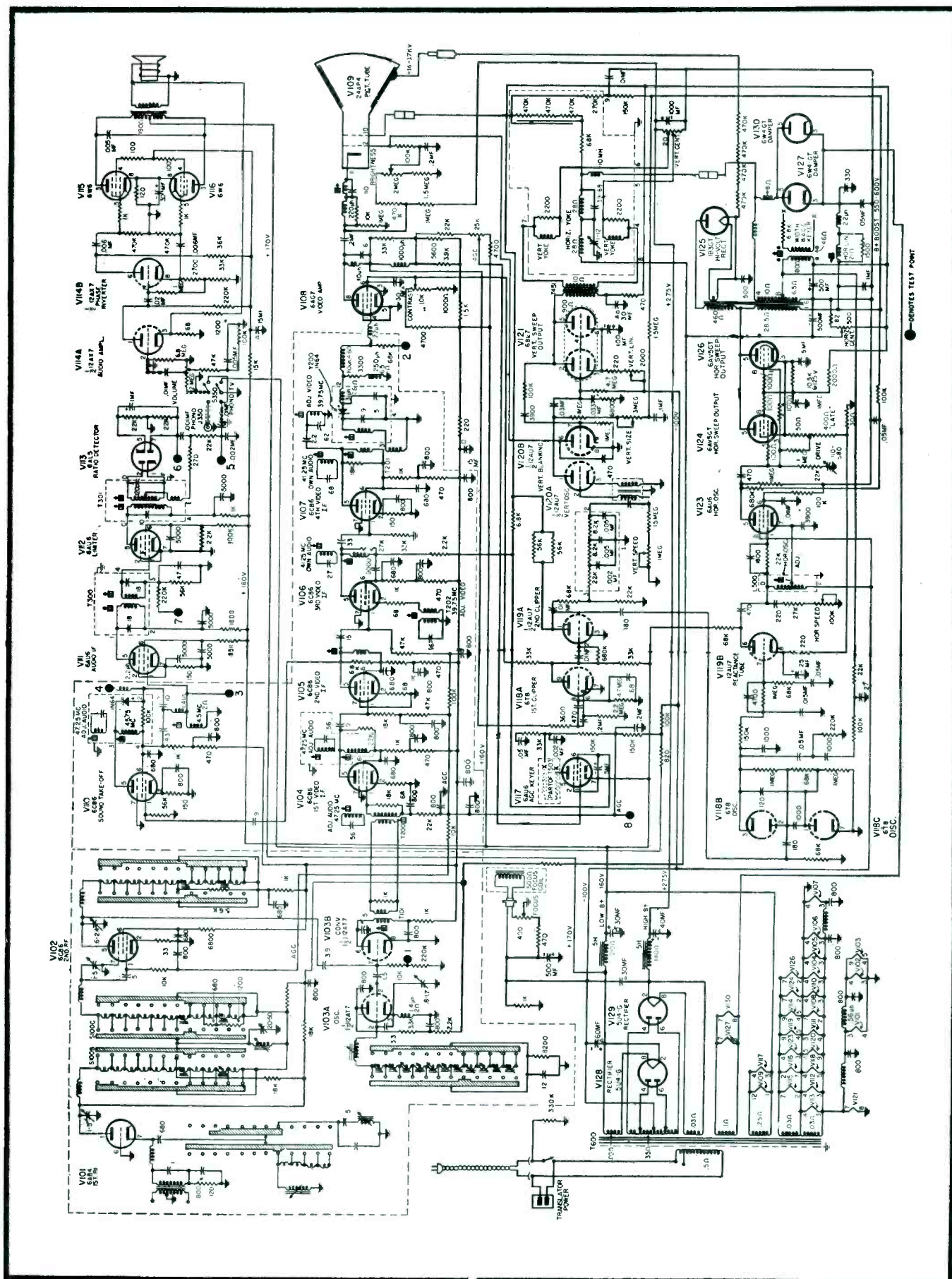

Fig. 1. Circuit of the G.E. 24C101 chassis.

Some Plain Talk about Making More Money

HOW WE CAN HELP

...with the RCA Battery Line

As Radio men, we can do it by working together

Here's how we'll help you build a more profitable business with RCA BATTERIES:



1 We will advertise you, the Radio Service-Dealer on national network radio and TV programs. We'll tell millions of listeners that you are best qualified to sell and install RCA Radio Batteries.



2 We will help you advertise for repeat sales on the RCA Battery carton. Millions of volume-type RCA Batteries will carry a printed message directing the user to come back to you for replacements. Below this message will be a space where you can stamp your own name with a personalized stamp which you may obtain from your RCA Battery Distributor.

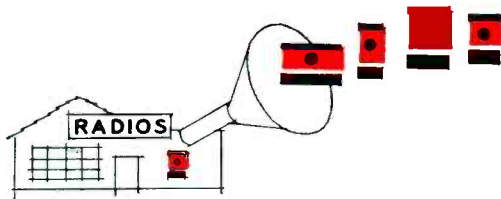

3 We will continue to channel our principal battery distribution to you as a Radio Dealer and Serviceman which means that you get profitable repeat business with RCA BATTERIES.

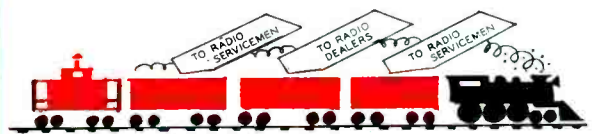

4 We will continue to provide speedy, dependable service backed by the only nation-wide warehousing and distribution organization geared to the needs of the radio trade.

DOESN'T THIS MAKE SENSE TO YOU?

As a Radio man, you should handle the Radio Battery line of the Radio Company that wants to help you prosper. By doing this, you get extra help . . . four-way help. And you make more money. It's as simple as that.

for Local Radio Dealers and Servicemen:

YOU MAKE MORE MONEY

With the RCA line you get ALL THESE EXTRA BENEFITS, TOO

You get **TREMENDOUS BRAND ACCEPTANCE** . . . because RCA is the best-known, most-advertised name in the radio field. This means your battery sales are fast, easy, profitable with RCA.

You get **COMPETITIVE PRICES**. RCA Batteries are priced to sell against the toughest competition.

You get **TERRIFIC SELLING AIDS** . . . signs, banners, displays, kits, merchandisers that are unique . . . to mark your store as headquarters for RCA Batteries.

You get **RADIO-ENGINEERED BATTERIES** . . . power-packed for *extra* listening hours . . . and built to exacting standards of quality. They represent the combined skills of both battery engineers and radio engineers.

You get a **ROUNDED LINE** to fill virtually every portable and farm radio requirement. Seven popular types will fill about 80% of your needs. You cut down on stocking problems . . . are sure to have the right batteries on hand—at the right time!

Get started with RCA Batteries . . . NOW

Let us help you make this your banner year for battery sales. Call your RCA Battery Distributor right now. Get set with the *Radio Battery* for the *Radio Trade* . . . RCA. And let us help you make more money . . . starting **TODAY**.

Why YOU are so important to us.

You're in the *Radio Business*. So are we.

You're interested in promoting the sale and use of *Radio products*. So are we.

If you prosper, so do we!

That's why we channel our battery distribution to *you as a Radio outlet*.

That's why we advertise *you, the Radio-Service Dealer* on national radio and TV programs. That's why we help promote your store right on the actual RCA Battery.

*You're a Radio Man.
We're a Radio Company.
Let's prosper together!*

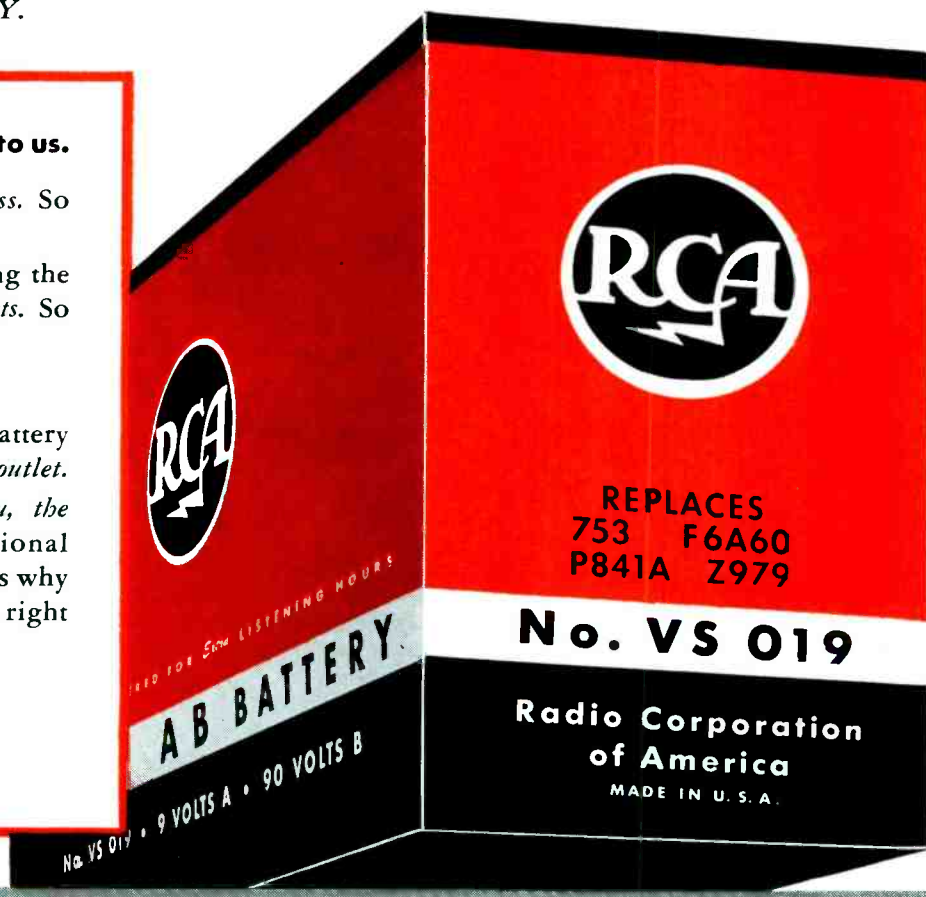

RADIO CORPORATION of AMERICA

RADIO BATTERIES

HARRISON, N. J.

TAPE-DISC

Recorder Amplifier System

by WYN MARTIN

[See Front Cover]

IN THE DESIGN of amplifiers for tape recorders several unusual factors must be considered. For instance, it is not desirable to use an amplifier with absolutely flat characteristics. As indicated in earlier discussions, the very nature of recording tape is such that its recording characteristics are not uniform at all frequencies, and the low-frequency as well as the high-frequency end of the recording spectrum require additional amplification over that of the middle portion of the spectrum.

There are several ways in which the proper equalization can be injected into the recording or playback amplifier. One approach is illustrated in the circuit on the cover wherein frequency discrimination is used. In this type of circuit, a small amount of voltage is taken from the plate circuit of one of the tubes and fed back to the plate circuit of the preceding tube. This is commonly known as inverse feedback and serves to improve the harmonic distortion of the particular stage in which the feedback is used. What actually happens is that the output voltage is fed back 180° out of phase, and if for any reason it is not identical to the input voltage, the gain at the point of distortion is changed so as to actually alter the input signal 180° out of phase; thus after being amplified it appears as an undistorted signal.

If it is then desirable to change appreciably the gain characteristics of the amplifier at different frequencies, it can be accomplished by incorporating into this feedback loop, frequency discriminating networks. As will be noted from the circuit, the pair of 100,000-ohm resistors, and .001 and .00047-mfd ceramics in the plate circuit of the 6AU6 would have a tendency to short-circuit or minimize the low frequencies which could be fed back to the plate of the tube. The capacitor-resistor series combination would minimize the high frequencies which could be fed back to the plate. With this type of arrangement only the middle spectrum of frequencies would be fed back and consequently would decrease the gain of the first section of the 12AX7 by the amount of feedback

voltage. Since no low frequencies or no high frequencies are being fed back the full gain of the amplifier is utilized at these frequencies, and the middle range of frequencies is quite appreciably attenuated. With the values of components in the frequency discriminating feedback loop as shown in the circuit, the recording characteristics of the tape are very nearly the direct opposite of the playback characteristics of the amplifier which results in an overall flat response characteristic.

In recording, the input signal of the microphone is applied to the grid of the first section of the 12AX7 and in turn applied to the grid of the second section which drives the output tube. When recording from phono or an auxiliary input, the voltage is applied to the grid of the second section of the 12AX7 and in turn applied to the output tube. During tape recording processes, the 6AU6 tube acts as a bias oscillator and its output voltage is fed through a 10-160 mfd trimmer capacitor to the grid of the output tube and thus amplified with the signal which is being recorded.

During playback of tape a higher gain is needed; the output of the head is applied to the grid of the 6AU6, which in turn drives the grid of the 12AX7, then to the second grid of the 12AX7, and on to the output tube resulting in a high-gain four-stage amplifier.

If the tape-disc recorder amplifier is to be built, special care must be taken to hold hum to an absolute minimum; this can best be accomplished by building the power supply on a separate chassis. Amplifiers have been successfully built by using the power transformer and power supply on the same chassis, although extreme care is

required. In any event, it is recommended that the amplifier be built on an aluminum chassis, thus holding eddy currents at an absolute minimum. Special care also must be taken in mounting the input tube, the 6AU6, to keep away from any microphonic effects when the speaker is mounted close to the amplifier assembly. Several types of resilient sockets are available, or it is possible to merely mount a standard miniature socket on rubber grommets to give the desired resilient mount.

In wiring the filament circuit of the amplifier, it is not desirable to ground one side of the filament to the chassis, as is normally done with steel chassis; it is recommended that separate wires be run for each side of the filament circuit to eliminate any possibility of voltage drop in the chassis between the various tubes.

Upon completing the amplifier, it is desirable to check first the plate voltage of the power supply; this should be approximately 285 volts, as measured from pin 2 of the power supply socket or at the screen of the output tube which is pin 6. After the amplifier has been found to pass a signal, it is desirable to adjust the oscillator bias frequency and the oscillator bias current.

The oscillator adjustment can be easily accomplished by inserting a 100-ohm carbon resistor in series with a lead (orange) from the recording head which is a part of the recording mechanism, and which connects to pin 2 of the recording head plug. With the amplifier in *record-tape* position, a voltage can be read across this 100-ohm resistor, measured on an *ac* *vrm* or a good high-resistance voltmeter. It is necessary to adjust the bias frequency by controlling the inductance of the 100-ohm coil, parallel to the .002-mfd capacitor in the input switch circuit. This adjustment is not particularly critical; if a horizontal linearity control is used†, a 30-kc bias frequency is usually obtainable when the adjusting slug is approximately 7/8" out of the top mounting screw surface. If test equipment is available, the frequency of the bias can be determined

(Continued on page 52)

*Based on data supplied by General Industries for amplifier suggested for model 250 tape-disc recorder.

†RCA 201R3.

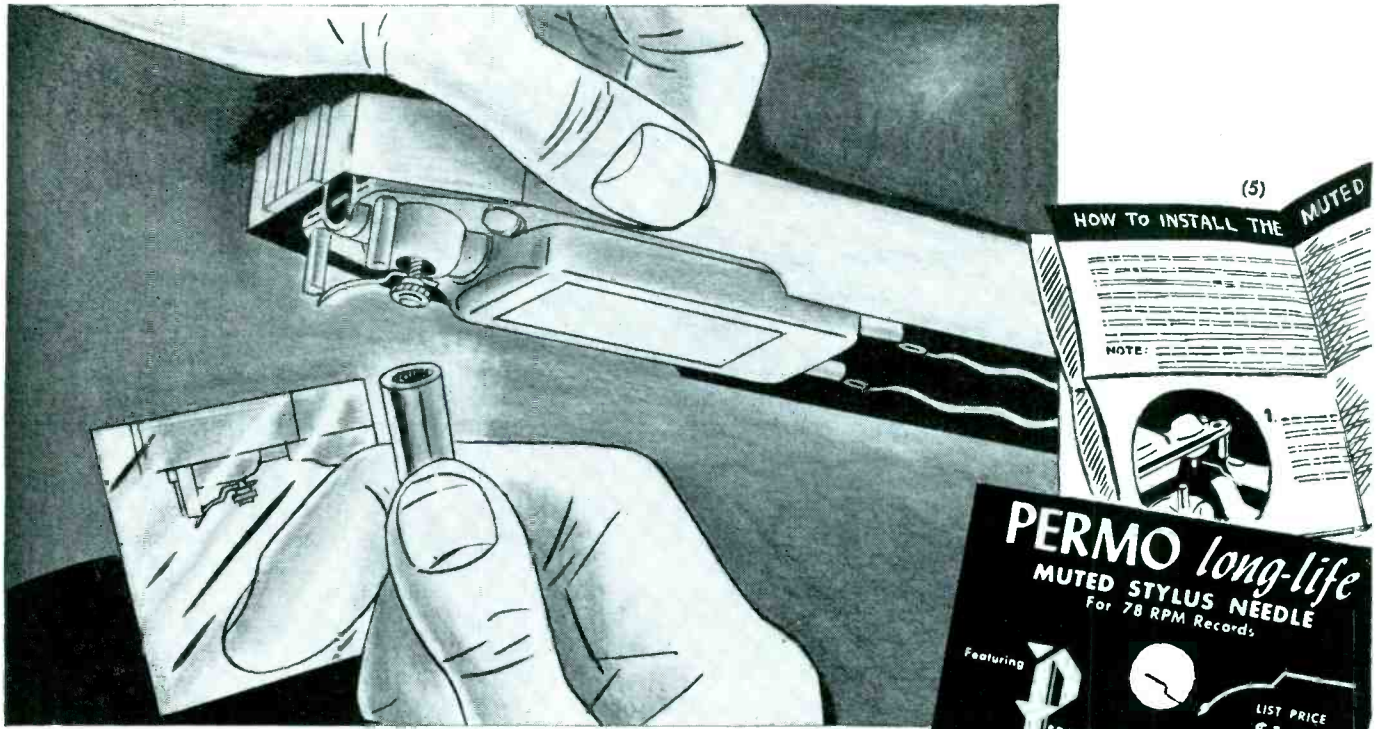

YOU SAVE TIME — MAKE MONEY — WITH
PERMO *long-life*
PHONO NEEDLES

Here's why:

1. COMPLETE "Facts" — Here is a needle replacement guide that's complete, authentic, *accurate*—one that tells *specifically* what needle goes *where*. It's Permo's "Phonograph and Needle Facts", and Permo took the time to do it right. A guide that gives you *everything* you need to know for fast, easy replacement needle sales.

2. COMPLETE NEEDLE STOCKS — Individually packaged Permo Long-Life Phono Needles come to you on convenient display cards. Each display card carries a full set of replacement needles for one manufacturer's sets.

3. REASONABLE INVESTMENT — Complete initial needle stocks and "Facts" for all post-war Admiral and Philco sets are yours for less than \$12.00 dealer cost. Make high profits selling the easy-replacement needle line—Permo Long-Life!



NO FUMBLING!

YOU GET EVERYTHING YOU NEED IN ONE PACKAGE

Permo Long-Life Phono Needles are individually packaged with *installation tools* where necessary, *spare parts* (nuts, screws, etc.) and *complete installation instructions*. The C-320 Muted Stylus package (above) for example, contains: (1) needle (2) wrench (3) mirror (4) extra nut (5) installation instructions. You get *everything* you need in one complete package when you buy Permo Long-Life needles.

NOW AVAILABLE
 Admiral, Columbia and Philco "Facts" and Replacement Needles. Others coming soon! Write for your free copies of the "FACTS".



PERMO, INC. *Champion of Perfection*

6401-33 N. RAVENSWOOD AVE.

CHICAGO 26, ILLINOIS

SERVICE, MARCH, 1952 • 39

Servicing Helps

by M. A. MARWELL

Eliminating Washout... Picture Sync Improvement... Fringe Compensator Adjustment... Picture Centering

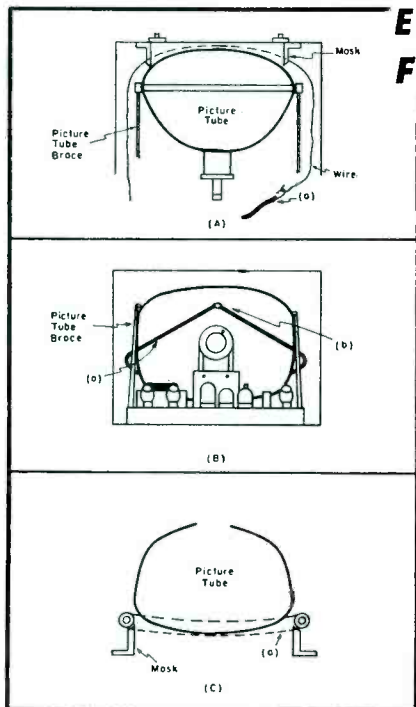
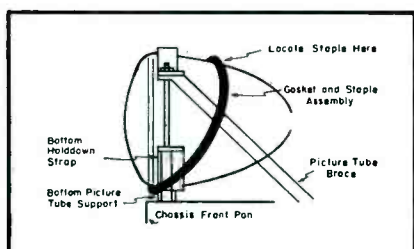

Fig. 1. Views of Sylvania chassis illustrating installation of dust seals in 17-inch models. A mask and gasket assembly may be installed with the chassis either in or out of the cabinet. With the chassis in cabinet a piece of moderately flexible wire approximately three feet long should be threaded around the inside of the cabinet in front of the picture table bottom supports, making sure that it passes above both control shafts (a). Staple should be unhooked from one end of gasket; one end wire should be attached to stapled end of gasket. Free end of wire should be pulled through until it is possible to grasp both ends of gasket at sides of chassis. Ends of gasket should then be hooked together with staple as shown in (b), making sure that gasket passes outside picture-tube braces. Finally, gasket should be pressed forward on picture tube until it falls evenly into groove between mask and picture tube as in (c).

Fig. 2. With the chassis out of the cabinet, the gasket should be stretched over face of picture tube with staple at top, making sure that the gasket lies between bottom hold-down strap and chassis front pan. Chassis should then be slid into cabinet and chassis-mounting bolts secured. Gasket should then be pushed forward on picture tube until it falls into gap between picture tube and mask, making sure gasket fits snugly.



OCCASIONALLY, WASHOUT is encountered when the contrast control is advanced to its nearly full clockwise position; the black part of the picture reaches a maximum black and then turns gray with further rotation of the contrast control. This condition has been observed in Philco chassis employing the Colorado tuner because the video level at the output stage tends to be high. Washout is actually evidence that the amplifier system is being overloaded. In those cases where washout occurs without sync instability, it is evident that the overload must occur after the sync pickoff point. In most cases, the overload occurs in the video output stage.

To correct washout, the supply point for the $B+$ to the screen of the 6AQ5 video output tube should be changed, to permit the tube to handle a large signal. (In the circuit, the screen grid is connected to the same $B+$ line as the *if* strip. Since the $B+$ at this point varies in response to the *agc* voltage or signal level in the *if* strip, the voltage applied to the video output tube screen grid will also vary in step with the change in $B+$.) The new supply point will provide a higher screen voltage and a voltage which does not vary as much with variations in *agc* voltage. It has been established that the change in screen voltage actually aggravates and contributes to the washout condition in areas of intermediate signal strength. At the same time that the screen voltage is changed, the control grid bias must also be increased. The control grid bias can be increased by changing the position of the two resistors in the grid circuit, or placing the 1.2-megohm resistor where the 1.8-megohm unit is, and vice versa.

Washout is in many cases very similar to overload of the audio system, which can be brought about simply by turning the volume control full on. In other words, washout in some cases indicates that the contrast control is being advanced too far. It should, therefore, be kept in mind that al-

though the changes suggested extends the contrast range before overload occurs, there must necessarily be some signal level at which overload will be inevitable.

In some chassis employing the Colorado tuner, it is possible that with very strong signals applied to the antenna, washout will occur when the contrast control is only about $\frac{3}{4}$ toward its maximum clockwise position. In these cases the *agc* control system to the tuner may be modified so that the signal delivered to the video output stage is maintained more nearly constant. In areas of extremely high signal level, it is also necessary to reduce the time constant in the grid of the first common *if* stage. This can be done by reducing the value of the 470-mmfd capacitor from the plate of the mixer to the grid of the first *if* down to 100 mmfd, and connecting a 40-microhenry choke across the grid resistor of the first *if*.

Picture Sync Improvement

To improve picture sync under adverse noise conditions, Emerson models 700D and 701D (chassis 120158B) coded with a *triangle A* should have the pigtail of the 2.2-megohm resistor, R_{305} , connected to the chassis instead of the +150-v line.

Triangle B chassis incorporates an adjustable type *fringe compensator*. It can be turned off when the receiver is used in strong signal areas, and adjusted for best picture performance in electrically noisy fringe areas. In most locations this added protection will not be necessary, and the fringe compensator should remain in the *off* position. Improper adjustment or application of the fringe compensator may result in excessive audio buzz or picture wobble.

Fringe Compensator Adjustment

To adjust the fringe compensator the set should be tuned to a low-

(Continued on page 64)

STIKIT-UP!

*the NEW
AMAZING*

INDOOR Directronic TV AERIAL SYSTEM

- ALL CHANNELS
- ANYONE CAN INSTALL
- ADHERES TO ANY SURFACE
- 360° ELECTRONICALLY-SWITCHED BEAM
- FLICK OF SWITCH CLEARS PICTURE

995
LIST



SNYDER MFG. CO.

PHILADELPHIA

DALIS, New York • ALMO, Philadelphia • RADIO PARTS, Chicago

FRESHMAN, Cleveland • WHOLESALE RADIO, Baltimore • KAEMPER & BARRETT, San Francisco

VAN DER HOUT, Canada • Export: ROBURN AGENCIES, New York • AND OTHER DISTRIBUTORS, EVERYWHERE

CLOSETS

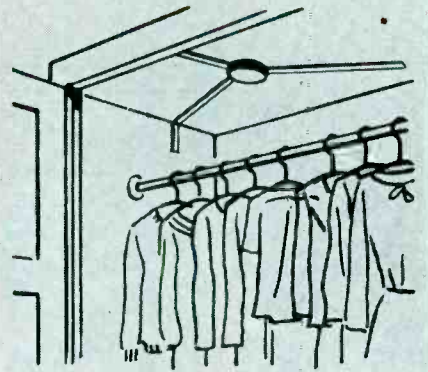

ATTICS

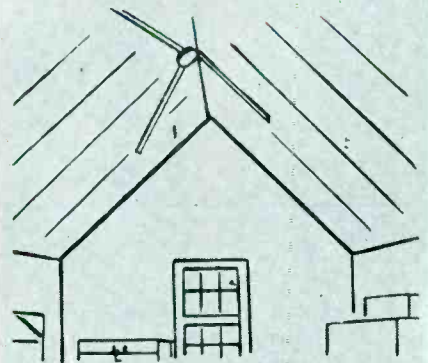

CEILING

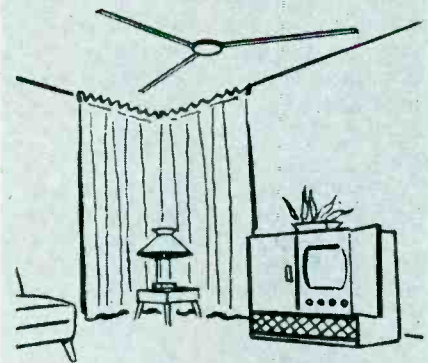

Fast-Acting AGC SYSTEMS

by CHARLES E. BOWERS

Staff Engineer, Bendix Radio

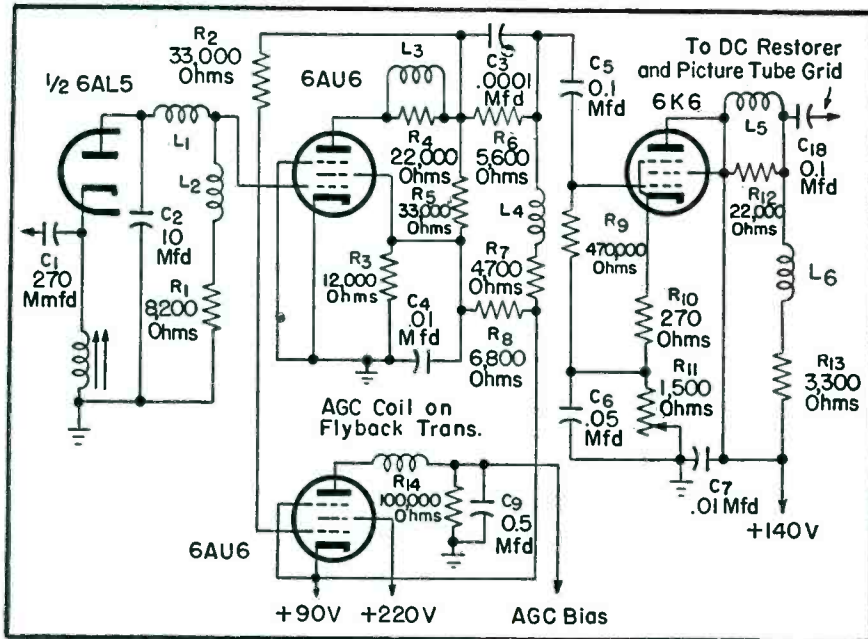

Fig. 1. Video amplifier with two video stages, in which a direct connection is made from the second detector to the grid of the first amplifier to preserve the *dc* component.

IN THE KEYED AGC systems, the keying pulse is, of course, a key factor. In the circuits illustrated and described last month*, this pulse is obtained from an additional winding on the horizontal output transformer. In experimental studies, this has been a small universal wound coil mounted over the secondary between the primary and the filament winding for the 1B3 on a standard RCA horizontal output transformer. With this type of coil it has been found that the peak-to-peak amplitude of the pulse voltage is about 300 to 350. However, the amplitude

of this keying pulse is not critical, as long as it falls within the two following limits: It must be sufficiently above the cathode-to-ground potential of the *agc* stage to assure that the tube is operating above the knee of the I_p-E_p characteristic in the high portion of that curve, so that changes in the amplitude of the keying pulse are not too important. Also, the upper limit of the pulse must not go above the plate voltage rating of the tube in use.

It is also important to remember that the cathode of the *agc* tube must always be sufficiently positive, with respect to the control voltage reference

Part III . . . Modifying Circuits for Keyed AGC Operation . . . Features of the Keyed AGC Amplifier . . . General Troubleshooting

point, to prevent plate current from flowing during any spurious variations which may take place in the plate pulse wave, such as the damping effect gotten from the horizontal output.

Keyed AGC Now in Use

The first step in changing any circuit to keyed *agc* is to make a direct connection from the second detector to the grid of the first video amplifier. The original circuit calls for a 3-volt bias on the grid, but that can be neglected if the plate voltage of this tube is dropped to 90. This also has an advantage; no special filament transformer is required for the *agc* tube since the cathode-to-filament potential is rated at approximately 100 volts.

The resistance network from the plate circuit of the first video amplifier to the *agc* tube is required to keep the tube capacity of the *agc* tube from altering the frequency response of the video stages. A 5,600-ohm resistor shunted by a 100-mmfd capacitor are inserted to help equalize the video frequency response.

The next major change is to find a source for the flyback pulse to key the *agc* tube. In the Fig. 1 circuit an additional winding on the flyback transformer has been used; about 80 turns of No. 34 enameled wire, wound on a $\frac{1}{16}$ " diameter form and slipped on the flyback transformer in the space between the main winding and the filament loop for the 1B3 high-voltage rectifier. The flyback transformer must be dismantled, and the holding

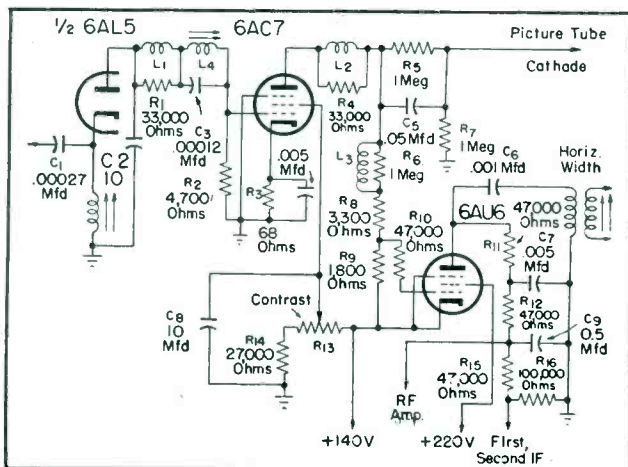
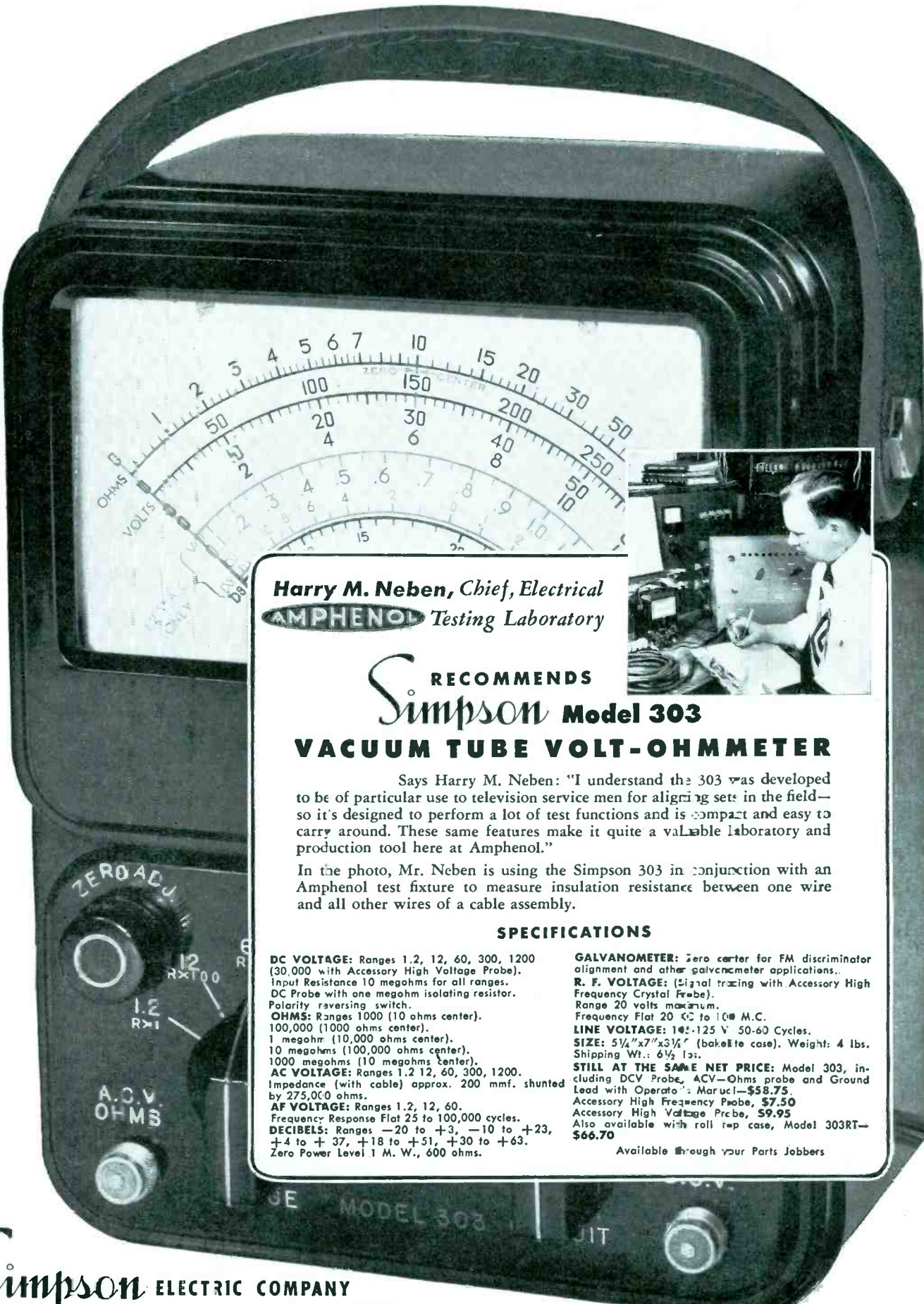

Fig. 2. Keyed *agc* circuit with single stage of video where cathode of picture tube is driven with picture signal. A 33,000-ohm resistor is used to reduce effect of peaking.

*SERVICE; February, 1952.



Harry M. Neben, Chief, Electrical
AMPHENOL Testing Laboratory



RECOMMENDS
Simpson Model 303
VACUUM TUBE VOLT-OHMMETER

Says Harry M. Neben: "I understand the 303 was developed to be of particular use to television service men for aligning sets in the field—so it's designed to perform a lot of test functions and is compact and easy to carry around. These same features make it quite a valuable laboratory and production tool here at Amphenol."

In the photo, Mr. Neben is using the Simpson 303 in conjunction with an Amphenol test fixture to measure insulation resistance between one wire and all other wires of a cable assembly.

SPECIFICATIONS

DC VOLTAGE: Ranges 1.2, 12, 60, 300, 1200 (30,000 with Accessory High Voltage Probe).
 Input Resistance 10 megohms for all ranges.
 DC Probe with one megohm isolating resistor.
 Polarity reversing switch.
OHMS: Ranges 1000 (10 ohms center), 100,000 (1000 ohms center), 1 megohm (10,000 ohms center), 10 megohms (100,000 ohms center), 1000 megohms (10 megohms center).
AC VOLTAGE: Ranges 1.2, 12, 60, 300, 1200. Impedance (with cable) approx. 200 mmf. shunted by 275,000 ohms.
AF VOLTAGE: Ranges 1.2, 12, 60. Frequency Response Flat 25 to 100,000 cycles.
DECIBELS: Ranges -20 to +3, -10 to +23, +4 to +37, +18 to +51, +30 to +63. Zero Power Level 1 M. W., 600 ohms.

GALVANOMETER: Zero center for FM discriminator alignment and other galvanometer applications.
R. F. VOLTAGE: (Signal tracing with Accessory High Frequency Crystal Probe). Range 20 volts maximum. Frequency Flat 20 KC to 100 M.C.
LINE VOLTAGE: 100-125 V 50-60 Cycles.
SIZE: 5 1/4"x7"x3 1/4" (bakelite case). Weight: 4 lbs. Shipping Wt.: 6 1/2 lbs.
STILL AT THE SAME NET PRICE: Model 303, including DCV Probe, ACV-Ohms probe and Ground Lead with Operator's Manual—\$58.75. Accessory High Frequency Probe, \$7.50. Accessory High Voltage Probe, \$9.95. Also available with roll top case, Model 303RT—\$66.70

Available through your Parts Jobbers

Simpson ELECTRIC COMPANY

5200 W. Kinzie St., Chicago 44, Illinois Phone: COLUMBUS 1-1221
 In Canada: Bach-Simpson, Ltd., London, Ont.

World's Largest Makers of Electronic Test Equipment

BURTON BROWNE ADVERTISING

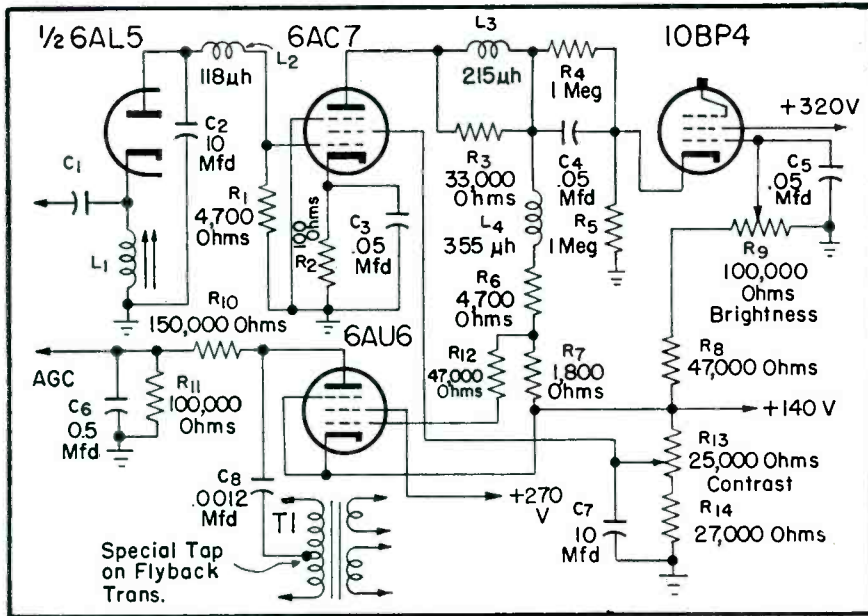

Fig. 3. A keyed *agc* circuit featuring use of a single 6AC7 video amplifier, with *agc* voltage obtained through voltage divider and decoupling net; 4700, 1800 and 47000-ohm resistors.

clamps removed, and the powdered iron core pushed out. Then, the main winding and its bakelike form can be slid out, and the *agc* coil slipped in place.

In place of the contrast control previously used a 1,500-ohm potentiometer must be connected in the cathode lead of the 6K6 video output tube. The .05-mfd cathode bypass should be located close to the cathode pin of the 6K6 and returned to the same ground as the .01-mfd screen bypass. If this is done a long lead can be brought to the contrast control mounted on the front panel.

A keyed *agc* system, which is very effective, is shown in Fig. 2. A single stage of video amplification is used here, and the cathode of the picture tube is driven with the picture signal. Since a direct connection exists between the second detector and the video amplifier and then to the pic-

ture tube, no *dc* restoration is necessary. The picture signal is brought to the grid of the *agc* tube through a voltage divider and decoupling network, consisting of 3,300, 1,800 and 47,000-ohm resistors in the plate circuit of a 6AC7 video amplifier. The cathode of the *agc* tube is connected directly to the 140 volts *B+* point, and although this means that the cathode-to-filament potential is higher than rated, actual life tests have shown that as long as this is a *dc* potential no harm will be done to the tube.

The screen grid of the *agc* tube is connected to a convenient source of about 220 volts *dc*. The plate receives the flyback pulse through a 1,000-mmf coupling capacitor from a special winding over the horizontal width control. The other side of this winding is connected to ground and polarities chosen so that a positive pulse reaches the plate of the *agc* tube. This

special winding provides a reduced cost in production, since changes or additions in the flyback transformer are much more costly than another winding over the horizontal width coil.

The contrast control consists of a voltage divider which determines the screen grid voltage of the 6AC7 video amplifier and thus the gain of that tube. The range of the contrast control is from about 65 to 140 volts, sufficient to give a proper picture or cut off the video signal completely. The *agc* bias filter and voltage divider are unconventional, only inasmuch as a slightly larger bias is applied to the *rf* amplifier than to the grids of the first two *if* stages.

In a variation of the keyed *agc* network, used in the previously mentioned receiver, a single 6AC7 video amplifier is used, as shown in Fig. 3; the *agc* voltage is obtained through a voltage divider and decoupling network consisting of 4,700, 1,800 and 47,000-ohm resistors. The contrast control is the same as in the previous model, but the method of obtaining the flyback pulse is different. Here, a special tap has been incorporated in the horizontal flyback transformer and the pulse coupled from that tap through a 1,200-mmf capacitor to the plate of the *agc* tube. The filter and voltage divider network for the *agc* bias are also different, providing a short time constant for fast *agc* action.

Field Test Results

Actual field tests of this circuit in the New York area indicated greatly improved noise characteristics especially on channel 13, received poorly in many locations. The *agc* bias voltages varied from 5 to 2 volts negative from channels 4 to 13 in one location, where the former was received with about 5,000 microvolts, and the latter (Continued on page 76)

Fig. 4 (right). Basic circuitry of a keyed *agc* amplifier.

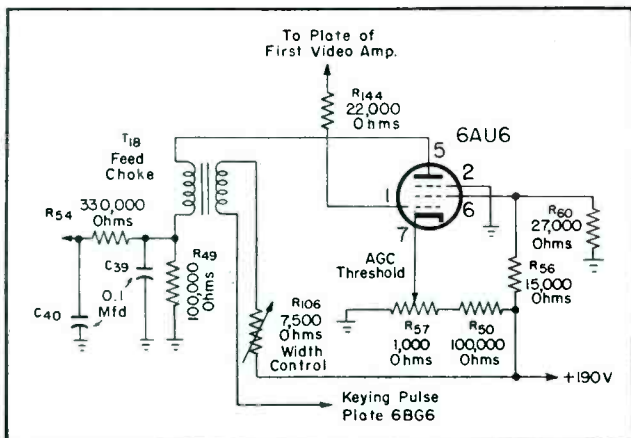
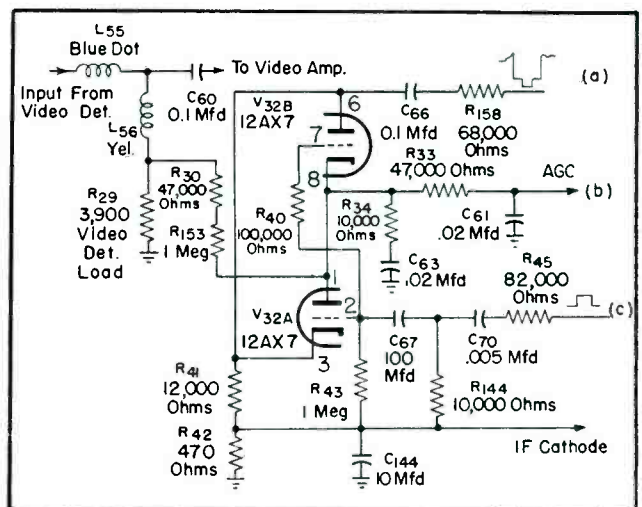

Fig. 5. Simplified circuit of a keyed *agc* system.



the tower servicemen dreamed up!

the TEL-A-RAY

SWING-OVER * TOWER

A serviceman's dream — an antenna tower that swings over to the ground for servicing — now being produced by Tel-a-Ray! The Swing-Over Tower makes all other types obsolete because it is the easiest tower for servicing ever made. Built from steel angles with welded construction, the Swing-Over Tower is guaranteed to withstand wind and weather. Yet one man can lower the tower top to the ground, or raise it, in just three minutes. Competitively priced and guaranteed, the Swing-Over Tower will be your biggest item in 1952.

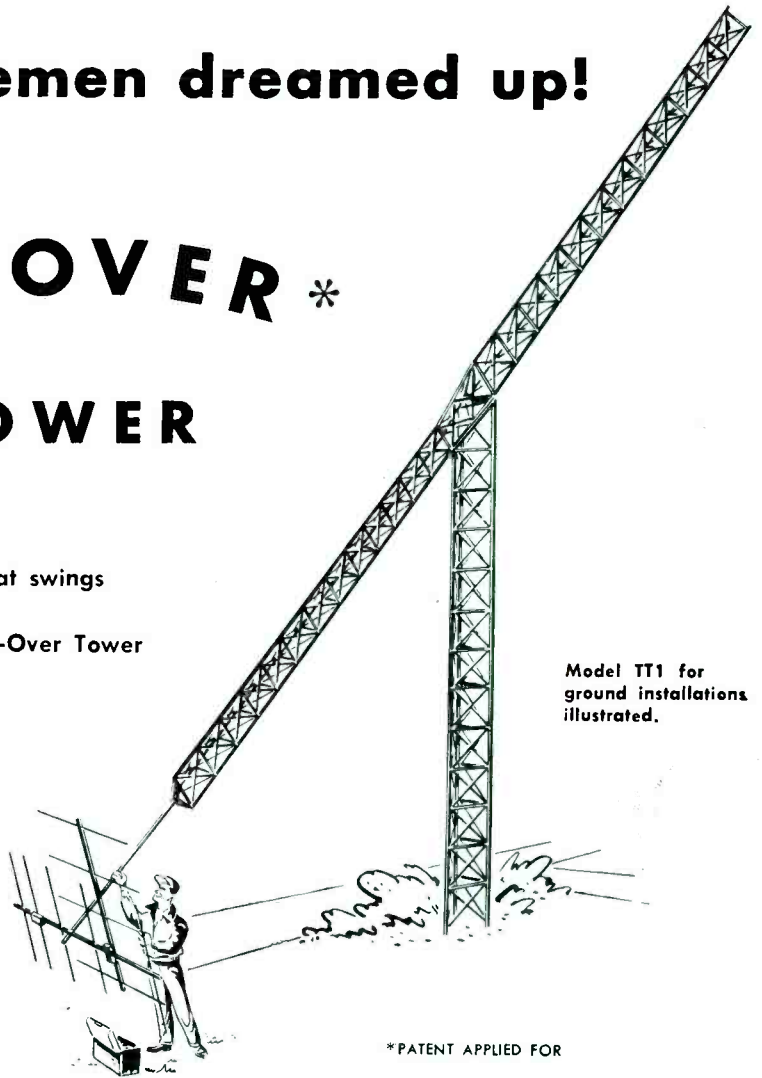

Model TT1 for ground installations illustrated.

*PATENT APPLIED FOR

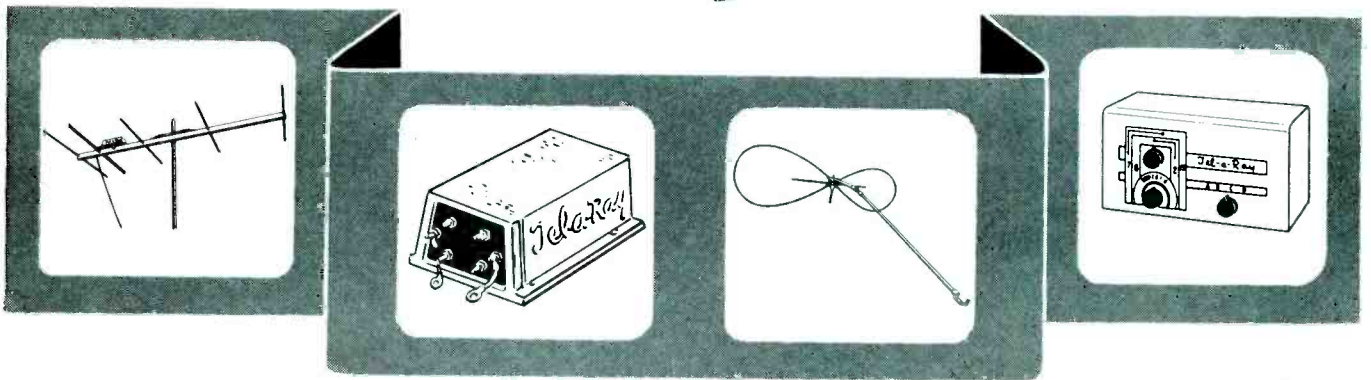

These Tel-a-Ray products are bringing more and better reception to television viewers every day . . . and bigger profits to their dealers: Left: The Model T antenna pulls in good reception up to 200 miles away! Cannot rust or corrode. Perfect for all fringe area reception. Left center: To complement the Model T antenna, the only antenna-mounted, low-cost preamplifier on the market, the model TB. High signal gain, low noise ratio make it outstanding.

Right center: The low-priced Butterfly antenna . . . receives 13 channels and FM radio in primary areas . . . completely guaranteed . . . swivel-mount permits erection anywhere! Right: The new Switching Booster (Model PTB1) — for areas where more than one channel can be received with separate antennas. Switches channels and antennas with one knob. Four antenna inputs. Furnishes high gain from antenna and voltage for four preamplifiers. A necessity in the fringes.

WRITE TODAY FOR COMPLETE INFORMATION

Tel-a-Ray
ENTERPRISES, INCORPORATED
 BOX 3325
 HENDERSON, KENTUCKY

Speeding Up

Part II . . . Accelerating Trouble Shooting Through Careful and Deliberate Checks...Use of Measurement Equipment Properly . . . Gain Checks . . . Avoiding Misleading Voltage and Resistance Readings . . . Using Correct Parts in the Proper Part of the Circuit... Systemic Application of Circuit and Analysis Data . . . Typical Examples of Troubles and Cures

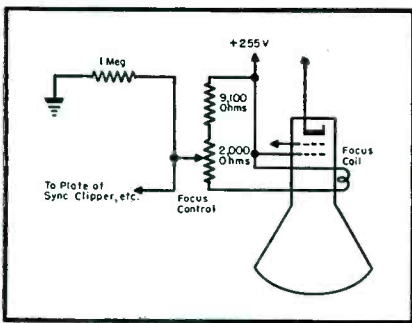

Fig. 1. Partial schematic of Motorola TS-52, showing focus circuit.

Fig. 2. Setup which can be used to check for a leaky paper or mica capacitor, one end of the capacitor being connected to a high potential point, the other end unsoldered and placed in series with a voltmeter to ground.

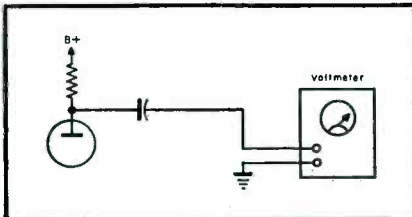

Fig. 4 (right, below). Circuitry which illustrates problem when C_1 is shorted, placing C_2 from grid to ground of first audio stage, when the pot is all the way up. Grid is shorted to ground through C_2 .

AS A RULE, only inexperienced technicians fail to make necessary checks, noting how the operation of various controls affect the symptoms of trouble, or failing to observe or to follow through on obvious clues from the picture tube or speaker. Possibly the greatest time-waster for some more experienced Service Men is the failure to localize the trouble to a defective stage. Suppose, in a split sound set, sound and raster are okeh, but the picture information is missing. The trouble is in the video strip; the video *if* stage, video detector or video amplifiers. To start a voltage and resistance check of the whole strip, to find the bad component, instead of first locating the defective stage is unnecessarily time-consuming. The same is true of any trouble which may originate in more than one stage. Some method should be used, if at all possible, to find the defective stage before looking for the defective part. This, of course, is the great advantage of good test equipment, such as a 'scope and a signal generator. They can help considerably in tracking down the defective stage quickly in many kinds of trouble.

Failure to change a bad tube is an-

other common oversight. Usually, other tubes are changed, but for some reason the bad one is overlooked. Once in a while, the Service Man will have the unfortunate experience of replacing one bad tube with another bad tube, and not finding out the sad news until some time later, when all the other possibilities of trouble have been eliminated. The moral of this is: Make certain all replacement tubes are good by checking them, if necessary, on an operating set.

All TV Service Men realize the importance of changing tubes first, before spending time on further troubleshooting. When a tube is not changed, it is not usually because of carelessness, but because of a failure to realize how it affects circuit operation. As an example, on one occasion, horizontal tearing appeared in an RCA ST241. All of the horizontal and sync tubes were changed in the home, or at least the Service Man thought so, and no improvement was noted. The chassis was pulled. In the shop, a check with the schematic showed that $\frac{1}{2}$ of a 6AL5 was used as a video detector and the other half as a clamping diode in the sync section. This tube had

Fig. 3. Use of a 'scope as an *ac* voltmeter. In (a) the 'scope is calibrated, with a 6.3-volt test signal, which is 18 v p to p . When test signal is made, three boxes high, each box equals 6 v . In (b), method of measuring amplitude of a waveform in circuit is shown. Since the observed waveform is two boxes high, it has a peak-to-peak voltage of 12; $6 \times 2 = 12$ v .

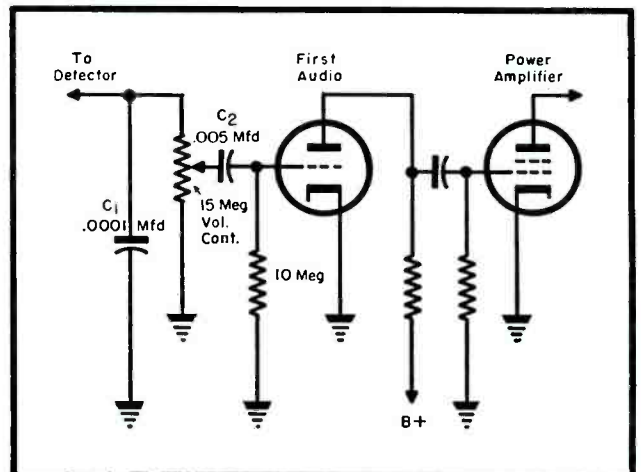
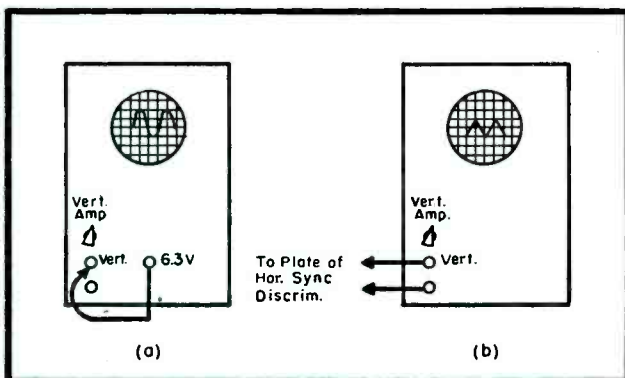

TV TROUBLESHOOTING

by **CYRUS GLICKSTEIN**

American Radio Institute

not been changed previously. Changing the tube cured the trouble.

In the second point under faulty techniques, we have the problem of unnecessary checks. Generally, if a necessary check is omitted, a great many unnecessary ones will be performed before the trouble is found. But aside from such situations, there are other instances where unnecessary checks are made. Most Service Men at some time have tracked down trouble to a particular stage and then have made complete measurements around that stage several times, without seeming to be able to put their finger on the trouble. Very often this situation occurs because the Service Man is reluctant to make the obvious deduction about the part which is at fault. This generally is true when he does not have a replacement part on hand and the component is one he prefers not to buy, unless he is certain the part in the receiver is defective.

An interesting example of the latter problem occurred in a Motorola receiver, model TS-52, with a defective focus coil. Sound was normal and pix information appeared to be okeh, but it was impossible to focus the picture properly. Turning the focus control had no effect at all on the focusing. A resistance check of the focus control showed the correct resistance value, according to the schematic. A voltmeter was placed across the focus coil and the focus pot was rotated. There was a normal variation of voltage across the focus coil as the pot was turned, indicating a normal change in the amount of current going through it. A resistance reading across the focus coil was inconclusive, since the schematic did not show any resistance value for the coil. Since all of the other components in the circuit checked properly, it was obvious that the focus coil was the culprit. Yet, the Service Man repeated the measurements several times. For some time, he was unwilling to accept the possibility of a defective focus coil, because he had no replacement on hand to check the diagnosis.

In another example, vertical fold-over appeared in a Crosley, chassis 331. The trouble had been traced to

the vertical oscillator stage by a quick check with a 'scope. Careful voltage and resistance measurements were made, but the circuit checked normal. No capacitors checked leaky, but they were replaced. A good deal of time was used in making repeated checks, although the possibility of trouble had actually been narrowed down to the only other component in the circuit, the blocking oscillator transformer.

To avoid unnecessary repetition of measurements, certain rules are helpful:

(1) An ohmmeter, when operating, gives reliable information concerning the value of resistors. The cold value and value under operating conditions will not be appreciably different.

(2) Paper and mica capacitors can be checked for leakage most effectively by having one end connected to a high-potential point and the other end unsoldered. A *dc* voltmeter should then be placed in series with the capacitor to ground. A leak will show up as a steady voltage reading on the meter, with the set on.

(3) To check whether there has been a change of capacity in a capacitor, a different capacitor of the correct value should be substituted.

Suppose, then, trouble has been localized to a given circuit, such as the Crosley horizontal oscillator circuit, previously mentioned. We find the tube had been changed for a known good tube. Ohmmeter readings showed that the resistors had not changed value. Capacitors were not leaky, but substitutions were made on the possibility that one or more may have changed value. The trouble still existed. The only other component in the stage was the transformer which provided a normal resistance reading. The Service Man at this point, had to blame either the transformer or gremlins. Repeating the readings around the circuit just once would be desirable, to recheck the capacitor and resistor situation. But there is very little point in an endless repetition of readings or going off to check another stage, simply because a replacement is not immediately available for the one component in the circuit which is indi-

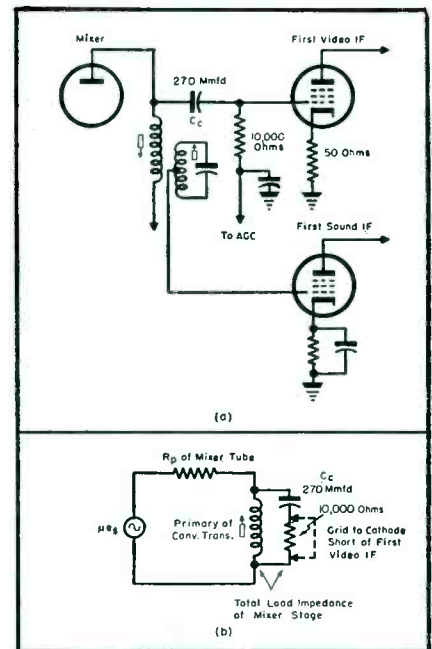

Fig. 5. Circuits illustrating (a) grid-to-cathode short in the first video if stage, which shorts out both pix and sound. In (b) appears an equivalent circuit of a mixer stage, which shows how such a short reduces the total load impedance of the stage. As a result, there is no output from the mixer.

cated as defective, even though the defect may not show up conclusively in a resistance check.

There often appears the situation which results in unnecessary repetition of measurements. This occurs when an inconclusive method is used to find a defective stage. For example, sound may be low, but video information is normal. Disturbance tests are used to try to find which stage in the sound strip has low output, but the tests are not conclusive. Instead of repeating the disturbance tests several times or starting a voltage and resistance check around the entire audio strip, it is preferable to switch to another, *more conclusive method* to find the defective stage; *gain checks*. It is a simple matter to feed in an audio signal to the grid of the *pa* stage, not the output, turn down the gain until the signal can barely be heard, and then feed the signal into the grid of the preceding stage, the first audio. The amount of amplification can be noted. This test can be repeated in the *if* stages using an *AM if signal*. In more difficult cases, the actual gain per stage can be measured.

In the third faulty technique point we find the problem of readings which mislead. Most Service Men, early in their career, learn how to interpret

(Continued on page 65)

Here's why it saves you Centralab switches —

*You'll get the switch you want...when you want it...at one source!
Your nearby Centralab distributor offers the most complete line of
switches, kits and parts available to the industry!*

"If it's available at all — my Centralab distributor will have it."

That's what more and more servicemen are saying. And that's why the trend to Centralab is growing every day. Today's servicemen know that Centralab carries the most complete line of switches and switch parts available to the industry.

If you need standard or special-purpose switches for AM, FM or TV repair, intercom installations, P. A. systems or medium-duty power applications — your

Centralab distributor has them in stock. Single- and multi-pole. Rotary or lever action (phenolic or steatite). Shorting or non-shorting contacts.

If you are building your own switches for test gear, etc. — you'll find switch parts, indexes, kits in Centralab's standard or "DD" line that meet your requirements. And that goes for highly rated switches for custom installations or high fidelity power supply, too.

When you need switches or switch parts, make your choice Centralab — the most complete line available.

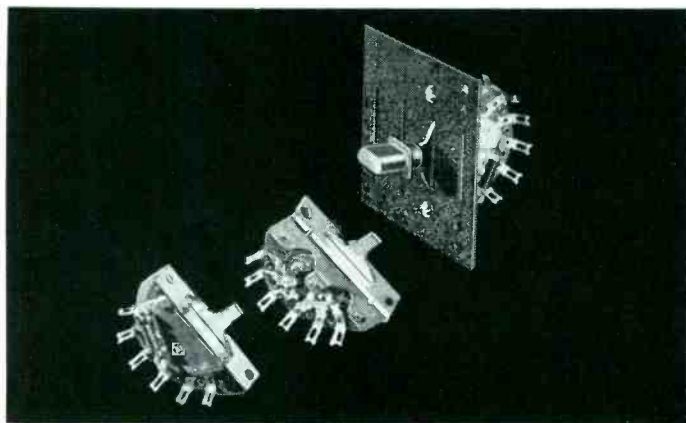

LEVER ACTION SWITCHES—for speech input equipment for line and program switching—monitoring, transceivers, band change, P. A. and intercoms, model railroad systems and industrial test equipment. Available in positive, spring return or combination. Coil spring index has minimum life of 150,000 switching cycles.

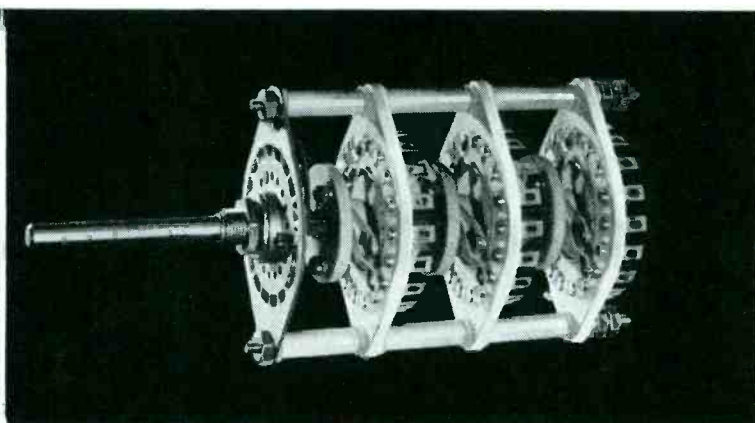

MEDIUM DUTY ROTARY SWITCH — for medium high power and excellent accuracy in transmitter, industrial control and balancing, laboratory testing, power supply converter and many other special applications. Rated at 750 watts ($7\frac{1}{2}$ amps, 60-cycle, 115 volts AC). 1, 2 or 3 poles... 18 contact sections... up to 20 sections per shaft.

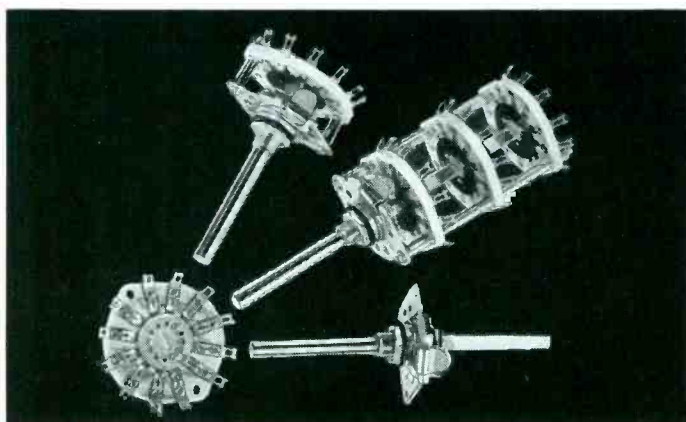

ROTARY SELECTOR SWITCHES — for use in fast, positive band switching in critical radio frequency circuit applications — in the oscillator, buffer or final amplifier stages of transmitters with input up to 75 watts and plate voltages up to 850 v.d.c. Also amateur rigs, test equipment and low current switching. Steatite or phenolic insulation.

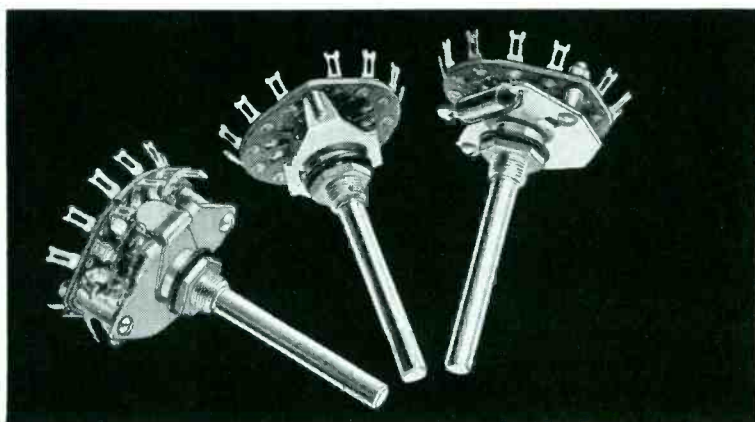

ROTARY ACTION FLAT SWITCHES—for program switching — monitoring, transceivers, band change, P. A. and intercoms. Phenolic insulation. Cadmium plated metal parts. A 4-pole, 2-position, non-shorting type with positive leaf spring index. Can be used a SPST, SPDT, DPST, DPDT, 3PST, 3PDT, 4PST or 4PDT.

time and money to buy



SMALL GENERAL PURPOSE SWITCHES—on-off and step control switches for radio, P. A. channel selectors, wave band, meter reversing, meter selector, intercom talk-listen,

momentary line or remote speaker return and dual auto radio speaker control. Clips and contacts heavily silver plated. Phenolic insulation. SPST, SPDT, DPST, DPDT, etc.

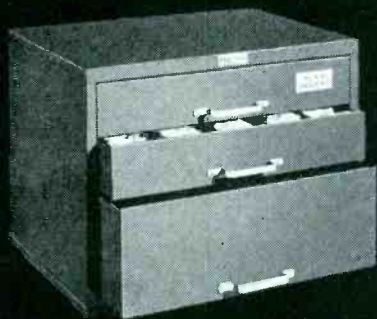

414-419 ROTARY SWITCH KITS—give you a convenient, easily available source of stock sections, indexes and hardware for assembling practically any standard or special switching arrangement desired. Contain Centralab "DD" Index and Section construction. Attractive steel cabinet, fits standard steel shelving. 17" x 11¹/₆" x 12³/₄".



1500 SELECTOR SWITCH KIT — ideal convenience for labs, design and service engineers, industrial electronic maintenance departments, hams and experimenters. 33 standard rotary switch phenolic sections, 16 index assemblies and adequate supply of flat shafts, spacers, nuts, bolts, lockwashers and knobs. 8" x 8" x 7".

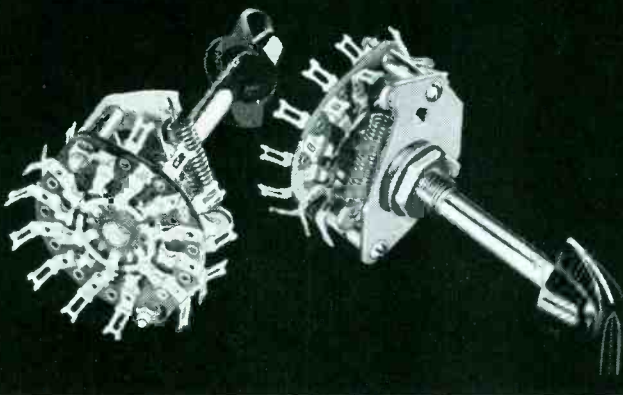

INTERCOM SWITCHES — for public address and intercom talk-listen systems. Six pole, 3 position. Available in two types — spring return from both sides to center and spring return one side, positive opposite side. For long, hard use in industrial test equipment. They are Centralab De luxe, "DD", style.

Centralab

A Division of Globe-Union Inc.
980 E. KEEFE AVE., MILWAUKEE

Get the whole story of Centralab switches for electronic and industrial uses. Write for Centralab Catalog.



ASSOCIATIONS



ESFETA

DELEGATES and guests from seven associations in New York State were present at a recent meeting of the Empire State Federation of Electronic Technicians Associations held in Poughkeepsie, N. Y.

Methods of increasing interest of Service Men in existing associations and in forming new associations were discussed. Exchange of ideas was urged, and an invitation was extended to the secretaries of all associations within the state and of federations of other states. Ed Fisk, 234 Knickerbocker Ave., Rochester, N. Y., was named as the coordinator of the plan.

The next meeting of the group will be held in the Hotel Arlington, Binghamton, April 27.

ARTSNY

AT A RECENT meeting of the Associated Radio and Television Servicemen of New York, Max Liebowitz was re-elected president. Ted Kaumont was elected vice president; O. Capitelli, re-

cording secretary; John Wagonny, corresponding secretary; Edward Eisen, treasurer; and Jack Katz, sergeant-at-arms.

Many different types of test instruments have been donated to the club room by various manufacturers. A variety of servicing material has also been contributed for the clinic and library.

RTG, FLORIDA

AT THE FIRST annual installation dinner of the Radio and Television Technicians Guild of Florida, Dade County Chapter, at Jackie Heller's Dinner Key Terrace Restaurant, the newly elected officers were officially installed. Among those at the dinner were Bob Collins, president; O. E. Smith, vice president; S. J. Petruff, secretary; A. E. Stevens, treasurer, and Charles W. Davis, John C. Gilbert, John E. Lockhart, John C. Ryan, Shan DesJardin, Samuel Kessler, Thomas Middleton, and R. H. Smithey, Jr., members of the board of

directors. Guest for the evening was Mayor Chelsie J. Senerchia.

Sam Kessler was chairman in charge of arrangements.

RTSA, Pittsburg

GEORGE SHARPE has been elected president of the Radio Television Servicemen's Association of Pittsburgh.

B. A. Bregenzer has been appointed program chairman, and will also act as editor for all news pertaining to the association.

TEN YEARS AGO

From the Association News Page

MASTER RADIO SERVICEMEN, INC., of N. Kentucky and Greater Cincinnati, announced a mutual assistance agreement with radio station WCKY, and received two spot announcements daily, stating that the work of each individual member is guaranteed by the entire association. E. C. Helmers was elected president of the association. Others elected were: William Stephenson, first vice president; William Halpin, second vice president; Ray S. Rohrer, treasurer; and Bob Pepper, secretary. . . . Radio Serviceman's Association of Pittsburgh held a dinner at the Hotel Keystone in honor of Dr. G. A. Scott, Dean of the College of Electrical Engineering, University of Pittsburgh. After the dinner, Dr. Scott addressed the association on the subject of *Electronics and Radio*. . . . Edward Nowicki, owner of Voss Sales Co., of Nanticoke, Pa., was host to the Radio Serviceman's Association of Luzerne County, the radio amateurs of this region, and the staff of WBAX, Wilkes-Barre, Pa., at the Nanticoke Quoit Club Rooms, Nanticoke, Pa. C. Foster Hick was master of ceremonies and introduced the officers of the association: Edward Buckman, president; J. Austin Renville, vice prexy; John Kennedy, treasurer; Walter Neeld, secretary; and the board of directors which included C. F. Hick, Dan Davis, Edward Tischler, Spencer Eddy, Pat Maneval and Edward Nowicki. Arrangements were made for John F. Rider to address the association.

During a recent meeting of the Long Beach Radio Technicians Association, Long Beach, Calif., when the executive body presented to Harry E. Ward, public relations officer, a life membership in the RTA of southern California, in appreciation for his fine efforts for the past years serving in that capacity. President Hal Myers (standing) presented the award. Ward, public relations officer for eleven years, will retain the position in the national field. Ward is also chairman of the radio-television committee of apprenticeship training, and also secretary to the over-all committee for all allied apprenticeship training. He is also a member of the Television Arts and Sciences. Looking on during the presentation: Left, Les Huckins, secretary of the RTA, and seated (right), Charles Becken, an apprentice soon to graduate.



Selenium Rectifiers†

SELENIUM RECTIFIERS are claimed to be a long-lived and trouble-free component; yet instances do occur when faulty operation may appear. This may be due to the rectifier becoming open circuited, short circuited, high in forward resistance, or low in reverse resistance. If trouble occurs, a visual inspection of the rectifiers and other components of the power supply may show whether replacement is necessary. As failure is not always accompanied by physical changes, an electrical test may be necessary to determine whether the rectifier is damaged.

Removal and Replacement

In soldering or unsoldering of leads to a selenium rectifier, a heated soldering iron should not be brought in contact with the plates making up the rectifier. The heat may melt the alloy on the plates or damage the protective coating.

The rectifier should be replaced in its original position, or in a position which provides better cooling. Best cooling is obtained when the rectifier is mounted with the plates vertical and when the passage of air through the plates is not restricted at the top or bottom.

When replacing a rectifier it must be firmly fixed in place so that it cannot turn and come in contact with the chassis, other components, or wiring of the set. Any barriers provided by the set manufacturer for this purpose which have become damaged should be replaced.

Rectifiers receive a moisture resistant coating before leaving the factory. Additional coatings should not be applied unless it is first determined from the manufacturer that the coating to be used will not affect the rectifier.

Mercury vapor is very harmful to selenium rectifiers and will destroy the rectifying action, even though they have been coated. Any mercury remaining due to a broken mercury-vapor tube should be carefully removed.

In radio and TV chassis, a line resistor is connected in series with the rectifier. While omission of this resistor will increase the voltage of the B+ supply, it serves an important purpose in protecting the rectifier and capacitor from heavy surge currents. These currents may damage or shorten the life of the rectifier or electrolytic.

†From an article by Walter F. Bonner appearing in *Replacement Guide*, published by Federal Telephone and Radio Corp., 100 Kingsland Rd., Clifton, N. J.; priced at \$.50.

IT'S CARTRIDGE

Check-up TIME!

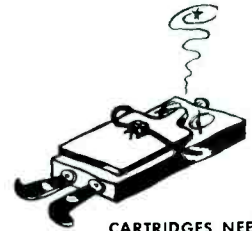
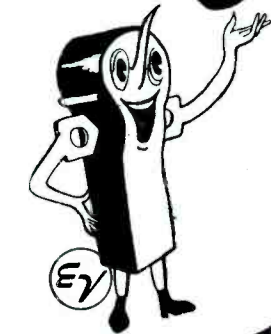

CARTRIDGES NEED NOT BE COMPLETELY DEAD TO NEED REPLACEMENT

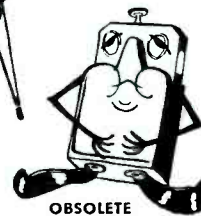

This is a good time to contact record-player owners and check the condition of their phono-cartridge. If it is not reproducing properly or is causing excess record and needle wear, chances are the cartridge has deteriorated or is obsolete—and should be replaced. You'll make new replacement sales, and open the way to other service business, too! A modern, lightweight, compliant E-V cartridge will give fullest record enjoyment and longer record life. You can demonstrate the difference. Remember, you can make most replacements with fewer E-V models!

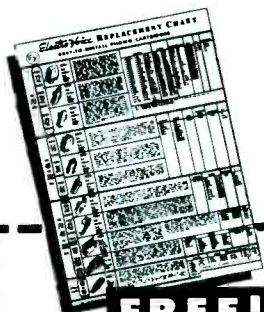
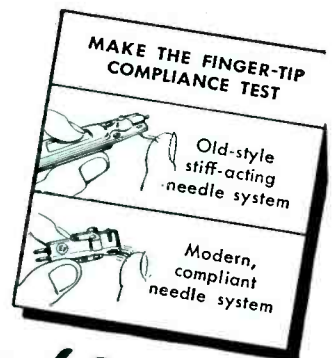

FREE!

REPLACEMENT CHART
Large, Complete Replacement Chart. Gives handy cross-reference and valuable data. Tells when to replace a phono-cartridge. Ask your E-V Distributor or send for it now.

Electro-Voice INC.

411 CARROLL STREET • BUCHANAN, MICHIGAN
Export 13 East 40th St., New York 16, U.S.A. Cables: Arlab
TV BOOSTERS • MICROPHONES • HI-FI SPEAKERS • PHONO-PICKUPS

Electro-Voice, Inc., Dept. S3-2
411 Carroll St., Buchanan, Michigan
Send FREE Cartridge Replacement Chart.

Name
Address (PLEASE PRINT)
City Zone State
 Service-Technician Dealer Record Fan

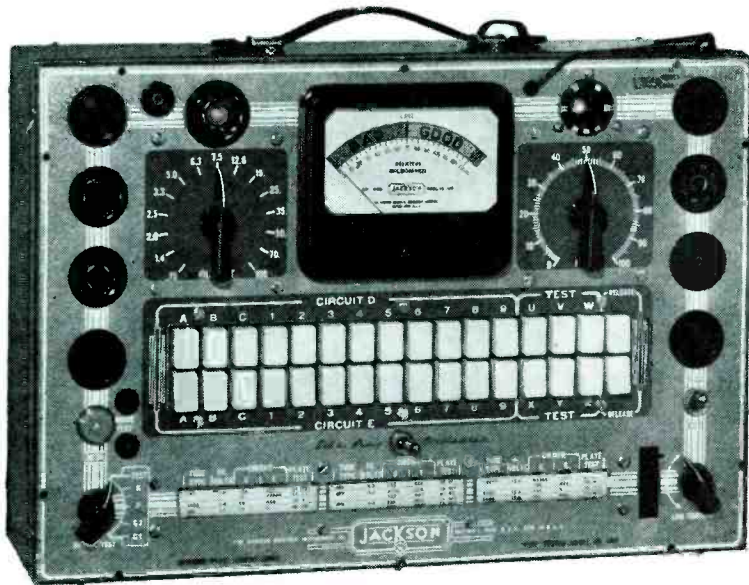

Tape-Disc Amplifier

(Continued from page 38)

by connecting a scope across the 100-ohm resistor and applying this voltage to the vertical deflection plate through the appropriate amplifier. An audio oscillator can then be applied to the horizontal deflection plate through an amplifier and adjustments made so as to procure lissajous type figures in which the frequency of the bias can be established against the known frequency of the audio oscillator. For all practical purposes, this critical adjustment is not necessary. Frequently amplifiers are used in which the bias frequency may be adjusted anywhere from 30 to 50 kc.

After the bias frequency has been established, it is then necessary to adjust the bias current. This is accomplished by adjusting the 10-160 mmfd trimmer until a voltage of .3 is read across the 100-ohm resistor, which had been placed in series with the (orange) lead of the recording head. If it is necessary to drastically change the original setting of the trimmer, it may be well to recheck the bias frequency.

After the bias has been adjusted, it is then necessary to establish the recording level. Quite likely, the neon bulb will just fire on the proper recording level. This recording level represents $\frac{1}{4}$ milliamp flowing through the recording head. To definitely check this current, the 6AU6 tube should be moved from its socket; this will eliminate the bias source and then only the recording level or the recorded signal will be measured as voltage across the 100-ohm resistor which is in series with the orange lead of the recording head. After this has been definitely established at .025 volt, which would represent the $\frac{1}{4}$ milliamp flowing through the head, the 6AU6 bias oscillator tube can be again placed in its socket and immediately the voltage will go back up to the .3 volt across the 100-ohm resistor which is the bias current. What actually happens in tape recording is that the audio or modulating signal will modulate the 40-kc bias in the recording head.

It is frequently desirable to record from the microphone when recording from phono records. This type of recording can be used when it is desirable for one to sing or play a musical instrument into the microphone in accompaniment with music recorded on phonograph records. This can be accomplished by adding a 2-megohm volume control and a double-pole, single-throw switch which can be attached to the volume control proper. The

Dependable—Simple—and, "Service-Engineered"

JACKSON "Dynamic" Tube Tester

Here is the tube tester used and recommended by manufacturers, laboratories and smart service organizations. Uses the "Dynamic" principle, pioneered by Jackson. Here are just a few of its major features.



Sequence Switching—no obsolescence with this amazing switch. Simple to use. Tube elements not connected together. Each element gets the right load or the right voltage.



Complete Shorts and Noise Tests

You test every element for shorts. Because tube elements are tested separately, you get a true picture of tube operation. Switch position shows which element is shorted—helps you locate source of circuit trouble.



Life-Line Indicator

Reduces normal heater or filament voltage. Tells you if tube is approaching the end of its life. Helps avoid troublesome call-backs. Insures more satisfied customers.

There are many more advantages to this fine Jackson tube tester—big, 4" meter—sockets for every type of tube, including sub-miniatures, blanks for future types—built-in roll chart. For the complete story, fill in and mail coupon today.

Available in bench, counter, or portable styles. Prices as low as

\$94⁵⁰

Jackson Electrical Instrument Company
Department 48
16-18 S. Patterson Blvd.
Dayton 1, Ohio

Gentlemen:

Please send information on:

- Model 648 Tube Tester Complete Jackson Line
 Low Cost Challenger Line TV Instruments

NAME _____

ADDRESS _____

CITY _____ ZONE _____ STATE _____

MY DISTRIBUTOR IS _____

JACKSON

"Service-Engineered"
Test Equipment
Dayton 1, Ohio

Tube Testers—Television Generators—
Oscilloscopes—AM-FM Generators—
Audio Oscillators—Condenser Check-
ers—Vacuum Tube Voltmeters.

*TM REGISTERED U. S. PATENT OFFICE

switch used on the volume control can be a standard switch.

When it is desirable to mix microphone with recorded phono records, it is first necessary to establish the microphone recording level by setting the controls for tape recording of microphone. It is then necessary to rotate the 2-megohm volume control so as to close the double-pole, single-throw switch. This will then connect the phonograph input into the grid circuit of the second section of the 12AX7. The control should be advanced to the point where the volume level of the recorded music and the microphone is approximately correct when heard through the loudspeaker. Normally, when recording from microphone, the speaker is eliminated from the output circuit to minimize the feedback effect from the speaker back to the microphone. In this setup, it will be necessary to keep the microphone some distance from the speaker to eliminate feedback effect.

UHF Tests

(Continued from page 21)

lent gain (6 db), good directivity, extended service range, and apparent lack of side lobes. However, this antenna was found to be bulky and rather expensive to manufacture and install. A typical model consisted of seven turns of half-inch copper tubing, with the turns seven and three-quarters inches in diameter and spaced five inches apart. The helix was fed between one end of the coil and a reflector plate perpendicular to the coil axis, and oriented with the axis pointed toward the transmitter.

The Six-Element Yagi

Yagi antennas have proved extremely valuable for special fringe applications on *vhf*, and it seems likely that this type will find similar use in *uhf*. Tests indicated that the shorter *uhf* wavelengths will make compact, lightweight multi-element yagis even more popular than at present. A characteristic of the yagi, however, is its limited frequency response range, which normally includes only one or two channels.

Existing *vhf* antennas have been found to be usable in strong *uhf* signal areas where reflection problems are not severe. In some other areas, a few minor changes in the existing *vhf* installation may be sufficient for satisfactory *uhf* reception.

Of the antennas tested, the corner reflector, the stacked fan dipole, the

(Continued on page 54)



\$10.00

FOR YOUR CARTOON IDEA

Have a pet peeve about service customers and their peculiarities? Help us keep the above "SERVICEMAN'S DIARY" cartoon series going by sending in your idea. No need to draw it—just write it out. Sprague will pay \$10.00 for every idea that is used.

Unequaled Dependability

Actual service records prove that Sprague Twist-Lok dry electrolytic capacitors are tops for keeping you out of trouble with service customers—by keeping their TV sets working right!

And Sprague has the *most* complete listing of *every* type of television electrolytic. Ask your Sprague distributor for a catalog or write to: SPRAGUE PRODUCTS COMPANY, 61 Marshall St., North Adams, Mass.



TWIST-LOK[®] 'LYTICS

The easiest to use, most reliable electrolytics[®]
for television replacement use

★ T.M. (Sprague Products Company is the Distributors' Division of the Sprague Electric Company)



C-D's Tiny Mike

takes 30,000 volts with a grin!

The famous ceramic body made by C-D with an original engineering job inside and out! More dependable, longer lasting than any previous TV high-voltage ceramic capacitor! Can be used at *full rated voltage*, because it's *conservatively* rated for DC flash test up to 2x rated working voltage!

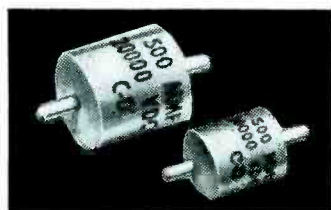

Send for Bulletin 2-614
Department S32
Cornell-Dubilier Elec. Corp.
South Plainfield, N. J.



CONSISTENTLY DEPENDABLE
CORNELL-DUBILIER
CAPACITORS

Plants in South Plainfield, N. J.; New Bedford, Worcester, and Cambridge, Mass.; Providence, R. I.; Indianapolis, Ind.; Fuquay Springs, N. C.; and subsidiary, The Radiart Corp., Cleveland, Ohio

UHF Tests

(Continued from page 53)

stacked *V* and the yagi appeared to be the best types for *uhf* use.

Transmission Lines

Five types of transmission lines were tested‡; flat twin, tubular twin, twinex (braid and foil shield) and coax. In Fig. 5 appears a tabulation of the results obtained with these leads.

During the *uhf* field tests in Washington, D. C., flat 300-ohm twinlead was used. It proved to be susceptible to moisture conditions and weather-

ing, with considerable losses resulting. Reception was also seriously affected by proximity to guy wires, rain gutters, and power lines. Supporting the line was also difficult because the position of standoff insulators along the line was critical.

Open-wire transmission lines were tested, and despite the apparent low-loss characteristics, they proved unsatisfactory because of problems in support, routing, cost, and impedance matching. In cases where flat twinline proved unsatisfactory, tubular twinline was substituted. It showed much better weather characteristics and was not so critical as to placement.

‡See tabulation on page 21, this issue.

RG59/U coaxial line was used to a great extent in the Stratford tests, despite its high initial loss of 9.5 db per 100' at 500 mc. This type of line was found to be weatherproof, free of interference from nearby noise sources, and could be routed conveniently without being affected by other objects in the immediate vicinity. Since RG59/U has 72 ohms impedance, unbalanced, the transmission line was matched to the antenna with a *balun* (balanced to unbalanced) matching device.

The Balun Lightning Arrester

The balun replaced the *bazooka* as a matching section because it could be much more quickly constructed. It also performed the dual function of matching 300-ohm to 72-ohm impedance, besides matching unbalanced coax line to a balanced antenna.

Extensive tests on commercial lightning arresters showed that attenuation of signal voltage through the arrester was marked in most locations. To overcome this, a combination matching transformer-lightning arrester was designed for use in conjunction with tubular balanced transmission line.

Crossover Network

For receivers having a single input, there has also been developed a crossover network. An outer sets of terminals permits connection to separate *vhf* and *uhf* antennas. Center terminals provide contact to the converter or receiver, through a single transmission line.

Evaluation of UHF Reception

The *uhf* antennas developed for this field test project, the special receivers and converters, and installation materials and devices required were tested at great length in Washington and

Fig. 11. Plot of gain in db (ordinate) of fan dipole.

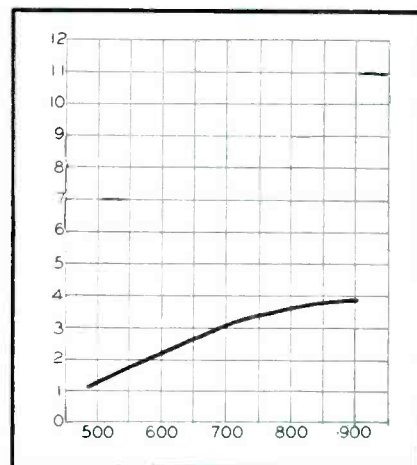

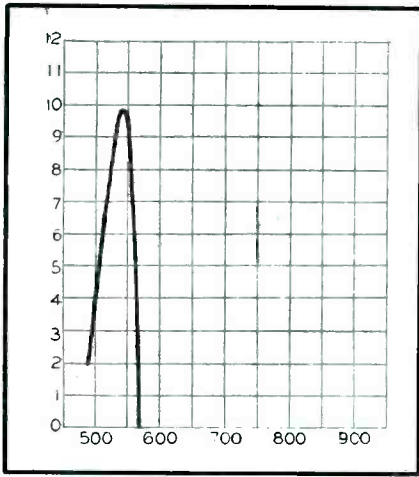

Fig. 12. Results achieved with a 6-element yagi; gain in db shown on ordinate and frequency on abscissa.

Stratford during the past three years. Approximately 150 complete installations were made in private residences and commercial locations throughout both areas, under all conditions and at a wide range of distances from the transmitters. Periodic observations were made at each test site, and the information compiled proved invaluable in deciding on specific product designs.

Every installation site was thoroughly surveyed for optimum results before a *ulif* antenna was installed. Often it was found that the fan dipole antenna did not produce sufficient pickup. In such cases, a stacked V was substituted. If this proved inadequate, a corner reflector antenna was tried. If improvement was insufficient with substitution of antennas, the height of the antenna was increased. Where signals were received by reflection, the best position of the antenna was found to be critical, as to orientation and height. A distance of a few

(Continued on page 56)

Fig. 13. Corner reflector gain in db (ordinate) plotted against frequency (abscissa).

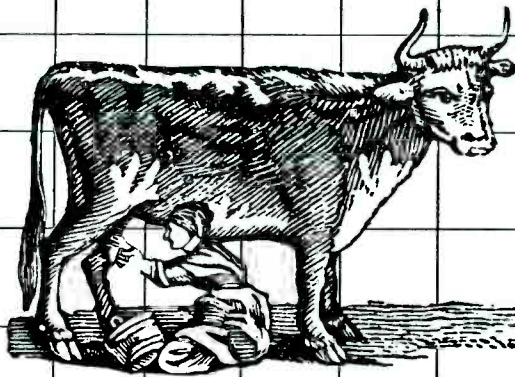
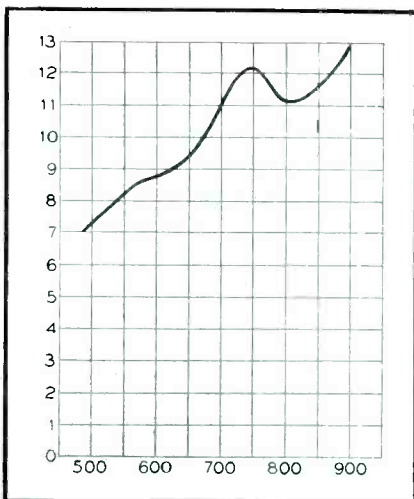

PRODUCES PROFITS

any season!

Fast or slow market — it makes no difference to Bossy ... she keeps on giving. That's the way it is with the Radion indoor TV antenna too! When business is bustling, Radion installations are profitable because they save you time and manpower. When the market slows, Radion's "Free Installation" promotion produces profitable action for you.

Finest quality ... high profit has made Radion the Industry Standard ... 2,500,000 units sold steadily since Radion originated the indoor antenna prove Radion's leadership — prove smart dealers use Radion in *all* seasons to sell TV. Get on the year-round profit wagon ... write Radion today!



Radion

The Radion Corp., 1130 Wisconsin Ave.
Dept. S-3, Chicago 14, Illinois
Send me free "8 ways to profit with Radion"

Name _____
Firm _____
Address _____

PHOTOFACT Users Write Our Best ADS!

Hundreds of unsolicited letters tell what the world's finest Radio & TV Data means to Service Technicians



Ronald W. Heckbert
30 Magoun Ave.
Medford, Mass.

"I have recently purchased some of your books and in my opinion they are priceless. They certainly cut down the service time on any job. I want to pass along a slogan you could rightfully use: 'More for your money than you expect'."



J. T. Cookson
Lock Box O
Puxico, Mo.

"I wouldn't part with PHOTOFACT for anything. For a fellow like myself who has most of his brains in his hands and eyes, they are a great help."



R. F. Dietz
1027 S. Main
Borger, Texas

"We have your complete set of PHOTOFACT, and we are convinced they are the best. We even prefer them above factory data. The TV data given in them is tops."

NOW! GET THE PROOF FOR YOURSELF!

FREE

We'll send you a Free Photofact Folder on any receiver listed in "PF Index & Technical Digest."

Learn for yourself—at our expense—how PHOTOFACT pays for itself by earning bigger repair profits for you! Select any Folder from the PF Index (if you haven't an Index, get a free copy from your distributor). When you write us for your Free Folder, be sure to state Photofact Set and Folder Number as shown in the Index. Get your Free Folder now. Examine, use, compare—see why you can't afford to be without PHOTOFACT!

HOWARD W. SAMS & CO., INC.
2201 East 46th Street • Indianapolis 5, Indiana

(Continued from page 55)

inches horizontally or vertically made a great difference in picture quality.

Where *uhf* and *vhf* antennas had to be installed, it was found that a survey had to be made for the *uhf* channel, since it was more critical as to location. In many installations, the *uhf* antenna may be mounted on the *vhf* supporting mast. However, it was found that sometimes separate masts were necessary.

Multipath reflections are present in *uhf* as in *vhf*, and can be eliminated for the most part by directive antennas.

The greater directivity obtainable with *uhf* antennas of practical size makes it possible to select a signal coming from a single direction to better advantage than with *vhf* antennas.

No interference from diathermy has been reported in the Stratford area, despite the fact that one location is directly across the street from a medical building with active diathermy equipment in use throughout the day.

Ignition interference is practically eliminated in *uhf*, except under the most unfavorable conditions. Even

Fig. 14. Plot of the results obtained with a rhombic, gain in db being shown on ordinate and frequency on abscissa.

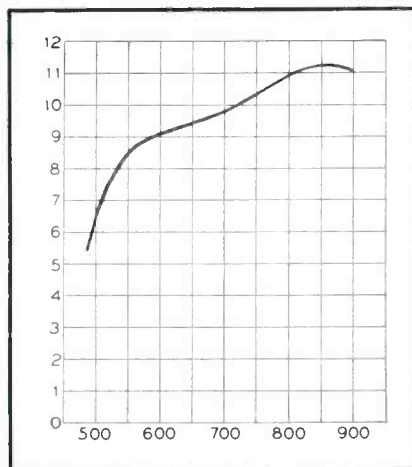

PLYMOUTH

TV and FM

Antenna Channel Transfer

SWITCH



For use with 300 ohm Twin Lead Transmission Line. The practical answer to better reception with easy cabinet installation. Positive action, minimum leakage contact.

Write today for free illustrated literature and price list.

PLYMOUTH 
electronic corp.
50 KINGSBURY STREET
WORCESTER 10, MASS.

Speakers
Need
Repairing?



Recone with a
WALDOM
CONE

Speakers are hard to obtain. Recone with Waldom cones.

Send for your **FREE WALDOM Replacement Cone Manual Catalog!**

FREE, 24-page manual is yours without obligation. Data on over 750 TV, FM, AM speakers. WRITE TODAY!

• WALDOM CONES

... maximum efficiency, R.M.A. warranty, true low frequency response, unconditionally guaranteed.

WALDOM ELECTRONICS, INC. 911 N. Larrabee St., Chicago 10, Ill.

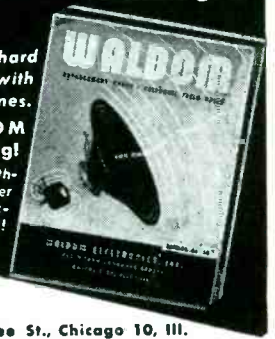

For
Finer Tone
a Waldom Cone

when present, this type of interference is so slight that it will probably go unnoticed by the layman.

Summer static produces no interference in *uhf* reception, although local lightning flashes may produce impulses sufficient to affect vertical synchronization momentarily and cause the picture to roll a few frames.

Where the choice of installation materials and methods was not the best, very heavy rain and snow storms attenuated *uhf* signals, because of higher losses in wet transmission line and increased propagation losses.

In such cases, tubular twinlead produced good pictures without noticeable vulnerability to wet weather, as evidenced by voltage measurements at the receiver with the line coated with ice and rain.

Fig. 15. Stacked *V* results, with gain in db appearing at left.

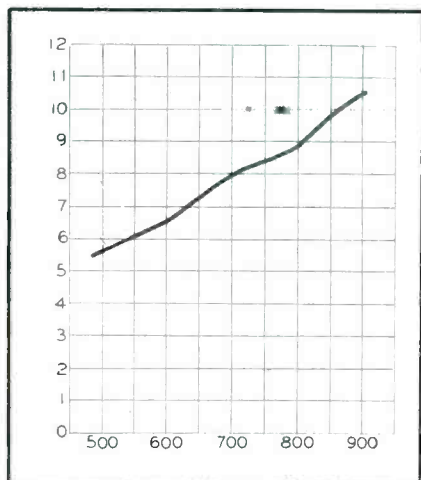

* * *

SYLVANIA TV-RADIO SERVICE PROMOTION

National promotion of TV-radio Service Men during 1952, has been announced by Sylvania Electric Products, Inc., Emporium, Pa.

Sylvania will use national weeklies and monthlies to carry messages from Jane Russell, Ann Blyth, June Havoc, Laraine Day and Leo Durocher to the public. These celebrities will testify that the TV-radio Service Man displaying the Sylvania seal does a good job. They will also tell the public how to select a reliable Service Man.

TV program presentations, also included in the plan, will stress the fact that TV repair requires a specialist; that he must study constantly to keep up with ever-changing TV circuit design in more than 1000 set models; that he must maintain a stock of more than 600 different types of tubes and parts; that he must purchase expensive test and repair equipment; and that he must be familiar with at least 300 possible trouble sources.

Tied in with this national advertising are local dealer advertising campaign kits that include window displays; counter cards; window streamers; 8" and 12" fluorescent service emblems for windows, doors, and trucks.

Alprodco

ALUMINUM TOWERS

TV • FM • AM

BROADCASTING
AND
RECEIVING

The Height of
Perfection

ALPRODCO AIRCRAFT ALUMINUM TOWERS

- Lower Cost per Installation
- Easy to Install
- Light Weight
- Strong
- Long Lasting
- Attractive

Alprodco Towers are sold through local parts distributors.

Write for literature and full details.

ADDRESS DEPT. E

Alprodco, Inc.

KEMPTON, INDIANA
MINERAL WELLS, TEXAS
DUBLIN, GEORGIA

there is only **1** **JC YAGI**

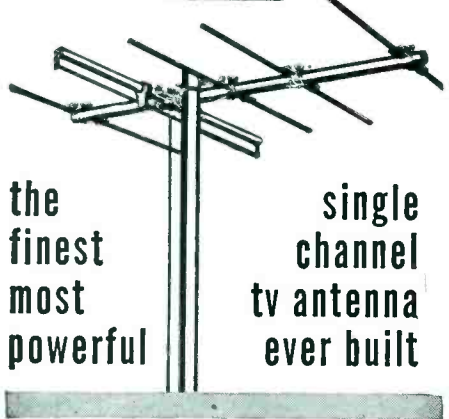

the finest most powerful

single channel tv antenna ever built

FOR SUPERPOWER

INSTALL **JC STACKED ARRAYS**

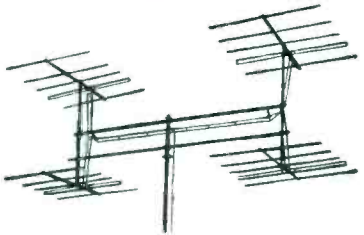

↑ 4 stacked side-by-side array. Ideal for powerful long distance reception in hilly and mountainous terrain.

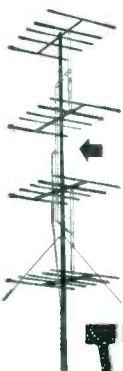

4 stacked vertical array. Extremely high gain and excellent signal-to-noise ratio. Ideal for areas with relatively flat terrain.



Double-stacked array with half-wave spacing. Provides added gain and better signal-to-noise ratio.

VEE-D-X

The World's Most Powerful TV Antenna Systems

THE LaPOINTE-PLASCOMOLD CORPORATION
Windsor Locks, Connecticut

Gentlemen:
Send me complete technical information on the JC Yagi and its stacked arrays.

Name

Street

City Zone State

Please check Jobber Dealer Technician

Replacement Cartridges

(Continued from page 22)

records indicate that they now represent less than ten per cent of the total number of players in use.

The high output cartridge will be found in the record player or children's phono type of reproducer. The higher the output of the replacement cartridge, the greater volume from the speaker. The low output cartridge appears in the record changer or radio-phono combination where the sound is amplified to a greater degree. The majority of these applications have standard 1/2" RTMA mountings. This means that the mounting holes of the cartridge are on 1/2" centers in accordance with the industry standards.

To simplify the replacement problem, there was evolved about a year ago, a universal replacement cartridge to fit almost all these old 78 sets to deliver the exact type of output required for best reproduction from the individual set.

This cartridge was designed to fit into the standard 1/2" RTMA mounting and produce two voltages or outputs; a high and low output. It was produced with three terminals for adjustment to the requirements of either high or low output reproducers, and supplied with a 3-mil osmium tipped needle and mounting accessories.

Other manufacturers followed along, offering cartridges to meet the dual output problem. High output cartridges, they can be adjusted to low output by means of a harness which affixes a capacitor to the cartridge.

The three-pronged cartridge weighs 25 grams and has tracking pressure of 3/4 of an ounce, a light weight which has been found to minimize record wear.

The universal cartridge features protection against humidity and moisture, via a special seal.† This protective coating has been found to prolong the life of the cartridge and is particularly important in sections of the country which are unusually humid or unusually dry.

†Developed by the Brush Development Company, who supply all manufacturers with rochelle salt crystals.

Three-terminal dual-output cartridge.

(Courtesy Webster Electric)

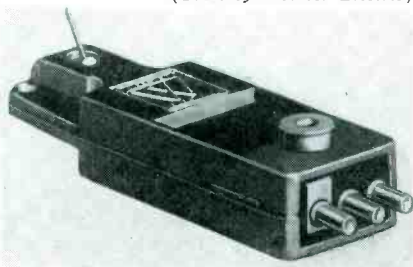

From the earliest days of Radio . . . to the present era of Television . . .



have been preferred for their

**ABSOLUTE UNIFORMITY
SUPERIOR QUALITIES
and
ULTIMATE ECONOMY**

for **SERVICE MEN**

A WORD TO THE WISE



CORNISH WIRE COMPANY, INC
50 Church Street, New York 7, N. Y.



**SOUTH RIVER METAL PRODUCTS
FACILITIES BOOKLET**

A 12-page booklet describing plant facilities and equipment has been released by South River Metal Products, Inc., South River, N. J.

Audio

(Continued from page 27)

lag in the record-reproduce process, but prevents spurious readings which might be caused if the tape was under abnormal tension in the monitor unit.

Tape-Recorder Service Aids

Some early production model *Soundmirrors** have been reported to have given some difficulty with high hiss in erase due to parasitic oscillation of the erase oscillator. This difficulty can be eliminated by installing a 22,000-ohm carbon resistor in series with the .0001-mfd feedback capacitor and the grid pin 4 on the 6SN7 oscillator.

It is often necessary to modify recorders to alter the operating speed and recording time. Generally, three changes are required: the capstan must be changed if the recorder is being converted to slower speed; the motor pulley must be replaced; and the amplifier equalization adjusted. In converting a slow-speed recorder to a recorder of higher speed, it is not necessary to change the capstan. When a recorder is converted to slower-speed operation, flutter will become more objectionable due to reduced inertia of the flywheel, and it is therefore necessary to use a heavier flywheel. It should be pointed out to the customer that the increasing of recording time does mean slowing down the tape speed with a resulting loss of fidelity; 3¾-inch speed is always satisfactory for speech recording, but is usually not too satisfactory for the recording of music.

In early models of the *Soundmirror* series, the output plug was mounted

(Continued on page 60)

*Brush BK 441-443.

Variable speed 10-watt portable player and public-address combination which plays all records, any speed, any size up to 17¼". A two-pound 10" turntable acts as a flywheel. Unit also has individual bass and treble tone controls; 12" Alnico 5 pm dynamic speaker, and dual needle variable reluctance magnetic pickup. (Model TR-16AM; Newcomb Audio Products Co., 6824 Lexington Ave., Hollywood 38, Calif.)

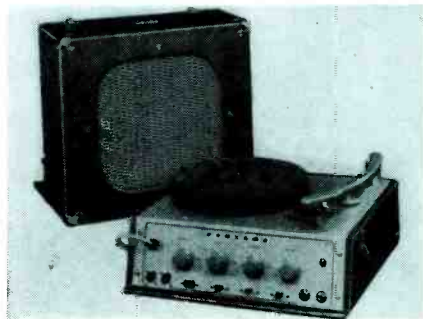



there's no finer
t.v. Antenna
for fringe areas!

THAN THE
G-C MASTER-LINE!

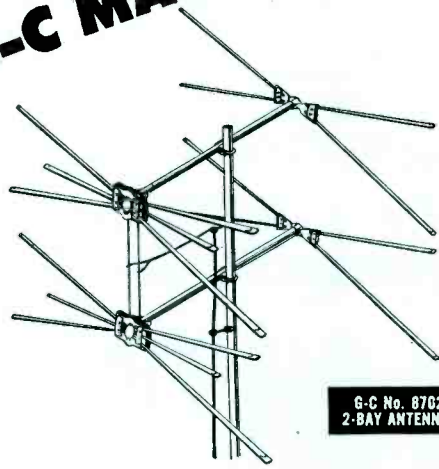

G-C No. 8702
2-BAY ANTENNA*

★ All-Weather Construction

★ Tempered Aluminum Di-Poles

★ Competitively Priced

G-C's popular Master-Line Antennas—designed for every location regardless of signal strength—are built right for long, trouble-free performance. That's why they're America's finest! Easy to install, too; pre-assembled cross bars save you time and labor.

*Also available in Single-Bay and 4-Bay

Complete line of TV Antenna Mounts, Parts and Hardware!

FREE!

G-C's new 80-page illustrated catalog.
Send coupon today for your copy!

GENERAL CEMENT MANUFACTURING COMPANY
901 Taylor Avenue, Rockford, Illinois



DETACH AND MAIL COUPON TODAY!



GENERAL CEMENT MANUFACTURING CO.
901 Taylor Avenue, Rockford, Illinois

Please send me without charge your big new G-C Catalog.

Name _____

Firm _____

Address _____

City _____ Zone _____ State _____

Mr. Serviceman:

YOUR CERAMIC CONDENSER STOCKING PROBLEMS ARE NOW SOLVED WITH THE INTRODUCTION OF THIS UNIQUE ERIE RESISTOR

"Breakaway" PACKAGE

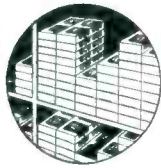
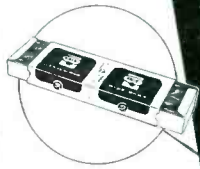

NOW IS THE TIME TO "Breakaway" FROM LESS EFFICIENT METHODS OF STOCK KEEPING AND MERCHANDISING OF CERAMIC CONDENSERS. THIS EXCLUSIVE NEWLY DESIGNED PACKAGE BY ERIE RESISTOR PROVIDES FOR:

- * Easy stacking on shelves
- * "At a glance" inventory control
- * Quickly dispensing one or several polyethylene bags containing 5 ceramic condensers of the same capacity (note: Trays slide from either end of package)

Complete package consists of a perforated outer sleeve and two trays each containing 25 Ceramicons. The package will "Breakaway" along the perforated edge thus making two "half boxes," each a neat box of 25 which your larger dealers and industrial customers will find ideal for keeping their stock of Ceramicons clean and orderly.



Electronics Division
ERIE RESISTOR CORP., ERIE, PA.
 LONDON, ENGLAND · TORONTO, CANADA

Audio

(Continued from page 59)

so that the shell of the plug could come in contact with the chassis, and it was possible for a short circuit to occur from B+ to ground through the metal shell of this plug. This failure caused a loud hum and often a burnout of either the rectifier or the output transformer. This can be remedied through the addition of an insulating washer over the prongs of the output plug, making it impossible for the plug shell to ground to the chassis; this change appears in later models. All recorders should be checked to see that either the output plug socket has been remounted, so that the plug shell cannot short, or the insulating washer is present.

Excessive hum in these recorders has been found to be due to improper placement of the grid lead of the first 6J7. This lead should be carefully oriented for minimum hum.

In some models difficulty has been encountered in the motor system, the switch failing to operate because the actuator ball has jumped out of the switch. If the ball is replaced and the

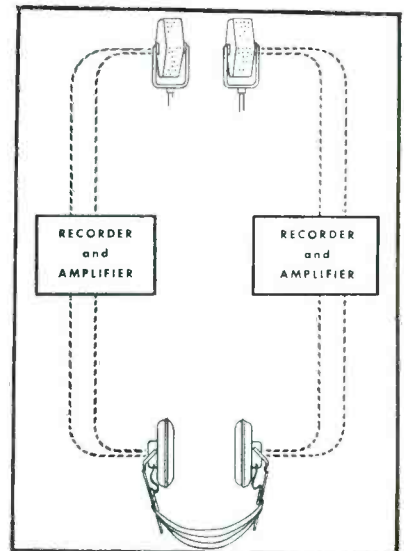

Arrangement for a binaural reproducing system, in which a pair of dynamic headphones, using moving-coil type motor assemblies, are used for listening. (Courtesy Permoflux)

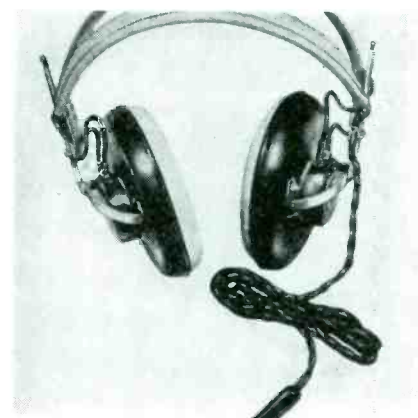

Perfection TV Components

Now-
 Individually
 Packaged!



More Popular Than Ever!

The new Perfection Kine-Center for finger-tip picture centering in electrostatic tubes—the BeamaJuster for 3-second centering of pictures in focus-coil tubes—the B. O. Eliminator for removing black lines caused by Barkhausen Oscillation—and easily installed Perfection Ion Traps—all are now available in handy individual cartons at no extra cost.

Order Today from Your Supplier!

PERFECTION ELECTRIC COMPANY
 2637 South Wabash Avenue, Chicago 16, Illinois
 MAKERS OF PERFECTION SPEAKERS AND TELEVISION COMPONENTS



recorder tripped into automatic re-wind, it will be found that the blade on which this ball rides almost escapes from under the ball. This switch should be carefully adjusted so that the ball remains positioned over the edge of the blade and the ball cannot escape. After this has been done, the switch should be checked to see that when the control lever is in the neutral position, the ball is actually in the center of the dimple made to receive it. In later models, a protuberance was staked out on the side of the actuator lever so that the ball is not permitted to escape. In most recent construction, the pivot tongue* has been lengthened so that this pivot point can be adjusted by bending the tongue to prevent difficulty in adjustment of the motor switch.

Binaural Systems**

Recently, the subject of binaural recording and reproduction of sound, also referred to as stereophonic or third dimension, has become extremely popular.

Stereophonic reproduction is not new to the audio art. It was first demonstrated as early as '33, but due to technical difficulties, it was not developed to any extent until the arrival of tape. This recording medium made binaural reproduction feasible.

For many years it has been known that the slightly different length of paths taken by a sound travelling from its source to each of our ears accounts for our ability to determine the direction and distance of the sound. If we cannot sense the location of the sound, it does not seem natural to us. In an artificial hearing system, such as the conventional monaural recorder, only one microphone channel or ear is used and the actual sense of sound location is lost.

To overcome this defect, it was decided to use a pair of microphones spaced about eight inches apart, about the same distance which obtains between the ears. The versatility of present day recording tape makes it possible to record the output of each of these mikes simultaneously, but separately. Standard quarter-inch recording tape is used and the output of each mike occupies one-half of the width of the tape and remains completely isolated from the other half.

This pair of sound channels, when played back through separate amplifiers and separate earphones, provide an accurate reproduction of sound. Effectively, the listener's ears are transported by means of the recording

heading the *Easter Parade*
 eureka picture tubes lead the field in...
 crystal-clear performance and longer life!



**Perfection
 in Clarity,
 Durability
 and Long Life!**

The living charm and elegance of the Easter Parade ushered into thousands of homes... such is the wonder of television electronics with which Eureka Picture Tubes are so vitally linked. Eureka's precision engineering assures crystal-clear reception and finer service... now at the peak of perfection, Eureka tubes are truly the finest available.

For immediate delivery the new 21EP4 and 21FP4
 Write or phone for complete information...

EUREKA TELEVISION and TUBE CORPORATION
 Manufacturers of Cathode-Ray Tubes and Electronic Products
 69 Fifth Avenue, Hawthorne, New Jersey • Telephone Hawthorne 7-3907

playback system to the position occupied by the two microphones.

Just as stereophonic photography makes each element of the picture stand out in proper relationship to the surrounding elements, so does the binaural system allow each instrument in an orchestra to be heard in its proper relationship to the other instruments. In a sense, it photographs a three-dimensional sound picture.

Reproduction of stereophonic sound is possible with two properly balanced

loudspeakers in an acoustically-treated room, or headphones.‡ Listening through such headphones is said to offer an unusual degree of realism.

Besides providing the hi-fi fans with natural reproduction of music, binaural recording may be used in business, education and industrial research. When used for recording conferences and board meetings, it is said to provide an accurate record of the proceedings and permits a stenographer, when transcribing for the written record, to identify and concentrate on an individual voice when several are speaking at once.

*Brush part 092. ‡Permoflux BDHS-17B.
 **Based on notes supplied by Permoflux.

Ser - Cuits

(Continued from page 34)

creases which results in good *agc* action.

To improve this system, it is important to operate the video amplifier stage as a noise limiter. Therefore, the signal applied to the grid of the video amplifier should be of such an amplitude that the plate current cutoff is almost reached on the peaks of the sync pulses. A large noise pulse is made harmless by clipping it, so that it extends only slightly beyond the tips of the sync pulses. For strong signal reception, a high *agc* bias voltage has to be developed, while for weak signal reception, a lower *agc* bias is required; *agc* level is adjustable through a 25,000-ohm resistor.

Sync System Analysis

Composite sync and video is taken from the video amplifier circuits and delivered to the first and second clipper tubes, V_{118A} and V_{118A} . The output signal consists of stripped sync which is divided as follows: A high-pass network, consisting of a 180-mmfd capacitor and 68,000-ohm resistor is used to couple sync to the horizontal phase detector $\frac{1}{2}$ of a 6T8, V_{118B} , for control of the horizontal oscillator frequency. A low-pass network, known as the *integrator* has been included to remove the high-frequency sync information and by combination of the equalizing pulses and the super-sync, forms the vertical sync pulse. This is then coupled to the vertical oscillator, $\frac{1}{2}$ 12AU7, V_{120A} , to control the vertical scanning frequency.

Vertical Sweep and Retrace Blanking

The receiver uses a twin triode, V_{120} , as a blocking oscillator and vertical retrace blanking tube. The vertical oscillator in conjunction with a parallel-connected twin amplifier, V_{121} , provides the vertical sweep voltage which is delivered to the deflection yoke.

The vertical blanking action occurs as follows: The retrace portion (a steep positive *spike*) of the vertical sweep is fed to the grid of the blanking triode. The *rc* time constant in this grid circuit, together with the positive *spike* pulse, causes a high-negative bias to be developed. This bias causes the blanking tube to be cut off. The plate voltage, therefore, reaches a maximum which is determined by the setting of the brightness control. Since the picture tube grid is directly tied to the blanking tube plate, it will

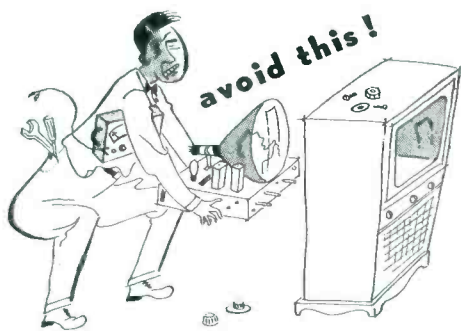

GET RMS

PIX-EYE

CHECK PICTURE TUBE
and VITAL RECEIVER
CIRCUITS
ON-THE-SPOT

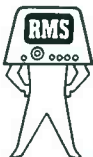

Model TE-5

\$9 95
LIST

PIX-EYE speeds TV trouble shooting . . . eliminates the time, labor and danger involved in unnecessary removal of picture tube. Plug Pix-Eye into the CRT socket . . . to help you quickly analyze the picture tube for shorts, intermitents, opens . . . make instant check of—

- brightness control circuits
- contrast control circuits
- video circuits
- low voltage circuits
- filament voltage circuits

Extension units EX-5 can be supplied for working at front of set. Take Pix-Eye on the call . . . keep one at the bench.

See your local RMS jobber today!

RADIO MERCHANDISE SALES, Inc.
NEW YORK 59, N. Y.

South River

NEWS



Combination Adjustable Wall Bracket
Model WB3-18A

Permits mounting by use of brackets fastened to eave and wall. All aluminum construction provides guarantee against corrosion and staining. Special "U" bolts provide most accommodation up to 1 1/2" O.D. and prevent mast from turning in high winds. Complete with hardware.

South River Antenna Mounting Accessories are carried by every leading TV Parts Jobber from coast to coast.
New catalog mailed to all Dealers and Service Men. Write, if you haven't received yours!

SOUTH RIVER METAL PRODUCTS CO., INC.
SOUTH RIVER, N. J.

PIONEER AND OUTSTANDING PRODUCER OF FINEST LINE OF ANTENNA MOUNTS

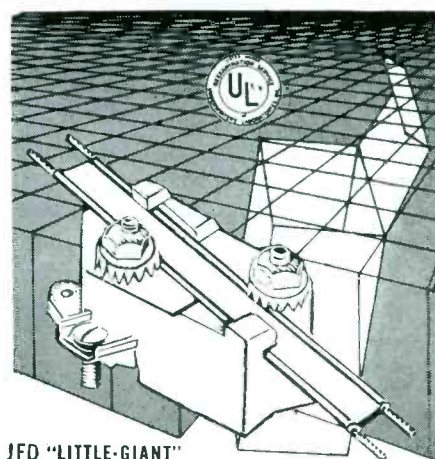

JFD "LITTLE-GIANT"

TV lightning arresters

millions sold!

because they have proved their worth in safety and sales!

no. AT105 \$1.25 list
no. AT105S (with strap) \$1.50 list
no. AT105T (with clamp) \$1.50 list

write for Form No. 84



JFD Mfg. Co.
Brooklyn 4, N. Y.
BEnsonhurst 6-9200

world's largest manufacturer of TV antennas & accessories

follow the plate voltage variations. The picture tube, therefore, conducts during the next sweep sawtooth period. At the end of this sawtooth, the positive spike again drives the blanking tube to heavy conduction, thereby causing the plate and consequently picture-tube grid voltage to fall to a very low value. At this time, the vertical retrace period, the picture tube is cutoff, thus accomplishing vertical retrace blanking.

AFC

The *afc* circuit maintains automatic control of the horizontal sweep oscillator over a considerable range above and below the horizontal frequency of 15,750 cps.

The horizontal oscillator tube, a 6AU6, V_{12B} , is of the electron-coupled type with the screen grid acting as a grounded plate in a conventional class C oscillator circuit. Its tank circuit consists of an inductance and a pair of capacitors; 220 and 3,900 mmfd, respectively. The 220-mmfd capacitor has a variable resistance arm in series with it; therefore, the net capacitive reactance across the coil can be varied by the setting of a 100,000-ohm horizontal-hold control, thereby changing the oscillator tank circuit's natural resonant frequency. A 470-mmfd capacitor is also tied across the tank circuit, but is in series with the plate resistance of a 12AU7 serving as a reactance control tube, V_{110B} . Any change in this tube-plate reactance, such as may be caused by a change in its *dc* grid voltage, will again modify the tank circuit's natural resonant frequency. It is only necessary, therefore, to obtain a suitable source of voltage for the reactance tube's grid which will be in proportion to any frequency or phase difference between the horizontal sweep oscillator and the incoming sync pulses. This voltage is obtained from the horizontal-phase detector (discriminator) by comparing the incoming sync pulses with a sample of the horizontal sweep output. The circuit is so designed that any difference in frequency or phase between the sync and sweep pulses will create a voltage proportional to the degree of displacement. If the horizontal oscillator natural speed is too low, this developed voltage will be negative in polarity. If the horizontal oscillator natural speed is too high, the developed voltage will be positive in polarity. There will be a zero-net developed correcting voltage when the incoming horizontal sync pulses and the horizontal sweep oscillator are at the same frequency and in phase. This voltage is applied to the reactance tube grid after suitable filtering. This filter

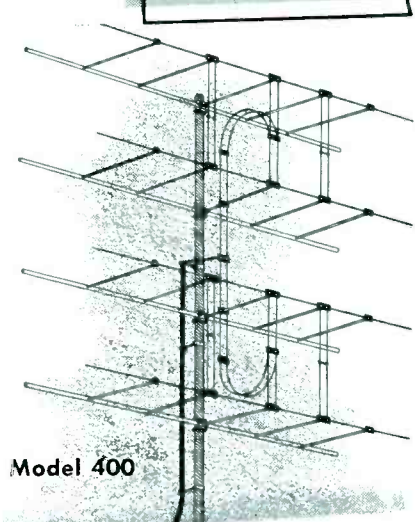

FINCO
PATENTED
20 in 1

Model 400

Features . . .

- Clear pictures up to 120 miles and more from station!
- 12 driven elements on high band!
- 8 driven elements on low band!
- High gain—low noise!
- One antenna—one transmission line!
- Total weight only 8 lbs.!

..Preassembled for easy-fast-simple installation!

the Sensational
TV ANTENNA
THAT WINS
FRIENDS
AND MAKES
MORE SATISFIED
CUSTOMERS!

Here's the key to more and more installations in fringe areas—the new FINCO 20-in-1 Antenna that provides the best reception over 100 miles from stations. Your customers will say "you are a magician" when they compare FINCO reception with any other antenna. You can build yourself an outstanding reputation by recommending the FINCO 20-in-1 because every satisfied customer tells and sells another. Get your share of the profitable sales that are just waiting to be made in areas where good reception has never been available before by getting acquainted with the FINCO 20-in-1 today. See your Jobber.

The Finney Company
4612 ST. CLAIR
CLEVELAND 3, OHIO

and its associated *anti-hunt* network, consisting of 4,700-mmfd and .05-mfd capacitors and 150,000-ohm and 1-meg-ohm resistors, is so designed that the time constant will not be too long and thereby permit hunting, nor shall it be too fast and allow the passage of random noise or permit fed-back horizontal sweep pulses to pass, which would cause undesirable feedback known as the *gear-tooth* effect.

Audio System

The audio system consists of a 12AX7 and two 6W6s. One-half of

the 12AX7 is the first audio amplifier stage which is followed by the other half, a phase inverter. The push-pull balanced output of the phase inverter drives push-pull pentode power amplifiers, which in turn deliver audio power to the loudspeaker circuits.

Negative Feedback

A portion of the output voltage delivered to the loudspeakers is fed back to the cathode of the audio amplifier. This negative feedback is said to stabilize and enhance the audio system performance.



The newest Rider TV Manual covering the very latest complete, factory-issued TV receivers servicing data for all prominent manufacturers. Make sure you get your copy. Order from your jobber — today!

TV8 and Vol. 22

TV8. The largest TV manual ever published by Rider. Covers the products of 52 TV manufacturers. Contents include chassis views, voltages, resistance



readings, trouble-shooting test patterns, waveforms, complete parts lists and values plus coverage of all models and circuit changes . . . and much, much more. Equivalent of 2694 pp. 8½x11" . . . \$24.

Vol. 22. Covers all AM-FM production runs of 62 manufacturers. Contents include all factory-issued servicing data on AM-FM receivers, auto radios, record changers, tuners and recorders . . . plus a cumulative index for vols. 16 through 22. 1520 pp. 8½x11" . . . \$18.

Make all your servicing easier — be sure your Rider Manual library is complete. Now available, Rider TV Manuals 1 through 8. AM-FM Manuals up to 22.

Get them from your jobber—today!

JOHN F. RIDER
PUBLISHER, INC.
480 Canal St., N. Y. 13, N. Y.

Servicing Helps

(Continued from page 40)

frequency channel in a normal fashion; if no low channels are available, a higher channel can be used. The fringe compensator switch should then be turned on, and the potentiometer adjusted to the center of its mechanical range. All channels normally received in the area should be checked and re-adjusted if necessary for best performance. *Note:* At the time triangle B was incorporated, a lead from each side of the horizontal phase coil was brought out to a 2-lug terminal strip which is mounted on the top-rear of the chassis next to the *hw* cage. This was done to facilitate alignment of the *miracle picture lock*; the horizontal phase coil can be shorted out without removing the chassis from the cabinet.

Stromberg-Carlson Notes

Removal of Horizontal Size Potentiometer (Model 317): On all receivers date coded 51-32 and later, the horizontal size potentiometer has been removed from the circuit and the horizontal-size coil has been repositioned to the rear chassis flange so as to be accessible for adjustment from the rear of the receiver.

Lead Dressing in HV Power Supply (321 Series): To avoid arcing, certain precautions must be observed in dressing the lead wires in the *hw* power supplies:

(1) The insulated lead from the flyback transformer to 1B3 rectifier plate cap should be dressed clear of the 6W4 damper tube envelope by running it midway between the 6W4 and 6AU5. If there is any excessive length, the 1B3 plate cap can be turned slightly so that the lead falls to the rear of the 6W4 toward the 1B3 supporting board.

(2) The white and red leads, from terminals 5 and 6 of the 6W4 socket to the fuse, should also be dressed clear of the 6W4 envelope.

It is important that these precautions be observed when replacing 1B3s or 6W4s in the field. It will be observed that the glass envelope on the 6W4s varies in length and that there is less possibility of arcing if the shorter envelope 6W4s are used in these receivers. Destruction of the 6W4 will occur if sustained arcing is permitted between the 1B3 plate lead and the 6W4 envelope.

Picture Centering

If it is impossible to center the picture on Stewart-Warner 9127 series chassis without producing *neck shadow*,

Improve Your TV Picture with GOLDEN WAND



Order from your Whole-saler

THREE MODELS
Model TG50
Model TG62
Model TG84 (shown)

GOLDEN WAND Indoor TV Antennas produce a better, clearer picture with any TV receiver because of their carefully engineered low-loss design. Admiralty brass dipoles with jamless action and perfect electrical connections at all joints—Polystyrene insulators—terminals and connections completely enclosed to prevent breakage—make GOLDEN WAND easier to sell and keep sold.



PEERLESS PRODUCTS INDUSTRIES
818 N. Pulaski Rd. Chicago 51, Ill.



THE LENGTH—
THE SIZE—
THE TYPE—
YOU WANT!

There's a "right" nut driver for every job, and XCELITE makes it! You can choose from a blade length of 6" down to Stubby (3¼" overall). You can get all regular nut drivers in 9 nut sizes, 3/16" to ½", Stubby drivers in ¼", 5/16" and ¾". And XCELITE hollow shaft nut drivers are in 7 nut sizes—insulated if desired. . . . WRITE for complete catalog!

XCELITE INCORPORATED

Formerly Park Metalware Co., Inc.
Dept. V,
Orchard Park, N. Y.



the following circuit modifications should be included (these changes have already been incorporated in chassis which include the letter C in the series coding):

- (1) Disconnect the yellow lead of focus coil socket from 340 v B+ supply and reconnect it to the red lead coming from pin 7 of the deflection yoke socket.
- (2) Disconnect the 12,000-ohm 2-watt resistor (363) in the screen circuit of horizontal-output tube from the 340 v B+ supply and reconnect it to the red lead coming from pin 7 of the deflection yoke.

Speed Troubleshooting

(Continued from page 47)

faulty voltage and resistance readings. They find that such readings are invaluable in indicating defective components. We are, therefore, not referring to elementary errors such as not being able to interpret properly meter readings around a circuit. However, as a Service Man becomes more experienced, he finds that voltage and resistance readings mean more to him. As a result, he is sometimes misled where a less experienced man may not be.

For example, let us suppose voltage readings are made around a circuit and a plate reading is found lower than the manufacturer's voltage chart by more than 20 per cent. The experienced Service Man may start tracking down possible troubles in the plate circuit; change of resistor value, leaky capacitor, etc. On the other hand, the less experienced man may continue checking the whole circuit and find a much more serious discrepancy in one of the other measurements. The point involved is: When taking measurements around a circuit, *complete them* before deciding what trouble is indicated. Many receivers have readings in some circuits which differ *considerably* from those provided by the manufacturer. *Yet the circuit operates normally.*

After *complete* readings are taken around the tube socket, then *all* of the readings can be analyzed carefully to decide what to do next. Additional checks made on the basis of incomplete readings may only serve to provide false clues and to waste time.

Another type of misleading reading sometimes occurs when the Service Man is in a hurry and forgets to check the amplitude as well as the waveform in using a 'scope. The 'scope may show the correct waveform at various points in the circuit. How-

MORE TV OUTLETS PER DOLLAR!

AMPLIFIED, ALL-CHANNEL MASTER ANTENNA SYSTEMS

FOR 2 TO 2000 TV SETS

NO
NO
NO
NO

Special connectors
Matching transformers
Engineers
Individual channel equipment

BLONDER-TONGUE systems are based on the use of "no loss" Distribution Amplifiers which split the signal from the antenna into the desired number of outlets... all having the same signal level and picture quality as though each TV set used the antenna alone.

The B-T Automatic, All-Channel systems, using three basic units in any desired number and combination, can be easily installed by any TV service man.

INSTALLED WITH THE TURN OF A SCREW



DISTRIBUTION AMPLIFIER, MODEL DAB-1-M
8 TV Outlets
Amplified and Isolated
List Price \$87.50



B-T HOME ANTENSIER MODEL HA-2-M



Model #CA-1-M
Commercial Antensifier
(30 Times Gain)
Use As Pre-Amplifier, Line Amplifier or de-luxe Booster
List Price \$77.50



MODEL #DA2-1-M
Distribution Amplifier
2 TV Set Outlets
List Price \$39.50



Finest All-Channel TV Booster. Fully Automatic, 16 Times Gain. In Metal Cabinet
List Price \$57.50



FREE INSTRUCTION BROCHURE ON MASTER ANTENNA SYSTEMS..Write Today. Dept. H-2

Blonder-Tongue Labs., Inc. Mt. Vernon, N. Y.

ever, the amplitude may not be correct. It is very important to note whether the proper quantity, as well as the proper waveshape, is present before deciding whether a given stage is operating correctly. The 'scope can be easily calibrated to show amplitude by using a known value of a signal, such as a 6.3 v ac test signal. The known signal can be fed into the vertical input terminals of the 'scope. The 'scope vertical amplitude control is used to make this signal a certain number of boxes high on the 'scope mask. For example, the 6.3 v signal

can be made 3 boxes high. Now 6.3 v is actually 18 v peak-to-peak, since 6.3 v is the effective value and approximately 9 v is the peak voltage of each half of the sine wave. Therefore, if an 18 v-signal is made 3 boxes high, each box represents 6 v ($6 \times 3 = 18$ v). When the 'scope is used to observe any other waveform, the amplitude can easily be checked, provided the vertical amplitude control of the 'scope is not moved after the above calibration. It is merely necessary to note how many boxes high the

(Continued on page 66)

Columbia 

Again—

A "New" TV service aid!

now—the

"Television Picture TUBE Extension Cable"



... just what every television serviceman should buy!

Here is another labor and time-saver from "Columbia." NOW . . . you can service the chassis without moving the picture tube; or remove the tube for testing without touching the chassis.

The complete cable is engineered for maximum performance . . . durable cotton braid covers 5 heavily insulated plastic wires . . . 4 feet long. Bakelite plugs on each end have positive contacts.

Carried by leading jobbers!

* * *
Have you seen our NEW "TV Service Light" and "All Purpose TV Service Card"?

We manufacture cord sets and cables to government and civilian specifications.

Columbia 
WIRE & SUPPLY CO.

2850 Irving Park Road • Chicago 18, Ill.

"National distributors and warehouse for ANACONDA denseath television and radio wires and cables"

(Continued from page 65)

observed waveform is and multiply by the number of volts each box represents.

In the fourth point under faulty techniques are incorrect repairs. Service Men generally understand the importance of using good quality replacement parts and it is unnecessary to stress this point. On occasion, the technician may inadvertently use an incorrect replacement, wire in a correct part incorrectly, or leave some other part of the circuit unwired or incorrectly wired. The result may be either no improvement on the original trouble or the original defect may be gone and a new trouble appears. In any event, it is always advisable to check any replacement part carefully before wiring it into the circuit.

If a part is replaced and the original trouble remains, it is necessary: (a) to recheck the part or try a new replacement or (b), if there was some question whether that was the faulty part, to check the other possibilities of trouble in the circuit.

Whenever *new* trouble appears immediately after a repair is completed and the set is turned on for testing, the experienced Service Man will check the repair. In most cases, it will be found that some error has been made which accounts for the new trouble.

The final factor which delays troubleshooting is lack of information. Particular servicing problems may be difficult because of insufficient information about theoretical circuit operation or servicing techniques or the individual peculiarities of the receiver being checked. Books, technical periodicals such as *SERVICE*, manufacturers' literature and lectures have all been helpful in providing new theoretical and servicing information. A complete file of commercial *TV* schematics helps overcome lack of information about specific models.

There will always be a certain number of unusual troubles which will greatly broaden the Service Man's background—after they are found. Some examples are:

(1) Emerson, model 609; set went out of horizontal sync intermittently. At first, trouble was suspected in the horizontal *afc* circuit or in the sync section. Then, it was noticed that there seemed to be a slight distortion in the sound when this occurred. Trouble was found to be a bad *rf* amplifier tube in the tuner.

(2) Dumont, model RA-105; pix had a broad vertical stripe about two inches wide running down the left side of the picture tube. A broad white stripe appeared on the right side of

for dependable sound, INDUSTRY relies on ATLAS



DR Double-Reentrant Projectors



Paging & Talk-Back Speakers



ALNICO-V-PLUS Driver Units



Dual Speakers



FULL-GRIP, VELVET-ACTION Mike Stands

DEPENDABLE QUALITY:

The latest electro-acoustic research and engineering—and over 20 years of manufacturing know-how—are behind every ATLAS product.

DEPENDABLE SERVICE:

Coast-to-coast and around the world today—in every Industrial, Marine, Railroad, Military, Educational, Civic, U.S. and Foreign Government application—under every kind of climate and noise condition—ATLAS sound equipment is famous for highest efficiency and durability. That's the proof of ATLAS performance dependability.

DEPENDABLE DELIVERY:

Yes, ATLAS gives our Government highest priority. And yes, we too feel the pinch of material shortages. But our customers will continue to get our usual dependable delivery—because we believe in equitable and dependable distribution to all ATLAS users.

DEPENDABLE PROFITS:

Completeness of line, excellence of product, dependable delivery, right prices—that's the ATLAS combination that means high, steady Industrial Sound profits for You!

JUDGE for yourself, COMPARE ATLAS at your local Jobber today. See why ATLAS is the preferred line for utmost dependability. Write NOW for FREE latest Catalog 551.



ATLAS SOUND CORP.

1442-39th Street, Brooklyn 18, N. Y.
In Canada: Atlas Radio Corp., Ltd., Toronto, Ont.

WHEN YOU CHANGE YOUR ADDRESS

Be sure to notify the Subscription Department of *SERVICE* at 52 Vanderbilt Avenue, New York 17, N. Y., giving the old as well as the new address, and do this at least four weeks in advance. The Post Office Department does not forward magazines unless you pay additional postage, and we cannot duplicate copies mailed to the old address. We ask your cooperation.

the picture tube when the brilliance was turned up. The picture was poor and unsteady. The pix circuits were checked and found normal. The trouble was found to be an open .01 bypass on the screen grid of the *crt*. The same voltage point connected to the *crt* screen and to the horizontal output circuit. There was a horizontal ripple component in this supply which showed up on the screen with an open bypass.

Circuit Oddities

Occasionally, the Service Man learns some theoretical points which many textbooks omit:

(1) A short on the plate of a previous stage can, in certain cases, prevent a signal from going through a following stage, even when a signal is injected at the grid of the following stage. An illustration of this appeared in circuit with a shorted bypass across a volume control. A finger applied to the grid of the first audio stage did not produce a hum in the speaker. It was logical to suspect that the trouble was between the grid and the speaker. Yet, the shorted bypass effectively placed the coupling capacitor, from grid to ground, when the pot was all the way up, thus acting to short or partially short the grid to ground. It may be helpful to remember this possibility of trouble in making checks at the grid of a given stage.

(2) The reverse can also be true. A short from grid to ground does not simply short out the signal at the grid, but at the plate of the *preceding* stage. For example, a short between the grid and cathode of the first video *if* stage will not only short out the video signal, but also the *sound*. This is because the coupling capacitor is thrown from plate to ground in the mixer stage. The capacitor in parallel with the plate load impedance reduces the total value of load impedance. The result is that most of the output is across the internal resistance of the tube and very little appears across the load.

The conclusion to be drawn from the two examples just cited is that in certain types of defects, it may be necessary to check immediately after or immediately before the usual point where trouble is indicated.

TV Service Men deal with one of the most complicated mechanisms, for its size, in modern industry. It is only because of his overall skill and ability that TV has been available on a continuing basis to the American public.

*** Compare**
Clear Beam's
T-MATCH YAGIS

From Every Angle...

CONSTRUCTION!
PERFORMANCE!
QUALITY!
COST!

*And if they aren't
The **BEST** VALUE
On the Market Today—
**WE'LL
EAT 'EM!***

Clear Beam
TV ANTENNAS and ACCESSORIES
The Largest and Most Complete Antenna Line
Manufactured Under One Roof
100 PROSPECT AVENUE
BURBANK, CALIFORNIA
Charleston 0-4886 ROckwell 9-2141

DUMONT INSTRUMENT DIVISION APPOINTMENTS

Five members of the instrument division, Allen B. Du Mont Laboratories, Inc., 1500 Main Avenue, Clifton, New Jersey, have been promoted to new posts within the division.

Dr. P. S. Christaldi has been named assistant division manager. He was formerly engineering manager. G. Robert Mezger has been named engineering manager. He was formerly technical sales manager. Emil G. Nichols, formerly assistant technical sales manager, has been appointed technical sales manager. Melvin B. Kline and William G. Fockler have been appointed assistant engineering managers.

AMPHENOL OPENS NEW SALES OFFICE IN N.Y.C.

The American Phenolic Corporation of Chicago has realigned its industrial sales staff in both the city and state of New York, and opened new offices in the Empire State Building, 350 Fifth Avenue, suite 7323.

Office, which will handle industrial sales only, is staffed by four men, headed by Ray Whitmore, district sales manager. He will be assisted by Herbert Brontsema, Herbert Motz and Henry Le Blanc.

D. R. Bittan Company, New York City, will continue to handle distributor sales.

COYNE BOOKS

SHOP-TESTED TECHNICAL BOOKS
ON RADIO, TV AND ELECTRONICS

Distributed by
HOWARD W. SAMS & CO., INC., Indianapolis 5, Ind.

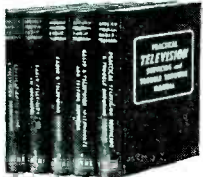

APPLIED PRACTICAL RADIO-TELEVISION

Brand new! Over 1500 pages on the latest in Radio and TV—EVEN COLOR TV and UHF. Over 5,000 subjects, 1,000 illustrations. Shows how to install, align, balance all Radio and TV sets . . . how to use test instruments for TV service . . . latest data on adaptors, converters, much more. Get this 5-Volume Library now.

No. CTB-11—Vol. 1 . . . \$3.25
No. CTB-12—Vol. 2 . . . 3.25
No. CTB-13—Vol. 3 . . . 3.25
No. CTB-14—Vol. 4 . . . 3.25
No. CTB-15—Vol. 5 . . . 4.25

5 VOLUME SET COMPLETE
No. CTB-50 **\$15.00**



CYCLOPEDIA OF TELEVISION Complete, Up-to-Date Reference Manual

Fact-packed reference book that covers every phase of Television, including COLOR TV and UHF. Gives you complete understanding of how TV receivers work, how to repair and keep them operating properly. Special complete section on picture pattern servicing (dozens of actual photos). 750 pages, over 450 photos, diagrams, charts, drawings, test patterns. In quick reference alphabetical order. **\$5.95** Order your copy now. No. CTB-1

PRACTICAL TELEVISION SERVICING, TROUBLE-SHOOTING MANUAL

SHOWS YOU HOW TO align, service, install, adjust and tune every part of the audio and video sections. Helps you handle all problems. Covers sweep oscillators, frequency control, FM, amplifiers, tuners, etc. Latest data on COLOR TV and UHF! 18 big chapters, 300 illustrations (many in 4 colors)—1500 TV facts. Complete, practical, up-to-date. **\$4.25** No. CTB-4



ELECTRONICS

You will find this book a "gold mine" of easy-to-follow "on-the-job" electronic data. Starts right at the beginning—explains in simple language all the basic principles of electronics. Fully illustrated with helpful photographs, diagrams, and tables. Endorsed by leading manufacturers, union officials and educators. 400 pages. **\$3.75** No. CTB-2

MODERN RADIO INSTRUMENTS AND TESTING METHODS

This up-to-the-minute book tells all about modern radio and electrical testing equipment and how to use it. Packed with money-making shortcuts on trouble-shooting, servicing, construction and other jobs. Over 350 pages, 220 photos and diagrams. Covers Multipliers, Resistors, Ohmmeters, Oscilloscopes and many other subjects. All data has been pre-tested and checked in the Coyne radio shops. No. CTB-3 **\$3.25**



RADIOMAN'S HANDBOOK

Here is a remarkable radio "answer" book. 3,000 facts packed into 350 pages give you complete instructions to speed trouble-shooting. Illustrated with hundreds of charts, diagrams, tables, circuits and short-cuts. Fully indexed. No. CTB-5 **\$2.75**

Order from your Parts Jobber today, or write direct to Howard W. Sams & Co., Inc., 2201 E. 46th St., Indianapolis 5, Ind.

\$ enclosed (no C.O.D.'s please). Send the following Coyne Books:

- CTB-11 CTB-14 CTB-1 CTB-4
 CTB-12 CTB-15 CTB-2 CTB-5
 CTB-13 CTB-50 CTB-3

Name

Address

City Zone State

Rep Talk

R. W. WOODBURY, formerly a partner in Electronic Equipment Distributors, now represents Sprague Products Co., in southern California. . . . *Gordon Marshall Co.*, 40 S. Los Robles, Pasadena, Calif. (southern California); and *Ken Randall Co.*, 121 N. Broad St., Philadelphia, Pa. (Pennsylvania, Washington, Delaware and Maryland), have been appointed reps for Ward Products, Division of the Gabriel Co. . . . *Walter J. Brauer and Associates*, 15631 Lakewood Heights Blvd., Cleveland, Ohio; *Jack Brown*, 1631 Walton Ave., New York, N. Y.; *Herb Erickson Co.*, 201-09 N. Main St., Chicago, Ill.; *Cassner and Clark Co.*, 6349 N. Clark St., Chicago, Ill.; *Laub-Dale, Inc.*, 1951 University Ave., St. Paul, Minn.; *Sidney M. Levin*, Main P. O. Box 405, St. Louis, Mo.; *Jim Packard and Co.*, P. O. Box 7, Fort Smith, Arkansas; *Technical Representation*, 506 Wyndmoor Ave., Philadelphia 18, Pa.; *Emmet J. Tydings*, 1565 McFarland Rd., Pittsburgh 16, Pa.; and *Meyer and Ross*, 1355 Market St., San Francisco, Calif., are now representing Kenwood Engineering Co., Inc. . . . *Gordon C. Leroy*, 29 Bancroft Dr., Rochester, N. Y. (New York State except metropolitan New York City); and *Ellinger Sales Co.*, 6663 Northwest Highway, Chicago, Ill. (northern Illinois), have been appointed reps for the David Bogen Co., Inc. . . . *James C. Schmitter*, formerly manager of Radio Supply Co., Syracuse, N. Y., has been added to the sales staff of Land-C-Air Sales Co., and will cover upstate New York from Albany west to Buffalo. . . . *Charles B. Wirth* has been appointed engineering rep for Audio and Video Products Corp. . . . *D. G. Wilson* has formed his own rep agency at 549 West Randolph St., Chicago 6, Ill. He formerly was sales manager of D. M. Steward Manufacturing Co. in Chattanooga, Tenn. . . . *Byron H. McDonald Co.*, Los Angeles, Calif., has been named rep for Industrial Television, Inc. . . . *Gerry Moch*, formerly purchasing agent of Tele-Tone Radio Corp., has joined Wally Shulan and Co. as associate manufacturers rep. . . . *William N. Mooza*, National Sales Engineering Co., 60 E. 42nd St., New York City (metropolitan New York City); and *George Davis*, 5127 Whittier Blvd., Los Angeles, Calif. (southern California), have been appointed reps for Tricraft Products Co. . . . *L. F. Waelterman Co.* has been named rep for Permo-flux Corp., in Kansas, Missouri, Iowa and Nebraska (except Sioux, Scotts Bluff, Banner and Kimball counties). . . . *Charles J. Nace*, treasurer of W. Bert Knight Co., Inc., has been elected to senior membership in the Los Angeles chapter of the Reps. *Richard A. Strassner* has been elevated from associate to senior, and two new associate members, *Larry Lindsey* of W. S. Harmon Co. and *Rick Stone* of Carl Stone Associates, were also elected.

L. F. Waelterman



Presenting THE NEW Mueller NEEDLE CLIP

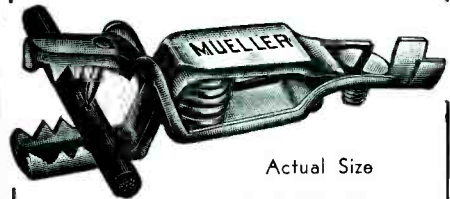

Actual Size

PIERCES INSULATION TO MAKE QUICK CONTACT

Solid bronze, non-corroding. Wire centers itself in notched jaw. Teeth on sides of jaw allow use for many other applications.

— USED IN —

- Electric and radio service shops
- Telephone and power company testing and maintenance
- Laboratory test work
- Hooking up truck trailer lights
- Field telephone and signal work

SEND FOR FREE SAMPLE AND CATALOG 810



1565 East 31st Street, Cleveland 14, Ohio

DRAKE PeeWee

the mighty mite with a PROFITABLE future



ACTUAL SIZE 7 1/2 IN.

Yes sir! PeeWee in your kit means saved time—extra profits. A full 35 watts, with 3/16" tip, the Drake PeeWee gets right into those tight corners—has baffle plates to keep handle cool. Order from your distributor now.

DRAKE ELECTRIC WORKS, INC.
3656 LINCOLN AVE. CHICAGO 13

Business Aids . . .

[In response to many requests, arrangements have been made to feature every month in SERVICE a column devoted to a discussion of Business Aids for the Service Shop, based on queries submitted by readers of SERVICE. Topics to be reviewed will include advertising, bookkeeping, customer relationship, filing systems, displays, direct mail, etc. These columns are being conducted by a veteran Service Man with over a quarter of a century experience in the field, who is currently operator of a large Service Shop, and is also extremely active in association affairs. If you have a business-aid problem, send it to ye editor, and every effort will be made to publish a solution in an early edition of SERVICE.]

Dear Editor:

I had been plagued by complaints from customers claiming that they were not informed and did not understand that all repairs and service work done by our shop was on a C O D basis. To void this misunderstanding and resulting ill will I set up a charge and billing system. Now I find that many are very slow in paying their bills. As my shop is a two-man business the chore of trying to collect is tying us up. Can you advise what might be done to solve this vexing problem?—D. J. P.

Dear D. J. P.:

Your complaint is common. Many independent Service Men have been confronted with it for years. According to the experiences of yours truly and many Service Men queried recently, a number of practical solutions are available.

Signs should be placed in a conspicuous place in the shop where customers will see that all work is on a C O D basis; the same information should also be placed on all bills, receipts, and service work orders. On receiving service calls in person or by phone, callers should be advised that the Service Man is to be paid when work is completed. When receiving set or chassis in the shop or picking up from a home, a receipt should be left with the customer with terms clearly indicated, advising customer that when set or chassis is returned the Service Man is to be paid for work done.

It is also important to remember that customers must be contacted before making delivery to advise C O D charges. This approach can also be used when advising that work on chas-

BY ACTUAL COUNT...

THE LARGEST AND MOST COMPLETE TV GUIDE IN THE INDUSTRY!

NEW 10th EDITION OF THE

STANCOR

TV TRANSFORMER REPLACEMENT GUIDE and CATALOG

NEW... Stancor Part Nos. A-8133 and A-8134

"Flyback" transformers—exact replacements for Admiral #79C30-1, 79C30-3, 79C30-4 in 80 Admiral TV models. See Stancor Bulletin #391.

This big new reference book lists transformer replacement information on 2416 TV models and chassis made by 82 manufacturers. The catalog section carries detailed electrical and physical specifications on 106 Stancor TV Replacement Transformers. A frequency chart shows the number of chassis that use each component.

To save your valuable time, this Guide lists all models and chassis components in numerical order under each manufacturer's name. Every replacement recommendation is listed with the manufacturer's part number for instant identification.

Get this up-to-the-minute TV Guide from your Stancor distributor now—or write directly to Stancor.

STANDARD TRANSFORMER CORPORATION
3588 ELSTON AVENUE • CHICAGO 18, ILLINOIS

sis, that has been left in the shop, has been completed.

When arriving at a customer's home they should be advised that their set is being returned on C O D terms. Customer should be given an itemized bill on which should be stamped C O D.

It is also important to impress on employed Service Men that they must collect all C O D's or be held responsible for same. Calling the customer to advise him that his set will be returned at a certain date will also save many *not-at-home* calls. In the event that the customer may not be home, arrangements can be made for someone else to receive the set. The advanced call also permits the customer to provide either the exact amount of cash necessary to pay for set or a check covering the bill.

If the customer does not have a phone, it is then advisable to mail a notice of the charges and delivery date. It is also recommended that self-addressed envelopes be included for the customer to fill out and return. In case there is no phone or both man and wife are employed during the day and thus find it impossible to contact the shop during the day, the self-addressed envelope will be found very convenient.

All of these approaches have been used and have helped to reduce problems like yours. Of course, you will still have to do a certain amount of billing, especially on accounts that you've been serving for some time. It will be found profitable to extend this service to these old customers.

Sincerely,
DON KAY.

SO IMPORTANT — it was
Featured in Special Article
in
The New York Times

Jan. 28, 1952
FREE copy
of article on request

**UNITY REACTIVATES
TV PICTURE TUBES**

Small Electronic Device Tests
Sets at Home and May Add
Year or More of Use

By T. R. KENNEDY Jr.

A small electronic device that can be applied to home television receivers to test and reactivate picture tubes without removing the tube from the set, resulting in more brightness in many and consequently longer useful life, has been placed on the market for the first time by a New York manufacturer.

In some cases, it was said, the picture tube may be made almost as good as new and given as much as a year's useful life before replacement is necessary.

The instrument is small and compact. It weighs three pounds as large as the average lunch box, costs little and is simple to operate. Picture tubes, some of them new and never in a receiver, have shown remarkable improvement in brilliance and definition after a few minutes of reactivation here in the last few days.

Although the principle of its operation is not new—cathode-ray tube manufacturers have used it for years in the initial making of picture tubes—its incorporation in a small home

The almost immediate urgent need for such an instrument, which also soon may be produced in kit form for home assembly, is apparent. Eight to ten million TV sets estimate, have now been in use for three to four years or more, and probably are in need of test and reactivation to "renew" their brightness. Unfortunately, their brightness can be detected short of comparing the old tubes with new ones in lately produced sets.

Furthermore, picture tubes in their original cartons in stores may have lost some of their brightness, which has been described as a "kind of aging process" to which all large cathode-ray tubes and similar devices are subject. Such tubes in the current sizes most in use today, cost from \$25 to \$65.

New picture tubes can be tested and reactivated without removing them from their cartons, and tubes in TV sets without the receivers. It is done by attaching a standard picture-tube socket to the new instrument, turning a switch on the tester-reactivator, and noting the glow of a small neon bulb as a glow of the tube is indicated directly on a dial of the tester, which is plugged into an AC home electric socket. The receiver, meanwhile, is not turned on.

In some cases the test and reactivation is accomplished in less than five minutes.

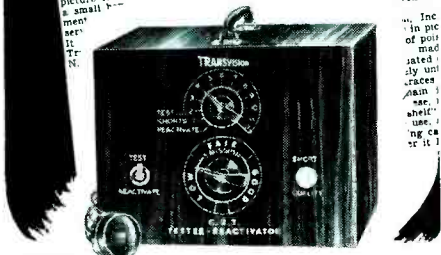

**TRANSVISION CR TUBE
TESTER - REACTIVATOR**
performs 2 vital functions:

- Tests Picture Tubes
- Renews Brightness of Many Dim Picture Tubes

It's a **TESTER**:

Without removing picture tube from set, you apply this precise instrument to—

- Measure Cathode emission
- Locate shorts between elements
- Locate high resistance shorts or leakage as high as 3 megohms

It's a **REACTIVATOR**

for dim CR Picture Tubes

Revives dim TV Picture Tubes, without removal of tubes from sets. Works on a great many tubes with low light output, if there's no mechanical defect in tube. 110 V—60 cycles. Portable, weighs only 3 lbs. One or two applications pays for instrument.

SATISFACTION GUARANTEED
or money refunded if you return the instrument in 10 days in good condition.

\$19.95
NET

—RUSH THIS COUPON—

TRANSVISION, INC.

DEPT. S3 NEW ROCHELLE, N. Y.

() Send me CR Tube Tester-Reactivator(s).

() Enclosed find \$___ deposit. Balance C.O.D.

() Enclosed find \$___ in full. Send prepaid.

Name _____

Address _____

City _____ State _____



RCA TUBE SOCKET MANUAL

A revised edition of the *Triple Pindex* socket manual with socket-connection diagrams for more than 660 receiving tubes and picture tubes, has been announced by the Commercial Engineering Division, RCA Tube Department, Harrison, N. J.

Priced at \$75, book is divided into three identical horizontal sections, each connected to a flip-over-type binding, enabling the Service Man to refer to a single composite page for simultaneous reference to any three socket diagrams.

Revised edition also contains a cross-index reference supplement which lists a variety of tube types used only occasionally. Although socket-connection diagrams for these tubes are not indicated in the *Pindex* section of the book, reference is made in each case to another tube with an identical socket arrangement, for which a diagram is included.

* * *

NEW RIDER TEK-FILE RELEASE

Packs 17 through 32, of the Tek-File series, are now available from John F. Rider Publisher, Inc., 480 Canal St., New York 13, N. Y.

Packs contain manufacturers' data on 734 models.

* * *

**BRACH APPOINTS SLAWSON JOBBER
SALES MANAGER**

William J. Slawson has been appointed distributor sales manager of Brach Manufacturing Corp., Division of General Bronze Corp., Newark, N. J. Slawson was formerly associated with John F. Rider Publisher, Inc. as sales manager.



William J. Slawson

* * *

DUMONT DISTRIBUTOR MANUAL

A 115-page manual, *Service Operations of the Du Mont Distributor*, has been published by the teletest service control department, Allen B. Du Mont Labs, Inc.

Guide consists of fourteen chapters, ranging from administrative service structure and personnel to distributor service operations in newly-opened TV areas. Included is information on distributor relations with factory, dealer, consumer and sales department. Also detailed is shop work control, equipment, service department layout and training of service personnel.

* * *

**R. SAICHEK NAMED EICOR
ADVERTISING MANAGER**

Robert S. Saichek, formerly technical data director, has been appointed advertising and public relations director for Eicor, Inc., 1501 Congress St., Chicago, Ill.

**MOSLEY OPEN-WIRE LINE
ACCESSORIES**

for Better Fringe Area TV

MOSLEY Open-Wire Line Accessories are especially designed to provide Better TV Pictures in areas of weak signal strength.

Open-wire line, made with MOSLEY Accessories, has less than one-sixth the loss of new standard 300 ohm ribbon line. Its use will often result in good, consistent TV pictures in fringe areas where TV reception had previously been considered impossible. Such line will not increase in loss with age and will withstand adverse atmospheric conditions indefinitely.

Cat. No. 450-1 Splicer.

Solderless splicer for joining sections of open-wire line. Maintains line impedance. List\$30



Cat. No. 450-2 Anchor Bar.

Holds open-wire line securely. Use with screw-eye stand-off of type ordinarily used for co-ax line. Maintains 1" spacing for constant impedance. List\$30



Cat. No. 450-3 Spacer.

Place 12" apart along line to maintain 1" spacing. List \$10



MOSLEY ELECTRONICS

2125 Lackland Rd., Overland, Missouri

Depend On . . .

Insist on . . .



You can depend on Astron for a complete line of multi-tested dry electrolytic and molded paper tubular capacitors for every radio, and television replacement job.

For quality next time . . . insist on Astron.

Write for catalog AC-3



255 Grant Avenue, E. Newark, N. J.

W. J. DOYLE NOW ASTATIC V-P

William J. Doyle, former general sales manager of The Astatic Corporation, Conneaut, Ohio, has become vice president in charge of sales.



W. J. Doyle

* * *

GHIRARDI SERVICING BOOK FOLDERS

The detailed contents of each of the 38 chapters in the first two volumes of the new Ghirardi *Modern Radio and Television Servicing Library* appear in two illustrated circulars issued by Rinehart Books, Inc., 232 Madison Avenue, New York 16, N. Y.

These books, 669-page *Radio and TV Receiver Troubleshooting and Repair*, and 822-page *Radio and TV Receiver Circuitry and Operation* by Ghirardi and Johnson, provide timely practical circuitry and servicing information.

Free copies of these circulars are available from the publishers.

* * *

HEATH CATALOG

A catalog covering a line of test equipment and amplifiers has been released by the Heath Co., Benton Harbor, Michigan.

Detailed are schematics, inside views, uses, specifications and circuit descriptions of the instruments.



* * *

CRESCENT APPOINTS ROLLINS AND GIETL

William L. Rollins has been named vice president in charge of industrial sales for Crescent Industries, Inc., Chicago, Ill.

Edward M. Gietl has been named manufacturing executive, and will be in full charge of production of speakers, 3-speed intermix record changers, other record changers, wire recorders and allied products.

Edward M. Gietl

William L. Rollins



"CONICAL-V-BEAMS"

*REGISTERED TRADE MARK

NOW! Improved "CLOVER-V-BEAM" features PRACTICAL E-Z RIG DESIGN

Offers high sensitivity reception on roof, window or in attic
 Weighs only 24 ounces—
 Minimizes wind, ice and weathering
 Supplied completely assembled—installs easily and quickly

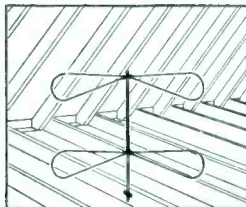

HIGH SENSITIVITY! Offers exceptionally high gain and high signal to noise ratio over the entire TV and FM bands. Low vertical angle results from 1/2 wave stacking—minimizes ghosts, airplane flutter and interference originating above or below. "Conical-V-Beam" dipoles provide 2 to 1 front to back ratio.

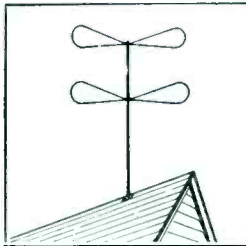

E-Z RIG SAVES TIME! Array comes compactly folded, completely pre-assembled and is speedily rigged by simply tightening two nuts. Servicemen acclaim its super-practical design and ease of installation in both indoor and outdoor applications.

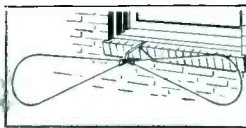

ECONOMY PRICED! Growing demand for the improved "Clover-Beam" makes it possible to offer this service-free antenna at a new low price of \$4.75 list. For illustrated data sheet and suggestions for unusual applications, call or write the Telrex Engineering Department.

"CONICAL-V-BEAMS" are covered by Patent No. 23,346
 CANADIAN and FOREIGN PATENTS PENDING

telrex INC.
CONICAL-V-BEAMS

AMERICA'S OUTSTANDING TELEVISION BEAM

Originators and Manufacturers of "CONICAL-V-BEAMS" —INSIST on the original!

ASBURY PARK 4, N. J.

SUNDBERG TO DIRECT OXFORD SALES

Hugo Sundberg, vice president and general manager of Oxford Electric Corp., Chicago, Ill., will direct future sales policies in addition to his other executive duties. John A. Proctor, Jr., formerly general sales manager of the firm, has resigned.

* * *

EICO DIRECT-MAIL BOOKLET

A booklet on basic instrument kits, for follow-through promotion, is now available to jobbers from Electronic Instrument Co., Inc., 84 Withers St., Brooklyn 11, N. Y. Will fit either standard number 10 or 634 envelopes.

GRAYBURNE BULLETIN

An equipment catalog, which includes an analysis of the specific market potential for products, now available, has been issued by the Grayburne Corp., 103 Lafayette St., New York 13, N. Y.

Described are ferri-loopsticks and vari-loopsticks, interference filters, tube carriers and TV-if signal boosters, etc.

* * *

RICE NOW MANAGER OF DUMONT PICTURE TUBE DIVISION

Fritz P. Rice has been named manager of the picture tube division, of Allen B. DuMont Laboratories, Inc., Clifton, N. J.

... if you are commercially or professionally interested in TV, you must read

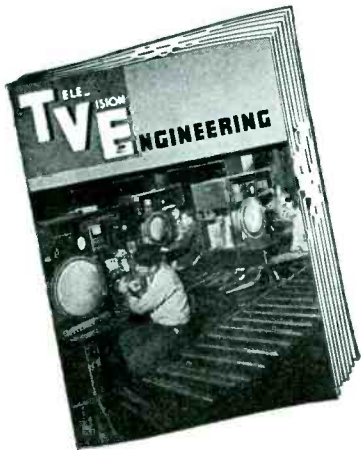

TELEVISION ENGINEERING

every month!

*Devoted exclusively to TV
Research . . . Design . . .
Production . . . Operation . . .
Instrumentation*

TELEVISION ENGINEERING is the *only* trade publication which directs its *entire* editorial content to executives and engineers who design, manufacture, operate and maintain television receiving and transmitting equipment—both commercial and educational.

Every issue is chock full of timely and thorough TV articles, authored by outstanding specialists. You'll find practical, carefully prepared reports and papers on such vital subjects as . . .

Color TV Systems . . . Ultrahigh Receiver-Transmitter Design Problems . . . Tube Production-Line Techniques . . . TV Broadcast Equipment . . . Camera Tube Research . . . Glass, Plastics and Metal in TV . . . TV Test Equipment in the Plant . . . Film Recording . . . Flying Spot Scanners . . . Tone Amplifiers for TV Films . . . Compact Motors for TV . . . TV Component Design . . . Mechanical Design Factors in Antennas . . . Quality Control Charting . . . Microwave Relays . . . Receiver and Transmitter Servicing . . . Production Aids . . . Instrument Activities . . . TV Sound Systems . . . Studio Lighting.

Enter your subscription NOW . . . Fill out the coupon below
(Not sold on newsstands)

MAIL COUPON

TeleVision Engineering
52 Vanderbilt Ave., New York 17, N. Y.

Here is my remittance for my subscription to **TeleVision Engineering** at the
SPECIAL RATE . . . 3 years (36 issues) only \$5.
(1 year subscription \$3.)

NAME

ADDRESS

CITY..... ZONE..... STATE.....

For our confidential records, open only to the Audit Bureau of Circulation, please supply the following information:

Occupation..... Title.....

Department in which employed

Operation Production Research

Employed by

Nature of Business.....
(State if TV Manufacturer, TV Broadcast Station, etc.)

MARESCA PROMOTED BY INSULINE

Joseph Maresca has been appointed assistant to Bernard L. Cahn, general sales manager of the Insuline Corporation of America, 36-02 35th Avenue, Long Island City 1, N. Y. In addition to his new duties, he will continue to act as manager of the sales order department, a post he has held for the past five years.



Joseph Maresca

* * *

MORSE NAMED EICOR TAPE RECORDER SALES MANAGER

Donald Morse has been named sales manager of the tape recorder division at Eicor, Inc., 1501 W. Congress St., Chicago 7, Ill. In his new position, Morse takes over the entire department and will be responsible for supervision of the manufacturer's reps.



Donald Morse

* * *

PERMOFLUX PRICE CHANGE

A decrease in prices on the champion line of replacement speakers, has been announced by the Permoflux Corp., Chicago, Ill.

Decreases on the individual models are said to range from 8% to 14%; the overall reduction is 11.2%.

* * *

LA POINTE PLASCOMOLD BUYS PRESS WIRELESS

LaPointe Plascomold Corp. has acquired Press Wireless Manufacturing Co., Inc., Hicksville, Long Island, and Springville Mill, Rockville, Conn., a four-story brick building with 156,000 square feet of production space.

AT RMS SALES MEETING



Sid Pariser, president RMS, and Marty Bettan, sales manager, with guest Maurice McDermott, Boston Red Sox pitcher, during their recent sales conference at Grossinger's Hotel and Country Club, in the Catskills, N. Y.

TV Parts

SNYDER INDOOR TV ANTENNA

An indoor *directronic* TV antenna system, that is said to be an all-channel antenna offering 360° orientation without the use of motors or electric power, has been announced by the Snyder Manufacturing Co., 22nd and Ontario Sts., Philadelphia 40, Pa. A selector, mounted on or near the TV set, provides remote control of element combinations.

Antenna has flexible tape elements which are said to adhere in a horizontal position to any ceiling for concealed installations.

* * *

NATIONAL TV BOOSTER

A TV booster, model *TVB-2BX*, has been announced by the National Co., Malden and Melrose, Mass.

Booster features a balanced input and output circuits, built-in power transformer (not *ac-dc*) with a selenium rectifier, turret tuner, and a pilot light to illuminate the selected channel.



* * *

TRICRAFT INDOOR ANTENNA

An indoor antenna, *Tenna-Boat* model 400, in the form of a ceramic sailboat in three colors, dark green, crimson and golden harvest, has been introduced by Tricraft Products Co., 1535 North Ashland Ave., Chicago 22, Ill. Sails are of pastel shaded plastic.

Boom of the boat is movable thereby allowing the user to orient the antenna for best reception without moving the boat itself. Features a variable capacitor, operated with a knob in the form of a mooring peg.

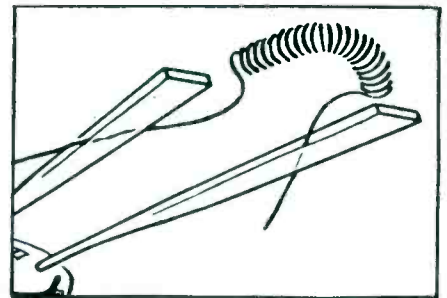
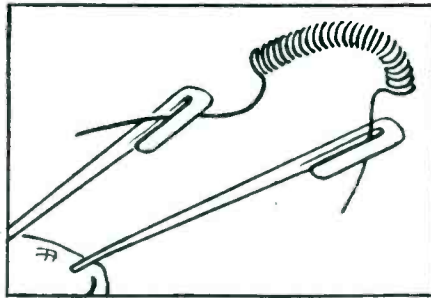
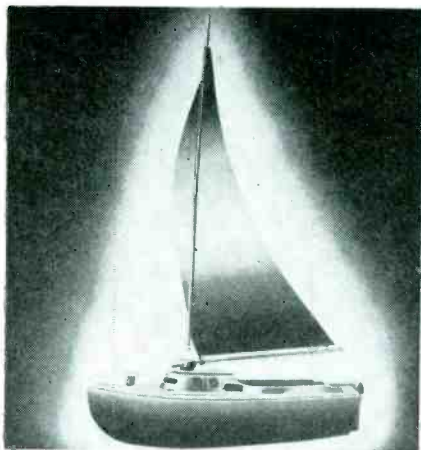

Why General Electric dial lamps don't cause static

SOME types of dial lamps can cause annoying radio interference. Old-type clamp joints in the bulb (diagram above, left) often permitted changes in resistance or tiny arcs that caused the lamp to radiate bothersome static.

But there's no static from G-E dial

lamps. To prevent their being noisy, General Electric engineers developed a better joint . . . one with tungsten filament legs pressed firmly into the softer metal of the lead-in wire. It's another reason why G-E dial lamps insure customer satisfaction!

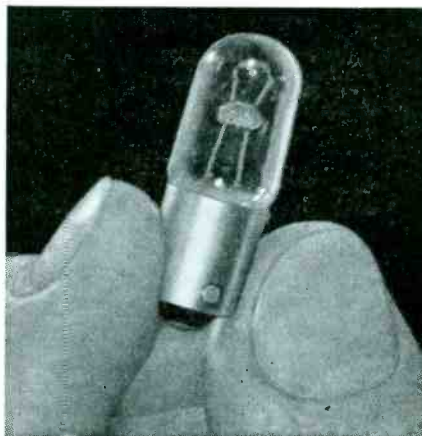

G-E dial lamps offer these advantages:

1. Dependable, trouble-free performance
2. High level of maintained light output
3. Low current consumption
4. Long life
5. Top customer acceptance

GENERAL ELECTRIC

VEE-D-X YAGI PHASING HARNESS

A phasing harness, *LJH*, has been designed for stacking *Vee-D-X Long Johns*. To minimize coupling effect between bays and maintain 300-ohm match, it was necessary to design this harness, which, it is said, permits assembly of a double-stacked 8-element yagi and produces 50% more gain than a single unit.

* * *

DAVIS FRINGE ANTENNA

A TV antenna, *Super-Vision*, has been announced by Davis Electronics, 3047 West Olympic Blvd., Los Angeles 6, Calif. Antenna designed for fringe areas is said to reduce or eliminate ghosts and, provide 10 db or more gain on high channels.

JFD STANDOFF

A strap-type screw-eye standoff with six machined threads has been introduced by the JFD Manufacturing Co., Inc.

Standoff features an arch-bridge construction for the buckle area that is said to prevent any bending of the clamp. Fits masts up to 2½" od.

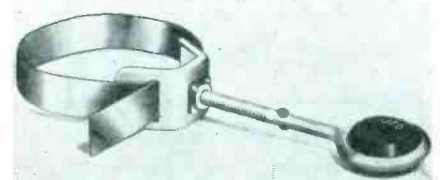

Complete TUBE TESTER and SET ANALYZER

HICKOK

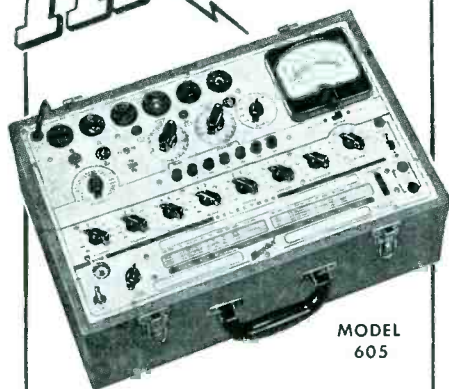

MODEL
605

Lower cost . . . Handier size
Ideal for house calls

**INCLUDES: HIGH SENSITIVITY
MULTIMETER**

YOU NEED THIS—at a price of only a little more than the standard HICKOK Tube Tester you get a built-in multimeter that uses a vacuum tube for its rectifying element to provide a better multimeter than any other you can buy. Measures volts, resistance, current and also capacitance—a very important servicing measurement.

All this is included in addition to the HICKOK Dynamic Mutual Conductance Tube Tester circuits. The 605 is complete. Entirely built to the high HICKOK standards.

DESIGN FEATURES

Scale readings in micromhos for most accurate tube evaluation Ranges: 0-3,000, 6,000, 15,000 micromhos.

HICKOK tube gas test.

Tests tubes under simulated operating conditions.

Contains all the latest tube sockets and complete built-in reference chart.

Test leads included.

Write for detailed information or see your HICKOK jobber today.

THE HICKOK ELECTRICAL INSTRUMENT CO.

10521 Dupont Avenue • Cleveland 8, Ohio

CLEARBEAM LEADIN AND ANTENNA

Air-spaced TV twin leadin, *Spaceline*, which is said to eliminate 50 per cent of the signal loss, and an indoor TV antenna, *Inductenna*, that works on the inductance principle, have been announced by Clearbeam TV and Accessories, 100 Prospect Ave., Burbank, Calif.

Leadin is made of 20-gauge copper-wire and 55-mil polyethylene, and is available in 1000' spools.

Antenna features copper-colored spirals with a walnut base.

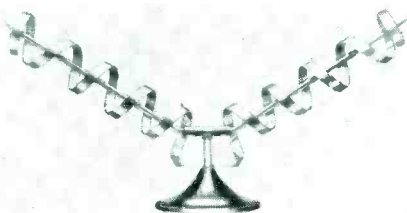

Clearbeam Inductenna.

* * *

INSULINE TV LIGHTNING ARRESTER

A molded phenolic TV lightning arrester (U.L. Approved), has been announced by the Insuline Corporation of America, Long Island City 1, N. Y. Contact to the latter's wires is made by means of cup-shaped washers with serrated teeth.

The new arrester is made in two styles: 6113, which has a binding post for a ground wire, and 6114, which has a grounding strap that fits around the usual metal pipe of the TV antenna.

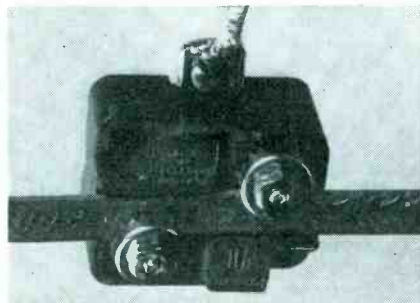

* * *

TODD-TRAN ANTI-CORONA COMPONENTS

Anti-corona deflection components, which include a sealed-in-plastic flyback transformer, and a sealed-in-plastic deflection yoke, have been developed by Todd-Tran Corp., 156 Gramatan Ave., Mt. Vernon, N. Y. This type of construction is said to minimize corona radiation and breakdown due to dust and grease particles attracted to or precipitated by deflection components. A universal mounting bracket is used for the flyback transformer so it can be mounted either vertically or horizontally.



Solderless Cable Fittings



By Workshop

Whenever you need a cable fitting for RG-8 U, RG-11 U and RG-59 U, specify **WORKSHOP** . . . Solderless silver plated connectors, receptacles, junctions and adaptors. Look for the complete line at your distributor's on the *red and white* display card.



**THE
WORKSHOP
ASSOCIATES**

Division of the Gabriel Co.
135 Crescent Road

Needham Heights 94, Mass.



Low Cost Powerful P.A.!

COMPLETE • READY TO USE

Tops for powerful indoor-outdoor use; ideal for electioneering. Easy portability. Covers 4,000 persons indoors, up to 25,000 sq. ft. outdoors. Full 30 watts usable output; 2 high-imp. mike inputs, 1 phono input, each with separate volume control; tone control; fidelity ± 2 db from 40-20,000 cps. Complete system includes: 30 watt amplifier and tubes, Electro-Voice "Cardax" unidirectional mike with adjustable floor stand and 20' cable; 2 General Electric 12" PM speakers, each with 30' cable; portable carrying case holds all, 16 $\frac{1}{4}$ x 12 $\frac{3}{4}$ x 25". For 110-130 v., 60 cy. A.C. Shpg. wt., 75 lbs. Complete, less only phono top.

93-372. Complete 30 Watt System. *Only \$119.75*
93-340. 3-Speed Phono Top for above. *Only \$16.95*
Available on *Easy Terms*—write for details

FREE See the 212-Page **ALLIED** Catalog for other Sound Systems, ranging from 8 to 80 watts. Write for Free copy of Radio's leading Buying Guide today.

ALLIED RADIO

833 W. Jackson Blvd., Dept. 23-C-2, Chicago 7, Ill.

TACOPLEX CHANNEL SEPARATOR

A two or three channel separator, 1512-1513, for use with master antenna distribution systems in community installations, is now available from Technical Appliance Corp., Sherburne, N. Y.

Unit separates the TV channel signals traveling along a common transmission line and feeds the separated signals through individual outputs to their respective amplifier strips; employed in a community system at all booster stations. Basic principle of the unit is to provide proper termination of the transmission line and to select the proper channel without amplification of adjacent channels.

Separators are housed in a compartmented metal housing that shields each individual channel filter. Each channel section is a pi-section type bandpass filter. Circuitry is said to have sharp cutoffs on both sides of the specified 6-mc bandwidth. Units are available for any combination of two or three low-band channels, not including adjacent channels, except 4 and 5.

* * *

RMS TV TESTER TUBE

A test instrument, *Pix-Eye*, which is said to permit on-the-spot checks of picture tubes and of receiver circuits, has been announced by Radio Merchandise Sales, Inc., 1165 Southern Blvd., New York 59, N. Y.

Instrument, it is claimed, will check picture tube for shorts, intermittents and opens, and permit spot check of brightness control, contrast control, low voltage and filament voltage circuits, without removing the picture tube or chassis.

Tube is plugged into the picture-tube socket of the receiver and various indications in the eye tube serve to guide the Service Man.

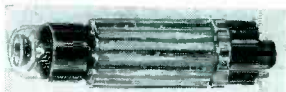

* * *

BRACH OPEN-WIRE LINE ARRESTER

A lightning arrester, 1004, for open-wire transmission lines, has been introduced by the Brach Manufacturing Co., Newark, N. J.

Arrester uses a rare-gas tube in which the charges are carried to electrodes sealed into this tube where they are instantaneously dissipated before they can enter and destroy TV receiver equipment.

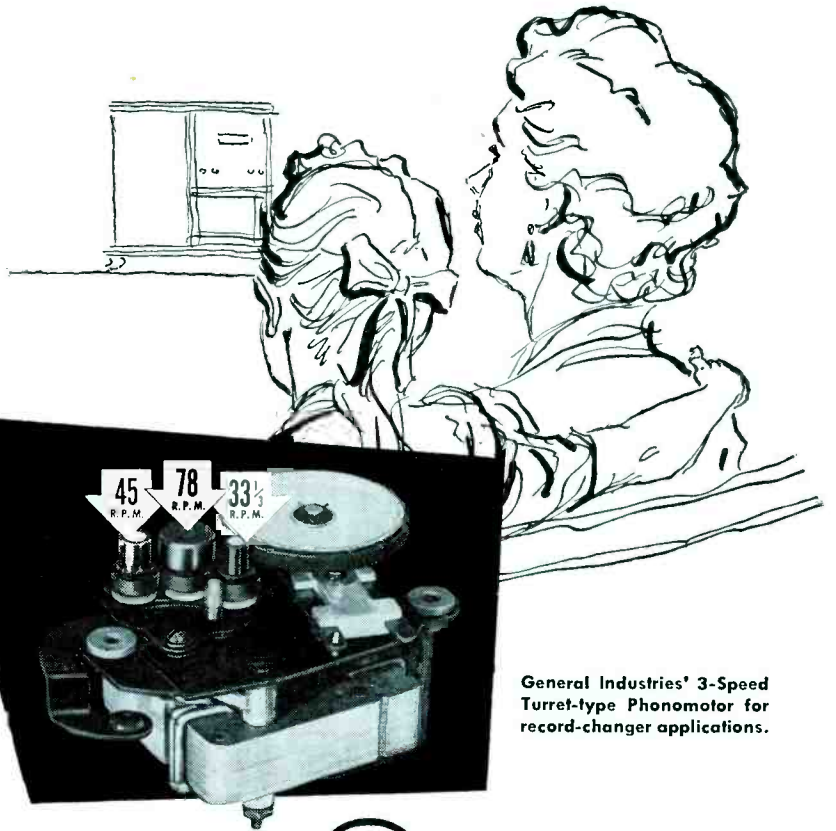
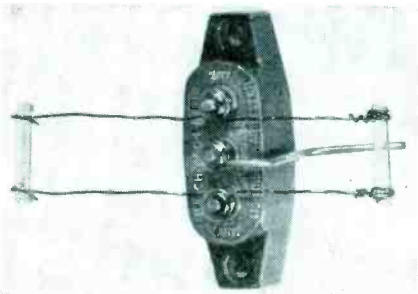

General Industries' 3-Speed Turret-type Phonomotor for record-changer applications.

Quietness...

an important reason why leading manufacturers prefer General Industries' 3-Speed Phonomotors

Because they are extremely low in hum, wow, rumble and speed variation, General Industries' Phonomotors meet every performance requirement of radio and television set manufacturers and record-changer producers alike.

Write *today* for detailed information, including specifications, design features and dimensions of General Industries' complete line of phonomotors.

THE GENERAL INDUSTRIES CO.
Department MF • Elyria, Ohio



KENWAY ANTENNAS-ACCESSORIES

Four TV antenna products are now available from Ken-Way Products Inc., Owensboro, Kentucky: a 5-element high-channel yagi and a low-channel yagi, a low-priced booster and 300-ohm leadin.

Yagis are said to provide a 9-db gain. Booster, model 611, is claimed to have a balanced input and output for 72-300 ohms and a balanced amplifier that features a push-pull neutralized 6J6 triode.

* * *

JFD INDOOR ANTENNA

An indoor antenna, TA137, which has two 3-section telescoping dipoles of aluminum, has been introduced by the JFD Manufacturing Co., Inc., 6101 16th Ave., Brooklyn 4, N. Y.

Antenna is said to be tip-proof.

CHANNEL MASTER TWO-CHANNEL YAGI

A two-channel yagi antenna, model 645, featuring a Z-match system, is now available from Channel Master Corp., Napanoch Road, Ellenville, N. Y.

Covering both channels 4 and 5, this antenna provides match to 300-ohm line, in both single and stacked arrays. A single bay is said to give over 8 db measured gain on each channel, and four stacked models a gain of over 14 db on each channel. In stacking, the center bar is removed from the larger folded dipole of each antenna, and center bars are then used as stacking bars. This action is claimed to reduce the impedance of each 300 ohm antenna, so that a 300-ohm match for the entire stacked array is obtained.

TUNG-SOL[®]

for
**Uniformity
and
Dependability**

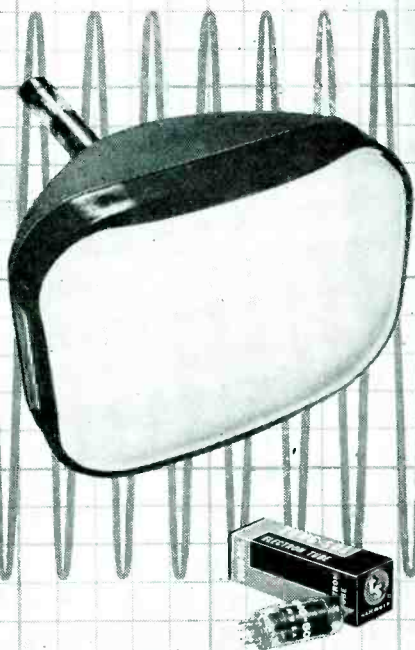

REPLACEMENT:

Tung-Sol tubes keep service standards up to set manufacturers' specifications.

INITIAL EQUIPMENT:

Tung-Sol tubes meet the highest performance requirements of set manufacturers.

TUNG-SOL
RADIO, TV TUBES, DIAL LAMPS

TUNG-SOL ELECTRIC INC., NEWARK 4, N. J.
Sales Offices: Atlanta • Chicago • Dallas • Denver
Detroit • Los Angeles • Newark

ALSO AUTO LAMPS, ALL-GLASS SEALED
BEAM LAMPS AND SIGNAL FLASHERS

AGC Systems

(Continued from page 44)

with about 75 microvolts signal strength.

The Keyed AGC Amplifier

In the keyed *agc* system, the 6AU6 functions to adjust automatically the sensitivity of the receiver in accord with the strength of the received signal. Fig. 3 (p. 44) illustrates how the system basically designed to have a high immunity to noise, operates.

The horizontal output system of this receiver uses a high impedance deflection coil connected directly to the plate of the horizontal output tube without the need of a transformer. The *dc* plate current of the horizontal output tube is supplied through a choke T_{18} . During the retrace period, which is approximately 6 per cent of the scan time of one line, a high-amplitude pulse is developed, due to the collapse of the field in the horizontal deflection coils. This pulse appears across the choke and is applied to the plate of the *agc* control tube by the second winding on this choke. The resulting pulse, applied to the plate of this tube, is its only source of plate voltage and the polarity of connections to the choke are such that when current flows in the plate circuit it will develop a negative voltage across the 100,000-ohm resistor, R_{16} . The plate current of the *agc* amplifier consists of *dc* pulses at line frequency rate and these pulses must be filtered into a steady *dc* voltage before the voltage is applied to the controlled tubes. A 330,000-ohm resistor, R_{51} , and a pair of .1-mfd capacitors, C_{38} and C_{10} , serve to provide this filtering.

The magnitude of the *agc* control voltage is made dependent upon the strength of the received signal by connecting the grid of the *agc* amplifier tube to the plate of the first video amplifier tube. Direct connection is permitted, and normal operating conditions for the tube are obtained by the circuit design of the *dc* power distribution system.

Since pulse plate voltage appears at the plate of the *agc* amplifier only during retrace time and this interval coincides with the time of the sync pulses, the video signal influence on *agc* voltage is only during the sync interval.

From the foregoing it becomes evident that this system of *agc* inherently possesses a high degree of noise immunity, since the circuit is quiescent during line scan period and becomes active only during the retrace or synchronizing interval. This also

accomplishes the desired condition of obtaining *agc* voltage that is proportional to the amplitude of the synchronizing pulses only.

An adjustable 1,000-ohm resistor, R_{57} , is provided in the cathode circuit of the *agc* amplifier tube to adjust the operating bias of this tube. Under average conditions the optimum value of this bias is one volt and the control is so adjusted on the receiver before leaving the factory. If the receiver is operated in an area of extremely strong or weak signals, it may be found advantageous to alter this adjustment. If overload from a strong signal is evident the control may be changed to reduce the bias on the 6AU6 and thereby obtain more *agc* voltage. In weak signal areas, the overall receiver sensitivity can be increased by increasing the bias on the tube and thereby delaying and reducing the *agc* voltage.

Operation

In Fig. 4 (p. 44) appears another *agc* circuit in simplified form. For clarity the 12AX7 is represented as two triodes, V_{22A} and V_{22B} . The circuit has two signal inputs: a constant amplitude, positive, horizontal sync pulse from the sync separator tube, and the composite video signal, with negative sync pulses, from the second video amplifier. The pulse from the sync separator tube is fed to the grids of the two triode sections of the 12AX7 and acts as a keying pulse to allow the triodes to conduct only during the horizontal sync pulse time; this means that the *agc* circuit makes a bias correction only at peak carrier amplitude and is independent of picture content. The composite video signal is applied to the plate of V_{22B} and to the cathode of V_{22A} , and the amplitude of the sync pulse of this signal determines the *dc* bias developed in the circuit.

The positive keying pulse is applied to the grid of tube *A* through the differentiator circuit consisting of capacitor C_{57} (100 mmfd) and resistor R_{43} (1 megohm), which filters out the vertical sync component. The peak-to-peak amplitude of this pulse is about 7 volts under normal conditions. At the same time, in a given case, the composite video signal, with negative sync pulses, applied to the cathode of tube *A* may have a peak-to-peak amplitude of about 9 volts. The grid-cathode bias developed would be about 8 volts, cutting off tube *A*. During the sync-pulse interval the grid is driven positive by the keying pulse from the sync separator tube, and the cathode is driven negative by the sync pulse in the composite signal.

[To Be Continued]

Hi-Q*

STANDS FOR

HIGH-VOLTAGE CERAMICS



It's just common sense. By settling on one 6000-volt rating, your essential tubular ceramic needs boil down to this handy SE-TV series.

Adequate safety factor avoids voltage breakdowns. These Hi-Q* tubular ceramics are available in eleven capacitance values — 4.7 to 47 mmf. Packed five to the unique Aerovox window-carton, but also available as individual pieces.

And of course the Hi-Q* line includes other tubulars, discs, stand-offs, high-voltage, feed-thru and other popular ceramics.

Ask your distributor for Aerovox Hi-Q* Ceramics for any and all your ceramic capacitor needs.

*Trade Mark registered U. S. Pat. Off. by AEROVOX CORPORATION



FOR RADIO-ELECTRONIC & INDUSTRIAL APPLICATIONS

AEROVOX CORPORATION
NEW BEDFORD, MASS., U. S. A.

In Canada: AEROVOX CANADA LTD., Hamilton, Ont.
Export: 41 E. 42nd St., New York 17, N. Y.

FM Servicing

(Continued from page 32)

may appear due to trouble in the detector stage. Usually it will be one or a combination of the following: No output, distorted output, weak output, high-frequency hiss, noise or static. It is true that some of these symptoms may be caused by trouble in other stages, and it is important that the trouble is localized to the detector stage before looking for trouble in that stage. Trouble in the mixer, *if* or *af* stages should be found easily by the usual methods of troubleshooting. If the set incorporates facilities for a phono input, the audio stages can be checked quickly by connecting the output from a pickup to the phono terminals and listening to the output. If there is no distortion and sufficient volume, the trouble must be before the audio stages. Switch trouble must also be considered. To check the stages before the discriminator, a signal should be applied at the *if* to the mixer grid and the voltage, across the discriminator grid-leak resistor, measured at point G. If there is a negative voltage developed when the signal is applied, the *if* stages are operating.

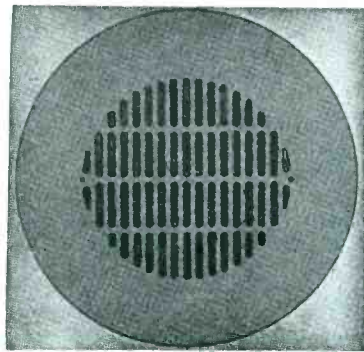

Model 10-P Grille

An attractive, well finished installation is a standing advertisement that draws more business.

That is why particular Sound Engineers are using the 10-P Flush Mounting Grilles.

Write for literature on our
Speakers, Baffles and Grilles.

WRIGHT Inc.

2233 University Avenue, St. Paul 4

SHOOT TV TROUBLE FAST!

With H. G. Cisin's Copyrighted RAPID "TV TROUBLE SHOOTING METHOD"

Without experience or knowledge, this guaranteed new method of servicing TV sets enables you to DIAGNOSIS TV troubles as rapidly as an expert. NO THEORY—NO MATH—you can locate all faults in record-breaking time, regardless of make or model. "TV TROUBLE SHOOTING METHOD" is the most valuable aid to TV servicing ever written. Be a TV Trouble Diagnostician. Increase your present earnings. Open your own Profitable Business or get a high-paying skilled job.

It's all in this book . . .

Nothing more to Pay—Nothing else to Buy
Alphabetically listed, there are 85 picture troubles, over 58 raster and 17 sound troubles and by this unique copyrighted method you know EXACTLY WHERE the trouble is; plus step-by-step instructions, including 69 RAPID CHECKS, enabling you to find the faulty part.
13 IMPORTANT PRELIMINARY CHECKS NEED NO INSTRUMENTS! Of the 69 Rapid Checks, OVER 65 ALSO REQUIRE NO INSTRUMENTS! Rapid checks include emergency checks for distorted pictures, defective tubes including PIX tube, plus 57 others. ALL EXPLAINED IN SIMPLE LANGUAGE. PERFORMED WITHOUT INSTRUMENTS. MANY CHECKS USE THE PICTURE TUBE AS A GUIDE.
H. G. Cisin, the author, is the inventor of the AC/DC midget radio. He licenses RCA, AT&T, etc. He has also trained thousands of technicians now owning their own prosperous TV service organizations or holding highly paid TV positions. His years of experience are embodied in this remarkable new TV TROUBLE SHOOTING METHOD.

Guaranteed. Money Back in 5 Days if Not Satisfied!

Send your name and address today with \$1 for your post-paid copy; you'll say it's worth hundreds! **\$1** Postpaid

H. G. CISIN—CONSULTING ENGINEER
(Dept. S-10), 200 Clinton St., Brooklyn 2, N. Y.

Name
Address
City Zone State

FIRST AID FOR TV SETS!

H. G. CISIN's "TV DOCTOR"

Shows you how to fix TV sets RAPIDLY!



Save money—do a better job faster. Here's a really practical TV book. An amazing, quick, copyrighted method of fixing TV troubles. Written by a noted inventor and educator, H. G. Cisin, in plain language.

MAKES TV SERVICING EASY! TUBES CAUSE 80% OF TV TROUBLES!

TV DOCTOR shows how to quickly locate all defective tubes. WITHOUT EXPERIENCE—PICTURES & TEXT SHOW YOU THE QUICK, EASY WAY TO FIX FAULTY TV SETS

Reveals many closely guarded TRADE SECRETS. Lists over 123 trouble conditions. Method applies to all TV sets from oldest to newest.

11 money-making, fact-crammed, detailed, illustrated chapters include: practical ways to combat interference and ghosts, how to appraise TV sets, valuable information on antennas, lead-ins, color, practical—not theoretical—pointers on TV sets, ion traps, tubes used in TV, addresses of manufacturers—a veritable encyclopedia.

Only \$1—you'll say it's worth hundreds. 5-day Money Back Guarantee.

FREE SPECIAL OFFER

Get a new, full-size, profusely illustrated, \$1 book—"TV TROUBLE SHOOTING METHOD" INCLUDING TV TERMS SIMPLY EXPLAINED" as a FREE GIFT, by ordering the "TV DOCTOR" and H. G. Cisin's famous "TV TROUBLE SHOOTING METHOD" which trains you to be a TV Diagnostician, selling for \$1. Think of it— all 3 TV books postpaid for only \$2—you save \$1.

\$1 Postpaid

H. G. CISIN, Consulting Engineer (Dept. S-10)
200 Clinton Street, Brooklyn 2, N. Y.

Enclosed find \$2, full payment for "TV DOCTOR" & "TV TROUBLE SHOOTING METHOD" PLUS my FREE copy of "TV TROUBLE PICTURE GUIDE." Rush all three books postpaid.
 Enclosed find \$1, full payment for "TV DOCTOR." Rush copy postpaid.

Name
Address
City Zone State

Choice of the Leaders!

ELECTROX

D.C. POWER SUPPLIES!

Leading companies—General Motors • Sears Roebuck • Goodrich • Lincoln-Mercury • Western Auto Supply • Firestone • many others—have standardized on Electrox D.C. Power Supplies for demonstrating and testing auto radios and other low voltage D.C. equipment. And servicemen everywhere have followed their lead—for the Electrox is today's outstanding D.C. Power Supply . . . in performance and dollar-for-dollar value!

NEW MODELS!

Two new Electrox Models are now available—compact—dependable—low cost! They deliver smooth, hum-free D.C. which will operate practically any auto radio—either push-button or manually tuned. They are designed to give the utmost in reliable, dependable service.

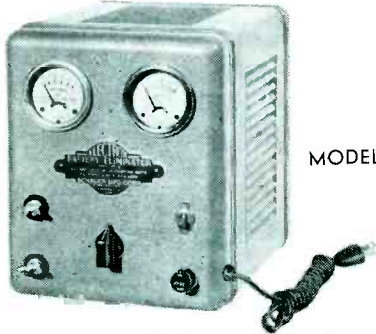

MODEL AR-5

Delivers 6 volts D.C.—smooth, hum-free. Output voltage adjustable for any load current between 3 to 15 amperes, indicated by 0-15 ampere D.C. ammeter; 0-8 volt D.C. voltmeter. Size: 7½" wide, 9¼" deep, 8" high.



MODEL AR-4

Same size, constructed to same high standards as Model AR-5 above, except output voltage is not adjustable. Delivers 6 volts D.C. at approx. 15 amperes.

ORDER NOW FROM YOUR DISTRIBUTOR. WRITE FOR FREE COPY OF BULLETIN 1467 GIVING COMPLETE DETAILS.

Rectifier Division

SCHAUER MANUFACTURING CORP.
4512 Alpine Ave. Cincinnati 36, Ohio



Ask for the **SMITH**

Roof Mount
FOR TV MASTS
Made of Sturdy
Cast Aluminum

- JUST WHAT TELEVISION INSTALLERS HAVE BEEN LOOKING FOR.
- 1—ALL ALUMINUM CASTINGS WITH PLATED STEEL BOLTS.
 - 2—TESTED TO WITHSTAND ANY NORMAL LOAD UP TO 1500 LBS.
 - 3—WILL TAKE TUBING O D ¾" TO 2".
 - 4—THE ORIGINAL SADDLE MOUNT FOR ROOF RIDGE.
 - 5—CAN BE USED ANY PLACE ON ROOF.
 - 6—IDEAL MOUNT FOR TALL MAST.
 - 7—HOLDS BASE OF PIPE AT FIXED POSITION FOR RAISING OR LOWERING.

Thousands in use. Ask your Jobber—or write for Circular

SMITH ELECTRIC MFG. CO.
Ashland, Ohio

**Tools . . .
Instruments
Parts . . .**

RADIART AUTO-RADIO VIBRATORS

Replacement auto-radio vibrators, that feature an automatic vent incorporated in the base, has been introduced by the Radiart Corp., Cleveland, Ohio.

Vent is wax sealed, which is said to prevent oxidation of the points prior to being put in use. When the vibrator is put into use, the temperature rise inside the vibrator melts out the wax and permits air circulation.

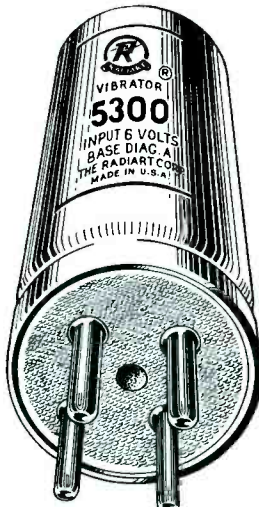

ARGOS JUNIOR TUBE CADDY

A smaller-size, leatherette-wood cabinet, *Tube Caddy Junior TC-2*, designed to carry up to 143 receiving tubes, has been announced by Argos Products Co., Genoa, Ill.

Model has two drawers at top for miniature and medium size tubes, plus space at the bottom for larger tubes. Partitions in drawers are removable. Small tools or a meter can also be carried. Cover is fitted with slip-out hinges. There are clips inside the cover to hold a mirror for use in picture tube adjustment or a price list.

Measures 15½" long, 13" high, and 8" wide. Carrying weight is 8 pounds, 2 ounces.

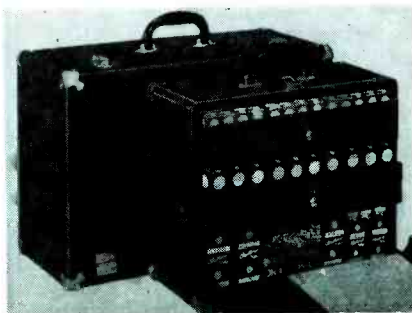

RCA MASTER VOLTOHMYST

A voltmeter, *WV-87A Master Volt-Ohmyst*, that includes facilities for the direct measurement, on separate scales, of peak-to-peak voltage values of complex waveforms and the rms voltage values of sine waves, has been introduced by the RCA Tube Dept., Harrison, N. J. Also reads *dc* voltage, resistance, and direct current.

Furnished with the instrument is a set of multi-purpose probes and cables for use in making measurements in all types of electrical equipment. Included are a direct probe and cable, a *dc* probe, an ohms probe and cable, a negative current cable, a positive current cable, and a ground cable.

Measures *dc* currents from 10 *ma* to 15 amps in seven continuous ranges. Instrument will also measure *dc* voltages in high-impedance circuits with *rf* present, *de*-current input to automobile radios and other equipment operating from *dc* sources, and resistances of low-power devices, such as the filaments of miniature vacuum tubes. Meter is electronically protected against burn-out on all *ac* and *dc* voltage and resistance ranges.

In *ac*-voltage measurements, instrument will read directly the peak-to-peak values of unsymmetrical complex waves from 0.2 volt to 2,000 volts, peak-to-peak values of symmetrical complex waves from 0.2 volt to 4,200 volts, and *rms* values of sine waves from 0.1 volt to 1,500 volts. *DC* voltages from 0.02 volt to 1,500 volts and resistance values from 0.2 ohm to 1,000 megohms may also be read directly.

* * *

HICKOK TV RF MARKER AND CALIBRATOR

A TV *rf* marker and crystal-controlled calibrator, model 680, that is said to be accurate to .05 per cent, has been announced by the Hickok Electrical Instrument Co., 10521 Dupont Ave., Cleveland 8, Ohio.

Instrument features an *rf* signal generator calibrated to cover the ranges from 53-89 mc and 174-217 mc on fundamentals, and to 868 mc on harmonics; a crystal-calibrated marker generator from 53-89 mc and 174-217 mc, in two bands; a crystal oscillator from 500 kc to 20 mc on fundamentals; a 2.5-mc crystal; a heterodyne frequency meter for calibrating other generators up to 900 mc; usable harmonics output on *vhf* and *uhf* bands; sound and picture frequencies for all 12 TV channels; variable frequency oscillator providing 31 crystal check points; tuning drive ratio of 11-1; and a built-in magic eye to provide a zero-beat indicator.



Now... Get ALL Your DRIVERS FROM VACO

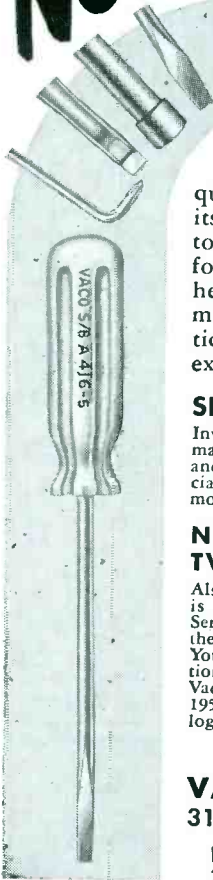

Only Vaco offers you the complete, fine quality line of drivers that daily is proving its superiority in service shops and on factory production lines . . . in terms of performance at low cost. Made of specially heat treated chrome vanadium blades mounted in break-proof, shock-proof plastic handles, Vaco drivers are the choice of experts in TV and radio.

SPECIAL RADIO AND TV DRIVERS

Investigate Vaco's new non-metallic aligners, non-magnetic beryllium copper focalizer screw drivers and other unusual products. They are made especially for radio and TV and have proved themselves most practical in delicate adjustment work.

NEW 27 PIECE TV SERVICE KIT

Also available from Vaco is a new 27-piece TV Service Kit made up at the request of TV men. You'll find a full description of this kit and other Vaco products in the new 1951 Vaco 3-color catalog. Send for it, today.



At Your Supplier or Write to:

VACO PRODUCTS COMPANY
317 East Ontario Street, Chicago 11

In Canada: Vaco-Lynn Products Co., Ltd.,
204 Laurier Ave., W., Montreal 8, Quebec.

THREE TYPES OF TWIN LINE CONNECTORS GIVE YOU A CHOICE FOR ANY INSTALLATION PROBLEM!



No. 14-0
A general purpose polarized connector.

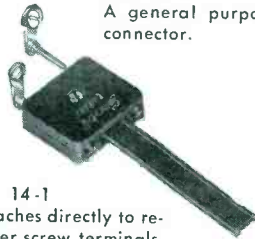

No. 14-1
Attaches directly to receiver screw terminals. Eliminates cutting line to install a connector.

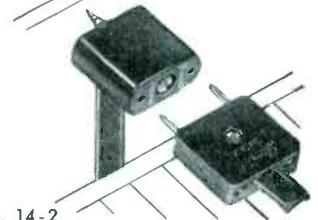

No. 14-2
A baseboard connector; serves as junction for antenna lead-in and inside lead to set. Mount them in parallel to accommodate the receiver in various locations.

Grayhill

GET DETAILS—Write for the Grayhill Catalog NOW

4532 W. Madison Street

Chicago 24, Illinois

Finest TV Reception



the *Hi-Lo*
TV Spiral Indoor
ANTENNA

*U. S. Patent No. 2,495,579
Canadian patents 1951

\$9.95
LIST PRICE

Available at leading jobbers!

Hi-Lo TV ANTENNA CORP.
3540 N. Ravenswood Chicago 13

Model 101*



THE NEW
DuKANE
MAGNETIC
TAPE
RECORDER

THE FINEST IN
HIGH FIDELITY RECORDING
at LOW COST!

MAIL COUPON FOR INFORMATION TODAY!

DUKANE CORP. Dept. S-32 St. Charles, Ill.

Please send information on the DuKane Magnetic Tape Recorder.

Name _____

Address _____

City _____ State _____

ESTABLISHED AS "OPERADIO" 1922

ATR

Makes
it easy
to DEMONSTRATE
AND TEST
D.C. APPARATUS
FROM A.C. LINES



"A" BATTERY ELIMINATORS

For DEMONSTRATING AND TESTING
AUTO RADIOS

New Models . . . Designed for testing D.C.
Electrical Apparatus on Regular A.C. Lines.
Equipped with Full-Wave Dry Disc Type
Rectifier, Assuring Noise-less, Interfer-
ence-Free Operation and Extreme
Long Life and Reliability.

ATR

NEW MODELS

NEW DESIGNS

NEW LITERATURE

"A" Battery Eliminators, DC-AC Inverters
Auto Radio Vibrators

See your jobber or write factory

AMERICAN TELEVISION & RADIO CO.

Quality Products Since 1931

SAINT PAUL 1, MINNESOTA-U. S. A.

JOTS AND FLASHES

SERVICEABILITY has been cited as a major TV set feature by several manufacturers in their new-chassis announcements. An interesting illustration of this new trend appeared in a news note from *DuMont*, which declared that their new models feature a simplified open layout, selected test points which are outside the chassis and can be used for preliminary troubleshooting without removal of the chassis from the cabinet, a removable front safety glass to simplify cleaning or the removal of the picture tube, and an *afc* look point permitting alignment of the horizontal oscillator without removal of the chassis. . . . In an announcement from *Emerson*, a simplified scheme for picture-tube cleaning was also emphasized. It was pointed out that this facility, known as a *snap-on removable bezel and safety-glass device*, will permit the removal of the front plate without the aid of tools. . . . There are 861,653 TV sets in the Boston coverage area, according to *WBZ-TV* and *WNAC-TV*. . . . Metal-shell TV picture tubes, *RCA* reported recently, account for nearly 30 per cent of the total picture-tube sales. . . . The '52 *Audio Fair in Chicago* will be held at the Conrad Hilton Hotel, May 23-24. . . . The sixth in the series of *Most-Often-Needed 52 TV Servicing*

Information manuals has been issued by Supreme Publications, 3727 W. 13th St., Chicago 23, Ill. . . . Thirty-four persons from seventeen firms of sales reps of *Howard W. Sams and Co., Inc.*, attended a two-day sales conference recently, at which company sales plans, promotions and policies for the Photofact publications were discussed. They were greeted by *Mayor Alex Clark* of Indianapolis, at a luncheon at the Indianapolis Athletic Club, where the reps were quartered. *Jack Keith*, vice president in charge of sales, presided at the general meetings. Speakers included *Howard W. Sams*, president; *Donald B. Shaw*, vice president-treasurer; *William D. Renner*, manager sales engineering department, and *Joe O. Goetz*, assistant sales manager. . . . *Louis B. Calanaras*, executive vice president of NEDA, has been appointed a member of a special Wholesale Trade Advisory committee. . . . A corrugated fibreboard carton for mailing and re-mailing individual reels of sound recording tape is now available from Minnesota Mining and Manufacturing Co. . . . *Roland J. Kalb*, vice president of Steelman Phonograph and Radio Co., has been re-elected president of Phonograph Manufacturers Association. Membership also reelected *Ben Birns*, president of Sonic Industries, as vice president, and *Joseph Dworken*, president of Dynavox Corp., as vice president and secretary-treasurer.

ADVERTISERS IN SERVICE—MARCH, 1952

AEROVOX CORP.	77	P. R. MALLORY & CO., INC.	Inside Back Cover
Agency: Austin C. Teschberger & Staff		Agency: The Aikin-Kennett Co.	
ALLIED RADIO CORPORATION	74	MOSLEY ELECTRONICS	70
Agency: George Brodsky, Advertising		Agency: Rudolph Bartz, Advertising	
ALPRODDCO, INC.	57	MUELLER ELECTRIC CO.	68
Agency: Paul J. Steffen Co.		NATIONAL COMPANY, INC.	8
AMERICAN PHENOLIC CORP.	30	Agency: John C. Dowd, Inc.	
Agency: Burton Browne, Advertising		NATIONAL VIDEO CORP.	3
AMERICAN TELEVISION & RADIO CO.	80	Agency: Martin Rothbard, Inc.	
Agency: Firestone-Goodman Adv. Agency		PERFECTION ELECTRIC CO.	60
ASTRON CORP.	70	Agency: Scantlin & Co.	
Agency: Salow & Associates		PEERLESS PRODUCTS INDUSTRIES	64
ATLAS SOUND CORP.	66	Agency: Bayard H. Clark, Advertising	
Agency: H. W. Hauptman Co.		PERMO, INC.	39
BLONDER-TONGUE LABS.	65	Agency: Symonds, MacKenzie & Co.	
Agency: Lester Harrison, Inc.		PLYMOUTH ELECTRONIC CORP.	56
CENTRALLAB DIV. GLOBE-UNION, INC.	48, 49	Agency: Howard-Vesson Co.	
Agency: Klau-Van Pietenom-Dunlop Associates, Inc.		PRECISION APPARATUS CO., INC.	13
H. G. CISH	77	Agency: Shappe-Wilkes, Inc.	
Agency: Janan Advertising, Inc.		RADIO CORPORATION OF AMERICA	29, 36, 37, Back Cover
CLEAR BEAM TV ANTENNAS	67	Agency: J. Walter Thompson Co.	
Agency: Stiller-Rouse & Associates		RADIART CORP.	Inside Front Cover
COLUMBIA WIRE & SUPPLY CO.	66	Agency: Stern and Warren	
Agency: Sander Rodkin Adv. Agency, Ltd.		THE RADION CORP.	55
CORNELL-DUBILIER ELECTRIC CORP.	54	Agency: Calkins & Holden, Carlock, McLinton & Smith, Inc.	
Agency: Heiss Advertising		RADIO MERCHANDISE SALES, INC.	62
CORNISH WIRE CO., INC.	58	Agency: Reid Associates	
Agency: Hart Lehman Advertising		THE RAULAND CORP.	19
DRAKE ELECTRIC WORKS, INC.	68	Agency: McFarland, Aveyard & Co., Inc.	
Agency: Symonds, MacKenzie & Co., Inc.		RAYTHEON MFG. CO.	14
DU KANE CORPORATION	79	Agency: Walter B. Snow & Staff	
Agency: Kennedy & Co.		REGENCY DIV. I.D.E.A., INC.	23
ELECTRO PRODUCTS LABORATORIES, INC.	2	Agency: Burton Browne, Advertising	
Agency: Clarence M. Gotsch Associates		JOHN F. RIDER PUBLISHER, INC.	58, 64, 74
ELECTRO VOICE, INC.	51	Agency: Corl Adv. Agency, Inc.	
Agency: Henry H. Tiplitz, Advertising		SCHAUER MFG. CORP.	78
ERIE RESISTOR CORP.	60	Agency: The Keeler & Stites Co.	
Agency: W. S. Hill Co.		HOWARD W. SAM'S & CO., INC.	56, 68
EUREKA TV AND TUBE CORP.	61	Agency: George Brodsky, Advertising	
Agency: Harry Belfor		SANGAMO ELECTRIC CO.	4
THE FINNEY CO.	63	Agency: Arthur R. Mogge, Inc.	
Agency: Allied Adv. Agency, Inc.		SIMPSON ELECTRIC CO.	43
GENERAL CEMENT MFG. CO.	59	Agency: Burton Browne, Advertising	
Agency: Paul J. Steffen Co.		SMITH ELECTRIC MFG. CO.	78
GENERAL ELECTRIC LAMP DEPT.	73	Agency: Brooks and London	
Agency: Batten, Barton, Durstine & Osborne, Inc.		SOUTH RIVER METAL PRODUCTS CO., INC.	62
GENERAL ELECTRIC	1, 10, 12	Agency: Art-Copy Adv. Agency	
Agency: Maxon, Inc.		SPRAGUE PRODUCTS CO.	53
THE GENERAL INDUSTRIES CO.	75	Agency: The Harry P. Bridge Co.	
Agency: Meldrum & Fowsmith, Inc.		STANDARD TRANSFORMER CORP.	69
GRAYHILL	79	Agency: Burnet-Kuhn Adv. Co.	
Agency: Merchandising Advertisers, Inc.		TEL-A-RAY ENTERPRISES, INC.	45
HALLDORSON CO.	5	Agency: Keller-Crescent Co.	
Agency: Western Adv. Agency, Inc.		TELREX, INC.	71
HEATH COMPANY	6	Agency: George Homer Martin Associates	
Agency: G. Denn, Jr., Advertising		TRANSVISION, INC.	70
HICKOK ELECTRICAL INSTRUMENT CO.	74	Agency: H. J. Gold Co.	
Agency: The White Adv. Co.		TRIPLETT ELECTRICAL INSTRUMENT CO.	9
HI-LO TV ANTENNA CORP.	79	Agency: Western Adv. Agency, Inc.	
Agency: Sander Rodkin Adv. Agency		TUNG-SOL ELECTRIC, INC.	76
HYTRON RADIO & ELECTRONICS CO.	33	Agency: E. M. Froststadt Associates, Inc.	
Agency: Bennett, Walther & Menadier, Inc.		U. S. TREASURY DEPT.	12
JFD MFG. CO., INC.	62	VACO PRODUCTS CO.	79
JACKSON ELECTRICAL INSTRUMENT CO.	52	Agency: Kurlitz-Breslin, Inc.	
Agency: The Parker Adv. Co.		WALDOM ELECTRONICS, INC.	56
JENSEN INDUSTRIES, INC.	7	Agency: Turner Adv. Agency	
Agency: Paul J. Steffen Co.		WORKSHOP ASSOCIATES, INC.	74
KESTER SOLDER CO.	16	Agency: The Hubbell Adv. Agency	
Agency: Paul J. Steffen Co.		WRIGHT, INC.	77
LAPOINTE PLASCOMOLD CORP. (VEE-D-X)	58	Agency: Kay Advertising, Inc.	
Agency: F. W. Prolle Co.		XCELITE, INC.	64
THE MACMILLAN CO.	31	Agency: Melvin F. Hall Agency, Inc.	
Agency: Atherton & Currier, Inc.			

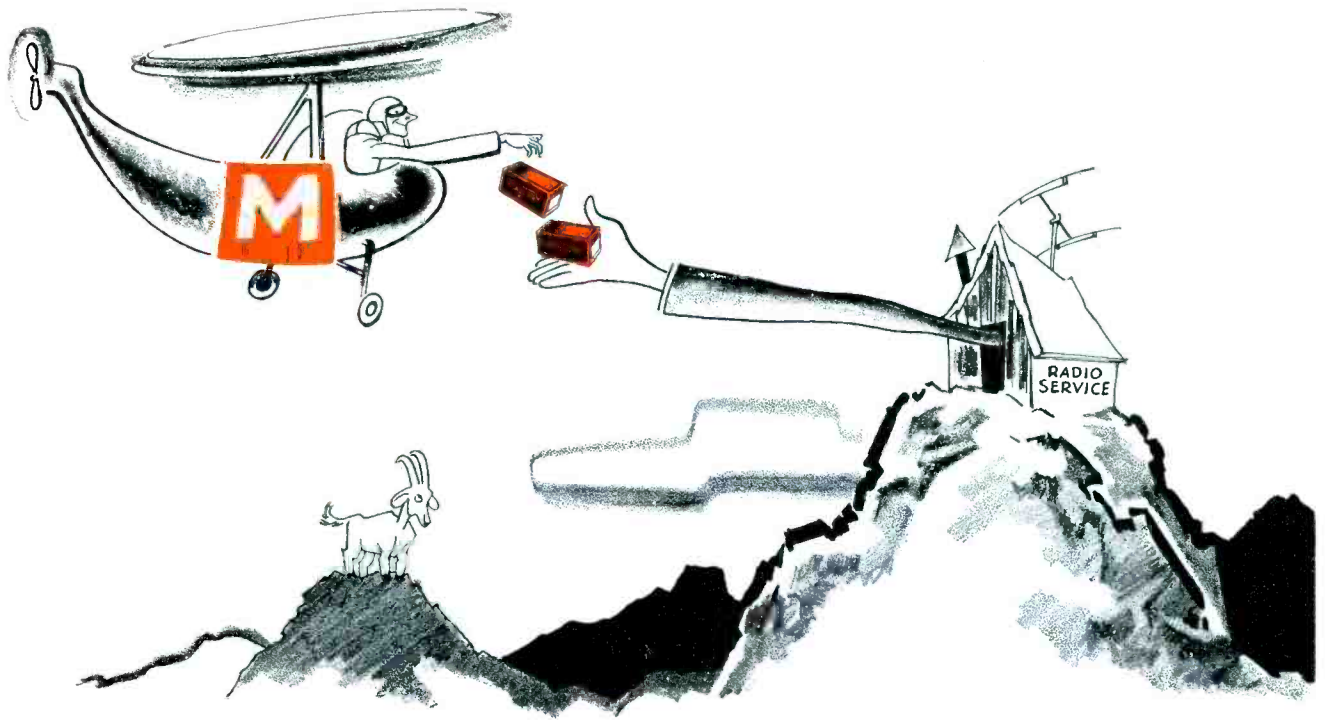

TOPS with Servicemen Everywhere . . .

MALLORY VIBRATORS

That's right! In a recent survey, more servicemen preferred Mallory vibrators than all other brands combined. And manufacturers use more Mallory vibrators as original equipment than all other brands combined. Here are the reasons . . .

- 1**— Slow contact impact for minimum wear
- 2**— High contact pressure for low resistance
- 3**— Fast contact break for reduced arcing, pitting



With Just ONE of Mallory's Special Vibrator Deals You Can Service 47 Different Makes of Radios

Think what that means from the standpoint of fast service for your customers . . . and smaller inventory for you—6 Mallory vibrators are all it takes to fix 47 radio makes. When you purchase one of these Mallory vibrator deals at *your regular discount price*, you get a handy parts cabinet at no additional cost. See your distributor today.

You get that vibrator combination *only* from Mallory—thanks to a patented, tuned mechanism. That's why Mallory vibrators give you and your customers long, trouble-free service. When you order vibrators, always . . .

Make Sure! Make it Mallory!

P. R. MALLORY & CO. Inc.
MALLORY

CAPACITORS • CONTROLS • VIBRATORS • SWITCHES • RESISTORS
• RECTIFIERS • VIBRAPACK* POWER SUPPLIES • FILTERS

*Reg. U.S. Pat. Off.

APPROVED PRECISION PRODUCTS

P. R. MALLORY & CO., Inc., INDIANAPOLIS 6, INDIANA

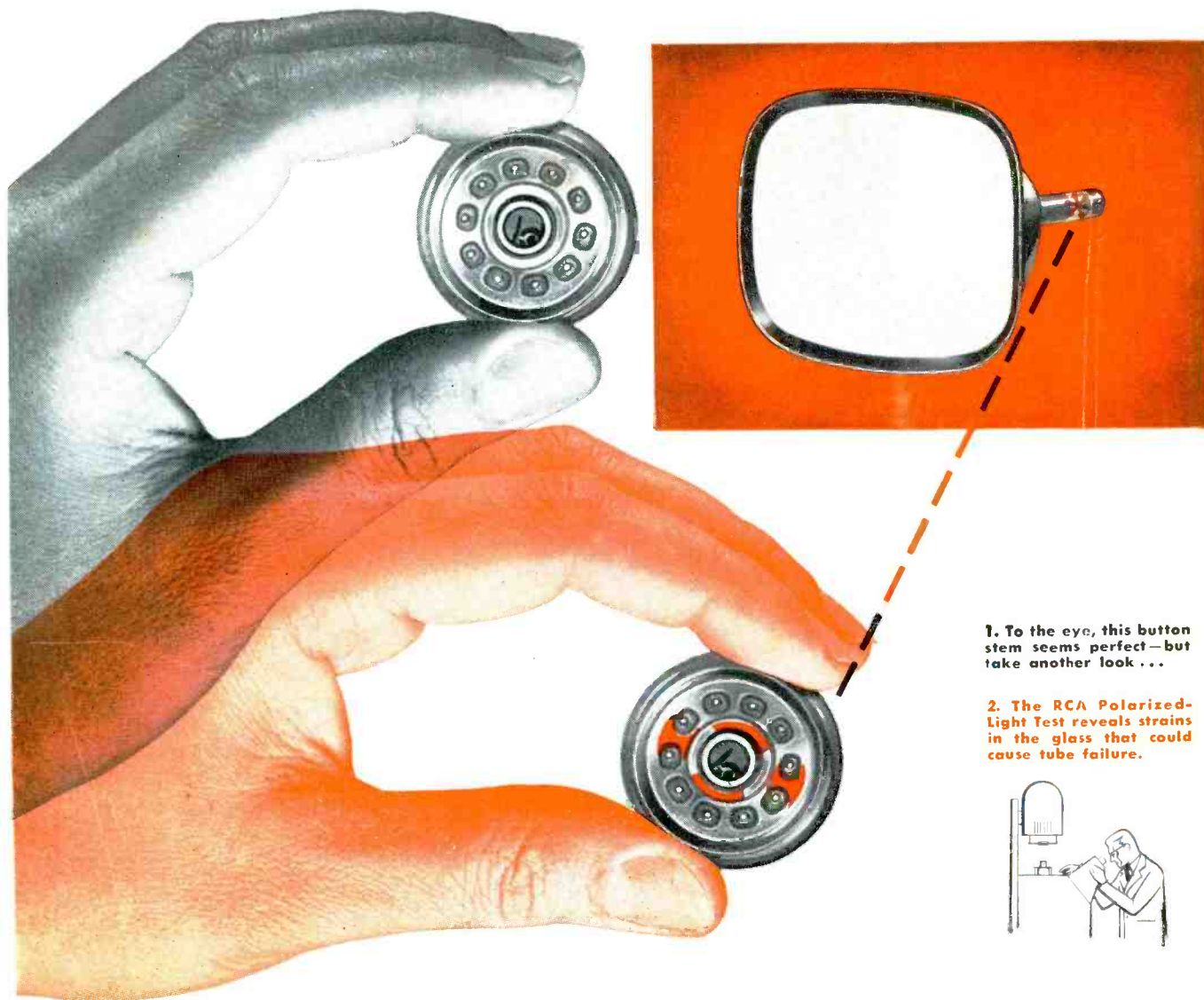

1. To the eye, this button stem seems perfect—but take another look...

2. The RCA Polarized-Light Test reveals strains in the glass that could cause tube failure.

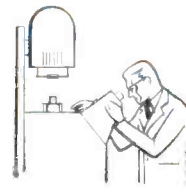

A DOUBLE-TAKE to safeguard your reputation

AT FREQUENT INTERVALS throughout the day, RCA production inspectors pick finished button stems hot off the griddles of the sealing machines, and subject them to an ingenious "polarized-light test." Reason? Even slight variations in sealing temperature can, and do, set up strains in the areas of glass-to-glass and glass-to-metal seals that could result in fractures. The Polarimeter... especially designed for RCA... reveals these otherwise invisible strains, and prevents im-

perfect assemblies from reaching the final production line.

By taking a second look, RCA virtually licks a possible fracture before it occurs... not only on button stems, but also neck-to-flare seals and the face-plate section adjacent to the rim seal of metal-shell picture tubes.

This constant vigilance and *quality control* at *all* stages of manufacture assure that RCA standards will be met on the final assembly line. In this way, RCA closely guards its own reputation

for quality... and yours as well.

In RCA picture tubes, the difference is *top-quality control*. That's why, dollar for dollar, RCA picture tubes have no equal.

With RCA Receiving Tubes, as well as RCA Kinescopes, TOP-QUALITY CONTROL makes the difference.



RADIO CORPORATION of AMERICA
ELECTRON TUBES
HARRISON, N. J.