

SERVICE

DECEMBER
1951

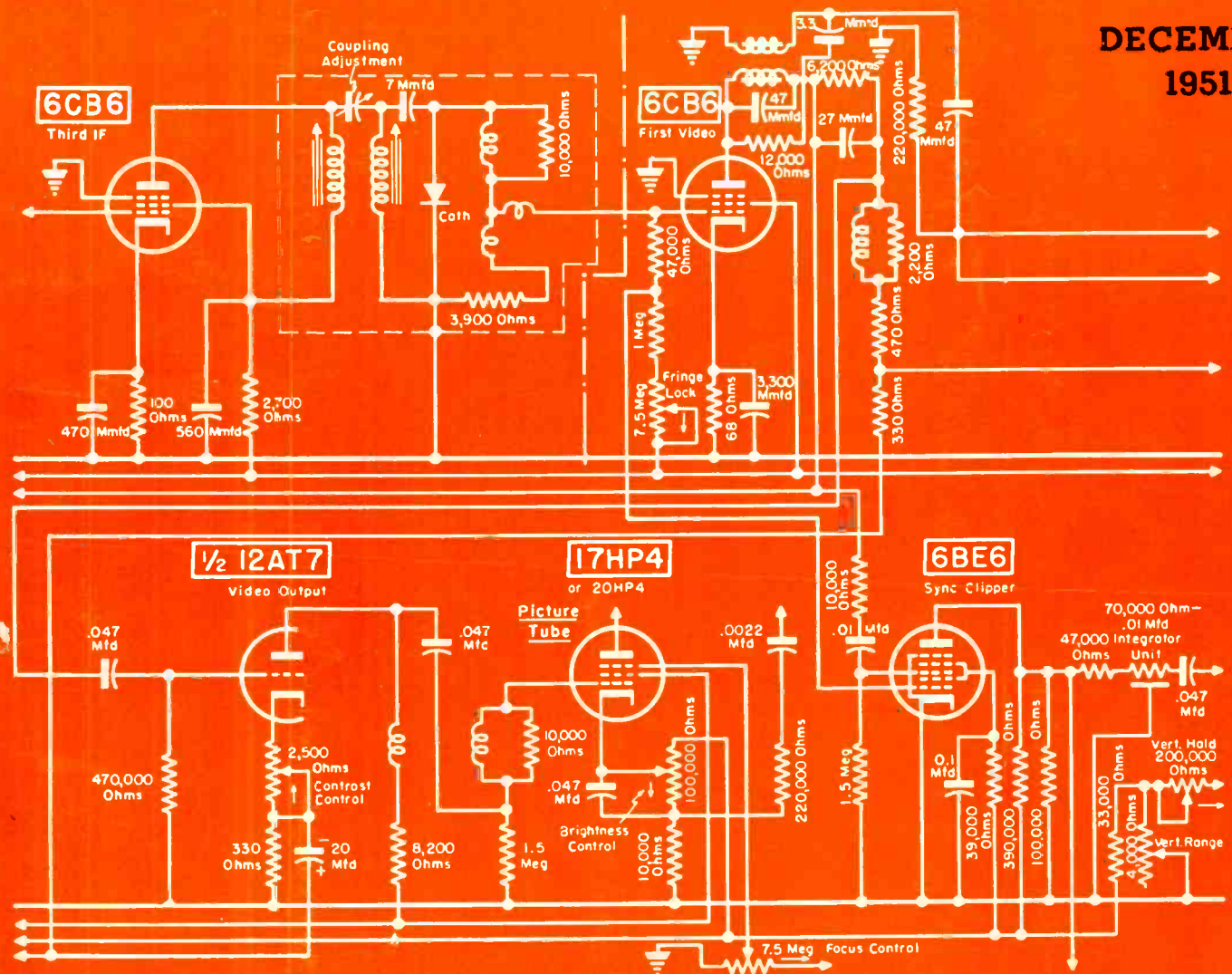

Sync clipper, video and picture-tube circuitry of low-voltage electrostatic-focus 17 or 20-inch chassis, with a 6BE6 fringe-lock system.

[See page 2]

*STILL...
the Standard
of Comparison*

**STILL... the best
all-channel TV antenna**



the **RADIART**

"LAZY X"

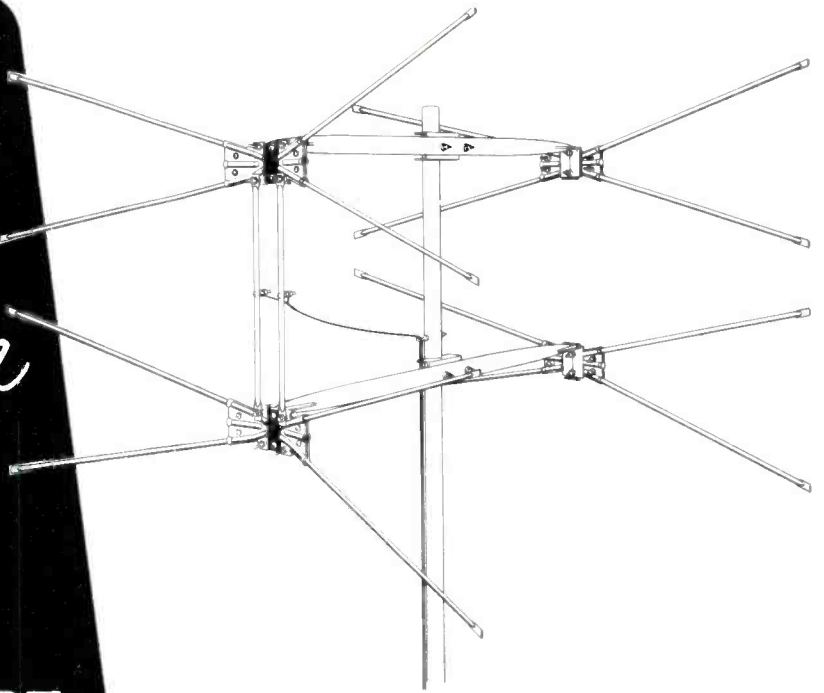

Antennas may come and antennas may go... but the RADIART "LAZY X" goes on and on and on! And there is good reason for this continued preference. Basically... it's this! Performance-wise... the RADIART "LAZY X" has no equal for all-around, all-channel coverage... easy to install... the well-engineered design makes it a matter of minutes to put them up... and there are no call-backs or failures. Check your jobber... and get on the "LAZY X" bandwagon!

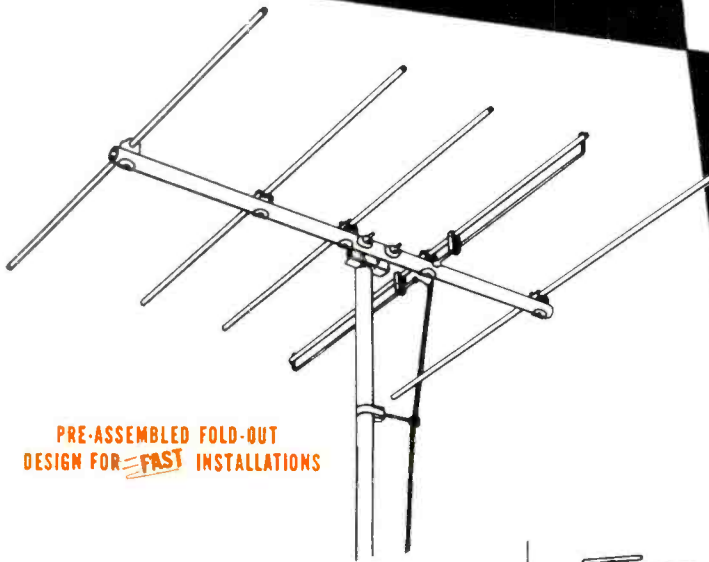

PRE-ASSEMBLED FOLD-OUT
DESIGN FOR **FAST** INSTALLATIONS

the **RADIART YAGI**

For Maximum Signal Pick-up In Fringe Areas

The RADIART "YAGI" is an engineering triumph... precisely manufactured for maximum pick-up on each channel for which the YAGI is cut! Features include low standing wave ratio... over 8 db. forward gain... single — 1T db. stacked... high signal-to-noise ratio, and superb front-to-back rejection.

You Can't Beat
a RADIART
Antenna On
a TELE-ROTOR
It's Tops



SUBSIDIARY OF



THE RADIART CORPORATION CLEVELAND 2, OHIO

VIBRATORS • AUTO AERIALS • TV ANTENNAS • ROTATORS • POWER SUPPLIES



FM ANTENNAS

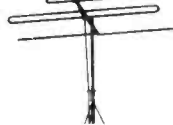

STRATE-LINE ANTENNAS



INDOOR ANTENNAS



HI-LO ANTENNAS

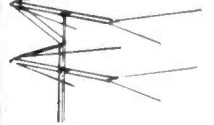

SUPER-VEE ANTENNAS



Aluminum Voice Coil
SPEAKERS

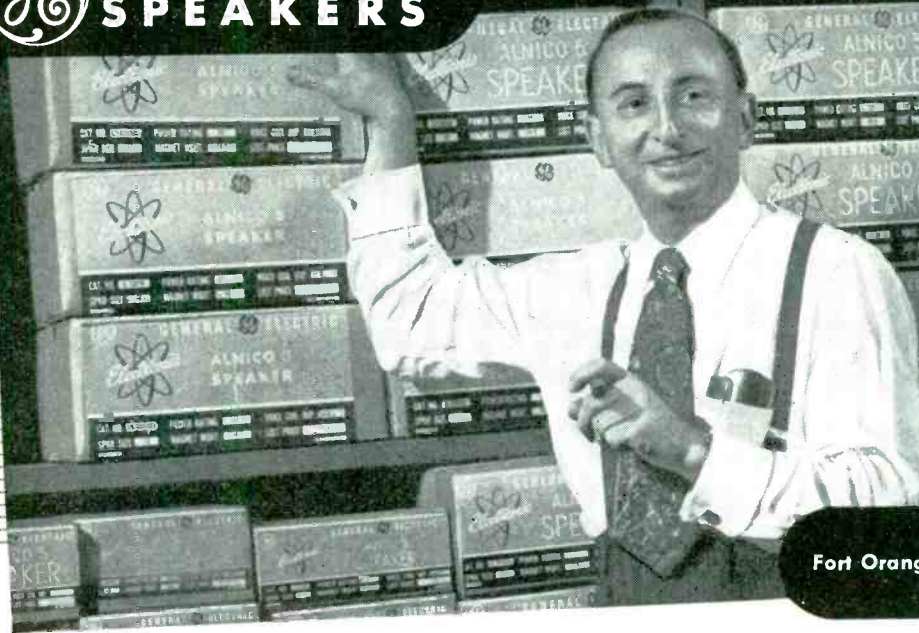

DAVE MARKS, President
Fort Orange Radio Distributing Company, Inc.
Albany, New York

"OUR FASTEST SELLING SPEAKER LINE FOR THE PAST 7 YEARS!"

Quality Product Plus Smart Promotion Spell Success for Aggressive Parts Jobber

"MY dealer customers don't bother to open the cartons — as they do with other brands — before buying G-E speakers. They know that General Electric factory-packed Alnico units come to them in perfect shape, ready for use. Customer confidence pays off. Because I stock all 27 G-E models, my dealers know I can fill any speaker need."

What Dave Marks does not mention is that his merchandising skill has made him one of the top parts distributors in the East. He makes frequent and profitable use of all G-E sales tools: catalogs, booklets, envelope stuffers, display pieces of all kinds. They're available to you, too, through your General Electric distributor or representative. Call him today for your share of these sales helps.



Drive-In Theatre Speaker Sales Hot! With G.E.'s special weather-tested outdoor speaker, Dave Marks, shown here with general manager Ted Sharaf, has increased his drive-in business four times over in two years!

DEALERS AND SERVICEMEN



Here's a complete new service manual on all General Electric television receivers — 102 models manufactured since 1945! You get 80 pages packed with circuit diagrams, symbols and numbers, tube locations, top and bottom chassis views. Plus photographs and lists of service aids. Mail coupon for it today. Only \$1.00.



General Electric Company, Section 3121
Electronics Park, Syracuse, New York

Send me copies of the new 80-page service manual on General Electric TV receivers at \$1.00 each. I enclose \$

Check Money Order

NAME

ADDRESS

CITY STATE

GENERAL  ELECTRIC

how to
choose a
high
fidelity
loudspeaker

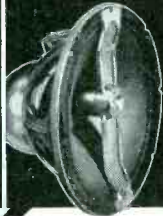

Jensen
WIDE RANGE



G-610
TRIAxIAL
3-WAY

SINGLE-UNIT
DIRECT RADIATOR
TYPES (5"-15")

"Genuine Jensen Wide Range" means much more than wide frequency range — it means superior performance all the way — in every attribute that makes for enhanced listening pleasure: 1. Wide Frequency Range . . . 2. Balanced Frequency Response . . . 3. Smooth Response . . . 4. Wide Angle Distribution . . . 5. Low distortion . . . 6. Good Efficiency . . . 7. Adequate Power-Handling Capacity.

Whatever the cost or size, a choice from the Genuine Jensen Wide Range series insures a maximum of performance to today's new high fidelity standards.

Write for free booklet—"Let Music Come to Life"—it includes a listing of Genuine Jensen Wide Range loudspeakers.

Jensen

MANUFACTURING COMPANY
Division of the Muter Company
Export Department at the Factory
6601 S. Laramie • Chicago 38, Illinois

BURTON BROWNE ADVERTISING

Vol. 20, No. 12

RADIO • TELEVISION • ELECTRONIC

December, 1951

SERVICE

LEWIS WINNER
Editor

F. WALEN
Assistant Editor

Registered U. S. Patent Office
Including Radio Merchandising and Television Merchandising

AFC Sync Circuit Servicing. By Solomon Heller and Peter Orne	36
Annual Index to SERVICE (January to December, 1951)	40
Association News	50
Audio Installation and Service (Hi-Fi Amplifiers . . . Multiple-Speaker Cabinet Systems). By Kenneth Stewart	20
Business Aids (Estimate Charges)	49
Intercom Systems. By Jack Darr	18
Low-Voltage Electrostatic-Focus Chassis With Fringe-Lock (Cover). By Wyn Martin	24
Ser-Cuits (Interlace and Fringe-Compensator Systems). By M. W. Percy	26
Service . . . The National Scene	15
Servicing Helps. By M. A. Marwell	32
Speedy Trouble Shooter. By James S. Kendall	22
Ten Years Ago in Associations	51
Tube News (Subminiatures). By L. M. Allen	62
Views and News. By Lewis Winner	13

AUDIO INSTALLATION AND SERVICE

Hi-Fi Amplifiers	20
Three-Way Speaker System	21
Tone Control Preamp	21

CIRCUITS

AFC Setting Circuits	38
AFC Sync Circuit in 630 Chassis	36
All-Master Intercom Wiring System	19
Bendix T-9 Magic Interlace System	28
Crossover Networks for Three-Speaker System	21
Hartley-Turner 14- and 20-Watt Hi-Fi Amplifier	20
Multivibrator-Signal Generator Hookup	22
Multivibrator Speed Tester	22
Packard-Bell 2118 TV 24-Inch Electrostatic-Tube Model	30
Sylvania 1-502-1 CO1 With 6CB6 Third Video IF Instead of 6BC5	34
Talk-Listen and Station Selector Switches for Intercom Systems	18
Westinghouse Improved AGC Distribution System	34
Westinghouse Retrace-Suppression Circuit	34
Westinghouse V-2200-1, V-2204-1 and V-2206-1 Modified Video-Amplifier Circuitry	32
Zenith 20-J Series TV Chassis (Cover)	24

COVER

Low-Voltage Electrostatic-Focus Chassis With Fringe Lock (Zenith 20-J Series)	24
---	----

SERVICING HELPS

AGC Distribution System Modification	32
Auto-Radio Intermittent Servicing	34
HV Increase Circuitry	32
Improved Picture Resolution	32
Increasing Audio Output	32

Index to Advertisers

Index to Advertisers	64
--------------------------------	----

Manufacturers

Jots and Flashes	64
News	60
New Parts . . . Tools . . . Instruments	58
Rep Talk	52
TV Parts . . . Antennas . . . Accessories	55



Entire contents Copyright 1951, Bryan Davis Publishing Co., Inc.

Published monthly by Bryan Davis Publishing Co., Inc.

52 Vanderbilt Avenue, New York 17, N. Y.

Telephone MURRAY Hill 4-0170

Bryan S. Davis, Pres. Paul S. Weil, Vice-Pres., Gen. Mgr. F. Walen, Sec. A. Goebel, Cir. Mgr. Mid-West Representative: Stuart J. Osten, 333 N. Michigan Ave., Chicago 1, Ill. Telephone: Dearborn 2-3507 East-Central Representative: James C. Munn, 2253 Delaware Dr., Cleveland 6, Ohio. Telephone: ERview 1-1726 Pacific Coast Representative: Brand & Brand, 1052 W. Sixth St., Los Angeles 14, Calif. Tel.: Michigan 1732 Suite 1204, Russ Building, San Francisco 4, Calif. Telephone: SUTTER 1-2251

Entered as second-class matter June 14, 1932, at the Post Office at New York, N. Y., under the Act of March 3, 1879. Subscription price: \$2.00 per year in the United States of America and Canada; 25 cents per copy. \$3.00 per year in foreign countries; 35 cents per copy.

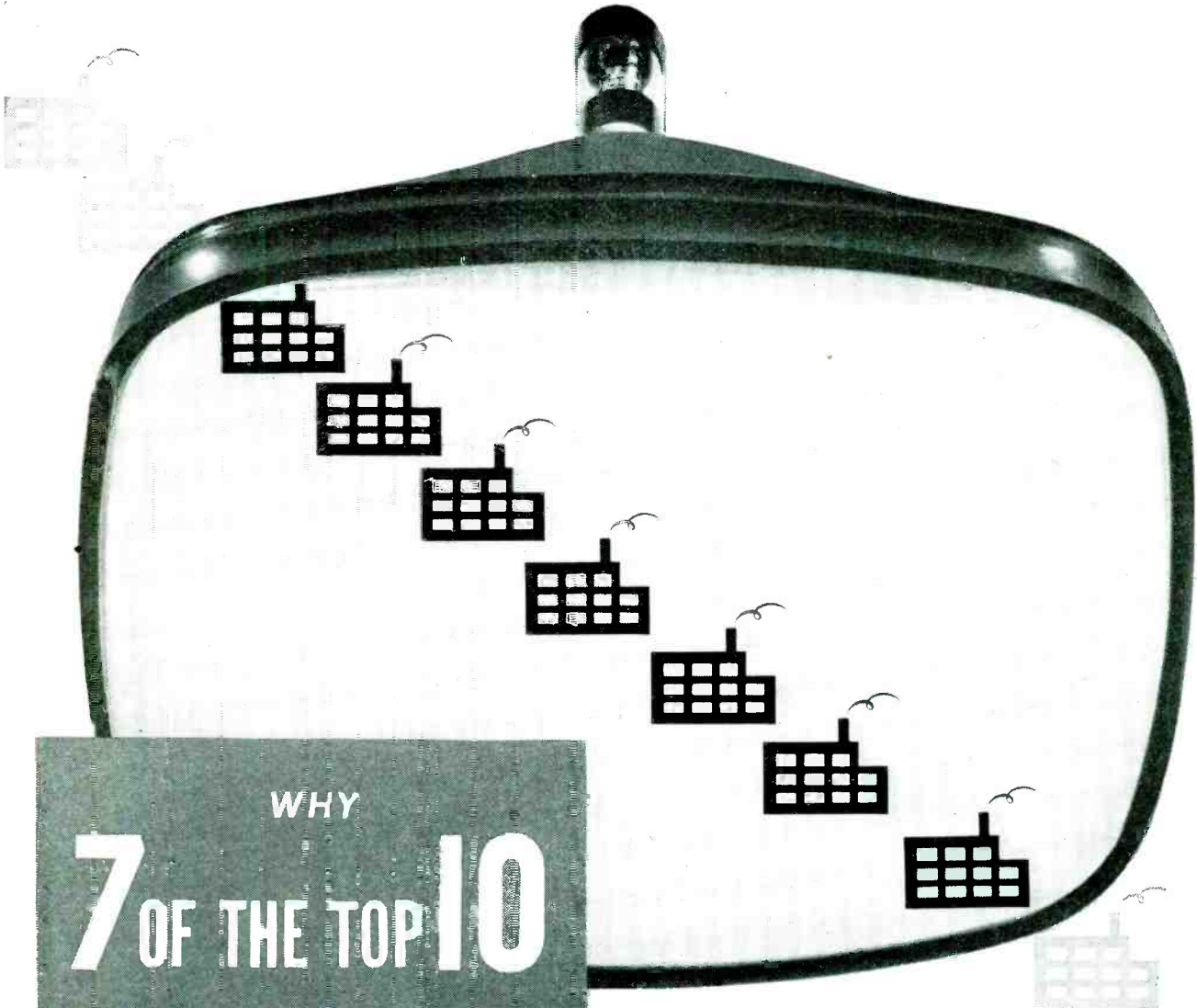

WHY

7 OF THE TOP 10

TELEVISION SET
MANUFACTURERS USE

SYLVANIA

PICTURE TUBES

A Sylvania tube engineer, for example, invented the famous Ion Trap now generally adopted, under special Sylvania license, by other leading picture tube makers.

Sylvania's 25 years of lighting research, including advances in phosphors and filamentary wire techniques and coatings, has also contributed to the outstanding clarity and long life of Sylvania picture tubes.

Popular TV show tells millions

Set owners are being kept informed of Sylvania's leadership by the big, popular television show, "Beat the Clock," on CBS-TV. Every week this program emphasizes Sylvania's unique background and the fine quality of all Sylvania products, thus assuring you of an enthusiastic acceptance of Sylvania Tubes used as replacements in the sets you service.

To help you choose the right Sylvania Tube for each service job see your Sylvania Distributor now for your free SYLVANIA TV TUBE SELECTOR, a handy wallet folder which explains the differences between more than 100 types of picture tubes. Sylvania Electric Products Inc., Dept. R-2612, Emporium, Pa.

The important reasons behind the steadily increasing demand for Sylvania TV Picture Tubes are: (1) high quality performance, (2) broad national recognition.

Sylvania's picture tube experience includes leadership in 4 specialized fields... all basic to TV picture tube production. These are *radio, electronics, lighting, and phosphors.*



SYLVANIA



RADIO TUBES; TELEVISION PICTURE TUBES; ELECTRONIC PRODUCTS; ELECTRONIC TEST EQUIPMENT; FLUORESCENT TUBES, FIXTURES, SIGN TUBING, WIRING DEVICES; LIGHT BULBS; PHOTOLAMPS; TELEVISION SETS

**★ Build Your Service-
Sales Future on a Firm
Foundation with**

**PRECISION
TEST EQUIPMENT**
Standard of Accuracy...

**...These 5 Matched "Precision"
Instruments provide a Complete
MODERN SERVICE LABORATORY for
TV-FM-AM at only moderate cost.**

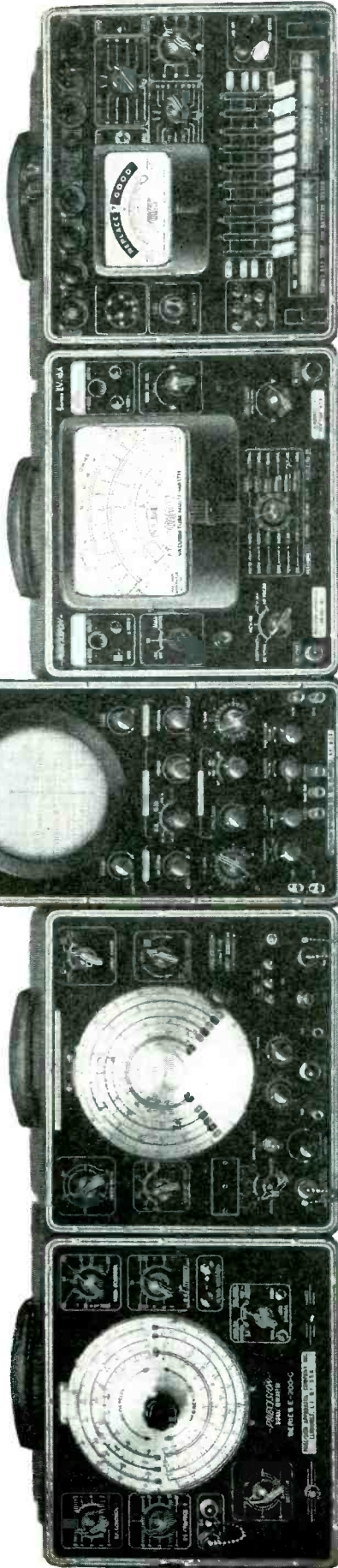

**SERIES E-200-C—Modern Multi-Band
SIGNAL and MARKER GENERATOR
for A.M., F.M., and TV alignment.**

Exceptional Accuracy and Stability! 1000 pt. vernier calibrating scale! 0-100% Modulation! A.V.C. — A.G.C. substitution-override network! Direct reading 88KC to 120 MC! Complete with Coaxial output cable and technical manual! In matched, heavy gauge steel case 10½ x 12 x 6".

Net Price: \$71.25

**SERIES E-400—Wide Range H.F.
SWEEP SIGNAL GENERATOR
Direct Reading from 2 to 480 MC.**

Narrow and Wide Band Sweep for F.M. and TV, 0-1MC and 0-15MC. • 1500 pt. vernier calibrating scale • Multiple Crystal Marker • 8 tubes including V.R. and rectifier • RG/620 Coaxial Terminated Output cable • Complete with 2 crystals • In matched copper-plated case 10½ x 12 x 6".

Net Price: \$134.50

**SERIES ES-500A—20 MV.
High Sensitivity, Wide Range
5" C.R. OSCILLOGRAPH.**

Push-Pull "V" and "H" amplifiers • 1 MC Band Width • High impedance, compensated "V" input Step Attenuator • Z axis modulation • 12 tubes incl. V.R. and 2 rect. • Light Shield and Mask • Heavy Steel Case, 8½ x 14½ x 18".

Net Price: \$169.50

**SERIES EV-10A—High Sensitivity
True Zero-Center VTVM—MEGHOHMETER
—with large 7" meter.**

58 ranges to 6000 Volts, 2000 Megs, ±70DB, 12 Amps • Direct Reading R.F. VTVM scales via optional RF-10A High Freq. probe • Voltage Regulated bridge type circuit • Constant 13½ Megs input resistance to 600 V. 133½ Megs at 6000 V • Complete with test cables and manual • Matched heavy gauge steel cabinet 10½ x 12 x 6".

Net Price: \$94.50

**SERIES 612—Modern Free-point
Cathode Conductance TUBE TESTER,
and dynamic A-B-C Battery Tester.**

Incorporates RTMA recommended circuit principles! 10 lever free-point element selection Built-in roller chart! Dual short-check sensitivity! Noise, Ballast and Pilot Tests! Free replacement tube test data chart serviced Complete, ready to operate! In matched heavy gauge steel cabinet 10½ x 12 x 6".

Net Price: \$69.75

BUY PERFORMANCE—NOT SPECIFICATIONS!—BUY "PRECISION"

"PRECISION" PERFORMANCE, ACCURACY, WORKMANSHIP and VALUE have been setting a standard of comparison for over 15 years DO NOT BE MISLED It is not "PRECISION" test equipment unless it is manufactured by Precision Apparatus Co., Inc., Elmhurst, L. I., N. Y.

OTHER MATCHED COMBINATIONS

The instruments shown above illustrate one of many possible MATCHED COMBINATIONS of diversified "PRECISION" Test Equipment for TV-FM-AM. Each combination provides a selected and basic, modern, efficient Laboratory at moderate cost.

SERIES TV-4—Super-High Voltage Safety Test Probe.

Extends range of Series EV-10A (above) to 60 KV direct reading, with full safety to operator and equipment. Multiplier cartridges also available to match most VTVM's and 20,000 ohms/V. test sets.

Series TV-4:—Complete, for use with EV-10A.

Net Price: \$14.75



"Precision" Performance—Engineered Instruments are on display at leading radio parts and equipment distributors.



PRECISION APPARATUS CO., INC.

92-27 Horace Harding Boulevard, Elmhurst 6, New York
Export Division: 458 Broadway, New York, U.S.A. • Cables—Marhanex
In Canada: Atlas Radio Corp., Ltd., Toronto, Ontario

Convenient "Precision" Purchase Terms can be arranged with your favorite authorized Precision Distributor.

AM • FM • TV • AM • FM • TV

AM • FM • TV • AM • FM • TV

MERIT

TV full-line* Components For
Improvement, Replacement, Conversion

SELL IMPROVED RECEPTION

MERIT "TV" Kit No. 1000 consists of matched units for sharp, edge to edge focus — the MDF-70 Cosine Yoke, the HVO-7 Universal Flyback and the MWC-1 Width Linearity Control. Keep a MERIT "TV" Kit handy on service calls — when you spot fuzzy edge focus you'll get plus business and a reputation for real "know-how."

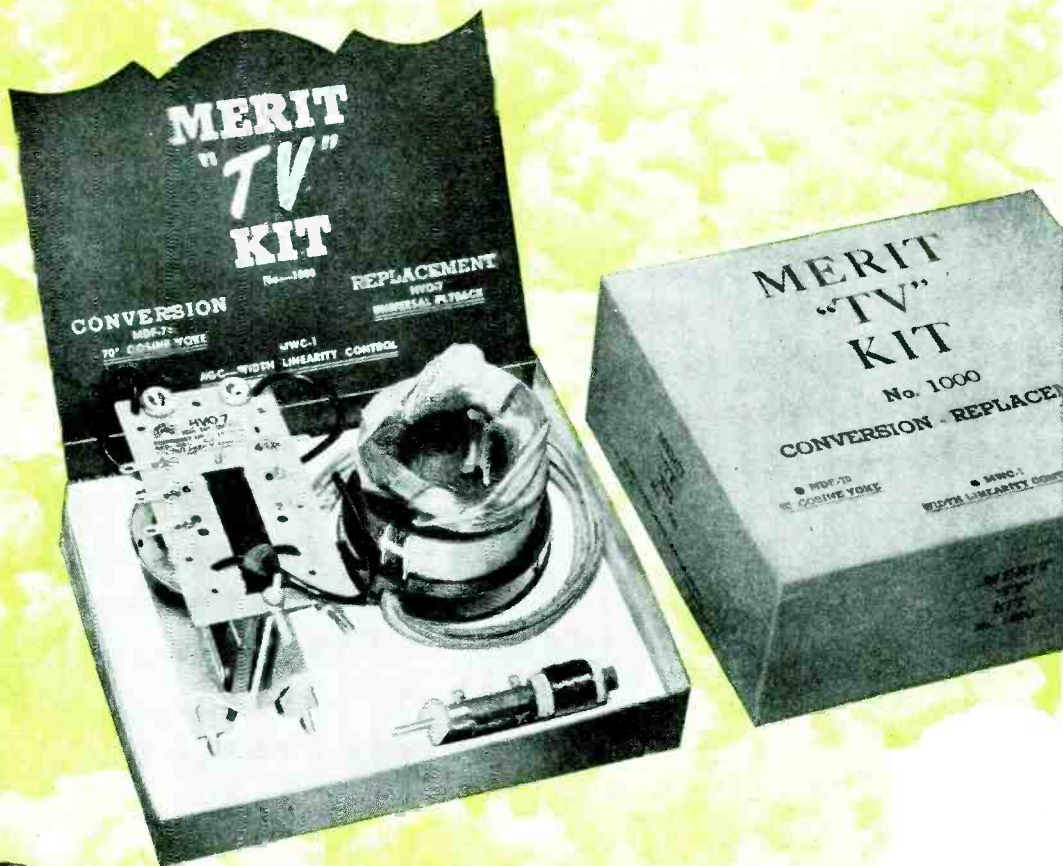

MERIT MDF-70 . . . original of the "cosine" series — low horizontal and high vertical inductance. Now used by such famous sets as Radio Craftsman, the cosine series will improve 10,000,000 sets now on the market!

MERIT . . .

HQ for TV Service Aids

MERIT'S new 1952 Catalog #5211 is now available . . . introducing MERIT IF-RF Coils and giving complete MERIT Coil and Transformer data and listings. Other MERIT service aids for TV improvement, replacement and conversion problems: TV Replacement Guide #404, September 1951 issue — covers 3000 models and chassis of 82 manufacturers; Cross Reference Data on IF-RF Coils, Form #14.

Write: Merit Coil and Transformer Corporation, 4425 North Clark Street, Chicago 40, Illinois.

These three MERIT extras help you:



..... Exclusive: Tapemarked with specifications and hook-up data

- Full technical data packed with every item
- Listed in Howard Sams Photofacts



*Merit is meeting the TV improvement, replacement and conversion demand with a line as complete as our advance information warrants!

BURTON BROWNE ADVERTISING

Introducing...

THE MAGIC OF MODEL M

"The Magic of Model M" ... a new trend for TV antennas! And Walsco introduces the *first* antenna with chromate-coated Magnesium cross-arms. Structural strength is almost equal to steel, and yet is 1/3 lighter than aluminum. Once you install, *that's all!* No costly call-backs that eliminate your profit. Chromate-coating assures positive corrosion resistance. Elements are made of high-conductivity, super-strength aluminum alloy, reinforced with Swiss "Permalum." Guaranteed sturdier, more dependable under severest weather conditions. Equipped with famous Walsco "signal director" and unbreakable insulator. Same high standards of Walsco crystal-clear TV reception.

*** NEW**
WALSCO
TV ANTENNA Model M

Once you install... that's all!

WALTER L. SCHOTT CO., 3225 Exposition Place, Los Angeles 18, Calif.

Branch: Chicago 6, Ill.

M^{*}

M
Structural strength almost equal to steel

M
One-third lighter than aluminum

M
Chromate-coating for positive corrosion resistance.

AVAILABLE AT PARTS JOBBERS EVERYWHERE.

Model 4090 M—Single Bay — List \$ 9.25

Model 4092 M—Dual Array — List \$19.85

Model 4094 M—4 Bay Stack — List \$44.50

All prices without mast.

Walsco quality earned its reputation

WALSCO

Mr. Serviceman!

get a *Real* service-aid
with every Du Mont Teletron!

- The advance version of the old "Cheater-Cord."
- The Tele-Lead gives you a power connection plus a probing light to see into the back of the receiver.
- A double plus value because: With each replacement Du Mont Teletron you purchase from January 1 through February 29, you will receive free a Tele-Lead, and the assurance of a satisfied customer.

a sure double plus value!



**the
Tele-Lead**

**see
your
jobber**

DUMONT

Teletrons^{*}

*Trade-mark

CATHODE-RAY TUBE DIVISION, ALLEN B. DU MONT LABORATORIES, INC., CLIFTON, N. J.

SERVICE, DECEMBER, 1951 • 7



"Say, Bill! Have you subscribed to Rider's NEW monthly TEK-FILE service? It's the hottest thing to ever hit the servicing field. It's just like carrying Rider TV Manuals around in my pocket."

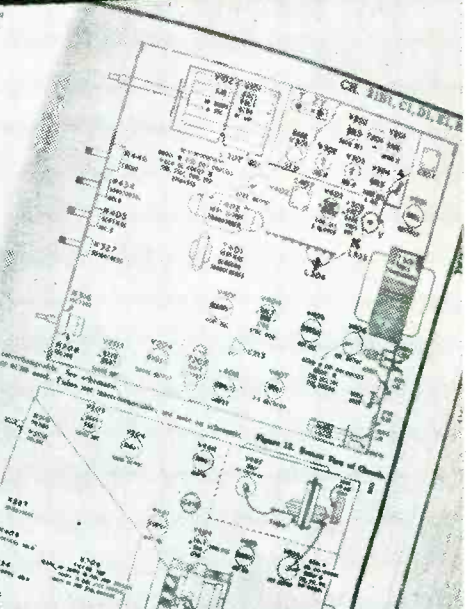
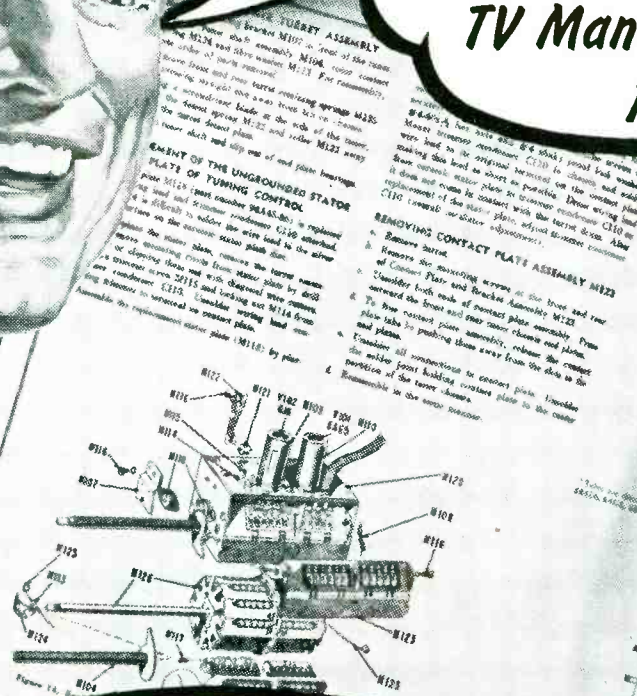

"You're right, Ed! I've never seen so much really useful TV information....and each manufacturer's data is individually bound in separate file folders. An average of 160 pages for only \$2.00! All production runs are covered—and the data matches the set I'm working on!"

Listen friends: take a tip from Bill and Ed—ask your jobber for Tek-File, today!



JOHN F. RIDER Publisher, Inc.
480 Canal Street, New York 13, N. Y.

This TV team is what you need



for sure television capacitor replacements

When you replace television capacitors you want to *know* that your replacements won't cause "headaches" in unnecessary call-backs because of premature failure. You *can* be sure that these Sangamo TV replacements will live up to their reputation. Used as original equipment, they're "tops" for dependable replacements.



THE REDSKIN is a molded paper tubular, especially adapted to television. It's easy to work with—the leads are securely imbedded in a hard plastic case and have been especially designed to resist breakage. The REDSKIN is strong and it's dependable at 85° C, even under extreme humidity.

THE CHIEFTAIN is a dry electrolytic that fits anywhere! Tiny, but durable, it is ideal for application in tight spots beneath a chassis. Bare tinned-copper wire leads make it easy to mount. Maintains uniform capacity when subjected to high ripple currents at 85° C.

REMEMBER . . . these are only two of a complete line of mica, paper and electrolytic capacitors that will take care of practically any replacement requirement in the radio and television field.



Your Assurance of



Dependable Performance

SANGAMO ELECTRIC COMPANY

MARION, ILLINOIS

IN CANADA: SANGAMO COMPANY LIMITED, LEASIDE, ONTARIO

8C51-10A

SERVICE, DECEMBER, 1951 • 9



for greater speed and
accuracy of TELEVISION INSTALLATIONS
in any locality use the new

Simpson

MODEL 488

TV FIELD STRENGTH METER

In addition to location of maximum signal areas, the Simpson Model 488 Television Field Strength Meter is also ideal for antennae orientation, comparison of antennae systems, adjustment of TV signal boosters and checking antennae and lead-in installations to list but a few of the many functions available . . . THE 50 MICROVOLT FULL SCALE RANGE IS AN OUTSTANDING FEATURE FOR THOSE CONCERNED WITH FRINGE AREA INSTALLATIONS WHERE MAXIMUM EFFICIENCY MUST BE ATTAINED . . . The 500, 5,000 and 50,000 microvolt ranges extend the usefulness of the Simpson Model 488 into areas of higher signal strength. The large 4 1/2-inch modernistic meter is easily read from a considerable distance and all controls and connections are arranged for greatest accessibility. Model 488 is housed in a beautiful gray hammerloid finished case for greater portability. LINE VOLTAGE: 105-125 volts, 50-60 cycles. SIZE: 8" x 11" x 8 1/2"

WEIGHT: 11 1/2 lbs. Shipping weight 15 lbs.

DEALER'S NET PRICE, including operating instructions and shoulder strap . . . \$89.50

SIMPSON ELECTRIC COMPANY

5200 WEST KINZIE STREET, CHICAGO 44, ILLINOIS

Phone: COlumbus 1-1221

In Canada: Bach-Simpson, Ltd., London, Ontario

CONSERVE
CRITICAL
MATERIALS

Skysweeper

**FIRST CHOICE OF THE
SERVICEMAN WHO
WANTS TO PROVIDE
ALL THE PICTURE QUALITY
BUILT INTO THE SET!**

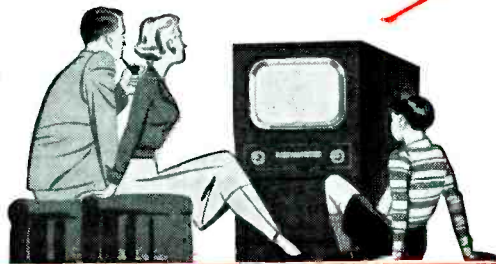

**LIGHT WEIGHT!
FAST AND EASY
TO INSTALL!**

**CLEAR, BALANCED
BEAM! LONGER
RANGE RECEPTION!**

**BETTER BALANCED
FRONT-TO-BACK
RATIOS!**

**GREATER GAIN
IN FRINGE AREAS!**

You can't go wrong! Clear, brilliant pictures result from teaming quality receivers with quality antennas. So when you want the best, all-channel reception, install the best antenna! Install Ferro's Skysweeper*—the all-purpose parabolical and conical antenna!

For here's the antenna that conquers distance... that cuts "ghosts" and interference to an irreducible minimum... that reaches out and pulls in a strong, powerful signal even in difficult locations and remote fringe areas.

Here's the antenna that *nets you more profit* by eliminating antenna failures, by cutting call backs and by reducing installation time.

Precision-engineered, the Skysweeper is rugged and of heavy-duty construction. Made of lightweight, corrosion-resistant aluminum alloys, this all-weather, all-location antenna offers many exclusive advantages including:

Strong, high-impact polystyrene reversible head block that permits either a parabolical or conical installation.

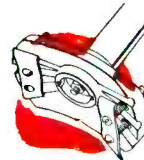

Wooden dowels in dipoles, reflector members and crossarms enable you to draw clamps up tighter without collapsing parts.

Special corrugated clamps on crossarms and terminal blocks for firm positioning.

Standardize upon Skysweeper antennas for all your installations! Available in single-bay, double-bay or four-bay models complete with stacking bars, phasing bars and terminal blocks.

If your jobber can't supply you from stock, write, phone or wire us direct and we will air mail or special delivery your requirements. Write for this new folder which describes all models in detail.



*T. M. REGISTRATION PENDING



FERRO ELECTRIC PRODUCTS, INC.

A Subsidiary of Ferro Corporation

KIRKLAND, ILLINOIS

SERVICE, DECEMBER, 1951 • 11

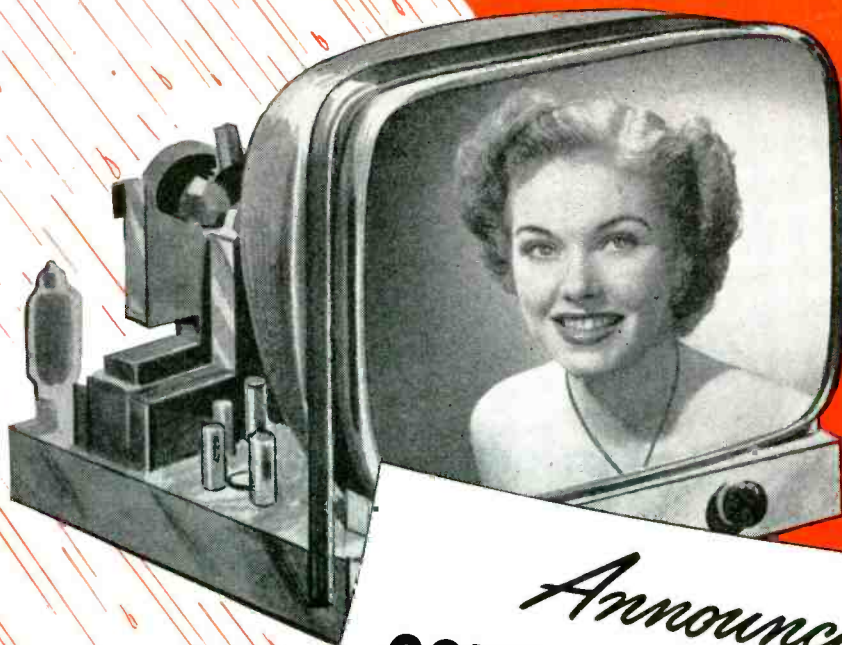

Right for Sight!®

Announcing
CORONA INHIBITOR

Now, for the first time, you can get television picture tubes that are *not affected by atmospheric conditions*. Ordinary picture tubes may lose as much as one-tenth of their brightness on humid or rainy days, but RAYTHEON made Tubes with CORONA INHIBITOR are 100% efficient *rain or shine*.

This amazing new weather-proofing is so effective, that even when tested with a water spray on the high voltage contact, RAYTHEON Tubes with the CORONA INHIBITOR showed *no loss of brightness* due to arcing around the high-voltage connection.

Ask your RAYTHEON Tube Distributor for Raytheon Picture Tubes with CORONA INHIBITOR. Your customers will like them... and so will you.

the new



development that keeps

**TELEVISION
PICTURE TUBES**

at peak performance

Rain or Shine



Excellence in Electronics

RAYTHEON MANUFACTURING COMPANY

Receiving Tube Division

Newton, Mass., Chicago, Ill., Atlanta, Ga., Los Angeles, Calif.

RADIO AND TELEVISION RECEIVING TUBES, PICTURE TUBES, SPECIAL PURPOSE TUBES, SUBMINIATURE TUBES, MICROWAVE TUBES

RADIO · TELEVISION · ELECTRONIC
SERVICE

New-Town Servicing

EXPANDED PLANTS, enlarged decentralized-facility programs and accelerated-construction activities, which have highlighted the calendar of '51, have introduced a unique era for the ambitious Service Man, ever on the alert for new prospects for his business. For, wherever a new plant has opened its doors, or more buildings have been added, more people have come to town, some to stay and some to explore, but all to be considered as new business leads.

With the shortage of living quarters in many of these areas, trailers have become the homes of thousands, and the nucleus of the new-servicing front. The locations of these trailers, normally in remote areas, have introduced many unusual servicing problems. Due to their distance from stations, DX type of receivers have been quite common, and in many instances, shortwave listening has become a necessity. As a result, the boys in the field have had to become familiar with gear, whose popularity had been assumed to have waned, a long time ago. Not only has there been the repair item, but installation problems have also appeared. The long-distance pickups have demanded the installation of highly efficient antennas, or carefully positioned receivers for best pickup. The proximity of families of motor cars in these crowded areas has also introduced the headache of ignition and other types of interference, necessitating the use of all types of filtering systems. Faced with these knotty situations, the new-town Service Men have had to be truly stouthearted individuals, not to be dismayed by mounting trying moments.

Those who have dared to venture in these new locals have found the moves to be extremely profitable, although arduous.

Not only have these new boom towns created an exciting market for servicing, but the sale of a host of accessories, too, particularly in the audio field. It appears as if many families are phono conscious, and quite anxious to have the best reproduction possible. Accordingly, they have exhibited an interest in improved speaker systems,

hi-fi pickups and needles, and in many instances, better amplifiers.

The next twelve months will undoubtedly see a growing trend in trailer and other new-town living, offering the Service Man a sterling opportunity to build business.

Windproof Installations

AS THE WINTRY, gale months approach, and the tragic wreckage of thousands of poles and towers in late '50 and early '51 are recalled, there appears that urgent need to make a year-end resolution exclaiming that there'll be no breakdowns in '52. And it should not be difficult to follow the pledge. All doubtful installations, made during the calm months of the spring and summer, can be reexamined, and installations of the future planned so that pole or tower destructions become impossible.

In many communities it has become mandatory to follow a strict set of regulations, to insure breakage resistance during storms and prevent roof damage and possible injury to pedestrians. In other towns, similar stern measures are being considered if Service Men continue to overlook this important installation practice.

Those who have planned all of their installations carefully, and employed mounting techniques that provide insurance against swaying and perhaps eventual smashups, have found the approach to be profitable and an excellent goodwill builder. Actually, it is so simple to make a sturdy installation that one wonders why makeshifts are so common.

Manufacturers have developed a wide assortment of accessories which will prevent storm damage, and prepared reams of installation information.

It is hoped that in '52 all Service Men will see to it that all their installations are truly stormproof!

Successful Meetings

DURING '51, more association and group meetings, featuring informative talks, were conducted than ever before. While most sessions featured vital subject discussions of import to all Service Men, all Service Men did not at-

tend. In fact, attendance was tragically low on too many occasions.

Surveys to learn why this weak interest prevailed revealed one particular fault, a lack of careful administration of details, which when properly taken care of, can build audiences. The details, to many, appear to be trivial. But they are important and must be considered.

Among the items that have been found to bring the boys in are the promotional aids. It's necessary to employ a complete routing procedure, involving the mailing of invitation bulletins and attendance reply cards plus telephone-followup calls or reminder postcards shortly before the meeting. Tickets for admission are also attractive, particularly those carrying a brief description of the meeting, and possibly a reference to a door prize that will be offered. Invitations to wives are also important, for too often this neglect and disinterest in the better half can cut attendance way down.

Where possible, soft drinks and sandwiches might be served. It is true that this is an expensive item, but there are always local merchants who would like to lend a hand. Publicizing of meetings through the local press, as well as the trade journals, has also been found to be an attendance-builder.

The procedures suggested are not new, but rather time tested, and part of a proved pattern designed to attract more people to meetings.

Customer Relations

APPEARANCE, ATTITUDE AND ATTENTIVENESS have always been the three A's of good customer relations. Commenting on these key ingredients recently, one set maker noted that attitude can play quite a role in cementing friendship. Customer confidence can be easily restored by a reassuring, sympathetic interest.

Nothing is more important than a complete awareness of customer relations, which simply means that you'll get maximum returns from your business if you know how to handle people.
—L. W.

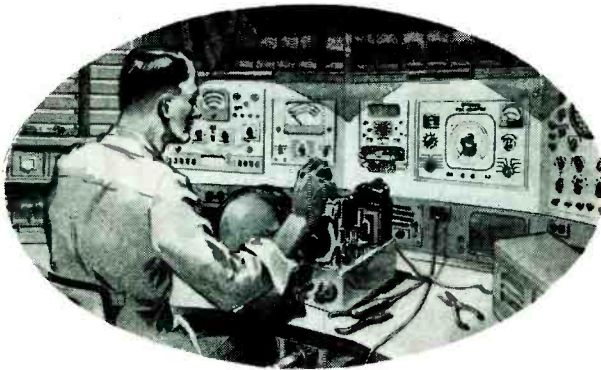

GIANT WINDOW-SIZE
REPRINTS OF THIS
MESSAGE
are yours for the asking.
Please send 10¢ to cover
handling and postage.



ARE SERVICEMEN GYPS?

Every so often, some national magazine sounds off about radio-television servicemen.

"Servicemen are a bunch of gyps," is the general theme. "They'll clip you if you don't watch out."

They might just as well write the same thing of doctors, lawyers, storekeepers, auto mechanics—or anyone else. There are gyps in every line. Actually, the percentage in radio is far lower than in most.

The average serviceman—and I have met thousands during 30 years in radio parts manufacture—is a hard-working, straight-shooting individual. Rather than gyp customers, he is far more likely to spend more time on a job than he knows he will be paid for—simply as a matter of personal pride in doing things right.

The other evening, a friend's TV set went bad. A serviceman called for it in his truck and returned it in good working condition within 48 hours. His bill came to \$10 for service plus \$2.68 for replacement parts.

My friend argued that this was too much—yet he would never dream of complaining to the medical specialist who charged him \$10 for a 15-minute office visit; the lawyer whose bill for writing a simple will was \$75; or the garage man who, as my friend laughingly admits, charges \$5 for "just raising the hood" of his car.

In a very large Eastern city the Better Business Bureau received fewer than 1,000 complaints about service in a year. Most of the complaints came from folks who expected first-class reception in doubtful fringe areas; who tried to operate their sets without suitable

antennas, or who had bought sets "wholesale" or at ridiculously low prices from cut-rate dealers who could offer little or no service.

Actually, it takes almost as long to become a good serviceman as it does to train for any other profession. Beyond this, it calls for regular study to keep up with the constant stream of new developments. Also, it requires a surprisingly big investment in test instruments, manuals and other shop equipment. The modern radio or TV receiver is by far the most intricate piece of equipment the average person ever owns or uses.

Servicemen are not fly-by-night businessmen. Ninety-nine out of 100 radio-television servicemen run their businesses properly. The other one per cent—the gyps—can usually be spotted a mile away. Nine times out of ten, they are the shops that feature "bargain" prices and ridiculously liberal service contracts. And their victims are generally set owners who expect to beat the game by "getting something for nothing."

Good television sets or good TV service are not things to be bought on a "bargain counter" basis. Set owners who recognize this aren't likely to get gyped.

Instead, they'll find that they get more real value for their television entertainment dollars than for almost any other dollars they spend!

Harry Nathan

PRESIDENT

SPRAGUE PRODUCTS COMPANY
North Adams, Mass.



PIONEERS IN DEPENDABLE CAPACITORS
AND RESISTORS FOR RADIO AND TELEVISION SERVICING

SERVICE... The National Scene

CEILING-PRICE CHECKUP TO BE WAGED BY OPS AGENTS--Non-compliance of the price-ceiling regulation has become so widespread that the OPS enforcement office has been compelled to conduct a nationwide survey. Practically all shops will be visited, and owners will be asked to show their public listings and receipts. Violators will be dealt with harshly, according to Washington, with the guilty facing immediate injunction action. Reviewing the importance of service trades, the government pricing agency declared that they represent about 12 per cent of the average consumer's budget, and cannot be overlooked. Complete compliance with the official regulation is imperative and will be enforced vigorously, vowed the officials in their report on the drive to seek out violators.

COIN-TV CHASSIS ON WAY--The silver quarter will soon become an ace partner in the TV business, with the installation of some 4000 sets in motels and hotels within the next year. Operating under a financial scheme evolved by a credit-insurance group in the midwest, the receivers will be installed by selected servicing companies, and installations will share in the gross receipts. Many have indicated extreme interest in the plan, and it appears as if the idea will spread throughout the country.

PENNSYLVANIA TOWN TO HAVE COAX SUBSCRIPTION TV--Improved reception, over the facilities of a coax line connected to a tower erected on a mountain, has been promised to residents of Hazleton, Pa., pickup being available on a subscription basis which will amount to about \$3.50 a month. The original contact to the line will cost system users about \$100. The installation is unique in that the town is not too remote from TV stations, but reception is poor because of topographical and interfering problems. It is believed that the mountain-top direct-tie approach should present the ideal solution to the problem. Valley communities nearby Hazleton already boast of similar installations which have proved very successful. . . . Laconia, N. H., may soon have a wired service also. Two groups have been bidding to install the cables, and indications are that in the early spring approval will be granted to someone for such an installation.

TV ANTENNA ORDINANCES INCREASE--According to a report by the American Society of Planning, the regulation of antenna installations is on the rise. During the past year many towns have issued local laws prescribing the exact heights for towers and methods of installation. Recently, in Greensboro, N. C., there has appeared a bill which limits the antenna tower to a height of 50 feet above the roof, or 70 feet above the ground. The ruling also specifies that the antenna must be of a non-corrosive material and securely anchored with guy wires. Kansas City, Mo., also has a measure on the books which states that any antenna located on the roof, which is over 25 feet in height, must be wind resistant.

INDUSTRY EXECS INDICATE PARTS-WARRANTY PRACTICE SHOULD BE MODIFIED--The parts-warranty plans practiced by many setmakers are wrong, many national manufacturers have indicated, and will probably be altered very soon. It was pointed out that the move may be accelerated if associations and other trade groups advise each manufacturer what procedures should be adopted to assure an equitable warranty plan. According to a spokesman for RTMA, it was felt that the situation would be improved as soon as these comments were received and reviewed thoroughly.

SERVICE... *The National Scene*

JUKE-BOX REPAIR PARTS MAY BE SCARCE IN '52--The servicing of some 400,000 juke boxes may be seriously curtailed during the new year as a result of the reductions in allotments of steel, copper and aluminum. In the allocation slash, the coin operators are scheduled to receive only around 17,000 pounds of copper in the first quarter of '52 instead of some 65,000 pounds received in the fourth quarter of '51, and around 98,000 pounds of aluminum instead of over 233,000 pounds. During the last half of '49, 119,303 pounds of copper were available, and over 490,495 pounds of aluminum were provided. It appears, therefore, as if many of the juke boxes may be stilled, unless Service Men adopt very ingenious repair methods.

PACIFIC COAST RADIO-TV ACTIVITY BOOMS--Chassis, component and tube manufacturing in the far west, which only a few years ago was a struggling effort, has surged ahead in striking fashion to become quite a factor in industry. Today, more than 12,000 are employed in factories, occupying two-million square feet of plant facilities. There are quite a few setmakers producing broadcast and TV chassis, whose products have not only become extremely popular in the west, but throughout the country. Also extremely active are speaker manufacturers, transmitting and picture-tube makers, and particularly test-instrument fabricators, whose products have been widely approved not only on the test bench, but in the labs and factories. The Pacific coast is also known as the home of many popular hardware, antenna and accessory producers. Predictions indicate that '52 will be a banner year for Pacific coast radio and TV.

PUBLIC RELATIONS PLAN FOR SERVICE MEN--In an effort to describe accurately the capabilities of Service Men, many groups have devised promotional programs, involving the use of radio and TV, and direct mail. Recently, a committee in Philadelphia appeared with a format which seems to have many excellent ingredients. In a detailed analysis of what type of public relations Service Men should have, there was suggested the use of films which might contain a searching review of the techniques employed in servicing today. Also proposed were announcements over radio and TV stations urging consumers to seek competent and reliable Service Men. The latter has been used widely by associations, and many independent groups are now endeavoring to follow this interesting and useful idea. National advertisers were asked, in this plan, to include reference to the services a repairman can offer. The preparation and distribution of pamphlets, describing the cost of TV service that is competently and honestly rendered, was also proposed. This move has also been followed faithfully by many groups with significant success. The establishment of a committee of Service Men who would investigate and mediate complaints, also appeared in the list of suggestions. This idea has also been found very practical by several associations, providing solutions to many knotty and embarrassing problems. Also proposed was a speakers' bureau, comprising outstanding members of industry who would address meetings and community functions and point out what the Service Men must know to repair a chassis, and how this knowledge has helped him keep in operation the millions of broadcast and TV sets to the complete satisfaction of Mr. and Mrs. Consumer.

A READER'S VIEW--In a recent report on a proposed checkup plan, it was noted that Service Men should . . . "cleanup and polish the safety-glass panel and tube face." According to H. M. Layden, a New York City Service Man, the boys would find it quite difficult to do this, since most of the sets on the market today make no provisions for removing the safety glass from the outside of the cabinet; the only way the glass and tube face can be cleaned is to remove the chassis and picture tube from the cabinet, certainly a time-consuming project, especially where metal tubes are involved. Apparently some of the manufacturers have become aware of this cleanup problem and are now trying to help. In one instance, a dust seal is now provided. Describing this seal, the set maker says it is an anti-corona sponge rubber unit arranged to fit between the mask and picture-tube cone. . . . We are very grateful to HML for his constructive comments on a vexing problem, which it is hoped will disappear in new-line production.--L.W.

ANCHOR Boosters

First in Preference!
First in Fringe
Reception!

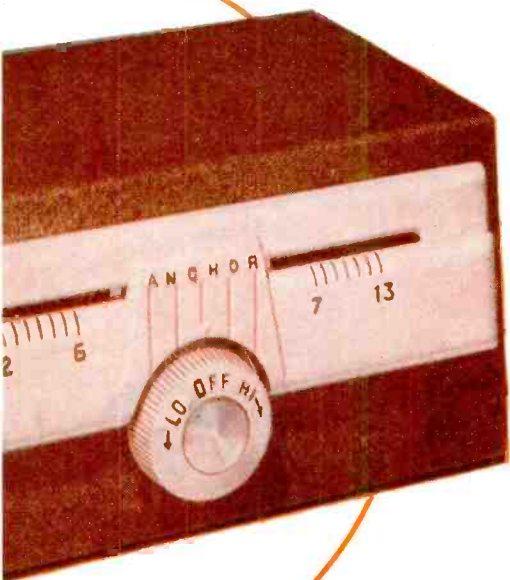

REACHING NEW

horizons

*Anchor engineering
always a year ahead!*

ANCHOR RADIO CORP.

2215 SOUTH ST. LOUIS AVENUE
CHICAGO 23, ILLINOIS

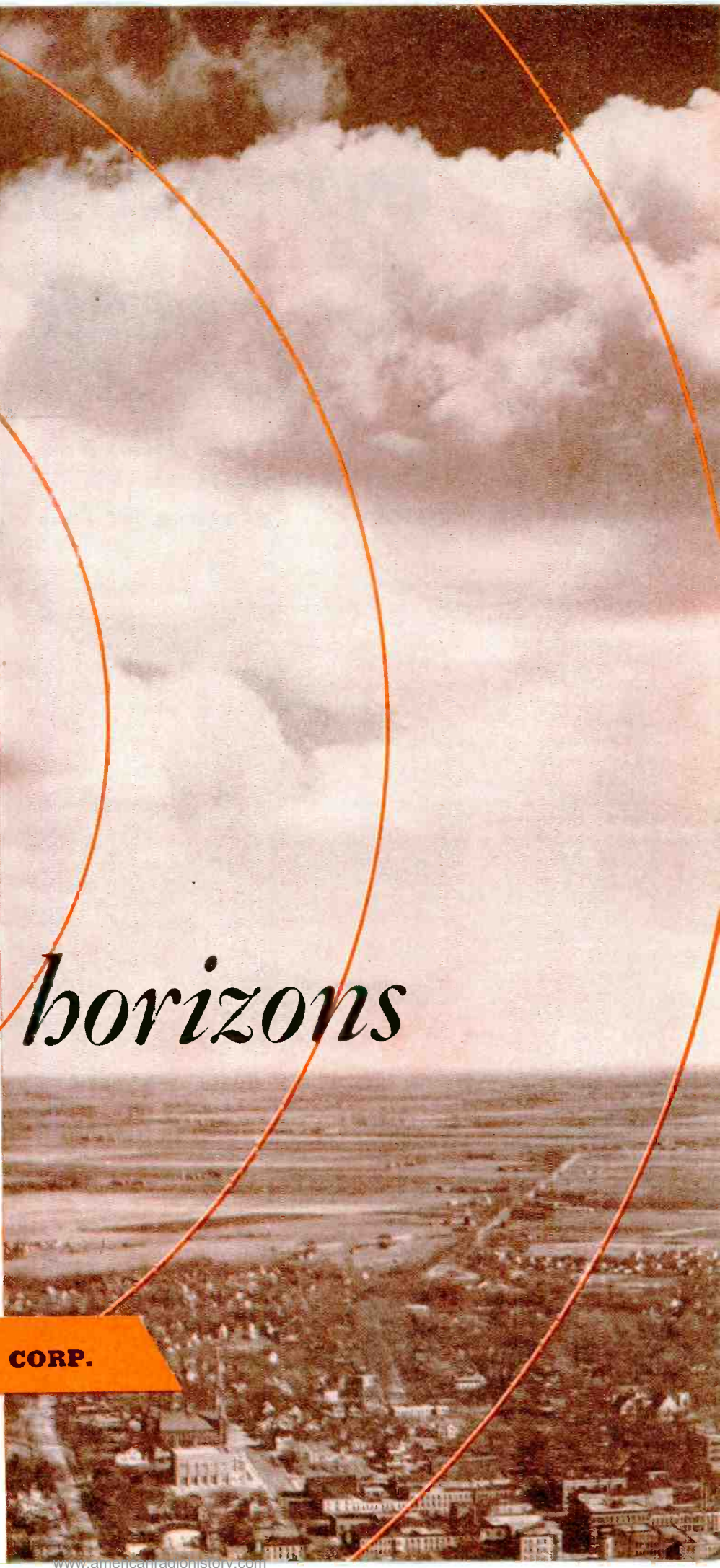

INTERCOM Systems

by JACK DARR

Ouachita Radio Service

Potentials of Systems . . . Types of Systems Now in Use: Battery, AC-DC and AC . . . Servicing the Equipment . . . Wiring Techniques . . . Speaker Characteristics . . . Estimating for Jobs . . . General Hints.

THE INTEROFFICE-COMMUNICATION system, or *intercom*, which today is an essential link in the operation of any modern business establishment, has become a favorite item in the installation-service kit of many Service Men. The boys have found that businessmen realize that a system of this nature properly used, can streamline procedure and eliminate many steps that are time consuming. Time saved is money, to any businessman. Any business which covers more than one room is a prospect for an intercom service. Prospects are numerous, even in the smaller towns. The auction barn represents a typical rural-area application that has broad possibilities. In this instance, the auctioneer can call for stock to be sold, make announcements, etc., from his stand connected to the barns, yards, pens, and so on.

Dentists and doctors can use the line from the waiting room to examination rooms, labs, x-ray room, etc.

In hospitals, lines can serve to connect the main office to the offices of the manager, doctor, dietician, as well as the floor-nurse's desk, ambulance drivers, garage, janitor, etc.

Garages are also ideal for intercoms, connecting the salesroom to the garage or shop or used car lot, and the garage to the parts room.

In mills and factories intercom lines have been set up between office and factory, mills, stockrooms, plant fire and protection department, gate to police office, boiler room and warehouses. Its use has also provided contact to planers and operators of saws or noisy machinery. Newspaper offices have been elaborate users, networking the editor's desk, business office, pressroom, composing, linotype and makeup rooms, circulation department, morgue, etc. Photographers have employed the intercom from front office to darkroom, studios, to speed operation.

Schools have been found to be the largest user in town providing a line from the principal's office to classrooms, gym, coach's office, shops, garage, janitor's office, auditorium. Department stores have found the system invaluable for connecting store to stockroom, warehouse, bookkeeper's office and credit department. The theatres have used the intercom to join the box office to the projection room, manager's office, etc. There are dozens of other applications in general offices, professional suites, municipal agencies, etc.

Technical Features of Intercom Systems

Every intercom has as its basic unit an audio amplifier. Power output of these range from a half-watt up to 15 or 20 watts for the larger industrial and school systems. Each uses a mul-

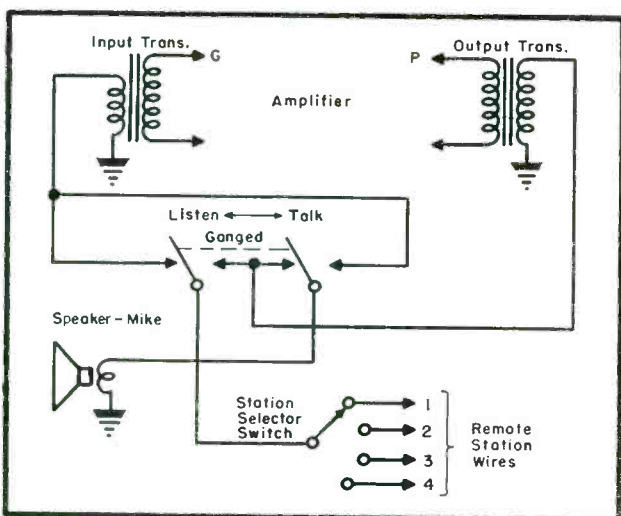

(Left)
Fig. 1. Basic schematic of talk-listen switch and station-selector switch for any intercom system.

(Below)
Fig. 2. Applying scotch-tape markers to intercom wiring for identification.

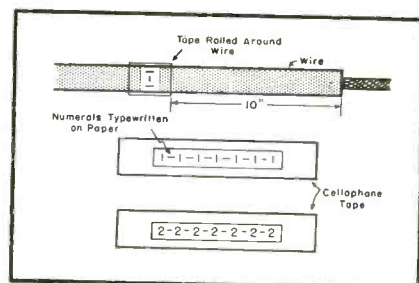

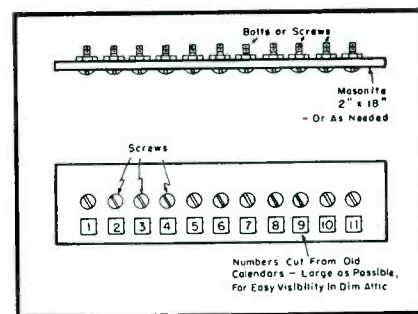
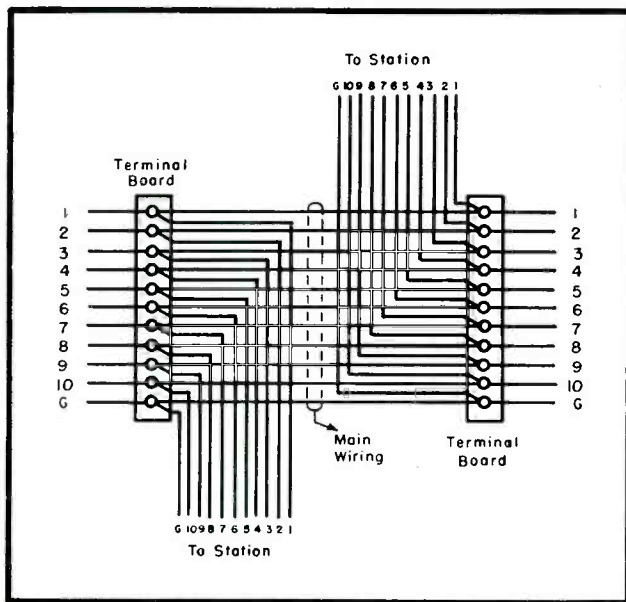

(Above)
 Fig. 3. Home-made terminal board for intercom. Numerals from old calendar leaves can be used. They should be as large as possible.

(Left)
 Fig. 4. Recommended wiring system for all-master installation. Main line carries all wires from station to station; individual stations are connected to terminal boards.

tiple-selector switch, usually of the pushbutton type, which allows selection of any individual station or combination of stations. Most of the larger systems have what is known as an *all-call* position, which throws all remote stations into the circuit at once, and is normally used for fire alarms or emergency calls.

Three variations of the basic circuit are found. The smaller sets use 1.4-volt battery type tubes, which heat up instantly. These systems remain *off* until the *talk* switch is depressed, and come on quickly enough to enable conversation to start at once. This effects a saving in power consumption and tube life. Selenium rectifiers are normally used in these sets, since tubes do not heat quickly enough. Power output of this type is usually less than one watt, and for short distances this is ample.

Next is the *ac/dc* system, using such tubes as 35Z5, 50L6 and 12SJ7. These develop a power output of about 2 watts. Sometimes a pair of 50L6s are used to increase the power. This type of unit will handle up to five stations, or even more if the all-call feature is omitted. Obviously, an infinite number of stations could be used, one at a time, but there is a definite limit to the number of speakers that can be driven simultaneously.

The largest systems that will be encountered in commercial practice will be the *ac* sets for school and factory use, their power output ranging up to 15 watts or more. As many as 24 remotes may be used with these sets. Such high power is needed to drive all speakers to a sufficient level.

Industrial systems may require the use of small auxiliary amplifiers, or

boosters, at especially noisy points. If a station is set up at a planing machine, hammer, etc., the best results will be obtained by using a compact *paging* speaker. These are small reentrant trumpets, with a high conversion efficiency. They can provide more than three times as much power as cone speakers. Most of this energy is concentrated in the higher frequencies; thus a penetrating *beam* of sound is focussed directly at the area to be covered. It has been found that this beam will drive through an amazing amount of background noise and reach the person called. For talkback from such a location, a handset, or a *close-talking* carbon microphone, can be used. A matching transformer and battery will be necessary, but by using the switch on the mike, battery life will be good.

Speakers

Speakers used with this equipment usually have a 40-ohm impedance, although some makers use conventional 4-ohm voice coils. High-impedance speakers are popular since they can be used as microphones for talkback purposes. In an emergency, the low-impedance speaker may be used as a temporary replacement. Only a slight loss in volume will be noted.

Remote stations usually feature a speaker, *dpdt* or *spdt* switch for originating calls to the master station, and some sort of cabinet to house the unit.

Servicing Intercom Equipment

Most of the troubles encountered with the units will be in filters, tubes, coupling capacitors, noisy controls, dirty switches, etc. Open voice coils

on speakers have been found to be about the most common form of failure.

Wiring Intercom Systems

By far the most complicated job encountered in intercom work will be laying out and installing the wiring system. This is the heart of the system and extra care taken here will pay big dividends.

In intercom wiring it is necessary to be very familiar with the individual items which make up the system. In the remote station, for instance, we have only a speaker, but no amplifier. This may have a switch permitting calls to be originated to the master station. The master station is the central unit where the amplifier is located. The input transformer of the master is connected through a *talk-listen* switch. This switch is so wired in that the input transformer is connected to the *call-wire* going from the master to all remotes. Thus, when the call-switch is depressed at any remote, its speaker is connected across the master's input. The talk-listen switch, at rest, also connects the master's output transformer across its own speaker. When depressed to *talk*, it connects its speaker across the input and the output secondary across the wire leading to the station called, through the selector switch. All stations are connected through a common ground wire. This is not switched and usually consists of the shield necessary on the master's *call-wire*. The lead from the master to each station is that particular station's *call-wire*, though for simplicity it is usually referred to by the number of the station.

[To Be Concluded in January]

AUDIO *installation and service*

Phono-Tape-Wire-PA-Amplifiers-Speakers

by **KENNETH STEWART**

Design and Application Features of Hi-Fi Amplifiers . . . Multiple-Speaker Cabinet Systems . . . Dual Reversible Stylus . . . Binaural Headphones . . . Portable Tape Recorder-Playback . . . Acoustical Lens.

THE ROLE OF HIGH FIDELITY, in generating a continuing enthusiastic interest in audio systems, has been commented on frequently. During the recent Audio Fair in New York City, the rousing popularity of this feature was truly a headline attraction of the show. For in practically every booth, there were on view equipment designed especially for hi-fi applications.

Extended-range amplifiers, multiple-speaker cabinets, disc and tape recorders and playbacks, cartridges, headsets for binaural use, and speakers were prominent in the parade of wide-frequency items.

A interesting example of hi-fi type of amplifiers displayed at the fair appears in Fig. 1.* Designed to provide

either 14 or 20 watts, with output controlled by power-transformer size and the type of pushpull used, the circuit provides for both voltage and power stages.

The 14-watt model employs two 807s in class *A* pushpull with plate voltage of 250, while the 20-watt amp has the same output tubes, but in class *AB1* with a plate voltage of 400.

Pentode-Tetrode Uses

According to the amplifiers' designers, the pentode as a voltage amplifier has been found to distort less than a triode, while a tetrode output stage distorts no more than a triode type, and is much more efficient. It is, of course, critically important that the

pentode and tetrode be properly used. A triode output stage usually requires a pushpull driver stage, and in spite of the most careful design and balancing, there is usually no guarantee that the two pushpull stages will continue to operate in a non-distorting condition. In the circuit illustrated the only balancing adjustment that is said to be necessary is the screen-feed potentiometer of the pushpull circuits. When this control is set to provide equal plate current for the pushpull tubes, the whole amplifier is balanced, since all voltages which could cause distortion by variation are said to be stabilized. The phase-splitting 6J5 triode has been found to continue to function without distortion, as long as it works as a tube.

The output power of the amplifiers

Arrangement for a binaural reproducing system, in which a pair of dynamic headphones, using moving-coil type motor assemblies, are used for listening. (Courtesy Permoflux)

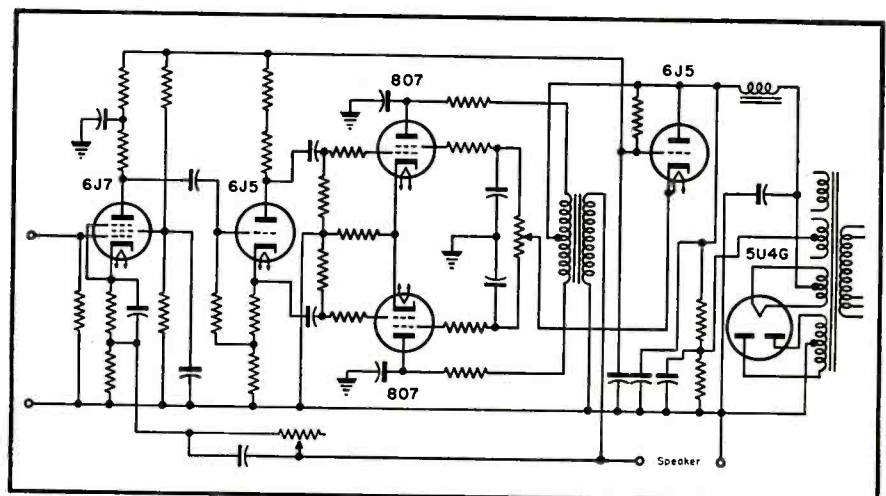
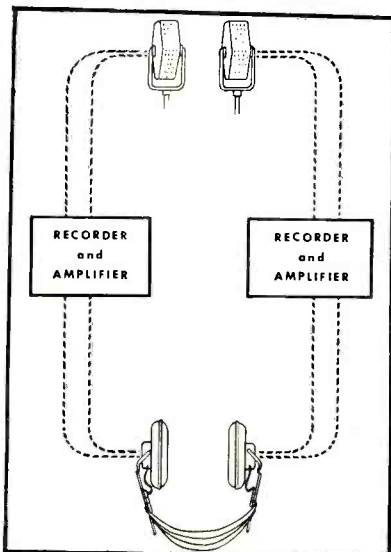

(Above)

Fig. 1. Schematic of the Hartley-Turner 14 and 20-watt hi-fi amplifier.

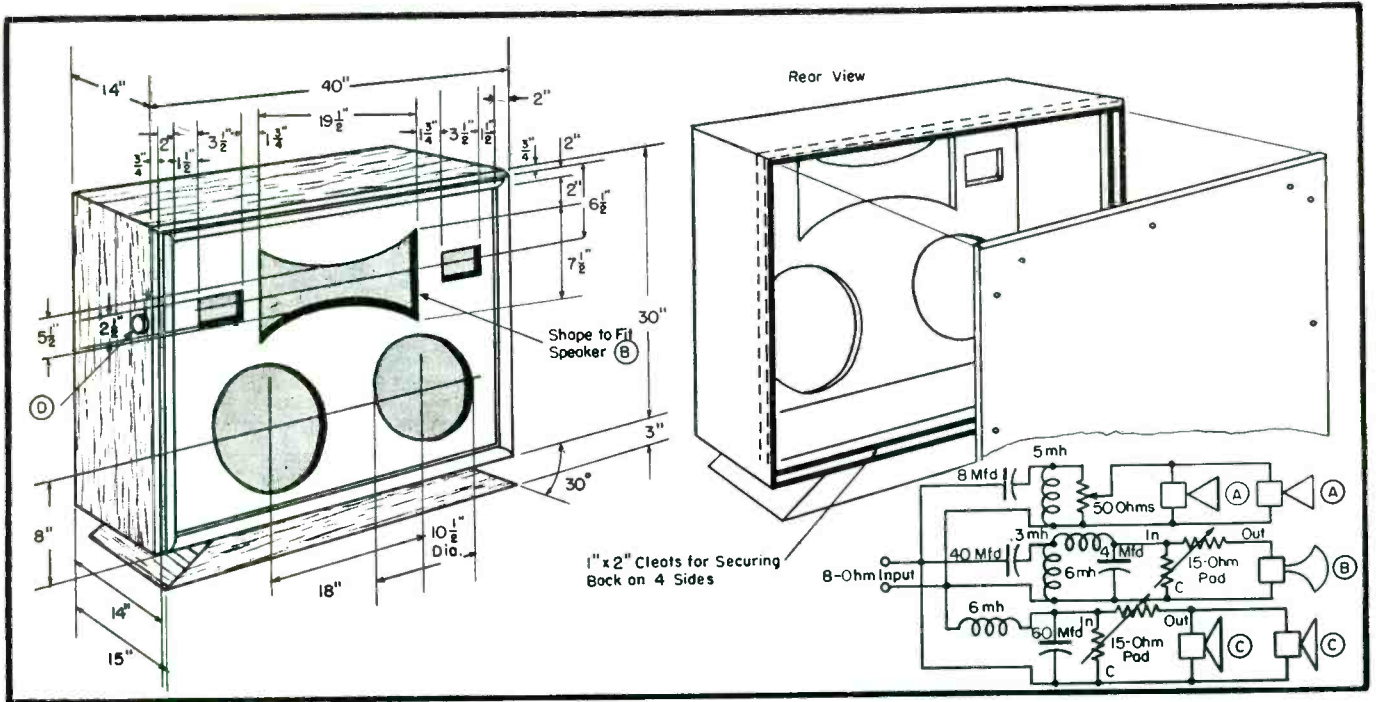

Fig. 2. Low-boy cabinet 3-way system featuring use of a pair of cone speakers, two tweeters and a cobra-type unit.
(Courtesy University Loudspeakers)

are 14 and 20-watts into a 4-ohm load. Input voltage for 20-watts output is 1 volt *rms.* Tests have indicated that the frequency range is 40 to 20,000 cps; -1.5 db at 32 cps and -4 db at 30,000 cps. Total distortion content is said to be 1 per cent at 20 watts; hum level -90 db at 20 watts. Input impedance is 1 megohm. Two power-supply sockets are provided for preamp and tone control, and radio: 6.3 v at 1 amp and 300 v at 5 ma (stabilized) for preamp tone control; 6.3 v at 2 amps and 300 v at 25 ma for an rf unit or any other radio unit.

The tone-control preamp, designed for use with this amplifier, features a 6SQ7 preamp stage, to increase the output of the pickup. The signal is

A 3-speed automatic phono with a slotted cone speaker. Automatic record changing mechanism plays and intermixes records of all 3 sizes and speeds. Has automatic shut-off and 4-tube, push-pull amplifier. (Pentron Corp., 221 East Cullerton Street, Chicago 16.)

then fed simultaneously to another 6SQ7 and a summing amp, 1/2 of a 6SN7. This latter channel has been designed to have a flat response to 1,000 cps and then fall at 12 db per octave. The signal amplified by the second 6SQ7 is split into two chan-

¹University Loudspeaker 6200; ²University 12; ³University 4401.

Battery-operated portable tape recorder-playback unit, weighing 9 3/4 pounds. Has a spring wound motor which is said to be vibrationless and will run 15 minutes on a single winding. May be rewound during operation. A warning light indicator flickers approximately two minutes before rewinding is required, as a precaution to rewind. A weighted and balanced governor is said to assure smooth mechanical action and constant tape speed. Operates from self-contained dry batteries which are said to last 100 hours. At the tape speed of 1 1/4 inches per second, with a frequency response to 3000 cycles, two hours of recording time can be accommodated on a single 5" reel of 1/4" wide tape. Playback is accomplished through crystal earphones. An external power amplifier and speaker may also be connected to the output terminals. (Magnemite; Amplifier Corp. of America, 398 Broadway, New York 13, N. Y.)

nels: a bass channel with a +40 db level at very low frequencies as compared with the main channel, falling at 12 db per octave from 50 cps; and a treble channel which rises at 12 db per octave to 15,000 cps, where it is +40 db above the main channel. All three channels are combined in the summing amplifier, the output of which is fed to a cathode follower. This tone-control amp can be used remote from the main amplifier.

3-Way Cabinet System

In Fig. 2 appears another unusual hi-fi contribution which was on exhibit at the fair. A 3-way cabinet system, with a housing content of 8 cubic feet, there are provisions for six speakers: a pair of cone types,¹ a cobra type² and a pair of tweeters.³

Also introduced at the convention
(Continued on page 53)

Dual reversible baton stylus, designed for use with variable reluctance cartridges, which employs .003 sapphire and a .001 diamond styli. (Courtesy G.E.)

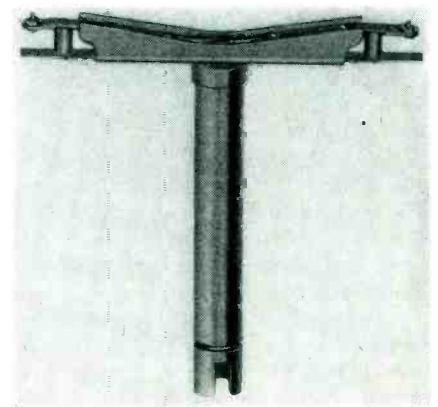

Speedy Trouble Shooter

by **JAMES S. KENDALL**

Instructor in Radio and TV
Four Dwellings School, Birmingham, England

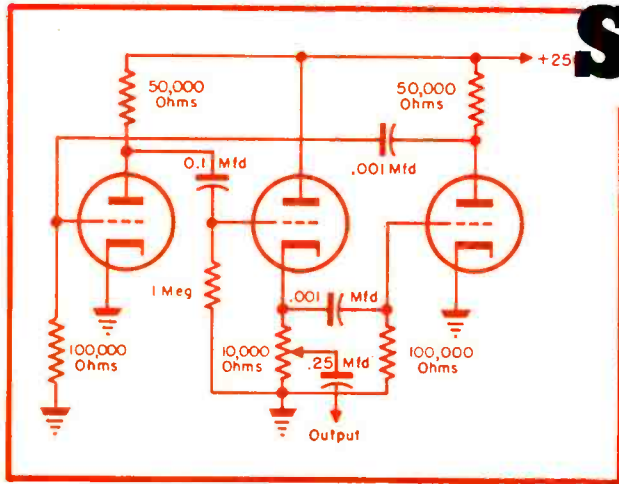

(Above)

Fig. 1. Basic circuit of speed tester which features a multi-vibrator with a pair of 6SN7GT double triodes, one double triode acting as oscillator and half of the other as a cathode follower.

(Right)

Fig. 2. How to use multi-vibrator with signal generator. The four-range switches are ganged.

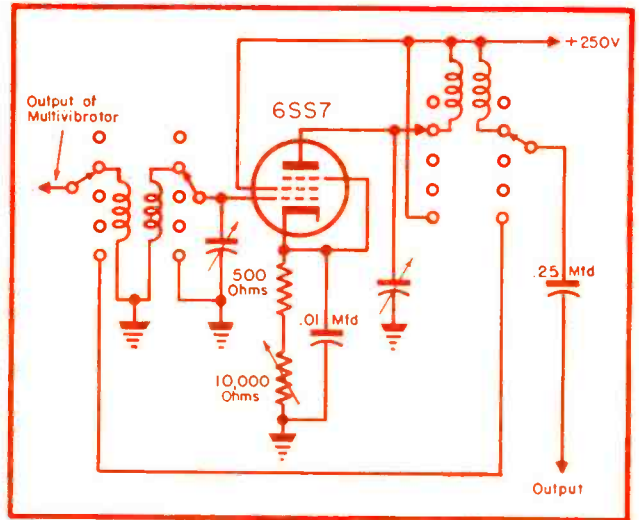

Multivibrator Type Tester Expedites Fault Finding and Alignment

EQUIPMENT, which will permit rapid repair, has always interested Service Men. And with more and more chassis in the field, the speed requirement has become extremely important.

With this thought in mind the equipment diagramed in Fig. 1 was designed.

The circuit consists essentially of a multi-vibrator consisting of two double triodes of the 6SN7GT type, with one double triode acting as the oscillator and half the other acting as a cathode-follower output. It has been found that this type of circuit will deliver quite a high power output with a very high harmonic content; in fact the harmonics are easily detectable up to and including 10 mc, with the circuit shown in Fig. 1. There are many small transformers available that will deliver the requisite high voltage and heater current.

With the multi-vibrator it is quite a simple matter to trace a fault. First, with the output of the unit turned up to maximum, the test prods should be placed across the output transformer primary. A note of about 1,000 cycles should be heard. The speech coil could, of course, be the first point, but if the primary winding is used, both the transformer and the speaker can be tested at the same time, saving one test. If this test indicates that the unit is okeh, you can proceed to the control

grid of the output tube and then to the control grids of the various tubes until no signal is heard. There will be a sharp drop in volume between the first audio stage and the last *if*, as the harmonics are being used instead of the fundamental. The fault is always in the section between the last signal and the first no-signal test. The field can then be narrowed down by testing from the plate. If there is a signal at the plate and not at the grid, the tube might be faulty. However, this may not be the case and the voltages at the various electrodes should be tested. If these are correct, then the tube should be replaced. If the trouble still persists, a careful check of the components in that part of the circuit should result in the finding of the fault. It has been found that the fault will usually show during the initial test runs.

Very often the receiver requires aligning, as with time and the replacement of the tubes, the settings of the various trimmers will have wandered. The tester can be used for this operation by converting the multi-vibrator into a signal generator, as shown in Fig. 2. In this addition, a variable mu *hf* pentode, 6SS7, is used, with tuned input and output, the actual tuning being accomplished by the use of a 500-mmfd two-gang variable capacitor. The desired number of ranges can be selected by the use of a wafer

switch; the highest frequency should not be above 10 mc.

The output can be varied by the adjustment of the resistance in the cathode circuit.

After the *if* portion of the set is aligned, the oscillator section will have to be adjusted. If the full output from the multi-vibrator is fed to the antenna socket, it is only necessary to set the padders and trimmers of this section for the largest output volume from the receiver.

The multi-vibrator has been found to be excellent in tracing intermittent faults with a minimum of time. In the test, the output of the multi-vibrator is connected in that portion of the circuit suspected of trouble and the output of the receiver plugged into a self-locking relay. The spare half of the 6SN7GT can be used for this purpose and the receiver left working. The section in which the fault exists, can be found by dividing and then subdividing the circuit until two points close together are found.

The circuit consists of a tuned-output transformer, with tuning being set to the same frequency as the multi-vibrator coupled to one-half of the 6SN7GT. When the receiver under test fails, a rise in plate current will occur, lock the relay contacts and ring an alarm bell indicating that the intermittent has been at last found.

Now ... a NEW Junior VoltOhmyst* ...the WV-77A

For all regular measurements and specialized measurements as illustrated.

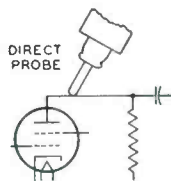

MEASURES AC VOLTS ... such as signal voltage on plate of af tube.

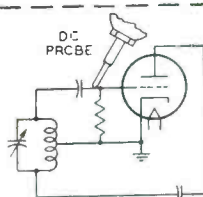

MEASURES DC VOLTS ... such as oscillator grid bias. One-megohm resistor in probe prevents circuit loading.

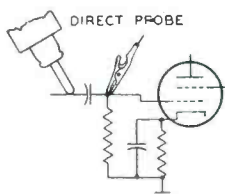

MEASURES RESISTANCE ... such as leakage in coupling capacitor up to 1000 megohms.

Check these important features . . .

- ✓ Accurate laboratory calibration.
- ✓ Meter electronically protected against burn-out.
- ✓ Metal case shielding . . . extra stability in rf fields.
- ✓ Sturdy 200-microampere meter movement.
- ✓ Carbon-film 1% multiplier resistors . . . dependability plus.
- ✓ Zero-center scale . . . for discriminator alignment.
- ✓ Frequency response flat from 30 cps to approximately 3 Mc.
- ✓ High ac input resistance for greater accuracy.
- ✓ Constant dc input resistance . . . 11 megohms on all scales.
- ✓ Negative feedback circuits for greater over-all stability.
- ✓ Ohms cable always positive . . . for quick leakage measurements of electrolytic capacitors.
- ✓ Polarity reverse switch . . . eliminates cable switching.
- ✓ $\pm 3\%$ over-all accuracy on +dc scales, and $\pm 5\%$ on ac and -dc scales.

Available from your RCA Test Equipment Distributor

Just one probe cable and one slip-on probe handle all measurements.



An all-electronic ac-operated vacuum-tube volt-ohmmeter by RCA
ONLY \$47.50.

Includes DC probe, AC direct probe and cable, ground lead, and alligator clip.

The RCA WV-77A VoltOhmyst* provides the extra features you have tried to find in an inexpensive VTVM. Using the famous Volt-Ohmyst electronic bridge circuit, 200-microampere meter movement, and carbon-film multiplier resistors, the WV-77A incorporates features you would expect to find only in more expensive instruments. Sturdily built . . . calibrated against laboratory standards . . . and backed by a 12-month warranty . . . the WV-77A has the durability, versatility, and accuracy to please discriminating customers such as service technicians, engineers, amateurs, and military personnel.

As a DC Voltmeter it measures dc from 0.05 volt to 1200 volts in five ranges. Uses 1-megohm resistor in isolating probe; probe has less than 2-uuf input capacitance. Has 11-megohm input; useful for measuring high-resistance circuits such as oscillator, discriminator, and avc.

As an AC Voltmeter it measures ac from 0.1 volt to 1200 volts rms in five ranges.

Uses high-impedance diode tube as signal rectifier. Frequency range is more than adequate for measurement of power line, audio, and ultra-sonic frequencies.

As a wide-range Ohmmeter the WV-77A measures resistance from 0.2 ohm to 1 billion ohms in five ranges. Requires only 1.5-volt battery as burn-out protection in measuring such low-power elements as battery-type tube filaments.

The all-new RCA WV-77A VoltOhmyst comes completely equipped with probes and cables as illustrated. For complete details, see your RCA Test Equipment Distributor today . . . or write to RCA, Commercial Engineering, Section 56LX, Harrison, N. J.

Accessories Available on Order

The WG-289 High-Voltage Probe and WG-206 Multiplier Resistor extend the dc range of the WV-77A to 50,000 volts.

The WG-264 Crystal-Diode Probe extends frequency range of the WV-77A to 250 Mc.

*Reg. U. S. Pat. Off.



RADIO CORPORATION of AMERICA
TEST EQUIPMENT
HARRISON, N. J.

Low-Voltage Electrostatic-Focus Chassis with FRINGE-LOCK

by WYN MARTIN

[See Front Cover]

WITH THE FREEZE STILL ON and station installation at a standstill, but reception interest on a continuing rise, more and more DX areas have become prospects for receivers. The development of highly-effective boosters, high-gain antennas and improved receivers has made it entirely practical to install equipment with complete confidence that successful results would obtain in the remote communities. Receiver manufacturers have evolved many unusual circuits to help the DX cause. On the cover appears the design of one such chassis, which has a *fringe-lock* system.

By a gate-like action, the circuit blocks off undesirable disturbances and prevents them from getting into the TV picture. The result is a steady image that is locked into place and virtually without side wobble or vertical roll.

Employed in the Zenith 20J21, 20J22, 21J20 and 21J21 chassis, the sets use electrostatic-focus picture tubes. The 21J-series receivers utilize high-voltage electrostatically-focused tubes which obtain approximately 2200 volts from a 5642 rectifier for the focusing anode, while the 20J-series use low-voltage-focus tubes which obtain 0 to 400 focusing anode voltage from the regular power supply of the receiver and do not require the 5642 rectifier. The circuit on the cover represents the 20-J series of chassis design.

The Fringe-Lock Circuit

The fringe-lock circuit uses a 6BE6 heptode, which can be adjusted to assure sync stability over a wide range of noise and signal levels encountered in different areas. In this circuit the output of the crystal detector, approximately -2 volts peak-to-peak, is fed to grid 1 of the 6BE6. The same signal, after it has been inverted and amplified

to approximately 40 volts peak-to-peak by the first video amp, is applied to grid 3 which in this circuit is the signal grid. A fringe-lock control is used to preset the bias on grid 1 so that the normal 2-volt signal allows proper sync clipping action; i.e., the sync pulses, which have been stripped from the composite video signal appearing at grid 3, will appear at the plate. If a noise pulse drives grid 1 beyond the 2-volt level, plate current cutoff occurs and the noise pulse cannot get through to trigger falsely the sweep oscillators. On rare occasions, a strong noise pulse may occur at the time of the sync pulse and the tube likewise will cutoff. However, the flywheel action of the sweep oscillators will maintain sync during this brief period. The entire fringe-lock system is based on the fact that the loss of an occasional sync pulse is to be preferred over having a noise pulse get through to trigger falsely the sweep oscillators.

Fringe-Lock Adjustment

In operation, the fringe-lock control should be turned clockwise and then backed off approximately $\frac{1}{4}$ turn. The vertical and horizontal hold controls should then be adjusted, and the operation of the receiver checked to see that it syncs normally when the turret is switched from channel to channel.

If the picture shows evidence of delay, tearing, split phase, etc., it will be necessary to back down further the fringe-lock control, a few degrees at a time, each time readjusting the hold controls until normal sync action is obtained.

In noisy and weak signal areas, the fringe-lock and hold adjustments must be made for best sync under existing conditions. Under these conditions it will be found that clockwise rotation of the fringe-lock control will increase sync stability.

Controls and Functions

The controls in this receiver have been designed to simplify any readjustment that might be required. After the receiver has been properly adjusted, the horizontal hold, brightness, fine tuning, vertical hold, and contrast control knobs can be removed and repositioned so that a dot stamped on the outer edge of each knob faces upward. The positioning of the knobs aids the customer in resetting the controls should they be accidentally moved.

Each control has, of course, a definite relationship to the circuit's operation. For instance, the fine tuning control provides a means of varying the frequency of the local oscillator to compensate for any frequency deviation which may result from tube and circuit variations. In operating this control, it will be found that the range of sound is quite broad. Proper setting is the point where the best picture is obtained within the range of best sound.

The vertical-hold and vertical-hold range controls provide a means of changing the cathode resistance of the vertical oscillator to effect synchronization of the vertical sweep with the transmitted sync pulses. Adjustment is made by setting the vertical-hold control in the center of its range and adjusting the vertical-hold range control for proper sync. Improper adjustment will cause the picture to roll vertically.

The contrast control, in the cathode circuit of the 12AT7 second video amp, regulates the magnitude of video signal applied to the grid of the picture tube.

The horizontal-hold control is used to tune the horizontal oscillator to the frequency of the transmitted sync

(Continued on page 53)

Tel-a-Ray's



BIG

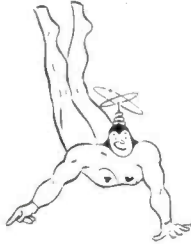

FOUR

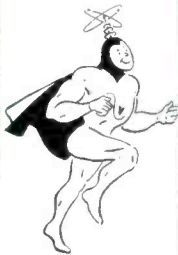

of TV reception

For television that's
bright and clear
Wherever you are . . .
far or near



HOW TO MAKE MORE MONEY WITHOUT CALL-BACKS

With the aid of Tel-a-Ray's "Big Four," you can give your customers brilliant, stable television reception almost anywhere . . . beyond the fringe areas, in outer service areas, in the primary areas. Reception problems are solved in a jiffy. Installation is amazingly easy and fast. Call-backs are reduced to a minimum. The quality of these Tel-a-Ray products shows in their appearance . . . in their rugged construction of the finest corrosionproof materials . . . in their unconditional guarantee against wind and weather damage.

Use them to sell television beyond the fringe areas . . . to make more money out of the replacement market in the established TV areas . . . to give your customers the finest TV reception at low cost. Send the coupon for full information.

**MAKE MORE MONEY WITH
LESS WORK AND TROUBLE**

Send the coupon now

Good reception up to 200 miles or more!

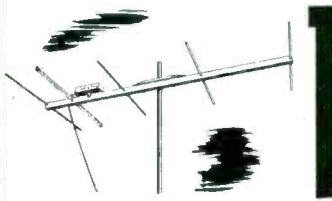

Models T and TD Antennas . . . famous for providing clear, stable, interference-free reception at almost unbelievable distances. With the Pre-Amplifier, they give up to an amazing 300 times gain over dipole. Rugged, weatherproof construction.

Signal amplification without noise!

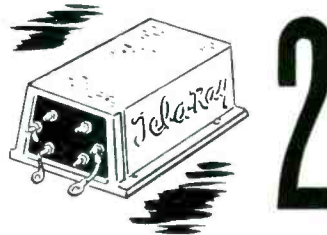

The unique, research-perfected Pre-Amplifier . . . the only device of its kind . . . an antenna- or mast-mounted installation that dramatically multiplies the signal gain while keeping noise at a minimum. Eliminates snow and makes signals strong and stable. Sold as a weather-sealed unit and guaranteed against weather damage.

Middle-distance champions!



Models R and RD Antennas . . . designed to give the finest TV reception to the outer service areas at low cost . . . America's champion middle-distance performers. Same quality construction features as Models T and TD.

**Now, primary area reception benefits from
Tel-a-Ray Antenna know-how!**

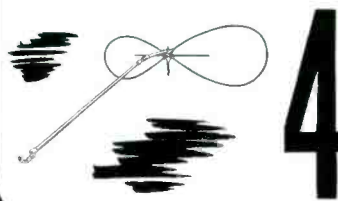

Butterfly Swivel-Positioned TV Antenna . . . low cost, high gain . . . easy to adjust for best primary area reception . . . self-mounted on three-way bracket for quick installation almost anywhere . . . an all-channel antenna designed and priced for the mass market.

Tel-a-Ray, America's most progressive antenna manufacturer, has applied to the FCC to operate a UHF television station on Channel 50 . . . Tel-a-Ray's research engineers, keeping pace with America's fastest-growing industry, have developed an effective UHF antenna. Such progress assures you finer television.

Tel-a-Ray ENTERPRISES, INC., P.O. Box 3325, Henderson, Kentucky

Yes . . . I'd like descriptive literature on the Tel-a-Ray line, and the name of my nearest Tel-a-Ray Distributor.

NAME.....

COMPANY.....

ADDRESS.....



by M. W. PERCY

Improved Interlace and Fringe-Compensator Systems in Bendix, and Packard-Bell and Emerson Chassis With Electrostatic Tubes.

[See full-page circuit diagrams on pages 28 and 30]

DURING THE PAST FEW MONTHS, there have appeared announcements that the '51-'52 series of chassis would feature innovations in circuitry which would not only insure complete locking of signals even in the extreme fringe areas, but provide more highly-defined pictures through the use of new components and allied network systems, plus new types of picture tubes.

Some of these developments have been discussed briefly in these columns. This month, a more detailed analysis of locking and picture-improvements used in Bendix, Packard-Bell and Emerson chassis are offered on these pages, as well as on the cover-circuit page (p. 24) where the Zenith lock system is reviewed.

In Fig. 1 (p. 28) appears the circuitry of one of the new systems designed to improve picture reproduction. Known as *magic interlace*, and incorporated in the Bendix T9 chassis, there are featured a modified vertical-integrating network, uniquely designed vertical multivibrator, and a deflection yoke with a minimum cross-talk specification.

The incoming sync signal is taken from the cathode of one-half of a 6SN7GT (V_{13A}) sync clipper and fed to the intergrating network. Cascade coupling to the multivibrator is utilized to minimize the effect of noise pulses riding through with the triggering pulses.

The vertical deflection system consists of a free running multivibrator (V_{11B} and V_{12}) which is locked into synchronism by vertical triggering pulses. The circuit used in this receiver employs a coupling circuit between V_{11B} and V_{12} , which consists of three *rc* networks in cascade, instead

of the usual single *rc* network. These networks consists of C_{20} , C_{31} , C_{60} , C_{80} , R_{60} , R_{61} , and R_{17} ; .0027, two .001 and .033-mfd capacitors, and 33,000, 3,300 and 27,000-ohm resistors. This system has been found to make the vertical sweep circuit much less likely to be triggered by noise and much more smoothly triggered by the sync pulses. The use of cascade coupling causes the grid voltage curve of V_{11B} to cross the cutoff voltage line at a much steeper angle than it would with a single coupling circuit. The 3,300 and 27,000-ohm resistors, R_{46} and R_{17} , are effectively across the vertical deflection coils (L_{13} , L_{14}) and it is these resistors which provide the damping action across the deflection coils during the retrace period. The cascade coupling networks between V_{11B} and V_{12} also filter out any 15-kc horizontal pulses that may get through the intergrating networks, thus greatly improving the interlacing.

Packard-Bell Chassis

In Fig. 2 (p. 30) appears the Packard-Bell 2118 chassis circuit with a recently-developed 24-inch low-voltage, electrostatic-focus picture tube (24BP4), and new high voltage and horizontal deflection circuits. The horizontal output tube is a 6AU5GT, while the damper is a 6AX4GT. Picture tube, horizontal hold and width adjustments may be reached through a *trap-door* located on the back of the cabinet.

Models for 17- and 20-inch low-voltage, electrostatic-focus picture tubes have also been produced. Two types are used in 20-inch and 17-inch chassis, a 17KP4 and 17HP4 for the 17-inch models and a 20JP4 and 20HP4 for the 20-inch models. The

17KP4 and 20JP4 may be referred to as the fixed-focus type, since the cathode and focusing anode are internally connected within the picture tube. There is no focus anode connection on the base of the tube. Actually then, the focus control is disconnected and picture focus will remain constant with a variation of line voltage and when switching from channel to channel.

The 17HP4 and 20HP4 are the variable-focus type. Picture focus will remain constant in these tubes just as in the 17KP4 and 20JP4. There is, however, a focus anode connection and the focus control is connected in the circuit. The rated voltage on the focus anode is 200 volts \pm 200 volts, which means that the focus control will tune very broad. Naturally, the focus coil has been entirely eliminated.

Production was confined to one or the other type of tube because of availability. Focus controls have been left in the receiver for use when the fixed focus tube is used. In the 24-inch model illustrated a variable focus is shown.

Magnetic Mechanical Center Device

A magnetic mechanical centering device, weighing less than five ounces, is featured in these chassis. It is clamped around the neck of the picture tube in front of the ion trap. This method of centering has, thus far, proven to be very stable. The device should be positioned almost flush with the yoke coil and rotated around the neck of the tube until proper centering is reached.

A 20.5-mc trap has been added in the second video *if* stage for effective reduction of sync buzz. Alignment of

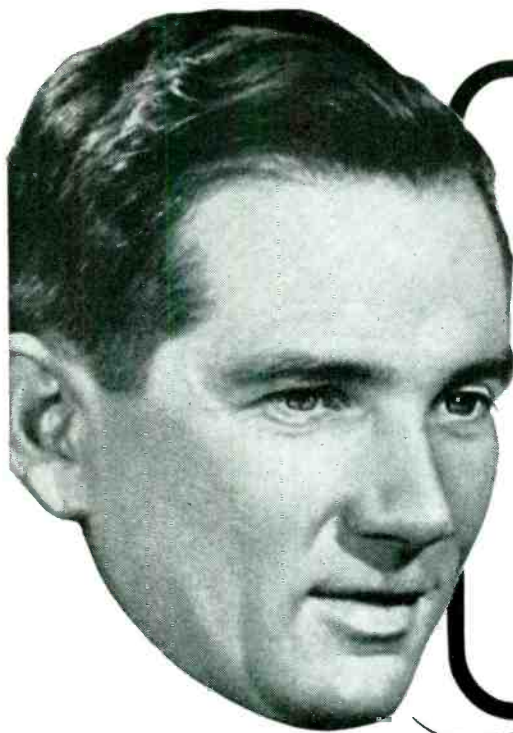

*How come you
sell so many
picture
tubes,
Sam?*

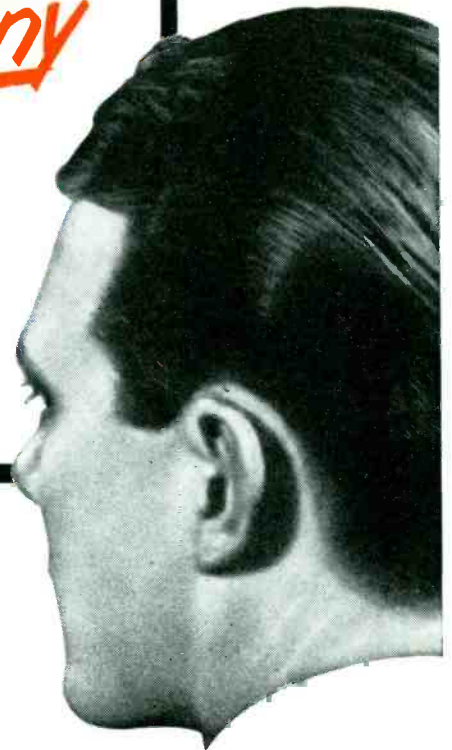

"I'm using the CBS-Hytron Easy Budget Plan, Joe. My CBS-Hytron distributor gave it to me."

"Tell me more."



"Well, CBS-Hytron's Plan helps me sell TV picture tubes and service to many a customer who just doesn't have \$50 cash. My customer now pays for the job painlessly a few dollars a month. Yet I get my cash right away."

"Fine! How does it work, Sam?"



"Simple. I introduce my customer to the finance company authorized by CBS-Hytron. The finance company does the rest . . . acts as my credit department . . . arranges all details. My customer gets his tube and I get my cash — at once."



"That's swell, Sam! I've sure been losing sales I shouldn't. I need that CBS-Hytron Easy Budget Plan. CBS-Hytron tubes are tops, too. Thanks for the tip. I'll see my CBS-Hytron distributor today."

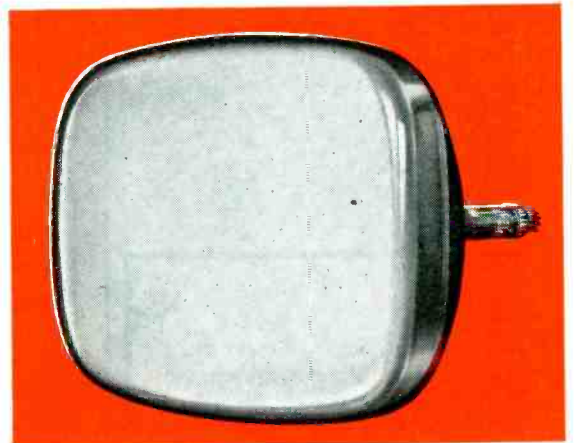

SAVE THE SALE No need for *you* to miss a single profitable picture-tube sale . . . just because your customer does not have the cash. Get the details on this original CBS-Hytron service for you. See *your* CBS-Hytron jobber . . . or mail this coupon . . . today!



MAIN OFFICE: SALEM, MASSACHUSETTS



HYTRON RADIO & ELECTRONICS CO.
SALEM, MASSACHUSETTS

Please rush me details on the CBS-Hytron Easy Budget Plan.

NAME.....
(Please print)

STREET.....

CITY.....STATE.....

Fig. 1. Magic interlace system used in the Bendix T9 chassis.

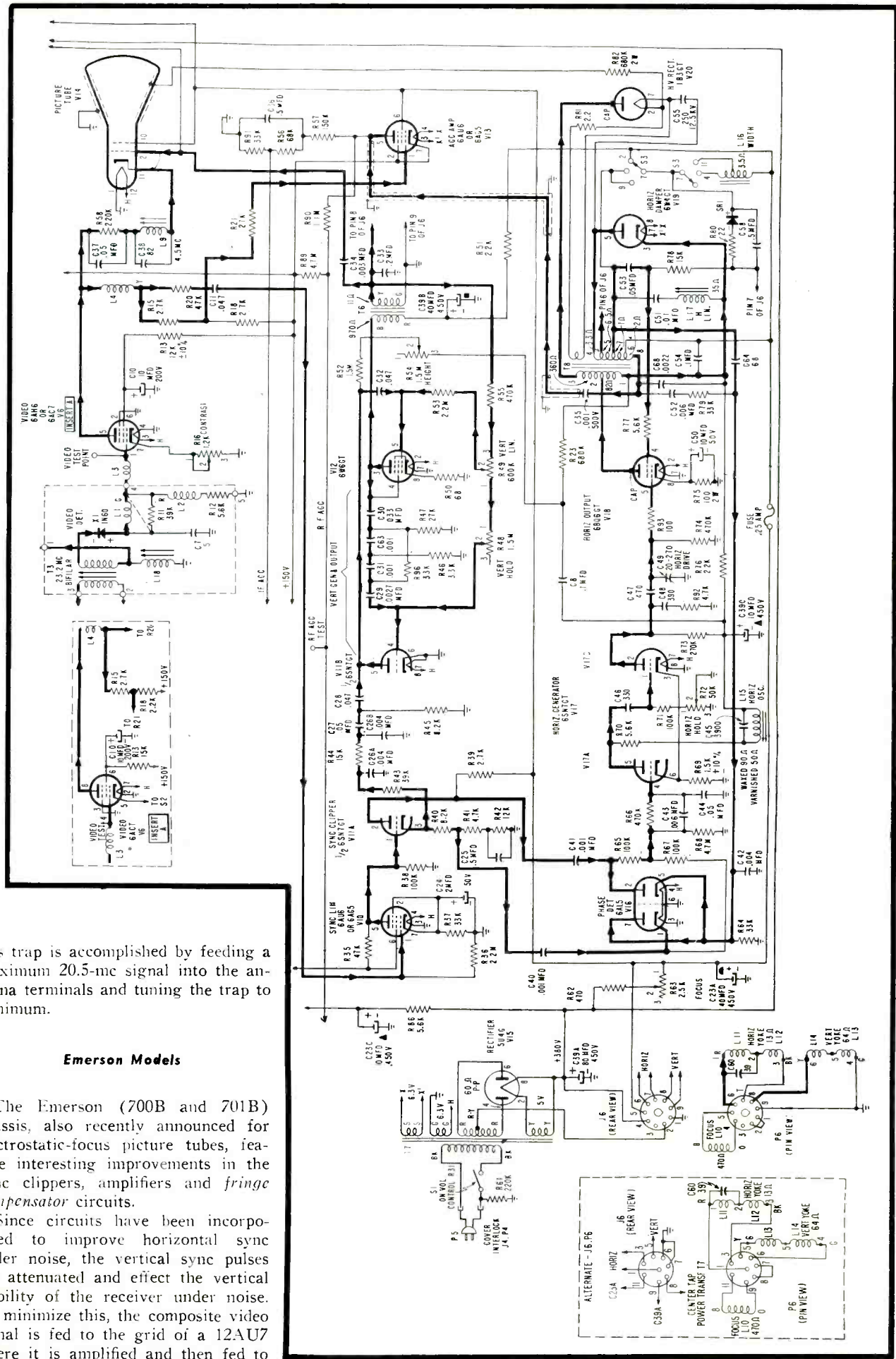

this trap is accomplished by feeding a maximum 20.5-mc signal into the antenna terminals and tuning the trap to minimum.

Emerson Models

The Emerson (700B and 701B) chassis, also recently announced for electrostatic-focus picture tubes, feature interesting improvements in the sync clippers, amplifiers and fringe compensator circuits.

Since circuits have been incorporated to improve horizontal sync under noise, the vertical sync pulses are attenuated and effect the vertical stability of the receiver under noise. To minimize this, the composite video signal is fed to the grid of a 12AU7 where it is amplified and then fed to

HIS CHOICE IS

Regency

CHARLIE GOLENPAUL
EMINENT DISTRIBUTOR SALES MANAGER
AEROVOX CORPORATION
PHOTOGRAPHED IN HIS HOME

LARGEST SELLING BOOSTER
AT ANY PRICE

BURTON BROWNE ADVERTISING

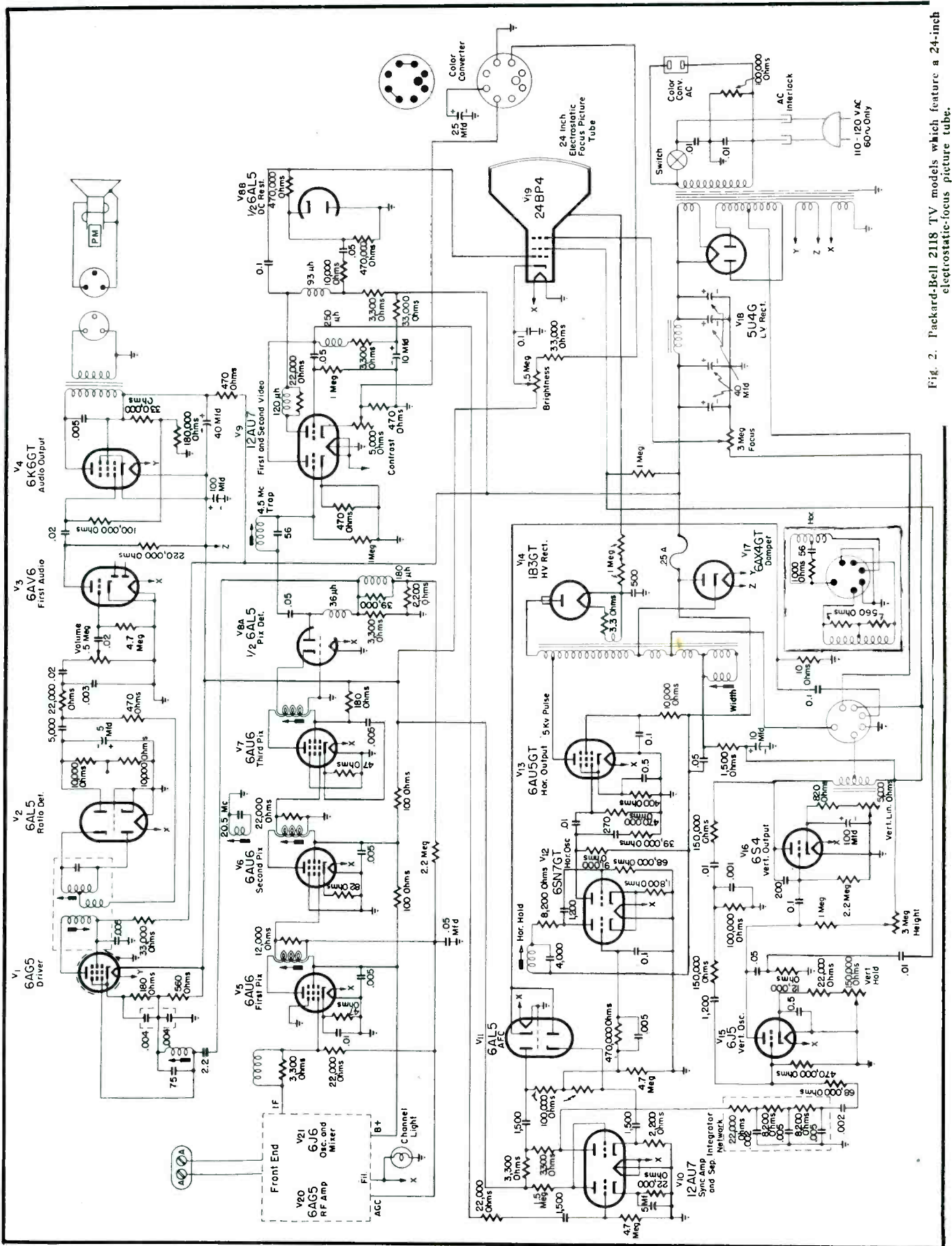

Fig. 2. Packard-Bell 2118 TV models which feature a 24-inch electrostatic-focus picture tube.

separate vertical and horizontal sync separators; $\frac{1}{2}$ a 12AU7 for both units. By utilizing a separate vertical-sync separator, 12AU7, with a low-

pass filter in its grid circuit, using a 100,000-ohm resistor and 47-mmfd capacitor, the vertical sync-to-noise ratio is said to be improved. The out-

put of the vertical sync separator is then fed directly to the grid of a 6SN7 multivibrator. No series-type
(Continued on page 54)

3 Important Rauland Policies

...Are they
paying off for you?

1 Did you know that Rauland's Replacement Picture Tube Warranty and Adjustment Policy provides a 6 months warranty from the date of purchase by the consumer? And that all Rauland replacement tubes now carry a triple registration card providing protection for jobber, dealer and consumer?

2 Did you know that Rauland provides a full 120-day price protection on distributor inventory of replacement picture tubes? That Rauland distributors can carry a stock adequate for their territories without risk of loss through price adjustment?

3 Did you know that Rauland offers valuable premium points for the prompt return of warranty registration cards? Each card returned promptly entitles dealer and distributor to premium points redeemable in valuable merchandise prizes.

• • •

If you have not received full details on all of the above, write, phone or wire your distributing contact on Rauland tubes. If you have not received your prize merchandise catalog, use the coupon below today.

THE RAULAND CORPORATION



Perfection Through Research

4245 N. KNOX AVE. • CHICAGO 41, ILLINOIS



The Rauland Corporation
4245 N. Knox Ave., Chicago 41, Illinois

Please rush premium merchandise catalog and full information on:

Earning Premium Prizes 6 Months Warranty
 Distributor Price Protection

Name _____

Address _____

City _____ State _____

Improving Picture Resolution . . . Increasing Protection Against Overload in Strong Signal Areas, and Insuring Maximum Gain in Weak Signal Areas . . . Retrace Line Suppression . . . Auto-Radio Intermittent Servicing.

Servicing Helps

by M. A. MARWELL

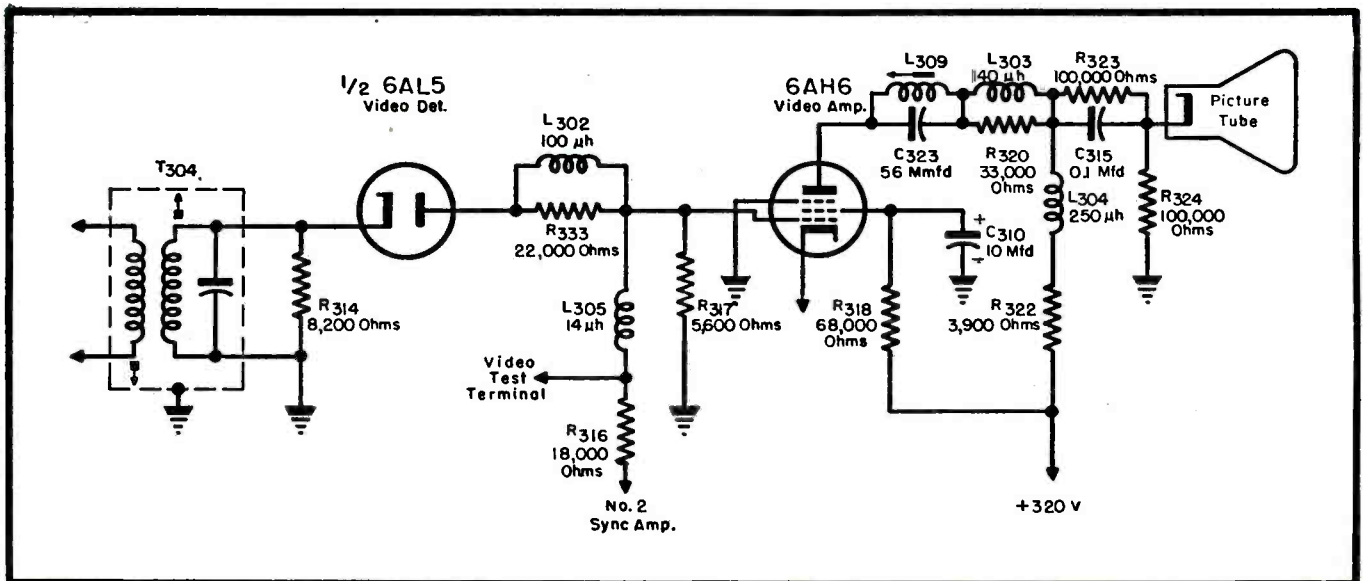

Fig. 1. Modified video-amplifier circuitry in Westinghouse chassis; V-2200-1, V-2204-1 and V-2206-1.

To PROVIDE BETTER picture resolution, Westinghouse has modified the video amplifier circuit in the V-2200-1, V-2204-1 and V-2206-1 chassis. The new circuit is shown in Fig. 1. Parts that have been changed include C_{315} , L_{303} , L_{304} , R_{314} , R_{317} , R_{320} , and R_{322} , while three parts have been added: C_{323} , L_{309} and R_{316} . In the new circuit a 4.5-mc trap has also been included.

Improved AGC Distribution System

Late Westinghouse chassis contain an *agc* distribution system which provides increased protection against overload in strong signal areas and maintains maximum gain in weak signal areas. The circuit employed is shown in Fig. 2. The previously unused diode in the 6T8 ratio detector and first audio amplifier tube (pin 6) is used as part of the new system. Parts added include C_{136} , R_{110} , C_{228} , R_{227} ,

R_{210} , C_{322} , and R_{332} . Some chassis do not have the 560-ohm resistor at the plate of the diode (R_{220}). Without the resistor, harmonics of the 4.5-mc sound signal may in some cases be coupled into the *agc* line, causing *rf tweet* on the picture. The resistor has therefore been included in later production.

H V Increase

In some Westinghouse chassis, high voltage has been increased by connecting the *hv* filter capacitor (C_{131}) to terminal 7 of the horizontal output transformer rather than to chassis ground. This has been found to improve the picture brightness and clarity. It also has the effect of decreasing the picture size.

Audio Output

The schematic diagram of Westing-

house models shows a 150-ohm resistor (R_{216}) in series with the control grid of the 6W6GT audio output tube. It was installed to prevent an audio-frequency oscillation which may be heard as a hiss or high-pitched whistle. Instead of the resistor, some chassis have a .005-mfd capacitor connected between the 6W6GT screen grid and ground to prevent the oscillation. Some early chassis do not contain either the resistor or the capacitor. If oscillation occurs in chassis that do not contain either component, the 150-ohm resistor should be inserted.

Retrace Line Suppression

A retrace suppression circuit evolved by Westinghouse appears in Fig. 3. In this new system, the .1-mfd capacitor, C_{313} , has been removed from its original position at pin 2 of the

Golden Opportunity

to prepare for better pay jobs in

Television Servicing

for men in
radio-electronics



YOU STUDY AT HOME

In your spare time, you learn pre-tested "How-to-do-it" techniques with "How-it-works" information in easy-to-study lessons. The course is based on the experience of the RCA Service Company in servicing thousands of home television receivers.

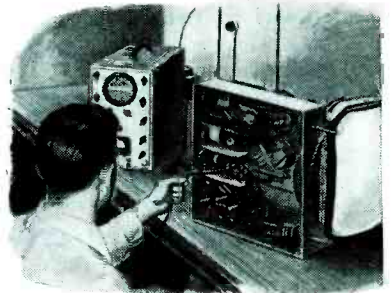

YOU KEEP WORKING ON YOUR JOB

Because you work in the radio-television-electronics industry, your job provides the laboratory work of the course. There are no kits, parts or equipment to buy. Self-employed independent radio and television servicemen are eligible for enrollment.

No vocational field offers more opportunities for "career" jobs and good pay than television—America's fastest growing industry. The demand for TRAINED and EXPERIENCED TV SERVICEMEN is growing. There is a big shortage of such men now and will be for several years to come.

PLENTY OF GOOD JOBS OPEN TODAY

Radio-Television jobbers, dealers and service companies offer lifelong opportunities with excellent salaries for qualified service technicians. Manufacturers of television receivers are looking for men with good service training as inspectors, testers and troubleshooters. Many experienced servicemen go into business for themselves. Others hold their regular jobs and earn extra money servicing TV receivers in their spare time.

Radio-electronics manufacturers busy with defense equipment contracts offer excellent job opportunities for men with a television technician background. Servicemen called into military service are further reducing the supply of skilled TV servicemen available for civilian activities. Think what television servicing offers *you* in terms of a lifetime career and financial security.

RCA INSTITUTES Home Study Course in TELEVISION SERVICING—

A Service to the Industry

Because of the critical shortage of TRAINED and EXPERIENCED TV SERVICEMEN, RCA Institutes is offering this highly specialized and practical home study course as a service to the working members of the radio-television-electronics industry. Its object is to train more *good* servicemen and to help make good servicemen *better*.

Never before has this course been available to anyone outside of RCA. It is now offered to *you*, through RCA Institutes, one of America's oldest and most respected technical training schools. The course covers most major makes and types of TV receivers. Available exclusively to men in the radio-television-electronics field. Not offered to the general public, or under G.I. Bill.

The cost is low . . . only \$9 a unit for 10 units or \$90 total, on an easy pay-as-you-learn plan. At successful completion of the course you earn an RCA Institutes certificate that can lead straight to a better job at higher pay.

RCA Institutes conducts a resident school in New York City offering day and evening courses in Radio and TV Servicing, Radio Code and Radio Operating, Radio Broadcasting, Advanced Technology. Write for free catalog on resident courses.

SEND FOR FREE BOOKLET. Find out complete details of the RCA INSTITUTES Home Study Course in TELEVISION SERVICING. Don't pass up this opportunity to prepare yourself for a money-making career in the television industry. Illustrated booklet explains all the features of the course. Mail coupon in an envelope or paste on a penny postcard—NOW!

MAIL COUPON NOW!

RCA INSTITUTES, INC.
Home Study Department, S-1251
350 West Fourth Street, New York 14, N.Y.

Without obligation on my part, please send me copy of booklet "RCA INSTITUTES Home Study Course in TELEVISION SERVICING." (No salesman will call.)

Name _____ (Please Print)

Address _____

City _____ Zone _____ State _____



RCA INSTITUTES, INC.
A SERVICE OF RADIO CORPORATION OF AMERICA
350 WEST FOURTH STREET, NEW YORK 14, N.Y.

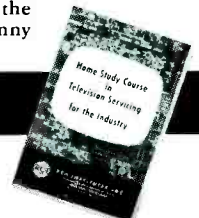

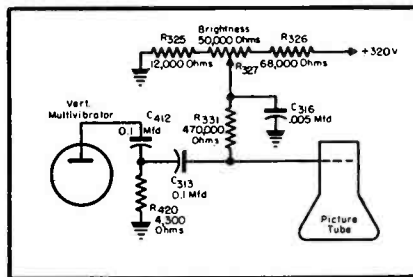
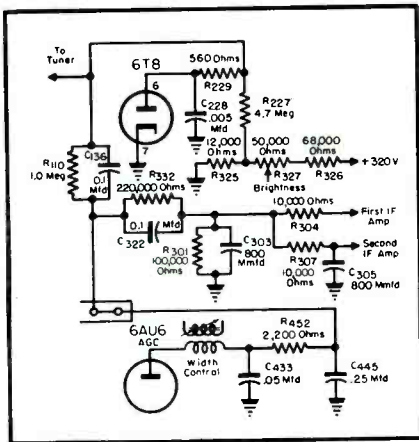

Fig. 2. New age distribution system used in Westinghouse models.

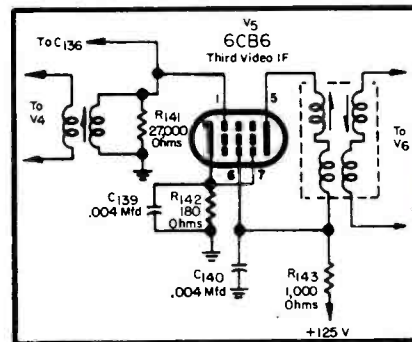

Fig. 4. Partial schematic of Sylvania 1-502-1 CO1, in which the third video if tube was changed from a 6BC5 to a 6CB6.

picture tube and a 470,000-ohm resistor (R_{331}) inserted between pin 2 and the junction of C_{316} and the arm of the brightness control.

The electrical positions of C_{412} and R_{420} were interchanged so that C_{412} connects to pin 2 of the vertical multi vibrator and R_{420} connects to ground. The new position of C_{313} is between pin 2 and the junction of C_{412} and R_{420} .

Auto-Radio Intermittent Servicing†

In intermittent tracing, fuse-blowing is often encountered, due to abnormal voltages. Many localities experience periods of high voltage, such as late at night when the load is least, and low voltage, such as the evening hours in residential neighborhoods or during the day in industrial locations. It will be noticed that often what appears to be an intermittent trouble is merely an inability on the part of the set to operate on other than normal voltage from the lines. One such complaint could be that the set shuts off for several minutes at irregular intervals during the evening. This may be a case of low supply voltage, or low oscillator emission, which is further lowered below the set's operating point by the added load of, let us say, an electric refrigerator.

It is known that blown fuses are the complaint in a high percentage of auto-radio repairs. A large number of these cases can be remedied by the location and removal of a direct short to ground caused by a bit of solder or wire in the high voltage or B+ section or the replacement of a shorted filter section. Usually, these troubles will cause fuses to blow consistently as soon as voltage is applied.

Occasionally, a set will come in with a blown fuse and operation on the bench will be perfectly normal. At

this point many Service Men replace the vibrator and return the set as repaired, with dire results.

During normal vibrator operation, the voltage to the set may vary from 5.2 to as high as 8 v, depending on the condition of the car battery, the setting of the voltage regulator and the resistance in the car wiring. This is a variation of 2.8 v and can cause the voltage at the secondary to range between 200 and 310 v on a normal power supply designed to furnish 250 v at 6.3 v input.

To locate power-supply troubles (as well as oscillator failure, regeneration

Fig. 5. Multiple-dwelling TV-antenna arrangement for single channel operation, using an antenna-mounted booster* providing a 1050-mv output. Amplified signal is fed down transmission line and coupled off through coupling blocks** that are said to provide the right amount of voltage transfer without affecting line balance. The line is then terminated in its characteristic resistance by a block that is said to minimize the standing waves on the line. The transferred signal is amplified by a booster** mounted on the back of each set, eliminating re-radiation from one set to another. At the output of the single-channel booster** on the fourth floor, the gain has been found to be 1575 mv; on the third floor, 1500 mv; on the second floor, 1425 mv and on the first floor, 1350 mv. In this instance the signal at the antenna (A) has been found to be 175 mv, while at (B), the booster output, the signal increases to 1050 mv.

*Vee-D-X Rocket Booster. **Vee-D-X.

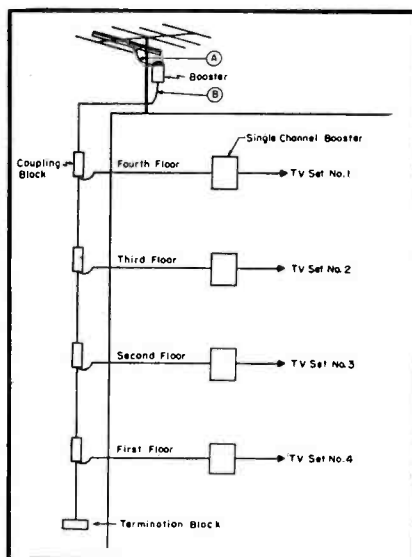

and high-voltage breakdown) it is advantageous to be able to simulate input voltage fluctuations between the foregoing limits. As this cannot be done with a common storage battery, it is advisable to equip the test bench with a manually variable low-voltage, dc-power supply.

In bench-testing a set which has blown a fuse, the input voltage should be set to the nominal value as given by the manufacturer, usually 6.3 v, and the input current noted. If the current is more than 1 amp greater than that set forth in the specifications, the chassis should be thoroughly checked. The rectifier tube should be replaced temporarily to see whether the current is reduced to normal. Then the secondary buffer capacitor should be checked and replaced if necessary, using a capacity-voltage rating and type as recommended by the manufacturer. Bypass capacitors should be checked for shorts or leakage, especially in screen-grid circuits. Next, the feed-through capacitors on the A circuit and the hash capacitor between B+ and ground should be checked if they are used. Electrolytics should also be tested. Tubes, especially output tubes, should be checked for shorts or abnormal consumption of current.

If the current is normal at 6.3 v, the voltage should be raised slowly, meanwhile watching the input current for signs of a rapid increase indicating a breakdown. The voltage should not exceed 8 v input during the tests.

When replacing vibrators and buffers, it should be remembered that the capacitance of the buffer capacitor, and the inductance of the secondary plus the reflected inductance of the primary form a resonant circuit which must be matched to, or track with, the cycling period of the particular type of vibrator used in the circuit. Thus, it can be seen that proper buffer values are extremely important, as the life of a vibrator can be shortened by as much as 50 per cent by incorrect buffering.

†From copyrighted Philco service notes.

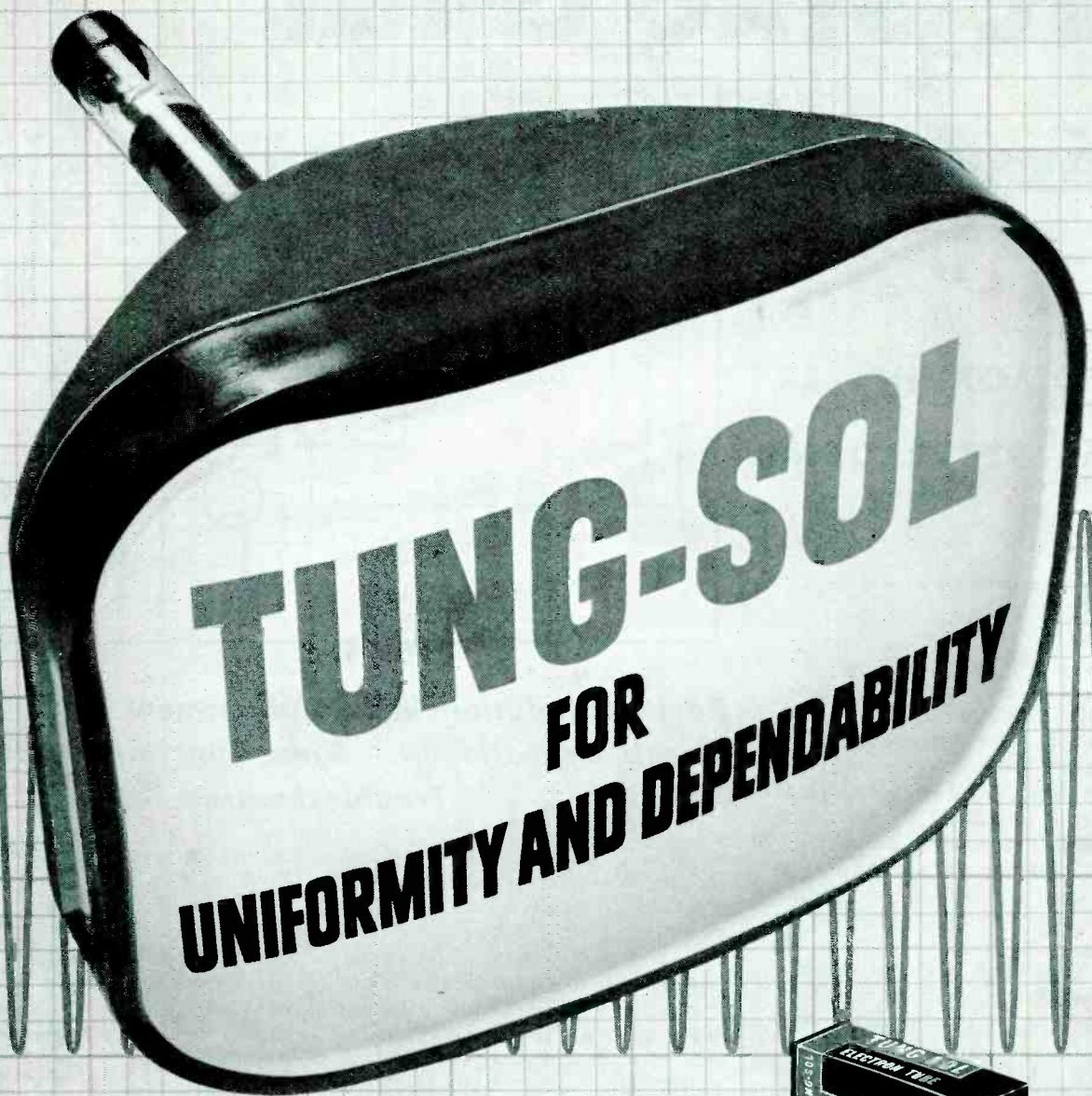

REPLACEMENT:

Tung-Sol Tubes keep service standards up to set manufacturers' specifications.

INITIAL EQUIPMENT:

Tung-Sol Tubes meet the highest performance requirements of set manufacturers.

TUNG-SOL ELECTRIC INC., Newark 4, N. J. Sales Offices: Atlanta
Chicago • Dallas • Denver • Detroit • Los Angeles • Newark

TUNG-SOL
RADIO, TV TUBES, DIAL LAMPS

AFC SYNC Circuit

Servicing

by

SOLOMON HELLER*

and PETER ORNE

Fig. 1. Schematic of 630 afc sync circuit.

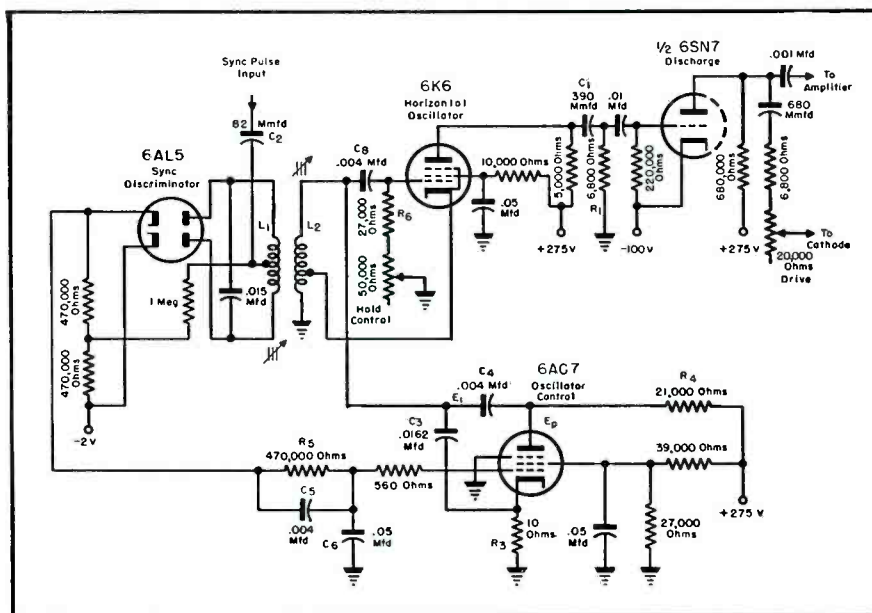

Part III: Relationship of Adjustment Settings and Circuit Operation . . . Time Constant Choice . . . Troubleshooting

WITH A CLOSE FAMILIARITY OF CIRCUITRY, it becomes possible to appreciate fully the complete value of various controls. For instance, in the *afc* sync circuit featured in the 630 chassis, the front panel horizontal hold control will be found to have little effect when the circuit is properly adjusted. Rotating it can affect the horizontal centering of the picture slightly, but should not throw it out of hold. With proper adjustment, the picture should pull in almost instantly when the set is switched on, regardless of the setting of the horizontal hold control.

Should the control position results indicate that the circuit requires adjustment, three steps can be taken:

(1). The contrast control should be turned to a low point, to make sure that the incoming sync pulses will not be excessively large. (2). The hori-

zontal hold control, on the front panel, should then be set to its middle position. (3). Finally, the lock control should be adjusted. (The lock control is a thumb-screw adjustment of the primary of the sync discriminator transformer; L_2 , Fig. 1. It is located in the center of the back panel. If the lock control is considerably out of adjustment, the oscillator frequency will be incorrect, and a single, steady picture will be unobtainable. If the lock control is slightly out of adjustment, the picture may not pull in at all or most settings of the horizontal hold control.) The lock control may be adjusted by turning the control

until the picture pulls in; point *A*, Fig. 2. Then the lock control should be rotated until the picture tears out; point *B*. In the next step, the lock control should be rotated in the *opposite direction*, until the picture pulls in again; point *C*. Finally, the lock control should be set half-way between points *A* and *C*.

Suppose that from *A* to *B*, five full turns or rotations are counted. When we move backwards from point *B*, to *C*, we count, let us say, two turns. That means we have three turns left between points *C* and *A*. One-half of three turns is $1\frac{1}{2}$ turns. To set the control half-way between *C* and *A*, then, we count $1\frac{1}{2}$ turns from point *C*, and leave the lock control set at this point.

If, after the adjustment of the lock control, the horizontal blanking bar

*Instructor at American Radio Institute; co-author of "Television Servicing."

Fig. 3. When the sync-discriminator secondary is incorrectly adjusted, the horizontal blanking bar appears as indicated in this illustration.

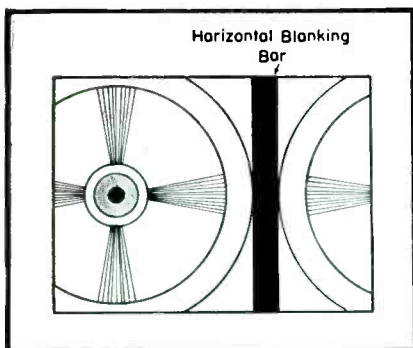

Fig. 2. Lock control setting; the correct position is $\frac{1}{2}$ way between points *A* and *C*.

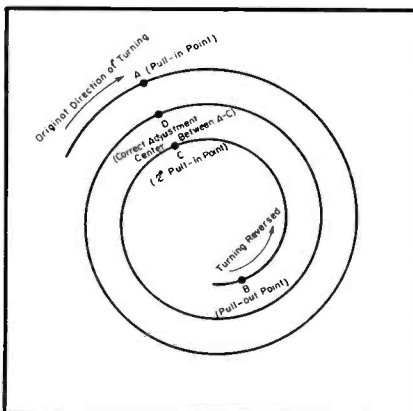
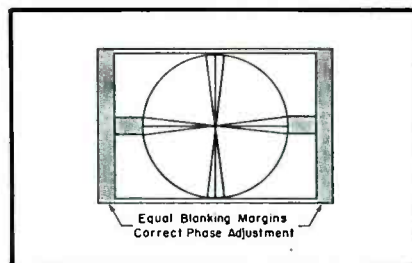
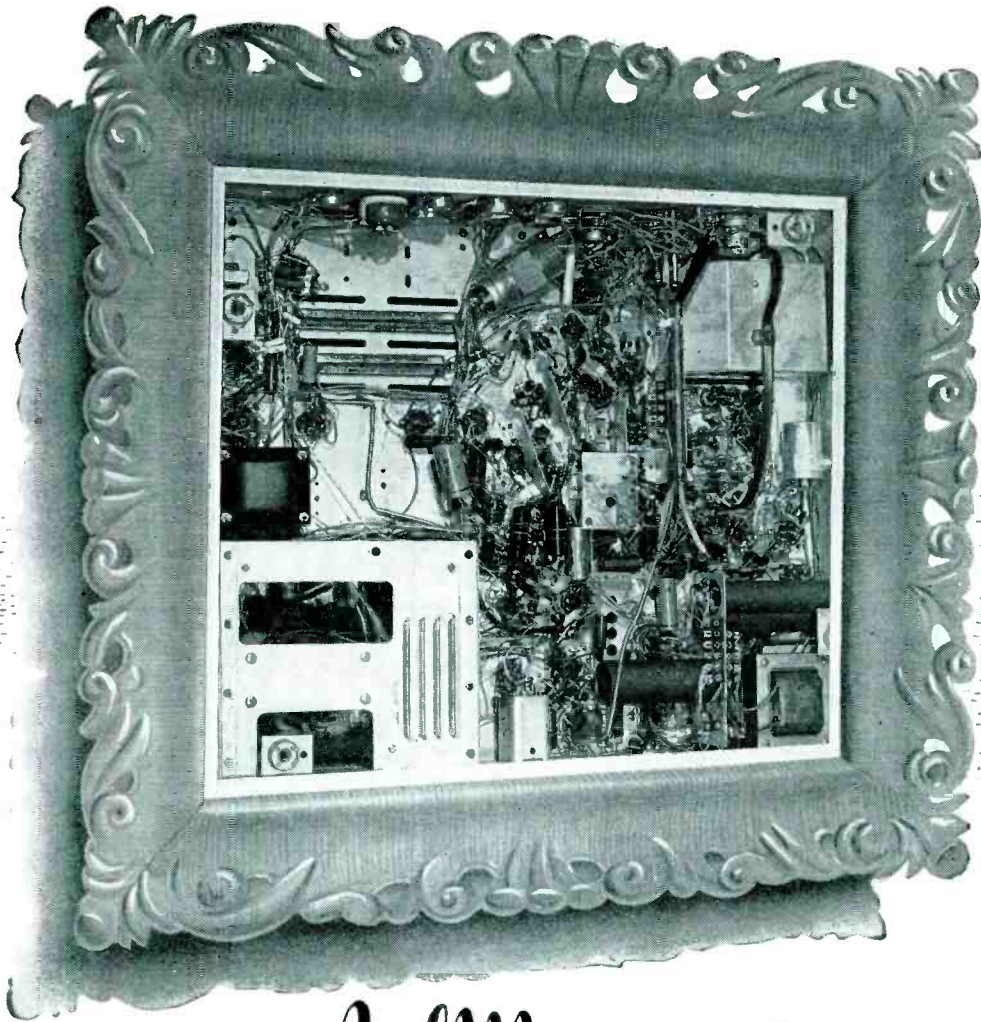

Fig. 4. Equal amounts of blanking information should be present at each side of the picture or test pattern, as shown in this drawing.





A Masterpiece

COMPLEX, EFFICIENT . . . KESTER SOLDER MAKES IT POSSIBLE

Good fast work can only be done with the best materials. Kester Plastic Rosin-Core Solder and the more active Kester "Resin-Five" Core Solder, made only from the finest grades of tin and lead commercially available, are formulated especially for TV, radio, and electrical work. Kester Solders flow better . . . handle easier . . . faster to use.

Free Technical Manual—Send for your copy of "SOLDER and Soldering Technique."



SAVES TIME

DEPENDABLE

EASIER TO USE

FASTER



**KESTER
SOLDER**

KESTER SOLDER COMPANY
4248 Wrightwood Ave., Chicago 39, Ill.
Newark, N. J. • Brantford, Canada

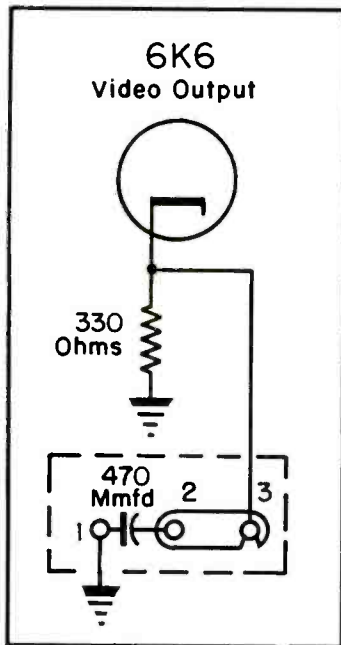
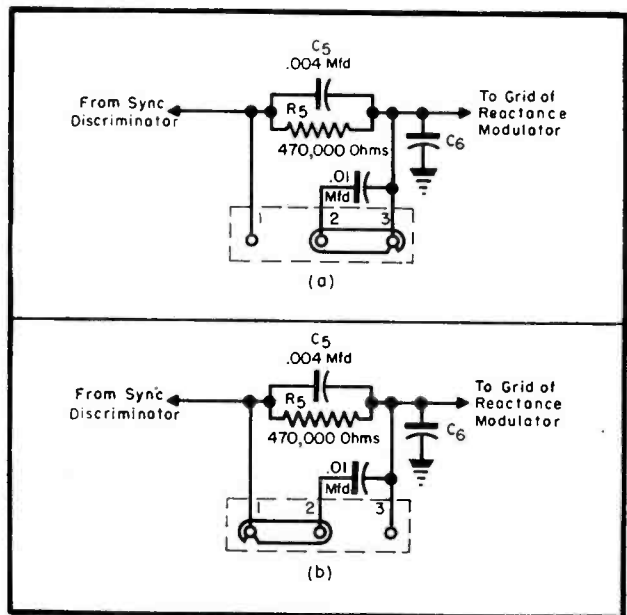

Fig. 5 (left). A link at the rear of 630 chassis, which can provide a choice of video peaking settings.

Fig. 6 (right). Link at the rear of the 630 chassis may also provide a choice of two *afc* settings. The units shown are in the input to the reactance modulator. In *A* the normal link position, 2-3, is shown. Where the sync is unstable, position 1-2 is used as illustrated in *B*. This arrangement will serve to prevent phase modulation from pulling out picture.



(Fig. 3) appears in the picture or test pattern, the secondary winding of the sync discriminator needs adjustment. To make this adjustment, the phasing control should be located. This control will be found under the chassis; it is the slug which tunes the secondary winding (L_s , Fig. 1).

When the phasing control is properly adjusted, the picture will show equal amounts of blanking information at its right and left hand side; Fig. 4. If no phasing adjustment can remove the blanking bar, trouble is present in the circuit.

When the adjustments have been made, they should be rechecked as follows:

The horizontal hold control should be turned to one extreme, and all picture information removed from the picture tube by reducing the contrast setting, shorting out the antenna input, or switching to a channel on which no picture or test pattern is being received. After this removal of picture information, the picture information should be brought back. The picture should remain stable when it has been brought back. This procedure should be repeated with the hold control setting at the opposite extreme. The picture should still remain stable when removed and brought back.

If it does, the pullin range will be correct. If the picture remains stable at one extreme of the hold control setting, but not at the other, the hold control should be rotated away from its extreme setting. If a rotation of $\frac{1}{4}$ or less of the total possible rotation brings the picture into synchronization, the pullin range is $\frac{3}{4}$ or more of the total range of the hold control, and is there-

fore correct. If more than $\frac{1}{4}$ rotation of the hold control is required, the pullin range is too narrow.

The phasing adjustment is probably incorrect in such a case, and should be reset slightly. The lock control should then be readjusted, and the pullin range checked once more.

It is advisable to recheck the pullin range in the manner described when any adjustments have been made in either the *afc* or the horizontal deflection system.

There is another adjustment that may, in some cases, have to be made. This is the link connection that is present in the rear of some 630 sets.

Sometimes the link is used to select one of two video peaking circuits; Fig. 5. In other cases, the link connection permits two settings of the *afc* system; Fig. 6. The Service Man may be uncertain what the link in the receiver he is working on is intended for; video peaking, or *afc* adjustment. A quick identification check may be made by first placing a finger on the link. If the picture shifts horizontally, the link is in the *afc* system. If it does not move horizontally, it is in the video amplifier circuit.

When the link is in the *afc* system, it is used to provide two different time constants in the grid circuit of the reactance modulator. One is relatively

Fig. 7. Sync pulses are uni-directional. In a sequence, as illustrated, noise pulses are bi-directional, i.e., positive and negative-going.

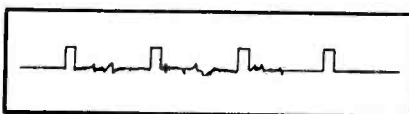

short, Fig. 6*A*, while the other is relatively long, Fig. 6*B*. To understand when each is used, it would be helpful to consider the function and action of C_5 , R_5 and C_6 . This network constitutes a noise filter which operates in the following manner.

C_5 and C_6 act as a voltage divider; it is assumed the link is in its normal position, illustrated in Fig. 6*A*. Since C_5 's reactance is large compared with the reactance of C_6 , high-frequency noise pulses will be attenuated across C_5 , and very little of the noise pulse will appear across C_6 . Now, the reactance modulator responds only in accordance with the charge present on C_6 . If a small-amplitude, short-duration noise pulse is applied to C_6 , this capacitor will not charge very much, and therefore the bias of the reactance modulator will not be appreciably altered.

A series of noise pulses would, if they all had the same polarity, cause C_6 to charge up appreciably. Since in a series of noise pulses, however, there are, by and large, as many negative-going as there are positive-going pulses, a cancellation of the charges they contribute occurs, and the net resultant charge on C_6 is too small to affect the reactance modulator bias.

The longer-duration sync pulses are, like the shorter-duration noise pulses, attenuated by C_5 . A series of sync pulses will, however, cause a charge to accumulate on C_6 , since the sync pulses are all going in the same direction (Fig. 7); the sync pulses will, therefore, affect the bias of the reactance modulator.

[To Be Concluded in January]

New 1952 HEATHKITS

Heathkit
TELEVISION
GEN. KIT \$39.50

Heathkit
ELECTRONIC
SWITCH KIT \$19.50

Heathkit
AUDIO GEN.
KIT \$34.50

Heathkit
CONDENSER
CHECKER KIT \$19.50

Heathkit
R. F. SIGNAL
GEN. KIT \$19.50

Heathkit
A.C. VOLTMETER
KIT \$29.50

Heathkit 5" OSCILLOSCOPE KIT

- New "spot shape" control for spot adjustment — to give really sharp focusing.
- A total of ten tubes including CR tube and five miniatures.
- Cascaded vertical amplifiers followed by phase splitter and balanced push-pull deflection amplifiers.
- Greatly reduced retrace time.
- Step attenuated — frequency compensated — cathode follower vertical input.
- Low impedance vertical gain control for minimum distortion.
- New mounting of phase splitter and deflection amplifier tubes near CR tube base.
- Greatly simplified wiring layout.
- Increased frequency response — useful to 5 MC.
- Tremendous sensitivity 03 RMS per inch Vertical .6V RMS per inch Hor.
- Dual control in-vernier sweep frequency circuit — smoother acting.
- Positive or negative peak internal synchronization.
- Multivibrator type Wide Range Sweep Generator.

A brand new 1952 Heathkit Oscilloscope Kit with a multitude of outstanding features and really excellent performance. A scope you'll truly like and certainly want to own.

The kit is complete with all parts including all tubes, power transformer, punched and formed chassis, etc. Detailed instruction manual makes assembly simple and clear — contains step-by-step instructions, pictorials, diagrams, schematic, circuit description and uses of scope. A truly outstanding value.

MODEL C-7
SHIPPING WT. 24 LBS.

\$43.50

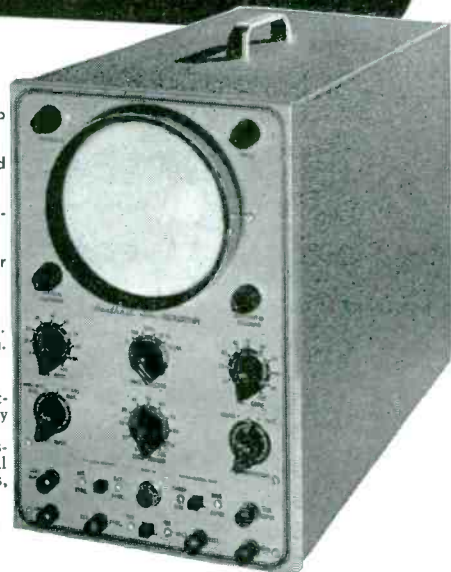

Heathkit VACUUM TUBE VOLTMETER KIT

- New styling — formed case for beauty.
- New truly compact size — Cabinet 4 1/8" deep x 4-1/16" wide x 7 3/8" high.
- Quality Simpson 200 microamp meter.
- New ohms battery holding clamp and spring clip — assurance of good electrical contact.
- Highest quality precision resistors in multiplier circuit.
- Calibrates on both AC and DC for maximum accuracy.
- Terrific coverage — Reads from 1/2V to 1000V AC, 1/2V to 1000V DC, and .1 to over 1 billion ohms resistance.
- Large, clearly marked meter scales indicate ohms, AC Volts, DC Volts, and DB — has zero set mark for FM alignment.
- New styling presents attractive and professional appearance.

The 1952 Model Heathkit Vacuum Tube Voltmeter! Newly designed cabinet combines style and beauty with compactness. Greatly reduced size to occupy a minimum of space on your work-bench. Covers a tremendous range of measurements and is easy to use. Uses only quality components including 1% precision resistors in multiplier circuit for greatest accuracy. Simpson 200 microamp meter with easy to read scales for fast and sure readings.

All parts come right with kit, and complete instruction manual makes assembly a cinch.

MODEL V-5
SHIPPING WT. 5 LBS.



\$24.50

Heathkit
SQUARE WAVE
GEN. KIT \$29.50

Heathkit
INTERMODULATION
ANALYZER KIT \$39.50

Heathkit
AUDIO FREQ.
METER KIT \$34.50

YOU SAVE BY ORDERING DIRECT FROM MANUFACTURER

SOLE AGENT
ROCKE INTERNATIONAL CORP.
311 40th ST.
NEW YORK CITY (16)
CABLE: ARPLAB-N.Y.

The **HEATH COMPANY**

... BENTON HARBOR 11, MICHIGAN

JANUARY-DECEMBER, 1951

ANTENNAS

- Antenna Rotator Accelerates Installation and Minimizes On-the-Job Costs..... Jan.
 Antenna Tools Required and Test Procedure (*Auto Radio*)..... May
 Approved Method for Grounding TV Antennas..... Apr.
 Auto Radio Antennas—(Cowl or fender): 3-section disappearing fender-mount, 3- and 4-section side-cowl, 2- and 3-section adjustable cowl-mount, 3-section adjustable cowl-mount, 3-section adjustable angle-disappearing fender mounts..... May
 Boosters for Master-Antenna Systems..... Feb.
 Boosters (High-Gain) and Properly-Aligned Receivers in DX Pickup..... Oct.
 Circuit Revisions for Fringe-Area Pickup..... Oct.
 Fringe-Area TV Installation; *Marty Bettan*..... Sept.
 Fringe Reception Requirements; *Bill Claps*..... Oct.
 Grounding Methods Used to Assure Maximum Protection from Lightning..... Apr.
 Isolation of TV Chassis in Single-Antenna Multiple-Receiver Installations..... Sept.
 Master-Antenna Systems..... Feb.
 Master-Antenna System Installations; *John B. Ledbetter*..... Aug.
 Methods Used in Installing Multiple-Receiver Links in Apartments..... Aug.
 Multi-booster (ITL-77A)..... Feb.
 Probing Site for Best Pickup, Using Field-Strength Meter, and Selecting Low-Loss Line Required for Signal Feed Over Long-Distance Antenna-to-Receiver Route..... Sept.
 Selecting and Installing Antennas (*Pickup or Heavy Trucks*)..... Feb.
 TV Antenna Grounds; *C. H. Jensen*..... Apr.
 TV Master-Antenna Distribution System; *John D. Harper and D. J. Tomcik*..... Sept.
 TV Booster; *Plug-In*..... Aug.

AUDIO INSTALLATION—SERVICE

- Accessory Data..... Jan.
 Application of Damping to Phono Arms..... Aug.
 Attaching Phono Pickups to TV Chassis..... July
 Audio Definitions..... July and Aug.
 Audio Installation and Service; *Kenneth Stewart*..... Jan.-Dec.
 Audio Mixing..... Jan.
 Audio-System Trouble Checks..... Mar.
 Baffle Box Dimension Chart for 12" Speaker..... Apr.
 Battery-Operated Intercom..... Apr.
 Binaural Amps for Tape Systems..... Nov.
 Changes Required When Substituting Variable Reluctance for Crystal Pickups..... May
 Construction and Operating Characteristics of Wire and Tape Recorders..... May
 Cycling Operation of Simplified 3-Speed Changers..... Mar.
 Determining the Source of AF Intermittents..... Mar.
 Dual-Console Design..... Mar.
 Editing and Splicing (*Magnetic Recording*)..... July
 Eliminating Groove Skipping, Erratic Trip Action and Record Slipping on 45s..... May
 Equalization Techniques..... DC Operation of Wire Recorders..... July
 Estimating for Jobs and General Hints (*Intercom*)..... Dec.
 Evaluation of Music and its Relationship to Human Behavior Response, and Application Possibilities in Plant, Office, Store, Shop, Etc..... Oct.
 Evolution of the Phono Pickup..... Nov.
 Features of Mixer-Preamps (*Magnetic Recording*)..... June
 Fluid-Sound Phono Pickups..... Sept.
 Four-Channel Mixer and Preamp..... June
 Groove-Dimension Control in Disc Recording..... June
 Hi-Fi Amps and Remote Controls with Preamps..... Nov.
 Hi-Fi Amplifiers..... Dec.
 Home Demonstrations, Involving Compliance Weight Comparison and Track-Force Tests, Check-up Charts (*Replacement Cartridges*)..... June
 Intercom Design..... Nov.
 Intercom Systems..... Apr.
 Intercom Systems; *Jack Darr*..... Dec.
 Intermittent Servicing; *Jack Darr*..... Apr.
 Key Frequencies on the Piano Keyboard..... May
 Loudness Controls for AM, FM and TV..... June
 Magnetic Recording (*Part I*); *L. S. Hicks*..... May
 Magnetic Recording (*Part II*); *L. S. Hicks*..... May
 Magnetic Recording (*Part III*); *L. S. Hicks*..... July
 Magnetic Recording Business Opportunities..... July
 Magnetic-Tape Recorder Circuitry (*Cover*); *Wyn Martin*..... Aug.

- Method to Adapt AF Amplifier for PA, Phono or General Amplification..... May
 Mike and Speaker Relationship, General Positions of the Mike and Mike Addressing..... Feb.
 Microphone Extension Installations..... June
 Microphones Which Can Be Used in Magnetic Recording..... June
 Microphone Techniques for PA Men; *Wyn Martin*..... Feb.
 Musical Instrument Amplifiers (*Cover*); *Jack Darr*..... June
 Music as a Production Tool; *Lawrence J. Epstein*..... Nov.
 Music..... The Modern Production Tool; *Lawrence J. Epstein*..... Oct.
 Negative Feedback Amplifier Circuitry..... July
 Non-Directional Mike Design..... Aug.
 Phono-Pickup Cartridges..... Nov.
 Phono Preamp and Noise Eliminator..... Nov.
 Playing Back Magnetic Recordings..... July
 Portable Tape Recorder Features..... Aug.
 Preamp Design..... Aug.
 Preamp Equalizers..... Jan.
 Probing the Second-Detector First-AF Stage..... Mar.
 Procedures Providing Best Results in Indoor and Outdoor Activities..... Feb.
 Push-Pull Circuitry Eliminating Need for Output Transformers..... July
 Recording Techniques Which Provide the Best Results..... May
 Recording Without a Microphone or From the Receiver and Phono Record..... June
 Reducing Radio Talk in G.E. Phono Systems..... Mar.
 Remedies for Common Problems in Three-Speed Changers..... May
 Removing Microphonics in Sylvania TV-Phono Models..... Mar.
 Repairing Audio-IF Transformers..... Mar.
 Rerecording Possibilities..... July
 Rim-Drive Three-Speed Changers..... Sept.
 Second-Detector-Stage First-Audio Problems..... Apr.
 Selecting Speakers for Average-Type Broadcast and TV Chassis..... Oct.
 Selling and Installing Replacement Cartridges; *John D. Harper*..... June
 Servicing Instrument Amplifying Equipment..... June
 Servicing Intercom Equipment..... Dec.
 Simplified AF Amplification Auxiliary Application System; *H. G. Cisin*..... May
 Speaker Characteristics (*Intercom*)..... Dec.
 Speaker Enclosure Design Characteristics..... Apr.
 Speakers..... Jan.
 Speakers, Cabinets, 3-Speed Standard and Transcription Players, Needles..... June
 String-Instrument Amplifiers, Speakers, Mikes and Pickups..... June
 Substitution Hints for PA, IF Amplifier, Oscillator and Mixer Circuits of Broadcast Household and Auto Models..... Apr.
 Tape Recorders, AM/FM Tuners with Preamp, Dual Speaker Systems, Corner Speakers, Remote Amplifiers, and 33 and 78 Cartridges..... Oct.
 Tape Recorder Power Supply..... Aug.
 Tape Recording and Playback..... Feb.
 Tape Transport Mechanisms..... Nov.
 Three Speed Transcription-Type Equipment..... Jan.
 Three-Way Speaker System..... Dec.
 Tone Control Preamp..... Dec.
 Triode Push-Pull Amplifier Systems..... July
 Tube Substitution Techniques; *Wyn Martin*..... Apr.
 Turnover Pickups..... Jan.
 Two- and Three-Speed Changer Design..... Nov.
 Types of Systems in Use: Battery, AC-DC and AC (*Intercoms*)..... Dec.
 Typical Auditorium Floor Plan Setup..... Feb.
 Utilized Amplifiers..... Feb.
 Closed Box Enclosure Diameters for Stand and Loudspeakers..... Apr.
 Williamson Hi-Fi Amplifier..... Sept.
 Wire-Defect Problems..... Mar.

AUTO RADIOS

- Antenna Tools Required and Test Procedures..... May
 Auto Bench Power Supply; *J. T. Cataldo*..... Jan.
 Auto-Radio Antenna Installation; *Jack Darr*..... Apr.
 Auto-Radio Antenna-Installation Testing..... May
 Auto-Radio Antenna-Installation Tools..... May
 Auto-Radio Auxiliary Power Supply..... Aug.
 Auto-Radio Installation in Pickup or Heavy Trucks; *Jack Darr*..... Feb.
 Auto-Radio Intermittent Servicing..... Dec.
 Auto-Radio Power Supply Filtering..... Jan.
 Auto-Radio Servicing (*Editorial*)..... Jan.

- Cowl-Antenna Installation..... May
 Dashboard Mount Arrangement..... Feb.
 Eliminating Noise..... Feb.
 Front-Fender Antenna Installation..... May
 Long-Haul Trailer-Truck Installation Precautions..... Feb.
 Mounting Chassis Arrangements..... Feb.
 Power Supply Filter Capacitor-Values Curve..... Jan.
 Rear and Front Speaker Setups..... Feb.
 Receiver Mounting With a Brace..... Feb.
 Selecting and Installing Antennas..... Feb.
 Speaker Mounted in Kick Pad..... Feb.
 Testing 2, 4 and 6-Volt Bridge Chassis Featuring Single-Phase T-type Metallic Rectifier System and 11,000-Mfd Electrolytic for Filtering..... Jan.
 Truck Antenna Systems..... Feb.
 Supplementary Power Supply for Auto-Radio Servicing..... Aug.

CIRCUITS

- Admiral 3C1 Radio Chassis..... Jan.
 Admiral 20T1 and 20V1, 20B1, etc., Modified AGC Circuit..... Feb.
 Admiral 20T1 and 20V1 TV Chassis..... Jan.
 Admiral 21B1 Chassis Gated AGC, Video Detector and Video Amplifier..... Sept.
 Admiral TV Chassis Modification for Phono Pickup..... July
 Admiral 4W18, 4W19, 4T11 (*Cover*)..... July
 AFC Setting Circuits..... Dec.
 AFC Sync Circuitry (RCA 630)..... Nov.
 AFC Sync Circuit in 630 Chassis..... Dec.
 AGC Circuit in Westinghouse Chassis..... Mar.
 AGC, Gated (Admiral 21B1)..... Sept.
 AGC, Modified (Admiral 20T1 and 20V1, 20B1, etc.)..... Feb.
 AGC With RF and FM Traps (Westinghouse V-2192-1)..... Sept.
 AGC, Without FM and RF Traps (Westinghouse V-10279-1 and V-10279-2 Tuners)..... Sept.
 AGC, Keyed (G.E. 19C105)..... Feb.
 All-Master Intercom Wiring Systems..... Dec.
 Automatic Sync Circuit for Color-Wheel TV..... Sept.
 Autotransformer Test Circuit..... Sept.
 Auxiliary B-Power Supply..... Aug.
 Auxiliary B-Power Supply Designed to Facilitate Troubleshooting..... July
 Belmont 7-Inch Electrostatic-Tube Vertical and Horizontal Sawtooth Generators..... Aug.
 Belmont Vertical and Horizontal Circuits Altered for Color TV..... Aug.
 Bendix C-172 and C-200 TV Chassis..... Apr.
 Bendix T-9 Magic Interlace System..... Dec.
 Blocking Oscillator with Switch for Color Pickup..... Aug.
 Capacitance Impedance-Meter System..... July
 Capacitance Testing Impedance Meter Setup..... Aug.
 Capacitor-Discharge Short-Blower Test Circuit..... Oct.
 Capehart C-295 Phono Preamp and Noise Eliminator..... Nov.
 Capehart, Magnavox and Sylvania Sync Circuits..... Oct.
 Circuits to Remove 4.5 Mc-IF Signal from Video Amplifier in Intercarrier Sound System..... Feb.
 Cisin AF Coupling System..... May
 Color Pickup Blocking Oscillator with Switch..... Aug.
 Color-TV Saturable Reactor System..... Sept.
 Color-Wheel TV Automatic Sync Circuit..... Sept.
 Color TV Circuit Modifications..... Aug.
 Color TV; Hallifracers T-54 Revision..... Aug.
 Color TV; RCA 9T246 Modification..... Aug.
 Color-TV Sync Current-Flow Circuits..... Sept.
 Color TV Vertical and Horizontal Circuitry of Belmont Chassis..... Apr.
 Colpitts Oscillator..... Feb.
 Combination Trimmer IF-Filter Capacitor Assembly..... Mar.
 Concertone 1401 Tape Recorder (*Cover*)..... Aug.
 Concertone 1401 Tape Recorder Power Supply..... Aug.
 Connecting Stationary Pickup Coil in Circuit of Receiver for Auxiliary Phono Operation..... May
 Coupling Circuit Illustrating Capacitor-Leakage Test Points..... July
 Crosley TV Inductance Sources of Trouble..... Mar.
 Crossover Networks for Three-Speaker System..... Dec.
 Current-Flow Circuits for Color-TV Wheel Synchronization..... Sept.
 Discriminator Alignment Setup with AM Signal Generator..... Jan.
 Distribution Unit Installation Layouts..... Sept.
 Double-Tuned Critically-Coupled Circuit..... Feb.

DuMont M-Derived Band Elimination Filter Nov.

DuMont Parallel-Tuned FM Trap Nov.

DuMont RA-112A, RA-113 and RA-117 Modification for Increased Gain July

DuMont 73C Inputuner Oct.

DuMont 30-Inch Chassis HV Supply July

DuMont 30-Inch Chassis Video, IF, Video Detector, Video Amplifier and Picture Tube Circuit July

DuMont Y2A Deflection Yoke Circuitry Nov.

Eicor Model 15 Wire Recorder and Playback Feb.

Eight and Twelve-Channel Turret Tuners (Philco; Cover) Oct.

Eliminating Microswitch in Auxiliary Phono Circuit (Cisin Method) May

Emerson 699B Turret-Tuner Chassis Sept.

Emerson TV Chassis Continuous-Type Front End Aug.

Emerson TV Chassis Turret-Type Tuner Aug.

EV-3100 TV-Antenna Distribution Unit (Cover) Sept.

Eye-Tube VTVM RF Test Circuit June

Farnsworth CT-20 (Cover) May

Farnsworth Modified Circuit Affording Increase of Vertical-Hold Range May

Flyback Circuit Using Grounded Ceramic Core Feb.

Four-Channel Mixer and Preamp June

G.E. 19C105 Keyed AGC Circuit Feb.

G.E. Screen Supply for Keyer Feb.

G.E. 77J1 Horizontal Flyback Circuit Jan.

G.E. Video Detector Circuitry Sept.

Germanium-Diode Sync Separator Sept.

Hallcrafters Model 800 Chassis TV Tuner May

Hallcrafters Model 800 with Production Changes May

Hallcrafters T-54 Revised for Color TV Operation Aug.

Hallcrafters T-54 Vertical and Horizontal-Sweep Circuits Aug.

Hartley Oscillator with Intermittent Check Points Apr.

Hartley Presence-Detector Oscillator Feb.

Hartley-Turner 14 and 20-Watt Hi-Fi Amplifier Dec.

Hi-Voltage Neon Tester Oct.

Horizontal-Deflection and High-Voltage Circuit Apr.

Horizontal Flyback with a Ceramic Core Flyback Transformer (Conversion, Cover) Jan.

Impedance Meter Setup for Capacitance Testing Aug.

Installation Layouts for Distribution Units Sept.

Installation of Selenium Rectifiers in Standard Chassis Apr.

Intercom Circuit (Talk-O Battery-Operated Model) Apr.

Intermittent Check Points in Output Stage Mar.

Intermittent Test Points in Push-Pull Stage with Single Phase Inverter and Driver Mar.

Intermittent Test Points in Two-Stage AF System Mar.

ITI-77A Multiplier Feb.

Large Picture-Tube Conversion Circuitry Oct.

Loudness-Control Circuitry System June

Loudness Control Circuits Oct.

LV Supply for Large Picture-Tube Chassis Sept.

Mallory Filtered Power Supply Jan.

Master-Antenna Apartment-House Layout Aug.

Master-Antenna System Feb.

Master-Antenna System Layout Nov.

Meck Horizontal-Phase Detector Sept.

Metallic Rectifier Capacitive Setups May

Metallic Rectifier Center-Tap and Bridge Circuits May

Metallic Rectifier Dual Bridge-Circuit and Typical Assembly Electrical Circuits May

Metallic Rectifier Fundamental Circuits May

Micro-Electronic FM Set (Cover) Feb.

Motorola Circuit With 220-Ohm Resistors to Remove Sound Beat Interference Feb.

Motorola Clipper, Vertical Screen and Vertical Output Modifications Feb.

Motorola TS-88 TV Chassis Jan.

Motorola TS-101/TS-119 Revamped Vertical Block Oscillator and Vertical Output Feb.

Multiple Input Musical-Instrument Amplifier June

Multivibrator-Signal Generator Hookup Dec.

Multivibrator Speed Tester Dec.

Musical Instrument Amplifier (Cover) June

Negative Feedback Amplifier Circuitry July

Packard-Bell Sync Amplifier Alterations for Fringe Areas Oct.

Packard-Bell 2118 TV 24-Inch Electrostatic-Tube Model Dec.

Parallel-Resistor Neon Tester Oct.

Pentode (6AK5 or 6AG5) Permeability-Tuned RF Amp. Oct.

Pentagrid Converter-Tube Oscillator Circuit Apr.

Philco (48-700, 48-1000, 48-2500 and 49 Series) Revised for Inputuners Oct.

Philco 8-Channel Turret Tuner (Cover) Oct.

Philco Revised RF TV Circuit to Prevent Overloading May

Philco Tapered-Line Matching Transformer Circuit May

Philco 33 and 38 Chassis, VIF, Video, Sound, RF and Sync Sections Nov.

Philco 33 and 38 Sync, Power, Vertical and Horizontal Sweep Nov.

Philco Twin-Triode Tuner System May

Phono Reproducer Arm-Pickup Cartridge Circuitry Aug.

Plug-In TV Booster Aug.

Printed Circuit AM Portable (Admiral 4W18, 4W19, 4T11; Cover) July

Printed Circuit Assemblies (Audio and TV) May

Printed-Circuit TV Booster (Cover) Mar.

RCA BX55 Oscillator-Coil Circuitry Oct.

RCA 9T246 Dual-Frequency Synchroguide Scanning Circuit Aug.

RCA 9T246 Modified for Color Aug.

RCA 1R81 AM/FM Chassis Oct.

RCA 16-Inch Chassis Modified Sync, DC Restorer and Vertical Oscillator Jan.

RCA 19-Inch Chassis Sync Separator, DC Restorer, Sync Amplifier and Vertical Restorer Jan.

RCA 17-Inch Chassis Electrostatic HV Circuit June

RCA 7T103 Modified for Improved Fringe-Area Pickup Oct.

RCA 17T153 and 21T176 Input for RF Section with Filter Nov.

RCA 16-inch Sync Separator, DC Restorer, Sync Amplifier and Vertical Restorer Jan.

RCA 630 AFC Sync Circuit Nov.

RCA 630TS Dual-Frequency Synchrolock Horizontal-Scan Circuit Aug.

RCA T-108 Direct-Drive Horizontal Output Mar.

Ram Horizontal Flyback Circuit (Cover) Jan.

Ratio-Detector Alignment Arrangement Jan.

Raytheon 20AY21 Chassis May

Raytheon TV Chassis Continuous Tuner Aug.

Raytheon TV Tuner with 12AT7 in Place of 6T6 Feb.

Recording Dual Tone-Control Circuit for Use When Rerecording from Master to Bank of Recorders July

Record-Player Circuit With and Without Loudness Control June

Remote-Control Conversion Circuit (Cover) Apr.

Remote-Control System Using a Pentode Apr.

RF Amplifier Plate-Load Circuitry Feb.

Selenium and Germanium Rectifier Circuits Oct.

Selenium-Cell Modification of 6X5 Circuit Nov.

Selenium-Rectifier Circuitry Nov.

Selenium Rectifier Installation in Standard Chassis Apr.

Sentinel Chassis with Increased Focus Current Apr.

Sentinel Modified Horizontal Hold Circuit Mar.

Sentinel Revised Focusing Circuits Mar.

Sentinel Series YA, YB, YC and YD Focusing Circuit Mar.

Sentinel Series YA, YB, YC, YD, YE and YF Horizontal-Hold Circuit Mar.

Sentinel TV Tuner Apr.

Series-Filament Heating-Supply Network Sept.

Simplified Circuit for Electrostatic Focusing June

Simplified Input Circuit (TV Booster) Mar.

6X5 Damping-Tube Circuit Nov.

Spellman HV RF 5 and 10-15 Kv Circuits May

Spellman 90-Kv RF Circuit for TV Projection Nov.

Stagger-Tuned Triple-IF Amplifier Feb.

Stancor Horizontal-Deflection Output and HV Transformer Circuit Sept.

Standard B-51 TV booster (Cover) Mar.

Stewart-Warner Air Pal Altered for Replacement of 25D8GT Sept.

Stewart-Warner IF Amplifier Changes to Improve Sensitivity and Sync Stability Oct.

Stewart-Warner TV Chassis Revised for Adjacent-Channel Sound Trap Sept.

Stromberg-Carlson 24C-24RP Sync Clipper, Video and Audio Amp. June

Stromberg-Carlson 24C-24RP Tuner June

Stromberg-Carlson 24C-24RP Vertical Blocking Oscillator, Vertical Output Amp. and HV Supply June

Stromberg-Carlson 24C-24RP Video IF Strip June

Stromberg-Carlson TV Chassis Gain-Reduction Modification Aug.

Surround-Lighting TV Chassis (Sylvania 25M; Cover) Nov.

Sylvania Corrected-Bias Circuit Apr.

Sylvania First Audio and AGC TV Circuit Sept.

Sylvania Horizontal Oscillator Revision May

Sylvania Improved Horizontal-Sync Circuit Apr.

Sylvania I-139, I-108, I-186 Improved Horizontal-Hold Circuits Mar.

Sylvania I-139, I-108, I-186 Improved HV Supply Mar.

Sylvania (I-290 Chassis) Modified Horizontal-Scan and HV Circuit May

Sylvania I-366 (Code C10) and I-441 (Code C04) Circuit Revised to Provide for Suppression of Vertical Retrace Lines Nov.

Sylvania I-387 Revision for Vertical-Trace Suppression Aug.

Sylvania I-502-1 CO1 6CB6 Third Video IF Instead of 6BC5 Dec.

Sylvania Revised Circuit to Stop Vertical Roll May

Sylvania TV-Console Audio Revision to Eliminate Microphonics Mar.

Sylvania 22-M Continuous Tuning Chassis Sept.

Sylvania 25M (Cover) Nov.

Sylvania Vertical Oscillator Revision to Eliminate Vertical Foldover Apr.

Talk-Listen and Station Selector Switches for Intercom Systems Dec.

Talk-O Battery-Operated Intercom Circuit Apr.

Three-Phase Bridge and Three-Phase Half-Wave Metallic-Rectifier Systems June

Thyratron Circuit With 2D21 Feb.

Transformerless LV TV Supply Sept.

Triode Push-Pull Amplifier Systems July

Triode (6I6 or 12AT7) Permeability-Tuned RF Amp. Oct.

TV AC/DC Power Supply Sept.

TV Color Circuitry Modifications Aug.

TV Discriminator Circuitry Feb.

TV Interference Trap Circuits Feb.

TV Mixer System Feb.

TV Ratio-Detector Circuit Feb.

TV Remote Contrast-Control Systems May

TV Remote Volume-Control Circuitry May

TV Remote Converter Outputs (Admiral, Packard-Bell, Sears, Stewart-Warner, Philco, Scott, G.E., Hoffman, Zenith, RCA, Westinghouse) May

TV Remote Tuner Preamp May

TV Tuning Input Feb.

Vertical Output System with Feedback Oscillator Apr.

Vertical Output with Blocking Oscillator Apr.

Voltage-Doubler Dry-Disc Rectifier Installation Apr.

VTVM Designed for Leakage Testing Aug.

VTVM for Leakage Testing July

Westinghouse AGC Circuit (Simplified Diagram) Mar.

Westinghouse Improved AGC Distribution System Dec.

Westinghouse Retrace-Suppression Circuit Dec.

Westinghouse Sync Amplifier and Noise Clipper Mar.

Westinghouse 20-Inch Chassis; V-2178-1 and 3 Mar.

Westinghouse (V-10279-1 and V-10279-2 Tuners) AGC, Without Traps Sept.

Westinghouse V-2192-1 Chassis With RF and FM Traps in AGC Sept.

Westinghouse V-2200-1, V-2204-1 and V-2206-1 Modified Video-Amplifier Circuitry Dec.

Williamson Hi-Fi Amplifier Sept.

Zenith 20-J Series TV Chassis (Cover) Dec.

COVER DIAGRAMS

Clock-Radio with Printed Circuit (Farnsworth CT-20; Printed Circuits in TV and Radio Chassis) May

Eight and Twelve-Channel Turret Tuners (Philco; Wyn Martin) Oct.

Horizontal Flyback for Rectangular Picture Tube (Wide-Angle Deflection Conversion Techniques for Rectangulars); Walter H. Buchsbaum Jan.

Low-Voltage Electrostatic-Focus Chassis With Fringe-Lock (Zenith 20-J Series); Wyn Martin Dec.

Magnetic Tape Recorder (Concertone 1401, Magnetic-Tape Recorder Circuitry) Aug.

Musical Instrument Amplifiers; Jack Darr June

Printed-Circuit AM Portable (Admiral 4W18, 4W19, 4T11) July

Printed-Circuit TV Booster (Standard B-51) Mar.

Remote-Control Conversion Circuit (Arm-Chair TV Remote Tuner); Jay H. Prager Apr.

Shirt-Pocket FM Set (Micro-Electronics); M. W. Percy Feb.

20-Inch TV Chassis With Surround Lighting (Sylvania 25M); Wyn Martin Nov.

TV-Antenna Distribution Unit (E-V Master-Antenna Distribution Systems); John D. Harper and D. J. Tomcik Sept.

EDITORIALS

Accessory Installations Apr.

Advertising with Sterling Copy May

A Unique Blueprint for Licensing June

Auto Radio Servicing Jan.

Conservation and the Service Man Apr.

Converters, Adapters and Slaves For Color TV July

Custom Installation Popularity Oct.

Customer Relations Dec.

Distributors and the Service Man Mar.

Mobile TV Service Jan.

New Horizons for TV Aug.

New Town Servicing Dec.

On Trial Again Feb.

Operation Confusion (Misleading UHF Promotion) May

Profit and Loss in TV Installations Mar.

Profits in the Small Shop Jan.

Red and Black (Picture-Tube) Conversions Oct.

Reducing Callbacks Mar.

Rooftop Checkup Time July

Service Men and Distributors.....	Sept.
Seven Keys to Success.....	Feb.
Successful Meetings.....	Dec.
The \$887-Million Service Market.....	Nov.
The Fringe TV Boom.....	Sept.
These New TV Terms.....	Feb.
What Future Service Men Must Be.....	July
Windproof Installations.....	Dec.

FEATURES

Accelerated Testing Techniques; Philip H. Greeley.....	July
Accelerated Testing Techniques; Philip H. Greeley.....	Aug.
AFC Sync Circuit Servicing (Part III); Solomon Heller and Peter Orne.....	Dec.
Arm-Chair TV Remote Tuner (Cover); Jay H. Prager.....	Apr.
Annual Index to SERVICE.....	Dec.
Association News.....	Jan-Dec.
Audio Installation and Service (Preamp-Equalization Systems... Hi-Fi Record Player-Amplifier Combinations Mixers... Replaceable and Turnover Pickups... 3-Speed 7- to 17-Inch Record Players... Corner Speakers); Kenneth Stewart.....	Jan.
Audio Installation and Service (Wire and Tape Equipment); Kenneth Stewart.....	Feb.
Audio Installation and Service (3-Speed Changers... Reducing Talk in G.E. Phono Systems... Removing Microphonics in Sylvania TV-Phono Models Repairing Audio-IF Transformers); Kenneth Stewart.....	Mar.
Audio Installation and Service (Speaker Enclosure Design Characteristics, Intercom Systems); Kenneth Stewart.....	Apr.
Audio Installation and Service (Eliminating Groove Skipping... Erratic Trip-Action Cues... Stopping Record Slipping on 45s... 3-Speed Changer Troubleshooting... Variable-Reluctance Cartridge Pickup Coil Tests); Kenneth Stewart.....	May
Audio Installation and Service (Groove-Dimension Control... Loudness Controls); Kenneth Stewart.....	June
Audio Installation and Service (Push-Pull Circuitry Eliminating Need for Output Transformers... Attaching Phono Pickups to TV Chassis... Audio Definitions); Kenneth Stewart.....	July
Audio Installation and Service (Damping in Phono Arms... Audio Definitions... Preamp Design... Portable Tape Recorder Features); Kenneth Stewart.....	Aug.
Audio Installation and Service (Fluid-Sound Phono Pickups... Williamson Hi-Fi Amplifiers); Kenneth Stewart.....	Sept.
Audio Installation and Service (Speaker Characteristics); Kenneth Stewart.....	Oct.
Audio Installation and Service (Phono-Pickup Evolution... Binaural Amplifier for Tape Recorders... Language of Acoustics... Phono Preamps); Kenneth Stewart.....	Nov.
Audio Installation and Service (Hi-Fi Amplifiers... Multiple-Speaker Cabinet Systems); Kenneth Stewart.....	Dec.
Auto Bench Power Supply; J. T. Cataldo.....	Jan.
Auto Radio Antenna Installation; Jack Darr.....	May
Auto-Radio Installation in Pickup or Heavy Trucks; Jack Darr.....	Feb.
Autotransformer Tester; Jack Darr.....	Sept.
Business Aids (Solutions to Typical Shop-Administration Problems).....	Nov.
Business Aids (Estimate Charges).....	Dec.
Color Television (Part I); Philip Selvaaggi.....	July
Color Television (Part II)... Conversion Circuitry); Philip Selvaaggi.....	Aug.
Color TV Wheel Synchronization; Philip Selvaaggi.....	Sept.
Credit Management for the Small Shop; Jack Darr.....	Nov.
Damping Tube Replacement Circuitry; J. T. Cataldo.....	Nov.
Defense-Program TV Chassis Substitution and Conservation Practices; Walter H. Buchsbaum.....	June
Direct-Drive Horizontal Output System; Wyn Martin.....	Mar.
Eight and Twelve-Channel Turret Tuners (Cover); Wyn Martin.....	Oct.
Finding Your Way Around a TV Chassis (Part II); Cyrus Glickstein.....	Jan.
Fringe-Area TV Installation; Marty Betten.....	Sept.
Fringe Reception Requirements; Bill Claps.....	Oct.
Identifying Unmarked Power Transformers; Melvin C. Sprinkle.....	Nov.
Installing a TV Remote Tuner; Jay H. Prager.....	May
Intercom Systems; Jack Darr.....	Dec.
Intermittent Servicing; Jack Darr.....	Apr.
Low-Voltage Electrostatic-Focus Chassis With Fringe-Lock (Cover); Wyn Martin.....	Dec.
Magnetic Recording (Part I); L. S. Hicks.....	May
Magnetic Recording (Part II); L. S. Hicks.....	June
Magnetic Recording (Part III); L. S. Hicks.....	July

Magnetic-Tape Recorder Circuitry (Cover); Wyn Martin.....	Aug.
Master-Antenna System Installations; John B. Ledbetter.....	Aug.
Metallic Rectifier Design and Application; Julian Loebenstein.....	May
Metallic Rectifiers (Part II); Julian Loebenstein.....	June
Microphone Techniques for PA Men; Wyn Martin.....	Feb.
Musical Instrument Amplifiers (Cover); Jack Darr.....	June
Music... The Modern Production Tool; Lawrence J. Epstein.....	Oct.
Music as a Production Tool; Lawrence J. Epstein.....	Nov.
National Associations and the Service Man; Dave Krantz.....	Sept.
Picture-Tube Servicing; Victor I. Robinson.....	Mar.
Plug-in TV Booster; Jack Grand.....	Aug.
Presence Detector Circuitry; Alan Smolen.....	Feb.
Printed-Circuit AM Portable (Cover); Wyn Martin.....	July
Printed Circuits in TV and Radio Chassis (Cover); Wyn Martin.....	May
Printed-Circuit TV Booster (Cover).....	Mar.
Rectangular Wide-Angle Deflection Conversion Trouble Shooting; Walter H. Buchsbaum.....	Feb.
Reverse Voltage Ratings... Life Aging AC-DC Voltage Ratios (Metallic Rectifiers).....	June
RF and IF Amplifiers in the TV Chassis; Sam Goldfus.....	Feb.
RF Testing Procedures; Philip H. Greeley.....	Jan.
Saving Time and Labor in TV Servicing; Hugh P. McTeigue.....	Jan.
Selling and Installing Replacement Cartridges; John D. Harper.....	June
Ser-Cuits (Admiral and Motorola 14-Inch Rectangular TV Models).....	Jan.
Ser-Cuits (Keyed AGC System in G.E. TV Chassis, Boosters for Master Antenna Systems).....	Feb.
Ser-Cuits (Westinghouse 17- and 20-inch TV Chassis); Cyrus Glickstein.....	Mar.
Ser-Cuits (Bendix 17- and 20-Inch TV Chassis... TV Tuners Using 6CB6, 6AG5 or 6BC5); M. W. Percy.....	Apr.
Ser-Cuits (Raytheon Rectangular Tube Chassis... Philco Twin-Triode Tuners); M. W. Percy.....	May
Ser-Cuits (Stromberg-Carlson 24-Inch TV Chassis); M. W. Percy.....	June
Ser-Cuits (DuMont 30-inch and Stromberg-Carlson 24-Inch TV Chassis... UHF Tuner and Converter Features); M. W. Percy.....	July
Ser-Cuits (Emerson and Raytheon Continuous and Turret-Type TV Chassis Tuners); M. W. Percy.....	Aug.
Ser-Cuits (Emerson and Sylvania Two-Control 17- and 20-Inch TV Chassis); M. W. Percy.....	Sept.
Ser-Cuits (RCA AM/FM Chassis... DuMont TV Continuous Tuners); M. W. Percy.....	Oct.
Ser-Cuits (RCA TV Noise-Attenuation Circuitry... Philco Variable-Delay AGC Systems); M. W. Percy.....	Nov.
Ser-Cuits (Interlace and Fringe-Compensator Systems); M. W. Percy.....	Dec.
Service... The National Scene.....	Jan-Dec.
Servicing AFC Circuits (Part I); Solomon Heller and Peter Orne.....	Oct.
Servicing AFC Sync Circuits (Part II); Solomon Heller and Peter Orne.....	Nov.
Servicing FM Detectors (Part III); Allan Lytel.....	Jan.
Servicing Helps; M. A. Maxwell.....	Jan-Dec.
Servicing Intermittent AM and FM Receivers; Jack Darr.....	Mar.
Shirt-Pocket FM Set (Cover); M. W. Percy.....	Feb.
Simplified AF Amplification Auxiliary Application System; H. G. Gisin.....	May
Simplified Tester for the Service Shop; Philip H. Greeley.....	Oct.
Speedy Trouble Shooter; James S. Kendall.....	Dec.
Ten Years Ago in Associations.....	Jan-Dec.
The Licensing Threat; Charles Golenpaul.....	Nov.
Trend to Standardized Replacement Parts; Clint R. Bowman.....	Nov.
Tube News (17 and 20-Inch Rectangulars, Thyatron Tubes, Wide-Angle Vertical Deflection Double Triodes); L. M. Allen.....	Jan.
Tube News (17-Inch Metal Shell Rectangulars); L. M. Allen.....	Feb.
Tube News (17- and 20-Inch Electrostatics); L. M. Allen.....	Mar.
Tube News (Rectangular 14- and 17-Inch Wide-Angle Circuitry); L. M. Allen.....	Apr.
Tube News (Large-Screen Deflection Systems); L. M. Allen.....	May
Tube News (14-, 17- and 20-Inch Rectangulars With Electrostatic Focusing... 9-Pin Triode-Pentode Converter); L. M. Allen.....	June
Tube News (Application Features of Horizontal Deflection Output and HV Transformers for Electrostatic Picture Tubes,	

Rectangular-Tube Deflecting Yokes and Automatic-Focusing Picture Tubes); L. M. Allen.....	July
Tube News (Minimizing Pulse Voltages in TV Vertical-Deflection Amplifiers Phosphors in Picture-Tube Production... Automatic Focus Picture-Tube Design Features); L. M. Allen.....	Aug.
Tube News (21-Inch Rectangular, 30-Inch Round and 17, 20 and 21-Inch Electrostatic Picture Tubes); L. M. Allen.....	Sept.
Tube News (Wide-Angle Large Picture-Conversions); L. M. Allen.....	Oct.
Tube News (Dampner Diodes... Miniature Triode-Pentodes); L. M. Allen.....	Nov.
Tube News (Subminiatures); L. M. Allen.....	Dec.
Tube Substitution Techniques; Wyn Martin.....	Apr.
TV Alignment Jigs.....	Nov.
TV Antenna Grounds; C. H. Jensen.....	Apr.
TV Master-Antenna Distribution System; John D. Harper and D. J. Tomcik.....	Sept.
TV Receiver Simplification Techniques; David T. Armstrong.....	Sept.
20-Inch TV Chassis With Surround Lighting for Picture Tube (Cover); Wyn Martin.....	Nov.
UHF in TV; P. Selvaaggi.....	Nov.
Wide-Angle Deflection Conversion Techniques for Rectangulars (Cover); Walter H. Buchsbaum.....	Jan.

FM

Alignment of Frequency-Modulation Detectors.....	Jan.
FM Audio-System Trouble Checks.....	Mar.
Connecting Up a VTVM and Signal Generator in a Ratio-Detector System.....	Jan.
Determining the Source of Intermittents in FM Chassis.....	Mar.
IF/FM-TV Trap Circuitry Designed to Provide High Attenuation to Signals of All Frequencies Below 47 MC.....	Nov.
Probing the Second-Detector First-AF Stage.....	Mar.
Servicing FM Detectors (Part III); Allan Lytel.....	Jan.
Servicing Intermittent AM and FM Receivers; Jack Darr.....	Mar.
Shirt-Pocket FM Set (Cover); M. W. Percy.....	Feb.
Table Model AM/FM Receiver with Eight-Inch Speaker.....	Oct.
Three Ways to Use a VTVM in Alignment (FM Detectors).....	Mar.
Tracing Intermittents in the IF Stages.....	Mar.
Wire-Defect Intermittent Problems.....	Mar.

MANAGEMENT

Advertising with Sterling Copy.....	May
A Unique Blueprint for Licensing.....	June
Auto Radio Servicing.....	Jan.
Business Aids (Solutions to Typical Shop-Administration Problems).....	Nov.
Conservation and the Service Man.....	Apr.
Continued Practice of Few Who Overcharge and Misrepresent Viewed as Invitation to Troublesome Legislation.....	Nov.
Credit Management for the Small Shop; Jack Darr.....	Nov.
Custom Installation Popularity.....	Oct.
Customer Relations.....	Dec.
Distributors and the Service Man.....	Mar.
Mobile Service Practices.....	Jan.
New Horizons for TV (Increased TV Powers).....	Aug.
New Town Servicing.....	Dec.
On Trial Again (Service Men and Licensing).....	Feb.
Operation Confusion (Misleading UHF Promotion).....	May
Profit and Loss in TV Installations.....	Mar.
Profits in the Small Shop.....	Jan.
Red and Black (Picture Tube) Conversions.....	Oct.
Reducing Callbacks.....	Mar.
Roof-top Checkup Time.....	July
Service Men and Distributors.....	Sept.
Seven Keys to Success.....	Feb.
The \$887-Million Service Market.....	Nov.
The Fringe TV Boom.....	Sept.
The Licensing Threat; Charles Golenpaul.....	Nov.
What Future Service Men Must Be.....	July
Windproof Installations.....	Dec.

NATIONAL SCENE NEWS

A Reader's View.....	Dec.
Added Life for Picture Tubes.....	Feb.
An Interesting TV School.....	Jan.
Another Video Antenna Fee Plan.....	Feb.
Antenna Bills Approved for New York and Wisconsin.....	Apr.
Antenna Makers Organize.....	Apr.
A Wonderful Deed by TCA.....	Jan.
Boosters Being Built into TV Chassis.....	Apr.
Box-Office TV.....	Sept.
Built-In Antenna Interest Dwindles.....	Mar.
California Association Opens Season with Instrument Talks.....	Sept.
Canadians Adopt Car-Radio Service-Rate Schedule.....	Oct.
Ceiling Price Checkup Now Being Waged by OPS Agents.....	Dec.

Civil-Defense Equipment Scheduled to Be-
come Vital Project of Service Men... Mar.
Civil Defense Receivers Ready for Duty... Apr.
Coin-TV Chassis on Way... Dec.
Color Still in Experimental Stage... Mar.
Color TV Systems Still Being Probed... June
Color TV Warehoused... Jan.
Community Antenna System Business
Booms... June
Contrast Measurements Now Important Fac-
tor in Tube Production... Feb.
Country-Wide Problems Studied by Na-
tional Servicing Group... Mar.
Dead Batteries Can Not Be Rejuvenated... May
Distributors Cited as Misusing Service
Men Sales Promotion Allowances... Nov.
Electrostatics Slated to Become Picture
Tube Vogue... Feb.
EPEM Submits MRO Component Plan to
Washington... Feb.
Factory-Guaranteed TV-Service-Contract
Plan Acceptance Growing... Aug.
FCC Probing Common Carrier Aspects of
Community Antennas... Aug.
FCC Witness Mass Industry Demonstration
of UHF Gear... July
Fifteen Key Subjects to be Reviewed at
Parts Distributor Show... May
General Servicing Licensing Bill Favored
by Pennsylvania Service Men... Aug.
Government Issues Rules to Outlaw Mis-
representative Advertising... Sept.
Ideal Type of Service Shop Designed... May
Independent Service Men Pool Advertising... Apr.
Industry Execs Indicate Parts Warranty
Practice Should Be Modified... Dec.
Installation and Servicing Bills Still Being
Introduced... Jan.
Industry Groups Submit Replacement Parts
Supply Plan... May
Juke-Box Repair Parts May Be Scarce... Dec.
Labor Department Predicts Sunny Roads
Ahead for Service Men... Sept.
L.A., N.Y. TV Licensing Measures
Praised by Service Groups... Oct.
Legislation Sought in Pasadena, Calif... Nov.
Less Cobalt, Copper, Aluminum and Steel
in New Sets... Mar.
Licensing Now Under Consideration on Pa-
cific Coast... July
Licensing Proposal Rejected in Milwaukee... Oct.
Metal Shell Fears Fold... Feb.
Miami and Boston Say "No" to Licensing... Mar.
Milwaukee TV Servicing Legislation Now
Being Studied... Aug.
NEDA to Aid Scrap Drive... June
New TV Licensing Plan for New York... May
New York Becomes Sizzling Proving
Ground for Color TV... July
N. Y. Servicing Group Opens Club Room-
Clinic... Oct.
New York State Approves TV Home Study
Course... Mar.
Non-Profit TV Service Plan Initiated... Aug.
No Stripped TV Chassis Yet... Jan.
NPA Task Committee Offers Parts-Replace-
ment Plan... Feb.
Old Light Bulbs Called Picture-Tube
Trouble Makers... Feb.
Pacific Coast Radio-TV Activity Booms... Dec.
Parts Priority Usable Only on Shop and
Business Repair... May
Parts Substitutions Now a Standard Plant
Practice... Apr.
Parts Warranty Plan Offered to Eliminate
Inequities... Nov.
Pennsylvania Towns to Have Coax Sub-
scription TV... Dec.
Philadelphia Group Acts to Solve Intra-
Industry Problems... Sept.
Philo Develops Special Austerity-Type
Chassis... Mar.
Price Control Records... Jan.
Public Relations for Service Men Proposed... Dec.
Rectangulars Now Setmakers Choice... Jan.
Rectangular Picture-Tube Interest Spirals... Mar.
Repair Parts Win Priority Rating... Mar.
Replacement Parts Supply Outlook Found
Bright... June
Room Reflections Routed... Jan.
RTMA Service Plan Applauded and Cen-
sured... Oct.
Scope Sales Mount... May
Service Association Head Seeks Industry
Regulatory Board... Sept.
Service Club Idea Growing... Oct.
Service Contract Renewals Slowing Up... Jan.
Service Industry Receives Special Price
Ceiling Regulation... June
Service Men Applauded by Industry Asso-
ciation Head... Nov.
Service Men Blue-Booked... Nov.
Service Men to Receive National Pro-
motion... Feb.
Setmakers Parts Warranty Practices De-
clared Misleading... Oct.
Setmakers Service Practices Chided by
Dealer Association... July
Setmakers Told How to Relieve Local Parts
Shortages... May
Shop Owners Find TV Contracts Unnec-
essary... July
Slower LP Speed Equipment Announced... Dec.

(Continued on page 44)

Two Cartridges...

MEET COMPLETE SERVICING REQUIREMENTS

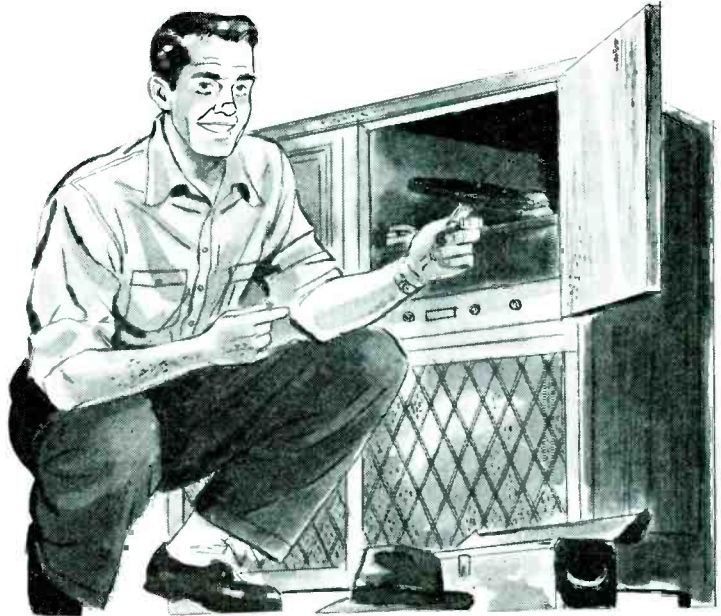

**Small investment • no inventory • fast turn-over
no replacement chart needed**

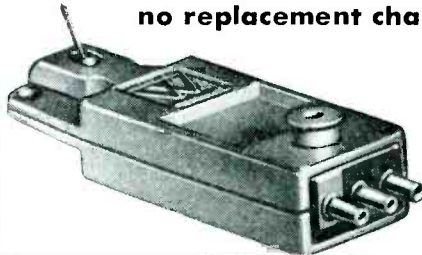

**The 78 RPM
twin output
Featheride Cartridge
MODEL WS**

**Replacement for more than
100 types for 78 RPM records**

The WS is a complete, compact, factory assembled and pre-tested cartridge that can be installed in any 1/2" standard tone arm. The one cartridge develops either 1 1/2 volts or 4 volts at 3/4 ounce tracking pressure. Osmium-tipped replaceable needle, rest button, terminal clips, extra needle screws and instructions for installing included. The Dri-Seal protected crystal and the exclusive Dri-Pack container assure a cartridge always ready to deliver peak performance.

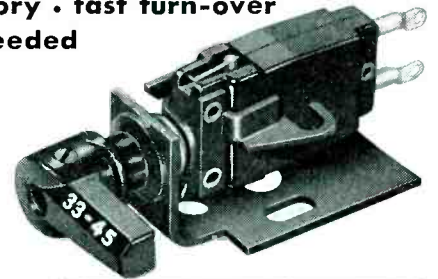

**The NEW
two-needle, three-speed
Featheride Cartridge
MODEL AX**

**Replacement for Two-needle
Three-speed cartridges**

This two-needle, three-speed replacement cartridge ends the need for replacement charts and big inventories. It is a complete unit, including twist mechanism, cartridge, needles and instructions for installing in any standard 1/2" mounting. Model AX twist mechanism is easily removed when cartridge is to be installed in tone arms in which such mechanism is an integral part. Double-protected against moisture by the Dri-Seal Crystal and Dri-Pack packaging.



WEBSTER ELECTRIC
R A C I N E ♦ W I S C O N S I N

"Where Quality is a Responsibility and Fair Dealing an Obligation"

Dependability is the word for

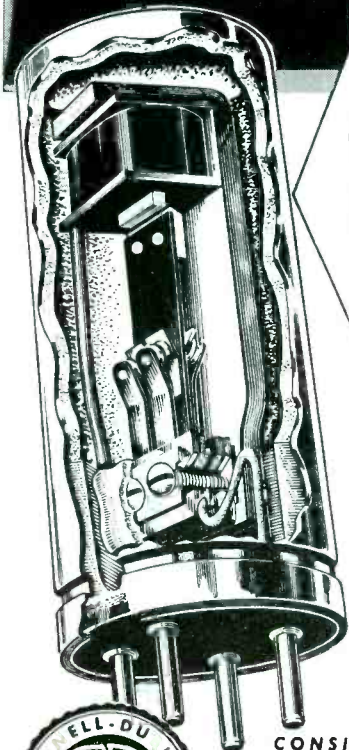

CORNELL-DUBILIER VIBRATORS

CORNELL-DUBILIER . . . the name that stands for quality — assures you of the finest in vibrators. A type for every replacement need . . . engineered for dependable peak performance under even the most adverse conditions. And they are QUIETER . . . affording the maximum in vibrator value . . . yet at no extra cost.



CONSISTENTLY DEPENDABLE
CORNELL-DUBILIER
SOUTH PLAINFIELD, NEW JERSEY



- CAPACITORS
- ANTENNAS
- ROTATORS
- VIBRATORS
- CONVERTERS

Annual Index

(Continued from page 43)

Streamlined Servicing Reports Produced	Apr.
Technical Education Advisory Panel Proposed	Nov.
Training Plan Submitted to Setmakers	June
TV Antenna Ordinance Rules Increase	Dec.
TV-FM Antenna Safety Measure Handbook	Aug.
TV Licensing Bill Passed by Council in New York City	Nov.
TV Master-Antenna Systems Winning Widespread Favor	Nov.
TV Service Education Program Launched by RTMA	Nov.
TV Still Growing and Growing Fast. Industry Head Reports	June
Two-Way Radio System Speeds Up Service in New Jersey	July

UHF-Color Chassis Provisions Reveal Interesting Developments	Oct.
UHF/VHF Proposals Brighten TV Lane.	Apr.
Western New York Group Forms Association	Oct.
Western Union Now in Service Business.	May
W.U. to Service All Sets	Aug.
Wired-TV Service	Sept.

SERVICING HELPS

Admiral Service Aids; AGC Improvement for Weak Signal Areas; Eliminating Vertical Foldover	Feb.		
Admiral Service Aids: Elimination of Intermittent Contacts on Color TV Socket	12H6 Substitutions	15.75-Kc Radiation Control	Aug.
Admiral TV Receiver Service Helps: Eliminating Horizontal Instability; Improving Reception in Weak Signal Areas; Minimizing Long Warmup Time; Removing Vertical Bars; Securing Additional Picture Contrast	May		

AGC Distribution System Modification	Dec.			
Air-King Chassis Hum and Buzz Removal	Aug.			
Ansley Receiver Helps: Avoiding Burnouts of AGC Coils; Broad-Bandpass Alignment Techniques; Eliminating Flyback Systems Arcing and Synchronlock Adjustments	Mar.			
Auto-Radio Intermittent Servicing	Dec.			
Avoiding Picture Bending	Sept.			
Circuit Revisions for Fringe-Area Pick-up	Oct.			
Correcting Arcing	Jan.			
Corona and Arcing	Jan.			
Crosley TV Chassis Servicing Notes; Avoiding Breakage of Inductuator Shafts; Eliminating Picture Streaking; Horizontal Drift Remedies; Intermittent Cures and Tracing Lack of Raster	Mar.			
Cures for Erratic HV in TV Chassis	Sept.			
Curing Vertical Roll and Picture Wash-Out in Fringe Areas	Nov.			
Electrostatic-Focus Circuitry Changes	June			
Electrostatic-Tube Focusing	Aug.			
Eliminating Picture Smear	Apr.			
Eliminating Picture-Tube Shadow	Nov.			
Farnsworth Chassis Service Note: Improved Interlacing	May			
Gated AGC Troubleshooting	Sept.			
Germanium Diode-Detector Servicing	Sept.			
Hallcrafters Service Hints: Eliminating Chirping Sounds, Tube Substitutions	Apr.			
HF Degeneration Cures	Sept.			
Horizontal Drive Adjustments	Oct.			
Horizontal-Line Improvement	Sept.			
Horizontal Scanning Coil Puller Application	July			
HV Increase Circuitry	Dec.			
Improved Picture Resolution	Dec.			
Improving Sensitivity and Sync Stability	Oct.			
Increasing Gain in DuMont Chassis	July			
Identifying Unmarked Power Transformers; Melvin C. Sprinkle	Nov.			
Increasing Sync Stabilization in RCA 16- and 19-Inch Chassis for Improved Fringe Reception	Jan.			
Loudness Controls for AM, FM and TV Chassis	June			
Minimizing Sound and Video Detector Radiation	Nov.			
Motorola TV Service Notes: Avoiding Compression at Top and Bottom of Picture; Eliminating Sound Beat Interference in Picture; Improving Fringe Reception by Adding More Vertical Sync; Removing Speaker Hum	Feb.			
Oscillator Coil Substitutions	Oct.			
Packard-Bell Alignment Notes	Aug.			
Picture-Cutoff Prevention	Sept.			
Replacement Guide for 16-Inch Rectangulars	Apr.			
Replacement of 12AT7 for 6J6 in Raytheon TV Tuner	Feb.			
Retrace Line Suppression	Dec.			
RF Tester with VTVM	June			
Selenium and Germanium Diode Circuitry	Oct.			
Selenium Rectifier Substitution in 3-Way Portables, AC/DC Chassis	Apr.			
Sentinel Horizontal-Hold Improvements	Aug.			
Sentinel TV Receiver Service Hints: Eliminating Semi-Circular Shadow Around Corner of Pattern; Increasing Range of Focus Control and Improving Horizontal Hold	Mar.			
Stewart-Warner Adjacent-Channel Sound-Trap Installation	Sept.			
Stewart-Warner Pal Chassis Modification: Substitution for 25D8GT	Sept.			
Stromberg-Carlson Notes: Avoiding Picture Tube Pulling or Kinking; Changing 6AC7 in Video Amplifier to 6AG7; Circuit Modifications for Horizontal Phase Detector; Minimizing Signal Overload; Picture-Tube Protection; Preventing Failure of Bifilar IF Coils	Jan.			
Stromberg-Carlson Service Notes: Correcting Picture Bending	Interlace Improvements	Removing Buzz or Whistle in HV Supply	Sync Modification to Eliminate Picture Pulling	Aug.
Sylvania TV Chassis Notes: Correcting Bias; Eliminating 4.5-Mc Harmonic Interference; Eliminating Vertical Foldover; Minimizing Intercarrier Buzz; Reducing Picture Distortion; Repairing Power Transformers to Eliminate Lamination Buzz	Apr.			
Sylvania TV Notes: High Voltage Regulation and Improved Horizontal Drive	Mar.			
Sylvania TV Set Service Aids: Adjustment of Focus, Ion Trap and Centering Magnets; Removing 16-Inch Tube Shock Hazards; 6AG5 Replacements	May			
Sync-Circuit Troubleshooting with Wide-Band Scopes	Nov.			
Test Pattern Factors	July			
3Z5 Tube Substitution	June			
Westinghouse TV Service Hints: Curing White Horizontal-Line Troubles; Eliminating BC Interference; Eliminating Deflection Troubles Caused by Component Variations; Removal of Tunable Beat Patterns	May			
Westinghouse V-2171/2172/2176/2177 Tube Substitution Charts	Aug.			
Yoke Ringing Correction	Sept.			

TELEVISION

Admiral 14-Inch Rectangular Chassis... Jan.
 Admiral Service Aids: AGC Improvement for Weak Signal Areas; Eliminating Vertical Foldover... Feb.
 Admiral Service Aids: Elimination of Intermittent Contacts on Color TV Socket 12H6 Substitutions... 15.75-Kc Radiation Control... Aug.
 Admiral TV Receiver Service Helps: Eliminating Horizontal Instability; Improving Reception in Weak Signal Areas; Minimizing Long Warmup Time; Removing Vertical Bars; Securing Additional Picture Contrast... May
 AFC Sync Circuit Servicing (Part III); Solomon Heller and Peter Orne... Dec.
 AFC Sync Troubleshooting... Dec.
 AGC Distribution System Modification... Dec.
 Air-King Chassis Hum and Buzz Removal... Aug.
 Ansley Receiver Helps: Avoiding Burnouts of AGC Coils; Broad-Bandpass Alignment Techniques; Eliminating Flyback-System Arcing and Syncrolock Adjustments... Mar.
 Antenna Rotator to Accelerate Installation and Minimize On-the-Job Costs... Jan.
 Arm-Chair TV Remote Tuner (Cover); Jay H. Prager... Apr.
 Attaching Phono Pickups to TV Chassis... July
 Automatic Frequency Control System Analysis... Oct.
 Automatic Focus Picture-Tube Design Features... Aug.
 Avoiding Picture Bending... Sept.
 Beam Current Used to Disclose Picture-Tube Condition... Mar.
 Bendix 17- and 20-Inch Rectangular Picture Tube Models... Apr.
 Boosters for Master-Antenna Systems... Feb.
 Cathode-Follower Stage in Output of TV Tuner... Apr.
 Characteristic 'Scope Waveshapes for Sync Circuits... Dec.
 Characteristics of 17- and 20-inch Rectangular Chassis... Jan.
 Characteristics of 21-Inch Metal Rectangular, 30-Inch Round, and 17, 20 and 21-Inch Electrostatic Picture Tubes... Sept.
 Color Television (Part I); Philip Selvaggi... July
 Color Television (Part II); Philip Selvaggi... Aug.
 Color-TV Drum Receiver Design Features... Sept.
 Color-TV Receiver Modifications and Circuits Utilized in Adapters, Converters, Slave Units and Complete Receivers... July
 Color TV Status: Compatible and Incompatible Systems; Receiving and Transmission Characteristics... July
 Color TV Wheel Synchronization; Philip Selvaggi... Sept.
 Color-Wheel Mechanical Requirements... Sept.
 Continuous and Turret-Type TV Chassis Tuners... Aug.
 Converting Electrostatic and Electromagnetic-Type Receivers to Color-Wheel System for Black and White, and Color Pickup... Aug.
 Corona and Arcing... Jan.
 Correcting Arcing... Jan.
 Crosley TV Chassis Servicing Notes: Avoiding Breakage of Inductance Shafts; Eliminating Picture Streaking; Horizontal Drift Remedies; Intermittent Cures and Tracing Lack of Raster... Mar.
 Cures for Erratic HV in TV Chassis... Sept.
 Curing Vertical Roll and Picture Wash-Out in Fringe Areas... Nov.
 Dampner Diodes for Transformerless Receivers and for Direct-Drive Deflection Circuits... Nov.
 Damping-Tube Replacement Circuitry; J. T. Cataldo... Nov.
 Defect Results Which Serve to Identify Troubles in Horizontal Sweep Circuits and Sync Systems... Jan.
 Defense-Program TV Chassis Substitution and Conservation Practices; Walter H. Buchsbaum... June
 Deflection Systems for Large Screen Picture Tubes... May
 Deflection Yoke and Circuit Changes to Provide Drive Signal and Operating Voltages (Conversion)... Jan.
 Deflection Yoke, Serving as Portion of Output of Horizontal Sweep, With Coils Connected in Series with Primary Winding... Mar.
 Dimensional Outline of RCA 17CP4 Rectangular Picture Tube... Jan.
 Direct-Drive Horizontal Output System; Wyn Martin... Mar.

(Continued on page 46)

only \$67⁵⁰
 for this

"Challenger"
 tube tester
 by JACKSON



As the name implies, we ask you to compare our "Challenger" instruments with any and all others at anywhere near the price.

In the Model 115 "Challenger" Tube Tester, the famous Jackson Dynamic® test principle is employed. Separate voltages are applied to each tube element. Tests can be made under actual use conditions.

A feature of this instrument is the high voltage power supply. It affords more accurate results because of high plate voltages—over 200 v. for some types of tubes.

Spare socket positions are provided for future use, thus avoiding obsolescence.

Push-button and selector switch controls simplify operation. The 4-inch-square meter is easy to read. The instrument gives complete short tests. It is applicable to over 700 types of tubes including TV amplifiers and rectifiers. The built-in roll chart is frequently revised to provide data on new tubes. This service is free for one year.

Finish is attractive Challenger Green with harmonizing knobs, meter cover, and push-buttons. Size, as of all "Challenger" instruments, is 13" x 9½" x 5½". Weight, 11 lbs.

Each of these "Challenger" instruments

\$59⁵⁰



Condenser
 Tester
 Model
 112



Test
 Oscillator
 Model
 106

Push-button controlled. Provides quick positive range selection for capacity and leakage tests. Shows up all types of faulty condensers, using a new method for detecting leakage. No need to count flashes on the electron ray tube indicator! Test voltages from 20 v. to 500 v. in six steps. Glass-enclosed dial with Jackson "Scale Expander" pointer which doubles effective scale length. Power factor measured on Direct Reading Scale calibrated from 0 to 60%. Ranges from .00001 to 1000 mfd in four steps.

Here's a "Challenger" instrument for testing AM and FM radios. It is also used as an auxiliary TV marker generator. Range of fundamental frequencies is 100 kc to 54 mc. Harmonics calibrated 54 mc to 216 mc. Two-circuit attenuator controls signal strength. 400 cycle audio modulation, or may be used for straight RF unmodulated signal. Accuracy is ½ of 1% in all ranges. Same finish and dimensions as other "Challenger" instruments. Compare this instrument with any low-priced signal generator or with any so-called kit.

JACKSON ELECTRICAL INSTRUMENT CO.

"Service Engineered"
 Test Equipment

DAYTON 2, OHIO

In Canada:
 The Canadian Marconi Co.

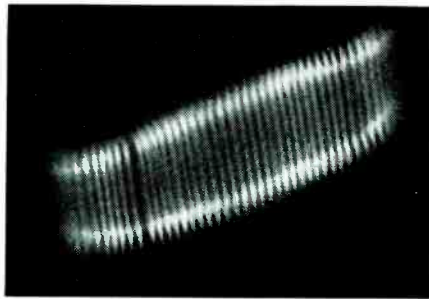
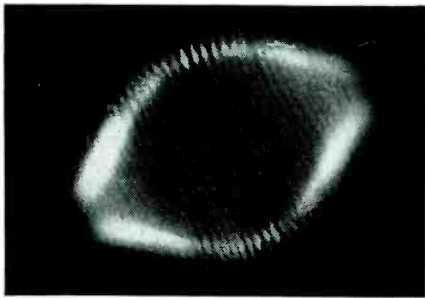

Why General Electric dial lamps stand the high notes

THE high "C's" of a soprano often cause vibrations in the filaments and lead-in wires of radio dial lamps. In old-style lamps, these vital parts sometimes vibrate in different frequencies, setting up a whipping action (photo above, left) that eventually tears the filament apart.

But in G-E dial lamps, General Electric engineers have changed the filament supports so that the frequencies of the filament and lead-in wires match, thus greatly reducing the effect of the vibration (photo above, right). As a result, General Electric dial lamps give longer, more dependable service.

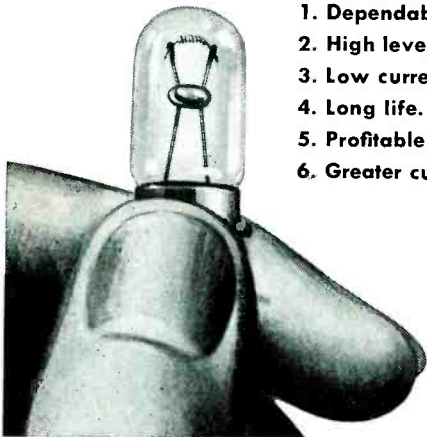

1. Dependable, trouble-free performance
2. High level of maintained light output
3. Low current consumption
4. Long life.
5. Profitable to handle
6. Greater customer acceptance.

**Always replace
with G-E dial lamps**

GENERAL  ELECTRIC

Annual Index

(Continued from page 45)

Dual Volume Controls Employing Selective Construction Nov.
 DuMont 30-Inch Chassis July
 Eight and Twelve-Channel Turret Tuners (Cover); Wyn Martin Oct.
 Electrostatic-Focus Circuitry Changes June
 Electrostatically-Focused Picture Tubes Feb.
 Electrostatic Focusing Circuitry June
 Electrostatic-Tube Focusing Aug.
 Eliminating Picture Smear Apr.
 Eliminating Picture-Tube Shadow Nov.
 Farnsworth Chassis Service Note: Improved Interlacing May
 Finding Your Way Around a TV Chassis (Part II); Cyrus Glickstein Jan.
 14-, 17-, and 20-inch Rectangulars With Electrostatic Focusing June
 Fringe-Area Pickup Circuit Revisions Oct.
 Fringe-Area TV Installation; Marty Bettan Sept.
 Fringe Reception Requirements; Bill Claps Oct.

Gated AGC Troubleshooting Sept.
 Germanium Diode-Detector Servicing Sept.
 Grounding Methods Which Should Be Used to Assure Maximum Protection From Lightning Apr.
 Hallicrafters Service Hints: Eliminating Chirping Sounds . . . Tube Substitutions. Apr.
 HF Degeneration Cures Sept.
 High-Gain Boosters and Properly Aligned Receivers in DX Pickup Oct.
 Hi-Voltage Tester for TV Oct.
 Horizontal Deflection Output and HV Transformers Designed for Electrostatic Picture Tubes July
 Horizontal Drive Adjustments Oct.
 Horizontal-Line Improvement Sept.
 Horizontal Scanning Coil Puller July
 How to Avoid Picture Tube Damage by Ion-Trap Magnet Alignment Apr.
 HV Increase Circuitry Dec.
 IF/FM-TV-Trap Circuitry Designed to Provide High Attenuation to Signals of All Frequencies Below 47 MC Nov.
 Improved Picture Resolution Dec.
 Improving Sensitivity and Sync Stability Oct.
 Increased Deflection Power and Higher Voltage for Wider Angle Tubes (Conversion) Jan.
 Increasing Sync Stabilization in RCA 16- and 19-Inch Chassis for Improved Fringe Reception Jan.
 Increasing Gain in DuMont Chassis July
 Input Matching Problems Feb.
 Installing Multiple-Receiver Links in Apartments Aug.
 Interference Traps Feb.
 Inter-carrier Sound Variables Feb.
 Installing a TV Remote Tuner; Jay H. Prager May
 Interlace and Fringe-Compensator Systems in Bendix, and Packard-Bell and Emerson Chassis With Electrostatic Tubes Dec.
 Isolation of TV Chassis in Single-Antenna Multiple Receiver Installations Sept.
 Keyed AGC System in the G.E. TV Chassis Feb.
 Leads with Smaller Strands June
 Loudness Controls for AM, FM and TV Chassis June
 Low-Voltage Electrostatic-Focus Chassis With Fringe-Lock (Cover); Wyn Martin Dec.
 Master-Antenna System Installations; John B. Ledbetter Aug.
 Metallic Rectifier Design and Application; Julius Loebenstein May
 Metallic Rectifier Fundamental Assemblies. May
 Metallic Rectifier Parallel Assemblies, Center-Tap and Bridge Circuits, Doubler Arrangements, Capacitive Setups May
 Metallic Rectifiers (Part II); Julian Loebenstein June
 Miniature Triode-Pentodes Nov.
 Minimizing Pulse Voltages in TV Vertical-Deflection Amplifiers Aug.
 Minimizing Sound and Video Detector Radiation Nov.
 Modified Converter Outputs, Specially-Built Preamp, Altered Volume and Contrast Control Circuitry, and Construction Modifications in Basic Chassis (TV Remote) May
 Motorola 14-Inch Rectangular Chassis Jan.
 Motorola TV Service Notes: Avoiding Compression at Top and Bottom of Picture; Eliminating Sound Beat Interference in Picture; Improving Fringe Reception by Adding More Vertical Sync; Removing Speaker Hum Feb.
 9-Pin Triode-Pentode Converter June
 One-Tube Additional IF Stage for Video or Sound System Aug.
 Oscillator Coil Substitutions Oct.
 Packard-Bell Alignment Notes Aug.
 Parts to Simplify Inventory Requirements for Service Shops Nov.
 Philco Tuner with Twin Triode May
 Phosphors in Picture-Tube Production Aug.
 Picture-Cutoff Prevention Sept.
 Picture Tube Common Defects Mar.
 Picture Tube Element Functions Mar.
 Picture-Tube Open-Heater Characteristics. Mar.
 Picture Tube Servicing; Victor I. Robinson Mar.
 Plug-In TV Booster; Jack Grand Aug.
 Polarity Designations (Metallic Rectifiers). June
 Portable Test Meter for Picture-Tube Servicing Mar.
 Printed Circuits in TV and Radio Chassis (Cover); Wyn Martin May
 Printed-Circuit TV Booster (Cover) Mar.
 Probing Site for Best Pickup, Using Field-Strength Meter, and Selecting Low-Loss Line Required for Signal Feed Over Long-Distance Antenna-to-Receiver Route Sept.
 Problems Involving Arcing or Corona in HV Compartment Feb.
 Properties of RF Amplifiers Feb.
 Raytheon Twenty-Five Tube 20-Inch Rectangular Tube Chassis May
 Rectangular-Tube Deflecting Yokes and Automatic-Focusing Picture Tubes July
 Rectangular Wide-Angle Deflection Conversion Trouble Shooting; Walter H. Buchsbaum Feb.
 Redesigned Flyback Systems June
 Relationship of Adjustment Settings and Circuit Operations for AFC Sync Circuits Dec.
 Replacement Guide for 16-Inch Rectangulars Apr.
 Replacement of 12AT7 for 6J6 in Raytheon TV Tuner Feb.
 Retrace Line Suppression Dec.
 RF and IF Amplifiers in the TV Chassis; Sam Goldfus Feb.
 Saving Time and Labor in TV Servicing; Hugh P. McTeigue Jan.
 Selecting Speakers for Average-Type Broadcast and TV Chassis Oct.
 Selenium Rectifiers as Substitute for 6X5 Damping Tube in Flyback Circuit of Transvision 12-Inch TV Chassis Nov.
 Selenium Rectifiers in Doublers June
 Sentinel Horizontal-Hold Improvements Aug.
 Sentinel TV Receiver Service Hints: Eliminating Semi-Circular Shadow Around Corner of Pattern; Increasing Range of Focus Control and Improving Horizontal Hold Mar.

Servicing AFC Circuits (Part I); Solomon Heller and Peter Orne.....Oct.
 Servicing AFC Sync Circuits (Part II); Solomon Heller and Peter Orne.....Nov.
 17 and 20-Inch Electrostatic Tube Design and Application.....Mar.
 17-Inch Metal-Shell Picture Tubes with Low-Voltage Electrostatic Focus.....Nov.
 17-Inch Metal Shell Rectangular Tubes.....Feb.
 Slave-Control Installation Techniques.....May
 Sound, IF, Discriminator or Ratio Detector Stages.....Feb.
 Small-to-Large Screen Conversions.....Apr.
 Stewart-Warner Adjacent-Channel Sound-Trap Installation.....Sept.
 Stewart-Warner Pal Chassis Modifications; Substitution for 25D8GT.....Sept.
 Stromberg-Carlson Notes: Avoiding Picture-Tube Pulling or Kinking; Changing 6AC7 in Video Amplifier to 6AG7; Circuit Modifications for Horizontal Phase Detector; Minimizing Signal Overload; Picture-Tube Protection; Preventing Failure of Biflar IF Coils.....Jan.
 Stromberg-Carlson Service Notes: Correcting Picture Bending.....Interlace Improvements.....Removing Buzz or Whistle in HV Supply.....Sync Modification to Eliminate Picture Pulling.....Aug.
 Stromberg-Carlson 24-Inch Chassis.....July
 Stromberg-Carlson 24-Inch TV Chassis Highlights.....June
 Subminiatures Designed to Replace Miniatures in Wide-Band IF and RF Amps, UHF Oscillators, Triode RF Mixer Circuits, etc.....Dec.
 Substitute Components in TV Chassis During Defense Effort, and How Replacements Will Affect Operation.....June
 Sylvania and Emerson Two-Control TV Chassis Featuring 17 and 20-Inch Rectangular Picture Tubes.....Sept.
 Sylvania TV Chassis Notes: Correcting Bias; Eliminating 4.5-Mc Harmonic Interference; Eliminating Vertical Fold-over; Minimizing Intercarrier Buzz; Reducing Picture Distortion; Repairing Power Transformers to Eliminate Lamination Buzz.....Apr.
 Sylvania TV Notes: High Voltage Regulation and Improved Horizontal Drive.....Mar.
 Sylvania TV Set Service Aids: Adjustments of Focus; Ion Trap and Centering Magnets; Removing 16-Inch Tube Shock Hazards; 6AG5 Replacements.....May
 Sync-Circuit Troubleshooting with Wide-Band Scopes.....Nov.
 Table of Clues for Identifying TV Stages.....Jan.
 Test Pattern Factors.....July
 35Z5 Tube Substitution.....June
 Thyatron Tube Design.....Jan.
 Time Constant Choice in AFC Sync Circuits.....Dec.
 Tracing With Chassis In and Out of Housing.....Jan.
 Transformer Type of Drive Eliminated in RCA Chassis.....Mar.
 Trends in Parts Economies.....June
 Trends Involving Germanium Crystal Detectors, Video Amps, Audio and AGC, Deflection Systems, and Power Supplies Using HV Selenium Rectifiers.....Sept.
 Trend to Standardized Replacement Parts; Clint R. Bowman.....Nov.
 Tuners Which Provide for Use of Either of Three Tube Types: 6CB6, 6AG5 or 6BC5.....Apr.
 TV Alignment Jigs.....Nov.
 TV Antenna Grounds; C. H. Jensen.....Apr.
 TV Master-Antenna Distribution System; John D. Harper and D. J. Tomcik.....Sept.
 TV Receiver Simplification Techniques; David T. Armstrong.....Sept.
 TV Variable-Inductor Continuous-Tuning RF Assembly.....Oct.
 20-Inch Electrostatic Picture-Tube Cross-Sectional.....Mar.
 20-Inch TV Chassis With Surround Lighting for Picture Tube (Cover); Wyn Martin.....Nov.
 UHF in TV; P. Selvaggi.....Nov.
 UHF Tuner and Converter Features.....July
 Use of Tube Withdrawal Procedures to Check Problems.....Jan.
 Variable-Delay AGC With Sound AGC Boost and Sync Systems.....Nov.
 Westinghouse 17 and 20-Inch Chassis: Noise Clipper; Phase-Detector Horizontal AFC; Horizontal Sweep Oscillator; Vertical Sweep; Keyed AGC; Video Amplifier and Sync System.....Mar.
 Westinghouse TV Service Hints; Curing White Horizontal-Line Troubles; Eliminating BC Interference; Eliminating Deflection Troubles Caused by Component Variations; Removal of Tunable Beat Patterns.....May
 Westinghouse V-2171/2172/2176/2177 Tube Substitution Charts.....Aug.
 Wide-Angle Deflection Conversion Techniques for Rectangulars (Cover); Walter H. Buchsbaum.....Jan.
 Wide-Angle High Efficiency Horizontal-De-

(Continued on page 48)



Directronic

MOTORLESS TV AERIAL SYSTEMS

360° ELECTRONICALLY SWITCHED BEAM

GIVES SAME CLEAR PIX AS MOTOR
DRIVEN AERIALS AT $\frac{1}{3}$ THE COST

SIMPLE FLICK OF SWITCH
CLEARS PICTURE **INSTANTLY**
NO WAITING

OPENS BIGGEST
REPLACEMENT MARKET
IN TV HISTORY

MAIL THIS COUPON TO-DAY!

SNYDER MFG. CO. A
22nd & Ontario Sts., Phila. 40, Pa.

Please send me free copy of authoritative
booklet TENNA TIPS on Directronic and
all other types of aerials, plus catalogs.

NAME _____
 ADDRESS _____
 CITY _____ ZONE _____ STATE _____

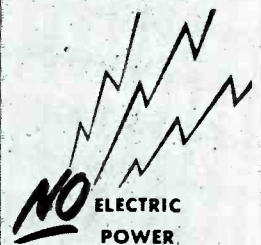
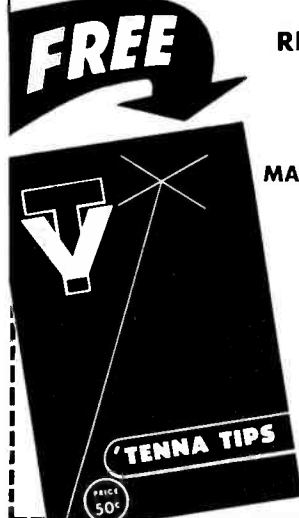

PHOTOFACT Users Write Our Best ADS!

Hundreds of unsolicited letters tell what the world's finest Radio & TV Data means to Service Technicians



Norman H. Otto
726 Cherry Ave.
San Bruno, Calif.

"The extent of your PHOTOFACT service amazes me more and more at each publication. Your new P.F. Index is very handy."



E. A. Randall
4710 Annette St.
New Orleans, La.

"I have all PHOTOFACT Folders and use them quite often. Your circuit diagrams help plenty and save a great deal of time. I have been in service work since 1934."



Harry Larrison
1723 Oakwood Ave.
Akron, Ohio

"In my opinion, PHOTOFACT is to radio and TV servicing what the five cent cup of coffee was to the American scene of yesterday—and this isn't idle praise, but cold facts, proved by the needs of everyday servicing."

NOW! GET THE PROOF FOR YOURSELF!

FREE We'll Send You a FREE Photo-fact Folder on any postwar receiver listed in the PF Index.

Learn for yourself—at our expense—how PHOTOFACT pays for itself by earning bigger repair profits for you! Ask for a FREE Folder covering any postwar AM, FM or TV receiver listed in the PHOTOFACT Cumulative Index. Examine it. Put it to work at your bench—then judge for yourself!

WRITE FOR FREE FOLDER TODAY!

HOWARD W. SAMS & CO., INC.
2201 East 46th Street • Indianapolis 5, Indiana

Annual Index

(Continued from page 47)

Deflection Circuitry Requirements for 14- and 17-Inch Picture Tubes Apr.
Wide-Angle Large Picture Conversion Oct.
Wide-Angle Vertical Deflection Double Triode Jan.
Yoke Ringing Correction Sept.

TEST EQUIPMENT

Accelerated Testing Techniques; Philip H. Greeley July
Accelerating Testing Techniques; Philip H. Greeley Aug.
Alignment of Frequency-Modulation Detectors Jan.
Auto Bench Power Supply; J. T. Cataldo Jan.
Autotransformer Tester; Jack Darr Sept.
Capacitor Discharge Unit Oct.
Checking Q of Coils and Capacitors with RF Test Instrument Jan.
Circuit-Continuity and Leakage Checking with Streamlined Setups Aug.
Comparison Component Testing Aug.
Connecting Up a VTVM and Signal Generator in a Ratio-Detector System Jan.
Hi-Voltage Neon Tester for TV Oct.
Multivibrator Type Tester Expedites Fault Finding and Alignment Dec.
Neon Lamp Hi-Lo Resistance Checkers Oct.
Paper-Capacitor Leakage Tests with a VTVM Aug.
Portable Test Meter Picture-Tube Servicing Mar.
RF Testing Procedures; Philip H. Greeley Jan.
RF Tester with VTVM June
Servicing FM Detectors (Part III); Allan Lytel Jan.
Simplified Testers for the Service Shop; Philip H. Greeley Oct.
Speedy Trouble Shooter; James S. Kendall Dec.
Three-Ways to Use a VTVM in Alignment (FM Detectors) Jan.
Time-Saving Test Setups to Expedite Troubleshooting in Broadcast, Auto and TV Chassis, and Locating of Defective Electrolytics, etc. July
Tracing Wiring and Locating Shorts Jan.
Troubleshooting Assembly Employing a Step-Type Transformer, Providing 90-135 Volts in Ten Taps Sept.
Supplementary Power Supply for Auto-Radio Servicing Aug.

TUBE NEWS

Automatic Focus Picture-Tube Design Features Aug.
Dumper Diodes for Transformerless Receivers and for Direct-Drive Deflection Circuits Nov.
Deflection Systems for Large Screen Picture Tubes May
Dimensional Outline of RCA 17CP4 Rectangular Picture Tube Feb.
Electrostatically-Focused Picture Tubes Feb.
14-, 17- and 20-Inch Rectangulars With Electrostatic Focusing June
Horizontal Deflection Output and HV Transformers Designed for Electrostatic Picture Tubes July
How to Avoid Picture Tube Damage by Ion-Trap Magnet Alignment Apr.
Miniature Triode-Pentodes Nov.
Minimizing Pulse Voltages in TV Vertical-Deflection Amplifiers Aug.
9-Pin Triode-Pentode Converter June
Oscillator and Thyatron System in Capacitive Detecting Setup Used for Alarms, etc. Feb.
Phosphors in Picture-Tube Production Aug.
Picture-Tube Open-Heater Characteristics Mar.
Presence Detector Circuitry; Alan Smolen Feb.
Rectangular-Tube Deflecting Yokes and Automatic-Focusing Picture Tubes July
Replacement Guide for 16-Inch Rectangulars Apr.
17 and 20-Inch Electrostatic Tube Design and Application Mar.
17 and 20-Inch Rectangulars Jan.
17-Inch Metal-Shell Picture Tubes with Low-Voltage Electrostatic Focus Nov.
17-Inch Metal Shell Rectangular Tubes Feb.
Small-to-Large Screen Conversions Apr.
Subminiatures Designed to Replace Miniatures in Wide-Band IF and RF Amps, UHF Oscillators, Triode RF Mixer Circuits, etc. Dec.
Thyatron Tubes Jan.
20-Inch Electrostatic Picture-Tube Cross-Sectional View Mar.
21-Inch Metal Rectangular, 30-Inch Round, and 17, 20 and 21-Inch Electrostatic Picture Tubes Sept.
Wide-Angle High-Efficiency Horizontal-Deflection Circuitry Requirements for 14- and 17-Inch Picture Tubes Apr.
Wide-Angle Large-Picture Conversion Oct.
Wide-Angle Vertical-Deflection Double Triode Jan.

RADELCO

LIGHTNING ARRESTOR

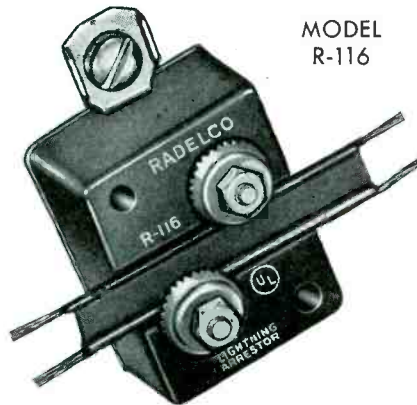

MODEL R-116

IT'S THE LOWEST PRICE UNDERWRITERS' LISTED ARRESTOR ON THE MARKET

ORDER FROM YOUR NEAREST PARTS JOBBER

LIST PRICE **90¢**

SERVICE

assures every advertiser of 100% buying power reader-ship without costly fringe or outside industry waste circulation.

Among radio and TV service trade papers, SERVICE ranks

First in number of articles
First in number of pages
First in volume of advertising
First in number of advertisers

Manufacturers of tubes, test equipment, components, accessories, sound and intercom equipment, antennas, tuners, boosters, hardware, etc.—SERVICE will do a sales job for you—economically and efficiently.

Let SERVICE sell for you in 1952

Business Aids . . .

[In response to many requests, arrangements have been made to feature every month in SERVICE a column devoted to a discussion of Business Aids for the Service Shop, based on queries submitted by readers of SERVICE. Topics to be reviewed will include advertising, bookkeeping, customer relationship, filing systems, displays, direct mail, etc. These columns, the second of which appears below, are being conducted by a veteran Service Man with over a quarter of a century experience in the field, who is currently operator of a large Service Shop, and is also extremely active in association affairs. If you have a business-aid problem, send it to ye editor, and every effort will be made to publish a solution in an early edition of SERVICE.]

Dear Editor:

My shop is located in a manufacturing area. My customers are mainly those in the low or middle income bracket, who have been bringing their radios, phonos and auto radios to me for servicing on their way to and from work. When older sets are left to be checked and costs estimated, I find that there is a reluctance to pay for estimating and the repair job is often lost in the debate that follows. Although I know that it is not possible to force the customer to let you repair every set that enters the shop, I still don't want to lose the job and their friendship, too. What can be done to avoid this situation?—L. J.

Dear L. J.:

From the information supplied, it appears that you inform the set owner of the service charge only after he, for some reason or another, doesn't want the set repaired. In accordance with the OPS rulings all charges must be posted within your place of business where they can be seen. It has been found that the posting of prices for set tests or estimates, tube testing, or any other service rendered has been a wise move. By calling these charges to the attention of the set owner or person bringing the set in for repairs and explaining the reason for the charges, Service Men have found that most of the sets are left for repairs, if the estimate is a fair one. Of course, there are always a few who think that your services aren't worth much or that the set being repaired isn't worth the additional investment. Posting and advising the customer of your service charges before the set is handled will eliminate a lot of ill-will between yourself and your customer.

Under the OPS rulings, you must supply the customer with an itemized list or bill for all parts and services. You must always remember that the only item you have to sell is your skill and knowledge and for these you must receive a fair compensation. Remember, you are not just a salesman for parts and tubes.

Sincerely,

Don Kay

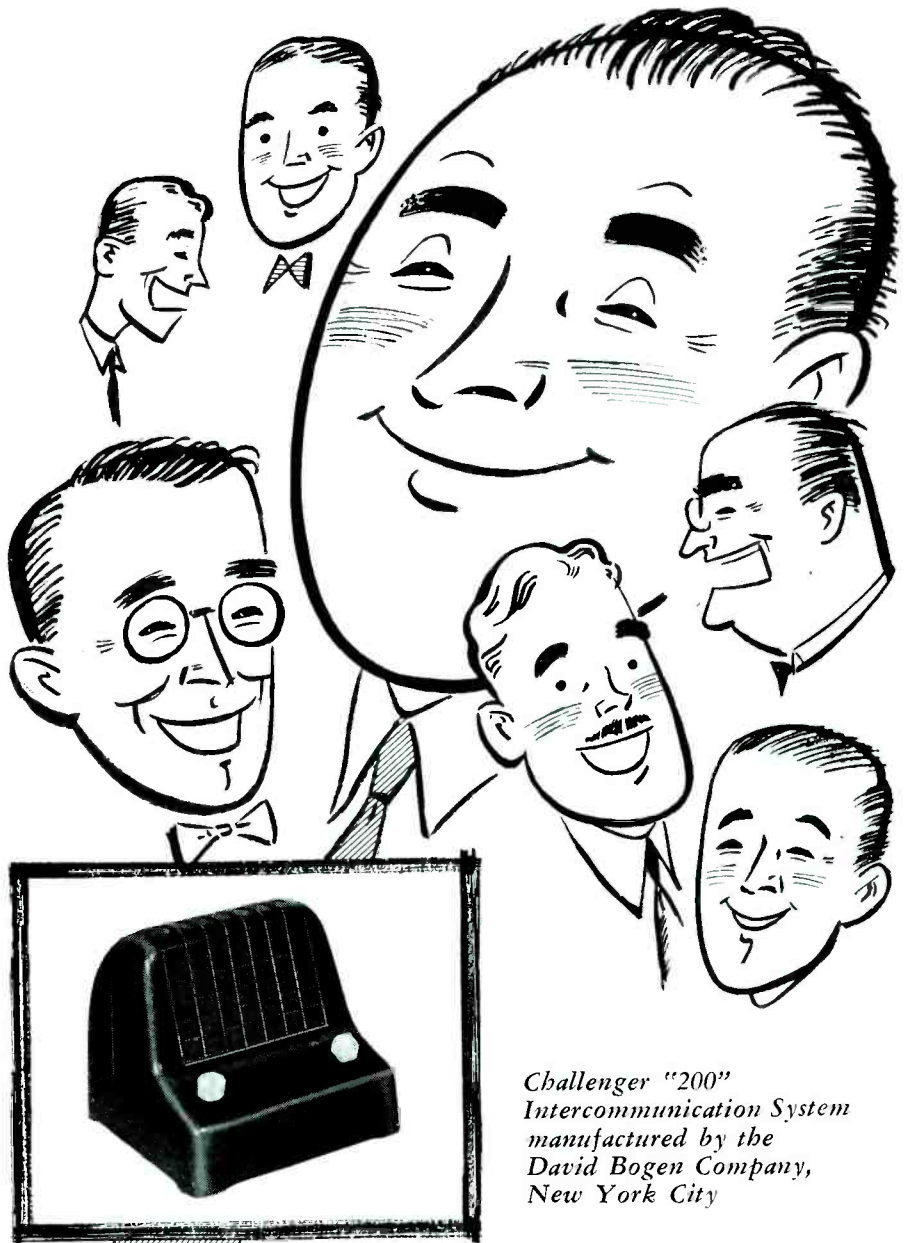

Challenger "200"
Intercommunication System
manufactured by the
David Bogen Company,
New York City

**we're
happy**

Sound reproduction is of the utmost importance to the David Bogen Company. We, at Oxford, are happy because OXFORD SPEAKERS are used in David Bogen products.

We're pleased with this testimony that we meet the most critical demands for high fidelity performance.

For over a quarter of a century Oxford has been manufacturing speakers to the most exacting requirements. We're happy that we can provide the most complete speaker line . . . for TV, FM, AM, Auto, PA and outdoor applications.

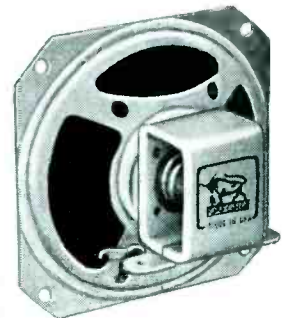

Leading jobbers carry
OXFORD SPEAKERS.
Write for your copy of
our latest catalog.



OXFORD ELECTRIC CORPORATION

3911 South Michigan Avenue • Chicago 15, Illinois

EXPORT: ROBURN AGENCIES, NEW YORK CITY



Consecrated
to Quality Output and
Golden Rule Service

ASTRON

FIXED CAPACITORS

The three popular types here illustrated are specified by leading set makers, and they fit as perfectly into the SERVICE scheme. They are small . . . adaptable . . . the product of lifetime experience in Capacitor engineering. Use them with complete assurance of maximum satisfaction through, high standards of quality control.



MINIMITE—Metal tubular dry electrolytics—Compact, hermetically sealed capacitors with exceptionally low leakage—capable of withstanding high surge voltage—exceptionally long shelf life—ideally suited for under chassis mounting.

EY—Twist prong dry electrolytics—most popular type used by television and radio set manufacturers; simple to mount, specially processed for long-life operation at ambient temperatures up to 85° C.; Centrifuge electrolyte impregnation; spot welded cathode tabs; excellent stability; low leakage.

AM—Molded paper tubulars—designed for continuous operation at 85° C.; molded in high temperature, heat resistant plastic compound for perfect seal against most severe humid conditions; won't cold flow at 100° C.

WRITE FOR CATALOG AC-2

ASTRON CORPORATION

255 Grant Ave., East Newark, N. J.

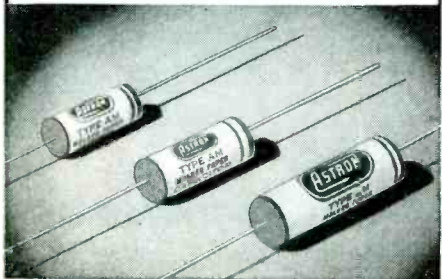

Associations

NETSDA

E. W. MERRIAM, formerly service manager for RTMA, and now service manager at Sylvania, was guest speaker at a recent meeting of the National Electronic Technicians and Service Dealers Association, held in the Hotel Stacy Trent, Trenton, N. J. Merriam gave an outline on his proposed projects to promote a program presented by NETSDA at a Chicago meeting of the RTMA service committee. Delegates to the Trenton meeting voted to give. . . "All the cooperation necessary to Merriam in helping him to promote a concrete program for the servicing industry."

The group voted to hold a national meeting of the various heads or representatives of servicing associations throughout the country in May, '52, at which time reps of the manufacturers, distributors, broadcasters and sales reps will be requested to attend.

A national code of ethics was adopted by the body and will be presented for vote and ratification by all chapters.

LCRSA, Penna.

A. G. PETRASAK, of the RCA tube department, presented a lecture on *uhf*, better business methods, and a discussion on the various circuits in the RCA TV receiver, before the Radio Servicemen's Association of Luzerne, County. Motorola, Inc., also presented a lecture and demonstration of their receivers. Earlier Bill White and Fred Muller of G. E. appeared and discussed TV chassis.

A basket picnic was held at Toby Park, Blakeslee, and attended by members and their families.

At recent meeting of the Mid-State Radio Servicemen's Association of Harrisburg, which featured a talk by A. G. Petrasak of the RCA tube department.



MOSLEY OPEN-WIRE LINE ACCESSORIES

for Better Fringe Area TV

MOSLEY Open-Wire Line Accessories are especially designed to provide Better TV Pictures in areas of weak signal strength.

Open-wire line, made with MOSLEY Accessories, has less than one-sixth the loss of new standard 300 ohm ribbon line. Its use will often result in good, consistent TV pictures in fringe areas where TV reception had previously been considered impossible. Such line will not increase in loss with age and will withstand adverse atmospheric conditions indefinitely.

Cat. No. 450-1 Splicer.

Solderless splicer for joining sections of open-wire line. Maintains line impedance. List \$30



Cat. No. 450-2 Anchor Bar.

Holds open-wire line securely. Use with screw-eye stand-off of type ordinarily used for co-ax line. Maintains 1" spacing for constant impedance. List \$30

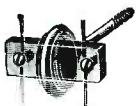

Cat. No. 450-3 Spacer.

Place 12" apart along line to maintain 1" spacing. List \$10



MOSLEY ELECTRONICS

2125 Lackland Rd., Overland, Missouri

GENUINE TWIN LEAD

300 OHM WIRE

ALSO ROTOR 4 WIRE

All wire made with 7 strands of copper covered with virgin polyethylene.

*Lowest prices—immediate delivery
Samples and prices on request.*

TV Wire Products Company

250 W. 57th St., New York 19, N. Y.
'Phone Circle 6-0244

ARTSNY

MAX LEIBOWITZ, prexy of the Associated Radio and Television Servicemen's Association of New York, has

prepared a series of articles for local newspapers on the need for licensing, and has supplied a story. . . . *Here's A Law to Protect You to TV Guide.*

Liebowitz also appeared as a guest on a program on WCBS-TV, in New York City, at which time he presented the Service Men's view on licensing.

Oak Ridge has agreed to supply all the necessary test equipment for the association's club room and service clinic.

RSAT, New Jersey

GIBSON GRANDLY has been appointed chairman of the membership committee of the Radio Servicemen's Association of Trenton, New Jersey.

A series of technical and business lectures have been arranged for, to promote a more progressive and active program within the association. The discussions will be held in the studios of the local broadcasting stations.

TEN YEARS AGO

From the Association News Page

AT A MEETING of the Radio Servicemen's Association of Luzerne County held in the Chamber of Commerce Rooms, Miners National Bank, Wilkes-Barre, Pa., *service* and its relationship to the National Defense program was discussed. The law requiring all aliens to surrender short-wave receivers was reviewed, and it was agreed that the method of removing the shortwave band from such a set before it is returned to the individual be standardized. . . . Nominations for RSA directors were announced for the following districts: District 5 (Iowa and Missouri); District 7 (Wisconsin, Minnesota, North Dakota, South Dakota, and the northern peninsula of Michigan); and District 9 (Michigan, excepting the northern peninsula, and the Province of Ontario, Canada). . . . A column of RSA ads, sponsored by the Chicago chapter, appeared in the *Herald American* radio program section, under the heading *Don't Just Call a Radio Service Man*. The same radio section carried a question and answer feature, *Dr. RSA*, in which common questions asked by radio owners were answered by RSA members. . . . The Cleveland chapter of RSA planned a reorganization meeting. . . . *The Christmas Sets for the Needy* program was announced as a great success by the Danville chapter of RSA. Station WDAN and the *Danville Commercial News* advertised for old receivers to be donated.

"Workshop DUBL-VEE antennas
are second to none."

Francisco Laboratories
HYPROD SERVICE FOR HEYER DEVICES
EQUIPMENT REPAIRED. REMANUFACTURED AND EXCHANGED

39 3015 GLENDALE BOULEVARD
LOS ANGELES 24 CALIFORNIA
HOLMADAY 8876
OLYMPIA 0607

20 August 1951

Workshop Associates, Inc.
135 Crescent Road
Needham Heights 94, Massachusetts

Gentlemen:



Having originated products in other fields, we can appreciate to the fullest extent a quality product. We have used Workshop DUBL-VEE antennas extensively since they were first introduced to the Southern California market. The results of tests in low signal fringe areas convinced us that the Workshop TV antennas are second to none.

There are many imitators of your products, as you are doubtless aware, but the differences are apparent once the DUBL-VEE is compared in operation against the others. Your engineering department is to be complimented for originating what we believe is one of the finest television antennas on the market.

Yours very truly,
FRANCISCO LABORATORIES
Wallace E. Francisco
Wallace E. Francisco

"The Workshop-patented DUBL-VEE is tops for all-channel performance. And remember last winter? Rugged DUBL-VEE's stood up best. Specify DUBL-VEE and be sure."

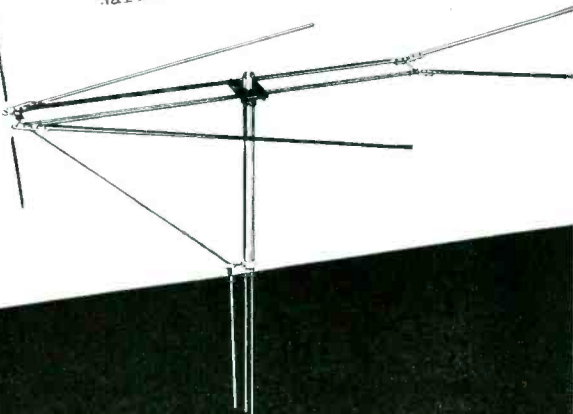
The WORKSHOP ASSOCIATES
DIVISION OF THE GABRIEL COMPANY
Specialists in High-Frequency Antennas
135 Crescent Road, Needham Heights 94, Massachusetts

Rep Talk

... if you are commercially or professionally interested in TV, you must read

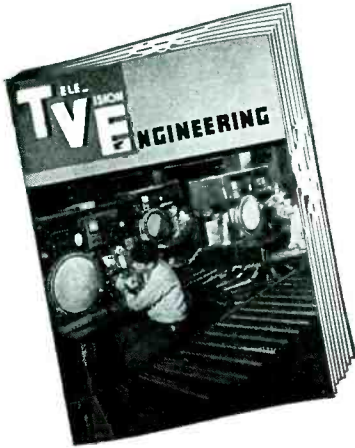

TELEVISION ENGINEERING every month!

Devoted exclusively to TV Research . . . Design . . . Production . . . Operation . . . Instrumentation

TELEVISION ENGINEERING is the *only* trade publication which directs its *entire* editorial content to executives and engineers who design, manufacture, operate and maintain television receiving and transmitting equipment—both commercial and educational.

Every issue is chock full of timely and thorough TV articles, authored by outstanding specialists. You'll find practical, carefully prepared reports and papers on such vital subjects as . . .

Color TV Systems . . . Ultrahigh Receiver-Transmitter Design Problems . . . Tube Production-Line Techniques . . . TV Broadcast Equipment . . . Camera Tube Research . . . Glass, Plastics and Metal in TV . . . TV Test Equipment in the Plant . . . Film Recording . . . Flying Spot Scanners . . . Tone Amplifiers for TV Films . . . Compact Motors for TV . . . TV Component Design . . . Mechanical Design Factors in Antennas . . . Quality Control Charting . . . Microwave Relays . . . Receiver and Transmitter Servicing . . . Production Aids . . . Instrument Activities . . . TV Sound Systems . . . Studio Lighting.

Enter your subscription NOW . . . Fill out the coupon below
(Not sold on newsstands)

MAIL COUPON

TeleVision Engineering
52 Vanderbilt Ave., New York 17, N. Y.

Here is my remittance for my subscription to **TeleVision Engineering** at the

SPECIAL RATE . . . 3 years (36 issues) only \$5.

(1 year subscription \$3.)

NAME

ADDRESS

CITY ZONE STATE

For our confidential records, open only to the Audit Bureau of Circulation, please supply the following information:

Occupation Title

Department in which employed

Operation Production Research

Employed by

Nature of Business

(State if TV Manufacturer, TV Broadcast Station, etc.)

BOB MORRISON has joined the Burt C. Porter Co., Seattle, Washington, and will represent Eicor in that territory. . . . *Gordon C. LeRoy* has been named rep for the tape recorder division of Eicor in New York state, including New York City. . . . *Robert A. Stang*, 509 Fifth Ave., New York 17, N. Y., has been appointed rep for Electronic Instrument Co. in metropolitan New York, New Jersey, eastern Pennsylvania, Maryland, Delaware and District of Columbia. . . . *Elliott Equipment Co.*, 712 Sixth Ave., South Minneapolis, Minn., has been named rep for the picture-tube division of the Allen B. DuMont Labs, in Minnesota, and North and South Dakota. . . . Six new senior and associate members have been elected to the *Reps*. Senior members include: *Melvin S. Levison*, 5 Waverly Place, New York 3, N. Y., and *B. J. Taylor*, 150 Broadway, N. Y. 38. (New York chapter); *Francis Kriegner*, 201 S. Broadway, Camden 3, N. J. (Mid-lantic chapter); and *Joseph W. Loukota*, 1052 W. 6th St., Los Angeles 17, *Irving M. Cochran*, 408 S. Alvarado, Los Angeles 5, and *Samuel Siegel*, 1145 S. La Cienega Blvd., Los Angeles 35, Calif. (Los Angeles chapter). Associate members elected were: *Cecil E. Webb*, 4014 Washington Blvd., Indianapolis 5, Ind. (Hoosier chapter); *S. Victor Malta*, Box 205, Camden, N. J.; *John Mustico*, 506 Wyndmoor Ave., Philadelphia 18, Pa., and *Joseph F. Whitaker*, 401 N. Broad St., Philadelphia 8, Pa. (Mid-Lantic chapter). . . . *Lester Brown*, formerly factory sales rep for Pilot Radio in Pennsylvania, Virginia and the Carolinas and southeastern district manager for Universal Electronics, has joined the staff of *Harry Estersohn and Co.*, 395 East Cliveden St., Philadelphia, Pa.



Gordon LeRoy



Robert A. Stang

Charles Ollstein, president of the N. Y. Chapter of NEDA and head of Sanford Electronics Corp., receiving a plaque, betokening the appreciation of the New York Chapter of the *Reps* for the pleasant relations with the respective groups, from James Pickett, president of the New York Chapter of the *Reps*, during the recent *Rep stag* party in N. Y. City. Marty Camber served as chairman of the entertainment committee, and was assisted by Jules Bressler, Cliff Landis and Sam Shaw. The arrangements committee consisted of Bob Breuer, Leo Freed, Bill Gold, John Kopple and Wally Shulan.



Audio

(Continued from page 21)

was a dual-reversible sapphire and diamond stylus.⁴

This stylus features a sapphire for standard records and a diamond, for *lp* and 45s. A twist of a positioning knob places either the diamond or sapphire in playing position without moving the cartridge or arm.

The *double twist* feature of the baton unit, which is said to permit the stylus to follow the record groove accurately, has been incorporated in the design for this new stylus.

The model has been designed to be used with the variable reluctance cartridges.⁵ Both have a double coil construction and a high permeability metal case which is noted as providing a reduction in hum pick up to a minimum. No weight adjustment or compensation is said to be needed and the tracking pressure is constant at from six to eight grams.

⁴G.E. RPJ 013.

⁵G.E. RPX 047 and RPX 050.

Acoustical lens developed for loudspeaker use, which is said to distribute uniform sound wave over the entire audio spectrum. The lens is claimed to smooth out the high frequencies. Lens and horn is for use with the Lansing 175 high-frequency driver. (Type 175 DLH; James B. Lansing Sound, Inc.)



Fringe Lock

(Continued from page 24)

pulses. The vertical-size control is part of the vertical oscillator plate load, and is used in conjunction with the vertical linearity control to adjust the size of the picture vertically.

The vertical-linearity control, in the cathode circuit of the vertical output tube, is used to shift the operating point of the tube so that the sweep is amplified along that portion of the plate current curve which results in a linear output. The position of the horizontal drive and width controls affect linearity, and possible interaction of these controls must be taken into consideration when making linearity adjustments.

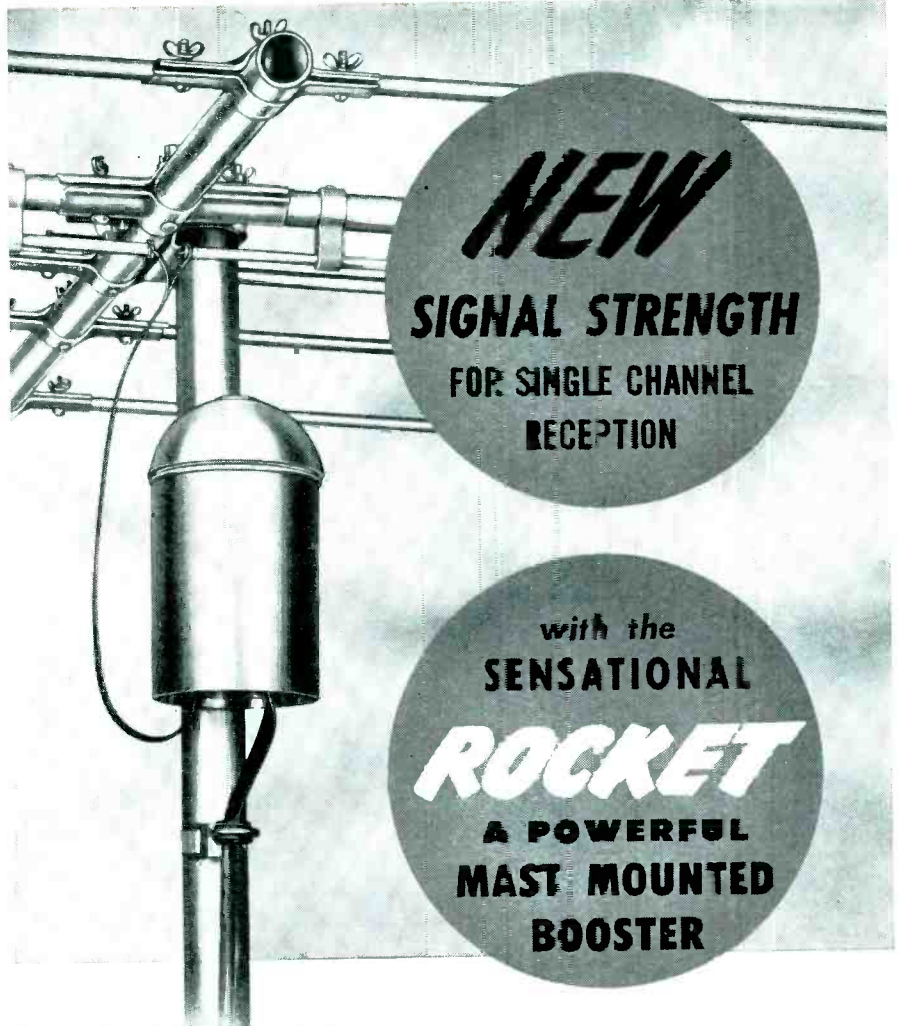

Research and laboratory tests have long proved that the best point to boost a TV signal is at antenna height — where the most favorable signal-to-noise ratio exists. But it remained for VEE-D-X engineers to perfect the extremely powerful Rocket Booster that delivers an 18 db gain with full 5 megacycle band width. The Rocket Booster has two components — (1) the booster itself, and (2) a control unit. It is factory preset for peak performance on any desired channel and once installed needs no further adjustment. For complete information on the sensational new Rocket Booster see your distributor or write to The La-Pointe-Plascomold Corporation, Windsor Locks, Conn.

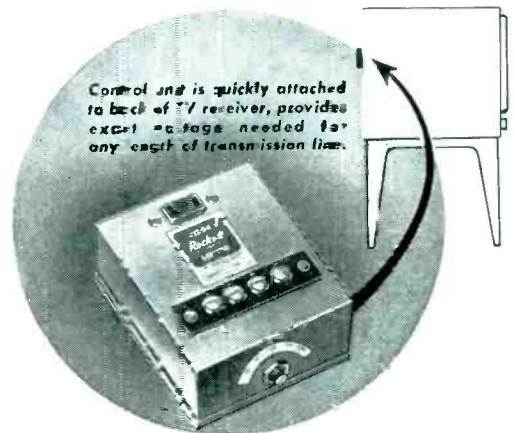

Control unit is quickly attached to back of TV receiver, provides excellent coverage needed for any length of transmission line.



VEE-D-X

MAKERS OF THE WORLD'S MOST POWERFUL ANTENNA SYSTEMS

EICO

gives you Laboratory Precision at
Lowest Cost!

NEW **EICO**
Instruments and **KITS**

... with a complete line

Over 50,000 servicemen have bought one or more EICO Kits and Instruments. That's the proof of EICO's leadership in value to the serviceman!

For latest precision engineering, finest components, smart professional appearance, lifetime performance and rock-bottom economy—see and compare the EICO line at your jobber's today before you buy any higher-priced equipment! You'll agree, with over 50,000 others, that only EICO Kits and Instruments—no other—give you the industry's greatest values for the industry's lowest costs!

Read the full story on the complete EICO line. Write today for your free latest Catalog S-12



221K VTVM Kit
Wired \$49.95

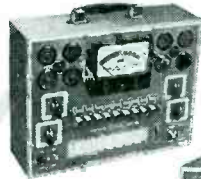

625K Tube Tester
Kit \$34.95
Wired \$49.95



820K Sig. Gen. Kit
Wired \$29.95



145K Sig. Tracer
Kit \$19.95
Wired \$28.95

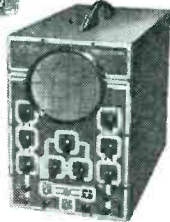

425K 5" Scope Kit
Wired \$79.95



310K Deluxe Sig.
Gen. Kit \$39.95
Wired \$59.95



HV Probe \$6.95



1040K Battery Elim.
Kit \$25.95
Wired \$34.95



511K VOM Kit
\$14.00
Wired \$17.95

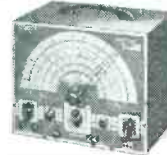

380K Sweep Gen. Kit
\$34.95
Wired \$49.95
C-5 5mc Crystal \$3.95



RF Probe Kit \$3.75
Wired \$5.95

ELECTRONIC INSTRUMENT CO., Inc.
276 NEWPORT STREET, BROOKLYN 12, N. Y.

Due to unsettled conditions, prices and specifications are subject to change without notice.
Prices 5% higher on West Coast

Ser-Cuits

(Continued from page 30)

intergrating network was used since the horizontal sync pulses are not passed by the vertical sync separator. Since the first sync pulse always triggers the vertical multivibrator in this circuit, superior interlacing is also said to develop.

The horizontal sync pulses are obtained from the plate of the horizontal sync separator, 12AU7, and are fed to the grid of the horizontal sync amplifier, where it is amplified and used to control the frequency of a horizontal blocking oscillator through the horizontal control tube.

For noisy fringe areas, provision has been made to connect a *fringe compensator* network in the plate circuit of the 12AU7 sync amplifier tube. This network limits the amplitude of the noise pulses into the sync separator to that of the sync pulses, resulting in improved picture stability. If this network is connected in strong signal areas, vertical jitter or audio buzz may result.

Horizontal Sweep

The horizontal-deflection circuits contain an automatic frequency stabilizing circuit (*miracle picture lock*) which is said to improve stability and ease of operation. The horizontal blocking oscillator, 6SN7GT, is controlled by a horizontal oscillator-control tube. This is done by properly phasing two wave forms at the input grid of the horizontal control tube; plus-width frequency control. A 53-ohm phasing coil has a fly-wheel effect and helps greatly in stabilizing the sync. A sawtooth voltage is built up across an 820-mmfd capacitor which is charged through a 68,000-ohm resistor, and then is coupled to the grid of the 6BQ6GT horizontal output tube. The damper tube, 6W4GT, is effectively connected across the horizontal deflection yoke to damp out oscillations which occur over part of the horizontal scanning cycle. The resultant energy from these damped oscillations provide the boosted B+ voltage.

Vertical Sweep

A multivibrator is used as a vertical oscillator, 6SN7GT, and a 1-megohm vertical hold control controls the free-running frequency of this tube. The vertical-sync pulses fed from the vertical sync separator causes the vertical oscillator to lock in at the proper frequency.

FOR PERFECT PICTURE CENTERING IN ELECTRO-STATIC TUBES

Use the **NEW** PERFECTION *Kine-Center*

Here is the simplest of all centering devices for the new electrostatic tubes. It is also the most efficient and positive—as your own tests will prove.

- **Quickly Mounted.** Slip the Kine-Center over the tube neck and tighten the holding screw. It stays firm. No wobble. No wiggle.
- **Finger-Tip Control.** Picture is centered by rotating the two rings either independently or together.
- **Positive Centering.** Once adjusted, the rings stay put.
- **No Distortion of Focus** as with many other centering devices.

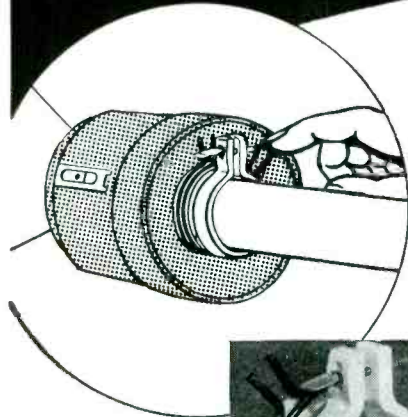

MORE EFFICIENT

Rings are closer to deflection yoke (the most effective operating area) and to the tube neck. They are stabilized magnetically.



Order today from your supplier!

PERFECTION ELECTRIC COMPANY
2635 South Wabash Avenue, Chicago 16, Illinois
MAKERS OF PERFECTION SPEAKERS AND TELEVISION COMPONENTS



TV Parts

[Additional new-product news on page 56]

INSULINE INDOOR ANTENNA

A table-top indoor antenna, the *Meteor*, with adjustable arms, from 15" to 38," that are hinged so that they can be closed in completely or opened out flat, has been announced by the Insuline Corporation of America, 36-02 35th Ave., L. I. City 1, N. Y.

Included is a weighted padded bottom, and a four-foot length of 300-ohm lead, fitted with spade lugs.

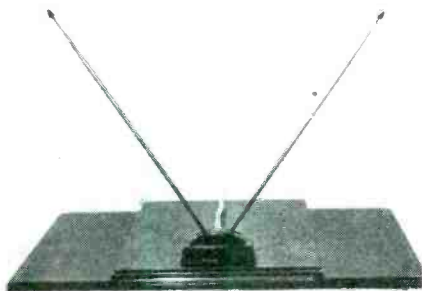

* * *

ALL-STAR PIN-CUSHION CORRECTOR SET

A two-piece pin-cushion corrector set, *PK-1*, that is said to eliminate TV image distortion in the corners of the picture tube caused by errors in the deflection fields and in the picture tube geometry either separately or in combination, has been announced by All-Star Products Co., Defiance, Ohio.

Set consists of a small piece of Alnico V magnet material with correctly designed pole pieces. Two units in the set provide for mounting on the deflection-yoke mounting bracket on each side of the picture tube. Control of the amount of correction is obtained by moving the item toward the face of the tube or toward the base. Correction is achieved by providing a magnetic field with the same curvature and strength as the error component of the deflection field but in the opposite direction. Field of the set produces a correction on the motion of the electron beam after the error has been introduced, rather than on the field produced by the deflection yoke.

Installed with screws that fasten the *PK-1* to the deflection-yoke mounting bracket. Control of the field strength of the *PK-1* is achieved by moving each unit laterally toward or away from the face of the tube.

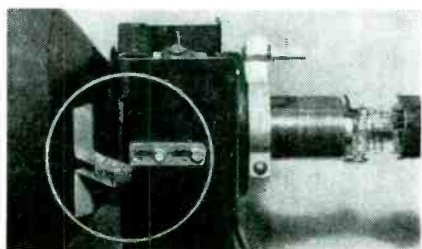

Now BLONDER-TONGUE BRINGS YOU FOR THE FIRST TIME IN TV HISTORY

An ALL-CHANNEL MASTER ANTENNA SYSTEM that YOU can install—in a matter of minutes—that is guaranteed to out-perform any other system.

...AND AT THE LOWEST COST!

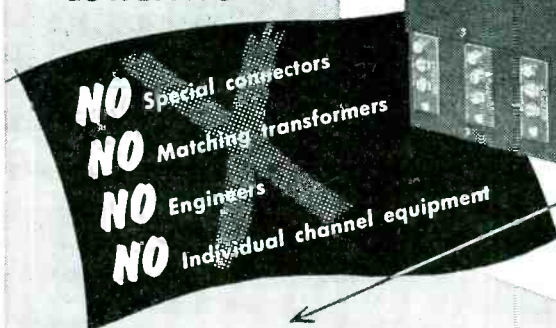

Distribution Amplifier
8 TV Outlets at Lowest Cost



Model #DA8-1-M
\$87.50

Model #DA8-1-M Distribution Amplifier

Full electronic isolation (min. 35db. between outlets). Amplifies as it distributes... Variable Gain Control. No signal loss. Automatic All-Channel transmission. Ordinary screw terminals assure faster, simpler installation.



MODEL #DA2-1-M
List Price \$39.50
Distribution Amplifier
2 TV Set Outlets

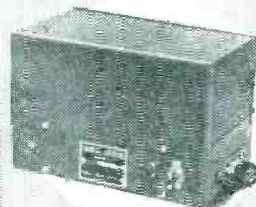

Model #CA-1-M. List Price \$77.50. Commercial Amplifier (30 Times Gain) Use As Pre-Amplifier, Line Amplifier or ce-luxe Booster.

Combine these B-T units to serve up to 2,000 TV sets from 1 antenna.



Literature on Request write Dept. H-1
Mt. Vernon, N.Y.

Model #HA-2-M
HOME ANTENSIIFIER — Fully automatic, all-channel TV booster. 16 times gain. In meta cabinet. 57.50



ARGOS TV CABINETS

A line of leatherette table-model TV cabinets has been announced by Argos Products Co., Genoa, Ill. Cabinets are ready-cut for Radio Craftsman, Tech-Master, Philmore, and Mattison 16 or 17-inch chassis and Radio Craftsman 20 or 21-inch chassis. A blank model is also available for other 16 to 21-inch chassis.

Cabinets are constructed with 3/8" 3-ply sides and 1/2" 5-ply bottom. Speaker grilles, on both sides of cabinet, are plastic. Two wire-mesh panels in bottom provide extra ventilation. Leatherette is pyroxylin-coated, and grained for rich appearance. A gold bead line is used at all joints and along each side.



TV Parts

BUD SWIVEL CHIMNEY MOUNT

A chimney-type antenna mounting bracket, *AM-18*, that it is claimed can be installed by one man, has been developed by Bud Radio, Inc., 2118 East 55th St., Cleveland 13, Ohio.

Installation is accomplished by first attaching the brackets to the chimney by steel straps. Antenna is then fastened to the mast and taken to the roof, mast is inserted into the lower bracket and tightened, and then mast and antenna are swung into a vertical position and bolted into the top bracket.

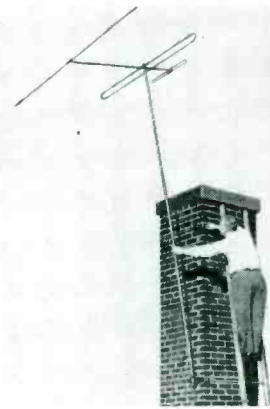

* * *

B-T HOME ANTENSIFIER

An improved version of the home antensifier, model *HA-2-M*, that has no knobs or controls, and goes *on* and *off* with TV set operation by means of an automatic thermo-relay power switch, has been introduced by Blonder-Tongue Laboratories, 38 N. 2nd Ave., Mount Vernon, N. Y.

Featuring a 4-tube chassis with 4-stage cascaded amplification, and a push-pull circuit, unit is said to have an average gain of 16 times, 24 db, over all channels. Tube complement is three 6J6s and one 12AV7.



* * *

GC TV ANTENNA CLIP

A plastic TV antenna clip, *Tenna-Klip*, to be used where frequent changes and rapid connections are needed, has been introduced by the General Cement Manufacturing Co., 919 Taylor Ave., Rockford, Ill.

Clip is spring loaded with metal contacts, and is available in a variety of colors. Wires fasten under screws.

**RECORDS SHOW
THERE'S NO
BOOSTER**

**LIKE... SEC
BOOSTER**

* Actual records show less than one return for every 1,000 SEC Boosters shipped

The extremely high efficiency of SEC's newly designed tuned circuits eliminates the usual loss of gain on high channels, provides the ultimate gain and picture clarity on both high and low channels. SEC's superior design and rigid inspection by qualified engineers assure you the highest performance.

Available at your favorite distributor; however, if you are in one of the few areas not yet represented, send orders direct.



**LIST PRICE
\$34.95**

(Usual trade discounts apply)

SPECIFICATIONS

Tube complement:
Single 6J6
Coverage:
Channels 2-13 incl.
In-put: 75-300 ohms
Output: 75-300 ohms
Current:
110-120V 60 cycles
Size: Height, 4 1/4",
Width, 6", Depth, 4"

STANLEY SALES

600 WEST THIRD

NATIONAL DISTRIBUTORS

OWENSBORO, KENTUCKY

It's SENSATIONAL!

**CLEARBEAM'S
NEW ALL-CHANNEL
RHOMBIC**

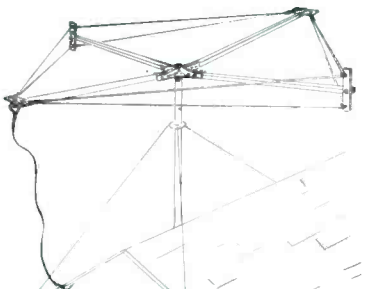

**Electronically Engineered for
LONG DISTANCE
(DX) RECEPTION
and unusually
SHARP DIRECTIVITY
Over the Entire TV Spectrum**

Clear Beam

TV ANTENNAS & ACCESSORIES
100 Prospect Ave., Burbank, Calif.
ROckwell 9-2141 • CHARleston 0-4886

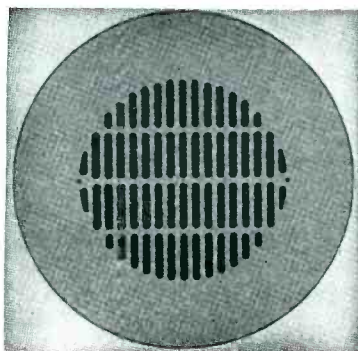

Model 10-P Grille

Because it brings additional orders, more and more smart Sound Engineers are finishing their installations with the 10-P Flush Mounting Grilles.

They come in two finishes: Beautiful Chrome Plate or with a baked on prime coat for painting.

Our increased production has made it possible to reduce our price. List \$4.00.

Write for literature.

WRIGHT Inc.

2237 University Ave., St. Paul 4, Minn.

VIKING ANTENNA ROTATOR

An antenna rotator has been introduced by the Viking Tool and Machine Corp., Belleville, N. J. Powered by a impulse motor, the rotator is said to assure full starting torque of 50-inch pounds. Also available with direction indicator.

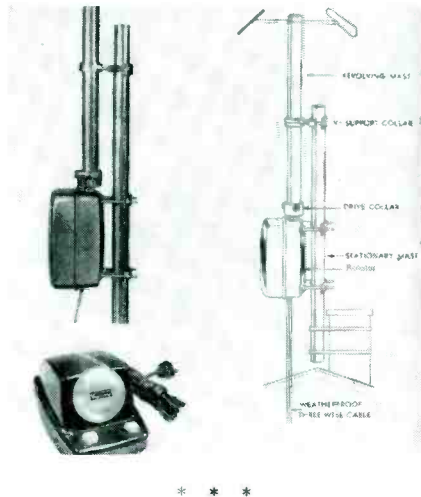

* * *

JFD OPEN-LINE LIGHTNING ARRESTER

A lightning arrester, AT107, that may be used with open-line installations, has been developed by the JFD Manufacturing Co., 6101 Sixteenth Ave., Brooklyn 4, N. Y.

Arrester, constructed of porcelain, is said to be sealed in permanently against temperature and humidity changes, and employs a clear polystyrene cover. Packaged with four feet of aluminum ground wire and equipped with a perforated steel strap for wall, window sill or grounded-pipe mounting.

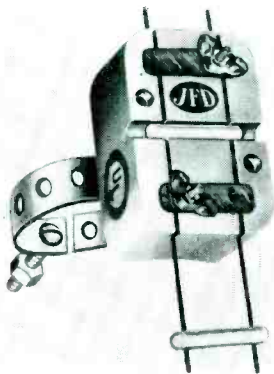

* * *

G.E. TV JUMPER CORD

A TV jumper cord that serves as a connector between the two parts of the interlock after the back has been removed from the set, automatically disconnecting the power, is now available through G.E. tube distributors.

Jumper cord is a six-foot length of 18-gauge parallel cord with an all-rubber female connector molded on one end and a miniature male connector substituted for the conventional plug on the other.

With the device, the Service Man removes the back of the set, stands it in some convenient location, and plugs the jumper cord into the two parts of the interlock.

NEW! STANCOR



Here are three of the newest additions to the most complete transformer replacement line in the industry.

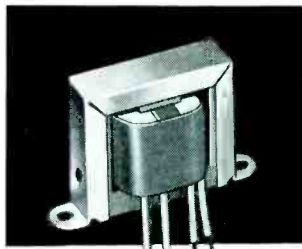

A-8124, VERTICAL BLOCKING-OSCILLATOR TRANSFORMER

A three winding transformer for replacement in 7 Dumont models, 9 Crosley models and Stromberg Carlson model TV-125. See Stancor Bulletin 384.

FC-11, FOCUS COIL.

For use with picture tubes up to 24". Equivalent to RCA 202D2. See Stancor Bulletin 383.

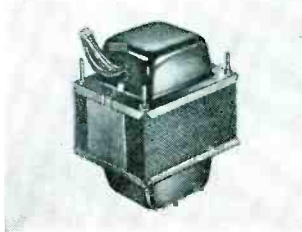
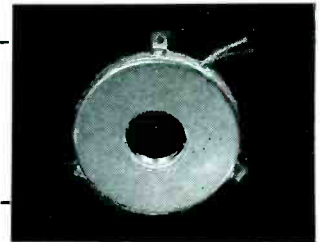

P-8163, TV POWER TRANSFORMER

Equivalent to RCA 75508 (971316-1), used in 28 RCA models. See Stancor Bulletin 388 for a complete list.

Your Stancor distributor has data sheets on these new Stancor TV transformers. Ask him for the latest Stancor Bulletins.

Other new Stancor TV components include **DY-8**, **DY-9**, and **DY-10**, 70° deflection yokes with ferrite cores, nylon coil bobbins and anti-astigmatic focusing (resulting from "cosine" distributed windings) for tubes up to 24". **A-8131**, an air core "flyback" for direct drive circuits, to be used with **DY-10**.

STANCOR TV TRANSFORMER CATALOG AND REPLACEMENT GUIDE lists transformer replacements for over 1500 TV models and chassis. Available FREE from your Stancor Distributor.



STANDARD TRANSFORMER CORPORATION

3588 ELSTON AVENUE, CHICAGO 18, ILLINOIS

COIL SHIPMENT CHECKUP



Mel Brown, president and owner of Melvin Electronics Company, 321 Madison Street, Oak Park, Illinois, checking his first order of the new line of coils now being shipped by Merit Coil and Transformer Corp., 4427 N. Clark St., Chicago, Ill. Brown won the *National Jobber of the Year* award, at the '51 Chicago parts distributors' trade show.

RCA'S VOLTOHMYST CONTEST WINNER



Max Cramer (left), of Hatry and Young, Inc., Boston, receiving an RCA WV97A senior volt-ohmyst meter, the first prize in a product-information contest staged by the RCA tube department during the recent NEDA show in Cleveland. Witnessing the presentation is Jim Owens, manager of RCA's test equipment group.

From the earliest
days of Radio ...
to the present
era of Television ...



have been
preferred for their

**ABSOLUTE UNIFORMITY
SUPERIOR QUALITIES
and
ULTIMATE ECONOMY
for SERVICE MEN**

A WORD TO THE WISE



CORNISH WIRE COMPANY, INC
50 Church Street, New York 7, N. Y.



Ask for the
SMITH
Roof Mount
FOR TV MASTS
Made of Sturdy
Cast Aluminum

- Pat. App. For
JUST WHAT TELEVISION INSTALLERS
HAVE BEEN LOOKING FOR.
- 1—ALL ALUMINUM CASTINGS WITH PLATED STEEL BOLTS.
 - 2—TESTED TO WITHSTAND ANY NORMAL LOAD UP TO 1500 LBS.
 - 3—WILL TAKE TUBING O D 3/4" TO 2".
 - 4—THE ORIGINAL SADDLE MOUNT FOR ROOF RIDGE.
 - 5—CAN BE USED ANY PLACE ON ROOF.
 - 6—IDEAL MOUNT FOR TALL MAST.
 - 7—HOLDS BASE OF PIPE AT FIXED POSITION FOR RAISING OR LOWERING.

Thousands in use. Ask your Jobber—or
write for Circular
SMITH ELECTRIC MFG. CO.
Ashland, Ohio

New Parts . . . Instruments . . . Tools

ELECTRONIC MEASUREMENT VTVM

A *vtm*, 106, designed for field alignment of radio and TV sets, has been developed by Electronic Measurements Corp., 280 Lafayette St., New York 12, N. Y.

Instrument includes five *ac-dc* and ohm ranges, featuring a 1½-volt range for both *ac-dc* volts. Measures 7¼" x 5¼" x 2¾" and weighs three pounds.



* * *

CLAROSTAT LOCKING DUAL-CONCENTRIC CONTROLS

Adaptation of a design for locking shafts at a desired setting on a dual-concentric control has been announced by Clarostat Mig. Co., Inc., Dover, N. H.

Construction is said to allow the replacement of two panel units requiring locked semi-permanent settings. Control is a dual-concentric unit with concentric operating shafts. Tapered jam nuts are used for locking the individual controls at any desired settings.

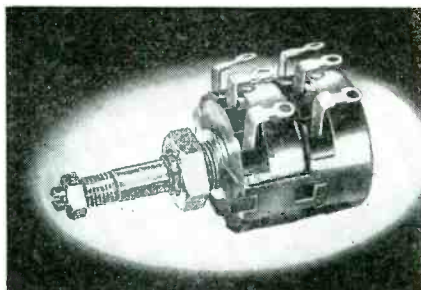

* * *

AEROVOX HV TUBULAR CERAMIC CAPACITORS

High-voltage tubular-ceramic capacitors, *SI-TV*, available in a 6000-volt rating, have been announced by the Aerovox Corp., New Bedford, Mass.

Available in eleven capacitance values from 4.7 to 47 mmfd.

THE WORLD'S LEADING TWIN LEAD TELEVISION LIGHTNING ARRESTER

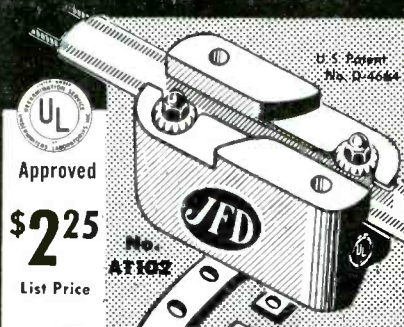

Approved

\$225

List Price



completely waterproof

SAFE TV GUARD

Protects television sets against lightning and static charges. Simple to install everywhere and anywhere... no stripping, cutting or spreading of wires. More than 500,000 in use today!

See your jobber or write to —



MANUFACTURING CO., INC.
8109-M 16th Ave., Brooklyn 4, New York
FIRST In Television Antennas and Accessories

HEATH VTVM KIT

A *vtm* kit, *V5*, which features a three-piece cabinet consisting of front panel and rear cover fitting over a recessed flange on the case, has been announced by the Heath Co., Benton Harbor, Michigan.

Kit includes a 4½" meter that is said to have a 200-microampere movement and a two-color meter scale which indicates db, *ac* volts, *dc* volts, ohms, and mid-scale zero set mark.

Instrument reads from ½ to 1000 *v* on either *ac* or *dc* in six different voltage ranges of 0.3, 10, 30, 100, 300 and 1000. Measures resistance from .1 ohm to over 1 billion ohms in six ranges of R x 1, x 10, x 100 x 1,000, x 10,000 and x 100,000.



JENSEN INDUSTRIES CUTTING NEEDLES

A line of cutting needles has been announced by Jensen Industries, Inc., 329 S. Wood Street, Chicago 12, Ill.

The needles are available with either steel or sapphire points. They are packaged six to a box.

* * *

KESTER INSTANT-ACTION RESIN-CORE SOLDER

An active resin flux, *44 resin*, for resin-core solder has been announced by Kester Solder Co., 4201 Wrightwood Ave., Chicago 39, Ill.

Solder melts, wets the metal, and flows or spreads all in one action. Resin is said to be non-corrosive and electrically non-conductive.

* * *

HICKOK VTVM

A vacuum-tube voltmeter, model 215, that features a dual-purpose *ac-dc* probe as a single unit, with builtin switching arrangement, has been introduced by The Hickok Electrical Instrument Co., 10521 Dupont Ave., Cleveland 8, Ohio.

Ranges include . . . *dc* voltmeter: volts, 0 to 1.5, 3, 12, 30, 120, 300, 1200; input resistance, 10 megohms with dual-probe. Accuracy is said to be $\pm 3\%$ of full scale. Zero center scale for discriminator alignment and other galvanometer applications. Ohmmeter design center is 10 ohms; ranges, $\times 1$, $\times 10$, $\times 100$, $\times 1000$, $\times 10,000$, $\times 100,000$, $\times 1$ megohm; readability, .2 ohm to 1000 megohms. *AC* voltmeter has 7 *ac rms* ranges, 0 to 1.5, 3, 12, 30, 120, 3000, 1200; 7 *ac* ranges, peak-to-peak, 0 to 4, 8, 32, 80, 320, 800, 3200. Frequency is said to be flat from 40 cps to 3.5 mc (crystal probe available to extend useful range to 250 mc). Input impedance, with dual-probe, 30 megohms shunted by 150 mmfd. Accuracy said to be $\pm 5\%$ of full scale.



* * *

INSULINE METAL CABINETS

A line of utility metal cabinets, featuring removable front and back covers, has been announced by the Insuline Corp. of America, 3602-35th Ave., Long Island City 1, N. Y.

Cabinets may be used for amplifiers, monitors, test sets, control units, miniature receivers and transmitters, etc., and range in size from 4" x 2" x 4" to 12" x 11" x 8". Available in natural and gray aluminum and in black ripple steel. Covers are fastened by means of self-tapping screws.

ANASTIGMATICALLY

CORRECT

UNIFORM FOCUS

UNIVERSAL TV DEFLECTION YOKES

FOUR MODELS DIRECTLY REPLACE IN 80% OF ALL TV RECEIVERS

CLETRON Yokes include the latest advances in design to simplify replacements and large picture tube conversions. Excellence in quality and workmanship combine to give the finest possible performance in a TV receiver.

Anastigmatically corrected coils are used in all units to insure sharp focus over the entire picture area.

High-temperature insulating materials provide for widely varying conditions without breakdowns.

Quadruple formvar insulation affords maximum protection from high voltage failures.

Write for complete information today.

LIST PRICES:

For 55° Deflection Angle . . . \$7.50
For 70° Deflection Angle . . . 10.50

CLEVELAND ELECTRONICS, INC.

6618 Euclid Ave. • Cleveland 3, Ohio

Morhan Exporting Corp., 458 Broadway, NY, NY.



Quality manufacturers of a complete line of

**Radio TV Speakers
Waterproof Speakers
TV Lightning Arresters**

Cletron

PERCO LIGHTNING GUARD

A 15-ampere lightning guard twinlead designed to prevent damage caused by lightning has been announced by Perco Precision Electronic Research Co., Garland, Texas. Manufactured in short lengths of 6' with lugs attached for fastening to the TV set. In the near future, lengths of 25' to 100' will be available so that the entire ordinary twin lead may be replaced.

Also available is a lightning guard fuse-tube for lightning protection on the 110-v-side of the TV set. Has a 10" glass tube designed for mounting on the back of the set. Fuse tube supplied with mounting clips and 6' cord set. It replaces the standard cord set.

ERIE MINIATURE TUBULAR CERAMIC CAPACITORS

A line of miniaturized ceramic capacitors, *GP3 ceramicons*, has been announced by Erie Resistor Corp., Erie, Penna.

Capacitance values as high as .002 mfd are available on a basic 1/8" x 3/8" long tube, and .005 mfd on a 1/8" x 5/8" long tube.

Capacitors are flash tested at 1500 *v dc*, and are said to withstand 700 *v dc* life test at 85° C for 1000 hours. Standard capacitance tolerance is +80%, -20% and power factor is 2.5% maximum.

PLYMOUTH

Quality

Antenna Mounts

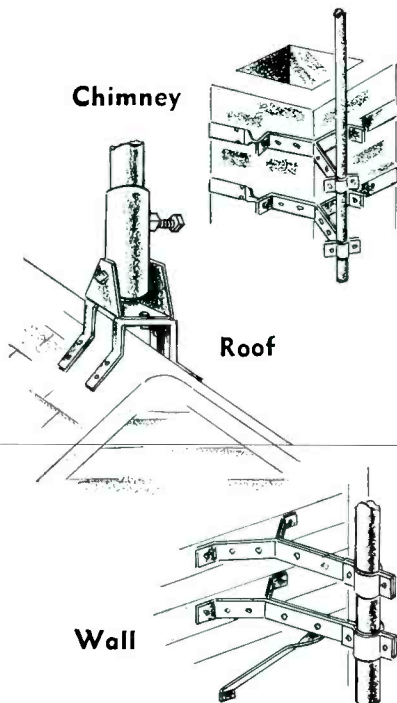

Individually packaged, complete with hardware, ready for installation. Send today for free catalog showing entire line and price list. More than 15 styles in stock.

PLYMOUTH

electronic corp.

50 KINGSBURY STREET
WORCESTER 10, MASS.



MEMBERSHIP

assures integrity of circulation
SERVICE has belonged to ABC for over 16 years

WHEN YOU CHANGE YOUR ADDRESS

Be sure to notify the Subscription Department of SERVICE at 52 Vanderbilt Avenue, New York 17, N. Y., giving the old as well as the new address, and do this at least four weeks in advance. The Post Office Department does not forward magazines unless you pay additional postage, and we cannot duplicate copies mailed to the old address. We ask your cooperation.

NEWS

RCA TUBE DEPARTMENT APPOINTS STAMM AD MANAGER

Harold S. Stamm has been appointed manager of advertising and sales promotion of the RCA tube department, Harrison, N. J., succeeding Lawrence LeKashman, who has resigned.

Formerly administrative assistant to the advertising manager, Stamm has also been an instructor at the Newark division of Rutgers University, conducting courses in advertising.



Harold S. Stamm



Fred H. Garcelon

GARCELON BECOMES HYTRON EASTERN S-M

Fred H. Garcelon has been appointed eastern sales manager for Hytron Radio and Electronics Co., Salem, Massachusetts.

Garcelon joined Hytron in June '49, handling sales to equipment manufacturers in the eastern area.

* * *

LOUIS MARTIN JOINS STANDARD COIL AS GENERAL SALES MANAGER

Louis Martin has been appointed to a newly created post of general sales manager of Standard Coil Products Co. Inc., Chicago, Los Angeles and Bangor, Michigan.

Martin was formerly with General Instrument Corp., where he was general sales manager of the Elizabeth and Sickles divisions. He will direct all sales operations from the Standard Coil main office, 2329 North Pulaski Road, Chicago 39, Ill.



Louis Martin



C. J. Luten

LUTEN NOW SYLVANIA NEWS EDITOR

C. J. Luten has been appointed editor of *Sylvania News*. Luten succeeds Robert A. Penfield, who has been named advertising and sales promotion supervisor.

Formerly, Luten served as assistant director of educational advertising to The Ronald Press Co., New York.

* * *

Presenting THE NEW Mueller NEEDLE CLIP

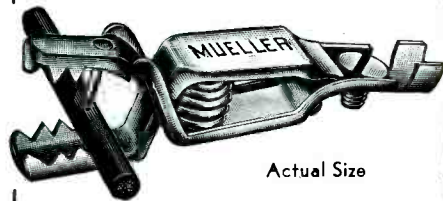

Actual Size

PIERCES INSULATION TO MAKE QUICK CONTACT

Solid bronze, non-corroding. Wire centers itself in notched jaw. Teeth on sides of jaw allow use for many other applications.

— USED IN —

- Electric and radio service shops
- Telephone and power company testing and maintenance
- Laboratory test work
- Hooking up truck trailer lights
- Field telephone and signal work

SEND FOR FREE SAMPLE AND CATALOG 818

Mueller Electric Co.

1565 E. 31st St., Cleveland 14, Ohio

RCA '52 POCKET REFERENCE BOOK

Publication of the '52 edition of the yearly reference book on RCA tubes, electronic components, test equipment, batteries, and miniature lamps, has been announced by RCA tube department.

Book contains complete product listings and comprehensive data on the characteristics, interchangeability, and socket requirements of more than 450 RCA receiving tubes, including picture tubes. It provides similar data on 75 dry batteries.

Other sections of the book include an interchangeability directory on non-receiving tube types; a battery replacement guide showing RCA replacement batteries for more than 300 portable radios of 47 manufacturers; section on radio and TV test equipment, which gives detailed descriptions of essential test instruments and outlines their uses in servicing and trouble shooting; components directory for RCA Victor TV receivers; and a description of technical literature available on the various RCA products.

In addition, the reference book offers basic data on fundamentals of TV, and some helpful hints on television troubleshooting, compiled by John Meagher. Other convenient features of the book are a 56-page daily diary for '52, calendars for '52 and '53, and 16 pages of full-color maps.

* * *

ELECTRONIC PUBLISHING MOVES

The Electronic Publishing Co., Inc., producers of radio parts and equipment catalogs for distributors, has moved to 108 North Wacker Dr., Chicago 6, Ill.

**SPRAGUE 4TH EDITION OF
TV CAPACITOR MANUAL**

The fourth edition of the Sprague TV replacement capacitor manual, *M-481*, has been published. It contains capacitor replacement data on 1561 receiver models by 63 manufacturers.

Edition shows set-by-set listings of original equipment capacitors and recommended Sprague replacements. Rating data and manufacturer's part numbers are listed for the original capacitor, while Sprague catalog numbers and electrical specifications are given for the replacement unit. A condensed listing of all Sprague TV capacitors is also included in the manual.

A special section lists capacitor *service packages* which contain all the electrolytics necessary to service any particular brand of TV set.

Free copies of the manual are available from local Sprague distributors, or may be obtained directly from Sprague Products Company, North Adams, Mass., on receipt of 10c to cover mailing and handling.

* * *

**JOHN GILTNER TWIST NOW SANGAMO
CAPACITOR DIVISION S-M**

John Giltner Twist has been appointed sales manager of the capacitor division of Sangamo Electric Co., located at Marion, Illinois. Twist has served as assistant sales manager of the division during the past five years. He joined Sangamo in '46 after serving as Lt. Col. in Air Force Communications.



John Giltner Twist

* * *

**TAYLOR BECOMES SANGAMO SALES-
PROMOTION MANAGER**

William W. Taylor has been appointed sales promotion manager of the capacitor division of the Sangamo Electric Co., Springfield, Ill. He will be in complete charge of all phases of capacitor advertising activities.

* * *

TV-Q OPENS NEW BUILDING

A 1-story building has been opened by the TV-Q Custombilt Tube Corp. at 170 Fifth Ave., Hawthorne, N. J.

At a recent board meeting V. E. Havers was elected president and treasurer of the company. Others elected were: M. Dwyer, first vice president; Alfred Steinberg, comptroller and second vice president; K. Havers, secretary; and M. Camera, assistant secretary.



OAK RIDGE CRT TESTER



"CATHETTE"

is the **ONLY CRT Tester** that checks **ALL** the following:

- HIGH VOLTAGE BREAKDOWN
- BEAM CURRENT MEASUREMENT
- ELECTRON GUN CONDUCTANCE
- SHORTS BETWEEN ANY ELEMENTS

Plus these additional features:

- Checks gas between elements in Electron Gun
- Checks gas between High Voltage Anode and Electron Gun
- Checks conductance between Cathode, Control Grid, and Screen Grid
- Checks filament continuity
- Checks high voltage on Anode
- Checks Screen to Control Grid voltage from set
- Checks Control Grid to Cathode voltage from set
- Checks leakage
- Tests and positions Ion Trap
- Checks brightness control voltage
- Easy - to - read calibrated DC Voltage scales (0 - 500V, 0 - 15KV)
- Easy - to - read tube test scales
- Supplied with duo-decal plug and socket. (Special adaptors available as accessories)
- Pocket size: 5 1/2 x 3 7/8 x 2 1/4". Shipping weight 3 lbs.

Ask to see this *indispensable* new tool at your nearest jobber. You'll agree that it's a *must* for every TV Serviceman today!

MODEL 106 "CATHETTE" CRT Tester. ----- Net **\$29⁹⁵**
 MODEL 108 POWER SUPPLY (Pocket Size, same as above), used in conjunction with Cathette CRT Tester, permits testing of Picture Tubes in carton! ----- NET **\$19⁹⁵**

Send NOW for your copy of our complete new catalog, illustrating and describing the above equipment, as well as all other OAK RIDGE TV Test Instruments.
 Cable Address: "UNIONTEX" N. Y.



OAK RIDGE PRODUCTS, Dept. S
 37-01 Vernon Blvd., Long Island City I, N.Y.

Please send your complete new OAK RIDGE Catalog at once, to:

Name -----
 Address -----
 City ----- State -----

OAK RIDGE PRODUCTS
 37-01 Vernon Blvd. Long Island City I, N. Y.
 Mfg Division of VIDEO TELEVISION, INC.

**WILLIAMS NAMED STACKPOLE
ELECTRONIC DIV. MANAGER**

H. A. Williams has been appointed manager of the electronic components division of the Stackpole Carbon Company, St. Marys, Pa.

* * *

HALLDORSON CATALOG

A catalog-manual which includes, not only a complete TV and auto replacement guide, but also other useful information, has been published by the The Halldorson Co., 4500 N. Ravenswood Ave., Chicago 40, Ill.

The catalog-manual features an up-to-date listing of TV replacements such as flybacks, deflection yokes, focus coils, etc.

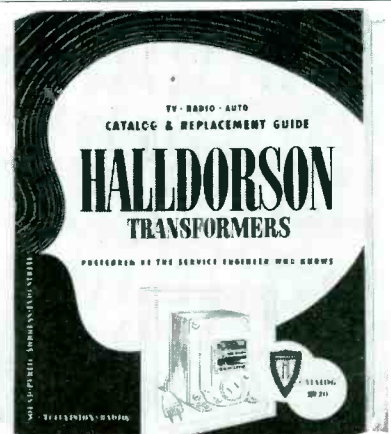



TUBE News

by L. M. ALLEN

Features of Subminiatures Designed to Replace Miniatures in Wide-Band IF and RF Amplifiers, UHF Oscillators, Triode RF-Mixer Circuits, etc.

SUBMINIATURES, which have made it possible to develop and construct many unusual and highly efficient types of special apparatus, are now rapidly being adopted as substitutes for larger tubes in standard types of gear where space and, in some instances, operational economy, are key factors.

There appear to be many subminiatures which can be used as large-tube alternates. There is the CK6148* which is an equivalent of the well-known miniature 6AK5, and has been available in subminiature form for over five years as CK605CX* or CK5702*. Within the past year a design modification was made in the CK5702 which was found to improve the microphonic characteristics. Aside from slightly different interelectrode capacitances, and higher heater current, the CK6148 duplicates the basic 6AK5 characteristics and has the same oval cathode, and grid 1 and 2 parts. Many have found that this subminiature equals and in some cases exceeds the *rf* class A and C performance of the 6AK5. The uses have been in wide-band *if* and *rf* amplifiers.

Because of its size, the tube does have a few negative properties, which, however, can be corrected. For instance, the tube is not free of heater-cathode leakage, particularly the low-voltage leakages that are commonly the cause of hum trouble in audio-frequency circuits. To eliminate this the cathode of this tube must always be adequately bypassed to ground to prevent unexpected variations (par-

ticularly at high-heater voltage) from tube to tube, producing hum effects. The amount of bypassing necessary depends upon the frequency range and signal level of particular equipment design. It has been found that a rough determination of the susceptibility of a particular circuit to hum may be established by temporarily shunting a ½-megohm resistor from cathode to each heater lead. The normal 100-volt heater-cathode leakage tests do not serve as a suitable indication of the hum characteristics for any tube type since the heater-cathode voltage-current curve is nonlinear, especially

in the ±20-volt range. For this reason, a tube whose heater-cathode resistance appears to be 20 megohms at 100 *v* may have a heater-cathode resistance as low as ¼ megohm in the ±20 *v* range. Frequently, this low voltage heater-cathode leakage hum can be reduced appreciably by biasing the heater at a potential of 20 to 50 volts positive with reference to the cathode, to operate above the knee of the heater-cathode leakage curve and at a point where the *ac* resistance is relatively high.

VHF/UHF Subminiature

Another interesting type of subminiature, which uses the basic oval cathode and grid construction of the 6AK5 is the CK6149*. It is suitable for *rf* applications up to 500 mc such as oscillators, frequency doublers, and grounded-grid class A or class C *rf* amps. As an oscillator operating from a 150-volt plate supply, the CK6149 will produce approximately 0.9 watt useful power output at 500 mc with 3 watts plate-input power. The improved microphonic characteristics of the tube have been found to make it an attractive low-signal level audio and video amplifier. For high-peak current class C applications, such as *uhf* oscillators, where performance at low-filament voltage is the prime requisite, the shorter life, higher-cathode temperature type CK5703* has been found preferable to the CK6149, providing more reliable operation.

*Raytheon.

Ferrite-core nylon-coil bobbin anti-astigmatic focusing (resulting from cosine distributed windings) 70° deflection yokes, DY-8 and DY-9, announced by Standard Transformer Corp. The DY-8 has a horizontal inductance of 8.5 mh and a vertical inductance of 50 mh, while the DY-9 has a horizontal inductance of 13.5 mh and a vertical inductance of 50 mh.

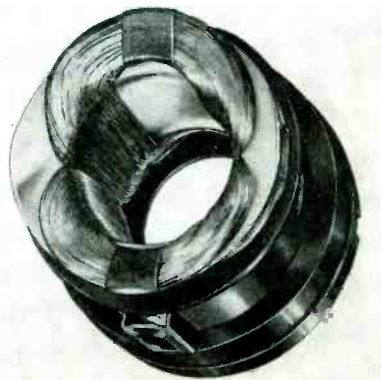

How Bing Crosby's Shavex Speeds up Electric Shaving

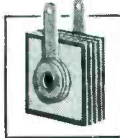
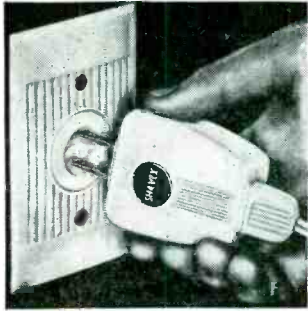

Model 5M4
Rectifier
Illustrated
Current rating
75MA. Max.
Input 120V. RMS
Max. Inv. Voltage
300V. Size 1"
square.

... THANKS TO VERSATILE SELETRON SELENIUM RECTIFIERS

A wonderful boon to faster whisker removal as smooth as Bing's voice is the Crosby Shavex* which changes household alternating current to D.C., thus boosting the power and speed of any electric razor as much as 40% . . . And built into each unit is a miniature SELETRON Selenium Rectifier No. 5M4 for trouble-free operation.

The Shavex is very small, and excessive heating within such a compact enclosure could be a problem. Yet President William H. Burgess of Shavex Division, Electronic Specialty Co., Los Angeles 39, says that extensive temperature tests under full load show SELETRON rectifiers operate much cooler than other rectifiers tested . . . and SELETRON's reliability has been confirmed by successful use of the Shavex under varied conditions of temperature and humidity over a period of several years.

SELETRON builds 'em midget size for radio, TV and other electronic circuits, all the way up to the giant stack assemblies for industrial use. Perhaps the unusual Shavex application may give you an idea for putting these versatile selenium rectifiers to work in some other unique spot . . . If so, SELETRON engineers can be of real assistance. Write us today, and request your copy of bulletin 104-B-1.

*Reg. T.M. of
Electronic Specialty Co.

SELETRON DIVISION
RADIO RECEPTOR COMPANY, INC.



Since 1922 in Radio and Electronics



Sales Dept.: 251 W. 19th St., New York 11, N. Y. - Factory: 84 N. 9th St., Brooklyn 11, N. Y.



BUY A BETTER ANTENNA

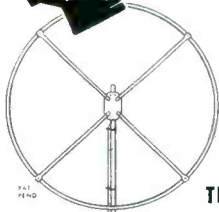

It's Circle-X for clear, sharp pictures on all channels, compare it and note the superiority . . .

Buy Circle-X chimney mounts, twin lead, guy wire, ground rods, wrenches, etc.

TRY A CIRCLE-X ON YOUR NEXT INSTALLATION

Air express or parcel post, special delivery direct from factory to you through your distributor.

CIRCLE-X ANTENNA CORP.
511 MARKET ST., PERTH AMBOY, N. J.



*If you haven't received your copy
of the new*

1952 SOUTH RIVER CATALOG
*on the World's Finest Antenna
Mounting Materials just mailed to
all Jobbers, Dealers and Service
Men, write*

SOUTH RIVER METAL PRODUCTS CO., INC.
SOUTH RIVER, NEW JERSEY

Specified by Manufacturers* for Servicing 2-Way Mobile Radios



**FILTERED
DC POWER SUPPLY**

Leading Radio Manufacturers Say . . . "It's the only Power Supply to withstand continuous high overloads, so we specify the Model 'B' for servicing." Exclusive "Electro" application of selenium rectifiers, aided by conduction cooling, doubles rectifier power rating, dissipates over 3 times the heat at lowest cost per ampere output. Supplies 1 to 20 amperes continuous duty with a peak instantaneous rating of 35 amperes. Operates two auto radios with push-button solenoids simultaneously.

Other Uses: Phone circuits, relays, instruments, low voltage devices. Battery charging and electroplating.

**Names on request.*

**MODEL "BJ" LOW COST POWER SUPPLY
6 VOLTS DC, 1 to 12.5 AMPERES—Net \$37.50**

Model "S"
Converts Battery
Radios to AC
ALL-ELECTRIC



Cash In On Big Battery-Radio Market

Hum-free reception from any 1½ volt, 4 to 6 tube battery radio using 115 volt, 50/60 cycle source. Uses less than ¼ the power of cheapest AC radio. Fits battery space.

Many Other Models Available



ELECTRO PRODUCTS LABORATORIES
4501-5M N. RAVENSWOOD AVE., CHICAGO 40, ILL.

Name _____

Firm _____

Street _____

City _____ Zone _____ State _____

Mail Coupon
for Catalog

In Canada . ATLAS RADIO CORPORATION . LTD. . TORONTO

For AC CURRENT ANYWHERE
NO MAGIC just use
ATR
INVERTERS



ATR
STANDARD AND HEAVY DUTY INVERTERS



For Inverting D. C. to A. C.
 Specially Designed for operating A. C. Radios, Television Sets, Amplifiers, Address Systems, and Radio Test Equipment from D. C. Voltages in Vehicles, Ships, Trains, Planes and in D. C. Districts.

NEW MODELS **NEW DESIGNS**
NEW LITERATURE

"A" Battery Eliminator, DC-AC Inverters
 Auto Radio Vibrators

ATR See your jobber or write factory

AMERICAN TELEVISION & RADIO Co.
 Quality Products Since 1931
 SAINT PAUL 1, MINNESOTA-U. S. A

JOTS AND FLASHES

TV DXING, with the advent of super-gain *rf* inputs and *if* stages, and particularly, highly-effective sync circuits for signal locking, has become as exciting a pastime as the long-distance pickup hobby of the early days. With practically every manufacturer seeking this market, the so-called primary-viewing area has broadened everywhere. On the pacific coast, the setmakers are producing chassis with quite an assortment of fringe-viewing features, one company producing a chassis known as *Fringe-O-Matic*. In the middle west and east, the chassis are featuring fringe-lock, super-power, etc., types of circuits. Full details on representative-types of such DX chassis appear in this issue on pages 24 and 26. Subsequent issues will feature a continuing analysis of this interesting developmental cycle. . . . U.A. Sanabria is now prexy of a new corporation, American Television Manufacturing Corp., which has been organized to engage in government contracts in picture tubes, TV and electrical devices, etc. . . . Seven basic circuit and component requirements determine the overall performance of TV picture tubes, according to W. B. Whalley of the physics lab, Sylvania Electric. Appearing before a session of the AIEE, Whalley said that the seven basic criteria include resolution, synchronization, contrast and gamma, control of black level, noise and interference contrast, picture-area stability and brightness. Detailed considerations of synchronization, Whalley said, should include the sync amplifier and separation filter, the noise-pulse reduction characteristics of the video amp, the influence of horizontal *agc*, ripple voltages, and undesirable *ac* magnetic fields. . . . Kendrick Lippitt, chief engineer of TACO, recently presented a talk on *Antennas and Master-Antenna Systems* before a jobber meeting in Minneapolis, Minn. . . . Percy M. Stewart has been elected to the board of directors of DuMont Labs. . . . Sylvania has announced the official opening of a radio tube plant in Shawnee, Okla. To celebrate the opening, two service meetings were held, one at Tulsa and the other at Oklahoma City. H. Allen White of the Sylvania factory sales service engineering staff presented a lecture and a demonstration on actual TV servicing problems. Other Sylvania personnel present included Arden Still, sales manager, distributor tubes; John Hauser, assistant sales manager, distributor tubes; William Buschmann, merchandising coordinator; and C. J. Luten, editor of *Sylvania News*. . . . A booklet, *Television Interference*, representing a collection of articles by Phillip S. Rand, of Remington Rand Inc., has been released by the Remington Rand Laboratory for Advance Scientific Research, South Norwalk, Conn. . . . A new version of the DuMont TV picture-tube selector, introduced recently, is now available. . . . The merchandising and selling team of Allied Radio now consists of Alex Brodsky, merchandising manager; S. H. Levey, sales manager; J. W. Rubin, sales promotion and advertising manager; and L. M. Dezettel, purchasing agent. . . . Richard H. Schneberger is now general service manager of the Crosley division of Avco Manufacturing Corp. . . . Douglas Wright, president of Wright Inc., St. Paul, Minn., has reported that he has not been associated with Wright-Zimmerman Inc., for several years, and has nothing to do with the operations of that company.

ADVERTISERS IN THIS ISSUE

SERVICE INDEX—DECEMBER, 1951

AMERICAN TELEVISION & RADIO CORP.	64
Agency: Firestone-Goodman Adv. Agency	
ANCHOR RADIO CORP.	17
Agency: Symonds, MacKenzie & Co.	
ASTRON CORP.	50
Agency: Hart Lehman, Advertising	
BLONDER-TONGUE LABS.	55
Agency: Lester Harrison, Inc.	
CIRCLE-X ANTENNA CORP.	63
Agency: Homer Harding	
CLEAR BEAM TV ANTENNAS	56
Agency: A. James Rouse Co.	
CLEVELAND ELECTRONICS, INC.	59
Agency: The White Adv. Co.	
CORNELL-DUBILIER RADIART	44
Agency: Stern and Warren	
CORNISH WIRE CO., INC.	58
Agency: Hart Lehman, Advertising	
ALLEN B. DUMONT LABORATORIES, INC.	7
Agency: Austin C. Lescaurhoura & Staff	
ELECTRONIC INSTRUMENT CO., INC.	54
Agency: H. W. Hauptman Co.	
ELECTRO PRODUCTS LABORATORIES, INC.	63
Agency: Clarence M. Gotsch Associates	
FERRO ELECTRIC PRODUCTS, INC.	11
Agency: Fuller & Smith & Ross, Inc.	
GENERAL ELECTRIC	1
Agency: Maxon Inc.	
GENERAL ELECTRIC LAMP DEPT.	46
Agency: Batten, Barton, Durstine & Osborn, Inc.	
THE HEATH COMPANY	39
Agency: G. Dean Arend, Advertising	
HYTRON RADIO & ELECTRONICS CO.	27
Agency: Bennett, Walthier & Menadier, Inc.	
JACKSON ELECTRICAL INSTRUMENT CO.	45
Agency: Parker Adv. Co.	
JFG MFG. CO., INC.	58
Agency: Shappe-Wilkes Inc.	
JENSEN MFG. CO.	2
Agency: Burton Browne, Advertising	
KESTER SOLDER CO.	37
Agency: Paul J. Steffen Co.	
LA POINTE-PLASCOMOLD CORP. (VEE-D-X)	53
Agency: The F. W. Prella Co.	
P. R. MALLORY & CO., INC.	Inside Back Cover
Agency: The Altkin-Kynett Co.	
MERIT COIL AND TRANSFORMER CORP.	5
Agency: Burton Browne, Advertising	
MOSLEY ELECTRONICS	50
Agency: Rudolph Bartz, Advertising	
MUELLER ELECTRIC CO.	60
OAK RIDGE PRODUCTS	61
OXFORD ELECTRIC CORP.	49
Agency: Sander Rodkin Adv. Agency	
PERFECTION ELECTRIC CO.	54
Agency: Seantlin & Co.	
PLYMOUTH ELECTRONICS CORP.	60
Agency: Howard-Wesson Co.	
PRECISION APPARATUS CO., INC.	4
Agency: Shappe-Wilkes Inc.	
RCA INSTITUTES, INC.	33
Agency: J. Walter Thompson Co.	
RAD-EL-CO MFG. CO.	48
Agency: Lehman Wood	
RADIART CORP.	Inside Front Cover
Agency: Stern and Warren	
RADIO CORPORATION OF AMERICA	23, Back Cover
Agency: J. Walter Thompson Co.	
RADIO RECEPTOR CO.	63
Agency: Walter J. Zimmerman & Associates	
RAULAND CORPORATION	31
Agency: MacFarland, Aveyard & Co.	
RAYTHEON MFG. CO.	12
Agency: Walter B. Snow & Staff	
REGENCY DIV. I.D.E.A., INC.	29
Agency: Burton Browne, Advertising	
JOHN F. RIDER PUBLISHER, INC.	8
Agency: Contl Adv. Agency, Inc.	
HOWARD W. SAMS & CO., INC.	48
Agency: George Brodsky, Advertising	
SANGAMO ELECTRIC CO.	9
Agency: Arthur R. Mogge, Inc.	
WALTER L. SCHOTT CO.	6
Agency: Tilds & Cantz	
SIMPSON ELECTRIC CO.	10
Agency: Burton Browne, Advertising	
SMITH ELECTRIC MFG. CO.	58
SNYDER MFG. CO.	47
Agency: Brooks and London	
SOUTH RIVER METAL PRODUCTS CO., INC.	63
Agency: Art-Copy Adv. Agency	
SPRAGUE PRODUCTS CO.	14
Agency: The Harry P. Bridge Co.	
STANDARD TRANSFORMER CORP.	57
Agency: Burnet-Kuhn Adv. Co.	
STANLEY SALES	56
Agency: C & D Advertising Agency	
SYLVANIA ELECTRIC PRODUCTS, INC.	3
Agency: Cecil & Preshrey, Inc.	
TEL-A-RAY ENTERPRISES, INC.	25
Agency: Keller Crescent Co.	
TUNG-SOL ELECTRIC INC.	35
Agency: E. M. Freystadt Associates, Inc.	
TV WIRE PRODUCTS CO.	50
WEBSTER ELECTRIC	43
Agency: Hamilton Adv. Agency, Inc.	
WRIGHT, INC.	56
Agency: Kay Advertising, Inc.	
THE WORKSHOP ASSOCIATES, INC.	51
Agency: Larcom Randall, Advertising	



Don't take chances with misfits!

In a field survey of servicemen on the subject of desirable volume control features, by far the most comments concerned easy adaptability and installation. If you want a control that is tailored for the job . . . and one that will deliver thousands of hours of smooth, quiet performance . . .

Make Sure! Make it Mallory!

When you use the Mallory Midgetrol* you are using a control designed to make your job easier and at the same time give your customer outstanding performance. Here is the unbeatable combination of Midgetrol features:

First, you get a permanently fixed, tubular brass shaft that can be adapted for split-knurl or flatted type knobs in a few seconds by inserting one of the steel shaft ends supplied in every package. This means utmost convenience without sacrificing the stability

of permanent, two-point shaft suspension.

Second, you get the convenience of AC-switch design that permits secure attachment, without removing the control housing. Positive indexing assures proper position.

Third, you get exceptionally accurate resistance values and taper curves.

Fourth, you can be sure of years of quiet, satisfactory service life through extremes of humidity and temperature.

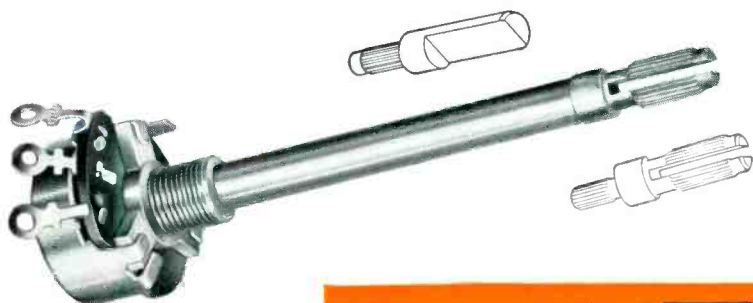

Make it Mallory and make sure! Ask your distributor to show you the time-proved Mallory Midgetrol with the new features that make installation faster and simpler than ever.

In addition to single controls, dual concentric Mallory Midgetrols can be made up easily by combining factory-assembled front and rear sections of desired resistance values. Ask your Mallory Distributor for details!

*Reg. U.S. Pat. Off.

P. R. MALLORY & CO. Inc.
MALLORY

CAPACITORS • CONTROLS • VIBRATORS • SWITCHES • RESISTORS
• RECTIFIERS • VIBRAPACK* POWER SUPPLIES • FILTERS

*Reg. U.S. Pat. Off.

APPROVED PRECISION PRODUCTS

P. R. MALLORY & CO., Inc., INDIANAPOLIS 6, INDIANA

You get all five

...with RCA Batteries

1. Radio-Engineered Quality

(for extra listening hours)

2. Radio Trade Distribution

3. Top Brand Acceptance

4. Greatest Array of Selling Aids

5. Completely Rounded Line

What is "radio-engineered quality"?

It's the extra performance you get from batteries that are specifically designed for radio use and built to exacting quality standards of RCA's tube and battery engineers.

For your customers, "Radio-Engineered Quality" means extra listening hours, greater satisfaction.

For you, it means more repeat sales, greater profits.

You get plenty of other benefits, too, when you stock and sell the RCA line . . .

You get Radio Trade Distribution . . . RCA Battery distribution steers customers back to radio dealers and servicemen . . . away from the non-radio outlets. Repeat sales come back to you, again and again.

You get Top Brand Acceptance . . . a pre-sold name that's known to every radio and TV set owner in America, a name that sells itself.

You get the greatest array of Selling Aids . . . signs, displays, merchandisers, servicing aids . . . all helping you to make sales right at the point of purchase.

You get a Completely Rounded Line . . . for example, there are seven batteries designed to meet most of your demand. The complete line provides a type for almost every portable and farm radio need.

Call your local RCA Battery Distributor now. Get full details on how you too can join in the radio-trade switch to RCA Radio-Engineered batteries. Hundreds of other radio dealers and servicemen are finding they are the batteries geared to their radio trade. You will too. So call your RCA Battery Distributor. Get lined up for more battery sales, better profits . . . today.



RADIO CORPORATION of AMERICA
RADIO BATTERIES **HARRISON, N. J.**