

SERVICE

JUNE
1951

6SJ7
Plate

6SL7

6L6

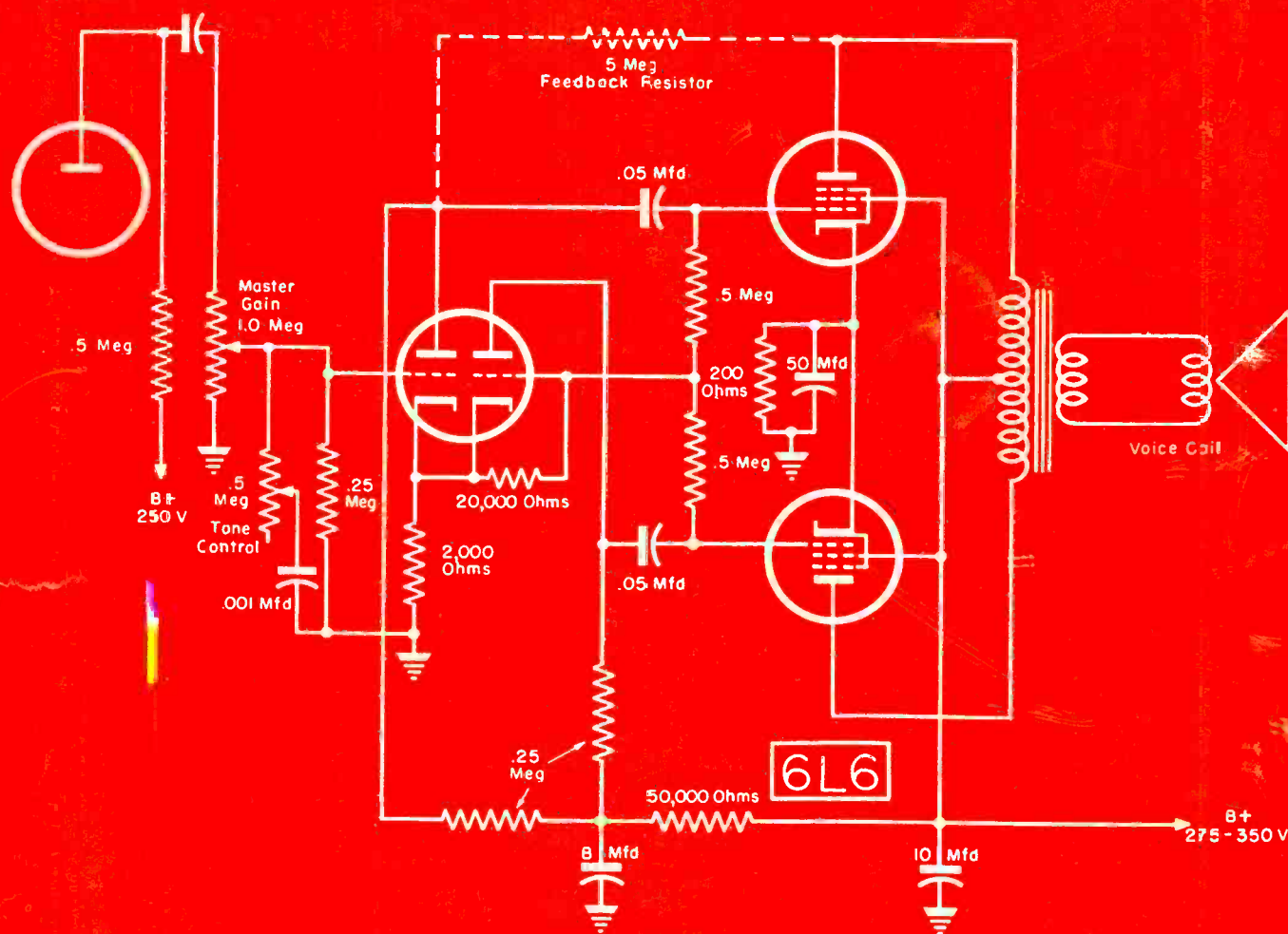

Multiple-input musical-instrument amplifier system.

[See page 2]

channel for channel

model for model

RADIART TV ANTENNAS

Outperform ALL Others!

regardless of price!

★ We can't make all the antennas in the world . . . so we make the best of it. Whatever the need . . . whatever the location . . . there is a RADIART antenna that will do the job better — and at no greater cost! Servicemen everywhere prefer RADIART antennas because of their many advantages! Easily and quickly installed . . . they stay up without maintenance and costly call-backs. The fine manner in which they perform is a credit to the installation company! AND . . . the complete variety of types makes it easy for servicemen to select the best antenna for his area. Recommended by all good distributors.

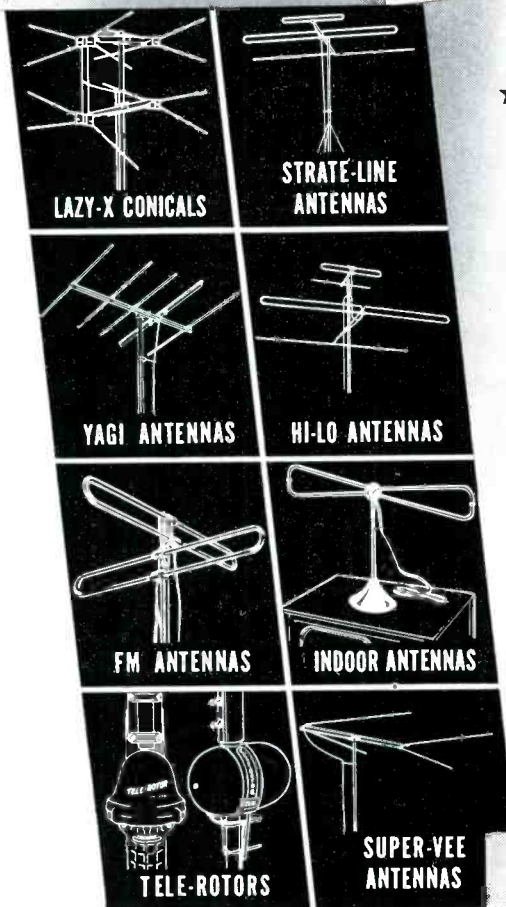

IT'S RIGHT WHEN IT'S RADIART

THE **RADIART** CORPORATION
CLEVELAND 2, OHIO



- VIBRATORS
- AUTO AERIALS
- ROTATORS
- TV ANTENNAS
- POWER SUPPLIES

"TO CUT COSTS, WE HAD TO CUT CALL-BACKS!"

**"Call-backs tied up our repairmen
—wasted valuable working time.
Quality tubes solved the problem
for us . . . G-E tubes!"**

Says

**EVERETT CAUDILL, Manager
Tel-Rad Center
829 Madison Ave., Covington, Ky.**

"We were building up a big log of repair time that we couldn't invoice—and profits were narrowing in consequence. Too many of our Cincinnati and Covington customers kept phoning in that their sets wouldn't work, anywhere from a day to a week after our repairmen had been there. The trouble was mostly tube failures. We had to stop that in its tracks—and we did, by going over 100-percent to quality tubes. . . . When we say 'quality tubes' here at Tel-Rad Center, we mean, first of all, General Electric tubes. Our whole staff agrees on that!"



● Receiver owners, Tel-Rad finds, ask to be shown the G-E label on tube cartons. They've learned that when quality tubes—G-E tubes—are installed as replacements, their TV sets will perform better; will give many more hours of trouble-free enjoyment.

● How well-made can tubes be? Study G-E tubes to find out! Below, a polariscope is used to check G-E receiving-tube stems for glass strains that might result in warping or fracture. Only one of many scientific G-E factory tests for top tube quality!



FOR QUALITY TUBES TO CUT DOWN YOUR CALL-BACKS, SEE YOUR G-E TUBE DISTRIBUTOR!

GENERAL  **ELECTRIC**
181-KA8

LEWIS WINNER
Editor

F. WALEN
Assistant Editor

Including *Radio Merchandising* and *Television Merchandising*
Registered U. S. Patent Office



CUTAWAY
VIEW

**"no one has
ever heard a
G-610
who didn't
want one!"**

**We believe this state-
ment is literally true . . .**

The Jensen G-610 Loudspeaker System brings you clear, clean, life-like reproduction with thrilling transport-to-the-original such as you have never heard before. Of course G-610's are in short supply, for the government has restricted cobalt for Alnico V magnets — and the G-610 has more magnetic energy than any speaker ever built. But when restrictions are relaxed and G-610's are again plentiful, then be sure you get a G-610 . . . **NO ONE** has ever heard one who didn't want one!

*Furnished complete with Crossover
and Control Network illustrated below.*

Jensen
MANUFACTURING COMPANY

Division of The Muter Company

6601 So. Laramie Ave. • Chicago 38, Illinois

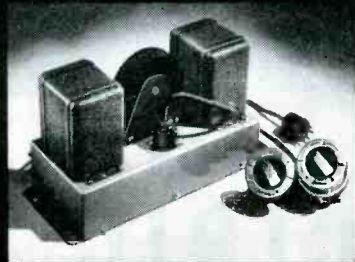

Association News	64
At Chicago Parts-Show Clinics	58
Audio Installation and Service (Groove-Dimension Control Loudness Controls). By Kenneth Stewart	28
Defense Program TV Chassis Substitution and Conservation Practices. By Walter Buchsbaum	18
Magnetic Recording (Mike Features and Application Possibilities). By L. S. Hicks	33
Metallic Rectifiers. By Julian Loebenstein	26
Musical Instrument Amplifiers (Cover). By Jack Darr	22
Selling and Installing Replacement Cartridges. By John D. Harper	20
Ser-Cuits (Stromberg-Carlson 24-Inch TV Set)	42
Service . . . The National Scene	15
Servicing Helps. By M. A. Marwell	40
Ten Years Ago in Associations	65
Tube News (Electrostatic-Focusing Rectangulars). By L. M. Allen	38
Views and News. By Lewis Winner	13

AUDIO INSTALLATION AND SERVICE

Corner Speakers	28
Dynamic Headphones	28
Groove-Dimension Control in Disc Recording	28
Loudness Controls	30
Three-Speed Record Changer	30
Three-Speed Transcription Player	28

CIRCUITS

Eye-Tube VTVM RF Test Circuit	40
Four-Channel Mixer and Preamp	34
Loudness-Control Circuitry System	30
Multiple Input Musical-Instrument Amplifier	23
Musical Instrument Amplifier (Cover)	22
RCA 17-Inch Electrostatic HV Circuit	40
Record-Player Circuit With and Without Loudness Control	30
Simplified Circuit for Electrostatic Focusing	19
Stromberg-Carlson 24C-24RP Sync Clipper, Video and Audio Amp	44
Stromberg-Carlson 24C-24RP Tuner	42
Stromberg-Carlson 24C-24RP Vertical Blocking Oscillator, Vertical Output Amp, and HV Supply	44
Stromberg-Carlson 24C-24RP Video IF Strip	43
Three-Phase Bridge and Three-Phase Half-Wave Metallic-Rectifier Systems	26

COVER

Musical Instrument Amplifier	22
--	----

SERVICING HELPS

Electrostatic-Tube Circuitry	40
Operation of RF Tester with VTVM	40
35Z5 Tube Substitutions	70

Index to Advertisers

Manufacturers	72
Jots and Flashes	72
News	61
New Parts . . . Tools . . . Instruments	66
Rep Talk	60
TV Parts . . . Antennas . . . Accessories	68



Entire contents Copyright 1951, Bryan Davis Publishing Co., Inc.

Published monthly by Bryan Davis Publishing Co., Inc.

52 Vanderbilt Avenue, New York 17, N. Y. Telephone MUrray Hill 4-0170

Bryan S. Davis, Pres. Paul S. Weil, Vice-Pres., Gen. Mgr. F. Walen, Sec. A. Goebel, Cir. Mgr.
Mid-West Representative: Stuart J. Osten, 333 N. Michigan Ave., Chicago 1, Ill. Telephone: Dearborn 2-3507
East-Central Representative: James C. Munn, 2253 Delaware Dr., Cleveland 6, Ohio. Telephone: ERIEview 1-1726
Pacific Coast Representative: Brand & Brand, 1052 W. Sixth St., Los Angeles 14, Calif. Tel.: Michigan 1732
Suite 1204, Russ Building, San Francisco 4, Calif. Telephone: SUtter 1-2251

Entered as second-class matter June 14, 1932, at the Post Office at New York, N. Y., under the Act of March 3, 1879. Subscription price: \$2.00 per year in the United States of America and Canada; 25 cents per copy. \$3.00 per year in foreign countries; 35 cents per copy.

ARE YOU CONFUSED ABOUT PICTURE TUBES?

19AP4?
19AP4A?
19EP4?

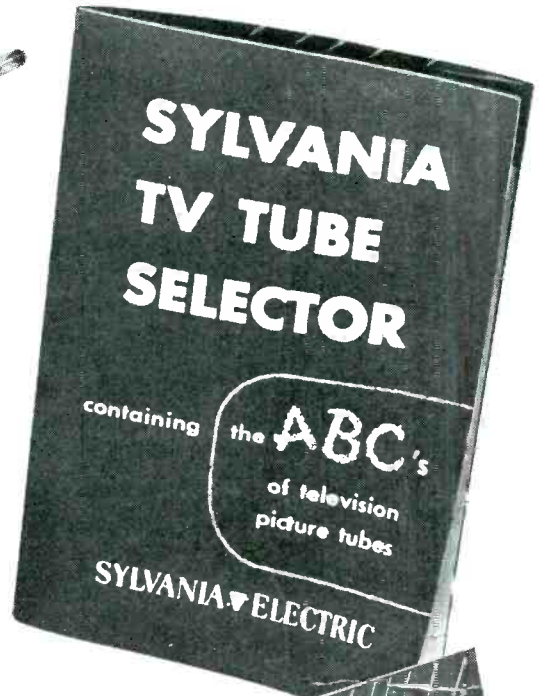
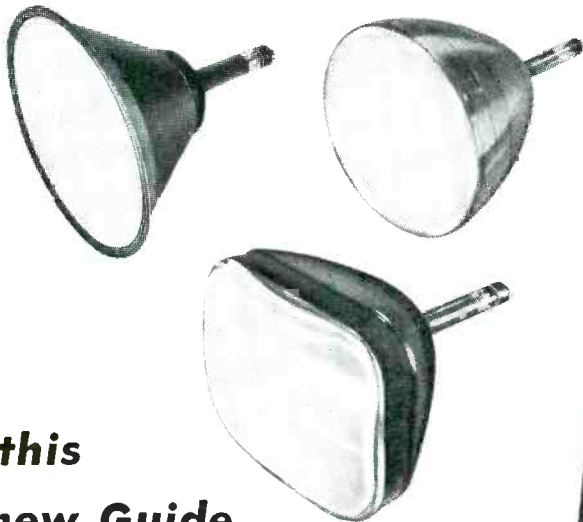

Get this helpful new Guide...

FREE FROM YOUR SYLVANIA DISTRIBUTOR

HERE'S the handiest little pocket guide since television came of age! At a glance, it gives you the information you need concerning 100 different types of Television Picture Tubes.

Especially prepared for service men, it quickly indicates the difference between similar tubes having different suffix letters. More, it gives you facts about face plates, shape, glass or metal construction, conductive coatings, and price. A column is also left for your personal pencilled inventory notes.

Remember this guide is FREE. Your Sylvania distributor has them now. Ask him to give you a "Sylvania TV Tube Selector" when you next stop in or phone for those top quality Sylvania Tubes.

TUBE TYPE	SUFFIX	FACE PLATE	SHAPE	MATERIAL - GLASS	CONDUCTIVE COATING	LIST PRICE	INVENTORY NOTES
14CP4						\$35.00	
14DP4							
14EP4							
14FP4							
15CP4							
15DP4							
16AP4	A					58.50	
16BP4							
16CP4							
16DP4							
16EP4	A						
16FP4	A						
16GP4	A						
16HP4	A						
16IP4	A						
16JP4	A						
16KP4	A						
16LP4	A						
16MP4	A						
16NP4	A						
16OP4	A						
16PP4	A						
16QP4	A						
16RP4	A						
16SP4	A						
16TP4	A						
16UP4	A						
16VP4	A						
16WP4	A						
16XP4	A						
16YP4	A						
16ZP4	A						

This Selector will save you lots of time and bother... eliminate errors. Get your FREE copy!



SYLVANIA ELECTRIC

Sylvania Electric Products Inc., Television Picture Tube Division, Emporium, Pa.

TELEVISION PICTURE TUBES; RADIO TUBES; ELECTRONIC PRODUCTS; ELECTRONIC TEST EQUIPMENT; FLUORESCENT TUBES, FIXTURES, SIGN TUBING, WIRING DEVICES; LIGHT BULBS; PHOTOLAMPS; TELEVISION SETS

THE NEW PRECISION CR-30 CATHODE RAY TUBE TESTER

TESTS ALL TV PICTURE TUBES

(MAGNETIC AND ELECTROSTATIC)

'SCOPE TUBES AND INDUSTRIAL CR TYPES

for True Beam Current (Proportionate Picture Brightness)
Tests ALL CR Tube Elements—Not Just a Limited Few

IN FIELD OR SHOP

Tests CR Picture Tubes
Without Removal from
TV Set or Carton!

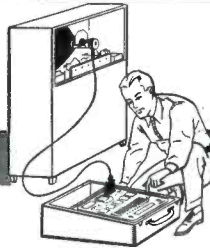

The new Precision CR-30 fills an obvious gap in the test equipment facilities employed by TV service and installation technicians.

Because of the absence of a reliable cathode ray tube tester, up to 50% of so-called "rejected tubes" are found to be fully serviceable and should rightfully never have been "pulled out."

Proven product of extended development, the CR-30 has been

specifically engineered to answer the question, "Is It the TV Set or is it the Picture Tube?"

The Precision CR-30, a complete and self-contained Electronic Instrument, incorporates a TRUE BEAM CURRENT Test Circuit. The CR-30 checks overall electron-gun performance for proportionate picture brightness as well as additional direct testing facilities for accelerating anodes and deflection plate elements.

The Precision CR-30 should not be confused with mere adapters connecting to ordinary receiving tube testers which were never designed to meet the very specialized needs of CR tube checking. Similarly, it is not to be confused with neon-lamp units or similar devices of limited technical merit and which do not check all CR tubes or all tube elements.

GENERAL AND TECHNICAL SPECIFICATIONS

- ★ Tests All Modern Cathode Ray Tubes—Magnetic and Electrostatic, 'Scope Tubes and Industrial Types.
- ★ Tests All CR Tube Elements—Not just a limited few.
- ★ Absolute Free-Point 14 Lever Element Selection System, independent of multiple base pin and floating element terminations, for Short-Check, Leakage Testing and Quality Tests. Affords maximum anti-obsolescence insurance.
- ★ True Beam Current Test Circuit checks all CR Tubes with Electron-gun in operation. It is the Electron Beam (and NOT total cathode emission) which traces the pictures or pattern on the face of the CR tube.
- ★ Voltage Regulated, Bridge Type VTVM provides the heart of the super-sensitive tube quality test circuit. Such high sensitivity is also required for positive check of very low current anodes and deflection plates.
- ★ Micro-Line Voltage Adjustment
Meter-monitored at filament supply.
- ★ Accuracy of test circuits closely maintained by use of factory adjusted internal calibrating controls; plastic insulated, telephone type cabled wiring; highest quality, conservatively rated components.
- ★ Built In, High Speed, Roller Tube Chart.
- ★ Test Circuits Transformer Isolated from Power Line.
- ★ 4 1/2" Full Vision Meter with scale-plate especially designed for CR tube testing requirements.
- ★ Heavy Gauge Aluminum Panel etched and anodized.
- ★ PLUS many other "PRECISION" details and features.

Total cathode emission can be very high and yet Beam Current (and picture brightness) unacceptably low. The CR-30 will reject such tubes because it is a true Beam Current tester. Conversely, total cathode emission can be low and yet Beam Current (and picture brightness) perfectly acceptable. The CR-30 will properly pass such tubes because it is a true Beam Current tester. The significance of the above rests in the fact that Beam Current (and picture brightness) is primarily associated with the condition of the center of the cathode surface and not the overall cathode area. (See illustration below)

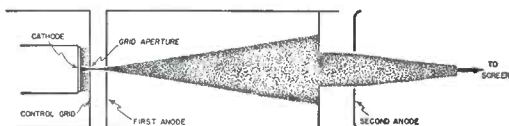

SERIES CR-30—In hardwood, tapered portable case, with hinged removable cover. Extra-Wide Tool and Test Cable Compartment. Overall Dimensions 17 1/4 x 13 3/4 x 6 3/4". Complete with standard picture tube cable, universal CR Tube Test Cable and detailed Instruction Manual.

Shipping Weight:—22 lbs. Code: Daisy
NET PRICE:—\$99.75

See the new CR-30 on display at leading electronic equipment distributors. Place your orders now to assure earliest possible delivery.



PRECISION APPARATUS CO., INC.

92-27 Horace Harding Boulevard, Elmhurst 6, New York

Export Division: 458 Broadway, New York, U.S.A. Cables—Morhanex
In Canada: Atlas Radio Corp., Ltd., Toronto, Ontario



*These three braves
scalp TV Capacitor
problems!...*



SANGAMO'S TV TRIO

Used as original equipment Tops for replacement needs

Sangamo offers three top television capacitors that you can use with confidence. You'll like these tested, *proved* performers for their quality, their small size and their stability.

The **REDSKIN** is a plastic molded paper tubular that is easy to work with—on production line or on the bench—because its strong, tough casing stands rough handling and the flexible leads can't pull out! It gives long life at 85° operation.

The **CHIEFTAIN** is a dry electrolytic that fits anywhere! Tiny, but durable, it is ideal for application in tight spots beneath a chassis. Bare tinned-copper wire leads make it easy to mount. Maintains uniform capacity when subjected to heat and high ripple currents.

The **SIoux** is a 6,000 volt paper television capacitor with a new standard of permanence. Designed to withstand continuous operation at 85° C, it is mineral oil impregnated to provide longer life and more stable performance over a wide range of operating temperatures.

A trial of these replacement capacitors will convince you. See your Jobber . . . if he can't supply you, write us.



Your Assurance of



Dependable Performance

SANGAMO ELECTRIC COMPANY
SPRINGFIELD, ILLINOIS

IN CANADA: SANGAMO COMPANY LIMITED, LEASIDE, ONTARIO

6C50-7D

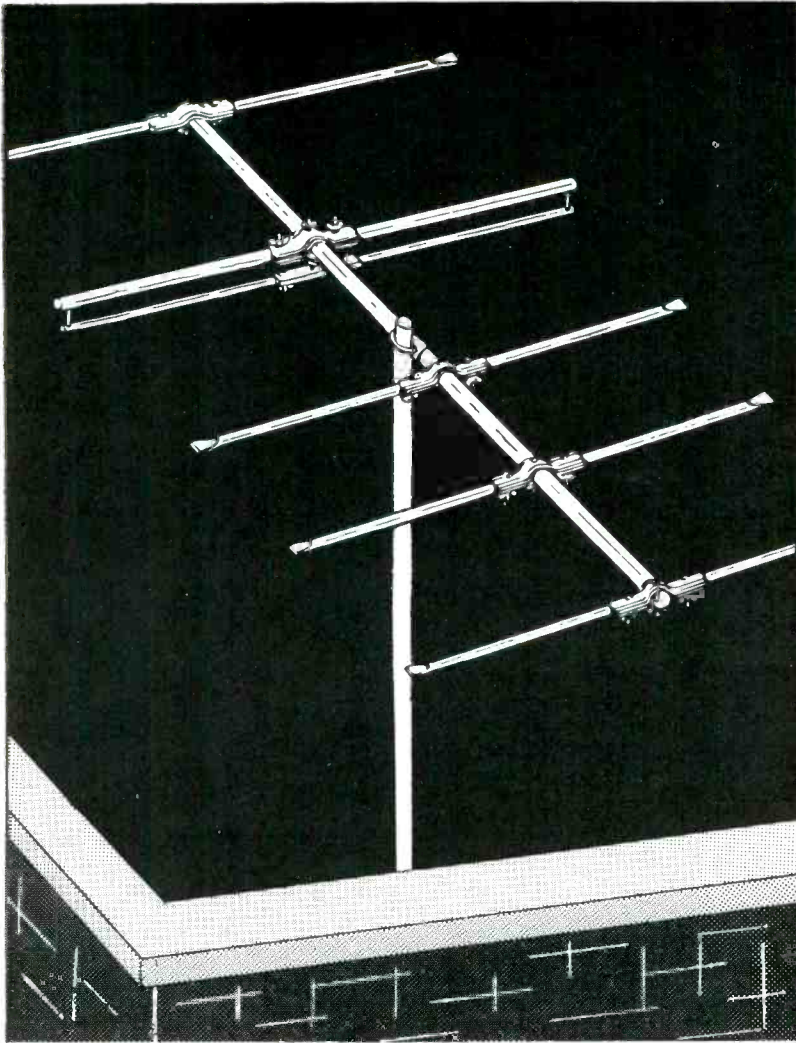

Everything you need for safe, sure, TV installation

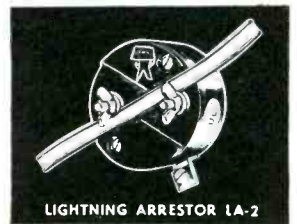

Everything you want...in Antenna Design

RMS YAGI

Extreme high gain and sharp directivity.

Completely pre-assembled.

All aluminum, rib-reinforced—stress-proof construction.

Write for useful accessory guide and latest catalog. See your local jobber.

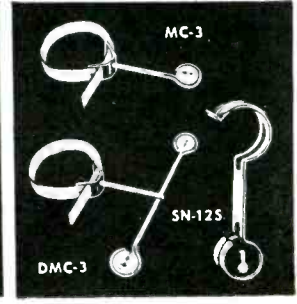
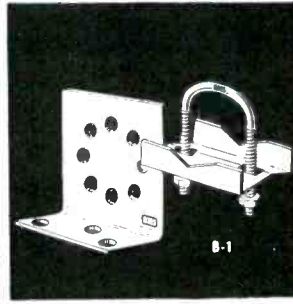
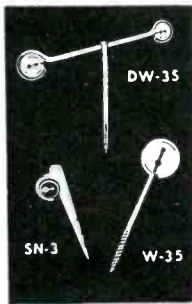
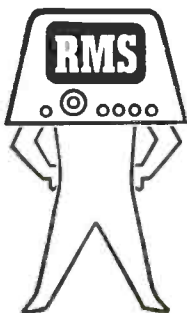
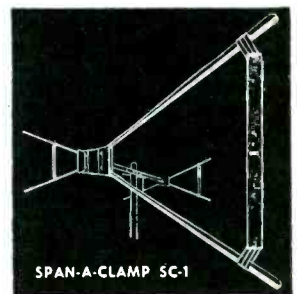

RADIO MERCHANDISE SALES, INC.

1165 SOUTHERN BOULEVARD • NEW YORK 59, N. Y.

Golden Opportunity

to prepare for better pay jobs in

Television Servicing

for men in
radio-electronics

No vocational field offers more opportunities for "career" jobs and good pay than television—America's fastest growing industry. The demand for TRAINED and EXPERIENCED TV SERVICEMEN is growing. There is a big shortage of such men now and will be for several years to come.

PLENTY OF GOOD JOBS OPEN TODAY

Radio-Television jobbers, dealers and service companies offer lifelong opportunities with excellent salaries for qualified service technicians. Manufacturers of television receivers are looking for men with good service training as inspectors, testers and troubleshooters. Many experienced servicemen go into business for themselves. Others hold their regular jobs and earn extra money servicing TV receivers in their spare time.

Radio-electronics manufacturers busy with defense equipment contracts offer excellent job opportunities for men with a television technician background. Servicemen called into military service are further reducing the supply of skilled TV servicemen available for civilian activities. Think what television servicing offers *you* in terms of a lifetime career and financial security.

RCA INSTITUTES Home Study Course in TELEVISION SERVICING—

A Service to the Industry

Because of the critical shortage of TRAINED and EXPERIENCED TV SERVICEMEN, RCA Institutes is offering this highly specialized and practical home study course as a service to the working members of the radio-television-electronics industry. Its object is to train more *good* servicemen and to help make good servicemen *better*.

Never before has this course been available to anyone outside of RCA. It is now offered to *you*, through RCA Institutes, one of America's oldest and most respected technical training schools. The course covers most major makes and types of TV receivers. Available exclusively to men in the radio-television-electronics field. Not offered to the general public, or under G.I. Bill.

The cost is low . . . only \$9 a unit for 10 units or \$90 total, on an easy pay-as-you-learn plan. At successful completion of the course you earn an RCA Institutes certificate that can lead straight to a better job at higher pay.



YOU STUDY AT HOME

In your spare time, you learn pre-tested "How-to-do-it" techniques with "How-it-works" information in easy-to-study lessons. The course is based on the experience of the RCA Service Company in servicing thousands of home television receivers.

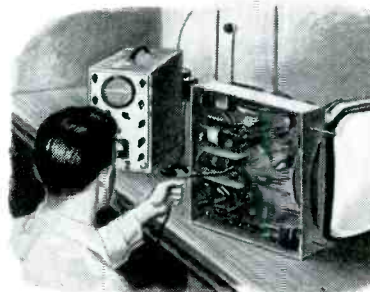

YOU KEEP WORKING ON YOUR JOB

Because you work in the radio-television-electronics industry, your job provides the laboratory work of the course. There are no kits, parts or equipment to buy. Self-employed independent radio and television servicemen are eligible for enrollment.

★ **LOWER RATES FOR GROUPS!** Employers in the radio-electronics industry who desire to enroll six or more of their employees for this course, may do so at lower rates for the group. A special group application form is available for employers desiring to take advantage of this offer. ★

SEND FOR FREE BOOKLET. Find out complete details of the RCA INSTITUTES Home Study Course in TELEVISION SERVICING. Don't pass up this opportunity to prepare yourself for a money-making career in the television industry. Illustrated booklet explains all the features of the course. Mail coupon in an envelope or paste on a penny postcard—NOW!

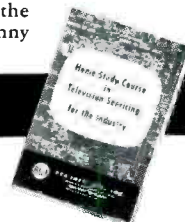

MAIL COUPON NOW!

RCA INSTITUTES, INC.
Home Study Department, S-651
350 West Fourth Street, New York 14, N.Y.

Without obligation on my part, please send me copy of booklet "RCA INSTITUTES Home Study Course in TELEVISION SERVICING." (No salesman will call.)

Name _____ (Please Print)

Address _____

City _____ Zone _____ State _____



RCA INSTITUTES, INC.
A SERVICE OF RADIO CORPORATION of AMERICA
350 WEST FOURTH STREET, NEW YORK 14, N.Y.

*"I want to see
Americans save . . ."*



JOHN L. COLLYER

President, The B. F. Goodrich Company

"I want to see Americans save for their own personal security, and I want to see them, as stockholders in our government, urge economy in all phases of our national life in order to provide national security against aggression."

By their rapidly mounting participation in the Payroll Savings Plan, Americans *are* saving for their personal security, fighting the menace of inflation and making a major contribution to America's defense against aggression. In Mr. Collyer's own company 80% of the 38,000 employees throughout the company have already enrolled in the Plan, with two large divisions still to report.

As Chairman of the Ohio Payroll Savings Advisory Committee, Mr. Collyer knows what is being accomplished by leaders of industry, top management and labor in their joint effort to step up the Payroll Savings Plan. A few recent figures should be interesting to those not so familiar with the national picture:

- In the steel industry campaign, Carnegie-Illinois Steel Corporation (now U. S. Steel Company), recently raised its payroll participation from 18% of 100,000 employees to 77% . . . Columbia Steel Company of California went from 7.9% to 85.2% . . . American Bridge Company signed 92.8% of the workers in the large Ambridge plant . . . 87%

of Allegheny-Ludlum Steel Corporation's 14,000 employees are now on the Payroll Savings Plan . . . Crucible Steel Company of America, reinstating its plan, signed up 65% of its 14,500 employees.

- In the aviation industry, Hughes Aircraft Company went from 36% to 76%; Boeing Aircraft enrolled 10,000 new names before Christmas.

Some dollars and cents figures? In the last quarter of 1950, sales of \$25 E Bonds—the denomination so popular with payroll savers—increased 2.5% by 245,000 bonds more—over the last quarter of 1949.

If you do not have The Plan That Protects the personal security of your employees, the national economy and our country's defense, phone, write or wire to U. S. Treasury Department, Savings Bonds Division, Washington Building, Washington, D. C. Your State Director is ready to help you install a Payroll Savings Plan or step-up your employee participation.

The U. S. Government does not pay for this advertising. The Treasury Department thanks, for their patriotic donation, the Advertising Council and

S E R V I C E



Everybody's Tuning it!

"THE STANDARD BOOSTER"

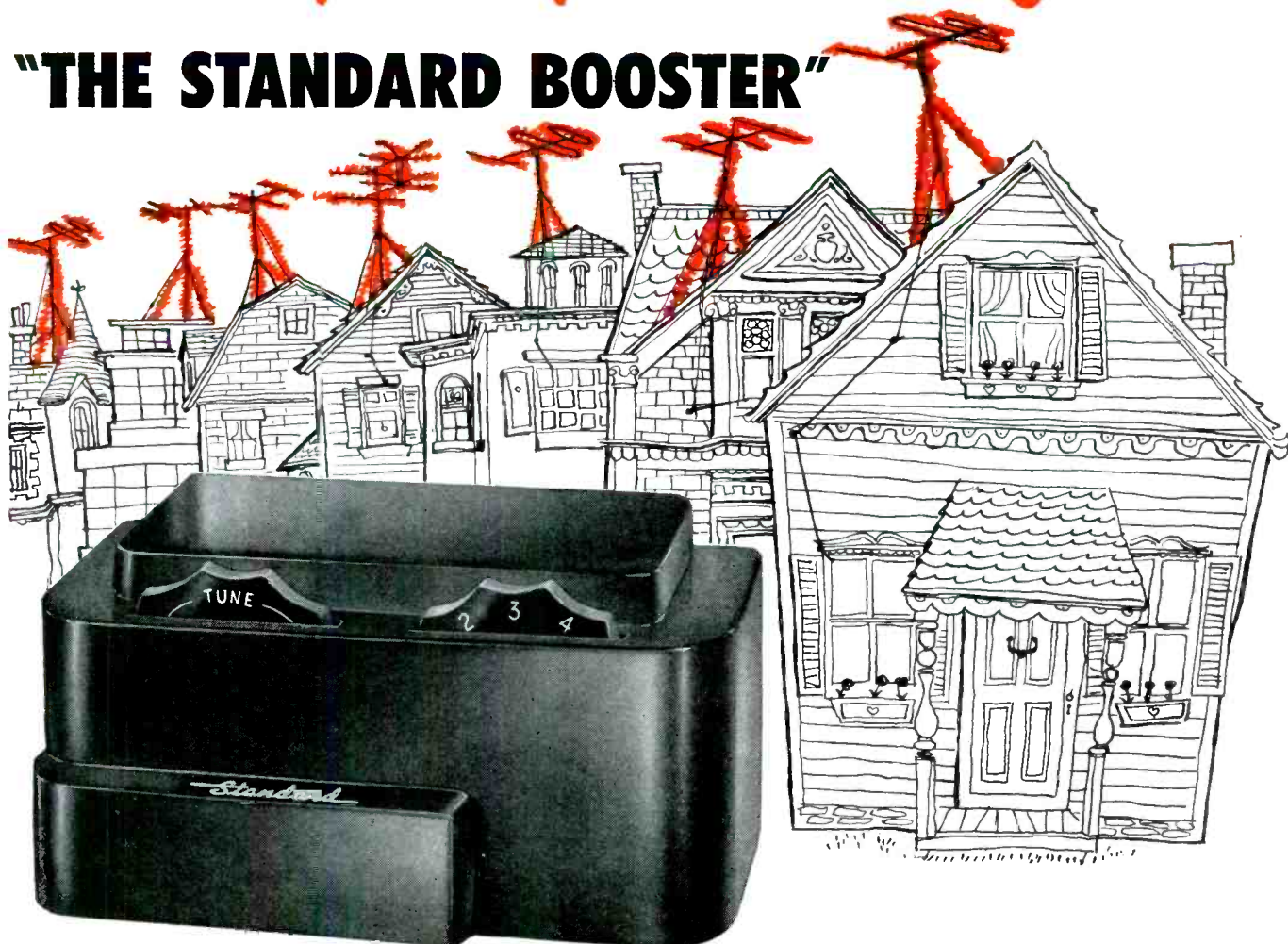

Model B-51

in tune with the tuner

The new and improved "Standard TV Booster" is daily winning greater acceptance by dealers and customers alike in every Television market.

Here is the booster that gives real customer satisfaction, superior performance, trouble-free operation. The Model B-51 is engineered by a company that has demonstrated the greatest TV tuner know-how in the business.

Have your local distributor show you the outstanding features and money-making possibilities of this great new "Standard TV Booster."



The "Standard Tuner" is used by over 75 TV set manufacturers. Nearly 50% of the TV sets made today are equipped with this outstanding front-end.

Standard COIL PRODUCTS CO. INC.

CHICAGO • LOS ANGELES • BANGOR, MICHIGAN

"You just

when I replace



Vacuum Tube Volt-Ohmmeter Model 303

FM-TV Genescope Model 488



TV Field Strength Meter Model 488



Micro-Scopes Model 476



Capacity Bridge Model 381

Simpson

Volt-Ohm-Milliammeter Model 260 (shown at right)

Thomas

PHOTO-TRON

— *Exact* original equipment with these 20 TV makers and many others.....



Thomas

can't beat a deal like this!

a picture tube with a

Thomas

PHOTO-TRON

my customer benefits because . . .

THOMAS PHOTO-TRON Picture Tubes are the exact original equipment used by the 20 famous-name TV set makers listed below . . . Because servicemen everywhere know you take no chances when you replace with Thomas because you replace with the exact make of tube you are taking out. If the set is not listed in the 20 famous brands listed below you make the set perform better by using a THOMAS PHOTO-TRON picture tube!

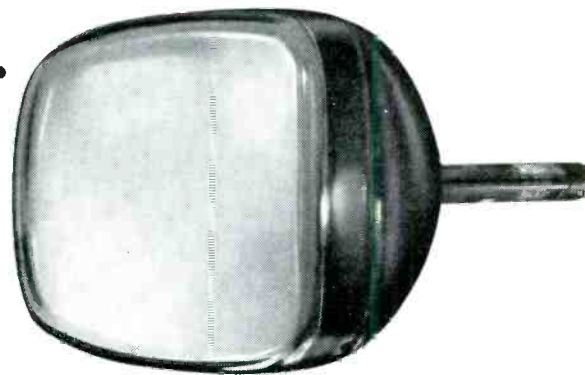

and I benefit too, by the **Thomas Bonus Plan**TM

Because with the Thomas Free Test Equipment Bonus Plan, with every Thomas Photo-Tron Picture Tube I buy I receive a certificate entitling me to a discount on the purchase price of any piece of Simpson test equipment, and my Parts Distributor benefits because he makes his regular profit on both.

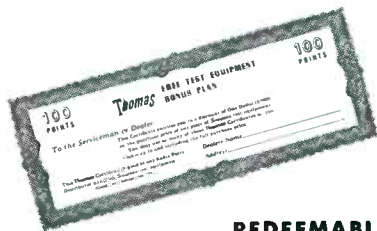

REDEEMABLE THROUGH ALL LEADING PARTS DISTRIBUTORS

Admiral
Westinghouse
Hoffman
Meck
Olympic
Calbest
hallicrafters
Bendix
Television
Magnavox
SCOTT
Imperial
Tele King
Starrett
Packard Bell
PILOT
Motorola
Stewart-Warner
CROSLEY
Tele-tone

AS ADVERTISED IN THE SATURDAY EVENING POST

ELECTRONICS, Inc. • PASSAIC, NEW JERSEY



Replacements and Conversions with Television Tubes please everyone..



*Thanks to
Raytheon's 101*

RAYTHEON TELEVISION PICTURE TUBES will please you because they are mechanically and electrically perfect. 101 basic quality tests, checks and inspections made during the various steps of a Raytheon Tube's construction — components, chemicals, processing, assemblies — assure unexcelled performance. You can make conversions and replacements with complete confidence that your skill plus RAYTHEON quality will result in superb picture reproduction.

Your customers will be delighted with Raytheons because they'll be receiving the finest TV picture they've ever seen. It will be a

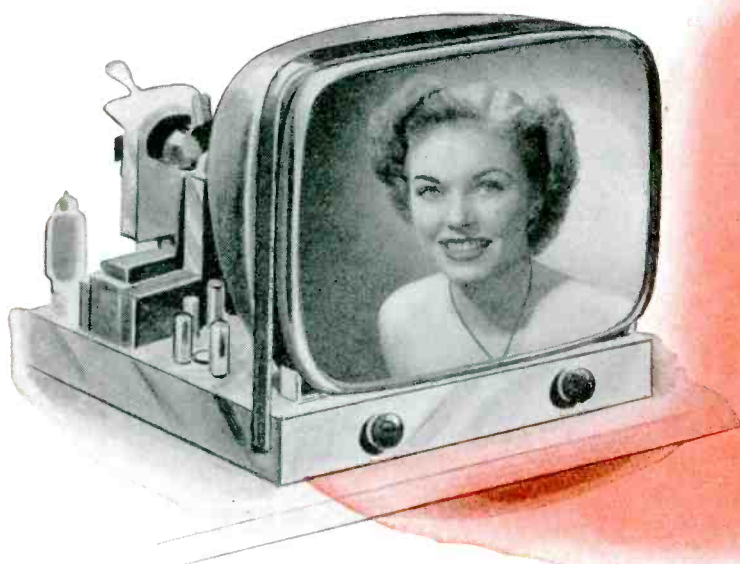

crisp, clear, contrasty, longer-lived picture — thanks to the superior quality of Raytheon Tubes — a quality that could only result from the knowledge gained through Raytheon's more than 25 years of experience in the pioneering and manufacture of all kinds of high fidelity electronic tubes.

Team your skill with Raytheon Quality.
You'll find it pays in many ways. See your
Raytheon Tube Distributor today.

**Right for
Sight...**



Excellence in Electronics

RAYTHEON MANUFACTURING COMPANY

Receiving Tube Division

Newton, Mass., Chicago, Ill., Atlanta, Ga., Los Angeles, Calif.

RADIO AND TELEVISION RECEIVING TUBES, CATHODE RAY TUBES, SPECIAL PURPOSE TUBES, SUBMINIATURE TUBES, MICROWAVE TUBES

CONSIGN 112

A Unique Blueprint for Licensing

IN THE SERVICE INDUSTRY, there has been one thorny issue—*licensing*—which has been a constant subject of debates, surveys and probes by many in and out of the repair world. In early days of radio, and even recently, there were roaring demands for controls, particularly from legislative bodies who insisted that the Service Man could not conduct himself honorably unless he was under the jurisdiction of the city fathers. Fortunately, the boys proved that they could police themselves quite effectively through associations and the adoption of bold codes of operation. Intensive training programs provided by industry, as well as associations, also helped to improve the stature of the Service Man, so that the complaints of misrepresentation, overcharging and bungling really became a rare item on the calendar.

With the advent of television and its enlarged costly chassis, the insistence for controls reappeared, with two basic factors contributing to the renewed outcries: the contract business and its involved financial aspects, and the complexity of the television set requiring an extremely comprehensive knowledge of circuitry. While many rose to the occasion through the application of sound banking and advanced technical know-how, many faltered, unfortunately, not only failing to provide adequate service, but to maintain a satisfactory financial status. Associations in many communities came to the rescue and checked the embarrassing situation, and did so to the complete satisfaction of the gentlemen in town hall. However, in some large metropolises, it has been found difficult to control completely the operation of everyone; and since a few can be the cause of an endless stream of heartaches and headaches, often inevitably resulting in a general indictment of the industry, some form of official control has been deemed essential.

In New York City, there has been proposed a measure which appears to represent an ideal approach to a solution to this problem, not only serving to protect the public, but providing an official stamp of approval on the technical and financial responsibility of license holders. The bill provides for the issuance of licenses and

permits to TV contractors, subcontractors, service shops, technicians and apprentices. To obtain a license the bill states that a contractor will have to assure the commissioner that he has taken adequate steps to provide, that upon default in performance of any service contract, advance payments made, less the reasonable value of the service actually rendered to the date of the default, will be refunded to the purchasers or owner of the contract. If he meets these requirements he will receive a type *A* license. A type *B* license will be issued to those who either have not applied or who are not qualified financially to handle the initial contract. However, the latter type of license may be used by a subcontractor. Operators of service shops may acquire a license, too, according to this bill, provided they have in their employ a qualified technician or apprentice, or, of course, they have been qualified themselves to hold a license or permit.

In the provisions for technician's licensing appears a unique ruling. At the present time, the bill stipulates that technicians will be able to receive *permits only*, with 1953 set as the date on which official licenses will be granted. At that time it will be necessary to take an examination, held under the jurisdiction of a board of examiners. It was felt that this 2-year gap would permit the boys to brush up and even become more thoroughly familiar with all phases of the art, so that on examination day they'll be well equipped to take and pass the city test. In the meanwhile, to qualify for a permit a technician will have to show that he has had 21 months of full-time experience in the servicing and maintenance of TV equipment or is a graduate of an accredited school, and had 6-months of apprentice work in the field prior to the date of the permit, or 6-months of experience after he has graduated from the school. Apprentice permits will be issued to any person who can furnish satisfactory proof that he is employed by an accredited technician or a licensed service contractor. According to the proposed control, the only operation that an apprentice will be able to perform in the home will be: changing of a tube, installation of the antenna, and

adjustment of external controls, such as vertical and horizontal sync, etc. He will not be permitted to make any internal alterations.

Four types of fees have been suggested in the bill: technician's permit, \$15 covering a 2-year period; apprentice permit, \$5 upon issuance and \$5 upon renewal; service shop or service contract license, \$25 upon issuance and \$15 upon renewal; and technician's license, \$15 upon issuance and \$5 upon renewal.

Proposed also is a supervising committee consisting of seven, appointed by the mayor, who would be responsible for the recommendation of rules, regulations, procedures, qualifications and standards. According to present plans, this committee would consist of a member of the Board of Education, designated by the superintendent of schools, who is a regularly appointed teacher of radio mechanics in a radio school; a member of the law department of the city; a person who is a licensed professional radio engineer and who is also a member of the IRE; a person who for at least 10 years prior to his appointment has been continuously engaged in servicing electronic apparatus, not less than three years of which shall have been in the servicing of TV equipment; one who has been engaged for at least three years as a service contractor; a person who has for 5 years been a dealer in the city; and one who has also for 5 years been a distributor. All members will serve without compensation.

Stiff penalties are cited in the bill; a fine of \$500 or imprisonment of not less than six months, or both, upon conviction of a violation.

The measure notes too that it will not only be necessary to post the licenses and permits, but also display on bills, cards, advertising or stationery, the number and type of the license or permit, and the category—service contractor, technician or apprentice.

The bill is expected to become a law in the early fall, with September, '53, set as the first technician's license test date.

Many have spent countless hours in preparing this unusual measure, particularly Max Liebowitz, prexy of ARTSNY and NETSDA, who has attended numerous round-the-clock sessions, and striven to see that the bill was just and practical, and provided every Service Man with an equal opportunity to practice equitably in the TV field.—L. W.

With every \$2.00 purchase of WALSCO products or \$10.00 worth of antennas...

it's

FREE!

WALSCO

12th

ANNIVERSARY

GIFT package



...all YOURS!

- WALSCO LUBRICATOR
- WALSCO CONTACTENE INJECTOR
- WALSCO TUNERLUB
- WALSCO NO-OX
- WALSCO CEMENT



A TERRIFIC FREE OFFER!

Each item in this attractive GIFT package will be useful to you. And it's yours at *no extra cost!* All 5 handy items in this package are from the famous line of WALSCO quality products. Every radio and TV service man will want one. Get yours today!



\$2.00 value **FREE**

with every \$2.00 purchase of WALSCO products... or \$10.00 worth of WALSCO antennas.

FREE GIFT PACKAGE available at your local parts jobber. Get yours today!

WALSCO

WALTER L. SCHOTT CO.
Los Angeles 18, Calif. • Chicago 6, Ill.

SERVICE...The National Scene

REPLACEMENT PARTS SUPPLY OUTLOOK FOUND BRIGHT--Despite military commitments and shortages, critical materials will be available for repair and replacement purposes, reported RTMA board chairman, Robert Sprague, during the recent Parts Show in Chicago. This optimistic view, he indicated, was based on the reports of government officials which noted the importance of a continuing supply of components to keep in operation all types of receivers. Describing market prospects, Sprague said that due to the greater number of tubes in an average TV set, as compared to those in the average radio chassis, the ratio being about 4 to 1, a substantial increase in components appears in every chassis. Specifically, he pointed out, these larger chassis indicate an increase of about 50 per cent in the replacement market for tubes, capacitors, resistors, transformers, and other parts. With a continuing sale of radio sets, and television models, too, there should be in the hands of the public by the end of '51 not less than 95-million radio sets, and nearly 16-million TV sets, or the equivalent of 155-million radio sets from the standpoint of the replacement parts business. Quite a bright picture!

COLOR TV SYSTEMS STILL BEING PROBED--Notwithstanding the recent Supreme Court decision, providing full official sanction to the FCC-approved incompatible-disc method, industry committees, particularly the National Television System Committee, an RTMA unit, have declared that the issue is still far from a closed one, and that methods which will provide a practical compatible system may still appear on the scene. In fact, as a result of one group study, involving specialists from RCA, Hazeltine, G.E., Philco, Sylvania and DuMont, a composite system of color TV combining the best elements of the furthest advances of existing systems has been evolved, and field tests will begin as soon as possible, with January, '52, set as the date when the tests should be completed and the results submitted to the FCC. Briefly, the NTSC approach provides for the addition of the necessary chromatic information (to color the black and white picture) on a subcarrier transmitted simultaneously with the black and white signal, and, of course, contained within the 6-mc band. Commenting on the new approach and the court decision, G.E.'s vice prexy, Doc Baker, declared that... "If this compatible system is achieved and should ultimately be adopted, then the CBS system will have been, in fact, an interim system, approved by the FCC in order to insure color during this transition period to those who desire to make the necessary investment in this type of receiver."

COMMUNITY ANTENNA SYSTEM BUSINESS BOOMS--In nearly a dozen areas, from New York to Nebraska, there are now being installed and planned centralized antenna-pickup systems, providing boosted signals to one or more communities, who because of a poor or remote location, are unable to tune in satisfactory pictures. In Falls City, Nebraska, a 200-foot tower has been installed for piping signals to residents of this community. A 60-foot tower will soon be installed on top of South Mountain in Bethlehem, Pa. Officials of the valley city of Frankfort, Kentucky, are also considering the possibilities of a hilltop antenna, with the installation being municipally controlled. Other cities and towns which may soon have TV booster service are Claremont, N.H., and Rice Lake, Wisconsin. . . . In an early issue of SERVICE there will appear a detailed analysis of the equipment and installation procedures involved in these booster pickup systems. Watch for it!

TV STILL GROWING AND GROWING FAST, INDUSTRY HEAD REPORTS--In a striking talk before the National Association of Electrical Distributors, in California, Joseph B. Elliott, RCA vice prexy, declared that the television industry is still a very young one, but it has more vigor than any enterprise born in this country since the automobile. In Elliott's opinion, the TV market for the next 10 to 12 years will average 6 to 9 million sets per year, and from coast to coast.

SERVICE... *The National Scene*

SERVICE INDUSTRY RECEIVES SPECIAL PRICE CEILING REGULATION--Service charges and the selling price of replacement components will hereafter be controlled by a regulation, known officially as regulation 34. According to this ruling, a shop's service ceiling price, in most instances, will now be the highest price charged during the base period from December 19, '50 to January 25, '51. In other words, a shop will not be able to charge more for a job now, than was charged during the base period. If a quotation on a job was made during the base period, it will not be possible to make a higher charge for the same type of service at this time. . . . If you did not supply a service of a specific type during the base period, which you are now being called upon to render, the ceiling price will be, according to the regulation, the highest price of your closest competitor. If this rule is followed, a statement must be filed with the district OPS office, showing how the price was computed, and this information must be presented to the office within 10 days after the charge was offered. . . . Should there appear a need to replace a part which was not used previously, the ceiling price for the repair will have to include the hourly rate, plus the OPS ceiling price for the part. Charges for parts should be identical to those made during the base period; most shops have used and are using manuals, manufacturer's list price or parts catalogs, as pricing schedules. In filing a report of the shop's pricing operations with the OPS, the ruling notes that it will be necessary to identify these published pricing lists by name, edition and date. . . . According to the regulation, ceiling prices on base operations and the normal complement of parts used in servicing must be posted, and list prices of all components must be available for inspection.

NEDA TO AID SCRAP DRIVE--A drive to seek out dormant scrap of scarce materials and place it in normal channels, as quickly as possible, has been inaugurated by NEDA. According to Arthur C. Stallman, NEDA prexy, Service Men can help meet the shortage by saving defective or burned-out transformers, chokes, yokes, etc., and bringing them to their distributor's store, or requesting that the distributor's salesmen pick up these scrap items. Perhaps not much copper or steel is used in each small part, but cumulatively a substantial tonnage can result from these salvaged parts. This is an important drive and every Service Man is urged to cooperate to the utmost.

TRAINING PLAN SUBMITTED TO SETMAKERS--In a recent talk before the service committee of RTMA, TCA prexy Al Haas, declared that the manufacturers should let the service industry assume the responsibility for education and training, and that funds and facilities for this operation should be made available until . . . "such time as the service industry is well organized to handle these things itself." In the long run, he felt, this would be a very effective and economical program. . . . Haas pointed out that the service industry has advanced much since the inception of commercial television. He stressed the fact that the industry is now at a point where a great number of service groups are being operated by trained, experienced businessmen, whose businesses are certain to grow in stature. In his opinion it is important that set manufacturers seek ways and means of encouraging the responsible organization of TV service trade groups on the contractor and independent Service Man level.

MORE BOUQUETS FROM READERS--In a group-subscription order recently received from Rockaway Beach, L. I., ye editor was told . . . "Your magazine has proved to be very helpful in my daily work and therefore I have taken time to procure additional subscribers for you." Out in San Lorenzo, Calif., a group of 12, subscribing to SERVICE, reported that they were very impressed with each successive issue. The publication represents a tremendous value, they noted. SERVICE, they declared, is a radioman's magazine! Deeply grateful to you gentlemen for these interesting comments.--L. W.

Snyder
PHILADELPHIA

Directronic*

MOTORLESS

TV AERIAL SYSTEM

360° ELECTRONICALLY SWITCHED BEAM

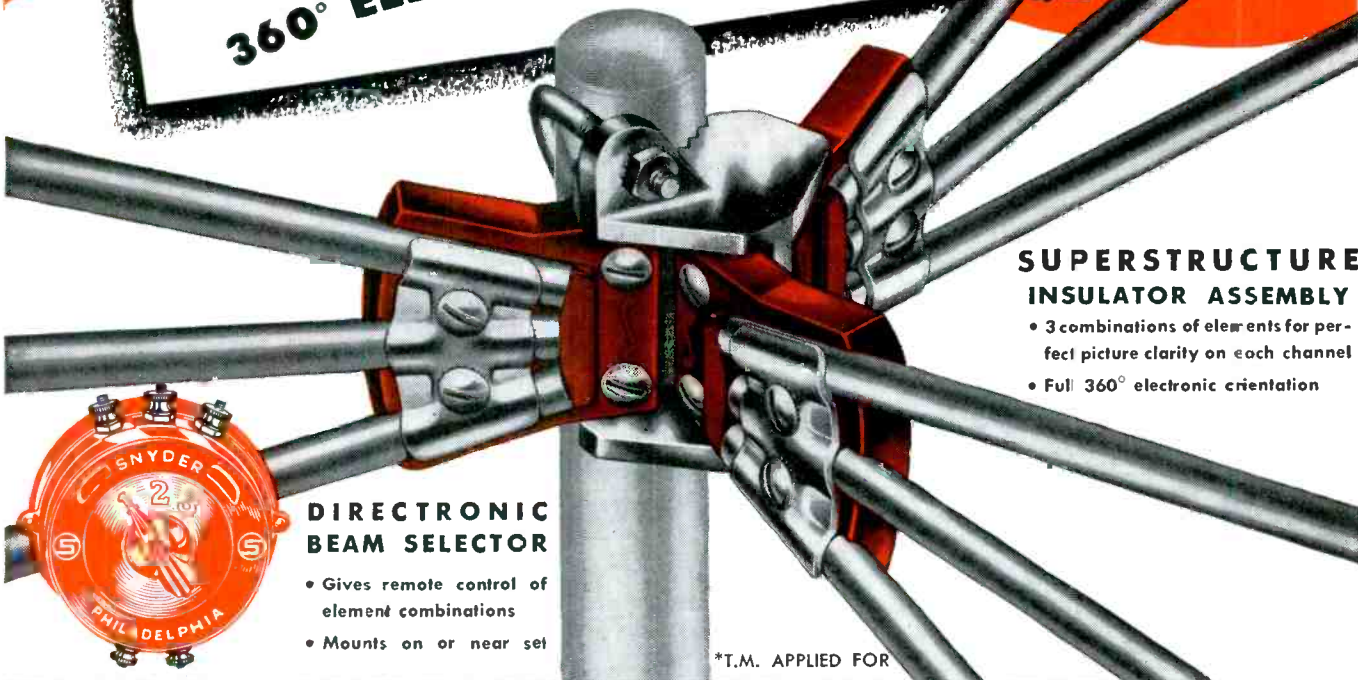

SUPERSTRUCTURE INSULATOR ASSEMBLY

- 3 combinations of elements for perfect picture clarity on each channel
- Full 360° electronic orientation

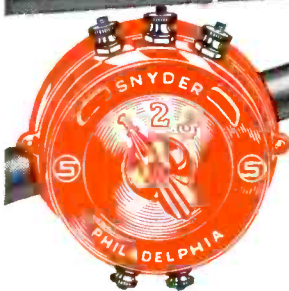

DIRECTRONIC BEAM SELECTOR

- Gives remote control of element combinations
- Mounts on or near set

*T.M. APPLIED FOR

<p>NO MOTORS OR MOVING PARTS</p>	<p>NO ROOF ORIENTATION</p>	<p>NO ELECTRIC POWER</p>	<p>NO GHOSTS</p>
---	---	---	-----------------------------

SNYDER MFG. CO.

ANTENNA ENGINEERS
PHILADELPHIA 40 • U. S. A.

EXPORT: ROBURN AGENCIES, INC., NEW YORK 7, N. Y.

P. S. ONLY ONE
LINE TO INSTALL



German [Eiap]

680 Ohms, 1 Watt
non-insulated¹



French

1,000 Ohms, 1/2 Watt
non-insulated



German [Eiap]

150,000 Ohms, 1/2 Watt
non-insulated



U.S.

680 Ohms, 1 Watt
insulated



U.S.

1,000 Ohms, 1/2 Watt
insulated



U.S.

150,000 Ohms, 1/2 Watt
insulated

Foreign-type resistors (top) which have been used to replace American counterparts in many TV chassis, because of type shortages.

Defense-Program TV Chassis Substitution and Conservation Practices

by **WALTER H. BUCHSBAUM***

AS THE DEFENSE EFFORT gathers momentum, increasing amounts of material are being placed on the critical list and TV manufacturers are finding it necessary to cast about for all possible means to keep going despite these shortages. The purchasing and expediting departments of most manufacturers are buzzing today, trying to locate parts, tubes and even raw materials which they might sell to the component manufacturers and thus be assured of deliveries. But the department which appears to be most seriously affected in any plant is the engineering section, which must check and approve substitute components and modify existing designs for use with available material. Many new chassis are being developed with a view to various shortages, and the availability of components is often the guiding factor in circuit design.

Actually, when defense production is in full swing, everything becomes scarce. Metals, as well as plastic, are in short supply, but without some of either it would be impossible to pro-

duce TV receivers. The degree of scarcity of various items changes often, and that is the worst source of headaches. However, certain rules are now commonly used and they represent, at least, educated guesses. Steel, while in short supply for large quantity users, will not be one of the bottlenecks for the TV industry. Polyethylene, wax and other insulating materials are also not likely to stop TV production. The shortage of copper wire and silicon steel for transformers is much more serious and steps are being taken to reduce the amount of these items used in each set. In general, raw material shortages are not affecting the TV industry too much at the present time. The really serious shortages appear to be in the finished component field involving carbon resistors, electrolytics, and, worst of all, tubes.

The reason for the current bottleneck is the fact that the armed services require the same basic components,

resistors, capacitors, coils and tubes, as the TV industry, while the output of these items is limited by the capacity of the automatic machinery which makes them. For example, the recent shortage of the 12AU7s was due to the fact that the military ordered a quantity of nine-pin miniature tubes which tied up the machines making 12AU7s and similar types.

Shortages of certain brands of resistors or capacitors have likewise been caused by government approval of these particular components.

Part Economies

TV components have been hardest hit by shortages and that is where most manufacturers are trying to conserve as much as possible. To save tubes, some chassis will be found without diode detectors, restorers and elaborate *agc* circuits. Instead germanium diodes will be found, with *agc* bias often obtained from the detector load resistor or a suitable point in the sync clipper. The tube types

*Author of *Television Servicing*; Prentice-Hall, 1950.

used are usually those also approved by the military and found in many types of equipment. Because of this situation, the special TV types, as the 6T8, are avoided, even though it may mean using two tubes instead of one. At least the two tubes, usually a 6AL5 and a 6AV6, might be available while the 6T8 might not even be in production. Using selenium rectifiers in the $B+$ supply obviates the need for the conventional 5U4. In many instances, selenium rectifiers will be found in a doubler or tripler circuit to save the power transformer steel and copper as well. In reducing the number of tubes several manufacturers have been able to design 14- to 15-tube TV sets, but in general such a set will not perform as well as one using at least 18 or more tubes or tube substitutes.

Another approach to beat the parts shortages is to be less discriminating and employ lower quality items. Unfortunately many large manufacturers are following this trend. For instance, in many cases, tolerances are being reduced. In places where only a 10% resistor of a certain well-known make was used, a 20% substitute may now be found, often of inferior quality. Up to now most manufacturers used only electrolytics rated to work up to 85°, but now working temperatures of only 65° are being accepted. It is true that normally the 85° figure is not reached, but it is possible that the heat in a set does reach 65° and then the electrolytics may deteriorate rapidly. Cutting the working voltage of capacitors down from a value having a reasonable safety factor to the actual operating voltage is another step used when parts get tight. This can only result in an increase of breakdowns and not in any real saving since the replacement parts are also taken from the already short supply.

A more reliable way of beating certain parts shortages is to use scarce parts only in critical circuits and second grade parts in non-critical parts of the chassis. For example, non-insulated resistors such as the foreign makes can be used in grid and bias circuits, where an occasional short will not immediately

Fig. 2. The dc focusing voltage, which actually contains a pulse component; as the beam approaches the edge of the tube, the focusing potential increases, shifting the focus farther out. The end result is a sort of automatic focusing.

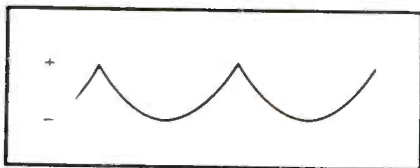

Report on Substitute Components and Materials Service Men Will Encounter in TV Chassis During the Defense Effort and How the Replacements Will Affect Operation; Analysis Describes Trends in Part Economies... Electrostatic Focusing Circuitry... Redesigned Flyback Systems... Expanded Use of Selenium Rectifiers in Doublers... Leads With Smaller Strands, etc.

damage the rectifier and $B+$ supply. Wire-wound resistors can be used wherever no rf or if frequencies are present. The use of multiple ceramic capacitors and entire printed networks also saves scarce resistors and molded paper capacitors. In many if sections the $B+$ or agc decoupling resistors can be replaced by rf chokes made out of a few turns of fine wire. Such design changes can help conserve critical components without any deterioration in set performance or increase in breakdowns. Some parts, unfortunately, require material so short in supply that the entire component must be redesigned or else a circuit must be used in which the particular item is not required. In the redesigned category are such items as if coils in aluminum cans and pm speakers. The most popularized part which is being entirely eliminated is the focus device, em or pm .

Electrostatic Focus

Through the use of electrostatic focusing, it has been found possible to eliminate the focus coil and save about two pounds of copper. In addition, it has been found that the dc energy in the focus coil could be saved, per-

mitting a smaller $B+$ power supply. Of all the different conservation measures, electrostatic focus represents probably the most outstanding and permanent change in TV receiver design. Many companies expect to make only electrostatic focus receivers in the third quarter of '51.

A simple circuit for electrostatic focusing is shown in Fig. 1. It will be noted that an additional tube, resistors and a hv capacitor are required. There is no saving in cost in the use of a focus coil or pm device, but since this circuit uses less scarce materials it is a definite improvement. The dc focus voltage is 22.5% of the second anode voltage and in most cases will range from 3200 to 4500 volts. R_1 and R_2 can be either several resistors in series or a special, carbon-coated hv resistor. R_3 , the focusing potentiometer, represents a special, new design which permits simple, insulated mounting with a non-metallic shaft, its resistance being from 10 to 15 megohms. While a 1X2 is shown as hv rectifier, a 1V2 or the new socketless hv diode² can also be used. It may be contended that it would be simpler to obtain the focusing voltage from a suitable bleeder

(Continued on page 46)

¹Sylvania.

Fig. 1. Simplified circuit for electrostatic focusing system.

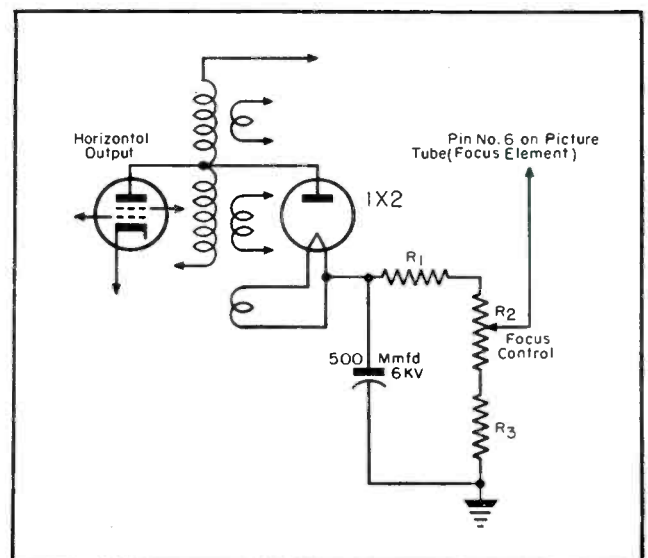

SELLING and INSTALLING Replacement Cartridges

by JOHN D. HARPER

Electro-Voice, Inc.

Millions of Phono Owners Revealed as Potential Purchasers of Cartridges, Units Being Sold Through Simple Home Demonstrations, Involving Compliance, Weight Comparison and Track-Force Tests, The Use of Check-Up Charts, Plus Personal, Mail and Phone Follow-Through.

To THE SERVICE MAN determined to keep right on with his activities through a period of shortages and threatened shortages, a program of phono modernization by the installation of new, modern replacement cartridges offers a well-balanced, broad vision plan.

Such a program appeals to the record fan's cardinal desire of greater enjoyment from his musical hobby, and thus renders a service he will instantly recognize and appreciate.

The program also has another advantage. Because cartridges do not require large quantities of critical materials, they are in fairly stable supply and thus the Service Man is assured of a continuing service which will keep his name prominently before his customers all through the emergency period.

The cartridge replacement-modernization market is truly tremendous! Actually, it includes 10,000,000 record fans owning phonos which still use out-of-date, old-fashioned, stiff-acting cartridges designed prior to the introduction of microgroove records. The sales potential of this market alone is \$70,000,000, based on the average list price of the modern replacement car-

tridge. This estimate does not include any installation charge the Service Man may make. But the total potential market is even larger. It includes the millions of owners of more modern sets with inefficient phono-cartridges which have deteriorated through abuse or use. Although many crystal cartridges operate perfectly for much longer periods of time, normal changes in temperature and humidity make it wise to check a cartridge for replacement after 18 months service. Lastly, the market includes the thousands of new converts to fine quality sound reproduction who require wide-range, high-fidelity cartridges to satisfy their refined tastes.

This, then, is the broad market in which the Service Man is conspicuously well equipped to do an outstanding job. Neither his customers nor the other sales factors, interested in the phono-cartridge market, have his technical background or his knowledge of developments within the audio industry. The record fan looks to the Service Man as an authority on sound reproduction. He is willing to accept the recommendation of the Service Man on matters concerning his radio, TV receiver and phono when the technician shares his intimate, specialized

knowledge of developments and trends in audio with him.

To efficiently use his background of audio experience and competence, the Service Man must first appreciate the reason his skill is of such importance to the audio enthusiasts among his customers.

Briefly, it is this: *The technical knowledge of the Service Man is the bridge by which the record fan can reach his happiest goal; the most enjoyment possible from his musical hobby.*

The record fan wants good quality sound from his phono system. (We'll admit that some record fans have individual opinions of good and poor quality audio reproduction.) He wants the music in his home to have all the realism of the music hall. He enjoys listening to music, and (although he won't admit it) he wants *his* phono system to sound better than his neighbor's.

The continuing enthusiasm for everything audio is evidence of this analysis. The current boom in recorded sound was initially revealed in the increased editorial coverage afforded audio components by trade journals, such as SERVICE, read by Service Men, but recently non-technical articles on audio have appeared with increasing frequency in the columns of *mass* and *class* circulation magazines. Fine quality audio has arrived. The new trend in sound reproduction is not limited to high fidelity alone, but has spilled over to the vast number of record fans owning *commercial* quality radio and TV-phono combinations and record players. It is here that the

Fig. 1. Finger-tip compliance tests: View at right illustrates test for old-fashioned cartridge; moving needle from side-to-side. Stiffness of needle system reveals non-compliance of cartridge. When a modern cartridge is tested in similar manner, the free-moving needle system discloses why compliance assures more faithful sound reproduction and less record wear.

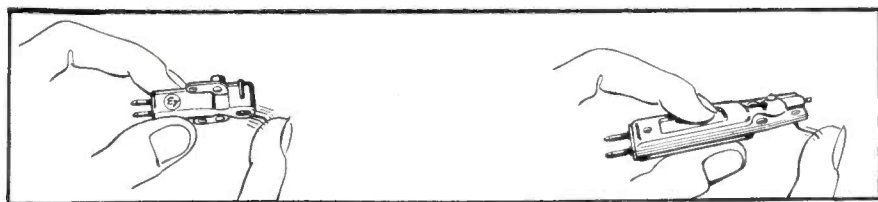

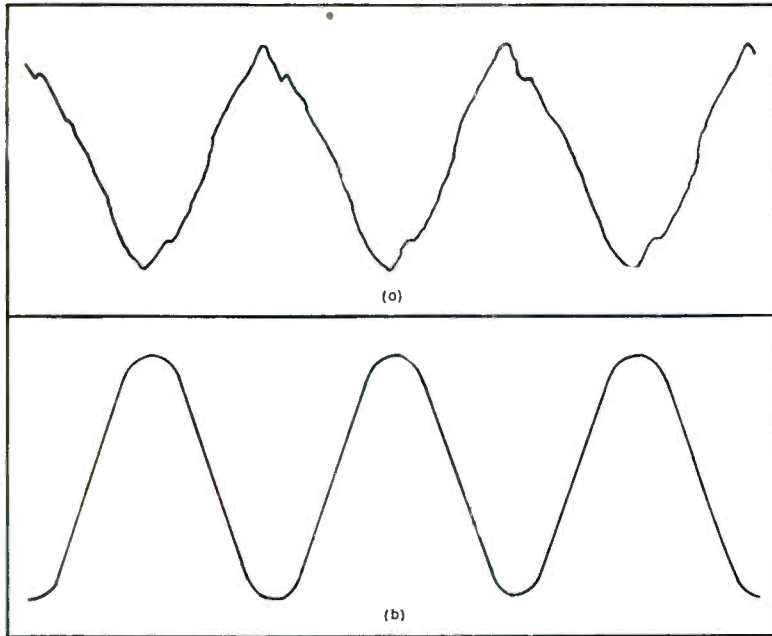

Fig. 2 (a and b). In (a) appears a trace, viewed on 'scope, of the output voltage of an old-style cartridge with a compliance of .3, when the phono-needle tracks a sine-wave modulated groove. The discrepancies in the wave form indicate that the needle tip rattled in the groove instead of following the groove trace. The wave-form illustrates the effect of the added high-frequency distortion and indicates that distortion and fuzziness have been introduced into the reproduced tone. The 'scope view in (b) is the output voltage of a modern type crystal cartridge with a compliance of unity (1), when the phono-needle tracks a sine-wave modulated groove. It will be noted that the voltage output of the cartridge faithfully reproduces information on the record because the needle tip is free to follow all groove excursions easily.

Service Man will find his greatest sales potential. And to these millions of record fans he can render a vital service.

The recordings an audio fan buys are of his favorite artists, orchestras and compositions. As part of his record library, these recordings are among his most valued possessions. Thus, the technician who can guarantee the record fan more authentic reproduction of his recorded favorites and longer life and service from them is performing a service the customer eagerly desires.

The Service Man, then, should organize his extensive audio knowledge and experience so that he can interpret them for his customers in terms which they readily can comprehend. In the case of phono-cartridges, it is a matter of

informing his customers how and why modern cartridges can *guarantee* better quality sound reproduction and longer record life from a phonograph. These two features immediately and patently add to the record fan's enjoyment of his musical hobby.

Most record fans have an extremely vague conception of how music is recorded on a record. All of them would be interested in having the Service Man explain the method simply, in a non-technical manner:

Tone variations of a recorded passage on a phono-record are pressed by a stamper to form wavy grooves in a record disc. The spacing of the waves is determined by the frequencies of the tones recorded. High frequencies produce many waves in a short length of the record groove, and low frequencies

produce fewer waves, or groove excursions, in an equal length. Thus, a record consists of wavy lines spiraled around the center of the disc. The spacing between the waves changes as the tone of the recorded music or speech is changed.

From this explanation it is easy to define the function and operation of the phono-cartridge and to properly correlate it with the phono-record:

The phono-cartridge translates the lateral motion of the needle as it follows the wavy path of the record grooves into electrical impulses. After they are amplified, the electrical impulses are directed to the loudspeaker which reproduces the original recorded sound.

Most record fans don't understand the important role the phono-cartridge plays in the operation of a phonograph. To many, the cartridge is merely a chuck to support the needle. It is important to explain to them that the phono-cartridge determines the range and fidelity of the music first picked up from a record, and as a result, the cartridge actually establishes the quality

(Continued on page 50)

Fig. 3 (a and b). Results of a test of record wear after 5 hours of continuous playing by cartridge tracking at 1½ ounces appear in (a). The dark spot on the white pad reveals the amount of record disc material actually worn off groove walls. In (b) appears result of a test of record wear after 5 hours of continuous playing by cartridge tracking at 8 grams. Here, it will be noted, there is a negligible amount of record wear, indicated by the small deposit of powder worn off the record grooves and deposited on the pad.

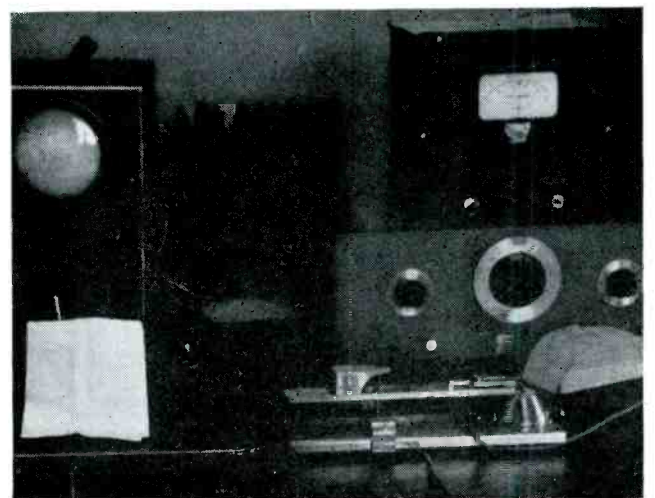

MUSICAL INSTRUMENT AMPLIFIERS



by JACK DARR

Ouachita Radio Service

Features of String-Instrument Amplifiers, Speakers, Mikes and Pickups . . . Procedures Which Should be Followed in Servicing Instrument Amplifying Equipment.

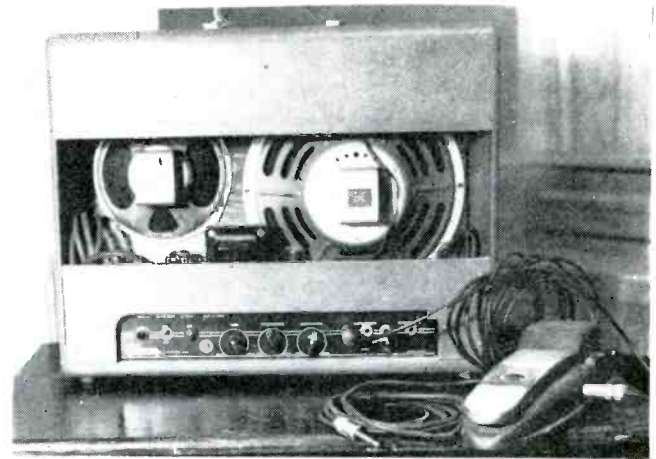

WITH STRING MUSIC, more popular than ever, thanks in part to the mounting enthusiasm for *hill-billy* type of music, the favorite feature of these instruments, *electronic amplifiers*, has become an extremely important factor. In practically every string band, you'll now find guitars, both *steel* (Hawaiian) and *standard*, violins, mandolins, and even the *doghouse* bass viol, equipped with pickups or contact microphones, so that their music may be amplified. The bands use from one to five amplifiers, or one large amplifier with several input channels.

This trend has brought about an increase in the demand for service on these instruments, a task for which all Service Men are well qualified.

The amplifiers are of the standard *pa*, the main difference being in the multiple-inputs used on the *guitar-amplifier* systems. At least three inputs are provided, even on the smaller jobs. The average gain of each of these is usually sufficient to operate a crystal microphone. The voltage output of the various types of pickups is about equal to a crystal mike, or from -55 to -70 db. Very few of these units are equipped with the familiar *phono* input, there being no need for it. Mixers, in these systems, are sometimes quite elaborate. Each input channel normally uses half of a twin-

[See Front Cover]

triode, with its own volume control, and the plates of all of them tied together. The combined outputs are fed into a phase inverter, or into a driver, in the larger size amplifiers.

Power output ratings for these amplifiers run about the same as for *pa* systems: 8 watts, with one 6V6; 15-17 watts, with a pair of 6V6s, and 25 watts, with two 6L6s. Ratings are similar to those found on *pa* sets. If the amplifier is to be used with only one or two instruments, for small parties or broadcast work, the small amplifiers will be adequate. For dance work, especially where vocal solos require the use of a microphone, the larger more powerful units will be necessary.

Front Cover Circuit

On the cover and in Fig. 1 appear typical schematics of a multichannel musical instrument amplifier. Several well-known amplifier manufacturers are making similar units, under their own names, as well as those of musical instrument makers and mail-order houses. Circuitry differs somewhat

from set to set, as might be expected, but basically they're all alike.

Contact Microphones and Pickups

There must be some way of converting the sound vibrations from each instrument into electrical signal voltages, so that they may be amplified. Any kind of microphone may be used, of course, but this method has its drawbacks. The output of each instrument must be individually controllable, without interfering with others, so that one may play the *lead* or melody, and others furnish the rhythm or *second*. Because of this, individual pickups must be used exclusively.

There are several types available. The most popular, made for guitars and other similar instruments, using metallic strings, is the *magnetic* pickup, commonly known among guitarists as the *electric* pickup. This consists of a flat, thin coil, usually with a permanent-magnet core, mounted under the strings in such a way that the metal strings vibrate within the magnetic field of the coil. This induces a varying voltage in the coil, which is fed to the amplifier. This pickup is mounted where the vibration of the strings is the greatest, usually just at the end of the neck of the guitar. On specially-

built *electric* guitars, the pickup is built into the body of the guitar itself. These are much smaller than conventional guitars, as the need for the large hollow body, or sounding board, can be eliminated. Some of these *custom-built* jobs use individually adjustable cores, one under each string, which may be screwed up or down to adjust the amount of energy picked up from each string.

For violins, *bass-fiddles*, and others using gut strings, contact-microphones are used. These are really miniature microphones, constructed so that they are not sensitive to air-borne vibrations, but only to vibrations picked up from a structure with which they are directly in contact. They are actually modifications of the old *vibration-pickup*, used extensively in engine design, etc.

Each of these pickups is provided with a volume control, mounted on a bracket, so that it is accessible to the musician. This eliminates the need for stooping or moving to the main amplifier whenever a change in volume is necessary. The connecting cables are usually small. A *lapel-microphone* cable is excellent for this purpose, as its size makes it less subject to interference with the musician's movement.

Servicing Pickups and Contact Microphones

The most common trouble with these musical units has been found to be broken cables, due to constant flexing. Breaks are usually found at the plug, or at the instrument itself. If it's not within twelve inches of either end, it's recommended that the whole cable be replaced for you'll have an impossible job; finding one break in fifteen or twenty feet of shielded cable! Besides, if the cable is old enough to break in the center, it's old enough to be replaced, as it will almost certainly break again soon. Customers will be much happier, if the replacement is made now.

If there are breaks in the magnetic pickups themselves, they should be replaced, too. These units consist of a coil of very fine wire, with a *dc* resistance of 500-600 ohms. If the coil itself is open, you can sometimes find the break in the connections, just inside the case. If it isn't there, it's best to stop and replace the coil unit, for you'll be a long time trying to find that one small break in that mass of tiny wire. The same practice applies to the contact microphones, which are usually very small dynamic microphones. In these units, the coil connections can give trouble. If you can see the break,

its okeh to fix it; if not, the mike should be replaced.

The volume controls are usually .5-megohm standard units, with very short shafts. If they're found to be noisy, some cleaner will fix them up.

On an emergency call when it's impossible to secure the required pickup, a phono cartridge can be used, with a clipped needle in the chuck. The cartridge should be placed on a pad of felt or sponge rubber which is thin enough to let the needle go through and touch the case of, for instance, the guitar. The assembly should be taped to the instrument, and connected to the regular volume control. The small *cart-ridges* sold for replacement in crystal microphones make excellent substitute pickups, as do the units found in *ear-plug* type headphones. These are actually small dynamic speakers, and will work very well as emergency contact mikes.

A supply of metal-shell type phone plugs is a must item in musical-amplifier work. These are almost universally used on electronic musical instruments. The metal-shelled plugs have been found to stand up much better than the plastic shells, under the rough treatment encountered in the field.

Servicing the Amplifiers

The amplifiers themselves are normally conventional *pa* type units, espe-

cially as far as the power supplies, output stages, drivers, and the like are concerned. Cone-type speakers are used in all of them, for there is very seldom a need for outdoor or long-range work with these sets. The cabinets are basically all alike, with the speakers mounted in the lower half, the amplifiers above them, and the controls on a sloping panel, to make them accessible from above. Dual speakers are found on some of the larger sets, but these are usually of the 10 and 14-inch styles, and not the woofer-tweeter combinations.

The use of twin triodes (6SL7, 6SN7, 6SC7, etc.) for input tubes is common. In most instances, the grids are fed from the individual potentiometers used for gain controls. The plates are tied together, or with small isolating resistors, and the combined outputs fed into the driver input, sometimes through a *master* gain control. In some cases, one of the units is labelled *microphone*, but almost any of the inputs has sufficient gain to handle the average microphone.

Tone controls would seem to be superfluous on these special-application type of amplifiers, but they're found on quite a number of them. Bass-boost circuits are also used, and on one model there is even a volume compressor and expander.

In servicing these amplifiers, it isn't necessary to add to the regular stock of *pa*-system parts. Except for the 8-watt

(Continued on page 55)

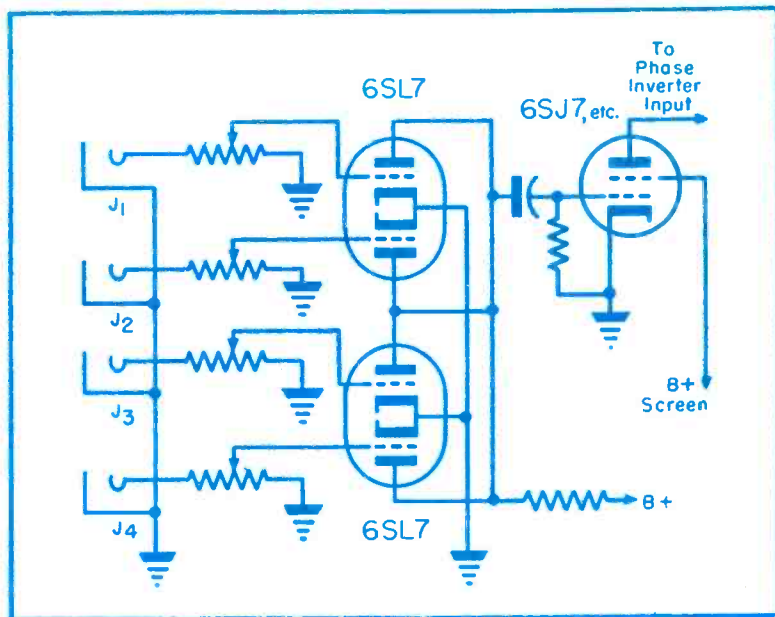

Schematic of a typical multiple-input musical instrument push-pull amplifier. J1, J2, J3, J4 represent phone-plug input jacks, with individual gain controls. The master-gain control for the system is in the phase-inverter input grid circuit (see cover diagram). The driver tube, 6SJ7, may be omitted, and the combined output of the mixer tubes applied directly to a phase inverter. The phase inverter may be either a twin-triode, as shown, a *split-load* using one triode, or an input transformer may be used. The gain of all inputs should be approximately equal, with this system. It is important to watch out for unbalance in the phase-inverter plate-load resistors and grid resistors, as well as the shifting values of the bias resistors and open bias bypass capacitors. Negative feedback may be used in this type of amplifier; dotted lines in the cover circuit.



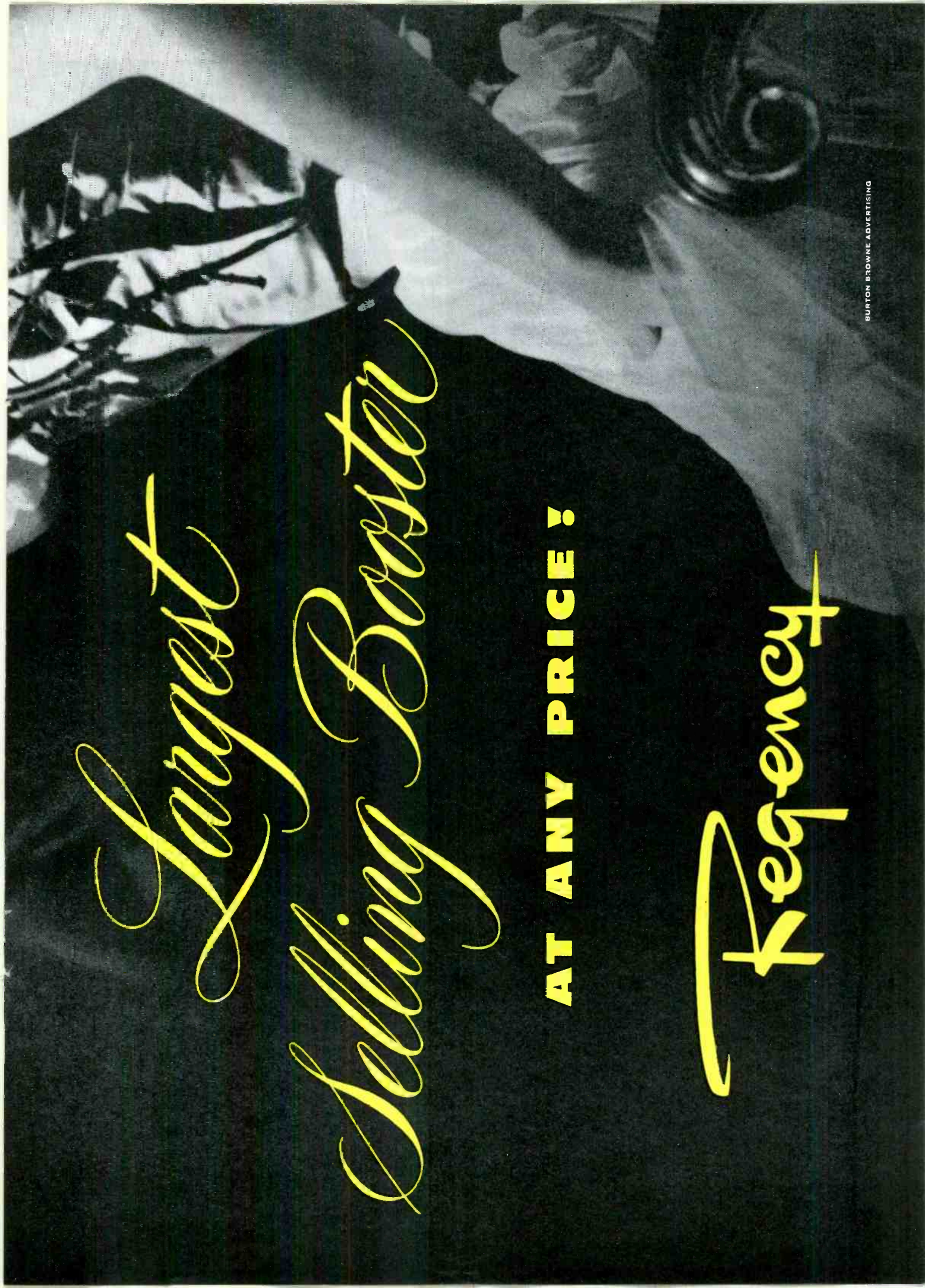

*Largest
Selling Boston*

AT ANY PRICE!

Regency

"We're building up a stock of Amphenol antenna equipment—you should too! . . . because—in times like these—the big Fall market is going to create a demand out of proportion to the supply. A large inventory of the best 7 V antennas, rotators and twin-lead is Fall dollar-volume insurance for us, and can be for you. Start today adding Amphenol antenna equipment . . . have the most of the best and be ready for a profitable summer's-end business . . . get ahead of the shortages."



for **TV** ANTENNAS
LEAD-IN WIRE
ROTATORS

Specify **AMPHENOL**

AMERICAN PHENOLIC CORPORATION
1830 SOUTH 54th AVENUE • CHICAGO 50, ILLINOIS

METALLIC

	Copper Oxide	Magnesium Copper Sulphide	Selenium
Withstand high temperature	3	1	2
Weight	2	3 ^B	1 ^A
Efficiency ^C	1	2	1
Reverse voltage per cell	2	3	1
Life	1	2	1
Temporary overload ^(V) (amperes)	2	1	3
Cost depends upon use			
Deforming when out of use	1	3	2

^AOn aluminum.
^BOn iron (lightweight with magnesium plate).
^CDepends upon voltage of use. Selenium usually excels for power applications.
 Numbers 1-2-3 indicate relative merit, with number 1 highest.

Table 1. Relative merits of metallic rectifiers.

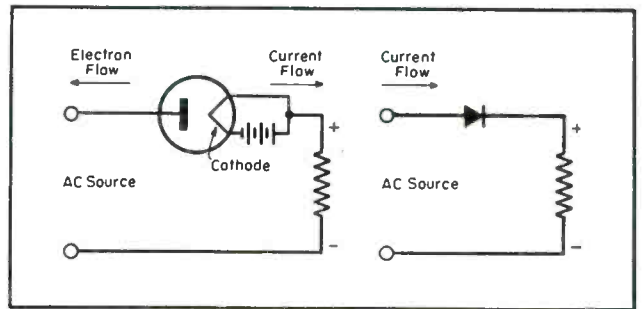
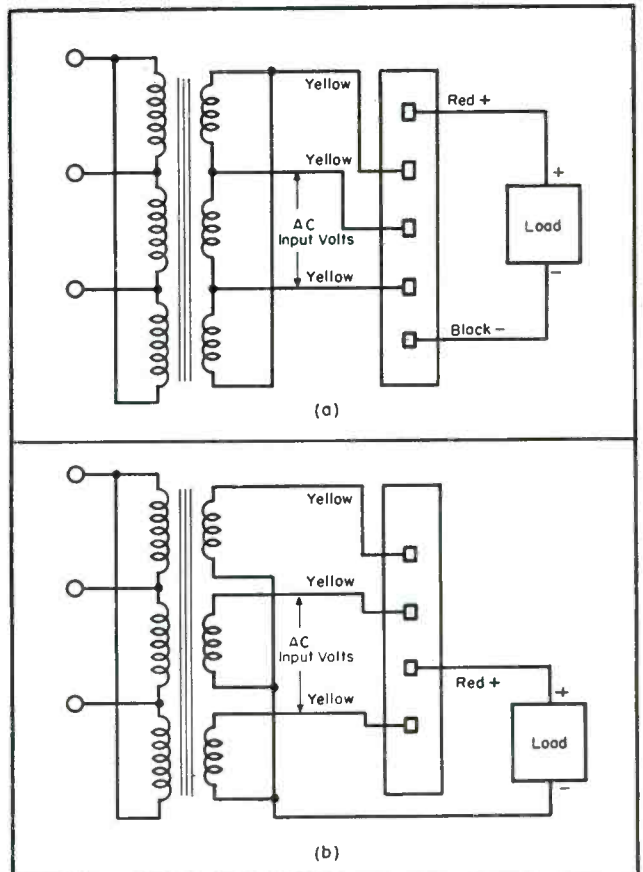

Fig. 1. Circuits illustrating electron flow in tube and metallic-rectifier systems.

Fig. 2. Three-phase bridge (a) and three-phase half-wave circuits (b).



RECTIFIERS

by JULIAN LOEBENSTEIN

Manager, Rectifier Division, Radio Receptor Co., Inc.

Concluding Installment: Polarity Designations . . . Reverse Voltage Ratings . . . Life Aging . . . AC-DC Voltage Ratios . . . Relative Advantages of Different Types of Stacks.

THE DESIGNATION of polarity in half-wave rectifier stacks has been found to be confusing to many. In this stack, the positive terminal is the one to which current flows within the stack. It is often designated as the cathode and marked *K* as well as $+$. Confusion may arise from the fact that in a diode vacuum tube electrons flow when the anode or plate is positive with respect to the filament or cathode. This electron flow is from the cathode to the plate, but by convention the current flow is opposite to electron flow, i.e., from the anode to the cathode. If a tube is inserted into an *ac* circuit, current will flow out of the cathode. This, as well as the flow in a metallic rectifier, is shown in Fig. 1.

The problem may be clarified if the rectifier is considered as a source of *dc* electromotive force, such as a battery. In that case the cathode is the terminal at which the current leaves the battery and is marked positive.

Reverse Voltage Ratings

It has already been stated that each cell is capable of withstanding only a given voltage before puncture, but this statement requires some additional explanation. When a cell is subjected to an alternating voltage the rectifier current will flow in the forward direction, but there will also be a small current which leaks in the reverse direction. The magnitude of this leakage or reverse current will increase as the voltage increases. Since the cell will be heated partly by the forward current, and partly by the reverse current, it is desirable to keep the reverse current reasonably small. Generally, therefore, the voltage rating of a cell is based on the number of volts above which an excessive reverse current would flow and overheat the cell. In almost all cases, there is a reasonable margin of safety above this voltage before the cell will puncture and thus fail. For this reason, most rectifiers are able to withstand short line surges without being injured.

Metallic rectifiers will age. This is defined as any persisting change (except failure) which takes place, for

any reason, in either the forward or reverse resistance characteristic. There is some tendency to age when rectifiers are idle, especially when they are exposed to high temperatures and humidities. Except when they are exposed to extreme conditions, this aging may in general be neglected. However, when rectifiers are in use, aging will take place and in general it is accelerated by temperatures above normal. Likewise, it may be retarded by operation below normal. The individual aging will vary, depending upon the characteristics of the individual rectifiers and the circumstances of their use. Therefore, information on this point should be sought from the manufacturer.

It is obvious that if a rectifier is to be operated at an ambient temperature above that set for its normal rating, its current or voltage rating or both may have to be reduced provided its aging is not to be accelerated. It is desirable, therefore, that some information regarding life expectancy be furnished in specifications calling for increased ambient temperatures. This is a factor often overlooked in specifications written by equipment manufacturers making items for the armed services. In fact, government agencies themselves have been prone to be vague on this point.

Duty Cycles

From the foregoing it may be concluded also that if a rectifier is used intermittently it will run cooler than if used continuously under otherwise identical conditions. This, in turn, means that a smaller rectifier may possibly be used. However, intermittent duty relates only to short-time cycles such as on one minute and off one minute, and not to extended periods such as, on half an hour and off half an hour. For this reason, designations are meaningless when, for instance, they call for a duty cycle of 50%.

By blowing air across a rectifier, heat is rapidly carried away and thus forced cooling also permits the use of cells at current ratings higher than

when cooling is accomplished by natural convection alone.

At the other end of the temperature scale, the rectifier is also affected by extreme cold. But within reasonable limits down to 0°C , the effect of cold may be disregarded. This is because the rectifier has a high resistance at low temperature, but this resistance decreases as the temperature increases. As soon as current starts to flow, the rectifier will usually get warmer with a further decrease in resistance. This continues until a stable condition is reached at a cell temperature reasonably elevated above the ambient temperature.

In using selenium rectifiers, it should also be remembered that the aging characteristics of the half-wave miniature or radio stacks differ considerably from those of the power stacks. The former have a much shorter life for the same operating conditions. But even these radio stacks may be used advantageously for long life under reduced loads or for intermittent duty.

AC-DC Voltage Ratios

Sometimes manufacturers are asked to supply a rectifier which, without using a transformer, will give the same output *dc* voltage as the *ac* input line voltage. Circuit conditions, however, do not yield such results.

In a single-phase bridge an *ac* input of 130 volts will yield approximately 105 volts *dc* output. On the other hand, in a three-phase bridge, an *ac* input of 208 volts will give approximately 260 volts output. This type of circuit is frequently used connected direct to the line and without a transformer to supply power, for example, to the solenoids operating contactors on elevator control boards.

In the half-wave, three-phase circuit in which the *ac* voltage is measured to the center of the wye, the voltage conversion is approximately even. An input of 15 volts *ac* will result in approximately 15 volts *dc*. As in the case of the single-phase center-tap circuit, this half-wave, three-phase circuit

(Continued on page 56)

AUDIO *installation and service*

Phono-Tape-Wire-PA-Amplifiers-Speakers

by **KENNETH STEWART**

IN RECORDINGS ON DISCS, there is one factor which must receive particularly close attention if quality reproduction is to be attained; the *groove dimension*. Specifically, the width or depth of the groove should be governed solely by the dimensions of the playback tip and not by modulation or the spacing between the grooves. It is the primary function of the groove to provide a means of establishing good, firm mechanical contact with the playback stylus tip. To do this, a recording stylus having a suitable tip shape must be selected and the depth of cut properly adjusted when recording. The depth must be such that the contact with the groove sidewalls is well below the top, so that surface scratches and edge irregularities are not reproduced as noise. It has been found that, for lateral recordings, contact along the bottom of the groove is not desirable; hence it is usual practice to use a cutting stylus with a tip radius much smaller than that used for reproduction. For normal groove recording where a 2.5 or a 3.0-mil stylus is used for playback purposes, the groove

*Based on RCA notes.

Corner speaker system which consists of a direct radiating horn cabinet, a *hf* unit mounted on a multicellular horn, two *lf* units, and an 800-cycle crossover network. (Model 820 A; *Altec Lansing Corp., Beverly Hills, Calif.*)

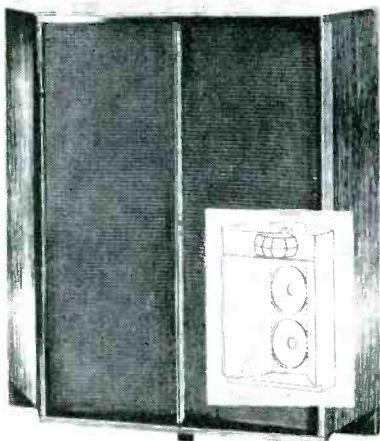

Groove-Dimension Control in Disc Recording* . . . Loudness Controls for AM, FM and TV Chassis . . . Features of Speakers, Cabinets, 3-Speed Standard and Transcription Players, Needles.

depth and width should be greater. Thus, the principle of maintaining contact below the surface of the disc is still retained.

Innermost Diameters

When the outside diameter is fixed by selection of a disc size, the starting diameter is thus essentially fixed, too. The pitch or number of grooves per inch, for a particularly playing time then depends upon the innermost diameter. In determining the innermost diameter, consideration should be given to reproduction. Some reproducers or pickups use a rounded tip of a finite radius, and when the recorded wavelengths become short and comparable to the size of the playback tip, difficulty in tracing the path of

the recording stylus can occur. The resulting effect is known as tracing distortion, and it can reach serious proportions near the inside of the disc where the wavelengths are short.

Number of Grooves per Inch

After the value of the innermost recording diameter is determined (that does not exceed 10 per cent intermodulation) it is possible to calculate the number of grooves per inch. For turntable speeds of both 45 and 33 $\frac{1}{3}$, the total number of grooves, (*G*), for 15 minutes will be

$$(45) G = 15 \times 45 = 675$$

$$(33\frac{1}{3}) G = 15 \times 33\frac{1}{3} = 500$$

The usable playing radius (*PR*) available is

$$(45) PR = \frac{11.5 - 4.90}{2} = 3.3''$$

Dynamic headphones, which it is claimed have a frequency response of from 100 to 7,000 cps (high-fidelity series) and up to 4,500 cps in standard series. (*Permoflux Corp.*)



Three-speed transcription player which can handle from 7" to 17 $\frac{1}{4}$ " recordings and is adjustable for 33 $\frac{1}{3}$, 45 and 78 rpm. Features patented *Varipole* speed control which is claimed to permit gradual adjustment of turntable speed from 25% below normal to 10% above normal. Employs two Alnico V 12-inch speakers, and push-pull 6L6s. Power output is 16 watts. Frequency response said to be ± 2 db from 45 to 14,000 cps. Has two high impedance microphone inputs with separate controls; mixer controls from microphone and phono; tone controls for boosting or attenuating both treble and bass. (Model 24 MUY; *Califone Corp., 1041 N. Sycamore Ave., Hollywood 28, Calif.*)

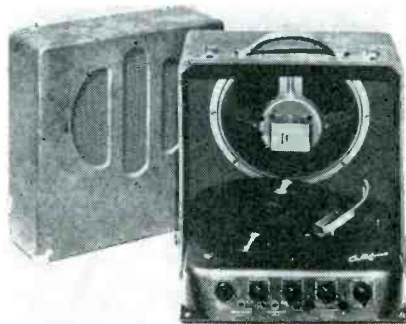

NEW INDICATOR ION TRAP

*A
Rauland
"Exclusive"*



Speeds Service — Builds Profits

Rauland's new Indicator Ion Trap is winning the cheers of more service men and dealers every day — because of the time and trouble it saves in Ion Trap Magnet adjustment, and because it eliminates mirrors and guesswork.

Now it's a matter of seconds to adjust the ion trap magnet with absolute precision. The service man simply moves the magnet until the signal glow is reduced to minimum.

This important new Rauland development is incorporated in all Rauland tubes produced today — as a feature of Rauland's new Tilted Offset Gun. This gun offers the additional advantages of giving only a single Ion Trap Magnet and of maximum sharpness of focus.

Only Rauland offers this advanced feature — one of half a dozen post-war developments from Rauland.

For further information, write to . . .

RAULAND

The first to introduce commercially these popular features:

Tilted Offset Gun

Indicator Ion Trap

Luxide (Black) Screen

Reflection-Proof Screen

Aluminized Tube

THE RAULAND CORPORATION



Perfection Through Research

4245 N. KNOX AVENUE • CHICAGO 41, ILLINOIS



$$(33\frac{1}{3}) PR = \frac{11.5 - 6.5}{2} = 2.5''$$

where 11.5 is the starting diameter and 4.9 and 6.5 are the finishing diameters in inches.

The number (n) of grooves per inch will therefore be

$$(45) n = \frac{675}{3.3} = 204$$

$$(33\frac{1}{3}) n = \frac{500}{2.5} = 200$$

To allow a few blank grooves at the beginning and ending of the recording the foregoing number should be increased to 208 for either 45 or 33 $\frac{1}{3}$ rpm.

The pitch (p) would therefore be

$$P = \frac{1.00}{208} = .0048''$$

If we maintain the groove width, the *land* (material between the grooves) will be .0025". For ease of adjustment in recording, the depth of cut can then be adjusted so that (for a stylus that cuts a groove having a 90° included angle) the width of the groove will be equal to that of the land.

A greater number of grooves per inch can be used. Many fine-groove records have been cut with as high as 275 to 300 grooves to the inch. When the playing time is such that close spacing is unnecessary, it is advantageous to cut a slightly wider and deeper groove so that better contact is assured between groove and reproducer tip.

Loudness Controls

In the audio system, it is desirable to maintain a proper balance of all frequencies in the audio spectrum at any listening level. To provide this result, it has been found necessary to use a loudness control, particularly one that is continuously variable.

With such a control it becomes possible to reduce the output level of a good audio system to nearly whisper volume and still hear most tones with nearly perfect balance. This reproduc-

A talk-test on one of the microphone lines at Shure Brothers, Inc.

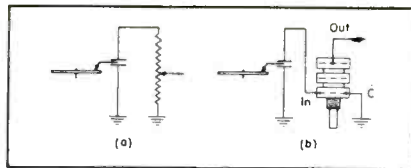

Original (a) and revised record player circuit (b) employing a loudness control.

tion is usually not available with the ordinary volume control since the human ear is very insensitive to both low frequencies and high frequencies of reduced volume levels. This accounts for the reason that many audio systems have to be operated at such high levels.

To obtain correct tonal balances tapped volume controls, various types of bass and treble boost circuits and stepped type loudness controls have been employed. Recently, however, there was developed a continuously variable loudness control¹ featuring the use of three variable resistance units, operated from one common shaft and in combination with the proper resistors and capacitors. A panel section functions as a standard volume control supplying a variable voltage to the other sections which form frequency-compensating networks. A center section forms one variable leg of a potentiometer circuit, and a rear section forms

©R.C. L.C.I.

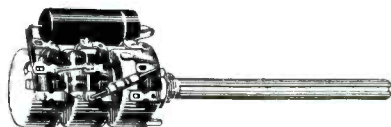

Above, loudness control, and below, circuitry which illustrates how the control works. The unit consists of three variable resistance units, R_1 , R_2 and R_3 , operated from one common shaft and in combination with an assortment of resistors and capacitors, as shown. R_1 is the panel section, which functions as a standard control supplying a variable voltage to the other sections which form the frequency-compensating networks. The center section, R_2 , forms one variable leg of a potentiometer circuit, and the rear section, R_3 , forms the other leg. A fixed resistor, R_4 , acts as a limiting resistor to keep the input impedance as constant as possible when the control is set near maximum output. The rear section, R_5 , fixed resistor, R_5 , and capacitor C_2 , form the arm of a variable voltage-divider network that increases the impedance as the frequency is decreased.

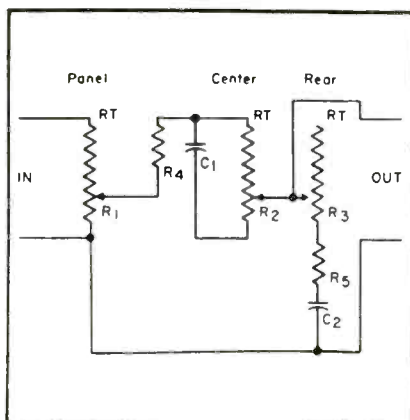

the other leg. A fixed resistor acts as a limiting resistor to keep the input impedance as constant as possible when the control is set near maximum output. The center control in combination with a capacitor forms the arm of the variable voltage divider network, which decreases in impedance as the frequency increases, causing the output voltage to rise at frequencies above 1,000 cps.

The rear section, a second fixed resistor and an additional capacitor form the arm of the variable voltage divider network that increases in impedance as the frequency is decreased, causing the output voltage to rise at frequencies below 1,000 cps.

Use of Control

In installing the control, it is necessary to know if the audio system has sufficient gain; this can be checked by setting the original control so that the resistance from the low side to the center terminal equals its total resistance times 0.011. At this setting the sound output of the midrange frequencies should be such as to give comfortable room volume. If this is not the case, the loudness control will not be effective unless additional gain is supplied.

Typical Circuits

In some amplifiers .5-megohm controls are used in the plate circuit of such tubes as the 6J7, 7C7 and 12SJ7. The control should only be used in such circuits if in its normal usage it is never operated above 60 per cent of its rotation. Above this value of rotation its impedance drops to approximately .2 megohm causing a loss of gain.

In some AM receivers where the vc is a diode load, a fixed stop of 50,000 ohms is used to replace the 47,000-ohm resistor. If this is the case a 47,000-

(Continued on page 32)

Three speed automatic record changer, which incorporates automatic set down selection of 7", 10" and 12" records; record protection (records are lowered on spindle shelf); automatic intermix of 10" and 12" records of same speed; automatic shut-off; dual needle reversible cartridge; and centralized controls. (Model 920; V.M. Corp., Benton Harbor, Mich.)





Here's how YOU
 can sell more
 Picture Tubes
 WITH
 HYTRON'S NEW
 EASY BUDGET PLAN!

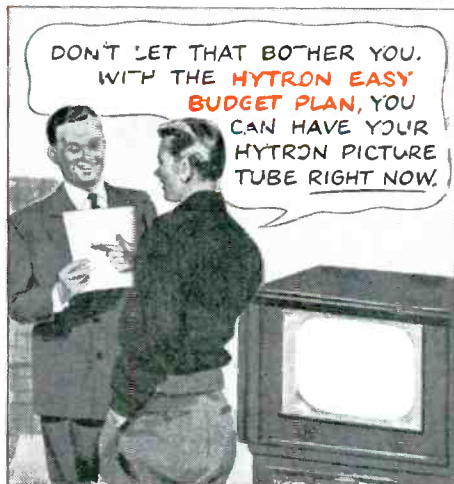

ANOTHER HYTRON FIRST FOR YOU!

No need to miss that profitable picture-tube sale — just because the customer doesn't have the cash. The original Hytron Easy Budget Plan saves the sale. Gives you a competitive edge. Hytron has arranged the details for you. A national credit organization, with facilities in all TV areas, stands ready to serve you.

Find out how you can put this wonderful, timely Hytron plan to work right now! Write for complete information today.

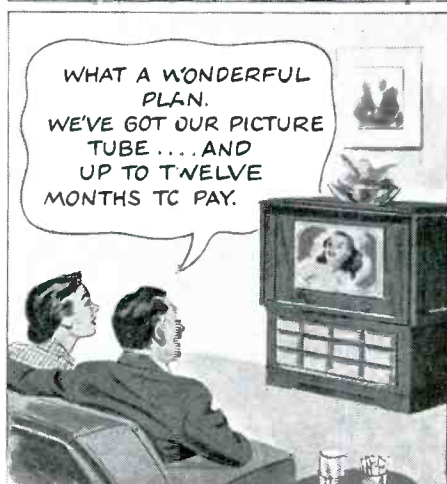

ANOTHER
 HELPFUL SERVICE
 FOR YOU FROM...



MAIN OFFICE: SALEM, MASSACHUSETTS

Stimulate More Sales for BURGESS BATTERIES

USE THESE NEW BURGESS PROFIT AIDS IN YOUR STORE!



COUNTER MERCHANDISER SELLS THE PRODUCT!

This handsome little counter display takes up little space and displays portable radio battery XX45. This model is most used in the popular smaller portable radios. Consumer benefit printed at top prompts sales. Red, yellow and black.

Contact your jobber now for this material.

EYE-CATCHING WINDOW BANNER MAKES CUSTOMERS OUT OF PASSERS-BY!

This attractive new Burgess window streamer gets immediate customer attention—ties in with Burgess advertising in big national magazines and newspaper supplements with national circulation—reminds customers to buy fresh Burgess portable radio batteries for summer fun. Colorful red, black, yellow on durable stock.

ATTENTION-GETTING COUNTER CARD REMINDS TO BUY!

Folks just browsing through your store, and customers for other purchases, are reminded to buy Burgess when they spot this colorful red, black, yellow counter card. Printed on heavy cardboard stock with sturdy easel.



Audio

(Continued from page 30)

ohm unit should be added. If the original control had a tap for tone compensation, components connecting to this tap should be omitted.

Since the loudness control boosts the low frequencies several times, any hum pickup will be boosted that amount. Thus, the input lead to the control should be kept as short as possible and if over 2" long should be shielded. Shielded leads should be of the low-capacity type, so that high frequencies will not be unduly cut. In high quality amplifiers, loudness control can be mounted in a steel can, if there is sufficient room, to eliminate any possibility of hum pickup. Switches can be attached to the loudness control, but great care must be exercised in wiring to reduce the possibility of hum pickup.

Audio Literature

Stylus and Cartridge Replacement Guide: A guide which charts the use of styli and cartridges in G. E. as well as competitive phono combinations has been published by the G. E. receiver division.

Included with the guide is a revised variable reluctance cartridge folder which includes a finger-tip index for cartridge use.

Phono Cartridge Directory and Replacement Guide: A directory (form S-168) listing cartridge models of all major cartridge manufacturers has been published by Astatic Corp., Conneaut, Ohio. Units made by Astatic competitors are listed alphabetically and numerically, and recommended Astatic replacement for each is indicated.

The guide includes illustrations of all Astatic cartridges and needles, together with performance data on each. Another section carries a listing, also in table form for reference, of discontinued Astatic cartridges and the proper current replacements for them.

Magnetic Tape Dictating Machine Brochure: A four-page leaflet describing a tape-recorder designed especially for dictation purposes has been released by the Permoflux Corp., 4900 W. Grand Ave., Chicago 39, Ill.

Phono Pickup Cartridge Replacement Manual: A 16-page manual listing over 1,500 phono and radio-phono combinations, as well as radio-TV-phono combinations using crystal cartridges has been published by Shure Brothers, Inc., Chicago 19, Ill. Also described are the complete family of crystal and ceramic cartridges made by Shure and an assortment of needles also available from the manufacturer.

BURGESS BATTERIES
BURGESS BATTERY COMPANY • FREEPORT • ILLINOIS

MAGNETIC RECORDING

by L. S. HICKS

Webster-Chicago Corp.



Professional recording studio of Max McKahan, who operates the McKahan Radio and Recording Service in Buchanan, Mich. Ten years ago McKahan experimented with a home recorder for a hobby. Although he recorded his favorite programs primarily, soon his neighbors and friends took much of his time with requests that he record their special talents. As his interest in home recording grew, McKahan studied professional recording techniques in his spare time. Recording as a sideline became too important for the living room of his house and in '45, he built the studio and control room shown in the photograph. Through the years professional quality equipment was added to the studio to replace the home recorder he started with originally. Finally, in '50, a broadcast quality control console, designed and built by McKahan and a broadcast limiter, were added. At the present time, the dollar volume of McKahan's recording business nearly equals that of his radio and sound work. His customers include aspiring artists, professional performers, public speakers and musicians. In addition fond parents frequently have the voices of their off-spring preserved on recordings. The recordings made are used for auditions, home critique, public announcements at local events, family albums, spot announcements for broadcast and remembrance albums for small vocal groups. (*Microphone used in this studio is an E-V 636*).

Part II . . . Properties of Microphones Which Can be Used in Magnetic Recording . . . Microphone Extension Installations . . . Features of Mixer-Preamps . . . Recording Without a Microphone or From the Receiver and Phono Record.

THE MICROPHONE is one of the important factors affecting the fidelity of a recording. Recorders are normally supplied with crystal types, with a frequency response usually flat within ± 3 db from 70 to 7,000 cycles, and an output of about -50 db. This means that it is unusually sensitive and that its response is more than adequate for most recordings.

Special microphones are sometimes desired for unusual recording conditions, but in the main, you will then find that special types are really not needed.

Five Types of Mikes in Use

There are five different microphone types in common use today: crystal, dynamic or moving coil, ribbon or velocity, condenser, and carbon.

The crystal and dynamic types are most often used for recording. The crystal microphone has the advantage of lightweight, small size and good fidelity over a wide frequency range. It delivers a strong signal, usually has an output rating of -52 to -50 db, offers a *high impedance* output and may be operated directly into the grid

of the first amplifier tube. The moving coil or dynamic type has the advantage of being able to withstand wide temperature and pressure changes. It features good fidelity, small size and rugged construction. The output is usually less than from a crystal microphone, so one must be certain that the one being purchased has enough power to work with the recorder. One with an output of -55 db or better is usually satisfactory.

Ribbon, Condenser and Carbon Mikes

The ribbon microphone is one of the highest fidelity types made, and is small in size and lends itself to special pickup patterns. Its greatest disadvantages are its low output and the fact that it is quite delicate. It is ideally suited for use in special locations under controlled conditions.

The condenser microphone is a high-quality type with excellent characteristics. Its chief drawback is that it has to be associated with an amplifier and have various voltages fed back to it. It cannot be used with the usual home recorder either.

The carbon microphone is a poor quality type, and has to have voltage

fed back to it. It has a high output level and is widely used in military and voice-frequency operations. It is not suitable for magnetic recording purposes.

Low-impedance mikes are used where the microphone cable is long or where *ac* hum may be picked up by the cable. High-impedance microphones are used with short cables, up to about forty feet in length, and where no input transformer is used. High-impedance crystal microphones operate directly from the high-impedance crystal itself.

In general, it is good practice to keep the microphone cable as short as possible. A cable longer than about thirty feet on high-impedance models tends to cut out the high frequencies; up to forty-five feet of cable may be used when recording speech only.

Microphones which have maximum pickup from the front and a progressively decreasing pickup ability from front to back are known as cardioid types, because of the heart-shaped pickup pattern. On some installations, it is desirable to have a little pickup from the sides and back, and this microphone meets such requirements.

A truly cardioid microphone is not always the most desirable type, since sounds originating from the sides cause as much feedback as those from the rear. The so-called *super-cardioid* and *hyper-cardioid* patterns have been developed to give better feedback reduction.

In selecting a microphone, thought must of course be given to the acoustics of the installation. If a large num-

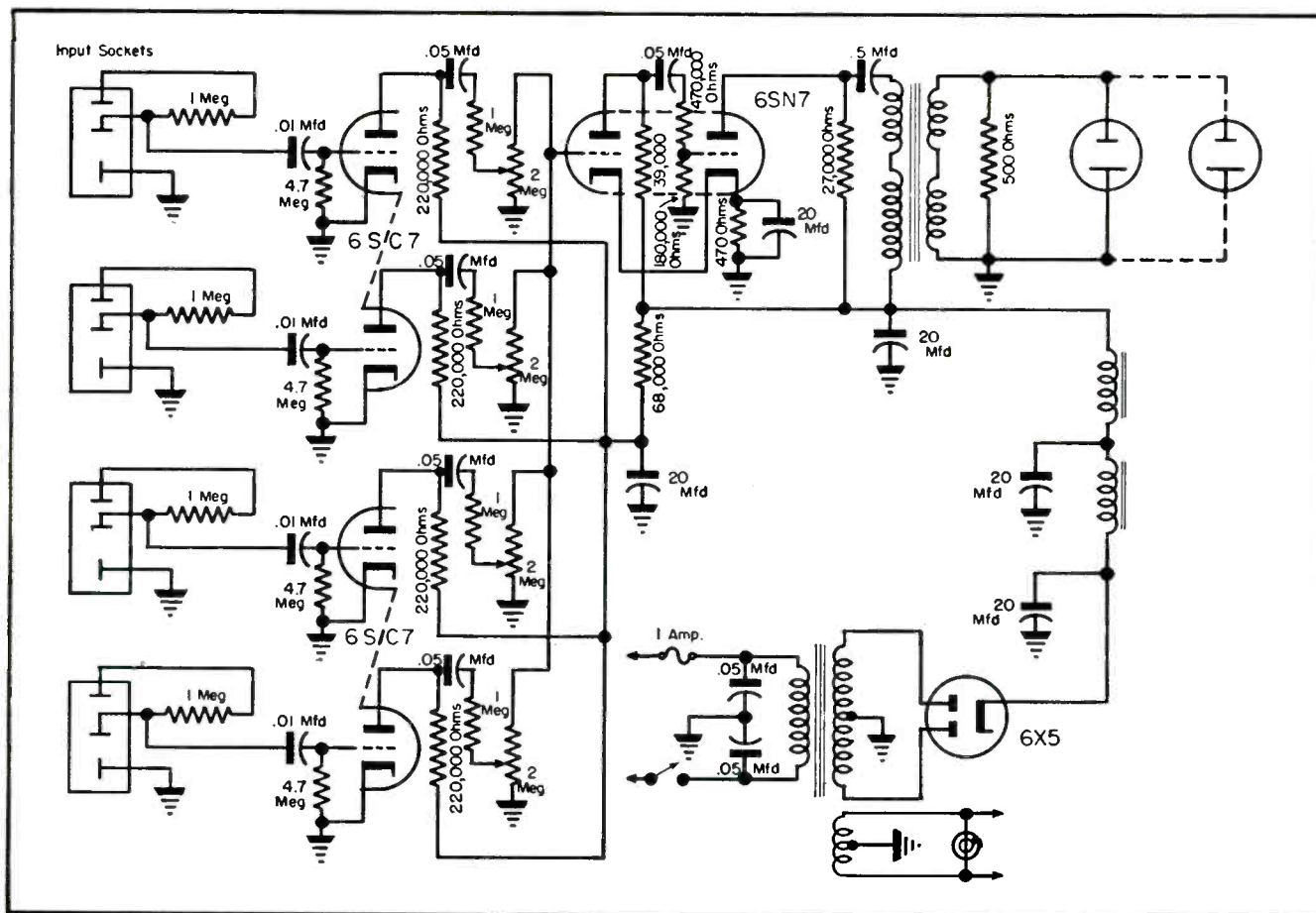

Fig. 1. Four-channel mixer and preamp.

ber of people are to use the microphone at the same time, a non-directional type is to be preferred, so that they may stand around the microphone and it will pickup in any direction. The microphone supplied with a recorder laid on its back, is ideal for such an installation. A single speaker or group can best be picked up with a semi-directional type as it is most sensitive on the front and sides. A very *live* room with reflections and echoes from the walls should use a cardioid microphone to cut down this unwanted pickup.

Microphone Extensions

Up to fifty feet of microphone extension cable can be used with the usual high-impedance microphone without serious loss in volume or frequency response.

When making an extension, good quality microphone cable must be used. A male connector should be soldered to one end and a female connector to the other end of the cable to fit the plugs and receptacles on the particular microphone and recorder in use. If in doubt as to what is required, the parts distributor should be consulted.*

If the microphone must be placed more than fifty feet from the recorder to get a good signal-to-noise ratio, it's wise to use a low-impedance microphone, ordinary two-conductor *ac* cord

and a line-to-grid matching transformer at the recorder. A 200-ohm impedance is common. Most microphone manufacturers offer a suitable transformer for use with their particular microphones.

The reduction of feedback or squealing is always a problem in public address work. This can best be reduced by the use of a microphone with a cardioid pickup pattern.

Orchestras, bands, choirs or other musical ensembles may require a microphone with a wider frequency range than your standard mike or with a special pickup pattern. This would usually call for a dynamic microphone with a cardioid pickup pattern.

Mixer-Preamps

It is often desirable to mix the output of several microphones or to mix voice, picked up by the microphone,

with music from a phono pickup or a radio receiver.

A temporary method of mixing several microphones would be to parallel two or three of them. When microphones are connected in parallel, each affects the other and the total output of all of them is less than the output of an individual microphone. However, the fact that the microphones can be brought nearer to the sound source is an advantage and the over-all signal-to-noise ratio is improved sufficiently to warrant such a make-shift hookup.

The best method of *mixing* is electronic. Each input or sound source is fed into an amplifier stage of a *mixer-preamp*, mixed electronically in a tube circuit and then fed to the phono input of the recorder.

To increase the sensitivity of the microphone a preamp is also needed, where the sound source is quite a distance from the microphone. The recording of bird calls or of distant conversations are typical examples.

It is most convenient to combine the features of a mixer circuit and pre-amplifier circuit into one unit. The circuit shown in Fig. 1 is typical. Its use permits the gain of each microphone or sound source to be varied independently of the other and without affecting the volume of the other sources, at the same time avoiding any loss which is inherent in straight

*Many recorders use a Cinch number M-95 plug on the microphone. Thus an M-95 plug and a Cinch 1144 shell and 2811 connector would be required. Webster-Chicago uses Jones plugs; thus Jones P-303-CCT plug and a Jones S-303-CCT socket are necessary. The shield of the cable is connected to terminal 1 and the conductor to 2. Terminal 3 is not used with a microphone. Some recorders use Amphenol connectors; an Amphenol 75-MC1M plug and a 75-MC1F socket is therefore necessary. If a telephone type plug is used, a plug such as a Mallory 75N and a socket such as a Mallory 100N can be used.

The RCA "TV Duo"...



... the last word in *precision* and *versatility*

RCA WR-59B Television Sweep Generator

What it does—Provides fast and accurate sweep alignment and trouble shooting of TV front ends . . . sound and picture if amplifiers . . . discriminators and ratio detectors . . . trap circuits . . . video amplifiers . . . and if amplifiers in FM sets.

What it features—Preset switch positions for TV channels 2 to 13 . . . continuous tuning from 300 kc to 50 Mc . . . flat output, within ± 1.5 db even at maximum sweep width . . . fundamental oscillator output on all TV channels . . . filtered beat-frequency-fundamental output on if/vf range . . . zero-voltage reference line provided by return-trace blanking . . . dual piston attenuator with maximum attenuation ratio of 20,000 to 1 . . . continuously variable sweep width up to 10 Mc . . . output frequency-modulated at the fundamental frequency by a precision-type vibrating capacitor, for long life and good linearity . . . balanced rf output cable terminated in 300 ohms . . . fully shielded circuits and filtered power line . . . resistance-terminated if/vf output cable.

For complete details ask your RCA Test Equipment Distributor for Bulletin 2F753-R.

RCA WR-39C Television Calibrator

What it does—Provides dual markers for rf picture and sound carriers . . . provides signals for peak alignment of stagger-tuned if amplifiers . . . develops vertical bar pattern for horizontal linearity adjustments . . . generates a crystal-controlled AM signal for alignment of inter-carrier sound if's . . . provides triple markers for sound discriminator adjustment . . . allows adjustment of local oscillators in TV front ends with crystal accuracy . . . checks reception on all 12 channels by means of video signal obtained from single channel of a TV set.

What it features—Variable-frequency oscillator operating on fundamentals over entire range . . . sound and picture carrier frequencies marked on expanded, easily-read scale . . . two crystal oscillator stages with 3 crystals supplied . . . wide-band modulator stage with range of 0 cps to 30 Mc . . . crystal standard supplying over 600 calibration check points at 0.25-Mc intervals . . . bar-pattern generator for linearity adjustments.

For complete details ask your RCA Test Equipment Distributor for Bulletin 2F751-R2.

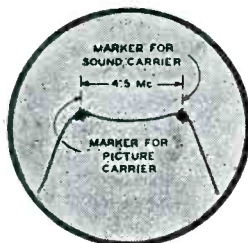

"Scope pattern of dual markers for rf picture and sound carriers, produced by the "TV Duo."

Available from your RCA Test Equipment Distributor



RADIO CORPORATION of AMERICA
TEST EQUIPMENT
HARRISON, N. J.

parallel connections. It is permissible to feed the 500-ohm output of this mixer direct to the high-impedance phono input of the recorder without a matching transformer. Voltage only is being transferred, not power; thus the *mismatch* will not be noticeable.

The circuit shown provides four input channels. Either microphones or phono pickups can be fed into any channel because each includes one half of a voltage divider network. The other half is the resistor in the 3-prong input plug as shown. This resistor is used only when recording from a high-level sound source such as a phono pickup or a radio tuner.

A 500-ohm output permits long extension lines between the mixer and the wire recorder when desired. Even ordinary lamp cord can be used for the connecting line with no danger of hum pickup or noise. Two or more output sockets can be used, as indicated by the dotted lines, if more than one recording is to be made at one time.

With an input of .02 volt from a microphone or 1 volt from a phono pickup or radio tuner, the output from the mixer should be 1.7 volts. If the input from the high-level source is more or less than 1 volt, the value of the external input resistor can be changed to apply .02 volt to the grid of the 6SC7 triode section used.

When using a preamp it must be remembered that the background noise, (any noises near the microphone) will be amplified in the same or in greater proportion than the signal you are seeking. One cannot use the preamp and have the sound source a long distance from the microphone, unless there are no nearby noises, for the nearby noises overshadow the more distant sound you want to pick-up. This is because sound intensity varies logarithmically or as the square of the distance from the sound source.

Sound Effects

Home made sound effects can easily be prepared to add realism to the production. For example, a thin sheet of tin can be bent and rattled to make it sound like thunder. Crumpling a piece of cellophane close to the microphone will reproduce as a wood fire.

A pillow can be hit with a stick to produce a gun shot. Two small, pliable sticks should be used and the pillow hit rapidly for a machine gun or rapid fire. Rolling roller skates over a rough surface will imitate train wheels. Any kind of a wind from a summer's breeze to a hurricane can be recorded by blowing across the face of the microphone. Popping the finger from the side of the mouth sounds like

the pop of a bottle being opened. The possibilities are wide and new effects will come with practice.**

If two recorders are available, one to play back pre-recorded sound effects and one to make the new recording, sound effects can be recorded from life. However, it will be often found that artificial sounds sound more natural than the actual when reproduced through the loudspeaker.

Recording Without a Microphone

Recording A Radio Program: Initially, many will probably place the microphone near the loudspeaker to record their favorite programs. This will be easy, although there must be complete silence in the room. Of course the fidelity of the recording will not be as good as that available from a direct recording from the radio itself. Thus, there will soon be a graduation to direct recording.

Most recorders have two jacks. One is marked *microphone* and the other *radio-phono*. The microphone input may also be marked *low level* and the radio-phono input *high level*. Regardless of the labelling, the radio-phono input is used for direct recording from the radio.

Two methods of picking up the radio signal for making direct recordings are in use. The most convenient method is to connect a shielded cable across the voice coil of the receiver and to the phono input of the recorder. Many recorders supply a special cord for this purpose, complete with alligator clips to clip onto the voice coil solder terminals. One disadvantage of this method is that the recording volume is controlled by the volume control of the radio, as well as the control on the recorder. It is not possible to turn the volume of the receiver down to zero and still record. Another theoretical disadvantage is that there is a mismatch between the 3.2-ohm (average) impedance of the voice coil and the high impedance grid of the wire recorder input circuit.

**Many organizations also offer sound effects on phono records. Sears, Roebuck offers several sound-effect records as part of a home movie synchronization kit. Several firms, who offer sound effects discs to radio stations, also sell direct. Among the largest firms are Gennett Records (division of Starr Piano Co., Inc.), Richmond, Ind., and 1344 S. Flower St., Los Angeles, Calif.; Standard Radio Transcription Service, Inc., 140 N. LaBrea Ave., Hollywood 36, Calif.; 360 N. Michigan Ave., Chicago, Ill., and 1 E. 54th St., New York 22; and Thomas J. Valentino, Inc. (Major Sound Record), 1600 Broadway, New York 19. Both RCA and Columbia also list sound effects records in their catalogs.

‡As in the Webster-Chicago 288.

‡‡As in the Revere or Ekotape models.

The more difficult, but best method, is to take the signal off the radio from across the volume control. The volume control is at a strategic position, for it is the input to the audio amplifier or the gate that regulates the amount of loudness of the signal going to the loudspeaker. A radio signal may be *picked off* at this point or a wire recording played back to this same position. When recording, the setting of the volume control for the radio amplifier will have no effect on the recording. When playing back, it will act in the usual way to control the volume, along with the volume control of the recorder.

Special Connecting Cable

It may be convenient to make a special connecting cable to record from and play back through the receiver. A single length of microphone cable should be used and two ends provided at the recorder end, one to fit the input receptacle and one to fit the output. If the input and output receptacles differ,‡ a cord will be needed. If the two receptacles are the same‡‡, only one plug is needed.

Provision for Dubbing

When recording a radio program, the wire or tape should be allowed to run a few seconds with the volume control turned *off*. Then the operator can *fade in* just as the program begins or after the *commercial* is over. This will provide a blank space on which to dub in announcements or comments. Fading in or out by means of the volume control results in a smooth, professional recording.

Recording From A Phono Record: If a magnetic pickup is used, it is possible to record directly from the phono pickup, or the output of the preamp. This connection is ready made if the radio is a phono combination. Those who desire to record all the *highs* possible will disconnect the phono pickup from the radio and connect it directly to the recorder. Actually, the average person can hardly discern the difference in response, but theoretically the pickup is incorrectly loaded when both the recorder and amplifier are connected to it.

It must be remembered that the signal delivered by the usual phono pickup is much higher or louder than that from a microphone. It is important to use the *high level* or phono input connection.

[To Be Concluded in July, SERVICE]



TELE-ROTOR

This heavy-duty TELE-ROTOR has no match! It's more powerful . . . will turn any TV antenna array under any weather conditions. Easily installed . . . it is trouble-free in performance. Easiest of all to operate!

MODEL TR-2 . . . rotator with "compass control" cabinet having illuminated "perfect pattern" dial . . . (uses 8 wire cable) \$49.95

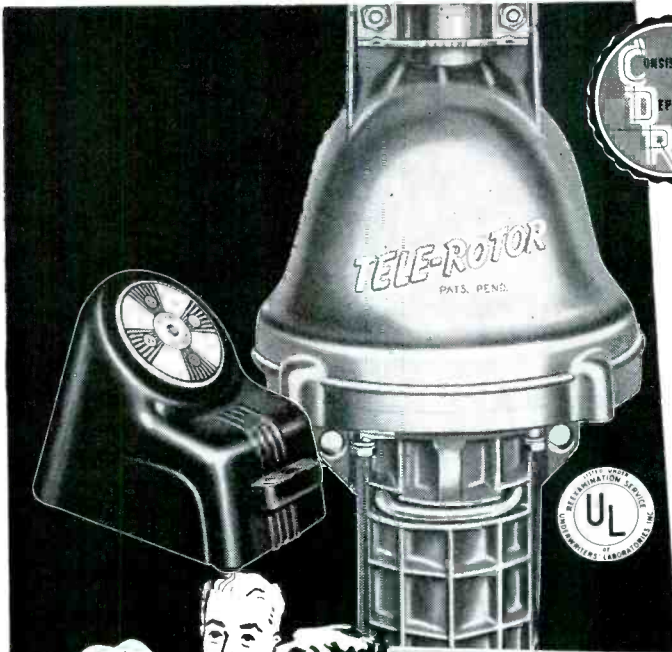

Give your Customers the Best
You Can't Beat A
TELE-ROTOR



TELE-ROTOR CUB

The new TELE-ROTOR "CUB" is ideal for average installations. The same husky motor as the Heavy-Duty model . . . the "CUB" is the fastest and easiest of all rotators to install. All-In-Line design . . . with true in-line thrust between antenna and mast. The 3/4" STEEL shaft rotates on a case hardened steel ball . . . with in-line reamed oilless bearings.

MODEL 502A Rotator with plastic control cabinet having indicating meter for "hairline" tuning. (Uses 5 wire cable) . . . \$44.95

MODEL 501A rotator with control cabinet having end-of-rotation signal. Light flashes every 7.2° showing antenna is turning. (Uses 5 wire cable) \$34.95

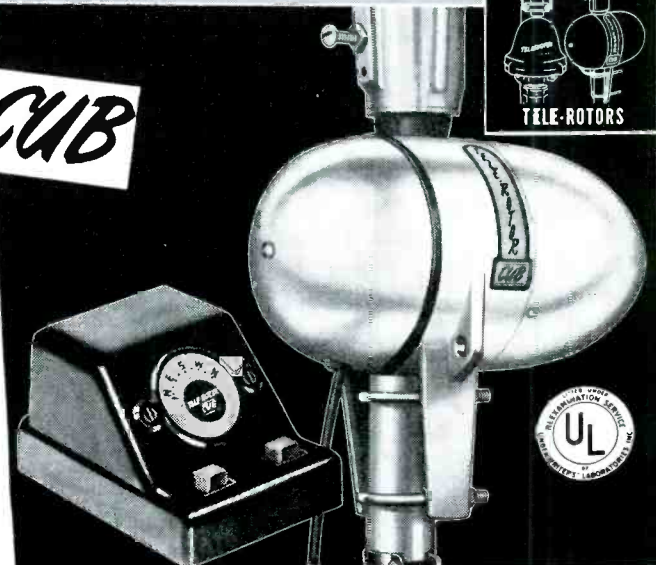

THE RADIART CORPORATION CLEVELAND 2, OHIO

CORNELL-DUBILIER SOUTH PLAINFIELD, N. J.





TUBE

News

by L. M. ALLEN



Features of 14, 17 and 20-Inch Rectangulars With Electrostatic Focusing . . . Design and Application Characteristics of 9-Pin Triode-Pentode Converter.



ELECTROSTATIC FOCUSING, developed to conserve materials, is rapidly becoming a feature of not only all popular sizes, 14, 17 and 20-inch, but rectangular shapes as well. Three types, announced by RCA recently, are rectangulars; 14GP4, 17GP4, and 20GP4.

Focus in each of these types can be maintained automatically with variation in line voltage and with adjustment of picture brightness. Need for alignment of a focusing magnet is eliminated.

The 14GP4, of the all-glass type with external conductive bulb coating, has a maximum high-voltage rating of 14 *kv* (design center), and produces 11 $\frac{3}{8}$ " x 8 $\frac{1}{2}$ " pictures.

The 17GP4, of the metal-shell type, has a maximum high-voltage rating of 16 *kv* (design center), and produces 14 $\frac{5}{8}$ " x 11" pictures on a relatively flat face of frosted Filterglass.

The 20GP4 is of the all-glass type

(Above)

Electrostatic-focus, magnetic-deflection 17 inch (17GP4) rectangular metal-shell picture tube. (Courtesy RCA)

with an external conductive bulb coating. It has a maximum high-voltage rating of 18 *kv* (design center), and produces 17 $\frac{1}{4}$ " x 13 $\frac{1}{4}$ " pictures on a Filterglass face.

Employing magnetic deflection, each of the three types has a diagonal deflection angle of 70° and a horizontal deflection angle of 66°.

The rectangular shapes, which allow reproduction of the transmitted picture without waste of screen area, permit use of a cabinet having about 20 per cent less height than is required for a round-face tube having the same picture width.

The 14GP4 has a white fluorescent screen on a face made of Filterglass. This plate incorporates a neutral light-absorbing material which reduces ambient-light reflections from the phosphor and reflections within the face plate itself in a very much higher ratio than it reduces the directly viewed light of the picture.

Other design features of the 14GP4 are short overall length; an external

conductive coating which with the internal conductive coating forms a supplementary filter capacitor for the *hv* supply; and an ion-trap gun requiring a single-field, external magnet.

Focusing of the beam is accomplished by adjustment of the voltage applied to grid 4. Because this electrode takes very low current, the focusing voltage can be readily provided. When the high voltage supply is of the pulse-operated, limited-energy type, commonly used, the focusing voltage can be obtained by means of a rectifier system connected to a suitable tap on the horizontal-deflection output and high-voltage transformer. Such an arrangement produces negligible drop in the output voltage of the high-voltage supply.

The ion-trap magnet, required to recenter the electron beam in the gun

(Continued on page 57)

(Above)

Electrostatic-focus 14-inch rectangular with glass envelope; 14GP4. (Courtesy RCA)



A Masterpiece

COMPLEX, EFFICIENT . . . KESTER SOLDER MAKES IT POSSIBLE

Good fast work can only be done with the best materials. Kester Plastic Rosin-Core Solder and the more active Kester "Resin-Five" Core Solder, made only from the finest grades of tin and lead commercially available, are formulated especially for TV, radio, and electrical work. Kester Solders flow better . . . handle easier . . . faster to use.

Free Technical Manual—Send for your copy of "SOLDER and Soldering Technique."

KESTER SOLDER COMPANY
 4248 Wrightwood Ave., Chicago 39, Ill.
 Newark, N. J. • Brantford, Canada



SAVES TIME

DEPENDABLE

EASIER TO USE

FASTER



Servicing Helps

by M. A. MARWELL

Operation of RF Tester with VTVM . . . Changes in Circuits Using Electrostatic Focusing . . . 35Z5 Tube Substitution

IN APPLYING AN RF test unit of the type described by Philip Greeley in the December, 1950, issue of SERVICE, some may prefer to use the instrument with an external *dc vtvm*. For such operation, the *rf* circuit is set off resonance or can be shorted to eliminate *ac* input to grid of T_1 (Fig. 1) and connections made with pin jacks 1 and 2. The test lead in 2 should have a probe terminating with a resistor or about 1 megohm. For negative voltage tests, as *avc* in AM sets or checking oscillator grid voltage for operation, the *eye control* is first set for eye open. For leakage tests, as across a grid resistor following an audio coupling capacitor, the eye should be set closed and will stay closed unless the capacitor leaks. By setting the eye closed and using pin jacks 2 and 3, a very sensitive leakage test for separate coupling and bypass capacitors becomes available. The eye will open until the capacitor becomes charged, but should return to closed if the capacitor does not leak appreciably. Capacitors larger than .01 mfd on this test will be slow on charging, unless a lower value resistor of .5 megohm is temporarily switched across terminals 2 and 1.

This is an interesting *vtvm* circuit which may have other uses and modifications. The cathode-follower design reduces loading on a tuned circuit, giving sharper resonance indications than a system in which the rectifier is directly connected across the tuned circuit. Although the eye tube is not suited for good voltage calibrations, it is a sensitive indicator and excellent for showing a peak voltage and other qualitative voltage conditions. In the *rf* tester, also, the quick response of the eye is advantageous in checking circuits that may have loose connections or other intermittents.

Quality or *Q* indications on *rf* tests are extremely useful in detecting deteriorated coils and capacitors. Close-wound, fine-wire coils that have absorbed moisture, give poor *rf* tests and show relatively high *rf* resistance even

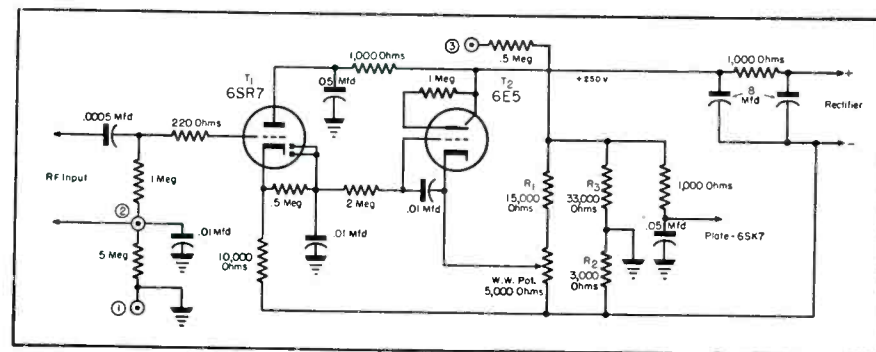

Fig. 1. Circuit of eye-tube *vtvm* system used with *rf* test instrument described by Greeley in the December, '50, issue of SERVICE. The 220-ohm resistor, in series with the tube grid, is used to curb any tendency to oscillation at the higher frequencies. It will be also noticed that the ground potential is about 30 v positive, and thus the cathode of the 6SR7 is a few volts more positive; normal cathode-follower operation with the tube grid return to ground. The cathode of the 6E5 eye tube T_2 , can be set at a suitable working potential, corresponding with the cathode potential of T_1 , by adjusting the wire-wound pot, which covers a range of about 60 v.

though the *dc* resistance is okeh. Capacitors, particularly electrolytics, which have developed excessive series resistance may cause little or no closing of the eye. Usually, there is no need to disconnect a coil or capacitor from its circuit for test. When the action of the *rf* tester on good components has been observed, it is not difficult to note, by the lack of good eye closing, such parts as are in relatively poor condition.

On *ac* voltage input, as used in the *rf* reactance measurement tester, the voltage appearing at the grid of T_1 follows at the cathode and is rectified by diode plates for application to the grid of tube T_2 . A grid-to-cathode voltage change of from 0 to 6 or 8 v varies the eye tube shadow angle from 90° to 0°, with best reading sensitivity appearing when eye just closes. By adjusting the *pot* or *eye control*, best

performance of the eye tube can be readily attained.

Electrostatic-Tube Circuitry

Late production RCA 17" television receivers are featuring electrostatic focus 17GP4s¹ with circuitry revisions, as indicated in Fig. 2, the changes being shown in heavy lines. A new high-voltage transformer is required and a 1V2 rectifier is provided to supply focus potential. A focus control potentiometer is also supplied and is located on the back of the chassis.

Since the focus magnet is dispensed with on the 17GP4, a new centering magnet has been provided to center the picture on the screen. This magnet assembly is in the form of two wire rings mounted on a non-magnetic form which is placed around the neck of the
(Continued on page 70)

¹Letter B follows model number in those chassis using an electrostatic focus tube.

Fig. 2. Revised *hv* circuit of RCA 17-inch TV chassis, which provides for use of the new electrostatic focus tubes.

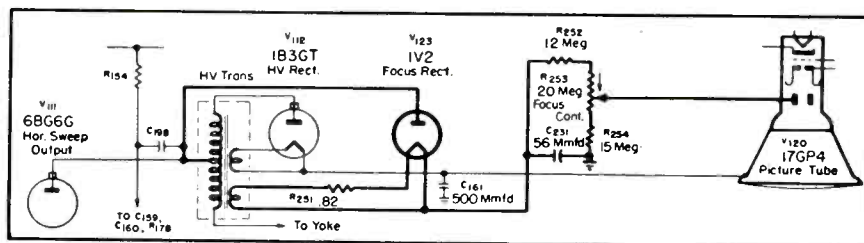









PERMO *long-life*
PHONOGRAPH AND NEEDLE FACTS







ADMIRAL LISTING

CHANGERS BY MODEL NUMBERS OF
COMPLETE SETS, PLAYERS, ETC.

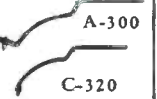
FIND NEEDLE NUMBER BY LOOKING UP CHANGER NUMBER IN PART 2

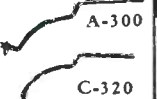
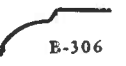
ADMIRAL MODEL NO. OF SET	MODEL NUMBER OF RECORD CHANGER OR CHANGERS USED
4H15A or B	-Nos. RC221 or RC321.
4H15S or SN	-Nos. RC210, RC211, RC212, RC221 or
4H16A or B	-Nos. RC221 or RC321.
4H16S or SN	-Nos. RC210, RC211, RC212, RC221 or
4H17A or B	-Nos. RC221 or RC321.
4H17S or SN	-Nos. RC210, RC211, RC212, RC221 or
4H18C	-Nos. RC221 or RC321.
4H18S or SN	-Nos. RC210, RC211, RC212, RC221
4H19C	-Nos. RC221 or RC321.
4H19S or SN	-Nos. RC210, RC211, RC212, RC221 or
4H115S or SN	-Nos. RC210, RC211, RC212, RC221
4H116S or SN	-Nos. RC210, RC211, RC212, RC221 or
4H117S or SN	-Nos. RC210, RC211, RC212, RC221
4H126A or B	-Nos. RC221 or RC321.
4H126C or CN	-Nos. RC221 or RC321.
4H126S or SN	-Nos. RC210, RC211, RC212, RC221
4H137A or B	-Nos. RC221 or RC321.
4H137S or SN	-Nos. RC210, RC211, RC212, RC221
4H145A or B	-Nos. RC221 or RC321.
4H145C	-Nos. RC210, RC211, RC212, RC221
4H145S or SN	-Nos. RC221 or RC321.
4H146A or B	-Nos. RC210, RC211, RC212, RC221
4H146C or CN	-Nos. RC221 or RC321.
4H146S or SN	-Nos. RC210, RC211, RC212, RC221
4H147A or B	-Nos. RC221 or RC321.
4H147C or CN	-Nos. RC221 or RC321.
4H147S or SN	-Nos. RC210, RC211, RC212, RC221
4H148A or B	-Nos. RC221 or RC321.
4H148C or CN	-Nos. RC221 or RC321.
4H148S or SN	-Nos. RC210, RC211, RC212, RC221
4H149A or B	-Nos. RC221 or RC321.
4H149C or CN	-Nos. RC221 or RC321.
4H149S or SN	-Nos. RC210, RC211, RC212, RC221
4H150A or B	-Nos. RC221 or RC321.
4H150C or CN	-Nos. RC221 or RC321.
4H150S or SN	-Nos. RC210, RC211, RC212, RC221
4H151A or B	-Nos. RC221 or RC321.
4H151C or CN	-Nos. RC221 or RC321.
4H151S or SN	-Nos. RC210, RC211, RC212, RC221
4H152A or B	-Nos. RC221 or RC321.
4H152C or CN	-Nos. RC221 or RC321.
4H152S or SN	-Nos. RC210, RC211, RC212, RC221
4H153A or B	-Nos. RC221 or RC321.
4H153C or CN	-Nos. RC221 or RC321.
4H153S or SN	-Nos. RC210, RC211, RC212, RC221
4H154A or B	-Nos. RC221 or RC321.
4H154C or CN	-Nos. RC221 or RC321.
4H154S or SN	-Nos. RC210, RC211, RC212, RC221
4H155A or B	-Nos. RC221 or RC321.
4H155C or CN	-Nos. RC221 or RC321.
4H155S or SN	-Nos. RC210, RC211, RC212, RC221
4H156A or B	-Nos. RC221 or RC321.
4H156C or CN	-Nos. RC221 or RC321.
4H156S or SN	-Nos. RC210, RC211, RC212, RC221
4H157A or B	-Nos. RC221 or RC321.
4H157C or CN	-Nos. RC221 or RC321.
4H157S or SN	-Nos. RC210, RC211, RC212, RC221
4H158A or B	-Nos. RC221 or RC321.
4H158C or CN	-Nos. RC221 or RC321.
4H158S or SN	-Nos. RC210, RC211, RC212, RC221
4H159A or B	-Nos. RC221 or RC321.
4H159C or CN	-Nos. RC221 or RC321.
4H159S or SN	-Nos. RC210, RC211, RC212, RC221
4H160A or B	-Nos. RC221 or RC321.
4H160C or CN	-Nos. RC221 or RC321.
4H160S or SN	-Nos. RC210, RC211, RC212, RC221
4H161A or B	-Nos. RC221 or RC321.
4H161C or CN	-Nos. RC221 or RC321.
4H161S or SN	-Nos. RC210, RC211, RC212, RC221
4H162A or B	-Nos. RC221 or RC321.
4H162C or CN	-Nos. RC221 or RC321.
4H162S or SN	-Nos. RC210, RC211, RC212, RC221
4H163A or B	-Nos. RC221 or RC321.
4H163C or CN	-Nos. RC221 or RC321.
4H163S or SN	-Nos. RC210, RC211, RC212, RC221
4H164A or B	-Nos. RC221 or RC321.
4H164C or CN	-Nos. RC221 or RC321.
4H164S or SN	-Nos. RC210, RC211, RC212, RC221
4H165A or B	-Nos. RC221 or RC321.
4H165C or CN	-Nos. RC221 or RC321.
4H165S or SN	-Nos. RC210, RC211, RC212, RC221
4H166A or B	-Nos. RC221 or RC321.
4H166C or CN	-Nos. RC221 or RC321.
4H166S or SN	-Nos. RC210, RC211, RC212, RC221
4H167A or B	-Nos. RC221 or RC321.
4H167C or CN	-Nos. RC221 or RC321.
4H167S or SN	-Nos. RC210, RC211, RC212, RC221
4H168A or B	-Nos. RC221 or RC321.
4H168C or CN	-Nos. RC221 or RC321.
4H168S or SN	-Nos. RC210, RC211, RC212, RC221
4H169A or B	-Nos. RC221 or RC321.
4H169C or CN	-Nos. RC221 or RC321.
4H169S or SN	-Nos. RC210, RC211, RC212, RC221
4H170A or B	-Nos. RC221 or RC321.
4H170C or CN	-Nos. RC221 or RC321.
4H170S or SN	-Nos. RC210, RC211, RC212, RC221
4H171A or B	-Nos. RC221 or RC321.
4H171C or CN	-Nos. RC221 or RC321.
4H171S or SN	-Nos. RC210, RC211, RC212, RC221
4H172A or B	-Nos. RC221 or RC321.
4H172C or CN	-Nos. RC221 or RC321.
4H172S or SN	-Nos. RC210, RC211, RC212, RC221
4H173A or B	-Nos. RC221 or RC321.
4H173C or CN	-Nos. RC221 or RC321.
4H173S or SN	-Nos. RC210, RC211, RC212, RC221
4H174A or B	-Nos. RC221 or RC321.
4H174C or CN	-Nos. RC221 or RC321.
4H174S or SN	-Nos. RC210, RC211, RC212, RC221
4H175A or B	-Nos. RC221 or RC321.
4H175C or CN	-Nos. RC221 or RC321.
4H175S or SN	-Nos. RC210, RC211, RC212, RC221
4H176A or B	-Nos. RC221 or RC321.
4H176C or CN	-Nos. RC221 or RC321.
4H176S or SN	-Nos. RC210, RC211, RC212, RC221
4H177A or B	-Nos. RC221 or RC321.
4H177C or CN	-Nos. RC221 or RC321.
4H177S or SN	-Nos. RC210, RC211, RC212, RC221
4H178A or B	-Nos. RC221 or RC321.
4H178C or CN	-Nos. RC221 or RC321.
4H178S or SN	-Nos. RC210, RC211, RC212, RC221
4H179A or B	-Nos. RC221 or RC321.
4H179C or CN	-Nos. RC221 or RC321.
4H179S or SN	-Nos. RC210, RC211, RC212, RC221
4H180A or B	-Nos. RC221 or RC321.
4H180C or CN	-Nos. RC221 or RC321.
4H180S or SN	-Nos. RC210, RC211, RC212, RC221
4H181A or B	-Nos. RC221 or RC321.
4H181C or CN	-Nos. RC221 or RC321.
4H181S or SN	-Nos. RC210, RC211, RC212, RC221
4H182A or B	-Nos. RC221 or RC321.
4H182C or CN	-Nos. RC221 or RC321.
4H182S or SN	-Nos. RC210, RC211, RC212, RC221
4H183A or B	-Nos. RC221 or RC321.
4H183C or CN	-Nos. RC221 or RC321.
4H183S or SN	-Nos. RC210, RC211, RC212, RC221
4H184A or B	-Nos. RC221 or RC321.
4H184C or CN	-Nos. RC221 or RC321.
4H184S or SN	-Nos. RC210, RC211, RC212, RC221
4H185A or B	-Nos. RC221 or RC321.
4H185C or CN	-Nos. RC221 or RC321.
4H185S or SN	-Nos. RC210, RC211, RC212, RC221
4H186A or B	-Nos. RC221 or RC321.
4H186C or CN	-Nos. RC221 or RC321.
4H186S or SN	-Nos. RC210, RC211, RC212, RC221
4H187A or B	-Nos. RC221 or RC321.
4H187C or CN	-Nos. RC221 or RC321.
4H187S or SN	-Nos. RC210, RC211, RC212, RC221
4H188A or B	-Nos. RC221 or RC321.
4H188C or CN	-Nos. RC221 or RC321.
4H188S or SN	-Nos. RC210, RC211, RC212, RC221
4H189A or B	-Nos. RC221 or RC321.
4H189C or CN	-Nos. RC221 or RC321.
4H189S or SN	-Nos. RC210, RC211, RC212, RC221
4H190A or B	-Nos. RC221 or RC321.
4H190C or CN	-Nos. RC221 or RC321.
4H190S or SN	-Nos. RC210, RC211, RC212, RC221
4H191A or B	-Nos. RC221 or RC321.
4H191C or CN	-Nos. RC221 or RC321.
4H191S or SN	-Nos. RC210, RC211, RC212, RC221
4H192A or B	-Nos. RC221 or RC321.
4H192C or CN	-Nos. RC221 or RC321.
4H192S or SN	-Nos. RC210, RC211, RC212, RC221
4H193A or B	-Nos. RC221 or RC321.
4H193C or CN	-Nos. RC221 or RC321.
4H193S or SN	-Nos. RC210, RC211, RC212, RC221
4H194A or B	-Nos. RC221 or RC321.
4H194C or CN	-Nos. RC221 or RC321.
4H194S or SN	-Nos. RC210, RC211, RC212, RC221
4H195A or B	-Nos. RC221 or RC321.
4H195C or CN	-Nos. RC221 or RC321.
4H195S or SN	-Nos. RC210, RC211, RC212, RC221
4H196A or B	-Nos. RC221 or RC321.
4H196C or CN	-Nos. RC221 or RC321.
4H196S or SN	-Nos. RC210, RC211, RC212, RC221
4H197A or B	-Nos. RC221 or RC321.
4H197C or CN	-Nos. RC221 or RC321.
4H197S or SN	-Nos. RC210, RC211, RC212, RC221
4H198A or B	-Nos. RC221 or RC321.
4H198C or CN	-Nos. RC221 or RC321.
4H198S or SN	-Nos. RC210, RC211, RC212, RC221
4H199A or B	-Nos. RC221 or RC321.
4H199C or CN	-Nos. RC221 or RC321.
4H199S or SN	-Nos. RC210, RC211, RC212, RC221
4H200A or B	-Nos. RC221 or RC321.
4H200C or CN	-Nos. RC221 or RC321.
4H200S or SN	-Nos. RC210, RC211, RC212, RC221

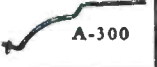
{ RC210 RC211 RC212 }	 For 33 1/2 & 78 R.P.M.
{ RC150 RC160 RC160A RC200 }	 For 78 R.P.M.
RC182	 For 33 1/2 R.P.M.
{ RC221 RC222 RC321 RC322 }	 For 33 1/2, 45 & 78 R.P.M.
{ RC500 RC550 }	 For 33 1/2, 45 & 78 R.P.M.
{ C500 C550 }	 For 33 1/2, 45 & 78 R.P.M.
RC400	 For 45 R.P.M.
RC400	 For 45 R.P.M.

A-300 C-320	 A-300 C-320
{ C-323 or C-325 }	 C-323 C-325
A-311	 A-311
A-300 C-320	 A-300 C-320
B-306	 B-306
B-307	 B-307
A-300	 A-300
A-305	 A-305

Save Your Time
use complete authentic
PERMO "FACTS"
TO MAKE HIGH-PROFIT
PHONO-NEEDLE SALES

ADMIRAL • PHILCO • COLUMBIA
SECTIONS OF PERMO *long-life* PHONO AND NEEDLE FACTS
NOW AVAILABLE—OTHERS FOLLOW IN '51

PERMO, INCORPORATED



Champion of Perfection
6401-33 N. RAVENSWOOD AVE.
CHICAGO 26, ILLINOIS

SEND FOR YOUR FREE "FACTS" NOW!

Permo, Inc.,—Dept. D
6401-33 N. Ravenswood Ave.,
Chicago 26, Illinois

Gentlemen:
Please send me the FREE sections of Permo Long-Life Phonograph and
Needle Facts I have checked below:
 Admiral Philco Columbia

Name _____
Address _____
City _____ Zone _____ State _____
Name of Jobber from whom you usually order _____



by M. W. PERCY

Circuit Highlights of Stromberg-Carlson 24-Inch TV Chassis.

IN VIEW OF THE PUBLIC'S enthusiasm for larger and larger screens on TV chassis, several manufacturers have decided to go beyond the size which has become somewhat of a standard, or 20 inches, and produce models with 24 and 30-inch tubes. This month, a

model using the 24-inch tube will be discussed, and next month, the 30-inch chassis will be analyzed.

The 24-incher, developed by Stromberg-Carlson (24C-24RP) employs a tuner with two completely separate

sections for low band and high band operation. The low band handles channels 2-6, the high band channels 7-13. Each section has its own *rf*, mixer and oscillator stages. Input to both sections is through separate broadly tuned antenna transformers. Trimmers are

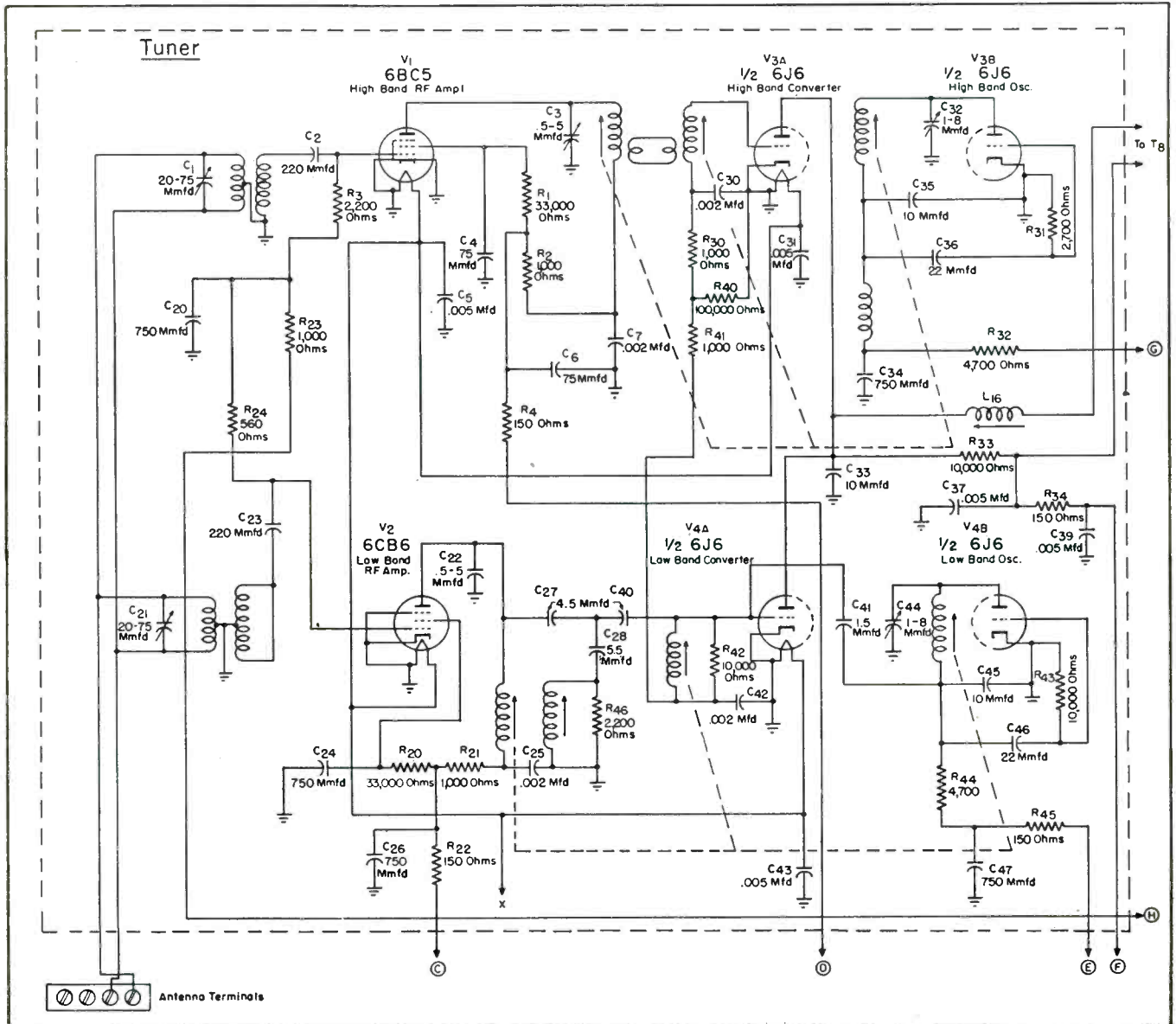

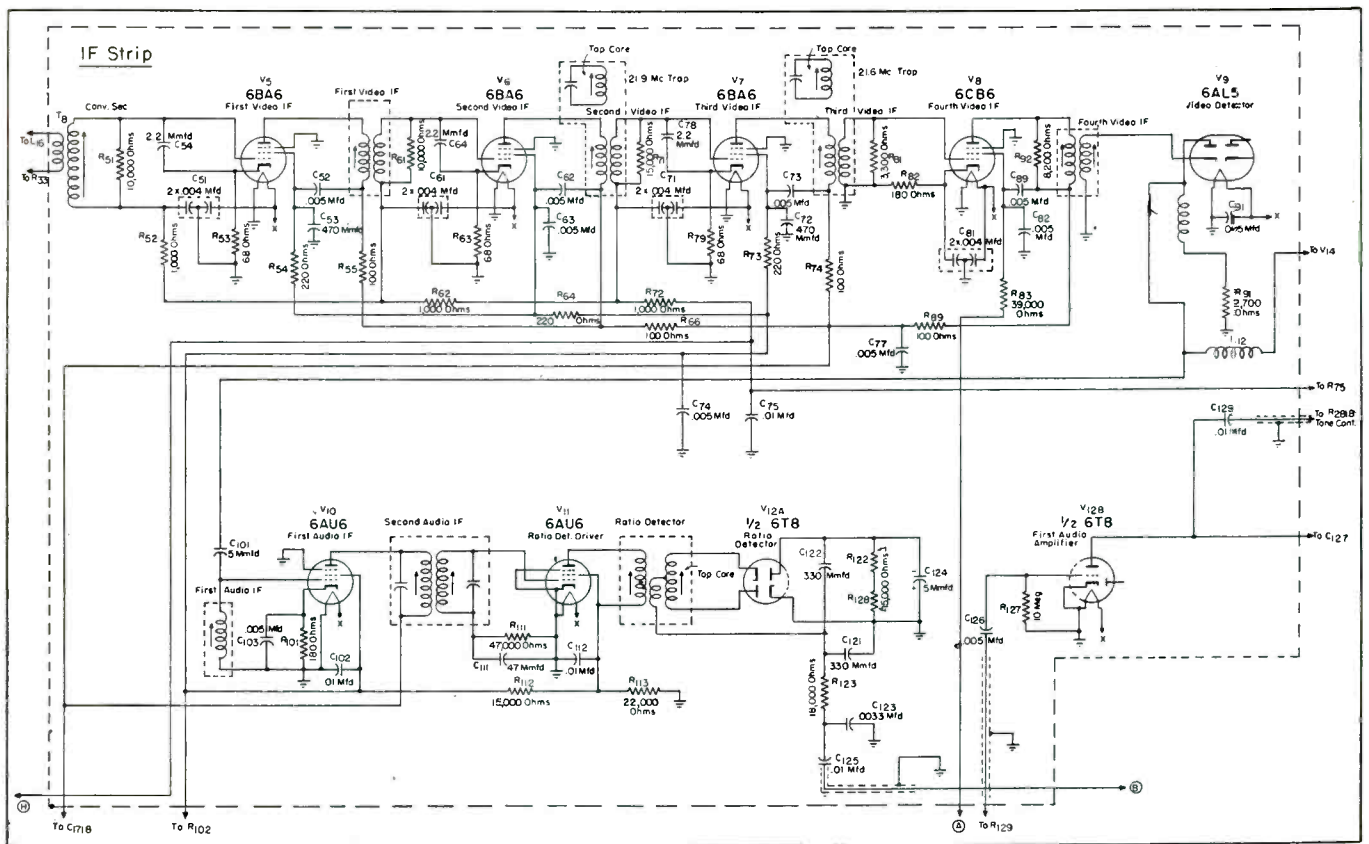

Fig. 2. The video if strip section of the 24-inch set.

factory adjusted to give a broad band pass. Both sections are continuously tunable through the range of the band. Ganged variable inductances in the plate of the *rf* and oscillator stages and in the grid of the mixer stage provide frequency variation. In the high-band section, the incoming audio and video signals are passed from the plate of the 6BC5 *rf* stage to the grid of a mixer, $\frac{1}{2}$ of a 6J6, by link coupling. The oscillator is a modified Colpitts, using $\frac{1}{2}$ of a 6J6.

For low-band operation, a 6CB6 *rf* amplifier is used. The *rf* signals are fed from the plate of the amplifier to the grid of the mixer, $\frac{1}{2}$ of a 6J6, through a *T* network, designed to give the required band-pass. A series resonant circuit is included to provide additional image rejection. As in the high-band section, the oscillator is a modified Colpitts, using $\frac{1}{2}$ of a 6J6.

The range switch governs change-over from one band to the other. Depending on which range is selected, one section of the range switch feeds plate voltage to one of the oscillators, while another section of the switch feeds plate voltage to one of the *rf* stages. Output of the converters is transformer-coupled to the first common *if* stage. Through loading both primary and secondary with low values of resistance, a band pass of approximately 6 mc is secured.

Common IF System

There are four common *if* stages

(three 6BA6s and one 6CB6), using overcoupled transformers for inter-stage coupling to secure the desired bandwidth. Both sound and video *if* signals pass through to the video detector stage which has a 6AL5. Sound *if* is taken off at this point. Since intercarrier sound is used, front-end tuning is not as critical. Taking sound off at the detector minimizes the possibility of *intercarrier buzz*, because of the relatively low amplitude of the AM which is superimposed on the 4.5-mc FM signal. This AM can be eliminated without much difficulty by limiting action in the audio ratio detector and driver stages.

Video Detector and Video Amplifiers

From the detector-load resistor, the detected video information is passed through two stages of video amplification and on to the grid of the picture tube, all by direct coupling. Since there is no intervening capacity coupling to remove the *dc* component, no *dc* restoration circuit is necessary.

Because of the direct coupling from the plate of the first 6AU6 video amplifier, to the grid of the second video 6AR5 amplifier, there is a high positive voltage of +110 on the 6AR5 grid under normal operating conditions. For proper operation of this stage, the cathode voltage is made higher or +125. The cathode is returned to a high potential point on the voltage

divider across *B+*. Contrast control is in the cathode leg of this stage. By varying cathode resistance, the bias, gain and thus the amplitude of the video signal is controlled.

Sync Circuits

The composite video signal is tapped off the load resistor of the first video amplifier and fed to the grid of the first sync clipper, a 6CB6, by direct coupling. The grid of the first clipper is at plate potential of the first video stage. Cathode of the 6CB6 is 15 *v* higher because the cathode is tapped off a series of voltage-dividing resistors from ground to *B+*. Polarity of the incoming signal is positive, with the sync pulses on top. Because of the high bias, only the most positive portion of the signal, the sync pulses, are amplified in this stage. The video information in the negative portion of the signal drive the stage to cut-off and thus do not appear in the output.

From the plate of the first sync clipper, the now negative-going sync pulses pass through a 1N65 crystal diode stage. The cathode of the crystal is directly connected to the plate of the first clipper. By voltage division, the anode of the diode is at a small negative *dc* potential compared to the cathode. The diode, therefore, conducts only when the negative sync signals appear at the cathode, at which time the cathode becomes more negative than the anode. As a result, only

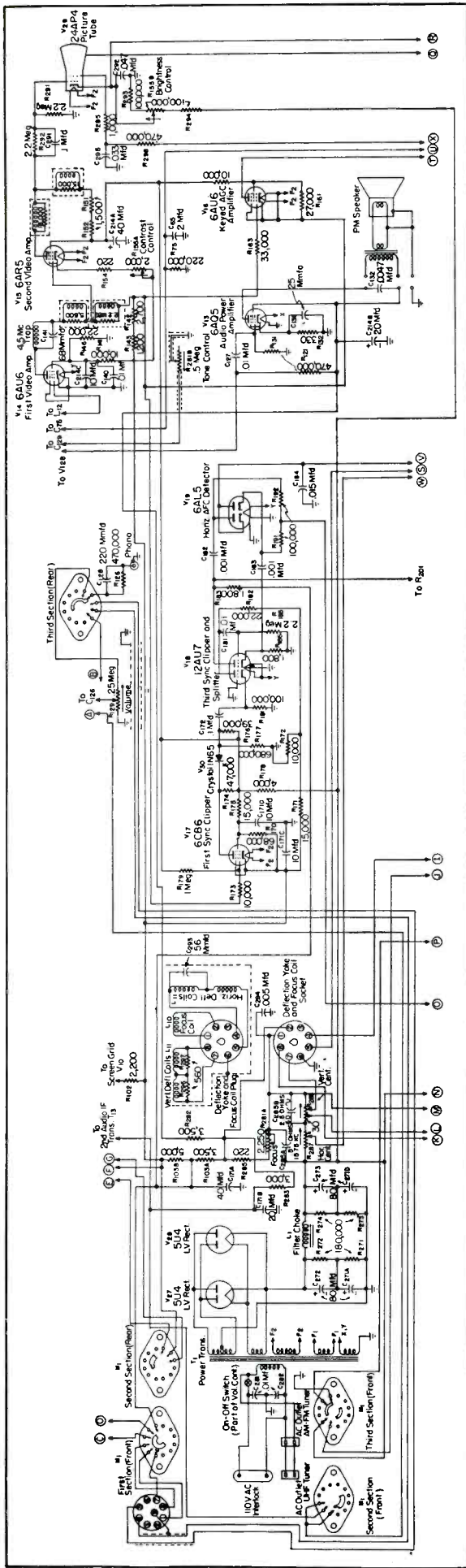

(Above)
Fig. 3. Sync clipper, video amp, audio amp and keyed agc circuits used in the Stromberg-Carlson TV receiver.

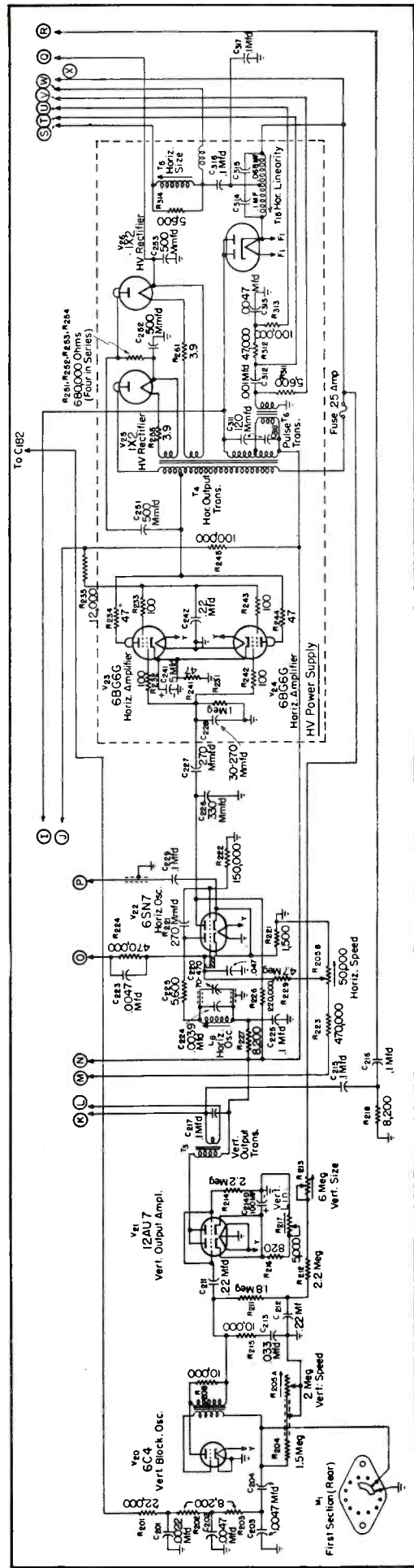

(Below)
Fig. 4. Vertical-blocking oscillator, vertical-output amp, horizontal oscillator, horizontal amp and hv supply circuitry of Stromberg-Carlson 24-inch model.

Ser-Cuits

(Continued from page 43)

the more negative portions of the sync pulses (peaks of the sync pulses) appear in the output. Thus, further clipping action is accomplished. The negative pulses are then applied to the cathode of the third sync-clipper stage, $\frac{1}{2}$ of a 12AU7, which is connected as a grounded-grid amplifier. Plate of this stage is at a low potential. Because of the large value of the cathode resistor, 100,000 ohms, and low plate voltage, the tube is almost at cut off. The negative signals arriving at the cathode cause conduction, and negative signals appear at the plate.

These are fed to a sync-splitter stage, $\frac{1}{2}$ of a 12AU7, hooked up as a paraphase amplifier. This is one method for securing phase-inverter action. Horizontal pulses of equal amplitude, but opposite polarity, are taken off the cathode and plate of this stage and fed to a 6AL5 horizontal *afc* phase detector.

Vertical sync pulses are taken off the plate of the sync splitter and delivered to an integrating net to trigger the vertical blocking oscillator.

Horizontal AFC Phase Detector

The function of the phase-detector circuit is to compare the time of arrival of the sync pulses with the phase of the horizontal sawtooth, and to develop a correction voltage if they are not properly synchronized. The correction voltage is then fed to one grid of the horizontal oscillator to make an appropriate change in frequency.

Positive sync pulses are applied to the plate of one diode, pin 7 of the 6AL5, while negative pulses are fed to the cathode of the other diode at pin 5. A sawtooth voltage is taken off a pulse transformer connected to part of the horizontal output transformer secondary. The sawtooth is fed to the plate of one diode and the cathode of the other, pins 1 and 2, tied together.

When a positive sync pulse voltage is applied to a .001-mfd capacitor (C_{182}), this capacitor has two paths for charge: (1) from ground, through a .015-mfd unit (C_{184}) through the diode and (2) from ground, up through a .047-mfd capacitor (C_{223} , at the grid of the horizontal multivibrator), and 470,000-ohm (R_{224}) and 100,000-ohm (R_{192}) resistors and a .0047-mfd capacitor (C_{223}).

[Data on this analysis are based on notes prepared by Cyrus Glickstein of American Radio Institute. Additional circuitry details on this chassis, involving the horizontal amplifier and keyed age system, will be presented next month.]



The Super-Cardioid "Monoplex"

... kills feedback and reduces random noise energy pickup more than any other crystal microphone!

... REDUCES RANDOM NOISE ENERGY PICKUP BY **73%**

THE "MONOPLEX" is the only Super-Cardioid Crystal Microphone made. It employs the same type of acoustic phase-shifting network used in the highest cost Shure Broadcast Microphones. The "Monoplex" permits more volume without feedback—greatly improves sound systems using conventional cardioid microphones.

THE "MONOPLEX" is superior to conventional microphones: gives very satisfactory operation under the most adverse conditions of background noise, where conventional microphones would be practically useless. You are invited to test the "Monoplex" against all other crystal microphones. The results will speak for themselves...



"Monoplex"
MODEL 737A

LIST PRICE
\$39⁷⁵

Every "Monoplex" employs the famous Shure "Humi-Seal" moisture-proof element for protection from heat and humidity.

Manufactured Under Shure Patents.
Licensed Under Patents of Brush Development Company.

SHURE

SHURE BROTHERS, Inc.

Microphones and Acoustic Devices

225 West Huron Street, Chicago 10, Ill. ★ Cable Address: SHUREMICRO

GENERAL ELECTRIC

RADIO DIAL LAMPS

Designed and engineered for the job

GENERAL ELECTRIC radio dial lamps are especially made to withstand the conditions under which they must operate. Their filaments take vibration without being damaged. The joint that secures them has

been made shock-proof.

These G-E lamps are constantly being put through shock tests, vibration tests and base torsion tests to make certain that they will give your customers the best service possible.

Features like these make it worthwhile for you to sell and install G-E lamps:

1. Dependable, trouble-free performance.
2. High level of maintained light output.
3. Low current consumption.
4. Long life.
5. Preferred by both dealers and customers.

MINIATURE LAMP TYPES



T-3/4
Miniature
Bayonet

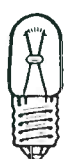

T-3/4
Miniature
Screw



G-3/2
Miniature
Bayonet



G-4 1/2
Miniature
Bayonet

LARGE LAMP TYPES

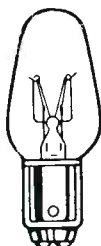

C-7
Double-Contact
Bayonet

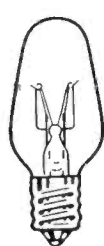

C-7
Candelabra
Screw

SPECIFICATIONS

LAMP NO.	VOLTS	AMPS	BULB	BASE
40	6-8	0.15	T-3/4	Min. Screw
41	2.5	0.50	T-3/4	Min. Screw
42	3.2	0.35	T-3/4	Min. Screw
43	2.5	0.50	T-3/4	Min. Bay.
44	6-8	0.25	T-3/4	Min. Bay.
45	3.2	0.35	T-3/4	Min. Bay.
46	6-8	0.25	T-3/4	Min. Screw
47	6-8	0.15	T-3/4	Min. Bay.
48	2	0.06	T-3/4	Min. Screw
49	2	0.06	T-3/4	Min. Bay.
51	6-8	Max.0.25	G-3/2	Min. Bay.
55	6-8	Max.0.45	G-4 1/2	Min. Bay.
1490	3.2	0.16	T-3/4	Min. Bay.
10C7	115-25	10 watts	C-7	Cand. Screw
10C7DC	115-25	10 watts	C-7	D.C. Bay.

General Electric makes a complete line of neon glow lamps—including NE-51, NE-2, NE-45, NE-48, NE-16, NE-17—for radio and other electronic applications.

GENERAL ELECTRIC

Defense Program Chassis

(Continued from page 19)

across the entire *hv* supply without the use of an additional rectifier tube. This has been tried and it was found that a 100-microamp bleeder reduced the 14-kv anode voltage to 12.5 kv, and in addition the regulation of both focusing and anode voltage became quite poor. Practically, a chain of resistors suitable for this would add up to 140 megohms, and in order to keep the voltage across each 1-watt resistor below 1000 volts, 14 resistors

of 10 megohms each would be required. The use of a special carbon coated, spiral type resistor might eliminate this objection, but the poor regulation and loss of high voltage remain.

Other Circuits Being Studied

Various other circuits, some involving trimmers instead of the resistive control network in Fig. 1, are under consideration. The most widely used

²Rauland,
³RCA method.

circuit will probably make use of the new 15-megohm focus potentiometer.

Actual tests show that electrostatic focusing may be a good solution for obtaining full focus across the entire screen. The *dc* focus voltage, it appears, is not truly a *dc* voltage, but contains a pulse component as shown in Fig. 2; p. 19. This means that, as the electron beam approaches the edges of the tube, the focusing potential increases, shifting the focus further out. The pulsations of the focus voltage depend on the horizontal sweep voltage and therefore focus is shifted slightly as the beam travels from left to right. A sort of automatic constant focus action takes place which results in proper focus over the entire screen area. In one type of electrostatic focus tube² announced, a focus voltage of only about 100 to 150 volts is required; this would remove the need for an additional *hv* rectifier and generally simplify the circuit.

Summing up, electrostatic focus can be described as a distinct improvement in the TV art and not just an emergency necessity.

Electromagnetic Speakers

Another item where Alnico V, and the very scarce cobalt have been used, is the conventional *pm* speaker. Most good speakers use approximately 2 to 2.5 ounces of *Alnico V*. To solve this problem, two different methods of approach are available. *Alnico V* can be eliminated entirely, either by using *Alnico III*, which is not quite so scarce, or employing an *em* type speaker. In another approach³ the speaker has been redesigned to use less *Alnico V*, with only about 0.75 ounce of metal being used. This new speaker also features savings in steel and brass parts.

Alnico III is not as satisfactory for speaker use as *Alnico V* and the sound reproduction appears to suffer somewhat. Thus, the simplest solution provides for the use of an *em* speaker and use of the field coil also as the *B+* choke. This is not really a new system since the earliest 630 TV sets and many low-cost units since then have used it. It permits savings in two important spots; no Alnico is used at all and the choke with its copper and silicon steel content is also eliminated.

Em Installation Precautions

In installing *em* speakers the Service Man must note the polarity of the voice coil leads. In such a speaker a hum-bucking coil is used and usually its leads are brought out and connected in series with the voice coil. Since one of the voice coil leads is grounded

to the chassis, a bad hum can result if wrong connections are made.

Other Conservation Steps

Ferrite, the core material for high-efficiency deflection systems, contains nickel oxide, zinc oxide and 55% iron, all scarce materials. To conserve ferrite, horizontal flyback transformers are being redesigned for smaller cores and at the same time different mixtures are being developed which use less of the critical materials. With one newly designed flyback⁴, an auto-transformer type, a yoke⁵ is used and 16 kv are produced, with a full sweep on a 20-inch tube, with an input voltage of 300 volts *dc*. Since this circuit, however, requires a separate 6.3-volt filament winding for the 6W4 damper tube, true material economy is not completely achieved.

To conserve silicon steel, the kind required for transformer laminations, several steps are being taken. First, the power transformers are being either reduced as much as possible, and secondly, selenium rectifiers are being used more and more as voltage doublers. The selenium-type power supply is nothing new, but many manufacturers who have shunned it up to now are going to turn to it to keep their plants going.

Series-filament tubes are in very short supply. Such types as the 19BG6, 25W4, 25BQ6, etc., are so scarce that most manufacturers are planning to save all available silicon steel for use in the relatively small filament transformer, and thus be able to use 6.3-volt tubes.

Transformer steel and copper wire can be conserved by eliminating the vertical blocking oscillator transformer and reverting to a multivibrator circuit. For good operation a multivibrator may require both sections of a double triode and thus make it necessary to add another tube as a vertical output amplifier, but the saving is often well worth it. In addition, this may permit the use of a smaller vertical output transformer.

Chassis steel is not in such short supply as some of the other items mentioned. Some redesign is being practiced to reduce the amount of steel needed for the chassis and associated mounting brackets. Most of the crucial aspect of chassis work however appears in the shortage of cadmium used for plating. Different substitutes are being used successfully, which take solder and resist corrosion as good or better than cadmium plating. A few low-cost receivers are being

(Continued on page 48)

⁴RCA 225T1; ⁵RCA 209D1 (Tube News, SERVICE; April, 1951).

we had problems, too!

— the problems of countless manufacturers of the finest equipment who needed speakers for their specific requirements. We, at Oxford, have effectively solved these problems for over 25 years by manufacturing the outstanding speaker line.

If you have a replacement problem and it involves speakers, relax as so many countless others have done. Select the speaker or speakers you need from the most complete speaker line, OXFORD. There are no obsolete numbers . . . each will prove of utmost importance to your needs . . . each will eliminate any speaker problem you may have.



"Master" Audograph
Electronic Soundwriter
manufactured by
the Gray Manufacturing Co.
Hartford, Connecticut



OXFORD manufactures speakers
for TV, FM, AM, AUTO, PA
and outdoor applications
. . . available at leading jobbers.

A copy of our latest
catalog is available.

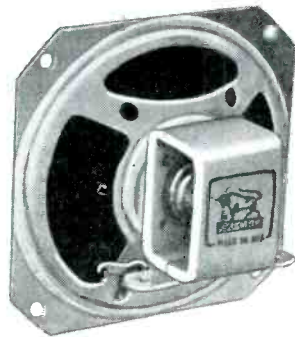

OXFORD ELECTRIC CORPORATION

3911 South Michigan Avenue • Chicago 15, Illinois
EXPORT: ROBURN AGENCIES, NEW YORK CITY

Keep Picture Quality UP Keep Service Calls DOWN



**JUST PRESS THE BUTTON,
SPRAY IT ON —
NO SPECIAL
EQUIPMENT NEEDED!**

Spray on antenna and lead-in terminals

Krylon prevents corrosion and pitting, even in salt-spray areas. It seals antennas and connections in a waterproof acrylic (not vinyl) blanket. (When aluminum finish is desirable, use special aluminum Krylon.)

Spray on high voltage circuits

Spray Krylon on the high voltage coil and insulation . . . in the socket of the high voltage rectifier . . . on component parts of rectifier circuit. Helps prevent corona because of its high dielectric strength.

Two types—clear and non-conducting aluminum. Both have exactly the same qualities. Packed in 12 oz. aerosol spray cans. List prices: \$1.95 clear, \$2.25 aluminum. Also available in gallons for application by brushing or dipping. See your jobber, or write direct.

KRYLON, INC., Dept. 612
2601 No. Broad St., Philadelphia 32, Pa.

Advertised in
"The Saturday
Evening Post"



THE ACRYLIC SPRAY THAT PREVENTS TV TROUBLE

(Continued from page 47)

made on unplated chassis containing lead as well as steel. Such chassis will take solder well, but its corrosion resistance is not quite as satisfactory.

Aluminum, of course, is again a scarce material. To conserve this metal, many of the brackets, shields and similar items are now being made of steel. The aluminum cups used on the back of most TV sets over the picture tube socket are now made of plastic. Shield cans used in the picture and sound *if* stages can be eliminated by changing the coil design and the chassis layout so that the coils are

mounted beneath the chassis, without interfering with each other. In installation the aluminum problem can be overcome by using steel tubing as masts. To conserve zinc or other plating material a special plastic weatherproofing compound is now on the market which can be painted or sprayed on steel masts. The antenna elements should still consist of aluminum tubing, since its low resistance and light weight make it far superior to any other antenna material. By using a stronger aluminum alloy, the antenna manufacturers have found it possible to reduce the wall thickness of the tub-

ing resulting in some conservation of the total amount of aluminum used.

Copper is one of the most vital materials for any electric device and TV is no exception. Without any copper, TV production would have to stop. Therefore, it is quite vital that the industry stretch the available amount of copper to the utmost. Elimination of power transformers, vertical blocking oscillator transformers and focusing coils can save from 6 to 8 pounds of copper per set. Further savings are being effected by using a smaller gauge wire for the actual wiring of the set, such as 24 instead of 22; by redesigning width, linearity and *if* coils for use with smaller gauge wire, and in addition eliminating much of the waste due to long leads on capacitors and resistors, which are cut off in wiring. The latter step is already in evidence, all capacitor manufacturers having shortened the standard lead length on paper units. Long leads on cardboard electrolytics and larger resistors are also being reduced by about 20% and in the case of *B+* chokes and power transformers the lead wire will be found to be often copper clad steel, rather than pure copper. Most TV power transformers now use a heavy copper shorting strap to reduce stray fields which might affect the picture. In many cases, it has been found possible to eliminate this strap entirely by changing the position of the transformer, or in some instances the thickness of the strap, usually 40 mils, has been cut in half.

Standard 300-ohm twin lead contains seven strands of 28 copper wire, but *conservation* samples developed now feature seven strands of 30 wire. The most widely used and presently available type of 300-ohm line will be found to contain very little copper, the conductors being *copperweld* steel wire. This type of transmission line weighs about the same as the original, but is much stronger, but a little harder to handle for stripping and soldering. Coax cable also uses great amounts of copper, especially in the shielding braid. To conserve this scarce material one manufacturer⁶ has introduced a cable which has an inner copper conductor and an outer shield of thin aluminum foil. Where about 20 pounds of copper were used in the shielding braid per 1000', in a particular cable, the new type uses only $\frac{3}{4}$ pound of aluminum.

Other scarce materials include tungsten, nickel, barium, and similar materials used mainly in the manufacture of tubes and special components. All major tube manufacturers have begun to employ various methods to conserve and reduce the amount of critical ma-

⁶Anaconda Wire and Cable Co.

terial in their tubes. It has been possible to effect major savings of scarce materials in tube production without affecting either the life or the performance of the tubes. The Service Man will not be able to differentiate either by appearance or performance between the new and the older tubes.

New Models and Their Performance

TV engineers, as well as management have agreed that it would be better to reduce the number of sets made, if shortages interfere, than to reduce the quality of their TV sets. A receiver that does not give a perfect picture and good sound is not going to sell, regardless of shortages or buying sprees. Therefore, all designs will be consistent with good set performance as well as material conservation. Electrostatic focus, as mentioned before, is certain to be used in almost every new model. A redesigned *B+* supply, using either selenium rectifiers or a smaller power transformer is also a certainty.

This may take different forms, including combinations of small filament transformers or autotransformers for a higher *B+* voltage. Chassis layouts may be affected with less shield cans and fewer interstage shields in the *rf* and *if* sections. Many smaller economies will crop up, such as a shorter bushing on potentiometers, steel or plastic shafts instead of precious brass, and a switch to plastics wherever this material can replace such small metal parts as cable clamps, escutcheons, etc.

Speaker Features

Loudspeakers will either use smaller *Alnico V*, larger *Alnico III* magnets or else use a field coil which will also serve as *B+* choke. Increasing use of nonstandard resistors, foreign as well as domestic, lower working voltage capacitors and generally lower tolerance components will also appear in the new TV receivers.

Prospects for the Future

All in all, the new sets will be at least as good, not much more expensive and certainly as carefully designed as the '50 and '51 models were. Although the total production is expected to be less in '51 than it was in '50, the general outlook for the TV industry is still towards good business and good profits.



DON'T LET THIS HAPPEN TO YOU!

AVOID COSTLY SERVICE CALLBACKS

When you replace a defective capacitor with a Sprague, it stays replaced!

Why risk your reputation and customers' goodwill when the best costs no more?

Sprague capacitors are the dependable capacitors.

P.S. Do you have the latest Sprague Catalog C-607-61 on your bench?

SPRAGUE
PIONEERS IN

SPRAGUE PRODUCTS COMPANY
(Distributors: Division of Sprague Electric Co.)
NORTH ADAMS, MASSACHUSETTS

ELECTRIC AND ELECTRONIC DEVELOPMENT



Consecrated
to Quality Output and
Golden Rule Service



FIXED CAPACITORS

The three popular types here illustrated are specified by leading set makers, and they fit as perfectly into the SERVICE scheme. They are small . . . adaptable . . . the product of lifetime experience in Capacitor engineering. Use them with complete assurance of maximum satisfaction through, high standards of quality control.



MINIMITE—Metal tubular dry electrolytics—Compact, hermetically sealed capacitors with exceptionally low leakage—capable of withstanding high surge voltage—exceptionally long shelf life—ideally suited for under chassis mounting.

EY—Twist prong dry electrolytics—most popular type used by television and radio set manufacturers; simple to mount, specially processed for long-life operation at ambient temperatures up to 85° C.; Centrifuge electrolyte impregnation; spot welded cathode tabs; excellent stability; low leakage.

AM—Molded paper tubulars—designed for continuous operation at 85° C.; molded in high temperature, heat resistant plastic compound for perfect seal against most severe humid conditions; won't cold flow at 100° C.

WRITE FOR CATALOG AC-2

ASTRON CORPORATION

255 Grant Ave., East Newark, N. J.

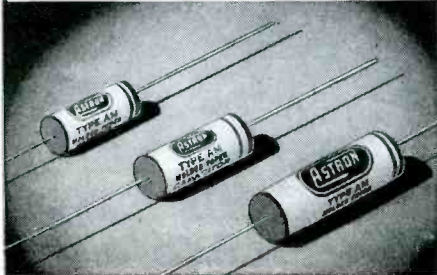

Replacement Cartridges

(Continued from page 21)

of reproduction possible from a record player within the limits established by the design of the phonograph.

Again, most record fans don't fully appreciate the vital function of the phono-cartridge in establishing the speed of wear of the record. Few understand that the cartridge determines the force with which the needle is pressed against the record grooves and that the compliance or flexibility of the needle system of a cartridge regulates the ability of the needle to follow all record grooves. Yet, he must know these facts to understand why the new design techniques of modern phono-cartridges guarantee extended record life and more authentic sound reproduction.

Remember, the first step in selling a record fan a modern replacement cartridge is to inform him of the proper role of the cartridge in his phonograph.

It is not necessary to explain the technical theories behind the design changes made in the drive or needle systems of modern cartridges . . . only to demonstrate the result of these improvements.

The improvements in phono-cartridge design are most apparent in three features . . . compliance, which influences faithfulness of sound reproduction and speed of record wear; and weight and tracking force, which determine the rate of wear of record grooves. Of these, compliance and weight can be easily demonstrated by simple tests which the customer himself can perform. Tracking force can be explained simply; in terms familiar to the customer.

The compliance or flexibility of a cartridge determines the ease with which it permits the needle to follow the wavy path of the record groove. A compliant cartridge permits the needle to follow *all* the excursions or side-to-side swings of the record groove. Thus, all the music recorded on a record is picked up for amplification and reproduction. A non-compliant or stiff cartridge holds the needle so inflexibly that at times the needle is unable to track wide excursions of the record grooves, particularly in low frequency passages. As a result, the needle skips or rattles in some grooves and the music they should reproduce is lost or distorted.

The compliance of a cartridge also determines the force the needle exerts against the side walls of the record grooves. This force is independent of that caused by the tracking force re-

GET RID OF B. O.*



in TV Pictures!

*BARKHAUSEN OSCILLATION

When vertical black bars appear in TV pictures, as shown above, they are the result of *Barkhausen Oscillation* occurring in the horizontal sweep output tube (such as the 25BQ6, 6BQ6, 6EV5, 25EV5, 6AU5, or 25AU5, etc.). To correct this difficulty our engineers have developed the

PERFECTION B.O.*ELIMINATOR



B.O. ELIMINATOR
(Actual Size)

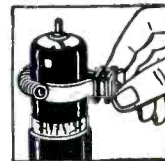

EASY TO INSTALL

Just slip the B.O. Eliminator over the tube, move down, or up, or turn until the dark vertical bars disappear from the picture. Spring grip holds the Eliminator in place.

This compact device fits over the horizontal sweep output tube, and because it brings a concentrated magnetic field near the source of the Barkhausen Oscillation—namely the screen grid—it usually eliminates the oscillation and the black lines on the face of the picture tube. Service men who have used the B.O. Eliminator say it is the simplest and most positive method of getting rid of the vertical bars that they have ever known. They see a big demand by service men in maintaining the 10,000,000 TV sets now on the market.

Order Today from Your Supplier!

PERFECTION ELECTRIC CO.

2641 South Wabash Ave., Chicago 16, Illinois
Makers of Perfection Speakers, Ion Traps and BeamAjuster TV Picture Centering Controls

big FREE
GIFT offer

SEE
PAGE

14

quired to keep the needle tracking record grooves. The stiff or non-compliant cartridge thrusts the needle with terrific pressure against the side walls of the grooves as the needle swings from side-to-side. Because the needle is inflexible its natural inclination is to cut through the groove side walls; however, in practice it is literally forced to slide and scrape around the walls or skip out of the groove entirely. The enormous pressure exerted against the groove walls rapidly wears them down and the record is considered worn out.

The modern, compliant cartridge, however, permits the needle to move from side-to-side freely and easily. Thus, the needle follows the grooves lightly and is instantly able to move laterally at only a whisker touch as the groove swings from side-to-side. The record lasts much longer and needle tip wear is greatly retarded.

Compliance Tests

Compliance can be demonstrated dramatically to the record fan. Let him perform the finger-tip compliance test in his own home. First, the record fan should test the old cartridge in his phono by moving the needle from side-to-side. The stiffness or non-compliance of the cartridge needle system is immediately apparent. Then the record fan should be allowed to test the modern replacement cartridge in the same way. The ease with which the needle moves, demonstrating the flexibility or compliance of the modern cartridge, makes a convincing comparison. The record fan may not have the Service Man's technical understanding of compliance, but he will understand what its results are and how they affect the quality of sound reproduction from his phonograph and the life of his records.

On p. 21, Fig. 2(a) and (b), appears a comparison of the voltage output of an old-fashioned, stiff-acting cartridge and a modern, compliant cartridge tracking at the same force. In (a) is illustrated the trace, viewed on a 'scope, of the output voltage of an old-style cartridge with a compliance of .3 when the phono-needle is tracking a sine wave modulated groove. The discrepancies in the wave form indicate that the needle tip rattled in the groove instead of following the groove trace. The wave form illustrates the effect of the added high-frequency distortion and indicates that in reproduction, distortion and fuzziness have been introduced into the reproduced tone.

In (b) is represented the trace, on a 'scope, of the output voltage of a modern type cartridge with a compliance of unity (1.0) when the needle

(Continued on page 52)



Hi-Lo at the PUPPET SHOW

Sell the Hi-Lo TV Spiral ANTENNA

Model 101*

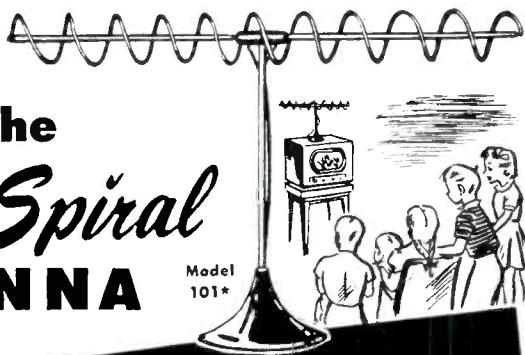

... for unsurpassed indoor TV reception!

\$9⁹⁵
LIST PRICE

You'll have your customers "on a string", eager to purchase HI-LO . . . the indoor TV Spiral Antenna with top reception. High fidelity plus remarkably sound engineering techniques make HI-LO the fastest selling indoor TV antenna.

Join the alert merchandisers who are now "pulling the strings" for more profits from satisfied customers . . . demonstrate HI-LO.

ORDER TODAY!

Don't forget . . . the HI-LO OUTDOOR TV SPIRAL ANTENNA!

*U. S. Patent No. 2,495,579
Canadian patents 1951

Hi-Lo TV Spiral Antennas are sold through recognized jobbers.

ONLY Hi-Lo provides complete powerful, localized advertising support. Write for full particulars.



FREE to Radio-TV
Service
Technicians

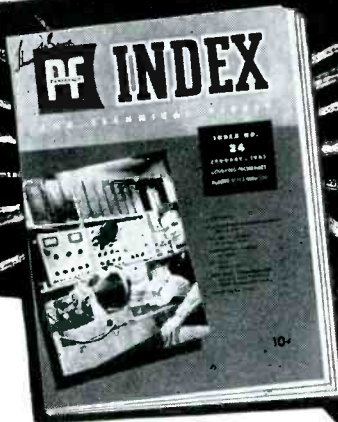

the new fact-packed
PF INDEX!
(PHOTOFACT INDEX AND
TECHNICAL DIGEST)

★ Each issue packed with authoritative articles on TV, Radio, latest servicing techniques

★ Latest complete Index to PHOTOFACT, world's finest service data

Don't miss a single issue! Be sure to get your PF INDEX—the valuable new publication you'll read from cover to cover—and use at your bench every working day.

PF INDEX brings you complete, fully illustrated discussions of latest developments in Radio and TV. Keeps you up-to-date on new circuit designs, latest testing methods, time-saving repair techniques, good shop practices—helps you operate a better, more profitable business.

Have all this practical, authoritative information *plus* the complete Index to PHOTOFACT Folders—the quick reference guide to the world's finest service data. PF INDEX is worth dollars to you—and costs you nothing. Get your FREE copy today!

Ask Your Jobber for It!

HOWARD W. SAMS & CO., INC.

Get the current PF Index from your Parts Jobber, or write us direct on your letterhead (or enclose business card). Address: Howard W. Sams & Co., Inc., 2201 E. 46th St., Indianapolis 5, Ind.

FREE

Send FREE copy of the current PF Index

Name.....

Address.....

City..... State.....

(Continued from page 51)

tracks a sine wave modulated groove. It will be noted that the output of the cartridge faithfully reproduces the music recorded on the record.

The weight comparison test is another effective way of demonstrating the improvements made in phono-cartridge design. In this instance, the record fan is asked to balance the old-style cartridge from his phono and the modern replacement in his hands. Because the modern cartridge weighs only about one-fifth as much as the out-moded unit, he can easily recognize the difference between the new and old. The Service Man then should interpret the importance of the drastic reduction in weight by explaining to the record fan that the lighter cartridge, the lighter the force with which the needle is pushed down on the record. Reducing needle pressure on the record grooves naturally reduces record and needle wear.

These two simple tests permit the record fan to compare actively his old phono-cartridge with the modern replacement. They make such a comparison doubly effective in convincing him of the benefits in replacing his out-of-date phono-cartridge. But there is a third feature of the new style phono-cartridges that should be made clear to the record fan—reduced tracking force.

Tracking force is the force with which the cartridge is pressed down on the record to keep the phono-needle following the side-to-side swings of record groove (or groove excursions) and to prevent the needle from skipping out of the groove completely. Old-fashioned cartridges, designed before the introduction of microgroove records, required a force of 1 to 2 ounces (28 to 56 grams) to keep the needle tracking properly. Modern cartridges track perfectly at only 5 to 10 grams.

By reducing the pressure with which the needle tip is pushed down against the record grooves to only a fraction of the oppressive force formerly required, modern cartridges add months and months of life and service to phono-records.

A comparison of the wear caused by an old-style cartridge and a modern cartridge is shown on p. 21; Fig. 3 (a) and (b). A new Majestic 1170B record was played continuously for 5 hours on a popular make changer by an old-style, non-compliant cartridge, tracking at 1¼ ounces force. At the end of that time a clean, white pad was wiped across a small segment of the record. Fig. 3 (a) indicates the large amount of powder deposited in

Presenting
THE NEW
Mueller
NEEDLE CLIP



Actual Size

**PIERCES INSULATION
TO MAKE QUICK
CONTACT**

Solid bronze, non-corroding. Wire centers itself in notched jaw. Teeth on sides of jaw allow use for many other applications.

— USED IN —

Electric and radio service shops
Telephone and power company
testing and maintenance
Laboratory test work
Hooking up truck trailer lights
Field telephone and signal work

SEND FOR FREE SAMPLE AND CATALOG 810

Mueller Electric Co.
1565 E. 31st St., Cleveland 14, Ohio

the record grooves by wear of the record. The powder consisted of the record material actually worn off the groove walls.

In (b) appears the results when a second Majestic 1170B record was played continuously for 5 hours on the same changer, equipped with a modern, compliant cartridge tracking at 8 grams. The almost negligible amount of record wear is indicated by the small deposit of powder wiped off the record. A comparison of these results reveals how modern cartridges can drastically reduce record wear and extend the life and usefulness of records.

Comparisons of cartridge compliance, weight and tracking force are three effective sales points to make in convincing a record fan that a modern phono-cartridge will improve the quality of musical reproduction from his records and will extend their life and serviceability. But the Service Man must be certain to explain and demonstrate clearly to the record fan just what these features are and what they mean to the ability of his phonograph to give him more enjoyment from his recordings.

Armed with this sales-producing ammunition, the Service Man must be

constantly alert to find ways of exploding it before his customers. His service calls, of course, provide the most direct opportunity. This should be a cardinal rule: *check the phono-cartridge on every call*; even if the purpose of the call is to service another component of the customer's set.

Every owner of a phonograph should be asked: "When did you last change your phono-cartridge?" The answer is the cue to a cartridge sale. Most record fans do not understand that cartridges should be changed regularly; that because of extremes of temperature and humidity, the crystal generating element of the cartridge deteriorates, curtailing response and reducing output. Because most cartridges that need replacement are out-of-date models, the answer to this question will serve as an entree for the Service Man's explanation of why the modern replacement cartridge will guarantee finer sound reproduction and longer record and needle life.

Cartridge check-up charts offer another method of directing the record fan's attention to the benefits he will receive from a modern phono-cartridge. By checking the obvious performance characteristics of the old cartridge (playing speed, voltage output, crystal leakage, compliance, playing quality and tracking force on the record) and presenting the chart to the customer, the Service Man can select the sales points he will expand in his sales presentation.

However, the Service Man can not wait on service calls to provide him with all the opportunities to sell phono-cartridges. He should schedule calls for himself by telephone appointments or by direct mail postcards which not only tell the record fan that the Service Man can guarantee to bring him more enjoyment from his phonograph, *but which set a date for the Service Man to call and demonstrate the phono-cartridge which makes more authentic musical reproduction and longer record life possible.* It takes follow through to sell phono-cartridges just as it does to sell any other product. Make the call and make the sale.

Envelope stuffers are an effective means of telling record fans how phono-cartridges can increase the enjoyment they receive from their phonographs. They should be written from a consumer point of view and be informative in content. The main purpose of the stuffer should be merely to lay the groundwork for a sale. The stuffers should provide factual information about how and why the

(Continued on page 54)

How you can get

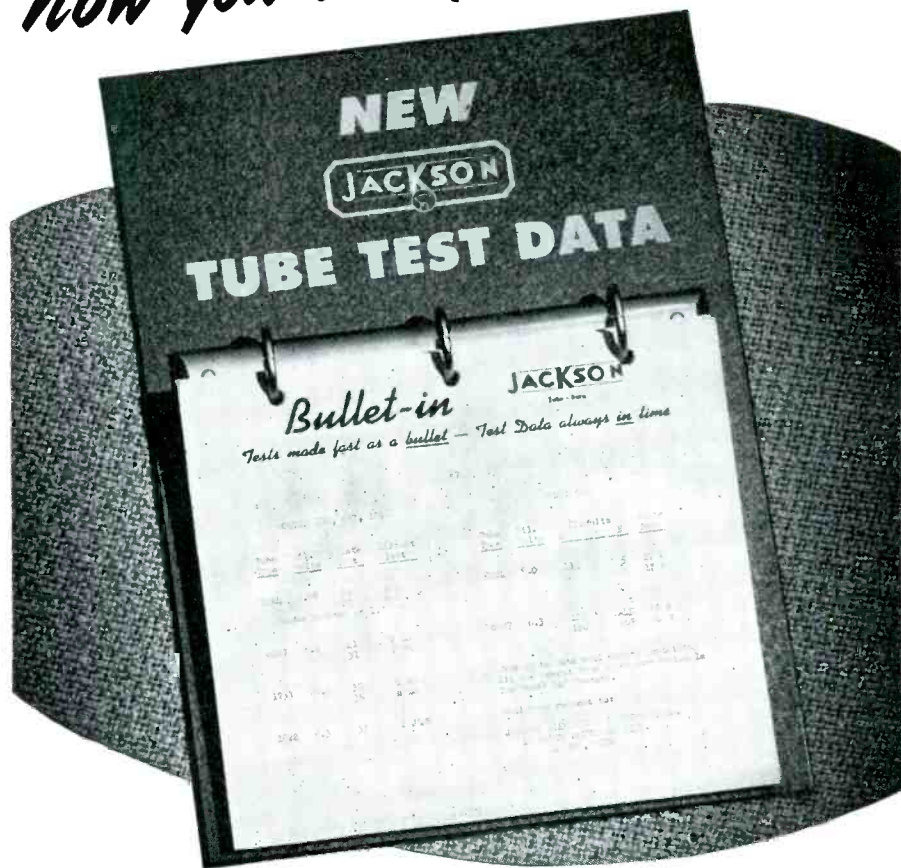

QUICK test setting data on new tubes

Two weeks after a manufacturer has made the characteristics of a new tube available, we supply a test setting bulletin to distributors. The above photograph shows the "Bullet-in" board that is furnished free and upon which each bulletin is posted as soon as a distributor receives it.

Users of Jackson Testers can obtain the information from distributors immediately instead of waiting until a new roll chart is issued.

Recognizing the value of this service, alert distributors post each new bulletin promptly so that their customers can get the benefit at the earliest possible moment.

For the convenience of Jackson Tester users who are no longer entitled to free roll charts, the bulletins advise when new charts are ready.

Look for the bulletin when you visit your distributor's store. If you see it, copy the test setting data. If you can't locate the bulletin, tell the distributor you want to see it.

JACKSON ELECTRICAL INSTRUMENT CO.

"Service Engineered"
Test Equipment

DAYTON 2, OHIO

In Canada:
The Canadian Marconi Co

YOUR BEST BUY IN POWERFUL P.A.



**IMMEDIATE
Delivery from ALLIED!**

Here's the outstanding 30 Watt Sound System buy of the country—KNIGHT—tops for power, quality, value. Just check these features: Covers up to 25,000 square feet outdoors, or up to 4,000 persons indoors. Full 30 watts usable output at 3 db down, ± 2 db from 40 to 20,000 cps on phono and microphone; 3 inputs—two for high-impedance mikes, one for phono, each with individual volume control; tone control attenuates treble 15 db at 10,000 cps. Complete system includes: 30 watt amplifier and tubes, Electro-Voice unidirectional "Cardax" microphone with adjustable floor stand and 20' cable; two 14.7 oz. Alnico V magnet General Electric 12" "Safused" PM speakers, each with 30' cable; portable carrying case, 16 $\frac{3}{4}$ x 12 $\frac{3}{4}$ x 25". For 110-130 volts, 60 cycle A.C. Shpg. wt., 75 lbs. **93-372. Complete System (less phono—\$11875 top). Only . . .**

\$17.81 down, \$8.92 monthly for 12 months

93-340. 3-Speed Phono Top with dual crystal cartridge, for above system. Only . . . \$16.95

Headquarters for P.A. and Hi-Fidelity
ALLIED carries the world's largest stocks of P.A. amplifiers and systems—8 to 80 watts. Look to ALLIED, too, for High-Fidelity amplifiers, tuners, speakers, and all other Custom Sound components and accessories.

FREE 212-PAGE ALLIED CATALOG



Write today for the only complete Buying Guide to everything in Sound, Radio and Television. Make your selections from the world's largest stocks at lowest money-saving prices. You save time and effort and get the best when you order from your ALLIED Catalog. Send for your FREE copy now.

ALLIED RADIO

ALLIED RADIO CORP., Dept. 23-F-1
833 W. Jackson Blvd., Chicago 7, Illinois

Send FREE 212-Page ALLIED Catalog
 Ship the following: _____

\$_____ enclosed. Full Pay.
 Part Pay. (bal. C.O.D.)

Name _____

Address _____

City _____ Zone _____ State _____

(Continued from page 53)

phono-cartridge improves quality of reproduction and extends record life. Remember, the stuffer serves as a *teaser*; it remains up to the Service Man to make the actual sale by a personal sales presentation.

Properly coordinated, a program of phono modernization by the installation of new, modern replacement phono-cartridges would involve the following:

Envelope stuffers which inform the record fan of the benefits he will receive from modern cartridges and which arouse his interest in having a modern unit installed in his phono-graph.

Postcards or telephone calls which advise the record fan that the Service Man can guarantee him better quality sound reproduction and longer record life by replacing his old phono-cartridge with a modern unit, and which set a date for the service technician to call and demonstrate the replacement cartridge.

Finally, personal calls. It is prudent, of course, to use all sales aids, cartridge check-up chart, finger-tip compliance test and cartridge weight test, in addition to an explanation of why the compliance, weight and tracking pressure of the modern replacement cartridge mean more authentic sound reproduction from the phono system and months and months more service from the records.

To expand the coverage of his advertising, the Service Man can display streamers or decals in the windows of his shop to announce that he is in the phono-cartridge replacement business and that he knows his business.

The cartridge replacement market is big! It is important! And *you*, the Service Man, are the most important single factor in making it prosperous. You are important to 10,000,000 record fans because *you* can bring them more enjoyment from their musical hobby.

But these same record fans are important to you, too, because . . . *they have \$70,000,00 to spend with you, right now!*

BURGESS PORTABLE BATTERY CAMPAIGN

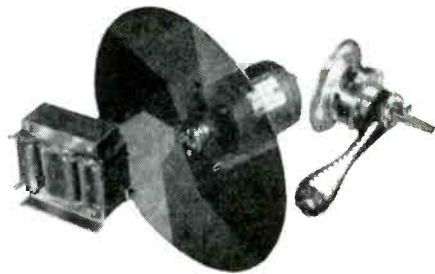

COLOR CONVERTER- ADAPTER KITS

Convert TV set to receive CBS Color



Write today for complete data

COLOR SALES CO.

295 West Shore Dr., Massapequa, Long Island

**big FREE
GIFT offer!**

**SEE
PAGE 14**

CONVERSION DATA!

See Ad—
Page 52

For RCA Victor 730TV1
see PF INDEX No. 26

FREE—GET IT NOW!

(Left)

Window streamers, counter and window display cards and envelope enclosures being used by Burgess in their 1951 portable radio battery promotion. Offered are replacement data with a six-page replacement guide listing 1500 sets by more than 100 manufacturers, ready-to-run mats for local advertising, etc. Promotional material available without cost from distributors or by writing direct to Burgess Battery Co., Freeport, Ill.

Instrument Amplifiers

(Continued from page 23)

sets, components used are similar to those found in public-address gear. Quality parts should be used when making replacements, and they should be mounted solidly! These amplifiers get some real rough treatment, and poorly mounted parts will soon be torn loose, with consequent damage to your reputation!

On general principles, it's wise to use 600-volt filter and bypass capacitors. If you want to really lean over backward with caution, try using 1,600-volt buffers for coupling replacements. They will stay there for a long time!

If output transformer replacement is necessary, it is important to be sure to use adequate wattage rating types.

Speakers, as indicated earlier, are mostly *pm*'s, with an occasional electrodynamic. If a speaker has to be reconed, it will be necessary to use a heavy-duty voice-coil and cone. If the whole speaker has to be replaced, one of the *pa*-type cone speakers should be used. There seems to be only one place for the volume control on these jobs; wide open! The high volume levels and constant vibration will tear up a light cone in a short time.

If the complaint involves low volume, the rectifier and power tubes should be checked for emission and transconductance. If there is no trouble here, but the voltages are running low on the plates, in the output, the coupling capacitors should be checked for leakage. If one is bad, both of them should be replaced. All coupling capacitors should be checked carefully, especially in the phase inverter and driver stages. If the trouble is not in the capacitors, the load resistors, screen dropping resistors and filter resistors should be tested for changes in value. One resistor off, in the plate or cathode of a single-ended phase inverter, for instance, could cause no end of trouble. Open plate load resistors, especially, can affect the total volume.

Microphonic tubes in the input are another constant source of trouble. If there are more than one of these in the amplifier, you should try exchanging them.

Since the gain controls are usually used with full-gain, they are prone to noise trouble. They should be given a liberal dose of some good cleaning compound, such as *Quietrole*, *Contactene*, etc. It's a good idea to use the cleaner each time the amplifier is in the shop, just in case.

Musical-instrument amplifier servicing offers an excellent opportunity for substantial income in practically any community today.

The spotlight falls on
another Webster Electric first!

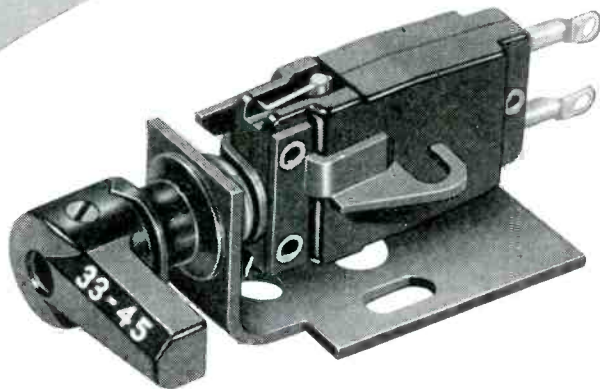

Introducing a **new** two-needle, three-speed Replacement Cartridge...

the model **AX**

The new model AX cartridge replaces ninety percent of the two-needle, three-speed cartridges on the market today.

The model AX comes as a complete unit, including twist mechanism, cartridge, needles and instructions for installing in any standard $\frac{1}{2}$ " mounting. Twist mechanism is easily removed when cartridge is to be installed in tone arms in which twist mechanism is an integral part.

This new cartridge is double-protected against moisture by the Dri-Seal crystal and Dri-Pack packaging.

Tops in quality and competitively priced, the model AX eliminates the need for large and varied stocks of three-speed replacement cartridges... as well as the need for replacement charts. Just one cartridge to stock and to sell.

Available around June 15; write for descriptive folder.

WEBSTER ELECTRIC
RACINE ♦ WISCONSIN

"Where Quality is a Responsibility and Fair Dealing an Obligation"

HEY, DOC! MAYBE THAT SABOTAGING

"KREMLIN GREMLIN"*

HAS THE PARTS YOU'RE LOOKING FOR!
HOW MANY TIMES BEFORE HAS THIS
HAPPENED TO YOU?
CONFESS, FELLA!!
DO YOUR INSTALLA-
TIONS TAKE HOURS
INSTEAD OF MINUTES???

... if so, it's costing you quite a few dollars every time you install a T-V set. Exterminate those "Kremlin Gremlins" that are sabotaging you or your business!

The NEW, exclusive T-V Products Company line of Yagi's, straight and folded dipoles, in-a-line, and Super-V's... which have just been added to the regular line of Conical Antennas... is designed with YOU in mind.

Just remove the completely pre-assembled antenna from the carton, snap the elements open, and "QUICK-AS-A-WINK" you're all set up. No loose nuts or bolts to plague you, and no thumb-screws or wing-nuts to tighten.

REMEMBER, time is money! And, if you want to save money...

YOU NEED OUR . . .

*NOTE TO JOE STALIN
"SO SUE US"

"QUICK-AS-A-WINK"

OPEN — SNAP — IT'S LOCKED

ASSEMBLY

FEATURED IN OUR NEW LINES OF YAGI • SUPER-V • IN-A-LINE • STRAIGHT AND FOLDED DIPOLE ANTENNAS.

T-V PRODUCTS
COMPANY
152 SANDFORD STREET
BROOKLYN 5, N. Y.



Metallic Rectifiers

(Continued from page 27)

is best applied to voltages not exceeding the critical cell voltage. This connection is widely used in the electroplating field. Diagrams showing connections for these two types of circuits appear in Fig. 2. In each case a single, three-phase stack is illustrated.

Relative Advantages of Different Types of Stacks

There are, at present, three types of metallic rectifiers in general use: selenium, copper oxide and magnesium copper sulphide. The oxide and sulphide types are sometimes confused with each other because of the use of copper in each. Selenium rectifiers are being more and more widely used because they are available in a higher voltage per cell than are the other two types. Also, most selenium cells are made with aluminum base plates, which results in a lighter stack. However, one manufacturer of the magnesium copper-sulphide type uses a magnesium base plate which also yields a light stack.

Questions are frequently asked regarding the respective merits of the three types. It is difficult to give a general answer to this, for regardless of the advantage of each type in its particular field, there are some overlapping fields where the various individual merits would have to be weighed in arriving at a decision. This is true also in comparing metallic rectifiers with other means of rectifications such as tubes, motor-generator sets or mechanical rectifiers. Germanium rectifiers are now also available. However, their use is limited to such extremely small currents, generally in the magnitude of milli-amperes; thus they fall in an entirely different class of application from those of the other three types.

In table 1 (p. 26) appears a tabulation citing the relative advantages of each type with respect to various characteristics. In this table, the numbers 1, 2, 3, serve to indicate the relative merits of the rectifiers in order. The relative ratings must, however, be considered in the light of the particular application.

In general, it may be said that the outstanding advantages of each of the three types of rectifiers are:

Selenium . . . High efficiency, lightweight, high voltage.

Copper Oxide . . . Stable and uniform characteristics. Especially desirable for *dc* valve use, ring rectifiers for modulators and meters. Capable of withstanding large voltage and

MUSIC for MERMAIDS-

University Speakers functioning under water—

This is the submergence-proof MM-2F, designed for tough naval combat and railroad service. Like all UNIVERSITY speakers, it more than meets requirements! This one is installed and operates year-round for swimming instruction.

University
LOUDSPEAKERS
...will do more!
...last longer!
...sound better!

UNIVERSITY ENGINEERS, through painstaking research, recognize both idiosyncrasies of the human ear and the severe conditions under which sound equipment must many times be called upon to operate. They meet this double challenge by combining the finest engineering human ingenuity can devise with rugged, all-weather, all-climate construction. The result is better-performing, super-dependable reproducers. For reliability plus, for installations that function day-in, day-out under the most grueling conditions—specify UNIVERSITY loudspeakers.

UNIVERSITY
LOUDSPEAKERS • INC

80 SO. KENSICO AVE., WHITE PLAINS, N Y



Write for
the new

TECHNILOG

Contains a wealth of useful data for engineers, installation men and service personnel. Reserve your copy today!

Address requests to
DESK 55



current overloads for extremely short periods as in reclosing circuit breakers.

Magnesium Copper Sulphide . . . Ability to withstand high temperature for extended periods. Can withstand high current overload. This is essentially a low-voltage high-current device.

Tube News

(Continued from page 38)

structure, should be of the single-field type. Direction of the field of the ion-trap magnet should be such that the north pole is adjacent to vacant pin position 8 and the south pole to pin 2.

Centering of the pattern for all types may be accomplished by the use of a small, adjustable centering magnet located near the base end of the deflecting yoke. The position of the centering magnet on the tube neck must be within a distance of $3\frac{1}{4}$ " from the *reference line*. When the magnet is positioned at the limiting distance, the *ac* field of the deflecting yoke is relatively weak and will have little demagnetizing effect. When placed closer to the deflecting yoke, the magnet must be made of material capable of withstanding a stronger *ac* field without demagnetization. If the magnet is placed too far from the deflecting yoke, appreciable deflection defocusing or neck shadow will result.

Triode-Pentode Converter

A multi-unit tube of the 9-pin miniature type, 6X8, containing a medium- μ triode and a sharp-cutoff pentode in one envelope, has been developed by RCA. It is designed primarily for use as a combined oscillator and mixer tube in television receivers utilizing an intermediate frequency in the order of 40 mc. In such service, the 6X8 is said to give performance comparable to that obtainable with a 6AG5 mixer and an oscillator consisting of one unit of a type 6J6.

The pentode mixer unit of the 6X8 provides low grid-1-to-plate capacitance as compared with a triode mixer and also has low output capacitance. The low value of capacitance between grid 1 and plate minimizes feedback problems often encountered in mixer circuits operating at 40-mc *if*. When an *if* of this order is employed, feedback problems are especially troublesome on channel 2, because of the small difference between the channel

(Continued on page 59)



**I SELL ONE OUT OF THREE
BY ASKING:
"When did you
last change your
Phono-Cartridge?"**

This is a typical experience of service-technicians who pop the \$70 (Million) question—because it's the cue to cartridge replacement sales.

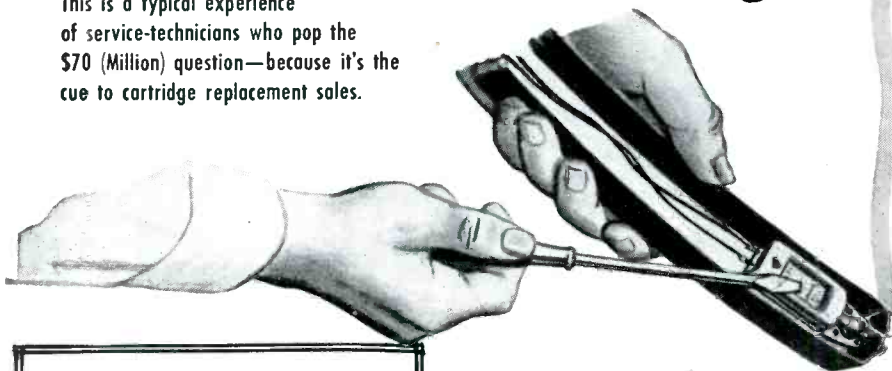

Make the Finger-Tip Compliance Test

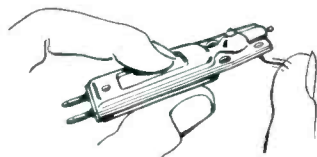

Old style, stiff-acting needle system

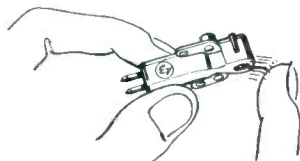

Modern, compliant needle system

It makes record-player owners aware of the importance of the cartridge. It gives you the opportunity to prove that a *modern, lightweight, compliant* cartridge will greatly improve reproduction and save records and needles.

Right now...10,000,000 old-style, heavy, stiff-acting phono-cartridges in existing players need replacing. Current cartridges that are inefficient should be replaced, too.

Follow the E-V plan — *it works*. Check the cartridge on every job — you'll make more sales, more profit!

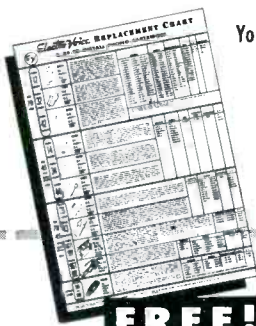

FREE!

REPLACEMENT CHART
Large, Complete Replacement Chart. Gives handy cross-reference and valuable data. Tells when to replace a phono-cartridge. Ask your E-V Distributor or send for it now.

You can make most cartridge replacements with fewer E-V models

Electro-Voice INC.

411 CARROLL STREET • BUCHANAN, MICHIGAN
Export: 13 East 40th St., New York 16, N.Y., U.S.A. Cables: Arlab

Electro-Voice, Inc., Dept. S6-1
411 Carroll St., Buchanan, Michigan

Send FREE Cartridge Replacement Chart

Name (PLEASE PRINT)

Address

City Zone State

Service-Technician Dealer Record Fan

ATLAS Built to take it!



ATLAS DR PROJECTORS, non resonant, uniform response, sturdy, storm proof, compact, demountable.

Regardless of the application Atlas Sound speakers are built to "take it." In the Armed Forces . . . Industrial plants . . . public gatherings . . . under any climatical conditions, Atlas Sound speakers stand up.

Over twenty years' experience in the manufacture of sound equipment goes into every Atlas product. Years of diligent research in Electro Acoustics and constant experimentation in mechanical developments guarantees quality, complete and lasting satisfaction.

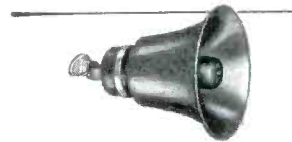

ATLAS PAGING AND TALK BACK SPEAKERS with ATLAS "Alnico-V-Plus" driver unit. A medium size speaker ruggedly constructed 12 watt input power.

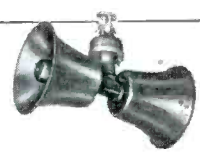

Dual speaker excellent for industrial and talk back applications, simplifies installation in long corridors, hallways, etc.

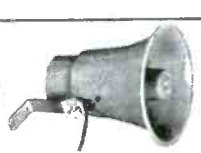

A super efficient sub miniature speaker produces clear intelligible speech at a minimum input power.



ATLAS De-Luxe "Alnico-V-Plus" Driver Units with built in "uni-match" transformers. 30 watt input.

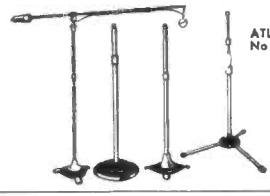

ATLAS "FULL GRIP VELVET ACTION" MICROPHONE STANDS. No slipping—No noise—No rattle—No scratching—No wear.

Write for new No. 551 catalog

ATLAS SOUND CORP.
1442 - 39th STREET, BROOKLYN 18, N. Y.
in Canada, Atlas Radio Corp., Ltd., Toronto, Ont.



AT CHICAGO PARTS SHOW CLINICS

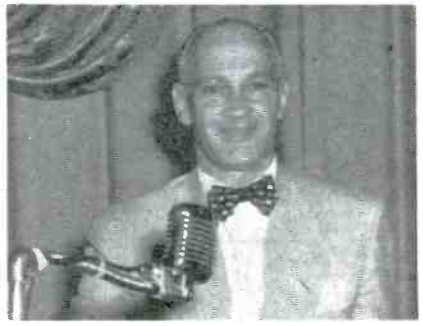

Howard W. Sams, who addressed one of the clinics.



RTMA board chairman Robert Sprague.



Indiana Steel prexy A. D. Plamondon, Jr.



Shure Brothers vice prexy Jack Berman.

John F. Rider, during one of the clinic sessions.



HEATHKITS . . . OFFER UNMATCHED ADVANTAGES

Heathkit
OSCILLOSCOPE
KIT
\$39.50

Heathkit
TUBE CHECKER
KIT
\$29.50

Heathkit
VACUUM TUBE
VOLTMETER
KIT
\$23.50

Heathkit
ELECTRONIC
SWITCH
KIT
\$19.50

Heathkit
TV ALIGNMENT
GENERATOR
KIT
\$39.50

Heathkit
SIGNAL
TRACER
KIT
\$19.50

Heathkit
AUDIO
GENERATOR
KIT
\$34.50

Heathkit
BATTERY
ELIMINATOR
KIT
\$22.50

Heathkit
CONDENSER
CHECKER
KIT
\$19.50

Heathkit
RF SIGNAL
GENERATOR
KIT
\$19.50

Heathkit
IMPEDANCE
BRIDGE
KIT
\$69.50

Heathkit
HANDITESTER
KIT
\$13.50

You'll find unmatched advantages in HEATHKITS—the most complete line of test equipment in kit form. Careful engineering and extensive laboratory testing in the development of each kit, coupled with the use of only highest quality components give you RUGGED, DEPENDABLE, and ACCURATE test equipment.

You SAVE MONEY when you build your own because all expensive factory wiring and construction costs are completely eliminated . . .

All kits are COMPLETE and a real pleasure to build—Every part necessary is furnished—and the clear, detailed instruction manual makes construction easy and educational. (And, the finished kits are truly professional in appearance.) Order your HEATHKIT today and enjoy these tremendous advantages!

HEATH COMPANY

BENTON HARBOR 11, MICHIGAN

EXPORT AGENT: ROCKE INTERNATIONAL CORP., 13 EAST 40th STREET, NEW YORK CITY 16

Tube News

(Continued from page 57)

frequency and the intermediate frequency. The low value of output capacitance enables the tube to work into a high-impedance plate circuit with resultant increase in mixer gain.

The 6X8 is also suitable for use in AM/FM receivers. In the AM section, the pentode unit may be used as a pentode mixer to provide high gain; in the FM section, the pentode unit may be used either as a pentode mixer or as a triode-connected mixer depending on signal-to-noise considerations. Because triode mixers have relatively low equivalent noise resistance, they are preferred for receiver designs which do not include an *rf* stage. For receiver designs with an *rf* stage, a pentode mixer not only provides higher gain but better performance because in such designs the noise introduced by the mixer is negligible. For both sections, the triode unit of the 6X8 makes a satisfactory oscillator.

Wide-Band CRT

A *crt*, type 5YP, has been designed for low- and medium-voltage operation by Du Mont. It is said to be suited especially for wide-band equipment.

According to the designers, one inch of vertical deflection can be obtained with an input to the deflection plates of 12 volt peak, per *kv* of accelerating potential applied to the second anode. The tube also employs an intensifier for increased brightness and smaller spot size.

Has elongated, vertical-deflection plates similar to those used in the 5XP-, high-voltage *crt*s. These plates are said to have been spaced to provide maximum sensitivity commensurate with a distortion-free performance over a 3-inch usable vertical scan of the tube.

RCA BATTERY SALES PROMOTION AIDS



RCA battery sales and servicing aids recently announced. Included in the promotional line is a battery *Fact-Finder*, *Interchangeable Types* automatic pencil, *Portable Radio Sales-Service* sign and a giant, illuminated, flashing battery display.



ANY SERVICEMAN CAN DO IT...

More jobs in Less time = Greater Profit!

With a COMPLETE Library of RIDER AM-FM-TV MANUALS you have all the information you need for a quick, efficient, profitable servicing job. Have at your fingertips these...

EXCLUSIVE RIDER MANUAL FEATURES:

- CIRCUIT ACTION DESCRIPTIONS
- COMPLETE ALIGNMENT DATA
- SIGNAL WAVEFORMS FOR TROUBLE SHOOTING
- LARGE, EASY-TO-READ DIAGRAMS
- COMPLETE PARTS LISTS AND VALUES
- UNPACKING AND INSTALLATION DATA
- FACTORY AUTHORIZED DATA

RIDER TV MANUAL Vol. 6



All TV production runs and changes from August, 1950, through January, 1951. ACCURATE...FACTORY-AUTHORIZED servicing material direct from 66 manufacturers. Convenient 12" x 15" page size, all pages filed in place. Equivalent of 2320 pages (8 1/2 x 11) plus Cumulative Index Volumes 1 through 6. Only \$24.00

RIDER MANUAL Vol. XXI



Don't let any job get away from you. Complete your RIDER MANUAL Library with this important volume. FACTORY-AUTHORIZED servicing information from 61 manufacturers. AM-FM-Auto Radios...Record Changers...Disc and Tape Recorders. Coverage from December 1949, through October 1950. 1648 pages plus Cumulative Index Volumes XVI through XXI. Only \$21.00

MAKE MONEY WITH RIDER BOOKS, TOO!

RECEIVING TUBE SUBSTITUTION GUIDE BOOK

by H. A. Middleton



For TV-AM-FM receivers and allied equipment. 2500 radio and TV tube substitutions listed... tube types classified by functions... plus other important data you must have in order to keep receivers going. 224 pages, 8 1/2" x 11" Only \$2.40

VACUUM-TUBE VOLTMETERS (REVISED EDITION)

by John F. Rider

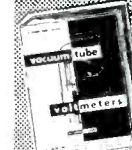

Up-to-the-minute in its coverage of all types of vacuum-type voltmeters. Discusses design, construction, maintenance and applications. Review questions at the end of each chapter. 432 pages, 5 1/4" x 8 1/2", 215 illustrations. Only \$4.50

ORDER RIDER FROM YOUR JOBBER TODAY!

JOHN F. RIDER PUBLISHER, Inc. • 480 Canal St., New York 13, N. Y.

Rep Talk

... if you are commercially or professionally interested in TV, you must read

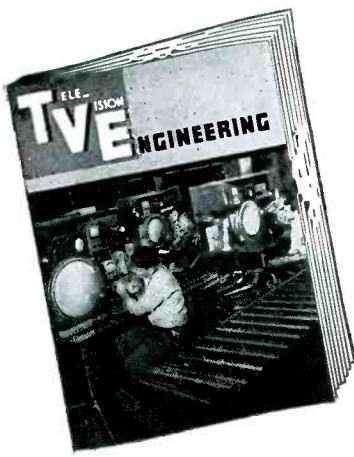

TELEVISION ENGINEERING every month!

Devoted exclusively to TV Research . . . Design . . . Production . . . Operation . . . Instrumentation

TELEVISION ENGINEERING is the *only* trade publication which directs its *entire* editorial content to executives and engineers who design, manufacture, operate and maintain television receiving and transmitting equipment—both commercial and educational.

Every issue is chock full of timely and thorough TV articles, authored by outstanding specialists. You'll find practical, carefully prepared reports and papers on such vital subjects as . . .

- Color TV Systems . . . Ultrahigh Receiver-Transmitter Design Problems . . . Tube Production-Line Techniques . . . TV Broadcast Equipment . . . Camera Tube Research . . . Glass, Plastics and Metal in TV . . . TV Test Equipment in the Plant . . . Film Recording . . . Flying Spot Scanners . . . Tone Amplifiers for TV Films . . . Compact Motors for TV . . . TV Component Design . . . Mechanical Design Factors in Antennas . . . Quality Control Charting . . . Microwave Relays . . . Receiver and Transmitter Servicing . . . Production Aids . . . Instrument Activities . . . TV Sound Systems . . . Studio Lighting.*

Enter your subscription NOW . . . Fill out the coupon below
(Not sold on newsstands)

MAIL COUPON

TeleVision Engineering
52 Vanderbilt Ave., New York 17, N. Y.

Here is my remittance for my subscription to **TeleVision Engineering** at the **SPECIAL RATE . . . 3 years (36 issues) only \$5.**
(1 year subscription \$3.)

NAME

ADDRESS

CITY..... ZONE..... STATE.....

For our confidential records, open only to the Audit Bureau of Circulation, please supply the following information:

Occupation..... Title.....

Department in which employed

Operation Production Research

Employed by

Nature of Business.....
(State if TV Manufacturer, TV Broadcast Station, etc.)

CHARLES E. SCHOLL, 67 Ash St., Bridgeport 5, Conn., has been appointed sales rep for Cornish Wire Co., N. Y. C., in the New England states, except Conn. . . . *Progressive Marketers*, 41 Union Square, New York City, have been named sales reps in metropolitan New York for Standard Wood Products Corp., 43-02 38 St., Long Island City, N. Y. . . . *L. D. Lowery*, 1343 Arch St., Philadelphia, Pa. (Eastern Pennsylvania, Virginia, Washington, D. C., Delaware and southern New Jersey), and *Mack, Kaelber and Mack* (metropolitan New York and northern New Jersey) have been appointed reps for M. A. Miller Mfg. Co., 1165 E. 43 St., Chicago 15, Ill. . . . *Henry Segel*, Clarostat's New England sales rep, gave a resistor-durability demonstration at a recent meeting of the Radio Technicians Guild at the studios of WCOP in Boston, Mass. . . . The *Gopher* chapter of the *Reps* recently voted to make the *Gopher Regional Conference* a biennial affair, the next meeting to take place in '52. . . . *Charles W. Pointon*, 1926 Gerard St., Toronto, Canada, has been appointed Canadian sales rep for Astron Corp., East Newark, N. J. . . . *Burt C. Porter Co.*, 729 Securities Bldg., Seattle, Washington (Washington, Montana, Oregon and Idaho), and *The Herbert Sierk Co.*, 2705 Canton St., Dallas, Tex. (Mississippi, Texas, Oklahoma, Arkansas and Louisiana), have been named sales reps for the Circle-X Antenna Corp., Perth Amboy, N. J. . . . *J. Earl Smith*, 505 North Ervay St., Dallas, Tex. (southwestern states) and *Carl A. Stone and Associates*, 1102 South Western Ave., Los Angeles, Calif., have been appointed reps for Anchor Metal Co., New York 13, N. Y. . . . *Phil Cooper* has been appointed factory rep for Louis Brothers, 3543 E. 16 St., Los Angeles 23, Calif. . . . *W. C. Hitt*, 1169 South Broadway, Los Angeles, Calif., visited the DuMont Laboratories in Clifton, N. J., recently. . . . *JKM, Inc.*, 510 N. Dearborn St., Chicago 10, Ill., has been appointed rep for Standard Wood Products Corp., in Illinois, Wisconsin, Indiana, Missouri and Kansas. *Oden F. Jester*, *Robert M. Karet* and *John S. Margolin* staff JKM. . . . The Los Angeles Chapter of the *Reps* has been incorporated. . . . *Arthur H. Lynch and Associates*, P. O. Box 466, Ft. Myers, Fla., have been appointed reps for Gertsch Products, Inc., Los Angeles, for Florida and north to and including Mobile, Ala. . . . *Norman R. MacInnis*, 53 Youle St., Melrose 76, Mass., and *Preston H. White*, 111 Hoover Rd., Needham Heights 94, Mass., have been elected senior members in the New England chapter of the *Reps*. . . . *Everett P. Bean*, 1336 Madison St., Memphis 4, Tenn., *Harry K. Harpe*, 1036 Peachtree St., N.E., Atlanta, Ga., and *Henry E. Cain*, 317 Forrest Ave., Atlanta, Ga., have become members in the Dixie chapter of the *Reps*. . . . *Norman H. Rahe* and *Alvin A. Berman* have been elected to associate membership in the Buckeye chapter of the *Reps*. . . . *Harry W. Gebhard*, 5129 W. Devon Ave., Chicago 30, Ill., has become a senior member in the Chicagoland chapter of the *Reps*.

HALLDORSON CATALOG

A 20-page catalog, 19, that lists a line of radio and television transformers, has been released by the Halldorson Co., 4500 Ravenswood Ave., Chicago 40, Ill.

Described are isolation, stepdown, filament and voltage-regulating transformers. Included is a replacement guide for pre-war and postwar transformers.

* * *

SYLVANIA TV TUBE GUIDE

A vest-pocket TV tube selector listing more than 100 TV picture tube types, and indexing them as to round or rectangular shape, metal or glass construction, clear, grey, aluminized or frosted face plates, and presence or absence of external conductive coating, has been announced by Sylvania Electric. Guides are supplied by distributors.

* * *

WILLIAM H. ROUS APPOINTED AMPHENOL VP

William H. Rous, sales manager for the American Phenolic Corp., Chicago, has been elected vice president of the company.



W. H. Rous

* * *

THOMAS TEST EQUIPMENT BONUS PLAN

A plan whereby Service Men who buy Thomas tubes will get an added bonus in the form of a certificate which has a currency value when purchasing test equipment, has been announced by Thomas Electronics Inc., Passaic, N. J. Simpson instruments for television and FM servicing, including a model 260 ac-dc volt-ohm-milliammeter, are included in the plan. Certificates are packed in the carton of each individual tube and are good as partial or complete payment.

* * *

RCA GUIDE FOR TUBE INVENTORY CONTROL

A 16-page book in chart form, 1951 *Tube Movement and Inventory Guide*, designed as a year-round master control covering more than 400 receiving tubes and picture tubes, has been released by the RCA tube department.

Charts are arranged in double-page spreads to provide tabular space for a full 12-month inventory-order record for every tube in stock. One column lists the *US Ratio* of each tube type, based on a study of national movement in the renewal market. Another column enables the dealer to list his own movement of each type, based on the national figure and his own local market. In addition, there are columns for the dealer's inventory, orders, and average monthly movement by type.

CIVIL DEFENSE BOOMS MARKET FOR WARD MOBILE ANTENNAS

HAMS, FEDERAL, STATE, MUNICIPAL AND COMMERCIAL FLEET OPERATORS NEED 2-WAY COMMUNICATIONS

Your big market for radio communication equipment is wide open. Civil Defense preparation is vastly widening the demand. Your sales potential will be greatly increased by handling Ward special purpose antennas and mounts. Ward engineered antennas and mounts meet all installation requirements . . . stand the gaff of hardest mobile use. A special selling advantage is Ward's capacity to not only supply complete antenna units for initial installation, but to provide separate components that may be combined to solve any requirement. Be ready to fill the urgent and constantly growing need for mobile communications . . . order and stock Ward SPP antennas and mounts . . . TODAY.

THE WARD PRODUCTS CORPORATION

Division of the Gabriel Co.
1523 East 45th Street
Cleveland 3, Ohio
IN CANADA:
ATLAS RADIO CORP. LTD.,
Toronto, Ontario

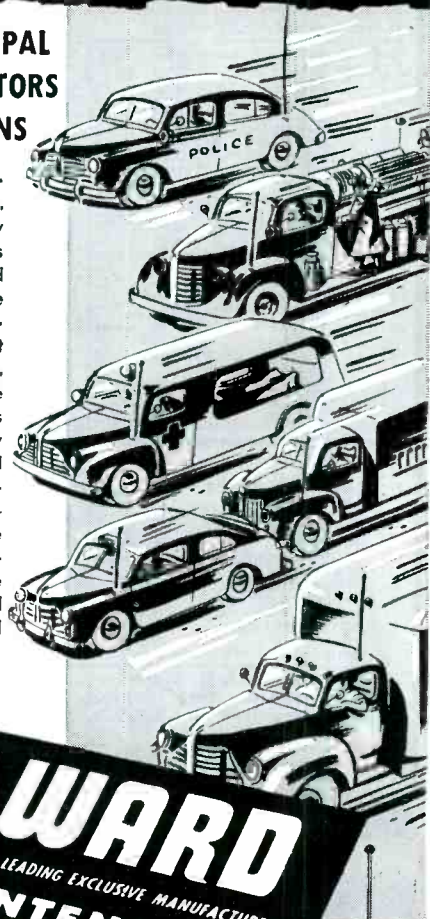

SPP-38 SINGLE ROD

SPP-71 OR SPP-143 UNIVERSAL MOUNT

SPP-3 SWIVEL BASE

SPP-3A SHOCK MOUNTING SPRING

SPP-18 ROOF MOUNTED ANTENNA

JFD TV WINDOW ANTENNA BROCHURE

A 4-page brochure, 92, describing and illustrating two types of all-channel television window antennas (conical model C119 and H-Lo model C120) has been published by JFD Manufacturing Co., 6101 16th Ave., Brooklyn 4, N. Y.

* * *

SUPREME MASTER INDEX

A 16-page manual, *Master Index*, that presents a complete cross-reference to the contents of all ten volumes of *Most-Often-Needed Radio and Television Diagrams*, has been released by Supreme Publications, 3727 W. 13th St., Chicago 23, Ill.

NOLL NOTEBOOK ON UHF TV AND UHF-VHF TUNERS

A notebook on *uhf* characteristics and *uhf-vhf* tuners, illustrated with basic and circuit schematics, block diagrams and waveforms, has been announced by the Paul H. Wendel Publishing Co., Inc., P. O. Box 1321, Indianapolis 6, Indiana.

Notebook prepared by Edward M. Noll, describes the characteristics of *uhf* tuners with respect to gain; sensitivity; bandwidth; signal-to-noise ratio; various types of interference; and alignment.

Contains a bibliography of *uhf*; table of proposed channels for *vhf-uhf* stations, indicating frequency ranges; and a tabulation of proposed allocations of *vhf-uhf* channels by cities and states. Price is \$1.00.

RCA COMMUNITY TV ANTENNA SYSTEM DEMONSTRATED IN PA.

A community TV *Antenaplex* system, designed to bring TV programs to areas where reception previously was poor or unavailable, was demonstrated recently at Pottsville, Pa.

System consists of a master antenna assembly, mounted on a tall mast on the highest nearby elevation; a network of coax cable strung over utility poles from the antenna site through the areas to be served; amplifiers, mounted on poles at fixed intervals to boost the strength of the signals; and leadoff lines, terminating in wall or baseboard outlets in the homes of set-owners subscribing for the service. On the antenna mast are separate elements tuned for each channel on which programs are available.

Local operating companies, such as the Trans-Video Corp. whose proxy is M. A. Malarkey, Jr., are offering the service for a fixed installation fee, plus a monthly service charge. Pottsville residents using the system pay a \$135 initial fee, and \$3.75 monthly.

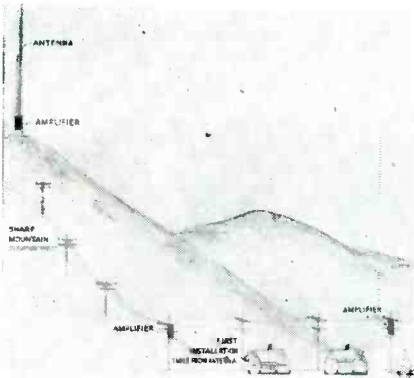

RCA community antenna system

* * *

AEROVOX ACQUIRES WILKOR

Wilkor Products, Inc., Cleveland, O., manufacturers of precision resistors of critical value, has been acquired by Aerovox Corp., New Bedford, Mass. Wilkor Products will continue to operate in its own 35,000 square feet plant space in Cleveland.

W. M. Kohring, sole founder and owner of Wilkor Products prior to the merger, will continue in direct charge of the wholly-owned subsidiary.

* * *

CRL BULLETINS

Eleven technical bulletins covering three product classifications have been released by Centralab, 900 E. Keefe Ave., Milwaukee 1, Wis:

Ceramic Capacitors: Transmitting capacitors (high voltage type) bulletin 42-102; standoff capacitors, tubular type, bulletin 42-121; solder-sealed button capacitors, bulletin 42-122.

Printed Electronic Circuits: Model 2 Ampec, three-stage *PEC* amplifier, PC-200, PC-201, bulletin 42-117; *PEC* TV vertical integrator networks, PC-100 and PC-101, bulletin 42-126; *PEC* triode couplers, PC-70 and PC-71, PC-80 and PC-81, bulletin 42-127; *PEC* pentode couplers, PC-90 and PC-91, bulletin 42-128; Audet *PEC* PC-150 and PC-151, bulletin 42-129; model 3 Ampec, three-stage *PEC* amplifier, PC-202, PC-204, bulletin 42-130.

Switches: Lever action switch, 1452 series, bulletin 42-141.



C-D's Metapup

Best by Field Test!

Chassis space at a premium? Dependability a "must"? Then the job calls for METAPUP, C-D's new and advanced metallized paper tubular capacitor. Metal-encased, hermetically-sealed, self-healing, ultra-compact... every inch a champion!



Send for Bulletin NB144. S-61
Cornell-Dubilier Electric Corp.
South Plainfield, N. J.

1910-1951 SUBSIDIARY

CONSISTENTLY DEPENDABLE
CORNELL-DUBILIER
CAPACITORS

Plants in South Plainfield, N. J., New Bedford, Worcester and Cambridge, Mass.; Providence, R. I.; Indianapolis, Indiana; Fuquay Springs, North Carolina, and subsidiary, The Radiant Corporation, Cleveland, Ohio.

G.E. TUBE HANDBOOK

A 107-page pocket-size handbook, listing the essential characteristics of practically every type of AM-FM-TV receiving tube has been published by the G. E. tube divisions, Syracuse, N. Y.

Contains ratings and other data essential for trouble shooting, and basing diagrams for each of the 856 different tube types listed.

Included are receiving tubes recently announced for use in television applications, subminiature tubes, and a new section listing the essential physical and electrical characteristics of television picture tubes. A section entitled *Interpretation of Ratings and Technical Data* has also been included. There is, in addition, a chart of recommended types.



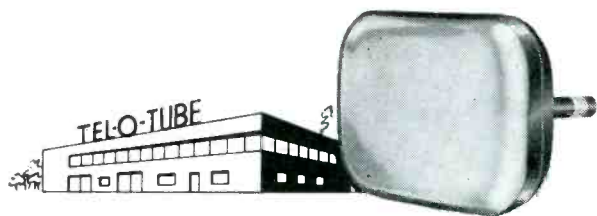

TEL-O-TUBE

The World's Finest Television Picture Tube

10 to 20 inches Round and Rectangular

Electrostatic Focus Tubes

Send Today For Complete Specifications

TEL-O-TUBE CORPORATION OF AMERICA

E. PATERSON NEW JERSEY

Sales Office: Tel-O-Tube Sales Corporation

580 5th Ave. New York 19, N. Y.

TWO SETS IN EVERY HOME Made Easy with New Coupler

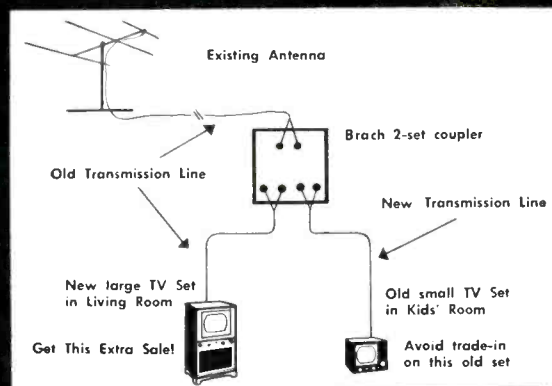

The Brach 2-Set Coupler

- Eliminates interference
- Matches 300 & 75 ohm lines
- Installs with hand tools
- Low in cost
- Avoids trade-in sales

ONLY
\$14.95
List

BRACH

MANUFACTURING CORP.

(Div. of
General Bronze Corp.)

200 Central Ave. Newark 4, N. J.

ASSOCIATIONS



NETSDA

AT A RECENT MEETING of the National Electronic Technicians and Service Dealers Associations, held at the Stacy-Trent Hotel in Trenton, N. J., the group voted to present annual awards

to those set manufacturers whose products exemplify ease in TV servicing. Four categories will be considered: TV receivers, auto receivers, TV-phono-radio combinations, and phono-radio combinations.

Washington, D. C., was selected as

At the recent Philadelphia meeting of NETSDA, left to right: Al Steinberg, president Keystone chapter NEDA; Ken Kenyon, vice prexy Philco; Richard G. Devaney, corresponding secretary NETSDA; Max Liebowitz, prexy NETSDA; Mort Faar, prexy NARDA; Roger Haines, recording secretary NETSDA; Al Haas, prexy Philadelphia TCA; and E. C. Cahill, prexy RCA Service Co.



the next site for the monthly meeting of the association.

RTTG

A NOTE from Tom Middleton, former prexy of PRSMA, reveals that he has become a member of the Radio and TV Technicians Guild of Florida, whose membership includes representatives of the shops in the greater Miami area. Tom's new location in Florida is at 2191 N.W. 89th St., Miami 47, Fla.

ARTSNY

A RECENT MEETING of the Associated Radio and Television Servicemen of New York featured a talk by a representative of Philharmonic on general TV servicing.

The association, through its very active prexy, Max Liebowitz, has played a key role in formulating a new TV licensing bill, which it is expected will become a law of the five boroughs very soon. Highlights of the bill include granting of licenses and permits for TV contractors and Service Men, as well as apprentices; a special license exam to be conducted in 1953, the passing of which will permit a TV Service Man to identify himself as a licensed

TEN YEARS AGO

From the Association News Page of SERVICE, June, 1941

THE STORY OF RSA was described by Joe Marty, Jr., who was then executive secretary of the organization. Joe revealed that the formation of the association was due to the action of the representatives of the Institute of Radio Servicemen, the National Radio Servicemen's Association and the Radio Technicians' Guild. It was also disclosed that the control of the policies and operations of the association were vested in a national board of 20 members elected at regular intervals by the membership. . . . The Johnstown, Pa., chapter of the RSA, announced that it would pay all transportation expenses of members who were planning to attend the national convention in Chicago. . . . A note from Alfred A. Kilian, secretary of the Chicago chapter of the RSA, disclosed that 22 technical meetings had been held during the past year. . . . Bob Pepper was announced as president of Master Radio Servicemen, Inc., the greater Cincinnati affiliate of RSA. William Stephenson was named vice president, Ray S. Rohrer, secretary, and Sid Smith, treasurer. . . . An election announcement from the Fremont, Ohio, chapter indicated that William Brown was chairman; Ralph Eversole, vice chairman; Robert Uhl, secretary, and Ralph Witter, treasurer. . . . Jack Jacobs of Sanford Samuels delivered a talk on rates for specific radio repair jobs, before a meeting of the New York chapter of RSA. A lecture and demonstration on FM by Earl R. Reihman of General Electric was a feature of another of the group's meetings.

operator; and a stiff penalty of up to \$500, as well as a jail sentence, for violators. For a complete report on this bill, see the editorial page, this issue.

ART, BC

THE NAME AND CONSTITUTION of the Associated Radio Technicians of B. C. has been changed to the Radio Electronic Technicians Association of B. C., providing dominion-wide operation, and tying in with the RETA of eastern Canada.

At the meeting, during which the name-change was announced, the results of a recent election for officers of RETA, in Vancouver, were also released. Al Clarke was disclosed as the new prexy. Other new officers are:

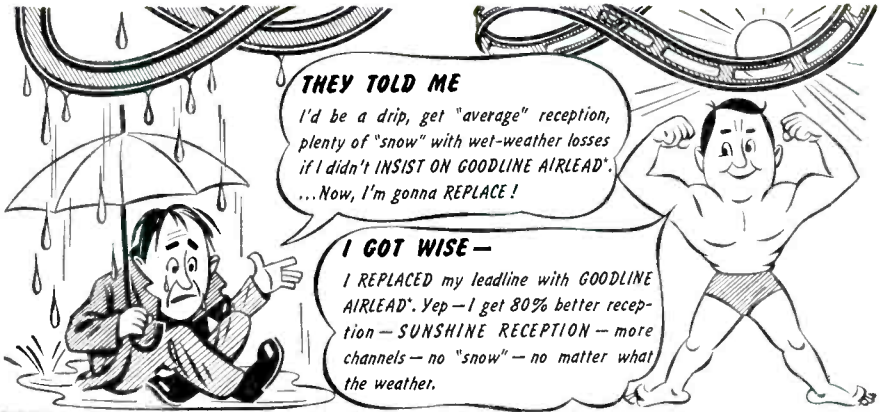

TV set owners are learning FAST that plain airlead isn't giving them top reception. When they see a TV show with GOODLINE AIRLEAD* installed BETWEEN antenna and set, THEY SEE THE DIFFERENCE—want to REPLACE—and do.

With the GOODLINE AIRLEAD* 80% of the LOSS PRODUCING DIELECTRIC WEB IS REMOVED. . . . People who know TV say they get reception that was impossible before—brighter, clearer pictures. . . . A BIG FACTOR: GOODLINE AIRLEAD* effectively eliminates wet weather losses. Also, standard close wire spacing and nominal 300 Ohm impedance reduces re-radiation due to poor balance to ground so prevalent in wide-spaced lines.

GOODLINE AIRLEAD* is made with weather-resistant polyethylene with nominal dimensions of .375" x .083". No special insulators required. Packaged for easy handling and installation. STANDARD REEL LENGTHS. 55'—100'—250'—500'—1,000'—2,500'.

NEW, GOOD VARIABLE TELETRAPS*

NO. R-301 FM—88 MC to 110 MC. Wonderfully effective for eliminating interference from FM Stations within its tuning range.

NO. R-302 DA. 26 MC to 32 MC. Without an equal for effectively eliminating interference from DIATHERMY and AMATEUR signals within its tuning range.

Both above for quick, simple installation at TV Receiver Antenna Terminals.

CORRECTLY PRICED at \$3.95 LIST

NEW, GOOD HI-PASS TV FILTER*



ELIMINATES or GREATLY REDUCES INTERFERENCE which may be picked up by I.F. Amplifier or TV Receiver. Effectively eliminates interference arising from strong, local low-frequency fields: Amateur Radio Stations, Diathermy Equipment, X-Ray, Industrial Induction Heaters, Household Appliances, Neon Lights, etc. . . . Pre-tuned at factory. No adjustments required. Easily installed at antenna terminals. In low-loss Polystyrene case. . . . TWO MODELS: No. 300—for 300 Ohm Line. . . . No. 72—for 72 Ohm line. . . .

Receiver. Effectively eliminates interference arising from strong, local low-frequency fields: Amateur Radio Stations, Diathermy Equipment, X-Ray, Industrial Induction Heaters, Household Appliances, Neon Lights, etc. . . . Pre-tuned at factory. No adjustments required. Easily installed at antenna terminals. In low-loss Polystyrene case. . . . TWO MODELS: No. 300—for 300 Ohm Line. . . . No. 72—for 72 Ohm line. . . .

CORRECTLY PRICED AT \$3.95 LIST

ASK YOUR LOCAL DEALER—OR WRITE



*Patent Pending *Trade Mark
U. S. and Foreign Patents Pending
EXCLUSIVE LICENSEE AND SOLE MANUFACTURER
1014 FAIR OAKS AVENUE
SOUTH PASADENA, CALIFORNIA

Ed Mullens, vice prexy; Fred Lewis, corresponding secretary; W. Wheatcroft, treasurer; and H. Ames, recording secretary.

Dale Donaldson, R. J. Watts and G. Pearsall received membership certificates.

(Right)

Carmen Miranda, of TV, radio, stage and screen, with E. I. Montague, advertising and sales promotion manager of Raytheon's receiving tube division, admiring Raytheon's new picture-tube display which features picture of the very popular international entertainer. Display will be available for distribution to Service Men through Raytheon tube distributors.

CARMEN MIRANDA MODELS FOR RAYTHEON



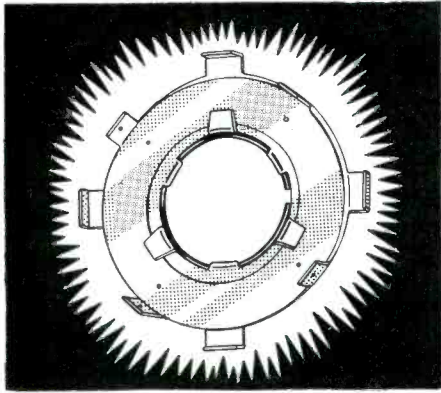

Center TV Pictures in 3 Seconds with the NEW BeamaJuster

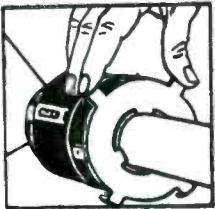

1. Snap BeamaJuster on back cover of tube yoke. (Fits any standard yoke and ANY SIZE TUBE.)
2. Rotate BeamaJuster as shown here for approximate centering of picture.
3. Make final adjustment by sliding outer plate of BeamaJuster vertically or horizontally.

Now service men can center TV pictures in 3 seconds instead of 20 to 30 minutes. The new Perfection BeamaJuster eliminates costly and complicated centering controls of the resistor type. It also replaces mechanical centering controls which tilt the focus coil to center the picture and require numerous springs, wing nuts and special brackets.

The BeamaJuster not only saves time and money but assures lasting results. No drifting of the picture once it is set by the BeamaJuster. This control does not affect spot size, focus or picture definition. Over 10,000,000 TV sets need this simpler centering control. Also perfect for conversions from 10 and 12 inch tubes to larger size tubes. Order today from your supplier.

PERFECTION ELECTRIC COMPANY
2641 S. WABASH AVE., CHICAGO 16, ILL.

Makers of Perfection
Alnico 5 Speakers
and Ion Traps



UNITED TEST PRODS

A series of test prods, featuring a *Klipzon* self-holding jaw, have been announced by United Technical Laboratories, Box 425-K, Morristown, N. J. Built-in jaws slip onto wires, lugs, terminals, pin jacks, sockets, binding posts, etc.

Points are of non-magnetic, alloy steel with duralumin holders. Handles are of synthane, 4 3/4" long. Adaptors are available for wires up to No. 4, B & S gauge, No. 12 machine screws and equivalent sized lugs and terminals.



New Parts . . . Instruments . . . Tools

G.E. MICROWAVE 'SCOPE

A 5" 'scope, type ST-2C, designed especially for use in microwave installations has been announced by the G. E. commercial equipment division.

Vertical sensitivity *ac* input is 0.075 volt *rms* per inch; vertical amplifier frequency response is said to be 20 cycles to 3 mc.

The vertical input attenuator is designed to permit selection of three levels of input from the input binding posts or three levels of input from an *RC* probe. This compensated attenuator will, it is claimed, attenuate voltages by as much as 1000 to 1 without frequency discrimination.

Wide frequency response is said to be obtained without recourse to peaked amplifier coupling circuits. Straight resistance coupling is used and there is said to be no positive slope to the frequency response curve. The response falls off gradually and the slope can be used to view signals containing frequency components up to seven megacycles.



HICKOK PORTABLE 3" 'SCOPE

A 3" 'scope, the 380 *Miniscope*, with a frequency coverage to 2.5 mc, has been developed by The Hickok Electrical Instrument Co., 10529 Dupont Ave., Cleveland 8, Ohio. Features a sensitivity of .1 *rms* volts-per-inch, direct connection to *crt* elements, provision for Z-axis modulation, and telescopic light shield.

Frequency range: Vertical amplifiers . . . *dc*, 0 to 1 mc flat (full gain setting); *ac*, 5 cycles to 2.5 mc, -3 db.

Horizontal amplifier range, 25 to 100,000 cycles.

Input impedance: Vertical amplifier . . . *ac*, 1.5 megohms shunted by 25 mmfd; *dc*, 2 megohms shunted by 5000 mmfd. Horizontal amplifier, 2 megohms shunted by 25 mmfd. Vertical direct, 12 megohms shunted by 15 mmfd. Horizontal direct, 12 megohms shunted by 15 mmfd.

Deflection sensitivity: Horizontal and vertical, 0.1 *rms* volts/inch; vertical direct, 22 *rms* volts/inch; horizontal direct, 28 *rms* volts/inch.

Amazing VEE-D-X MIGHTY MATCH

Permits The Use Of A Single Transmission Line Between Separate High And Low Channel Antennas Mounted On The Same Mast.



Only
\$4.20 LIST
SET OF 4
FILTERS

Saves

300 ohm transmission line • Installation time and money • Extra accessory costs

THE LaPOINTE-PLASCOMOLD CORPORATION
Windsor Locks, Connecticut

JFD "Little Giant" TWIN LEAD LIGHTNING ARRESTER

Protects TV Sets Against
Lightning and Static Charges

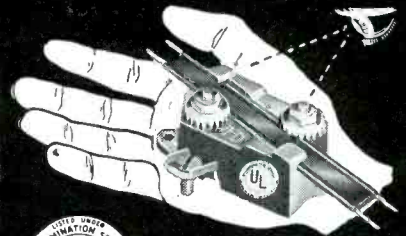

Underwriters
Laboratories
Approved

No. AT105

\$7.25
List

For Regular Twin Lead

SFEING IS BELIEVING!

ONLY JFD Lightning Arresters offer you these exclusive patented features . . .

1. Patented strain-relief Retaining Lip which prevents pulling or straining against contact points.
2. You actually see positive contact made with lead-in wire.
3. Lead-in contact remains fully visible at all times.
4. No wire stripping. No Arrester Cover to Hide Poor Contacts!

At Your Jobber or Write Direct



MANUFACTURING CO., Inc.
6109-F 16th AVENUE, BROOKLYN 4, N. Y.
FIRST in Television Antennas and Accessories

RADIO CITY SIGNAL GENERATOR

A signal generator, model 705A, has been announced by Radio City Products Co., Inc., 152 W. 25th St., New York City.

Instrument covers 150 kc to 220 mc. in eight ranges, six being fundamental frequencies covering through 55 mc. Accuracy is said to be maintained within 1% of calibration. Adjustment and recalibration is available by air trimmers.



GRAYBURNE FERRITE ANTENNA

A 2' long ferrite-core antenna, the *Ferrite-Loopstick*, has been announced by Grayburne Corp., 20 S. Broadway, Yonkers 2, N. Y. Antenna is said to feature a Q of 240-275.

Unit is claimed to be equally sensitive and efficient at every angle.

Ferrite core (produced by *Ferricore, Inc.*) is formed by a special process which is said to provide high permeability.

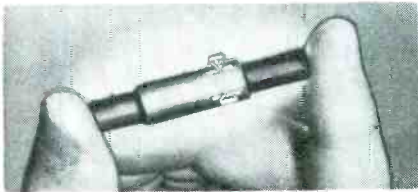

PRECISION APPARATUS 'SCOPE

A 5-inch 'scope, series *ES-500A*, has been introduced by Precision Apparatus Co., Inc., 92-27 Horace Harding Blvd., Elmhurst, L. I., N. Y.

Featured are a push-pull vertical amplifier that is said to have a response beyond 1 mc, 2 megohm input resistance, approximately 20 mfd input capacity, and voltage regulation.

'Scope is claimed to have better than 20 millivolts per inch vertical amplifier sensitivity. Has a calibrated, frequency-compensated, wide-band V input step-attenuator, x1, x10, x100.

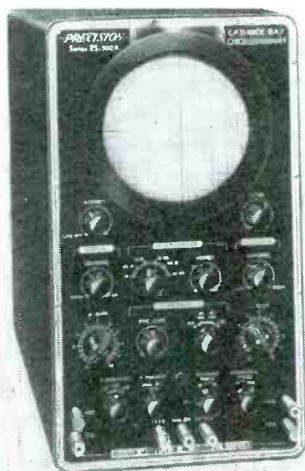

*Save Time
Save Money
with these...*

New
**STANCOR
REFERENCES**

The big new Stancor 1951 Mid-Year Catalog lists 441 Stancor transformers ... the most complete catalog line in the industry. All transformers, including television components, are classified and indexed so you can easily locate the unit you need. Each listing includes electrical specifications, dimensions, weight and list price. Clear illustrations show each mounting type in detail.

The 8th Edition of the Stancor Television Catalog and Replacement Guide provides you with quick, easy-to-read replacement information on 1511 TV models and chassis made under 79 brand names. All manufacturers are listed alphabetically and the models and chassis are listed in numerical order. A separate section lists all Stancor TV transformers and related components by part number.

Both of these up-to-date references are now stocked by your Stancor distributor, or write Stancor directly for your free copies.

AUDIOPHILES—Use Stancor transformers to build the famous Williamson High Fidelity Amplifier. Circuit diagrams and complete parts lists are available in Stancor Bulletin 382 at your Stancor distributor.



*Most Complete Line
in the Industry*

STANDARD TRANSFORMER CORPORATION

3588 ELSTON AVENUE, CHICAGO 18, ILLINOIS

JAMES ANGLE-DRIVE VIBRATOR

A vibrator design, featuring *Angle Drive*, (U. S. Patent 2,536,748), which is described as the perpendicular positioning of the reed arm with respect to the reed, has been announced by the James Vibrapowr Co., 4036 N. Rockwell St., Chicago 18, Ill.

Operation of the design is claimed to result in extreme contact pressures, dynamic wiping action, low-voltage starting, and matched circuit closure, features which are said to eliminate *piling*, *hash*, sticking contacts, and high mechanical noise.

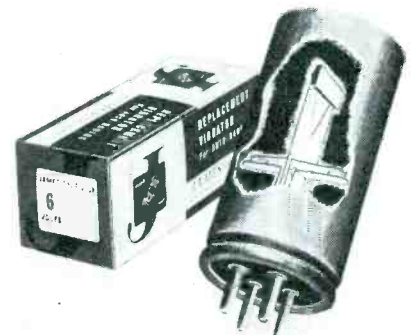

Right: James vibrator.

Phoenix

• Speed-Tennas
• Speed-Mounts
• Hardware

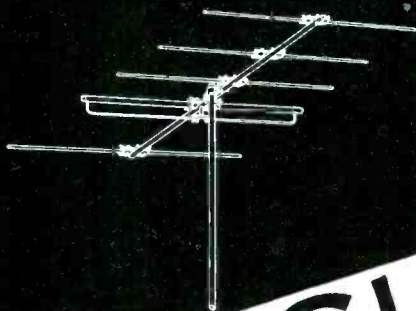

HIGH GAIN YAGI

HIGH GAIN
INLINE

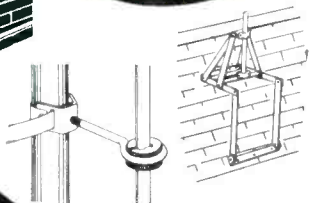

PHOENIX ELECTRONICS
INC.
LAWRENCE, MASS.

big **FREE**
GIFT offer

SEE
PAGE

14

TV Parts

TELREX CONICAL-V-BEAMS

A line of conical V-beam antennas, the *Vanguard* series, have been announced by Telrex, Inc., Asbury Park, N. J. Available in 4 models; VM-2X-6, VU-2X-8, VM-4X-12 and VU-4X-16.

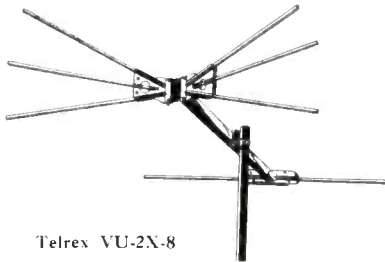

Telrex VU-2X-8

INDIANA STEEL ION TRAP

An ion trap, the *E-Zee-On*, has been announced by the Indiana Steel Products Co., Valparaiso, Ind.

Trap is said to have a uniform field pattern which can be adjusted with one hand. Unit has a slip-on, grip-snug beam bender made of one piece, a permanently magnetized *cutife* that can't be put on backward, and is said to require no manual clamping.



VEE-D-X PLASTIC LINE MATCH

A plastic line-match unit, the *mighty match*, which is said to permit the use of a single transmission line between separate high and low channel antennas mounted on the same mast, is now available from the La Pointe Plascomold Corp., Windsor Locks, Conn.

JFD 4-ELEMENT BEAM YAGI

A series of 4-element yagi television antennas has been added to the yagi line of the JFD Manufacturing Co., Inc., 6101 Sixteenth Ave., Brooklyn 4, N. Y.

Incorporating twin directors, collector and reflector elements, cut to exact channel wavelength, the new yagi is said to have improved forward gain, sharp horizontal directivity and reduced interference. Features *quik-rig* construction.

Available for both high- and low-band channel reception stacked and double stacked arrays, and with jumper bars for stacking of low-band 4-element yagi arrays.

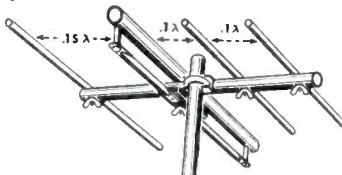

AMPERITE

Studio Microphones
at P.A. Prices

Ideal for
BROADCASTING
RECORDING
PUBLIC ADDRESS

"The ultimate in microphone quality," says Evan Rushing, sound engineer of the Hotel New Yorker.

• Shout right into the new Amperite Microphone—or stand 2 feet away—reproduction is always perfect.

• Not affected by any climatic conditions.

• Guaranteed to withstand severe "knocking around."



Models
RBLG—200 ohms
RBHG—Hi-imp.
List \$42.00



"Kontak" Mikes
Model SKH, list \$12.00
Model KKH, list \$18.00

Special Offer: Write for Special Introductory Offer, and 4-page illustrated folder.

AMPERITE Company, Inc.

561 BROADWAY • NEW YORK 12, N. Y.

Canada: Atlas Radio Corp., Ltd., 560 King St. W., Toronto

YOUR SERVICE BUSINESS NEEDS!!

TELEVISION SERVICE REPORT.....	\$3.95
(Box of 100—3 copy business form)	
TELEVISION SERVICE PLAN.....	2.25
(Book of 100 TV service contracts)	
TELEVISION JOB TICKET.....	1.60
(Book of 100 TV job tickets)	
TELEVISION SERVICE CALL BOOK.....	.75
(Salesbook of 50 triplicate sets)	
RADIO SERVICE RECORD.....	1.50
(Book of 100 Radio job tickets)	
RADIO WORK SHEET.....	.60
(Pad of 50 repair sheets)	
RADIO SERVICE STANDARD RATE BOOK....	1.00
TROUBLE TRACING IN AC-DC RADIOS.....	1.00

See them at your RADIO PARTS DISTRIBUTOR

or write for Illustrated Catalog 2A

OELRICH PUBLICATIONS

4135 N. Lawler Ave. Chicago 41, Ill.

SPECIFY BLACO
(formerly BLACKBURN)

A-1 Ground Clamps

Fit 3/8" to 1 1/4" Pipe

ASK YOUR JOBBER

BLACO MANUFACTURING CO.

(formerly Blackburn Specialty Co.)

6525 EUCLID AVE., CLEVELAND 3, OHIO



CONVERSION DATA!

See Ad—
Page 52

for MOTOROLA VF103
see PF INDEX No. 27

FREE—GET IT NOW!

MOSLEY 3-POSITION TV ANTENNA SWITCH

A 3-position 2½-ounce TV antenna switch, F-20, that can be mounted inside or on the back of the TV set, on the wall, baseboard or window sill or in any other convenient place, has been announced by Mosley Electronics, Overland, Missouri. In the event that there is no space available for mounting the switch on a flat surface, it can be suspended by leads which extend from the molded housing.

The unit consists of a constant-impedance rotary switch employing low resistant silver-to-silver contacts on phenolic insulation enclosed in a cream-colored molded plastic case. Switch positions are marked on the face of the unit. Leads of standard 300-ohm transmission line are brought out of the case for connection to set and to three antenna transmission lines. Unit mounts with two wood screws furnished.

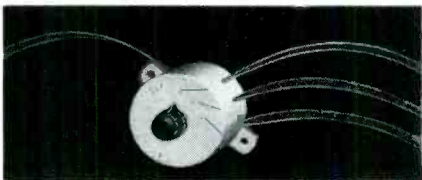

* * *

T-V PRODUCTS 5-ELEMENT YAGI

A 5-element yagi antenna has been developed by T-V Products Co., 152 Sandford St., Brooklyn, N. Y.

Antenna is pre-assembled with a spring construction that is said to lead the various elements into position and to hold them in place.



* * *

EPCO ANTENNA COUPLER

An antenna coupler, model AC-1, which couples one antenna to two 300-ohm inputs, is now available from Epcoc Electronics, Inc., 140 Liberty St., New York 6, N. Y. Unit is housed in a shielded aluminum case, and operates two television or FM receivers from one antenna. Three other TV products have also been developed by Epcoc; antenna switch (AS-1), matching transformer (MS-1) and hi-pass filter (HPF-1).

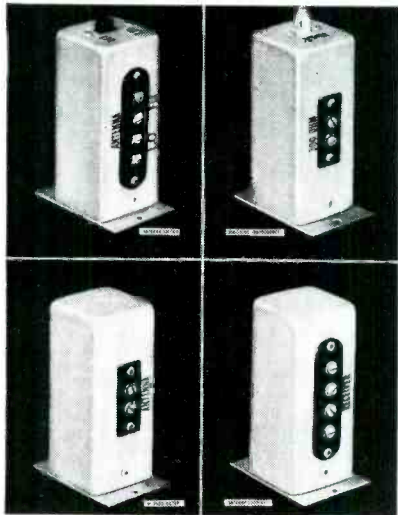

E-ZEE-ON

A NEW AND BETTER

ION TRAP

"E-ZEE-ON" Already Standard on Many New TV Sets



Indiana's "E-ZEE-ON" Ion Traps. Four points of contact with tube neck provide positive grip. Easy to adjust — stays put! Instructions for use included in attractive protective package.

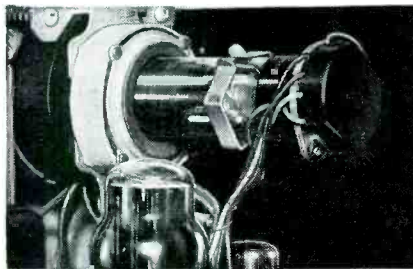

"E-ZEE-ON" ADVANTAGES

- More Efficient, Uniform Field Pattern
- Brighter — More Even Tube Definition
- Easiest to Install and Adjust
- Won't Jar Loose or Slip

Here's another important development from the world's largest producer of permanent magnets — a slip-on, grip-snug Ion Trap that outperforms them all. It permits precise, ONE-HAND ADJUSTMENT . . . stays put and in adjustment because its weight is uniformly distributed. It's made of one piece permanently magnetized Cunife and can't be put on backward . . . requires no manual clamping . . . can't damage tube neck . . . eliminates danger of over-tightening.

"E-ZEE-ON" MORE EFFICIENT

Provides more uniform magnetic field pattern. This evenness of field pattern results in brighter, more uniform definition — easily attained by sliding "E-ZEE-ON" forward or backward on the tube neck. It's the essence of simplicity — one piece of Cunife, formed into an ingenious hexagonal "spring." Fits all tubes. Complete directions furnished with each "E-ZEE-ON" Trap.

Here-to-fore available only to manufacturers, "E-ZEE-ON" will now be stocked by your jobber.

Write for Descriptive Folder

THE INDIANA STEEL PRODUCTS COMPANY

VALPARAISO, INDIANA

SPICO INDOOR ANTENNAS

Two indoor-antenna developments have been announced by the Spirling Products Co., 62 Grand Street, New York 13, N.Y., whose prexy is Milton Spirt. The first is an impedance matching stub which matches the 300-ohm impedance of the antenna to any TV set. The second is an Adjusta-Knob which enables the user to fine-tune the antenna with a special finger-tip control.

Models with these improvements are known as the Super-Phantom, model TV-503, with telescopic dipoles, and the Phantom-Tenna, model TV-501, with fixed dipoles.

Right: Spico TV-501 indoor antenna.

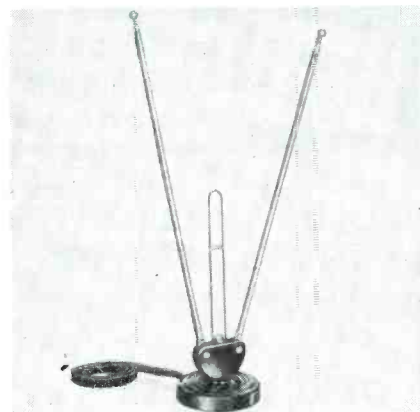

BRAND NEW PROFIT MAKER

FOR
RADIO
SERVICE
MEN!



Model AR-3
ElectroX Vibra-
tor Analyzer &
Power Supply

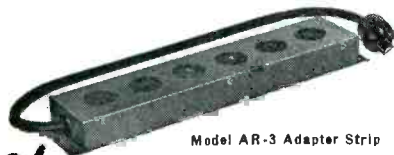

Model AR-3 Adapter Strip

New ELECTROX

VIBRATOR ANALYZER AND POWER SUPPLY

Here's a new ElectroX test unit that's indispensable for shops servicing auto radios, 2-way mobile communication systems or other equipment using 6-volt vibrators.

TWO VALUABLE TEST UNITS IN ONE!

This instrument combines an adjustable POWER SUPPLY that provides smooth, hum-free direct current in any voltage needed to test auto radios, with a VIBRATOR ANALYZER that thoroughly tests practically all synchronous and non-synchronous vibrators found in auto radios today!

TESTS OVER-ALL VIBRATOR PERFORMANCE!

Vibrator Analyzer accurately determines shorted and otherwise defective vibrators and predicts vibrator failures before they occur. It measures starting voltage, current consumption, output voltage and indicates irregular operation. Subjects vibrator to voltage conditions normally encountered when connected to the electrical system of the car. Over-voltage is available for starting vibrators with oxidized contacts. A standard oscilloscope can be attached for wave form observation.

It's a top quality test instrument—a must for every service shop. It safeguards your auto radio repairs—increases your parts sales—steps-up your efficiency and earnings. ORDER NOW FROM YOUR DISTRIBUTOR.

Write for Free Bulletin No. 1466, Giving Full Details

Rectifier Division
SCHAUER MANUFACTURING CORP.
2078 Reading Road • Cincinnati 2, Ohio

CONVERSION DATA!

See Ad—
Page 52

For RCA Victor 630TS
see PF INDEX No. 25

FREE—GET IT NOW!

COLOR TV CIRCUITRY IN JULY SERVICE

A comprehensive explanatory report on the RCA, CBS and CTI Systems—information of basic value to every service technician.

DON'T MISS IT!

Servicing Helps

(Continued from page 40)

tube, and at a distance of about $\frac{3}{8}$ " in back of the deflection yoke.

When the magnets are rotated on the tube so that the gaps in the rings are together, then maximum picture shifting effect is produced. When the rings are rotated so that their gaps are 180° apart, then little or no shifting of the picture is obtained.

To shift the picture, one of the magnets must be rotated with respect to the other. To remove the picture in a desired direction, the entire centering magnet assembly must be rotated around the neck of the tube. These two adjustments must be repeated until the picture is properly centered and no corner shadows are obtained.

The ion trap magnet on the neck of the tube must be adjusted for maximum brightness as on previous receivers. The position of the ion trap magnet also has an effect on picture centering. However, it should not be used to improve centering if such adjustment causes any reduction in picture brightness. Any adjustment of the ion trap magnet which causes a reduction in brightness, causes the electron beam to strike the edge of an aperture in the gun structure and may eventually cause damage to the picture tube.

35Z5 Tube Substitutions

When replacing 35Z5s with selenium rectifiers, the 200-ohm resistor normally used to take the place of the filament, can be replaced with a negative-temperature coefficient resistor. These have been found to not only absorb the excess voltage, but also take up the harmful surge on first turning on the set. These resistors will save many times their cost, in increased life, for the rest of the tubes.

Portable Transcription Player



Portable transcription player featuring a 5-watt ac amplifier, 10" loudspeaker and a 3-speed turntable. Plays $33\frac{1}{3}$, 45 or 78 rpm discs up to 17 $\frac{1}{4}$ " diameter. Has a microphone jack and mixing volume control. (Model R-16; Newcomb Audio Products Co., 6824 Lexington Ave., Hollywood, Calif.)

"HAVE YOU HEARD
THE SOUND OF QUALITY?"

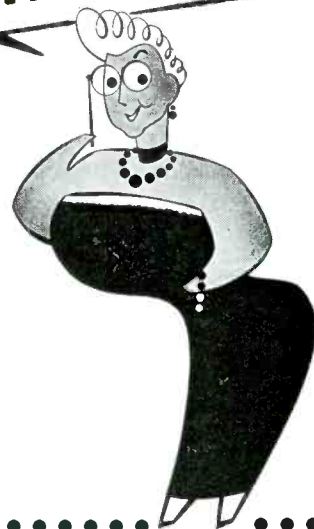

NEWCOMB SOUND IS BETTER

Manufacturers of public address, mobile, phonograph, musical instrument and wired music amplifiers • Portable systems • Portable phonographs and radios • Transcription players • Rack and panel equipment.

Write today! Circle items of interest and indicate whether you are a Dealer, Parts Jobber or Sound Specialist.

NEWCOMB AUDIO PRODUCTS CO.
DEPT. E, 6824 LEXINGTON AVE.
HOLLYWOOD 38, CALIFORNIA

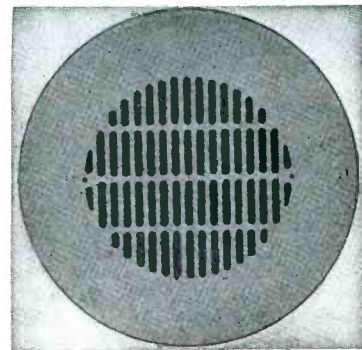

Model 10-P Grille

The 10-P Flush Mounting Grille will give a perfect finish to that sound installation.

Increasing re-orders prove that Sound Engineers are appreciating what these good looking Flush Mounting Grilles can do for them.

There are two finishes: Beautiful chrome plate or bonderized and given a baked-on prime coat for painting.

The grille opening is for an eight-inch speaker.

Write for literature

WRIGHT Inc.
2237 University Ave., St. Paul 4, Minn.

BURNELL NOW BURLINGAME AD DIRECTOR

S. K. Burnell, formerly an advertising product specialist for Westinghouse Electric International Co., has been appointed advertising director of Burlingame Associates, 103 Lafayette St., New York 13, N. Y.



S. K. Burnell

* * *

UTAH RADIO REORGANIZED

Reorganization of Utah Radio Products Co., Inc., at 1123 E. Franklin, Huntington, Indiana, as a subsidiary of Newport Steel Corp., has been announced. A. H. Schenkel has been elected president. Other officers include E. V. Norfleet, secretary and treasurer; F. W. Tower, general sales manager; and M. G. Wike, sales manager of the jobber and industrial division.

Now available are permanent-magnet and electromagnet speakers as replacement and original equipment.

* * *

PERMOFLUX NAMES HUTMACHER SM

Ray R. Hutmacher, formerly midwestern salesmanager of North American Philips Co., has been appointed sales manager of the jobber division of Permoflux Corp.



Ray Hutmacher

* * *

BUILT-IN TV ANTENNA FOR L. I. HOMES



At recent signing of contract authorizing installation of Brach TV antennas and multiple outlets in 140 ranch-type homes in Garden City, L. I. Martin Moss, vp of Moss and Sons, builders of the homes, concluded negotiations for the installation with Morris Salit, head of the jobber organization who merchandise the Brach Mul-Tel system. Contract covers installation of stacked TV antennas, distribution unit and four TV outlet devices to be installed in two bedrooms, the living room, and play room. Left to right: Martin Moss, Morris Salit, Anthony M. Salvati (Moss homes architect), Ira Kamen, director of TV development for Brach, and Aaron Saphier, president of General Bronze, of which Brach is a subsidiary.

The New Leader!

Yagi

By Clear Beam

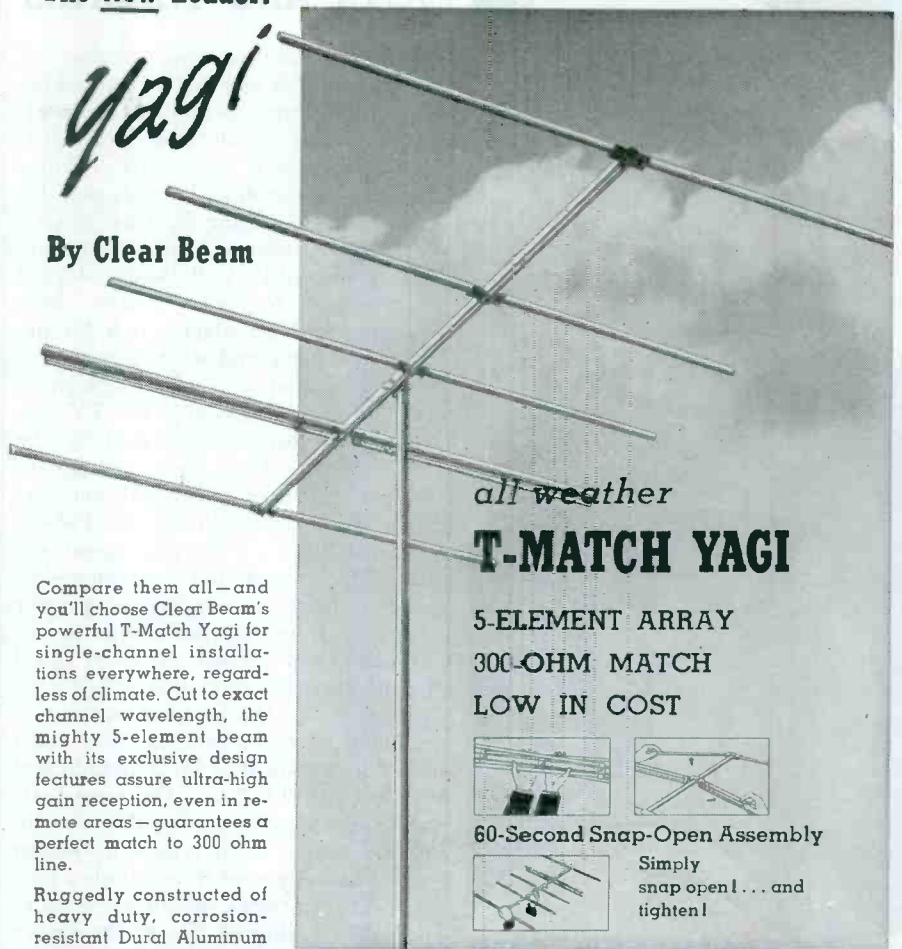

all weather
T-MATCH YAGI

5-ELEMENT ARRAY
300-OHM MATCH
LOW IN COST



60-Second Snap-Open Assembly

Simply snap open!... and tighten!

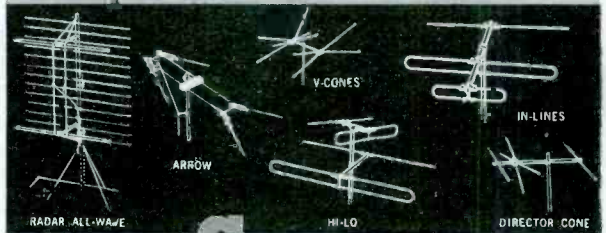

A COMPLETE LINE OF QUALITY ANTENNAS TO MEET EVERY TV RECEPTION REQUIREMENT

Clear Beam

Antennas

CLEAR BEAM ANTENNAS 618 No. La Brea Ave. Los Angeles 36, Calif. YOrk 1682

SYLVANIA PROMOTIONS AND APPOINTMENTS

Raymond W. Andrews, formerly merchandising manager of the radio tube and television picture tube divisions of Sylvania Electric Products Inc., has been promoted to manager of factory sales. He will direct tube merchandising, sales planning and customer service activities, and will be responsible for maintaining sales department liaison with tube plants.

William G. Blowers, formerly with the Franklin Life Insurance Co., as agency manager, has been appointed merchandising supervisor, television picture tube division. He will locate at Seneca Falls, N. Y.

William T. Buschmann, formerly with Socony-Vacuum Oil Co., has been appointed merchandising coordinator for the radio tube and television picture tube divisions.



Raymond W. Andrews



William G. Blowers

* * *

Correction

THE JACKSON Instrument Company *Bullet-In* test data holder described in the May, 1951, issue of SERVICE, is available free to Jackson Instrument distributors only. Information on tests for new tubes, is supplied by Jackson for posting in holder, on display at distributor.

JOTS AND FLASHES

Most TV CHASSIS now coming off the line, as well as those earmarked for '52, will feature outputs for the projected ultrahigh bands and color signal pickup, in black and white. Philco has already announced eleven new 16- and 17-inch rectangular-tube chassis with these features. Stewart-Warner has announced that all chassis shipped since last November have been equipped with an adapter jack for tie-in with a black and white adapter for color reception. . . . A campaign to achieve higher standards for TV servicing has been inaugurated by the RCA Service Co. In a message to dealers and those who install and service, RCA prexy Frank M. Folsom declared that . . . "Service—good, dependable, prompt and courteous—has always been an important partner along with good merchandise in the progress and success of every good business organization that sells to the public. . . . While good service is essential to every product, how much more important it is for a complicated product like TV." . . . The term *base-reflex*, has now become a public domain phrase, thanks to its release by Jensen who originally used it as a trade name. . . . Transformers, which are said to provide a saving of 25% of the copper and silicon steel normally required, have been developed by Philco and Chicago Transformer Corp. The transformer features the use of nylon insulation for magnetic wire, and asbestos type material for coil insulation, permitting the operation of the coils 25° C higher than usual. . . . Raytheon is now building a new receiving-tube pilot plant in Quincy, Mass., which will employ 1,300, the bulk of which will be women. . . . The spring 1951 catalog of John F. Rider, Publisher, 480 Canal St., New York 13, N. Y., has been released. . . . Credda, Inc., has been appointed New York City distributors for Westinghouse industrial tubes. I. R. Ross is prexy of Credda. . . . Recent issues of *Telerex News* have featured data on the design and application of yagis, TVI, the use of antennas for individual channels and voltage and power ratios in chart form. . . . A new tube plant in Cincinnati has been dedicated by RCA. Plant occupies about 17 acres and has about 136,000 square feet of floor space. . . . The tolerances of the resistors used in the *Rochester Electronics* decade resistor, described in the May issue of *SERVICE*, are of the 10% RTMA type. . . . Thomas Electronics, Inc., has become a participant in the Howard W. Sams & Co., Inc., services.

ADVERTISERS IN THIS ISSUE

SERVICE INDEX—JUNE, 1951

ALLIED RADIO CORPORATION	54
Agency: George Brodsky, Advertising	
AMERICAN PHENOLIC CORP.	26
Agency: Burton Browne, Advertising	
AMERICAN TELEVISION & RADIO CO.	72
Agency: Firestone-Goodman Adv. Agency	
AMPERITE COMPANY, INC.	68
Agency: H. J. Gold Co.	
ASTRON CORPORATION	50
Agency: Hart Lehman, Adv.	
ATLAS SOUND CORP.	58
Agency: Nathan Fein, Advtg.	
BLACO MFG. CO.	70
Agency: C. F. Peters and Assoc.	
L. S. BRACH MFG. CORP.	64
BURGESS BATTERY CO.	32
Agency: Ruthrauff & Ryan, Inc.	
CLEAR BEAM TV ANTENNAS	71
Agency: A. James Rouse Co.	
COLOR SALES CORP.	54
Agency: Wm. Wilber, Advertising, Inc.	
CORNELL DUBILIER ELECTRIC CORP.	63
Agency: Reiss Advertising	
CORNELL DUBILIER, RADIART	37
Agency: Stern & Warren	
ELECTRO-VOICE, INC.	57
Agency: Henry H. Teplitz Adv. Agency	
GENERAL ELECTRIC LAMP DEPT.	46
Agency: Batten, Barton, Durstine & Osborn, Inc.	
GENERAL ELECTRIC	1
Agency: Maxon, Inc.	
DON GOOD, INC.	65
Agency: Clark Collard Adv. Agency	
GREYLOCK ELECTRONICS SUPPLY CO.	62
HEATH COMPANY	58
Agency: G. Deiss, Advertising	
HILLO TV ANTENNA CORP.	51
Agency: Sander Rodkin Adv. Agency	
HYTRON RADIO & ELECTRONICS CORP.	31
Agency: Bennett, Walther & Menadier, Inc.	
INDIANA STEEL PRODUCTS COMPANY	69
Agency: Rudolph Bartz, Advertising	
J. F. D. MFG. CO., INC.	66
Agency: Shappe-Wilkes, Inc.	
JACKSON ELECTRICAL INSTRUMENT CO.	53
Agency: The Parker Adv. Co.	
JENSEN MFG. CO.	2
Agency: Burton Browne, Advertising	
KESTER SOLDER COMPANY	39
Agency: Frank C. Nahser, Inc.	
KRYLON, INC.	48
Agency: Gray & Rogers	
THE LA POINTE-PLASCOMOLD CORP.	66
Agency: The F. W. Prella Co.	
P. R. MALLORY & CO., INC.	Inside Back Cover
Agency: The Aitkin-Kynett Co.	
MUELLER ELECTRIC CO.	52
NEWCOMB AUDIO PRODUCTS CO.	70
Agency: Stuart Stevens, Advertising	
OELRICH PUBLICATIONS	68
Agency: Sander Rodkin Adv. Agency	
OXFORD ELECTRIC CORP.	47
Agency: Sander Rodkin Adv. Agency	
PERFECTION ELECTRIC COMPANY	50, 66
Agency: Scantlin & Company	
PERMO, INC.	41
Agency: Wm. Hoffman & Associates	
PHOENIX ELECTRONICS, INC.	68
Agency: Milton Richards Adv. Co.	
PRECISION APPARATUS CO., INC.	4
Agency: Shappe-Wilkes, Inc.	
RCA INSTITUTES, INC.	7
Agency: J. Walter Thompson Co.	
THE RADIART CORPORATION	Inside Front Cover
Agency: Stern & Warren	
RADIO CORPORATION OF AMERICA	35, Back Cover
Agency: J. Walter Thompson Co.	
RADIO MERCHANDISE SALES, INC.	6
Agency: Reiss Associates	
RADIO RECTOR COMPANY, INC.	62
Agency: Walter J. Zimmerman & Associates	
THE RAULAND CORPORATION	29
Agency: MacFarland, Aveyard & Co.	
RAYTHEON MFG. CO.	12
Agency: Walter B. Snow & Staff	
REGENCY DIV. D. E. A. INC.	24, 25
Agency: Burton Browne, Advertising	
JOHN F. RIDER PUBLISHER, INC.	59
Agency: Shappe-Wilkes, Inc.	
HOWARD W. SAMS & CO., INC.	52
Agency: George Brodsky, Advertising	
SANGAMO ELECTRIC CO.	5
Agency: Arthur B. Mogge, Inc.	
SCHAUER MFG. CORP.	70
Agency: The Keeler & Stites Co.	
WALTER L. SCHOTT CO.	14
Agency: Tilds & Cantz	
SHURE BROTHERS, INC.	45
Agency: Casler, Hempstead & Hanford, Inc.	
SNYDER MFG. CO.	17
Agency: Brooks and London	
SPRAGUE PRODUCTS CO.	49
Agency: The Harry P. Bridge Co.	
STANDARD COIL PRODUCTS CO., INC.	9
Agency: Frank C. Nahser, Inc.	
STANDARD TRANSFORMER CORP.	67
Agency: Burton Lehigh Adv. Co.	
SYLVANIA ELECTRIC PRODUCTS, INC.	3
Agency: Cecil & Freshley, Inc.	
T. V. PRODUCTS CO., INC.	56
Agency: Adrian E. Clark, Jr.	
TEL-O-TUBE CORPORATION OF AMERICA	64
Agency: Salow Advertising Agency	
THOMAS ELECTRONICS, INC.	10, 11
Agency: Burton Browne, Advertising	
U. S. TREASURY DEPT.	56
UNIVERSITY LOUDSPEAKERS, INC.	56
Agency: George Homer Martin Associates	
THE WARD PRODUCTS CORPORATION	61
Agency: The Atubell Adv. Agency	
WEBSTER ELECTRIC	55
Agency: Hamilton Adv. Agency, Inc.	
WRIGHT, INC.	70
Agency: Kay Advertising, Inc.	

For AC CURRENT ANYWHERE . . . NO MAGIC just use ATR INVERTERS



STANDARD AND HEAVY DUTY INVERTERS



For Inverting D. C. to A. C.
Specially Designed for operating A. C. Radios, Television Sets, Amplifiers, Address Systems, and Radio Test Equipment from D. C. Voltages in Vehicles, Ships, Trains, Planes and in D. C. Districts.

NEW MODELS **NEW DESIGNS**
NEW LITERATURE

"A" Battery Eliminator, DC-AC Inverters
Auto Radio Vibrators

ATR
See your jobber or write factory

AMERICAN TELEVISION & RADIO CO.
Quality Products Since 1931
SAINT PAUL 1, MINNESOTA—U. S. A.

Don't gamble with comebacks!

Hundreds of servicemen, interviewed in a recent survey, say that to avoid comebacks they use Mallory Vibrators. For right-the-first-time jobs, their rule is . . .



Make Sure! Make it Mallory!

We called on every serviceman in the phone book—in widely scattered cities—talked to every one we could find in his shop. We found that servicemen prefer Mallory vibrators in a ratio of two to one over any other brand!

Why? Better performance! Longer life! Less service trouble!

Mallory vibrators give you the performance you want because of experience dating back to the first commercial vibrator development—because of a patented design that gives you positive starting, quiet operation, long life. Mallory gives you a better vibrator, available in a complete line, meeting original equipment specifications . . . and you pay no more.

Don't just order vibrators. Order Mallory! Get the benefit of the precision quality that is the reason for more Mallory vibrators being used in original equipment than all other makes combined.

Depend on your Mallory Distributor for precision quality at competitive prices.



MALLORY

CAPACITORS • CONTROLS • VIBRATORS • SWITCHES • RESISTORS
• RECTIFIERS • VIBRAPACK* POWER SUPPLIES • FILTERS

*Reg. U. S. Pat. Off.

APPROVED PRECISION PRODUCTS

P. R. MALLORY & CO., Inc., INDIANAPOLIS 6, INDIANA

You get all five...with RCA Batteries



PERMANENT DISPLAY SIGN

Here's an 8 by 20 inch display sign providing triple sales impact for counter or window. Helps you sell Portable Radios, Radio Service, and RCA Batteries.

1. Top Brand Acceptance

2. Unique Selling Aids

3. Radio Trade Distribution

4. Completely Rounded Line

5. Radio-Engineered quality



RCA BATTERY
FACT-FINDER

A fast answer to quick battery sales. Just set index pointer, press the release—and the Fact-Finder opens with the battery information you want before you. Contains prices, techni-

cal data on the complete RCA line, interchangeability directory, and the Battery complement of 590 portable radios of 32 manufacturers...always at your fingertips.

RCA is *first* with the greatest array of selling aids in the field . . . *all geared to the radio trade.*

And . . . *the selling power* of the RCA Trade-Mark makes it *easy* for you to move RCA Batteries. You gain a satisfied customer every time.

Remember, too, that RCA Batteries are *radio-engineered* for *extra* listening hours . . . with a type for practically every renewal requirement.

So—starting now—push RCA Batteries. Build a profitable repeat business with virtually no competition from non-radio outlets.



ILLUMINATED
GIANT BATTERY
DISPLAY

A flashing beacon that attracts battery sales. Stands 12" high—comes complete with bulb, 6' cord, and detachable flasher-unit.

INTERCHANGEABLE
TYPES
AUTOMATIC
PENCIL

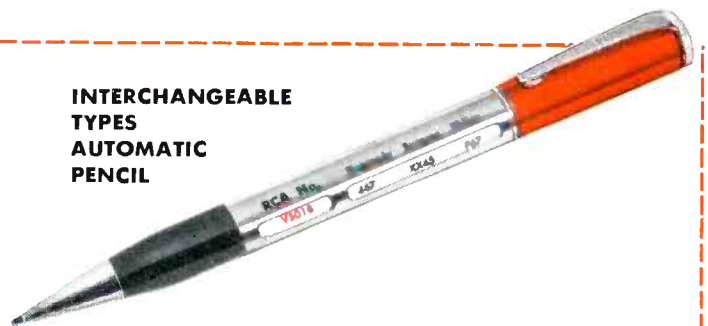

Revolving mid-section tells at a glance the stock numbers on the ten fastest-moving, interchangeable types of four leading battery brands . . . the types that comprise 85% of your interchangeability problems!

Learn how you can get these selling aids at no cost to you by contacting your RCA Battery Distributor today!



RADIO CORPORATION of AMERICA
RADIO BATTERIES

HARRISON, N. J.