

SERVICE

6J6

6AG5-6CB6

Cathode Follower

APRIL
1951

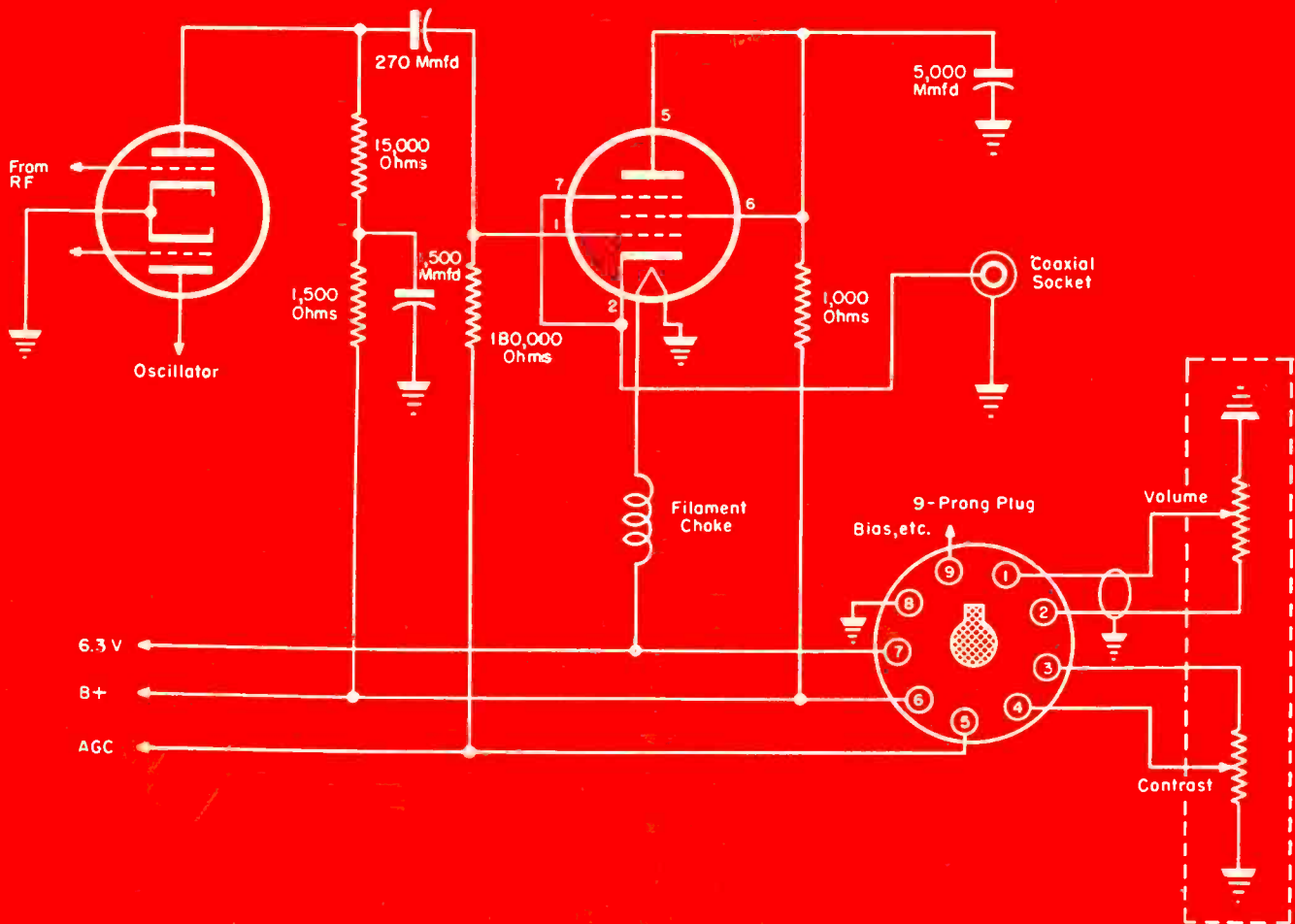

A TV remote control conversion circuit.

[See page 2]

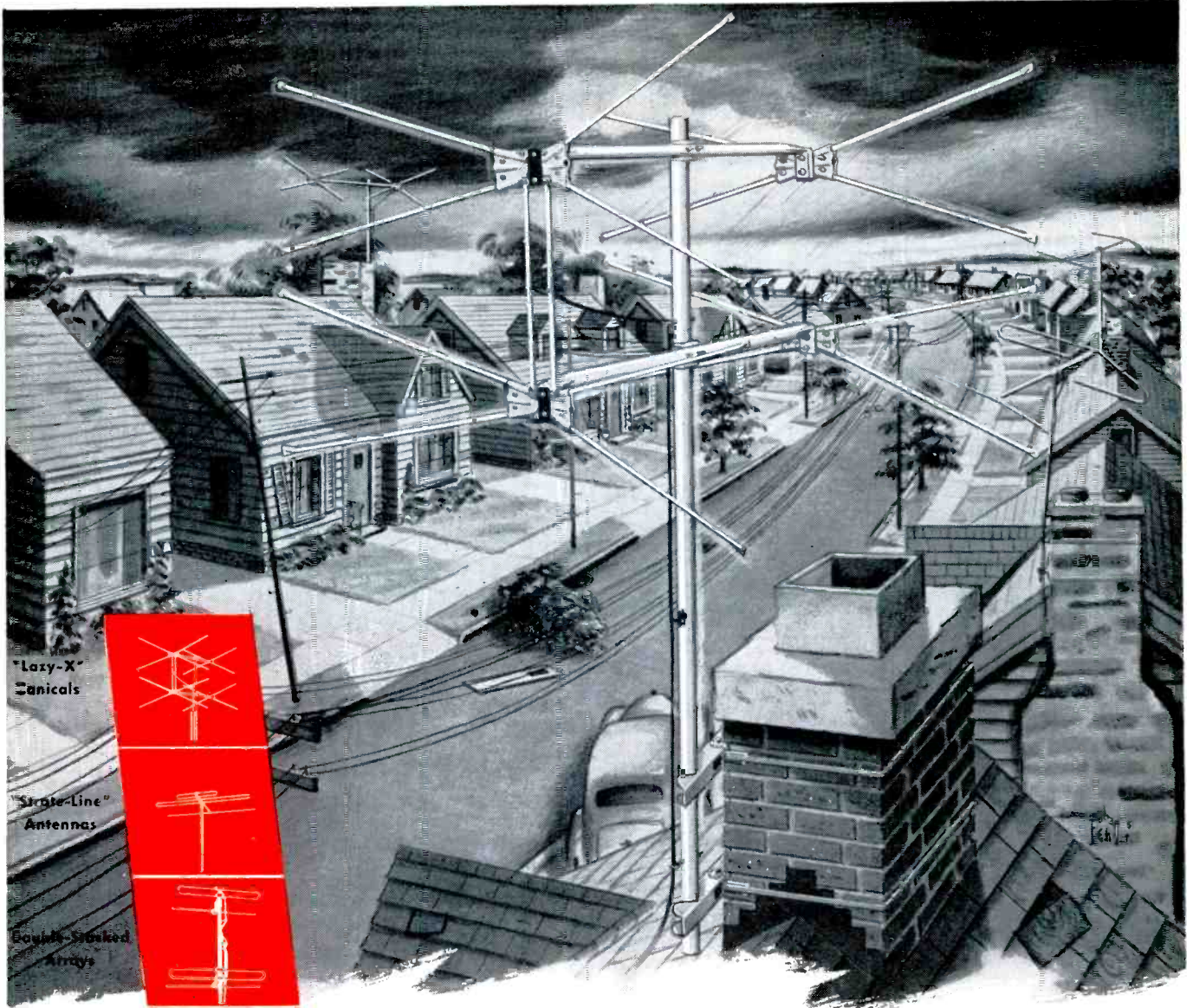

"Lazy-X"
Antennas



"Strike-Line"
Antennas



Double-Straked
Arrays

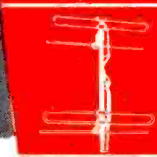

"Hi-Lo"
Antennas

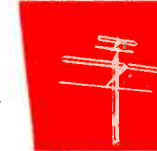

Indoor
Antennas



FM
Antennas



"Super-Vee"
Antennas



Antenna
Rotators



When It's Needed the Most...

RADIART Quality Meets the Challenge

STORM warnings mean nothing in the life of a RADIART antenna! Designed and engineered to deliver maximum pick-up of the TV signal, RADIART antennas have an added PLUS built into them that has caused them to be stamped as the outstanding line in the field. Recent storms across the nation saw thousands of antennas torn, mangled and twisted... BUT NOT A SINGLE CASE OF WIND DAMAGE DUE TO INFERIOR DESIGN OR POOR QUALITY WAS REPORTED ON A RADIART ANTENNA. If proof were needed... this, then, is positive evidence of RADIART supremacy. Again, RADIART QUALITY MEETS THE CHALLENGE... and there is a complete range of antenna types for any and every application.



THE RADIART CORPORATION CLEVELAND 2, OHIO

VIBRATORS • AUTO AERIALS • TV ANTENNAS • ROTATORS • POWER SUPPLIES

"WE HAD TO LICK CALL-BACKS BEFORE THEY LICKED US!"

"Quality tubes proved to be the answer. That's why we feature G-E."

"We were giving time away—in repeat visits to customers who complained their sets didn't work properly. Most of the trouble came from tube failures. We had to stop them, if our radio-TV service was to keep on paying. So we made quality tubes a "must" at Chambers—principally G-E tubes, the brand every serviceman respects! Now our men, when they repair sets, know that the owners will *stay satisfied*. And service shows a steady profit on our books. Consequently, all of us here are strong for General Electric tubes—boost them every chance we get."

Says **HAROLD K. CHAMBERS**
Chambers Radio and Appliance Co.
3546 North Ashland Avenue,
Chicago, Illinois

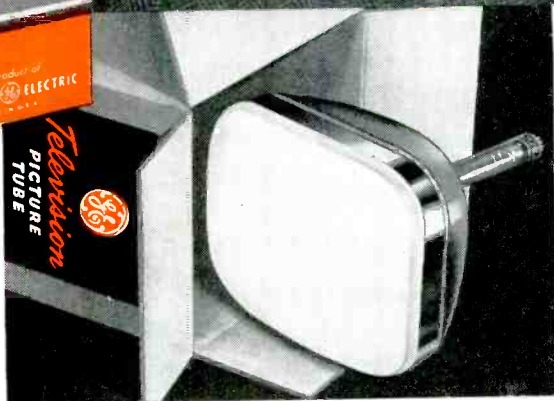

Service customers ask to see the G-E monogram on tube cartons. Chambers and other radio-TV firms have found that out. It's visible proof of tube quality—extra evidence to owners that good receiver performance may be expected long after the serviceman has left.



Test after test assure the uniform high quality of G-E tubes. Here G-E receiving tubes get a factory "short" test. Later comes an electrical-characteristics check; also tests for noise, microphonics, life, appearance, gas, air, and hum. G-E tubes perform better because they are better!

FOR QUALITY TUBES TO CUT DOWN YOUR CALL-BACKS, SEE YOUR G-E TUBE DISTRIBUTOR!

GENERAL  **ELECTRIC**

181-KA4

FOR FINE SPEAKERS
World's Finest
 Reproducer Cabinet
 by **Jensen**



These new Customode Imperial Reproducer Cabinets combine fine acoustic performance with beautiful modern styling and new features for convenience. Speaker is easily, quickly installed or removed from the front. Adjustable Base Reflex port. Optional protective grille assembly furnished. Positive anchor nut attachment of speaker to baffle — no wood screws. Fine mahogany veneer, blonde or Cardovan finish. Ask for data sheet 61.

Jensen
 MANUFACTURING CO.
 Division of The Muller Company
 6601 SO. LARAMIE, CHICAGO 38

Vol. 20, No. 4



April, 1951

LEWIS WINNER
 Editor

F. WALEN
 Assistant Editor

Including *Radio Merchandising and Television Merchandising*
 Registered U. S. Patent Office

	Page
Arm-Chair TV Remote Tuner. (Cover) By Jay H. Prager	24
Association News	60
Audio Installation and Service. (Speaker Enclosures . . . Intercom Systems) By Kenneth Stewart	30
Intermittent Servicing. By Jack Darr	34
Ser-Cuits. (17- and 20-inch TV Chassis) By M. W. Percy	38
Service . . . The National Scene	19
Servicing Helps. By M. A. Marwell	40
Ten Years Ago in Associations	61
Tube News. (Rectangular 14- and 17-Inch Wide-Angle Circuitry) By L. M. Allen	36
Tube Substitution Techniques. By Wyn Martin	22
TV Antenna Grounds. By C. H. Jensen	28
Views and News. By Lewis Winner	17

AUDIO INSTALLATION AND SERVICE

Enclosure Design	30
Intercom Systems	31

CIRCUITS

Bendix C-172 and C-200 TV Chassis	39
Hartley Oscillator with Intermittent Check Points	34
Horizontal-Deflection and High-Voltage Circuit	37
Installation of Selenium Rectifier in Standard Chassis	22
Pentagrid Converter-Tube Oscillator Circuit	34
Remote-Control Conversion Circuit (Cover)	24
Remote-Control System Using a Pentode	25
Sentinel Chassis with Increased Focus Current	40
Sentinel TV Tuner	38
Sylvania Corrected-Bias Circuit	43
Sylvania Improved Horizontal-Sync Circuit	42
Sylvania Vertical Oscillator Revision to Eliminate Vertical Foldover	42
Talk-O Battery-Operated Intercom Circuit	31
Vertical Output with Blocking Oscillator	37
Vertical Output System with Feedback Oscillator	37
Voltage Doubler with Selenium Cells	23

COVER

Remote-Control Conversion Circuit	24
-----------------------------------	----

SERVICING HELPS

Eliminating Picture Smear	40
Hallcrafters Service Hints:	
Eliminating Chirping Sounds	43
Tube Substitutions	43
Replacement Guide for 16-Inch Rectangulars	40
Sylvania TV Chassis Notes:	
Correcting Bias	43
Eliminating 4-5-mc Harmonic Interference	41
Eliminating Vertical Foldover	42
Minimizing Intercarrier Buzz	41
Reducing Picture Distortion	42
Repairing Power Transformers to Eliminate Lamination Buzz	41

Index to Advertisers	72
----------------------	----

Manufacturers

Jots and Flashes	72
News	63
New Parts . . . Tools . . . Instruments	70
Rep Talk	62
TV Parts . . . Antennas . . . Accessories	64



Entire contents Copyright 1951, Bryan Davis Publishing Co., Inc.

Published monthly by Bryan Davis Publishing Co., Inc.

52 Vanderbilt Avenue, New York 17, N. Y.

Telephone MURRAY Hill 4-0170

Bryan S. Davis, Pres. Paul S. Weil, Vice-Pres., Gen. Mgr. F. Walen, Sec. A. Goebel, Cir. Mgr.
 Mid-West Representative: Stuart J. Osten, 333 N. Michigan Ave., Chicago 1, Ill. Telephone: Dearborn 2-3507
 East-Central Representative: James C. Munn, 2253 Delaware Dr., Cleveland 6, Ohio. Telephone: ERievew 1-1726
 Pacific Coast Representative: Brand & Brand, 1052 W. Sixth St., Los Angeles 14, Calif. Tel.: Michigan 1732
 Suite 1204, Russ Building, San Francisco 4, Calif. Telephone: SUTter 1-2251

Entered as second-class matter June 14, 1932, at the Post Office at New York, N. Y., under the Act of March 3, 1879. Subscription price: \$2.00 per year in the United States of America and Canada; 25 cents per copy. \$3.00 per year in foreign countries; 35 cents per copy.

FREE!

With purchase of ONE Sylvania Picture Tube

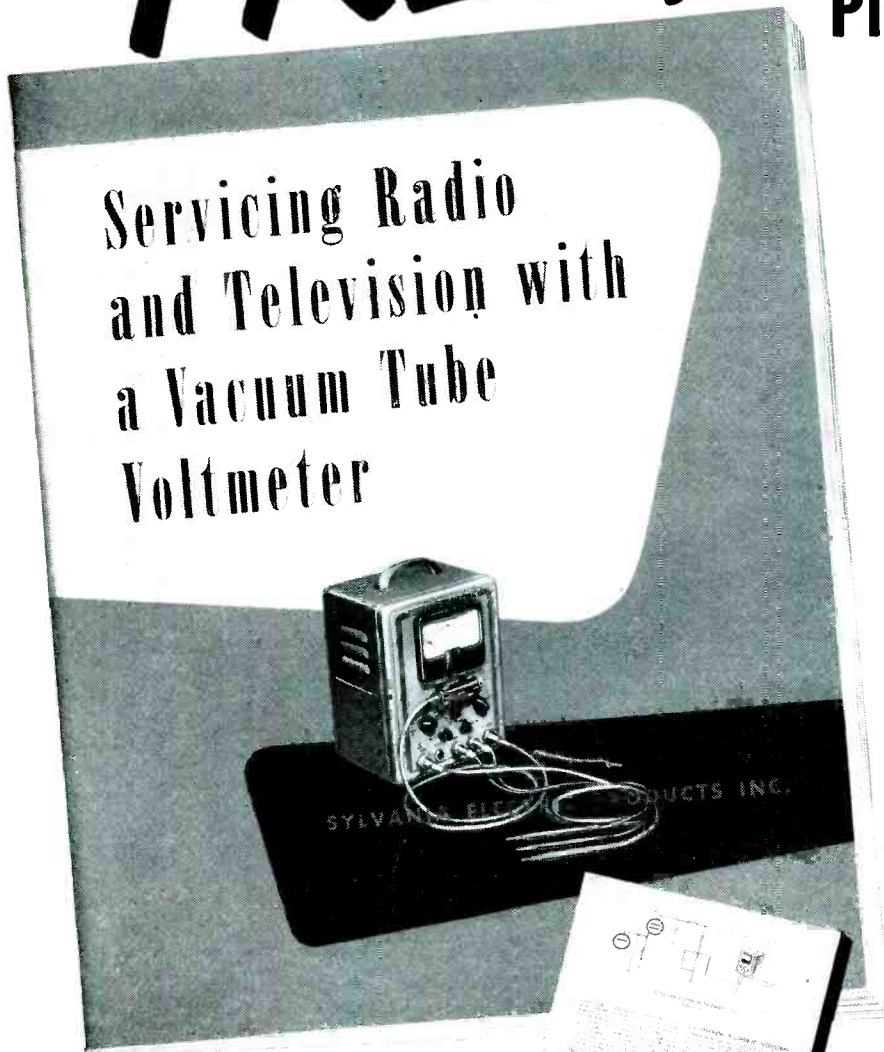

Servicing Radio and Television with a Vacuum Tube Voltmeter

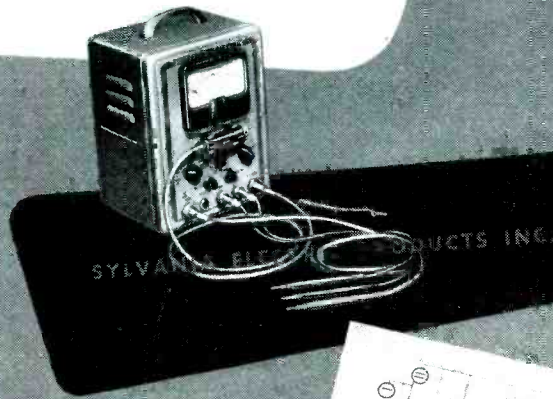

**ACT NOW! Offer good
only April 1st to May 31st**

Here's a book that will save you hours of service time every week. You'll be amazed how it will simplify everyday service problems. You can't buy this book! It comes to you FREE with the purchase of just one Sylvania TV Picture Tube from your regular Sylvania Distributor. That's all, simply buy a Sylvania Picture Tube, of any type, and your Distributor will give you a copy free. See or write him today.

- 48 pages of pictures and diagrams.
- **COVERS RADIO SERVICING**—Signal Tracing, Alignment, AVC and AFC Checking, Measurement of Voltages, Signal Levels, Power Output, Bandwidth and much more.
- **COVERS TV SERVICING**—Signal Tracing, Bandwidth Measurements, Wavetrap Checking, Sound Channel Tests and Alignment, Low and High Voltage Checks, Signal and Deflection Voltage Measurements etc.
- **COVERS AUDIO AMPLIFIER SERVICING**—DC, AC, and Signal Level Measurements; Tone Control, Fidelity, and Gain Tests, Distortion, Power Output and Noise Level Measurements; Signal Tracing, Speaker Matching.
- Covers 19 Miscellaneous Applications of VTVM—Detecting Gassy Tubes, Checking Capacitors, Q Measurement, Turns Ratio Measurement, Impedance Checking.

SEE YOUR
SYLVANIA
DISTRIBUTOR
FOR YOUR COPY
TODAY

Sample pages
showing detailed,
easy-to-read
diagrams.



SYLVANIA ELECTRIC

RADIO TUBES; TELEVISION PICTURE TUBES; ELECTRONIC PRODUCTS; ELECTRONIC TEST EQUIPMENT; FLUORESCENT TUBES, FIXTURES, SIGN TUBING, WIRING DEVICES; LIGHT BULBS; PHOTOLAMPS; TELEVISION SETS

TRIPLETT

Load-Chek

introduces
**Servicing
by
Power
Consumption**

MODEL 660



LOAD-CHEK for the first time makes it possible for every technician to utilize what is perhaps the simplest and quickest of all service methods—Servicing by Power Consumption Measurements.

Power consumption measurement has long been proved by auto-radio servicemen as a rapid method of localizing troubles in auto radios. But Triplet's new **LOAD-CHEK** is the first Wattmeter to be produced at moderate cost, and with the proper ranges, to bring this short-cut method within the reach of every radio and TV service man.

Basis of the **LOAD-CHEK** method is the tag or label on every radio and TV chassis which shows the normal power consumption. The following examples are only two of many time-saving uses of this new instrument.

LOCATING A SHORT—The chassis tag may show a normal consumption of 225 Watts. Simply plug the power cord of the chassis into **LOAD-CHEK** (there are no loose ends to connect or be in the way). Note the reading—which should be possibly 350 Watts. By removing the

rectifier tube you can determine at once which side of the tube the short is on. With a soldering iron and long-nosed pliers you can check through the chassis, locate and correct the trouble without having to lay down tools or to check with lead wires!

REPLACING BURNED OUT RESISTORS—With the chassis to be repaired plugged into a **LOAD-CHEK MODEL 660**, note the wattage reading with the burned out resistor circuit open. Now replace the resistor. Should the increase in watts be greater than that of the resistor rating being installed, it indicates that an extra load has caused the trouble which has not been cleared.

LOAD-CHEK is made-to-order for the busy service man and can help stop costly "come back" repair jobs. It's a profit-maker because it's a Time-Saver. And at its moderate cost **LOAD-CHEK** can be standard equipment on every service bench. By all means, inspect this versatile instrument at your distributor and place your order, for under present conditions we must fill all orders on a basis of "First Come, First Served."

SEE MODEL 660 LOAD-CHEK AT YOUR DISTRIBUTOR'S

FOR THE MAN WHO TAKES PRIDE IN HIS WORK

Triplet

TRIPLETT ELECTRICAL INSTRUMENT COMPANY • BLUFFTON, OHIO, U.S.A.

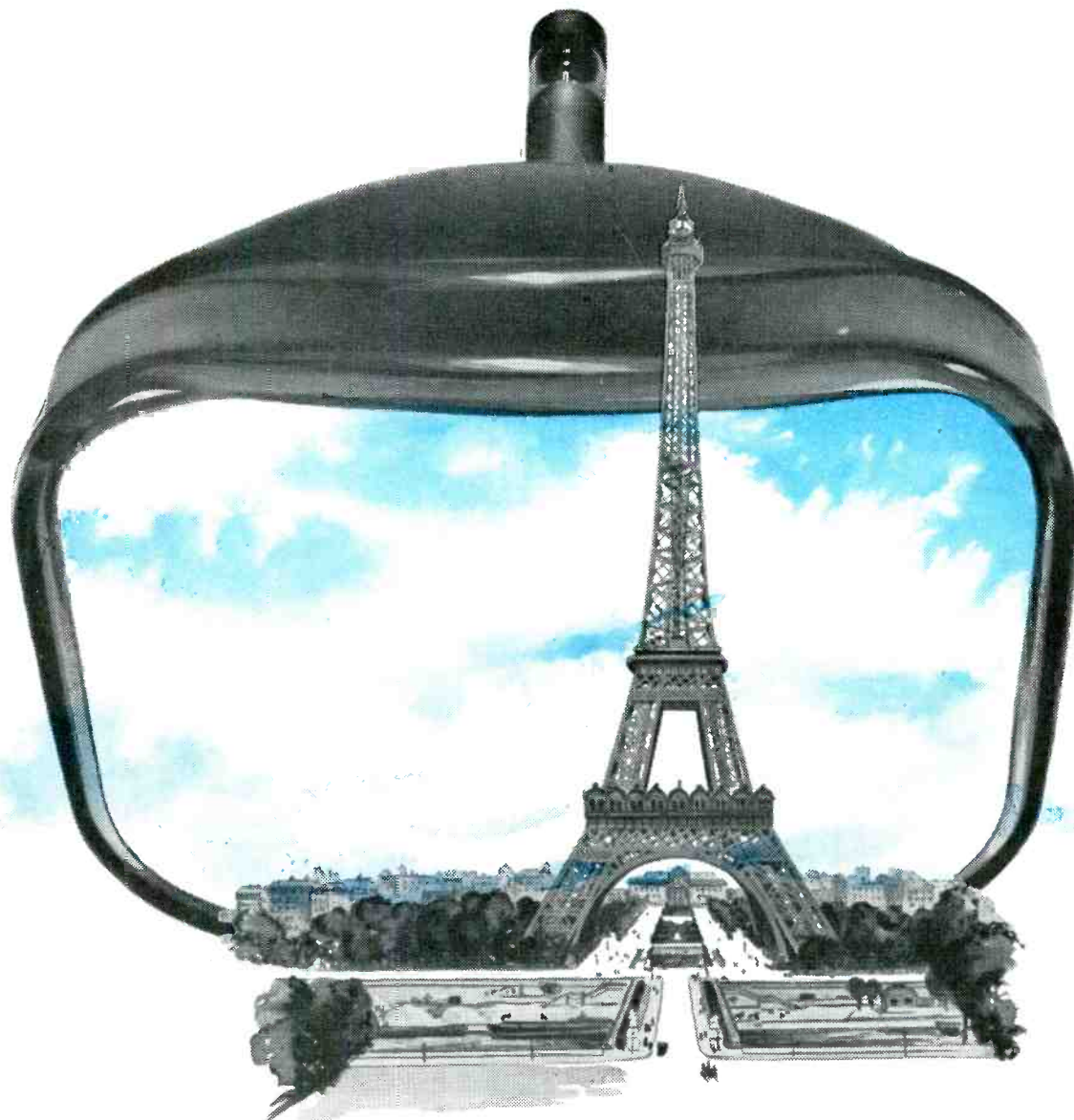

Engineering Achievement

Since the Eiffel Tower was first opened 62 years ago this month it has thrilled millions and become a world-famous Parisian landmark, standing as a monument to the engineering skill of its builder.

Similarly the "T. E. I." insigne of Thomas is a hallmark of picture tube engineering and production skill known throughout the television industry. More than one-half million homes today enjoy the finest television reception on Thomas picture tubes.

For, manufacturers, distributors, and servicemen alike know that when they buy Thomas, they buy an engineering achievement! See just how good a tube can be — try Thomas!



THOMAS ELECTRONICS, Inc.

118 Ninth Street

Passaic, New Jersey



The 7" TV scope for professionals

RCA WO-56A

DUAL CONTROLS FOR "COARSE" AND "FINE" ADJUSTMENTS

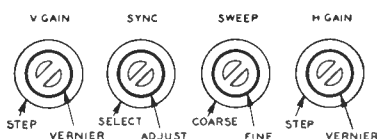

No hunting or fumbling for controls when adjusting Vertical Amplifier Gain, Sweep Frequency, Sync Injection, and Horizontal Amplifier Gain.

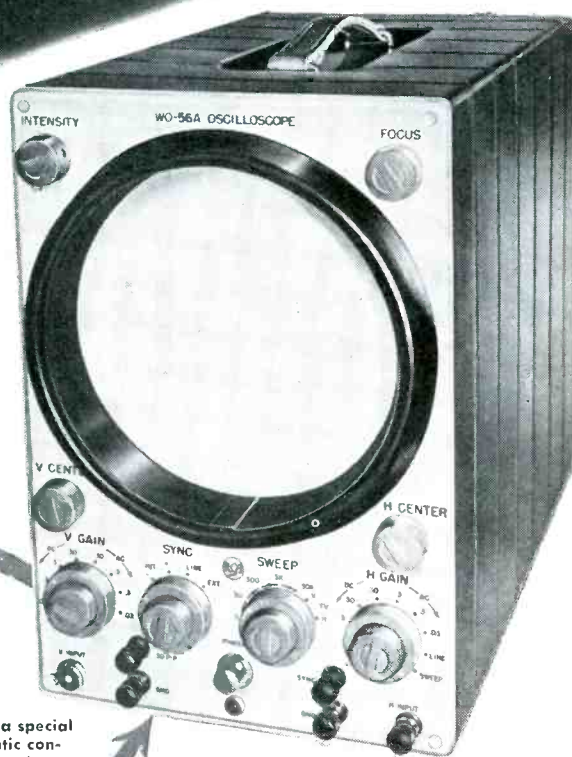

FEATURING—

- Giant RCA 7JP1 cathode ray tube.
- Direct-coupled, 3-stage, push-pull, vertical and horizontal amplifiers.
- Frequency-compensated and voltage-calibrated attenuators on both amplifiers.
- A set of matched probes and cables.
- Panel source of 3 volts peak-to-peak calibrating voltage.
- Identical vertical and horizontal amplifiers with equal phase-shift characteristics.
- Retractable light shield for maximum visibility.
- New filter-type graph screen with finely ruled calibrations.
- Magnetic shield enclosing CR tube to minimize hum-pickup from internal and external fields.

SPECIFICATIONS—

- Vertical Deflection Sensitivity: 10.6 rms millivolts per inch.
- Frequency Response: Flat within -2 db from dc to 500 kc; within -6 db at 1 Mc; useful beyond 2 Mc.
- Input Capacitance: Less than 10 uuf with WG 216A Low-Capacitance Probe.
- Square-Wave Response: Zero tilt and overshoot using dc input position. Less than 2% tilt and overshoot using ac input position.
- Linear Sweep: 3 to 30,000 cps with fast retrace.
- Trace Expansion: 3 times screen diameter with corresponding centering control range.
- Power Supply: 105-125 volts 50/60 cycles; power consumption 65 watts.
- Size 13 3/4" h, 9" w, 16 1/2" d. Weight only 31 pounds (approx.).

ADVANCED SWEEP FACILITIES—

- Preset fixed sweep positions for vertical and horizontal television waveforms.
- Positive and negative syncing for easy lock-in of upright or inverted pulse waveforms.
- 60-cycle phase-controlled sweep and synchronizing.

NEW!

The WO-56A has a special circuit for automatic control of synchronization over a wide range of input-signal levels.

Supplied with direct probe, low-capacitance probe, and ground cable.

Built for laboratory, factory, or shop use, the WO-56A combines the advantages of high-sensitivity and wide-frequency range in a *very small* instrument with a *large* cathode-ray tube.

Designed with the user in mind, this new 'scope can be depended upon to provide sharp, bright, large, and accurate pictures of minute voltage waveforms over the entire useful surface of the 7JP1 screen.

The amplifier selector switches are provided with both "AC" and "DC" positions so that measurements can be made with or without the effects of any dc component.

Square-wave reproduction is excellent, whether the application is low-frequency TV sweep-alignment or observation of high-frequency steep-fronted sync and deflection voltage waveforms:

A special sync-limiter circuit automatically maintains proper synchronization of the sweep oscillator over a

wide range of input-signal levels without the need for manual adjustment of the sync-vernier control.

The excellent linearity and fast retrace of the sweep or time base are functions of the Potter-type oscillator. Undistorted reproduction of the sawtooth waveform is assured by use of a horizontal amplifier with a wide-band characteristic. The preset sweep positions provide rapid switching between vertical and horizontal TV waveforms.

Truly, the WO-56A is a most useful and practical instrument for everyday work in the fields of television, radio, ultra-sonics, audio, and a wide array of industrial applications.

For details, see your **RCA Distributor**, or write RCA, Commercial Engineering, Section 56DX, Harrison, N. J.



RADIO CORPORATION of AMERICA
TEST EQUIPMENT

HARRISON, N. J.



The Redskin of course...

SANGAMO'S NEW MOLDED PAPER TUBULAR CAN HELP SOLVE YOUR CAPACITOR PROBLEMS!

The Sangamo Redskin has the "How" it takes to lick paper tubular troubles. The strong, tough plastic casing stands rough handling and the especially designed, flexible leads are troublefree . . . they resist breakage and they can't pull out. It is used extensively by television manufacturers because it gives dependable *long life* operation at 85° C. The thermo-setting plastic case is molded under low pressure—assuring elements undamaged in fabrication, longer life, greater dependability, and the absence of "hot spots."

A trial of these *better* molded tubulars will convince you. See your Jobber for the Redskin and the other capacitors in the Sangamo Tribe.

NEVER FLINCHES IN THE PINCHES!



WATER TEST

Far surpasses any existing specification requirement.



HEAT TEST

Excellent operation under high temperature conditions.



PULL TEST

Leads resist breaking or pulling out. Takes rough handling.



LIFE TEST

Long life even under most severe operating conditions.



SANGAMO ELECTRIC COMPANY SPRINGFIELD, ILLINOIS

In Canada: Sangamo Electric Company Limited, Leaside, Ont.



8C50-8B



A Compact, Versatile, Portable
Circuit-Testing Laboratory for
TV — FM — AM
The New
PRECISION
SERIES EV-20
VTVM and Multi-Range Test Set

Net Selling Price... **\$68²⁵**

A Modern, Portable VTVM—Megohmmeter.
TRUE ZERO-CENTER on ALL VTVM ranges
PLUS Direct Reading High Frequency Scales
ALSO, complete, standard 1000 ohms per volt functions
48 RANGES TO
1200 Volts*, 2000 Megohms, 12 Amperes, +63DB

* D.C.—VTVM ranges to 12,000 and 30,000 Volts when
used with Series TV Super-High Voltage Test Probe.

Range Specifications

- ★ SIX ALL-ZERO CENTER VTVM RANGES: —13½ Megs. Constant Input Resistance. ±3, ±12, ±30, ±120, ±300, ±1200 volts. Direct Reading to ±12 KV and ±30 KV with Series TV Super-High Voltage Test Probe
- ★ SIX SELF-CONTAINED OHMMETER-MEGOHM-METER RANGES: 0-2000 - 200,000 ohms. 0-2-20-200-2000 Megohms.
- ★ FOUR DIRECT READING HIGH FREQUENCY VTVM RANGES: 0-3-12-30-120 volts. (When used with RF-10A High Frequency Vacuum Tube Probe, Net Price \$14.40. No crystal rectifiers employed.)
- ★ SIX AC-DC AND OUTPUT VOLTAGE RANGES at 1000 ohms/volt. 0-3-12-30-120-300-1200 volts.
- ★ EIGHT D.C. CURRENT RANGES: 0-300 microamps. 0-1.2-3-12-30-120-1200 milliamperes. 0-12 Amperes.
- ★ SIX DECIBEL RANGES from —20 to +63DB. Calibrated for 600 ohm, 1 mw., zero DB reference level.

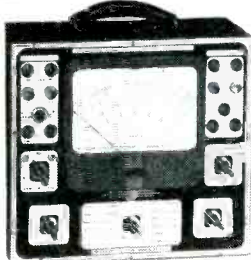

Also ask to see the "Precision" Series EV-10, DeLux VTVM—Megohmmeter with extra-large 7" meter. 59 self-contained ranges to 6000 volts and 70 DB.

Series EV-10, affords to the discriminating instrument purchaser, and equipment-conscious service-laboratory, the ultimate in visibility and performance.

EV-10-P
(Closed portable)—\$97.25
EV-10-MCP (Illustrated)
(Open Lab. Type)—\$94.50.

See complete EV-10 specifications on page 4 of latest Precision catalog, available at leading radio equipment distributors or write directly to factory for full details.

IMPORTANT FEATURES

- ★ VOLTAGE REGULATED—BRIDGE CIRCUIT.
- ★ DIRECT READING. ALL ZERO-CENTER VTVM —indicates BOTH Polarity and Magnitude without switching or test lead reversal.
- ★ MASTER RANGE AND FUNCTION SELECTORS eliminate frequent and inefficient shifting of test leads.
- ★ SHIELDED CONNECTORS for both D.C.—VTVM and RF—VTVM. Permits simultaneous and non-interfering connection of both Circuit Isolating Test Probe and optional H.F. Vacuum Tube Probe Series RF—10A.
- ★ HIGH FREQ. VOLTAGE SCALES—Direct Reading.
- ★ DUAL-BALANCED ELECTRONIC BRIDGE OHMMETER—MEGOHMMETER uses two 1.5 volt flashlight cells easily replaced at rear of cabinet.
- ★ 1000 OHMS/VOLT MULTI-RANGE FUNCTIONS permit simple AC-DC voltage, DB and current measurements free of power line requirement.
- ★ 4½" RECTANGULAR METER—200 microamperes, ± 2%. Double-Sapphired, D'Arsonval construction.
- ★ 1% Film type. Metallized and Wire-Wound resistors for all shunts and multipliers.
- ★ Heavy gauge, round-cornered, louvred steel case with plastic handle. Etched, anodized, aluminum panel.

NET SELLING PRICE \$68²⁵

Complete with coaxial Circuit Isolating Test Probe, Shielded Ohmmeter Test Cable, Standard #227 Super-Flex Test Leads, Ohmmeter battery and full operating instructions.

Case dimensions—10½" x 6¼" x 5"

Shipping Weight: 11 pounds.

CODE:—Party



PRECISION APPARATUS CO., INC.

92-27 Horace Harding Boulevard, Elmhurst 6, New York
Export Division: 458 Broadway, New York, U.S.A. • Cables—Morhanex

SAVE CRITICAL MATERIALS!

Sheldon

ELECTROSTATIC

FOCUS*

"Telegenic" Picture Tubes

ARE

NOW AVAILABLE

FOR PROMPT DELIVERY

SHELDON ELECTRIC CO.

A Division of ALLIED ELECTRIC PRODUCTS INC.

68-98 Coit Street, Irvington 11, N. J.

Branch Offices & Warehouses: CHICAGO 7, ILL., 426 S. Clinton St. • LOS ANGELES 26, CAL., 1755 Glendale Blvd.

* GET COMPLETE DATA! MAIL COUPON TODAY

Sheldon
NATURAL IMAGE

SOFT GLOW
Picture Tube

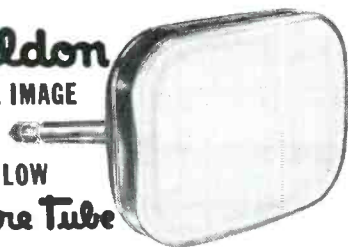

Sheldon Electric Company, 68-98 Coit Street, Irvington 11, New Jersey A

- Send me Complete data on Sheldon Electrostatic Picture Tubes
 Television Mis-Information No. 4 with its feature story on Color.
 Tube Characteristics & Dimensions Chart
 Bulletin T-2 on "Ion Burns—and How to Prevent Them".
(They're FREE—but please print your name)

Name Title
 Company
 Street
 City Zone State

© 1951—ALLIED ELECTRIC PRODUCTS INC.
 SHELDON TELEVISION PICTURE TUBES • CATHODE RAY TUBES • FLUORESCENT LAMP STARTERS AND LAMP HOLDERS • SHELDON REFLECTOR & INFRA-RED LAMPS
 PHOTOFLOOD & PHOTOSPOT LAMPS • SPRING-ACTION PLUGS • TAPMASTER EXTENSION CORD SETS & CUBE TAPS • RECTIFIER BULBS

* SEE IT AT BOOTH 201, PARTS DISTRIBUTOR SHOW, STEVENS HOTEL, CHICAGO, MAY 21-23

Licking co-channel ~~INTERFERENCE!~~

30 db

FRONT-TO-BACK RATIO

The New

TITANIC

Special **TWIN-DRIVEN YAGI**

THIS IS IT—the answer to co-channel interference.

Better than twice the front-to-back ratio of previous antenna designs.

Gain comparable to regular Twin-Driven Yagi.

Pinpoint directivity eliminates

other forms of interference picked up at antenna.

Comes tuned for any low-band channel, either stacked or single.

TECHNICAL APPLIANCE CORPORATION

SEND FOR
ENGINEERING
BULLETIN
NO. 65

SHERBURNE, N. Y. IN CANADA: STROMBERG-CARLSON CO., LTD., TORONTO 4, ONT.

A RAULAND EXCLUSIVE!

New
"Tilted-Offset" Gun
WITH
**INDICATOR
ION TRAP**



For Faster Service—Bigger Profits

More and more dealers and service men are swinging to Rauland picture tubes because of Rauland's exclusive development—the Tilted Offset Gun with mistake-proof Indicator Ion Trap.

This new feature—the most recent of many Rauland firsts in picture tube design—saves time and trouble in Ion Trap Magnet adjustment, eliminates mirrors and guesswork. A vivid green glow on the anode tube signals when adjustment is incorrect. The service man simply moves the magnet until the glow is reduced to minimum. Adjustment becomes a matter of complete precision, yet one accomplished in a matter of seconds without equipment of any kind.

In addition, the Tilted Offset Gun offers the advantage of maximum sharpness of focus and requires only a single Ion Trap Magnet.

Only Rauland offers these important advancements. For further information, write to . . .

RAULAND

The first to introduce commercially these popular features:

Tilted Offset Gun

Indicator Ion Trap

Luxide (Black) Screen

Reflection-Proof Screen

Aluminized Tube

THE RAULAND CORPORATION



Perfection Through Research

4245 N. KNOX AVENUE • CHICAGO 41, ILLINOIS





Here are some of the many reasons why there are more Simpson 260 high sensitivity volt-ohm-milliammeters in use today than all others combined. The Simpson 260 has earned world-wide acceptance because it was the first tester of its kind with all these "Firsts":

Simpson 260 SET TESTER

WORLD FAMOUS FOR ALL THESE "FIRSTS"

- First high sensitivity instrument to use a metal armature frame.
- First to use fully enclosed dust proof rotary switch with all contacts molded in place accurately and firmly.
- First to do away with harness wiring.
- First to provide separate molded recesses for resistors, batteries, etc.
- First to cover all resistors to prevent shorts and accidental damage and to protect against dust and dirt.
- First with a sturdy movement adapted to the rugged requirements of a wide range of service work or laboratory testing.
- First to provide easy means of replacing batteries.
- First to use all bakelite case and panels in volt-ohm-milliammeters.
- First volt-ohm-milliammeter at 20,000 ohms per volt with large 4 1/2" meter supplied in compact case (size 5 1/4" x 7" x 3 1/8").
- First and only one available with Simpson patented Roll Top Case.
- First to provide convenient compartment for test leads (Roll Top case).
- First to offer choice of colors.

RANGES

20,000 Ohms per Volt DC, 1,000 Ohms per Volt AC
VOLTS: AC & DC—2.5, 10, 50, 250, 1,000, 5,000
OUTPUT: 2.5, 10, 50, 250, 1000
MILLIAMPERES, DC: 10, 100, 500
MICROAMPERES, DC: 100
AMPERES, DC: 10
DECIBELS: (5 ranges)—12 to +55 DB
OHMS: 0-2,000 (12 ohms center), 0-200,000 (1200 ohms center), 0-20 megohms (120,000 ohms center).

Prices: \$38.95 dealers net; Roll Top \$45.95 dealers net.



The Model 260 also is available in the famous patented Roll Top safety case with built-in lead compartment. This sturdy, molded, bakelite case with Roll Top provides maximum protection for your 260 when used for servicing in the field or shop.

25,000 volt DC Probe for television servicing, complete, for use with 260, \$12.85

SIMPSON ELECTRIC COMPANY: • 5200 W. Kinzie St., Chicago 44, Ill. • In Canada: *Bach-Simpson, Ltd., London, Ontario*





Fountain of youth*

A Zetka picture tube stays young . . . stays brilliant always . . . is sharply focused . . . safe . . . long lived. There's no old, dull, tired look on the face of a Zetka tube. It will always reflect the brightness of your reputation, because only Zetka utilizes the power-tube method of producing pace-setter picture tubes.

In addition, each and every Zetka tube (no spot checking permitted) is set-tested in the factory before being shipped. Here indeed is proof positive that Zetka is by far your best buy in picture tubes. Rectangulars and rounds in 16", 17", 19" and 20"

THE SAFEST PICTURE TUBE

IN THE WORLD . . .



zetka*

THE ARISTOCRAT OF TELEVISION TUBES

* *Most Trusted Name in Picture Tubes*

zetka

TELEVISION TUBES, INC. 131-137 GETTY AVE. • CLIFTON, N. J.
 For 37 years, Zetka has been a respected name in the radio and television industry.

*"I want to see
Americans save . . ."*



JOHN L. COLLYER

President, The B. F. Goodrich Company

"I want to see Americans save for their own personal security, and I want to see them, as stockholders in our government, urge economy in all phases of our national life in order to provide national security against aggression."

By their rapidly mounting participation in the Payroll Savings Plan, Americans *are* saving for their personal security, fighting the menace of inflation and making a major contribution to America's defense against aggression. In Mr. Collyer's own company 80% of the 38,000 employees throughout the company have already enrolled in the Plan, with two large divisions still to report.

As Chairman of the Ohio Payroll Savings Advisory Committee, Mr. Collyer knows what is being accomplished by leaders of industry, top management and labor in their joint effort to step up the Payroll Savings Plan. A few recent figures should be interesting to those not so familiar with the national picture:

- In the steel industry campaign, Carnegie-Illinois Steel Corporation (now U. S. Steel Company), recently raised its payroll participation from 18% of 100,000 employees to 77% . . . Columbia Steel Company of California went from 7.9% to 85.2% . . . American Bridge Company signed 92.8% of the workers in the large Ambridge plant . . . 87%

of Allegheny-Ludlum Steel Corporation's 14,000 employees are now on the Payroll Savings Plan . . . Crucible Steel Company of America, reinstating its plan, signed up 65% of its 14,500 employees.

- In the aviation industry, Hughes Aircraft Company went from 36% to 76%; Boeing Aircraft enrolled 10,000 new names before Christmas.

Some dollars and cents figures? In the last quarter of 1950, sales of \$25 E Bonds—the denomination so popular with payroll savers—increased 2.5% by 245,000 bonds more—over the last quarter of 1949.

If you do not have The Plan That Protects the personal security of your employees, the national economy and our country's defense, phone, write or wire to U. S. Treasury Department, Savings Bonds Division, Washington Building, Washington, D. C. Your State Director is ready to help you install a Payroll Savings Plan or step-up your employee participation.

The U. S. Government does not pay for this advertising. The Treasury Department thanks, for their patriotic donation, the Advertising Council and

S E R V I C E



NEW ELECTROSTATIC RECTANGULAR 20FP4

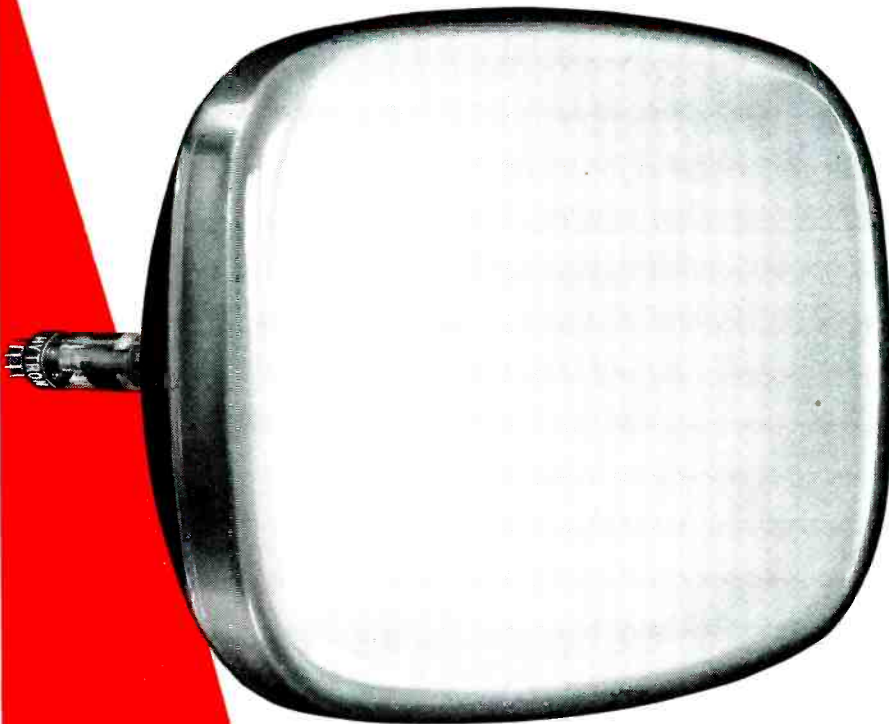

ANOTHER
HYTRON FIRST
FOR YOU

To its logically designed original *studio-matched* rectangular, Hytron now adds new advantages: the cobalt-and-copper savings of electrostatic focus.

The original Hytron electrostatic type 20FP4 eliminates the magnetic focus unit. Uses a single-field ion-trap magnet. Yet the 20FP4 gives you unsurpassed, clear, sharp pictures . . . despite economies in associated components enforced by defense needs.

Seeing is believing. Watch for this newest Hytron first from the world's most modern picture-tube plant. You'll be seeing it, buying it soon. You'll marvel at its sharp pictures, even at lower line voltages.

Again you'll say it pays to stay out front in picture tubes. It pays to insist on Hytron's original *studio-matched* rectangulars . . . choice of 9 out of 10 leading TV set makers.



MAIN OFFICE: SALEM, MASSACHUSETTS

HAVE YOU
GOT YOUR COPY?

The new 5th edition of the Hytron Reference Guide for Miniature Electron Tubes is out. See your Hytron jobber. Get your free copy of this old friend brought up to date today.





*The finest solder made
for all television and radio work
... Everything Electrical*

Kester Solder

Uniform

Efficient

Kester Plastic Rosin-Core and Kester "Resin-Five" Core Solders are recognized by the trade as outstanding for the finest type of radio, television and electrical work.

Kester Solders are made only from newly mined grade A tin and virgin lead. Fluxes chemically correct.

Only highly skilled craftsmen are employed by the Kester Solder Company. Flux formulas and specifications are rigidly adhered to for perfect uniformity.

Making Kester Solder is an exact science from the raw material to the finished product. Everyone knows and prefers Kester because it can be relied upon to do the job right every time, even under the most difficult soldering conditions.

KESTER MAKES GOOD SOLDERING EASY

The wise serviceman insists upon Kester Solder from his jobber. By using Kester, the solder used in making the original equipment, he will do his best work.

Kester...Standard for the TV and Radio Fields

KESTER SOLDER COMPANY

4248 Wrightwood Avenue, Chicago 39, Illinois
Newark, N. J. • Brantford, Canada



EASIER TO USE

FASTER

DEPENDABLE

SAVES TIME

MADE FROM VIRGIN METALS

ELIMINATES REJECTS



RADIO • TELEVISION • ELECTRONIC
SERVICE

Conservation and the Service Man

THE PAST FEW MONTHS have witnessed an increasing trend to *conservation*, prompted by defense requirements, particularly in the production of picture tubes, speakers and allied products. This concerted effort on the part of industry has been a valuable assist in the emergency program, in not only providing urgently needed materials for the military, but permitting the building up of stockpiles which can be used in extending civilian production of chassis, parts, accessories, etc.

A striking contribution to this campaign to save can be achieved by the Service Man, too, in his installation activities. According to one of the nation's largest service organizations, it has been possible to effect substantial savings in aluminum through, for instance, the replacement of the normal eight-foot masts by six-footers, wherever possible. In some cases, the standard twelve-foot masts are being changed over to ten-foot steel tubing units with walls of $1\frac{3}{8}$ inches. This has been found to provide a saving of over four pounds of aluminum per job.

Copper economies have also been effected through the application of several revised installation techniques. The footage of cable used per job has been reduced by placing the antenna as near as possible to the receiver, through measurement of the required length of line accurately and by splicing together and soldering short left-over lengths. The records show that these steps have resulted in reducing the transmission line usage from 123-feet per installation to 83-feet per job.

In order to conserve zinc normally used for plating steel masts and brackets, a plastic-coating material is now being used for rust-proofing steel masts and steel brackets. The total amount of zinc saved through this procedure has been approximately 320 pounds per-thousand antenna installations.

It has also been found possible to effect savings in steel, through the use of lighter-weight mounting brackets. In one instance, a bracket weigh-

ing over seven pounds has been replaced by two alternate types, one weighing around five and three-quarter pounds and another slightly less than five pounds.

Still another service group has found that further copper savings can be effected through the use of seven-strand 300-ohm line using No. 30 wire instead of No. 28, the normal gauge. The changeover was said to afford a saving of thirty-three per cent in copper, quite a substantial contribution to the stockpile.

Others have reported many other material economy practices which can be applied while on the job and in the shop. While it may be assumed that efficiency would be sacrificed in applying these alternates in materials and methods, this has not been the case. In fact, in all instances, the stress has been on the maintenance of efficiency, with warnings issued to the boys that they must save, but still see to it that the installation is sound and capable of providing the maximum in performance, mechanically and electrically.

Service Men can play a major role in the conservation drive. We're sure that they will contribute more than their share to this all-important effort!

Accessory Installations

IN FRINGE-AREA TV, there has always existed an unusual market for a variety of accessories, such as boosters, rotators, high-gain antennas, matching stubs, etc. Recently, however, it was found that local areas can also be a fertile field for the booster, rotator and window or indoor antenna.

This interesting possibility was uncovered during a series of tests in New York City, where because of building restrictions, plus a local rent law involving payment of a monthly increase in rent if an outdoor antenna

is installed, there has been a decided trend toward the indoor and window antennas. The improved receiving conditions, anticipated from the Empire State antenna system soon to begin operation, has also accented the window-indoor interest, it being felt that perhaps either of the systems might provide signals which would be quite satisfactory for the present.

In evaluating the types of setups that might be adopted for this interior type service, it was found that in most instances, the use of a booster and a rotator were invaluable aids in increasing gain. The rotator was found to be a particularly handy item, for it permitted complete flexibility of operation, with complete absence of those annoying body effects often present when it became necessary to turn the antenna to achieve best pickup. In addition, the remote rotator was found to permit placement of the antenna in that portion of the room or window that is best for pickup, normally a location not too attractive to the lady of the house as a site for the receiver.

With a simple rotator control mounted atop the console, the antenna at some remote point and a booster located beneath the set housing, it was found possible to secure substantial improvement in gain, on most channels, in many areas where previous tests with indoor or window antennas were not too successful.

While this type of installation is not recommended as a replacement for the outdoor rooftop system, it appears to be an ideal expedient for those areas beset by building restrictions and other installation complications. One Service Shop found the plan so effective that they surveyed areas in which the setup would be necessary and then proceeded to provide a packaged service with a booster, rotator and antenna, accompanied by a guarantee on pickup. The results, they state, have been grand, with substantial profits from the sale of the accessories and continuing recommendations from satisfied customers for additional sales.—L. W.



THE CATHODE —

THE WORLD'S GREATEST PAINTER —

SHARES

RAYTHEON'S 101



RAYTHEON TELEVISION PICTURE TUBES



ACTUAL SIZE

are given 101 basic tests and checks to insure their quality. The cathode pictured produces the electron ray that paints the picture on the tube's screen and will perform perfectly, because it has passed its share of Raytheon's 101 Tests.

This strict control of quality means Raytheon Picture Tubes, like all Raytheon Products, are precisely right both electrically and mechanically. As pioneers in the development and manufacture of almost every type of electronic tube, Raytheon has the know-how and skill that makes Raytheon Picture Tubes *Right for Sight!*

Add precision workmanship to advanced design and you'll readily realize why you're always right if you use Raytheon Picture Tubes for every replacement and conversion job.

Ask your Raytheon Tube Distributor about these Quality Raytheon Picture Tubes.

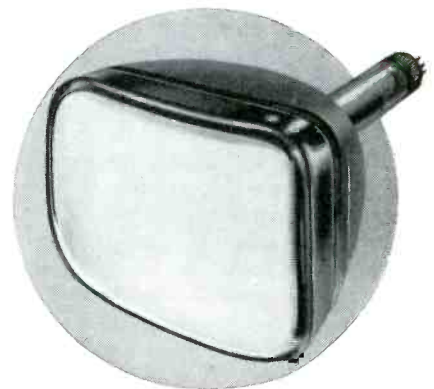

Right for Sight!



Excellence in Electronics

RAYTHEON MANUFACTURING COMPANY

Receiving Tube Division

Newton, Mass., Chicago, Ill., Atlanta, Ga., Los Angeles, Calif.

RADIO AND TELEVISION RECEIVING TUBES, CATHODE RAY TUBES, SPECIAL PURPOSE TUBES, SUBMINIATURE TUBES, MICROWAVE TUBES

COPYRIGHT 1951

SERVICE... The National Scene

UHF/VHF PROPOSALS BRIGHTEN TV LANE--With the prospect that up to 2,000 more stations may soon appear on the scene, by way of the new ultrahigh and modified veryhigh bands, should the recently announced FCC plan be adopted, there appears to be quite a program in sight for Service Men, who'll have to be geared for the liveliest days of their career. For the new high bands will require either modifications of chassis or the use of converters as well as the installation of new antennas, in many instances. There is a boiling debate on in the East and Midwest as to which tuning means will provide the best pickup, but regardless of which method is finally adopted, it will be up to the Service Man to see to it that installations are completed properly to assure maximum pickup. Those who favor converters state that only through such an external unit can reliable reception be provided. Others have indicated that the tuners can be modified; the turret type, for instance, requiring only the removal of a veryhigh coilboard on an idle channel, and the substitution of a suitable ultrahigh coilboard. In another plan involving the use of a continuous tuner, an adapter has been suggested with the band from 122-132 mc serving as the conversion band. The new channels are not here yet, and they may not be with us until '52, but they're coming, and those busy days for all Service Men are in the offing.

SIMPLIFIED UHF CONVERTER ANNOUNCED AT IRE MEETING--During the recent national convention of the IRE, B.F. Tyson of Sylvania Electric, disclosed for the first time the actual ingredients of an ultrahigh converter, pointing out that the essential elements were a crystal mixer and local oscillator. In operation the mixer is coupled to the antenna line through a high-pass filter having a cutoff frequency just below the lower edge of the 475-890 mc band. The mixer-output circuit features a double-tuned transformer with 300-ohm balanced outputs and a pass band of 174 to 216 mc. The local oscillator uses a conventional series-tuned circuit and has a frequency range of 301-679 mc. At the time of installation, the local oscillator is preset to a particular fixed frequency in the foregoing range, so that seven contiguous ultrahigh channels can be converted down to the 7-13 channel range of the receiver. The operation of the converter depends on the allocation of the ultrahigh channels, in blocks of seven, to each service area. In an early issue of SERVICE there'll appear a complete analysis of this system. Watch for it!

PARTS SUBSTITUTIONS NOW A STANDARD PLANT PRACTICE--Due to temporary shortages of materials it has become necessary to use substitutes of some capacitors and resistors during production. According to one manufacturer the substitutions are always within engineering limits and should not cause erratic or substandard operation. Resistor substitutes have usually involved use of parts with the same resistance value but with different wattage or tolerance, or a slightly different resistance value, or a combination of two or three resistors in parallel, series, or series-parallel to make up a close equivalent of the specified value. If replacements are required, the value, size and tolerance specified in the circuit should be used. In capacitor substitutions new RMA standard values have been used for old standard values, or vice versa; .012 for .01, .047 for .05, etc. In some instances, micas have been used in place of ceramic capacitors.

ANTENNA MAKERS ORGANIZE--To serve as a liaison for industry, with government agencies, and effect a flow of basic materials required for antenna manufacture, and in addition, establish standards for manufacturing, design and test, a group of TV antenna producers recently formed an association and elected Mike Roth of Radiart, president. Harold Harris of Channel Master was named vice president, and Ed Finkel of JFD, treasurer.

SERVICE... *The National Scene*

BOOSTERS BEING BUILT INTO TV CHASSIS--In an effort to increase the range of receivers, one manufacturer has announced the development of a chassis with a built-in booster, which it is claimed should double the range of pickup.

INDEPENDENT SERVICE MEN POOL ADVERTISING--In a unique move to impress their community with the specialized facilities that are available to provide guaranteed installation and service, seven TV service shops in Lawrence, Mass., recently set up a group advertising campaign, using a weekly schedule in a local paper. The series of ads, three columns by nine inches in size, published every Monday and entitled Television Topics, appear on the radio and TV program page. Copy emphasizes the fact that members of the service shops are true specialists in TV servicing. In one ad entitled "No, We're Not Conceited" . . . the Service Men declared that . . . "We just have understandable pride in the Service we offer, the products we use and the personnel we employ . . . When parts are necessary to repair your television set, rest assured that the units used will be the finest obtainable, and will be installed by the most competent electronic experts in this area."

CIVIL DEFENSE RECEIVERS READY FOR DUTY--Now available are two types of FM receivers for general civil defense work which can be used to alert key agencies and personnel, and remotely activate warning devices. Operating in the 30-50 and 152-174 mc bands, the receivers feature dual crystal-control design, double conversion, a tone operated switch and a gated beam discriminator. Models can be used either on ac or 6-volt dc through the use of a low power converter or storage battery. According to the manufacturer, many of these receivers are already on their way to civil defense units and Service Men are being recruited to install and main them.

ANTENNA BILLS APPROVED FOR NEW YORK AND WISCONSIN--In Manitowoc, Wisconsin, there is now an ordinance on the books which requires that TV antenna installations can only be made with a permit from the electrical inspector. Regulations require that the antenna must be supported with strong guy wires and that the electrical inspector check each installation and make any recommendations for changes in the setup. The rules also state that adequate grounding of the antenna must be provided and when the system is 35 feet or more above the roof base, a detailed sketch and location with respect to the sidewalk and existing electrical and communication lines must accompany the application for a permit. In New York there is now a bill, recently signed by Governor Dewey, which makes it unlawful to attach any antenna to a fire escape or to any soil and vent line extending above the roof of a building. According to Senator George H. Pierce, who introduced the bill, the attachment of an antenna to a fire escape has been a serious hazard, and in addition, connection to soil and vent lines have been found to loosen the waterproofing around them and cause bad leaks on the roof.

STREAMLINED SERVICING REPORTS PRODUCED--Forms which provide a detailed report of installation and service performance are now available. Of loose leaf design, the forms indicate checks made on the vertical, horizontal, sound and general parts of the chassis. Specific references are made to hold, drift, sweep, linearity, centering, hum, intermittents, distortion, noise, fading, channel-switch irregularities, picture jiggle, corona, etc. The form also discloses the type of alignment provided, checks made on tubes, parts, etc. For a systematized routine, which should certainly be a feature of every service shop, these forms should be ideal.

BOUQUETS--According to Phillip Haley . . . "I can not find enough words of praise . . . for what I really think of the magazine. It tops any I have ever read. . . I depend on it for guidance and help in many cases." And according to J. W. Russell . . . "We think Service is without equal." Grand news, gentlemen, grand news.--L. W.

Symbol of Superiority



Porcelain vase executed by the brilliant Danish designer, Gerhard Henning; recognized by many of the world's most esteemed pottery experts as a true symbol of some of the finest porcelainware produced in the twentieth century.

Henning vase courtesy Metropolitan Museum of Art

tel-o-tube . . .
symbol of picture
tube superiority

All Sizes Immediately Available for Conversion and Replacement

As a symbol of picture tube superiority, Tel-O-Tube too, has gained the recognition and esteem of many of the world's most renowned television experts. Outstandingly superior craftsmanship, unmatched performance, and record-breaking longevity are only three of the many reasons why these men—men who know picture tubes—have come to recommend Tel-O-Tube as the ideal tube for both original and replacement equipment. Today, Tel-O-Tube's complete line of cathode ray tubes is being offered for immediate availability—an excellent opportunity to find out for yourself how truly fine a picture tube can be!

The GREATEST Names In Television PROTECT Their Names With Tel-O-Tube

See Our Display at The Chicago Parts Show, Room 632, Stevens Hotel

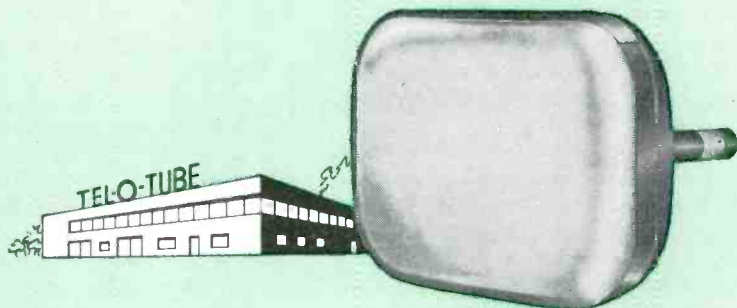

WRITE . . . WIRE . . . PHONE . . .
Please mention Dept. S



TEL-O-TUBE Corporation of America

EAST PATERSON, NEW JERSEY

Sales Office: TEL-O-TUBE Sales Corporation, 580 Fifth Ave., New York 19, N. Y.

TUBE SUBSTITUTION

by WYN MARTIN

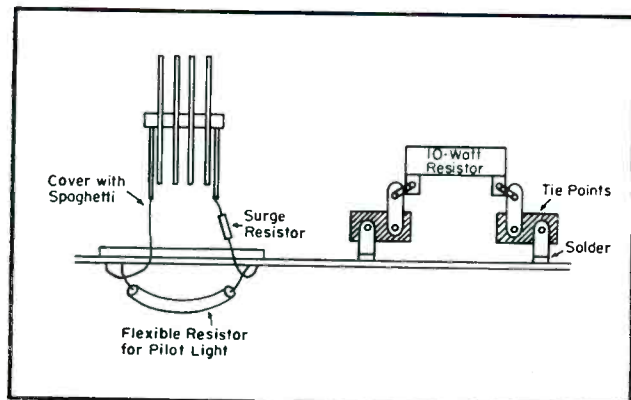

Fig. 1. Left: Installation of selenium rectifier in standard chassis using a 27 to 47-ohm surge resistor and a 27-ohm flexible resistor for pilot light, the entire assembly being placed on the tube's socket. Right: How a 200-ohm 10-watt resistor can be assembled on a tie-point mount, the resistor being used to take care of the voltage drop across the rectifier replaced in series-filament chassis.

Simplified Practical Substitution Procedures* Which Can Be Used to Install Selenium Rectifiers in Place of Tubes in 3-Way Portables, as Well as Standard AC/DC Chassis . . . Substitution Hints For PA, IF Amplifier, Oscillator and Mixer Circuits of Broadcast Household and Auto Models.

IN INSTALLATION AND SERVICE, there are few situations which can make a Service Man feel so helpless as those involving the lack of a tube. And with many of the popular types of tubes running out of supply quite frequently these days, not only because of some key material shortages, but particularly because of the heavy demand for the bulbs, the problem has been found to be quite acute. Fortunately, the difficulties have been carefully surveyed by many, resulting in the compilation of detailed simple solutions.^{1,2} As the result of one such study, revolving about tubes in the average broadcast receivers, a series of very practical modification procedures were evolved.

In a review of the problem of rectifiers, the selenium discs were found to be a perfect substitution media. Of course, there is nothing really startling in the news that these dry discs are so handy, since some of us have been replacing tubes with selenium rectifiers for some time, especially in the 3-way portables. In these models the discs have been found to afford superior service, providing rapid starting and long life.

Installation Practices

Generally, the probe disclosed, the dry rectifier can be mounted above the chassis, on the tube-rectifier socket. This can be done by attaching two pieces of solid wire, about 2" long, to the rectifier terminals. One of these may be for the 27-47-ohm surge re-

sistor, essential in selenium-rectifier systems. Spaghetti must be slipped over these wires; the spaghetti must be large enough so that it can go on up the rectifier lugs, to eliminate the possibility of shorts. The ends of the wires must then be threaded through the socket holes connected to the rectifier plate and cathode before, pins 8 and 5 for a 35Z5, for instance. The positive side of the rectifier, side with lettering and usually marked +, goes to the cathode pin, of course. If the tubes are of the 117-volt type, such as the 117Z3, 117Z6, etc., no further connections are necessary. However, if a 35Z5 type is used the filament-dropping resistor should be removed. This is particularly true in 3-way portables. In series-filament sets, resistors must be added in the circuit to take care of the voltage drop across the rectifier filament. It has been found that a 27-ohm flexible 2-watt resistor is excellent for the pilot-light section, and a 200-ohm 10-watt resistor,³ for the remainder of the circuit. The flexible resistor may be mounted beneath the chassis, connecting from pins 2 and 3 of the socket, and the heavier resistor above the chassis, for better heat dissipation. Two single tie-points must be installed in a clear space on the chassis, the resistor being fastened

solidly to these points. Wiring can be run back through the center hole of the socket. A good grade of braid-covered wire should be used. It is not advisable to use the plastic-covered wire, since the heat can soften the plastic and cause a short. One handy location for this resistor is the end-frame of the output transformer, if it's mounted on the speaker. The tie-points should be soldered down to the frame.

Voltage-Doubler Requirements

For the voltage-doubler types of chassis using 50X6 and 25Z6 tubes, two rectifiers will be necessary. These may be mounted on a common bolt, with a fiber washer between them. A long bolt can be run through the center hole of the socket, with a fiber washer below chassis and the rectifiers above. The wiring may be run through the socket holes. It is important to watch the polarity of the rectifiers.

Selenium rectifiers require the use of a small series surge resistor, to minimize the effects of the initial surge of voltage; this is usually greater than in the tube rectifier setups, since the rest of the tubes do not heat up enough to draw current. The resistor must not be too small; 47 ohms ($\frac{1}{4}$ watt) seems to be about the right size. These small resistors will blow up like a fuse, if the input capacitor should short out, thus saving the rectifiers from damage. Conversely, this same action will save the filters, if the recti-

*From notes prepared by Jack Darr.

¹Middleton, H. A., *Receiving Tube Substitution Guide Book*; John F. Rider, Publisher, Inc.

²Sylvania Tube Substitution Manual.

³Brown-Devil type.

Techniques

(Below)

Fig. 3. Voltage-doubler dry-disc rectifiers mounted above a tube socket.

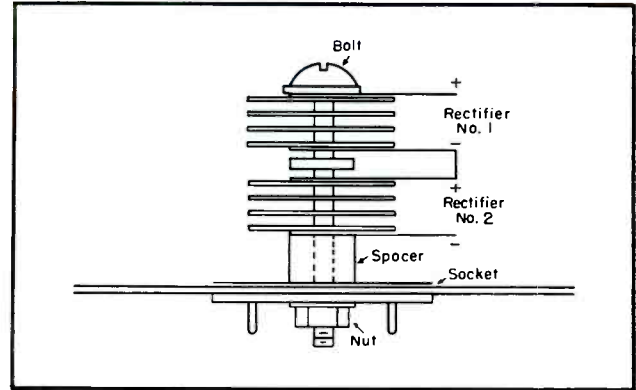
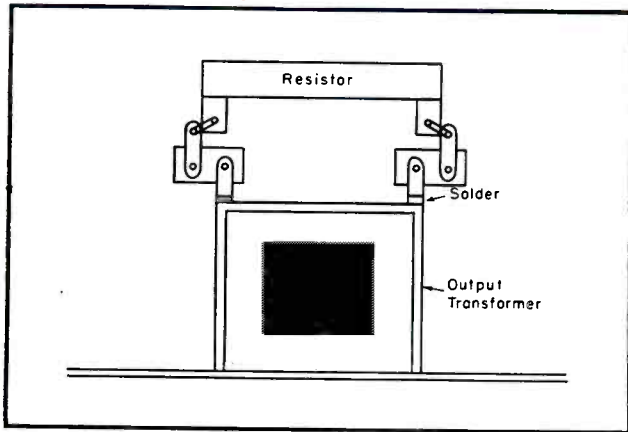

Fig. 2 (left). Alternate method which can be used to mount a 200-ohm 10 watt resistor in a selenium substitution job.

fier shorts out, thus applying *ac* to the capacitors.

The 3-way portables usually have only one tube on the *ac* line, the rectifier. It is wise to use a bit larger surge resistor here, as the voltage may be too high, as compared to the tube rectifier. It must be remembered that selenium rectifiers have only a 7-volt drop, across the rectifier.

If filters need replacement at the same time, the types⁴ especially designed for the higher surge currents of selenium rectifiers should be used.

Even tubes such as 5Y3, 5Z3, or 80s may be replaced with selenium rectifiers, if the maximum current drawn is taken carefully into consideration. These rectifiers are available in ratings up to 150 ma, and may be paralleled, if necessary, for still higher ranges. The high-current types must be mounted above the chassis for ventilation, so that stack temperature does not exceed the ratings.

Power Amplifiers

Tube substitution troubles in power amplifiers will be found mostly in the smaller *ac/dc* type sets; the output tubes used in *ac* sets, auto-radios, and *pa* systems have several replacement possibilities. The 6L6s, 6V6s, 6K6s, 6F6s, etc., are all near enough alike that a replacement tube may usually be found without too much trouble.

The series-filament sets, however, present a problem of matching of the heater-currents, and of providing the proper shunts, series resistors, etc. In some instances, the 50L6 can be used in place of the 35L6 with no change at all; 50B5 for 35B5; 35B5 for 50B5. In the latter instance it may be necessary to add small resistor, 100 ohms, to

take care of the extra 15 volts required in filament circuit. To replace a 50L6 with a 50B5 or 35B5, 2" solid wires should be soldered to each prong of the miniature socket, and the leads threaded through proper holes in the 50L6 socket; plate to pin 2, screen to 3, cathode to 8, etc. The mini-socket must be pulled down as close as possible to the original socket, and the wires tack-soldered to their connecting lugs on the socket, clipping off excess wires. This will provide a mounting rigid enough for home use, and also enable the substitute socket to be removed with very little trouble, when the original tubes become available.

Socket connections on these or any others may be traced out by referring to tube manuals. This plan may be used to replace any loctal or octal tube with an equivalent miniature type. It might even be used to replace a miniature with an octal, if necessary, and if space permits.

Intermediate-Frequency Amplifiers

The choice of a substitute amplifier tube for a high-gain stage often leads to plenty of headaches. It is important to avoid, if you can, substituting higher-gain tubes. If you must, and oscillation results, you can try adding some extra filtering, such as a 1,000-ohm resistor, bypassed with a .05-mfd capacitor, in the *B+*, and lowering the screen voltage, until stability is obtained. Additional shielding may be necessary, due to added height of the new tube and adaptor, exposed leads, etc. If oscillation is encountered while realigning, it will be necessary to try aligning with a 'scope, and an FM sig-

nal. Any trace of oscillation may be uncovered, and remedied, by this method. Sometimes the curve may be shaped up until smooth, and oscillation eliminated entirely, by merely aligning. Sometimes a small loop of wire, connected to ground, placed over the base pins of the socket may help out.

The same procedures can apply to *rf* amplifier stages, although control will not be quite so critical.

Oscillator-Mixers

The oscillator-mixer stages represent the most difficult to effect substitution. Fortunately, each type of oscillator tube has a near equivalent, with a different base; 6A7, 7A8, 6A8, etc., and 6SA7 for 12SA7, with shunt resistors for the filament circuit. The miniatures may be substituted for octals or loctals, by following the foregoing approach, with the miniature socket.

The miniatures, 12BE6, etc., are usually the most difficult to replace, because of the limited room. In one instance, a 12AW6 pentode has been used in the same socket. This will work well in some sets, and not at all in others. Any 12-volt pentode with the heaters, plate, screen and cathode on the proper pins, and the suppressor grid on 7, will have a good chance of operating. Sensitivity seems to be pretty good on several chassis tested.

It has been found that pentodes will work in the regular socket, and small triodes (6C4, etc.) will operate in an *outboard* socket, as the oscillator, coupling to the pentode through the suppressor grid or link-coupling to the coil. These substitutions may not work

(Continued on page 45)

⁴Sprague ELS series.

Arm-Chair TV REMOTE TUNER

by JAY H. PRAGER

Complete Electrical and Mechanical Details on System, Featuring Cathode-Follower Stage in Output of TV Tuner, Which Can be Applied to Practically All Types of Chassis.

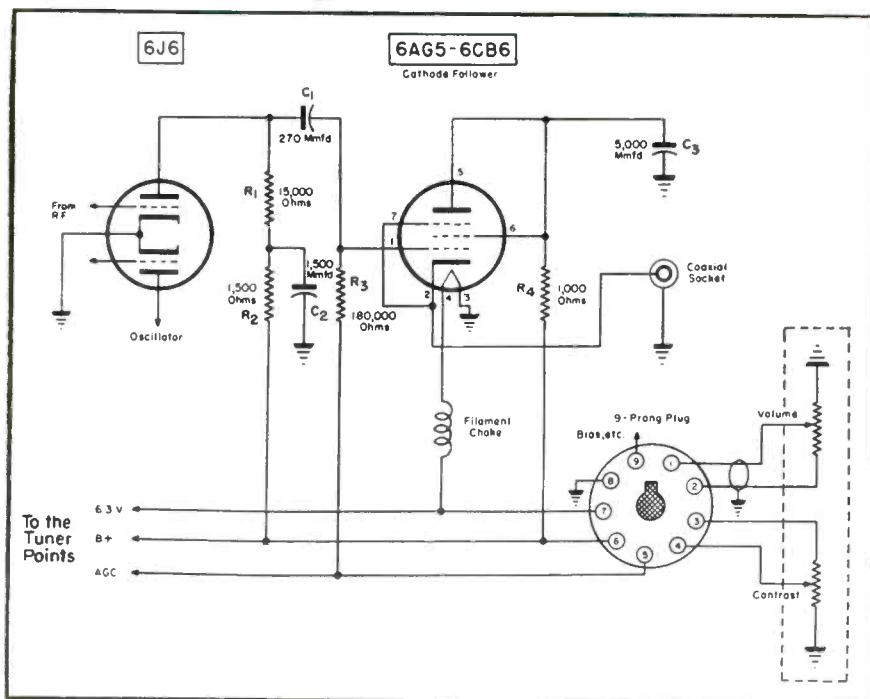

[See Front Cover]

(Left)

Fig. 1. Remote-control conversion circuit. The 6J6 represents the converter tube which is normally found in tuners.

REMOTE-CONTROL TUNING has proved in the past years to be a blessing, not only for the physically handicapped or bedridden, but the tired businessman and housewife during those pleasant moments of relaxation.

For the standard broadcast chassis, application of remote control has become a comparatively simple procedure. But in TV, where the remote system can be a particularly handy feature, there are many complexities to overcome. It is necessary to provide, for instance, complete control over such items as volume, contrast, fine tuning, station selection and hold. Operation must be suitable for comfortable viewing distances and still be capable of results equal to those now received by direct control.

In the system, it is important to employ circuitry which will eliminate the annoyance of frequent control changes and simultaneously guard against losses of signal or bandwidth, or the danger of any local interference. And, in addition, installation and operational simplification and reasonable com-

ponent and accessory costs must be considered, too.

Many types of television remote tuners have appeared recently. Several remotes have been developed for use as an integral part of the set. Others have used the beat-frequency approach and found to be objectionable because of the local interference produced. Custom-built models have been evolved, too, and in the main, found to be either too expensive or too difficult to install.

In an effort to solve the various problems, a detailed study of TV remote-circuit applications was made.

It was felt that the system should revolve about the tuner. Thus, a tuner was converted into a cathode-follower circuit. This required a long run of both coax and power supply cable. To match and maintain proper impedances and means of cable connections, a preamp was designed that would act not only electrically the same as the output of the tuner, but could also be interchanged mechanically. This was accomplished by taking the average set and determining the tuner

used. In all, the mechanical and electrical variations were close to the same operation.

The remote-control tuner unit, as finally developed, featured a modification of the tuner to a cathode-follower circuit, achieved by adding an additional stage to the output of the tuner's converter circuit. The converted signal of the tuner thus could be fed the cathode-follower, and the output fed to a coax line, such as RG/7U, matching both input and output without causing frequency distortion or loss of bandwidth. The converted signal appeared in the *if* frequency range of between 19 and 27 mc.

Using the preamp to match the coax line, which also provides proper matching to the *if* amplifier of the television set, was found to assure flexibility, permitting use with practically all types of receivers.

The preamp was found to act as an added *if* amplifier stage, its output being the same as the original circuit in the tuner that was removed from chassis, since it was coupled to the *if*

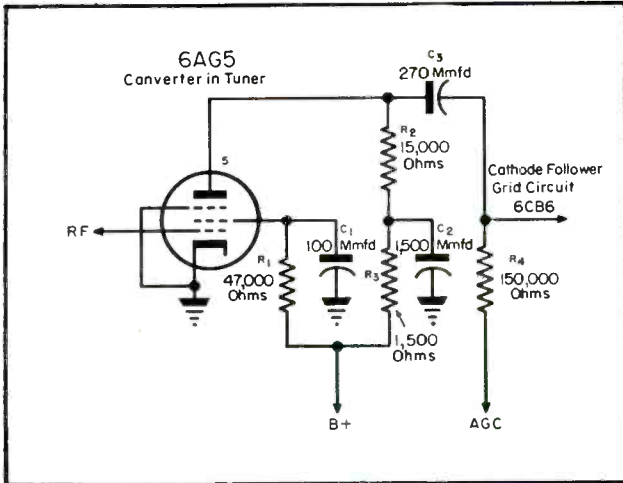

Fig. 2. Remote-system connections when the tuner uses a pentode for a mixer.

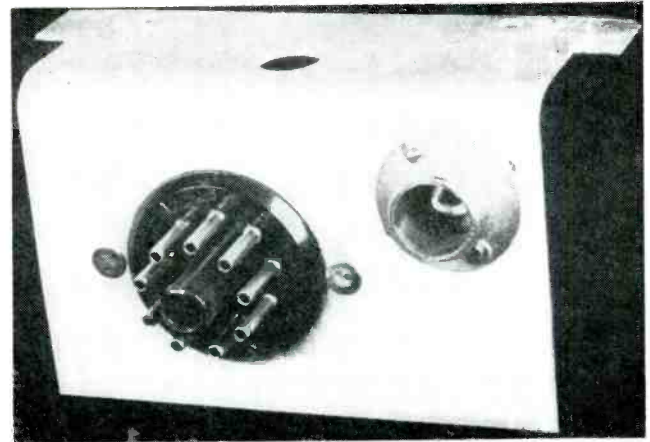

Fig. 3. Rear bracket for installation.

amplifier section in the same manner as before the removal of the tuner.

The mechanical layout of the pre-amp chassis was so designed that the unit could be installed in place of most of the tuners now used. In some sets new mounting holes may be required to facilitate installation.

Means for power to the remote tuner were provided for by the use of an 8-wire cable having at least two wires shielded, these being used for the volume control circuit. The other leads were connected up to carry B+, filament, agc (when used), etc. Connectors were incorporated on all parts to enable rapid service to either the set or the remote tuning unit. The connectors were also arranged to reduce shock hazards to a minimum.

The volume and contrast controls were mounted on the tuner itself, for which proper brackets were provided. A bracket was also used to house the rear connectors for the power cables and the coax cable between the remote unit and the preamp unit. Dual concentric type controls were used to assure simplicity in design. The entire unit was housed in a wood cabinet, the tuner fitted into a cutout provided to hold the entire tuner in position.

It was found possible to operate the unit up to approximately 100' from the receiver with slight loss.

Tuner Conversion

In making a conversion, the tuner, located in the television set, should be electrically and mechanically disconnected by removing the following leads:

- (a) Audio takeoff (when used).
- (b) Video takeoff (bare wire).
- (c) B+ (red).

(Continued on page 26)

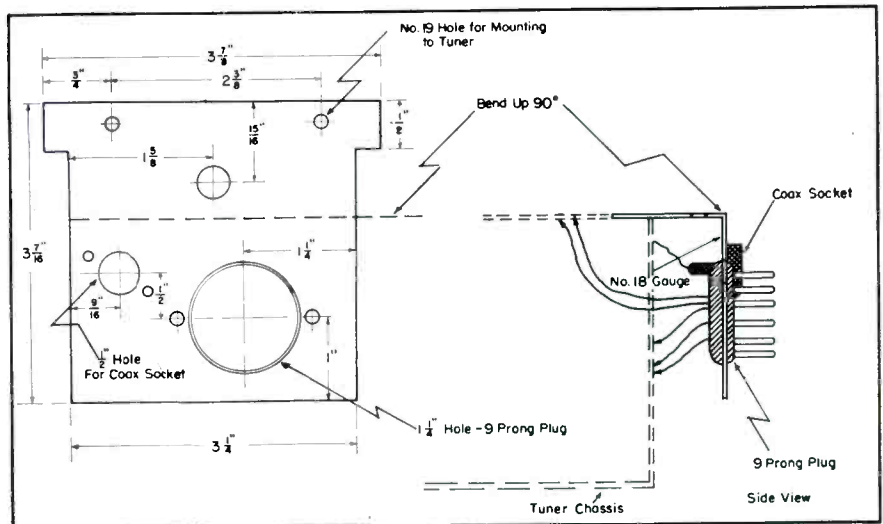

(Above)

(Below)

Fig. 4. Layout for the rear bracket.

Fig. 5. Rear bracket installed.

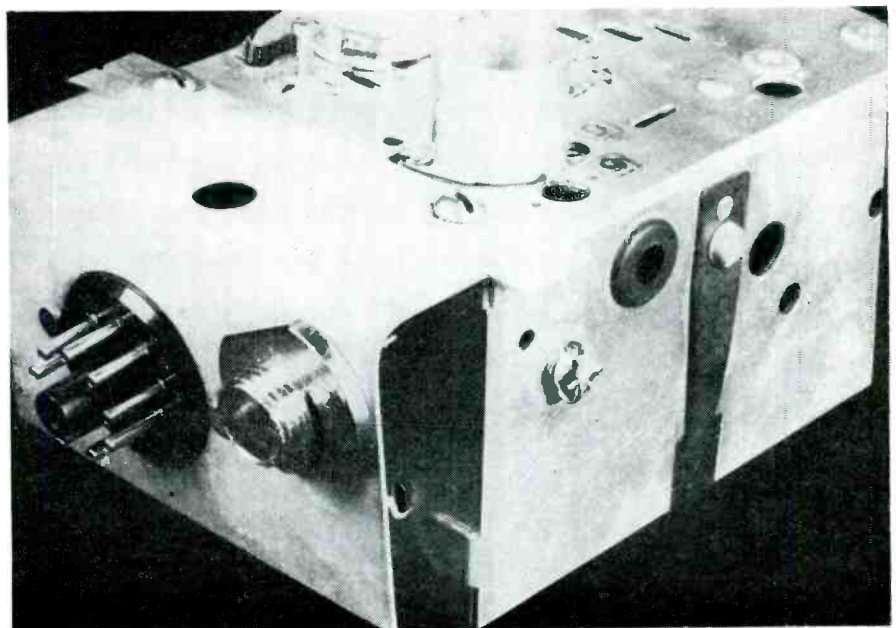

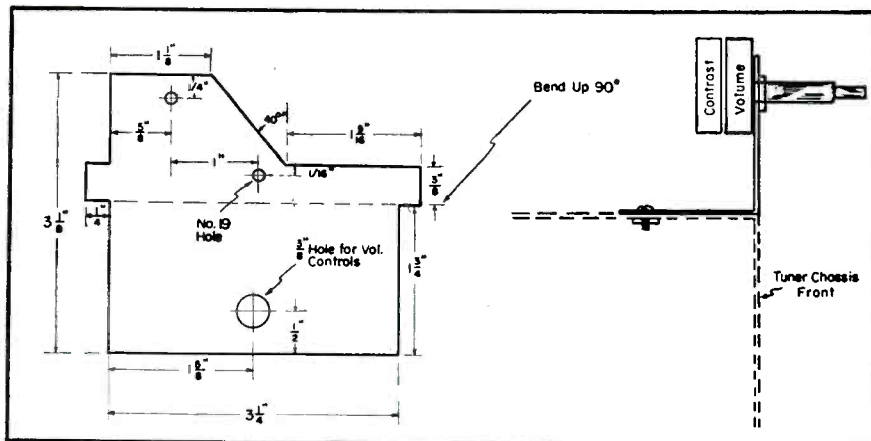

(Above)

Fig. 6. Front bracket layout drawing.

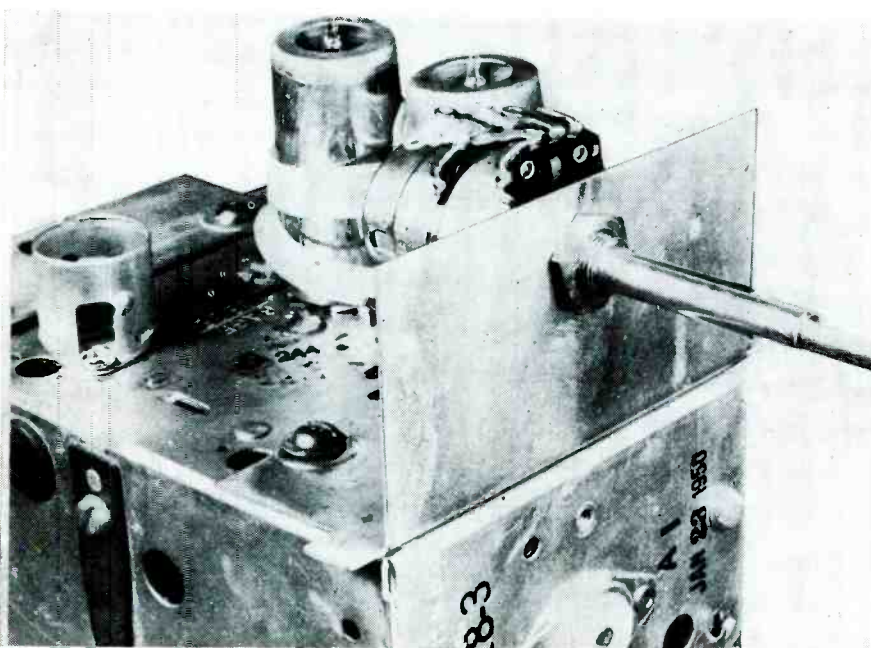

(Below)

Fig. 7. Front bracket installed.

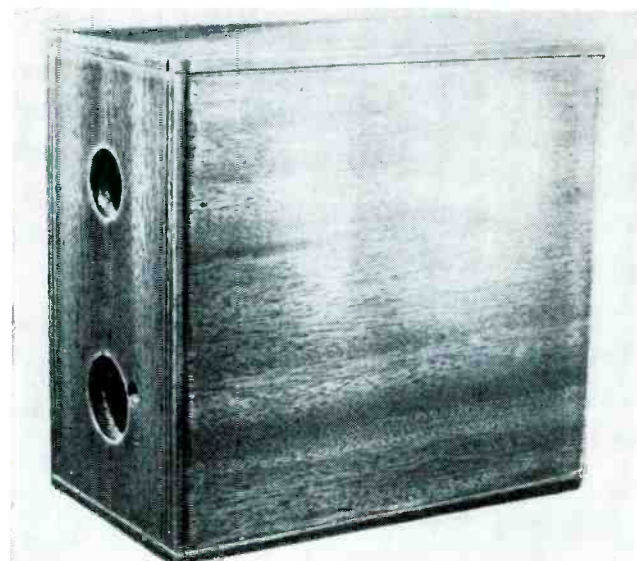

(Left)
Fig. 8. Completed wooden cabinet.

(Below)
Fig. 9. Wood cabinet specifications.

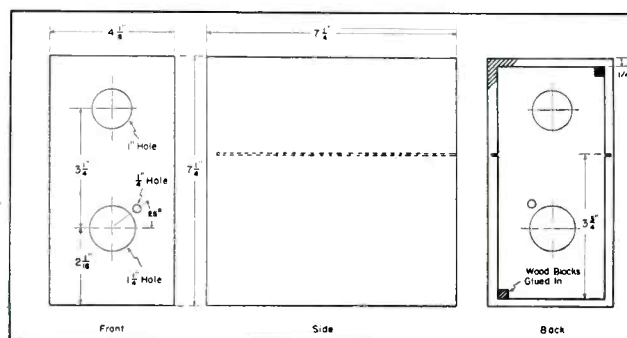

¹A Standard-type tuner was used in the model unit.

- (d) Agc (white wire, when used).
- (e) Filament black wire).
- (f) All grounding braid and bolts, screws, etc.

Most tuners are similar to one another electrically, but may differ in their converter output circuit or internal hookup. For this reason it is suggested that the circuit of the tuner output be traced carefully, if no circuit is available. The converter transformer or the first *if* coil must be used in the preamp circuit and will be similar in wiring.

After the tuner has been removed from the chassis, the turret assembly should be removed by releasing the two spring wires that hook the shaft to the frame.¹ It is important to be careful not to lose any parts from the tuner itself. Then the converter transformer or the first *if* coil should be removed from the tuner chassis. A 7-prong miniature socket should be installed in its place by punching out to a 5/8" hole for this socket. This socket should be wired up as shown in Fig. 4. Then the cathode-follower tube can be wired in, as shown in the cover diagram (Fig. 1). Either a 6CB6 or a 6AG5 can be used.

The plate of the converter stage is coupled to the grid of the cathode-follower through a coupling capacitor; *B+* to the converter uses a decoupling circuit, and the cathode-follower grid circuit is either grounded or tied to the *agc* line, when it is used in the TV set.

All the power leads in the tuner are fed through the rear hole of the tuner chassis. The cathode lead must be fed through the hole closest to the tube socket. Then a twin-shielded wire should be wired to pins 1 and 2; these leads are used for the volume control. These wires should not, at this time, be connected to the volume control itself. Pins 3 and 4, and 9 should then be connected up; Figs. 1 and 4. All the wires must be connected to the 9-prong plug before bolting down. The 9-prong

(Continued on page 45)

**for better tv
performance**

DuMont Electronic Parts

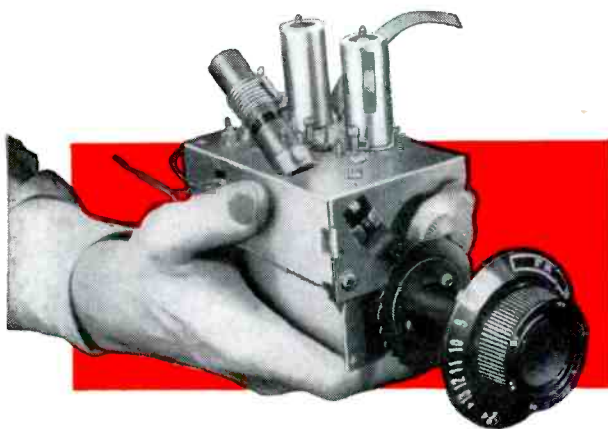

INPUTUNER* SERIES T3C

Five types offer more of everything you want in a TV tuner. Covers FM broadcast band in addition to TV channels. Employs continuous tuning action (Mallory-Ware Inductuner**) for utmost dependability, and detent action for quick channel selection. Mechanically and electrically a replacement for most switch-type tuners.

*Trade-mark
**RTM PRM Co., Inc.

DISTRIBUTED-WINDING DEFLECTION YOKES (Series Y2A)

Distributed-winding construction allows sharp focus over entire screen area. Compact design (overall length 2¾") lends itself for use with modern short-neck tubes. Retains shape of windings under extreme conditions of humidity and temperature. Will withstand 4000 volt d-c high potential between windings and between any winding and core, or any exposed metal contained in the yoke assembly. Available in several 70° deflection types, with or without matching networks.



DUMONT

FIRST WITH THE FINEST IN TV COMPONENTS

Electronic Parts

20th
YEAR
AS PIONEER

*Literature on request.
Available through
leading distributors.
Let us quote on
quantity requirements.*

ALLEN B. DUMONT LABORATORIES, INC.
ELECTRONIC PARTS DIVISION
EAST PATERSON, N. J.

Fig. 1. Approved method for grounding TV antenna.

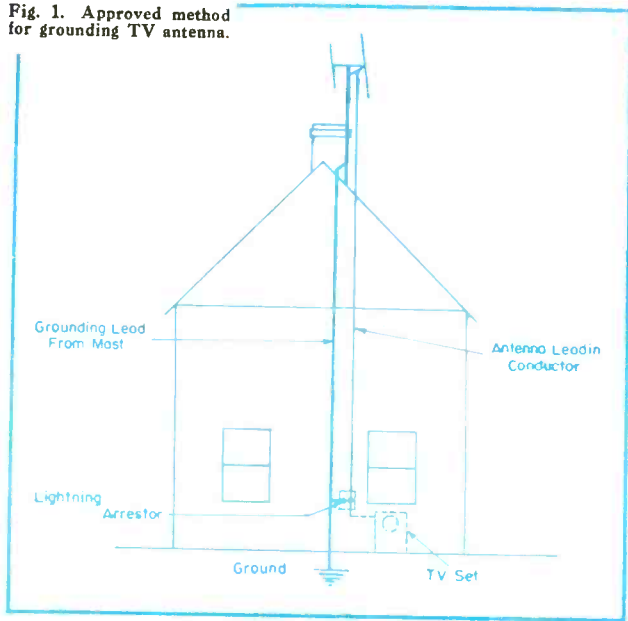

TV Antenna Grounds

by C. H. JENSEN

Electrical Engineer, Copperweld Steel Company

Grounding Methods Which Should be Used to Assure Maximum Protection From Lightning.

IN FRINGE AREAS TV sets are dependent on overhead outdoor antennas for proper reception. For these outdoor antennas, a ground connection is essential to protect the antenna, the television set and the building from lightning.

In most cases, the antenna extends well above the roof of the house and is therefore in a vulnerable position. It constitutes an excellent target for direct lightning strokes, streamers from a direct hit on an adjacent object or induced high voltage charges. Because of this, the antenna system must be adequately grounded so that lightning strokes will be conducted to ground without damage to the equipment or to the building.

Approved Methods

An approved method for grounding a TV antenna system is shown in Fig. 1. The grounding conductor must be securely attached to the metal supporting mast and then carried down on the outside of the building to ground. This grounding lead should be as short and

direct as possible, avoiding sharp bends or loops where the lightning might jump or arc across. It should also be of a size and type that it will not melt or burn in two when carrying heavy lightning discharge currents. Since this lightning conductor system, as a general rule, is expected to remain in working condition for long periods of time with little attention, the mechanical construction should be strong and the materials used such as to offer high resistance to corrosion.

Lead-in-Wire Connections

The lead-in wire to the TV set must be connected to the grounding lead through an approved type of lightning arrester, the purpose of which is primarily to provide maximum protection to the set. If twin lead is used for the down lead, the arrester should be inserted in each conductor, or a single arrester used which is designed to protect both wires.

The grounding wire from the antenna system must be permanently and effectively connected to the earth. The

success of the entire protective system is largely dependent on securing a satisfactory low-resistance ground connection. If the resistance is high, the lightning stroke or induced charge will not pass quickly and safely to earth and dangerous potentials can build up on the antenna system which can endanger life and property.

Plumbing-System Contacts

In some instances antennas have been grounded to the vent pipe of the plumbing system which extends through the roof of the building. However, it is frequently difficult to make a satisfactory connection to these vent pipes on the roof. Also the compounds used for sealing the pipe joints may be of an insulating type so that the resistance of the path to ground may be so high as to be of little value for conducting the lightning to ground. Furthermore, the metal plumbing pipes are frequently connected to terra-cotta or non-metallic sewer pipes under

(Continued on page 46)

Fig. 3 (right). Calculated effect on resistance, of one grade of soil, with electrode at various depths; based on uniform soil at all depths. (Courtesy Bureau of Standards)

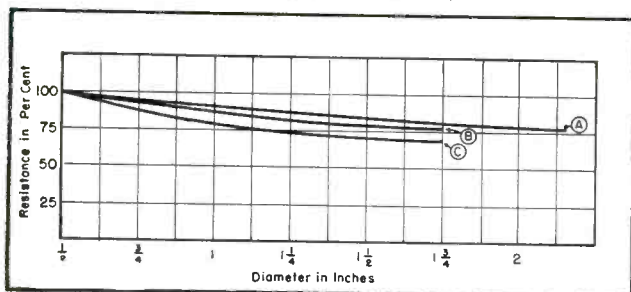
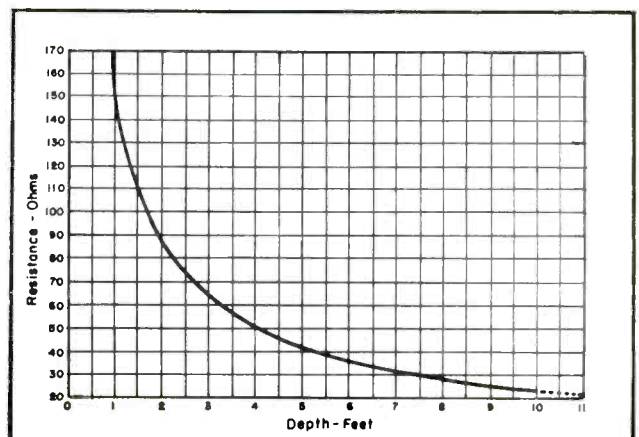

Fig. 2. Plot of effect of rod diameter on ground resistance, for single driven grounds. Curve A is from the Bureau of Standards technical paper 108; B, from Underwriter's Lab tests at Chicago (average of hundreds of measurements); C, from Underwriter's Lab tests at Pittsburgh.



IN TUNE WITH THE TUNER!

NEW...IMPROVED

**"STANDARD
TV
BOOSTER"**



MODEL B-5T

Millions of "Standard Tuners"

Now In Use

Used by over 75
TV Set Manufacturers

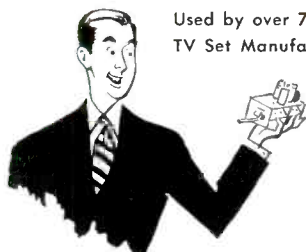

The new "Standard Booster" will increase the TV signal strength to a degree that will make possible "city" reception in areas remote from the TV transmitter. It reduces the "snow" or noise and interference to give a clearer, sharper picture and improved sound reception. It also makes possible receiving a picture in very remote areas or "blind" areas in close-to-transmitter locations where the TV set alone will not — makes a TV set a real enjoyment!

Standard COIL PRODUCTS CO. INC.
CHICAGO • LOS ANGELES • BANGOR, MICH.

AUDIO installation and service

Phono-Tape-Wire-PA-Amplifiers-Speakers

by KENNETH STEWART

LOUDSPEAKER ENCLOSURES or housings have often been described as one of the key factors in a quality audio system, and accordingly a media which merits more than casual attention. The interest has prompted many surveys of the types of enclosures which might provide the best results.

Enclosure Study

In one such recent study,¹ prepared by Dr. Leo Beranek of the MIT Acoustics Lab, there appeared a revealing analysis of one type of enclosure which has become quite popular; the rectangular closed box. Comparing this type of housing with the simple baffle, formerly considered an ideal mount, the audio specialist stated that the plywood unit was a rather poor

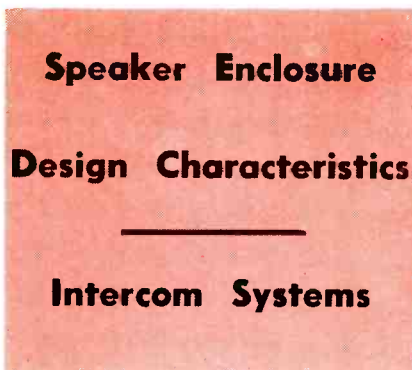

means for isolating the rear of the radiator from the front. And since the average listening room is quite live at the lower frequencies, sound from the

¹Presented at the annual NEC meeting in Chicago.

rear side of the speaker is reflected into the room combining with that from the front side. Thus, we are told, the flat baffle does little to improve the damping of the speaker at its resonant frequency or to control the acoustical impedance against which the rear side of the speaker diaphragm must work. In addition, the report indicated, flat baffles were more directive than are usually desirable.

Enclosure Design Criteria

Reviewing the design criteria of enclosures, Beranek pointed out that unfortunately no reliable subjective data concerning the low-frequency response of loudspeakers are available. Flat response to frequencies as low as 50 cps have been found desirable by most listeners. It is also believed that those speakers that sound best generally reproduce tone bursts.* In addition it is known, the report declared, that the ear has an integration time which is of the order of 0.05 to 0.10 second and the syllabic length for music and speech is of this same order of magnitude.

Box Dimensions

From this evidence, it appears that it is necessary to choose the dimensions of the box so that the resonant frequency is as low as possible and to shape the low-frequency end of the response curve so as to pass faithfully a time-burst of .1-second duration. A third criterion, declared the MIT expert, is to achieve this response with maximum efficiency.

Design Charts

In Fig. 1 appears a chart which was evolved to provide the dimensions of one type of baffle box, a 12-inch

*A tone burst is a wave-train pulse which contains a number of waves of a certain frequency.

Fig. 1. Chart for determining baffle box dimensions for a loudspeaker with an advertised diameter of 12", given the compliance desired and the frequency. The four experimental points shown were measured compliances for four sizes of baffle boxes using the W. E. 728B loudspeaker as the driving unit. To convert meters into inches, multiply by 39.37. To convert Newtons into dynes, multiply by 10^5 .

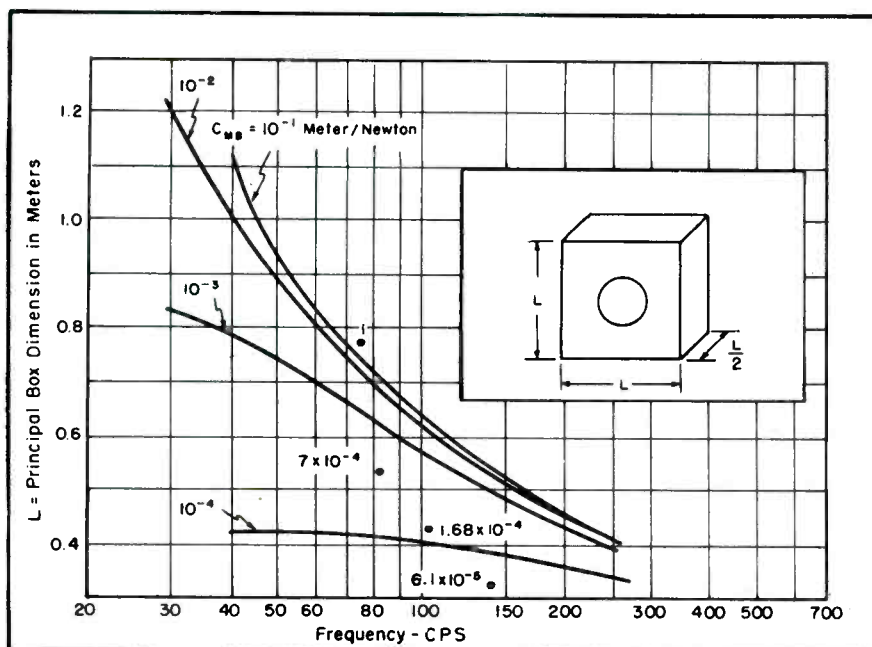

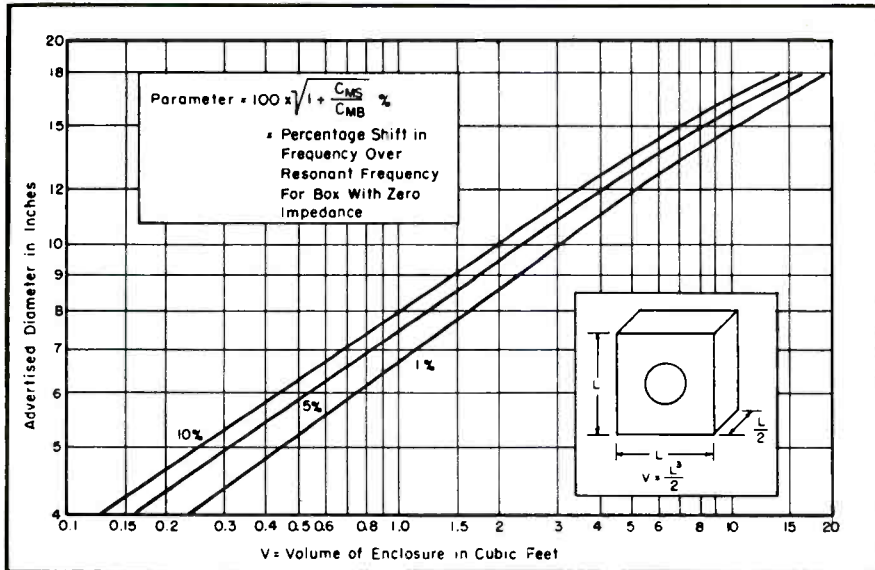

Fig. 2. Volumes of closed box enclosures for standard loudspeakers versus advertised diameters. The parameter is the shift in resonant frequency with respect to the frequency that would obtain if the compliance of the box was infinite.

speaker being used to prepare the plot. And in Fig. 2 appears a plot illustrating the volumes of closed box enclosures for standard speakers versus advertised diameters.

Absorbent Linings

Commenting on the use of absorbent linings for closed box baffles, Beranek said that the principal purpose of the lining is to reduce the effects of box resonances at higher frequencies. The first box resonance of importance oc-

curs when $f = c/L$; that is, when the depth of the box equals one-half a wavelength of sound. For a box which is 2' x 2' x 1' in size, $f = 1128/2 = 564$ cps. It was pointed out that the acoustical material selected must have a high absorption coefficient at this frequency and at all higher frequencies. According to tables acoustical materials absorb well at frequencies above 250 cps when used in thicknesses of one inch. In installation, the material must be placed on at least three of the six sides of the box such

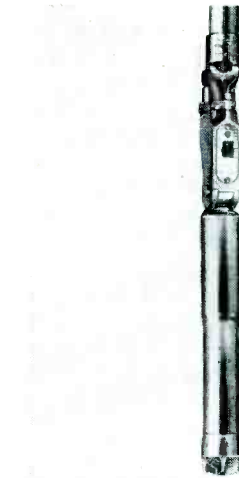

Dynamic microphone, 1 1/16" in diameter and 10" long (7 1/2" less studd), which features a grille head said to be acoustically treated to prevent wind and breath blasts, without affecting frequency response. Non-metallic acoustalloy diaphragm and special magnetic structure claimed to provide response to 13 kc. Has an omnidirectional polar pattern which becomes slightly directional at extremely high frequencies. Swivel head permits vertical tilt for aiming at sound source. Stand coupler has standard 3/8"-27 thread (Model 636 Slimair; Electro-Voice, Inc., Buchanan, Mich.)

that no two untreated walls of the box are parallel to each other.

Intercom Systems

Intercommunication links are now featuring many novel circuitry developments, included not only to expand applications of the systems but to simplify point-to-point contact operations.

In one setup,² for instance, battery-powered amplifiers are employed to permit broader installation possibilities. And to affect battery economy,

Fig. 3. The battery-type amplifier used in the Talk-O intercom system.

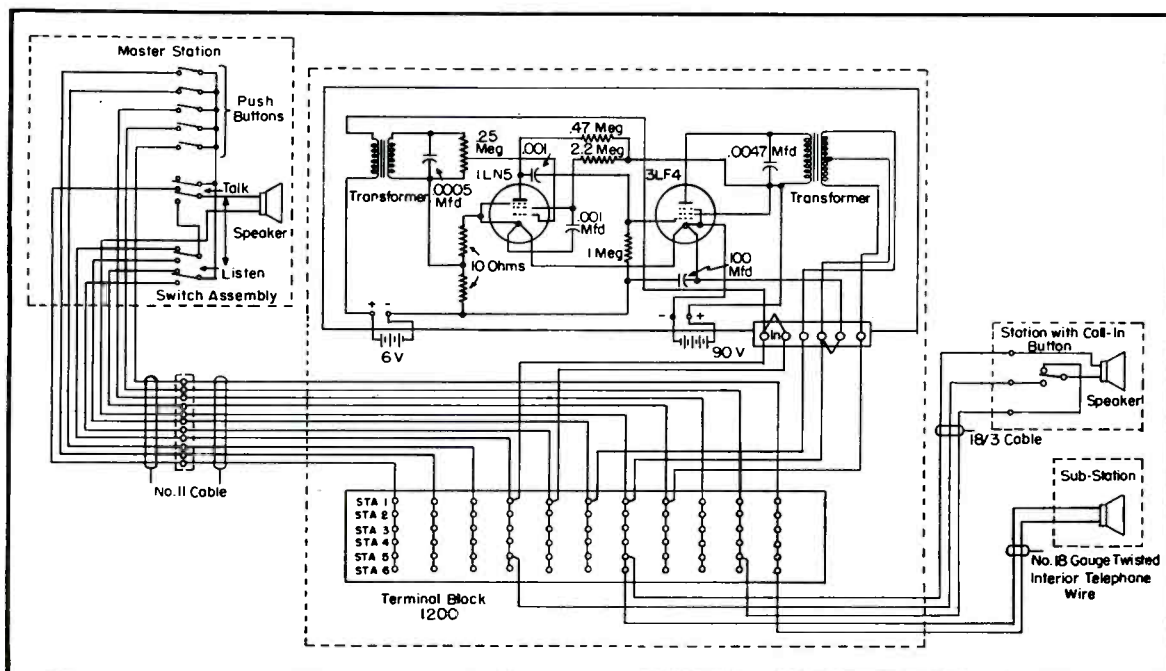

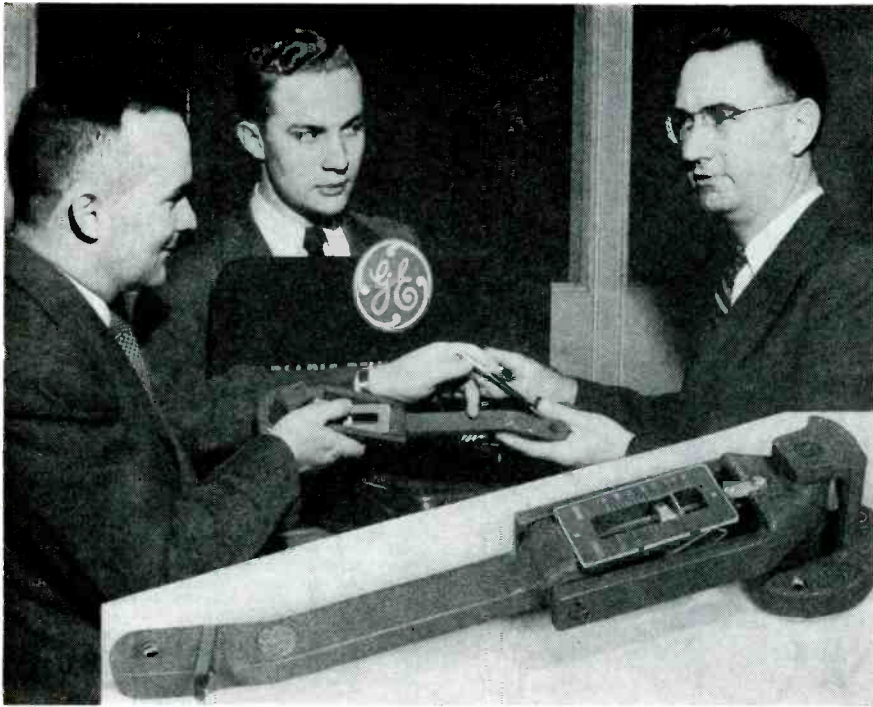

At lower right: Professional tone arm designed to mount variable reluctance cartridge, for use with lateral transcriptions and recordings. The mass of the transcription arm is said to have been reduced through functional design and the use of magnesium alloy for the moving parts. Both the lateral and vertical planes are claimed to have very low bearing friction due to hand-adjusted cone-type bearings. Additional features of the tone arm are said to be the absence of arm resonances in audio range, and a highly damped and compliant cartridge. Arm will mount on transcription machines whose dimension from the center of the turntable to the edge of the mounting surface is approximately 15" or less. The stylus is located by an arrow on the arm so that it may be accurately positioned for the play-back of transcriptions. The load on the cartridge stylus is adjusted by a precision spring loading system which is calibrated in ounces and grams. At left appears T. J. Nicholson (left), assistant sales manager of component parts for the G.E. receiver division; A. Jolly, advertising and sales promotion of component parts, and E. A. Malling, sales manager of component parts, discussing the transcription arm. (FA-21-A; G.E. receiver division.)

an automatic on-off system is included.

The circuit used in this system appears in Fig. 3. Amplifiers include one 1LN5 and one 3LF4, which require a 6 v A battery and two 45 v B batteries. This amplifier is used in all master, two-master and one-master-remote systems.

Advantages of Batteries

Since the tubes used draw little power it is possible to use the batteries.

Half-octave filter designed to meet requirements where extreme attenuation outside the pass band and sharp cutoff are required. Using a passive network, without vacuum tube, it is claimed not to be subject to overload. There are said to be no beats between normal modes and the inter-modulation products are extremely low. Can be used either as a band pass, low pass or high pass filter. Provides an attenuation outside the pass band of approximately 20 db for $\frac{1}{4}$ octave and 40 db for $\frac{1}{2}$ octave beyond the 3 db point. The minimum rejection outside the pass band is 40 db. Unit is comprised of separate high and low pass filters each having 17 different cutoff frequencies ranging from 37.5 to 13,600 cycles in $\frac{1}{2}$ octave steps, providing an adjustable band-pass from $\frac{1}{2}$ octave to $8\frac{1}{2}$ octaves, with a frequency tolerance of ± 2 cps or $\pm 2\%$, whichever is greater. The one-half octave bands center on 1000 cps and its one-half octaves. Selection of each cut-off frequency is made by means of push button switches which provide 203 useful positions, i.e., 17 high pass, 17 low pass, 168 band pass and 1 out. (Model BP-1; Gertsch Products, 11846-48 Mississippi Ave., Los Angeles 25, Calif.)

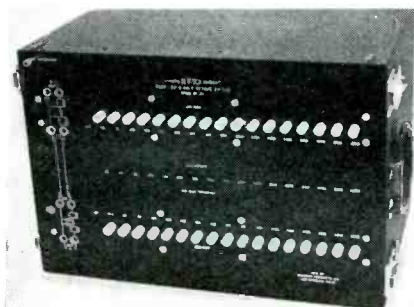

Batteries offer several advantages; power is instantly available and essentially noise free, as compared to slow-starting ac-operated amplifiers, which may have inherent noise as the result of ac ripple and extraneous interference pickup.

Remote-Control Service

The amplifier circuit provides for remote control. By connection of the input transformer winding in series with the battery and tube filament circuit, incoming voice currents and the

©Talk-O Products, Rochester 6, N. Y.

Phono-cartridge replacement chart, No. 161, published by Electro-Voice, Buchanan, Mich. Provides up-to-date replacement listing and tells when to replace a phono-cartridge, what tests to make, and what type cartridge to use. It explains the difference between old-style and modern cartridges and shows how to get cartridge replacement business. Size of the chart is 11" x 16 $\frac{1}{2}$ ". Free copy can be obtained from E-V distributors or by writing to Electro-Voice.

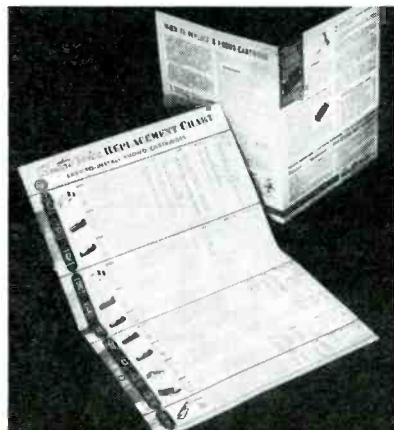

filament current are superimposed on one circuit. By this means a single central amplifier can be remotely controlled at any station.

Shielded wiring is unnecessary. And since the maximum voltage on the station connecting wires is 6 volts, there is no fire or shock hazard.

Also produced is a model used only in the open-call system. It is similar to the foregoing amplifier in all respects, except that a terminal board is not used. The amplifiers feature a 11-conductor color-code which allows wire connections to be quickly made. All wire terminals are stamped to indicate the correct wire color to be connected to them.

Cartridge especially designed as a replacement unit for 78 rpm snap-in Admiral tone arms. Has three-prong for the three snap-in receptacles found in the arms. Output is stated to be 0.7 volt at 1,000 cps on Audio-Tone test record; frequency range, 50 to 10,000 cps. Recommended minimum needle pressure is 12 grams; net weight of the cartridge eight grams. Unit employs type G replaceable needle with three-mil precious metal tip. This needle slips from rubber chuck with a quarter-turn sideways. At upper right is illustrated procedure followed in installing three-prong terminals of cartridge in three receptacles of Admiral snap-in tone arm. (102-M ceramic cartridge replacing Admiral cartridge No. A1372; Astatic.)

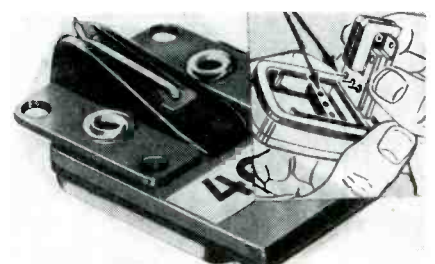



*We're Doing Our Best
to Keep Up With the Demand*



AND THE DEMAND IS PHENOMENAL — far beyond our material limitations . . . but be patient and your order will be delivered. We are distributing TELE-ROTORS uniformly throughout all TV areas . . . so wait . . . don't compromise with quality. **YOU CAN'T BEAT A TELE-ROTOR!**



This heavy-duty TELE-ROTOR has no match! It's more powerful . . . will turn any TV antenna array under any weather conditions. Easily installed . . . it is trouble-free in performance. Easiest of all to operate!

MODEL TR-2 rotator with "compass control" cabinet having illuminated "perfect pattern" dial . . . (uses 8 wire cable) . . . \$49.95

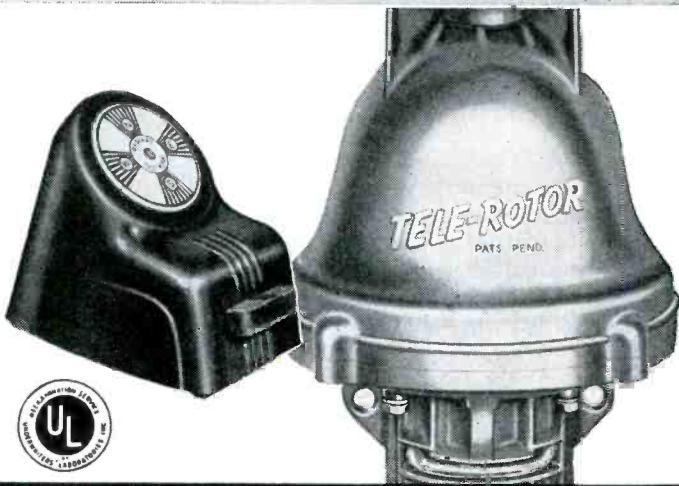

The new TELE-ROTOR "CUB" is ideal for average installations. The same husky motor as the Heavy-Duty model . . . the "CUB" is the fastest and easiest of all rotators to install. All-In-Line design . . . with true in-line thrust between antenna and mast. The 3/4" STEEL shaft rotates on a case hardened steel ball . . . with inline reamed oilless bearings.

MODEL 502A rotator with plastic control cabinet having indicating meter for "hairline" tuning. (Uses 5 wire cable) \$44.95

MODEL 501A rotator with control cabinet having end-of-rotation signal. Light flashes every 7.2° showing antenna is turning. (Uses 5 wire cable) \$34.95



CORNELL-DUBILIER SOUTH PLAINFIELD, N. J.

THE RADIART CORPORATION CLEVELAND 2, OHIO



INTERMITTENT Servicing

by JACK DARR

Quachita Radio Service

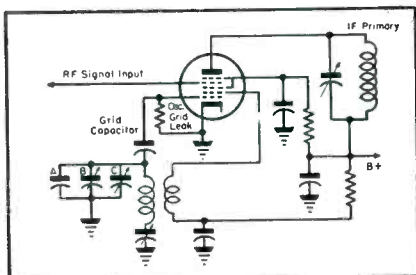

Left: Typical pentagrid converter tube oscillator circuit, which can use tubes such as 6A7, 1A7, 6A8. In this circuit intermittent checks should cover tuning coils, for high-resistance joints, and capacitors (B, trimmer and C, tuning) for shorts. Grid capacitors should also be traced for leakage, and grid resistors for proper value. Capacitor A, a negative-temperature-coefficient unit used to compensate for drift, must be checked carefully for value, if oscillator is intermittent. Shorted or leaky padders can also cause erratic operation of oscillator.

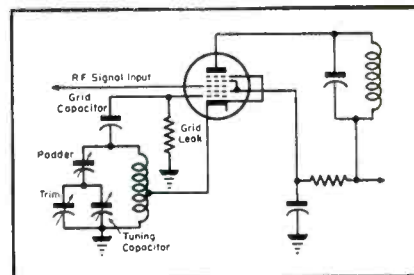

Right: Typical Hartley oscillator circuit, used with 12SA7, 12BE6, etc. Intermittent checks should cover coils for high-resistance joints, and padders and trimmers for leakage. Screen-grid resistor and bypass capacitors should also be checked for proper value and intermittent connections.

IN SEARCHING for the causes of intermittents, the chore can be substantially simplified if a planned approach is applied. This is particularly true in the involved stages, such as the mixer-oscillator, where almost any small defect will show up as a big trouble in operation. It is extremely important to learn to recognize the symptoms of oscillator trouble, and how to effect isolation of the difficulty.

The one instantly-recognizable symptom of a dead oscillator is the complete absence of any signal in the speaker, even though the set appears to be operating normally; with static or noise being heard. If the oscillator is only weak, stations at the high end of the band may come in, but the low end usually will be silent.

To test any oscillator, the developed *dc* grid voltage should be measured with a *dc-vtm*, from oscillator grid to ground. The voltage should be at least 4 to 6 negative, at the low end of the band, minimum, and rise as the set is tuned to the high end. No voltage or a small positive voltage is a definite indication of a dead oscillator.

The tube represents the first item which might be the cure. It's not a bad idea to change the tube, for there have been instances where tubes have simply refused to work as oscillators, although checker tests indicated that they were good. If a new tube doesn't help particularly in 3-way portables or battery models, the filament voltage must be checked. If it isn't at least 1.2 volts, you will find a lowered efficiency in the oscillator stage. The

power supply must be therefore checked to see that it is delivering the full-rated voltage to the filament string. It will also be wise to check all the other tubes to see that none of them are taking more of the voltage than they should, due to lowered emission, etc.

The next step involves a test of the oscillator coil for continuity. Average values, for two-winding coils, have been found to be: primary (plate) winding, 6 to 10 ohms; secondary (tuned) winding, 3 to 5 ohms. With the tapped coils used in the Hartley oscillator, employing 6SA7s and 12SA7s, the values will be from 3 to 5 ohms for the grid to cathode (tap) and from 1 to 3 ohms from the tap to grounded end. Oscillator grid-resistors must also be checked for drifts from the rated value. Oscillator grid capacitors must be tested for intermittent opens or shorts. If the set has a *temperature-compensating* capacitor in parallel with the tuner, it should be checked for changes in capacity and shorts. The variable capacitor oscillator section represents another trouble spot. The plates may be bent or there might be leakage across the stator supporting insulators. Dampness and dirt accumulations on these insulators can cause leaks as low as 20,000 ohms, which will play hob with oscillator efficiency. Dirt can be eliminated by washing out with carbon-tet, and drying out over heat. A soldering

iron will do the job. Then the insulators should be given a coat of *Q-dope* and dried out well. It is wise to test for leakage, before reassembling.

If the set is an oldie, which used a *gimmick* of two twisted wires on the gang-capacitor from oscillator section to mixer section, a moisture absorption and leakage test should be made. Cures have been effected through replacement with plastic-insulated wires.

Loctal sockets have been a source of intermittents. Innumerable troubles have been cured by simply washing the sockets out with carbon-tet and scraping with a knife. The miniatures, too, are trouble makers. All contacts should be clean and bright, if you want to avoid trouble in the future.

The older models using push-button tuning, with *manual-tuning* circuits, featured a switching operation through one of the push-buttons, labeled *dial*. These contacts have been found to become very dirty, and cause intermittent operation. One sure cure, if the owner doesn't object, is to eliminate the switch and run the wires direct. This usually entails a slight realignment, as the disturbance of the oscillator and *rf* wiring will throw the front end out of tune.

If there is no plate voltage on the oscillator, the primary winding of the coil must be checked. If this is open, the coil should be removed, making a rough sketch of the connections. In studying the coil you'll usually find a few pale green spots on the winding, the tell-tale signs of electrolytic cor-

(Continued on page 58)

Determining the Source of the Intermittent . . . Audio-System Trouble Checks . . . Second-Detector-Stage First-Audio Problems . . . Intermittents in the IF Stages . . . Correcting Wire Defects.

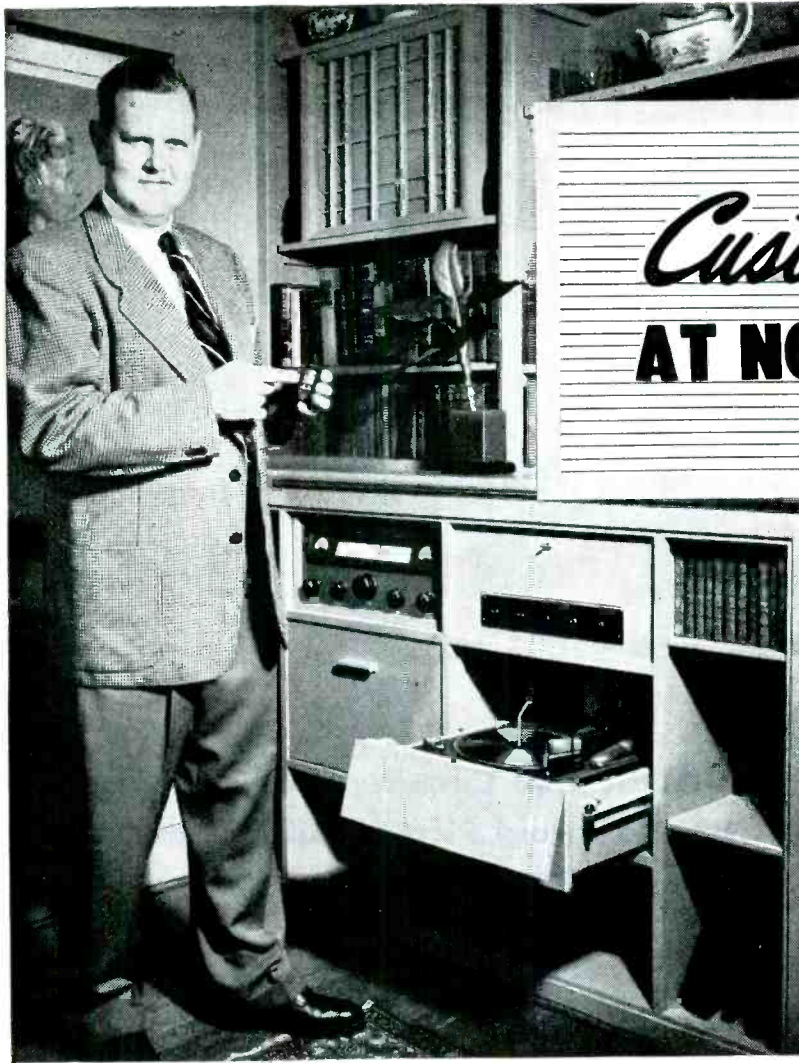

Custom Quality
AT NO EXTRA COST!



VARIABLE RELUCTANCE CARTRIDGES

WHERE cost is no problem, custom designers specify the best. Philip C. Kelsey of Guilford, Connecticut, shown here beside one of his made-to-order FM phonograph installations, says:

"Customer satisfaction means everything in my business. That's why G-E cartridges are standard in all my installations. I know they are the best."

This same cartridge—with diamond or sapphire tip—belongs in your line and in your customers' sets. More than 100,000 G-E cartridges were sold last year—a better score than all other VR cartridges combined! Today, more than ever before, dealers will push quality merchandise backed by a name people believe in—General Electric.

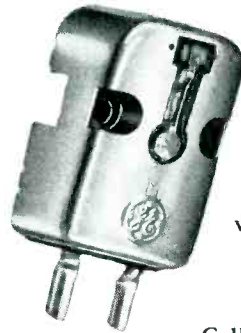

Build Your Profits... Build Your Reputation

Stock the complete G-E Parts Line now—let your customers know you can put new life into radios, phonographs, TV sets, with General Electric

- Speakers
- Styli
- Tone Arms

Call your G-E distributor today, or write: *General Electric Co., Electronics Park, Syracuse, N.Y.*

JUST OUT!

—GET YOUR COPY NOW!

General Electric Company
 Section 341
 Electronics Park, Syracuse, N.Y.

Send me your new stylus booklet
 "Why You Should Use a Diamond."



NAME _____
 ADDRESS _____
 CITY _____ STATE _____

GENERAL  **ELECTRIC**

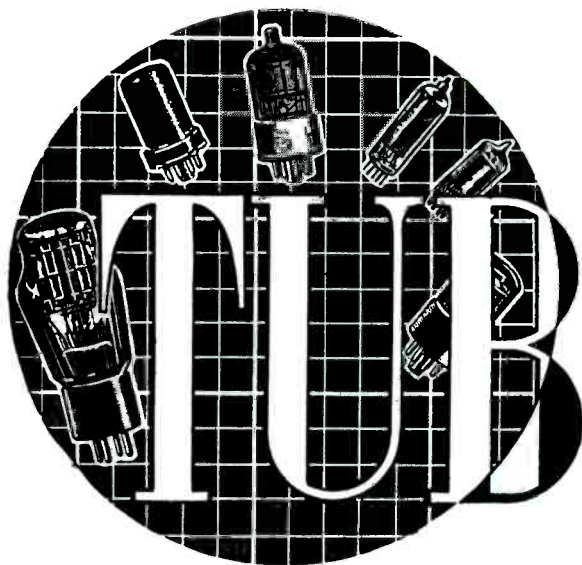

TUBE

News

by L. M. ALLEN

Wide-Angle High-Efficiency Horizontal-Deflection Circuitry Requirements for 14 and 17-Inch Picture Tubes* . . . How to Avoid Picture Tube Damage by Ion-Trap Magnet Alignment . . . Small-To-Large Screen Conversions.

TO ACCOMMODATE the new type wide-angle deflection high-anode voltage picture tubes, it has become necessary to develop high-efficiency horizontal deflection circuits using ferrite-type transformers. In one such circuit, recently announced for the 14EP4 and 17CP4 tubes, there appears a 14-kilo-volt anode supply and provision for horizontal-deflection angles of about 66°. The horizontal-deflection circuit was designed around a new ferrite-core transformer¹ and uses a single 1B3GT high-voltage rectifier, together with a 6BQ6GT horizontal-output and a 6W4GT damper diode. A B-supply of only 250 volts is required. With this voltage, the total power consumption of the horizontal-deflection and high-voltage circuit plus that of the vertical-deflection circuit has been found to be about 27 watts. During tests with the circuit it is said that Barkhausen oscillations were never detected. It is claimed that there is little possibility of their occurrence because the plate of the 6BQ6GT never becomes negative.

Transformer and Yoke

The horizontal-deflection-output and high-voltage transformer is of the autotransformer type with layer-wound coils. The high-permeability ferrite

core permits the use of a small coil and contributes to an overall compactness of the unit.

Transformer Ratio

The transformer ratio was designed for a deflecting yoke² which has horizontal-deflecting coils of approximately 14 millihenries. A .25-mfd was inserted in series with the horizontal-deflecting coils of the yoke to block direct current which would decenter the raster. The use of this value of capacitance was also found to improve the linearity for picture tubes requiring wide-angle scanning on a relatively flat face.

Width Control Methods

An unbypassed 200-ohm variable resistor, in series with the B-supply lead to the deflection circuits, functions as a width control. This arrangement for controlling picture width was found to be particularly suited to compensate for line-voltage variations. After the proper aspect ratio has been obtained by adjustment of the height control in the vertical-output circuit, picture width may be varied by adjustment of

the width control, an adjustment which automatically maintains the proper aspect ratio. In addition, with this type of control the anode voltage for a given beam current is dependent only upon the size to which the picture is adjusted. The power dissipation in this control can be determined from its resistance and *rms* current. The latter must be measured with a thermal-type instrument to avoid errors due to the fact that the current is non-sinusoidal.

Similar control of picture width may be attained with other methods. For example, a variable resistor may be used to vary the screen voltage of the 6BQ6GT and thus provide simultaneous variation of picture width and height. Care must be taken, however, that the screen input and screen voltage ratings of the 6BQ6GT can not be exceeded with any adjustment of this control.

Variable-Inductor Picture-Width Control

There is also another method which can be used to control picture width; this involves connection of a variable inductor across some portion of the ferrite transformer so that the inductor effectively shunts the horizontal-de-

¹RCA-224T1. ²RCA-209D1.
*Based on copyrighted data prepared by the tube department of RCA.

flecting coils. This method controls picture width but has little effect on picture height. A properly designed variable inductor permits width reduction without significant reduction in the voltage of the picture-tube anode.

This method of control imposes two limitations on the width adjustment. One limitation is the heating of the autotransformer windings caused by the current drawn by the width-control inductor. The second limitation results from the increase in plate dissipation in the horizontal-output tube due to the reduction of the effective plate-load impedance as the width is reduced. When a width-control inductor is used, it will be found connected to terminals 5 and 7 of the ferrite-core transformer. This connection minimizes transformer heating and permits the use of a coil having a relatively low inductance.

Lead Dress

The primary consideration in lead dress is to minimize stray capacitance. Excessive capacitance between any point on the transformer and ground appreciably increases the retrace time and reduces the high voltage obtained. The stray capacitance at the plate connection to the 1B3GT high-voltage rectifier is the most critical. Because most of the circuit capacitance introduced at that point is stray capacitance rather than the plate-to-filament capacitance of the tube, it is necessary to keep the plate lead as short as possible. It is also desirable to position the 1B3GT so that the capacitance between its plate and the chassis is minimized.

The leads of the ferrite-core transformer must also be dressed so as to minimize electrostatic coupling with the lead to the 6BQ6GT grid. If coupling of the retrace pulse into the 6BQ6GT grid circuit is not minimized, plate conduction may occur during retrace. Because the plate voltage during retrace is high, even a small amount of plate current during retrace would cause appreciable increase in plate dissipation and a substantial reduction of circuit efficiency.

Another consideration in lead dress is the possibility of coupling between the horizontal-deflection and high-voltage circuit and other parts of the chassis. Coupling of this circuit with the video amplifier or picture-tube grid lead may cause modulation of the beam and resultant light and dark bands in the raster. These bands have an appearance similar to the bands caused by *ringing* in the deflection transformer.

In Fig. 1 appears a circuit illustrating the use of a blocking-oscillator dis-

(Continued on page 48)

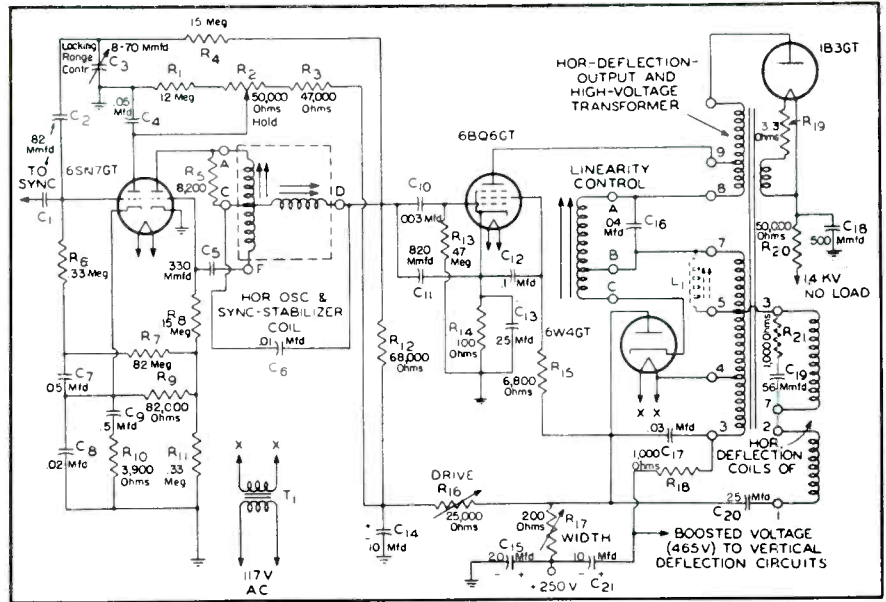

Fig. 1. Horizontal-deflection and high-voltage circuit. T_1 is a heater transformer insulated for a 1.5-kv peak. The resistance between terminals *A* and *B* is approximately 4 ohms and that between *B* and *C* is approximately 1.5 ohms.

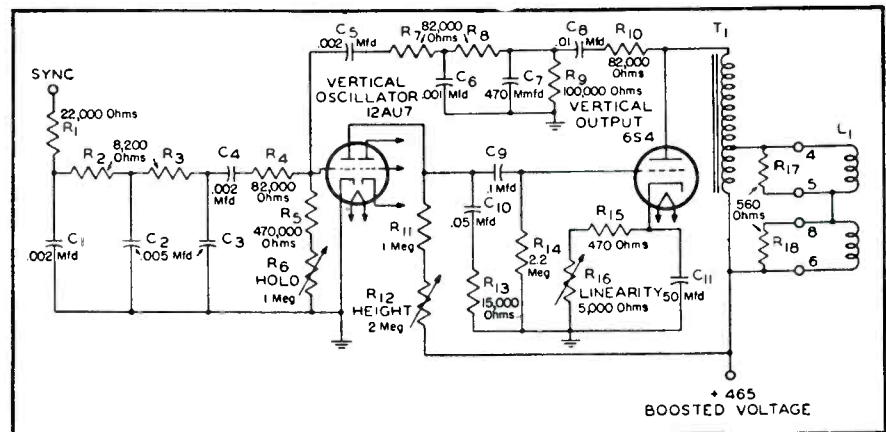
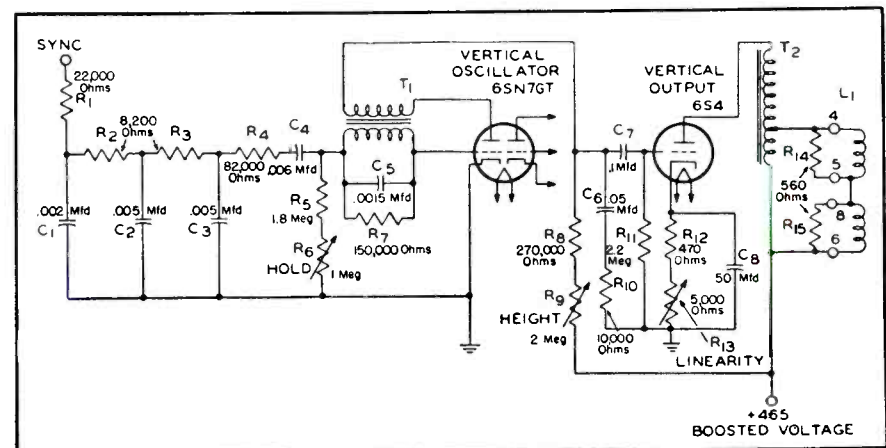

Fig. 2. Circuit of vertical-output system with a feedback oscillator. In this instance T_1 is a vertical output transformer with a turns ratio, in the primary to secondary, of 18:1.

Fig. 3. A vertical-output circuit with a blocking oscillator.



Servicing Helps

by M. A. MARWELL

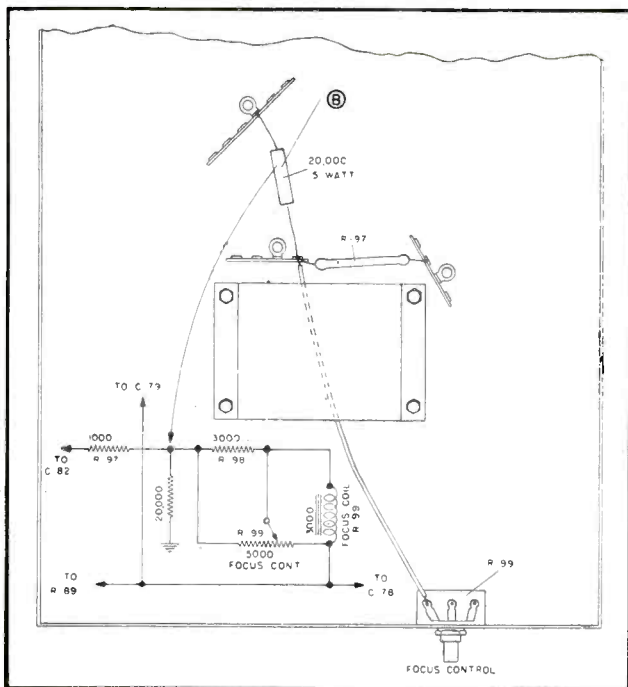

Replacement Guide for 16-Inch Rectangulars . . . Avoiding Picture Smear . . . Eliminating 4.5-Mc Harmonic Interference . . . Repairing of Power Transformers to Eliminate Lamination Buzz . . . Circuitry Changes in Sylvania Chassis Which Eliminate Vertical Foldover and Reduce Picture Distortion . . . Correcting Bias in Sylvania TV Sets. Hallicrafters TV Chassis Service Tips: Tube Substitutions . . . Minimizing Intercarrier Buzz Problems.

CURRENT SHORTAGES of some types of picture tubes have made it difficult to obtain exact field replacements. To solve the problem for 16-inch rectangulars, Sentinel has developed a procedure which permits the use of any standard make of 16TP4 or 16RP4 picture tube for replacement purposes.

Four steps are involved in the plan:

(1) Any standard make of 16TP4 or 16RP4 is first installed in place of the defective picture tube.

(2) The horizontal drive control is adjusted for its proper setting.

(3) If a circular corner shadow is noted on picture tube, it can be eliminated by adjusting the four focus coil assembly mounting screws.

(4) Focus control is adjusted for proper focusing.

Should it be found that when turning the focus control in the counter clockwise direction, focusing is improved but is *not proper* even when the control reaches the maximum counter clockwise position, the strength of focus magnet should be reduced by placing four steel strip shunts, approximately $\frac{3}{4}$ " x $\frac{1}{8}$ " x $\frac{1}{16}$ ", around focus magnet as shown in Fig. 1. If this brings position of proper focusing within range of the focus control, no

Fig. 2. Increasing current in Sentinel chassis through focus coil via installation of 20,000-ohm 5-watt resistor (b).

other changes are necessary. Should the addition of the four steel strip shunts improve focusing, but still not bring correct focusing within the range of the focus control, additional shunts will have to be added until focusing position is within range of the focus control.

Should it be found that it is neces-

Fig. 1. Reducing strength of focus magnet in Sentinel TV-131 chassis by installation of four steel strip shunts, (a).

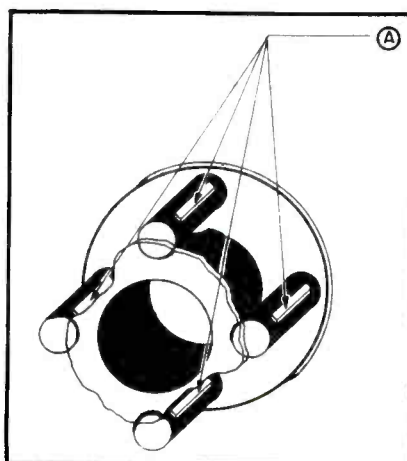

sary to turn the focus control in the clockwise direction, but focusing is improved but is not proper even when the control reaches the maximum clockwise position, it will be necessary to increase current through the focus coil by installing a 20,000-ohm 5-watt resistor, as shown in Fig. 2.

Picture Smear*

Smear is generally interpreted as an extension or washing out of white or black trailing edges so that the trailing edge is not sharply defined, but is smeared out toward the right side of the screen.

This type of smear may result from incorrect *rf* unit response in the receiver, *if* amplifier response in the receiver, overall *rf-if* amplifier response in the receiver, high-frequency response in the video amplifier in the receiver, high-frequency response in station transmission, and high-frequency response due to relayed or cabled transmission.

If smear is encountered, the initial step in correction is to make certain that the *rf* and *if* alignment is correct as indicated in service data. Particular

*From RCA service notes.

care should be taken to have the 26.25, 25.50, and 24.75 mc markers at the proper locations on the overall *rf-if* response curve.

Additional peaking of the high video frequencies can be obtained in the video amplifier in the RCA 16-inch models (6T53, —54, —64, —65, —71, —74, —75, —76, —84, —86, —87), and 19-inch models (9T57, —77, —79, —89) by: (1) adding 1500 mmfd across R_{120} (cathode of first video amplifier); (2) adding 100 mmfd from the junction of R_{120} and R_{221} to ground; (3) changing L_{102} (grid circuit of first video amplifier) from 120 mnh. to 500 mnh.; (4) dressing capacitors C_{104} , C_{102} , and C_{103} away from each other to reduce coupling.

Elimination of 4.5-MC Harmonic Interference

On certain channels, there often appear light and dark interference bands with a pattern similar to the graining in plywood which move about on the picture (similar to FM interference). This is due to harmonics of the 4.5-mc sound *if* in the receiver beating with picture signal. To reduce this type of interference in the Sylvania chassis two capacitors (.0001 and .005-mfd) should be returned to ground instead of *B-*. The .0001-mfd (C_{112}) is a plate bypass in the first audio amplifier section of 6T8. The .005-mfd (C_{115}) is a plate bypass in the 6V6GT audio output in the Sylvania 1-260, 1-261, 1-366, 1-366-66, 1-381, 1-387, 1-437 and 1-442 models; and a plate bypass (C_{110}) in the 6L6G audio output of the 1-271, 1-290, 1-356, and 1-357 models.

A .005-mfd capacitor must also be inserted between the volume control lead shields and ground on the terminal strip near the brightness and volume control.

At the chassis end of the volume control leads, one shield is tied to a terminal strip. It should be moved to connect to the same point as the other shield at pins 6 and 7 of the 6T8.

This change is incorporated in present production with codes 1-290, 1-366 (C06 and higher); 1-260, 1-381 (C05 and higher); 1-437, 1-442 (C02 and higher); and 1-356 (C01 and higher).

Intercarrier Buzz

There have been instances in Sylvania chassis where intercarrier buzz has been reported and found due to a cracked capacitor in the base of the sound discriminator transformer. These capacitors were built in as a part of this transformer. Correction of this condition necessitates replace-

(Continued on page 42)

Reach out **FARTHER...**
and bring 'em in **STRONGER!**



JFD

"Long Ranger"

YAGI TV ANTENNA ARRAYS

with High Impedance Driven Element for Direct Match to 300 Ohm Lead-in.

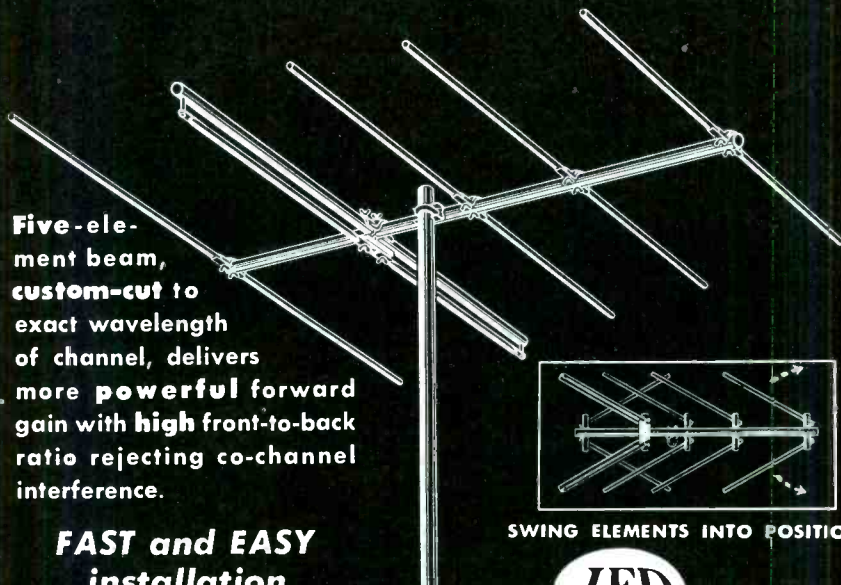

Five-element beam, custom-cut to exact wavelength of channel, delivers more powerful forward gain with high front-to-back ratio rejecting co-channel interference.

SWING ELEMENTS INTO POSITION

FAST and EASY installation

JFD YAGI antennas are completely pre-assembled at the factory. Just swing the "Quik-Rig" elements into position and tighten the wing nuts.

These all-aluminum JFD "Long Ranger" YAGI antennas are something to shout about... because even the really remote stations are now being pulled in with satisfactory viewing results. And JFD advanced design plus sturdy construction assure durability and long-lasting, trouble-free performance. Let these superior JFD YAGI installations help you e-x-p-a-n-d your television market.

Write for FREE Technical Data Sheet No. 59



5-ELEMENT YAGIS

LOW BAND	HIGH BAND
No. 5Y2 (Channel 2)	No. 5Y7 (Channel 7)
No. 5Y3 (Channel 3)	No. 5Y8 (Channel 8)
No. 5Y4 (Channel 4)	No. 5Y9 (Channel 9)
No. 5Y5 (Channel 5)	No. 5Y10 (Channel 10)
No. 5Y6 (Channel 6)	No. 5Y11 (Channel 11)
	No. 5Y12 (Channel 12)
	No. 5Y13 (Channel 13)

"Long Ranger" YAGI antennas for all of the high band channels are also available in stacked array. Jumper bars for stacking of low band "YAGIS" are also available.



MANUFACTURING CO., Inc.
6109D 16th AVE., BROOKLYN 4, N. Y.
FIRST In Television Antennas and Accessories

most everyone prefers a V-M tri-o-matic*

sell these V-M tri-o-matic RECORD CHANGERS



Cash in on a potentially great market, with the V-M tri-o-matic 950—the practical 3-speed replacement unit for obsolete one- and two-speed record changers!

V-M tri-o-matic changers play automatically all records, all speeds, all sizes, and shut off automatically after the last record plays.

(Automatic intermix for 10" and 12" records of same speed, too.)

Minimum mounting space, 13 $\frac{3}{16}$ " wide x 11 $\frac{7}{8}$ " deep, over-all height 7 $\frac{1}{4}$ ". Pre-cut mounting boards available.

Simple installation in any cabinet.



The V-M tri-o-matic 955 rounds out the home entertainment picture! Beautifully styled to harmonize with any cabinet, the tri-o-matic 955 plays through the amplifying system of any TV set or radio. The exclusive, patented tri-o-matic Spindle offers **POSITIVE RECORD PROTECTION**, since records are **LOWERED — NOT DROPPED** — on the spindle shelf. Equipped with 6-foot AC cord and a 4-foot sound cord and plugs.

FOR FULL DETAILS, SEE YOUR REP OR JOBBER
Registered, Spindle Design Patented



V-M CORPORATION • Benton Harbor, Mich.

*the phono in most top-brand radio-phono combinations

Servicing Helps

(Continued from page 41)

ment of the entire discriminator transformer.

Lamination Buzz in Power Transformers

Transformers in Sylvania sets suffering from lamination buzz may be effectively treated by inserting a wooden wedge between the coil and center leg of the core. This can be done without disconnecting the transformer by removing the transformer bolts and lifting the cover. It is important to be sure to retighten the bolts evenly and securely. This item is hard to replace and every effort should be made to salvage in the field.

Vertical Foldover

To eliminate vertical foldover on Sylvania chassis 1-108, 1-139, 1-186, the 3900-ohm resistor (R_{176}) in the vertical oscillator circuit should be changed to 4700 ohms as indicated in Fig. 3.

Picture Distortion

Picture distortion in Sylvania chassis 1-108, 1-139, 1-168, 1-186, can be reduced by improving the operation of the horizontal sync separation circuit as indicated in Fig. 4. The value of R_{131} should be changed from 18,000

(Below, left)

Fig. 3. Revised Sylvania vertical oscillator circuit which affords elimination of vertical foldover.

(Below)

Fig. 4. Improved horizontal sync circuit of Sylvania models, which reduces picture distortion; R_{131} and R_{132} go to +170 v.

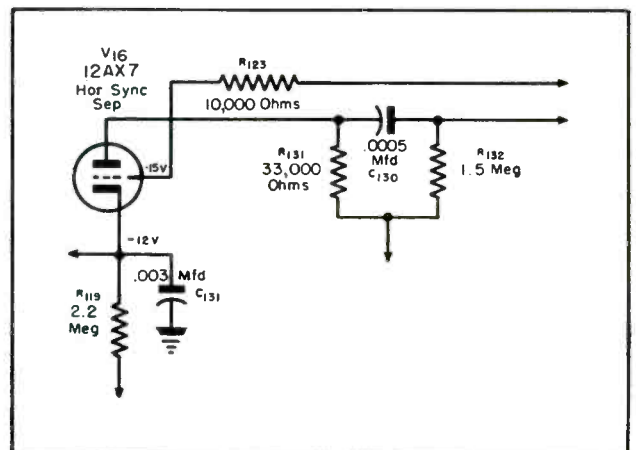
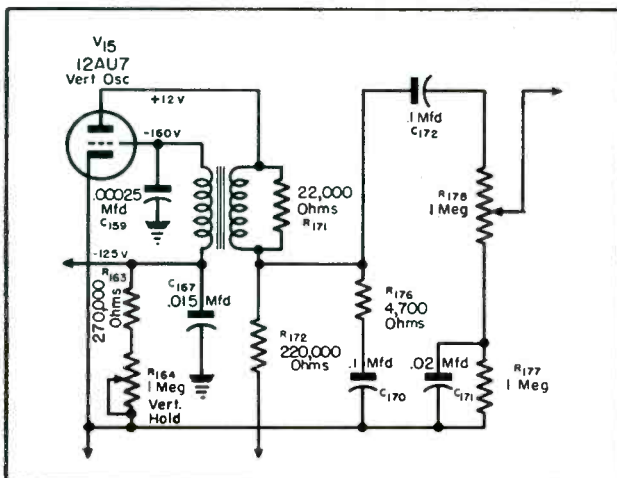

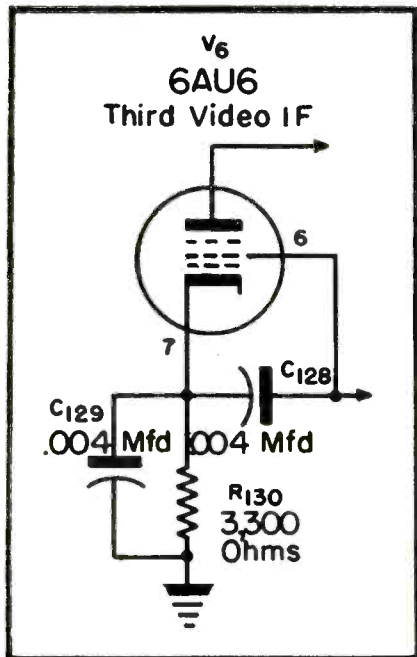

Fig. 5. Corrected bias circuit in Sylvania third video *if* amplifier stage.

ohms to 33,000 ohms, and C_{131} should be changed from .002 mfd to .003.

Bias Correction

To correct bias of the 6AU6 in the third video *if* amplifier of Sylvania models the 2200-ohm resistor (R_{130}) should be changed to 3300 ohms; Fig. 5.

Hallcrafters TV Chassis Service Tips

Due to tube supply shortages, the 6SN7GT has been substituted for the 12AU7 sync amplifier and separator tube. To effect these changes in the field, a 12,000-ohm resistor should be added from the plate pin 5 to ground, when using a 6SN7GT. Resistor R_{121} must be changed from 2.2 to 1 meg-ohm.

The 6SN7GT can be used to replace the 12AU7 sync clipper and vertical oscillator by socket replacement and observance of proper pin connections.

Chirping sound noted for brief intervals when switching from TV to radio reception (audible frequency produced by the horizontal sweep oscillator which is being picked up by the AM radio and prevails until sweep oscillation ceases) can be rendered inaudible by placing a momentary bias voltage on the *avc* buss of the AM receiver. This is accomplished by connecting a .1-mfd capacitor between the *avc* buss and the 335 *B+* buss that supplies power to the screen of the horizontal output tube; this *B+* circuit point is accessible at terminal 3 on the terminal strip at rear of the AM

(Continued on page 44)

CAN'T BREAK WON'T SAG

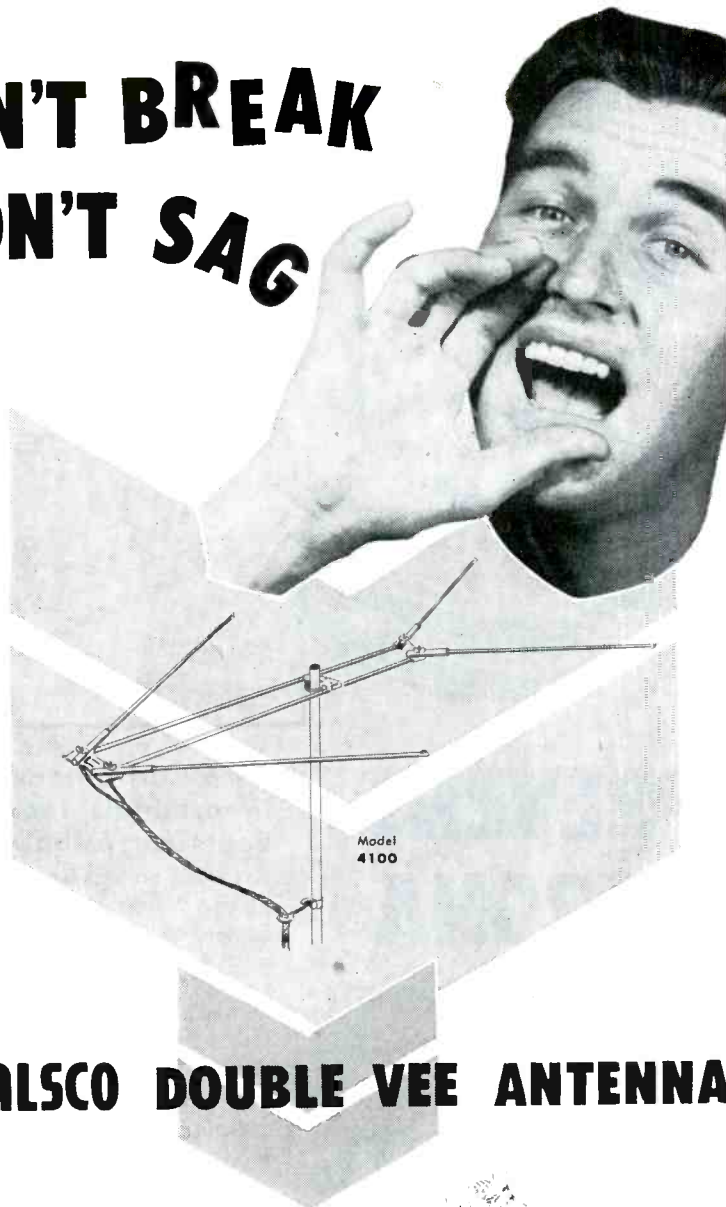

New!

WALSCO DOUBLE VEE ANTENNA

A great, new engineering idea! Walsco Double-Vee Antenna with "TWIN-TUBE" element construction eliminates sag . . . Guaranteed not to break. Elements stay firm in perfect alignment for lasting high gain performance. Highly directive . . . extra high gain on all channels. No mechanical failures even under severe weather. New molded insulators guaranteed unbreakable. Outstanding and lasting dielectric properties. Completely assembled . . . only 4 wing nuts to tighten.

WRITE
FOR BULLETIN
NO. 60-S

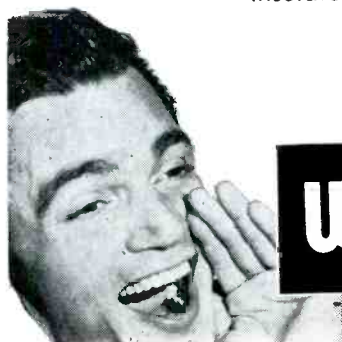

WALSCO

Walter L. Schott Co.

Los Angeles 18, Calif. • Chicago 6, Ill

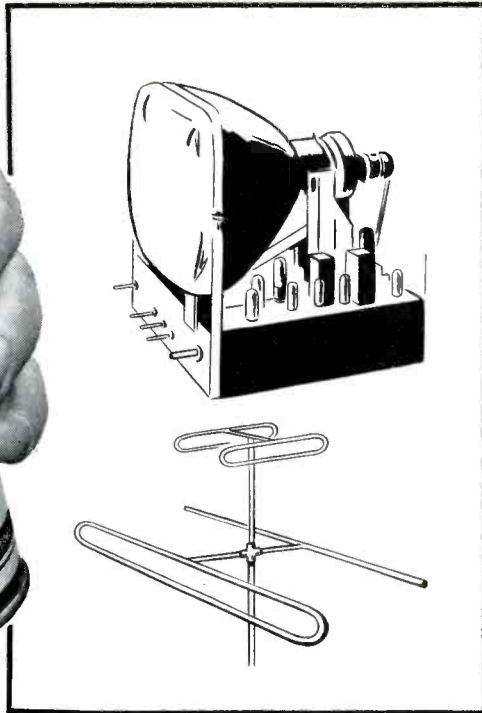

PREVENT CORONA

in high voltage circuits
with



ACRYLIC SPRAY

Spray on antenna and lead-in terminals, too; Krylon prevents corrosion and pitting

Krylon is an acrylic spray — not a vinyl plastic. Spray it, right from the 12 oz. aerosol can, on the high voltage coil and insulation... in the socket of the high voltage rectifier... on component parts of the high voltage rectifier circuit. Krylon dries in a few minutes to form a permanent protective coating of high dielectric strength.

Both inside the set and on the antenna, Krylon seals and protects... makes TV sets perform better, longer... cuts down service calls... builds customer good will. Two types — clear (list \$1.95) and nonconducting aluminum (list \$2.25). Also in gallons for application by brushing or dipping. See your jobber, or write direct.

KRYLON, Inc.

2601 North Broad St. Philadelphia 32, Pa.

TV CHASSIS TESTING

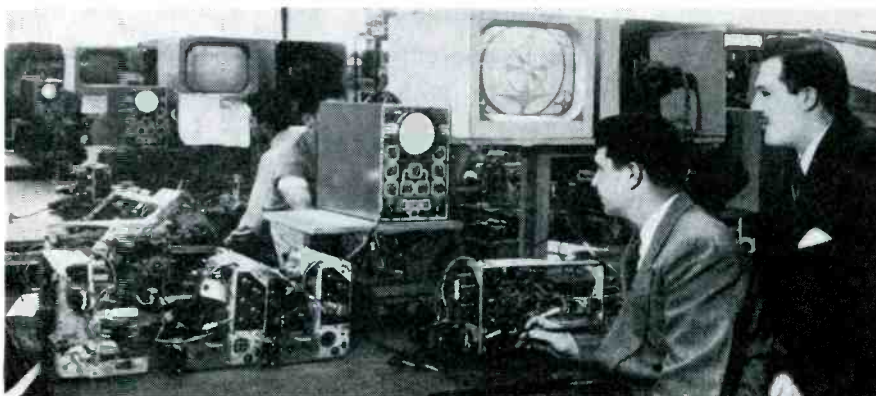

Servicing Helps

(Continued from page 43)

tuner assembly left hand strip when the tuner is viewed from underside of chassis. The normal AM-TV-phono switching action will then permit discharge of the .01 capacitor (in the AM position) and a momentary high bias voltage appears on the *avc* buss of the AM radio, thereby blocking any reception of the unwanted audio *chirp* of the horizontal oscillator.

Intercarrier Buzz Removal

Although intercarrier buzz is almost imperceptible in the Hallicrafters series 800 deluxe chassis, units have been encountered on rare occasions where the buzz was slightly audible. In those instances the following corrections have proved effective:

(1) Some chassis are equipped with two power transformers (due to shortage of single unit transformer) and location of the vertical output transformer is somewhat critical in these sets. Reorientation of the vertical output transformer (turning it to a slightly different position) can frequently make a great deal of difference in the amount of buzz noted, adjusting position for best results.

Lead Dress Arrangements

(2) Lead dress and component placement at terminals of the volume and contrast control should be arranged so as to prevent stray coupling between the two circuits. Coupling of contrast or volume circuit wiring must be avoided with elements of the brightness control circuit as portions of that circuit contain a strong vertical sweep output signal.

Sound-Disc. Transformer Adjustment

(3) Proper adjustment of the sound discriminator transformer secondary slug should be checked: this slug is accessible at top of transformer can. Adjustment should be made while listening to a TV station and set for minimum buzz and best audio response.

(4) Alignment of the video *if* stages should be checked for properly shaped response curve.

(Left)

Tele-Tone production engineer Sidney Wiesner testing TV chassis with an Eico 425 'scope in the *rf* test section of the new Tele-Tone Bayway, N. J., plant. Looking on is Harry R. Ashley, president of Eico.

Tube Substitutions

(Continued from page 23)

in all cases, but they have been found to be solutions on many occasions.

General Hints on Substitutions

In making substitutions, it is important to be careful in the mounting of resistors. Careful workmanship is imperative here. Resistors must never be placed under the chassis, where the heat radiated might cause damage to other parts. Many sets have been found with heavy resistors crammed in among coils, wiring, etc., where the heat had caused substantial damage, by melting wax, plastic wiring, etc.

Selenium rectifiers carry a dangerous potential on the edges of the plates, so they should be kept enclosed. If the cabinet doesn't have a back, one should be made or the rectifiers should be covered with a cage, made out of hardware cloth, soldered to the chassis. In short, in substitution work, you're going to be called upon to fulfill some of the functions of a designer; to add parts to a chassis not originally designed for them. How well you succeed, and how well the job performs, will be a measure of how good a craftsman you are!

Remote Tuner

(Continued from page 26)

plug and the coax socket can then be completely wired in and the bracket mounted to the rear of the tuner chassis.

The front plate, shown in Figs. 6 and 7, should be installed on the front part of the tuner. This enables the tuner itself to be supported by these brackets in the wood cabinet. Here, the dual concentric type control can be mounted; this is the last unit to be wired in. Number 20 gage steel should be used for the front and 18-gage steel for the rear bracket.

After completing the wiring and installation of all parts it is important to make sure that there is ample clearance for the turret assembly. Then the turret assembly can be reinstalled and the complete tuner checked for mechanical operation.

The layout of a cabinet suitable for use with this type of remote unit appears in Figs. 8 and 9. Made from $\frac{1}{4}$ " plywood and grooved for the T slide on the brackets, this houses the tuner unit without any additional bolts, nuts, etc.

[In a subsequent issue, data on the preamp hookup, volume and contrast control circuitry will be presented.]



A new SHURE family of crystal and ceramic fine-groove and standard cartridges

SPECIAL CRYSTAL MODEL W31AR and Ceramic Model WC31AR are unsurpassed for replacement of RCA "45" R.P.M. Changer Cartridges (ideal for $33\frac{1}{3}$ R.P.M. too)!

Unique needle design provides the easy needle replacement everybody has been looking for—and protects cartridge from mechanical shock.

THESE NEWLY DEVELOPED CARTRIDGES PROVIDE:
Easy Cartridge Installation • Maximum Fidelity • Easy Needle Replacement

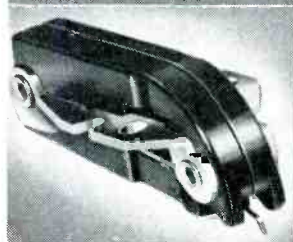

Universal, light-weight aluminum mounting ears will fit either $\frac{1}{2}$ " or $\frac{3}{8}$ " mounting.



Response-frequency characteristic designed to complement record response for maximum fidelity and minimum noise.

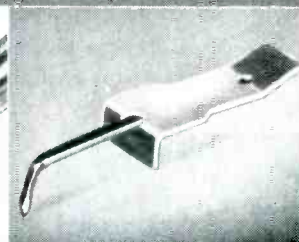

New, specially designed needle with broad shank and finger-nail grip bar. Long-life osmium point.

THIS NEWLY DEVELOPED SERIES OF CARTRIDGES

is the last word for first-place reproduction at low cost. So easy to install, the Serviceman will ask for them over and over again. High vertical compliance of the especially designed needle protects the crystal and ceramic elements from "drop-shock" damage.

Model	Type	List Price	Output Voltage	Needle Force	Shure Needle No.	Code
W31AR	Crystal 33 $\frac{1}{3}$ & 45 R.P.M.	\$6.50	2.1 V	7 grams	A53MG	RUGEB
WC31AR	Ceramic 33 $\frac{1}{3}$ & 45 R.P.M.	6.50	.65 V	7 grams	A53MG	RUGED
WC33B	Ceramic 78 R.P.M.	6.50	.75 V	9 grams	A52A	RUGEL
W36B	Crystal All-Purpose	6.50	2.5 V	9 grams	A56U	RUGEN
WC36B	Ceramic All-Purpose	6.50	.7 V	9 grams	A56U	RUGER

Shure Patents Pending.
Licensed Under Patents of Brush Development Co.

SHURE

SHURE BROTHERS, Inc. ★

Manufacturers of Microphones
and Acoustic Devices

225 W. Huron St., Chicago 10, Illinois • Cable Address: SHUREMICRO

PHOTOFACT Users Write Our Best ADS!

Hundreds of unsolicited letters tell what the world's finest Radio & TV Data means to Service Technicians



Samuel Goldish
Tulsa, Okla.

"PHOTOFACT is a priceless asset to any modern, well equipped service shop. I well appreciate the vast research that enters into compiling such a series . . . and the price set on each Folder is low indeed."



Edward N. Christner
Middletown, Ohio

"PHOTOFACT gives the answer to the question 'Can the one man service shop survive?' Yes! It's like having a whole crew of experts at your side."



Walter Vetromile
Malden, Mass.

"This is the best diagram layout I have ever seen. Anyone with only basic radio and TV training, using PHOTOFACT, should be able to maintain any set."

NOW! GET THE PROOF FOR YOURSELF!

FREE

We'll Send You a FREE Photo-
fact Folder on any postwar set
listed in the PF Index

Learn for yourself—at our expense—how PHOTOFACT pays for itself by earning bigger repair profits for you! Ask for a FREE Folder covering any postwar AM, FM or TV receiver listed in the PHOTOFACT Cumulative Index. Examine it. Put it to work at your bench—then judge for yourself!

WRITE FOR FREE FOLDER TODAY!

HOWARD W. SAMS & CO., INC.
2201 East 46th Street • Indianapolis 5, Indiana

TV Grounds

(Continued from page 28)

ground, in which case the resistance to ground would tend to be very high.

If the plumbing consists of metal pipes with good conducting joints throughout and these are tied in with a water system which covers an extensive area, this can be an acceptable ground connection. However, with this type of ground connection all of the plumbing pipes located within the building become a part of the system and a lightning discharge must either divide itself through these or otherwise find a shorter path to earth. If a lower resistance path such as water or gas pipes are closely adjacent to the plumbing, the high voltage may jump or arc across to the other pipes with the possible hazard of fire or explosion.

The method shown in Fig. 1 illustrates a safer practice with the grounding lead connected to the earth at a point outside the building. This connection may consist of a water pipe or a driven ground rod. A ground connected to a city water system provides a connection which usually has a very low resistance, but it is often inaccessible or in an inconvenient location. In rural areas, the extent of the water pipes in contact with the earth may be rather limited, particularly if supplied from a well and a satisfactory ground may not be readily obtainable. If the connection to a water pipe requires extending the grounding lead for a considerable distance, this can defeat the purpose of the ground, as the resistance and reactance of long leads will interfere with the quick discharge of the lightning currents to earth. Care should also be taken to insure that the connection between the pipes in the house and the main in the street is continuous. A jumper may sometimes be necessary at water meters because of gaskets and compounds which tend to give a high resistance at this point. For most installations, a driven rod therefore provides the simplest and most effective method of grounding the television antenna.

Ground rods for such installations should be of a non-ferrous, non-rusting type so as to resist corrosion when installed in the ground, thus providing a long life. The diameter of the rod is determined mainly by the mechanical rigidity required for driving. The effect of rod diameter on the electrical characteristics is negligible, as indi-

(Right)

Fig. 4. Procedure which can be used for driving a rod in a lawn several feet from the house.

GET RID OF B. O.* in TV Pictures!



*BARKHAUSEN OSCILLATION

When vertical black bars appear in TV pictures, as shown above, they are the result of Barkhausen Oscillation occurring in the horizontal sweep output tube (such as the 25BQ6, 6BQ6, 6EV5, 25EV5, 6AU5, or 25AU5, etc.). To correct this difficulty our engineers have developed the

PERFECTION B.O.*ELIMINATOR



B.O. ELIMINATOR
(Actual Size)

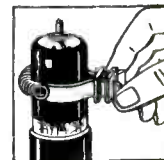

**EASY
TO INSTALL**
Just slip the B.O. Eliminator over the tube, move down, or up, or turn until the dark vertical bars disappear from the picture. Spring grip holds the Eliminator in place.

This compact device fits over the horizontal sweep output tube, and because it brings a concentrated magnetic field near the source of the Barkhausen Oscillation—namely the screen grid—it usually eliminates the oscillation and the black lines on the face of the picture tube. Service men who have used the B.O. Eliminator say it is the simplest and most positive method of getting rid of the vertical bars that they have ever known. They see a big demand by service men in maintaining the 10,000,000 TV sets now on the market.

Order Today from Your Supplier!

PERFECTION ELECTRIC CO.
2641 South Wabash Ave., Chicago 16, Illinois
Makers of Perfection Speakers, Ion Traps and
BeamAjuster TV Picture Centering Controls

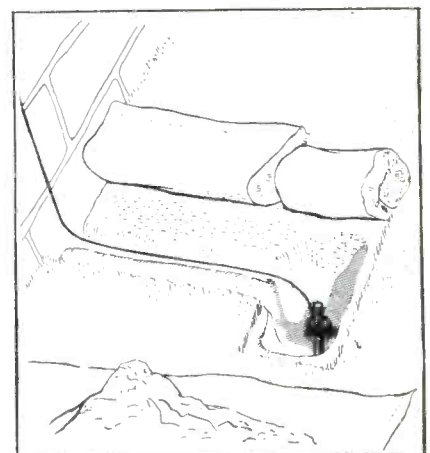

cated in the curves of Fig. 2. Comparing rods of $\frac{1}{2}$ " and 1" diameters, it will be seen that a 1" rod, with twice the diameter and four times the area and volume of earth displaced, decreases the resistance by only about 10%. It is economical to select the smallest diameter rod which meets the driving requirements for the location at which the rod is to be driven.

The length of the ground rod and the depth to which it is driven in the soil is the primary consideration. Long rods aid in obtaining reliable and effective low resistance ground connections. The chart, Fig. 3, illustrates the relation between depth and resistance for soil having uniform resistivity at all depth. In the usual field condition, deeper soils have a higher moisture content and the effect of depth on resistance is more pronounced.

From a practical standpoint, however, the rod lengths are often limited by other factors such as convenience in handling and driving, economic considerations, and the maximum depth to which a rod can be driven in a particular territory due to rock strata or other obstructions.

Soil conditions vary widely for different localities and a length which may be suitable at one location may not be applicable at another a short distance away. In addition, codes and local requirements may also specify certain requirements as to length. Consequently, rod lengths which are used for television antenna grounds will be found to vary widely throughout the different sections of the country.

In general, $\frac{3}{8}$ " x 4' rods have been widely used for television grounding. However, $\frac{3}{8}$ " x 6', $\frac{1}{2}$ " x 6', and $\frac{1}{2}$ " x 8' rods provide an added margin of safety and have also been used where shorter rods have proved inadequate or where driving conditions required larger and stiffer rods.

When installing a ground rod for a television antenna, it should be driven at a point well out from the building foundation. Rods driven too close to the foundation will often have high resistance. Where the rod has to be driven in the lawn several feet out from the house, the procedure shown in Fig. 4 can be followed.

The sod should be cut with a sharp spade on three sides of the point where the rod is to be driven and then should be carefully rolled back toward the fourth side. The dirt should then be removed to a depth of eight inches to a foot and the rod driven in this hole

(Continued on page 48)



**"BY GOLLY,
THERE GOES ANOTHER
CONDENSER, AND YOU CAN
BET YOUR SWEET LIFE
IT ISN'T A SPRAGUE!"**

Use dependable Sprague capacitors in every repair job.
The best costs no more!

Sprague Television Replacement Capacitors are designed to stand up in sweltering 185°F. chassis heat and give you the flexibility of small physical size. They can take it in any TV set!

Get your Catalog C-607-61 for the full listings of the complete Sprague line of Atom and Twist-Lok 'Lytics, Telecap Molded Tubulars, and tiny disc Cera-mites. Write today!

SPRAGUE

PIONEERS IN

SPRAGUE PRODUCTS COMPANY
(Distributors' Division of Sprague Electric Co.)
NORTH ADAMS, MASSACHUSETTS

ELECTRIC AND ELECTRONIC DEVELOPMENT

ATOM, TWIST-LOK, TELECAP, AND CERA-MITE ARE SPRAGUE TRADEMARKS

FREE TO TV SERVICEMEN THE LAST WORD IN TV 'TENNA INSTALLATIONS

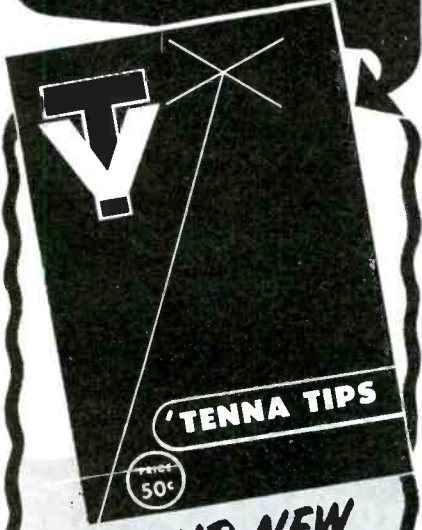

BRAND NEW AUTHORITYATIVE INFORMATIVE

Simplifies

TV-ANTENNA INSTALLATIONS

A fact-filled, pocket size reference manual edited by outstanding authorities. Packed with vital information on all types of antennas, Helpful Hints, Do's and Don'ts, Dimension Guide, Channel Frequencies, Proper Feed Methods and many other subjects.

LIMITED QUANTITY
 PUBLICATION PRICE 50c. AVAILABLE WITHOUT OBLIGATION IF YOU WRITE IMMEDIATELY. **FREE!**

MAIL THIS COUPON TODAY

SNYDER MFG. CO., Dept. N
 22nd & Ontario Sts., Phila. 40, Pa.

Please send free copy of TV 'TENNA TIPS

Name.....
 Address.....
 City..... Zone..... State.....

TV Grounds

(Continued from page 47)

to its full depth with the top about 4" or 5" below the level of the lawn.

To connect the grounding lead, a straight line toward the foundation should be cut with a spade and the sod rolled back carefully. A shallow trench should then be dug from the wall to the rod and the grounding lead placed in this and connected to the rod. If the rod has a pigtail, the grounding lead should be soldered to this pigtail. If a ground rod clamp is used, it should be of non-ferrous material such as brass or bronze so as to provide a copper-to-copper connection, thus avoiding corrosion. Clamps should also be of a heavy substantial construction so that when tightened they will not deform or bend out of shape, thus permitting the connection between the grounding wire and the rod to become loose.

After completing the installation and connection, the dirt and sod should be replaced and tamped so as to leave the lawn in its original condition. This method does take a very little more time than rough shod, careless grass destroying methods and the workman-like care is appreciated by the customer.

Tube News

(Continued from page 37)

charge circuit as a driver for the 6BQ6GT; any of the familiar sawtooth-generating devices may be used, provided it supplies a driving voltage of the proper amplitude and waveform to the grid of the 6BQ6GT.

Enough adjustment of the amplitude of the driving voltage must be provided in these circuits so that the condition of excess drive may be attained. Excess drive is characterized by the appearance of a bright vertical line near the center of the raster. The proper driving voltage is slightly less than that which just causes the bright line to appear.

For optimum circuit efficiency and picture linearity, the driving sawtooth must be somewhat nonlinear. It is possible to obtain a good sawtooth waveform by utilizing the normal exponential curvature of the sawtooth voltage developed by conventional drive circuits in which a capacitor is charged through a resistance. In practice, the desired waveform may be obtained by using the proper value of *B* supply voltage in the charging circuit.

Although it is easier to obtain a driving voltage of adequate amplitude

Presenting THE NEW Mueller NEEDLE CLIP

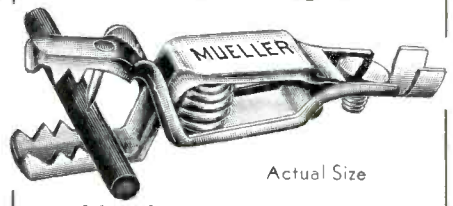

Actual Size

PIERCES INSULATION TO MAKE QUICK CONTACT

Solid bronze, non-corroding. Wire centers itself in notched jaw. Teeth on sides of jaw allow use for many other applications.

— USED IN —

- Electric and radio service shops
- Telephone and power company testing and maintenance
- Laboratory test work
- Hooking up truck trailer lights
- Field telephone and signal work

SEND FOR FREE SAMPLE AND CATALOG 810

Mueller Electric Co.
 1565 E. 31st St., Cleveland 14, Ohio

GET THIS FREE "W-J" CATALOG!

Thousands of Television Radio and Electronic Items at Your Finger-Tips!

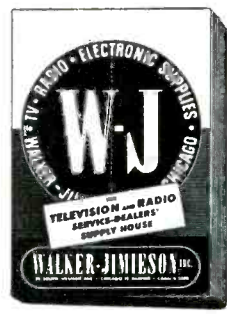

- Fast, Easy Selection
-
- Saves Time
-
- Saves Money
-
- Simplifies Parts Procurement

Complete buying guide for servicemen, dealers. New TV accessories, TV installation equipment, TV test instruments, tubes, radio accessories and other electronic supplies. Thousands of repair parts cross-indexed for quick, easy selection. Standard brands. Exact duplicate replacements. Fast, same-day shipment. Profit Guide sent only to those entitled to wholesale prices.

Send Coupon for Your Free Copy Now

WALKER-JIMIESON, INC. 485
 311 S. Western Ave., Chicago 12, Illinois

Please Send Your Free Profit Guide.

Name.....
 Company.....
 Address.....
 City..... Zone..... State.....

if the boosted B supply from the deflection circuit is utilized, two disadvantages result from the use of this supply. First, more power input to the deflection circuit is required because the drain from the boosted B supply is increased. Second, the regulation of the high-voltage supply is impaired slightly. The boosted B voltage decreases appreciably at high picture-tube beam currents, with the result that the amplitude of drive is decreased at high anode currents. The anode voltage is, therefore, further decreased.

Another method of obtaining the optimum driving waveform is to use degeneration in the cathode circuit of the 6BQ6GT. For the application of this method, it is necessary to start with a sawtooth voltage of reasonably good linearity. This requirement usually makes it mandatory that the sawtooth generator use the boosted B voltage supply. Also, the 820-mmf. discharge capacitor, C_{11} , must be returned to ground rather than to the 6BQ6GT cathode as shown in Fig. 1. The waveform of the driving voltage between grid and cathode of the 6BQ6GT will then be found to be altered by the use of a cathode-bypass capacitor which presents an appreciable impedance at the scanning frequency.

A further requirement of the driving voltage is that it cut off the 6BQ6GT rapidly at the end of each scanning cycle. Conventional blocking-oscillator discharge circuits complete the cutoff within a time equal to three per cent of the scanning period, a speed of cutoff which has proved to be adequate. If multivibrator or discharge-tube driving circuits are employed, it is necessary to use series-resistance peaking to increase the rapidity of cutoff.

1B3GT Filament Voltage

In this wide-angle circuit, the filament of the 1B3GT high-voltage rectifier is energized by a winding on the horizontal-deflection transformer. The voltage obtained from this winding depends upon the deflection energy delivered by the circuit.

The filament voltage of the 1B3GT may be measured with thermal-type instruments, or by a comparison of the brightness temperature of the 1B3GT filament under operation with that of a 1B3GT operated from a dc supply which can be accurately adjusted. The filament voltage-dropping resistor, if required, should be selected so that the filament voltage is approximately 1.25 volts with normal picture brightness and normal line voltage. In addition,

(Continued on page 50)

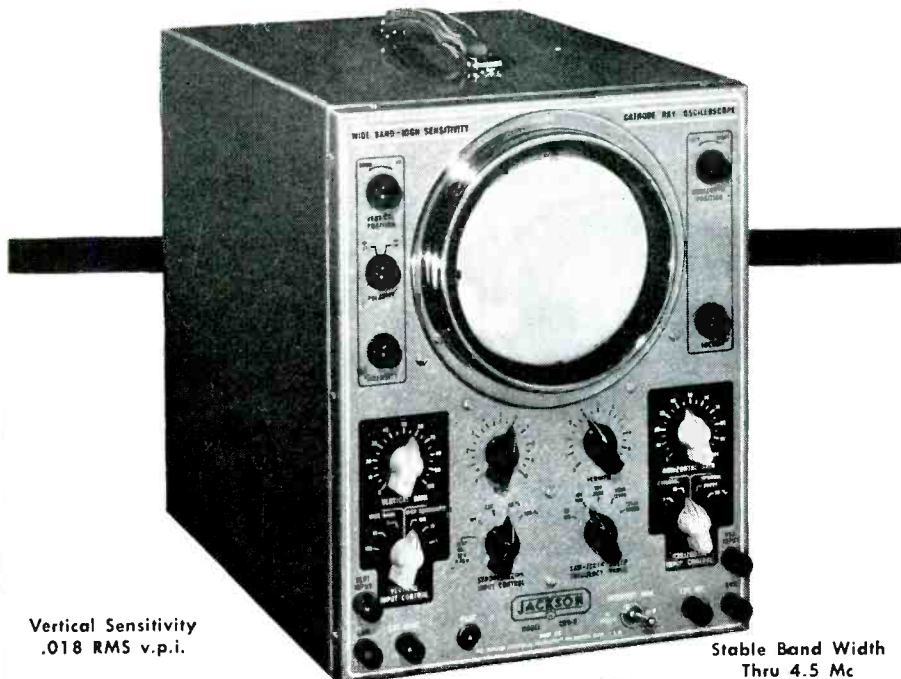

Vertical Sensitivity
.018 RMS v.p.i.

Stable Band Width
Thru 4.5 Mc

JACKSON Oscilloscope gives you "dual service"

This is a high-quality, laboratory-grade 5" Oscilloscope that provides the "dual service" of both high sensitivity and wide band width.

s p e c i f i c a t i o n s

Vertical Amplifier—Video-type frequency compensation provides flat response within 1.5 db from 20 cycles thru 4.5 Mc, dropping smoothly to a still useful value at 6 Mc.

Sensitivity Ranges—With a band width of 20 cycles thru 100 Kc, the sensitivity ranges are .018, .18, 1.8 RMS volts-per-inch. The wide band position 20 cycles thru 4.5 Mc has sensitivity ranges of .25, 2.5, 25 RMS volts-per-inch.

Horizontal Amplifier—Push-pull with sensitivity of .55 RMS volts-per-inch.

Input Impedances—Vertical: 1.5 megohms shunted by 20 mmfd. Direct to plates, balanced 6 megohms shunted by 11 mmfd. Horizontal: 1.1 megohms.

Linear Sweep Oscillator—Saw tooth wave, 20 cycles to 50 Kc in 5 steps. 60 cycle sine wave also available, as well as provision for using external sweep.

Input Voltage Calibration—Provides a standard voltage against which to measure

voltages of signal applied to vertical input.

Vertical Polarity Reversal—For reversing polarity of voltage being checked or for choosing either positive or negative sync. voltages.

Return Trace Blanking—Electronic blanking provides clear, sharp trace to prevent confusion in waveform analysis.

Synchronizing Input Control—To choose among INTERNAL, EXTERNAL, 60 CYCLE, or 120 CYCLE positions.

Intensity Modulation—60 cycle internal or provision for external voltage for intensity modulation uses.

Additional Features—Removable calibration screen—Accessory Model CR-P Demodulation Probe for Signal Tracing—All-steel, gray Ham-R-Tex cabinet. Total net weight only 26 pounds. Same height as other Jackson TV instruments: 13" H x 10 1/4" W x 15 1/8" D.

Prices: Model CR-2, Users' Net \$197.50
Model CR-P Probe, Users' Net \$9.95.

TWO OTHER FINE JACKSON INSTRUMENTS

Model 655 Audio Oscillator



Sine-wave 20 cycles to 200,000 cycles. Less than 5% harmonic distortion between 30 cycles and 15,000 cycles. Frequency calibration accurate within 3% or 1 cycle. Hum level down more than 60 db of maximum power output. Output impedances of 10, 250, 500, 5000 ohms or HI Z resistive output.

Model TVG-2 TV Generator



Sweep Oscillator in three ranges from 2 Mc thru 216 Mc, all on fundamentals. Reversible sweep direction. Sweep width variable .1 Mc thru 14 Mc. Marker covers 4 Mc thru 216 Mc. Crystal Oscillator to use as Marker or Callibrator. Video Modulation, from external source for using actual video signal for check, or for use with Audio Oscillator to produce bars for linearity checks.

See your electronics distributor for more information, or write

JACKSON ELECTRICAL INSTRUMENT CO. • DAYTON 2, OHIO
"Service Engineered" Test Equipment
IN CANADA: THE CANADIAN MARCONI CO.



Consecrated
to Quality Output and
Golden Rule Service

ASTRON

FIXED CAPACITORS

The three popular types here illustrated are specified by leading set makers, and they fit as perfectly into the SERVICE scheme. They are small . . . adaptable . . . the product of lifetime experience in Capacitor engineering. Use them with complete assurance of maximum satisfaction through, high standards of quality control.



MINIMITE—Metal tubular dry electrolytics—Compact, hermetically sealed capacitors with exceptionally low leakage—capable of withstanding high surge voltage—exceptionally long shelf life—ideally suited for under chassis mounting.

EY—Twist prong dry electrolytics—most popular type used by television and radio set manufacturers; simple to mount, specially processed for long-life operation at ambient temperatures up to 85° C.; Centrifuge electrolyte impregnation; spot welded cathode tabs; excellent stability; low leakage.

AM—Molded paper tubulars—designed for continuous operation at 85° C.; molded in high temperature, heat resistant plastic compound for perfect seal against most severe humid conditions; won't cold flow at 100° C.

WRITE FOR CATALOG AC-2

ASTRON CORPORATION

255 Grant Ave., East Newark, N. J.

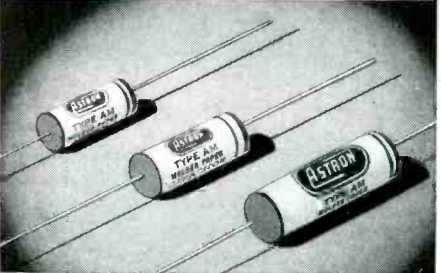

Tube News

(Continued from page 49)

the filament voltage should not exceed 1.5 volts under conditions of high line voltage and zero picture-tube anode current. The latter requirement normally necessitates some adjustment in the value of the resistor.

6BQ6GT Cathode Resistor

In these circuits the deflection tubes and receiver power supply must be protected in the event of failure of the horizontal-oscillator circuit. The plate dissipation of the 6BQ6GT increases when the drive voltage is removed, because the power input to the horizontal-deflection circuit increases and also because practically all the input is then dissipated in the tube. The tube currents, however, generally do not increase sufficiently to make the use of a fuse practical for the protection of the 6BQ6GT. The recommended method of protection, therefore, involves the use of a cathode resistance (usually 100 ohms) large enough to limit the current and dissipation in the 6BQ6GT to a safe value when the grid-resistor bias is removed. The 6BQ6GT can operate with a plate dissipation as large as three times the rated value of 10 watts for as long as five minutes with little danger of serious damage to the tube. When the proper value of cathode resistance is used, the power input to the deflection circuit does not change much when the drive is removed.

Vertical Deflection

One 6S4 is used in the vertical-deflection portion of the circuit. Because of the high *B* voltage available from the boosted *B* supply, a large step-down ratio is desirable in the vertical-output transformer to minimize current drain. A vertical-output transformer having a turns ratio of 18 to 1 has been found to provide ample vertical deflection with approximately 10 milliamperes of plate current. If the current drain on the boosted *B* supply is not kept below 12 milliamperes, the high voltage and the deflection width will be reduced.

Any of the conventional types of oscillators for vertical-deflection circuits may be used to drive the 6S4. Although there is danger of exceeding the peak plate-voltage rating (2,000 volts) of the 6S4, the peak voltage may be kept well within the rating if the wave form of the driving voltage applied to the 6S4s is proper.

Two vertical-deflection circuits using different oscillators are shown in Figs. 2 and 3; p. 37. To minimize peak volt-

VEE-D-X for the finest LIGHTNING ARRESTERS at the Lowest Prices



New!

**2-WIRE
RW-200**

only **125**
LIST

**4-WIRE
RW-204**

only **150**
LIST

The first and only arrester that will accommodate 4-wire rotor line as well as regular 2-wire transmission line.

The new VEE-D-X Model RW-200 is the popular low-priced arrester. Similar in design and construction to the RW-204. Two saw tooth contact points assure positive protection for any 2-wire installation.



**The Original 2-Wire
RW-300**

For use with 2-wire standard transmission line. An air gap plus resistor provide double protection. RW-300 is manufactured of moisture resistant Mica-fill Bakelite. RW-300A — highest quality thermo-setting plastic.



only **200**
LIST

LA POINTE-PLASCOMOLD CORP., WINDSOR LOCKS, CONN.

ages in the vertical output circuit, it is necessary to make the retrace time as long as practicable and to accomplish the retrace with a nearly constant rate of change of current in the yoke. For the circuits of Figs. 2 and 3, vertical retrace is completed in approximately three per cent of the field period. This duration of retrace is suitable for use with any standard duration of vertical blanking, which may be from five to eight per cent of the field period. Although peaking amplitude can be varied to adjust the retrace time, excessive peaking causes overshoots and ringing at the end of retrace, and insufficient peaking causes folding at the top of the raster. On the other hand, when the duration of the peaking pulse is varied to adjust retrace time, reasonably linear retrace can be maintained. In most of the designs for blocking oscillators in vertical-deflection circuits, it has been found that the peaking pulse is too brief and has to be increased in duration.

Linearity of Retrace

The linearity of retrace is influenced not only by the amplitude and duration of peaking, but also by the waveshape of the peaking pulse. Most blocking oscillators tend to produce a very rapid current change at the beginning of re-

trace and a large voltage peak results. Resistor R_4 (82,000 ohms) is used to correct this effect.

Ion Trap Magnet Alignment**

Of major importance in the installation of a TV set is the proper adjustment of the ion trap magnet on the neck of the picture tube. Improper positioning of the magnet may result in circular areas of discoloration developing on the face of the bulb, thus injuring the picture screen, even though the ions developed in the cathode section of the tube have been properly *trapped*. When the magnet is not in the correct position, the electron beam, instead of going through the aperture in the anode top disk, bombards the edge of the hole. The heat thus produced vaporizes the metal of the disk releasing gases which have a harmful effect on the operation of the tube. Some of this vaporized material may be deposited on the screen of the tube causing darkened areas.

To insure long life and satisfactory operation of the picture tube, the ion trap magnet must be adjusted immediately when the tube is installed in the set and, as a precaution, should be checked when the set is moved to a new location. If a permanent-magnet type is used, the magnet should be placed on the neck of the tube in the direction indicated by the marking on the magnet (usually an arrow which points toward the picture screen), so that the stronger magnet of the double magnet type is at the base end of the tube. This stronger magnet in the case of the double magnet type (or the only magnet in the case of the single magnet type) should be positioned over the internal pole pieces which are mounted on the gun structure for a tetrode tube, or over the gap in the gun structure for a triode tube. With the tube operating and with the brightness control adjusted for low intensity, the magnet should be moved a short distance forward and backward, at the same time rotating it to obtain the brightest raster.

Magnet Checks

If, in obtaining the brightest raster, the ion trap magnet has to be moved more than $\frac{1}{4}$ " from the internal pole pieces or if it is pushed against the focus coil, the magnet is probably weak and a new magnet should be tried. As a final check, for the tetrode tube, the ion trap magnet should again be adjusted for maximum raster bril-

(Continued on page 52)

**Based on notes prepared by the Sylvania Electric Products, Inc.



**ENGINEERED AND
MANUFACTURED BY**

TELREX

**TO OUTPERFORM ANY
COMBINATION OF CUT-TO-
FREQUENCY TV ANTENNA**

- **Longer Range**
- **All-Channel Reception**

For best reception in any TV area, depend on the antenna that's proven by actual performance to afford longer range and all channel reception everywhere. Near or far, you'll be sure of getting all the performance built into the receiver, with a genuine TELREX "CONICAL-V-BEAM"

**MORE THAN
1,000,000
INSTALLED
TO DATE!**

The fact that TELREX installations have exceeded the million mark is proof of their finer performance nation wide. Dealers and service men know from experience that TELREX superiority eliminates antenna failures, cuts call-backs to the bone and assures consistently better picture quality.

**CONICAL-V-BEAMS
ARE AVAILABLE IN
MODELS FOR EVERY
TYPE OF SIGNAL AREA**

WRITE FOR CATALOG

*Registered
Trademark

THE "CONICAL-V-BEAM" IS PRODUCED UNDER
PATENT NO. 2518297 - OTHER PATENTS PENDING

telrex INC.
CONICAL-V-BEAMS

AMERICA'S
STANDARD OF
COMPARISON

ASBURY PARK 4, N. J.

THE SKILL
TO DESIGN
THE FACILITIES
TO PRODUCE
THE ABILITY
TO DELIVER

Beat the Tube Shortage!

This invaluable book shows you how to keep radio and TV sets working . . . even though exact replacements are unavailable.

RECEIVING TUBE SUBSTITUTION GUIDE BOOK



For TV-AM-FM Receivers and Allied Equipment
by H. A. Middleton

2500 Radio and TV tube substitutions listed: TV receiver filament wiring; heater substitution wiring instructions; tube types classified by functions. Other priceless data you must have in order to keep your shop as well as receivers going. Get this book without further delay.

215 pages, 8 1/2 x 11, durable paper cover.
Only \$2.40

All About Antennas

No other book so thoroughly and clearly explains theory and practical aspects of TV antennas . . . a money-maker for you.

TV and OTHER RECEIVING ANTENNAS (Theory and Practice)



by Arnold B. Bailey

A "must" reference book on all types of receiving antennas. If you have any questions, you'll find all the answers in this volume. It incorporates 50 data pages, never before published, on approximately 50 different basic types of antennas. Shows which type is best . . . what it can do . . . and how to use it. Technician, teacher, student, engineer — all can use this book. And it's readable because mathematics has been translated into charts and graphs.

595 pages, 310 illustrations. . . . Only \$6.00

About Master Antennas

Master Antenna Systems are a big business. Make sure you get your share by making sure you know all about installations.



TV MASTER ANTENNA SYSTEMS

by Ira Kamen and Richard H. Dorf

More than 50 million dollars will be spent in 1951 for TV Master Antenna Systems installed in apartment buildings, hotels, hospitals, institutions, etc. . . . in both new and old buildings. This book provides a practical working manual that deals with installation, usage, maintenance, etc. It shows how the Master Antenna System is installed, how it works, and how you can capitalize on this fast-growing field.

356 pages. 234 illustrations. Cloth bound.
Only \$5.00

All About the Scope!

WHAT it is . . . WHAT it can DO . . . and HOW to use an oscilloscope PROPERLY for greater profit to you!

ENCYCLOPEDIA ON CATHODE-RAY OSCILLOSCOPES AND THEIR USES

by John F. Rider and Seymour D. Uslan

The ONLY book that so fully describes the oscilloscope . . . its applications in servicing, engineering, research . . . with thousands of time-saving and labor-saving references, charts, waveforms, etc. More than 70 different models are described with specifications and wiring diagrams. WE GUARANTEE that it will EARN many times its cost to you. 992 pages, 8 1/2 x 11. 500,000 words, 3000 illustrations. 22 chapters. Completely indexed, easy to read. Cloth bound.



Only \$9.00

At Your Jobber's or ORDER DIRECT on a 10-DAY MONEY-BACK GUARANTEE.

JOHN F. RIDER PUBLISHER, Inc.
480 Canal Street • New York 13, N. Y.

Tube News

(Continued from page 51)

liance, this time with the brightness control set to obtain a raster of slightly above average brilliance and with the focus adjusted for a clear line structure to simulate actual operating conditions with a picture. For the triode tube the proper functioning of the ion trap depends on anode voltages, so that it is important that it be adjusted, progressively increasing the brightness slightly each time until the brightness corresponds to normal viewing brilliance.

The ion trap magnet should never be moved to remove a shadow from the raster if by so doing the intensity of the raster is decreased. In such a case the shadow should have been eliminated by moving the focus or deflecting coils. The ion trap magnet should always be in the position to give maximum raster brilliance.

If the electromagnetic type ion trap magnet is used, it should be placed on the neck of the tube with the larger magnet over the internal pole pieces and nearest the base, and adjustment for brightest raster obtained by rotating the magnet and adjusting the current through it. The effect of current variation is the same as longitudinal movement of the permanent magnet type. The longitudinal position of the permanent magnet type or the current applied to the electromagnetic type is dependent upon the voltage applied to the tube and may vary for the same type of tube from one receiver to another.

If a raster is not obtained in a few seconds using the foregoing procedure, the set should be turned off and checked to make sure that the ion trap magnet is positioned according to the manufacturer's instructions or markings. If the desired results cannot be obtained, it is suggested that a new magnet be tried.

If the picture tube has just been installed or the set has been moved, it is imperative that the brightness control be kept low until after the initial adjustment of the magnet and also that adjustment of the magnet be made immediately when the set is turned on. It is important that the intensity of the beam be low when the set starts operating, if the magnet has not yet been adjusted, because tubes have been ruined in 15 seconds of operation due to the ion trap magnet being out of adjustment and the intensity being set too high. By keeping the intensity low, the beam current is low enough so that the electron beam is not likely

You need it! Get it...Now!

New Rider TV Manual . . . VOLUME 6



at your nearby Jobbers' today! Hurry in for your copy before the present supply is exhausted!

EXCLUSIVE FEATURES

- All TV Production Runs and Changes from August, 1950 Through January, 1951.
- Circuit Function Descriptions.
- Unpacking and Installation Data.
- Signal Waveforms for Trouble Shooting.
- COMPLETE Alignment Data.
- COMPLETE Parts List.
- Circuit Changes.

RIDER TV MANUAL...Vol. 6

ACCURATE . . . AUTHENTIC . . . FACTORY-AUTHORIZED TV servicing information direct from 66 manufacturers. BIG 12"x 15" page size, and all pages filed in proper place. Large, easy-to-read diagrams. Equivalent of 2320 pages, (8 1/2" x 11") plus Cumulative Index Volumes 1 through 6. . . . \$2400

With all 6 RIDER TV MANUALS on your shelves you will have the world's greatest compilation of TV servicing information — right at your fingertips. This information will save you time, save you trouble, help you do a better servicing job, and help increase your profits. SEE YOUR JOBBER TODAY!

Now Available! RIDER Manual . . . Vol. XXI



Here's another RIDER volume that you must have on your shelves...another time-saver . . . another money-maker for you! Factory-authorized servicing information from 61 manufacturers . . . AM-FM,

Auto Radios, Record Changers, Disc Recorders, Tape Recorders. Coverage from December, 1949 through October, 1950. 1648 pages plus Cumulative Index Volumes XVI through XXI. . . . \$2100

Every Day, More and More Servicemen Buy RIDER MANUALS For PLUS Profits!

JOHN F. RIDER PUBLISHER, Inc.
480 Canal Street • New York 13, N. Y.

to damage the anode top disk before the magnet is adjusted. The amount of damage that is done to the tube is a function also of the voltage applied to the tube; therefore, tube types which operate at high voltages may be ruined more easily than those operated at lower voltages.

To assure the magnet staying in place after it has been adjusted, care should be taken that the magnet fits the neck of the tube securely. If it is at all loose, a small piece of rubber placed under the clamps or a piece of friction tape wound around the clamps should prevent the magnet from slipping.

Ion-Trap Alignment Import

The procedure for aligning the ion trap magnet should not be omitted just because the set seems to be operating satisfactorily; it is not always safe to assume that the magnet is still in adjustment if the set has been transported. Even with the magnet poorly aligned a good picture can be obtained but within a short time circular darkened areas will appear on the screen.

Picture-Tube Conversion

A picture tube conversion and replacement chart, which lists the characteristics of all picture tube sizes from fourteen through twenty inches (both round and rectangular) and portrays graphically the circuit and component changes which must be made in order to convert to any desired size, is now available.‡

Chart is currently being released without charge, to part jobbers for free distribution to Service Men customers.

‡Tel-O-Tube Sales Corporation, 580 Fifth Avenue, New York 19, N. Y.

AT SYLVANIA INSTRUMENT MEETING



Clarence L. Simpson, radio and TV service engineer for Sylvania Electric, demonstrating trouble-shooting procedures for TV receiver sweep circuits at the first TV Service Men's meeting of '51 at Baltimore, cosponsored by Sylvania and the Radio Electric Service Company.



Hi-Lo at the OPERA

Feature the Hi-Lo TV Spiral ANTENNA

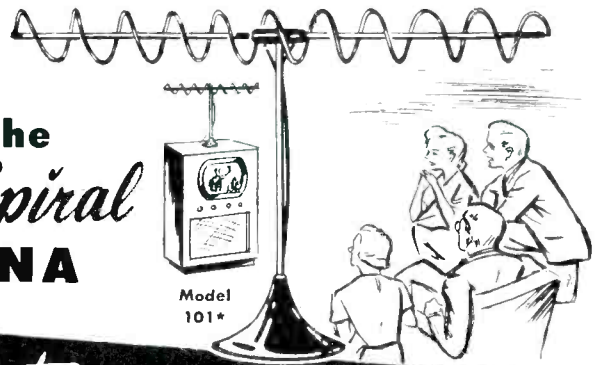

Model 101*

for the best indoor TV reception!

You will actually want to wear white tie and tails with the vivid portrayal of the finest operatic scenes . . . brought to fullest realism by the remarkable reception of the revolutionary Hi-Lo TV Spiral Antenna.

Here is the completely different indoor TV Antenna that will completely satisfy your customers. Your profits will rise with this new high in fidelity.

ORDER Hi-Lo TV Spiral ANTENNAS today!

Don't forget . . . the HI-LO OUTDOOR TV SPIRAL ANTENNA!

*U. S. Patent No. 2,495,579
Canadian patents 1951

\$9.95
LIST PRICE

Hi-Lo TV Spiral Antennas are sold through recognized jobbers.



ONLY Hi-Lo provides complete powerful, localized advertising support. Write for full particulars.



Ser-Cuits

(Continued from page 38)

ating point, and an integrating network provides the correct sawtooth waveform revolving around a zero axis. The sawtooth voltage thus developed is both positive and negative, and is applied to pins 5 and 7 of the phase detector tube.

The sync pulses and the sawtooth waveform are superimposed on each other in the phase detector. The amplitude of each sync pulse and the sawtooth wave remain the same, but any phase shift between the two causes a variation in the *dc* voltage developed at the junction of a pair of 100,000-ohm resistors, R_{6c} and R_{67} .

When both the horizontal oscillator and incoming sync are at the same frequency, they are properly phased and the amplitudes of the waveform in each section of the phase detector are equal. Each diode, therefore, conducts equally and the *dc* voltages across the two load resistors, R_{6s} and R_{67} , are equal but opposite in polarity. The voltage developed at the junction of these resistors is therefore zero. Since the output is zero, no change in grid bias takes place and there is no change in the oscillator frequency.

If the horizontal oscillator is *higher* in frequency than the incoming sync pulse, the sawtooth voltage being applied to pins 5 and 7 of the 6AL5 will be in the positive portion of its cycle by the time the sync pulses arrive on pins 1 and 2. This places a negative sync pulse on pin 1, equal amounts of positive sawtooth voltage on pins 5 and 7 and a positive sync pulse on pin 2, allowing more current to flow through the pin 1 and 7 section of the 6AL5. The result of this is a *positive* voltage at the junction of R_{6s} and R_{67} , which makes the grid (pin 4 of 6SN7GT) more positive and *slows down* the oscillator frequency.

If the horizontal oscillator is lower in frequency than the incoming sync pulse, the sawtooth voltage being applied to pins 5 and 7 of the 6AL5 will now be in the negative portion of its cycle at the time the sync pulses arrive on pins 1 and 2. This places a negative voltage on pins 5 and 7, instead of the positive potential that was there in the previous condition, and more current flows through the pin 2 and 5 section of the diode. The voltage developed at the junction of R_{6s} and R_{67} will now be at a *negative* potential, making the grid (pin 4 of the 6SN7GT) more negative and *speeding up* the oscillator frequency. A 4700-ohm resistor, R_{6s} , provides a *dc* return



Planet Quality Starts Here!

Basic quality control of finished condensers starts with the original design. Recognition of this fact has made Planet condensers a first choice among top engineers everywhere. For Planet electrolytics are laboratory-engineered—each design “spec” carefully worked out under the personal direction of an electrochemical engineer. His many years’ experience **exclusively** in design, manufacture and application of electrolytic capacitors are at your disposal. The attention given to the design of all Planet capacitors by specialists in a specialized field gives them the consistently high, **special** quality for which the Planet trademark stands.

Get complete information. Write today for our latest catalogue, C-2.

PLANET MANUFACTURING CORPORATION
225 Belleville Avenue, Bloomfield, N. J.



DOUBLE BAY CONICAL

No. 1214	3/8" seamless aluminum tube elements.
No. 1230	3/8" butt seam aluminum tube elements.
No. 1233	1/2" butt seam aluminum tube elements.
Quantity	1214 1230 1233
1	\$11.29 \$9.56 \$11.55
6	10.54 8.92 10.79
24	9.08 7.72 9.30
18 bulk pack	8.75 7.39 8.97

SINGLE REFLECTOR CONICALS

No. 1259	Single Bay 3/8" elements	\$3.90
No. 1256	Single Bay 1/2" elements	4.69
No. 1254	Double Bay 3/8" elements	8.15
No. 1253	Double Bay 1/2" elements	9.65
No. 1257	Four Bay 3/8" elements	18.15
No. 1253	Four Bay 1/2" elements	20.99

NO. 1905 MAST SNAP-ON FOR 1/4" MAST

1, .06, 100, .04, 1,000, .036 ea.

FOUR BAY CONICAL

No. 1226	3/8" seamless aluminum tube elements	Price Each
No. 1231	3/8" butt seam aluminum tube elements	Price Each
No. 1234	1/2" butt seam aluminum tube elements	Price Each
Quantity		
1	\$23.87	\$20.85
6	22.28	19.53
12	19.25	16.83

NO. 1873 3/2" MAST STAND-OFF INSULATOR

1, .08; 50, .07; 100, .065; 1,000, .06 ea.

FIVE ELEMENT TELEVISION YAGI

No. 1302 to 1313 Order as follows:
1302 for Channel 2, 1303 for Channel 3 etc.

Quantity	1	3	10	24
No. 1302 to 1306	\$13.62	\$12.71	\$12.10	\$10.75
No. 1307 to 1313	5.45	5.08	4.72	4.30

ECONOMY FIVE ELEMENT TV YAGI
(Butt seam elements)

Quantity	1	6	12
No. 2002-2006	10.62	9.90	8.60
No. 2007-2013	3.93	3.70	3.10

Check These Low Prices

No.	Description	Quantities of	Price
1221	H1 Channel Adapter	24	\$1.50 ea.
1222	H1 Channel Conical	24	2.26 ea.
1225	H1 Channel F.D. stacked array	24	2.75 ea.
1227	4 Bay H1 Channel conical	24	9.89 ea.
1228	Straight Low and Ref.	12	2.88 ea.
1238	F.D. & Ref. H1 Channel	24	1.51 ea.
1240	Single section conical	24	1.67 ea.
1246	Folded Low and Ref.	12	3.47 ea.
2109	1/2" carbide drill	1	1.31 ea.
2110	3/8" carbide drill	1	1.57 ea.
2111	1/2" carbide drill	1	1.97 ea.
2112	2 1/2" lead anchor bolts	100	5.09 ea.
1801	3 1/2" turnbuckle	12 for	1.00
1802	4 1/2" turnbuckle	12 for	1.06
1803	5" turnbuckle	12 for	1.58
1804	7 1/2" turnbuckle	12 for	3.95
1886	12" wallbracket Aluminum	6	1.89 pr.
1889	1/2"x1 1/2" lag bolts	10 for	.35
1890	1/2"x2" lag bolts	10 for	.40
1891	1/2"x3" lag bolts	10 for	.45
1896	4/20 steel guy wire	.55 per	100 ft.
1911	Straight High and Ref. Antennas below have 3/8" butt seam elements	12	1.40 ea.
1245	Straight Low and Ref.	12	2.42 ea.
1247	Folded low and Ref.	12	2.95 ea.
1248	H1 Channel F.D. & Ref.	12	1.27 ea.

NO. 1215 FOLDED-HI FOLDED-LO ALL CHANNEL ANTENNA

1, \$5.37, 6, \$4.98, 24, \$4.24.

NO. 1243 FOLDED-HI FOLDED-LO BUTT SEAM ELEMENTS

1, \$4.75, 6, \$4.43, 24, \$3.87.

Send for Catalog
REQUEST QUANTITY PRICE ON ANY ITEM

TELEVISION SUPPLY CO.
BOX 213, Dept. S
GRACIE STATION, NEW YORK, N. Y.

for the 6SN7GT, if the 6AL5 should fail or be removed from the socket.

RF System

The tuner in this chassis is of a rotary switch type, made up of a series of coils in cascade, which bridge the contacts of a 4-section switch.

The *rf* amplifier may be a 6AG5, 6CB6 or 6BC5. The plate is coupled to the grid of the 6J6 mixer by three capacitors .22, .68 and 1.8-mmfd units (C_{504} , C_{505} and C_{507}). The *rf* test point is used to check the *dc* voltage developed by the oscillator injection voltage. It may also be used for 'scope connections to examine the response curve of the *rf* system, with a sweep generator connected to the input terminals.

One-half of a 6J6 is utilized in a Colpitts type oscillator circuit. Frequency is controlled by varying the amount of feedback from plate to grid. There are two oscillator adjustments accessible from the front of the tuner, for the high and for the low bands. The fine tuning capacitor has sufficient range so that it is unnecessary to provide individual adjustments for each channel. Capacitive coupling is used to inject oscillator voltage into the mixer circuit. A 10-mmfd capacitor, C_{512} , bypasses the higher harmonics or any spurious oscillations produced in the oscillator. The output voltage of the mixer is developed across a load resistor and fed to the first *if* amplifier through a series tuned circuit.

IF System

A quadruple stagger-tuned, three-stage amplifier with crystal detector comprises the *if* system. Quadruple stagger tuning is used to achieve the maximum possible gain for a bandwidth of 3.6 mc within 6 db.

A unique feature of the *if* system is the design of the *if* transformers. The coils are bifilar wound (two windings interwound) with triple insulated wire. This type of winding approximates unity coupling and gives the effect of a single tuned coil. A number of advantages are derived from such an arrangement. Improved filtering of all plate and grid returns can be achieved since the bypass capacitors can be returned to the same ground as the associated cathode. It is also possible to keep the time constant in the grid circuit of each amplifier down to a low value to minimize charging of the grid circuit by heavy noise pulses, permitting picture information to be transmitted continuously through the *if* system. Unbypassed cathode resistors are

(Continued on page 56)



A. A. GHIRARDI

GHIRARDI SCORES AGAIN!

JUST OUT!

Radio and Television RECEIVER CIRCUITRY AND OPERATION

... your key to faster, more profitable servicing

Why? . . .

Why is a high-transconductance, low capacitance tube best for TV and FM receiver r-f amplifiers? How is a grounded-grid r-f amplifier connected? Why is this circuit so popular in TV? What is a "squelch" system? How many types of discriminators are used in FM receivers, and what are their circuits. Such are just a few of thousands of questions answered in this great book.

It pays to know!

Here are the basic circuit and design fundamentals covered:

- Amplitude Modulation and AM Signals
- Frequency Modulation and FM Signals
- RF Amplifiers and TRF Receivers
- AM Superheterodyne Receivers
- AM Detectors and AVC Systems
- FM Receivers
- Push-Button Tuning and AFC Systems
- Audio Frequency Amplifiers
- Loudspeakers
- Radio Receiver Power Supply Systems
- Television Receivers
- Receiving Antenna Systems
- Home Recorders
- Phono Pickups & Record Players
- Automatic Record Changers
- Mechanical Construction of Receivers, etc.

LEARN BASIC RADIO AND TV CIRCUITS FROM A TO Z

. . . and watch service troubles disappear

Actually, there are only a few really basic circuits in radio and TV receivers. Learn these from A to Z and even the most complicated of the countless modern circuit variations won't bother you. You'll work faster, better—and a lot more profitably!

Backed with what you can learn from A. A. Ghirardi's great new book, RADIO AND TELEVISION RECEIVER CIRCUITRY AND OPERATION, you'll find that nine out of ten difficult service jobs are tremendously simplified. Starting with a clear explanation of AM and

FM processes and characteristics, it progresses to a complete understanding of ALL basic circuits, shows how they operate, teaches you to recognize them quickly. Guesswork is eliminated. Laborious testing is greatly minimized. By making it easy for you to understand each circuit and its relation to other circuits, Mr. Ghirardi helps you go right to the seat of the trouble with far less time and effort. You work faster! You keep abreast of new developments with less time, money and effort!

HELPS YOU HANDLE TOUGH JOBS IN HALF THE USUAL TIME!

You'll know what to look for—and you'll have what it takes to enable you to repair troubles faster and more efficiently. In short, Ghirardi's 688 page RECEIVER CIRCUITRY AND OPERATION is the ideal book for the man who knows that the day of the "screw driver and pliers" service man is a thing of the past—that the way to get ahead

these days is to be equipped with the real "know how" of the job that spells more efficient work, better jobs and bigger pay!

Send coupon today. Our 10-day Money-Back Guarantee protects you fully. If not more than satisfied, return book and your \$6 will be refunded promptly!

10 DAY MONEY-BACK GUARANTEE

Dept. S-41, RINEHART BOOKS, INC.,
Technical Division,
232 Madison Ave., New York 16, N. Y.

- Enclosed find \$6 (\$6.50 outside U.S.A.) for Ghirardi's new RADIO AND TELEVISION RECEIVER CIRCUITRY AND OPERATION book; or
- send C.O.D. and I will pay postman this amount plus a few cents postage. If book is not satisfactory, I will return it in 10 days and you guarantee to refund my \$6. (Cash only outside U.S.A.—same return privilege.)

Name

Address

City, Zone, State

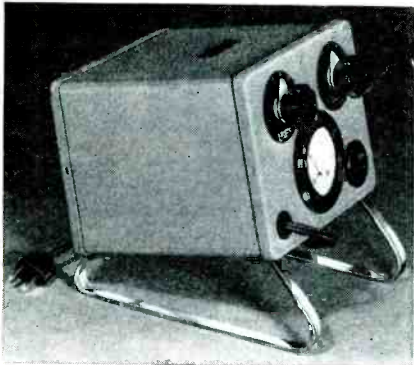

Halldorson's VARIVOLT MASTER

Voltage Adjusting Isolation
Transformer Model N-202

A new, larger capacity transformer that provides positive control of your voltage fluctuations—better than ever, and *safer* because it isolates you from your work. Raises voltage or lowers it—in 1½ volt steps—high for locating weak points, low for testing under minimum conditions. Handles the smallest or largest servicing job, even up to 20" TV Combinations!

A Complete Line of
Television and Radio Transformers

- Vertical Output Transformers
- Horizontal Blocking Oscillator Transformers
- Vertical Blocking Oscillator Transformers
- Plate and Filament Transformers
- Stepdown Transformers

Write for Free Catalogue

The Halldorson Co. 4500 N. Ravenswood, Chicago 40, Illinois

Halldorson
Vacuum Sealed Transformers

Ser-Cuits

(Continued from page 55)

used in the first two stages to minimize the variations of input capacity with *agc* voltage changes. The first two *if* stages are in cascade, with the first *if* receiving its plate and screen voltages from the cathode of the second *if*. Because of this arrangement, the first *if* tube controls the second. When a strong signal is applied to the grid of the first *if*, it causes a greater flow of plate current which in turn reduces the plate voltage. Since the plate is connected to the cathode of the second *if*, this cathode voltage is also reduced and consequently causes a greater flow of current in the second *if*. When a weak signal is applied to the grid of the first *if* stage, less current flows and the plate voltage increases. This also increases the cathode voltage of the second *if* and decreases its current flow.

The advantage of this circuit is that both stages are in series, making the overall impedance extremely high and therefore providing higher gain than obtainable with conventional circuits. Less power is consumed since the second *if* tube is effectively used as a plate load resistor, and the dissipation that normally takes place across a load resistor is utilized for amplification by the second *if*.

A 1N60 is used as the video detector. The detector load resistor is small in order to minimize attenuation at the higher video frequencies.

Design of the *if* system provides for an overall response curve which is flat topped with a bandwidth of at least 3.6 mc within 6 db. down from peak response. The band center is approximately 23.95 mc.

Video Amplifier

The video amplifier may be either a 6AH6 or a 6AC7, with the associated wide-band, low-pass filters. The out-

THE WORLD'S LEADING TWIN LEAD TELEVISION LIGHTNING ARRESTER

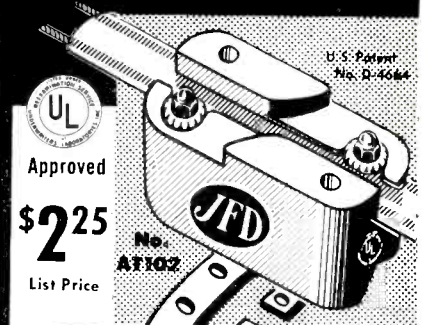

completely waterproof

JFD SAFE TV GUARD

Protects television sets against lightning and static charges. Simple to install everywhere and anywhere... no stripping, cutting or spreading of wires. More than 500,000 in use today!

See your jobber or write to —

JFD MANUFACTURING CO., INC.
6109-D 16th Ave., Brooklyn 4, New York
FIRST in Television Antennas and Accessories

put of the crystal detector is *dc* connected to the grid of the video amplifier through a filter circuit comprising a series and a shunt peaking coil.

The contrast is controlled by changing the amount of degeneration in the video amplifier. This is accomplished by varying a 1,000-ohm control, R_{12} , in the cathode circuit.

DC Restoration Omitted

No *dc* restoration is necessary at the output of the video amplifier because the entire video amplifier is direct coupled from the output of the crystal detector to the cathode of the picture tube. Therefore, the rectified video signal does not vary about an *ac* axis.

It will be noted that the polarity of the detector is such that a negative sync signal is applied to the grid of the video amplifier, resulting in a positive sync signal at the plate which is applied directly to the cathode of the picture tube.

Sentinel Tuners

In a tuner used in the Sentinel 425, 428, 432, 1U425, 1U428 and 1U432, provisions are made for the use of either of three tubes in the *rf* amplifier and mixer stage; 6CB6, 6AG5 or

FOR ORIGINALITY

LOOK TO XCELITE

What's The Right Screwdriver To Use?

IT'S THE ONE THAT'S
MADE FOR THE JOB!



DID YOU KNOW that using the WRONG size or type blade harms both blade and screw? In the XCELITE line, you can get the RIGHT screwdriver for every job—genuine Phillips, standard, Reed & Prince, clutch type, in the size you need. All are unreservedly guaranteed. Have your dealer show you XCELITE for best work on your job!

Quality Tools
PREFERRED BY EXPERTS

PARK METALWARE CO., INC.

DEPT. V

ORCHARD PARK, N. Y.

6BC5. The pin connections for all of these tubes are identical. However, there are some differences in inter-electrode capacities and gain. The 6CD6 provides most gain, the 6BC5 is next in gain, followed by the 6AG5.

The manufacturer notes that only the same type of tube should be used for replacement. They state that intermixing of these tubes may result in loss of sensitivity caused by the differences in tube capacities detuning the circuits, making it necessary to realign the *rf* amplifier and modulator stages by spreading or squeezing turns on the coils. The use of 6CB6s is not recommended in the video *if* stages in place of the 6AG5 because of the possibility of oscillation.

Tube Substitute Tests

However, in these days of tube shortages many Service Men will no doubt try any of the three types which may be available. It is possible that a trial of several may give satisfactory performance without the need for realignment. In view of the foregoing warning, though, it is important to check operation carefully on all channels when a substitute tube is used.

JENSEN ALNICO V SCRAP DRIVE LAUNCHED

A drive to salvage alnico V magnetics from discarded loudspeakers to provide a few more additional alnico V *pm*'s to the industry, was announced recently by Jensen Manufacturing Co., Chicago, Ill.

Salvage boxes will be displayed in jobbers' headquarters throughout the country. Service Men will be asked to bring their old speakers in and place them in these boxes. A record of the number of speakers contributed will be kept by Jensen and a special allocation made in consideration for the contributions.

Jensen is providing banners and other promotion material which is being designed by the Burton Browne Advertising Agency for this campaign. The Jensen factory will pay the freight on all discards returned to them. Jobbers are to send speakers in as large as 100 pound lots. As these are scrap, no special packing will be necessary.



Bill Schoning, prexy of Lukko Sales, Burton Browne and Thomas A. White, Jensen president, at Lukko headquarters in Chicago, inaugurating the Jensen alnico V scrap drive.

Just one cartridge to carry!

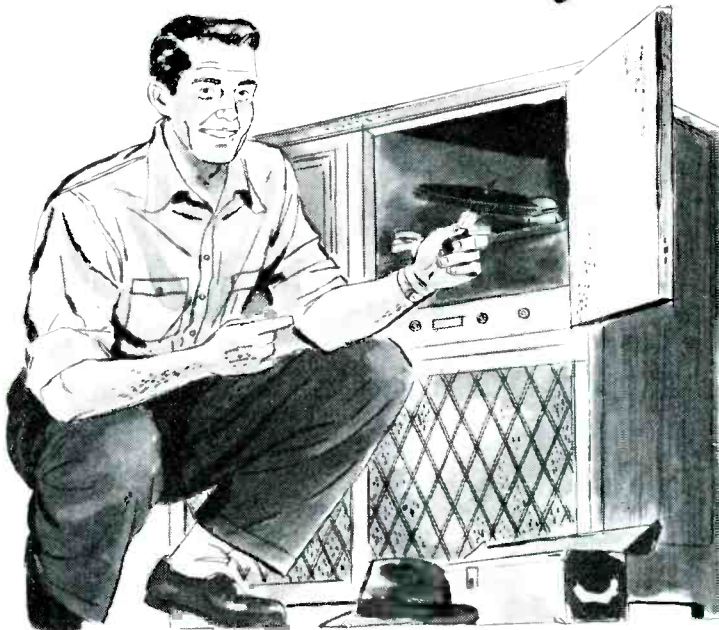

WEBSTER ELECTRIC

"Featheride"

Model W. S.*

CARTRIDGE

replaces over 50

current models!

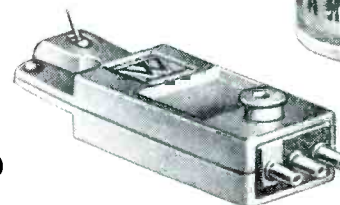

FEATURES

- Three-terminal construction provides either 1½ volts or 4 volts at ¾ ounce tracking pressure.
- May be installed in any ½" standard RMA tone arm.
- Complete with factory-tested, osmium-tipped removable needle for 78 r.p.m. records.
- Impervious to moisture. Dri-seal coated to protect it against humidity.
- Cartridge, rest button, terminal clips, needle and instructions packed in attractive Dri-Pack containers.
- Competitively priced at \$5.50 list

You can hold your investment in cartridges to a minimum with the Model W.S.* No excessive inventory — just one cartridge to carry in your repair kit. It's the handiest arrangement that servicemen can have . . . a complete replacement unit in one package . . . competitively priced.

Ask your jobber for Bulletin RC162A, review all its features, then try Featheride Replace-All Cartridge Model W.S.*

Webster Electric Company, Racine, Wisconsin. Established 1909.

*Patents Pending

WEBSTER ELECTRIC
RACINE ♦ WISCONSIN

"Where Quality is a Responsibility and Fair Dealing an Obligation"



FAST, EASY QUICK RIG!
MATCHES 300 OHM
IMPEDANCE!

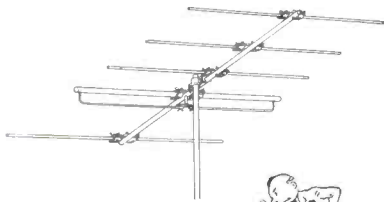

STURDY, TROUBLE-FREE CONSTRUCTION FOR LONG LIFE!



NEW!
SENSATIONAL GAIN!
PHOENIX YAGI



LICKS INTERFERENCE FROM GHOSTS AND NOISE!

PHOENIX
★ *Speed-Tennas*
★ *Speed-Mounts*
★ *Hardware*

PHOENIX ELECTRONICS INC. LAWRENCE, MASS.

HIGH GAIN INLINE

Intermittents

(Continued from page 34)

rosion. If the winding is small, as usual, it may be rewound easily. Before removing the wire, the turns should be counted. Then all the green spots should be cleaned from the form. Incidentally, not only is it important to make a careful note of the number of turns, but the direction of winding, and its position on the form with respect to the secondary. The form and secondary should be given a good coat of *Q*-dope, and allowed to dry. Then the primary can be rewound using wire as near to the original size as possible. Another coat of *Q*-dope should be applied and reassembly can follow. As these windings usually serve only as *ticklers*, they are not too critical, and your rewind coil will probably fall well within the tolerances of the circuit. Careful realignment should follow.

Some of the recent smaller models use an oscillator coil wound on a 1/4" dowel, about an inch long. Connections from the fine wires of the coil are made to pieces of about No. 16 wire, pushed into the ends of the dowel, the leads being soldered to these ends. If the coil shows signs of being intermittent, these connections must be checked carefully, all connections being resoldered.

Repairing Permeability Units

Open or damaged coils in *slug-tuned* sets, with permeability tuners, can be repaired by the same methods used for the standard-type coils, with perhaps more care required to get the coil in the same space on the form, because of the tracking. These coils will give the same troubles, corrosion, bad connections, etc., as other types. When doping these coils, it is necessary to see that the solution does not flow in-

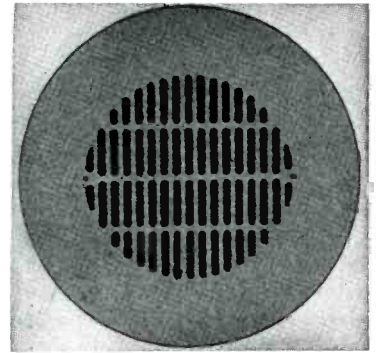

Model 10-P Grille

More and more Sound Engineers are finding the 10-P Flush Mounting Grilles the answer to many of their problems.

They come in two finishes; beautiful chrome plate or bond-erized and given a baked-on prime coat for painting. The grille opening is made for a 7- or 8-inch speaker.

Price \$4.40

Write for literature.

WRIGHT Inc.
2237 Univ. Ave., St. Paul 4, Minn.

side the coil, as it can interfere with the free movement of the tuning slug.

Tuning capacitors in some models were built with aluminum outer plates and iron inner plates. These have been found to gather metallic *fuzz*, and cause intermittent shorts. To cure this headache the capacitor should be disconnected and about 500 volts applied across it, while turning the rotor. Blowing out with an airhose will also be found helpful.

High-Resistance Leak Cures

Often, there appears a high-resistance leak caused by an accumulation of dirt and dust on the stator-support insulators. This may be removed by washing out with carbon-tet, and brushing with a small stiff brush. If it has absorbed moisture, it must be dried out thoroughly and given a coat of *Q*-dope. Another drying and the application of another coat can follow.

If the set is old enough to have tubes with top grid-caps, the flexible grid-leads will usually be a source of broken wires, normally inside the insulation. Some of these models had flexible resistors as grid leads, which

Television tube caddy

- Holds normal stock of 162 tubes, 221 total
- Compartments for fuses, small tools, etc.
- Designed especially for service technicians
- Everything in its place—Inventory at a glance
- Neat—Sturdy—Attractive—Businesslike
- Removable cover with space for mirror

\$13⁵⁰ DEALER NET
AT YOUR FAVORITE JOBBER

ARGOS PRODUCTS CO., Inc. • 4753 N. Broadway • Chicago 40

occasionally cause trouble from intermittent connections to the end-caps.

Antenna, RF and Mixer-Stage Intermittents

In those chassis using either tuned *rf* stages, or untuned resistance-coupled circuitry, the troubles can be in the capacitors (intermittent or leaky), resistors (change in value), or coils (corrosion). Intermittent *avc* bypasses have also been found to cause drops in volume and oscillation.

Loop antennas can be a source of endless trouble. Since, in the main, they are mounted on the cabinet, with flexible leads connecting them to the set, the leads often break inside the insulation, causing intermittents. Thus, these contacts must be checked. If connections to the loop have been reversed, oscillation at the low-frequency end of the dial may appear. Some of the bargain-type sets often present this trouble. To cure, a metal or foil shield should be installed between the loop and the chassis, at least as high as the top of the tubes. This will usually be about half the length of the chassis, and its position will be quite critical. It must be moved back and forth until the best operation is obtained, then screwed or soldered to the chassis. This will lower the sensitivity of the low end a little, but afford a general improvement in reception, due to the absence of the oscillation. The loop must be returned after the shield has been installed.

Intermittent trimmers are troublesome. Usually the start and stop problem is caused by metallic grit between the plates, which punctures the mica when the trimmer is screwed down. Mica should be replaced to cure.

If the set has an interstage *rf* transformer, it must be checked carefully for leakage between windings. This is particularly true on the older sets. If there is any leakage here, the plate voltage will cause the mixer grid to go highly positive, and block. To remedy, the coil should be removed and checked. It may be necessary to rewind the primary, which is usually only a few turns, and insulate well between windings. A couple of layers of transparent *scotch* tape will be found to be ideal for this job. An application of *Q-dope* is essential, in this instance, too.

Antenna coils are always subject to damage from lightning, misconnections to voltage, etc., and burnouts from connections to ground, in *ac* sets, if the line-bypass should be shorted, or the *ac* input grounded. When replacing these coils, it's wise to install a

(Continued on page 67)



I SELL ONE OUT OF THREE BY ASKING:

"When did you last change your Phono-Cartridge?"

This is a typical experience of service-technicians who pop the \$70 (Million) question—because it's the cue to cartridge replacement sales.

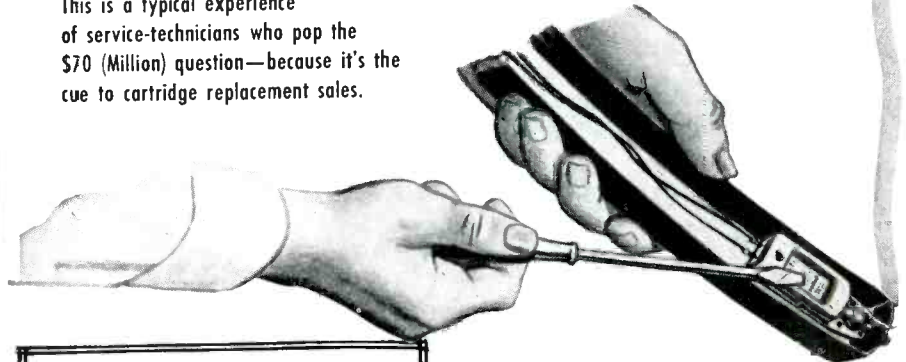

Make the Finger-Tip Compliance Test

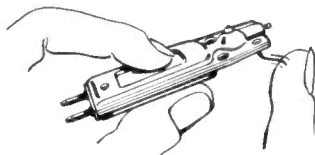

Old style, stiff-acting needle system

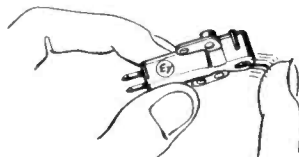

Modern, compliant needle system

It makes record-player owners aware of the importance of the cartridge. It gives you the opportunity to prove that a *modern, lightweight, compliant* cartridge will greatly improve reproduction and save records and needles.

Right now... 10,000,000 old-style, heavy, stiff-acting phono-cartridges in existing players need replacing. Current cartridges that are inefficient should be replaced, too.

Follow the E-V plan — *it works*. Check the cartridge on every job — you'll make more sales, more profit!

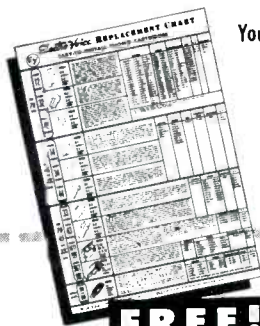

REPLACEMENT CHART
Large, Complete Replacement Chart. Gives handy cross-reference and valuable data. Tells when to replace a phono-cartridge. Ask your E-V Distributor or send for it now.

You can make most cartridge replacements with fewer E-V models

Electro-Voice INC.

411 CARROLL STREET • BUCHANAN, MICHIGAN
Export: 13 East 40th St., New York 16, N.Y., U.S.A. Cables: Arlab

Electro-Voice, Inc., Dept. S4-1
411 Carroll St., Buchanan, Michigan
Send FREE Cartridge Replacement Chart

Name..... (PLEASE PRINT).....
Address.....
City..... Zone..... State.....
 Service-Technician Dealer Record Fan

BRAND NEW PROFIT MAKER



**FOR
RADIO
SERVICE
MEN!**

Model AR-3
ElectroX Vibra-
tor Analyzer &
Power Supply

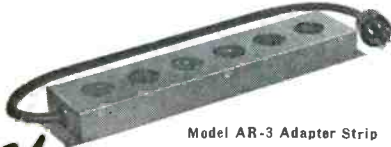

Model AR-3 Adapter Strip

New ELECTROX

VIBRATOR ANALYZER AND POWER SUPPLY

Here's a new ElectroX test unit that's *indispensable* for shops servicing auto radios. 2-way mobile communication systems or other equipment using 6-volt vibrators.

TWO VALUABLE TEST UNITS IN ONE! This instrument combines an adjustable POWER SUPPLY that provides smooth, hum-free direct current in any voltage needed to test auto radios, with a VIBRATOR ANALYZER that *thoroughly tests* practically all synchronous and non-synchronous vibrators found in auto radios today!

TESTS OVER-ALL VIBRATOR PERFORMANCE! Vibrator Analyzer *accurately* determines shorted and otherwise defective vibrators and predicts vibrator failures before they occur. It measures starting voltage, current consumption, output voltage and indicates irregular operation. Subjects vibrator to voltage conditions normally encountered when connected to the electrical system of the car. Over-voltage is available for starting vibrators with oxidized contacts. A standard oscilloscope can be attached for wave form observation.

It's a top quality test instrument—a *must* for every service shop. It safeguards your auto radio repairs—increases your parts sales—steps-up your efficiency and earnings. **ORDER NOW FROM YOUR DISTRIBUTOR.**

Write for Free Bulletin No. 1466, Giving Full Details

Rectifier Division

SCHAUER MANUFACTURING CORP.

2078 Reading Road • Cincinnati 2, Ohio

ASSOCIATIONS



TISA

A SERVICE INDUSTRY MEETING was held recently by the Television Installation Service Association, 5908 South Troy St., Chicago 29, Ill., at the Ashland Boulevard Auditorium. Among those who appeared were Louis B. Calamaras, executive secretary of NEDA; Martin E. Brunderman, secretary of NARDA; Don Bronson, director of the Philco factory supervised plant; Daniel Creato, vice prexy of RCA Service Co.; and Jack Johnston, assistant general manager of the Chicago BBB.

It was revealed at the meeting that the association's activities during the past year included exhibition of a service shop at the National Television and Electrical Living Show, and publication and distribution of a booklet entitled *This is the Story* which described the operation of a television system and the means used to install and maintain it. Detailed in the booklet were the instruments required to test a TV chassis, qualifications of a service company for installing and maintaining TV equipment, and the methods to be used to convert chassis for use with larger pictures.

According to the TISA code, described at the meeting, members must agree to employ qualified personnel to assure proper service; present to TISA a certified copy of a CPA's report on proper arrangement for the protection of reserve funds on contracts, and also offer a certificate of insurance showing adequate insurance coverage; have

available sufficient and proper test equipment to assure a good job; maintain an adequate service data library; render service no later than 24 hours, and be courteous, honest and treat each client in a professional manner. It was also revealed that all TISA members must adhere to service rates.

A data sheet, released during the session, disclosed that membership fee in TISA is \$100 a year, payable quarterly in advance, if preferred. To qualify for membership, members must submit to and assist in the investigation of shop and office facilities, stock on hand, certificate of insurance, financial statement and references. The data sheet also indicated that TISA represents a management group with membership opened to service contractors and not individuals.

LBRTA

DURING A RECENT ELECTION, Hal Meyers was elected president of the Long Beach Radio Technicians Association, Inc. Others elected were: Fred Abrams, vice president; Les Huckins, secretary; Joe Martin, technical advisor; Clarence Spencer, treasurer, and Harry E. Ward, public relations.

RETA, British Columbia

BOB MIDDLETON appeared during a recent meeting of the Radio Electronic Technicians Association and the Associated Radio Technicians of B. C., Canada, to demonstrate and lecture on Precision equipment.

NETSDA

THE THIRD MEETING of the recently-formed National Electronic Technicians and Service Dealers Association, held in New York City, featured a talk by John F. Rider, who surveyed the potentialities and problems of the servicing industry.

Commenting on the hourly charges that Service Men should make, Rider declared that a \$5.00-an-hour charge is becoming a standard, which certainly represents an improvement in billing practice. Pointing out this as an excellent trend, Rider said . . . "We should try and raise the industry financial status by teaching Service

Speakers
Need
Repairing?

Recone with a WALDOM CONE

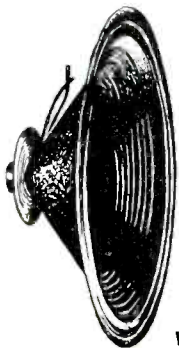

Speakers are hard
to obtain. Recone with
Waldom cones.

Send for your FREE WALDOM
Replacement Cone Manual Catalog!

FREE, 24-page manual is yours with-
out obligation. Data on over
750 TV, FM, AM speak-
ers. WRITE TODAY!

- WALDOM CONES
- . . . maximum efficiency,
- R.M.A. warranty, true low frequency
- response, unconditionally guaranteed.

WALDOM ELECTRONICS, INC. 911 N. Larrabee St., Chicago 10, Ill.

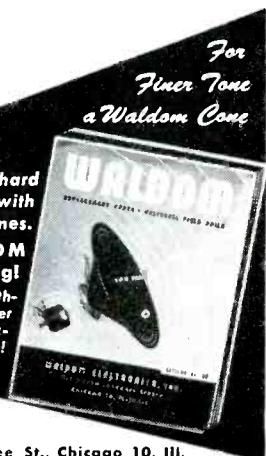

TEN YEARS AGO

From the Association News Page of SERVICE, April, 1941

THE BOSTON SECTION OF RSA commemorated *Radio Moving Day* with a meeting in the Memorial Drive building under the auspices of the Eastern Co. in Cambridge, Mass. Henry Jappe, one of the featured speakers, analyzed the opportunities open to the Service Man. Dan Fairbanks of IRC also presented a service-business talk. . . . George Feldman, past secretary of RTG in Boston, began service with the U. S. Army. . . . Ronald Bernard, president of the Lawrence chapter of RTG, was married. . . . Dick Purinton of Raytheon addressed the New York chapter of RSA covering new type tubes. The New York chapter announced that over a hundred receivers had been reconditioned by the boys and sent to Camp Dix, N. J. WOR cooperated in the move. . . . The monthly meeting of the RSA of Pittsburgh, held on the roof garden of the Mayfair Hotel, featured a talk by Ed Atkins of Tung-Sol on FM. Meeting was sponsored by Emmett Tydings, parts distributor in Pittsburgh. . . . Radio Electric Service Co., Century Radio Co., Raymond Rosen Co., Philco and WFIL had interesting displays at a special meeting of PRSMA, which featured a talk by Gene Rothman of Radio Electric. Others on the program were Ty Yonker of Raymond Rosen Co. and Bill Caskey of WFIL.

Men that a good profit can be made by giving good results."

Describing the significant advancements that could be made by the new national group, Rider pointed out that the new association represents a chance to place the servicing industry on a sound basis. He warned the group that they should set objectives that may be successfully completed within the next year. Declared Rider: "There are many problems to be solved throughout the entire industry, but this national group is too young to solve them all. Go slow, meet the problem squarely, one at a time, and success will be your reward."

In closing, the group was told that radio was not dead, and that TV, at present, reached only thirty million people, while radio covered one hundred million Americans.

According to Max Liebowitz, proxy of the association, it appears as if the Service Men of New York City and vicinity would very soon be licensed under a new law.

Groups from seven associations were present at the meeting, representing a total membership of several thousand.

POPULAR

MOST

BECAUSE THEY ARE

POWERFUL

MOST

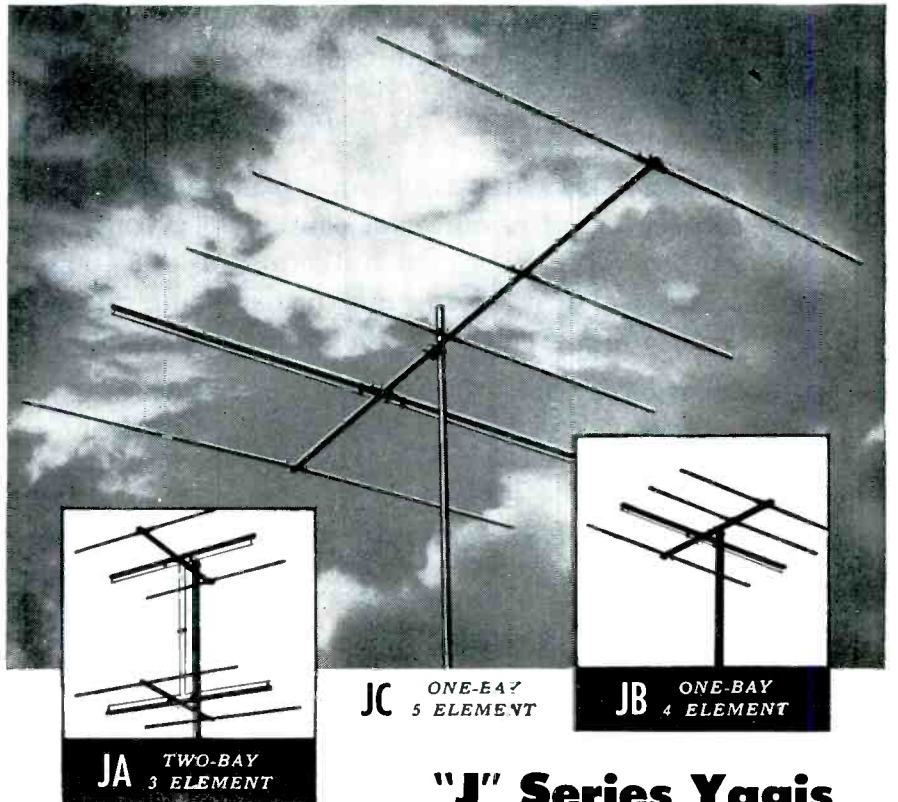

"J" Series Yagis

The VEE-D-X "J" series were the first preassembled, low cost Yagis to gain national recognition. They were developed to meet the demand of TV owners in areas where maximum signal pick-up from only a few channels was required. Each of these famous Yagis is cut for a specific channel and will provide extremely high forward gain, excellent front-to-back ratio, and nearly complete immunity to man-made noise, ghosts, etc. They can be used singly or stacked and are engineered to match standard 300 ohm line. For further information write the LaPointe-Plascomold Corporation., Windsor Locks, Connecticut.

VEE-D-X

THE WORLD'S MOST POWERFUL ANTENNAS

Rep Talk

... if you are commercially or professionally interested in TV, you must read

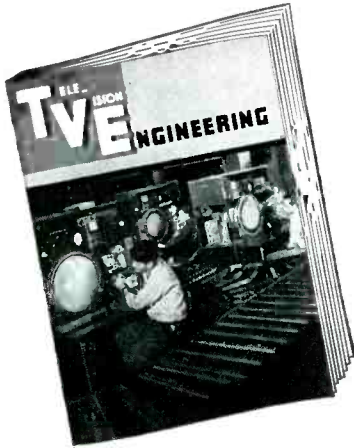

TELEVISION ENGINEERING every month!

Devoted exclusively to TV Research . . . Design . . . Production . . . Operation . . . Instrumentation

TELEVISION ENGINEERING is the *only* trade publication which directs its *entire* editorial content to executives and engineers who design, manufacture, operate and maintain television receiving and transmitting equipment—both commercial and educational.

Every issue is chock full of timely and thorough TV articles, authored by outstanding specialists. You'll find practical, carefully prepared reports and papers on such vital subjects as . . .

Color TV Systems . . . Ultrahigh Receiver-Transmitter Design Problems . . . Tube Production-Line Techniques . . . TV Broadcast Equipment . . . Camera Tube Research . . . Glass, Plastics and Metal in TV . . . TV Test Equipment in the Plant . . . Film Recording . . . Flying Spot Scanners . . . Tone Amplifiers for TV Films . . . Compact Motors for TV . . . TV Component Design . . . Mechanical Design Factors in Antennas . . . Quality Control Charting . . . Microwave Relays . . . Receiver and Transmitter Servicing . . . Production Aids . . . Instrument Activities . . . TV Sound Systems . . . Studio Lighting.

Enter your subscription NOW . . . Fill out the coupon below
(Not sold on newsstands)

MAIL COUPON

TeleVision Engineering
52 Vanderbilt Ave., New York 17, N. Y.

Here is my remittance for my subscription to TeleVision Engineering at the
SPECIAL RATE . . . 3 years (36 issues) only \$5.

(1 year subscription \$3.)

NAME

ADDRESS

CITY..... ZONE..... STATE.....

For our confidential records, open only to the Audit Bureau of Circulation, please supply the following information:

Occupation..... Title.....

Department in which employed

Operation Production Research

Employed by

Nature of Business.....

(State if TV Manufacturer, TV Broadcast Station, etc.)

HOWARD M. SAUL will celebrate his 25th year as a Los Angeles radio rep in May. . . . *H. A. Kittleson*, Los Angeles, has been appointed Calif. rep for National Coil Co., Sheridan, Wyoming. . . . *Norman B. Neely*, *J. T. Hill* and *Carl A. Stone* have been appointed to a committee of the Los Angeles chapter of the *Reps* to study current government taxation. . . . *Hundley R. Gover*, 500 Law Bldg., Charlotte, N. Carolina, has been named rep for Circle-X, Perth Amboy, N. J., for North and South Carolina and Tennessee; and *Haggerty Sales Co.*, 1507 W. Saratoga St., Ferndale 20, Mich., has been appointed to cover Michigan. . . . *Harry Esterson*, 395 Clivedon St., Philadelphia, Pa. (covering Eastern Pa., Southern N. J., Maryland, Delaware, Washington, D. C.) and *Henry P. Segal*, 143 Newbury St., Boston, Mass. (covering all the New England states), have been named sales reps for the Anchor Metal Co., 87 Walker St., New York 13, N. Y. . . . *Arthur E. Akeroyd*, Raytheon New England sales rep, attended a meeting of The Television Accessory House, Providence, R. I., for the inauguration of the Raytheon bonded dealer plan (L. L. Del Padre is prexy of the distributor organization). . . . *Frank Wainwright Wedel*, 3215 Western Ave., Seattle 99, Wash., and *Samuel N. Stroun*, 610 19th Ave., Seattle 2, Wash., were elected to senior membership in the Pacific Northwest chapter of the *Reps*. . . . *Jack West*, 6747 North Octavia Ave., Chicago 31, Ill., is now a senior member in the Chicago chapter of the *Reps*. *Lloyd L. Newell* and *Bernard Engle* have been elected associate members. . . . The Mid-Lantic chapter has elected *Kenneth Ward Randall*, 121 N. Broad St., Philadelphia 7, Pa., to senior membership, and *Edward H. DaCosta*, Norristown, Pa., to associate membership. . . . *Frank W. Rauer*, 4144 Marvin Ave., Cleveland 9, Ohio, has been named to a senior membership in the Buckeye chapter. . . . The New York chapter elected *Wally Shulan*, 136 Liberty St., to senior membership. . . . *John Joseph Hagerty, Jr.*, 1223 Longfellow Rd., Royal Oak, Mich., recently joined the Wolverine chapter of the *Reps* as an associate member. . . . *Joseph J. Peyser*, 318 Harvard St., Brookline, Mass., is now an associate member of the New England chapter of the *Reps*. . . . *Martin P. Andrews*, Mott Road, Fayetteville, N. Y., has been elected to senior membership in the Empire state chapter of the *Reps*. . . . *Bruce McPherson* and *James Wright* were reelected to the office of president and vice president, respectively, of the Hoosier chapter of the *Reps*. Others elected were *Quinn Cunningham*, secretary, and *Charles Hoemig*, treasurer. . . . *Maitland K. Smith*, *Victor Hutto* and *Johnny Thompson* were reelected president, vice-president and secretary-treasurer, respectively, of the Dixie chapter of the *Reps*. . . . *Mel Foster* has been elected president of the Gopher chapter of the *Reps*. . . . *Leonard D. Allen* has been elected president of the Empire State chapter. . . . *Grant Shaffer*, of the Wolverine chapter, and *Dean Lewis*, California chapter, have been elected president of their respective groups of the *Reps*. . . . *Charles Lienau*, 10203 McKenney Ave., Silver Spring, Md., is now jobber sales rep for the Virginia territory of Clarostat.

STROEMPEL JOINS RADIART

Frank J. Stroempel has been appointed executive assistant to Milton Roth, jobber sales manager of the Radiart Corp., and will assist in sales management, advertising and merchandising.



F. J. Stroempel

* * *

TV TECHNICIANS LECTURE SERIES

A series of six lectures on technical and business subjects, to start in September '51, which it is said will be available at *no cost* to cooperating associations, has been announced by the Television Technicians Lecture Bureau, P. O. Box 1321, Indianapolis 6, Ind.

Lectures, which will be slide-film-recorded presentations, will each be furnished with projector and sound reproducer, each unit being a complete one and one-half hour program.

* * *

NEWCOMB TO ADD FLOOR AREA

An additional 15,000 square feet will soon be added to the main plant of Newcomb Audio Products Co., Los Angeles.



Robert Newcomb

* * *

J. J. HILL JOINS TELEMATIC RESEARCH LAB

James J. Hill, formerly with Communications Products Company as vice-president in charge of research, has become head of the research lab of Telematic Industries, Inc., 1 Joralemon St., Brooklyn, N. Y. He also served in a research capacity with Dielectric Products, Jersey City, N. J.

* * *

MERIT REPLACEMENT CATALOG

A transformer catalog, *No. 5111*, with specifications on television, radio, amateur and industrial transformers, as well as TV replacements, has been announced by Merit Transformer Corp., 4427 North Clark St., Chicago 40, Ill.

Also made available is a TV *repl* guide which lists replacement parts for over 800 models from over 80 manufacturers.



C-D's Champion PUP

—from a long line of winners!

Just introduced—already rated “best in its class”! It's C-D's PUP, the new and advanced metallized capacitor. *Saves space*—half the size of conventional paper tubulars. *Saves trouble calls*—unique self-healing feature means extra long service life.



Write for Bulletin N142, Dept. S-41
Cornell-Dubilier Electric Corp.
South Plainfield, N. J.



CONSISTENTLY DEPENDABLE CORNELL-DUBILIER CAPACITORS

Plants in South Plainfield, N. J., New Bedford, Worcester and Cambridge, Mass., Providence, R. I., Indianapolis, Indiana, Fuquay Springs, North Carolina, and subsidiary, The Radiart Corporation, Cleveland, Ohio.

ZETKA CATALOG ON ROUND AND RECTANGULAR PICTURE TUBES

A 12-page catalog with complete data on 16, 17, 19 and 20-inch picture tubes has been released by Zetka Television Tubes, Inc., 131-137 Getty Ave., Clifton, N. J.

* * *

GABRIEL ASSOCIATES BUYS WORKSHOP ASSOCIATES

The Workshop Associates, Inc., Needham, Mass., has become a wholly-owned subsidiary of The Gabriel Co., Cleveland, Ohio.

Current plans are to keep both organizations intact, with no changes in existing operating policies and procedures of either.

STANCOR TV TRANSFORMER GUIDE

A 36-page edition of the *Stancor TV Transformer Catalog and Replacement Guide* is now available from Standard Transformer Corp., 3580 N. Elston Ave., Chicago 18, Ill. Includes replacement information on over 900 TV receiver models and chassis made by 71 manufacturers, specifications, dimensions and prices of 75 transformers and related components for TV replacements and conversion.

* * *

PERMO PRESIDENT DIES

Arthur J. Olsen, former founder-president of Permo, Inc., 6415 Ravenswood Ave., Chicago, Ill., died recently. Sherman E. Pate is now serving as Permo prexy.

[Additional news appears on page 69]

TV DX

is our business!

from BOSTON
from PHOENIX
from SEATTLE

from NEW YORK
from EVERYWHERE!

come unsolicited enthusiastic letters by dealers, installers and users reporting sensational results on the new

GONSET LOW CHANNEL RADARRAY

"We have tried them all and your antenna outperforms them all."

There are good, sound technical reasons for the superior performance of the

GONSET LOW CHANNEL RADARRAY

Users are interested in results, and it is the high gain and high front-to-back ratio on all the low channels that is making converts of confirmed "antenna cynics." For unexcelled performance on all the low channels (2 through 6) you need but one antenna, if it is a

GONSET LOW CHANNEL RADARRAY

Engineered and manufactured by pioneer fringe area antenna specialists. Write today for brochure describing this and other fringe area antenna products, such as the GONSET HIGH CHANNEL RADARRAY and GONSET LINE (ultra low loss open-wire line).



GONSET CO., BURBANK, CALIF.

GENUINE TWIN LEAD

300 OHM WIRE

ALSO ROTOR 3-4-6 WIRE

All wire made with 7 strands of copper covered with virgin polyethylene.

Buy direct from manufacturer.
Samples and prices on request.

TELEWIRE Mfg. Co., Inc.

2 Columbus Circle, N. Y. 19, N. Y.
Phone Circle 6-0244

read about
"Experiments
in
Audio"

you'll find it in
PF INDEX

FREE GET YOUR
COPY FROM
YOUR PARTS JOBBER

New TV Parts ... Accessories

JFD INDOOR ANTENNA

A *Tip-Proof* indoor TV antenna has been announced by JFD Manufacturing Co., Inc., 6101 Sixteenth Ave., Brooklyn 4, N. Y.

Balanced and weighted base is said to prevent the antenna from tipping or rocking at full extension of dipoles. Three-section telescopic dipoles can be adjusted from 15" to 41". Includes a 300-ohm twin lead.

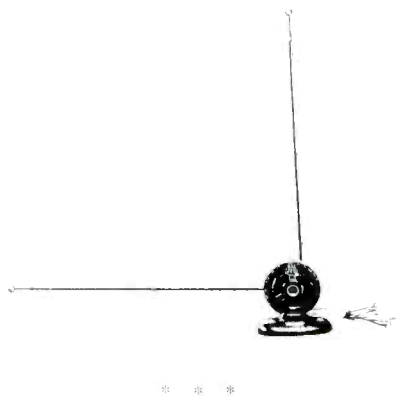

JAVEX TV ANTENNA SYSTEM

A TV antenna system, for 300-ohm lines, designed to mount flush, with or without the use of the usual wall box, has been announced by Javex, Garland, Texas.

Featured is a surface box which is said to eliminate cutting into a wall or using a wall box. A 1/4" leadin hole is covered by the plate. Where a twin lead has to be run on the surface, the surface box, being scored and recessed, is said to accept the leadin from any direction. Available in double and triple arrangements for multiple or bi-directional installations.



DUMONT FERRITE-CORE DEFLECTION YOKE

A ferrite-core distributed-winding type deflection yoke, Y2A, has been announced by the Electronic Parts Division of Allen B. Du Mont Laboratories, Inc., East Paterson, N. J. For use with TV tubes of 60° to 70° deflection angle.

Available for use with transformer or auto-transformer output circuits, and with different networks and lead lengths, or without networks and leads. It is said to withstand continuous operating temperatures up to 90° C. and voltages up to 4 kv between any windings or between windings and frame. Standard horizontal inductance is 10.5 millihenries, and vertical inductance 42 millihenries.



TECH-MASTER KIT

A TV kit that, it is said, will accommodate tubes up to 14" rectangular, has been developed by Tech-Master Products Co., 443 Broadway, New York 13, N. Y.

Featured are a hi-gain stagger tuned *if* system, turret type tuner, *agc* system, and two-knob control providing automatically synchronized picture and sound. Chassis is above ground, and test points are located on top of an *if synchro strip*. Tuner and *if synchro strip* are pre-wired, tested and aligned.

REMEMBER ...
the **1951** May is Market Month!

"The only all-industry sponsored Conference and Show in Electronics"

PARTS DISTRIBUTORS CONFERENCE AND SHOW

MAY 21-23 1951 - STEVENS HOTEL - CHICAGO

TELEMATIC CONICAL STABILIZER

A stabilizer, CS-21, which is said to reduce vibrations of elements on conical antennas, has been developed by Telematic Industries, Inc., 1 Joralemon Street, Brooklyn, N. Y. Has a weather-proofed wooden center and a steel jaw which retains grip on both $\frac{3}{8}$ " and $\frac{1}{2}$ " elements. Uses aluminum arms.

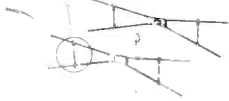

* * *

RAM FLYBACK TRANSFORMER

A flyback transformer, X045, for replacement and conversion purposes, has been announced by RAM Electronics, Inc., South Buckhout Street, Irvington-on-Hudson, N. Y.

Designed as a replacement transformer for TV receivers originally using 1B3 or 6BG6s. For 16" and 20" round and rectangular tubes, it generates 12.5-14 kv and 13.5 kv, respectively.

Unit has been specified as replacement transformer for G. E., Magnavox and Tele-Tone chassis.

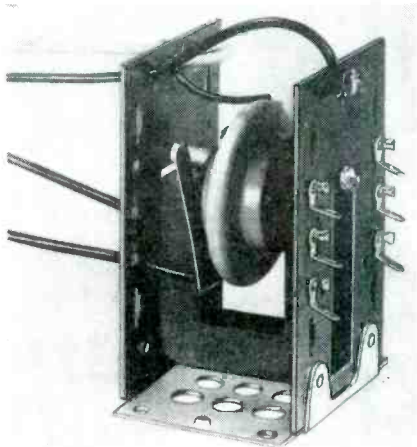

* * *

CLAROSTAT BALLAST REPLACEMENT

A TV ballast replacement for Pilot Radio, type 35-37, has been announced by Clarostat Mfg. Co., Inc., Dover, N. H. Plug-in tube-type wire-wound resistors available in 75 standard numbers for replacements, and in 10 universal numbers.

* * *

INSULINE TV INSTALLATION KITS

A series of eight TV antenna installation kits, designed to meet receiving requirements in either primary service or fringe areas, has been announced by the Insuline Corp. of America, 36-02 35th Ave., Long Island City, N. Y. Smallest kit contains a single conical antenna, a 5' steel mast, and 50' of leadin wire. Largest kit contains a stacked conical antenna, 10' mast, base mount, guy wire, 100' of leadin, lightning arrester, clamps, insulators, etc.

1951 Edition

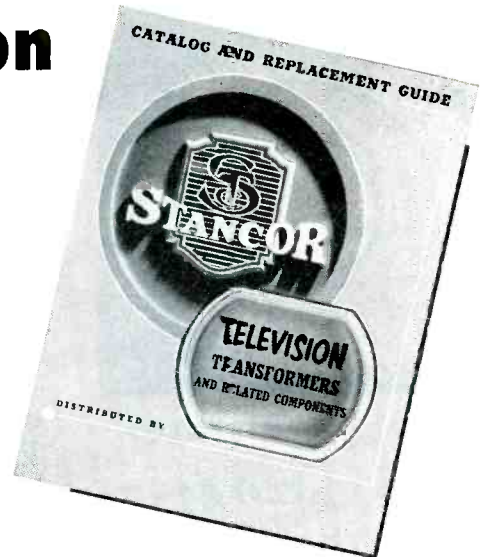

*Ready!
NOW!*

STANCOR'S

New

TV TRANSFORMER CATALOG AND REPLACEMENT GUIDE

Lists:

- Over 900 TV receiver models and chassis made by 71 manufacturers.
- Complete specifications, dimensions and prices of 75 STANCOR transformers and related components for replacement and conversion.

TAKE THE GUESSWORK OUT OF YOUR TV SERVICING! GET YOUR FREE COPY NOW AT YOUR STANCOR DISTRIBUTOR



STANDARD TRANSFORMER CORPORATION

3588 ELSTON AVENUE, CHICAGO 18, ILLINOIS

TACO TWIN-DRIVEN YAGI

An antenna which it is claimed will minimize, and in most cases eliminate co-channel interference, has been announced by Technical Appliance Corporation, Sherburne, N. Y. Antenna is said to measure a front-to-back ratio of 30 db.

Designated as the *special twin-driven yagi*, it is available for any one of the low-band channels. May be used as a single antenna, or as a stacked array. The elements consist of a director, two driven elements, and a reflector. Terminals are located at the rear folded dipole driven element.

Right: Taco Yagi

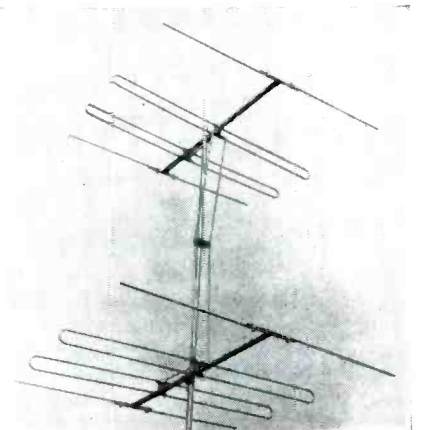

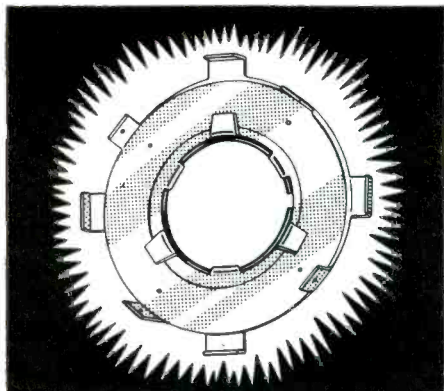

Center TV Pictures in 3 Seconds with the NEW BeamaJuster

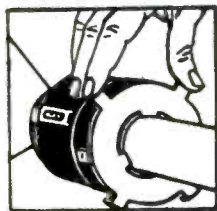

1. Snap BeamaJuster on back cover of tube yoke. (Fits any standard yoke and ANY SIZE TUBE.)
2. Rotate BeamaJuster as shown here for approximate centering of picture.
3. Make final adjustment by sliding outer plate of BeamaJuster vertically or horizontally.

Now service men can center TV pictures in 3 seconds instead of 20 to 30 minutes. The new Perfection BeamaJuster eliminates costly and complicated centering controls of the resistor type. It also replaces mechanical centering controls which tilt the focus coil to center the picture and require numerous springs, wing nuts and special brackets.

The BeamaJuster not only saves time and money but assures lasting results. No drifting of the picture once it is set by the BeamaJuster. This control does not affect spot size, focus or picture definition. Over 10,000,000 TV sets need this simpler centering control. Also perfect for conversions from 10 and 12 inch tubes to larger size tubes. Order today from your supplier.

PERFECTION ELECTRIC COMPANY
2641 S. WABASH AVE., CHICAGO 16, ILL.

Makers of Perfection
Alnico 5 Speakers
and Ion Traps



Trade Mark

STAHL TRUCK-UTILITY COMPARTMENTS

Utility compartments, model 50, for converting the standard pickup body to a service body, accommodating tools and materials, are now available for service trucks from Stahl Metal Products, Inc. (formerly Artisan Products, Inc.), 3490 W. 140 St., Cleveland 11, Ohio. Compartments are equipped with bins and shelf arrangement, compartment door locks and mounting brackets.



* * *

TV OPEN LINE LEADIN

Open line leadin is now available from T. V. Wire Products, Los Angeles, Calif. It is said to have low signal loss and permanent resistance to weather.

Claimed to feature 1/6 the loss from conventional twin leadin, 0.5 db loss per 100' at 200 mc. Air insulation provided through the use of polystyrene spacers placed every 6" throughout the length of the run.

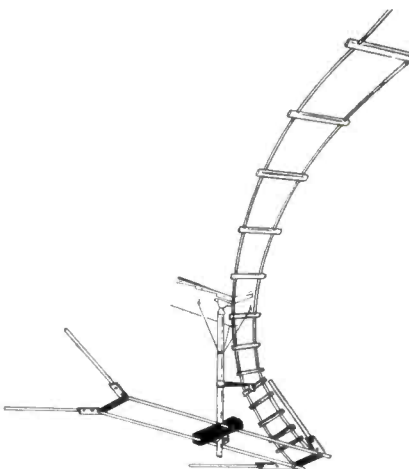

GONSET FRINGE ANTENNA

A broad-band low-channel array for fringe areas has been announced by the Gonset Co., 72 E. Tujunge, Burbank, Calif. Features stacked colinear dipoles ahead of a duplicate dipole curtain which is connected in quadrature with all elements driving the feed point.

* * *

CROWN ANTENNA ROTATOR

An antenna rotator drive motor which features 5/8" steel drive shafts and 3" final shaft steel gears, has been announced by the Crown Controls Co., Inc., 124 S. Washington St., New Bremen, Ohio.

Unit is available in two styles of mahogany control boxes: electric eye, which flashes the position of the antenna, and compass type, which shows actual position of antenna.

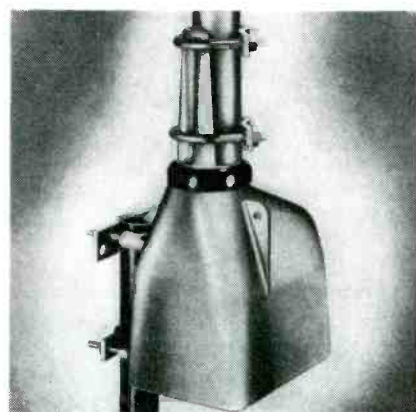

* * *

TELEMATIC MAST COUPLERS

A method for coupling two masts by sliding one end of a mast coupler into each mast section has been developed by Telematic Industries, Inc., 1 Joralemon St., Brooklyn, N. Y. Made of cadmium plated steel in two sizes, CU-1 to fit 1 1/4" o.d. mast and CU-2 to fit 1" electrical conduit.

PLASTIC-COATED ANTENNA MAST



Antenna mast, (Jones and Laughlin Permatube) of electricweld steel tubing, coated with vinyl plastic, which is claimed to be rust-resisting. According a J. and L. survey, these masts were found to have stood up ten to one better than other types of steel masts during the recent wind-storm in the N. Y.-N. J. area. (Mast, in illustration, atop a home in Ocean Grove, N. J., holds a Telrex, conical-V-beam antenna.)

Manufacturers! Distributors! Dealers!

WE HAVE
CRITICAL TYPE **TUBES**

WE ALSO HAVE FINE
QUALITY

300 ohm TV WIRE

In lots of 5,000 feet

Samples air-mailed on request

We can supply you with those hard-to-get
type radio and TV tubes at **REASONABLE
PRICES.**

We have substantial inventories of standard brand tubes
in individual cartons or bulk packing.

ALL GUARANTEED BRAND NEW

Write or Wire

GAMMA ELECTRONICS CORP.

103-17 Northern Blvd., East Elmhurst, N. Y.

Intermittents

(Continued from page 59)

small series capacitor of about .005 to .01 mfd in the antenna lead. This will prevent a coil burnout if grounding happens again.

AC/DC Chassis Intermittents

The *ac/dc* sets, with their series filaments, are subject to several intermittent troubles not found in other models, such as the intermittently open filament, which opens and closes with heating. There are several setups which can be used to locate this type of intermittent, all the way from a string of neon lamps, fixed up with clips, each clipped across a tube filament, to plugging in to a wattmeter and waiting for the open to show up. About the simplest method to use is the test with the chassis turned upside-down, and the volume kept low. When reception stops, the filament contacts of each socket should be checked with a 120-volt *ac* voltmeter. The line voltage will appear across the open filament.

A simple wattmeter, adequate for all tests of this type, can be made up from a 3-ampere *ac* ammeter. It should be connected in series with one side of the line to a special receptacle. The readings will not be exactly accurate, but they will be close enough for testing. Practice will reveal the proper current drain for each set. In an average 5-tube *ac/dc* set with a draw of around 30 watts, about .28 ampere should appear on the meter. An isolation transformer can be connected into this test socket.

If, during a test, the receiver suddenly starts operating, or opens up at regular intervals, on a clockwork basis, you can suspect the 50L6, 35L6, 50A5, 50B5, etc., or possibly the 35Z5 or 35Y4. This type of intermittent usually always appears in the high-voltage filament tubes.

Cathode-Heater Shorts

A cathode-heater short in the *if* or mixer tube will cause the set to go dead, the pilot light to brighten, and the power and rectifier tubes to overheat. This occurs because the cathodes of the *if* and mixer are returned directly to ground, a short here cutting off the *rf* and second detector tubes entirely, and applying the full line voltage across only three tubes. If the small bias resistor of the power tube is charred, a leaky plate bypass can be suspected. These capacitors are usually connected from plate to cathode

Famous for Firsts

DR. HIDEZUGU YAGI

World famous scientist,
originator of the YAGI
antenna principle.

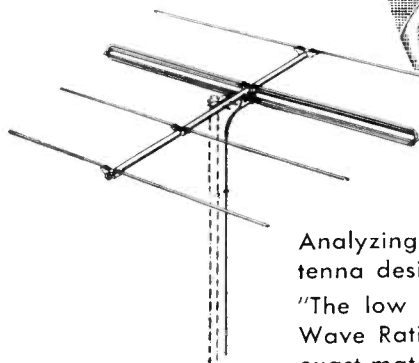

Analyzing the Ward engineered YAGI TV antenna design, Dr. Yagi recently wrote:

"The low numerical value of Voltage Standing Wave Ratio as recorded is . . . the proof of the exact matching between circuit elements. In this regard, I highly esteem the excellent ability of your engineers."

Ward antennas are the result of over 20 years of design and production experience. Ward, the oldest and largest exclusive manufacturer, builds the world's finest antennas.

WARD
WORLD'S LEADING EXCLUSIVE
MANUFACTURER OF
ANTENNAS

THE WARD PRODUCTS CORP.

Division of The Gabriel Co.

1523 East 45th St., Cleveland 3, Ohio

on the power tube, and leakage here can cause application of the plate voltage directly to ground through the small resistor, usually around 150 ohms. If the capacitor is all right, the tube can be suspected of an intermittent heater-cathode short. This will short the high-voltage filament directly to ground, through the resistor. If the regular test shows the tube to be okeh, the test should then involve a check with the filament down to zero. Then you can set up for a short-test, and increase the filament gradually. You may find that the short will show up on lowered filament, but disappears

when the full voltage is applied.

The *ac/dc* models appear to be quite prone to intermittent oscillation from squeals to motorboating, due to intermittent filters. This has been traced to the filters used as *rf* plate bypasses. If oscillation shows up, a good capacitor should be shunted across the suspected filter. If oscillation stops and the set begins to play, even after the shunt capacitor is removed, you'll probably be safe in replacing the filters. The trouble is apparently due to an intermittent contact inside the filter, which is momentarily cleaned up by a

(Continued on page 68)

TELEVISION and FM TRANSMISSION WIRE

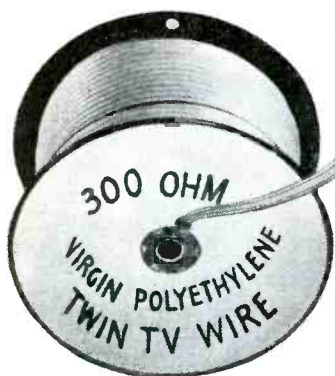

300 OHM TWIN LEAD TV WIRE

Fabricated by one of America's Leading Wire Manufacturers, this top quality wire designed to insure uniform impedance throughout is ideal for both Television and FM transmission lines. The low-loss 50 to 55 mill virgin polyethylene dielectric used in the web guarantees perfect insulation against every possible deterioration usually caused by constant exposure to weather. 20-gauge 7-strand bare electrolytic copper wire insures a maximum flexibility, eliminates possible breaking when used as lead-in exposed to strong changing winds. Comes in spools of 1,000 feet.

OUR SPECIAL PRICE PER SPOOL OF 1,000 FEET.....\$20.00

RG-59/U HIGH-FREQUENCY TV COAX CABLE

72 OHM No. 22 Solid Copperweld Wire covered by polyethylene plastic insulation with bare copper braided shield and with black vinyl plastic outer jacket over-all making it impervious to acids, alkalis, oil and gasoline. Manufactured to meet U. S. Government Standards and Specifications. Puncturing voltage 20,000 V. Comes in spools of 1,000 feet.

OUR SPECIAL PRICE PER SPOOL OF 1,000 FT...\$65.00



54 West Illinois Street

WEXCO INC.

Chicago 10, Illinois

Intermittents

(Continued from page 67)

surge occasioned by the good-capacitor shunt.

Intermittent *line-to-chassis* bypasses can also cause an *ac/dc* set to break into oscillation, as can missing tube shields, and bad connections to the internal shield, in some tubes; pin 1, on an octal socket. If none of the usual

remedies cure the squealing, the *if* and mixer tubes should be replaced, one at a time. High-gain miniatures have been found to be quite a source of trouble. Some of them have been found to work perfectly in one set, and squeal like a banshee in another! New tubes are definitely not immune to the problem either, we have found to our sorrow.

IRC Q CONTROL CATALOG

A 4-page catalog, A-4, with data on characteristics and specifications of type Q control, has been released by the International Resistance Co., 401 N. Broad St., Philadelphia 8, Pa. Offered are performance standards for Q controls with 76 switch, insulated shaft, split bushing, Q control plain dual, concentric dual, plain triple and with taps.

JOE B. HIGGINBOTHAM, JR.

Nuberg, Ga.

**THANKS,
Mr. Higginbotham!**

Radio Receptor Co., Inc.
West 19th Street
New York 11, N.Y.

Gentlemen:

Please send me your pamphlet on the design, application and servicing of selenium rectifiers.

Although I have serviced many receivers which have selenium rectifiers I have very little information on them and believe your pamphlet would be a valuable asset to my shop.

I use your rectifiers, supplied by Southeastern Radio Parts Co. and Specialty Distributing Co., of Atlanta, Ga., and like them very much. Also I appreciate your consideration of the radio repairman in that you supply a data sheet with each rectifier and the trouble taken to print the servicing information.

Yours Truly

Joe B. Higginbotham Jr.
Joe B. Higginbotham Jr.



SELETRON RECTIFIERS

... And our thanks go as well to the other thousands of servicemen and hams who insist upon top performing SELETRON Selenium Rectifiers in electronic circuits and as replacements in Radio and TV sets.

You can depend on SELETRON all ways... Full technical information is always available without obligation. Look for Howard W. Sam's Red Book Supplement listing SELETRON replacements, and write us for Bulletin No. SE-7.



SELETRON DIVISION
RADIO RECEPTOR COMPANY, INC.

Since 1922 in Radio and Electronics

Factory: 84 North 9th St., Brooklyn 11, N. Y. • Sales Department: 251 West 19th St., New York 11, N. Y.

SERVICE

Edited exclusively for professional independent service and sound men, service organizations and the service departments of established dealers.

Readership represents 100% buying power for manufacturers of tubes, test equipment, components, accessories, sound and intercom equipment, TV antennas, tuners, boosters, etc.

Advertising in **SERVICE** pays dividends

WHEN YOU CHANGE YOUR ADDRESS

Be sure to notify the Subscription Department of SERVICE at 52 Vanderbilt Avenue, New York 17, N. Y., giving the old as well as the new address, and do this at least four weeks in advance. The Post Office Department does not forward magazines unless you pay additional postage, and we cannot duplicate copies mailed to the old address. We ask your cooperation.

SYLVANIA VT VOLTMETER BOOKLET

A 48-page booklet by Rufus P. Turner, covering the use of *vacuums* in radio and television servicing has been announced by the Radio Tube Division of Sylvania Electric Products, Inc., 1740 Broadway, New York 19, N. Y.

Booklet has five chapters describing different types of *vacuums*, their adjustment and application for radio receiver tests and measurements, audio amplifier tests and measurements, television receiver tests and miscellaneous uses.

Available free, by purchasing Sylvania TV picture tubes, through May 31. After that date it will be sold at \$1.00 per copy.

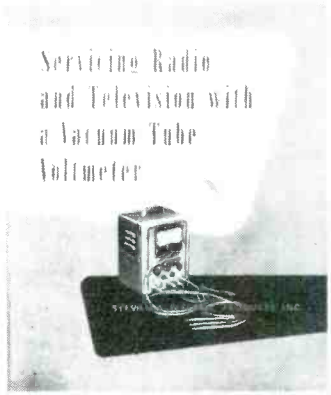

Servicing Radio and Television with a Vacuum Tube Voltmeter

G. E. PARTS CATALOG

A 144-page catalog for radio and TV replacement parts, listing parts for sets produced from '45 to December 1, '50, is now available from the Receiver Division, G. E., Syracuse, N. Y.

Featured are a cross reference between drawing number and part number, making it possible to determine, from the drawing number alone, all the information about any part. Also provided are alphabetical listings by part number, part descriptions, set models in which each part is used, list price, and a revision service.



E. A. Mallin, G. E. parts sales manager with parts replacement catalog.

LITTELFUSE VEST POCKET SIZE FUSE DISPENSER

For the fuse needs of the automotive Service Man, Littelfuse, Inc., Chicago, is now packaging 5 fuses in an all-metal box dispenser. The sliding top is designed as a permanent part of the box.

Container also features a fuse size guide printed on the back of the box, as illustrated at right.

The New Leader!

Yagi

By Clear Beam

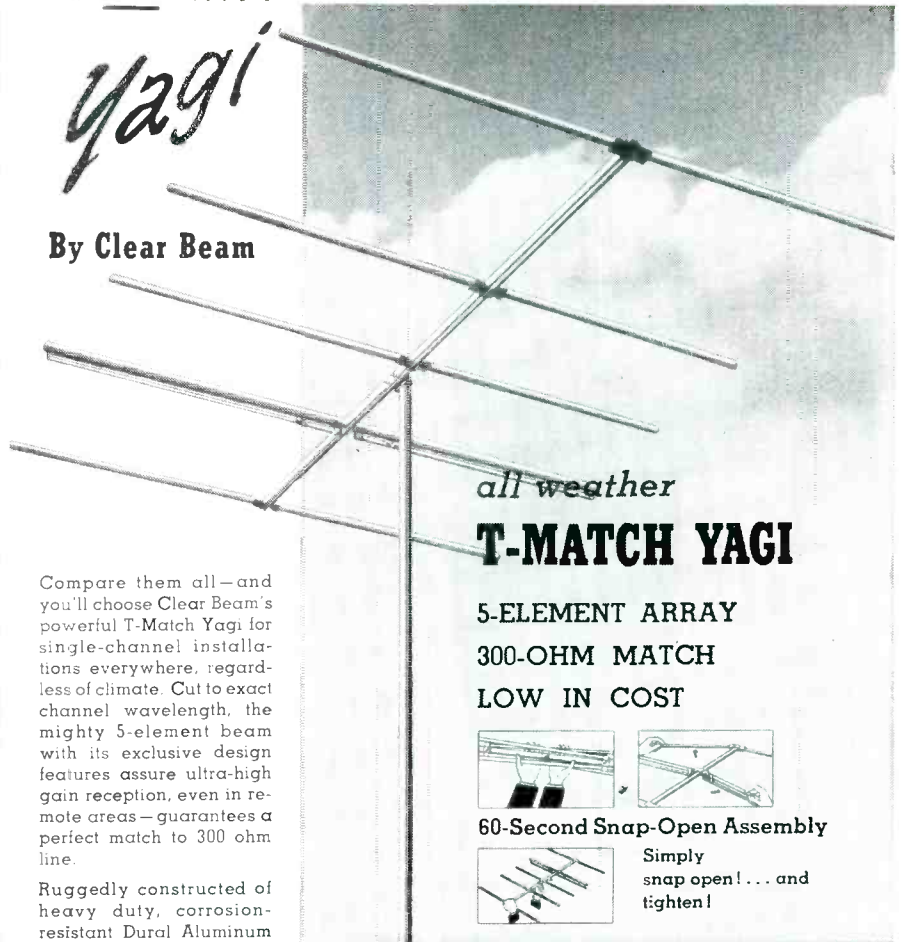

all weather
T-MATCH YAGI

5-ELEMENT ARRAY
300-OHM MATCH
LOW IN COST



60-Second Snap-Open Assembly

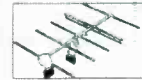

Simply snap open! . . . and tighten!

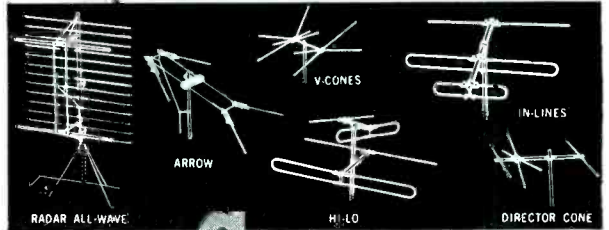

A COMPLETE LINE OF QUALITY ANTENNAS TO MEET EVERY TV RECEPTION REQUIREMENT

Clear Beam

Antennas

CLEAR BEAM ANTENNAS 618 No. La Brea Ave. Los Angeles 36, Calif. York 1682

MANY NOW SALES PROMOTION CONSULTANT

W. G. Many, formerly advertising and sales promotion manager of Cornell-Dubilier Corp., South Plainfield, N. J., and editor of the *C-D Capacitor*, has opened an office at Metuchen, N. J. (Box 265, R. D. 1), where he will conduct public-relations service, handling sales and engineering catalogs, literature, etc.



W. G. Many



JFD "Little Giant"
TWIN LEAD LIGHTNING ARRESTER
 Protects TV Sets Against
 Lightning and Static Charges



UL
 Underwriters Laboratories Approved

No. AT105
\$7.25 List

For Regular Twin Lead

SEEKING IS BELIEVING!
ONLY JFD Lightning Arresters offer you these exclusive patented features . . .

1. Patented strain-relief Retaining Lip which prevents pulling or straining against contact points.
2. You actually see positive contact made with lead-in wire.
3. Lead-in contact remains fully visible at all times.
4. No wire stripping. No Arrester Cover to Hide Poor Contacts!

At Your Jobber or Write Direct

JFD MANUFACTURING CO., Inc.
 6100th 16th AVENUE, BROOKLYN 4, N. Y.
 FIRST in Television Antennas and Accessories

SHOOT TV TROUBLE FAST!

With H. G. CISIN'S RAPID "TV TROUBLE SHOOTING METHOD"

EARN more money! Locate television troubles by this *quick*, entirely *new* method. Rapid checks enable you to locate all faults in record breaking time regardless of make or model! 160 Picture, Raster, Sound trouble symptoms. Over 100 Rapid Checks including over-all alignment checks, 26 illustrations; simplified step-by-step directions!

H. G. CISIN, well-known to radio men as a recognized electronic engineer, inventor, technical author and educator, has trained thousands of television technicians, many of them now owning their own prosperous TV service organizations. The results of his years of experience are embodied in this remarkable **TV TROUBLE SHOOTING METHOD**.

INCREASE your earning power with the most valuable aid to TV servicing ever written!

SEND YOUR NAME AND ADDRESS TODAY WITH ONLY \$1.00 FOR YOUR POSTPAID COPY

↓ RUSH COUPON NOW! ↓

H. G. CISIN, CONSULTING ENGINEER
 Dept. S-3, 200 Clinton St., Bklyn., 2, N. Y.

Enclosed is \$....., for which please rushcopies (postpaid) of your **TV TROUBLE SHOOTING METHOD**.

Name

Address

City..... Zone..... State.....

**New Parts . . .
 Instruments . . .
 Tools**

TRIPLETT TEST OSCILLATOR

A wide-range test oscillator, model 3432, is now available from the Triplett Electrical Instrument Co., Bluffton, Ohio. Featured are seven 330° scales with widely separated divisions.

Provides five fundamental ranges of 165 kc to 40 mc, and two harmonic ranges directly calibrated, 36 mc to 120 mc. Range selector has a five-position follow-up coil switch with complete shieldings. A *rf* selector provides high and low *rf* output. Output attenuator is said to provide fine control of *rf* output to coax output cable connector. Circuit selector provides for internally modulated signal, variable 0 to 100% at 400 cycles. Variable amplitude of external modulation 40 to 15,000 cycles; unmodulated signal or variable audio 0-10 volts at 400 cycles.

All *rf* and audio circuits are double shielded with copper plated steel shields. Size is 15 11/32" x 11 1/32" x 6 1/4".



* * *

CLAROSTAT SUBMINIATURE VOLUME CONTROLS

Subminiature controls, *series 48*, have been developed by Clarostat Mfg. Co., Inc., Dover, N. H.

Controls fit companions for subminiature tubes. Each unit measures 5/8" in diameter by 3/8" deep. Two units can be nested together and held by metal straps for a dual control combination. Available in resistance values up to 3 megohms linear, and in tapers up to 1 megohm with round or slotted shafts and a shaft-locking arrangement.

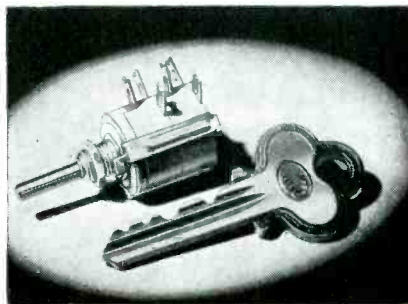

"HAVE YOU HEARD THE SOUND OF QUALITY?"



NEWCOMB SOUND IS BETTER

- Manufacturers of public address, mobile, phonograph, musical instrument and wired music amplifiers • Portable systems • Portable phonographs and radios • Transcription players • Rack and panel equipment.
- Write today! Circle items of interest and indicate whether you are a Dealer, Parts Jobber or Sound Specialist.
- **NEWCOMB AUDIO PRODUCTS CO.**
 DEPT. E, 6824 LEXINGTON AVE.
 HOLLYWOOD 38, CALIFORNIA

AEROVOX NOISE-SUPPRESSION FILTERS

Noise-suppression filters that are said to offer high attenuation and current ratings, housed in hermetically-sealed metal cases smaller than previous units, have been announced by Aerovox Corp., New Bedford, Mass.

Units are said to be of advanced pi type construction for high-efficiency filtering. Capacitor sections utilize metallized-paper dielectric, and include *fault-isolation* characteristics for protection against surge voltages above rated values. Filter chokes are said to contain high impedance to *rf* currents and low *dc* resistance.

Seven standard noise-suppression filters have metalized-paper capacitor sections, in ampere ratings from 2 to 100, all 150 volts. Sizes range from 1 1/4" x 1" x 7/8" to 3 1/16" x 2 1/8" x 2 7/8".



KAPNER POWER TOOL

A ¼" electric drill with attachments is now available from Kapner Hardware, Inc., 2248 Second Ave., New York 29, N. Y.

Tool combination includes a ¼" electric drill for 115 volts, ac operation, 4" portable electric saw attachment, 4" saw blade, lambs wool bonnet, 6 sanding disks, 7 assorted drills, steel arbor and attachments, cloth buffing wheel, grinding wheel, wire wheel brush, steel paint mixer, steel bench stand and a portable steel carrying case.

* * *

DAWN SELF-ADHESIVE FELT

Self-adhesive felt (dark brown) has been announced by J. B. Dawn Products, 3905 West 64th St., Chicago, Ill. Felt is 1/16" thick in forms of tape and strips, washers, discs and special shapes. Tape widths are from ⅛" to 6", in ⅛" multiples, and dots in diameters of ¼" and ½".

* * *

SPRAGUE CERAMIC CAPACITORS

A 500-mmfd 15,000-volt ceramic capacitor, 510C1, consisting of a ceramic slug encased in a molded rubber jacket has been introduced by Sprague Products Co., North Adams, Mass. Rated for continuous operation at 85° C, it is said to withstand a 22,500-volt dielectric test. Has a minimum insulation resistance of 10,000 megohms. Self-grommet provided for mounting in chassis.

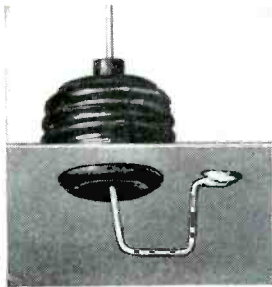

* * *

CLAROSTAT FIVE-WATT POWER RESISTORS

A series of 5-watt fixed wire-wound resistors, PR-5 F Greenohms, with inorganic cement coatings, are now available in 8000, 8500, 9000 and 10,000-ohm types from Clarostat Mfg. Co., Inc., Dover, N. H.

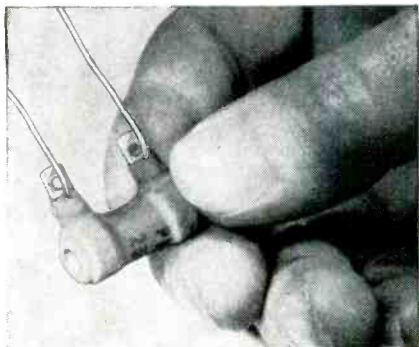

The tough little lamp that never talks back

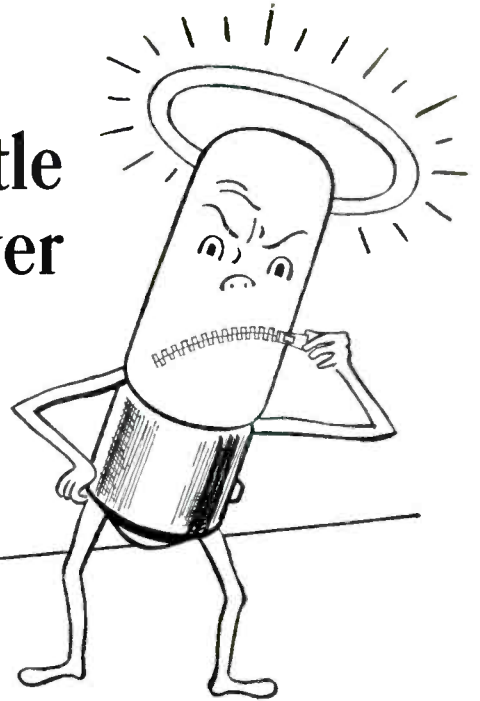

CALL it static if you will, but some radio interference is just plain "back talk" from old style panel lamps. Vibration caused by high notes loosens the joints between filament and lead-in wires. Tiny arcs result which are picked up by the speaker as static.

Not so with G-E panel lamps. Filament supports are longer and pressed firmly into the softer metal of the lead-

in wires—a vibration-proof joint. They take the shrillest soprano in stride without "talking back", last longer, assure customer satisfaction.

For full information on prices and types of G-E miniature lamps, call your G-E Lamp supplier. Or write Lamp Department, Division 166-S4, General Electric Company, Nela Park, Cleveland 12, Ohio.

1. Dependable, trouble-free performance.
2. High level of maintained light output.
3. Low current consumption.
4. Long life.
5. Profitable to handle.



GENERAL ELECTRIC

UNIVERSAL TV FM TUNER

An FM tuner, Ureco 501, with automatic drift compensation and a built-in transformer-operated power supply, has been announced by the Universal Television Manufacturing Co., 196 Bowery, New York 12, N. Y.

Circuit uses a stage of tuned rf amplification; two stages of ferrite-core if amplification and a ratio detector. High-Q air-form coils are used in the rf, antenna and oscillator circuits which are tuned by a 3-gang, copper plate capacitor. Five tubes and a selenium rectifier make up the tube complement. Dual terminals are provided for a dipole antenna.

The switching circuit is designed to automatically restore radio or phono operation when the FM tuner is turned off.

A 3-color, illuminated, calibrated dial is vernier driven.

C-D METAL-CASE TUBULARS

Miniature size paper capacitors in tubular metal casings, dykanol C impregnated and wax impregnated, are now available in six styles of case and bracket mountings from the Cornell-Dubilier Electric Corp., South Plainfield, N. J.

Featured are inserted tab construction for minimum size and extended foil construction. Available are: TWC or TWH unit, with both leads insulated from case; TWC or TWH unit with both leads insulated from case and provided with plastic insulating sleeve; TWC or TWH, one lead grounded to case with threaded stud mounting; TWC or TWH, one lead grounded to case; TWC or TWH, strap mounting bracket and one or both leads insulated from case; and TWC or TWH one lead grounded to case with plastic insulating sleeve.

ATR

"A" BATTERY ELIMINATORS

Makes it easy to **DEMONSTRATE AND TEST D.C. APPARATUS FROM A.C. LINES**

for DEMONSTRATING AND TESTING AUTO RADIOS

New Models . . . Designed for testing D. C. Electrical Apparatus on Regular A. C. Lines. Equipped with Full-Wave Dry Disc Type Rectifier, Assuring Noise-less, Interference-Free Operation and Extreme Long Life and Reliability.

NEW MODELS **NEW DESIGNS**
NEW LITERATURE

"A" Battery Eliminator, D.C.-AC Inverters
Auto Radio Vibrators

ATR See your jobber or write factory

AMERICAN TELEVISION & RADIO CO.
Quality Products Since 1931
SAINT PAUL 1, MINNESOTA-U.S.A.

JOTS AND FLASHES

TUBE SUBSTITUTIONS, which in '45 began to tenant the far-away lands to the delight of everyone, are back again and trying to raise havoc on many fronts. Fortunately, many means* have been devised to scalp the problem child. Comprehensive texts with factual solutions have been one of the media which have helped to effect a rout. In fact, one book has been found so helpful that the boys have bought over 50,000 copies, according to a report from *John F. Rider*, publisher of a substitution guide by *H. A. Middleton*. . . . *Park Metalware Co., Inc.*, Orchard Park, N. Y., manufacturers of Xcelite tools, have recently expanded their quarters. . . . A new distributor has opened house in Hicksville, Long Island, *Gem Electronics Distributors, Inc.*, 236 Broadway. Members of the new company are *Max Fine*, *Charles Shankman*, *David Kantrowitz* and *David Bernstein*. . . . *Harold M. Stral* has become advertising manager of *Standard Transformer Corp.*, Chicago. . . . *Bill Cameron* is now store manager of *Concord Radio Corp.*, Chicago. . . . *George M. Schau* has been named director of purchases of *Erie Resistor Corp.*, Erie, Pa. . . . *Olson Radio Warehouse, Inc.*, has opened a new store at 623 W. Randolph St., Chicago. . . . *Lewis Chaps* is now sales manager of *TV Materials Corp.*, New York City. . . . *Snyder Manufacturing Corp.*, Philadelphia, Pa., recently formed an athletic club for the benefit of members of the television, radio and automotive trade in Philadelphia. Headquarters of the club are at Tanglewood in New Hope, Bucks County, Pa. . . . *Federated Purchaser, Inc.*, has opened a store at 911 S. Grand Ave., Los Angeles, Calif. *Federated* now has offices in New York City, Newark, Allentown, and Easton, Pa. . . . *The Main T. V. Supply Co.*, Akron, Ohio, have become *Raytheon* sponsoring distributors for the bonded-dealer program. . . . *William Lightfoot* is now general manager of *Russell Electric Co.*, Chicago. . . . *Superior Television Service Co.*, 772 Sutter Ave., Brooklyn 7, N. Y., recently celebrated their third anniversary. . . . *David E. Harris* has been appointed manager of jobber sales for *Cleveland Electronics, Inc.*, Cleveland, Ohio. He will be responsible for the jobbing of the line of radio and television speakers and TV lightning arresters. . . . *Glen McDaniel* has assumed office as the first paid president of RTMA. *McDaniel* will headquarter in Washington at 1317 F St., N.W.

*On page 22, this issue, appears an extremely interesting article on tube substitutions.

ADVERTISERS IN THIS ISSUE

SERVICE INDEX—APRIL, 1951

AMERICAN TELEVISION & RADIO CO.	72
Agency: Firestone-Goodman Adv. Agency	
ASTRON CORPORATION	50
Agency: Hart Lehman Advertising	
ARGOS PRODUCTS COMPANY, INC.	58
Agency: M. Murray Adv. Agency	
BLACO MFG. CO.	64
Agency: C. F. Peters & Associates	
H. G. CISIN	70
Agency: A. D. Adams Advertising	
CLEAR BEAM TV ANTENNAS	69
Agency: James House Co.	
CORNELL-DUBILLIER ELECTRIC CORP.	63
Agency: Reiss Advertising Inc.	
ALLEN B. DUMONT LABORATORIES, INC.	27
Agency: Austin C. Lescaurou & Staff	
ELECTRO-VOICE, INC.	59
Agency: Henry H. Teplitz Advertising	
GAMMA ELECTRONICS CORP.	66
Agency: Leland Howe Associates, Inc.	
GENERAL ELECTRIC CO.	1, 35
Agency: Maxon	
GENERAL ELECTRIC LAMP DEPT.	71
Agency: Batten, Barton, Durstine & Osborn, Inc.	
GON-SET CO.	64
HALLORSON CO.	56
Agency: Western Adv. Agency Inc.	
HI-LO TV ANTENNA CORP.	53
Agency: Sander Rodkin Adv. Agency	
HYTRON RADIO ELECTRONICS CORP.	15
Agency: Bennett, Walther & Menadier, Inc.	
J. F. D. MFG. CO., INC.	41, 56, 70
Agency: Shappe-Wilkes, Inc.	
JACKSON ELECTRICAL INSTRUMENT CO.	49
Agency: The Parker Adv. Co.	
JENSEN MFG. CO.	2
Agency: Brown, Advertising	
KESTER SOLDER CO.	16
Agency: Frank C. Nahser, Inc.	
KRYLON, INC.	44
Agency: Gray & Rogers	
LA POINTE PLASCOMOL CORP.	50, 61
Agency: The F. W. Trelle Co.	
P. R. MALLORY & CO., INC.	Inside Back Cover
Agency: The Atkin-Kynett Co.	
MUELLER ELECTRIC CO.	48
NEWCOMB AUDIO PRODUCTS CO.	50
Agency: Stuart Stevens Advertising	
PARK METALWARE CO., INC.	56
Agency: Melvin F. Hall Agency, Inc.	
PERFECTION ELECTRIC CO.	46, 66
Agency: Spont & Co.	
PHOENIX ELECTRONICS, INC.	58
Agency: Milton Richards Adv. Co.	
PLANET MFG. CORP.	54
Agency: Conti Adv. Agency, Inc.	
PRECISION APPARATUS CO., INC.	8
Agency: Shappe-Wilkes, Inc.	
RADIART CORP.	Inside Front Cover, 31
Agency: Stern and Warren	
RADIO CORPORATION OF AMERICA	6, Back Cover
Agency: J. Walter Thompson Co.	
RADIO RECEPTOR COMPANY	68
Agency: Walter J. Zimmerman & Associates	
RAULAND CORPORATION	11
Agency: Sumner Rubin Adv. Co.	
RAYTHEON MFG. CO. RECEIVING TUBE DIV.	18
Agency: Walter B. Snow & Staff	
JOHN F. RIDER PUBLISHER, INC.	52
Agency: Shappe-Wilkes, Inc.	
RINEHART BOOKS, INC.	55
Agency: The Harry P. Bridge Co.	
HOWARD W. SAMS & CO., INC.	46
Agency: George Bradsby Advertising	
SANGAMO ELECTRIC CO.	7
Agency: Arthur R. Mogge, Inc.	
SCHAUER MFG. CORP.	60
Agency: The Keeler & Stites Co.	
WALTER L. SCHOTT CO.	43
Agency: Tids & Cantz	
SHELDON ELECTRIC DIV. ALLIED ELECTRIC PRODUCTS, INC.	9
Agency: Corbin Adv. Agency	
SHURE BROTHERS, INC.	45
Agency: Caslor, Hempstead & Hanford, Inc.	
SIMPSON ELECTRIC CO.	12
Agency: Burton Browne Advertising	
SNYDER MFG. CO.	48
Agency: Brooks and London	
SPRAGUE PRODUCTS CO.	47
Agency: Harry P. Bridge Co.	
STANDARD COIL PRODUCTS CO., INC.	29
Agency: Frank C. Nahser, Inc.	
STANDARD TRANSFORMER CORP.	65
Agency: Sumner Rubin Adv. Co.	
SYLVANIA ELECTRIC PRODUCTS, INC.	3
Agency: Cecil & Presbrey, Inc.	
TECHNICAL APPLIANCE CORP.	10
Agency: Austin C. Lescaurou & Staff	
TELEVISION SUPPLY CO.	54
TELEWIRE MFG. CO., INC.	64
TEL-O-TUBE CORPORATION OF AMERICA	21
Agency: Salow Adv. Agency	
TELREX, INC.	51
Agency: George Homer Martin Associates	
THOMAS ELECTRONICS, INC.	5
Agency: Conti Adv. Agency, Inc.	
TRIPLETT ELECTRICAL INSTRU. CO.	6
Agency: Warner Adv. Agency, Inc.	
U. S. TREASURY DEPT.	12
V-M CORPORATION	42
Agency: Mayard Sales & Adv. Counsel	
WALDOM ELECTRONICS, INC.	60
Agency: Sander Rodkin Adv. Agency	
WALKER-JIMIESON, INC.	48
Agency: Edward C. Kennedy	
WARD PRODUCTS CO.	67
Agency: The Hubbell Adv. Agency	
WEBSTER ELECTRIC	57
Agency: Hamilton Adv. Agency, Inc.	
WEXCO, INC.	68
Agency: Henry H. Teplitz	
WRIGHT, INC.	58
Agency: Kay Advertising, Inc.	
ZETKA TELEVISION TUBES	13
Agency: Art-Copy Adv. Agency	

You wouldn't risk your business on the turn of a card

... but a survey of hundreds of servicemen shows that 57% order capacitors by rating, without specifying a brand. Why risk your reputation on parts that may not deliver top performance?



Make Sure! Make it Mallory!

You'll get top performance every time you make it a Mallory Capacitor . . . top performance that stems from uniform capacity, long life, and outstanding service at high temperatures and heavy ripple currents.

Mallory produced the first dry electrolytic capacitor and has led the way in setting new standards for smaller sizes, uniform mounting, and resistance to heat in continuous service. Every Mallory FP assures you of trouble-free service, cuts down on comebacks.

MALLORY PLASCAP



The plastic tubular specifically designed to meet your field service problems. Available in a complete range of ratings.

You will like the Mallory Plascap*, plastic tubular capacitor, too! Ruggedly molded and securely sealed . . . it has clearly identified, permanently fastened leads, and stands up under high temperatures.

Don't be satisfied with less than the best. It costs no more to get the top performance that only Mallory Capacitors can give you!

**Trade Mark*

Depend on your Mallory Distributor for precision quality at competitive prices



P. R. MALLORY & CO. Inc.
MALLORY

CAPACITORS • CONTROLS • VIBRATORS • SWITCHES • RESISTORS
• RECTIFIERS • VIBRAPACK* POWER SUPPLIES • FILTERS

*Reg. U.S. Pat. Off.

APPROVED PRECISION PRODUCTS

P. R. MALLORY & CO., Inc., INDIANAPOLIS 6, INDIANA

You get all five

...with RCA Batteries

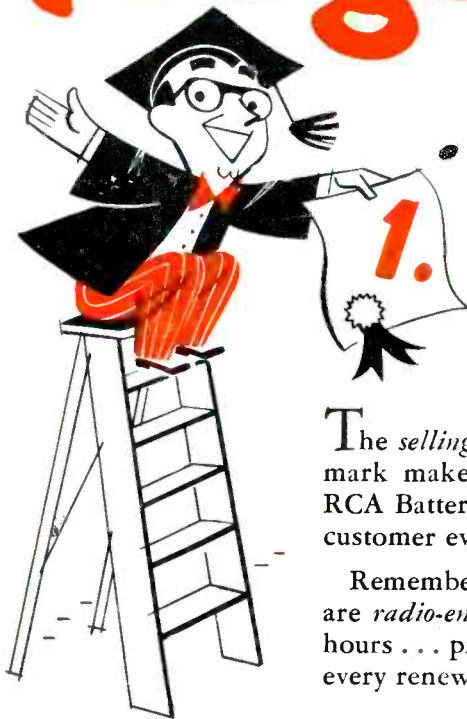

1. Top Brand Acceptance

... makes selling easy

The *selling power* of the RCA Trade-mark makes it *easy* for you to move RCA Batteries . . . and gain a satisfied customer every time.

Remember, too, that RCA Batteries are *radio-engineered* for *extra* listening hours . . . provide a type for practically every renewal requirement.

So—starting now—push RCA Batteries. Build a profitable repeat business with virtually no competition from non-radio outlets.

See your RCA Battery Distributor for fast, reliable service.

2. Radio Trade Distribution

3. Completely Rounded Line

4. Radio-Engineered Quality

5. Super Selling Aids

*The Batteries for
the Radio Trade!*



RADIO CORPORATION of AMERICA

RADIO BATTERIES

HARRISON, N. J.