

# SERVICE

July  
1950

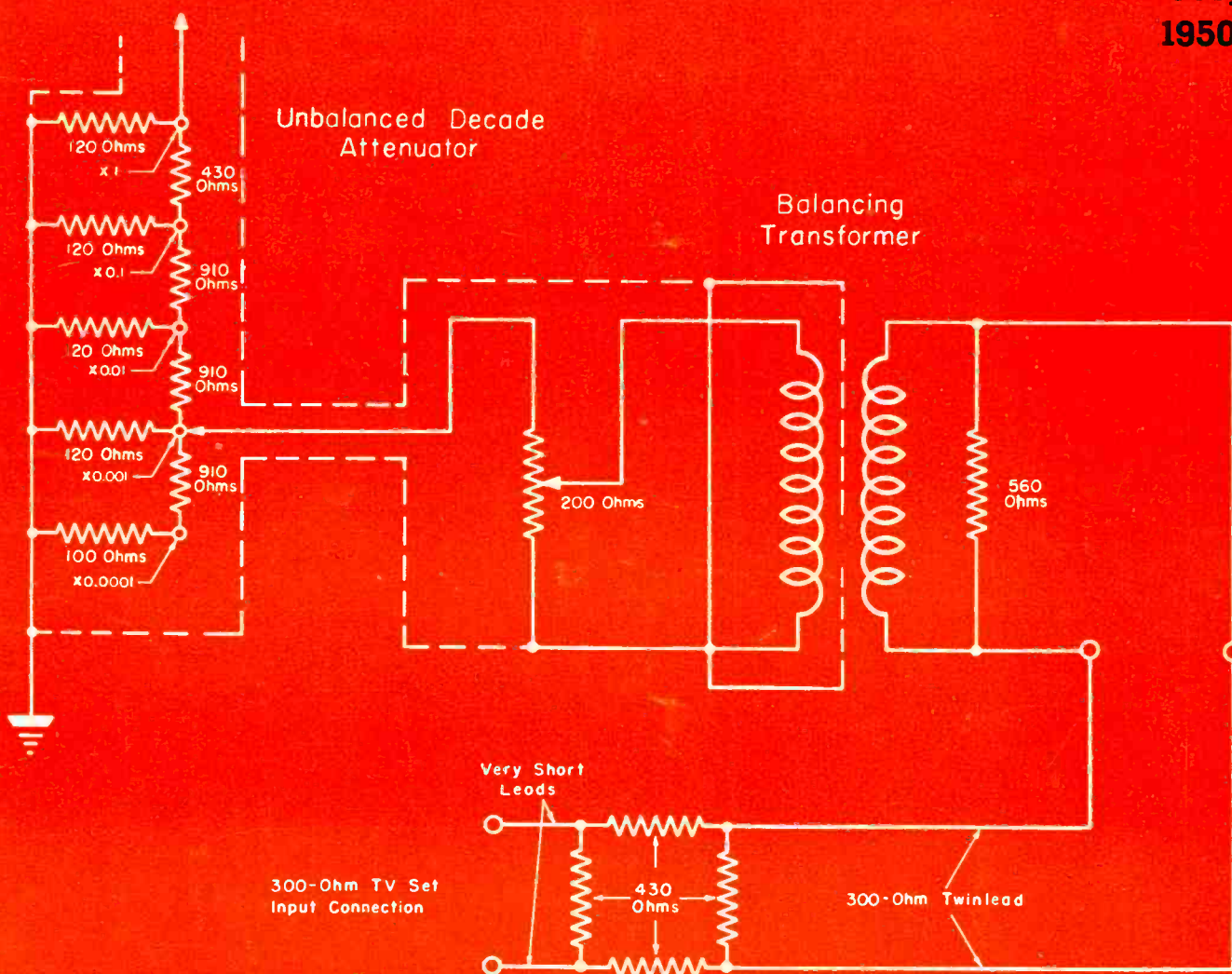

TV measurement circuit which provides a balanced output from an unbalanced decade attenuator feed.

[See page 2]

only

# C-D

## TINY MIKE®

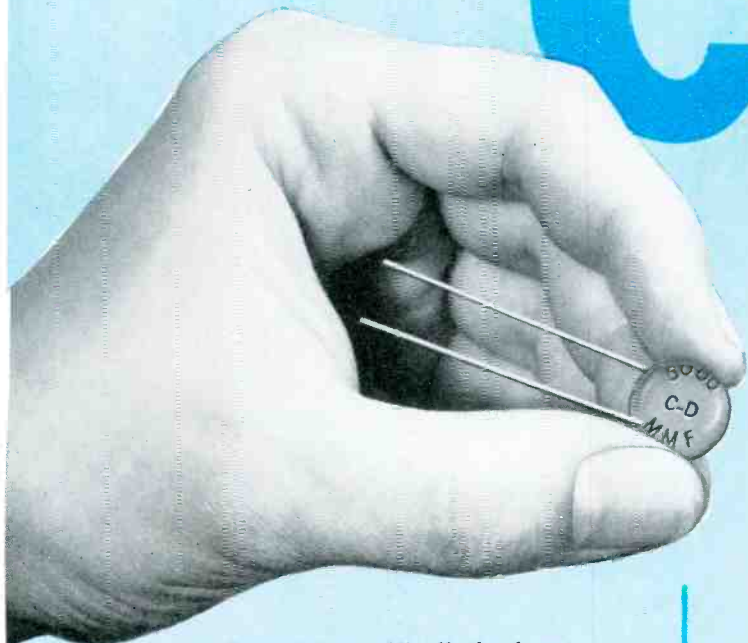

# CERAMIC DISC CAPACITORS

*designed specifically for bypass and coupling applications*

Here's why high-efficiency, low-cost, C-D Miniature Ceramic Disc Capacitors have won immediate acceptance throughout the field.

- Exclusive TINYMIKE® construction results in maximum dependability.
- Special TINYMIKE® shape provides short, wide current path.
- Parallel leads—another C-D first—produces lowest possible inductance, providing leads are kept short.
- Wire leads, connected directly to high purity silver electrodes result in low series resistance.
- Accurately positioned electrodes result in highest capacity with minimum eddy current losses and high Q.
- Special phenolic coating insulates capacitor against shorts to ground.
- High-temperature wax impregnation—exclusive with C-D TINYMIKES®—provides maximum humidity seal.

Insist on C-D TINYMIKE® Ceramics—the better ceramic proved best by field test!

**GIVE YOU:**

- LOWEST POSSIBLE INDUCTANCE**
- HIGH LEVEL SHUNT RESISTANCE**
- MINIMUM EDDY CURRENT LOSSES**
- MAXIMUM Q**

*now available from 50 to 5,000 mmf. at your C-D jobber*

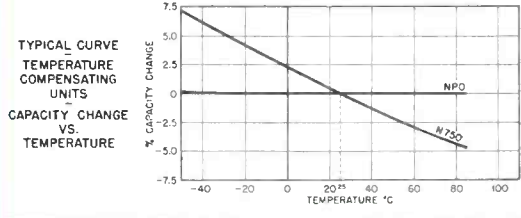
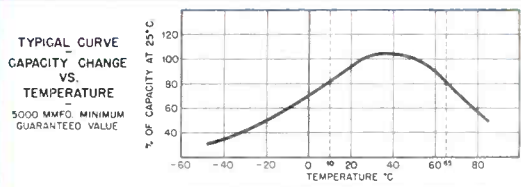

Write for catalog. CORNELL-DUBILIER ELECTRIC CORPORATION, Dept. S70, South Plainfield, New Jersey. Other plants in New Bedford, Brookline and Worcester, Mass.; Providence, R. I.; Indianapolis, Ind.; and subsidiary, The Radiart Corp., Cleveland, Ohio.

See your Classified Phone Book for nearest jobber.



CONSISTENTLY DEPENDABLE

# CORNELL-DUBILIER

CAPACITORS • VIBRATORS • ANTENNAS • CONVERTERS



# SALES POWER?

“Plenty . . . with the  
G-E monogram on the job!”

“ANOTHER way to put it is *acceptance*. ‘G-E’ on my store window, on tube cartons, makes my customers want to buy!” Testimony like this is common when radio-TV servicemen talk shop. They’ve found — sales have shown them — that it’s easy to market a tube product known favorably to millions. Just as *your* income, once you handle General Electric tubes, climbs because your public is pre-sold on G-E quality and value! . . . And you get plenty of help in acquainting prospects with your expert service facilities, as well as with your complete line of G-E tubes. General Electric signs, advertising aids, other attention-getters do an overtime job of bringing business to your door. Your G-E tube distributor will be glad to review for your benefit the folder describing the many colorful, effective, *tested* G-E sales helps, each a signpost along your road to bigger tube profits. See him today! *General Electric Company, Electronics Department, Schenectady 5, New York.*

*You can put your confidence in —*

GENERAL  ELECTRIC

181-JAS



**ONE SOURCE** for all your tube requirements—metal and glass tubes; miniatures; TV picture tubes in a wide range of sizes and types; also germanium diodes and selenium rectifiers. General Electric's line is complete! G. E.'s list of types includes newest tube designs for new radio-TV receivers! . . . Stock G-E 100-percent, to simplify ordering—to benefit from unit deliveries—to profit from General Electric tube quality and product popularity!



**LEWIS WINNER**  
Editorial Director

**F. WALEN**  
Assistant Editor

**ALFRED A. GHIRARDI**  
Advisory Editor

	Page
Association News .....	34
Auto Radio Service-Shop Facilities. By Jack Darr .....	16
Cabinets for a Custom-Built FM-AM Phono Combination. By Herbert G. Eidson, Jr. ....	18
PA System Service. By John B. Ledbetter .....	24
Phono Installation and Service (3-Speed Systems). By Kenneth Stewart .....	15
Ser-Cuits (TV Tuners ... Built-In Antennas) .....	28
Ten Years Ago in Associations .....	35
TV Alignment Procedures (Cover). By M. E. Clark .....	12
Views and News. By Lewis Winner .....	11

**CIRCUITS**

Auto Radio Power-Supply-System Setup .....	17
Auto Radio Portable Test-Ammeter Circuitry .....	17
Auto Radio Bench Test-Antenna-Lead Wiring .....	45
Auto Radio Test-Speaker Arrangement .....	45
Emerson TV Tuner .....	28
G. E. Balanced Output Adapter (TV Alignment) .....	13
Network for Matching 300 and 50-Ohm Unbalanced Lines .....	13
Network of 430-Ohm Resistors to Match Sweep Lead .....	14
Parallel-Connected Speaker Voice-Coil Test Setup .....	26
Power Output Measurement Setup .....	24
Receiver-Amplifier-Changer Assembly Circuit .....	20
TV Alignment Attenuator and Balanced-Output System (Cover) .....	12
Westinghouse Built-In Antenna .....	28
Westinghouse V-2150-61 IF Channel System .....	31
Westinghouse V-215-2152-61 Sync System .....	42
Westinghouse Keyed AGC .....	43

**COVER**

Attenuator and Balancing Circuit for TV Alignment .....	12
---	----

**PHONO INSTALLATION AND SERVICE**

Multiple-Speed Changers in Portable Phono Units .....	15
Three-Speed Automatic Record Changers Used in New Philco Models .....	15

Index to Advertisers .....	48
----------------------------	----

**Manufacturers**

Jots and Flashes .....	48
News .....	46
New Parts ... Instruments ... Accessories .....	40
Rep Talk .....	37
TV Parts ... Antennas ... Accessories .....	33

Entire contents Copyright 1950, Bryan Davis Publishing Co., Inc.



Published monthly by Bryan Davis Publishing Co., Inc.  
52 Vanderbilt Avenue, New York 17, N. Y. Telephone MUrray Hill 4-0170



Bryan S. Davis, President      Paul S. Weil, Vice-Pres., Gen. Mgr.      F. Walen, Secretary      A. Goebel, Circulation Manager

Mid-West Representative: Stuart J. Osten, 333 N. Michigan Ave., Chicago 1, Ill. Telephone: Dearborn 2-3507  
East-Central Representative: James C. Munn, 2253 Delaware Dr., Cleveland 6, Ohio. Telephone: ERview 1-1726  
Pacific Coast Representative: Brand & Brand, 1052 W. Sixth St., Los Angeles 14, Calif. Telephone: Michigan 1732  
Suite 1204, Russ Building, San Francisco 4, Calif. Telephone: SUTter 1-2251

Entered as second-class matter June 14, 1932, at the Post Office at New York, N. Y., under the Act of March 3, 1879. Subscription price: \$2.00 per year in the United States of America and Canada; 25 cents per copy. \$3.00 per year in foreign countries; 35 cents per copy.



**WIDE RANGE 5-INCH  
OSCILLOSCOPE  
MODEL 3440**

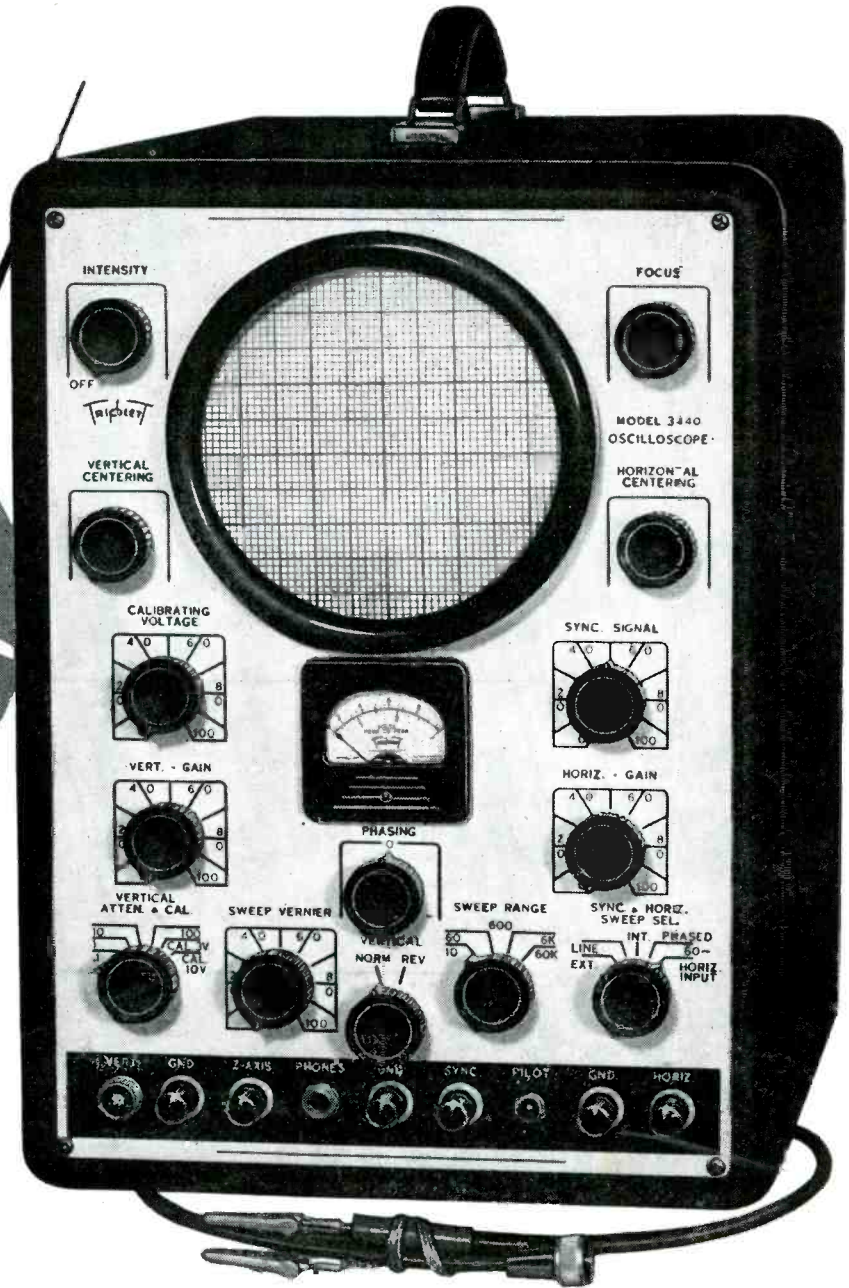

- \*● Provision for changing polarity—wave form shows in conventional manner.
- \*● Calibration Meter—to measure voltage of complex wave forms in TV receivers.
- \*● Vertical deflection sensitivity—.009 RMS volts/inch.
- Wide frequency range—20 cycles to 1 MC on Vertical—Services both TV & FM.
- Return trace eliminator.
- Internal phase controlled horizontal sweep.
- Internal sweep oscillator—10 to 60 MC/second linear.
- Z-axis input for intensity modulation.

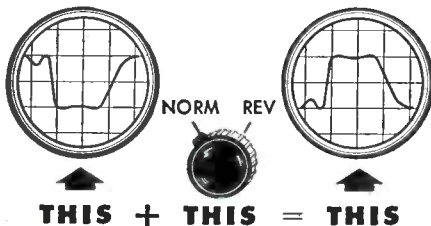

The first oscilloscope which permits changing polarity, thus keeping wave form showing in a conventional manner.

**ONLY \$189.50 AT YOUR DISTRIBUTORS**

● Copper plated feet for improved grounding.  
\* EXCLUSIVE AT THIS PRICE LEVEL

**FOR THE MAN WHO TAKES PRIDE IN HIS WORK**  
**Triplet**  
TRIPLET ELECTRICAL INSTRUMENT COMPANY - BLUFFTON, OHIO, U.S.A.



*The finest solder made  
for all television and radio work  
... Everything Electrical*

# Kester Solder

Kester Plastic Rosin-Core and Kester "Resin-Five" Core Solders are recognized by the trade as outstanding for the finest type of radio, television and electrical work.

Kester Solders are made only from newly mined grade A tin and virgin lead. Fluxes chemically correct.

# Uniform

Only highly skilled craftsmen are employed by the Kester Solder Company. Flux formulas and specifications are rigidly adhered to for perfect uniformity.

# Efficient

Making Kester Solder is an exact science from the raw material to the finished product. Everyone knows and prefers Kester because it can be relied upon to do the job right every time, even under the most difficult soldering conditions.

## **KESTER MAKES GOOD SOLDERING EASY**

The wise serviceman insists upon Kester Solder from his jobber. By using Kester, the solder used in making the original equipment, he will do his best work.

EASIER TO USE  
MADE FROM VIRGIN METALS  
FASTER  
ELIMINATES REJECTS  
DEPENDABLE  
SAVES TIME

Kester...Standard for the TV and Radio Fields

### **KESTER SOLDER COMPANY**

4248 Wrightwood Avenue, Chicago 39, Illinois  
Newark, N. J. • Brantford, Canada

**KESTER  
SOLDER**



# 4 SALES-PROVED "Package Deals" THAT BRING YOU MORE

# Money!

Over 1,000,000 sold!

## The METROPOLITAN—TA-49

The industry standard: Model TA-49 Indoor TV Antenna, Mahogany bakelite, 10 feet of 300 ohm line, 3-section telescoping tubular steel dipoles, covers all channels. Fully assembled. Individually packaged. Shipped six to a master carton. Shipping weight, 11 pounds. LIST PRICE, \$6.95.

Cinches "borderline" sales!

## The SUBURBAN—TA-51

Model TA-51 Conical Outdoor Antenna. For wall, window or attic mounting. Weatherized ebony bakelite head. 15 feet of 300 ohm line. Four 4-section telescoping tubular steel dipoles, triple chrome plated. 4-foot telescoping mast. Steel base mount, black copper-oxide, rustproof. Full channel coverage. Fully assembled. Individually packaged. Packed 6 to a master carton. Shipping weight, 30 pounds. LIST PRICE, \$9.95.

The newest in outdoor mounts

## The TOWN and COUNTRY

A fully assembled conical, complete with 12-foot mast, 50 feet of lead-in, universal mounting bracket for flat or sloping roofs, equipped with UHF stubs. Aluminum dipoles, steel mast. Individually packaged. LIST PRICE, \$14.95.

Fast sales! Fast installation!

## LINKED LEAD-IN

The new TL-10 . . . ten foot lead-in stripped, split . . . terminals already on . . . packaged complete with combination standoff and insulator . . . 12 to a box . . . 144 to a shipping carton. Shipping weight, 25 pounds. For 20 feet, snap 2 lengths together. A natural for counter sales . . . a time-and-money-saver for service departments! LIST PRICE, 69c.

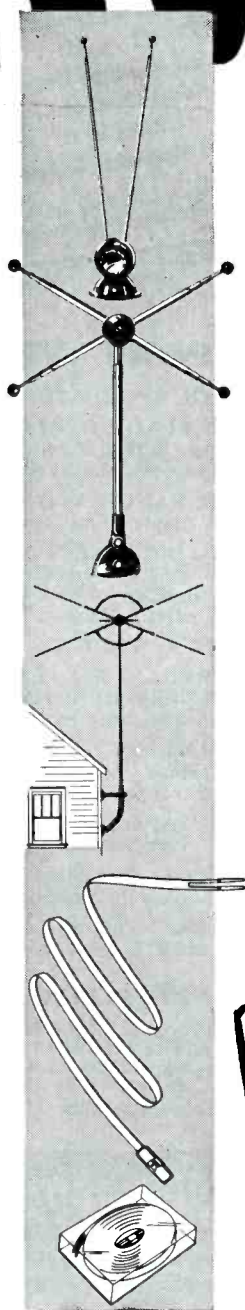

Two-way profit builders: (1) Big selling "traffic items" in their own right and (2) powerful sales-clinchers for T-V set sales because they mean QUICK, EASY and INEXPENSIVE installation. Many times, that's all a T-V prospect needs to make up his mind—and Radion has pushed across tens of thousands of set sales for its dealers!

With over a MILLION of its original and improved model TA-49's in use today, and its other models making equally impressive records, Radion is America's BIG NAME in indoor and packaged outdoor antennae. It's your *life-saver* when a set with new "built-in antenna" won't quite deliver the goods—a money-maker for you *all the time!* Phone, wire or write your jobber—or mail coupon TODAY.

# Radion

THE RADION CORPORATION

1137 Milwaukee Ave., Chicago 22, Illinois

## Make more money — Mail this

Right Now!

THE RADION CORPORATION

1137 Milwaukee Ave., Chicago 22, Illinois

S-7

For Data on Radion Products and your nearest Distributor, check here:

- TL-10 Lead-in Package       Town & Country No. TA-53 Outdoor Mount  
 Metropolitan No. TA-49  
 Suburban No. TA-51

Name.....

Company.....

Address.....

City.....Zone....State.....

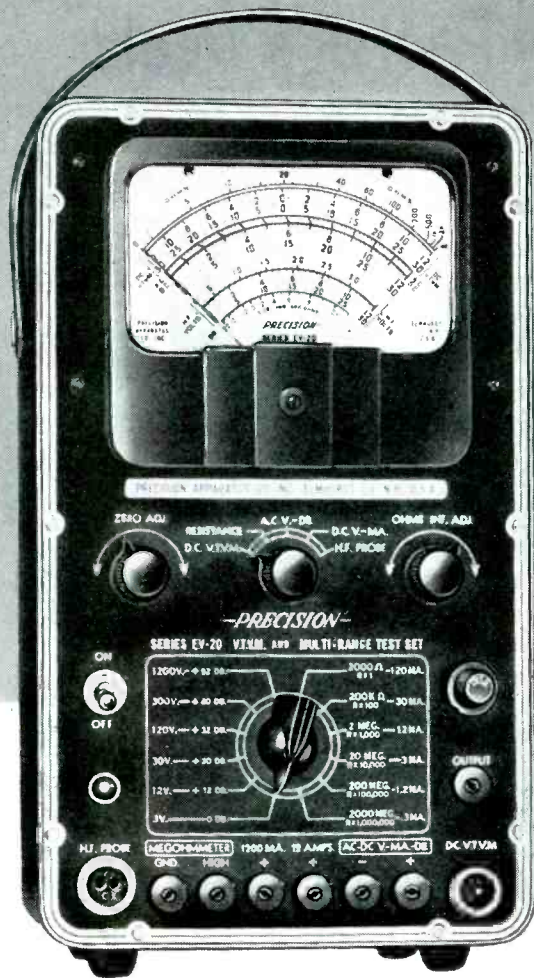

A Compact, Versatile, Portable  
Circuit-Testing Laboratory for  
TV — FM — AM  
The New  
**PRECISION**  
**SERIES EV-20**  
VTVM and Multi-Range Test Set

Net Selling Price ... **\$64<sup>75</sup>**

A Modern, Portable VTVM—Megohmmeter.  
TRUE ZERO-CENTER on ALL VTVM ranges  
PLUS Direct Reading High Frequency Scales  
ALSO, complete, standard 1000 ohms per volt functions

48 RANGES TO  
1200 Volts\*, 2000 Megohms, 12 Amperes, +63DB

\* D.C.—VTVM ranges to 12,000 and 30,000 Volts when  
used with Series TV Super-High Voltage Test Probe.

### Range Specifications

- ★ SIX ALL-ZERO CENTER VTVM RANGES: —13½ Megs. Constant Input Resistance. ±3, ±12, ±30, ±120, ±300, ±1200 volts. Direct Reading to ±12 KV and ±30 KV with Series TV Super-High Voltage Test Probe
- ★ SIX SELF-CONTAINED OHMMETER-MEGOHM-METER RANGES: 0-2000 - 200,000 ohms.  
0-2-20-200-2000 Megohms.
- ★ FOUR DIRECT READING HIGH FREQUENCY VTVM RANGES: 0-3-12-30-120 volts. (When used with RF-10A High Frequency Vacuum Tube Probe, Net Price \$14.40. No crystal rectifiers employed.)
- ★ SIX AC-DC AND OUTPUT VOLTAGE RANGES at 1000 ohms/volt. 0-3-12-30-120-300-1200 volts.
- ★ EIGHT D.C. CURRENT RANGES: 0-300 microamps. 0-1.2-3-12-30-120-1200 milliamps. 0-12 Amperes.
- ★ SIX DECIBEL RANGES from —20 to +63DB. Calibrated for 600 ohm, 1 mw., zero DB reference level.

### IMPORTANT FEATURES

- ★ VOLTAGE REGULATED—BRIDGE CIRCUIT.
- ★ DIRECT READING, ALL ZERO-CENTER VTVM —indicates BOTH Polarity and Magnitude without switching or test lead reversal.
- ★ MASTER RANGE AND FUNCTION SELECTORS eliminate frequent and inefficient shifting of test leads.
- ★ SHIELDED CONNECTORS for both D.C.—VTVM and RF—VTVM. Permits simultaneous and non-interfering connection of both Circuit Isolating Test Probe and optional H.F. Vacuum Tube Probe Series RF—10A.
- ★ HIGH FREQ. VOLTAGE SCALES—Direct Reading.
- ★ DUAL-BALANCED ELECTRONIC BRIDGE OHMMETER—MEGOHMMETER uses two 1.5 volt flashlight cells easily replaced at rear of cabinet.
- ★ 1000 OHMS/VOLT MULTI-RANGE FUNCTIONS permit simple AC-DC voltage, DB and current measurements free of power line requirement.
- ★ 4½" RECTANGULAR METER—200 microamperes, ±2%. Double-Sapphired, D'Arsonval construction.
- ★ 1% Film type, Metallized and Wire-Wound resistors for all shunts and multipliers.
- ★ Heavy gauge, round-cornered, louvred steel case with plastic handle. Etched, anodized, aluminum panel.

NET SELLING PRICE **\$64<sup>75</sup>**

Complete with coaxial Circuit Isolating Test Probe, Shielded Ohmmeter Test Cable, Standard #227 Super-Flex Test Leads, Ohmmeter battery and full operating instructions.

Case dimensions—10½" x 6¼" x 5"

Shipping Weight: 11 pounds.

CODE:—Party

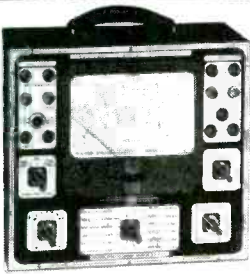

*Also* ask to see the "Precision" Series EV-10, DeLux VTVM—Megohmmeter with extra-large 7" meter. 59 self-contained ranges to 6000 volts and 70 DB.

Series EV-10, affords to the discriminating instrument purchaser, and equipment-conscious service-laboratory, the ultimate in visibility and performance.

EV-10-P  
(Closed portable)—\$92.70  
EV-10-MCP (Illustrated)  
(Open Lab. Type)—\$89.95.

See complete EV-10 specifications on page 4 of latest Precision catalog, available at leading radio equipment distributors or write directly to factory for full details.

**PRECISION APPARATUS CO., INC.**  
92-27 Horace Harding Boulevard, Elmhurst 6, New York  
Export Division: 458 Broadway, New York, U.S.A. • Cables—Morhanex



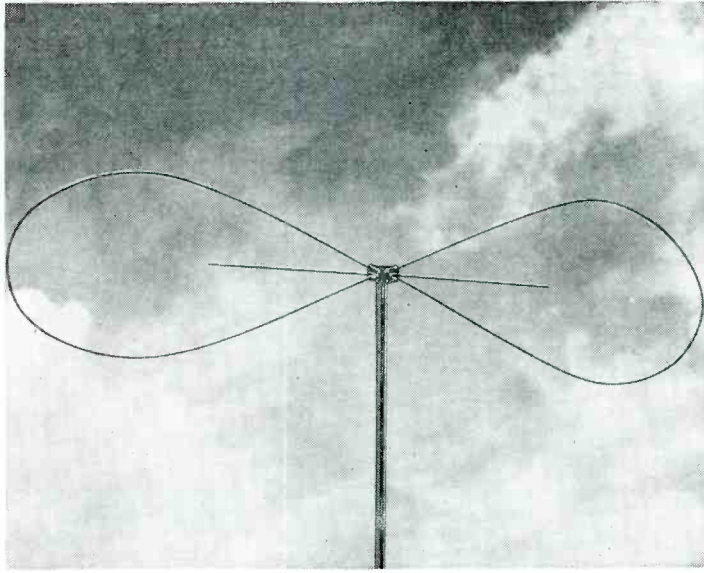

**THE ANSWER  
TO INSTALLATION  
PROBLEMS**

**Just unpack this antenna and mount to  
the mast . . . THE ECON-A-RAY *Butterfly***

and it sells for **\$2<sup>95</sup>** Suggested List

**T**HE FIRST antenna built with the problems of the serviceman in mind — the Econ-a-Ray Butterfly — for lightning fast installations at low cost.

There is nothing to assemble with the Butterfly. Just take it out of the box and mount it to the mast — for fine television.

The Butterfly will save you time and money — not only in installations — but by eliminating call-backs. Constructed from Dural, with stainless steel fittings, the Butterfly withstands winds up to 75 mph, is unaffected by any weather conditions, and cannot corrode.

This is a quality antenna — even though the price is low. It receives all 12 TV channels and FM radio, eliminates ghost images, and brings in a strong, sharp signal. It is designed for high signal areas, only.

The Econ-a-Ray Butterfly comes individually wrapped, 12 to a carton. Order yours today from your distributor.

TEL-A-RAY manufactures a complete line of TV and FM antennas including the Model T Reception Master which brings television to homes 200 miles away from the nearest station. All are guaranteed against weather and wind damage. We will be glad to send you our catalog.

**“FIRST—because they LAST”**

*Write Today for Information and Distributor's Name*

**Tel-a-Ray ENTERPRISES, INC.**

P. O. BOX 3325

HENDERSON, KENTUCKY

# Announcing...

# a revolutionary new oscilloscope

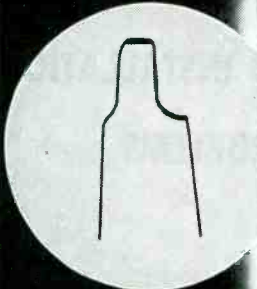

Horizontal sync-pulse as displayed on WO-57A screen



### Featuring

- ✓ **A Direct-Coupled, 2-stage, Push-Pull Vertical Amplifier**
- ✓ Deflection Sensitivity—30 millivolts RMS per inch deflection.
- ✓ Frequency Response—Flat within  $\pm 1.3$  db from dc to 500 kc; within  $\pm 3.5$  db at 1 Mc; useful beyond 2 Mc.
- ✓ Square-Wave Response—Tilt and overshoot less than 2%.
- ✓ Input Capacitance—14 uuf with WG-216 accessory probe.

### Special

- ✓ **Advanced Sweep Facilities**
- ✓ Preset Fixed Sweep Positions for viewing vertical and horizontal sync pulses and sweep oscillator waveforms.
- ✓ Positive and Negative Synchronizing for easy "lock-in" of upright or inverted pulse waveforms.
- ✓ Sweep Reversal Switch for left-to-right or right-to-left traces.
- ✓ Linear Sweep Range—15 to 30,000 cps.
- ✓ 60-cycle phase controlled sweep.
- ✓ Trace Expansion two times screen diameter for sweep-alignment applications.

### Plus These Extras

- + CR tube enclosed in nickel-iron alloy shield to minimize hum pick-up.
- + Push-pull vertical and horizontal amplifiers produce sharper trace and reduce astigmatism.
- + Frequency-compensated, and voltage-calibrated step and vernier attenuators.
- + Peak-to-peak calibrating voltage source.
- + New calibrating screen for ease in making voltage measurements.
- + Slanted light shield for better visibility.
- + Portable, compact design—small size, light weight.

**\$137<sup>50</sup>** Suggested User Price

## The RCA WO-57A

### High Gain—Wide Band—DC and AC Input.

The WO-57A is an outstanding innovation in portable oscilloscope design. Especially suited for television, this new scope is excellent for laboratory, factory, or shop use . . . for viewing and measuring square waves, pulses, TV sync signals, and sine waves.

Unusually versatile . . . newly designed from stem to stern . . . the RCA WO-57A Oscilloscope is a triumph of engineering.

Incorporating the features of far more expensive instruments . . . and with a sensitivity and response equal to that of many laboratory units . . . the WO-57A is the first inexpensive oscilloscope wholly equipped to handle every TV and radio service job.

Direct-coupled amplifiers are used to provide low frequency response flat down to dc. Excellent low-frequency square-wave reproduction, essential for correct sweep alignment, is thus assured. High-frequency

square-wave response up to 100 kc enables the WO-57A to reproduce blanking and sync pulse wave shapes with fidelity heretofore unobtainable in moderately priced service-type oscilloscopes.

For complete technical details, ask your RCA Test Equipment Distributor for the bulletin on the new WO-57A, or write RCA, Commercial Engineering, Section G56X, Harrison, New Jersey.

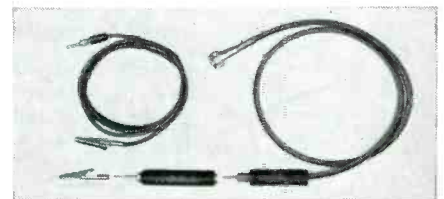

**Probe Kit (WG-214)—\$7.50.** Includes input cable with direct probe, slip on low-capacitance probe, and ground lead for observation of sync pulses, oscillator wave-forms and video signals without undue circuit loading.

Available from your RCA Test Equipment Distributor



**RADIO CORPORATION of AMERICA**  
TEST EQUIPMENT  
HARRISON, N. J.

# SNAP-ON TV FUSE HOLDER!

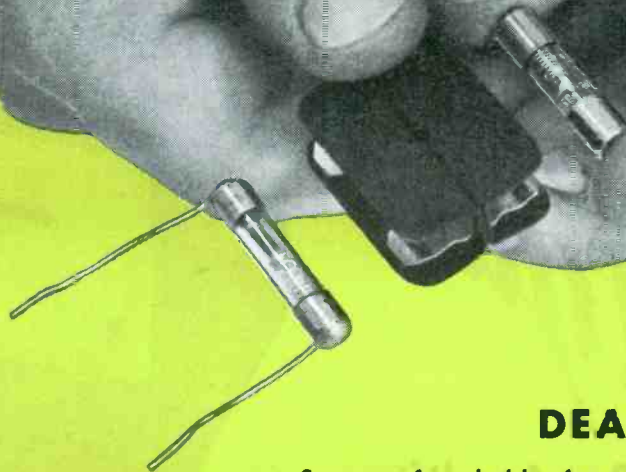

## DEAL NUMBER 1

Snap-on fuse holder for quick, easy replacement of TV pigtail fuses. Snap one side of holder on blown pigtail fuse in set. Snap regular replacement fuses in other side—the job is done. No more cutting out the pigtail. No more messy soldering. No more fuses blown by hot irons. Save time, save work, save the customer's money, and still make big TV profits. Service dealer cost, 15c each.

LITTELFUSE INC.

4757 N. RAVENSWOOD AVE., CHICAGO 40, ILLINOIS

# 2 TV PROFIT DEALS!

## DEAL NUMBER 2

TV fuse kit—10 assorted fuses that service all TV receivers — Admiral, Philco, RCA, Zenith, Emerson, Hallicrafters, etc., etc., etc. The serviceman needs the right fuse in his box — it is in this kit when he needs it. Saves time, saves profit. Service dealer cost, 98c each.

LITTELFUSE INC.

4757 N. RAVENSWOOD AVE., CHICAGO 40, ILLINOIS

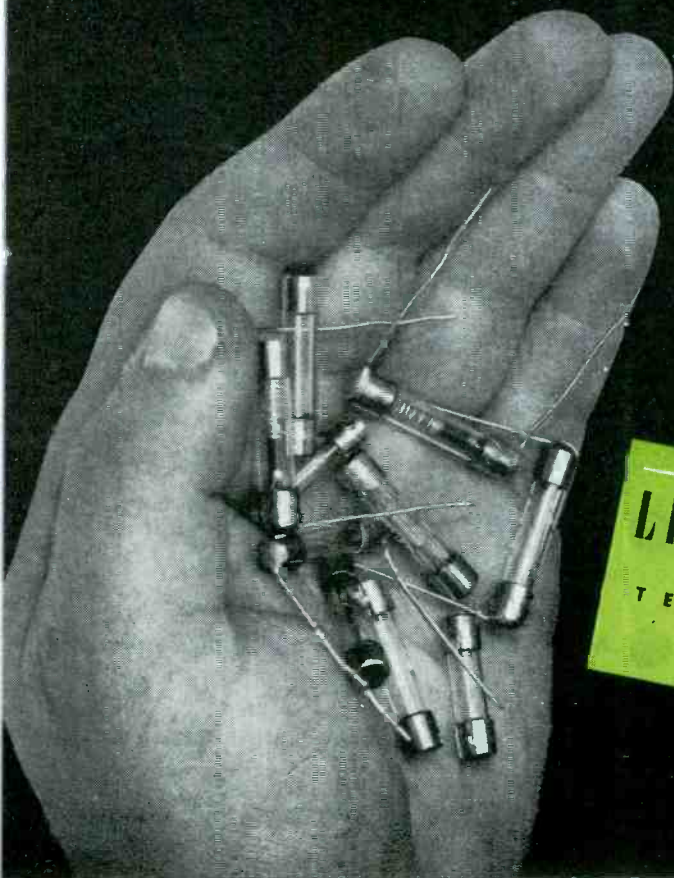

# TV FUSE KIT

# ANCHOR

*Ahead  
Again*



**New 2-Stage Pre-Amplifier  
Increases Original TV Signal  
Strength 5 TIMES**

LIST PRICE  
**\$44.95**

**You'll be Ahead Too . . . With Greater Profits Than Ever!**



## ANCHOR'S NEW 2-STAGE BOOSTER NOW Enlarges Your TV Market for Sales to Thousands of New Suburban and Fringe Area Residents

In 1949 the ANCHOR Single Stage BOOSTER improved television reception for 1 out of every 4 TV Set Owners. Thousands of apartment dwellers, suburban and fringe area residents the nation over demonstrated their preference by making ANCHOR the Number One BOOSTER in sets sold. ANCHOR developed this recognition only through its own top-notch performance by being able to deliver sharp snow-free pictures in most difficult conditions. Now ANCHOR has added the new Two Stage BOOSTER to their line to bring television, and the finest television reception, to everyone. The New ANCHOR Pre-Amplifier Will Out-perform Any Two Stage BOOSTER on the market.

ANCHOR'S performance curves have never been challenged. Undisputed laboratory tests prove that the ANCHOR Two Stage BOOSTER increases the original TV signal strength 5 TIMES.

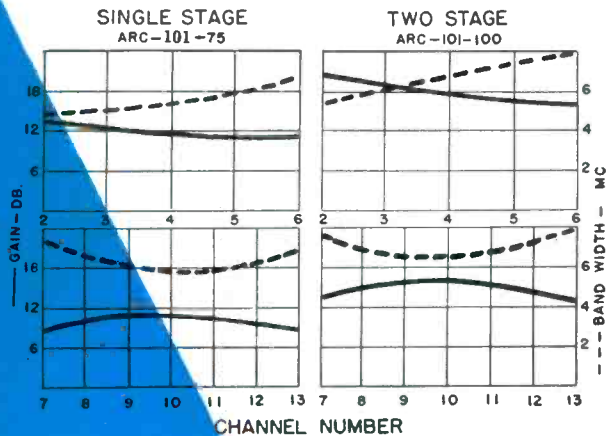

- Single Knob Construction allows switching and tuning with a flick of the wrist.
- Radically new switching of tube and circuit components.
- Modernly styled with streamlined plastic es-cutchion. Soft mahogany leatherette finish.
- Most stable non-regenerative unit available. The unit that is not returned.

ANCHOR  
ENGINEERING  
ALWAYS A  
YEAR AHEAD!

**ANCHOR** RADIO CORP.

2215 SOUTH ST. LOUIS AVENUE

CHICAGO 23, ILLINOIS





### Standards for TV Service

WITH THE ADVENT of the multi-million set era over two decades ago, and what then appeared to be a sudden brisk demand for service, industry faced quite a problem. With not too many trained men to place the sets in operation and keep them working properly, the situation was quite acute. Competent technicians found themselves taxed for time and the result was not a rosy one. Complaints poured in at such a rate in some areas that broad indictments against industry became quite common. Fortunately, through rigorous coordinated efforts, training programs were established on many fronts and many qualified men became available. In addition, substantial operational solutions appeared in the form of bold association codes of ethics, codes which became widely adopted and affected a real rout for the hapless problem.

The recent race of TV chassis into the homes of millions has introduced a situation, quite reminiscent of the days of the 20's and 30's, with manpower shortages, crowded servicing calendars, and too many rush calls. Fortunately, active programs instituted by industry and associations have affected many striking remedies. However, because of the rather complex nature of the video-sound chassis and the additional time required for installation and service, there have been difficulties. It has been necessary, for instance, to be particularly cautious about the ways and means employed to effect satisfactory service, and there have been many who have blandly dismissed this important requirement. As a result there have been complaints.

In an effort to stem the tide, the associations have tightened up their codes, but even this move hasn't struck the bell everywhere and as a result other plans have had to be considered. In New York City, the problem received critical study and admiral support was supplied by the BBB, who after months of careful probing came up with a plan which, it appears, may provide the ideal formula. Offered is a concise set of strict standards for TV servicing, with not only the exact procedures which Service Men should follow, but lucid explanations of various important terms.

Describing service, for instance, the

code declares that the word . . . "shall be construed to include inspection, any adjustment of sets and replacement of all parts necessitated by normal usage, at no extra charge above the advertised or service contract charge." Commenting on contracts, the code states that . . . "If a contract is advertised or offered which does not include replacement of parts, a specific statement shall be made that parts are not included or that an extra charge will be made for parts replacement. If inspection and adjustment of existing antennas are not included, this shall be stated."

Analyzing the problem of extra charges, the code states that . . . "If any extra charges may be made in some circumstances for inspection, for adjustment of any kind, or for necessary replacement of any parts, including the picture tube and existing antenna, above the advertised or quoted price of a service contract, in order to obtain an offered contract or during the life of the contract, this fact shall be made entirely clear in any advertisements or in advance to all prospective customers.

Describing the delicate problem of speed of service, which was commented on quite extensively in these columns several weeks ago, the BBB states that no unqualified statement as to the speed of service to be expected shall be made. Citing the use of the term 'service within 24 hours' as an example, the code says if this term is used . . . "A customer should expect to get exactly that . . . in all circumstances on any day of the week and without extra cost." Analyzing the use of the phrase further, the code states that . . . "A term such as '24 hour service,' unexplained, shall not be used since it can mean either service within 24 hours or immediate service during the whole 24 hours of the day." In the opinion of the BBB, the Service Men should say . . . "Service calls within 24 hours during the usual working hours."

Commenting on the use of the terms *free* or *gratis*, the code declares that the expressions . . . "Must not be used when the offer of an article is dependent upon the purchase of other merchandise or services." Two particularly important factors are covered in the code, too, *replacements* and *con-*

*versions*. According to this new set of standards . . . "All replacements shall be made with parts of equal value and equal performance capability to the parts replaced, except with the advance knowledge and consent of the customer. It is the intent of this standard that cheap or inferior or second-hand substitutions shall not be made." And on the topic of conversions, the standards declare that . . . "Any concern advertising or offering conversions from a smaller to a large picture tube shall be prepared to assume full responsibility for the performance of the converted set as relating to the new size."

So that the consumer might understand just what problems face the TV Service Man, during the servicing of a chassis, the BBB has prepared a novel 12-page booklet, which explains such key factors as types of interference, antennas, contracts, etc. The description of available antennas is extremely complete and covers the four common types . . . built-in, indoor, window and rooftop antennas. The BBB points out that the built-in antenna . . . "Will only operate with maximum efficiency under favorable conditions in some areas and locations. Generally, one of the other types of antennas will be required, in the New York area." The window antenna, according to the BBB, will usually give better reception than the indoor or built-in types because it is outside the building, but they say the roof antenna will . . . "ordinarily give . . . the maximum reception for most stations."

Reviewing the problems of interference for the consumer, the BBB provides a very frank comment, stating that sometimes . . . "The interference can not be corrected. This doesn't mean you have a 'lemon'. Television technicians can do wonders, but they can't alter essential characteristics of say, a skyscraper."

Thus far, about 50,000 of the consumer booklets have been distributed throughout greater New York and there are plans afoot for an ever broader distribution, not only in the New York area, but throughout other metropolitan centers of the nation.

A rousing round of applause to the BBB and the host of groups and persons who are responsible for this splendid TV service program.—L. W.

# TV Alignment Procedures\*

**How to Use the Sweep Generator, Marker Generator and 'Scope in Aligning TV Receivers Today. Solving Problems of Matching, Leakage, Attenuation and Linearity... Testing 'Scopes for Square-Wave Response... Checking Instrument Efficiency.**

[\*See Front Cover]

by **M. E. CLARK**

*Commercial Equipment Division  
Electronics Department, General Electric Company*

IN TV ALIGNMENT, it has been found that there are three instruments which are particularly vital for the operation: sweep generator, a marker generator, and a 'scope having better than average characteristics.

The sweep generator initiates the signal with which the job is to be done and thus can be considered as perhaps the key item. By tuning, or sweeping, the signal generator through the frequencies to be studied, we can observe the resultant amplitude versus frequency curve on a 'scope. If the amplitude versus frequency curve is to be accurate the amplitude out of the sweep must be independent of frequency as the signal is swept through the desired range. This is fairly evident and one commonly accepted standard is .1 db per mc amplitude change. Everything would be simple if the matter ended here, but such is not the case. Even after the generator has been internally designed to meet this specification, there remains the problem of delivering the voltage to the set to be tested.

The sweep must be built to match whatever cable is used with it on the sending end (generator end), and some arrangement must be provided to achieve a match on the receiving or TV set end. To keep all connecting cables cool and make metal top tables and bonding unnecessary, a balanced output must be used to drive a balanced load, an unbalanced output being used to drive a single-ended load. Both balanced and single ended output must be available from the sweep generator. The balanced output is re-

quired to drive the 300-ohm sets, while the single ended output is required for sets having unbalanced inputs and for all *if* work.

If TV sets actually had the impedance that the book says it would be only necessary to tie a 300-ohm balanced sweep to a 300-ohm set and reasonable results could be expected. However, in practice we find that the input impedance of a set will sometimes vary as much as ten to one, as it is tuned through the twelve channels. To drive such a set it is necessary to put in some sort of matching pad between the cable from the sweep and the set itself. At this point, we have an extremely important principle to consider. It is always possible to match two widely different impedances using resistive pads if there is enough voltage, so that a substantial loss can be tolerated. Let us consider an extreme case, just to illustrate the point. Let us assume that it is required to

match 300 ohms and 50 ohms, both unbalanced. A 300-ohm resistor and a 50-ohm resistor, terminating their respective cables, would meet the need if it were possible to connect the two together without disturbing either one. A 3000-ohm resistor would have no effect on the 50-ohm termination and very little effect on the 300-ohm termination. For all practical purposes this could be considered a perfect match; (Fig. 4). Of course the attenuation would be severe, but such arrangements are practical where the gain of several stages of amplification follows the pad. It will be noted, however, that such arrangements can not go from balanced to unbalanced conditions, effectively.

Let us consider one more practical example before leaving this important subject. When connecting TV test equipment to a 300-ohm set, it has been found that a much lower loss pad can be adequate. A short strip of twin lead can be connected from a balanced output adapter<sup>1</sup> of the sweep to a pad composed of four 430-ohm resistors, soldered together in the form of a square having the minimum lead length possible. This square then has two corners connected to the twin lead, with the opposite two corners connected to the set's input terminals directly on the head and chassis; Fig. 5. The pad here serves two purposes. It matches the lead from the sweep

Fig. 1. Overall frequency response curve which results when signal generator is swept through a band of frequencies.

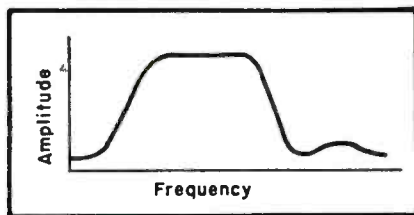

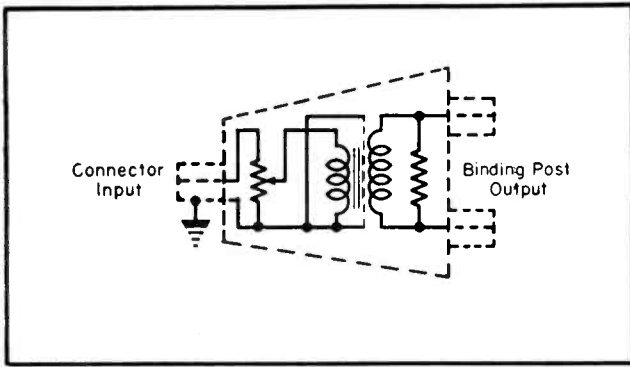
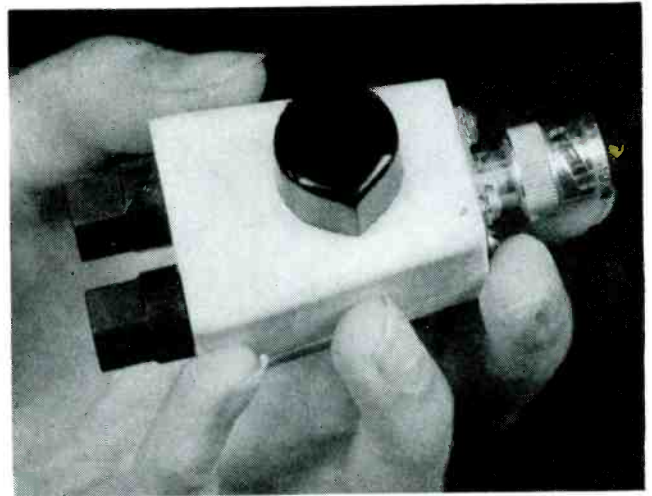

Fig. 3. Schematic of the balanced output adapter, which provides a balanced output by using a transformer with electrostatic shielding. Secondary features symmetry, with respect to ground.

Right: Fig. 2. Balanced output adapter.



nearly enough to prevent appreciable standing waves, and keeps the set looking back into approximately its design impedance of 300 ohms.

This discussion of resistive pads bears directly on earlier comments about amplitude modulation on the sweep generator's output. It should be noted that a mismatch which causes standing waves will also cause amplitude modulation. Since the sweep is covering a wide range of frequencies, the standing-wave pattern on a mismatched cable will change as the frequency changes. This, of course, means that the amplitude of the delivered voltage will be changing from frequency and providing a false pattern; a pattern which contains not only the desired pass-band shape, but also a pattern of the standing waves as a function of frequency. Since it is impossible to separate these effects, matched cables are absolutely necessary.

Another common cause of hot cables and amplitude variations is the leakage from the generator into the cable used between the generator and the television receiver, and the leakage directly into the set under observation. At first, it would seem that leakage would simply increase the minimum level at which the equipment could be used, but would have no effect on the apparent amplitude modulation. This belief, however, turns out to be quite inaccurate, since the leakage induces voltages both in the connecting cable and the receiver under test, which are a function of frequency, as the generator sweeps across the band of interest. While this situation is not actually amplitude modulation on the generator output voltage, it does appear as amplitude modulation in the overall pattern, because these voltages add to or subtract from the desired generator voltage. Here again, separa-

tion of the effects is impossible and thus elimination of leakage is mandatory.

After leakage has been reduced to the point where ordinary alignment can be successfully duplicated from time to time and no special grounds or metal top tables are required, then the degree of perfection has been reached where its effect on maximum sensitivity measurement can be considered. This is directly connected with the problem of attenuator design. Thus, if the television set is to be properly aligned the sweep generator involved must have an attenuator capable of reducing its output to a value as small as the weakest signal to be received. Having obtained an attenuator which will meet this specification, leakage again becomes important as a limitation on the attenuator. The actual leakage level which will cause trouble is much lower in this latter case, than in the case of inducing voltages in cables, etc. In practice, it has been found that double shielding and double filters are required if a suitable range of signal is to be available from the generator, so that high-level head-end work may be done readily, as well as overall alignment for fringe area operation with the same generator.

### Linearity

A term which has often been misused in connection with sweep align-

Fig. 4. Network, for matching 300 and 50-ohm lines, both unbalanced. This setup illustrates how 300 and 50-ohm units might be connected for matching when several stages of amplification follow the pad to provide for the high attenuation in the network.

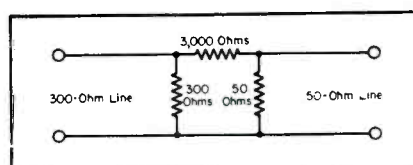

ment is *linearity*. In discussing visual alignment, linearity is often used to mean absence of amplitude modulation. However, there is another definition of the term, which it is felt is the correct one, that is never mentioned: The frequency of the output of an ideal sweep generator would vary exactly as the sweep voltage applied to the 'scope, and this generator would be perfectly linear by the correct definition. If a generator does not have this kind of linearity a curve, as presented on the 'scope, will appear to be crushed together on one side or expanded on the other; Fig. 6. It is often argued that a linear presentation is unimportant when a good marker system is used. Strictly speaking this may be true, but certainly confusion would be minimized and operation would be facilitated if the data offered on the 'scope were presented on a linear basis, so that it could be compared directly to the patterns shown in service notes and text books. This kind of linearity may readily be checked by causing the sweeping oscillator to beat with the harmonics of another oscillator of low frequency, in the order of one megacycle. The resulting display should be a row of equally spaced pips.<sup>2</sup>

Another factor which affects the accuracy of the final display is detector linearity. Here, the term refers to the amplitude of rectified *rf*, as compared to the amplitude of the applied *rf* in whatever is being used to demodulate the swept signal. For laboratory purposes a linear detector is ordinarily necessary. For alignment of television receivers the degree of linearity in the detector is generally determined by the level at which it is

<sup>2</sup>G.E. sweep generator, type ST4A, has been designed with these linearity considerations in mind. In the interest of speed, dials are direct reading.

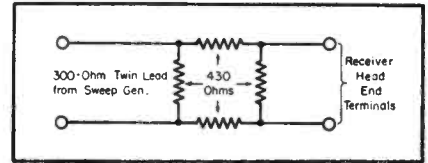
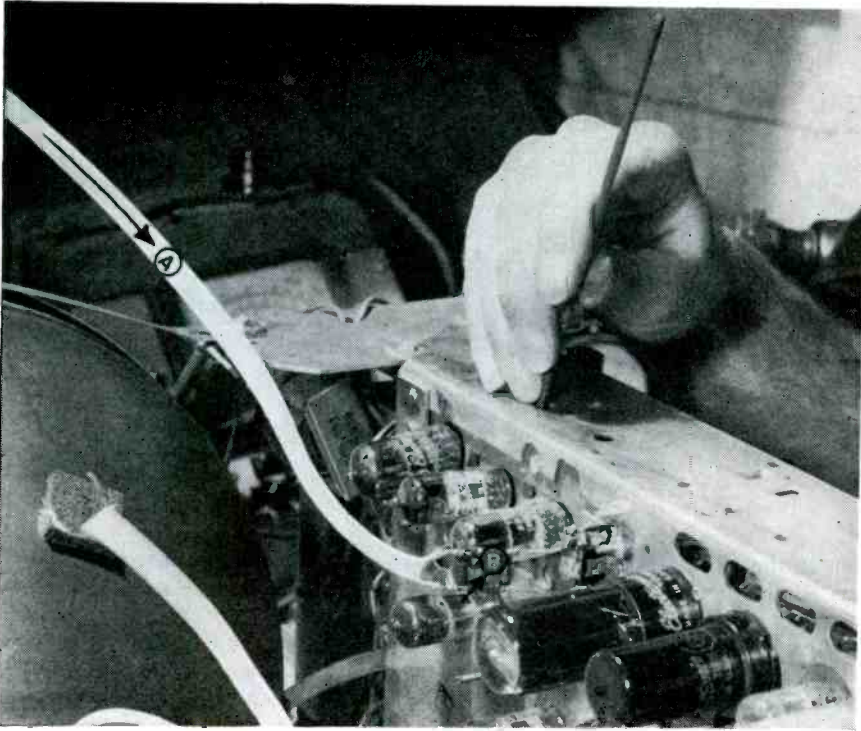
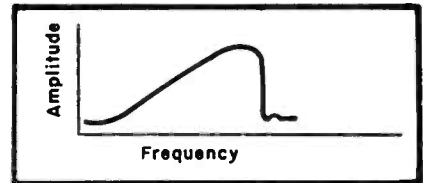

Fig. 5. Pad of four 430-ohm resistors which serves to match the lead from the sweep nearly enough to prevent appreciable standing waves and keeps the receiver looking back into approximately its design impedance of 300 ohms.

Fig. 6. Curve which results from a non-linear sweep.



Left: Use of balanced output adapter during an alignment step. Twin lead is at A. The required 300-ohm pad is shown at B.

operated. Service notes usually specify this level. In some cases, it may be high enough to yield linear operation, but in other cases it is not. Since the curves shown in service notes may be based on a given degree of known non-linearity, it is necessary to operate at the recommended level, if the curves are to be reproduced accurately.

Detector probes, as sometimes supplied as auxiliary equipment for this type of work, have the non-linearity difficulties mentioned, and also have been found to introduce reactive and resistive loads which have a great effect on the apparent pass band. For this reason, they are not generally recommended except possibly for trouble shooting various stages. They should not be relied upon to yield a true presentation of a TV receiver's response.

Another source of inaccuracy occurs, when one or more stages are overloaded. If levels as indicated in service notes are followed, overload does not present a problem in a normal set, but in many cases the set being worked on will have a faulty stage somewhere in the chain of amplification. If this is true, it is evident that an earlier stage may be overloaded in achieving the recommended detector or *agc* level. Usually, the result is an apparent flat top pass band, the top of which remains flat even when tuned circuits which should introduce severe dip are adjusted. This type of overload is accompanied by a clearly defined limiting action. If the sweep output is increased, there will follow very little increase in the amplitude of the dis-

played pass band, although there will often be further flattening of the top.

#### The 'Scope

Usually, in television alignment, the 60-cycle sweep rate is used. Since this is true, it is necessary that the 'scope have an excellent 60-cycle square-wave response. A square wave must be used for this check, because tilt in the displayed pass band will be due to slight phase shift, rather than a drastic amplitude reduction in 'scope response at 60 cycles. In a large percentage of cases it has been found that 'scopes of inadequate response are being used. The quickest and easiest way to make the square wave check is to turn the blanking on in the sweep generator that may be used, and then turn the sweep width to zero. Since there is no sweep, the amplitude of the rectified signal will remain constant and since the sweep generator is turned off on its return trace due to the blanking, the amplitude will be zero at this time. The pattern on the 'scope, if the 'scope is doing the job as it should, will be two absolutely straight and parallel lines.<sup>3</sup>

While we are on the subject of the 'scope it should be pointed out that the 'scope to be used for TV service work should have a suitable high-frequency response for observing sweep and sync pulses.<sup>3</sup> To meet such a requirement a 'scope need not have phenomenally wide frequency re-

<sup>3</sup>G.E. ST2A designed with these considerations in mind.

sponse, but it should have a gradual roll off, so that the transient response will be good up to the maximum frequency at which it will be used. A separate low-capacity input should be available with its own attenuator, so that these wave forms may be observed without disconnecting the 'scope from the sweep-alignment equipment. The most convenient arrangement has been found to include a low-capacity probe with separate attenuator switching on the 'scope panel.<sup>3</sup>

Some provision should be made for determining the peak-to-peak amplitude of wave shapes observed. Some 'scopes provide their own calibrating voltage, while others use separate calibrating devices.

It has been found that TV waveforms are presented with sufficient accuracy if the probe input capacity does not exceed 10 mmfd. High-frequency response can be down as much as 20% at 500 kc, provided it falls slowly. If the roll-off is very gradual, so that it is down no more than 50% at 1 mc, horizontal sync pulses will be accurately displayed.

#### The Marker-Generator

The ideal marker generator would require no special technique in applying it to the test setup. It would have no connections of temporary nature which have to be adjusted from time to time it would have no effect on

(Continued on page 38)



# PHONO *installation and service*

WHEN THE THREE-SPEED changers were introduced about a year ago, only about fifty per cent of the phono combinations included them, in view of their rather involved structure. Today, with the development of streamlined variable-speed techniques, practically all of the models have multiple-speed units.

Many novel features have been evolved. In the new Philco line, for instance, the automatic changer record platform is stationary, and has no moving parts. A new type sloped spindle nods forward and pushes the record off its shelf. There are no push-off blades on the record shelf, push-off being accomplished by moving the spindle toward the record shelf. This approach was found to simplify the construction since the movement is the same for all sizes of records and there is apparently no need for double-edged and hinged blades. Set-down selection is accomplished through the rotation of the record shelf, thereby eliminating feeler fingers.

A bridge assembly, which may be removed by taking out four screws, supports all of the operating mechanism with the exception of the actuating arms.

Next to the mounting stud is an interlocking switch to silence the

Speaker, said to be capable of a frequency response to over 10,000 cps and provide 30 watts continuous power, recently developed by University Loudspeakers. Incorporates a W shaped 1½ pound Alnico V magnet in a rim-centered type of assembly which is said to permit rapid replacement of the cone and voice coil.

Other features are: 3" duraluminum high-frequency and cone stabilizing dome at the apex of one-piece moulded cone, dural voice coil suspension, filtered back-pressure air conditioning of the voice coil, and cone edge damping—Model 6200.



## Features of Three-Speed Automatic Record Changers Used in New Philco Models. Characteristics of Multiple-Speed Changers in Portable Phono Units.

by **KENNETH STEWART**

changer when the wrong needle is selected. The trip used is a velocity type. Trip sensitivity may be adjusted.

The spindle is supported at two places, one just below the center of the turntable and one on the push-off lever assembly. There is a heavy spring, which keeps the spindle in the position determined by the push-off lever assembly. This spring, it is reported, will prevent damage to the spindle or record if an oversize (thick) record catches against the latch on the spindle during the change cycle. Bending the ear toward the spring will throw the top of the spindle away from the record shelf.

The trip plate assembly is quite interesting. There is a dog latch which falls down to engage a snag tooth on the turn table gear, starting the cycle. Before the changer trips, the dog latch

Speaker with a magnetically enclosed motor structure which is said to permit mounting in close proximity to the picture tube. Design, achieved by Francis Smith, chief engineer of Rola, employs Alnico V in a high efficiency magnetic structure which is said to use the minimum weight of Alnico V.

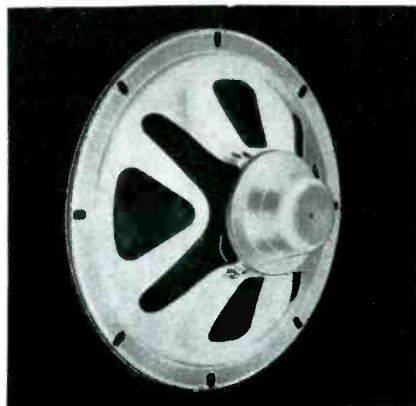

is supported by a finger on the trip plate. This support is provided as long as the finger is not moved away from the dog latch by the motion of the tone-arm. With each revolution of the turntable the reset cam strikes the ear of the reset arm, moving the finger of the trip plate back under the dog latch, provided that the motion has not been sufficient to disengage the latch from the finger and start the cycle.

For proper operation the trip-plate assembly must be adjusted so that the engagement of the dog latch and the trip-plate finger is 1/16" at the time

(Continued on page 39)

All-purpose driver unit which features a built-in 25-watt vacuum impregnated line matching transformer. Unit, produced by Racon, has a voice coil wound with aluminum wire. Coil terminals are welded. Voice coil lead is a strip of fatigue-resistant beryllium copper. Voice coil suspension is made of bakelized linen cemented to the phenolic diaphragm with a thermosetting plastic. Use of induction heating is said to bake diaphragm, voice coil suspension and voice coil into an unbreakable bond. Available impedances: 15, 500, 1,000, 1,500, 2,000 ohms.—Model PM-708TR.



# Auto Radio

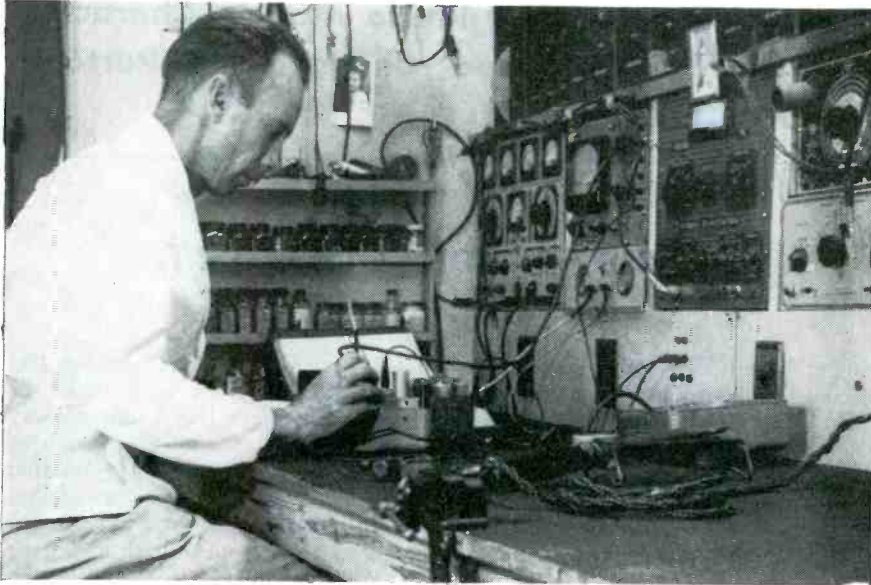

Jack Darr at his bench. Note method of connecting chassis to test panel.

Assortment of fuse holder leads used to connect car radios for bench testing. Chassis (ground) clip lead at right.

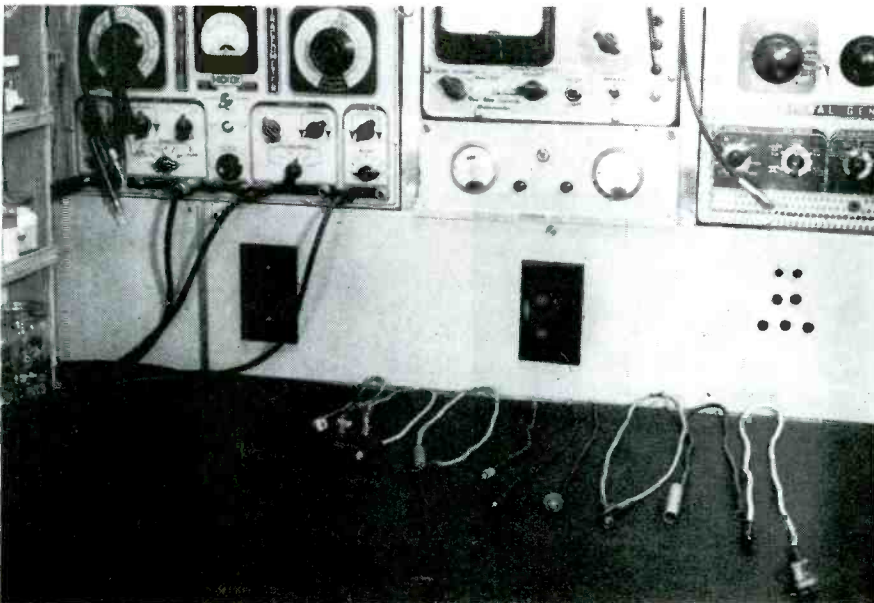

IN ORGANIZING A SERVICE shop, the test bench must receive considerable attention, for this area with its testers, tools and accessory check aids, can play quite a role in the servicing operation. In auto-radio activities, this is particularly true, since the bulk of service work involves the facilities of the service bench.

## The Bench

The bench should be a sturdily-built affair, with enough room to handle the largest chassis, which, with the attached control cables, speakers, etc., can be rather cumbersome. The bench used in our shop is approximately 27" wide, and around 10' long. This size has proved to be just about right.

The test instruments should be mounted in a panel or on a shelf, at the back of the bench, and elevated at least eight inches above the working surface. This will position the meters, dial and test connections high enough so that they won't be blocked off by the set on which you're working. A Masonite or similar wallboard panel has been found quite attractive and rugged as a back area, permitting the mounting of fixed meters, battery connections, and serving as a very handy mount for the test-speaker grille. In the instrument panel setup in our shop, an ammeter, and the battery and test speaker connections were mounted at the left. In the center the speaker grille was set up with a large *D* placed over the cloth. Another set of test speaker connections were installed here, and lined up with the speaker connections at the left, to permit the use of shorter leads.

## Power Supplies

One of the prime requisites of an auto service bench is, of course, a source of power for the sets undergoing repairs. For car radios, this must be six volts *dc*, with a capacity of at least ten amperes. For this purpose, it is possible to use either a storage battery, with a small (about 4-ampere) *battery-booster* or a *battery-eliminator*.

For power, a battery-charger system is used in our shop. Two light-duty auto batteries, connected in parallel, have been installed on a shelf in

# Service Shop Facilities

**Test Bench Construction... Power Supplies... Test Lead Design... Air Testing Techniques... Tuning Tools... Speaker Plugs... Test Instrument Requirements...**

**b y J A C K D A R R**

*Ouachita Radio Service*

the back room, just behind the bench. There's a small charger connected at all times, with a primary switch and charge-rate meter on the panel. Also installed on the panel has been a 30-0-30 *dc* ammeter, in series with one of the battery leads; either one. This has been found to be a very useful instrument, as will be explained later. It was salvaged, by the way, from a defunct 32-volt Delco light plant, and is of the *shunt* type, where no current actually passes through the meter-coil itself, but through a heavy shunt, mounted close to the coil. This design has been found to be quite a blessing, for even with a dead short to contend with, the movement will be unaffected.

The battery leads were brought up to the back of the panel with heavy No. 4 flexible wire and connected to two heavy binding posts.

To connect the various sets to this power supply, quite an assortment of leads have been found necessary. There is one base lead, the ground lead, which was constructed of heavy

flexible wire, with a heavy battery-charging clip on one end, and a spade lug on the other. The others were all supplied with spade lugs, on one end, and other ends terminated in fuse-holders. Incidentally, *glass* insulated wire, about No. 6 flexible, as used for primary leads on aircraft during the war, has been found to be excellent as leads for auto work.

To connect the older chassis to the power supply, a short *antenna-coupler* female may be used. For the newer *SFE* fuse holders, a lead can be made up using a female fuse holder, *bridging* the fuse with a couple of pieces of small wire or small straps, and soldering it into the little brass cup. This will be found to eliminate that search for a fuse every time it's required. The straps will keep it from blowing. You'll be able to see any overload instantly on the ammeter, and disconnect the set, if necessary. In auto service, one is not interested in whether the short is enough to blow a fuse, but

where is that short and what has caused it.

Separate speakers will be found on almost all of the newer chassis, especially the universal models, which may be installed in any make of car. These may be replaced, for testing, with your bench speaker, by making up a few more test-leads. We use standard pin jacks for connecting to the center-tap output transformer and to the voice coil, which may be disconnected from the output transformer secondary by a switch. For this purpose, old speaker plugs, of the three and four-pin *recessed-male* type, have been found quite helpful. To make up, test leads about 10" long, were attached to the plugs with pin-tips. With this arrangement, the speaker plug could be plugged in and the test-leads hooked into the test-speaker.

There are some models which have a volume-control unit in the remote

*(Continued on page 45)*

Fig. 2. Power-supply system setup.

Fig. 1. Circuit of portable test ammeter for car service work.

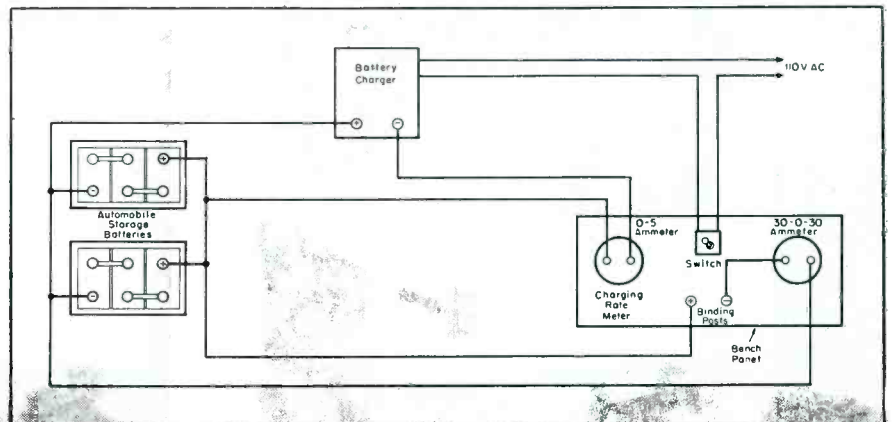
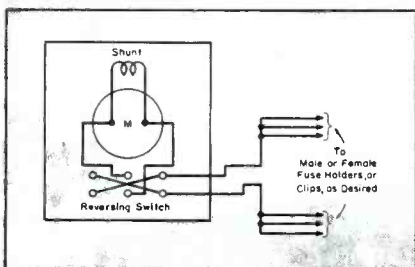

# Cabinets for a Custom-Built FM/AM Phono Combination

**Complete Constructional Details on Cabinets Required for Receiver, Preamp, Main Amplifier and Phono Mechanism, with Data on Types of Woods Necessary, Finishing Techniques, Speaker Baffle, Structure and Mount Procedures.**

**by HERBERT G. EIDSON, Jr.**

*Chief Engineer, WIS and WIS-FM; Technical Director, WIST*

IN PLANNING our two-unit radio-phono amplifier/record-changer system<sup>1</sup>, it was decided to construct the cabinets in our own workshop not only to provide woodwork which would harmonize with the room, but to provide housings which would permit the best placement of the receiver, amplifiers and changer from an operational view. And, of course, we wanted to build a speaker chamber which would be acoustically correct.

The first cabinet built was the receiver-amplifier console. We selected  $\frac{3}{8}$ " fir plywood for the main sections, since it was felt that this was considered strong enough to do the job. A top of  $\frac{3}{4}$ " thick plywood was chosen, and a similar piece set aside for the record cabinet. This heavier

material was used to reduce the possibility of warping. A recessed front receiver panel was constructed of  $\frac{1}{4}$ " thick plywood. This allowed greater ease of working and fastening into place. Back-band molding was used for the finishing trim around the speaker outlet and receiver facing panel. These pieces were cut one at a time and fitted together snugly so that friction was enough force for proper retention.

Four protective brass rods were placed in the horizontal plane across the speaker grill to make the cabinet appear slightly less in height and

more in width, which was found to be more pleasing to the eye. Welding rods,  $\frac{3}{16}$ " type, were used for this purpose and cut to  $15\frac{1}{2}$ ". The two end sections of the back band mold were drilled at properly spaced points to receive the rods, held in place by friction. When laying out the points to drill the mold, it is important to remember that there is even spacing between rods,  $2\frac{3}{4}$ ", center to center, but each end rod must be spaced only half this distance to the edge of the speaker opening. This is standard practice in wood work and serves to create the illusion that the rods con-

<sup>1</sup>Part I, containing a description of the electrical characteristics of the receiver, amplifier and changer, appeared in the June, 1950, issue of SERVICE.

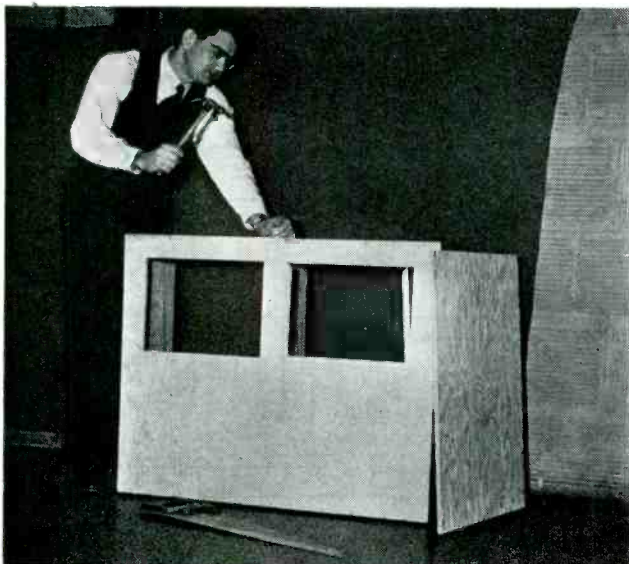

(Left)  
Author, applying a hammer and nail punch during finishing stage of receiver-amplifier cabinet construction. Back section appears at right.

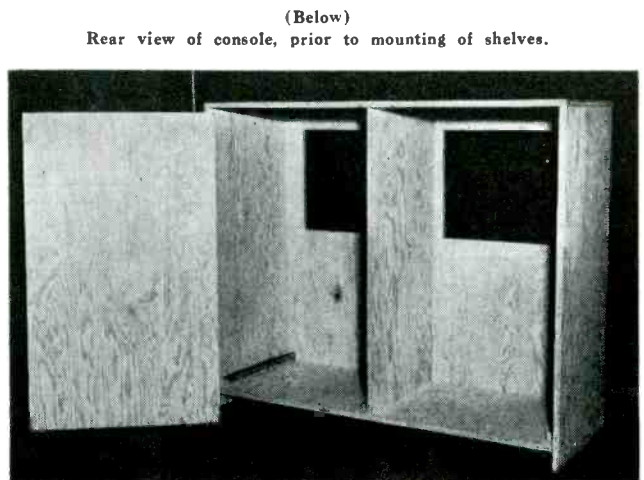

(Below)  
Rear view of console, prior to mounting of shelves.



*MR. DEALER: KEEPS  
Sell the Line that Builds  
CUSTOMER CONFIDENCE*

# VARIABLE RELUCTANCE CARTRIDGES

## WITH THE SENSATIONAL BATON STYLUS!

★ FOR QUALITY ★ FOR PRICE ★ FOR TURNOVER

Compare These General Electric Variable Reluctance Cartridges With Anything On The Market!

### NEW "BATON" STYLUS →

provides unexcelled delicacy of tone for critical ears. Dual-twist stylus assembly (inset) permits higher lateral compliance and improved tracking. Double damping blocks filter out needle talk and mechanical resonance. This new assembly now included in all types of G-E Cartridges. RPX-040 and RPX-041.

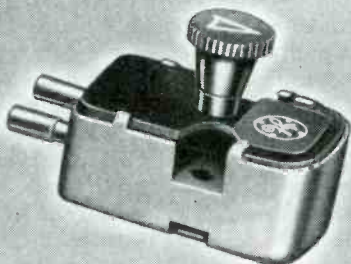
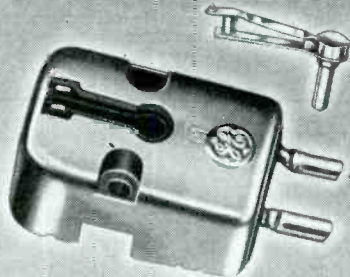

### ← TRIPLE PLAY CARTRIDGE

Ride the sales boom of this sensational new G-E model! Plays all three types of records without a change of position in the tone arm! A flick of the knob selects stylus. Requires no adjustment of tone arm weight. Costs 25% less than the 2 cartridges it replaces! A hit with manufacturers and listeners alike! Model RPX-050.

### PROFESSIONAL VARIABLE → RELUCTANCE CARTRIDGE —

One of the most popular cartridges of the G-E Line. Preferred by broadcast station engineers for its smooth, wide-range frequency response designed to match broadcast equalizers. Operates with any G-E stylus. Model RPX-046.

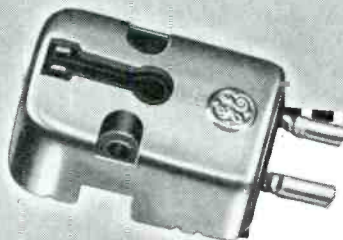

**Y**OU can't beat these General Electric Variable Reluctance Cartridges for superb reproduction, sturdy construction, and low cost. That's why manufacturers, radio stations, and the listening public everywhere continue to select the G-E Cartridge that fits their needs best.

You can get a bigger share of the valuable replacement business by stocking the models shown here. Don't delay—place your orders today!

### PLENTY OF PROMOTION!

Ask your distributor for complete G-E Parts Promotion Kit! Counter displays, ad reprints, full line sheets and folders, everything you need to sell more G-E speakers, cartridges, parts and accessories! Get it today!



General Electric Company  
Section 970  
Electronics Park  
Syracuse, N. Y.

Send me latest bulletin on the new G-E Tone Arm line.

NAME.....

ADDRESS.....

CITY..... STATE.....

*You can put your confidence in—*  
**GENERAL  ELECTRIC**

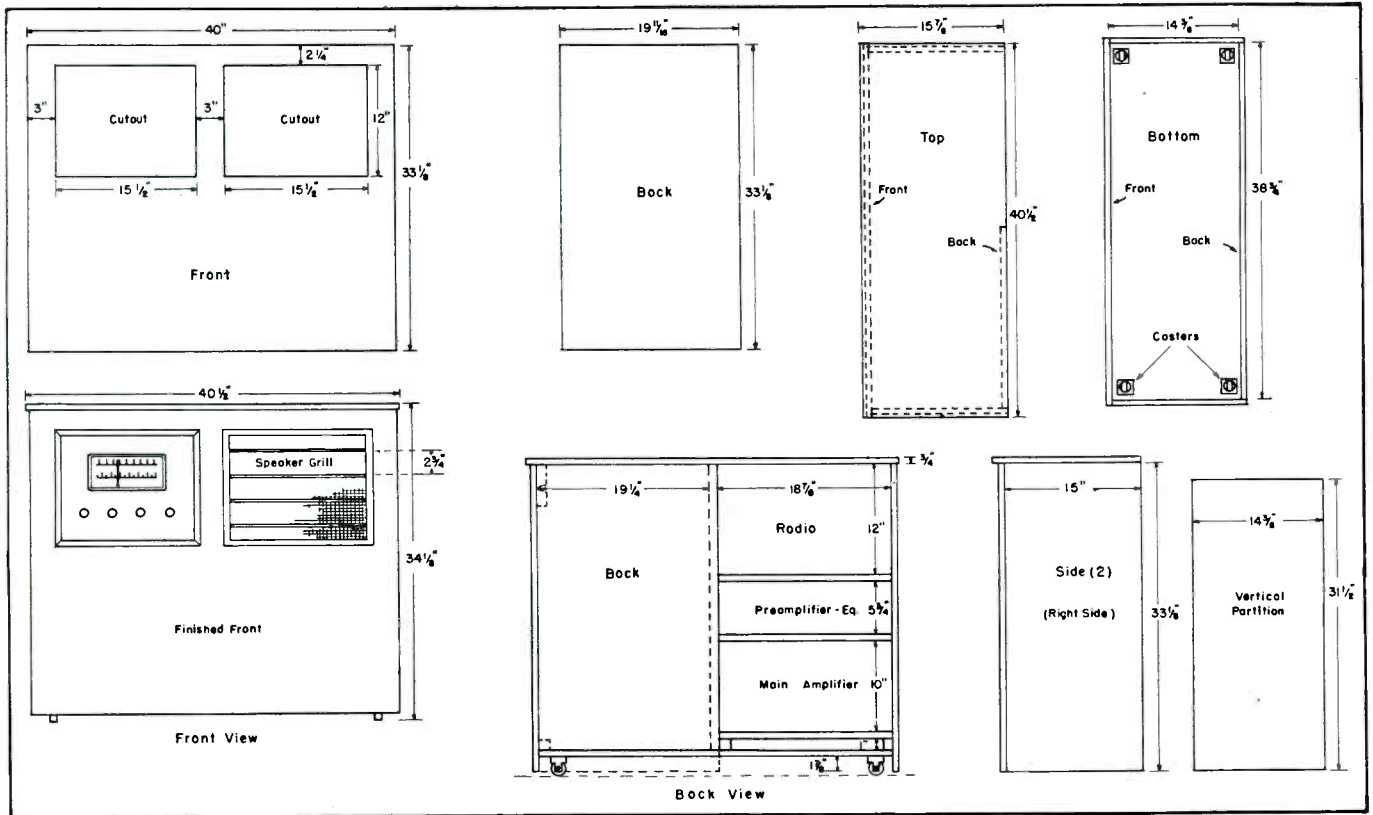

Front and rear view structure details of receiver-amplifier cabinet.

time on past the opening in the top and bottom directions. After the rods are installed, they should be carefully polished by rubbing with fine steel wool. Then, to prevent oxidation of the brass they must be varnished, using clear varnish from a fresh can.

In applying the varnish, a brush can be used. Small bubbles may be generated, many of which may not disappear before drying. However, by simply blowing on the rod immediately after brushing, the bubbles will disappear. Dipping of the rods in varnish has been found to produce a more even coating, although plenty of blowing is still required to provide that smooth, satin finish.

In the dipping process, the following procedure can be used: A burned-out 20-watt fluorescent tube can serve as the dipping vessel. To prepare for such use, the tube must be emptied of its end filaments, caps must be removed and the fluorescent surfacing removed. Several operations are in-

involved in this cleaning step. First, one turn of iron wire must be wrapped around one end, about 16" from the other end; the wire should not be allowed to touch itself. Into this turn about five volts of high current should be introduced. This will allow the wire to become red hot. After about five seconds, the circuit should be disconnected and the tube dipped into cold water. The glass tube will break off clean at the wire point. A mixture of sand, soap and water should then be poured into the length of tubing to be used, and sloshed firmly. The mixture should then be poured out and the tubing washed with water only. A clear, clean glass tube will remain after this washing ready to receive the varnish to be used for the dipping process. When the dipping is completed, each rod can be set up on end to dry.

After all sections of the cabinet have been cut out and the edges sanded with coarse sandpaper, being

careful *not* to round any edges, the top of the cabinet can be placed on a cloth covering underneath, so that the floor will not scar the top. The top extends over the sides and front (but not over the back) by 1/4". The two sides and front can then be placed in position on top of the 3/4" section, on the floor, and a check made to see if the four pieces will fit properly when nailed together. If all is well, then the front can be nailed to the two side sections, using small finishing nails, and being careful not to allow the hammer to touch the wood. The heads should be countersunk, about 1/8", with a punch.

The two sides can now be placed on the floor, with their back edges resting on the floor, and the front section laid across their top edges. The top-to-be of the cabinet can then be braced against a flat straight wall and the front and sides lined up in their proper places before nailing. This approach was found to insure the absence of cracks between the top and sides and front. The three sections, now assembled, can then be placed in an upright position and the top nailed into place. To hide these nails, several ways of securing this section of the cabinet into place were considered. Cementing was one, but this was found to require heat and inside brackets. It was found that if the nails were carefully countersunk and

Block diagram of receiver-amplifier-changer assembly.

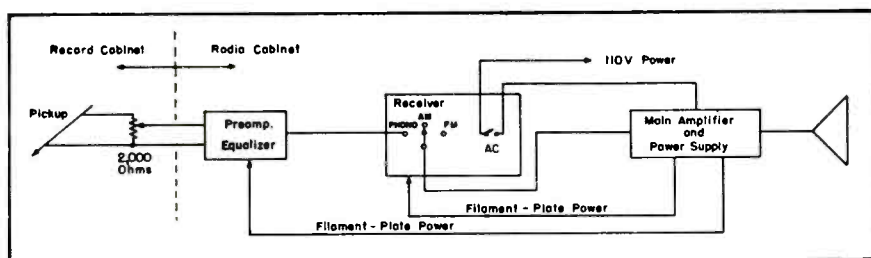

# JUST A MINUTE!

## *Drill Insert Tighten*

**1 MAN 1 MINUTE**  
**SELF-ALIGNING**

**Snyder**  
PHILADELPHIA

# TC-8

**REDI-MOUNT®**  
**AUTO AERIAL**

**3<sup>95</sup>**  
LIST

Complete with UHF Polyethylene Cable and Aircraft Fittings.

WRITE FOR COMPLETE  
TV & AUTO AERIAL CATALOG

**FREE!**  
COUNTER  
DISPLAY  
DB-8

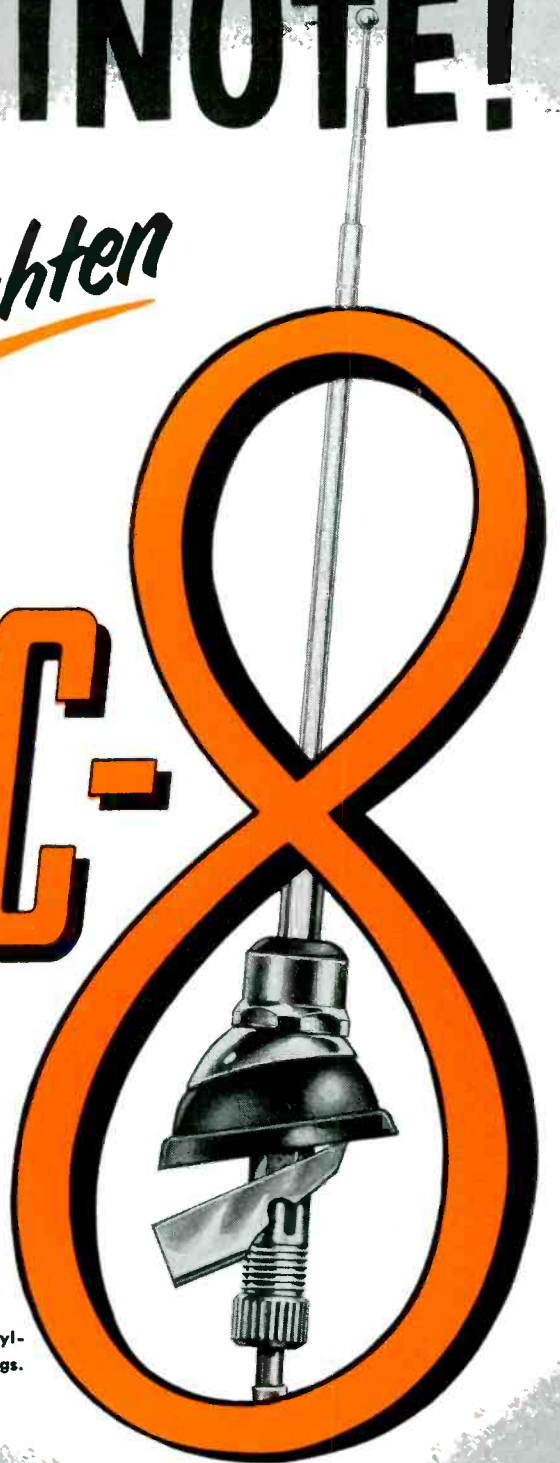

**SNYDER MFG. CO.**  
**ONTARIO RESEARCH CORP.**  
**ANTENNA ENGINEERS®**

PHILADELPHIA

Distributed By the Best—Everywhere

In New York it's H. L. DALIS, INC.

In Philadelphia it's ALMO RADIO CO.

Export: ROBURN AGENCIES, INC., N.Y.

**YOU MAKE MORE MONEY WITH Snyder**

filled, then sanded with care, the scars would not be too visible. As a matter of fact, many who have seen the console could detect nothing and wondered if the cabinet were held completely together with glue. Nails were used instead of wood screws, since a neater job of finishing could be accomplished. Screws were used to fasten the back into place, since that had to be made removable.

Four casters were attached to the bottom in the four corners. With the aid of four strips of  $\frac{1}{4}$ " plywood, upon which the backless cabinet can be placed, the bottom can be rolled into place inside the cabinet and nailed strongly. Two short wood strips should then be fastened on the sides and over the bottom piece for reinforcement. When the strips of plywood are removed, the cabinet will be found to roll alone,  $\frac{1}{4}$ " above the floor, and the casters will be hardly visible.

The receiver sub-panel, using  $\frac{1}{4}$ " plywood, should be cut out next, the finished size being  $17\frac{1}{2} \times 18\frac{3}{4}$ ". Openings for dial and controls then should be cut out.

Due to the back band mold extending slightly past the inside surface of the front, it was found necessary to screw strips of masonite around the edges of the opening on the inside, so that the  $\frac{1}{4}$ " sub-panel would not be pushed back when the mold was assembled. Short screws were used to hold the panel in place.

Next to be assembled was the center section. This step permitted fastening of shelves into their proper places, the top one supporting the tuner, the second one holding the preamp-equalizer for the record player, and the lower shelf supporting the heaviest of the components, the main amplifier.

An interesting design feature was included in the speaker chamber, with an unusual height of the speaker axis above the floor. This approach was followed to secure improved acoustical effects. It is well known that better quality and increased realism is experienced when the sound generator approaches ear level.

### Speaker Opening

The speaker opening was the next item on the constructional program. It was prepared to receive a gold and black grill by screwing strips of masonite around the edges of the opening on the inside. This must be done since the back band mold extends past the inside surface when it is in place. The stripping allows the grill to be stretched evenly across the aperture with no interference from the

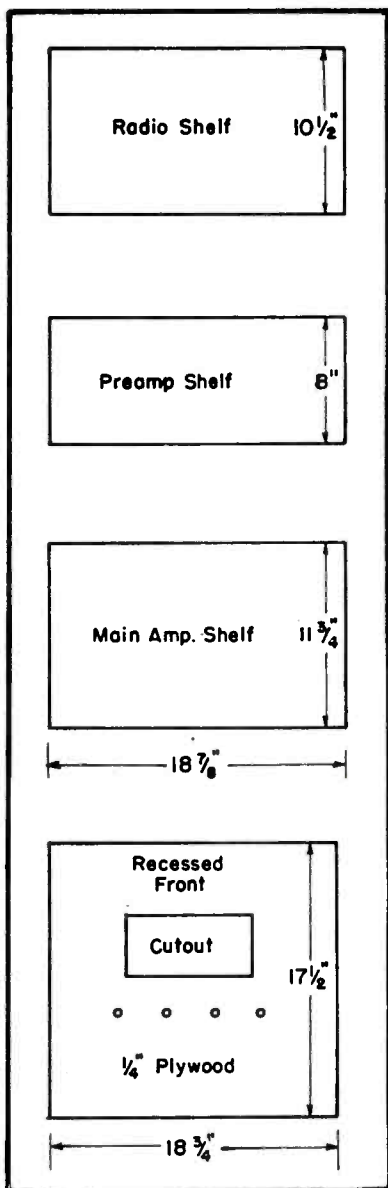

Details for the sections of the receiver-amplifier cabinet.

molding. The cloth grill can be fastened into place with small tacks, being careful not to stretch too tightly. Otherwise there will be strain lines visible.

In preparing the speaker baffle, a  $17\frac{1}{2}$ " Celotex square should be cut

The speaker baffle layout.

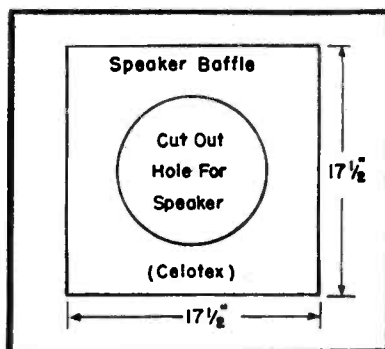

out. The center must then be located. This can be done by drawing straight lines from opposite corners. If a 12" speaker is to be used then a hole approximately  $10\frac{1}{2}$ " in diameter should be made in the center, using a hack saw blade.

Holes for the speaker-supporting bolts can then be drilled out in the baffle. If several types of reproducers are to be tried, then it will be necessary to mount proper sized bolts with respective washers and nuts into the baffle at this time. Enough bolt protrusion should be allowed to receive the speaker chassis. Extra nuts should be obtained to hold the speaker on the bolt ends for subsequent mounting.

The Celotex board can then be placed into position and screwed tightly down, the screws passing through the masonite strips and on into the plywood which is the front of the cabinet. It is important to note that the screws are not too long.

In the next step the sound-absorbing material<sup>1</sup> should be mounted on the inside of the four and one-half remaining sides of the speaker enclosure, using 1" nails with small heads. The heads can be effectively enlarged by the use of  $\frac{1}{2}$ " square pieces of cardboard, fastened to the nails as washers. This will be found to insure complete security of the sound-proofing material.<sup>1</sup>

The back of the cabinet, of  $\frac{3}{8}$ " plywood, and  $19\frac{1}{8} \times 33\frac{3}{8}$ " was treated with sound absorbing material on the inside surface. Four wood screws with neat washers were used to hold this into place after the speaker was installed, and leads brought out into the adjoining compartment, to be connected to the output of the main amplifier.

### The Record Cabinet

The wood used in this unit was of the same thickness as that used in the receiver console. All sections were sawed out, using a fine tooth saw for best results and all edges sanded down, but not rounded.

After carefully examining the sections of wood, to be sure that no errors had been made in the initial step, two sides can be nailed to the back, being careful that all top edges are straight and level. Wood stripping,  $1\frac{3}{4}$ " square, was used to reinforce the sides to back and the bottom to sides and back. The motor board was supported by strips of the same material.

The bottom was fitted into place upon its supporting strips and nailed firmly. The casters were screwed to

(Continued on page 44)

<sup>1</sup>Kimsul.



# FOLLOW THE LEADERS

BUY WISE...

BUY THE ORIGINALS...

BUY **HYTRON** TV FIRSTS



DUMONT

Emerson



Magnavox



Westinghouse

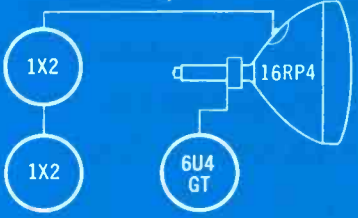

Admiral

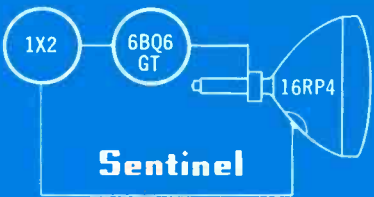
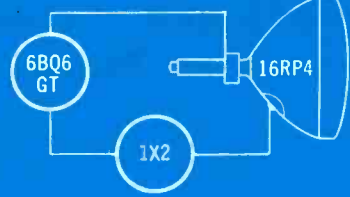

OLYMPIC



BENDIX



CROSBY

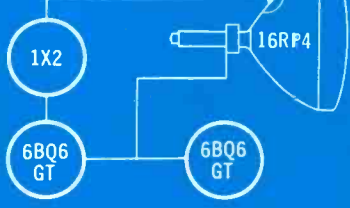

TRAV-LER



PHILCO

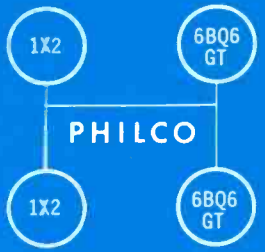

STROMBERG-CARLSON

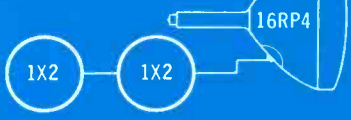

hallicrafters



Puckard-Bell

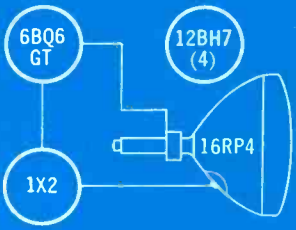

air-king

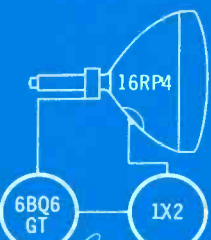

Sparton

Hoffman

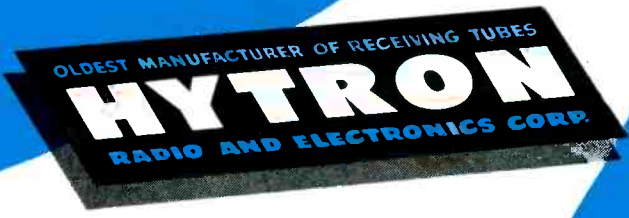
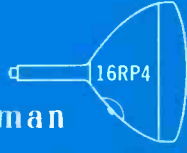

National

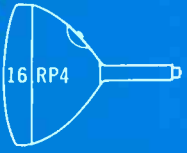

Motorola



Ask for the original Hytron TV firsts: Hytron 1X2 compact, high-voltage TV rectifier. Hytron 6BQ6GT, 25BQ6GT extra-performance deflection amplifiers. Hytron 6U4GT high-perveance damping diode. Hytron 12BH7 twin-triode sweep amplifier with superior efficiency. Hytron 16RP4 original rectangular TV picture tube.



MAIN OFFICE: SALEM, MASSACHUSETTS

# PA System Servicing

CONTINUING WITH OUR STEP-BY-STEP *pa* system analysis, let us now study the screen-grid circuit. A rapid and effective check on the condition of each stage can be obtained simply by touching the probe to the screen grid terminal. No signal voltage or hum voltage should appear at this point. Since the screen grid is normally grounded with respect to all *ac* voltages, the presence of a signal indicates an open filter, bypass, or insufficient filter capacity. Where the circuits employ special limiters, compressors and *avc*, which do not operate as ordinary voltage amplifiers, voltage measurements must be made with a *vtrm*, similar to the model shown in Fig. 1.

Intermittents may be checked by touching the probe to various circuits, working backward from the speaker until a stage is located, which is not affected by the intermittent. The fault can then be identified as being in the stage just passed. In some cases circuit interruption or the shock caused by applying the test leads may restore operation to normal. The use of a good electronic circuit, however, such as illustrated in the initial installment,<sup>1</sup> will reduce this possibility to a minimum.

The simple two-stage signal tracer, detailed last month<sup>1</sup> and revealed as a

---

**Checking for Intermittents, Audio Oscillation [Motorboating], Noise, Hum and Distortion. Tracing Troubles in Microphones and Cartridges. Measuring Amplifier Efficiency. Locating Troubles in Intermediate and Output Transformers. Determining Speaker Phasing with Simple Battery Tests.**

---

by **JOHN B. LEDBETTER**

Engineer, WKRC-TV

unit which could be used with an ordinary *vtrm* to check intermittent capacitors, resistors and other components in an amplifier, also may be used to check for audio oscillation (motorboating), noise, hum, and distortion. For these tests, headphones are inserted in the monitor jack and the probe used to locate the trouble. Motorboating may be located by applying the probe not only to the grid and plate but also to the suppressor,

screen and cathode terminals. This type of oscillation usually is caused by an open screen grid bypass, but can also be due to an open cathode or filter. In the latter case, the motorboating is usually, though not always, accompanied by a 60 or 120-cycle hum.

Noise can be located in the same manner, by tracing to the stage in which the noise level is highest. Tubes, carbon resistors, and audio transformers (in the order named) are the usual offenders. Hum can be

<sup>1</sup>SERVICE; June, 1950.

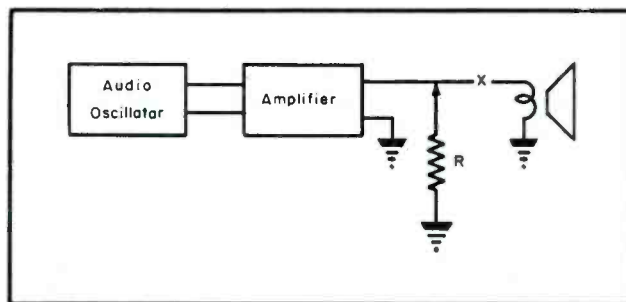
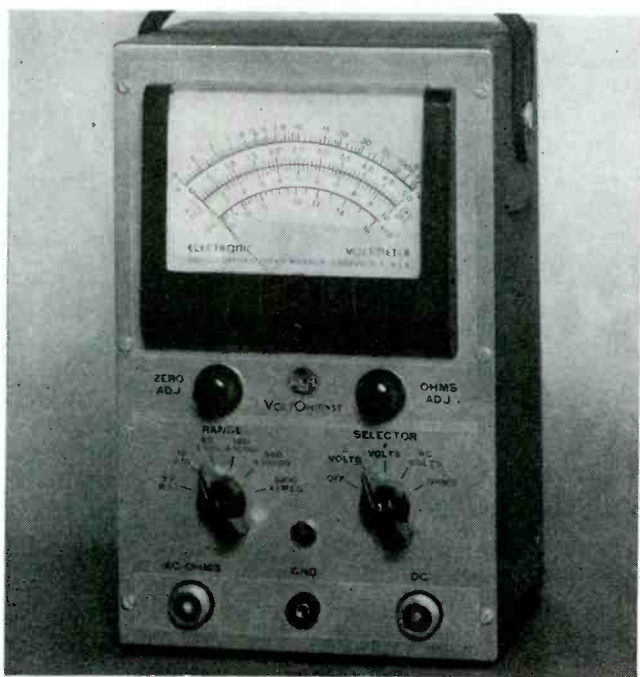
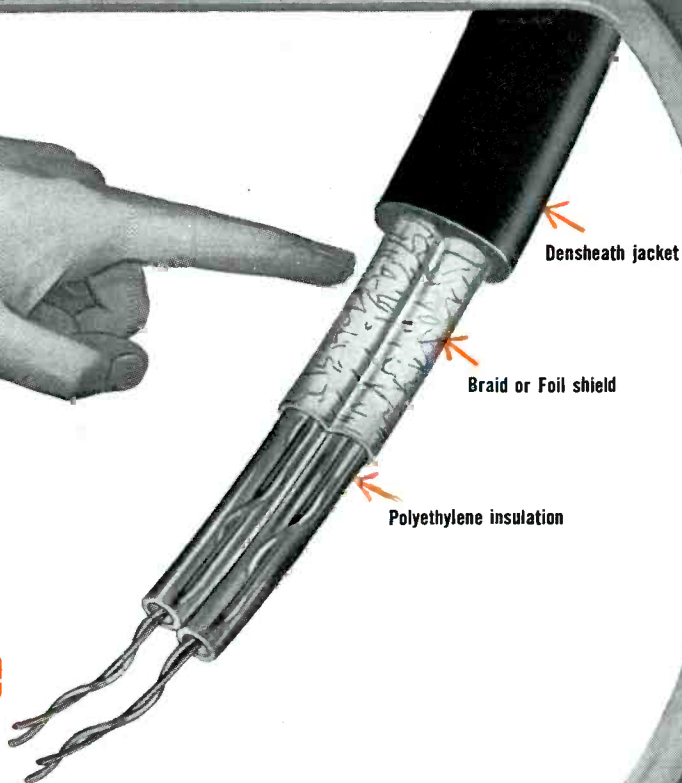
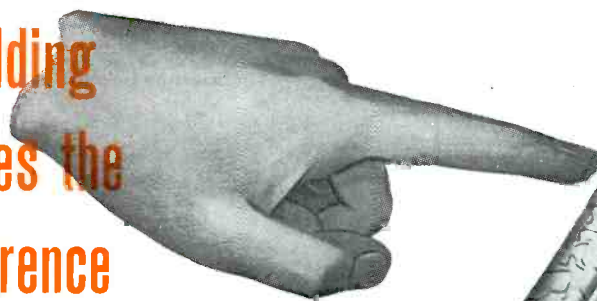

Fig. 2. Setup for power-output measurements. Resistor *R* is used to replace the normal load. It should be able to handle rated amplifier output.

Fig. 1. View of typical *vtrm* which will be found very useful in *pa* service work. (Courtesy RCA)

shielding  
makes the  
difference  
in ATV 225  
Shielded  
Lead-In-Line



When visible noise, caused by local electrical disturbances, distorts and blurs TV pictures, everyone gets annoyed — the owner, the service man and the manufacturer.

But when ATV\* 225 Shielded Lead-In-Line is installed, it shows as high as 85% noise suppression over unshielded lines. And here's why . . .

**high signal-to-noise ratio** — will not pick up unwanted local noise.

**matched impedance** — provides optimum balance between receiver input impedance and antenna impedance — broad band response is assured over all channels.

**operates** in open air or in conduits — without change in electrical characteristics.

**densheath\* thermoplastic jacket** combats all weather conditions . . . is flame resistant.

**polyethylene insulation** — for high dielectric qualities.

*Install ATV 225 Shielded . . . it's the Lead-In-Line that keeps pictures clean of "Noise." Anaconda Wire & Cable Company, 25 Broadway, New York 4, New York.*

ATV 225 Shielded and all ANACONDA ribbon-type and coaxial lines are distributed by **Columbia Wire and Supply Company**, 2850 West Irving Park Road, Chicago 18, Ill., and sold through recognized jobbers.

50384

The right cable for the job **ANACONDA**<sup>®</sup>  
**WIRE AND CABLE**

\*Reg. U. S. Pat. Off.

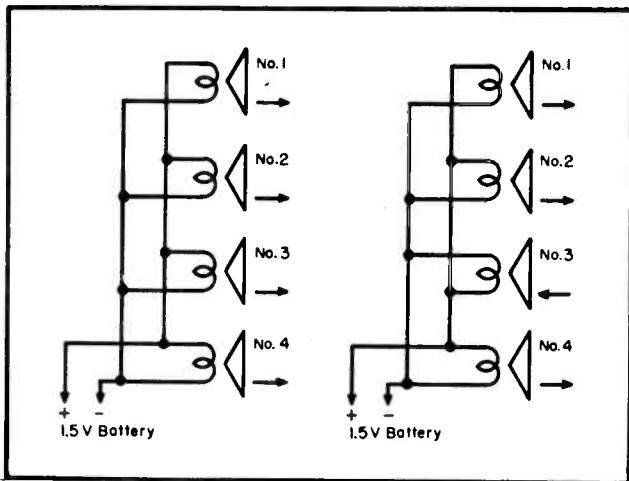

Fig. 3. Parallel-connected speaker voice coils. Left, voice coils correctly phased; right, voice coil in speaker 3 incorrectly phased. Arrows indicate direction of cone movement when battery is momentarily connected across *ac* leads.

localized by the same point-to-point method. Hum in the power supply can be checked by applying the test probe first to the rectifier filament or cathode, then successively to each choke and filter capacitor. The hum, loudest at the rectifier, should decrease with each filter section, the greatest drop in hum level being at the input filter capacitor. An appreciable amount of hum at any point in the filter section should be checked by bridging another filter across the suspected unit. If the capacitor is leaky it will be necessary to disconnect it from the circuit before any difference in hum level on substitution may be noted. Hum originating in other parts of the amplifier may be traced in the same way.

A rapid check for hum, noise and internal oscillation can be made by setting all gain controls at normal and then shorting the microphone and phono inputs. Any signal voltage remaining at the amplifier output can be considered as due to hum, oscillation, or some form of noise. Many times the exact nature can be identified by using the headphone monitor. Line hum, either 60 or 120-cycle, can be picked up in any part of the amplifier, especially the low-level and grid circuits. It can also be caused by tube leakage (usually from cathode to heater), by *ac* leads running parallel or close to grid circuits, or by inadequately filtered screen-grid circuits. The faulty stage or source of pickup can be found by making stage-by-stage hum comparison tests with the signal tracer.

Distortion can be checked by moving the test prod from point to point until the apparent source is located. Distortion may appear at any point, but usually is most prevalent in high-level stages. It can be due to a combination of several defects, some of the most common being: defective tubes, leaky coupling capacitors, de-

fective bias resistors, open or shorted cathode bypass capacitors, open plate bypass capacitors in the output stage, excessive or incorrect *avc* voltages, overloading, regeneration, undesirable rectifying action, and incorrect terminal voltages.

In testing, it is important to be certain that distortion heard in the monophones or speaker is due to an actual defect within the amplifier and not caused by overload, mismatch, or circuit unbalance caused by the shunting effect of certain test instruments. The point at which overloading of the input circuits occurs can be found by using an audio oscillator or record player, preferably the latter. The gain of the amplifier should be turned up until distortion is barely apparent, and the signal voltage at the output of that stage measured with the signal tracer. The output of the test oscillator or other service instrument should then be adjusted to keep that output voltage at, or slightly below, its measured value.

Distortion often has been found due to mismatch in the input and output circuits. Velocity or dynamic microphones, whose outputs normally are 30 or 250 ohms, must be equipped with a microphone-to-grid matching transformer before working into the high-impedance circuit of the usual *pa* amplifier. Speakers, which are improperly matched or phased, or incorrectly connected in the circuit, are common causes of distortion.

Crystal pickups and microphones should be checked while working into their normal grid load. Most crystal troubles are limited to low output accompanied by distortion, loss in low-frequency response, or cracked elements caused by rough handling. Hum appearing when the pickup arm or microphone case is touched is due to transposed cartridge leads (reversed ground and grid leads), or to an ungrounded case. This usually

must be connected to the common ground lead or shield.

Cartridge repair is not practical; either the cartridge or the entire unit should be replaced.

#### Power-Output Measurement

As a final check on amplifier efficiency, it is desirable to measure the actual power output. Power measurements can be made with the speaker or normal load connected, and with *ac* readings taken across the output transformer secondary. Such measurements, however, are extremely noisy and should be made with the speaker disconnected and a power resistor *R* (Fig. 2) connected in its place. This resistor should be a non-inductive, wire-wound type, of the same ohmic value as the load impedance and capable of dissipating the normal rated amplifier output. Suppose, for example, an amplifier rated at 50 watts works into a load of 500 ohms. The resistor *R* then must be a 500-ohm, 50-watt unit. A typical *ac* voltage reading across the load of an amplifier of this type might be 157 volts. Then, by using the power formula  $W = E^2/R$ , the actual power output would be  $24,649/500 = 49.3$  watts.

Common failures in intermediate and output transformers have been found to be: intermittents, open windings, and corrosion due to internal chemical reaction. In matching replacement interstage transformers, it is much easier to obtain the plate resistance and load impedance values from reference charts or tube manuals, and then select the correct transformer for replacement. In output transformers, determination of load impedance is more difficult, especially when multiple speakers are connected in series-parallel or when the load values or voice coil resistances are not known.

[To Be Continued]

**FEATURE  
FOR  
FEATURE**

**COMPARE  
FOR YOURSELF!**

and You'll See There Is **NO COMPARISON**



**THE RADIART  
TELE-ROTOR**  
is Head and Shoulders  
Above All Others!

The **ONLY** Rotator with  
**ALL** the Important Features

FEATURES	TELEROTOR		Rotator A		Rotator C	Rotator K	Rotator M	Rotator N	Rotator U
	TR-1	TR-2	Type 1	Type 2					
TORQUE FT. LBS.	36	36	5½		4.5	6.75	2.25	4.5	6.00
TORQUE PER POUND OF ROTATOR	3.13	3.13	0.91		0.55	1.08	0.35	0.58	0.96
SIDE THRUST OVERLOAD (FT. LBS.) TO STOP ROTATION	525	525	94		50	83	88	110	160
WEATHER PROOFING	One piece "Water Shed" Dome Housing		Rubber Gasket		Metal Ring	Felt Washers	Rubber Gasket	Rubber Gasket	Rubber Gasket
ELECTRICAL TO MECHANICAL EFFICIENCY TORQUE PER WATTS CONSUMED	72%	58%	16.4%	16.3%	13%	11%	4%	1%	11%
TYPE OF LOAD BEARING	Two 6½ in. dia. Ball Races		Double Sleeve		Sleeve & Ball 2 in. dia. Ball Race	Sleeve	Sleeve	Double Ball Race 1 in. dia. Ball Race	Double Sleeve
MAST CAPACITY	2"	2"	1½"		1½"	2"	1½"	2"	1½"
ALIGNMENT OF ROTATOR SUPPORT MAST AND ANTENNA MAST	In Line	In Line	Off Set		Off Set	Off Set	In Line	Off Set	In Line
MOUNTING VERSATILITY	Mast or Platform		Mast Only		Mast Only	Mast Only	Mast Only	Mast Only	Mast or Side Plate
TYPE OF DIRECTIONAL INDICATION	End of Rotation Light	Dial lights 8 Positions and end	End of Rotation Light	Meter	Meter	Meter	End of Rotation Light	Meter	Meter

You Can't Beat a RADIART ANTENNA on a TELE-ROTOR.... It's TOPS!



THE **RADIART** CORPORATION  
CLEVELAND 2, OHIO



- ROTATORS
- VIBRATORS
- AUTO AERIALS
- TV ANTENNAS
- POWER SUPPLIES

# SER-CUITS

## Analysis of Tuners used in Emerson TV and Stromberg-Carlson Chassis... Westinghouse TV Receiver Built-In Antennas and Sound IF Channel Circuitry.

BUILT-IN ANTENNAS, which for a time consisted of nothing more than 300-ohm line stripped along the interior of the cabinet, are quite different in appearance today and linked to special types of matching circuits, which are claimed to provide substantial pickup.

An interesting example of this design appears in the Westinghouse receivers (models H-600T16, H-601K12, H-602K12, H-603C12, H-604T10A, H-605T12, H-606K12, H-607K12, H-608C12, and H-609T10). In these models, the active antenna elements consist of two tapered pieces of aluminum foil, which are secured to the top inside of the cabinet. A length of No. 16 copper wire, bent in the shape of a hairpin with a small loop on each end, is connected at each end to the pieces of aluminum foil. In Figs. 1 and 2, the main loop of this hairpin is identified as  $L_3$ .  $L_1$  and  $L_2$  represent the small loops on each end of the hairpin. A trimmer,  $C_1$ , is connected across the

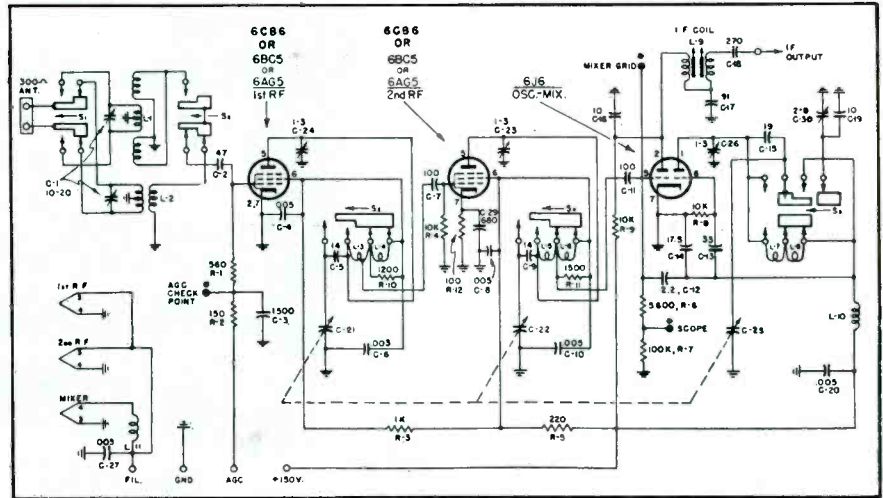

hairpin at the point where the small loops begin to take form. The transmission line is tapped to the hairpin approximately midway between  $C_1$  and

the closed end of the loop.

In the electrical equivalent of the antenna, shown in Fig. 2,  $X_a$  represents approximately midway between  $C_1$  and

(Continued on page 30)

(Above)

Fig. 3. Schematic of the Emerson TV tuner; 470606.

(Below)

Fig. 2. The electrical circuit of the Fig. 1 built-in antenna.

(Right)

Fig. 1. Physical arrangement of Westinghouse built-in antenna.

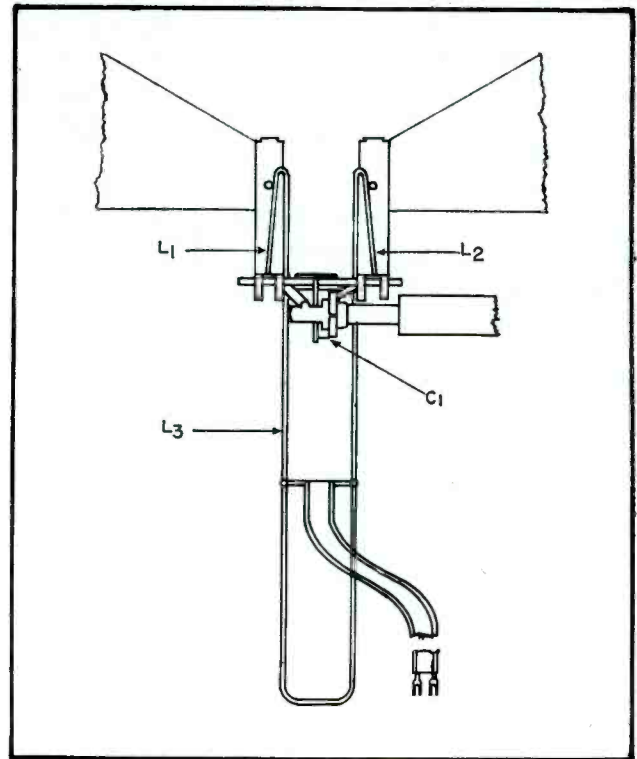
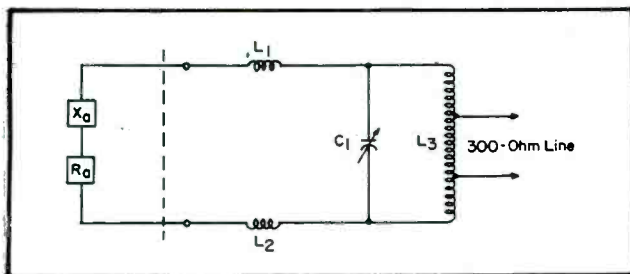

NO WONDER *Regency*

# TV IS THE LARGEST SELLING SIGNAL BOOSTER!

... it wins all  
performance tests!  
... is also  
lowest priced!

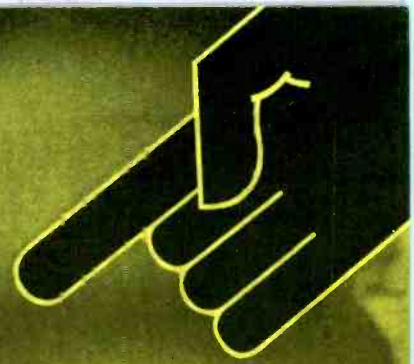

THE DB 400  
**\$29.95**  
LIST

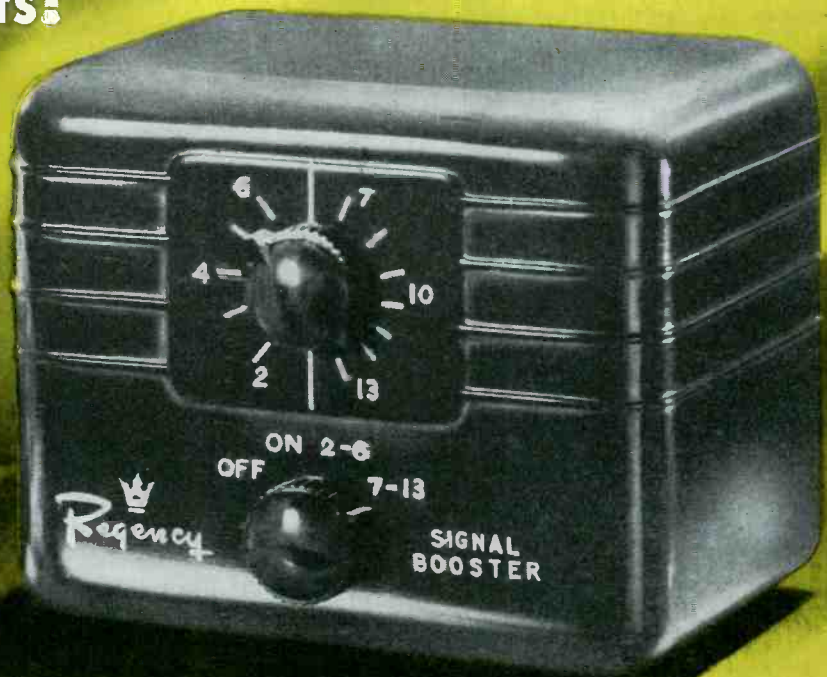

## REGENCY FEATURES:

- Single-knob tuning control.
- Off-on switch controls the TV set.
- Easy installation. TV set plugs into the booster—booster plugs into wall outlet!
- The use of Contra-Wound Bifilar Coils with push-pull triode design gives a balanced circuit.
- Electrical symmetry makes possible balanced-bridge neutralization which insures stability and eliminates self-oscillations.
- No external impedance matching devices required.

## REGENCY FEATURES:

- A handsome plastic cabinet design in mahogany or blonde; created to please the most discriminating interior decorator.
- Wide bandwidth assures equal enjoyment of both video and audio on all 12 channels.
- Underwriters'  Approved.



  
**Regency**  
Division, I.D.E.A., INC.

55 N. New Jersey St., Indianapolis 4, Indiana

# FREE WITH PHOTOFACT!



## "Bonus" TV Supplements

### Preliminary Service Data on Hundreds of Television Models for Your IMMEDIATE USE . . . AT NO EXTRA COST!

TV set owners are calling for service within days—even hours—after installation. That's why you, the TV Technician, must have your service data *right now!* And *right now*, PHOTOFACT brings you the "rush" preliminary TV service data you need for *immediate use* to keep you going at full speed. FREE with the purchase of PHOTOFACT Folder Sets No. 91 and No. 93, you receive with each a separate 64-page Supplement containing preliminary data (in *advance* of regular PHOTOFACT coverage) on over 100 popular TV models. Place your standing order for PHOTOFACT today—it's the only way to get *without delay* the TV service data you must have *right now!*

Buy PHOTOFACT Folder Set No. 91 and get **FREE TV SUPPLEMENT NO. 91A:**  
Covers 114 important Television Receiver models, produced by 11 leading TV manufacturers.

Buy PHOTOFACT Folder Set No. 93 and get **FREE TV SUPPLEMENT NO. 93A:**  
Covers more than 100 leading Television Receiver models, produced by 17 TV manufacturers.

**BUY BOTH! GET THE DATA YOU WANT  
NOW ON HUNDREDS OF TV MODELS**

PHOTOFACT Set Nos. 91 and 93 are going fast—  
order today to avoid disappointment

### HOWARD W. SAMS & CO., INC.

Order from your Parts Jobber today or write direct to HOWARD W. SAMS & CO., INC., 2201 East 46th Street, Indianapolis 5, Ind.

My (check) (money order) for \$..... enclosed. Send me the following:

- Photofact Set No. 91 and Supp. 91A, \$1.50  
 Photofact Set No. 93 and Supp. 93A, \$1.50

Name.....

Address.....

City.....Zone.....State.....

## Ser-Cuits

(Continued from page 28)

sents the reactance of the antenna, and  $R_a$  the radiation resistance.

On the low-band channels, the reactance of the antenna elements (aluminum foil) is capacitive. To resonate the system, the reactance of the network  $L_1$ ,  $L_2$ ,  $L_3$ , and  $C_1$  must be made inductive and equal in magnitude to the capacitive reactance of the antenna elements. This condition is obtained by adjusting  $C_1$ .

On the high-band channels, where the reactance of the antenna elements is inductive,  $C_1$  must be adjusted so that the reactance of the network  $L_1$ ,  $L_2$ ,  $L_3$ , and  $C_1$  is capacitive and equal in magnitude to the inductive reactance of the antenna elements to resonate the system.

$C_1$  and  $L_3$  form a parallel LC circuit of high impedance, as compared to the 300-ohm tuner input impedance. To obtain a matched condition, the transmission line is connected across only a part of  $L_3$ .

### Television Tuners

The tuners in the current models include many novel circuit features, too. In the tuner used in the Emerson models (tuner 470606), capacity tuning is employed, with continuous tuning provided in the 2 to 6 and 7 to 13 channel ranges; Fig. 3. To facilitate tuning, a certain amount of additional coverage above the highest and below the lowest tunable channel in each range is provided. A two position switch, actuated by a knob concentric with the fine tuning shaft, is used to switch all circuits.

Three tubes are employed: one 6AG5, 6BC5 or 6CB6 first *rf* amplifier; one 6AG5 or 6BC5 second *rf* amplifier; and one 6J6 oscillator-mixer.

A three-section gang capacitor is used for tuning, respectively, the first *rf* plate circuit, second *rf* plate circuit, and the plate circuit of the oscillator.

The antenna input system consists of two band-pass circuits. The required circuit is selected by the range switch. Each antenna band-pass circuit is a double tuned circuit, consisting of a center-tapped primary resonated by a trimmer capacity and suitably coupled to a secondary resonated by the first *rf* grid input capacity. The antenna circuits are designed to match a 300-ohm line.

The *rf* amplifiers are used as stagger-tuned amplifiers to provide a band-pass circuit of the proper bandwidth. In both *hi* and *lo* ranges, the plate circuit of the first *rf* amplifier provides the low-frequency stagger component, and the plate circuit of the second *rf*

More and More  
Service Men  
are switching to  
**ERIE RESISTOR**

In the last year over 300% more ERIE RESISTOR components have been used by service men for repairs and replacement. The reason...  
**ERIE RESISTOR QUALITY**

If your distributor cannot supply you, write us for information. New catalog on request.

Electronics Division  
**ERIE RESISTOR CORP., ERIE, PA.**  
LONDON, ENGLAND TORONTO, CANADA

"HAVE YOU HEARD  
THE SOUND OF QUALITY?"



NEWCOMB SOUND IS BETTER

Manufacturers of public address, mobile, phonograph, musical instrument and wired music amplifiers • Portable systems • Portable phonographs and radios • Transcription players • Rack and panel equipment.

Write today! Circle items of interest and indicate whether you are a Dealer, Parts Jobber or Sound Specialist.

**NEWCOMB AUDIO PRODUCTS CO.**  
DEPT. E, 6824 LEXINGTON AVE.  
HOLLYWOOD 38, CALIFORNIA



amplifier provides the *hf* stagger component.

### Stromberg-Carlson TV Tuners

The tuner used in the Stromberg-Carlson TS models<sup>1</sup> has many features, too. This tuner also covers the twelve channels on two bands. Both bands contain a tuned broadband antenna transformer for coupling the 300-ohm balanced input into the grid of each *rf* tube, a 6AG5 and 6BH6. Each input transformer is fixed tuned by trimmer capacitors in the primary to be essentially flat over the entire band. The plate-circuits are tuned by a variable inductance and the associated tube capacity in parallel with the trimmers.

In the *hi-band* section of the tuner, the *rf* signal is coupled from the plate coil into the grid coil of the converter through an inductive link, while in the *lo-band* section, the *rf* signal is coupled from the plate of the *rf* amplifier through a *T* network into the grid of the converter tube,  $\frac{1}{2}$  6J6 ( $V_{8A}$ ). The *T* network is designed to give proper bandpass, as well as to provide added image rejection through the use of a series resonant circuit.

The local oscillators are in a modified Colpits circuit. The voltage from the *hi-band* local oscillator is inductively coupled into the grid circuit of the *hi-band* converter by a link, while the voltage from the *lo-band* local oscillator is rejected through a 1.5-mmfd capacitor into the grid of the *lo-band* converter.

The rear half of section 2 of the range switch is used to disable the *hi-band* converter when using the *lo-band* section of the tuner, by applying a -22-volt bias to the converter grid. When the *hi-band* section of the tuner is operating, the *lo-band* converter is disabled by applying a -22-volt bias to the grid.

The *if* output from the converter plate is coupled into the grid of the first picture *if* tube through a double-tuned circuit.

### Sound IF Channels

Another section of the new TV chassis which includes an interesting type of circuitry is the sound *if* channel. In the Westinghouse models (series H-600T16, H-601K12, H-602-K12, H-604T10, H-604T10A, H-605-T12, H-606K12, H-607K12, and H-609T10), the video carrier and the sound carrier produce a 4.5-mc beat signal in the video detector output; Fig. 4. This beat, which contains the frequency modulation of the sound carrier, is developed between the video test jack and ground. It is applied to the tuned grid circuit ( $C_{221}$  and  $L_{201}$ ) of the first sound *if* amplifier

<sup>1</sup>SERVICE; June, 1950.

(Continued on page 42)

new

Permoflux

ROYAL EIGHT™

compares with  
any 12" speaker!



Permoflux  
ROYAL EIGHT™  
with the  
NEW ROYAL BLUE  
CONE



PERFORMANCE CURVE  
PERMOFLUX 8T8-1

RESPONSE IN DB  
FREQUENCY IN CYCLES PER SECOND

This averaged laboratory response curve of the Permoflux 8T8-1 proves that it compares with the finest speakers regardless of size or price.

It's Your "Springboard" to Extra Sales with Customers who want 12" performance but don't want to pay a 40% higher price.

From the resonant boom of jungle drums to the light warble of the flute, this new 8" speaker reproduces sound with superior sensitivity and fidelity. The tonal qualities of this magnificent speaker can only add to the excellence of any audio equipment.

Special processing provides extra-strong cone; allows cone to be soft-suspended from basket and held at coil-end by extra-large spider. Permits more faithful reproduction at lower frequencies. Deeper, curvilinear cone greatly extends high-frequency response.

Permoflux Royal Eight" (Model 8T8-1) is ruggedly-built, and simple to install. Provides big speaker performance in a small frame—uses smaller, more economical baffle. List Price \$15.00.

Send for Catalog No. J 201—Dept. SE



PERMOFLUX CORPORATION

4900 W. GRAND AVE., CHICAGO 39, ILL. • 236 S. VERDUGO RD., GLENDALE 5, CALIF.

Fig. 4. Sound *if* channel circuit of Westinghouse V-2150-61 chassis.

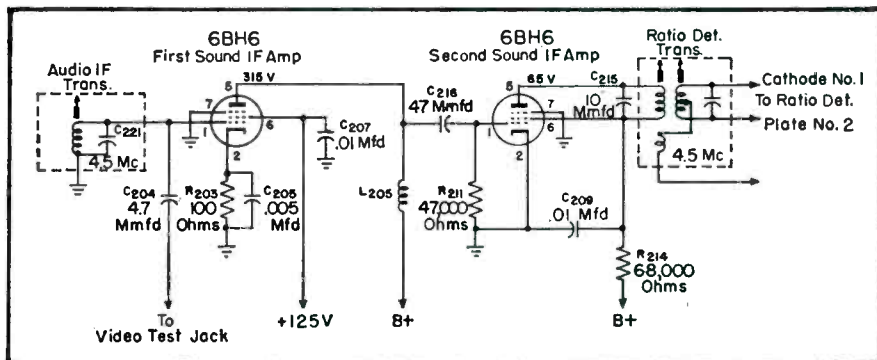

ANNOUNCING

# TELE-TURNER

## amazing NEW T.V. ROTOR

# - PRICED TO SELL!

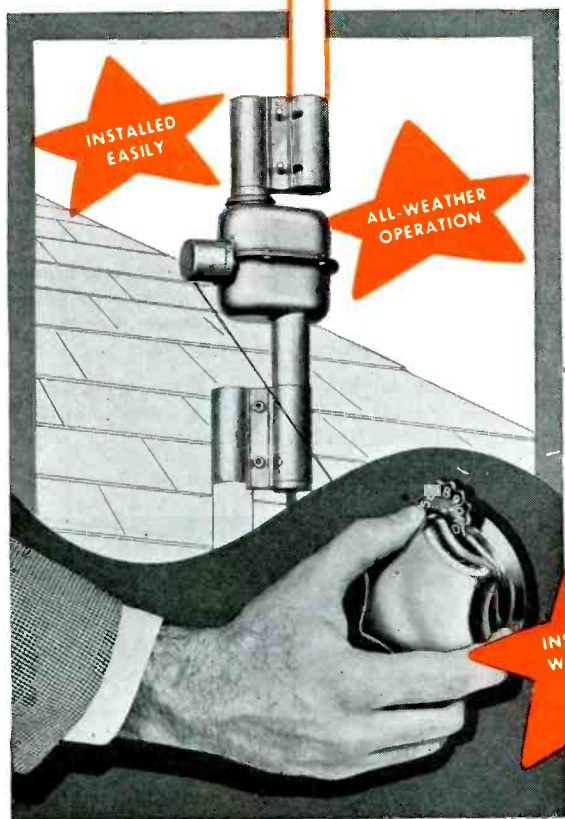

**TELE-TURNER**

**Top quality  
Lowest price**

**\$16<sup>45</sup>**

**RETAIL  
PRICE**

(Plus Cable)

Tele-Turner is the first to give you a quality TV Rotor at a price everyone can afford. Mechanically operated yet offering the performance of an electric rotor. Tele-Turner is easily installed and gives all-weather performance. Cash in now by mailing the attached coupon.

- FOOLPROOF MECHANICAL OPERATION
- EASY TO SELL
- ONE YEAR GUARANTEE

... learn more about profit-making TELE-TURNER ... mail coupon today!

Please send me full information on how I may cash in on the profit making Tele-Turner.

Name \_\_\_\_\_

Company \_\_\_\_\_

Street \_\_\_\_\_

City \_\_\_\_\_ State \_\_\_\_\_



**C. M. PENNEY CO.**

3471 West 140th St. • Cleveland, Ohio

# New TV Parts . . . Accessories

## RADIART ANTENNA PRODUCTS

A *Tele-Rotor* accessory for unusual rotor antenna installations, model TA-3, the *Tele-Rotor Superstructure*, has been announced by the Radiart Corp., Cleveland, Ohio. It incorporates three rigid brace rods around the upper structure terminating with the floating guy collar, which is said to allow smooth rotation of the antenna array. The lower section also has three rigid base rods to a stationary collar, offering rigid attachment and support from the lower mast base.

Two new antennas for television also have been developed. One is an indoor type, called the *Loaded X*. Made of polished aluminum and plastic. Delivered complete with eleven feet of leadin.

The other new antenna is an outdoor type and is called the *SuperVec*. Available singly and in models for double stacking.

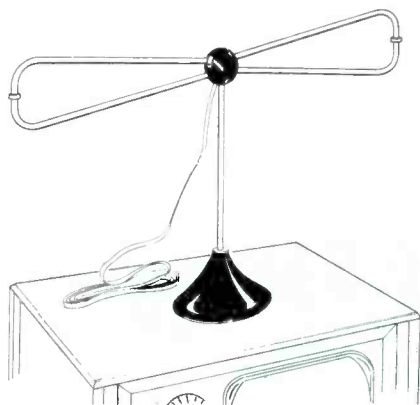

\* \* \*

## TELREX CLOVER V BEAM

A *Clover-V-Beam* stacked, bi-directional array, for both TV and FM reception, has been announced by Telrex, Inc., Asbury Park, N. J.

Beam is a closed loop *conical-V-beam*, with a high gain and signal-to-noise ratio said to be obtained, especially at the high frequency channels, due to the flat impedance characteristics and absence of *lobe-splitting* over the full frequency range.

The use of transposed transmission line bars also serve as co-linear elements. Universal clamps are supplied for coupling to standard diameter masting.

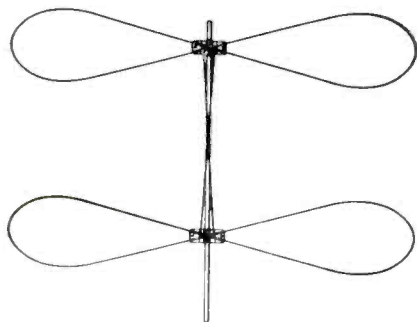

## KENWOOD ANTENNA MOUNT BRACKET

An all-position TV antenna mount bracket, which can be installed on the peak of a roof, as well as the side of a roof, wall, parapet or corner of a building, is now being made by the Kenwood Engineering Co., Inc., 265 Colfax Avenue, Kenilworth, N. J. Said to be adjustable to any desired position by properly locating a set of braces on each side of the uprights and fastening them into position by nut and bolt.

The bracket comes pre-assembled, except for the side positioning braces. The standard size takes a mast up through an 1½" mast, while the larger model accommodates up through a 2" mast.

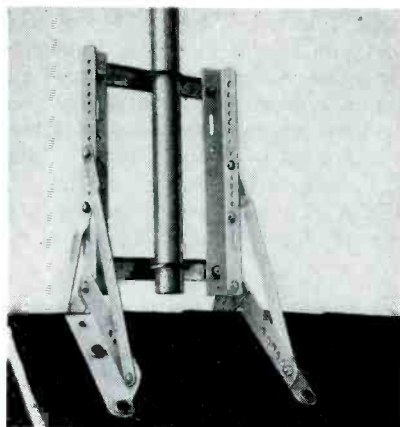

\* \* \*

## RMS TV DISTRIBUTION SYSTEM

A TV distribution system has been announced by Radio Merchandise Sales, Inc., 1165 Southern Boulevard, New York 59.

System features an iso-amplifier unit with a high-impedance input and an amplified output section. Reception to each receiver is said to be uniform and optimum.

\* \* \*

## SNAIDER PROJECTION RECEIVER

A projection slave receiver that may be attached to any type of TV receiver and deliver a projected picture up to 6' by 8' has been announced by Snaider Television Corp., 540 Bushwick Avenue, Brooklyn 6, N. Y.. Uses only the video signal and sound of the master set. The sync and sweep circuits are independent of the master set. The slave unit is said to hold sync even when master goes out of sync. Including the *cr* tube, there are a total of 21 tubes.

\* \* \*

## TV DEVELOPMENT NEUTRAL FILTER

A neutral filter designed for black tube TV sets is now being produced by the T. V. Development Corp., 2505 Surf Ave., Brooklyn 24, N. Y.

\* \* \*

## JFD VEE-BEAM ANTENNAS

*Vee-Beam* arrays, employing the *end-fire* principle, are now being made by JFD Manufacturing Co., Inc., 6101 Sixteenth Ave., Brooklyn 4, New York.

Features are said to be gain of 7 db for single-stack on upper channels, 11 db for double stacks.

## TEL-A-RAY BUTTERFLY ANTENNA

A TV antenna, the *Butterfly*, said to have wide band characteristics, has been announced by Tel-a-Ray Enterprises, Inc., Henderson, Ky.

Constructed from solid Dural with cast aluminum brackets and stainless steel hardware. The insulation block is of polished polystyrene.

Antenna is said to be bi-directional and can be used with a 72, 150, or 300 ohm impedance line.

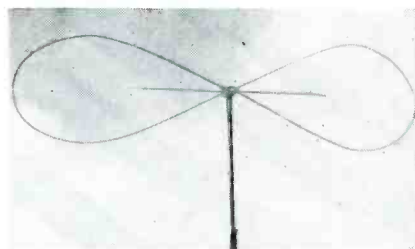

\* \* \*

## CLAROSTAT TV REPLACEMENT BALLASTS

Further expansion of its TV replacement ballast line has been announced by Clarostat Mfg. Co., Inc, Dover, N. H. The two latest additions are Teletone types TBR 103 D and TBR 104 D.

Other numbers of the line are Teletone, Motorola, Belmont, Emerson and Stewart-Warner replacement ballasts.

\* \* \*

## PENN TELEVISION ANTENNA MOUNTS

A line of base and peak-roof mounts, and guy wire rings and collars, has been announced by the Penn Television Products Co., Philadelphia, Pa.

Items use cast aluminum. Patented bearings are said to permit locking in any position with turn of a bolt. A patented tongue is also said to provide support to masts from ¾" to 1½".

\* \* \*

## SMITH TELE-LITE

A lamp, *Tele-Lite*, providing a soft glow of indirect light, that is said to be helpful in eliminating eyestrain during viewing, has been announced by James H. Smith & Sons Corp., Griffith, Ind.

The bulb in the lamp is said to be fully shielded from the television set screen by an etched metal reflector-shade. Lamp is made of aluminum.



# American Beauty

*dependable*



*durable efficient*

## ELECTRIC SOLDERING IRONS

are sturdily built for the hard usage of industrial service. Have plug type tips and are constructed on the unit system with each vital part, such as heating element, easily removable and replaceable. In 5 sizes, from 50 watts to 550 watts.

## TEMPERATURE REGULATING STAND

This is a thermostatically controlled device for the regulation of the temperature of an electric soldering iron. When placed on and connected to this stand, iron may be maintained at working temperature or through adjustment on bottom of stand at low or warm temperatures.



For descriptive literature write

111-1

**AMERICAN ELECTRICAL  
HEATER COMPANY**  
DETROIT 2, MICH., U. S. A.

# ASSOCIATIONS



## ARTSNY

IN ONE OF THE most dramatic service meetings ever held, over 1200 Service Men appeared at a school auditorium in New York City to protest a recently proposed municipal bill which would require payment of nearly \$600 for certificates of qualification and financial status, and a license to operate a servicing business.

Cosponsored by the Associated Radio-Television Service Men of New York, Inc., John F. Rider, Publisher, Inc., The American Legion and the National Electronic Distributors Association, the meeting was highlighted by addresses by John F. Rider; Louis B. Calamaras, executive secretary of NEDA; Tim Alexander, service manager of Motorola and chairman of the

Service Committee of RTMA; and Noel Payne, Arthur Silverberg and Max Liebowitz, secretary, vice president and president, respectively, of ARTSNY.

Reviewing the bill, Noel Payne declared that honest servicing, policed by the industry itself, offered the only answer to the present abuses.

Reporting on a letter sent by the RTMA Service Committee to Councilman Keegan, sponsor of the bill, Tim Alexander said that the letter declared in part . . . "We do not believe that licensing will help correct the evils in the industry, nor will it improve service . . . Complaints received are seldom about the small operator because he has to live with the customer . . . The situation existing today is only a temporary condition, and when more

View of portion of the large audience, at the Central Commercial High School auditorium, in New York City, during the mass meeting held to protest a recently-proposed municipal licensing bill.



## CONTINENTAL CARBOMITE RESISTORS



- ★ JAN R-11 Approved
- ★ Ratings, 1/2, 1 & 2 Watt
- ★ Tolerance 5% & 10%
- ★ Operate at 70° Amb

Ideal for service replacement, especially in television receivers. Available from stock through Continental Jobbers in cooperation with Allen-Bradley.

**CONTINENTAL CARBON Inc.** CLEVELAND 11, OHIO

**TEN YEARS AGO**

From the Association News Page of  
**SERVICE, July, 1940**

IN A REPORT from A. T. Marsh, the secretary-treasurer of the RTG of Rochester, New York, ye editor was told that the annual dinner-meeting had been held at Canandaigua, New York. Twenty-four members had attended and listened to a stirring talk on salesmanship by Frank M. Houston of the Rochester Gas and Electric Co. . . . A few weeks later, at a regular meeting, the RTG group heard an amusing talk on radio gadgets for the shop by John M. Thompson of Canandaigua.

Service Men learn, there will be better service."

Reemphasizing his firm stand of opposition to regulations, John F. Rider declared that . . . "Regulation never made a dishonest man honest." He then went on to say that the problems do not belong to the service industry alone, but to the manufacturer and dealer as well.

NEDA's executive secretary, Louis Calamaras, voiced strong opposition to the bill, declaring that it is . . . "Thoroughly impractical, because as proposed, it cannot possibly improve alleged existing conditions, but rather by its very wording and provisions, creates and gives legal sanction to abuses and practices against the public welfare."

At the conclusion of the meeting, cards, asking for specific commentary on the proposed legislation, were handed to everyone in the audience, with the request that they be returned immediately for official presentation to the Council.

It is expected that the Council will meet with representatives of industry to discuss these protests and review what plan might be adopted to alleviate the present difficulties.

**TCA**

TELEVISION SERVICE PROBLEMS in the Philadelphia area recently received a view-airing over WCAU-TV, with members of the Television Contractors Association, The Philadelphia Radio Service Men's Association and the Better Business Bureau, providing the answers.

TCA sponsored a series of advertisements in the local papers to promote the telecasts. Copy, posing the question . . . "What's Wrong With My TV Set" . . . suggested that view-

(Continued on page 36)

**Now all ASTATIC  
cartridges come  
in these RUGGED,  
TRANSPARENT  
PLASTIC BOXES**



*T*HERE'S no mistaking which Astatic Cartridge is in this box. You can see and identify the cartridge through the clear, transparent plastic. And there is also an identifying label at each end of the box. Nothing could be more convenient—a real time and mistake saver. Note the uniform size of boxes, regardless of cartridge size.

*T*HE lid comes off the large way, to make the cartridge easier to get at in the new Astatic box. The thickness of plastic is apparent in this view, which assures a rugged container that won't collapse, tear or gap open. Cartridges are kept safer and cleaner.

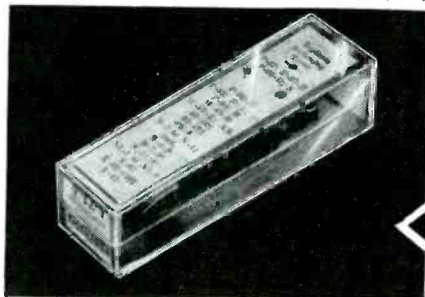

*C*LEARLY visible through the bottom is a list of the cartridges which the one inside the box replaces. Another convenience to save time and increase efficiency.

*T*HE uniform size and straight, rigid sides of the new plastic boxes make it easy to keep them on shelves in neat, orderly stacks that won't topple.



**THE**  
*Astatic*  
**CORPORATION**  
CONNEAUT, OHIO  
IN CANADA, CANADIAN ASTATIC LTD., TORONTO, ONTARIO

1  
One Cartridge  
Instead of fifty!

"Featheride"  
Replace-All  
Cartridge  
Model "WS"\*



**This cartridge will replace more than 50 currently used models**

Here is the serviceman's most convenient cartridge . . . the one cartridge will take care of most replacements . . . No extra stock to carry. Handy because it comes in a Dri-Pack container making it easy to carry in a kit. Has all the performance features to meet requirements. Investment in cartridges is held to a minimum. Check the features listed below—the next time you buy cartridges ask your jobber for the Webster Electric Featheride Replace-All Model "WS"\*. You'll enjoy the convenience.

\*Patent pending

**FEATURES**

- Three terminal construction provides either 1½ volts or 4 volts at ¾ ounce tracking pressure.
- Needle and cartridge are wedged at the factory.
- The needle you receive is the one approved by factory test. Replacement needles are also available.
- Crystal is Dri-seal coated to protect it against moisture and humidity.
- Rest button and terminal clips furnished.
- Packed individually in attractive Dri-Pack Containers.

**WEBSTER ELECTRIC**  
RACINE WISCONSIN

Established 1909

Webster Electric Company, Racine, Wisconsin  
"Where Quality is a Responsibility and Fair Dealing an Obligation"

**Association News**

(Continued from page 35)

ers . . . "Hear and see the experts tell you what to expect from your television receiver and your service technician."

Participating in one of the TV broadcasts were: Albert M. Haas, TCA prexy; Paul Lau, PRSMA prexy, and Hugh Smith, director of the Philadelphia BBB.

**PRSMA**

THE SECOND ANNUAL radio-television-electronics exhibition, sponsored by the Philadelphia Radio Service Men's Association, will be held at the Broadwood Hotel, Philadelphia, Sept. 25-27.

According to David Krantz, show committee chairman, over 5000 are expected to attend.

Programmed have been talks on ultrahigh problems, TV chassis conversion for large tubes, record changers, color television, etc.

The talks will be directed to the interests of Service Men, dealers and students, with sessions beginning at 7:00 P. M. on September 25th and running from 10:00 A. M. to 10:00 P. M. on September 26th and 27th.

Invitations to attend are being extended to all organizations and Service Men, with tickets of admission being distributed by all parts jobbers.

An interesting schedule of program planning for the future was recently evolved by the program committee of PRSMA. In a four-point setup, the technical, business and legal aspects of program procedure were outlined.

It was suggested, for instance, that the technical part of a program be devoted to the presentation of practical lectures and typical demonstrations involving test equipment, receivers and TV antenna equipment.

In a contest plan, it was suggested that constructive ideas regarding additional association activities, and service and installation hints and kinks for TV, be submitted, for which cash awards would be made.

Proposals for the business program included the possible presentation of a series of talks on bookkeeping systems, business ethics, etc.

Quite a few topics were included in the legal part of the program schedule. These included TV service contracts, bill collections, personal bonding, business insurance, business law, etc.

**RTA, ARKANSAS**

IN A REPORT FROM LeRoy Ragsdale, corresponding secretary of the Radio Technicians Association, Fort Smith, Arkansas, it was revealed that John Leedom, field engineer for Sprague Products, appeared recently as a guest speaker.

**DRAKE** *insta-heat*  
**SOLDERING GUN**

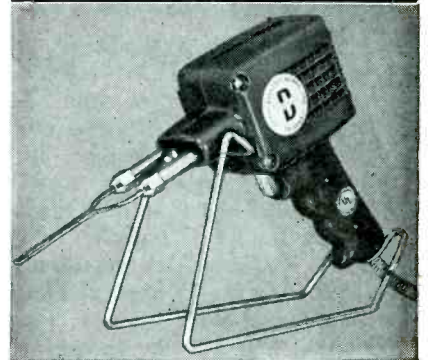

with the *New*

**READY STAND**

Designed and engineered for you, the perfectly balanced Drake "insta-heat" Soldering Gun features a full 135 watts, easy-removable tip and the ideally located *visa-lite*. Now with the new ready stand—to keep the Drake *insta-heat* Soldering Gun at hand for instant use — it's the gun with all the features you've wanted. See your distributor today.

**DRAKE ELECTRIC WORKS, INC.**  
3656 LINCOLN AVENUE CHICAGO 13



**UNIVERSAL ROOF MOUNT**  
Just What TV Installers Have  
Been Looking For

- 1—All-aluminum castings with plated steel bolts.
- 2—Tested to withstand any normal load up to 1500 lbs.
- 3—Will take tubing O.D. ¾" to 2".

Ask your jobber—or send for circular and prices.

**SMITH ELECTRIC MFG. CO.**  
ASHLAND, OHIO

**TV BOOSTER POINT-OF-SALE DISPLAY**



Point-of-sale display piece for *The Standard Booster*, produced by Standard Coil Products. Measuring 14¼" wide and 18¼" high, the easel-backed display may be obtained through factory reps, authorized jobbers, or by writing to Standard Coil Products Co., Inc., 2329 North Pulaski Road, Chicago 39, Illinois, or 2901 E. Slausson Ave., Huntington Park, Calif.

# Rep Talk

MAURY FARBER, 157 Hartwell Road, Buffalo 16, New York, is now a N. Y. State sales rep for John F. Rider Publisher, Inc., 480 Canal Street, New York 13, N. Y. Farber will cover Albany, Amsterdam, Auburn, Binghamton, Cohoes, Cortland, Croton-on-Hudson, Elmira, Glens Falls, Ithaca, Jamestown, Kingston, Middletown, Plattsburg, Rochester, Schenectady, Syracuse, Troy, Utica. . . . B. L. MacPherson, 601 Fort Wayne Bldg., Fort Wayne 2, Indiana, has been named to represent Rider in Indiana and Western Kentucky. . . . The Kansas, Missouri, and Southern Illinois territory of Rider is now being covered by Kathrinus & Co., 1218 Olive Street, St. Louis 3, Missouri. . . . John E. Burns, Hermann Professional Bldg., Houston, Texas, has been named C. P. Clare & Co. sales rep in Arkansas, Louisiana, Texas and Southern Oklahoma. . . . James L. Highsmith, Clare sales rep in the Carolinas and Virginia, has moved his headquarters from Durham to Charlotte, N. C., P. O. Box 1011. . . . Grant Shaffer, 1980 Lawrence Avenue, Detroit 6, Michigan, has been named FTR selenium-intelin rep in Michigan. Shaffer will cover both industrial and distributor accounts. . . . Synthane Corp., Oaks, Pa., has announced the appointment of Gene Rankin as sales rep in the Kansas City area to succeed the late Ernest Bernard, who died recently. . . . J. R. Dannemiller Associates, 4334 Groveland Road, Cleveland 18, Ohio, have become Ohio sales reps for the Eureka Television & Tube Corporation, Hawthorne, N. J. . . . *The Representatives of Radio Parts Manufacturers, Inc.*, have accepted a complimentary booth at the NEDA Convention in Cleveland, Ohio, August 28-31, 1950. In this booth the Buckeye Chapter will host an information center with message and directory services. The Board of Governors of *The Representatives* has authorized the Buckeye Chapter to assist Jane Drucker, public relations counsel, in setting up and rendering this service. . . . J. Y. Schoonmaker, Dallas, Texas, was unanimously elected national president of *The Representatives* for the '50-'51 term at the recent annual meeting of chapter delegates held at the Stevens Hotel, Chicago. Schoonmaker served as first national vice president last year, and as chairman of the Industry Relations Committee the preceding year. . . . Wilmer S. Trinkle, Philadelphia, has been elected as first national vice president; Norman B. Neely, Hollywood, second national vice president; and Russ Diethert, Chicago, third vice president. . . . The '50-'51 national secretary-treasurer will be Leroy W. Beier, member of the Chicagoland Chapter. . . . The Freed Transformer Company, Inc., 1718-36 Weirfield Street, Brooklyn 27, New York, has announced the appointment of M. F. Klicpera, P. O. Box 3113, Houston, Texas, as a rep to cover the states of Louisiana, Oklahoma, Texas and Arkansas. . . . Stephen Edward Grimm has been elected to associate membership in the Chicagoland Chapter of *The Representatives*. Grimm is a member of KaDell Sales Associates, 2406 W. Bryn Mawr Avenue, Chicago. . . . Charles N. Hoemig, 1730 Clover Lane, Fort Wayne 7, Ind., has been appointed Radiart rep and will cover Indiana and western Kentucky.

## Announcing the Sensational Low Cost



## CONICAL-V-BEAMS\*

OFFERING OUTSTANDING TELREX PERFORMANCE AND DEPENDABILITY

- SOLID DURAL ELEMENTS
- TELREX QUALITY THROUGHOUT
- ALL-CHANNEL RECEPTION
- ALL ALUMINUM CONSTRUCTION
- HEAVY GAUGE BUTTERFLY CLAMP
- LOW LOSS LAMINATED PHENOLIC INSULATOR

DESIGNED for results and profits! High performance, extra low priced, the VANGUARD will outperform and outsell any comparably priced TV antenna anywhere. Vanguard Conical-V-Beams have engineered design that guarantees finest reception, conservative ratings that assure top performance and super-rugged construction that means long, trouble-free service life. The next time you need antennas, order Vanguard by Telrex. Don't settle for less than the best—particularly when the price is right. Call or write for complete illustrated catalog and prices, now!

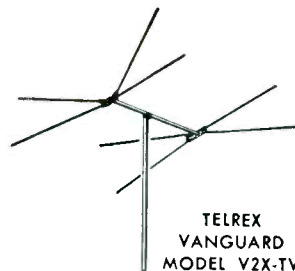

TELREX VANGUARD MODEL V2X-TV

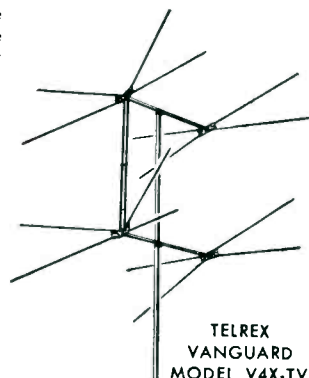

TELREX VANGUARD MODEL V4X-TV

### NOW — THE CLOVER-V-BEAM

for fast, inexpensive installations in all primary and secondary areas

Here's a new high efficiency, low cost antenna that's particularly easy to install. Recommended for all primary and secondary areas, this two stack, closed loop Conical-V-Beam weighs less than 2 lbs. Ask your distributor or write Telrex for details!

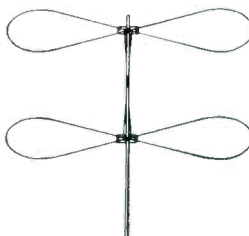

CLOVER-V-BEAM MODEL 2 BDS

NEW LOW PRICE FOR SUPEREX!

A buy at any price, now listing for \$225

Patents Pending  
Copyright 1950

**telrex INC.**  
CONICAL-V-BEAMS\*

\* REGISTERED TRADE MARK

Be sure it's a "CONICAL-V-BEAM"  
—Look for the TELREX\* Trademark

AMERICA'S  
STANDARD OF  
COMPARISON

ASBURY PARK 4, N. J.

# Terrific FOR TELE-CIRCUITS!

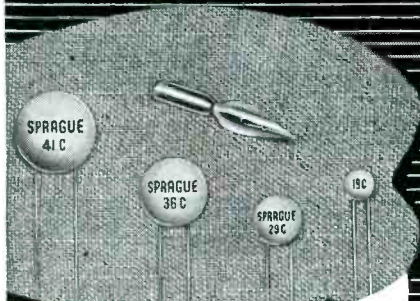

## Cera-mite<sup>★</sup> CAPACITORS

ARE  
THE *First* COMPLETE  
DISC CERAMIC LINE

DEVELOPED especially for the television industry, Sprague Cera-mite Capacitors fill the bill for the alert service technician!

Temperature-compensating, general-use, and high-K bypass types fit every type of circuit application. The low self-inductance feature of the flat plate with uni-directional lead design gives better high frequency performance than the older tubular ceramics which they replace. And they're ideal as mica capacitor replacements, too!

Tiny and dependable, every Cera-mite is rated at 1000 volts test, 500 wvdc, and for operation at 185°F.

Cera-mites are clearly stamped with capacitance—no confusing color coding.

Stock up at your Sprague distributor without delay!

Write for Cera-mite Bulletin

★Trademark

# SPRAGUE

## PRODUCTS COMPANY

Distributors' Division of the Sprague Electric Co.  
61 Marshall St., North Adams, Mass.

## TV Alignment

(Continued from page 14)

the response curve being observed. In other words, it should simply be a means to an end which in no way complicates the overall operation. It should supply all of the frequencies which are of interest with the necessary degree of accuracy. There does not seem to be any general agreement as to what constitutes the necessary degree of accuracy, nor in fact even what frequencies are necessary.

If speed and efficiency are to be achieved, the dials, which must be accurately set, should not require adjustment during the alignment. It would seem that this requirement would make necessary separate oscillators for all of the points of interest, in all of the presently available *if* channels, and that any change from the several presently accepted standards would obsolete such equipment. It has been found possible to avoid this by providing an accurately adjustable and stable variable frequency oscillator which can be amplitude modulated with the frequencies of interest. The factor which has been found to be important in aligning a television *if* is that all of the frequency separations should be correct. The actual frequency for the picture carrier is not critical within 50 kc or so, but the separation of the sound from the picture and separation of various traps from the picture is without question extremely critical. If the aforementioned amplitude modulation is available with crystal control accuracy at 4.5 mc and 1.5 mc, all of these important spacings will be presented as side bands of the original oscillator with crystal accuracy. These two frequencies or multiples thereof will supply all of the markers necessary for both sound and adjacent picture trap alignment. Since the picture carrier to which they are related need never be touched during the alignment procedure and since the *vfo* which creates the picture carrier may readily be made continuously variable over a wide enough range to be sure that it will include the present and future intermediate frequencies, we have met the original requirement suggested. This particular setup has an apparent limitation when it comes to aligning stagger tuned *if*'s. This limitation, however, has been found to disappear when it is realized that the crystal modulator may be turned off and the *vfo* used to supply a marker at any odd frequency which may be encountered. Due to the fact that single frequency alignment of stagger tuned



An Indispensable  
**EMERGENCY**  
Tool for Every TV and  
Electronic Technician!

## QUIK-SHOT<sup>®</sup> SOLDERING IRON

• 250 Watts • Maintains Soldering Temperature for 6 to 8 Minutes • No Electricity • No Flame • No Blowtorch  
Pull the Trigger and the Iron Heats Itself  
In Less Than 10 Seconds!

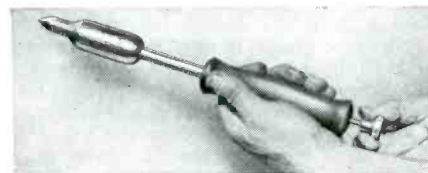

QUIK-SHOT is a "must" for every emergency when line power is not available nor convenient. Heat is generated internally through the QUIK-SHOT cartridge which is inserted into the iron. UNCONDITIONALLY GUARANTEED! Absolutely safe. Accepts 3/8", 3/4" and 1" tips.

Model QS 38 (3/4" Pyramid or Chisel Tip).....	\$7.50
Model QS 58 (1 1/2" Pyramid or Chisel Tip).....	\$7.50
Model QS 100 (1" Chisel Tip Only).....	\$8.25
All standard models complete with 4 QUIK-SHOT Cartridges and Pyramid Tip.	
QUIK-SHOT Cartridges (12 in carton).....	\$1.92
SEPARATE TIPS	
3/4" or 3/8" Pyramid or Chisel.....	\$2.25
1" Chisel Only.....	\$3.00

Ask your Jobber or write direct

**JOHN F. RIDER LABORATORIES, Inc.**

480 Canal Street • New York 13, N. Y.

*if*'s seldom yields exactly the curve desired, it is generally recommended that the overall response be viewed with the sweep generator after the spot frequency alignment has been completed. It should be noted that it is not necessary to waste time setting this spot frequency with great exactness, as the final results do not warrant the expenditure of time. As soon as the overall curve is put on the scope for final touch up, all of the previously mentioned frequencies are again the important ones to know, so no further adjustment of the *vfo* will be necessary to complete the alignment.

Since TV carrier frequencies are so high and since the range of vernier tuning of TV sets is generally limited, it is required that the high-frequency oscillator be accurately placed so that the tuning will approximately center when the picture and sound are where they belong. To meet this requirement in a practical way, crystal control of carrier frequency markers has been found necessary. This again obviates the necessity of accurately setting the variable frequency oscillator, since choosing of a channel marker is merely a matter of turning a switch. Since the overall



curve of a set from the antenna to the video detector is what actually controls the picture seen, it is a great help to have sound and trap markers available on any channel frequency. This might readily be accomplished by simply amplitude modulating the channel crystal marker in the same manner that the *vfo* was modulated at intermediate frequencies.<sup>4</sup>

<sup>4</sup>G. E. marker generator design has been based on the considerations analyzed in this section of the paper.

## Phono

(Continued from page 15)

when the ear of the reset arm is contacting the peak point of the reset cam. This is adjusted by bending the ear at the other end of the trip-plate from the reset arm.

A single tone arm is used in this changer, with about 1/8 ounce of pressure provided by the cartridge. It's possible to play twelve 10" or ten 12" 78 rpm records, or up to fourteen 33 1/3 and 45 rpm types on this player.

Three-speed portable record changers, which can be plugged into any radio or television speaker or used with a portable amplifier, have been developed, too.

The new model model<sup>1</sup>, produced by Webster-Chicago, utilizes as its basic operating unit a record-changer<sup>2</sup> which plays all three speeds and all three size records with one control, and also will play inside-out recordings without any adjustments. It has a velocity-trip for fast record change and minimum record wear, a balanced tone arm and an automatic stop when the last record has been played.

A recently developed 8-watt-push-pull amplifier<sup>3</sup> can be used with the changer. The amplifier and 10" pm speaker housed in a bass reflex cabinet, are contained in a carrying case.

In another 3-speed portable development, Newcomb Audio has produced a phono which features a lightweight crystal pickup, 6" x 9" dynamic speaker protected by a kickproof metal grill, and 5-watt amplifier using inverse feedback. A feature called *floating sound*, which is said to eliminate needle skipping, has been included.

<sup>1</sup>Webster-Chicago 100-641. <sup>2</sup>Webster-Chicago 100. <sup>3</sup>Webster-Chicago 166.

Newcomb 3-speed portable phono; type R-12.



Anyone  
Can build a  
HEATHKIT



Heathkit  
SIGNAL  
TRACER KIT  
\$19.50



Heathkit  
VACUUM TUBE  
VOLTMETER KIT  
\$24.50



Heathkit  
CONDENSER  
CHECKER KIT \$19.50

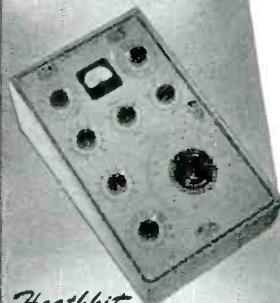

Heathkit  
IMPEDANCE  
BRIDGE KIT \$69.50

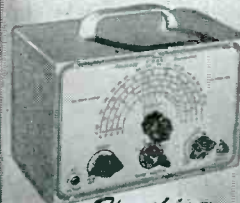

Heathkit  
R. F. SIGNAL  
GEN. KIT . .  
\$19.50

Heathkit  
HANDITESTER  
KIT . . . \$13.50

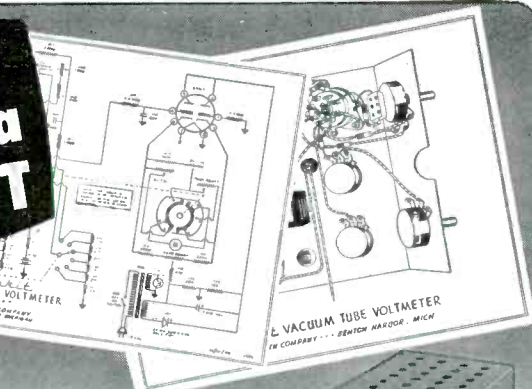

Heathkit  
TUBE CHECKER KIT  
\$29.50



Heathkit  
BATTERY  
ELIMINATOR KIT  
\$22.50



Heathkit  
AUDIO GEN.  
KIT . . . \$34.50



Heathkit  
ELECTRONIC  
SWITCH KIT  
\$34.50

Heathkits are beautiful factory engineered quality service instruments supplied unassembly. The builder not only saves the assembly labor cost but learns a great deal about the construction and features of the instrument. This knowledge aids materially in the use and maintenance of the equipment. Heathkits are ideal for and used by leading universities and schools throughout the United States. Each kit is complete with cabinet, 110V 60 cycle transformer (except Handitester), all tubes, coils assembled and calibrated, panel all ready printed, chassis all punched, formed and plated, every part supplied. Each kit is provided with detailed instruction manual for assembly and use. Heathkits provide the perfect solution to the problem of affording complete service equipment on a limited budget. The basic three instruments — an Oscilloscope, Vacuum Tube Voltmeter, and Signal Generator can be purchased in Heathkits for \$83.50, about the cost of a factory-built VTVM alone. Write for complete catalog.

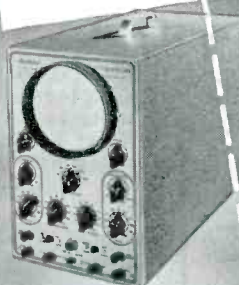

Heathkit 5"  
OSCILLOSCOPE  
KIT  
\$39.50



Heathkit  
TELEVISION  
GEN. KIT . . .  
\$39.50

**HEATH COMPANY**  
BENTON HARBOR 11,  
MICHIGAN

EXPORT DEPT., 13 E. 40th ST., NEW YORK 16, N.Y. . . . CABLE ARLAB-N.Y.

# NOW!

THE NEW RCP  
**Tube Tester**  
KIT  
Only \$25<sup>95</sup>



## MODEL 322 AK

Now you can get in KIT FORM the best professional test equipment made by RCP—precision equipment at the lowest prices ever. Each KIT contains simple step by step instructions.

### CHECK THESE FEATURES

- This tube tester has provisions for checking individual sections of multi-purpose tubes as well as miniature and subminiature receiving tubes.
- Convenient jack is provided for head-phone noise test to check noisy swinging, or high resistance internal tube connections.
- Neon lamp for rapid short and leakage tests between elements.
- Compact, sturdy construction.
- Operates on 100-130 volt, 50/60 cycle A.C. power supply.

Open-face in new hammertone grey finish steel cabinet with sloping panel. Size 5 1/4" x 12 3/16" x 8". Weight 11 lbs.

## AC-DC MULTITESTER



## MODEL 447BK ONLY \$12.75

NOW IN KIT FORM. these units are in a class with other makes of testers that sell for considerably more. A 3" square D'Arsonval meter is used, having an accuracy of 2%. Ring type shunts are employed.

### RANGES

DC Voltmeter: 0-5-50-250-500-2500 Volts at 1000 Ohm per Volt.  
AC Voltmeter: 0-10-100-500-1000 Volts.  
Output Voltmeter: 0-1-10-50-100-1000 MA.  
DC Milliammeter: 0-1-10-100-1000 MA.  
DC Ammeter: 0-1-10 Amperes.  
Ohmmeter: 0-10,000 Ohms—1 Megohm—10 Megohms Ext.

Decibel Meter: -8 to +55 decibels.  
Model 447BK—Open face instruments, supplied in hardwood case. Size 5" x 8 1/2" x 3". Weight 21 oz. Complete with batteries, ready to operate.

Send for Bulletin No. 7S

BUY IT FROM YOUR JOBBER

**RADIO CITY PRODUCTS CO., INC.**

152 West 25th St.  New York 1, N. Y.

# New Parts . . . Instruments . .

## HALLDORSON ISOLATION TRANSFORMER

A voltage-adjusting isolation transformer has been announced by the Halldorson Company, 4500 Ravenswood, Chicago.

The unit, model N-202, has provision for varying the voltage in approximately 1 1/2 volt steps by means of two switch knobs on the panel. If the line voltage at the input is the standard rated 117 volts, it can be varied through a range of from about 95 to 145 volts, and if the voltage drops to around 90, it can be varied from 75 to 115 volts. The rated capacity at 117 volt input is 500 watts. A voltmeter with an accuracy to 2 1/2% registers the output voltage.

Steel runners are said to facilitate movement over the bench, and provide a tilt to the instrument panel for easy reading.

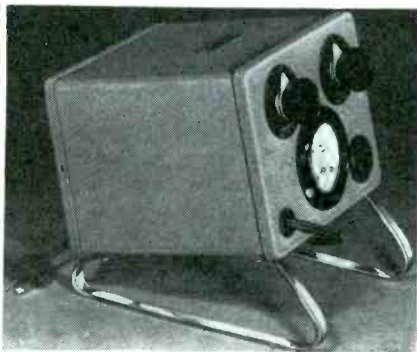

\* \* \*

## DUTCH BRAND PLASTIX TAPE

Plastix tape rolls, 1/2" wide x 150" long, have been introduced by Van Cleef Bros., Inc., 7800 Woodlawn Ave., Chicago 19, Ill.

Tape, Dutch Brand, is said to be super-thin, have 200% stretch and high dielectric resistance, and resist weather, water, oils, grease or corrosive chemicals.

\* \* \*

## STANCOR ISOLATION TRANSFORMER

An isolation testing transformer has been announced by Standard Transformer Corp., 3580 Elston Ave., Chicago 18, Ill. Unit is rated at 350 watts. May be used to correct a high or low line voltage. Three standard receptacles provide output voltages of 105, 115 and 125, with 117 volts, ac from the line.



## CLAROSTAT ATTACHABLE KNURLED SHAFT FOR CONTROLS

Finger-tip knurled and screwdriver-slot pick-a-shafts, type FKS-1/4", that snap on to any type AM or AT control, are now available from Clarostat Mfg. Co., Inc., Dover, N. H. This type shaft is said to be especially effective for those controls found at the rear of many TV sets and controlling such functions as horizontal linearity, horizontal and vertical size, horizontal and vertical position, and vertical hold. Since adjustments are rarely required, the knobs are usually omitted. The knurled and screwdriver-slot shaft is a short shaft, protruding only 1/4" beyond the control bushing.

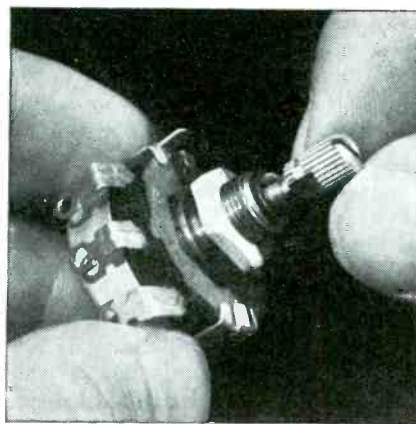

\* \* \*

## PRECISION APPARATUS INSTRUMENT PANEL MOUNT ASSEMBLY

A matched panel mounting combination, which includes the series E-200C-PM signal and marker generator, series 10-12-PM electronic tube master and battery tester, series E-400-PM sweep signal generator, mounted in standard matching panels, has been announced by Precision Apparatus Company, Inc., 92-27 Horace Harding Blvd., Elmhurst, L. I., N. Y. Also included in this set are a new EV-20 zero-center *vism* and multi-range test set, and the series ES-500, 5" scope.

The *vism* and the 'scope are portable.

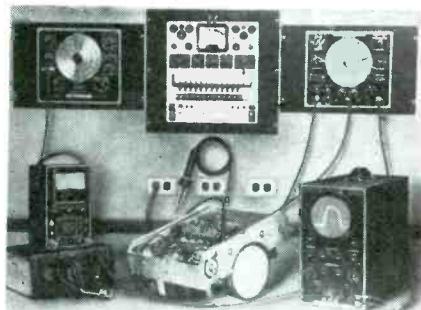

\* \* \*

## G.E. MODIFIED FIVE-INCH SCOPE

A modified five-inch 'scope, the ST-2A, which provides for direct connection to the deflection plates by means of binding posts and switches at the rear, has been announced by G. E. This feature is said to facilitate modulation measurement.

**HANDY NEW SELENIUM  
RECTIFIER BULLETIN READY**

**FREE!**

*... Makes Every Serviceman's  
Life Easier!*

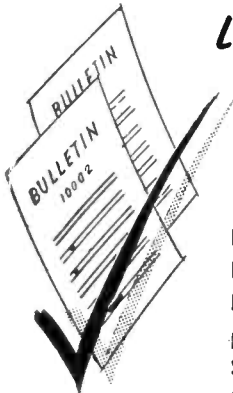

**SELENIUM RECTIFIERS**

It's SELETRON's Service Bulletin No. 10002 . . . Charts SELETRON Rectifiers which may be used as replacements in Radio and Television Sets of various manufacturers . . . Lists each manufacturer's Set Number, his Rectifier Number, and SELETRON's corresponding model!

Write for your copy of this valuable time-saving bulletin today—It's free!

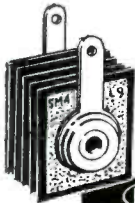

**RR SELETRON DIVISION RP**  
**RADIO RECEPTOR COMPANY, INC.**

Since 1922 in Radio and Electronics  
Sales Department: 251 West 19th St., New York 11, N. Y.  
Factory: 84 North 9th St., Brooklyn 11, N. Y.

**WHEN YOU CHANGE  
YOUR ADDRESS**

Be sure to notify the Subscription Department of **SERVICE** at 52 Vanderbilt Avenue, New York 17, N. Y., giving the old as well as the new address, and do this at least four weeks in advance. The Post Office Department does not forward magazines unless you pay additional postage, and we cannot duplicate copies mailed to the old address. We ask your cooperation.

**SERVICE** has an ABC NET PAID circulation in excess of 20,000.

Among radio service trade journals, it ranks **FIRST** in subscription renewal percentage — **FIRST** in total number of pages — **FIRST** in volume of advertising — **FIRST** in number of advertisers —

Reserve space now for the August NEDA Convention Issue and the Sept. Fall Buying Number.

**WALSCO ANNOUNCES**

**AMAZING NEW**

**NEW**

**SIGNAL KING ANTENNA**

FINALLY, the one antenna that does more to guarantee outstanding reception, trouble-free performance in even the fringe areas. The WALSCO Signal King, with its amazing new patented design, assures longer, dependable service under the most adverse weather conditions.

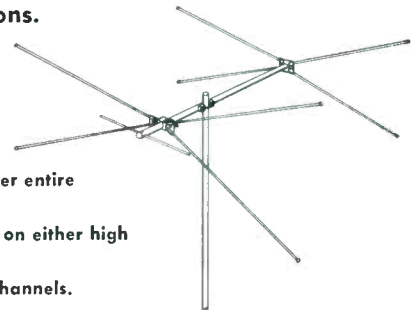

- Broad response over entire TV spectrum.
- No weak channels on either high or low band.
- Extra gain on all channels.
- Marine type high tensile strength aluminum alloy used throughout on elements, cross-arms and masts.
- Elements are reinforced with metal insert and are sealed on outer end.
- Full 1 inch O.D. cross-arm.
- U-bolt assembly fits mast from 3/4" to 1 1/2" O.D. Bracket made of serrated steel that bites into the mast. All cadmium plated.

➤ **WRITE FOR FREE ILLUSTRATED CATALOG 94-D**

**WALSCO**

*Quality Sells  
WALSCO Antennas*

WALTER L. SCHOTT CO. Beverly Hills, Calif. • Chicago 6, Ill.



Make Your  
Service Calls  
MORE PROFITABLE  
Specify

**Jensen NEEDLES**  
FOR ALL REPLACEMENTS

A Size and Shape to fit any Record Player

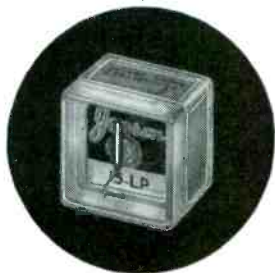

Jensen Needles come to you individually packed in a dust-proof container.

It's easy and profitable to recommend a new Jensen Needle when making a service call. What's more, it's still easier to order any needle required from your jobber by number. He can supply you from stock at once. A new needle assures a satisfied customer.



Free Replacement Needle Wall Chart

With this Chart, a quick glance gives you the number of the needle you need. Send for yours today.

**Jensen**  
INDUSTRIES, INC.

331 South Wood Street, Chicago 12, Illinois

JENSEN — THE OLDEST NAME IN SOUND ENGINEERING

## Ser-Cuits

(Continued from page 31)

stage through a 4.7-mmfd capacitor,  $C_{204}$ .

The first sound *if* amplifier is a high-gain stage operating at 4.5-mc. Impedance coupling is used to transfer the output signal to the grid of the 6BH6 second sound *if* amplifier.

In addition to driving a ratio detector, the second sound *if* amplifier stage serves as a limiter. It is operated with low plate and screen voltages so that the plate current cutoff and plate current saturation points are easily attained. A weak signal will not drive the grid hard enough to reach plate current cutoff or saturation and the signal will be amplified in the output. However, a strong signal will swing the grid beyond each extreme and the peaks of the input signal will be lost in the output. This limiting action on strong signals prevents the AM content of the output from reaching an amplitude that cannot be rejected by the ratio detector. In this manner, *sync buzz* is attenuated below an objectionable level.

### Sound Systems

The sound system employed in the Westinghouse V-2152-01 chassis, models H-603C12 and H-608C12, is also quite novel. In this audio system, when the selector switch is in the television position, power is removed from the AM/FM radio tuner section. This prevents the introduction of radio signals into the 4.5-mc *if* channel which serves as an *if* amplifier for FM reception as well as a sound *if* amplifier for TV. The 4.5-mc TV sound signal, which is developed in the video detector and appears at the video test jack, is applied to the grid of a 6BJ6 first sound *if* amplifier through  $C_{208}$ , 4.7 mmfd. The secondary of the 455-kc first *if* transformer ( $T_{204}$ ) presents a low impedance at 4.5-mc due to the distributed capacitance of its winding and its associated resonating capacitor. Therefore, the 4.5-mc signal is effectively applied across the tuned secondary of the 4.5-first *if* transformer. The same conditions exist in the plate circuit of the first sound *if* amplifier tube, where the amplified signal appears across a tuned primary.

The voltage developed across the transformer secondary is applied to the grid of the 6BH6 second sound *if*. This tube is operated with low plate and screen voltages so that the plate current cutoff and saturation points are easily reached. A weak signal will not drive the grid hard enough to reach plate current cutoff or saturation, and the signal will be amplified

Fig. 5. The sync system circuitry of Westinghouse V-2152-61 chassis.

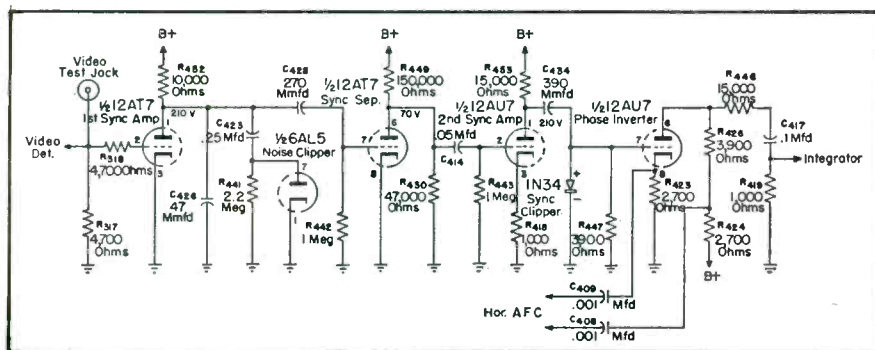

in the output. However, a strong signal will swing the grid beyond each extreme, and the peaks of the input signal will be lost in the output. In this manner, the tube functions as an amplifier for weak signals and a limiter for strong signals. The limiting action prevents the AM content of the output from reaching an amplitude that cannot be rejected by the ratio detector.

The output of the second sound *if* amplifier is applied to the ratio detector through T<sub>203</sub>. The audio voltage that is recovered in the ratio detector is applied through the selector switch to the volume control. From here the audio voltage is applied to the grid of the 6AV6 first audio amplifier, where it is amplified and passed on to the audio output connector on the television chassis.

When the selector switch is in the FM position, power is removed from the TV video *if* strip. This prevents the introduction of TV sound signals into the 4.5-mc *if* channel. The 4.5-mc output of the FM mixer is applied to the primary of T<sub>201</sub>, and from then on the FM *if* signal is treated in the same manner as the TV sound *if* signal.

#### Keyed AGC

The keyed *agc* circuit in the Westinghouse chassis (H-600T16 (with V-2150-61A and V-2150-61B chassis), H-603C12, H-605T12, H-606K12, H-607K12, H-608C12, and H-609T10) illustrated in Fig. 6, is quite unique in its design and operation.

The output of the first sync amplifier is coupled to the control grid of a 6BH6 *agc* keying tube, through a 4700-ohm resistor, R<sub>339</sub>. This places a positive potential of approximately 70 volts on the grid of the 6BH6. To counteract the positive voltage on the grid, a positive potential of approximately 95 volts is applied to the cathode of the 6BH6, through a voltage divider composed of 2200-ohm and 10,000-ohm resistors, R<sub>341</sub> and R<sub>340</sub>, thus making the grid negative with respect to the cathode.

There is no *dc* plate voltage applied to the plate of the 6BH6. Instead, a portion of the horizontal output voltage is applied to the plate through the capacity that exists between the wires in a length of 150-ohm twin lead. In this manner, a 15,750 *cps* pulse voltage is applied to the plate of the 6BH6.

The signal applied to the 6BH6 control grid meets three requirements: the sync pulses extend in a positive direction, its amplitude varies proportionately with the strength of the received signal, and the absolute peak level of the sync pulses is independent of variations in the *dc* component of the composite signal.

# The little lamp that knows how to stand the high notes

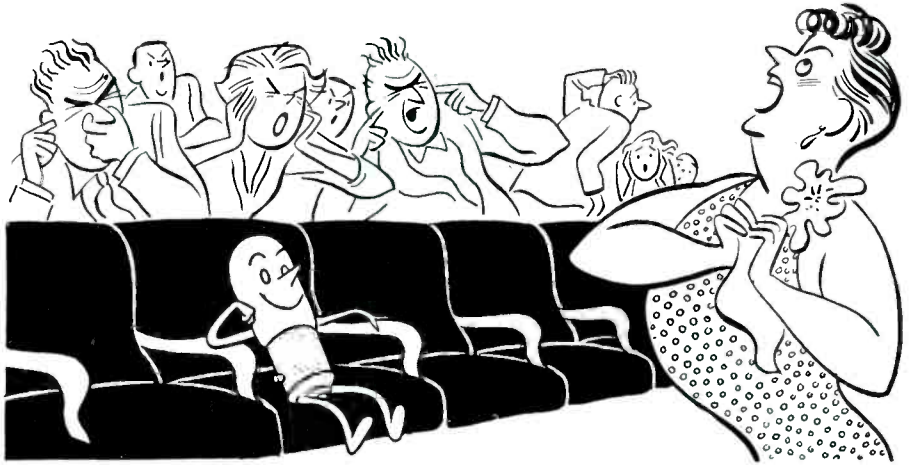

MANY dial lamps can't take a soprano's high "C". The vibration caused by such high notes creates a whipping action in old-style lamps which is sufficient to tear the tiny wires apart.

But General Electric dial lamps are specifically designed to withstand high sound frequencies. Filament supports are longer, with the

bead closer to the coil. Effects of vibration are greatly reduced. As a result, G-E dial lamps give longer life, assure customer satisfaction on lamp replacement jobs.

For information on prices and types of G-E miniature lamps, call your nearby G-E Lamp office. Or write to The General Electric Company, Div. 166-S7, Nela Park, Cleveland 12, Ohio.

1. Dependable, trouble-free performance.
2. High level of maintained light output.
3. Low current consumption.
4. Long life.
5. Profitable to handle.
6. Greater dealer acceptance.



## GENERAL ELECTRIC

Fig. 6. Keyed *agc* circuit used in Westinghouse chassis.

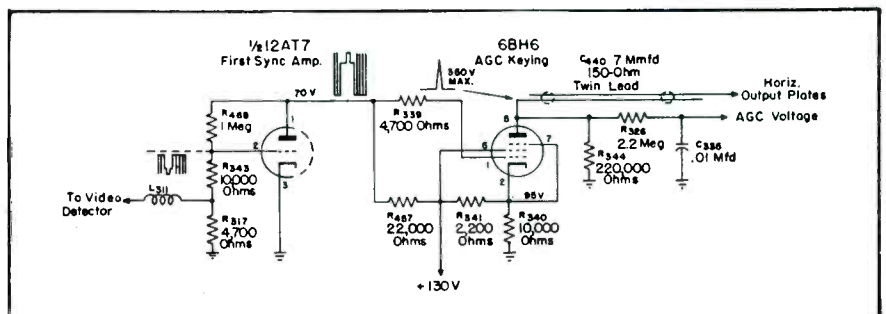

# Hi-Q

## Ceramic Capacitors

● For the best in ceramic capacitors, it's the well-known Hi-Q line now available through your Aerovox jobber. You can buy one or more units of any kind at any time. Available in several types—disc, tubular, stand-off, feed-thru, high-voltage, and zero temperature coefficient.

Hi-Q components are better four ways: (1) Precision. (2) Uniformity. (3) Reliability. (4) Miniaturization. Widely used in

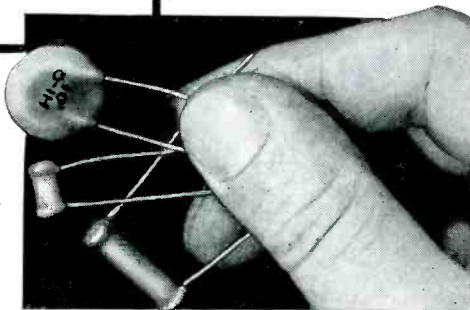

today's TV receivers.

### See Your Jobber . . .

He now stocks those Hi-Q ceramic capacitors for your convenience. Ask your local Aerovox distributor for latest catalog listing these and other new capacitor types.



CAPACITORS • VIBRATORS • TEST INSTRUMENTS

*For Radio-Electronic and Industrial Applications*

AEROVOX CORPORATION, NEW BEDFORD, MASS., U. S. A. • Sales Offices in All Principal Cities  
Export: 41 E. 42nd St., New York 17, N. Y. • Cable: AEROCAP, N. Y. • In Canada: AERVOX CANADA LTD., Hamilton, Ont.

# 8 Ways Better Polyken®

## No. 163 ELECTRICAL TAPE

First improvement in 70 years over sticky, old-fashioned friction tape . . . and costs less than most! Eight outstanding advantages include quicker, firmer "stick," greater dielectric strength, less bulk, no fraying, easier unwinding. And it's much cleaner. Doesn't pick up dirt or soil hands. See your dealer today!

3 Convenient Packs AVAILABLE NOW from Your Electrical Dealer



# Polyken®

INDUSTRIAL TAPE

DEPARTMENT OF

**BAUER & BLACK**

DIVISION OF THE KENDALL COMPANY  
222 W. ADAMS ST., CHICAGO 6

## Custom Cabinets

(Continued from page 22)

the strips which support the bottom on all four sides. The cabinet thus will be found to roll approximately 1/4" above the floor.

The motor board was placed three inches below the top edges of the cabinet to allow enough room for the arm and turn table to operate with the top in closed position.

The top of this cabinet was also constructed of 3/4" plywood, this thickness being necessary to prevent warping. Edges with an overhang of about 1/4" on sides and front were provided. A hinged back was used and the left side held in raised position by a chromed brass elbow.

A turntable with a 12" diameter and speeds of 78 and 33 1/3 was selected. Enough clearance was left, by proper placement of the turntable, so that 16" transcriptions could be played.

Partitions were made from Masonite, about 1/8" in thickness, and held in place by very small thin nails driven from the bottom and from shelf above. The shelf had to be previously drilled with small holes to enable the body of the nails to slip through. The nails could then be pushed through the holes and into the partitions, the nail heads acting as the required retaining force. Five sections, thus created, can be used for the storage of records, transcriptions, cleaning rags, etc.

### Preparing for Finishing

Cabinet finishing was the last item in our construction program. The finishing nail heads were the first to receive our attention. Using a six-penny nail with the point filed down slightly, all finishing nail heads were driven in the cabinets below the surface of the wood about 1/8". About six tablespoons of wood putty were prepared and all holes left by the foregoing operation filled in. All cracks that may have been left by improper fitting of sections were also filled in. After a drying period of twenty-four hours, sanding followed, using No. 1 sandpaper, finishing being completed with fine sandpaper. The grain of the wood used was found to protrude and therefore to be sure that it would be cut by the sandpaper, and at the same time avoid cutting of the soft wood between the grains, a small hand board was used (3" w x 5" l x 2" h). The sandpaper has to be wrapped around this board carefully so that the 3 x 5" level side of the board can be stroked against the wood.

All surfaces that have been sanded must be wiped with a damp cloth to remove the fine particles of wood.

[Additional Finishing Data, Next Month]

## Auto Radio

(Continued from page 17)

control head, which is mounted under the dash. Adapters for these chassis are not recommended. It's been found better to drop out the units and use them for tests. Quite often, auxiliary repairs, such as cleaning of the volume control might be necessary, a service simplified by the entire unit removal.

It hasn't been found necessary to rig up an elaborate antenna for air-testing car sets. In our setup a four-foot piece of flexible wire is used, with an antenna plug of the *pin* type on one end, and *bayonet* type on the other. This has been found to permit connection of either type of antenna socket. There are a few sets such as the old Wells-Gardners, Buicks, Airlines, etc., which require special antenna plugs. These may be tested with a test-lead installed in the socket. The adoption of this approach was predicated on the premise that the receiver will certainly have to exhibit plenty of sensitivity if it is to work properly in the car, and thus, if it will work well on just a test lead, it should provide super results in the car.

One other handy gadget around a shop is the tuning tool, or actually an assortment of *tuning-tools*. For those chassis using flexible shafts to control tuning and the control volume, the controls are turned by *splines* of various shapes and sizes. Some are square, others require a tongue, or a slot, and some of the older sets used a small pinion gear on the end of the control shafts. A full set of the *splines* needed can be constructed quickly by cutting up some old fiber neutralizing tools to the proper shape and size. For precision appearances and simplified use, too, they can be cut to three-inch length and knobs placed on the other end.

Extra leads and gimmicks are often helpful. The bench should have at least four short test leads, about 12" or 14" long, with a small *alligator* clip on each end. There should also be two test-leads using  $\frac{1}{2}$ " shielding braid, and small battery-clips. These leads can be used to connect the chassis and speaker, etc., when all the parts must be grounded (together) to work. The double-clip leads are quite useful when making temporary connections, extending speaker leads, shorting out oscillators for tuning *if's*, etc. The leads should be hung up at the *car-radio* end of the bench, where they can be reached in a hurry. We use screw-in hooks, about  $2\frac{1}{2}$ " long, which were originally supposed to hold up curtain rods. Enough hooks should be

## YOUR NEW STANCOR CATALOGS

*are ready!*

### CATALOG OF TRANSFORMERS FOR RADIO, SOUND AND OTHER ELECTRONIC USES.

Here's a "must" for every user of transformers—serviceman, ham, experimenter, engineer. Detailed listings of more than 400 Stancor part numbers. Includes accurate electrical and physical specs, dimensions, prices, illustrations. Complete and up-to-date. Handy charts and easy-to-use indexes help to make this new Stancor catalog the book you'll want to find the part you need.



### TELEVISION CATALOG AND REPLACEMENT GUIDE.

The sixth edition of the popular Stancor TV Replacement Guide (50,000 copies printed to date). Now combined in a big, 30-page book with a complete catalog of all Stancor TV components. Original part numbers, with Stancor replacements, are listed for more than 600 TV receiver and chassis models made by 64 manufacturers. Every Stancor component recommended in the guide is listed in the catalog section with complete specs, dimensions and prices. Gives you one convenient source of information. Makes your job quicker and easier.



And remember, when you buy a Stancor transformer, you get a quality product used by the country's biggest set makers as original equipment. Stancor transformers have to be good! See your Stancor distributor today for your free copies of these books. If he is out of stock, we'll be glad to send you copies. Write Standard Transformer Corporation, 3588 Elston Avenue, Chicago 18, Illinois.



*Most Complete Line in the Industry*

installed so that each type of lead may have a hook to itself. This will speed up the selection of the proper lead.

[To Be Continued]

Fig. 4. Wiring layout for bench-test antenna lead.

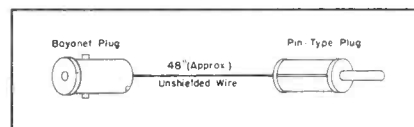
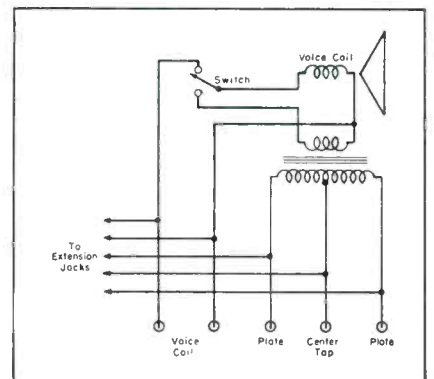
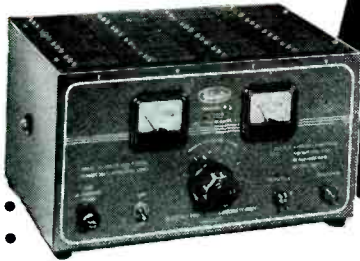

Fig. 3. Test speaker arrangement.



Patent Pending



# new! LOW COST DC SOURCE ELECTRO "BJ" JUNIOR

SUPPLIES 1 to 12.5 AMPS. 6 VOLTS CONTINUOUS DUTY  
3 to 9 Volts at Other Ratings

## Demonstrate and Test from AC Lines . . . Radios . Relays 'Phone Circuits . Instruments . Other Low Voltage Devices

New Model "BJ" Junior Filtered Power Supply utilizes same exclusive application of selenium rectifiers used in the famous Model "B." This application, using conduction cooling, doubles the rectifier power rating, dissipates over 3 times the heat and provides lower cost per ampere output over other types. Supplies ample power, with a peak instantaneous current rating of 25 amperes (from standard 50/60 cycle 115 volt source). Heavy duty components withstand high over-loads. AC ripple less than 0.4 volts at 6 volts DC 8 amperes.

Same top quality as famous Model "B"

### EXCLUSIVE FEATURES

Voltmeter 0-10 volts 5% accuracy.	8 Heavy-duty power tap adjustments.
Ammeter 0-20 amperes 5% accuracy.	2000 Mfd. filter condenser.
Heavy-duty selenium rectifiers, transformer and choke.	Readily accessible fuse.
	Steel cabinet, blue hammerloid finish.

NET PRICE ONLY \$32.40

Send for New Folder on Complete Line of Battery Eliminators



Pioneer Manufacturers

of Battery Eliminators

ELECTRO PRODUCTS LABORATORIES, INC. 4501-BJ Ravenswood Ave., Chicago 40, Ill.

## PEAK FOR PERFORMANCE *on your channels* with the new **RMS BOOSTER SP-5**

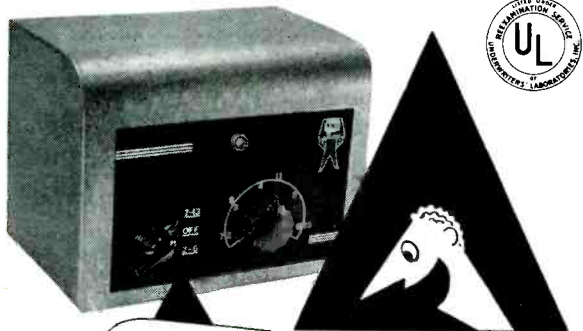

Here's the only Booster you can peak by simply tuning with an ordinary screw driver — from the outside of the cabinet!

### Has an edge in engineering!

Wide band width  
Lowest insertion loss  
Greatest signal to noise ratio.

### Has an edge in styling and simplicity!

All metal cabinet in mahogany ripple finish — blends with all furniture.  
Gear driven for velvet-smooth, 1-knob tuning.

Write for fuller details or See Your Jobber

RADIO MERCHANDISE SALES INC. • NEW YORK 59



### SOMMERS NOW SYLVANIA TUBE GSM

George R. Sommers has been appointed general sales manager of the Sylvania radio tube and television picture tube divisions. Sommers succeeds C. W. Shaw who has been made assistant to the vice president in charge of sales.

Sommers joined Sylvania in '40, becoming manager of the Capitol Division in Washington, D. C., three years later. There he inaugurated the decentralized regional sales program now in effect in all of the company's field sales offices. Later he became Pacific Coast sales director and a year ago was moved to headquarters office in New York to assist in the direction of radio and television tube sales.

\* \* \*

### R. F. DOYLE RESIGNS AS ALLIANCE PRESIDENT

R. F. Doyle has resigned as president of the Alliance Manufacturing Company. Doyle, who has been with the company since its inception and was named president in '46, previously served as treasurer and general manager. For the present, he will continue as a stockholder and director of the firm. Future business plans will be announced at a later date.

\* \* \*

### R. A. ELLIOT NOW STANDARD COIL PRODUCTS JOBBER SALES MANAGER

Robert A. Elliot has been appointed to fill the newly created post of jobber sales manager by Standard Coil Products Co., Inc., Chicago, and Bangor, Michigan. Elliot will have complete charge of jobber sales, advertising and merchandising for both the domestic and foreign markets.

Elliot was formerly with RCA.

\* \* \*

### RAULAND NAMES BEN FARMER SM

Ben Farmer has been appointed sales manager of The Rauland Corp., 4245 North Knox Ave., Chicago 41, Ill.

\* \* \*

### AT SHURE'S SILVER ANNIVERSARY



Jack Berman, vice president, and S. N. Shure, general manager of Shure Brothers, Inc., at the recent twenty-fifth year celebration, during which 400 employees attended a luncheon-afternoon party.



**SNYDER AUTO ANTENNA DISPLAY**

A counter display featuring the type TC-8 top cowl auto antenna, has been announced by Snyder Mfg. Co., 22nd and Ontario Streets, Philadelphia 40, Pa.

Antenna displayed is said to be self-aligning and eliminates interior car mechanics through a drill, insert and tighten operation.

Inquiries on display should be directed to Richard Morris.

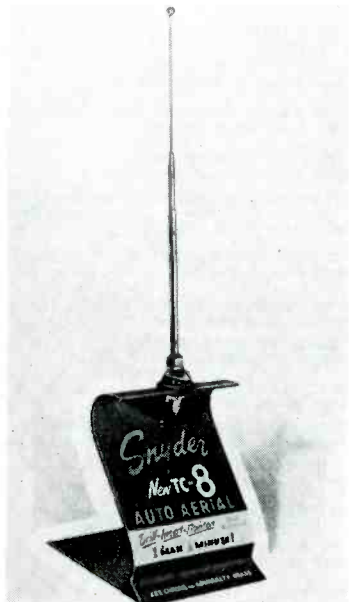

**NATIONAL UNION TV PICTURE-TUBE REFERENCE GUIDE**

A TV picture tube reference guide, which lists 12 electrostatic-deflection and 73 electromagnetic-deflection type tubes, has been published by National Union Radio Corp., Orange, N. J. Guide includes all picture tube types used to date in post-war television receivers, regardless of originating or producing manufacturers.

In addition to giving the usual rating and characteristics data, guide provides information necessary to show differences between various tube types which on the basis of less comprehensive data might appear to be completely interchangeable. Bulb outline drawings with dimensions as well as basing diagrams are included. Other significant data relative to anode terminal type and location, dimensions of outer conductive coating, ion trap field, focus coil, and length of neck on electromagnetic types are also included.

Guide is available free upon request from National Union distributors.

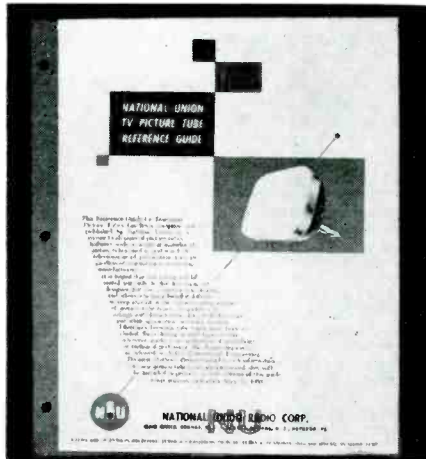

**YOU ASKED FOR IT...**

*here it is!*

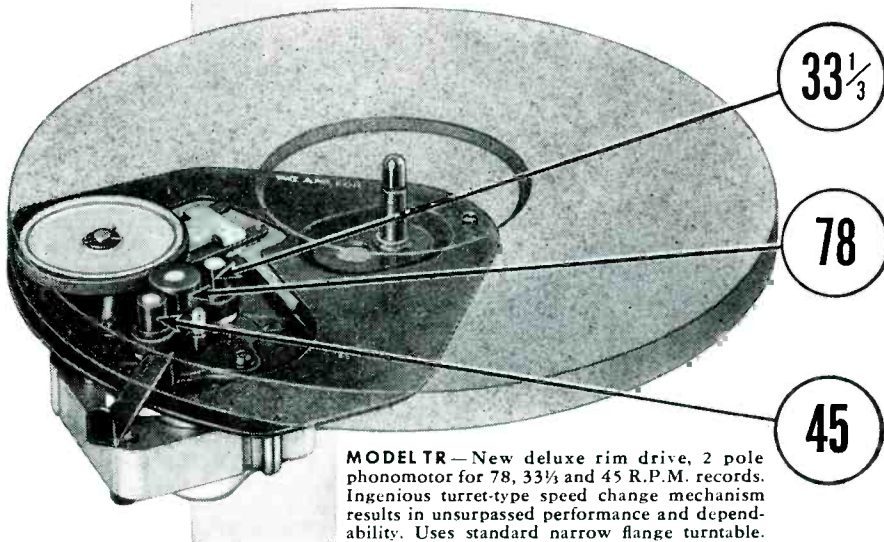

**General Industries' *New* Deluxe 3-SPEED PHONOMOTOR**

Now . . . in answer to the tremendous demand for a manual version of the popular GI turret model 3-speed record changer motor, General Industries presents the new Model TR. Truly the last word in compact 3-speed phonomotors, the Model TR is designed for use in the finest phonographs and radio-combinations.

In addition to the Model TR, General Industries will continue to offer the ever-popular Model TS, 3-speed neoprene belt-driven model for both manual and record-changer use.

Today, as always, General Industries leads the field with the *only* complete line of phonomotors for every record-playing requirement. Write, wire or phone for the latest General Industries catalog containing specifications and description of the full GI *Smooth Power* lineup.



**SAMS MOVES TO NEW PLANT**

The analytical engineering labs and technical publishing facilities of Howard W. Sams, Inc., are now housed in a new 30,000 square-foot air-conditioned building at 2201 East 46th St., Indianapolis.

\* \* \*

**FIDELITY TUBE CORP. ORGANIZED**

The Fidelity Tube Corp., with over 75,000 square feet of production space at 900 Passaic Avenue, East Newark, N. J., has been organized to manufacture larger size TV picture tubes, of both the metal and glass types.

Benjamin Ozaroff is president of the new company, and A. Green, vice president, in charge of engineering. Green was formerly associated with Thomas Electronics, Inc., in a similar post.

**HYTRON APPOINTMENT**

Richard A. Malmberg has been appointed renewal sales manager of the Hytron Radio & Electronics Corp. In this capacity Malmberg will be in charge of Hytron's replacement tube sales.

R. A. Malmberg





**FREE!**  
**MERIT TV**  
**"REPL" GUIDE**

MAY 1950 ISSUE  
 63 MANUFACTURERS.  
 575 MODELS. MOST COMPLETE,  
 UP-TO-DATE LISTING

Get this easy-to-use, time-saving guide to exact replacements for all popular television receivers. Simplifies servicing, cuts repair-bench time. Write us today for your free copy.

**USE MERIT TV!**  
 ONE SOURCE FOR  
 TV Tube-Units—Components:  
 Powers, Blocking Oscillators,  
 Vertical Outputs, Focus Coils,  
 Deflection Yokes, Flybacks.

WATCH FOR  
 Merit's future issues  
 of the TV "Repl"  
 Guide

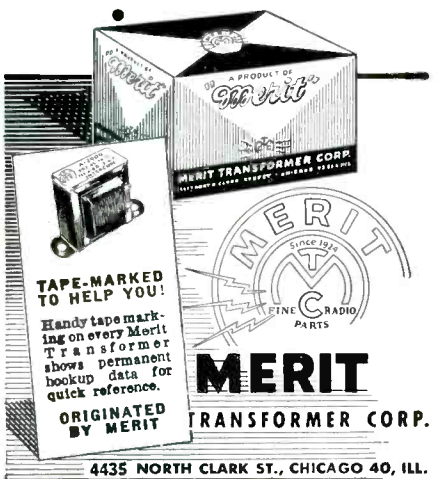

**JOTS AND FLASHES**

TV CONTINUES to streak ahead in servicing activity, according to not only the records of countless shops throughout the country, but official statements by representatives of leading manufacturers. Citing the mounting importance of TV Service, Charles Odorizzi, vice president in charge of service at RCA, declared during a recent talk in Chicago before the National Appliance and Radio Dealers Association that . . . "The real problem of the industry this fall will not be who shall render the service, but rather will there be a sufficient number of adequately trained technicians to install and service all the receivers which manufacturers have planned to produce and sell. . . . Here is a challenge. . . . The industry forecasts that more than three-and-a-half million receivers will be sold during the balance of the year. This means that . . . it will be necessary to install and service, during the balance of the year, almost as many receivers as were sold during the entire four-year period of '46, '47, '48 and '49. . . . While these figures may sound a little fantastic, they certainly emphasize the size of the job ahead. . . . It is not too early to begin planning now. . . . Next November will be too late." . . . The importance of visual patterns in TV service work were stressed recently by Clarence L. Simpson, field engineer of Sylvania Electric, in a report on his transcontinental lecture series. Simpson declared that . . . "Once a Service Man has acquainted himself with particular patterns . . . he can spot quite a few troubles almost at a glance." . . . The NEDA National Convention and Exhibition, which will begin on August 28th and run to August 31, will be held at the Public Auditorium in Cleveland, Ohio. . . . A line of cabinets for television conversions are now being produced by River Edge Industries, River Edge, New Jersey. . . . The second Audio Fair, sponsored by the Audio Engineering Society, will be held at the Hotel New Yorker in New York City, October 26-28. . . . The annual meeting of the show board of directors of the Radio Parts and Electronic Equipment Shows, Inc., will be held at the New Greenbrier Hotel, White Sulphur Springs, West Virginia, September 6 to 8. . . . Nicholas J. Giordano is now a field service engineer for Air King Products, Inc. . . . Federated Purchaser Inc., recently opened a branch in Newark at 114 Hudson St., at Central Avenue. Phil Barr has been named manager of the new store. . . . The 24th annual AAMA exposition, which will be held at the Grand Central Palace, February 5 to 8, 1951, is expected to feature an exhibition of television sets and parts. . . . Millard S. May is now sales manager of Speer Carbon Company, St. Marys, Pa. . . . A. S. Johnson has been appointed general manager of the National Carbon Division of Union Carbide and Carbon Corporation. . . . The Perma-Power Company, 4721 North Damen Avenue, Chicago 25, has been formed to manufacture selenium rectifier type battery eliminators. Nathan Goldman, former president of General Transformer Corp., is the owner of the new company. . . . Terminal Radio Corp., 85 Cortlandt St., New York 7, are now distributors for the Ampex Electric Corp., San Bruno, California. . . . Louis Silver has been named executive vice president and general manager of Majestic Radio and Television, Inc., Brooklyn, New York.

**ADVERTISERS IN THIS ISSUE**

**SERVICE INDEX—JULY, 1950**

AEROVOX CORPORATION	44
Agency: Austin C. Lescarbours & Staff	
AMERICAN ELECTRICAL HEATER CO.	34
Agency: Dudgeon, Taylor & Bruske, Inc.	
ANACONDA WIRE & CABLE CO.	25
Agency: Kenyon & Eckhardt, Inc.	
ANCHOR RADIO CORP.	10
Agency: Symonds, MacKenzie & Co.	
THE ASTATIC CORPORATION	35
Agency: Wearstler Advertising, Inc.	
BAUER & BLACK DIVISION, THE KENDALL CO.	44
Agency: Leo Burnett Company, Inc.	
CONTINENTAL CARBON, INC.	34
Agency: William Glazer Advertising Agency	
CORNELL-DUBILIER ELECTRIC CORPORATION	Inside Front Cover
Agency: Reiss Advertising	
DRAKE ELECTRIC WORKS, INC.	36
Agency: William Hoffman & Association	
ELECTRO PRODUCTS LABORATORIES, INC.	46
Agency: Gotsch and DeVille Advertising	
ERIE RESISTOR CORPORATION	30
Agency: W. S. Hill Co.	
GENERAL ELECTRIC CO.	19
Agency: Maxon, Inc.	
GENERAL ELECTRIC LAMP DEPARTMENT	43
Agency: Batten, Barton, Durstine & Osborn, Inc.	
THE GENERAL INDUSTRIES CO.	47
Agency: Meldrum & FewsSmith, Inc.	
HEATH COMPANY	39
Agency: G. Dean Arend, Advertising	
HYTRON RADIO & ELECTRONICS CORP.	23
Agency: Bennett, Walther & Menadier, Inc.	
JENSEN INDUSTRIES, INC.	42
Agency: Frank C. Nahser, Inc.	
KESTER SOLDER CO.	4
Agency: Frank C. Nahser, Inc.	
LITTELFUSE INC.	9
Agency: Burton Browne, Advertising	
P. R. MALLORY & CO., INC.	Inside Back Cover
Agency: The Altkin-Kynett Co.	
MERIT COIL & TRANSFORMER CORP.	48
Agency: Symonds, MacKenzie & Co.	
NEWCOMB AUDIO PRODUCTS CO.	30
Agency: Stuart Stevens Advertising	
C. M. PENNEY CO.	32
Agency: Belden & Hickox	
PERMOFLUX CORPORATION	31
Agency: Symonds, MacKenzie & Co.	
PRECISION APPARATUS CO., INC.	6
Agency: Shappe-Wilkes Inc.	
THE RADIART CORPORATION	27
Agency: Stern and Warren	
RADIO CITY PRODUCTS CO.	40
Agency: Jaman Advertising, Inc.	
RADIO CORPORATION OF AMERICA	8, Back Cover
Agency: J. Walter Thompson Co.	
THE RADION CORPORATION	5
Agency: W. W. Garrison & Co.	
RADIO MERCHANDISE SALES, INC.	46
Agency: Reid Associates	
RADIO RECEPTOR CO.	41
Agency: Walter J. Zimmerman & Associates	
REGENCY DIV. I.D.E.A. INC.	29
Agency: Burton Browne, Advertising	
JOHN F. RIDER PUBLISHER, INC.	38
Agency: Shappe-Wilkes, Inc.	
HOWARD W. SAMS & COMPANY, INC.	30
Agency: George Brodsky, Advertising	
WALTER L. SCHOTT CO.	41
Agency: Tilds & Cantz	
SMITH ELECTRIC MFG. CO.	36
SNYDER MFG. CO.	21
Agency: Brooks and London	
SPRAGUE PRODUCTS CO.	38
Agency: The Harry P. Bridge Co.	
STANDARD TRANSFORMER CORP.	45
Agency: Burnet-Kuhn Adv. Co.	
TEL-A-RAY ENTERPRISES, INC.	7
Agency: Keller Crescent Co.	
TELREX, INC.	37
Agency: George Homer Martin, Associates	
TRIPLETT ELECTRICAL INSTRUMENT CO.	3
Agency: Western Adv. Agency, Inc.	
WEBSTER ELECTRIC	36
Agency: Hamilton Adv. Agency, Inc.	

**For Long,  
Trouble-Free  
Service**



## **...You Can Rely On MALLORY VIBRATORS!**

You get long and trouble-free service from Mallory Vibrators because of a three-way combination that can't be beat. The patented tuned mechanism assures slow contact impact, for minimum wear—high contact pressure, for low resistance—fast contact break, for reduced arcing and pitting. That's a Mallory exclusive!

And that's another good reason why more Mallory Vibrators are used in original equipment than all other makes combined.

When you use Mallory Vibrators for replacement, you are sure of long life, dependable starting and high output efficiency. See your Mallory distributor now!

*More Mallory Vibrators Are Used In Original Equipment Than All Other Makes Combined.*



P. R. MALLORY & CO. Inc.  
**MALLORY**

CAPACITORS • CONTROLS • VIBRATORS • SWITCHES • RESISTORS  
• RECTIFIERS • VIBRAPACK\* POWER SUPPLIES • FILTERS  
\*Reg. U.S. Pat. Off.

**APPROVED PRECISION PRODUCTS**

**P. R. MALLORY & CO., Inc., INDIANAPOLIS 6, INDIANA**

# NOW... see how you score on the

## RCA BATTERY

# "Get the Facts" Quiz



### *The battery for the Radio Trade!*

Try yourself out on these leading questions about RCA Radio Batteries. You'll profit by the answers whether you get a

high score or not...because these are the facts about RCA Radio Batteries every dealer and serviceman should know.

**Official Questions and Answers from the  
\$10,000 RCA Battery "Get the Facts" Contest (Ended July 10, 1950)**

1. Of all the radio battery brands sold—which brand is recognized as "The Battery for the Radio Trade"?

(Answer) RCA.

2. Why is RCA recognized as "The Battery for the Radio Trade"?

(Answer) Because RCA sells its batteries to Radio Dealers and Servicemen through Radio-Electronics Distributors.

3. What sales advantage does RCA's Battery distribution give retailers?

(Answer) Virtually no RCA Battery competition from non-radio outlets.

4. How complete is RCA's line of Radio Batteries in terms of consumer needs?

(Answer) RCA's line covers 99% of today's radio battery demand.



5. What is the most outstanding Battery in RCA's line?

(Answer) The RCA-VS036—flashlight-size "A" battery.

6. Why is the RCA-VS036 an outstanding battery?

(Answer) Because it contains a Special Radio Mix—is completely Sealed-in-Steel—top, bottom, and sides.

7. What important advantages does the RCA-VS036 offer retailers?

(Answer) Sealed-in-Steel construction eliminates shelf-life problems—the battery stays fresh until used.

8. Why will customers prefer the RCA-VS036?

(Answer) It's virtually leakproof and, in radio operation, gives more operating hours than competitive flashlight-type batteries.

9. Is the RCA-VS036 good for Flashlight use?

(Answer) Yes. It exceeds the U. S. Bureau of Standards Household Flashlight Cell Capacity requirements by nearly 50%.



10. What RCA "Exclusive" helps you sell the RCA-VS036?

(Answer) The "Carry Kit" merchandiser—a "carry-away" container that sells batteries like soda pop—eight at a time!

11. What is your assurance of top quality in RCA Batteries?

(Answer) Only the finest materials and skilled workmanship go into RCA Batteries. Every cell is aged and individually tested.

12. How has it been proved that RCA Batteries give extra listening hours?

(Answer) Exacting laboratory performance tests show that RCA Batteries exceed the average of competitive brands.

13. What steps are taken to safeguard the quality standard of RCA Batteries?

(Answer) Constant research, product development, and the continued application of latest production techniques.

14. Are radio set manufacturers recommending RCA Batteries for their Portables?

(Answer) Yes—in ever-increasing numbers!

15. What specialized knowledge does RCA bring to Radio Battery retailers?

(Answer) RCA—World Leader in Radio—is closer to radio-battery market requirements than any other battery supplier. Such knowledge assures dealers availability of the right types—at the right time—backed by proved radio trade sales programs.

16. What selling aids does RCA provide?

(Answer) All types of displays and merchandisers, together with technical literature—the most complete line in the industry—all geared for radio trade use.

17. What are some RCA "Firsts" in battery sales promotion?

(Answer) The RCA "Carry Kit," Toy Shipping Container, Basic Sales Aid Kit, and, Radio-geared Sales Aids!

18. What is your guarantee of high consumer acceptance of RCA Batteries?

(Answer) Today, as always, the RCA Trade Mark is your assurance of immediate customer acceptance. Consumers everywhere recognize RCA as "the Greatest Name in Radio."

19. What can radio dealers and servicemen do to prove to themselves that they can sell more RCA Batteries than any other brand?

(Answer) Starting now—sell RCA Batteries. Watch your business grow!

**See your RCA Battery Distributor for fast, reliable service.**



**RADIO CORPORATION of AMERICA**  
RADIO BATTERIES

HARRISON, N. J.