

SERVICE

February
1950

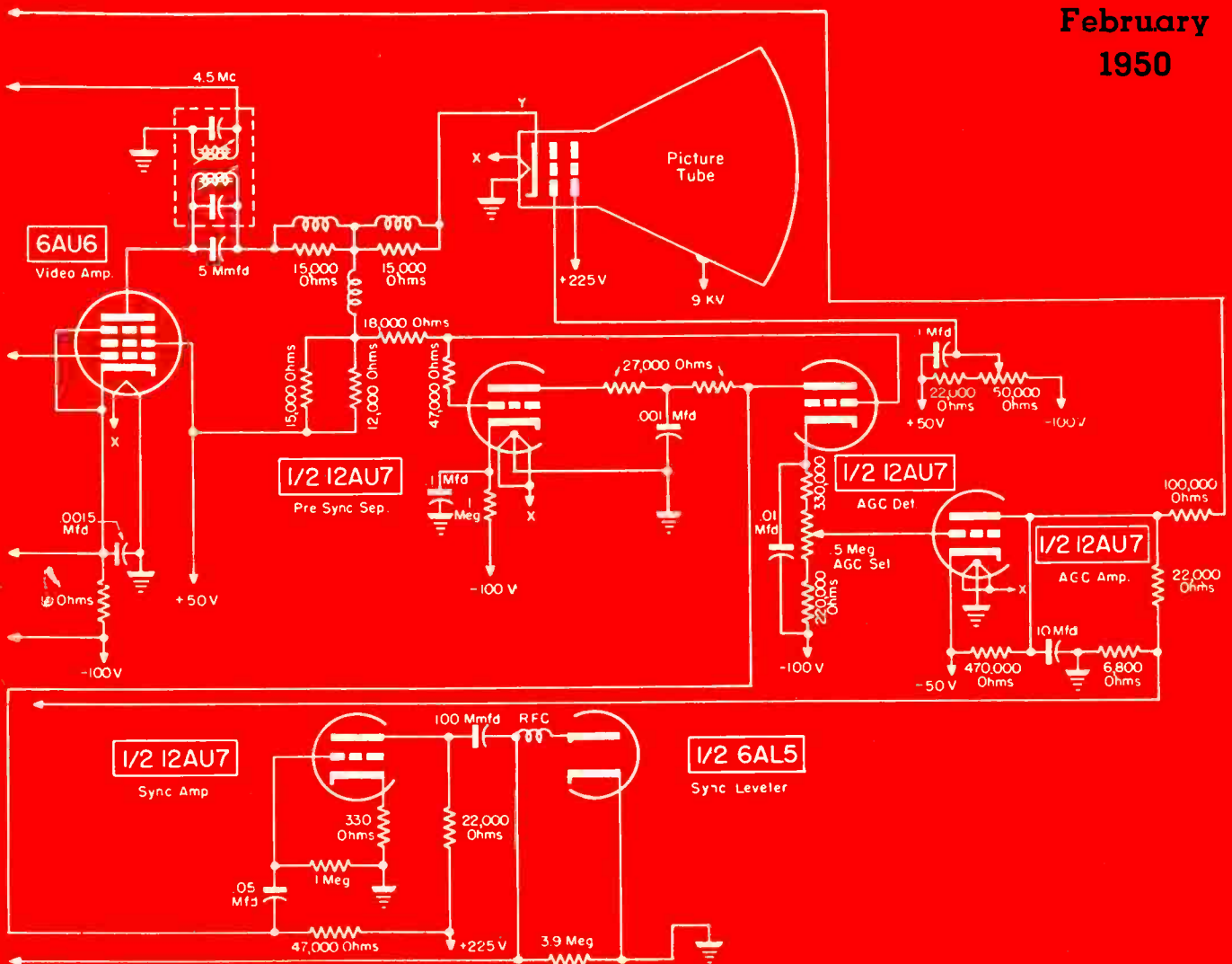

Video amplifier, pre-sync separator, agc detector and amplifier, sync amplifier and leveler, and picture-tube circuit of 24-tube intercarrier type TV receiver.

[See page 2]

For the **MOST** in Television Reception



THE **SKY HAWK**

TELE-ROTOR

For Clear Sharp Pictures and
Perfect Trouble-Free Performance

**C-D SKY HAWK
TELE-ROTOR
CONTROL**

with the "Perfect Pattern" Dial
... Gives Immediate Indication
... of Antenna Position.

Available in the Following Models:

- TR-1 ... rotator with control box \$39.95
- TR-2 ... compass control rotator with "Perfect Pattern" dial \$44.95

A Combination You Can't Beat ... It's a C-D
Sky Hawk Antenna with a C-D Sky Hawk Tele-Rotor

IT'S
POWER PACKED

A Triumph in Design!!! There's
Nothing Like It... It's Beyond Compare!

• Steamlined Weatherproof Housing - Keeps Out Weather, Snow and Ice

• Heavy-Duty Motor - Reverses Instantly

• Heavy-Duty Precision Gears

• 12 Heavy-Duty Ball Bearings in two 6 1/2" diameter Ball Bearing Races

• Will Handle 7/8" to 2" dia. Upper and Lower Masts

CHECK THESE FEATURES

- Handles Heavier Loads With Ease ... As Much As 150 Pounds
- Streamlined Weather-proof Design ... Durable Sturdy Construction
- 12 Heavy-Duty Ball Bearings in two 6 1/2" diameter Ball Bearing Races
- Heavily Reinforced Die-Cast Housing
- Heavy-Duty Precision Gears
- Positive Stop at End of Rotation
- Will Handle 7/8" to 2" diameter Upper and Lower Masts
- Heavy-Duty Motor - Reverses Instantly
- Mast, Tower or Platform Mounting
- Four Heavy-Duty Guy-Wire Lugs
- Completely Weather-Sealed ... Factory Lubricated For Life

The television industry has been looking for something like this ... and it took CORNELL-DUBILIER to produce it! THIS is the last word in ROTATORS ... the finest! ... BECAUSE IT HAS EVERYTHING! It wasn't developed overnight but is the result of fourteen solid months of research and development! BUT ... it has been worth it! ... BECAUSE IT MEASURES UP TO CORNELL-DUBILIER STANDARDS.

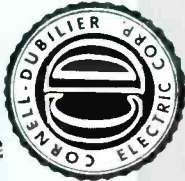

CONSISTENTLY DEPENDABLE

CORNELL-DUBILIER

SOUTH PLAINFIELD, NEW JERSEY

- ROTATORS
- CAPACITORS
- ANTENNAS
- VIBRATORS
- CONVERTERS



IF IT'S NEW...

KEN-RAD DEALERS HAVE IT!

YOU'RE in the driver's seat as radio-TV serviceman, if you stock and sell Ken-Rad tubes. Backed by General Electric's vast research and development facilities, Ken-Rad engineers provide you at all times with outstanding new designs. You can service late-model receivers in your neighborhood knowing that the Ken-Rad complete line of tubes, TV-picture, metal, glass, and miniature, includes the advanced types to be found in new circuits... Like the pace-setting gated-beam 6BN6 shown here (heater 6.3 v, 300 ma), or its 12BN6 companion (heater 12.6 v, 150 ma)... Get the service business that goes to the dealer who has the new types—who handles Ken-Rad tubes! It's new and profitable business, and builds prestige for your shop... Phone or write your Ken-Rad distributor today!

HOT THIS MONTH!

Here's a clear-all-wires news item! Ken-Rad 1950 advertising help is ready and on its way to you via your distributor. There are sales-getting small ads for newspaper use—postcard mailers that pull—spot announcements for your local radio station. Add these to the fine Ken-Rad displays and other promotions, and you as an alert Ken-Rad dealer have "what it takes" to profit from the active tube market in your area.



6BN6 MINIATURE

Typical Operating Conditions, TV Application

Plate supply voltage	175 v
Plate load resistance	.22 megohms
Accelerator voltage	85 v
Cathode resistance	145 to 400 ohms
Minimum signal voltage for limiting action	1.25 v RMS
Audio output voltage	12.5 v RMS

KEN-RAD *Radio Tubes*

PRODUCT OF GENERAL ELECTRIC COMPANY

Schenectady 5, New York

The gated-beam 6BN6 does three tubes' work. It functions as a limiter, discriminator, and audio-amplifier in new TV and FM receivers. You'll be servicing sets soon with 6BN6's in their circuits, and replacements will be in order. Make sure you have this essential new miniature when you need it... and other up-to-the-minute tube types... by stocking the Ken-Rad brand!

182-JA2



LEWIS WINNER
Editorial Director

F. WALEN
Assistant Editor

ALFRED A. GHIRARDI
Advisory Editor

	Page
Association News	58
Phono Installation and Service. By Kenneth Stewart	24
Remote Control for Garage Doors. By Max Alth	20
Ser-Cuits (Zenith 1950 TV Models)	30
Servicing Helps. By M. A. Maxwell	36
Ten Years Ago in Associations	58
The AF Sweep Generator in Servicing Operations. By John B. Ledbetter	16
12½"-16" TV Chassis (Cover). By J. F. Bigelow	22
Tube News (16" Tube Identity Chart). By L. M. Allen	34
TV Servicing Isolation Transformers. By Arthur Liebscher	18
Use of Tube Curves to Diagnose Circuit Performance. By Edward M. Noll	28
Views and News. By Lewis Winner	15
CIRCUITS	
Clarkstan 125 (AF Sweep Generator)	17
Federal Industries 12AU7 VHF Remote-Control Transmitter	20
Federal Industries Remote Receiver	20
G.E. 500 and 501 Clock Radio	36
Magnavox CT247, 248, 249 (Cover)	22
Philco Electronic Scratch Eliminator	25
Philco 3-Speed Setup in the M-20 Changer	25
RCA Iso Tap	18
6V6 Push-Pull Amplifier	28
Zenith 24G22/23	31
COVER	
12½"-16" TV Receiver (Magnavox CT247, 248, 249)	22
PHONO INSTALLATION AND SERVICE	
Eliminating Distortion in 2-Needle Cartridge Assemblies	45
How to Replace Phono Parts and Assemblies	25
Phono-Combination 3-Speed Changer Design and Operation	25
Scratch-Eliminator Circuitry	24
SERVICING HELPS	
Adapter Plug for Servicing TV Receivers	46
Clock-Type Receiver Alarm and Switch Adjustments	36
Clock-Type Receiver Cleaning and Lubricating Suggestions	36
Clock Trouble Remedies	36
Clock-Radio Production Changes	36
Correcting Tunable Audio Hum	48
How to Stop Arcing or Corona in 16" Type TV Receivers	46
Eliminating TV Interference Caused by Cash Registers and Electric Range Switches	48
Index to Advertisers	60
Manufacturers	
Jots and Flashes	60
News	56
New Parts . . . Accessories	49
TV Parts . . . Antennas . . . Accessories	35

Entire contents Copyright 1950, Bryan Davis Publishing Co., Inc.



Published monthly by Bryan Davis Publishing Co., Inc.
52 Vanderbilt Avenue, New York 17, N. Y. Telephone MURray Hill 4-0170



Bryan S. Davis, President Paul S. Weil, Vice-Pres., Gen. Mgr. F. Walen, Secretary A. Goebel, Circulation Manager

East-Central Representative: James C. Munn, 2253 Delaware Dr., Cleveland 6, Ohio. Telephone: Erievlew 1726
Pacific Coast Representative: Brand & Brand, 1052 W. Sixth St., Los Angeles 14, Calif. Telephone: Michigan 1732
Suite 1204, Russ Building, San Francisco 4, Calif. Telephone: SUTter 1-2251

Entered as second-class matter June 14, 1932, at the Post Office at New York, N. Y., under the Act of March 3, 1879. Subscription price: \$2.00 per year in the United States of America and Canada; 25 cents per copy. \$3.00 per year in foreign countries; 35 cents per copy.

**YOUR SYLVANIA TUBE
CARTONS ARE WORTH 2¢
IN TRADE!**

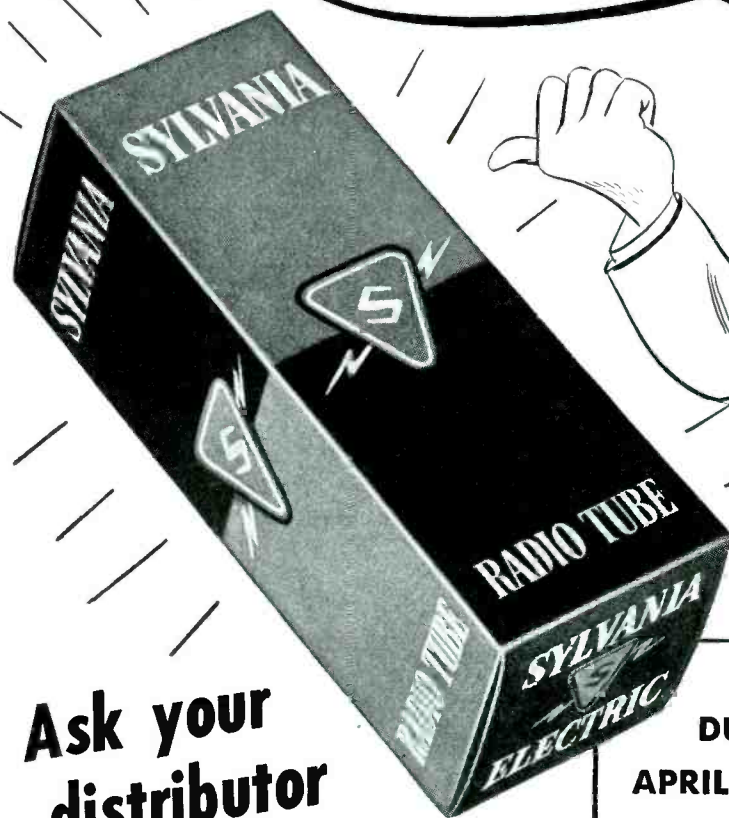

**Ask your
distributor
TODAY—
about Sylvania's
big tube carton
trade-in deal!**

**DURING FEBRUARY, MARCH AND
APRIL YOUR EMPTY SYLVANIA CAR-
TONS ARE WORTH 2¢ EACH AT YOUR
DISTRIBUTOR'S when applied against
the purchase of...**

- SYLVANIA ADVERTISING MATERIAL
- MORE SYLVANIA TUBES
- SYLVANIA TEST EQUIPMENT

SYLVANIA  ELECTRIC

RADIO TUBES; CATHODE RAY TUBES; ELECTRONIC DEVICES; FLUORESCENT LAMPS, FIXTURES, WIRING DEVICES, SIGN TUBING; LIGHT BULBS; PHOTOLAMPS

SERVICE, FEBRUARY, 1950 • 3

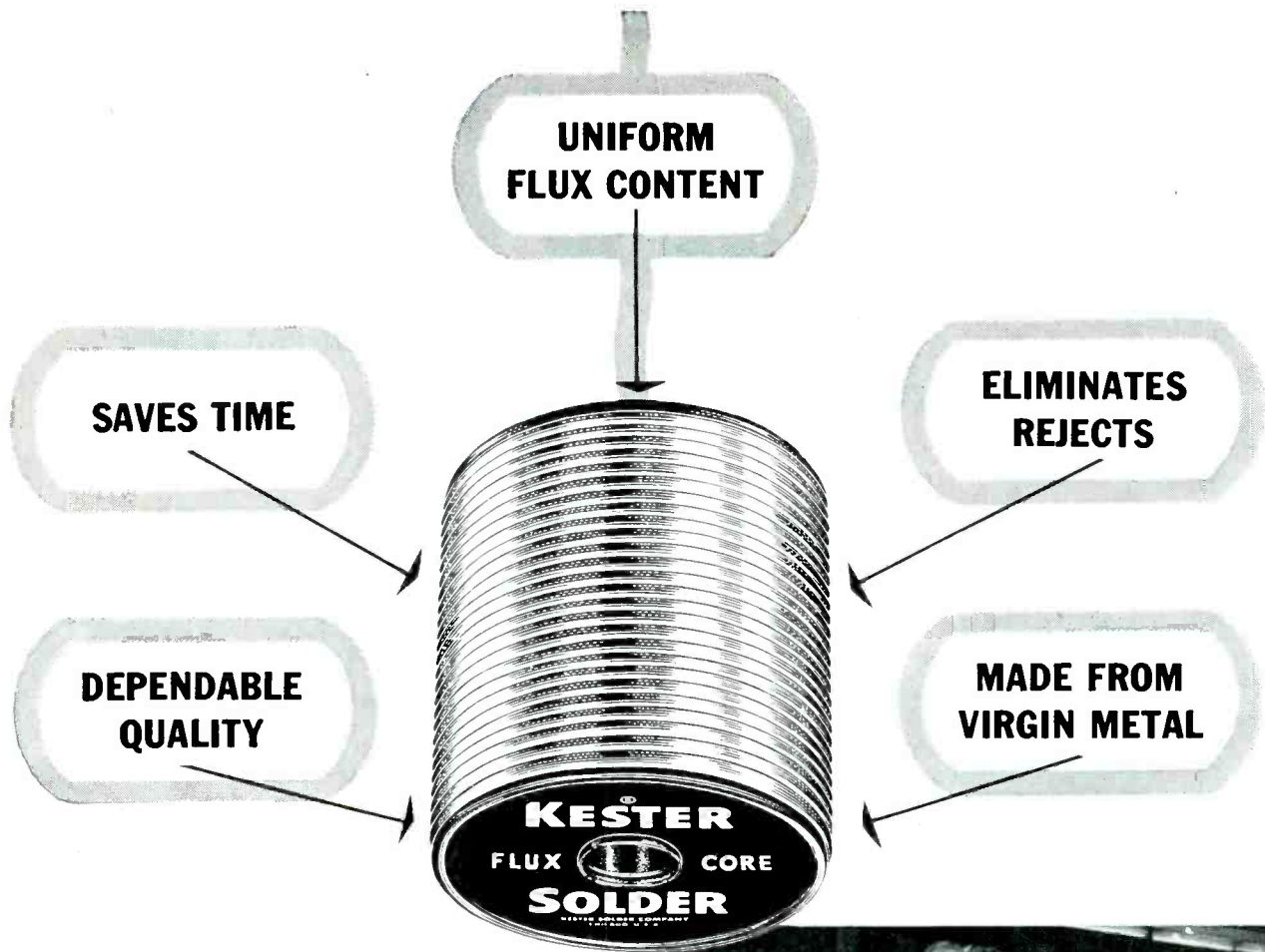

KESTER

the Solder

*that gets Speed
into
TV Production*

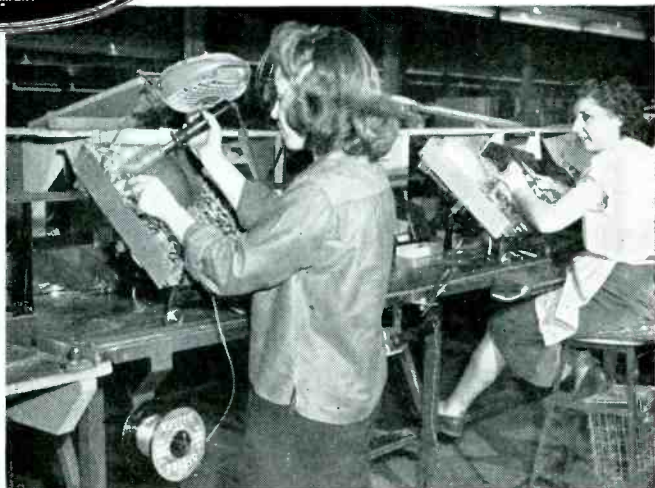

Using Kester Flux-Core Solders, Plastic Rosin or "Resin-Five" Core Solders—the same solder selected for original manufacture of TV sets and components—will enable you to do your finest work. Kester flows better—handles easier—faster to use. Kester Solders are made only from newly mined grade A tin and virgin lead.

KESTER SOLDER COMPANY • 4201 WRIGHTWOOD AVE.
CHICAGO 39, ILL. • NEWARK, N. J. • BRANTFORD, CANADA

**KESTER
SOLDER**



WE'RE STILL IN THE *RADIO* BUSINESS

Seems as though nowadays is TV... TV... TV. We've had so much TV news for you! Hytron's new 16RP4 rectangular picture tube. Hytron's new low-cost deflection-circuit tubes: 1X2, 6BQ6GT, 6J4GT, 6W4GT, 25BQ6GT, and 25W4GT. And many more Hytron designed-for-TV tubes coming.

But we're still in the *radio* business — both of us. Radio still is king. We realize that. Also that most service problems are still radio — not TV. You can depend on Hytron radio tubes. Whether it is the original Hytron GT... miniature... G... metal... or Octal. For a-c/d-c, portable, f-m, phono, or auto radio. Hytron will strive to give you the most dependable *radio* (as well as TV) replacement tubes.



OLDEST MANUFACTURER OF RECEIVING TUBES
HYTRON
RADIO AND ELECTRONICS CORP.



MAIN OFFICE: SALEM, MASSACHUSETTS

Relax! LET HYTRON TOOLS
EASE YOUR WORK



FREE
New Hytron Tool Catalogue. Describes all the famous Hytron service-shop tools to date: Soldering Aic., Tube Lifter, 7-Pin and 9-Pin Straighteners, Tube Tapper, and Auto Radio Tool. Find out how these Hytron tools can ease your work. Mail the coupon today.

HYTRON RADIO & ELECTRONICS CORP.,
Salem, Massachusetts

I want to know how the Hytron tools can help me make more money. Please send me the free Hytron Tool Catalogue at once.

(PLEASE PRINT)

NAME.....
STREET.....
CITY.....
STATE.....

New VIDEO RECTANGULAR 16 TP4

PHYSICAL DIMENSIONS—16" Rectangular—
16 1/4" Dia.—18 1/4" Long—14.738" Wide—11.5" High

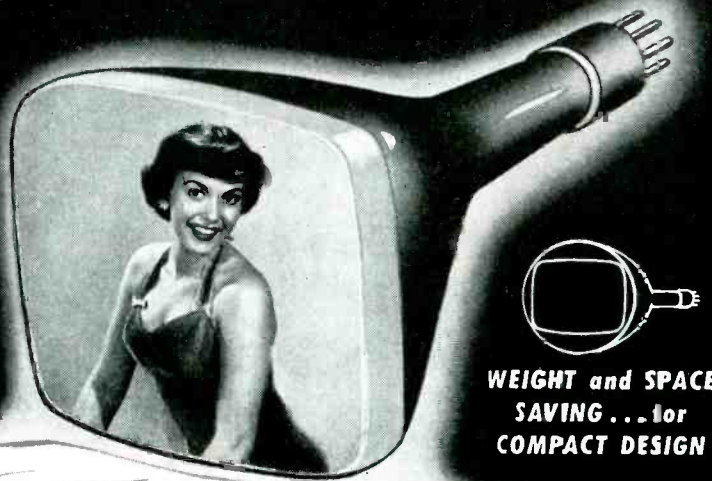

WEIGHT and SPACE
SAVING... for
COMPACT DESIGN

OVER AN ACRE DEVOTED TO PRODUCTION

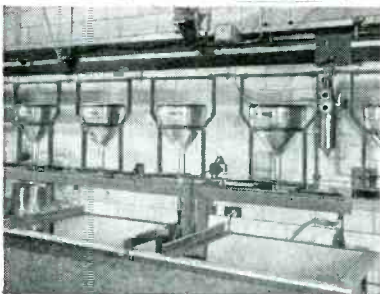
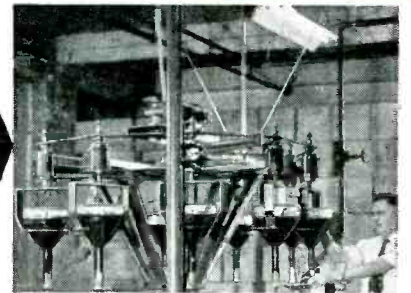
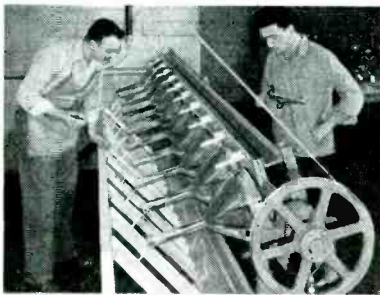
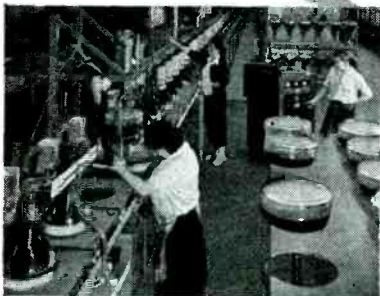

The new Video 16 TP4 sets a new standard in the all-glass rectangular television tubes. Combining all the precision engineering features and years of development, Video's new tube is the foremost in its line. It permits smaller cabinets, larger viewing screens, lighter weight units, and smaller dimensions.

With this new style magnetic focus tube, manufacturing problems are simplified.

Engineering and specification details giving complete data will be supplied. Write for Video's illustrated brochure today!



NATIONAL VIDEO CORPORATION

3019 WEST 47th STREET • CHICAGO 32, ILLINOIS

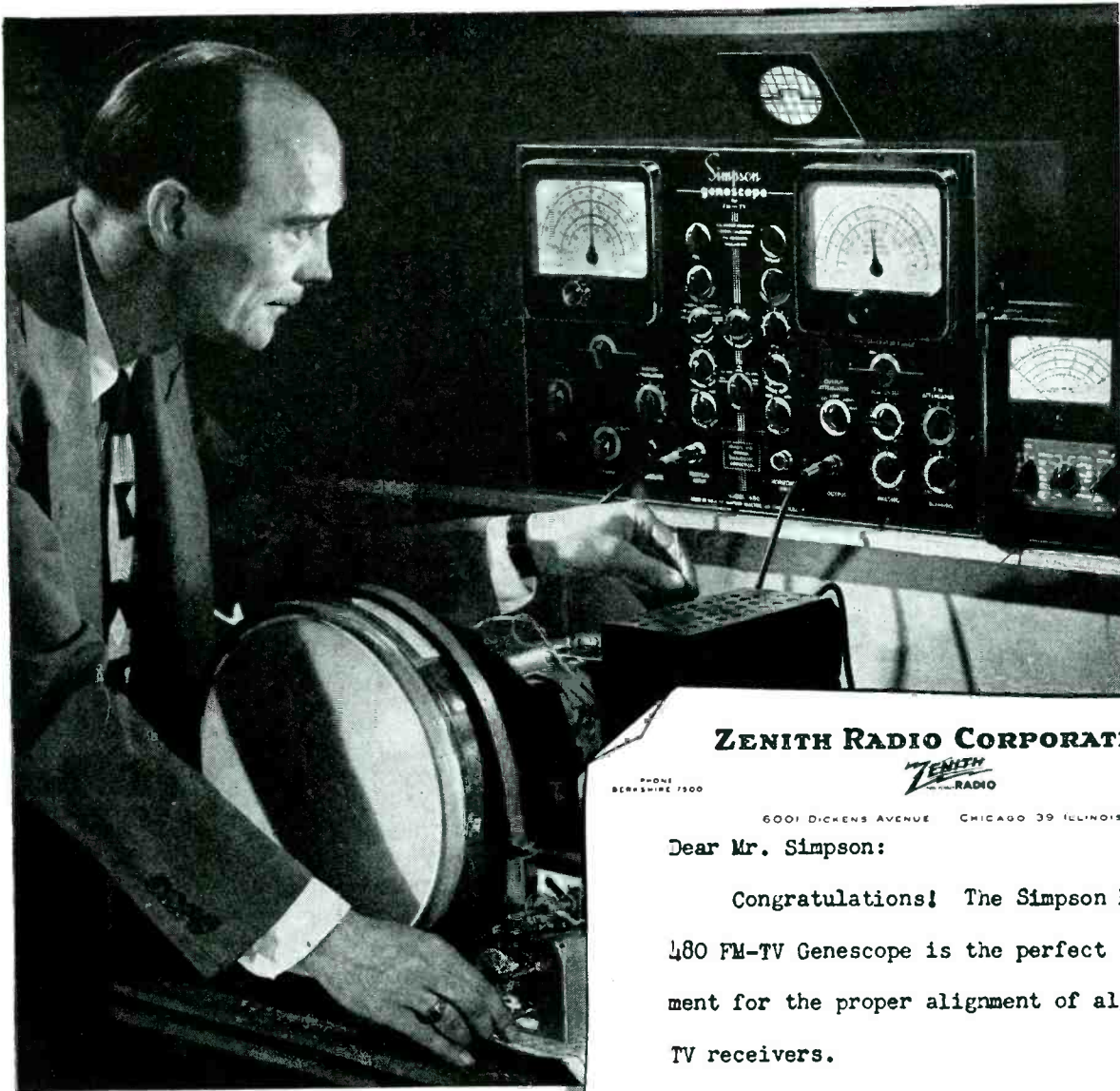

says FRANK SMOLEK,

General Service Manager of Zenith

In addition to providing all necessary signal sources, the new Simpson Genescope includes a high sensitivity oscilloscope of unique advanced design, complete in every detail. Sensitivity 25 millivolts per inch. Wide band response to 3 megacycles or more. Equipped with a high frequency crystal probe for signal tracing. AM and FM oscillator sections provided with large, easy to read dials with 20-1 vernier control and 1000 division logging scale. Revolutionary, Ingenious, Exclusive output termination provides for various receiver impedances, either direct or through an isolating condenser.

Step attenuator for control of output.

Size: 22"x14"x7 1/2". Weight 45 lbs. Shipping Weight 54 lbs.

DEALER'S NET PRICE complete with Test Leads and Operator's Manual \$375.00

ZENITH RADIO CORPORATION



CABLE ADDRESS
ZENITHRAD
ALL COUNTRIES

PHONE
BERKSHIRE 7500

6001 DICKENS AVENUE CHICAGO 39 ILLINOIS

Dear Mr. Simpson:

Congratulations! The Simpson Model 480 FM-TV Genescope is the perfect instrument for the proper alignment of all FM and TV receivers.

In addition to providing all necessary

CHECK THESE RANGES AND YOU WILL SEE HOW MUCH THE SIMPSON GENESCOPE CAN DO FOR YOU

RANGES
FREQUENCY MODULATED OSCILLATOR
 Band A—2-120 megacycles
 Band B—140-260 megacycles
 Sweep width variable from zero to 15 megacycles
 Sweep rate 60 cycles per second
 Specially designed frequency sweep motor
 Continuously variable attenuator
 Crystal calibrator—5 megacycles ± .05%
 Audio Oscillator 400 cycles

AMPLITUDE MODULATED OSCILLATOR
 Band A—3.2-16 megacycles
 Band B—15-75 megacycles
 Band C—75-250 megacycles
 30% modulation at 400 cycles or unmodulated
 Continuously variable attenuator
 Visual method of beat frequency indication

Modern FM and TV development and servicing requires the use of test equipment made to exacting standards. With this in mind Simpson offers you the Genescope with the assurance that everything possible has been done to make it the most accurate, flexible and convenient instrument available. The Genescope will render many years of uninterrupted service and always produce accurate results.

**HERE'S THE SIMPSON—MODEL 479
TV-FM SIGNAL GENERATOR**

Exactly the same circuits, ranges and functions as the Model 480, described above, with the exception of the oscilloscope.

Size 17"x14"x7 1/2". Weight 34 lbs.
Shipping Weight 40 lbs.

DEALER'S NET PRICE with Test Leads and Operator's Manual \$245.00

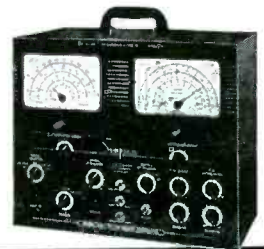

Simpson
INSTRUMENTS THAT STAY ACCURATE

SIMPSON ELECTRIC COMPANY
5200-5218 WEST KINZIE STREET • CHICAGO 44, ILLINOIS
In Canada: Bach-Simpson, Ltd., London, Ont.



FIELD TESTED

Installation Information on

TV and FM

RECEIVING ANTENNAS

TV . . . FM Antenna Installation

by IRA KAMEN

Manager, Antenaplex and TV Dept., Commercial Radio Sound Corp.

and LEWIS WINNER

Editorial Director, Bryan Davis Pub. Co., Inc.; Editor, SERVICE and TELEVISION ENGINEERING

The only practical book on the all-important item in TV and FM reception . . . based entirely on actual experiences in the most active TV and FM areas in the country. . . . Over 35,000 words of vital data with over 130 photos and drawings.

TEN CHAPTERS COVERING:

Installation Tools
Antenna Installation Procedures
Securing 12-Channel Coverage
HF Antenna Installations
TV Interference

Fringe Reception
Master Antenna Systems
FM Antennas
Installation Business Practices
Tricks of the Trade

The first book in which you'll find complete design and installation information on every type of TV and FM receiving antenna. . . . Contains detailed illustration and subject index for rapid reference.

✓✓ "The best book on the market at this time dealing with the problem of television antennas and antenna installation . . . If more Service Men would read this book, it would help them considerably in making better installations and providing better television reception for their customers."—*M. J. Shapp, President, Jerrold Electronics Corp.*

✓✓ "Will recommend it to all the Service Men and technical people I meet."—*Charles Cahn, Field Service Engineer, Bendix Radio.*

✓✓ "Well organized and illustrated, very complete and up-to-date, carefully detailed. It will definitely improve the ability of the man who studies it and therefore is mighty useful to a firm like ours."—*Hamilton Hoge, President, United States Television Mfg. Corp.*

✓✓ "Will certainly fill a long-felt need for some practical information . . . sincerest congratulations."—*George P. Adair, Former Chief Engineer, FCC, and now Consultant in Washington, D. C.*

✓✓ "A thorough-going compendium of the installing art . . . Going to recommend it highly to our Service Control Department and our service organizations."—*Ernest A. Mars, General Manager, Television Receiver Sales Div., Allen B. DuMont Laboratories, Inc.*

✓✓ "Informative and extremely well written."—*R. Morris Pierce, Vice President in charge of Engineering, WJR, WGAR, KMPC.*

BRYAN DAVIS PUBLISHING CO., INC., Book Dept.
52 Vanderbilt Avenue, New York 17, N. Y.

Send me a copy of TV . . . FM Antenna Installation, post-paid, for which I am enclosing \$2.00.

(Please print)

NAME

ADDRESS

CITY AND STATE

AT YOUR JOBBER
 OR ORDER DIRECT



Price \$2 Post Paid

Good News **FOR TV SERVICE MEN**



"THE STANDARD BOOSTER" A new high gain TV preamplifier that assures your customers studio clear reception. This means plus profits for you by boosting your TV set sales in fringe areas. "The Standard Booster" features 2 knob control... continuous tuning, eliminates a switch from high to low channels... printed circuit trouble free operation.

"The Standard Booster" For Fringe Areas

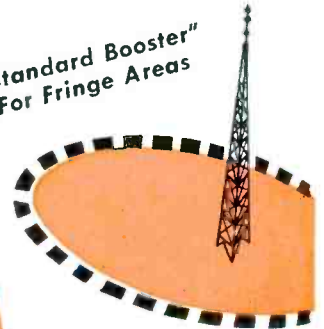

**Tomorrow's Market... Here Today
FOR TWO GREAT PRODUCTS
"THE STANDARD BOOSTER"
"THE STANDARD TUNER"**

"Over 1,000,000 Standard Tuners Now In Use"



"THE STANDARD TUNER" is nationally recognized as the accepted replacement tuner by the trade. Incorporated as original equipment in over a million TV sets produced by the majority of the outstanding manufacturers. This is the tuner for you. It gives higher sensitivity... quick interchanging of channel inductors... adaptable to U.H.F. See your jobber for details.

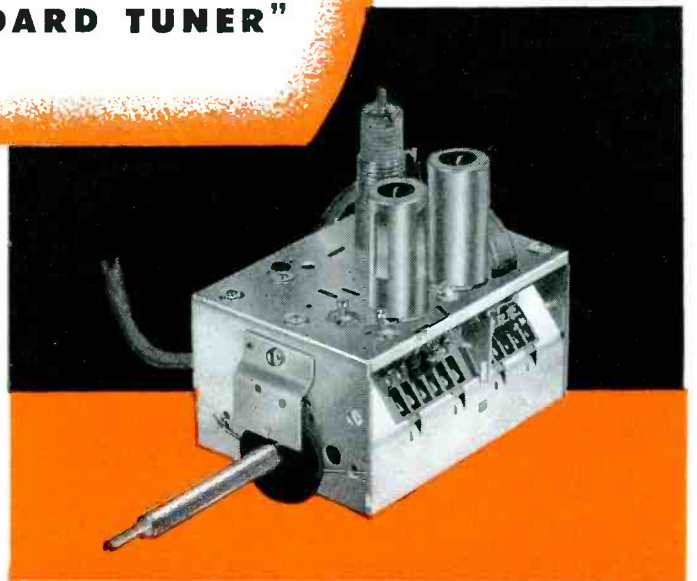

Build your profits and expand your TV service business now with these two great "Standard" products. Write today for complete profit information, specifications and performance data.

Standard COIL PRODUCTS CO., INC.
CHICAGO • LOS ANGELES • BANGOR, MICHIGAN

HERE IT IS...

The First Word In PERFORMANCE
...The Last Word In DESIGN!



THE RADIART TELE-ROTOR

For Clear Sharp Pictures and
Perfect Trouble-Free Performance

MORE POWER TO YOU
(More Than You'll Ever Need)

Sweatlined Weatherproof
Housing - Keeps Out Water,
Snow and Ice

Heavy Duty Motor -
Reverses Instantly

Heavy Duty Precision Gears

1/2 Heavy-Duty Ball Bearings in Two
6 1/2" diameter Full Bore Races

A Triumph In Design!!! Here's Nothing Like It — It Is Beyond Comparison

CHECK THESE FEATURES

- Handles Heavier Loads With Ease
... As Much As 150 Pounds
- Streamlined Weather-proof Design
... Durable Sturdy Construction
- 12 Heavy-Duty Ball Bearings in two
6½" diameter Ball Bearing Races
- Heavily Reinforced Die-Cast Housing
- Heavy-Duty Precision Gears
- Positive Stop at End of Rotation
- Will Handle 7/8" to 2" diameter
Upper and Lower Masts
- Heavy-Duty Motor — Reverses
Instantly
- Mast, Tower or Platform
Mounting
- Four Heavy-Duty Guy-Wire Lugs
- Completely Weather-Sealed
... Factory Lubricated For Life

The television industry has been looking for something like this ... and it took RADIART to produce it! THIS is the last word in ROTATORS ... the finest! ... BECAUSE IT HAS EVERYTHING! It wasn't developed overnight but is the result of fourteen solid months of research and development! BUT ... it has been worth it ... BECAUSE IT MEASURES UP TO RADIART STANDARDS ... The quality level that makes RADIART PRODUCTS THE STANDARD OF COMPARISON!

Available in the Following Models:

- TR-1 ... rotator with control box \$39.95
- TR-2 ... compass control rotator with "Perfect Pattern" dial \$44.95

A Combination You Can't Beat . . .

It's a Radiart Antenna with a Radiart Tele-Rotor



IT'S RIGHT WHEN IT'S RADIART

THE **RADIART CORPORATION**

CLEVELAND 2, OHIO

- ROTATORS
- VIBRATORS
- TV ANTENNAS
- AUTO AERIALS
- POWER SUPPLIES



THE RADIART TELE-ROTOR CONTROL

with the "Perfect Pattern"
Dial . . . Gives Immediate
Indication of Antenna
Position.

Will Handle 7/8" to 2" dia.
Upper and Lower Masts

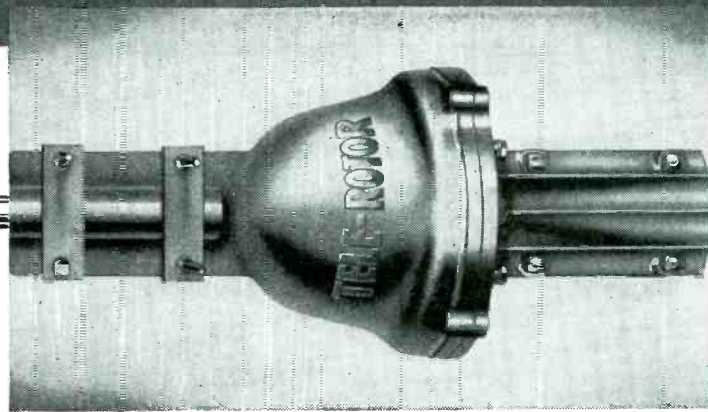

★ **Build Your Service-
Sales Future on a Firm
Foundation with**

PRECISION
TEST EQUIPMENT
Standard of Accuracy...

**... These 5 Matched "Precision"
Instruments provide a Complete
MODERN SERVICE LABORATORY for
TV-FM-AM at only moderate cost.**

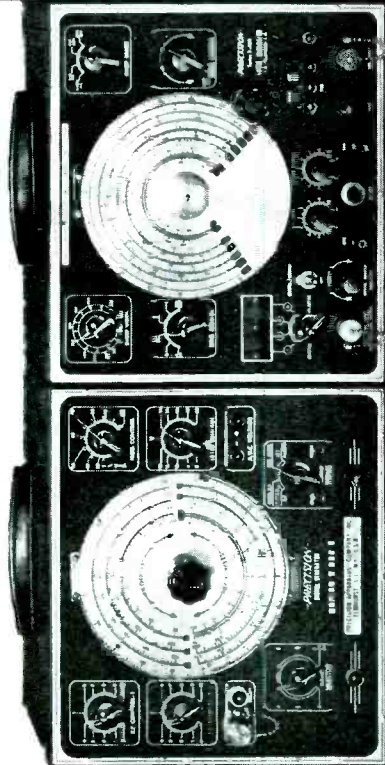

SERIES E-200-C—Modern Multi-band SIGNAL and MARKER GENERATOR for A.M., F.M., and TV alignment.

Exceptional Accuracy and Stability! 1000 pt. vernier calibrating scale! 0-100% Modulation! A.V.C. substitution network! Direct reading 88KC to 120 MC! Complete with output cable and tech. manual. In matched, heavy gauge case 10½ x 12 x 6".

Net Price:—\$67.25

SERIES E-400—Wide Range H.F. SWEEP SIGNAL GENERATOR Direct Reading from 2 to 480 MC.

Narrow and Wide Band Sweep for F.M. and TV • 1500 pt. vernier calibrating scale • Multiple Crystal Marker • 8 tubes including V.R. and rectifier • RG/62U Coaxial Terminated Output. Complete with 2 crystals. In heavy copper-plated case 10½ x 12 x 6".

Net Price:—\$124.70

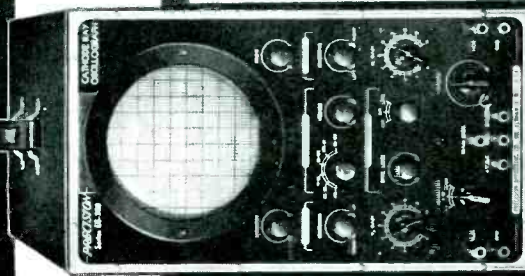

SERIES ES-500—20 MV. High Sensitivity, Wide Range 5 inch C.R. OSCILLOGRAPH.

V. Amp. Input to 1 MCI Low C. High R input Step Attenuator! Z axis modulation terminals! 9 tubes incl. V.R. and 2 rectifiers! Complete with light shield and mask. Heavy steel case 8¼ x 14½ x 18".

Net Price:—\$149.50

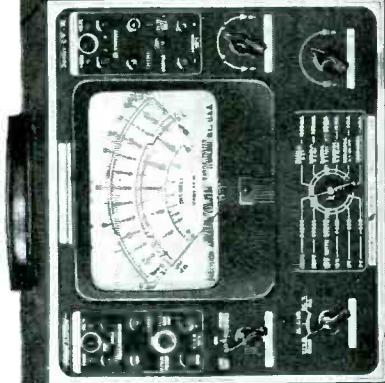

SERIES EV-10—True Zero-Center VTVM — MEGOHMMETER with large 7" meter — plus complete 1000 Ω/V. functions.

59 ranges to 6000 Volts, 2000 Megs. ±70DB, 12 Amps • Voltage Regulated bridge type circuit • Constant 13½ Megs input resistance to 600 V. 133½ Megs at 6000 V • Optional RF probe. Complete with test cables. Matched heavy gauge steel cabinet 10½ x 12 x 6".

Net Price:—\$89.95

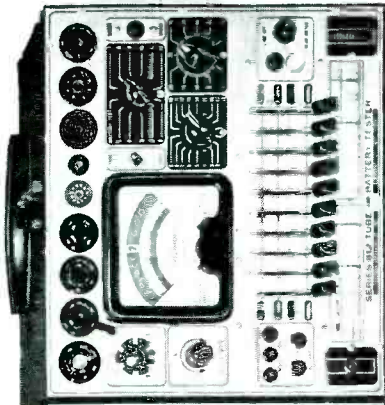

SERIES 612—Modern Free-point Cathode Conducance TUBE TESTER, and dynamic A-B-C Battery Tester.

Incorporates RMA recommended circuit principles! 10 lever free-point element selection! Built-in roller chart! Dual short-check sensitivity! Noise, Ballast and Pilot Tests! Complete, ready to operate. In matched heavy gauge steel cabinet 10½ x 12 x 6".

Net Price:—\$66.65

BUY PERFORMANCE — NOT SPECIFICATIONS

For over 15 years, "Precision" PERFORMANCE, ACCURACY, WORKMANSHIP and VALUE have set a standard of comparison...products of an organization whose sole efforts are concentrated exclusively in the design, development and production of the **FINEST TEST EQUIPMENT**...nothing else!

"Precision" Performance Engineered Instruments are an **display** at leading radio parts and equipment distributors.

PANEL MOUNTS, PORTABLES, COUNTER TYPES

Most "Precision" instruments are available in various enclosure styles to suit your individual application, field or shop. **WRITE FOR OUR LATEST ILLUSTRATED CATALOG** describing the full line of Precision quality test equipment for all phases of modern radio, television and communications.



PRECISION APPARATUS CO., INC.

97-27 Horace Harding Boulevard, Elmhurst 6, New York
Export Division: 458 Broadway, New York, U.S.A. • Cables—Morhanez

SERIES TV—Super-High Voltage Safety Test Probes.

Extends range of Series EV-10 (above) up to 30 KV or 60 KV direct reading, with full safety to operator and equipment. Multiplier cartridges available to match most VTVM's and 20,000 ohms/V. test sets. Complete with 30 KV multiplier cartridge for EV-10.

Net Price:—\$15.45

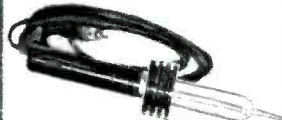

Convenient "Precision" Purchase Terms can be arranged with your favorite authorized Precision Distributor.

• TV • AM • FM • TV • AM • FM • TV • AM • FM • TV •

• TV • AM • FM • TV • AM • FM • TV •

picture of the Successful T-V Serviceman



© Allen B. Du Mont Laboratories, Inc.
*Trade-mark.



For superlative pictures, he installs Teletrons — in the 12½, 15, 16 and 19 inch sizes — selected from this Teletron Catalog. Write for your copy!



DUMONT

FIRST WITH THE FINEST IN T-V TUBES

Teletrons

ALLEN B. DU MONT LABORATORIES, INC. • TUBE DIVISION, CLIFTON, N. J. • PLANTS AT ALLWOOD AND PASSAIC, N. J.

SERVICE, FEBRUARY, 1950 • 13

<p>Picture and Sound IF and Video Coils—Kit #204X1 containing 15 coils for picture and sound if stages, and video circuits.</p>		<p>Type 208T2 Vertical Blocking-Oscillator Transformer—Generates 60-cps pulses to drive vertical-discharge tubes.</p>		<p>Type 204T2 Vertical Deflection Output Transformer—For vertical-deflection circuits using RCA-201D1, 201D3, or 201D12 Deflecting Yoke.</p>	
	<p>Type 203R1 Horizontal Oscillator and Synchronizing Control Coil—Permeability tuned center-tapped oscillator coil.</p>		<p>Types 201D1, 201D3, and 201D12 Deflecting Yokes—For RCA kinescopes 10BP4, 12LP4, and 16AP4.</p>		<p>Type 202D1 Focusing Coil—For kinescopes such as the RCA-10BP4 operating at anode potentials up to 10 kilovolts.</p>
<p>Type 203D3 Ion-Trap Magnet—For use with kinescopes which utilize ion-trap guns and operate with anode potentials of 7 to 14 kilovolts.</p>		<p>Type 211T5 Horizontal-Deflection-Output and High-Voltage Transformer—For pulse operated power supplies up to 13.5 kilovolts.</p>		<p>Type 208T3 Horizontal Blocking Oscillator Transformer—Designed to drive the grids of the horizontal discharge tubes.</p>	
	<p>Picture IF Transformers—Type 202K5 to 202K11—Seven coils for stagger-tuned IF systems such as used in RCA TV receiver models 8T241, 8T243, 8T244.</p>		<p>Type 201R4 Width Control—For controlling picture width in receivers using RCA-16AP4 kinescopes.</p>		<p>Type 203L5 Video-Circuit Trap—A 4.5-megacycle video-circuit trap designed to operate in the plate-circuit of the first video amplifier.</p>

Original

RCA TV COMPONENTS COST NO MORE

THEY CUT DOWN SERVICE RETURNS, AND INSURE SUPERIOR PERFORMANCE

RCA television components are "Originals," developed by famed RCA television engineers, and specifically designed to work with the tube types and circuits used in the top television receivers in the field. Millions of RCA TV Components are in use today. Play safe... replace with RCA "Originals." Use them in *your* shop.

GET YOUR FREE COPY OF THIS COMPONENT DIRECTORY

Tells at a glance the type numbers of RCA TV Components for replacement in 214 television sets of 38 manufacturers. Only guide of its kind! Get yours today from your RCA Distributor. (Specify Form SP-1006.)



RADIO CORPORATION of AMERICA
ELECTRONIC COMPONENTS
HARRISON, N. J.



New Stations and Servicing

TELEVISION installation and servicing, quite alive and kicking since the earliest days, now appears to be entering a rousing bouncing era, with mounting opportunities at every turn. Today, Service Men need not only be concerned with original installations and possible servicing, but modified installations and adjustments, required when TV stations change their locations and particularly when new transmitters are placed on the air.

In two instances in New York City, recently, these points received quite a healthy check and double check. In one case, the transmitter and tower were moved to a better site, and in another a new transmitter began telecasting. While the site transfer did not present too many viewing problems, the inauguration of the new service offered plenty of headaches. In a poll of over a hundred selected receiving locations, conducted to determine the reasons for volumes of reports on unfavorable reception, a variety of antenna and adjustment troubles were detected. It appears as if the majority of the sets in these areas were tuned up for the channels which had come on earlier, and accordingly reception from the new station, in most instances, was from poor to just bad.

The survey revealed that there were seven basic faults reported by viewers. These were . . . double or multiple images; snowy or washed-out pictures; intermittent streaks, bars or herring-bone patterns; jumpy pictures; no sync in sound and picture tuning; static on sound; no sound on channel.

Here were problems which were not due to transmitting inefficiency, a condition originally suspected, but due instead to either an improperly adjusted receiver or an ineffective antenna system . . . problems made to order for the Service Man. In probing for a solution to this rather odd situation, the broadcaster involved in this embarrassing series of events, agreed that the Service Man was the man for this serious job. Accordingly a cooperative program was decided on, which would include airing of the possible troubles and solutions, when viewing is

not satisfactory. Copy now being prepared will reveal viewers that . . . the Service Man may have to reorient your antenna; another antenna may have to be installed as an attachment; the tuner may have to be readjusted; and that the small sum paid to the Service Man for this service will be more than repaid for by the entertainment available over the channel.

There are many areas throughout the country in which the viewing problem is just as acute and broadcasters do or soon will recognize the critical aspects of the situation, which demands the attention of the TV Service Man.

In some localities, Service Men aware of the difficulties, have been quite resourceful and sponsored their own surveys, visiting TV set owners and making the required adjustments and often including modifications of the antenna system.

The antenna was found to be an excellent solution to many of the receiving variables. In the New York case, several types of antenna alterations were found to afford better viewing. Since signals from the new station came from a direction completely opposite from that of the other channels, the modifications involved were quite interesting. In one antenna change, advantage was taken of the side lobe pickup pattern of the conical pattern. It was found that straight and folded dipoles used as combinations do not have a high-gain side-lobe pickup. Therefore, a direct substitution of the conical was able to bring in the station which, in this instance, was on channel nine. The broadband inline type of antenna solved the problem in another instance. A high-frequency attachment added to the system, and pointed at approximately right angles to the inline array was very helpful. Tests indicated that there were times when the *hf* element would pick up a reflection on the *lf* channel and induce it into the antenna circuit so that it marred the reception on the low-frequency channel. (If the high-frequency attachment, when connected and adjusted, does mar the reception on both the high and low-frequency channels, a separate

coaxial transmission is then required, and a suitable coax switch introduced to affect a transfer of antennas.)

The single-channel yagi type of antenna was also found to have a place in the readjustment program, being used in the fringe areas where it was necessary to beam the antenna sharply to the transmitting tower.

In studying the receiving-set ailments, such as intermittent streaks, the result of sound in the picture, the New York investigators found that, in most cases, the front ends of the switch-type tuner in the receivers had not been adjusted for the specific channel. (To detect this trouble, the streaking must be viewed carefully to see if it follows the sound modulation of the program on the channel. When there is only a tone being transmitted with the pattern, continuous bars appear across the pattern, but when music is being transmitted along with the test pattern, streaking follows the tempo of the music.)

The complaints of jumping pictures were found to be due to insufficient signal on certain types of receivers which require heavy drive of sync level if the pictures are to be stable.

The static-in-the-sound difficulty, which is normally accompanied by an auxiliary complaint of low audio level, was found to be due to both channel alignment and antenna pickup, insufficient FM level being available to operate the noise limiting circuits in the FM sound section of the TV receiver. The starting and stopping of refrigerator motors and ignition discharges from autos, was found to cause much of the trouble, the noise riding into the 300-ohm twin lead. Replacement of the open lead with shielded-balanced line or coax line and a matching transformer served to relieve the situation.

The poll also disclosed one other vital factor; the urgent need for a complete familiarity with circuit design. Detection of the numerous problems cited would not and cannot be possible, unless there is a comprehensive circuitry knowledge at hand.—L. W.

The AF SWEEP

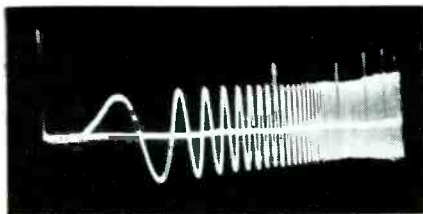

Fig. 2. Plot of signal as it comes from the generator which covers a band from 40 cps to 10 kc, and is flat over this range to within one db. Frequency markers occur at 1, 3, 5, 7, 9, and 10 kc. The base line is useful for determining relative amplitudes. The reduction of any point to half its amplitude is an attenuation of 6 db.

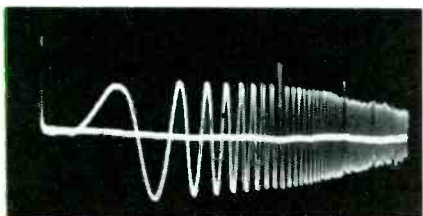
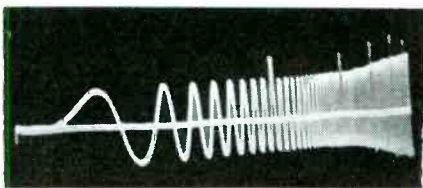

Fig. 3. Response of an amplifier to 10 kc. showing a gradual attenuation of highs with a maximum attenuation at 10 kc of 5 db. This same condition can be produced by a tone control.

(Below)

Fig. 4. Amplifier response in which the tone control has been set for enhanced highs.



(Below)

Fig. 5. Capacitor-reactance curve, where there is a capacitor in series with a 500-ohm line.

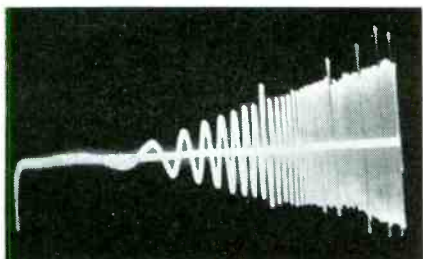
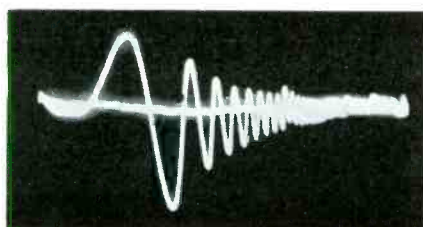

Fig. 6. The effect of an inductance of several henries in series with a terminated 500-ohm line. This simple element produces a clean wave form especially in the lower frequencies, because transients which are of a higher frequency will have been attenuated.



DID YOU ever try to check the bandwidth of an *rf* or video amplifier by touching the control grid with a screwdriver? A ridiculous question, isn't it? Yet in audio-amplifier servicing, this familiar test often represents the full extent of frequency-response and audio-quality measurements. Surveys and on-the-job checks have disclosed that measurements of distortion, bandwidth, and frequency-response characteristics are as important in *audio* work as they are for *rf* and video amplifiers. While it is true that the design and present condition of some of the *pa* amplifiers, music-playing systems, etc., are not such as to encourage an overall check of operating characteristics, the majority of these systems *do* rate a comprehensive analysis. A thorough checking in most instances will more than make up for the additional time and attention by improving the performance and output quality of the system. This, in turn, can be a very important factor in establishing a reputation for the Service Man and in soliciting business of a *higher caliber* for the shop.

Advantages of Sweep-Frequency Testing

Many Service Men shy away from making frequency-response measurements on any but the most expensive equipment. This is understandable from the viewpoint of the *ordinary* method, which consists of feeding a number of sine-wave frequencies (singly) into the amplifier under test and noting the amount of relative gain or loss at the output. Few Service Men have the time or inclination to run through a complete set of 15 to 20 readings and tabulate the results,

Fig. 7. Pattern which results from a band-pass network circuit in which *L* and *C* in shunt derivation are in series with a 500-ohm line, and the resonant frequency is 700 cps. This is a network used in communications work where a carbon microphone is used to produce narrow-band high intelligibility.

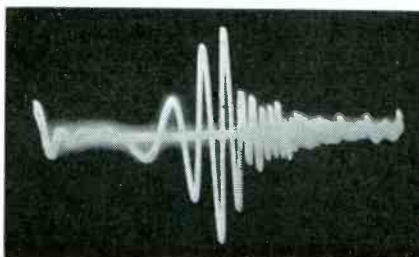

either graphically or visually. After all, this method gives only the frequency response; measurements of noise, distortion, hum, transients, etc., require still more time and more expensive equipment.

The logical instrument for use in audio-quality measurements has been found to be the audio-frequency sweep generator. With this instrument and a 'scope, the frequency response, noise, hum, harmonic distortion, transient response, and many other characteristics of any audio device can be determined at a glance. The effect of any of these characteristics at different signal inputs, volume and tone control settings, etc., or the effectiveness of various circuit changes, corrective measures, etc., can also be determined rapidly. The sweep-frequency method is also of particular value in the design of audio filters and attenuating networks, where the resonant frequency, cutoff point, band-pass or band-elimination characteristics, amount of attenuation, impedance match, harmonic content, etc., can be analyzed and changed at will. The effect and countereffect of each on the other with precise changes can be seen as they actually occur, and the results can be compared with theoretical computations. What is especially important to the sound engineer and Service Man is that a rough approximation of the desired circuit can be drawn and parts values *juggled* until the precise effects are obtained.

Basic Operation of the Generator

Early attempts to produce a stable, reasonably-priced audio sweep-frequency generator failed mainly because the systems used to produce the nec-

Fig. 8. Plot of a simple *LC* circuit calculated to be resonant at exactly 5,000 cps. The sweep-frequency generator checks the resonant frequency, *Q*, the attenuation of other frequencies. Note the pips at lower side of oscillogram due to phase change caused by capacitance in the circuit.

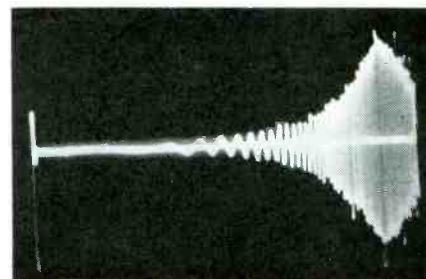

GENERATOR

In Servicing Operations

essary sweep were mechanical. The size, weight and subsequent wear of the purely mechanical systems made them too impractical.

In recent years, the problem appears to have been solved through the development of models using an electronic sweep,¹ and a rotating synchronous disc and a photoelectric scanning device² as the basis of a sweep system.

The scanning disc used in the rotating-sync disc unit is a transparent card 5" in diameter, with a photographic reproduction of the sweep waveform appearing along the outer edges and covering one-half the disc's circumference. (The original sweep waveform was plotted on a 4' card, then reduced photographically). The 5" disc is rotated by a synchronous motor at a speed of 600 rpm, scanned by a 927 type gaseous photoelectric cell, and the resultant pattern passed through a three-stage amplifier. The waveform which appears at the output of the generator is shown in Fig. 2. It will be noted that the output frequency not only is flat within 1 db from 40 cps to 10 kc, but frequency markers appear at 1, 3, 5, 7, 9 and 10 kc. These marker *pips* are included on the scanning disc and hence will always appear at precisely the same frequency. Since the sweep-frequency pattern is logarithmic in nature, its waveshape will exactly match the frequency-response curve of the amplifier as drawn on linear graph paper. The base line of the sweep waveform may be used to determine the relative amplitudes of any frequency, a reduction of any point to half its amplitude representing an attenuation of 6 db. In the instrument, a 1½-volt, 30-ampere-hour A battery operates a 2.2-volt exciter lamp Mazda 222) which provides the necessary light source for the photoelectric cell. (This source of direct current prevents introduction of 120-cycle hum into the system. Battery life usually exceeds 150 hours, while the exciter lamp is good for 1000 hours or more at the reduced 1½ voltage).

No time-consuming set-ups or calibration adjustments are necessary in

¹ Wayne R. Johnson development. ² Clarkstan model 125.

Use of AF Sweep Instrument and Scope Provides Effective Check on Frequency Response, Noise, Hum, Harmonic Distortion and Transient Response. Variety of Patterns Available Provide Instantaneous Location of Equipment Troubles.

by JOHN B. LEDBETTER

Engineer, WKRC-TV

sweep-frequency audio measurements. The generator is merely connected to the input of the device under test, and the output of the device connected to the 'scope, with the 'scope range set to 15 kc. Vertical and horizontal amplitude of the 'scope may be set wherever desired for easy reading.

Typical Waveform Patterns

The analysis of sweep-frequency patterns is not at all difficult. Once the Service Man has become familiar with the wave shape of an amplifier,

recording system, filter, or other audio device under normal conditions, he will be able to determine almost immediately where the trouble lies and what is causing it.

In Fig. 3 appears a normal response pattern of an amplifier which has a gradual attenuation of frequencies above 1 kc. The maximum attenuation is 5 db at 10 kc. This may also be the result of a tone control in the circuit. It will be noted that very little distortion is present (indicated
(Continued on page 39)

Fig. 1. Circuit of the af sweep generator: Clarkstan model 125.

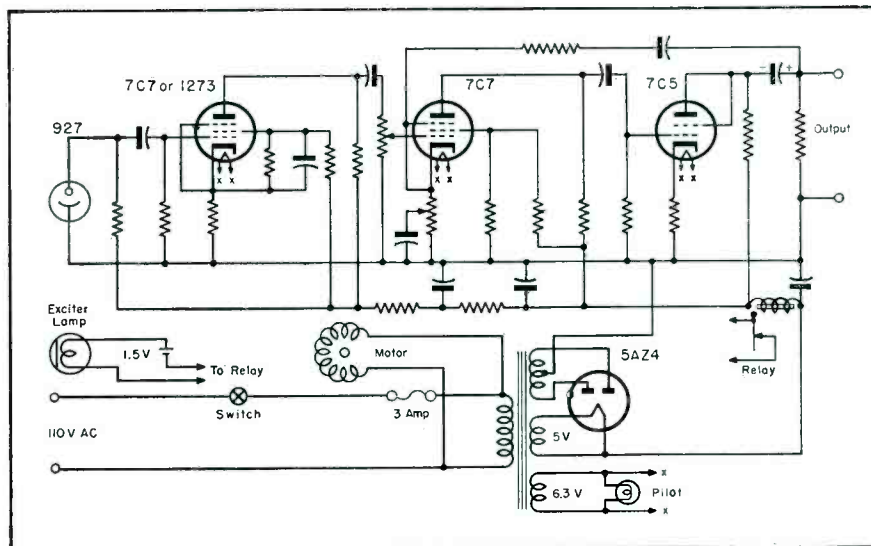

TV Servicing ISOLATION

Design and Application Features of Recently Developed Iso Units Which Isolate Transformerless TV Models While Servicing to Speed Troubleshooting.

by **ARTHUR LIEBSCHER**

Application Engineer, Test Equipment Engineering Section
RCA Tube Department

TELEVISION-RECEIVER service has brought new and unsuspected problems to the Service Man. No sooner had the Service Man learned how to deal safely with TV high-voltage systems, than there appeared sets of the so-called *ac-dc* type without power transformers. With them came the need for greater caution against electric shock, both from the chassis and from the exposed power-line voltage-doubler and series-filament wiring. While these transformerless sets operate much the same as transformer-type sets in normal service, they introduce special problems on the service bench. Their chassis may be *hot*, with respect to ground and to other chassis on the bench, and to valuable test equipment, which is grounded or in some way coupled direct to the power line.

Personal Injury Problems

Every Service Man knows how nasty a burn he can receive by an unexpected flash from shorting the power

line. He knows, too, that the power line is not a limited-current power source like the picture-tube high-voltage supply, but that there is a whole power house pumping energy into the grounded line.

Isolation Importance

The first time the Service Man comes up against a short in hooking up a TV receiver to a piece of test equipment, there may be substantial damage. This is the same type of difficulty that has been experienced for many years with *ac-dc* radios, but in TV it's much more serious because of the complexity of the TV receiver, its weight, and more costly components.

Isolating Transformer

The solution to the problem has been found in an isolating transformer, designed especially for TV receiver service.¹ The unit was provided with an

isolated secondary with a rating of 275 volt-amperes which was found to exceed the requirements of most transformerless sets now on the market. In addition to providing safety insurance, the transformer has also been found to be a valuable aid to fast, efficient servicing, since it also provides voltage adjustment through a primary tap switch and high, medium, and low-voltage output receptacles.

Line-Voltage Controls

With the new isolation transformer, line voltage can be adjusted quickly from one extreme condition to another and it is therefore possible to duplicate line-voltage conditions found in any customer's home. These conditions may be the cause of trouble.

Locating Receiver Defects

Using the low-output voltage setting of the unit, a check can be made to determine whether or not one or more of the several oscillators in a TV receiver cease to function, and also whether the picture becomes dim, distorted, or otherwise affected. Low voltage may also affect sound volume or distort the sound output. Using the transformer to operate the set at higher than normal line voltage may disclose defects not otherwise diagnosed easily.

Component Checks

Operating at higher-than-normal line voltage also *sweats out* those in-

¹RCA TV Isotap, WP-25A.

Fig. 1. Circuit of the isolation transformer system.

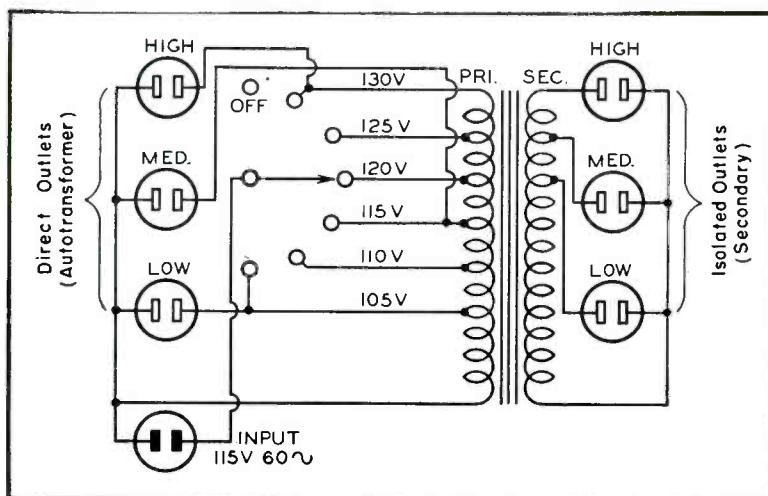

TRANSFORMERS

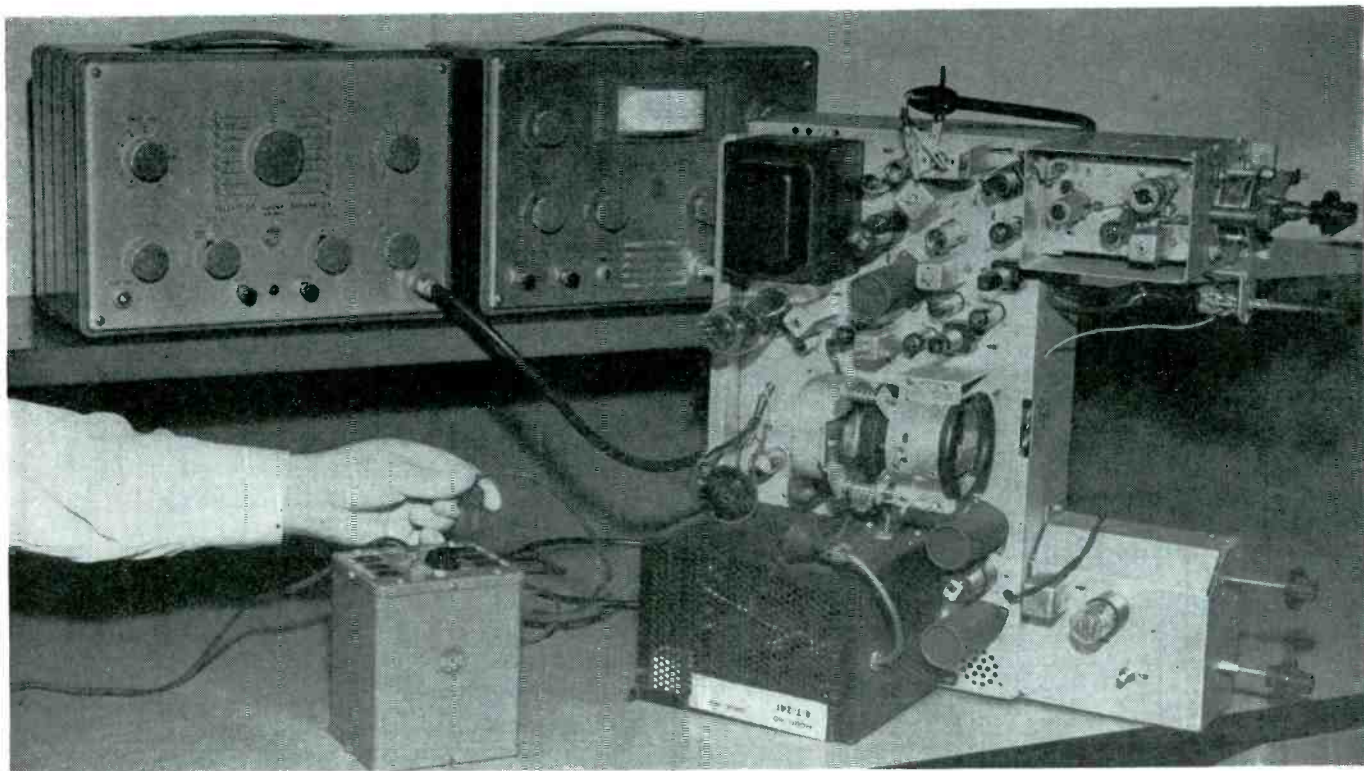

Fig. 2. Isolation transformer in operation on a TV service receiver bench.

intermittent conditions in TV receivers which will respond to an increase in temperature within the components, or to the breakdown effect of increased voltages. This *brute-force* method of determining causes of intermittent operation may save many hours of fruitless searching for components with internal defects.

Permanent Installations

Should it be found that an adjustment of line voltage is necessary to cope with a customer's complaint in TV receiver performance, it may be well worthwhile to install the isolation transformer, permanently set, to deliver the recommended receiver input voltage. This procedure alone may often mean customer satisfaction which can not be realized by any simpler method.

AC Set Applications

The unit also contains a 500-volt-ampere auto-transformer secondary

for use with *ac* types of TV sets. This winding, like the isolated secondary, is also provided with separate outlet receptacles for high, medium, and low voltages.

Primary Tap Switch

A primary tap switch, adjustable in 5-volt steps from 105 to 130 volts, is also available on the device to match *ac* line voltages. When this primary switch is set to correspond to the available power line voltage, the low, medium, and high-voltage receptacles provide 105, 115, and 130 volts, respectively, at normal loads.

Voltage Check Requirements

The value of the *medium* output receptacles must not be overlooked. Voltage measurement specifications, shown in the set manufacturers' service notes, are made with the sets operating from a normal line of 115 or 117 volts. To save time and error, the

Service Man should make service-check measurements with the set operating at the line voltage specified by the manufacturer, a facility provided by the iso transformer.

Voltage Flexibility Advantages

This flexibility of power-line voltage adjustment makes the iso unit useful for many applications other than TV servicing. To cite one example the item can be used as a temperature-adjusting device for a soldering iron. Set to low-voltage output, it will keep an iron warm during its idle periods. Set to high output, the unit will overheat a soldering iron as a temporary measure to make it useful in melting solder on large metal surfaces such as on receiver chassis.

Other Iso Unit Applications

The iso transformer can be used to provide an adjustable power line voltage for audio amplifiers, test equipment, neon or fluorescent signs, etc.

REMOTE-CONTROL

for Garage Doors

Fig. 1. Two types of transmitters used for garage door opening. (Courtesy Federal Industries, Inc.)

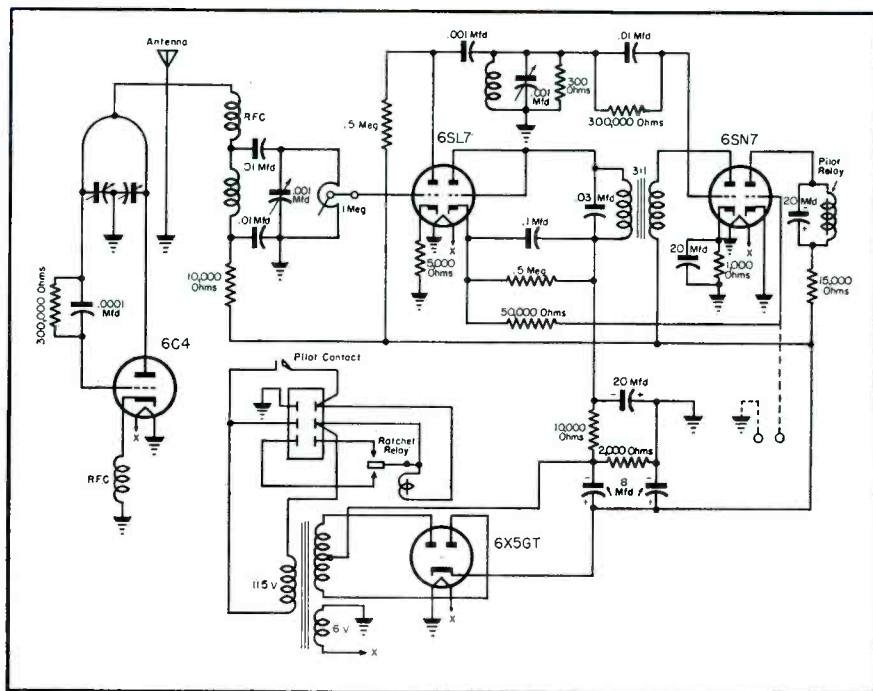
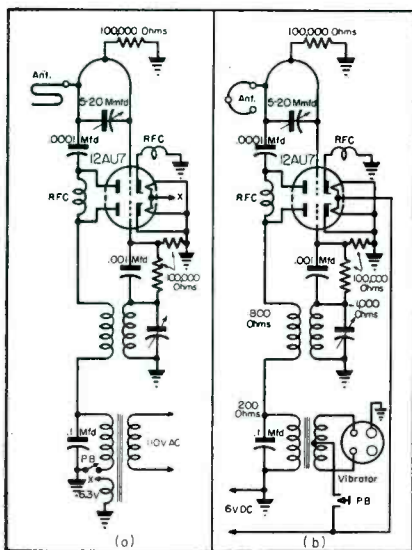

Fig. 2. The receiver used in conjunction with the garage-door-opener transmitter. (Courtesy Federal Industries, Inc.)

THE RECENT development of *vlf* transmitter-receiver combinations, affording activation of relays which can operate heavy doors, such as found in a garage, has introduced a new, novel installation field¹ for the Service Man. These systems, serving to open and close doors from a car up to 85' away, employ a transmitter mounted in the automobile, a receiver tuned to the transmitter, relays activated by the receiver, and an electrically-powered door mechanism.

It has been found that two men can completely install a door operator and one transmitter in three hours with the aid of a portable hole punch, a portable angle iron cutter, and electric drill.

The transmitter can be mounted anywhere in the automobile. Usually the engine compartment is the driest and most convenient place. It has but a single tube, a 12AU7, which is permanently connected to a 6-volt power system of the car through the ignition switch. Plate power is supplied by a vibrator. A push button mounted on

the dash or any other convenient place completes the vibrator circuit when a signal is desired.

Since there is a possibility that there may be two or more radio-controlled doors within 85' of each other, the transmitter has been designed to operate on any one of six allocated frequencies in the 210-250 mc band. To further reduce the possibility of fraudulent use of the door, or accidental electrical interference operation, the transmitter uses a so-called *triple-gate* system. In operation, the carrier signal is modulated by a 10,000-cycle note, interrupted at a rate of 115 cycles. Both the carrier and the modulating frequencies can be varied over a narrow band to further forestall thieves and accidental door operation. The interrupting frequency, of course, remains fixed.

The receiver, powered from the line, 115 volts ac, draws 12 watts and is on continuously.

¹An FCC operating license is necessary for this type of installation and test work.

The motor, which draws current only when it is in operation, is a single phase $\frac{1}{4}$ hp 115-volt capacitor start, induction, reversible type. One of its windings is reversed to effect a reversal of rotation.

The motor is belted to a worm upon which a traveling fork rides. When the motor turns in one direction the fork moves and opens the door. In the other direction, the door is closed.

There is a friction clutch on the worm between the thread of the worm and the pulley. When something obstructs the easy passage of the door, this clutch slips. This protects children and pets who may be under the door.

A long rod, mounted parallel to the worm, is able to slide and is connected to the stop and reversal switch on the motor. When the nib on the fork touches adjustable fingers on this rod the door stops. When it is again activated, the door moves in the other direction.

This type of door opener will handle

How to Install System, Designed for Sectional Doors, which Features a Single-Tube 12AU7 Transmitter Operating on Any of Six Frequencies in 210-250 Mc Band. Triple-Gated Circuit Used to Insure Operation of Specific Door To Which Signal is Beamed.

b y M A X A L T H

any type of sectional door, but not a hinge or the roll up type.

The first step in an installation consists of checking a door to make certain that its counter balances are functioning, and that it moves easily in its tracks.

Whenever possible, stops should be fastened in the door's track to prevent accidental over running.

The high rise of the door must then be measured; this is the closest the door comes to the ceiling and appears as the door makes its bend. The center of the worm should be about 4" above this level. When and where this clearance is not possible, special forks must be used.

The forward support is then mounted in the horizontal center of the door, on the header, because it is usually very strong. When this header is constructed of timber, $\frac{3}{8}$ " by 4", lag bolts must be used.

The worm need not be in the exact center of the door, but it has been found to be best that way. If the worm is mounted too far off center, and the door is loose in its tracks, the door may easily freeze, so that the entire door or track will have to be disassembled to free it.

The length of the worm used depends upon the height of the door to be raised. A 7' worm will clear any ordinary passenger car and most small trucks.

The other end of the worm must so be set up that the length of the worm is at right angles to the width of the door, or parallel to the motion of the door. This need not be exact, as the type of bearings used permits as much as 10° of deviation. The eye will be sufficiently accurate as a judge.

In the next step, the worm must be raised and placed in the forward bearing. The door may now be partially opened and the weight of the worm rested upon the top of the door. A

vertical line must then be drawn from the end of the worm to the ceiling. This point is marked, and a hammer used to locate the beams in the ceiling behind the plaster. A length of $1\frac{1}{4}$ " by $\frac{1}{4}$ " angle iron should be cut long enough to clear two beams. Holes are then drilled or punched to engage the beams, and engage two lengths of angle iron that will hang down and support the motor on its plate. The angle iron is bolted to the ceiling. Its length must be parallel to the worm, and x inches to one side; this distance is calculated by measuring the distance from the motor plate to the center of the rear bearing. In other words, the motor must be mounted to one side of the worm, or approximately 7" off center. The center of the overhead angle iron, the length fastened to the ceiling, should be about 5" to the rear of the end of the worm. The two lengths of angle iron dropping down are, of course, spaced the width of the motor plate, apart.

The drive wheel should then be forced on the end of the worm, and keyed in place.

The worm is raised until it is level with the ground, or parallel to the line the door takes when it is in an overhead position.

The next step involves raising of the motor unit and placing the worm in its rear bearing. When the works are in alignment, the position of the

necessary holes are marked. Then the holes are drilled or punched, and two more for the angle braces (1" by $\frac{1}{8}$ " or $\frac{1}{4}$ ") made from strap iron, half twisted. If the braces are first bolted to the angle iron, the vertical plane of the unit judged by eye, and then the lag bolts ($\frac{1}{2}$ ") are driven through the braces and into the ceiling, the task will not be difficult.

After the foregoing operations are completed, the door can be closed, the worm turned until the fork is 2" from the end of the worm. Then the length of the fork is cut to size. Holes are drilled in the top of the door for the bracket, and carriage bolts used to bolt the bracket fast. The fork is then bolted to this bracket. The door can now only be moved by turning the worm. In cases of emergency, power failure, and such, this is the bolt that has to be removed to restore hand operation.

The setup is tested by means of an extension cord, and a short length of wire used as a jumper, placed in a plug.

The receiver may be placed anywhere within reach of its cables, or further if they are lengthened, but the most convenient place is on the other side of the motor plate.

Then the connections to the motor can be made and the setup further checked by depressing the relays by hand.

The door stops, the fingers on the long metal rod, then require adjustment. This system requires that the door must go through its complete cycle. The door cannot be backed up.

The maximum open position is when the fork is 2" from the back end of the worm. The closed position finger should be so adjusted that the motor is shut off when the door is about $\frac{1}{4}$ " open. Momentum will move it the rest of the way. Without the clearance,

(Continued on page 42)

Fig. 3. Friction clutch on the motor shaft.

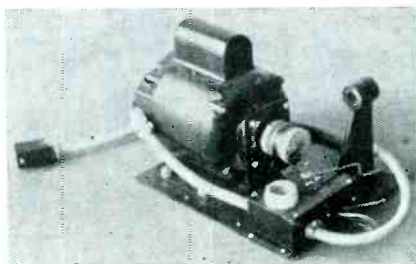

12 $\frac{1}{2}$ "-16" TV Chassis

DESPITE A reduction in the number of tubes in recently-produced TV chassis, the end-result effectiveness has not been materially altered. As a matter of fact, in some models, some of the streamlined circuiting provides a performance equivalent to and perhaps better than the more complex arrangements. In the Magnavox CT-247/248/249 chassis, for instance, there are sync separation circuits (*see cover*) which have been found to be the equal of the systems used in larger models.

Using a 12AU7, vertical pulses are partially separated by a long-time constant in the plate of one-half of the tube, serving as a pre-sync separator, and added to partially separated composite sync pulses from the other half of the tube, used as an *agc* detector. There is, therefore, reinforcement of these pulses as would be had by selective regeneration, without the hazards of regeneration. Further amplifica-

[See Front Cover]

by J. F. BIGELOW

The Magnavox Co.

tion, levelling and clipping results in clean sync pulses at low signal levels. A modified *syncrolok* discriminator type *afc* assures additional set stability.

The vertical-oscillator pulse fed back through the integrating network is prevented from mixing with horizontal sync through isolation in one-half of a 6SN7GT, serving as a sync clipper. Such a mixture would tend to curve picture sides at the top.

The vertical-oscillator output-tube circuit (other half of the 6SN7GT) is unusual in that the two circuits are combined, rather than separate oscillator output stages; one-half of the oscillator is a power amplifier feeding a signal of the proper polarity for regen-

eration to the tube. Both primary and secondary vertical deflection damping is used to enhance linearity and to reduce crosstalk.

High voltage in this model can be increased from 9 to 12 *kv* by connecting a *hw* filter capacitor ground end to terminal *four* of the transformer in the 1B3GT/8016 and 6W4GT damper circuit, instead of to ground. This added voltage is applicable to 16" picture tubes. The capacitor thus utilizes also the negative deflection coil pulse for high *dc* voltage.

Most prominent in causing 60 cycle *buzz* in receivers using intercarrier, as this model, is non-linear operation and overloading, leading to cross modulation between sound and video signals. To avoid this, tubes are operated conservatively, with efficient *agc* and audio amplifier degeneration. A ratio detector is employed because of its superiority in AM rejection even at

(Continued on page 43)

Fig. 1. Complete circuit of the Magnavox CT-247, 248 and 249 receiver, shown in part on the cover this month.

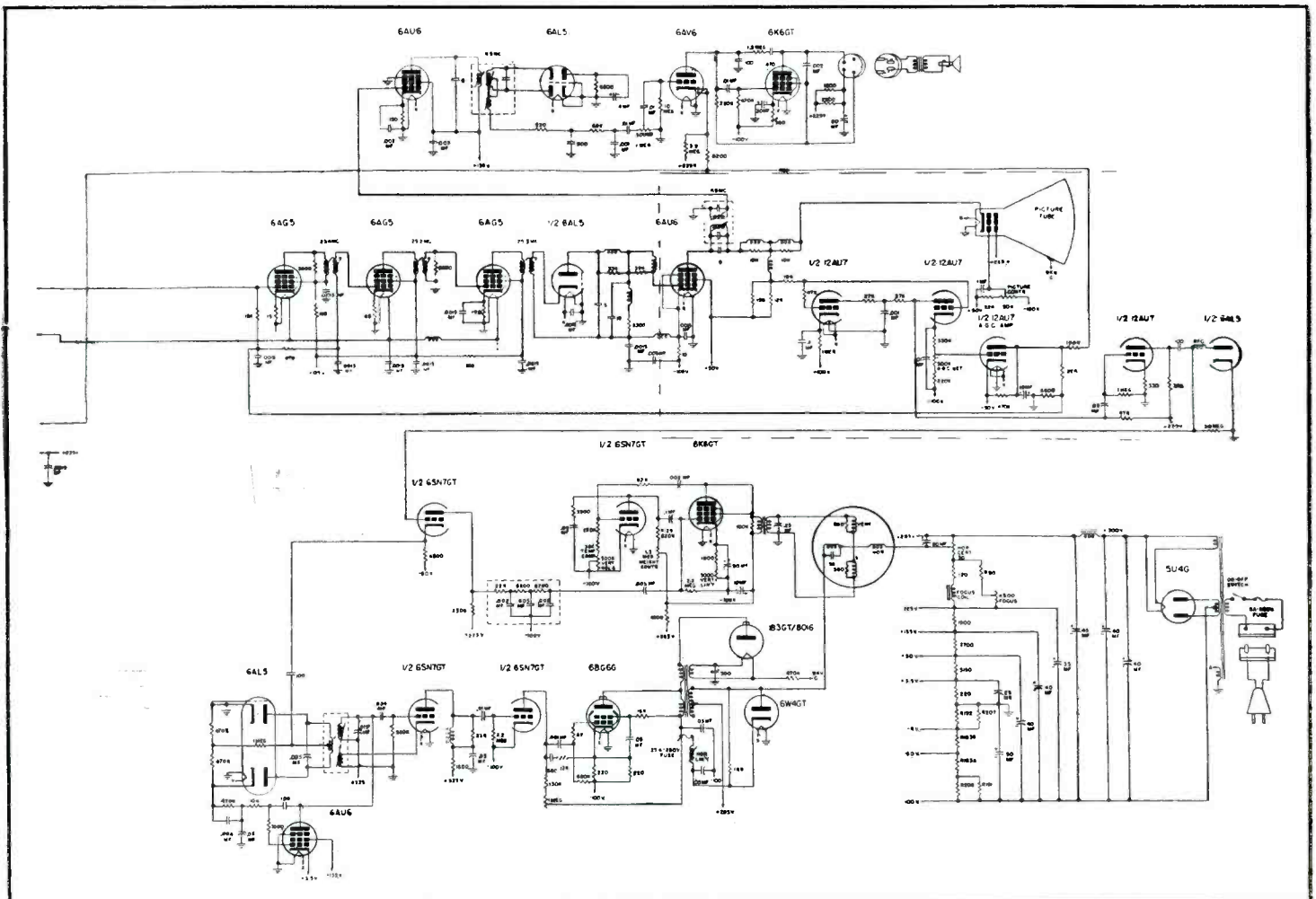

"Complete, Accurate

TV SET ALIGNMENT IN 15 MINUTES!"

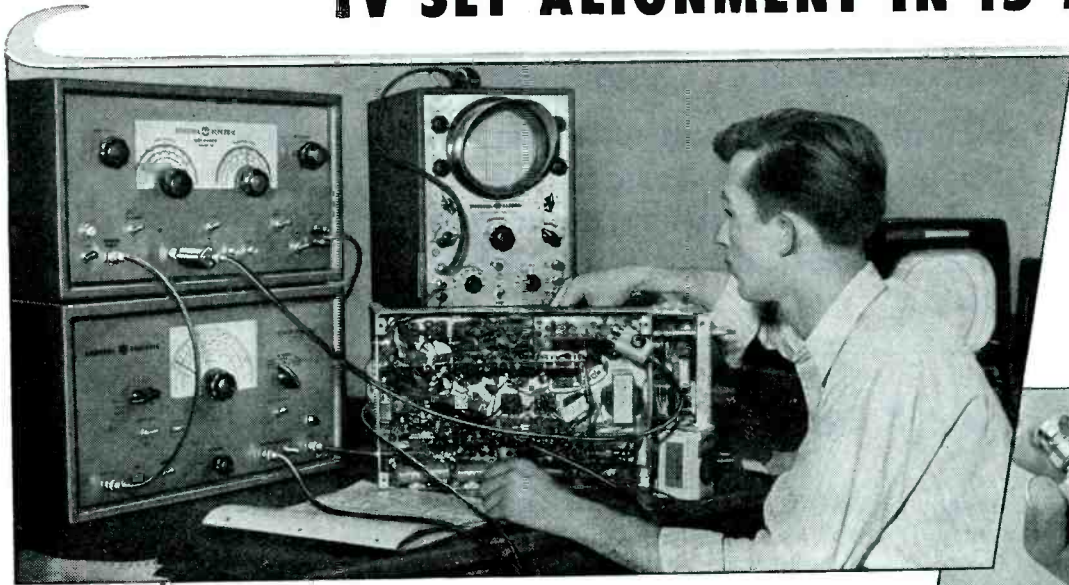

Says **JIM OTTMAN**
TV Service Supervisor
 General Electric Supply Corp.
 Buffalo, New York

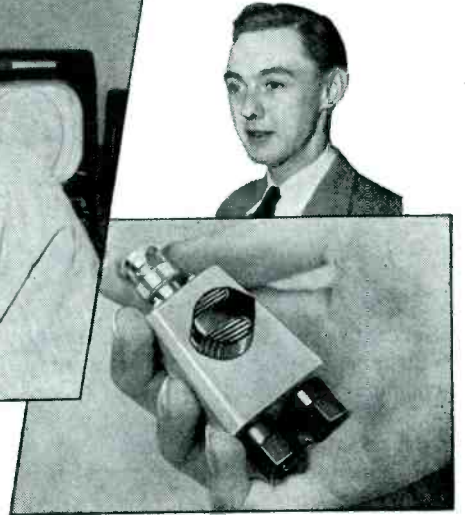

New! Balanced output adaptor (Type ST-8A) permits accurate alignment of balanced input receivers. Now G.E. offers you both single-ended and balanced output.

"COMPLETE alignments used to take us half a day when we used a conventional sweep. Now we do them in 15 minutes with our G-E Test Equipment Package!

"We align 60% of the sets that come into the shop—as an extra service to our customers. Result—we've been getting letters from pleased patrons who say their receivers work better than ever! *This has built our service business faster than anything we've done before.*

"We now repair most head ends right in the service shop because the G-E Variable Permeability Sweep has enough output to do the job alone. This G-E Package is the only equipment

we've found that will align an inter-carrier circuit receiver quickly and accurately. With it, we get accurate marking of frequency by crystal controlled markers, plus clear visual presentation from the wide-range Cathode Ray Oscilloscope.

"It does more things *better* than any equipment we've ever used. Without it we could never service so many receivers so fast, so accurately!"

That's the opinion of TV Service Manager Jim Ottman, of Buffalo. What this G-E equipment has done for his operation, it will do for yours. It's easy to buy—simple to use—and what a difference in results!

**ASK ABOUT THE G-E EASY BUDGET PLAN!
 LET THE EQUIPMENT PAY FOR ITSELF!**

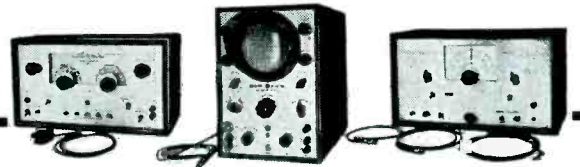

General Electric Company — Section 320
 Electronics Park
 Syracuse, New York

Send me complete information on the G-E Television Test Package and new Balanced Adaptor — plus TERMS OF THE EASY BUDGET PLAN.

NAME _____

ADDRESS _____

CITY _____ STATE _____

You can put your confidence in—

GENERAL  ELECTRIC

PHONO *installation and service*

Scratch-Eliminator Circuitry ... Phono-Combination Three-Speed Changer Design and Operation ... How to Replace Phono Parts and Assemblies ... Eliminating Distortion in Two-Needle Cartridge Assemblies.

by **KENNETH STEWART**

SPECIAL CIRCUITS to improve phono reception have become features of most combination models. One type of circuit which appears to have been widely adopted has been the scratch eliminator, an interesting version of which is shown in Fig. 1*.

This circuit, developed by Philco, may be switched on or off, as required. The pentode section of a 7E7 functions as a variable shunt capacitance at the phono-input circuit; at low signal levels, a controlled portion of the higher audio frequencies is bypassed to ground. The grid bias of the reactance tube controls the effective capacitance, which becomes maximum with low bias, and minimum with high bias. This control bias is developed by the audio signal itself; a proportionate amount of the signal is taken from the pickup output, amplified by each triode section of the 7E7, and rectified by the diode section of the 7E7.

The audio circuit of the receiver (model 50-1726) in which this system is used, also employs several novel arrangements to improve fidelity.

The triode section of a 7X7 functions as the first audio stage. A 6J5GT triode operates as a plate-and-

cathode-loaded phase inverter, driving two 6V6GT output amplifiers, in push-pull operation. Tone fidelity is obtained by the use of inverse feedback in the audio system; feed-back voltage is taken from the secondary of the output transformer.

Three-Speed Changer

The record changer (M-20) employed in this model has three speeds (standard, 45 and long play), controlled by a speed selector located to the right of the record-shelf assembly. These speed changes are brought about by the shift lever, which changes the

positions of the idler wheel and pulley with respect to the motor shaft.

The changer mechanism of the record changer is brought into action when a small retractable gear segment, mounted on the cam gear, is released, and engages the hub gear of the turntable shaft, causing the cam gear to be driven. While a record is playing, the retracted gear segment is held in the retracted position by a trip-plate retaining wall, which engages the roller of the gear segment. The segment is released either manually, by pushing a *off-man-aut-rej* control to *rej*, or automatically, when the changer tone arm reverses direction as the needle follows the eccentric finish groove of a record. For 45 rpm automatic operation, an additional trip mechanism is brought into play. This trip mechanism is actuated by a trip stop, mounted on the trip receiver. When the needle of the tone arm enters the finish groove of a 45 rpm record, the trip stop engages the trip lever, which releases the hammer; this hammer strikes

Speaker featuring an exponential design for its complete length—for the tone arm, the reflector and the bell. Has a low-frequency cut-off design point which is said to provide a rising response characteristic for sharper articulation. Features a built-in watertight cast aluminum transformer housing, aluminum-wound voice coil, 20 watts continuous capacity and 35 watts peak capacity. Frequency range 450-6,000 cycles. Available in 8, 15 or 45 ohms. (Type MN-15B; Racon Electric Co., Inc., 52 East 19th Street, New York 3, N. Y.)

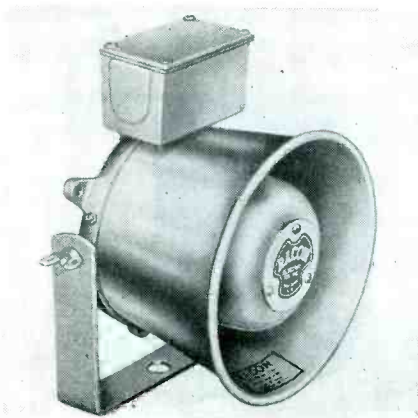

Modified replaceable stylus assembly for use with variable reluctance phonograph cartridge. Design, in which the horizontal stylus arm has been given a double twist and is double damped, has been named the *Baton* stylus. (Courtesy G.E.)

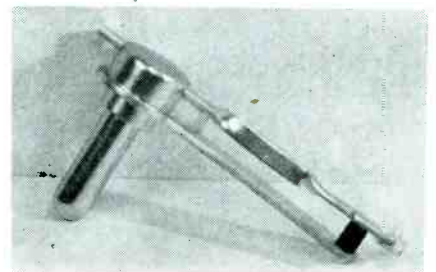

An automatic record cleaner which features goat hair. (Courtesy Zim Products, 6722 Devonshire Ave., St. Louis, Missouri.)

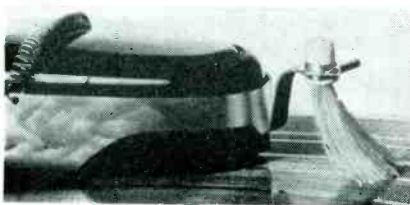

the trip plate, and pushes it aside. The gear segment is then released for either the standard or long-play operations.

The tone arm of the record changer is operated by two link assemblies attached to actuator levers, which are in contact with the cam surfaces of the cam gear. When the cam gear starts rotating, the lower actuator lever is pushed outward first, and the link assembly with a long cord attached to it raises the tone arm off the record. As the cam gear continues to turn, the upper actuator lever is pushed outward, and its link assembly pulls the tone arm out against the rest post. At this instant, a roller on the cam gear makes contact with the push-off actuator (which is connected to the record-shelf assembly through a series of push-off bars), and operates the record-dropping mechanism.

After the record has dropped to the turntable, the cam releases the upper actuator, permitting the tone arm to move inward. As the tone arm moves toward the center of the turntable, the index finger engages one of the selectors, which stops the tone-arm travel at a point just above the start groove of the record. Following this action, the lower actuator, which is engaged with the lower cam surface of the cam gear, starts riding inward, relaxing the long cord and link assembly, allowing the tone arm to set down onto the record.

Replacement of Parts and Assemblies

The removal of parts and assemblies from phono units, which is an exacting operation, can be simplified by following a definite pattern. For instance, in removing the crystal from the pick-up in the Philco models, it is suggested that the crystal be grasped with the fingernails. Then with the other hand, the tone arm should be held and slight pressure applied on switch lever, pulling down and to the outside. Replace by holding crystal contacts toward spindle, and pushing upward until firmly seated.

Removing the Needle

To remove the needle, Philco reports that it should be lifted out gently with a prying motion, using fingernail or knife point. When replacing needle, align key of needle shaft with keyway in chuck of cartridge, then push needle into cartridge.

In removing the spindle, the cotter pin should be removed from lower end.

*From service notes prepared by Philco.

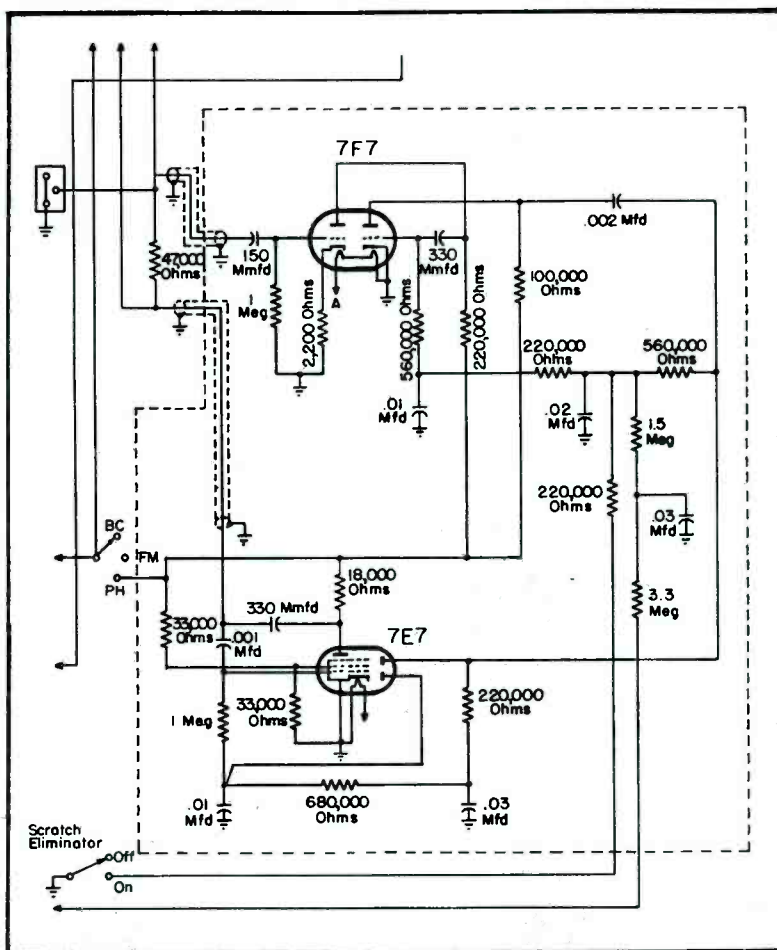

Fig. 1. Circuit of the Philco electronic scratch eliminator. The 7F7 serves as the scratch amplifier and the 7E7 as the rectifier-reactance control.

and spindle pulled out. The turntable may now be lifted off.

Replacing the Turntable

When replacing the turntable, the speed-control button should be positioned midway between long-play and 45. The idler wheel should be held back toward the center while positioning the speed control until the idler stays retracted. Then the turntable

can be replaced. This method will prevent damage to the idler-wheel tire.

Distortion in Record-Changer Reproduction

Some field reports have been received by Admiral indicating that record changers using the two-needle crystal have developed distortion in the field.

Investigation of the complaint has
(Continued on page 44)

Fig. 2. Circuit of the three-speed setup in the model M-20 Philco record changer.

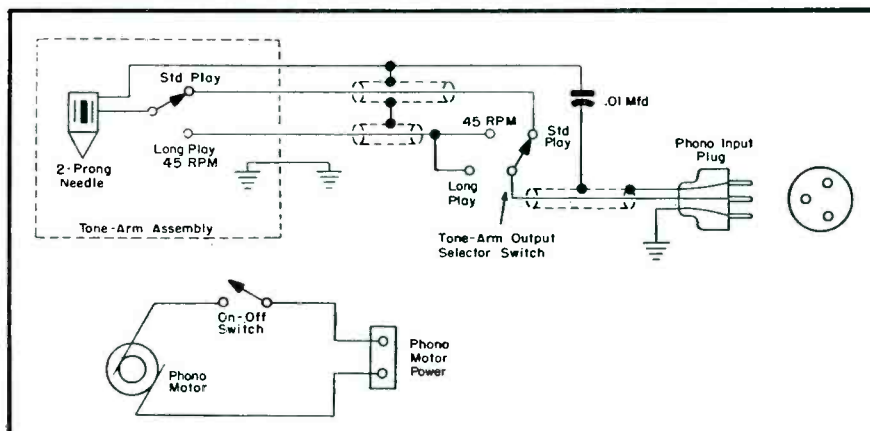

NOW..A NEW, WIDER LINE

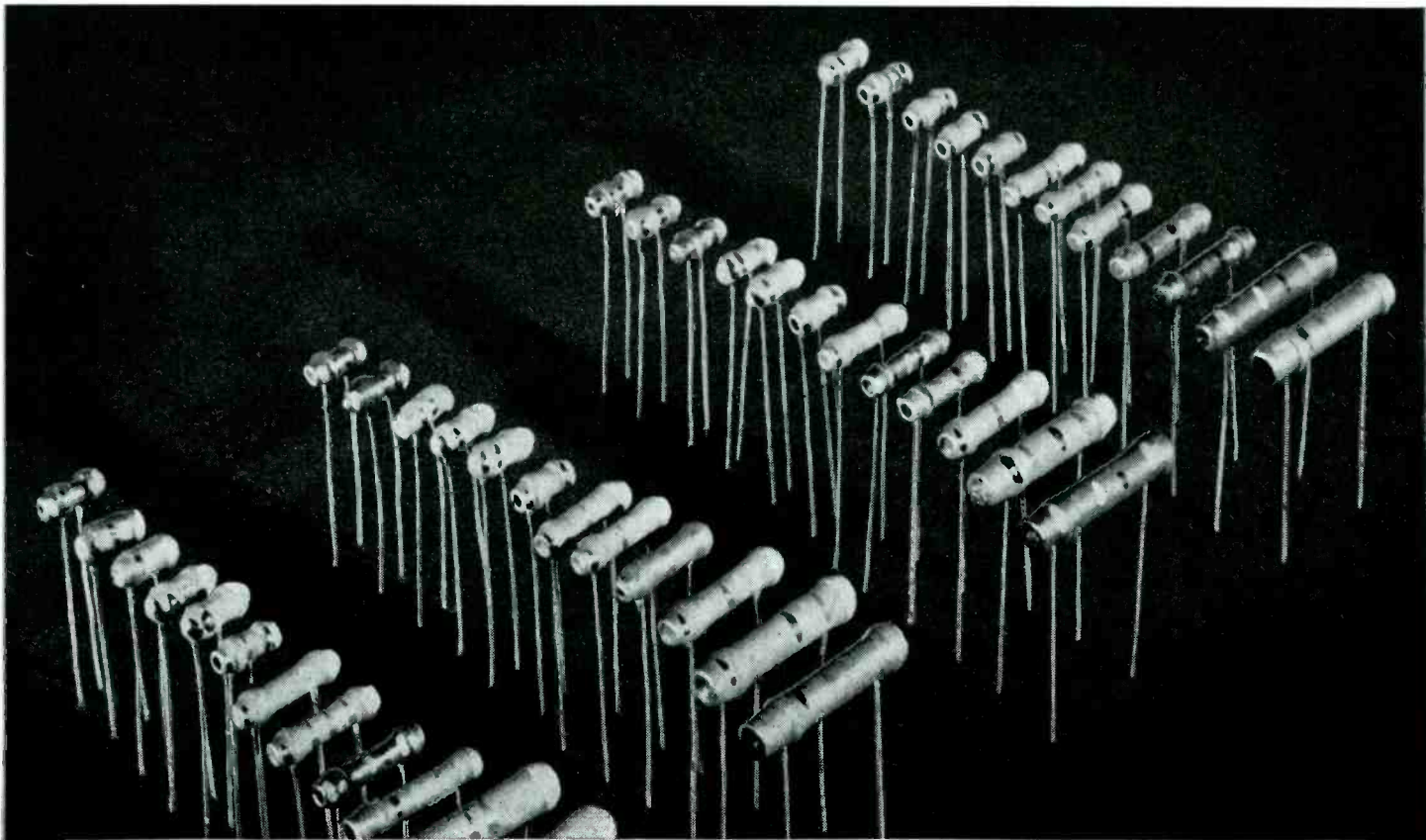

Choose from this Complete Ceramic Capacitor Line

Your radio parts distributor can supply you with these BC HI-KAP Tubular Ceramic By-pass and Coupling Capacitors in the following values — all rated at 600 WVDC, flash tested, 1000 VDC. Packaged in cellophane envelopes, 5 of one value per envelope.

Capacity	CRL Cat. No.	Capacity	CRL Cat. No.	Capacity	CRL Cat. No.
10MMF	D6-100	120MMF	D6-121	1,000MMF	D6-102
12MMF	D6-120	150MMF	D6-151	1,200MMF	D6-122
15MMF	D6-150	180MMF	D6-181	1,500MMF	D6-152
18MMF	D6-180	200MMF	D6-201	1,800MMF	D6-182
20MMF	D6-200	220MMF	D6-221	2,000MMF	D6-202
25MMF	D6-250	250MMF	D6-251	2,200MMF	D6-222
27MMF	D6-270	270MMF	D6-271	2,500MMF	D6-252
33MMF	D6-330	300MMF	D6-301	2,700MMF	D6-272
39MMF	D6-390	330MMF	D6-331	3,000MMF	D6-302
40MMF	D6-400	390MMF	D6-391	3,300MMF	D6-332
47MMF	D6-470	400MMF	D6-401	4,700MMF	D6-472
50MMF	D6-500	470MMF	D6-471	5,000MMF	D6-502
56MMF	D6-560	500MMF	D6-501	5,600MMF	D6-562
68MMF	D6-680	560MMF	D6-561	6,800MMF	D6-682
75MMF	D6-750	680MMF	D6-681	7,500MMF	D6-752
100MMF	D6-101	750MMF	D6-751	10,000MMF	D6-103

For other ceramic capacitor replacement needs, use CENTRALAB's line of TV HI-VO-KAPS, KOLORDISKS and TC capacitors.

OF TUBULAR BC HI-KAPS!

Mr. Service Engineer . . . If your profits and reputation depend on guaranteed repairs, then this message is for You! Centralab . . . the First name in ceramic components . . . gives you famous ceramic tubular BC Hi-Kaps in 48 different and many new values. Check their advantages . . . see why CRL BC Hi-Kaps are absolutely safest for guaranteed repairs.

The present trend to *guaranteed service policies* demands that service engineers take no profit-risking chances with replacement parts of doubtful performance and durability.

Chart below gives you the facts. Read them. See why we say *no other tubular by-pass and coupling capacitors made will outperform or outlast CRL Tubular Ceramic BC Hi-Kaps!*

Centralab

DIVISION OF GLOBE-UNION INC., MILWAUKEE, WIS.

Check these Features . . . See for Yourself why CRL BC Hi-Kaps are "safest"

"HI-KAP" FEATURES	DESCRIPTION			WHAT IT MEANS TO YOU
1. Impervious to moisture	Ceramic-X is non-hygroscopic. Moisture absorption is .007% or less.			No deterioration, no shorting. Longer life even under the most adverse conditions of humidity.
2. Low mass weight	AV. WT.	DIMENSIONS	VALUES	For unit size and weight, Centralab BC "HI-KAPS", made with Ceramic-X, are the only capacitors on the market which provide these voltage ratings.
3. Small Size	.029 oz.	D— .260" L— .530"	10—390 mmf.	
	.044 oz.	D— .260" L— .810"	400—3000 mmf.	
	.050 oz.	D— .280" L— .900"	3300—5000 mmf.	
4. High capacity	.082 oz.	D— .330" L— 1.200"	5600—10,000 mmf.	
Ratings: 600 WVDC — 1000 flash test.				
5. Special insulation	Low power factor resin and high temperature wax coatings, with an additional special phenolic jacket.			Prevents any possibility of shorting to adjacent leads, chassis or components.
6. Convenient side leads	Heavy No. 22 gauge tinned copper, silver soldered to electrodes.			Permit rapid, close-coupled connections. No tricky bending or fitting required.
7. Low power factor	Initial — .6%. After 100 hours, 95% humidity test — 3.0%.			More efficient circuit operation, fewer failures.
8. High leakage resistance	Initial — 5000 megohms. After humidity — 500 megohms.			Long life, more efficient performance.
9. Maximum dependability	Pure silver electrodes, electro-bonded to Ceramic-X dielectric. Protected against oxidation or mechanical damage by coatings of electrolytic copper and solder.			Moisture and puncture proof. Will not short or become intermittent.
10. Factory tested	For your protection, all units 100% factory tested before packaging and shipping.			Your guarantee to your customers of reliable service and performance.

Use of Tube Curves to Diagnose Circuit Performance

THE USE of tube curves¹ to determine possible circuit problems has been found particularly effective in the case of push-pull amplifiers.

In push-pull amplification it is necessary to consider the effects of two plate currents on the output and biasing. However, it is possible to plot push-pull conditions on a single tube set of curves, by using a plot of the type shown in Fig. 1 and the circuit of Fig. 2.

In applying the plot, it is first necessary to draw a load line which has a slope of one-quarter the plate-to-plate load. Both tubes see the impedance reflected across the primary from the secondary load. In this example, the impedance is 10,000 ohms.

In push-pull operation the plate current of one tube rises as the other tube's current falls and currents in each tube are only equal when signal variations pass through a zero-signal level. Inasmuch as one tube is connected across only one-half the primary it sees only one-quarter of the total primary impedance (reflected impedance varies as the square of the turns ratio). Thus, if we are to represent push-pull conditions on a single set of curves, a load

Part IV... Use of Tube Plots for Push Pull Amplifiers.

by **EDWARD M. NOLL**

*Instructor in Television
Temple University*

line must be drawn with a slope of 2,500 ohms.

One point on our load line is at the supply voltage point on the plate-voltage axis. Usually, with the plate winding, some plate current flows at the supply voltage level. Actually for each single tube of the push-pull stage this is still true. In push-pull zero output occurs when plate currents flow, but are equal and of opposite polarity. This equal plate-current point is, of course, at the operating bias level which, as in all transformer output systems, occurs at a plate voltage only slightly different than the supply volt-

¹SERVICE; November, December, 1949, and January, 1950.

age (drop because of *dc* resistance of winding). Thus, in push-pull service, the supply voltage is zero output level, because of cancellation caused by equal currents in both sides of the primary.

In the next step, we must draw a load line with the proper slope from this one known point.

To find the operating point of the tube a cathode line must again be drawn. Its slope must be the effective cathode resistance of the amplifier. To find this effective value the presence of two tubes' currents and screen currents must be considered. The value of the actual cathode resistor is doubled, because two tubes' currents flow through it and is further increased by

(Continued on page 45)

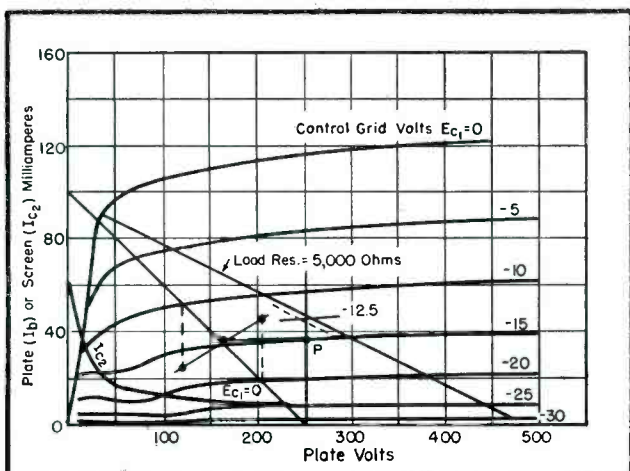
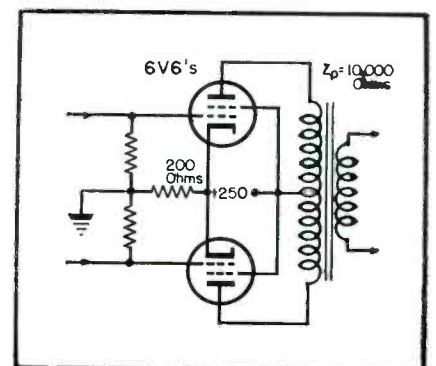

Fig. 1. Plot of the push-pull characteristics of a 6V6.

Fig. 2. A typical push-pull amplifier, used in securing the plot illustrated in Fig. 1.



new

TINY
MIKE[®]

miniature ceramic
disc capacitors

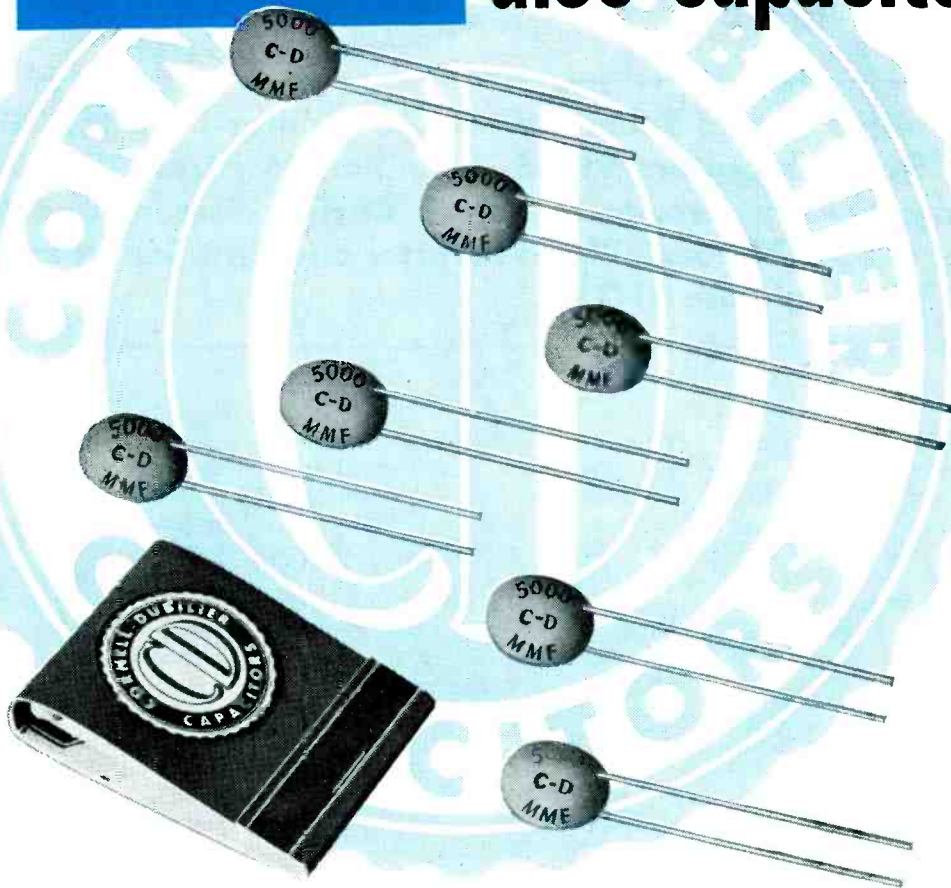

NOW—take advantage of these new, space-saving, miniature ceramic disc capacitors, designed for bypass and coupling in ultra-compact assemblies. These ceramics incorporate the same dependable performance built into the highly specialized C-D ceramic capacitors, used for years by the world's largest manufacturers of instruments and transmitter equipment.

C-D TINYMIKES OFFER YOU DISTINCT

ADVANTAGES IN CAPACITOR DESIGN:

- Ideal for cramped chassis layouts: only 19/32" in diameter, only 5/32" thick.
- TINYMIKES are lighter than other types of same capacity and voltage rating.
- Short current path and parallel leads reduce inductance to lowest possible level.
- Resistance is fixed at a low level by solder-connected leads directly to the high-purity silver electrodes.
- Use of two electrodes accurately positioned in relation to each other reduce eddy current losses to a minimum and increases the Q.

- High dielectric strength of C-D ceramic, high insulation resistance and low power factor assure constant and dependable service.
- Protected against the effects of humidity by a special phenolic coating and high-temperature wax impregnation.
- Presently available in capacities of 50 to 150 mmfd. at $\pm 20\%$ and 500 to 5,000 mmfd. guaranteed minimum capacity over a temperature range of $+ 10^{\circ}\text{C}$ to $+ 65^{\circ}\text{C}$, at 500 volts DC working.
- All C-D ceramics for servicemen are stamped with capacity ratings in micro-microfarads.
- C-D ceramics for servicemen packed 10 to convenient carton.

If your jobber doesn't have the new C-D TINYMIKE ceramic capacitor yet, write direct to the factory. We'll supply you promptly through the nearest C-D jobber stocking them. Bulletin on request. Address: CORNELL-DUBILIER ELECTRIC CORPORATION, Dept. S20, South Plainfield, New Jersey. Other plants in New Bedford, Brookline and Worcester, Massachusetts; Providence, Rhode Island; Indianapolis, Indiana and subsidiary, The Radiart Corporation, Cleveland, Ohio.

C-D Best by Field Test!

CONSISTENTLY DEPENDABLE

CORNELL-DUBILIER

CAPACITORS — AUTO VIBRATORS

TV AND FM ANTENNAS — ROTATORS — CONVERTERS



1910-1950





Analysis of 6BN6 Gated-Beam FM Sound Limiter-Detector, Gated AGC, Intercarrier, Sync Separator, Video Amplifier, Vertical Blanking, Vertical and Horizontal Sweep Circuits of Zenith Circular-Screen Models for 1950. Operation of the DC Restorer, Phase Inverter and Sync Separator, and Audio Channel of Westinghouse H-223.

CIRCUITRY, developed to provide not only increased receiver efficiency, but simplified control and servicing, has become an intriguing feature of the TV models of '50. One example of this trend appears on the cover this month.¹ Another illustration of this design appears in Fig. 1; the Zenith 24G22/23/24/25 series.

In these models, the *rf* shelf consists of a 6BJ6 *rf* amplifier, 6AG5 converter and a 6C4 oscillator. The oscillator frequency can be changed approximately 1 mc by the off-set tuning slugs which are attached to the fine tuning shaft. A master oscillator tank is a complete circuit in itself. It is shunted by the inductance on each channel strip so that the proper frequency of oscillation for the particular channel in use results. The oscillator operates above the incoming frequency on the low channels (2-6) and below on the high channels (7-13). Another feature is an adjacent low channel sound trap to eliminate sound interference from the adjoining lower frequency channel.

6BN6 Gated-Beam FM Sound Limiter-Detector

The recent development, the *gated beam FM limiter-detector*, is also used in these chassis. The fundamentals involved in this circuit are very interesting.

It has long been known that an ordinary converter tube may be used as a detector for frequency modulated signals, if the received signal is applied to both control grids in a manner so that the two grids are substantially in quadrature and that their relative phase varies with frequency. It was also known that a signal applied to the

first grid of a converter tube automatically produces a quadrature voltage on the second grid, through space charge coupling, if the second grid is also tuned to the frequency of the input signal.

FM detectors based on this principle, using converter tubes, have not been found satisfactory because the first grid of a converter tube has no limiter properties of its own. On the other hand, the *gated-beam limiter-detector* has been found capable of not only serving as an FM detector, but for limiting, too.

The tube used in this circuit, a 6BN6², is highly unconventional in structural design, as its operation is based on electron-optical principles.

The rectangular cathode is surrounded on three sides by a grounded focusing electrode and faces a positive accelerator plate on its only open side. Electrons emerging from the cathode are shaped into a compact sheet-like beam which is projected against the limiter grid through the narrow slot in the accelerator.

The limiter grid acts like a gate. With zero or a positive potential applied, it passes the beam; with a negative potential of a few volts or more on the grid, the beam is stopped, the electrons turn around and diverge like a fountain falling back on the accelerator.

If a sine-wave signal of 1 volt *rms* or more is applied to the limiter grid, the beam is alternately passed and stopped, so that the beam current behind the input grid has the form of a square wave. As long as the input signal remains over 1 volt *rms*, variations in its strength do not affect the intensity of this square wave; in other

words, limiting takes place right at the first grid.

In normal operation, the limiter grid is biased two or three volts negative with respect to the cathode. Input signals may easily be five or ten volts, so that the limiter grid is strongly positive during part of each cycle. The grid current, however, is limited to a few tenths of a milliamperes by the design of the tube, so that this type of operation does not produce objectionable damping of the input circuit. Leaving the limiter grid, the beam passes through the second accelerator—a somewhat wider slot covered with a screen—and is projected against the quadrature grid. The quadrature grid is tuned to the signal frequency and driven by space charge coupling. The anode is placed behind the quadrature grid and a positive potential is applied to it.

In the circuit a 4.5 mc *if* signal, between one and perhaps fifty volts, is applied to the limiter grid and for one-half of each cycle the electron beam is passed and projected upon the quadrature grid. The periodic variations of the space charge in front of this grid (space charge coupling) produce about five volts across its tuned circuit. The quadrature grid clips the leading portion from each half-cycle pulse and passes on to the anode periodic pulses of current about one-quarter cycle in length. Modulation of the signal frequency affects the phase displacement between the half-cycle electron stream and the voltage produced on the quadrature grid causing corresponding variations in the length of the anode current pulses. The plate load resistor is bypassed for *if*; but the *dc* voltage drop across this resistor is proportional to the pulse length and is, there-

(Continued on page 32)

¹Magnavox CT-247, 248, 249.

²Allen, L. M., *Tube News, SERVICE*; January, 1950.

Ser-Cuits

(Continued from page 30)

fore, a direct function of the original modulation.

Gated AGC

Another special feature of this chassis is *gated agc*.

The purpose of *agc* is to feed back a negative voltage, proportional to the strength of the received signal, to the grids of the *rf-if* amplifier tubes to automatically control their amplification. It is for this reason that strong signals do not overload the receiver because they cause the development of a considerable feedback voltage which reduces the sensitivity of the receiver. On the contrary, very little feedback voltage is developed by weak signals and as a result the receiver operates at its maximum sensitivity.

With ordinary *avc* circuits, such as used in broadcast receivers, the average of the rectified signal voltage is taken from the detector and fed back to the *rf-if* grids. With a television receiver it is impossible to use the average signal because the amplitude is constantly changing with picture content. However, the components in a composite video signal which do have a relatively constant amplitude are the sync pulses. These are maintained at a level approximately 20 to 25% above the blanking and video level. Therefore, it is the sync pulses which are used to control the gain of television receivers.

Standard methods of *agc* have certain disadvantages which have been overcome by using the gated system. If the automatic gain control is not gated, it remains open to noise impulses which can have an amplitude as great, and in some cases, greater than the sync pulses. The average voltage developed by these noise pulses creates a false *agc* voltage where the noise rather than the signal can be the controlling factor. Another disadvantage in the conventional circuits is the long time constant which must be used. The long time constant prevents the *agc* from following rapid changes in the amplitude of the received signal and undesirable effects such as a picture *breathing* result.

An *if* signal (before detection) is applied to the grid of the *agc* amplifier through a 200-mmfd capacitor. The intensity of this alternating voltage is proportional to the strength of the received signal and causes plate current conduction of the amplifier during its positive half cycles.

The plate voltage for the *agc* amplifier is a 15.75 kc pulse taken from a horizontal oscillator. Since the frequency of the plate voltage is the same as the horizontal sync pulses (15.75 kc), the *agc* tube can only conduct (open gate condition) during the time of the sync pulses and is non-conductive (gate closed) during the relatively long period of time between pulses when noise could develop a false *agc* voltage.

During plate current conduction of the *agc* tube, a *dc* voltage is developed across a plate load resistor, in a manner similar to a half-wave rectifier. The magnitude of this voltage depends on the *if* input voltage which is applied to the grid of the *agc* amplifier. The period of the conduction and delay cycle is determined by the specific setting of an *automatic gain control*

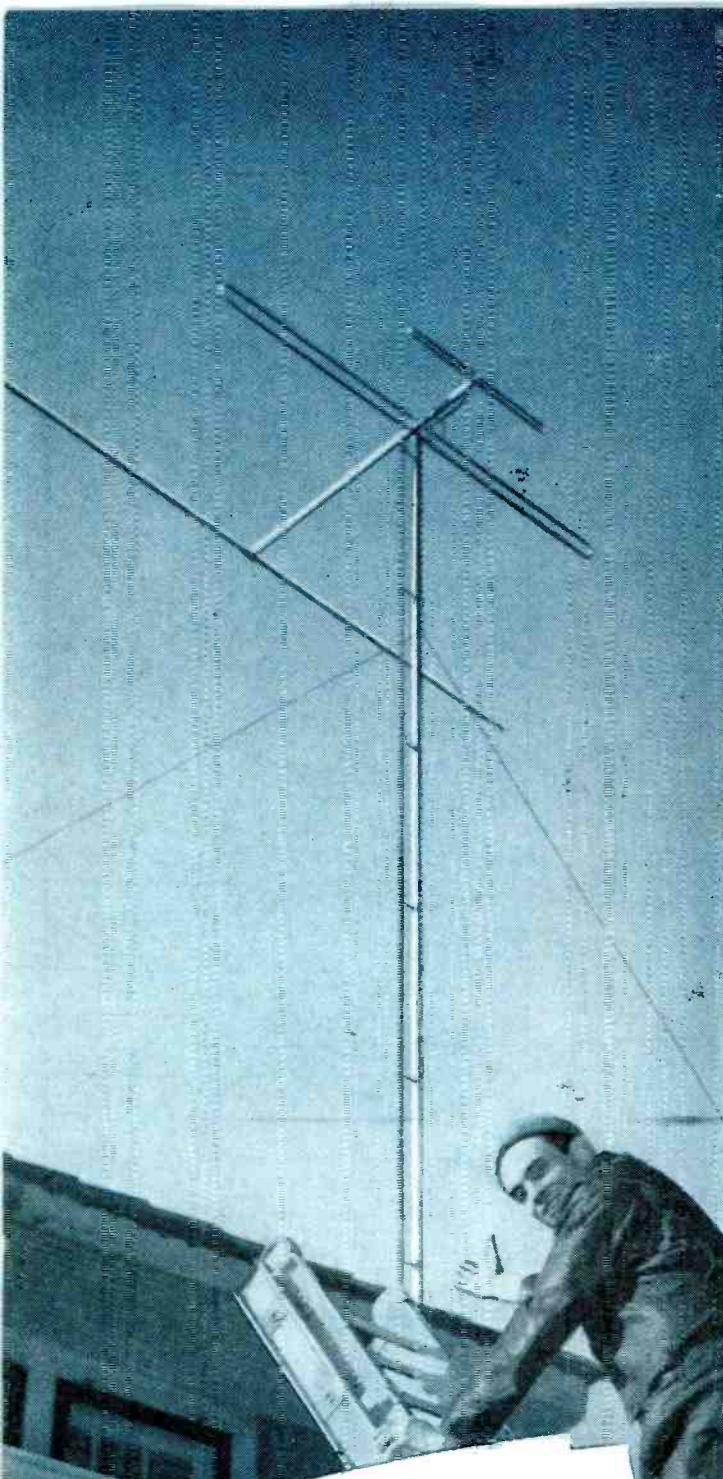

**"Partner, this Amphenol
INLINE* Antenna is up to
stay! Our boss knows his
business, because these
people will get the best
possible pictures and we
won't have any call-back
time here."**

AMPHENOL CORPORATION
1800 SO. 54TH AVENUE • CHICAGO 50, ILLINOIS
*U. S. PATENT NO. 2,744,480

AMPHENOL

delay control. The developed *agc* voltage is filtered by an *rc* filter and fed back to the *rf-if* grids.

The primary advantages of the gated *agc* system is the relative immunity to noise, and the fact that short time constants are used, which enable the *agc* to follow much faster changes in amplitude such as those developed by airplane reflections, etc.

If Amplifier

These models use a 40-mc *if* amplifier with four 6AU6 and a 1N64 germanium diode crystal detector. The transformers consist of bifilar windings with a single slug which tunes both primary and secondary inductances.

Intercarrier sound is used, and therefore the video and sound carriers pass through the *if* amplifier. The video *if* carrier is placed $2x$ down on the response curve and the sound carrier $20x$ down.

Intercarrier Sound

The video and sound carrier frequencies are 4.5 mc apart. When these carrier frequencies beat, a 4.5-mc difference frequency is produced which contains the original sound modulation. This 4.5-mc *if* is taken from the plate of the 12AU7 first video amplifier by a take-off coil, amplified by a 12AT7 intercarrier sound amplifier and applied to the grid of the 6BN6 gated beam limiter-detector tube where limiting and detection occurs. The output from the detector is fed to the grid of a 6AG7 power amplifier tube and reproduced by the speaker.

Sync Separator Circuit

The purpose of the sync separator circuit is to strip the vertical and horizontal sync pulses from the composite video signal. These pulses are then applied to their respective sweep circuits for triggering.

In these chassis, the composite video signal from the 1N64 detector is fed to the grid of a 6AB4 sync amplifier, where it is amplified and coupled to the grid of a 6BN6 sync separator. The sync pulses, which are more positive than the picture component, drive the grid of the 6BN6 and produce a step function in the plate current which results in clipping the top of the pulses and noise. The lower amplitude picture component does not have sufficient drive to produce plate current flow and does not appear in the output. The clipping and slicing action of the 6BN6 tube results in a

sync pulse output relatively free from picture and noise.

The Video Amplifier

The output from the video detector ranges in frequency from 30 cycles to approximately 4 mc. Since the output is very low, it must be amplified by the video amplifier without appreciable loss to the higher video frequencies. The high-frequency response of a video amplifier is limited by the impedance which the inter-electrode and stray capacities of tubes and circuits produce. Since the capacitive reactance decreases as the frequency increases, the higher frequencies could be relatively *shorted out* unless the effect of the undesirable capacities is removed. This is accomplished by inserting peaking coils to cancel the effect of the distributed capacities. The peaking coils form a resonant circuit in which the capacitive reactance is cancelled by the inductive reactance. In addition to the peaking coils, the plate load resistors are of low value so that their impedance at the highest video frequencies is approximately that introduced by the stray capacities. Use of peaking coils and low plate load resistors allows the video amplifier to have a reasonably flat frequency response to 4 mc.

Vertical Blanking Circuit

A blanking circuit which eliminates the vertical retrace lines is also incorporated in these receivers. The sweep voltage is taken from the plate of a vertical output tube, shaped into a sharp positive pulse and applied to the cathode of the picture tube. This pulse blanks out the picture tube during the retrace period.

The Vertical Sweep

The purpose of the vertical sweep is to gradually move the electron beam from the top of the picture tube to the bottom as it is swept from left to right by the horizontal sweep. It requires approximately 15,500 microseconds for the beam to move from the top of the picture tube to the bottom and approximately 1,166 microseconds to again return to the top and unblank for the next field. This period of time is the retrace and is blanked out. The frequency of the vertical sweep is 60 cycles. Because the 15.75-kc horizontal triggering must never stop, even during the vertical retrace, the vertical pulses are serrated so that they continue triggering the horizontal oscillator. Since the horizontal sweep continues, the beam does not go directly from the bottom of the picture tube to

the top during the retrace. It is zig-zagged back to the top by action of the horizontal sweep. Six equalizing pulses precede and follow the serrated vertical pulse. These stabilize the circuits before and after the vertical sync pulse and make interlacing practical. The circuits must be arranged so that the oscillator is triggered solely by the vertical synchronizing pulses and not from any other source such as noise, etc.

Both the horizontal and vertical pulses enter an integrator. Because of the long time constant in the integrating circuit, the short duration horizontal sync and vertical equalizing pulses have very little effect on developing a charge across the integrator. The slight charge that does develop, leaks off during the comparatively long interval of time between pulses, and for all practical purposes, has no effect. The serrated vertical pulse, on the other hand, has a time duration of approximately 190 microseconds and very little time interval between pulses. Each pulse charges an integrating capacitor to a higher potential until the voltage becomes high enough, and properly shaped, to trigger the blocking oscillator.

Vertical Saw-Tooth Voltage

The vertical saw-tooth voltage is developed across a .01 mfd vertical charge discharge capacitor. When plate current cut-off occurs, there is no appreciable voltage drop across the plate load resistor, which consists of a height control and a 3.3-megohm series resistor. Because there is very little voltage drop, the capacitor charges to nearly full plate potential in approximately 15,500 microseconds. This is the sweep portion of the saw-tooth voltage. When the vertical sync pulse causes the vertical oscillator tube to conduct again, the capacitor discharges through the internal resistance of the 12SN7GT vertical oscillator. This is the retrace and occurs in approximately 1,166 microseconds. A 33,000-ohm resistor, in series with the charge-discharge capacitor, shapes the voltage so that it will have a combination of saw-tooth and pulse which is necessary to produce a saw-tooth current through the deflection coils. A 6V6GTG serves as one leg of a multivibrator and as the vertical amplifier which develops the relatively high current for deflecting the beam.

Because the impedance of the vertical deflection coils is high at the 15.75-kc horizontal frequency, two-560 ohm damping resistors are shunted

(Continued on page 53)

Tube News

Characteristics of 20 16-inch Picture Tubes, Announced To Date By RMA, Set Up in Chart Form.

by L. M. ALLEN

IN AN EFFORT to accommodate the many electrical and physical variations now being included in TV receivers, quite a few types of picture tubes have been produced, particularly of the 16-inch type. Unfortunately, the characteristics of these tubes have not been generally available and Service Men have found it a bit difficult to determine the tubes' variables and what mechanical or circuit provisions were required for the different models.

To alleviate the problem, a chart, providing all the information in compact form, has been prepared.¹

All of the tubes listed use magnetic focus and magnetic deflection. The basing arrangement is the same on all tube types: pin 1 is the heater; pin 2, grid 1; pin 10, grid 2; pin 11, cathode; and pin 12, heater.

The *filter* characteristic on the *face glass* indicates a *gray* face type of tube.

Deflection angles of rectangular face tubes are signified by *D* for diagonal deflection and *H* for horizontal deflection.

Envelopes having an external conductive coating for use as a filter capacitor are identified by the term, *coated glass*.

¹Prepared by the radio receiving tube division of the Raytheon Manufacturing Co.

The 16-inch picture-tube reference chart.

Data	I6AP4	I6AP4A	I6CP4	I6DP4	I6EP4	I6FP4	I6GP4	I6HP4	I6HP4A	I6JP4	I6JP4A	I6LP4	I6LP4A	I6MP4	I6MP4A	I6QP4	I6RP4	I6SP4	I6SP4A	I6TP4
Envelope	Metal	Metal	Glass	Glass	Metal	Glass	Metal	Coated Glass	Coated Glass	Coated Glass	Coated Glass	Glass	Coated Glass	Coated Glass	Coated Glass	Glass	Coated Glass	Coated Glass	Coated Glass	Coated Glass
Face Type	Round	Round	Round	Round	Round	Round	Round	Round	Round	Round	Round	Round	Round	Round	Round	Rectangle	Rectangle	Round	Round	Rectangle
Face Glass	Clear	Filter	Clear	Clear	Filter	Clear	Filter	Clear	Filter	Clear	Filter	Clear	Filter	Clear	Filter	Filter	Filter	Clear	Filter	Filter
Face Radius	27"	27"	56 5/16"	60"	27"	27"	40"	56 5/16"	56 5/16"	27"	27"	56 5/16"	56 5/16"	27"	27"	27"	27"	56 5/16"	56 5/16"	27"
Maximum Length	22 5/8"	22 5/8"	21 7/8"	21"	20"	20 5/8"	17 11/16"	21 5/8"	21 5/8"	21 3/16"	21 1/8"	22 5/8"	22 5/8"	22 1/8"	22 1/8"	19 1/8"	17 11/16"	17 11/16"	17 11/16"	18 1/2"
Deflection Angle	53°	53°	52°	60°	60°	62°	70°	60°	60°	60°	60°	52°	52°	60°	60°	D 70° H 54.5°	D 70° H 65°	70°	70°	D 70° H 65°
Ion Trap Magnet	Double	Double	Double	Double	Double	Single	Single	Double	Double	Double	Double	Double	Double	Double	Double	Double	Double	Double	Double	Single
Anode Terminal	Cone Lip	Cone Lip	Cavity	Cavity	Cane Lip	Ball Cap	Cone Lip	Cavity	Cavity	Cavity	Cavity	Cavity	Cavity	Cavity	Cavity	Cavity	Cavity	Cavity	Cavity	Cavity
Typical Operation																				
Anode Voltage	12,000	12,000	12,000	12,000	12,000	13,000	12,000	12,000	12,000	11,000	11,000	12,000	12,000	12,000	12,000	12,000	12,000	12,000	12,000	12,000
Grid No. 2 Voltage	300	300	250	250	300	250	300	300	300	250	250	300	300	300	300	250	300	300	300	300
Grid No. 1 Voltage	-33 to -77	-33 to -77	-27 to -63	-27 to -63	-33 to -77	-27 to -63	-33 to -77	-33 to -77	-33 to -77	-27 to -63	-27 to -63	-33 to -77	-33 to -77	-33 to -77	-33 to -77	-27 to -63	-33 to -77	-33 to -77	-33 to -77	-33 to -77

New TV Parts . . . Accessories

CLEVELAND ELECTRONICS FM-TV LIGHTNING ARRESTER

An FM-TV lightning arrester, of combined bleeder and gap design, and built with a universal base to accommodate flat or round 300 ohm and twin-x, has been developed by Cleveland Electronics, Inc., 6618 Euclid Avenue, Cleveland, Ohio.

Balanced bleeder resistors prevent any static built up in the antenna. Momentary high voltages break the gap and are bypassed to ground.

Has Underwriters Laboratory listing. For complete information, write Bill Allen.

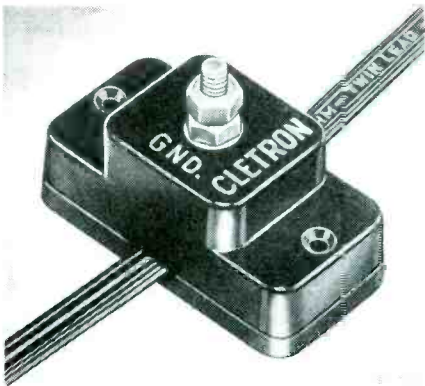

* * *

OAK RIDGE TV TEST INSTRUMENTS

A miniature type TV-FM signal generator, model 103, which features three separate tuning bands and modulation output and attenuator for TV and FM, has been announced by Oak Ridge Products, 239 East 127th Street, New York 35, N. Y.

Instrument can be used to check *rf*, oscillator, and mixer (first detector), video *if*, audio *if*, video and audio second detector, video and audio amplifier, sound-trap, and adjacent picture trap.

Can also serve as a marker generator, antenna orientation and antenna sensitivity tester.

Another instrument developed by Oak Ridge, a TV high-voltage tester, model 102, can be used to check high voltages in direct-view or projection TV sets. Features a precision 10,000 ohm/volt movement and three scales: 0-500 v, 0-15 kv, and 0-30 kv. Pocket size; 5 3/4 x 4 x 2 1/4".

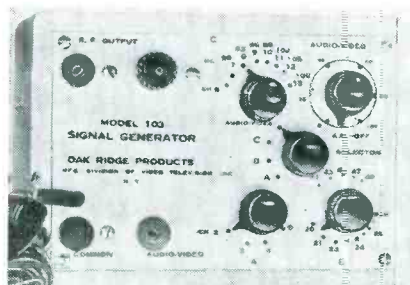

[See pages 38 and 49 to 53 for additional New Product news.]



**INSTALL THESE SUPER HI-GAIN
ANTENNAS FOR BETTER TV AND FM
RECEPTION IN ALL AREAS**

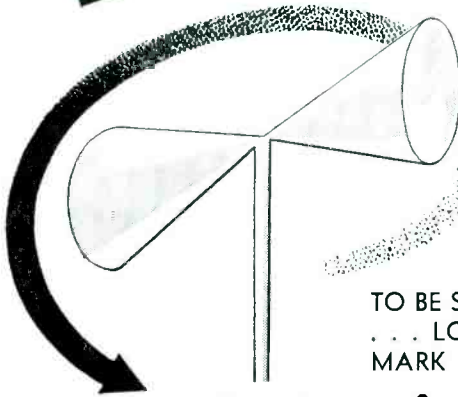

- THE ONE ANTENNA FOR ALL CHANNELS PLUS FM
- NO HIGH FREQUENCY HEAD NEEDED
- BETTER THAN 12 DB FRONT TO BACK RATIO ALL FREQUENCIES
- MODELS FOR EVERY INSTALLATION NEED
- CONICAL WINDOW MOUNTS FOR APARTMENT HOUSES

TO BE SURE IT'S A CONICAL "V" BEAM . . . LOOK FOR THE TELREX TRADE-MARK

**. . . true conical performance
without bulky metal cones**

Take a tip from Telrex! Look beyond the set for the cause of weak signals, ghosts and reflections. In many cases the antenna installation is the source of trouble. For sharper, brighter pictures follow the lead of thousands of other satisfied Telrex users. Install a Telrex Conical Antenna of proven performance—the antenna with the highest gain and highest signal noise ratio—on ALL channels. Telrex delivers the full strength of the signal received to the set with negligible loss, and with practically no reflections or ghosts. For local, congested or fringe reception areas, your one best buy is Telrex!

ALL TELREX ELEMENTS ARE MADE OF HIGH STRENGTH DURAL

PATENTS PENDING
COPYRIGHT 1949

Ask your distributor
for complete data or write
for illustrated catalog.

Telephone—ASBURY PARK 2-7252

telrex INC.
CONICAL ANTENNAS

AMERICA'S
OUTSTANDING
TELEVISION
BEAM

ASBURY PARK 4, N. J.

Servicing Helps

Clock-Type Receiver Alarm and Switch Adjustments, Cleaning and Lubricating Suggestions, and Clock-Trouble Remedies. Installation and Servicing of Adapter Plug for TV Sets. How to Stop Arcing or Corona in 16-Inch TV Models. Eliminating Interference in TV Receivers Caused by Cash Registers and Electric Range Switches. Correcting Tunable Audio Hum.

THE CLOCK-TYPE receiver, which has become very popular, includes many electrical and mechanical features which require rather careful study prior to servicing.

In the G. E. models 500, 501 and 64 and 65, for instance, one side of the power line is connected to B—and therefore no ground connections must be made to this point. An isolating transformer must be used in servicing, and the chassis should, of course, be removed from the cabinet.

The alarm and switch adjustments also demand close attention. In making these adjustments, there are six steps to follow:

(1) The *alarm-radio* shaft should be first turned to the alarm position.

(2) The time-set shaft should then be slowly rotated clockwise until the contacts of the switch assembly close.

(3) Then the dial face, alarm dial, the minute, hour and second hands which must be removed, prior to making the adjustments, should now be replaced, setting all hands and dial so that they indicate 12 o'clock. All hands and alarm dial should be tight on their respective shafts.

by **M. A. MARWELL**

(4) With alarm-set knob pulled out, the time-set shaft should be rotated clockwise until the vibrator arm drops against field core approximately 7-10 minutes later.

(5) The alarm should then be set at some other selected position, making sure that the mechanism actuates within limits (± 1 minute).

(6) Alarm tone of vibrator should then be checked. This can be adjusted by either bending vibrator arm nearer or farther away from field core. Bend arm near anchor point.

Cleaning and Lubrication

All moving parts should be cleaned in carbon tetrachloride or some similar cleaner.

The inside of the sleeves and shaft surfaces may be cleaned of oxidized oil by rubbing with a fine grade of steel wool dampened in carbon tetrachloride.

Too much oil should not be used, applying by means of a small wire

(drop oiler). Too much oil collects dust and later oxidizes. Use only recommended clock oil.¹

Clock Troubles

(1) Clock will not operate: Defective field coil, defective rotor, binding of parts.

(2) Clock loses time: Binding parts, too little friction on minute hand sleeve assembly, defective rotor; clock time-set shaft bent and rubs against hole in clock bracket.

(3) Noisy clock: Rotor defective, alarm armature improperly adjusted, loose parts, or binding of moving parts.

Production Changes

Early production clock-model receivers used individual component capacitors C₁₀, C₁₇, C₁₉, and C₂₀ (Fig. 2) while other chassis incorporated these in a single four-section unit. Some differences in capacitor values may be noted in early receivers from that shown in the schematic diagram. These values are not critical, however, and

¹G. E. recommends Nye's Celebrated oil produced by W. F. Nye Co., New Bedford, Mass.

Fig. 1. The GE 500 and 501-type clock-radio circuit.

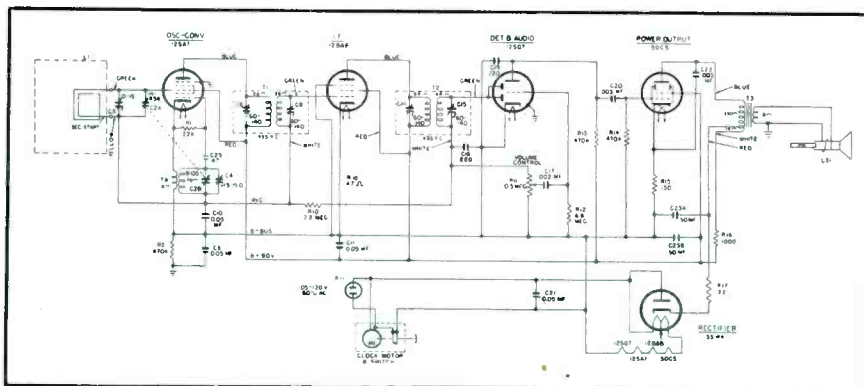
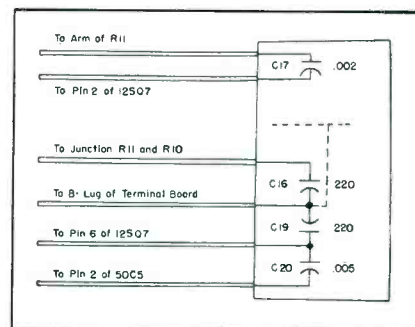

Fig. 2. Capacitor rearrangement suggested for later models of the G.E. clock-radio. R₁₀ = 2.2 megohm resistor and R₁₁ = .5-megohm control.



the stock catalogue item² corresponding to the capacitor symbol in the parts list can be used when replacement is necessary.

The lead identification for the four-section ceramic capacitor can be observed from the Fig. 2 illustration.

Though the models 64, 65, 66 and 67 clock-radio receivers were designed and connected to operate with a single loop input inductance, some production was made using a loop and antenna primary assembly employed in earlier model clock-radios (models 60 and 62). This assembly of cabinet back with loop and antenna primary is illustrated, with circuit connections for the models 64, 65, 66 and 67 in Fig. 3. Connections to the primary circuit winding are not made.

In other productions of the models 64, 65, 66 and 67 the single pick-up loop, L_1 (antenna primary omitted) was incorporated in the cabinet back; Fig. 4.

Replacement of Hinges

The hinge used in the G. E. 141 and 143 receivers can be removed and replaced in the plastic cabinet or cover by the application of heat. To remove the hinge from the back cover or cabinet proper, the hinge should be heated at the half to be removed from the cabinet with a soldering iron, and it may then be pulled out of the groove of the plastic hinge recess. Since the cabinet plastic softens at a relative low temperature, it will be unnecessary to apply the heat very long. To replace

(Continued on page 46)

²G. E. RCW 3013.

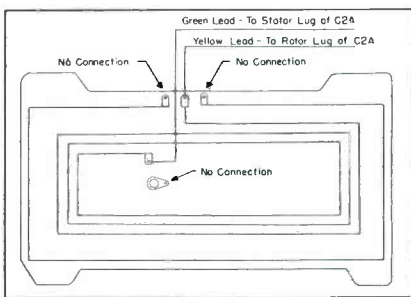

Figs. 3 (top) and 4 (bottom). In Fig. 3 appears the cabinet back and loop connections for one type of G.E. clock-radio and in Fig. 4 appears another version.

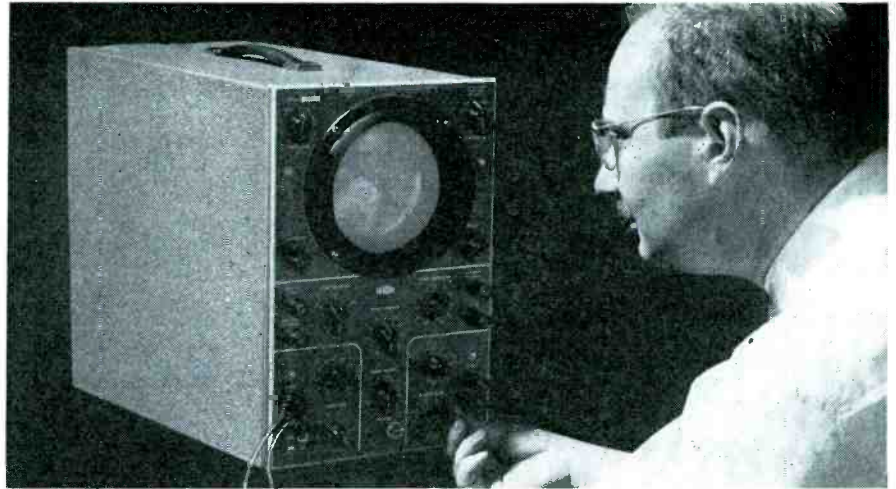
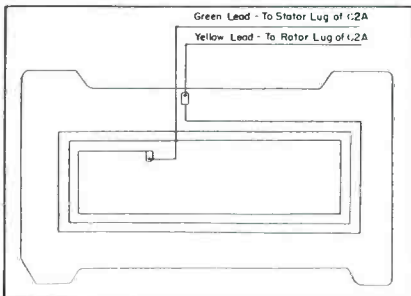

expert service . . . at your fingertips

DUMONT TYPE 304-H*

Cathode-ray Oscilloscope

*"A NEW STANDARD OF PERFORMANCE"

► The front panel of the DuMont Type 304-H puts to work—for you—the most recent and highly developed circuits in moderately priced oscilloscopes. It's your "instrument control" for expert radio and television servicing.

VERTICAL POSITIONING

On-screen positioning of entire signal expanded to four times screen diameter.

INTENSITY

High light output at 3,000 volts for photography of oscillograms and "permanent record file."

Y ATTENUATOR

Both a-c and d-c amplifiers. Frequency response to 300,000 cps.

Y AMPLITUDE

High-gain amplifier—sensitivity of 10 rms millivolts per inch. Stable operation even at signal overload.

X POSITION

Sweep expansion over five times screen diameter for detailed signal study.

SYNC AMPLITUDE

Locks in the pattern. A sync-limiting circuit maintains sweep length and synchronization as signal level varies.

X SELECTOR

Both driven and recurrent sweeps. May be synchronized externally, or internally from the line or amplifier.

SWEEP RANGE

Sweep frequencies continuously variable from 2 to 30,000 cps. Slower sweeps may be obtained conveniently by connecting external capacitance at X-input terminals.

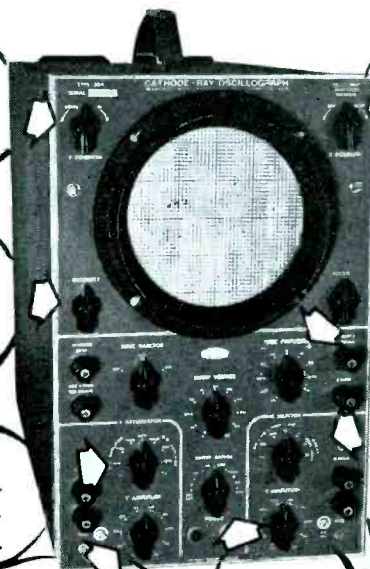

Send for descriptive 12-page bulletin.

DUMONT for Oscillography

ALLEN B. DU MONT LABORATORIES, INC. • INSTRUMENT DIVISION • CLIFTON, N. J.

SERVICE, FEBRUARY, 1950 • 37

New TV Parts . . . Accessories

SYLVANIA MINIATURE TV HIGH VOLTAGE RECTIFIER

A double-ended miniature high-voltage rectifier tube designed for use with *rf*, fly-back, and 60-cycle types of power supply for TV picture tube anodes, has been announced by the radio tube division of Sylvania Electric Products, Inc., 500 Fifth Ave., New York 18, N. Y.

The tube, type 1X2, is for use in power supplies where voltages up to 15,000 volts *dc* are required. Mounted in a T-6½ bulb, it has an overall height of 2 11/16".

Filament voltage is 1.25; filament current, 200 ma; peak inverse plate volts (max.), 15,000.

* * *

PRECISION APPARATUS MATCHED INSTRUMENT SETUP

A set of five matched instruments, serving as a basic AM-FM-TV testing and service laboratory, has been announced by Precision Apparatus Company, Inc., 92-27 Horace Harding Blvd., Elmhurst, L. I., N. Y.

Instruments included are marker-signal generator; sweep signal generator; cathode ray oscillograph; *atm*-megohmmeter and a tube tester.



SUPER-SONIC TV BOOSTER

A TV booster, model IT-4, using a 6AK5 and 6C4, and providing for a 72 or 300-ohm input and output, has been announced by Sonic Industries, Inc., 221 W. 17 St., N. Y. 11.

Covers TV and FM bands with one continuous control. Has high-ratio tuning, six turns from channel 2 to 13.

Features use of pure silver inductances and *rf* circuit contacts, copper-plated chassis and isolation-type power transformer.

According to an independent lab test, the unit provided the following voltage gains on channels 2 to 13: 22, 18.8, 17.7, 17, 15.1, 16.3, 18.5, 21.3, 23, 25.6, 27.8 and 22.

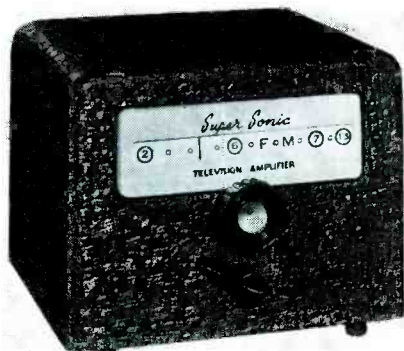

ODEGAARD NAIL POLEYTHYLENE STANDOFF

A nail polyethylene standoff (patent pending) has been announced by the Odegaard Manufacturing Company, 5416 Eighth Avenue, Brooklyn 20, N. Y.

Nail standoff consists of a cadmium-plated hardened high-carbon steel flat nail and a small piece of specially-punched low-loss polyethylene.

Shaped like a horseshoe nail, with small *steps* along one edge, it drives into wood, mortar, iron and aluminum for a locked permanent installation.

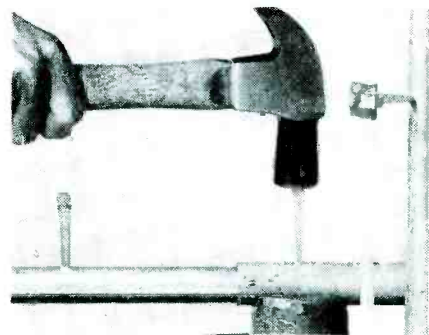

* * *

DRAKE TV HIGH-PASS FILTERS

A series of high-pass filters to aid in the reduction of TV interference have been developed by the R. L. Drake Company, 11 Longworth St., Dayton 2, Ohio.

The filters use an *m*-derived circuit with a cut-off frequency of 50 mc. Filter is said to attenuate all signals from zero to 50mc, with no adjustment.

Two models are available, TV-300-50HP for 300-ohm twin lead and TV-72-50HP for 72-ohm coaxial cable.

Filter will also keep harmonics of the TV sets 15.75-kc horizontal oscillator from being radiated by the antenna and interfering with AM broadcast band reception.

* * *

TRANSVISION VACUUM-TUBE VOLT-METER-OHMMETER—KILOVOLT METER

A vacuum-tube voltmeter-ohmmeter-kilovoltmeter has been produced by Transvision, Inc., New Rochelle, N. Y.

Features of this instrument include six *dc* ranges: 0 to 3-10-30-100-300 and 1,000 volts, (all ranges are said to have a constant input resistance of 11,000,000 ohms); kilovolt range from 0 to 30 kilowatts (input resistance 1,100 megohms, using high-voltage probe); 0 to 10-30-100-300 and 1,000 volt *ac* range at 1,000 ohms per volt; 0-1,000, 0-10,000 and 0-100,000 ohm, and 0-1, 0-10, and 0-1,000 megohm ranges; *rf* voltage ranges of 0-3-10-30-50 volts to over 100 mc.

Meter uses a bridge-amplifier circuit which is individually calibrated for use with a set of test leads, *dc* probe, and batteries.

High-voltage probe is insulated and has an internal resistance of 1,090 megohms.

[See pages 49-53 for additional New Product news.]

RIDER MANUALS MEAN SUCCESSFUL SERVICING • RIDER MANUALS MEAN SUCCESSFUL SERVICING

Like Money in the Bank
(NEW RIDER CATALOG)



Like money in the bank, the exciting RIDER Catalog of Manuals and Books really pays off. Here, completely described, are all the famous RIDER publications on TV, AM, FM, PA and record changer servicing. And here is PLUS information... Charts, Diagrams, Symbols and other DATA that you can use in your DAILY WORK. From cover-to-cover, the RIDER Catalog is "MUST" reading for everybody connected with the electronics industry. Write for it today!

IT'S FREE!

SEND MY COPY, PLEASE!

John F. Rider Publisher, Inc.
480 Canal Street, New York 13, N. Y.
Please send me my FREE Copy of the RIDER Catalog,
as soon as it is off the press.

Name.....
Address.....
City..... Zone..... State.....
I'm A..... Dealer. Radio Amateur,
(Engineer. Service Technician. Student. State which.)

AF Sweep Generator

(Continued from page 17)

by equal amplitude of positive and negative pulses). Harmonic distortion would be indicated as a bright line running irregularly through the middle of the pattern. This line may go up or down if phase shift is present. In the Fig. 4 pattern, the high-frequency response is up approximately 3 db at 10 kc. This can be accomplished with a tone control, or it may be the natural response of a particular amplifier. The pattern shown in Fig. 5 is a typical capacitor-reactance curve. This oscillogram was made with a capacitor in series with a 500-ohm line. Fig. 6 shows the effect of an inductance of several henries in series with a terminated 500-ohm line. Note the clean waveform, especially at the lower frequencies. This is due to attenuation of high-frequency transients. The pattern in Fig. 7 is that of a typical band-pass network often used in communications work in connection with a carbon microphone to produce narrow-band high intelligibility. The components *L* and *C* make up a shunt-derived network in series with a 500-ohm line. A simple *LC* circuit plot is shown in Fig. 8. This circuit has a resonant frequency of exactly 5 kc. It will be noted that the sweep-frequency generator not only checks the resonant frequency, but also the *Q* of the circuit and attenuation of other frequencies. (The pips occurring on the lower side of this particular oscillogram are due to phase change caused by capacitance in the circuit). Fig. 9 indicates a network composed of *C* and *L* across the line, where the *Q* is much higher, attenuation is 18 db, and resonant frequency is 450 cps. (An interesting feature of sweep-frequency testing is that any particular frequency or band of frequencies can be spread out as far as desired on the 'scope screen for more accurate counting of resonant frequency, observance of transients, etc. This is done simply by increasing the

(Continued on page 40)

Fig. 9. Pattern of a network composed of *C* and *L* across the line, where the *Q* is much higher, attenuation is 18 db, and resonant frequency is 450 cps.

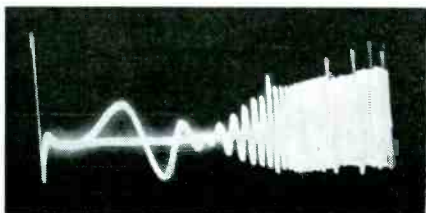

TV Service Tips

from **SPRAGUE**

WATCH OUT for overhead power lines whenever you install masts and antennas. Be especially careful that the top of the antenna does not become entangled with one power line and pull it into the companion power line.

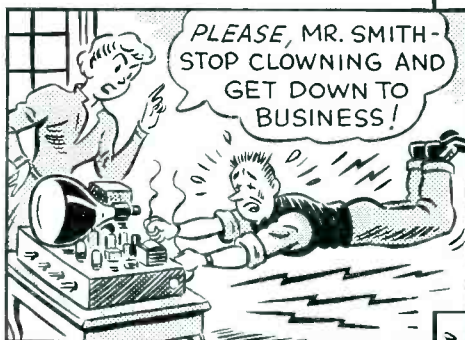

DON'T DISCARD old picture tubes or leave them lying around! Either break the vacuum or, better yet, pack old tubes in their original cartons, and shatter them by hitting the carton a heavy blow with an iron bar.

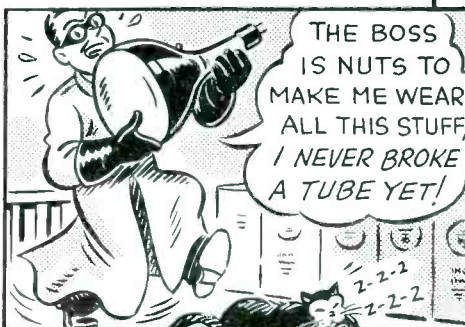

MAKE SURE that insulation on high voltage wires is not worn. To avoid grabbing a "hot" wire, it is a good idea to work with only one hand. Keep the other hand behind you, or in your pocket. Stand on a rubber doormat.

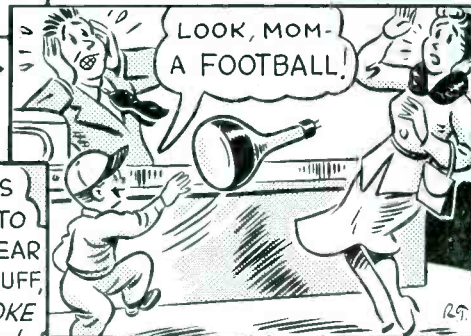

PLAY SAFE by wearing safety goggles, gloves and a heavy smock when handling picture tubes. A tube that implodes may spread shattered glass in more directions than you want it to.

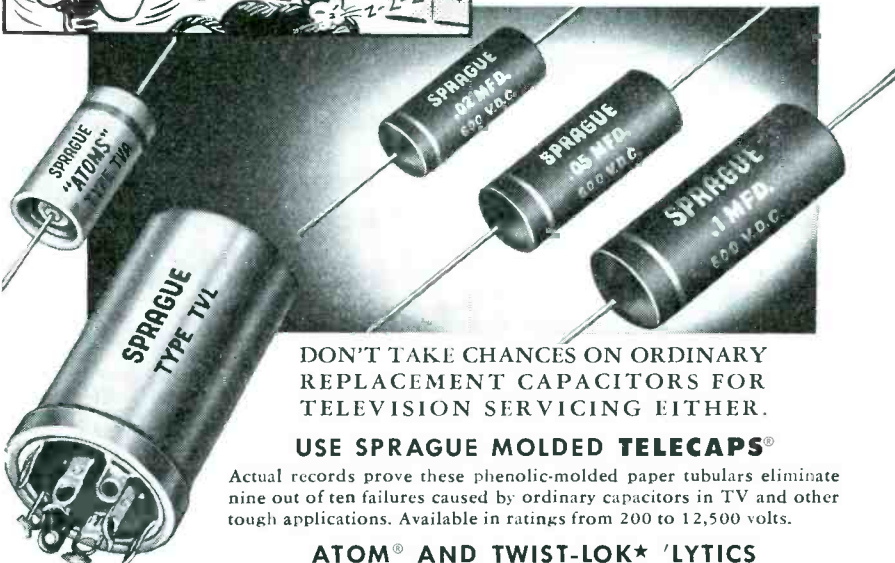

DON'T TAKE CHANCES ON ORDINARY REPLACEMENT CAPACITORS FOR TELEVISION SERVICING EITHER.

USE SPRAGUE MOLDED TELECAPS®

Actual records prove these phenolic-molded paper tubulars eliminate nine out of ten failures caused by ordinary capacitors in TV and other tough applications. Available in ratings from 200 to 12,500 volts.

ATOM® AND TWIST-LOK★ 'LYTICS

These extremely small, metal-encased, 185°F. (85°C.) dry electrolytics are specifically designed for TV... are more widely used by leading TV makers than any other brand BECAUSE THEY STAND THE GAFF!

★Trademark

Write for catalog or see your Sprague jobber today.

SPRAGUE PRODUCTS COMPANY 61 Marshall Street, North Adams, Mass.

NEW!

OHMITE OHM'S LAW CALCULATOR

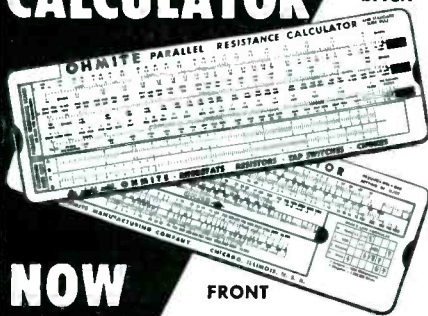

NOW HAS... PARALLEL RESISTANCE AND SLIDE RULE SCALES!

ONLY 25c

Redesigned! This new, improved version of the famous Ohmite Ohm's Law Calculator—popular the world over with servicemen, engineers, and students—now has scales for solving parallel resistance problems, and a standard slide rule. More useful than ever!

ONLY ONE SETTING REQUIRED

Solves Ohm's Law and many parallel resistance problems—simply, quickly, and accurately—with only one setting of the slide. Covers a range of values encountered in electronic and moderate power applications.

HANDY POCKET SIZE

Only 9" by 3"—fits the pocket. Slide rule scales multiply, divide, and find squares and square roots.

Be Right with

OHMITE

Reg. U. S. Pat. Off.

RHEOSTATS • RESISTORS • TAP SWITCHES

SEND FOR YOURS, TODAY

OHMITE MFG. CO.,
4877 Flournoy St.,
Chicago 44, Ill.

Send my new OHMITE Calculator. I enclose 25c in coin.

NAME.....
ADDRESS.....

AF Sweep Generator

(Continued from page 39)

horizontal gain of the 'scope as desired and bringing the observed frequency back if necessary with the horizontal centering control.)

LF Filter Patterns

The oscillogram in Fig. 10 is the result of a network composed of C , L , and R in series across a 500-ohm line. The resonant frequency in this case is 5500 cycles, and the attenuation is 6 db. Fig. 11 shows the result of two low-frequency filters in the same circuit. One filter is resonant at 100 cycles, the other at 1250 cycles. Attenuation is approximately 18 db and 10 db, respectively.

Wire-Recorder Patterns

Analysis of the waveform pattern in Fig. 12 should be interesting to those Service Men who are interested in checking the response of magnetic wire recorders. This particular waveform shows the response of a magnetically modulated wire in which there is insufficient bias. A normal attenuation of 6 db per octave toward the low frequencies is due to the velocity effect of the wire. From 1000 cycles up, the attenuation is due to the gap effect, in which the recording and playback gap dimensions approach the wavelength of the wire. This high-frequency response could be improved by applying more supersonic bias to the recorder. It may be possible that a defect in the bias oscillator circuit exists, or it may not have been designed to furnish the required output. Effects of increased bias on frequency, distortion, etc., may be seen very easily by observing the change in waveform.

Waveform Variables

There is no limit to the number and type of waveform patterns which can be obtained with the generator. Those

Fig. 10. Pattern of a network composed of C , L and R in series across a 500-ohm line. By observation the resonant frequency is 5,500 cps and the attenuation at that frequency is 6 db.

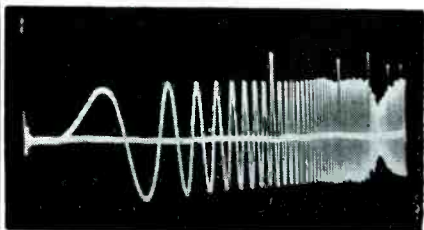

Mueller TENNA-CLAMP

COMPLETELY NEW AND DIFFERENT

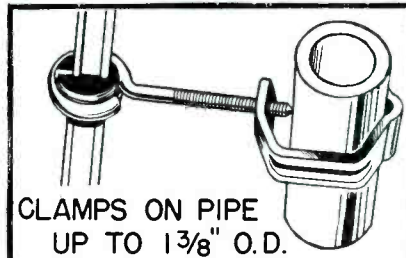

CLAMPS ON PIPE
UP TO 1 3/8" O.D.

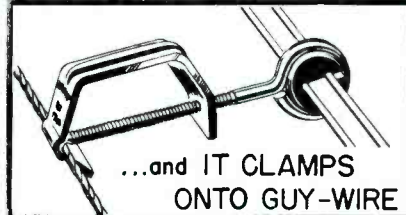

...and IT CLAMPS
ONTO GUY-WIRE

SUPPORTS TV LEAD-INS ON MASTS,
PIPES, CROSS-ARMS, GUTTERS
AND GUY-WIRES

- ONE STANDARD SIZE solves all sorts of lead-in problems.
- BRINGS LEAD-IN TO EDGE OF ROOF—right where you want it—holds lead-in away from gutters.
- DULL POINTED SCREW—solid grip on mast.
- ON MASTS TOO BIG for clamp—use the guy-wire.
- AVAILABLE FOR COAX and double lead-in.

LOW PRICES!

9c net—only \$7.80 per 100

SEND FOR FREE SAMPLE AND CATALOG 810

Mueller Electric Co.

1565 E. 31st ST., CLEVELAND 14, OHIO

PHOENIX
Speed-Tennas
**DO A BETTER
JOB!**

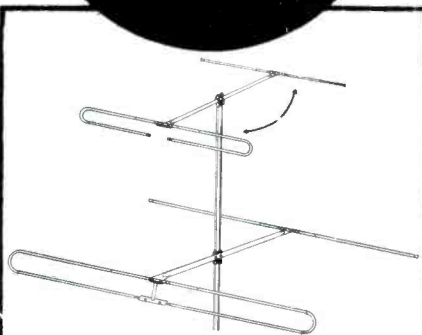

Strong—light in weight—fast, easy installation. Engineered to give highest quality electrical performance... and designed to withstand the toughest weather conditions. Pre-assembled—no loose hardware.

PHOENIX
ELECTRONICS, INC.
Lawrence, Mass.

AT LEADING
JOBBER'S
Write for
folder V of
complete line
of television
accessories.

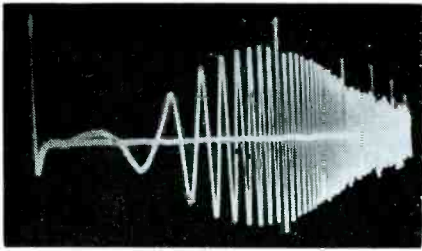

Fig. 11. Oscillogram resulting when two filter networks are in the same circuit, one resonant at 100 cps and another resonant at 1,250 cps.

shown represent only a few of the more common patterns.

Other Uses

The effect of tube replacement, different values of coupling capacitors, filters, etc., on frequency response, harmonic distortion and other operating characteristics also can be checked by observing waveform patterns. Linearity, taper and noise in volume and tone controls can be easily determined. A noisy or defective control will interrupt the pattern when moved; a defective or noisy tube will show up in a similar manner when it is vibrated. The Q , resonant frequency, bandwidth, characteristic impedance, etc., of recording heads, reproducers, filter networks, preamps, transformers, attenuators, tone control systems, bass and treble combination equalizers or booster circuits can be determined by simple visual analysis. Microphones and speakers can be analyzed by observing their polar patterns obtained by placing the units in a sound-deadened room and feeding the sweep frequencies through a high-quality two-way speaker system.

Credits

The author is grateful to R. S. Clarke, president of Clarkstan, for photos and material assistance in preparation of this article.

Fig. 12. Response of a magnetically-modulated wire from a wire recorder, in which there was insufficient bias. Normal 6-db per octave attenuation tending toward the lows is due to the velocity effect. From 1,000 cps up the attenuation is due to the gap effect in which the recording and playback gap dimensions approach the wavelength on the wire.

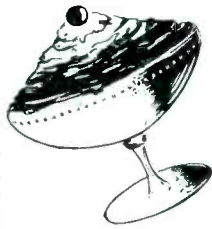
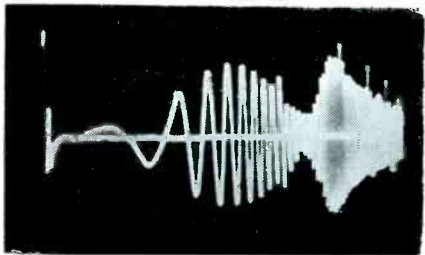

'the proof of the PUDDING!..

Impartial and exhaustive tests prove that the new **MODEL IT4-SUPER SONIC TV/FM AMPLIFIER** delivers a higher usable gain with full bandwidth and higher signal to noise ratio than other leading brands at any price!



model IT4

SUPER SONIC TV/FM AMPLIFIER

\$ **32**⁵⁰
List

- Improves TV reception in weak signal areas, with or without outdoor antenna.
- Continuous tuning of all 12 TV channels, also FM with ONE knob control.
- Reduces electrical, diathermy interferences and minimizes "ghosts and snow" effects.
- Frequency range: 50 mc to 220 mc, continuously tuned.
- Bandwidth: 6 mc. minimum all channels.
- Insertion gain: Minimum of 18 db at any frequency with 300 input and output impedances.
- Highest signal to noise ratio.
- Input and Output Impedances: 300 ohm balanced to ground and 72 ohms unbalanced.
- Inductances wound with PURE SILVER wire.
- All moving contacts heavily silver plated.

CHOICE TERRITORIES STILL AVAILABLE

Write for Free Brochure to Dept. S1

SONIC INDUSTRIES INC.

"MANUFACTURERS OF DUOSONIC PHONOGRAPHS"

221 WEST 17th STREET, NEW YORK 11, N. Y.

WHAT IS YOUR PROBLEM?

You will find the answer in

Radio & Television Mathematics

A Handbook of 721 problems AND SOLUTIONS

Save time and trouble. Arranged under radio and electronic headings and completely indexed for quick reference, these problems give you step-by-step solutions to every problem commonly arising in work on receivers, power supplies, antennas, amplifiers, tubes, transmitters, etc. If you are ever "stuck" on a calculation; if you need a check on your figuring; or if you want to refresh your memory on the formulas to use for a certain problem—you will find your answer quickly and easily in this book.

Good practice for your FCC exams. This book shows you how to solve every problem requiring mathematics in the FCC STUDY GUIDE for licenses of all classes. You will find no better handbook for practice in solving problems with ease, speed and accuracy. \$6.00

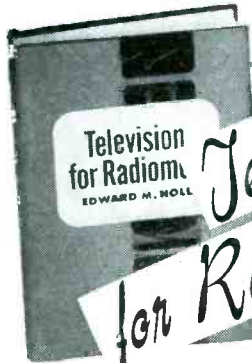

Just Published

Television for Radiomen

The how's AND WHY'S in the practical terms of operation & servicing

This book explains the *theory* as well as the techniques of television construction, operation, and servicing in the clearest, most practical terms. It gives the radioman all the basic information he needs to meet the increasing demand for skilled television technicians. It shows how and *why* all modern equipment operates; includes all the essential mathematics and especially good material on antennas. \$7.00

SEE THEM FREE

The Macmillan Co., 60 Fifth Ave., New York 11

Please send me a copy of the books checked below. I agree to remit in full or return the books within ten days without further obligation.

- Radio & Television Mathematics, \$6.00
 Television for Radiomen, \$7.00

Signed.....
 Address.....

Remote Control

(Continued from page 21)

momentum would slam the door into the ground.

In the final installation step, the transmitter is mounted in the car, and connected.

The position of the hood affects the transmitter frequency. It is thus important to watch this operation carefully.

The transmitter output may be checked by means of a 0-1 ma meter, a loop of wire in series with a 1N34 or a 1N23 fixed crystal across its input and a 50 to 100-mmfd capacitor across the input.

For test, the car can be brought close to the receiver, transmitter and receiver being allowed to warm up for a few minutes. The receiver can then be tuned by means of an 0-50-volt *dc* meter connected across the pilot relay, tuning for maximum. Normally the audio response need not be touched. In case of doubt this may be varied.

When the signal throws the meter needle off scale, the input must be reduced by means of the gain or sensitiv-

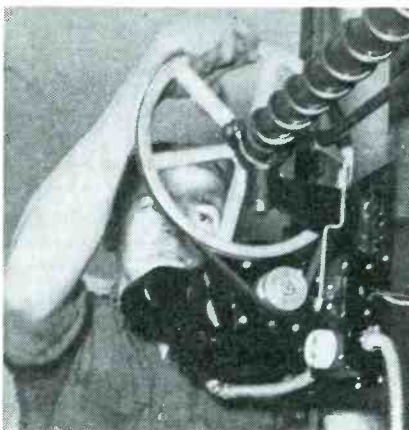
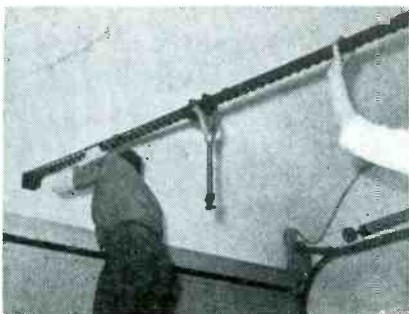

Fig. 4. Putting the belt on the pulleys. Notice the light metal rod that comes down and engages the motor toggle switch.

Fig. 5. Raising the heavy worm into position; worm is set into the bearing.



NEW ODEGAARD ORIGINAL NAIL POLYETHYLENE STANDOFF

HIGHEST EFFICIENCY AT LOWEST COST!

for Ribbon or Coaxial Cable

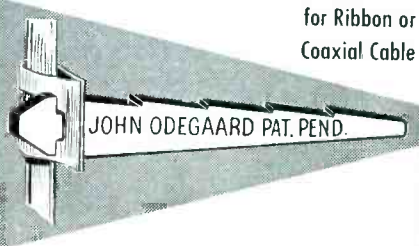

- Saves more labor, time and money than any other standoff!
- No drilling—just quick, easy hammer strokes
- Easily drives into wood, mortar, iron, aluminum, etc.
- Also excellent mast-coupler
- "Step"-locked, durable installation
- Cadmium-plated hardened high-carbon steel nail
- Specially punched lo-loss polyethylene

SERVICEMEN: For free sample and name of nearest distributor, write today to Dept. S.

PARTS DISTRIBUTORS: Choice protected territories still open. For full details write today to Dept. S.

ODEGAARD MFG. CO.

5416 Eighth Ave., B'klyn 20, N. Y.

Copyright 1950, Odegaard Manufacturing Co.

AMPERITE Studio Microphones at P.A. Prices

Ideal for BROADCASTING RECORDING PUBLIC ADDRESS

"The ultimate in microphone quality," says Evan Rushing, sound engineer of the Hotel New Yorker.

• Shout right into the new Amperite Microphone—or stand 2 feet away—reproduction is always perfect.

• Not affected by any climatic conditions.

• Guaranteed to withstand severe "knocking around."



Models
 RBLG—200 ohms
 RBHG—Hi-imp.
 List \$42.00

"Kontak" Mikes
 Model SKH, list \$12.00
 Model KKH, list \$18.00



Special Offer: Write for Special Introductory Offer, and 4-page illustrated folder.

AMPERITE Company, Inc.

561 BROADWAY • NEW YORK 12, N. Y.

Canada: Atlas Radio Corp., Ltd., 560 King St. W., Toronto



Fig. 6. Driving the pulley on to the end of the worm. Notice the position of the angle iron over head, and that the partly open door supports the weight of the worm.

ity control. If the peak seems rather broad, the car away should be backed away. Operation with full sensitivity should be dependable over 85'. The final adjustment should be made with the car at full distance. Because of metal in the area, the transmitter will often work over surprising distances.

When two or more transmitters are used, the second and subsequent transmitters have to be tuned to the receiver. The hood of the car must be closed when a reading is taken. Since the metal hood tends to decrease the frequency, it is best to peak the transmitter with the hood up, increase the frequency slightly, drop the hood, and note whether or not the peak has again been achieved.

12½"-16" TV Chassis

(Continued from page 22)

low signal input levels. Degeneration in the audio amplifier aids fidelity. As a protection against the output-transformer damage, provision has been made for removal of the plate-screen potential when the speaker plug is removed.

To reduce flashing of the screen in the presence of noise bursts, video signal circuit time constants have been minimized by a dc video amplifier and by unique *if* amplifier transformers. The latter are bifilar windings of the *unity coupling* type giving *lc* coupling, and eliminating coupling capacitors and grid resistors (reduction of time constant elements).

TV TEST EQUIPMENT STUDY



W. L. Parkinson, left, supervisor of technical service for the G. E. receiver division, explaining the operation of TV test equipment to G.E. Supply Corp. personnel who attended a recent weeklong TV service meeting at Electronics Park, Syracuse, (left to right): A. J. Parsons, GESCO vice president from Bridgeport; T. L. Campbell, Atlanta; E. A. Anthony, service manager for GESCO, New York; and Samuel Cooper, TV service supervisor for GESCO, San Francisco.

TWO Sensational New JACKSON Television Instruments

ONE! NEW TV SWEEP GENERATOR

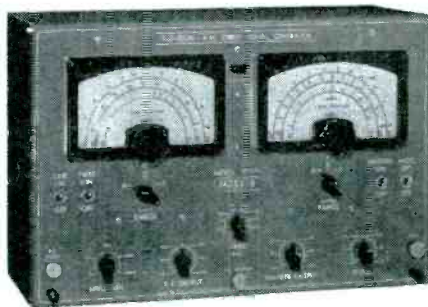

Model TVG-1 Net Price \$220.00

The ONE generator for accurate complete TV servicing. Look at these features:

Built-In Marker Generator. On fundamentals from 4 to 54 Mc. Harmonics readily usable to 216 Mc. Three ranges, accurately calibrated dial.

Crystal Calibrator. Jack provides means for calibrating Marker for any frequency within the range of the instrument.

Complete Sweep Generator. Provides frequencies from 2 Mc. to 216 Mc. in three ranges. Accurately calibrated dial with TV channels and FM band clearly indicated.

Adjustable Sweep width. Easily and quickly adjustable from 100 Kc. to a full 12 Mc. for FM and TV servicing.

400 Cycle Modulation. For use with Marker Generator.

Scope Timing. Provides a phased sinusoidal voltage for the Horizontal timing axis of the oscilloscope. Built-in phasing control assures a single pattern indication on the scope screen.

TWO! NEW 5" OSCILLOSCOPE



Model CRO-1 Net Price \$195.00
Demodulation Probe Net 9.95
(For Signal Tracing)

Thanks to an amazing JACKSON discovery, this fine laboratory-type instrument gives you either wide band or high sensitivity. Check these features against any other oscilloscope.

Wide Band Amplifier. Vertical amplifier flat within plus or minus 1.5 db from 20 cycles to 4½ Mc. Readily usable to full 5 Mc! Such band width is essential for accurate picture of TV sync pulses.

High Sensitivity. Vertical sensitivity .018 RMS volts-per-inch. Ideal for proper analysis of low voltage signals. Band width on High Sensitivity ranges is 20 cycles to 100 Kc.

Sweep Oscillator. Saw tooth wave 20 cycles to 50 kilocycles in 5 steps. Provision for external sweep.

Extra Features. Provision for direct connection of AC voltages. Internal and External Intensity Modulation. Synchronizing Input Control. Removable calibration screen. Height same as TVG-1 (above) for compact service-bench installation.

Get all the facts! Mail the coupon today!

JACKSON

"Service-Engineered"
Radio-Television
Test Equipment

Dayton 1, Ohio

Jackson Electrical Instrument Co.
14-16 S. Patterson Blvd.,
Dayton 1, Ohio

Please rush complete information on the following Jackson instruments:

TVG-1 Television Generator Complete line of Jackson Test Equipment CRO-1 5-Inch Oscilloscope

NAME _____

STREET _____

CITY _____ ZONE _____ STATE _____

MY DISTRIBUTOR IS _____

It's New!

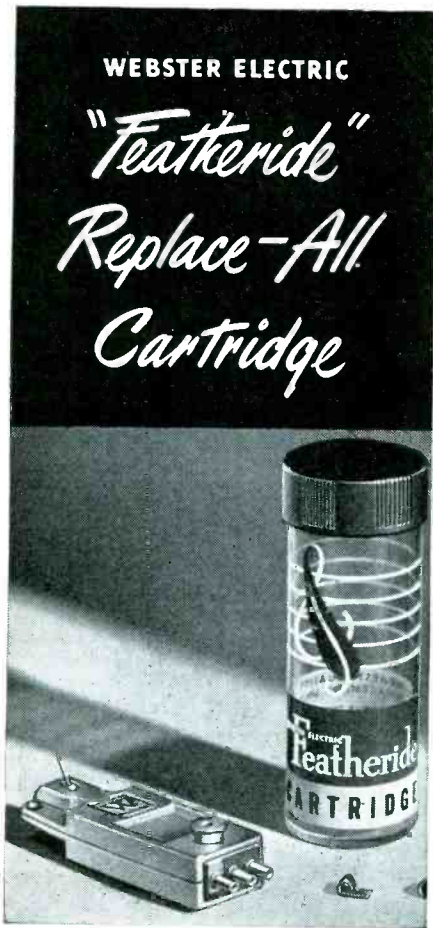

Replaces at least
45 current models of
crystal cartridges!

The New Featheride Replace-All Cartridge may be installed in any tone arm having 1/2 inch standard R. M. A. mounting. The versatility of this one cartridge means less inventory on the part of service men. Three terminals permit the selection of either of two voltages from the same cartridge. You'll find it competitive in price, quality and performance.

FEATURES

- Develops 1 1/2 volts at 3/4 ounce tracking pressure, or 4 volts at 3/4 ounce tracking pressure.
- Needle and cartridge are wedged at the factory. The needle you receive is the one approved by factory test. Replacement needles are also available.
- Crystal is coated to protect it against moisture and humidity.
- Rest button and terminal clips furnished.
- Packed individually in attractive Dri-Pack Containers.

WEBSTER ELECTRIC



Webster Electric Company, Racine, Wisconsin • Established 1909 • Export Dept., 13 East 40th Street, New York 16, N. Y. Cable Address: "Ariab", New York City.

"Where Quality is a Responsibility and Fair Dealing an Obligation"

Phono

(Continued from page 25)

revealed that the distortion is of two types:

- (1) Distortion due to crystal deterioration. This is ordinarily accompanied by reduction in output from the crystal as well as distortion and is properly solved by replacing the crystal.
- (2) Distortion due to motor vibration. Some motors develop enough vibration to cause distortion by modulating the crystal output at the frequency of

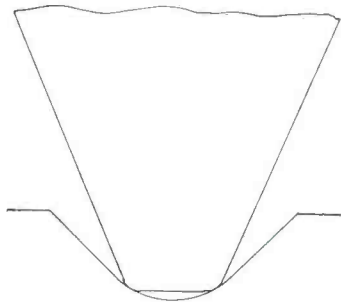

Single needle truncated design which permits a single needle to fit and track in both the conventional 78 rpm groove (above) and microgroove (below). (Courtesy Electovox Co., East Orange, N. J.)

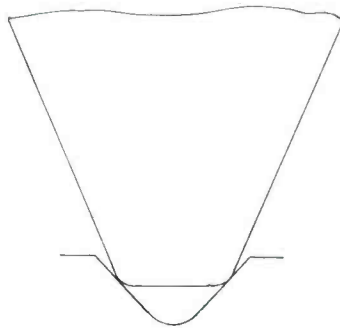

Multi-play record changer with a tone-arm design which is said to permit handling when it's in cycle without injury to arm. Needle is a permanent osmium-tipped variety and needs no changing for microgroove or regular play. Changer has simplified controls requiring only the setting of record speed and pulling out record rack to desired size. A special spindle is available for 45 rpm records. Manual reject knob can reject any record at any point of progress before completion. (Courtesy Motorola)



SHOOTS TROUBLE FASTER!

Makes more money for you on job or at service bench!



PRICE \$9.95

at distributor or postpaid, direct. Sorry, no C.O.D.'s. Oblige and add 3% State Sales Tax.

Signalette

MULTI-FREQUENCY GENERATOR

In radio service work, time means money. Locate trouble faster, handle a much greater volume of work with the SIGNALETTE. As a trouble shooting tool, SIGNALETTE has no equal. Merely plug in any 110V. AC-DC line, start at speaker end of circuit and trace back, stage by stage, listening in set's speaker. Generates RF, IF and AUDIO Frequencies, 2500 cycles to 20 Megacycles. Also used for checks on Sensitivity, Gain, Peaking, Shielding, Tube Testing. Wt. 13 oz. Fits pocket or tool kit. See at your distributor or order direct.

Clippard INSTRUMENT LABORATORY Inc.

DEPT. S, 1125 BANK STREET
CINCINNATI 14, OHIO
QUALIFIED JOBBERS WRITE,
WIRE FOR DETAILS.

QUICK, EASY WAY TO READ TUBULAR CAPACITOR CODING

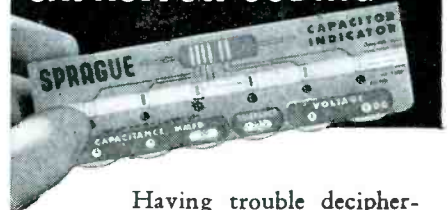

Having trouble deciphering the color coding on tubular molded capacitors in new TV and Radio sets? There's no need to consult complicated wall charts or tables!

JUST FLICK THE DIALS

The Sprague Capacitor Indicator gives you the needed data in a jiffy. Just flick dials to the color bands and read capacitance, tolerance, and voltage directly.

GET YOURS TODAY!

This slick plastic service help fits your pocket. Always on hand, it saves time and avoids mistakes . . . and it's only 15c. Ask for one at your Sprague distributor's store today!

SPRAGUE PRODUCTS COMPANY

Distributors' Division of the Sprague Electric Co.
NORTH ADAMS, MASS.

the motor vibration. This is coupled through the turntable to the needle, causing the vibration to appear in the output of the player. This type of distortion will usually be more noticeable as the needle approaches the center of the record, especially on 33-rpm records.

The solution to this type of distortion is to either tighten the motor mounting which alters the amount of vibration transmitted to the crystal or to change the motor.

Needle pressure must not be increased by reducing the weight of the counterweight. Increasing needle pressure will result in short-record and needle life.

Tube Curves

(Continued from page 28)

a factor determined by the ratio of screen and plate current.

$$\begin{aligned} \text{Effective } R_k &= 2 R_k (1 + A) \\ &= 2 \times 200 (1 + .071) = 430 \text{ ohms} \end{aligned}$$

The point of intersection of the plate and cathode lines determines the operating plate current, but as yet does not locate the operating point. The operating point can be found by drawing a straight horizontal line from this point of intersection to where it crosses a vertical supply voltage line, drawn from the plate voltage axis. The operating point for each tube is at E_p of -15 volts, E_b of 250 volts, I_o of 35 ma, and I_{sc} of 2.5 ma.

The power output from the load line thus equals:

$$\begin{aligned} P_o &= (I_{max} - I_{min})^2 \times .707^2 R_L \\ &= (88 - 3 \times .707)^2 \times 2,500 = 9 \text{ watts.} \end{aligned}$$

SYLVANIA POINT-OF-SALE DISPLAYS



Point-of-sale material used by the radio tube division of Sylvania Electric Products, to supplement its national advertising to promote the radio-television Service Man.

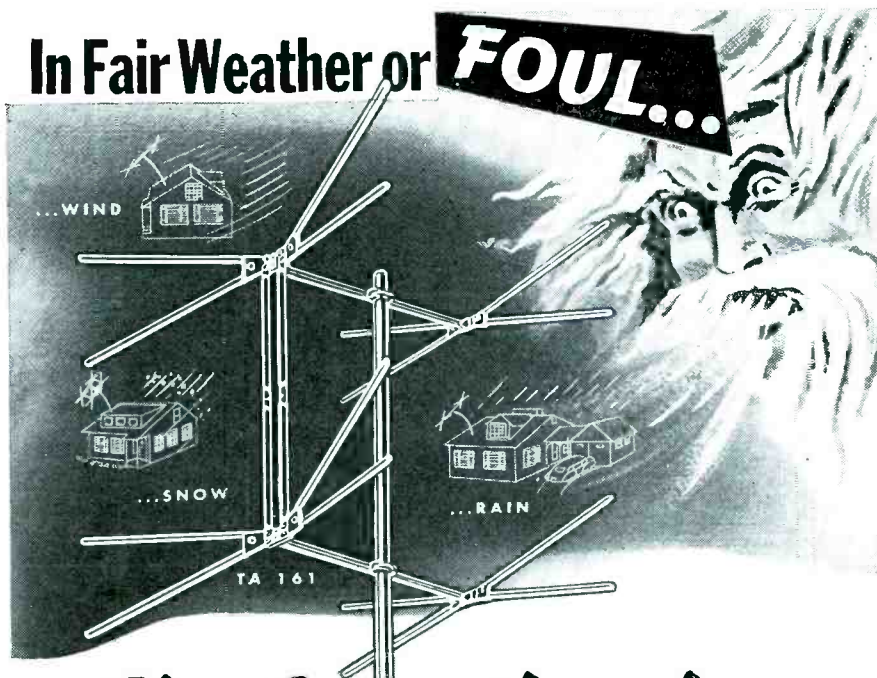

The Sensational... JFD "D-Xer" ALL-ALUMINUM CONICAL ANTENNAS

ARE STRONGER!

MORE ECONOMICAL!

FASTER SELLING!

MORE PROFITABLE!

Rugged construction. The only Conicals with reinforced elements. Will not bend, sag, sway or whip. Withstand all kinds of rough weather — wind, snow, rain, hail, etc.

Feature-for-feature, quality-for-quality, performance-for-performance, JFD "D-Xer" All-aluminum Conicals give more for the money than any other antenna. The smart serviceman looks for the reinforced element.

The proof of a product's popularity is in the reorder. Daily, our list of reorders grows longer and longer.

"D-Xer" Conicals sell faster — more easily. They require minimum servicing. Once put up, they stay put up — and they stay sold!



TA 160

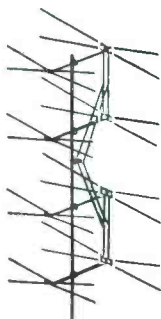

TA 164

TA 161 ... Double "D-Xer" All-Band Conical. 1/4 wave-length stacked. Provides exceptionally high DB gain on both bands. Channels 2 to 13.

TA 162 ... same as TA 161, but 1/2 wave-length stacked.

TA 160 ... "D-Xer" All-Band Conical, channels 2 to 13 and FM. Good front-to-back ratio on all TV frequencies.

TA 164 ... "Super D-Xer" Double Stacked Conical, channels 2 to 13 and FM. Complete with most-supported aluminum jumper harness. Unsurpassed for bringing in weak signals over long distances.



**WRITE FOR
FREE BULLETINS**

Now...right now...put your name on the JFD list to receive informative bulletins of JFD "D-Xer" Conicals, and all other fast-moving, profitable JFD products.

**BUY YOUR TV ANTENNAS
AND ACCESSORIES FROM
ONE SINGLE DEPENDABLE
SOURCE OF SUPPLY
... JFD**



MANUFACTURING CO., Inc.

6109 16th AVENUE, BROOKLYN 4, N. Y.

FIRST in Television Antennas and Accessories

FITS ANYWHERE!

- ★ Only 15/16" in dia.
- ★ Features Clarostat stabilized element.
- ★ Tapers. Also with one tap.
- ★ Knurled aluminum shaft, standard.

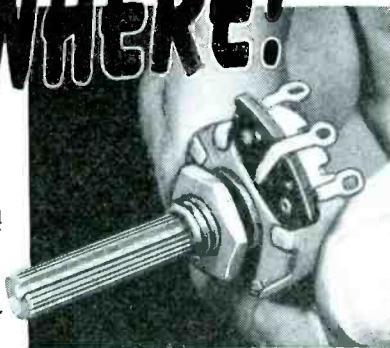

THE TINY CONTROL FOR THE FULL-SIZED JOB!

★ Just the thing for extra-tight spots — Clarostat's 15/16" control. Quite a lot smaller than the usual carbon controls but handles the load.

No-wiggle no-wobble aluminum knurled shaft; velvety-smooth rotation; longest-wearing element; special alloy contact arm; easy-to-solder tinned terminal lugs; and QUIET! It's a honey!

And typically Clarostat construction:

★ Ask your Clarostat jobber for these 15/16" controls. Ask for latest Clarostat catalog — or write us.

CLAROSTAT



Controls and Resistors

CLAROSTAT MFG. CO., INC. • DOVER, NEW HAMPSHIRE • In Canada: CANADIAN MARCONI CO., LTD. Montreal, P.Q., and branches

Servicing Helps

(Continued from page 37)

the hinge into the new unit, the hinge should be started into the slotted recess in the plastic, and then heat the hinge with the soldering iron and gently push the hinge into place.

Adapter Plug for Servicing Television Receivers

An adapter plug may be made, which makes it unnecessary to remove the television chassis, when service has to be rendered on the radio chassis only of G. E. models 818 and 12K1.

A standard octal tube base is wired up with a jumper connected between pins 7-8 and also between pins 2-3. This plug is then inserted into the J₁ socket on the radio chassis to reinstate audio continuity and to energize the tube filaments when the radio is separated from the TV chassis. *Ac* power is furnished either at pin 3-4 of P₂ or with a suitable plug in receptacle J₂. When using the latter point for power connection, a male pin jack which makes the pins *hot* at 110 volts, must be used.

When the plug is inserted into the octal socket, J₂, on the TV chassis, power can be applied to the TV chassis for alignment or trouble-shooting purposes.

Arcing or Corona in 16" TV Sets

Arcing or corona in the second anode supply circuit of the picture tube in the Admiral 21A1 chassis will generally produce a sharp crackling noise in the sound of the receiver, a faint hissing sound, or an odor of ozone. It can also cause the raster to vary in brightness. Arcing or corona is generally aggravated by conditions of high humidity.

If the noise in sound, hissing sound, or odor of ozone stops when the second anode connector is disconnected from the chassis, the difficulty is in or at the picture tube mounting assembly. If these symptoms persist after disconnecting the second anode connector, the difficulty will be found in the second anode supply in the chassis.

In general, the exact spot of arcing or corona can be located by close observation under subdued light. However, if location or arcing or corona is not visible, it may be located by listening through a length of fibre or bakelite tubing (approx. 1" diameter, at

ABSORB TV Interference with the DECIMETER TVI WAVE TRAP

You can make MORE satisfactory TV installations — and quickly — by making use of the simple, fool-proof Decimeter TVI Wave Trap to attenuate interference from DIATHERMY, FM BROADCAST, 10-METER AMATEUR, SPURIOUS IF. The Wave Trap is easy to install. You don't need to cut the lead in — the Wave Trap simply slides over it.

TVI Wave Traps are designed to absorb interference in three frequency ranges: 20 Mc. to 26 Mc.; 25 Mc. to 35 Mc.; 88 Mc. to 108 Mc. They are not intended to eliminate pulse-type interference from ignition, neon signs, etc.

Thousands of TVI Wave Traps are now in use, and users find that they contribute immeasurably to good reception where specific interference needs to be eliminated.

Order today from your jobber — see how efficient the TVI Wave Traps are!

DECIMETER INCORPORATED
1430 MARKET STREET DENVER 2, COLORADO

least 18" long). The tubing should be held close to the ear with the other end directed to suspected point of arcing or corona.

(Caution: The second anode voltage is approximately 12,000 volts; extreme precaution should be exercised when making this test.)

Suggested Remedies

If the arcing or corona is located in or at the picture tube assembly (stops when second anode lead is disconnected), the remedy may be found in the following:

Except for very early sets, a polyethylene insulating sheet is mounted in back of the picture window. A polyethylene insulating sheet should be installed if the set does not have one or if original one is deteriorated, torn, or has deep scratches or holes in it. (A plastic sheet, part 32D122, is used in sets having a rectangular picture window and part 32D126 is used in sets having a rounded-end picture window. To avoid arcing or corona to cabinet, the insulating sheet must be mounted with short tacks or staples applied as far to the top or sides of the cabinet as possible.)

Arcing or corona from the front of the picture tube (cone or screen) to the polyethylene insulating sheet may be due to presence of moisture or dust on the screen of the picture tube and on the polyethylene insulating sheet. It may also be due to locating the insulating sheet mounting staple too close to the edges of the picture window.

Picture tube screen should be cleaned. The polyethylene sheet should also be removed and cleaned with carbon tetrachloride. If insulating sheet is deteriorated, torn, or has deep scratches or holes in it, it should be replaced.

Arcing Inside Connector

If there is arcing or corona inside the connector on the second anode connector lead, the connector should be pushed together for good contact. If the connector does not fit together securely, excess material should be trimmed off with a file or sharp knife.

Corona on Second Anode

If the arcing or corona is located in the second anode supply in the chassis (does not stop when second anode lead is disconnected) the remedy may be found in the following:

Arcing or corona between or across components mounted on the 1B3/8016 rectifier tube mounting strip may be cleaned up by making proper clearances tightening mounting screws,

NEW!

DIRECTION INDICATOR



TV ANTENNA ROTATOR

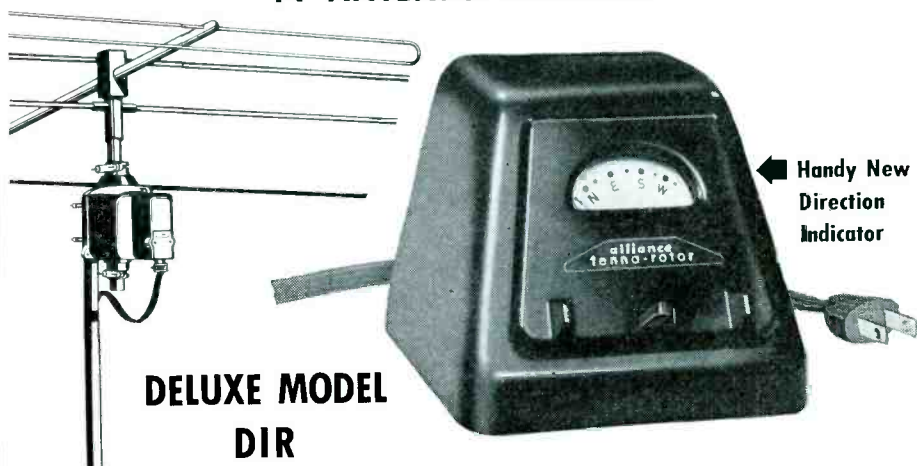

DELUXE MODEL
DIR

Handy New
Direction
Indicator

● This deluxe model Alliance Tenna-Rotor is in use and on sale in every TV market! Priced only slightly higher than the standard ATR, it provides a direction indicator which quickly shows where the antenna is pointed!

Here's why it pays to sell Tenna-Rotor!

- The only rotator proved by thousands of users in major TV markets from coast to coast!
- Tenna-Rotor is demonstrated in over a million TV homes each week! Millions see the Alliance films now scheduled on 52 TV stations!
- Tenna-Rotor has Underwriters' Laboratories' approval!
- Tests conducted by Electrical Testing Laboratories Inc. prove Tenna-Rotor works in sub-zero—rainy, snowy and icy weather!

The only rotator featuring the Alliance 4-conductor cable with "Zip" feature which makes for faster, easier installations!

Guaranteed for one year!

Write for your copy of "Fastest profit maker in Television today."

Alliance Manufacturing Company • Alliance, Ohio

Export Department: 401 Broadway, New York, N. Y., U. S. A.

and checking soldered connections, Clearance between the corona ring (below the 1B3/8016 tube socket) and the chassis should be approximately $\frac{3}{4}$ ". Leakage across 500-mmf capacitors should be checked (C_{440} , C_{411} or C_{427}). Surface of capacitors, tube sockets, phenolic mounting strip, etc., should be cleaned with carbon tetrachloride.

Arcing Across Transformer

If arcing occurs across terminals, leads or windings of horizontal output transformer, a check should be made

for protruding edges of solder or strands of wire.

Arcing Across Leads

If arcing occurs between wire leads, leads should be separated. If insulation on leads is not burned badly, the surface of wire and terminal may be cleaned with carbon tetrachloride and the part may still be usable.

General TV Service Hints

The following service hints, prepared for the Admiral 20A1, 20B1, (Continued on page 48)

Presenting... NEW ADDITIONS TO THE

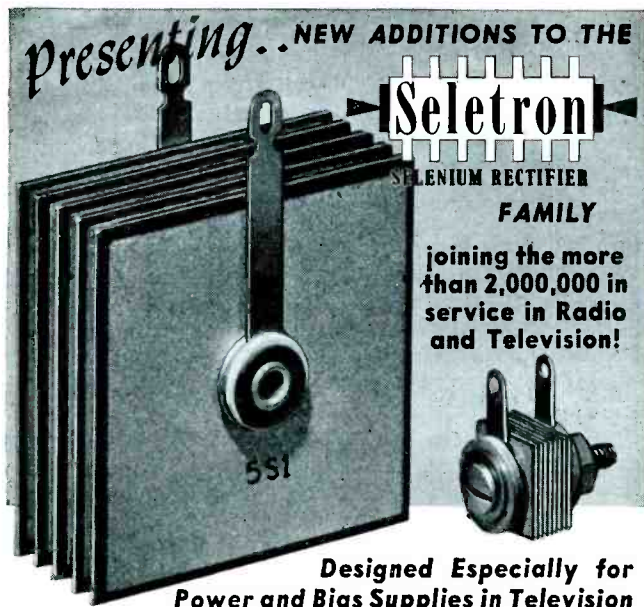

Seletron
SELENIUM RECTIFIER
FAMILY

joining the more than 2,000,000 in service in Radio and Television!

Designed Especially for Power and Bias Supplies in Television

NOW SELETRON brings you these two new models ideally suitable in size and rating: No. 551 at 500 Mils — No. 8Y1, the "baby" of them all, measuring only 1/2" square and rated at 15 Mils, 130 volts. While these rectifiers are designed to meet television needs, engineers will find many applications for them in other electronic circuits. Other bias type rectifiers rated up to 250 volts will also be available.

A new leaflet on Bias Type 8Y1, describing its circuit possibilities is available. For a copy, write Dept. SE-2

SELETRON DIVISION
RR RADIO RECEPTOR COMPANY, INC. RR
Since 1922 in Radio and Electronics
Factory: 84 North 9th St., Brooklyn 11, N. Y. • Sales Department: 251 West 19th St., New York 11, N. Y.

SERVICE has the largest ABC NET PAID circulation in the radio trade field — over 20,000.

FIRST in subscription renewal percentage —
FIRST in total number of pages —
FIRST in volume of advertising —
FIRST in number of advertisers —

19th year of publication

Advertising in SERVICE pays dividends.

WHEN YOU CHANGE YOUR ADDRESS

Be sure to notify the Subscription Department of SERVICE at 52 Vanderbilt Avenue, New York 17, N. Y., giving the old as well as the new address, and do this at least four weeks in advance. The Post Office Department does not forward magazines unless you pay additional postage, and we cannot duplicate copies mailed to the old address. We ask your cooperation.

Servicing Helps

(Continued from page 47)

21A1, 4J1 and 4K1 receivers, also can be applied to other similar type receivers.

Shadows Or Rounded Corners In Picture When Ion Trap Is Adjusted For Maximum Brightness: Always adjust ion trap for maximum brightness. If shadows appear on the picture raster, adjust the deflection yoke until it is as far forward as possible. Then center the picture by carefully moving the focus coil forward or backward on the neck of the picture tube. If it is impossible to remove the shadows, try reversing the leads of the focus coil.

Interference From Electric Range Switches: If an electric range switch or other electric range switches create an electrical disturbance in the television set, connect a .25-mfd 1000-volt dc capacitor across the line input terminals to the switch. If necessary, a smaller capacitor should be used from each terminal to the range body or neutral.

Interference From Cash Registers: Television interference which is caused by operation of a cash register can be eliminated by installing an inductive-capacitive line filter. The line filter should be installed inside the cash register as close to the motor as possible, and should be mounted on clean surface of the metal frame. The connecting leads should be as short as possible.

Vertical Line At Left Of Picture: If a white vertical line appears at the left side of the picture, it is probably due to misadjustment of the horizontal drive, C₄₂₁. Adjust the horizontal drive until the line disappears.

Sound Has Excessive Bass Response: If the bass response of the set seems over-emphasized, check the capacitor which shunts the primary of the output transformer. If this capacitor is .01 mfd, it should be replaced with a .002 mfd, 600-volt unit. Over-emphasized bass response can often be determined by mechanical vibrations such as rattle of the cabinet grille.

Tunable Audio Hum: If audio hum is present which is tunable, but may be *tuned out* at a particular setting of the *sharp tuning* control, try connecting a 2,200-ohm, 1/2 watt resistor and a .1-mfd, 400-volt capacitor in series from the *agc* tube plate (pin 5) to ground.

Weak Sound In High Signal Strength Areas: If the sound is weak in a high signal-strength area, and all other possibilities of a defective sound system have been checked, disconnect the green *agc* lead going to the tuner from the junction of R₁₄₇ and R₃₀₃. Then, reconnect this lead to the junction of R₃₀₃ and R₃₀₈. The decreased *agc* will increase the gain of the *rf* amplifier, and thus increase the gain of the sound as well as the video signal.

Audio Hum: Connect 25" of 1/2" bonding braid under the bracket holding the webbing for the picture tube, on the side nearest the audio lead; connect the other end of the braid under the power supply chassis, at the mounting screw nearest the audio lead.

The **"ULTIMATE"**
in **YOUR**
Listening Pleasure

Dual
Speakers

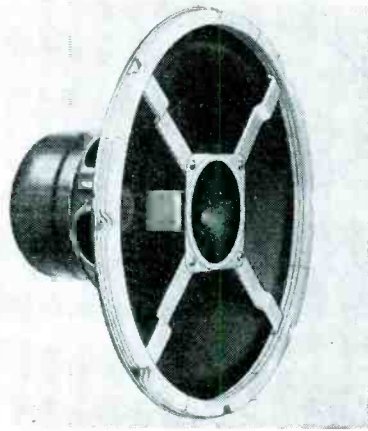

Coaxially
Mounted

Frequency Range 30 to 15,000 c.p.s.
Two Models — CSP15P-5 15" Woofer 5" Tweeter
— CSP12J-3 12" Woofer 3" Tweeter

Write for NEW CATALOG—No. 201

UTAH, INC.

HUNTINGTON, INDIANA

SUPERIOR INSTRUMENT MULTI-METER

A combination multi-meter, 20,000 ohms-per-volt and TV kilovoltmeter, model TB-20, has been produced by Superior Instruments Co., 227 Fulton St., New York 7, N. Y.

Has *dc* volt ranges (at 20,000 ohms per volt) from 0-2.5/10/50/100/250/500/1,000/5,000/50,000. The *ac* voltage ranges are (at 1,000 ohms-per-volt) 0-2.5/10/50/100/250/500/1,000/5,000 volts; *dc* current ranges. . . . 0-50 microamperes, 0-5/50/500 milliamperes, 0-5 amperes; resistance ranges. . . . 0-2,000/20,000 ohms, 0-2/20 megohms; and *db* ranges . . . (based on 0 db = 1 mv into a 600-ohm line) . . . -4 to +10, +8 to +22, +22 to +36, +28 to +42, +36 to +50, +42 to +56, +48 to +62. Output voltage ranges: 0 to 2/5/10/50/100/250/500/1,000.

An *uhf* voltmeter probe is included to provide a frequency range up to 1,000 mc. Plugged into the unit, it converts the unit into a negative peak-reading *hf* voltmeter.

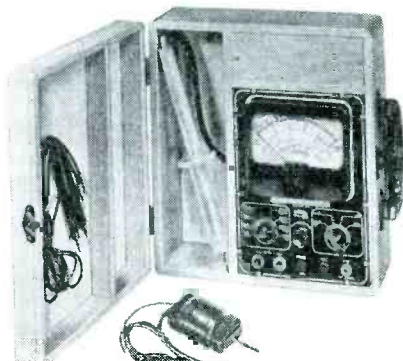

New Parts, Accessories

IRC UNIVERSAL REPLACEMENT FOR CONCENTRIC DUAL CONTROLS

A packaged set of eleven universal parts, trade-named *concentrik* has been announced by International Resistance Co., 401 N. Broad St., Philadelphia 8, Pa.

The universal parts, combined with a selection of shaft ends and base-elements, which are purchased separately, are said to provide maximum coverage of concentric dual replacement in home and auto radios, as well as television sets.

Base-elements supplied in conjunction with *concentrik* are complete with no loose parts. Blue molded base has element, collector ring and terminals installed.

In addition to a step-by-step instructions which are included with each *concentrik*, IRC has published a comprehensive *concentric dual control* replacement manual. Catalog DC1A contains complete data.

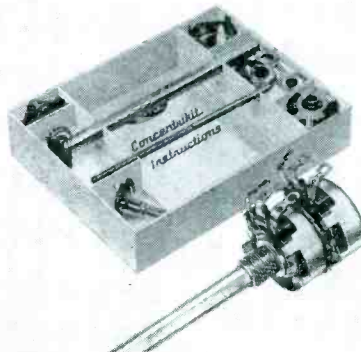

HEATH VTVM KIT

A *vtvm* kit, model V-4, featuring automatic meter protection on all functions, an electronic *ac* voltmeter and push-pull *dc* voltmeter circuit, has been announced by Heath Company, Benton Harbor, Michigan.

Electronic *ac* voltmeter circuit incorporates a balance control which is said to afford elimination of contact potential, avoid meter shift with various ranges, assure accurate readings on all ranges, and compensate for variations in tube elements. A 200-microampere meter uses Alnico V magnet. Ceramic divider resistors of 1% precision are used. Twenty-four complete ranges are included. Meter pointer can be offset from zero for FM and TV alignment. Has a *dc* isolated probe which can be used for dynamic measurements of receiver voltages without disturbing receiver operations.

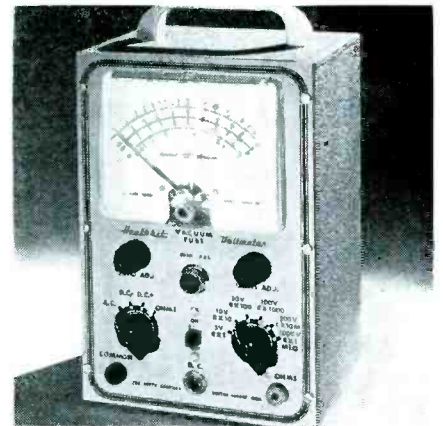

G. E. 3" ELECTROSTATIC CRT

A three-inch *crt*, the 3MP1, has been announced by the tube division of G. E. Tube is an electrostatic focus and deflection type with a bulb diameter of 3 3/8" and useful screen diameter of 2 3/4". Equipped with a small-shell, duodecal base which has been set as the standard base on all TV tube types.

Maximum ratings for the new tube include an anode 1 *dc* voltage of 1,000 and an anode 2 *dc* voltage of 2,500. Maximum negative-bias value is 200 volts *dc* and the positive-bias value 2 volts *dc*. Maximum circuit values: Grid 1 circuit resistance, 1.5 megohms; resistance in any deflecting electrode circuit, 5 megohms.



* * *

ELECTRO-VOICE HIGH-FIDELITY DYNAMIC MICROPHONE

A high fidelity dynamic omnidirectional microphone, type TV665, which becomes slightly directional at extremely high frequencies, has been announced by Electro-Voice, Inc., Buchanan, Michigan.

Said to provide effective individual or group pickup, and peakfree response 40-15,000 cps, ±2.5 db. Hole in lower section of case permits control of bass response. Impedance is 250 ohms; can be changed to 50 ohms at internal terminal strip. Has acoustalloy diaphragm. Uses Alnico V in a specially designed magnetic structure.

Removable swivel mounting; 1/2" pipe thread on microphone and swivel for stand coupling; 5/8"-27 thread adapter furnished. Case is lathe-turned aluminum with *aluminite* finish.

Supplied with 20' of two-conductor shielded synthetic rubber jacketed broadcast type cable. Size of microphone with swivel, 1 1/8" long; without swivel, 8 3/4" long. Diameter, 1 1/16".



- ✓ Bayonet type fitting provides rigid, rapid assembly.
- ✓ High quality corrosion resistant aluminum.
- ✓ High frequency type seatite for superior electrical connection.
- ✓ Circular design — rugged construction — no loose ends.

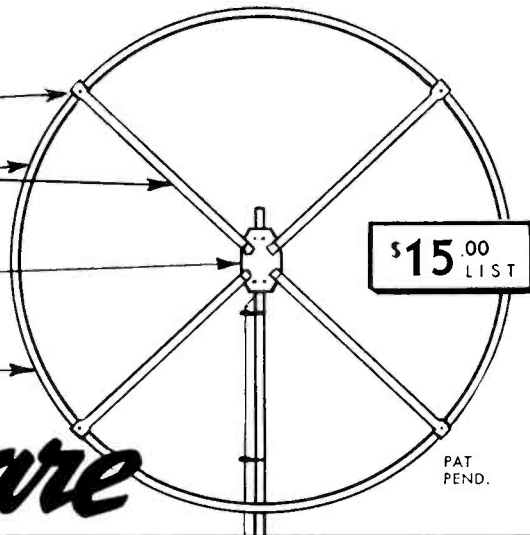

Compare

CIRCLE-X TO ANY OTHER TV ANTENNA

The mechanical and electrical construction of Circle-X is unsurpassed. No other antenna combines all the features that are engineered into the Circle-X. It is perfectly matched to 72, 150 and 300 ohm receiver input circuits.

- One type antenna for all jobs.
- One wire lead-in.
- Clear, sharp pictures on all channels.
- Eliminates ghosts.
- Weighs only 1 1/2 lbs.

DEALERS: Air Express or Parcel Post Special Delivery direct from factory to you through your jobber, if he cannot supply you with the Circle-X from his stock.

CIRCLE-X ANTENNA CORP.
503 MARKET ST., PERTH AMBOY, N. J.



Build YOUR OWN

Heathkit TEST EQUIPMENT

Heathkit ALDIO GEN. KIT
\$34.50

Heathkit TUBE CHECKER KIT
\$29.50

Heathkit 5" OSCILLOSCOPE KIT
\$39.50

Heathkit BATTERY ELIMINATOR KIT
\$22.50

Heathkit TELEVISION GENERATOR KIT
\$39.50

Heathkit SIGNAL TRACER KIT
\$19.50

Heathkit ELECTRONIC SWITCH KIT
\$34.50

Heathkit CONDENSER CHECKER KIT
\$19.50

Heathkit VACUUM TUBE VOLTMETER KIT
\$24.50

NEW Heathkit IMPEDANCE BRIDGE SET
\$69.50

Heathkit R.F. SIGNAL GEN. KIT
\$19.50

NEW Heathkit HANDITESTER KIT
\$13.50

HEATH COMPANY
BENTON HARBOR, 11 MICHIGAN

EXPORT DEPARTMENT
12 EAST 40th STREET
NEW YORK 16, N.Y.
CABLE - ARLAB - N.Y.

Heathkits are beautiful factory engineered quality service instruments supplied unassembled. The builder not only saves the assembly labor cost but learns a great deal about the construction and features of the instrument. This knowledge aids materially in the use and maintenance of the equipment. Heathkits are ideal for and used by leading universities and schools throughout the United States. Each kit is complete with cabinet, 110V 60 cycle transformer (except Handi-Tester), all tubes, coils assembled and calibrated, panel already printed, chassis all punched, formed and plated, every part supplied. Each kit is provided with detailed instruction manual for assembly and use. Heathkits provide the perfect solution to the problem of affording complete service equipment on a limited budget. Write for complete catalog.

SIMPSON TV VACUUM-TUBE VOLT-OHMMETER

A vacuum tube volt-ohmmeter, model 303, designed especially for television servicing, has been developed by the Simpson Electric Company, 5200-18 W. Kinzie St., Chicago. Instrument is 120 cubic inches (5¼" x 7" x 3⅛") in size, and equipped with a 4½" meter.

The *dc* input resistance is said to be 10 megohms for all ranges. Has five *dc* voltage ranges, five *ac* voltage ranges, five resistance ranges, three *af* voltage ranges, db from -20 to +63 in five ranges, a zero center galvanometer for FM discriminator alignment, and an *rf* voltage range with 20 volts maximum and flat frequency measurements between 20 kc and 100 mc.

The *ac* voltage range of the unit is said to be from a 1.2 minimum to 1,200 maximum.

Equipped with a *dc* voltage probe, an *ac* voltage-ohms probe and a ground lead. Accessory equipment includes a high frequency probe and a 30,000-volts high-voltage probe.

* * *

MALLORY MINIATURE A BATTERY

A smaller mercury type A battery, the RM-1, which is .625" in diameter, .644" high, weighs .39 ounce and has a capacity of 1,000 milliampere hours, has been announced by P. R. Mallory & Co., Inc., Battery Division, North Tarrytown, N. Y.

The mercury battery is said to have a long shelf life, uniform discharge voltage, high ratio of energy to volume and weight, resistance to impact and acceleration, constant no-load voltage, and ability to operate under extreme pressure and temperature ranges. It is also said to be leak-proof and dimensionally stable and offer resistance to humidity and corrosion.



* * *

TEC TELEBOOSTER

A TV booster, requiring no tuning, model S-504, has been announced by Television Equipment Corp., 238 William St., New York 7, N. Y.

Amplification said to be 20 db over entire range. Input and output, 300 ohms. Has a 3 position *hi-lo* and *off* switch.

Uses two 6AK5 pentodes and one 12AT7 duo triode.



FOR . . .

- RADIO SERVICING
- TELEVISION SERVICING
- AMATEUR RADIO
- HIGH FIDELITY SOUND

Stancor transformers are original components in thousands of radio and television receivers made by the biggest names in the industry—they have to be good to be specified by critical design engineers and value-conscious purchasing men!

Why shop around? Specify Stancor for your replacement work. You will get a dependable, honestly-rated transformer. You'll cut down on expensive call-backs. You will keep your customers.

FREE For complete, accurate specs and prices of the complete Stancor stock line, write for your copies of the literature illustrated above. Just ask us for the Stancor transformer library. Standard Transformer Corporation 3588 Elston Avenue, Chicago 18, Illinois.

It's Stancor
FOR

TRANSFORMERS

MOST COMPLETE LINE IN THE INDUSTRY



AMSTERDAM SALES ELECTRIC TESTER

An electric tester, model 100, designed to test electrical appliances such as ranges, shavers, ironers, fans, vacuum cleaners, refrigerators, etc., has been introduced by Amsterdam Sales Co., 98 Park Place, New York 7, N. Y.

Measures voltages, both *ac* and *dc*, between 70 and 660 volts. Also indicates whether current is *ac* or *dc*, and if the frequency is 25 cycles or 60 cycles.



Right: Amsterdam Tester.

PHOTOFACT Users Write Our Best ADS!

Hundreds of unsolicited letters tell what the world's finest Radio Data means to Service Technicians



P. Cesare
5410 Trask St.
Oakland, California

"Your PHOTOFACT Folders, in my estimation, are priceless. In fact, the same applies to all your servicing materials which are of the greatest aid to us who service radios, phono changers, etc., and want to do so by the simplest and yet the proper method."



Richard O. Cranston
2112 Brown St.
Flint, Michigan

"... your T.V. PHOTOFACTS are a sure fire help to Television Servicing."



Harry D. Kratz
4112 Frederick Ave.
Baltimore, Maryland

"The frequent \$1.50 Folders helps a fellow to 'budget' his library, while being up-to-date as well. Orchids to you."

NOW! GET THE PROOF FOR YOURSELF!

FREE

We'll Send You a FREE Photofact Folder on any postwar set

Learn for yourself—at our expense—how PHOTOFACT pays for itself by earning bigger repair profits for you! Ask for a FREE Folder covering any postwar AM, FM or TV receiver listed in the PHOTOFACT Cumulative Index. Examine it. Put it to work at your bench—then judge for yourself!

WRITE FOR FREE FOLDER TODAY!

HOWARD W. SAMS & CO., INC.
2201 East 46th Street • Indianapolis 5, Indiana

APPROVED ELECTRONIC INSTRUMENT SUPERHET TUNER

A broadcast superhet tuner, model A-600, has been announced by Approved Electronic Instrument Corp., 142 Liberty St., New York 6, N. Y.

Tubes used are 12BE6 converter, 12BA6 *if* stage, 12AT6 diode detector and first audio, and a 35W4 rectifier.

Output is adjustable in 3 steps or 10 volts, 5 volts and 1 volt. Supplied is a 2½' shielded output cable.

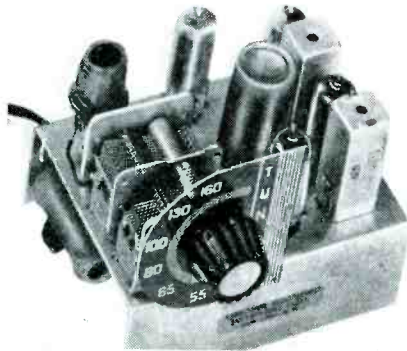

* * *

INDUSTRIAL DEVICES MINI-VOLT VOLTMETER

A *Mini-Volt Voltmeter*, the 410A, which features an expanded scale centered on the common 110 and 220-line voltages, has been announced by Industrial Devices, Inc., Edgewater, N. J.

Said to be accurate to within 2 volts at 110 volts *ac*. Practically burnout proof operation is said to be assured by a glow-lamp indicator which is guaranteed for 25,000 hours' operation minimum. Flexible test leads (12") are tipped with heavily insulated test prods.

Can check voltage, *ac* or *dc*; tell whether *ac* or *dc*; check for continuity; check blown fuses; locate grounded components.

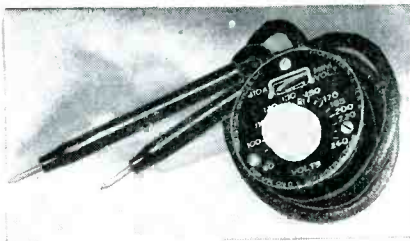

* * *

MAGNA-TOOL SCREW DRIVERS

A line of power-driven and hand-driven screw drivers has been announced by the Magna-Tool Corporation, Buffalo, N. Y. The power-driven line incorporates magnetic finders which are said to pick up and automatically position the screw so that the retracted bit can be driven into the screw slot to complete the driving operation.

Both the power and hand-driven types are said to permit 'one-hand' operation. Both models have interchangeable bits.

Permanently magnetized holders of Alnico charge the bit.

CIRCLE-X INDOOR ANTENNA

An indoor antenna which is circular in design and incorporates many of the features of the outdoor *Circle X* antenna, has been announced by the Circle "X" Antenna Corp., 500 Market St., Perth Amboy, N. J.

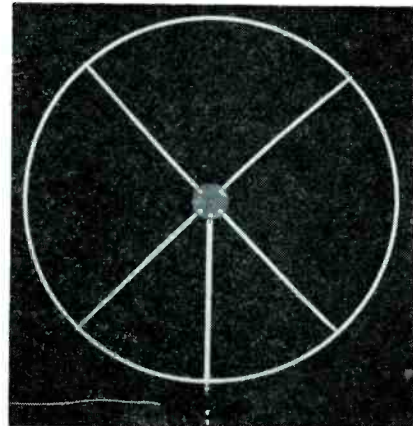

* * *

KNIGHT MAGNETIC TAPE RECORDER

A magnetic tape recorder has been announced by the Allied Radio Corp., 833 W. Jackson Boulevard, Chicago 7, Ill.

Recorder features simplified tape threading which is said to eliminate fumbling, and only one control for tape transport mechanism (with three positions: *record-play, off, rewind*).

Unit records for a full hour on a 1,200' reel of tape, with 30 minutes for each half of tape width. Recording speed is 7½" per second. Rewind speed is 20 times as fast.

Other features include a special speaker switch that permits muting speaker when recording from microphone and a constant speed capstan drive. Proper recording level at all times is said to be assured by the neon bulb level indicator.

Recordings can be made from the microphone supplied or from any radio, FM tuner or phonograph. Recorder is complete with a built-in amplifier and *pm* speaker for playback, and also has provision for connection to an external amplifier and speaker. In addition, unit can serve as a medium coverage *pa* system with an output of 5 watts.

PICTURE-TUBE INSPECTION



TV picture-tube inspection station under a conveyor line at the Ottawa, Ohio, plant of Sylvania Electric. Foreground operation involves settling out of the fluorescent coating.

MUELLER ELECTRIC NEEDLE CLIPS

Solid bronze needle clips, type 50-C, for making electric contact by piercing insulated wires, have been announced by the Mueller Electric Co., 1583 E. 31 St., Cleveland 14, Ohio.

Sharp needle in one jaw makes quick contact right through insulation, thus eliminating the necessity of disconnecting a wire to make a test.

Clip is non-corrosive and equipped with brass screw connection. It may be used with or without an insulator on it.

Another addition to the line is the same clip without the needle feature, type 51-C. This has a high current carrying and non-corrosive clip of the crocodile type jaw.



* * *

SCHAUER BATTERY CHARGERS

A line of home-type battery chargers, approved by Underwriters' Laboratories, Inc., has been announced by the Schauer Manufacturing Corp., Cincinnati, Ohio.

Four models ranging in capacity from 4 to 20 amperes are included in the line. Said to provide a safe charging rate that will not overheat the battery, and which automatically tapers down as the battery becomes charged. The rectifying element used is selenium. Manufacturer states that the chargers will not cause radio interference when in operation.

A feature of the charger is a *charger guard* which is said to act as a corrector instantly in the case of an overload or short circuit. Eliminating the ordinary fuse, the *guard* automatically resets the circuit breaker after the overload or short circuit has been remedied.

* * *

TRICRAFT DUO-BAND ANTENNA

A *Duo-Band* type antenna, model 950, featuring a matching connecting harness, designed to match high band elements with low band elements has been announced by the Tricraft Products Co., 1535 N. Ashland Ave., Chicago 22. Constructed entirely of weatherproof aluminum.

CONICAL TV ON NAVY SHIP

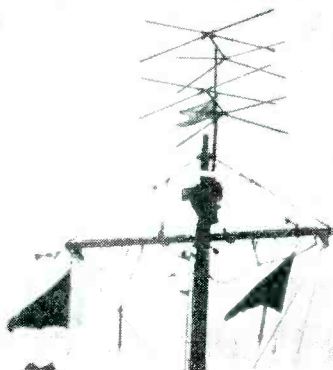

Conical type TV antenna (Sayder TX-2) recently installed on the USS Sierra.

STEPHENS HF SPEAKER SYSTEM

A *hf* reproducer system for the 3500-20,000 cps. range, model 107, has been introduced by the Stephens Manufacturing Corp., 8538 Warner Drive, Culver City, Calif.

In combination two-way speaker systems, or conventional single voice coil speakers, the system is said to give a clean extension of high frequency reproduction. Due to a small mass of the moving system, together with a specially designed throat configuration, very low distortion is claimed.

A conversion may be accomplished by connecting the input to the system across the *hf* driver of an existing dual system, or by shunting it across the input to a conventional speaker.

Specifications: Power input above 3,500 cps, 20 watts from program material, 5 watts steady tone. Reproducing range said to be flat ± 3 db to 15,000 cps. Impedance, 16 ohms. Voice coil diameter 1". Weight of unit and crossover combined, 5½ pounds. Size, driver only, 3½" diameter by 2½" deep, with 2x4 40° x 80° *hf* horn attached, 7" deep overall.

* * *

WALSCO ANTENNAS

TV antennas featuring silicone treated styron molded insulators, marine type high tensile chromium-aluminum alloys for elements, and butt-seamed tubing elements have been announced by the Walter L. Schott Co., Los Angeles, Calif.

Ser-Cuits

(Continued from page 33)

with the windings to prevent interaction between the two sweep voltages.

A 5,000-ohm vertical linearity control shifts the operating point of the tube so that the sweep is amplified along that portion of the plate current curve which results in a linear output.

Horizontal Sweep

The purpose of the combined horizontal sweep circuits is to develop a saw-tooth current through the horizontal deflection coils which develops a magnetic field that moves the electron beam horizontally across the picture tube screen. The saw-tooth voltage originates in the plate circuit of a 12SN7GT horizontal discharge tube. Although the horizontal tube could normally be triggered by noise as well as sync pulses, the sweep is designed so that the frequency, which is unaffected by noise, is the controlling factor.

The frequency control circuit consists of a 6SN7GT 15.75-kc horizontal oscillator, a 6AL5 phase detector and a 6SN7GT horizontal control tube.

To maintain horizontal synchronization, the 15.75-kc horizontal oscillator must be properly phased with the

(Continued on page 54)

2 IMPORTANT NEW PHOTOFACT BOOKS

"TELEVISION TUBE LOCATION GUIDE"

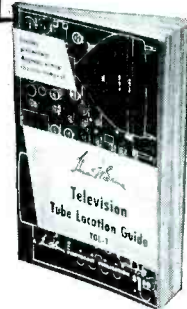

Gives Tube position and function in hundreds of important TV receiver models, made by 56 manufacturers.

FIND THE TROUBLE AND REPLACE TUBES WITHOUT REMOVING CHASSIS

Nothing like it! The only book that shows the *position and function* of tubes in hundreds of TV receivers. Often an operational check in the customer's home . . . looking at the picture tube and listening to the sound . . . can give you a clue to the trouble. Many times only a tube failure is responsible. TGL-1 makes trouble diagnosis and tube replacement quick and simple, in most cases *without removing the chassis!* Each model has its own clear, accurate diagram. Book fully indexed for quick reference. Over 200 pages, handy pocket size, 5½ x 8½". Get two copies . . . one for outside calls and one for your bench. Pays for itself on the first job!

ORDER TGL-1 Only. \$1.50



"DIAL CORD STRINGING GUIDE"

NEW!

SECOND VOLUME

Covers models from 1947 to October 1949

Over 45,000 servicemen bought the first volume of this invaluable book! New second volume includes 511 different dial cord stringing diagrams used in almost 1000 receivers produced from 1947 to October, 1949 (all new data continuing from where the first volume left off). There's only *one right way* to string a dial cord . . . and here's the *only* book that shows you how. Saves time—saves effort. Handy pocket size. Order copies for your tool kit and work bench today.

ORDER DC-2 Only. \$1.00

HOWARD W. SAMS & CO., INC.

Order from your Parts Jobber today, or write direct to HOWARD W. SAMS & CO., INC., 2201 East 46th Street, Indianapolis 5, Ind.

My (check) (money order) for \$ enclosed. Send the following books:

- TGL-1 "TV Tube Location Guide" \$1.50
- DC-2 "Dial Cord Stringing Guide" \$1.00

Name

Address

City Zone State

TRIPLE YOUR TV SALES!

TENNA-TRAILER SAVES TIME AND MONEY
IN "ON THE SPOT" ONE MAN INSTALLATIONS



The new Price Tenna-Trailer will put you way out front of your competition. It enables you to quickly raise a 51 foot mast. One man can set the versatile unit in position, crank up telescoping mast, rotate for best signal — all in a matter of minutes. You'll be thrilled with its ingenious, sturdy construction!

MAST AVAILABLE SEPARATELY

With adaptor kit, Tenna-Trailer Mast becomes versatile means for permanent rotatable TV installations on ground or side of house.

Trailer is ruggedly constructed of steel, tires are excellent retreads. Standard trailer coupler with ball included. Unit trails easily, stands rigid in highest winds, yet is the lowest price portable mast in the field!

Write for illustrated folder for full details. Don't delay. You, too, can get the jump on your competition with the Price Tenna-Trailer.

Complete, Trailer with Mast, Net \$225.00
Mast Only, List \$99.50

PRICE TENNA-TRAILER CO.
WATSEKA, ILLINOIS

CONTINENTAL CARBOMITE RESISTORS

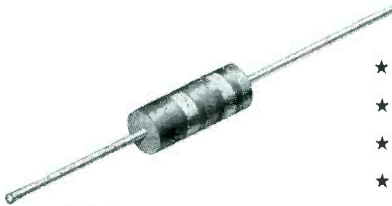

- ★ JAN R-11 Approved
- ★ Ratings, 1/2, 1 & 2 Watt
- ★ Tolerance 5% & 10%
- ★ Operate at 70° Amb

Ideal for service replacement, especially in television receivers. Available from stock through Continental Jobbers in cooperation with Allen-Bradley.

CONTINENTAL CARBON Inc. CLEVELAND 11, OHIO

MODEL 209A

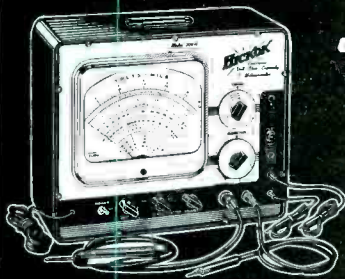

HICKOK Volt-Ohm-Capacity MILLIAMMETER

- Easy to read, long scale 9" meter.
- Zero-center DC scale for faster alignment.
- Resistance measurements to 1/10 ohm.
- New 1200 Volt AC scale.
- Low capacity, high frequency probe. Peak-to-Peak or RMS — Flat freq. response to 300 megacycles.

THE HICKOK ELECTRICAL INSTRUMENT CO.
10521 DUPONT AVE. • CLEVELAND 8, OHIO

SEE YOUR JOBBER OR WRITE FOR COMPLETE INFORMATION TODAY

Ser-Cuits

(Continued from page 53)

transmitted synchronizing pulses. To accomplish proper phasing, the use of a horizontal control tube and a phase detector is required.

The phase detector compares the transmitted sync pulses with the sweep voltage which is removed from the secondary of a horizontal sweep transformer.

Westinghouse H-223

Continuing our probe of the Westinghouse H-223 TV model,³ which features a common *if* setup, we find a novel arrangement in the *dc* restorer, phase inverter and sync separator circuit.

One-half of a 12AU7 dual-triode tube serves as a *dc* restorer and sync separator, while the other half serves as a phase inverter.

In one triode section, the cathode (pin 3) and the grid (pin 2) serve as a diode which performs the *dc* restorer function. The output of the video amplifier is applied to the cathode through a .1-mfd capacitor and 2,200-ohm resistor. When the signal drives the cathode negative with respect to ground, the diode conducts and effectively shorts out a 470,000-ohm resistor in the cathode circuit. This shortens the time constant of the circuit that would otherwise include the 470,000-ohm unit, the .1-mfd capacitor and the 2,200-ohm resistor. As a result of the relatively short time constant, the .1-mfd capacitor will charge to almost the peak amplitude of the sync pulse which is *negative going* at this point in the circuit. During the time that the applied signal is at zero or positive potential, the diode is non-conductive and the time constant as determined by the resistor-capacitor combination is relatively long. During this time, the .1-mfd unit discharges slowly through the resistor and develops a potential that is positive with respect to ground across the resistors. Since the charging rate of the capacitor is much greater than the discharge rate, the positive potential will be maintained throughout the cycle and its amplitude will be determined by the average amplitudes of the sync pulses. The positive voltage thus developed is applied as bias to the grid of the picture tube where it counteracts some of the positive voltage applied to the *cathode* of the picture tube through a voltage divider and brightness control. The varying bias applied to the picture-tube grid then holds the blanking

³Ser-Cuits, SERVICE, January, 1950.

Nation-wide
ACCEPTANCE
on Proven Superiority



ANCHOR
TV PRE-AMPLIFIER
Here's Proof of Distributor Acceptance

SOUTH BEND, IND.—"We have found Anchor TV Pre-Amplifier to be superior in performance to anything else on the market. It has been a profitable item on which we have built up dealer good will."
COMMERCIAL SOUND & RADIO CO.—A. E. Kester, Pres.

PHILADELPHIA, PA.—"Anchor Booster's consistency, its high gain and its performance in outer fringe areas have built for it a reputation which cannot be beat in our area. The excellency of this product has opened up many television areas and many additional sales in Television Receivers, their component parts and accessories."
RADIO ELECTRIC SERVICE COMPANY OF PENNSYLVANIA
Albert N. Kass, Sales Manager

ANCHOR has established general acceptance and good will for all good boosters through its own top-notch performance!

Unanimous proven verdict of users. Anchor's engineering is not approached—nor will it ever be.

The ANCHOR BOOSTER is built to help you make the best TV installations possible for your customers.

Why then be satisfied with the ordinary? Anchor builds demand for reliable boosters—making more sales—adding good will. Tie Anchor Booster into every television sale.

Here is dependability with instant sales appeal—2½ times average gain (Voltage Ratio), guaranteed coverage of low and high band—precision with beauty—pride in having the best!

Get in touch with your jobber—or write ANCHOR ANCHOR ENGINEERING ALWAYS A YEAR AHEAD

ANCHOR
RADIO CORP.
2215 S. St. Louis Ave.
Chicago 23, Ill.

PUSH TO LOCK

GET THIS

QUICK-WEDGE SCREW-HOLDING SCREWDRIVER
Holds, Starts, and Drives Screws with same tool!
Eliminates Fumbling!

6 inch 90c 8 inch 95c

Made in Three Types
Light Duty 2" to 8"
Medium Duty 4" to 8"
Heavy Duty 4" to 14"

ASK YOUR JOBBER OR ORDER DIRECT
Machinery Sales & Equipment
626 Broadway, Cincinnati 2, Ohio

pedestals of the signal at a constant level, and the brightness control is adjusted so that this level corresponds to the cut-off point of the picture-tube. In this way, the *dc* component of the original signal is effectively reinserted.

At the same time as the grid and cathode of the triode section are functioning as a *dc* restorer, the entire triode section, including the plate (pin 1) serves as a sync clipper. As a result of the *dc* restorer function, a potential that is approximately 25 volts positive with respect to ground is developed across the 470,000-ohm resistor. With this voltage applied to the cathode, the triode is operating well below cutoff. The circuit is actually a grounded-grid amplifier with the input signal applied to the cathode. The operating conditions are such that only the *negative going* sync pulses are of sufficient amplitude to counteract the high bias and thus appear within the operating range of the tube. As a result, only a portion of each sync pulse appears at the plate of the tube; the blanking pedestals and video component are clipped because they appear below cutoff and the tops of the sync pulses along with any strong noise peaks are clipped because the low plate voltage (approximately 8 volts) allows the tube to operate over only a very limited range. A 22-mmf capacitor serves to bypass any video component that may leak through.

The other triode section of the 12AU7 operates as a *paraphrase* amplifier. The output from the sync clipper section of the 12AU7 is coupled into the grid of the phase inverter section through a .01-mfd capacitor. The cathode (pin 8) is returned to ground through a 3,900-ohm resistor. From across this resistance is taken one of the output voltages, and from across the plate load resistor is taken the other output voltage. These two voltages, which are 180° out of phase and approximately equal in amplitude, are fed to a 6AL5 horizontal *afc* tube where they are used to control the frequency of the horizontal multivibrator.

Synchronizing voltage for the vertical multivibrator is also taken from the cathode (pin 8) of the 12AU7 phase inverter section. From this point, the voltage is fed to the integrating network where it is reshaped.

Audio Channel

The 4.5-mc signal is taken from the plate of the video amplifier and fed to
(Continued on page 59)

CORROSION-PROOF!

Snyder
PHILADELPHIA

TV MASTS OF walker Conshohocken

DUALCOTED STEEL

DEVELOPED AND ENGINEERED ESPECIALLY FOR TELEVISION AERIALS.

Tough flexible coating on inner and outer tube wall.
Prevents corrosion from salt, acids, caustics.
Will not crack or chip.

SOLE SELLING AGENT
ONTARIO RESEARCH CORP.
An Affiliate of SNYDER MFG. CO.
2218 W. ONTARIO ST.
PHILA. 40, PA.

INSIST ON TITANCO

All the Way!

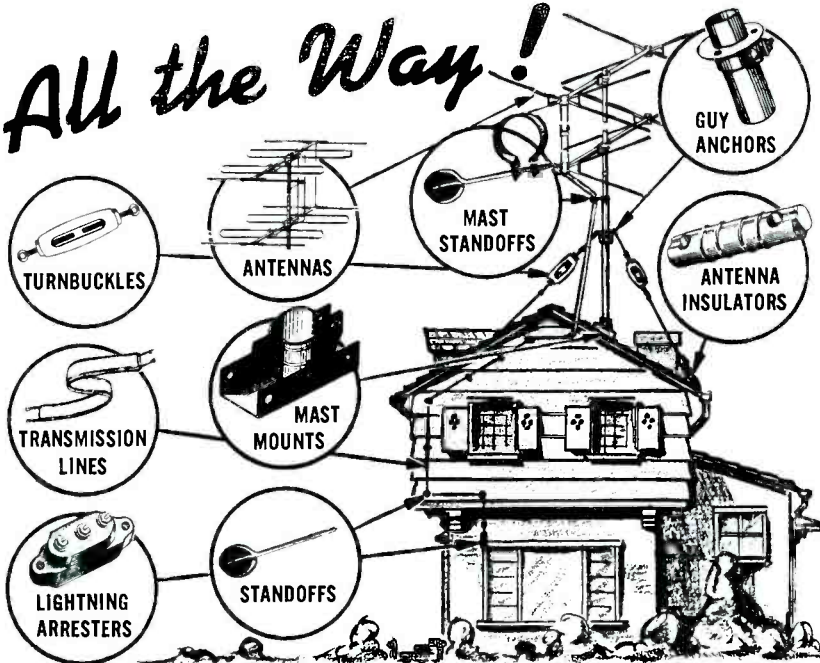

RADIO AND ELECTRONIC EQUIPMENT

TECHNICAL APPLIANCE
CORP.
SHERBURNE, N. Y.

In Canada: Stromberg-Carlson Co. Ltd., Toronto 4, Ont.

TITANCO



OHMITE OHM'S LAW CALCULATOR SLIDE RULE

A pocket-size Ohm's law calculator, featuring separate slide rule and parallel resistance scales, has been announced by Ohmite Manufacturing Co., 4937 Flournoy St., Chicago, Illinois.

One setting of the slide is said to provide the answer to any Ohm's law problem, reading directly in ohms, volts, amperes and watts.

Two scales on the back provide a standard slide rule as well as a one-setting means of solving parallel resistance problems. The slide rule will multiply, divide, and find squares and square roots.

Calculator is made of heavily varnished cardboard, in pocket size (9" x 3"). Priced at 25c.

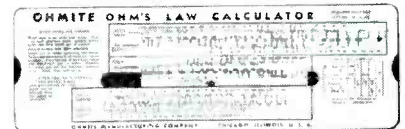

* * *

SYLVANIA TV VIEWING-TUBE BOOKLET

A 20-page booklet providing TV picture tube and general-purpose *crt* characteristics; replacement tube data; base diagrams; suggestions for tube handling; and a concise description of 'scope use in TV servicing, has been published by the radio tube division of Sylvania Electric Products, Inc., Emporium, Pennsylvania.

A section of the booklet, in the form of a TV viewing-tube replacement chart, lists interchangeable types; changes required for tubes of different face sizes and overall lengths; service data for TV sets designed for obsolete picture-tube types; and data for kit builders wishing to increase picture tube size.

Covered are 165 tube types with faces ranging from two to twenty inches maximum dimension, utilizing electrostatic or magnetic deflection systems. A nomenclature chart explains the meaning of type number letters and figures, and applications for different types of tube screens.

Booklet, 8 1/2" x 11", is available through authorized Sylvania distributors.

* * *

K. C. MEINKEN, JR., JOINS NATIONAL UNION

Kenneth C. Meinken, Jr., has been appointed midwestern sales manager of tube sales to initial equipment manufacturers by the National Union Radio Corp., Orange, New Jersey.

Headquarters are at 2800 North Milwaukee Ave., Chicago.

FOR ORIGINALITY

LOOK TO XCELITE

Only \$9.95 for This COMPLETE Nut Driving, Screwdriving, Reaming Kit!

The big XCELITE handle fits the detachable blades—gives you 12 QUALITY TOOLS. 9 chrome plated nut drivers, 3/16"-1/2" sizes, two screwdriver sizes, one reamer, in durable roll kit! NOW AVAILABLE—#1 and #2 Phillips points on ONE blade! Order No. 99-82 blade. List price \$1.05 (P.S. We left a space for it in both 99 kits). ASK YOUR SUPPLIER OR WRITE:

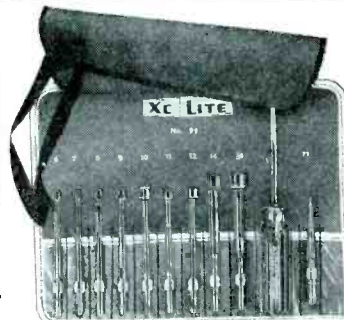

Quality Tools
PREFERRED BY
EXPERTS

PARK METALWARE CO., INC.
Dept. V Orchard Park, N. Y.

Canadians Send Orders Direct to: Chas. W. Pointon, Canadian Warehouse Distributor, 1926 Gerrard St., Toronto, Ont.

RADIO RECEPTOR SELENIUM BULLETIN

A four-page pamphlet on the design, application and servicing of selenium rectifiers has been released by the Seletron Division of Radio Receptor Co., Inc., 251 West 19th Street, New York 11.

Presents a complete description and tabulation of test and repair procedures, and authoritative information on troubleshooting methods for the half-wave circuit. Rectifier repair and replacement technique is also described fully.

* * *

OXFORD CATALOG

A catalog listing electrodynamic, *pm*, TV, *pa*, auto, intercom and weather-proof speakers has been published by Oxford Electric Corp., 3911 S. Michigan Ave., Chicago.

CYCLE INVENTORY CONTROL

A system facilitating inventory control has been developed by Henry Hutchins, P. O. Box 5081, Tucson, Arizona.

Known as the *cycle inventory control*, the method provides complete sales and stock information. Specially-designed forms have columns for name of supplier, where to send orders, supplier's discount and order restrictions, prices, inventory-control figure, etc.

* * *

MERIT TV REPLACEMENT GUIDE

A replacement booklet, *the 1950 TV Repl Guide*, listing approximately 400 popular television receiving sets, made by 60 manufacturers, has been released by the Merit Transformer Corp., 4425 N. Clark St., Chicago 40, Ill.

TELEVISION SCOPE

SUPERIORITY AT A GLANCE!

The vertical response of this economy TV scope is usable to 5000 kc, not 50 kc. Response is flat to 750 kc, down 3 db at 1000 kc. Amplifier supplies a voltage gain of 20 at 5000 kc.



AR-3

Check this necessary feature before you buy any scope for TV use.

The R.S.E., AR-3 Scope has been built by Ross Armstrong to our rigid specifications. It's a complete unit that embodies standard horizontal amplifier and sweep circuits with normal sensitivity.

The case is 8" high x 5" wide x 14" long, attractively finished in "hammered" opalescent blue enamel. Operates on standard 110 volts—60 cycles—40 watts. Tubes, 3BP1-6AC7-6SJ7-6X5-5Y3-884. Instructions included. Complete specifications upon request. Satisfaction or your money back.

PRICE
\$4995

AVAILABLE TO JOBBERS
IN QUANTITY

F. O. B.
DETROIT

INTERCOM & RADIO

AT A
PRICE
THAT
CAN'T
BE BEAT



6 tube superhet—3 tube intercom permits communication between radio-master and up to 4 sub-stations.

WHILE THEY LAST
\$2995

With 1 sub-station and 50 feet of cable
Extra Sub-stations
\$3.95 each

Original cost \$64.50

PUSHBACK WIRE



25% BELOW MILL COST!

1st class, Essex or Lens, ALL SOLID finned copper, double cotton serve, waxed finish.

SIZE	COLORS	100 feet	1000	Production Reel
22	BLACK-BROWN	.39	3.75	3.65M
20	RED-WHITE-BLUE	.49	4.49	3.95M
18	BROWN	.69	5.98	

ORDER INSTRUCTIONS



Minimum order—\$2.00. 25% deposit with order required for all C.O.D. shipments. Be sure to include sufficient postage—excess will be refunded. Orders received without postage will be shipped express collect. All prices F.O.B. Detroit.

Quantity and Export
Orders Solicited

RADIO SUPPLY & ENGINEERING CO., Inc.
85 SELDEN AVE. DETROIT 1, MICH.

W. HARTER NOW CENTRALAB DISTRIBUTOR DIV. S-M

Wickham Harter has been named sales manager of the distributor division of the Centralab Division of Globe-Union, Inc., Milwaukee, Wisconsin.

Harter formerly was vice president and sales manager of Solar Manufacturing Corp., North Bergen, New Jersey.



W. Harter

SYLVANIA PROMOTES HAUSER

John H. Hauser, former assistant manager of Sylvania distributor sales at Emporium, Pa., has been transferred to the Chicago sales office of the Sylvania radio tube division.

He will direct and coordinate distributor sales activities in twenty-four mid-western and southern states which include five of the company's sales divisions.



J. H. Hauser

G. E. TUBE CAMPAIGN

A customer-prospect mailing campaign, business solicitation plan, low-cost newspaper and radio advertising schedule, and a store tie-in which re-emphasizes and combines all the efforts, have been included in a six-month tube-campaign kit developed by the tube division of G. E.

Kit includes a series of one-a-month postcards each fully imprinted. The cards which can be mailed to both regular and prospective customer, have different monthly themes. A total of 600 cards is contained in the basic kit.

Door knob hangers are a feature of the business-solicitation plan. Three hundred of these, in three different styles, are packed with each kit. A detailed suggestion folder tells how these hangers may be used to best advantage. Sample phone conversations are also included in this package.

Varied radio announcements, including those for use on the *disc jockey* programs have also been prepared. Newspaper ads mats are also in the kit. In the store tie-in part of the kit appears two brightly colored, luminescent decals. Window streamers, two for each month, are also in the package.

A booklet which pictorially displays television picture tubes, and offers four current classifications of tubes, together with graphic comparisons of their screen images are also in the merchandising kit.

BIG OR SMALL RCP has them all!

GIANT SIZE METER MULTITESTER MODEL 462

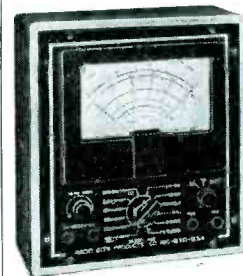

20,000 Ohms per Volt
D.C.
5,000 Ohms per Volt
A.C.
NO FREQUENCY ERRORS

Unusual because of the many desirable features that are combined in one instrument. The size of the meter, 6 1/2", provides a very long scale with excellent legibility so important for bench work. Uses germanium crystal rectifier which has no frequency error for output measurements or even high radio frequencies.

Uses individual unit cells for ohmmeter. Easy and economical to purchase and replace—snap into terminal clamps—no soldering.

RANGES

D.C. Voltmeter 0/2.5/10/- 200/200,000 0/20 megohms.
50/250/. 1000/5000 volts. Decibel Meter—10 to/55 db.
A.C. Voltmeter 0/2.5/10/- Meter of 50 microampere
50/250/. 1000/5000 volts. sensitivity permits current
D.C. Milliammeter 0/10/- readings of less than 1
100/500 milliamperes. microampere.
D.C. Microammeter 0/100 Shunts and multipliers are
microamperes. Ohmmeter 0/- calibrated to 1% accuracy.

Model 462 Multitester is a beautiful large instrument with 6 1/2" meter, bakelite panel and oak case. Size 4 1/4" x 8 1/2" x 10 3/4". Weight 5 lbs.

Net Price **\$41.50**

Model 462P comes in a portable hinged cover oak carrying case having a tool compartment and includes deluxe pencil prod test leads. Size 5 1/4" x 8 1/2" x 11 3/4". Weight 6 lbs.

Net Price **\$45.95**

POCKET SIZE METER MULTITESTER MODEL 449A

Versatile multi-tester remarkably accurate. It's tops for general circuit testing and for speed in trouble-shooting. Uses a 3" square meter at 5,000 ohms per volt with a basic movement of 200 microamperes. Batteries are mounted in special spring clips readily accessible for replacement—no wires to solder. Combines 6 instruments in one small unit.



RANGES

DC Volts: 0-5-50-250-1000
Volts.
AC Volts: 0-5-50-250-1000
Volts.
DC MA: 5-10-100-1000 MA
Ohms: 0-2000-20,000-0-2-2.
Megohms
Decibels: -6 to +52 DB in
four ranges.
Output Meter: 0-5-50-250-1000.

Model 449A—Pocket Multitester supplied in black metal case complete with self-contained batteries. Ready to operate. Size 5 1/4" x 3 1/16" x 2 1/4". Weight 1 1/2 lbs.
Net Price **\$24.50**

Model 449AP—Same as 449A but supplied in portable oak case with leads.
Net Price **\$28.50**

BUY IT FROM YOUR JOBBER
Write for Catalog SV

RADIO CITY PRODUCTS CO., INC.

152 West 25th Street, New York 1, N. Y.

Like peas

in a pod

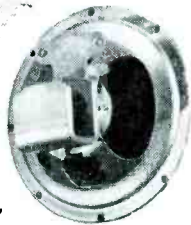
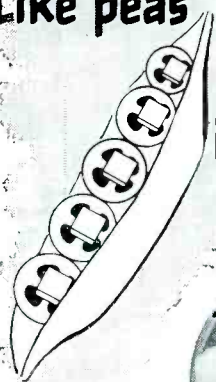

except for

QUAM

Only Quam offers more! The U-Shaped Coil Pot, providing an unbroken path for the magnetic lines of force, thus producing a stronger magnetic field with higher efficiency and improved performance, is an exclusive Quam feature.

The Quam Adjustable Voice Coil, permitting accurate centering after assembly and virtually eliminating rubbing voice coils, is also found *only* on Quam Speakers.

No other speaker offers such outstanding extra features — such extra value. For all your replacements, specify Quam.

Mail This Coupon
for Free Catalog



QUAM-NICHOLS CO.

526 E. 33rd Place
Chicago 16, Illinois

Please send me Quam catalog.

Name

Address

City..... State.....

NEW!

Color Tone on your Television!

Simply attach TELECOLOR FILTER to front of your set, and enjoy favorite programs in a glorious color tone, instead of dull black and white. 'TELECOLOR' Filter is one of the latest discoveries. It has a special formula fluorescent coloring, that gives brilliant pleasing color tone. You will find new happiness in the enjoyable color depth, reduced glare, fog, snow and less eye strain.

Everyone is talking about and waiting for 3 color Television costing hundreds of dollars. For a small sum you can enjoy color toning now.

TELECOLOR FILTER is a wonderful gift to friends or relatives who own sets.

10 inch tube — \$3.00	
12½ " " — \$4.00	Dept.
16 " " — \$6.00	S 2

HARVARD LABORATORY

659 Fulton St., Brooklyn 1, N. Y.

ASSOCIATIONS



TEN YEARS AGO

From the Association News Page of
SERVICE, February, 1940

THE RSA *Give-A-Radio* campaign, conducted in cooperation with WGAR, Cleveland, and the Cleveland Welfare Federation, was very successful resulting in the distribution of eighty-one receivers to orphan asylums, social-settlement houses and the homes of needy shut-ins. Alex Plakadis, president of the Cleveland chapter, played an important role in this campaign by arranging to have members of the association make all the necessary repairs to the receivers. . . . The *Give-A-Radio* campaign effort was duplicated in Pittsburgh by the Pittsburgh chapter and stations KDKA, WWSW, KQV and WJAS. Hundreds of sets were donated as a result of the campaign and according to Samuel Avins, general counsel for the association, many more could have been received if the pickup and repair facilities had been available. As a result of this successful effort a goal of 2,500 sets was set for 1941. The entire membership of the association contributed 1,000 tubes for the receivers. . . . George W. Bain, chief engineer at Ken-Rad and Charles Wexler, head of Ken-Rad's circuit laboratory, appeared before the monthly meeting of the Radio Servicemen's Association of Evansville, Indiana, and presented papers on FM and receiver design analysis. Van C. Norwood, who had been elected president of the association at a previous meeting, also offered a short technical talk. . . . John Meagher, RCA Service engineer, appeared before the New York chapter and presented a talk on the RCA dynamic demonstrator. Announcement was made that J. C. Aceves of Any, Aceves and King would discuss antenna coupling systems at a subsequent meeting. . . . Walter R. Jones, Hy-Grade Sylvania commercial engineer, completed a tour of more than one-half dozen associations in the South and Southeast during which he presented a diagrammatic story of tubes of 1940.

FRSAP

THE ANNUAL ELECTION of the Federation of Radio Servicemen's Associations of Pennsylvania was held recently and David Krantz was reelected chairman for the year.

T. L. Clarkson of the Mid-State Association, in Harrisburg, was named vice chairman. Others elected were: Leon Helk of the Lackawanna servicing group, in Scranton, recording secretary, and John G. Raeder, of the Berks county section in Reading, corresponding secretary and treasurer.

The delegates from the nine chapters attending the meeting extended membership to new chapters in York, Lancaster and Sunbury. It was also decided at the meeting to request a corporate setup for the group which would operate under the State non-profit corporation laws.

Members at the meeting revealed that the FRSAP award plaque will be presented at the annual Harrisburg luncheon meeting to a leading tube and set manufacturer.

ARTSNY

MAX LIEBOWITZ was reelected president of the Associated Radio-Television Servicemen of New York during the annual election.

Others elected at this meeting included: Arthur Silverberg, vice presi-

HOT CLAMPS
Ground & Guy Wire

the **HOT** TV LINE

Adjustable . . . Positive Contact

Used by leading
TV installers!

NON-CORROSIVE
FITS 5/8" to 3/2" PIPE
NO PIPE CLEANING
LOW COST

FREE: Write today for illustrated catalog and prices!

THE HOUSE OF TELEVISION
INCORPORATED

40 WEST FOURTH STREET
NEW YORK 12, N. Y.

CROWN[®]
has **ALL** the Features



Directional Indicator
Electrical Stops
Easy Installation
Life-Time Lubrication
One-Year Guarantee
Electrically Safe
Non-Warp Castings
Ball Bearing Equipped
Machine Cut Gears

list \$5950

CROWN[®]
Antenna Rotator

Write for details
CROWN CONTROLS CO., Inc.
New Bremen, Ohio

dent; Jack Edel, treasurer; Jerry Maccherone, recording secretary, and Noel Payne, corresponding secretary.

The board of directors was enlarged to include ten members.

An announcement at the meeting relative to future activities revealed that the first annual dance of the association would be held at the Hotel Diplomat on March 3.

According to prexy Max Liebowitz, the Board of Education—Association television courses have been extremely well attended. Three types of sessions have been planned covering elementary, intermediate and advanced phases of radio and television. Liebowitz also reported that *no fee* is being charged for the courses or equipment used.

DVRA

THE 5TH ANNUAL Old Timers' meeting of the Delaware Valley Radio Association will be held on April 9 at the Stacy-Trent Hotel ballroom in Trenton, New Jersey, according to a note from Edward G. Raser, general chairman of the banquet committee.

Quite a gala night is planned with informal talks by such personalities as Lloyd Espenschied, Irving Vermilya, Clarence D. Tuska, Major C. F. Welch and George W. Bailey.

Ser-Cuits

(Continued from page 55)

the audio *if* amplifier. In this stage the signal is amplified sufficiently to drive the ratio detector. The function and operation of the audio channel is the same as that of an FM receiver except that the *if* is 4.5 mc rather than 10.7 mc.

The *avc* system used in the audio channel is unusual in that *avc* is applied to a 6BH6 suppressor grid as well as to the control grid. A portion of the audio *if* amplifier output is coupled through a 10-mmfd capacitor to one of the diode plates in the 6AT6 first audio amplifier tube. The diode will conduct during the positive portion of the cycle, and current will flow through a string of three resistors to ground (470,000 and 2,200 ohms). The current flow develops a voltage that is negative with respect to ground across these resistors. A portion of the developed voltage is applied to the suppressor grid, and a lesser portion is applied to the control grid due to the voltage divider action of the three resistors. Greater control over the stage gain is obtained by applying the *avc* voltage to both grids rather than to the control grid only. The *avc* line is bypassed for *rf* by a 47-mmfd capacitor which serves also as part of the *avc* time constant network.

TELREX ANTENNA PRICE REDUCTIONS

Price reductions averaging between 15 to 22% on their complete line of TV antennas and accessories have been announced by Telrex, Inc., Asbury Park, N. J.

"The lower prices," according to a statement by M. D. Ercolino, president of Telrex, Inc., "have been made possible by new, improved production methods." "A new addition to our plant, coupled with the acquisition of additional engineering talent," Ercolino added, "has more than trebled our capacity."

The company, designers and manufacturers of antennas since 1921, has been especially identified with the development and introduction of the conical *V* beam antenna.



NATIONAL Videometer

Now, at last, you can predict TV receiver operation at a given location with laboratory accuracy! Now, you can make a perfect TV installation every time — ghost and interference free — and eliminate costly call-backs! The National Videometer, described in the December issue of SERVICE, shows you BOTH the TV picture AND meter readings on both field intensity and line voltage — gives you a complete, fool-proof check on antenna orientation, transmission line, voltage, etc.



METER
A.C. LINE SIG. STR.

METER CHECK ON BOTH FIELD INTENSITY AND LINE VOLTAGE

Set the meter switch to A.C. LINE and read the line voltage at the receiver input terminal directly on the 0-150 volt scale. Set the switch to SIG. STR. and read the field intensity on the 0-10 scale. A table is provided to convert directly to microvolts. Reading indicates field intensity at antenna input and is independent of contrast and brightness controls. \$169.95



SOLVE your hi-fidelity problems with

University TWEETERS

WIDEST SELECTION • BEST VALUE • HIGHEST QUALITY

SINGLE UNIT TWEETERS

MODELS 4408, 4409—600 CYCLE TWEETERS: Recommended for highest quality reproduction systems requiring a low crossover frequency. Cobra shaped horn results in perfect wide angle distribution. Frequency response 600 to 15,000 cycles. Model 4408 handles 6 watts and 4409 25 watts.

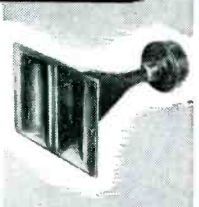

MODEL 4407 ADAPTER MOUNTS 4401 TWEETER IN ANY 12" CONE UNIT: Converts any 12" cone speaker into a wide-range coaxial reproducer in a few minutes. Installation is extremely simple and results in a dual speaker occupying little more space than the original cone speaker. Complete with 4401 tweeter.

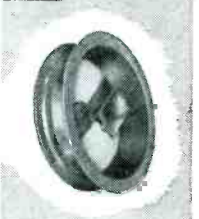

MODEL 4401—2000 CYCLE TWEETER: An economical 6 watt unit for converting any good 10-15" cone speaker for extended response to 15,000 cycles. Wide Angle horn, compact design and low price bring excellent high fidelity well within the popular price range.



DUAL TWEETERS

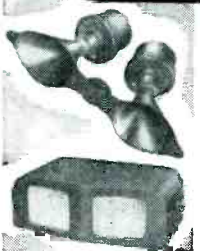

MODEL 4402, MODEL 4404: Model 4402 reproduces to 15,000 cycles. Crossover at 2000 cps. Horizontal dispersion 100°, Vertical 50°. Handles 12 watts. Compact design mounts in any radio, phono, or speaker cabinet. Model 4404 incorporates 4402 tweeter in handsome walnut cabinet complete with high-pass filter and high frequency volume control. Anyone can install.

CROSSOVER NETWORKS



MODEL 4405 HIGH PASS FILTER: An effective and economical unit for preventing lows reaching the tweeter unit. Contains high frequency control to balance highs and lows. Cutoff frequency 2000 cycles.



MODEL 4410, 4420 LC CROSSOVER NETWORK: Genuine LC frequency dividers for segregating highs and lows. Not to be confused with ordinary high-pass filters. Crossover frequencies: Model 4410 600 cycles, Model 4420 2000 cycles. Attenuator controls included and wired.

Write today for illustrated literature — address inquiries to Department C

University LOUDSPEAKERS • INC

80 SO. KENSICO AV., WHITE PLAINS, N.Y.

JOTS AND FLASHES

THE TREND to larger picture tubes was emphasized recently in a report from RMA which cited that in 1949 more than 43 per cent of the picture tubes sold to set manufacturers were from 12 to 13.9 inches in size, as compared with 6 per cent in 1948. The 16-inch type became a substantial factor as the year drew to a close and it appears now as if the 16-inchers will become the predominant item for the year. An interesting review of the 16-inch types now being produced appears in the L. M. Allen *Tube News* analysis this month. . . . A map detailing where prospective TV set owners live in relation to available transmission has been prepared by Sylvania. . . . The American Society of Industrial Engineers recently presented its 1950 Merit Award to RCA for the development of the 45-rpm record-playing system. . . . Harold W. Schaefer has become a special assistant in the research and engineering department of Philco Corp. Schaefer was formally with Westinghouse as assistant manager of the home-radio division. . . . Astatic's TV booster is being promoted over television in Cleveland, Philadelphia, San Francisco and Erie, Pennsylvania, via a motion-picture film presentation. . . . The Philadelphia division of D. R. Bittan Co. will hereafter be known as Bittan-Boenecke Co., Inc., 1505 Race St., Philadelphia. . . . Bruce Cumming and Associates, 228 No. LaSalle St., Chicago 1, are now representing Clarostat in all of Illinois with the exception of Benton and Harrisburg counties, and Wisconsin with the exception of Marinett, Eau Clair, La Cross and Wassau. . . . Tel-O-Tube Corp. of America, East Paterson, N. J., have added a new plant in which rectangular, 19-inch glass and glass-metal tube production will be featured. . . . Remington Rand, 315 Fourth Ave., New York 10, N. Y., have developed a service-order-card carrying case which holds 6" x 4" cards on which can be noted service call information. . . . Television is being used to promote the products of the Regency Division of Industrial Development Engineering Associates, Inc., Indianapolis. . . . Jerome E. Respass, president of the LaPointe-Plascomold Corp., Unionville, Conn., recently delivered a series of six lectures in Louisiana and Texas. . . . Victor Mucher, president of Clarostat, is now a member of the board of directors of the Dover (N. H.) Chamber of Commerce. . . . W. Bert Knight will represent the House of Television, Inc., and Hot Nails, Inc., in Southern California and Arizona. . . . Jules Bressler, 220 W. 42 St., New York 18, N. Y., has become a Telrex, Inc., sales rep covering New York City and lower Hudson Valley. . . . Mark Glaser, chief engineer and vice president of the DeWald Radio and Television Corp., Long Island City 1, has invented an electronic color TV system which is said to be fully compatible with present transmission standards. . . . R. W. Farris has been named chairman of the board of governors of *The Representatives*. . . . Harry J. Mayer, former manager of Technical Products Service of the RCA Service Co., in Chicago, is now N. Y. District Manager of the Technical Products Service Division. . . . R. L. Grove has been appointed chief engineer of the C-D ceramic division in New Bedford, Mass.

ADVERTISERS IN THIS ISSUE

SERVICE INDEX—FEBRUARY, 1950

ALLIANCE MFG. CO.	47
Agency: Foster & Davies, Inc.	
AMERICAN PHENOLIC CORP.	32
Agency: Burton Browne, Advertising	
AMPERITE CO., INC.	42
Agency: H. T. Gold Co.	
ANCHOR RADIO CORP.	55
Agency: Symonds, MacKenzie & Co.	
CENTRALAB DIV. GLOBE-UNION, INC.	26, 27
Agency: Klau-Van Pietersom-Dunlop Associates, Inc.	
CIRCLE-X ANTENNA CORP.	52
Agency: Homer Harding	
CLAROSTAT MFG. CO., INC.	46
Agency: Austin C. Lescaurou & Staff	
CLIPPARD INSTRUMENT LABORATORY	44
Agency: The S. C. Baer Co.	
CONTINENTAL CARBON, INC.	54
Agency: William Glazer Adv. Agency	
CORNELL-DUBILIER ELEC. CORP.	Inside Front Cover
Agency: Stern and Warren	
CORNELL-DUBILIER ELECTRIC CORP.	29
Agency: Reiss Advertising, Inc.	
CROWN CONTROLS CO., INC.	59
Agency: Don Kemper Co., Inc.	
DECIMETER, INC.	46
Agency: Wayne Welch, Inc.	
ALLEN B. DUMONT LABORATORIES, INC.	13, 37
Agency: Austin C. Lescaurou & Staff	
GENERAL ELECTRIC CO.	23
Agency: Maxon, Inc.	
HARVARD LABORATORIES	58
Agency: Jamani Advertising, Inc.	
THE HEATH CO.	52
Agency: G. Dean Arend, Advertising	
HICKOK ELECTRICAL INSTRUMENT CO.	54
Agency: White Adv. Co.	
HOUSE OF TELEVISION, INC.	62
Agency: A. D. Adams Advertising	
HYTRON RADIO & ELECTRONICS CORP.	5
Agency: Bennett, Walther & Menadier, Inc.	
J. F. D. MFG. CO., INC.	45
Agency: Shappe-Wilkes, Inc.	
JACKSON ELECTRICAL INSTRUMENT CO.	43
KEN-RAD DIV. GENERAL ELECTRIC CO.	1
Agency: Maxon, Inc.	
KESTER SOLDER CO.	4
Agency: Frank C. Nahser, Inc.	
MACHINERY SALES & EQUIPMENT CO.	55
Agency: Hieser-Guenther, Inc.	
THE MAC MILLAN CO.	42
Agency: Atherton & Currier, Inc.	
P. R. MALLORY & CO., INC.	Inside Back Cover
Agency: The Altkin-Kynnett Co.	
MUELLER ELECTRIC CO.	40
NATIONAL CO., INC.	59
Agency: John G. Dowd, Inc.	
NATIONAL VIDEO CORP.	6
Agency: A. Martin Rothbardt, Inc.	
ODEGAARD MFG. CO.	42
Agency: H. W. Hauptman Co.	
OHMITE MFG. CO.	40
Agency: The Fensholt Co.	
ONTARIO RESEARCH CORP.	55
Agency: Brooks and London	
PARK METALWARE CO., INC.	56
Agency: Melvin F. Hall Agency, Inc.	
PHOENIX ELECTRONICS, INC.	40
Agency: Milton Richards	
PRECISION APPARATUS CO., INC.	12
Agency: Shappe-Wilkes, Inc.	
PRICE TENNA-TRAILER CO.	54
Agency: Rudolph Bartz, Advertising	
QUAM-NICHOLS CO.	58
Agency: Triangle Adv. Agency, Inc.	
THE RADIART CORP.	14, 15
Agency: Stern and Warren	
RADIO CITY PRODUCTS CO.	57
Agency: Jamani Advertising, Inc.	
RADIO CORPORATION OF AMERICA	14, Back Cover
Agency: J. Walter Thompson Co.	
RADIO RECEPTOR CO.	48
Agency: Walter J. Zimmerman & Associates	
RADIO SUPPLY & ENGINEERING CO., INC.	57
Agency: Claude E. Whipple	
JOHN F. RIDER PUBLISHER, INC.	38
Agency: Shappe-Wilkes, Inc.	
HOWARD W. SAMS & CO., INC.	52, 53
Agency: George Brodsky, Advertising	
SIMPSON ELECTRIC CO.	7
Agency: Burton Browne, Advertising	
SONIC INDUSTRIES, INC.	41
Agency: Jamani Advertising, Inc.	
SPRAGUE PRODUCTS CO.	39, 44
Agency: The Harry P. Bridge Co.	
STANDARD COIL PRODUCTS CO., INC.	9
Agency: Frank C. Nahser, Inc.	
STANDARD TRANSFORMER CORP.	51
Agency: Burnet-Kuhn Adv. Co.	
SYLVANIA ELECTRIC PRODUCTS, INC.	3
Agency: Cecl & Presbrey, Inc.	
TECHNICAL APPLIANCE CORP.	56
Agency: Austin C. Lescaurou & Staff	
UNIVERSITY LOUDSPEAKERS, INC.	60
Agency: George Homer Martin Associates	
UTAH, INC.	49
Agency: Adare Adv. Agency	
WEBSTER ELECTRIC	44
Agency: Hamilton Adv. Agency, Inc.	

...speaking of
fan mail



THE MALLORY MIDGETROL IS GETTING FAN MAIL FROM COAST TO COAST

Run your eyes down the quotes below. They are convincing proof that the Mallory Midgetrol is a star performer with servicemen everywhere.

FAN MAIL FROM SERVICEMEN WHO KNOW!*

- "The Midgetrol is a life-saver in the radio repair business!"
- "The new Mallory Midgetrol is the handiest control I have seen."
- "I have been in the servicing game for 17 years now and this is really the first universal control I have ever seen."
- "Your many innovations make this the outstanding control."
- "I like it very much... the small size, the better shaft and the improved switch are all very good."
- "It is sure a time and space saver."
- "Thanks for Midgetrol. It's a sensation!"

*Actual quotations from a few of hundreds of unsolicited letters from servicemen.

MALLORY MIDGETROL

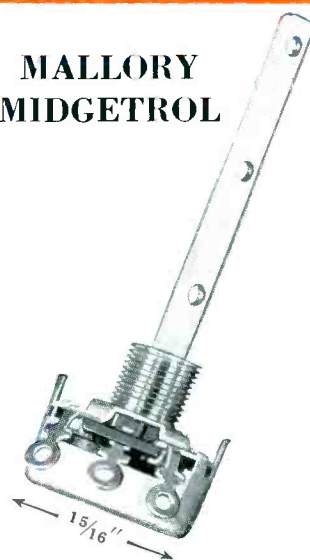

- *Fastest of all to install*
- *Saves time*
- *Saves trouble*
- *Saves money*
- *Easiest switch to attach*
- *Eliminates sawing and filing*
- *15/16" size fits all sets*

See your Mallory distributor
today!

P. R. MALLORY & CO. Inc.
MALLORY

CAPACITORS • CONTROLS • VIBRATORS • SWITCHES • RESISTORS
• RECTIFIERS • VIBRAPACK® POWER SUPPLIES • FILTERS

*Reg. U. S. Pat. Off.

APPROVED PRECISION PRODUCTS

P. R. MALLORY & CO., Inc., INDIANAPOLIS 6, INDIANA

A clear selling



field



You can sell **MORE RCA Batteries** because...

RCA BATTERIES give you a clear selling field—they're distributed primarily to the radio trade!

You have less competition from non-radio neighborhood stores. Sell RCA Batteries and repeat sales stay with **YOU!**

RCA Batteries are *radio-engineered* for extra listening hours. The completely rounded line covers *virtually all renewal requirements.*

Closely co-ordinated production meets seasonal demand, assures fresh stock always.

RCA provides the greatest array of battery selling aids in the industry—all geared to the *radio trade.*

Smart packaging, competitive prices and "the greatest name in radio" are compelling reasons why RCA Batteries are your best buy by far.

See your RCA Battery Distributor for fast, reliable service.



RADIO CORPORATION of AMERICA
RADIO BATTERIES **HARRISON, N. J.**