

# SERVICE

January  
1950

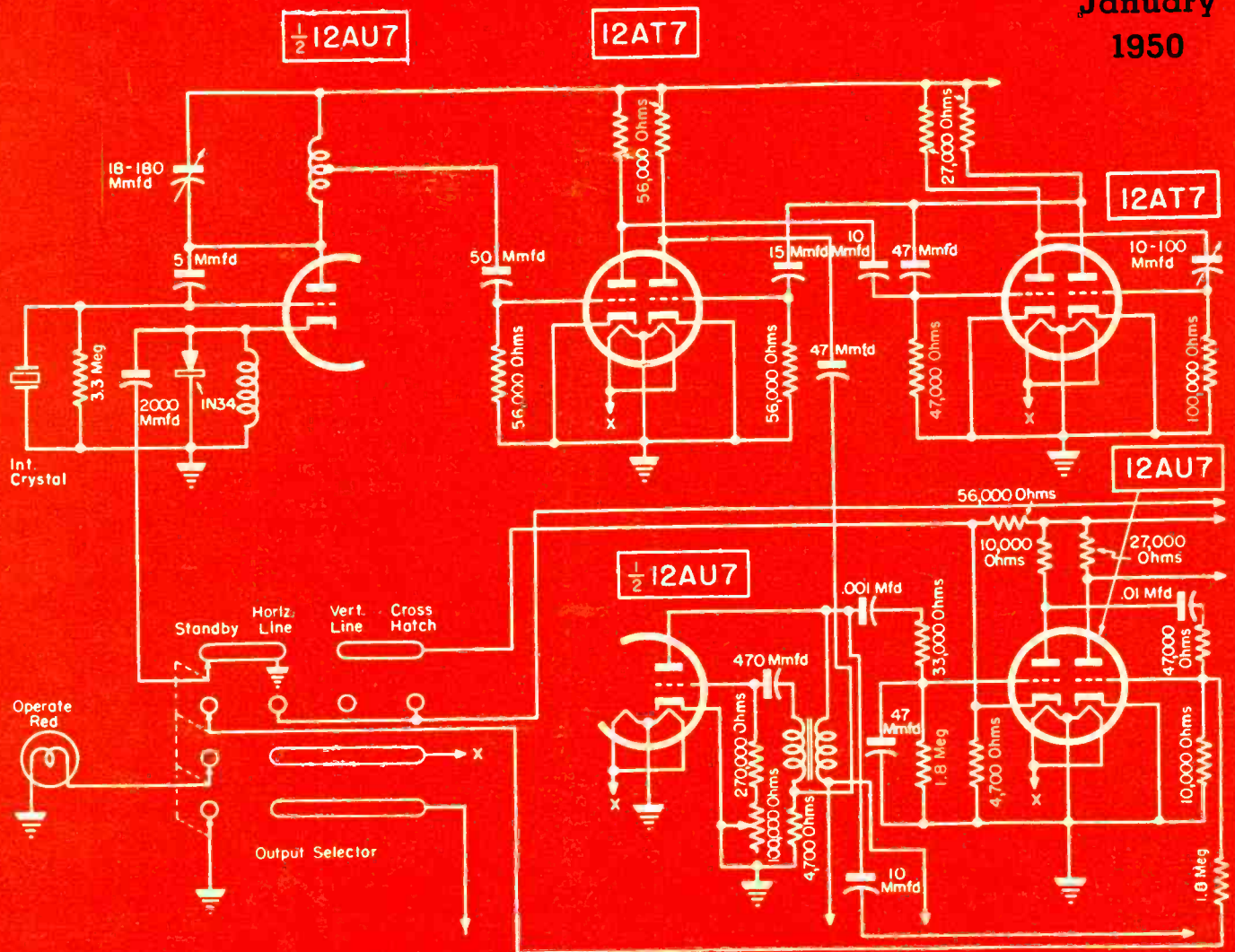

Input system of cross-hatch generator which serves to provide controlled linearity patterns.

[See page 27]

Want to know  
 how you can  
 knock 15 minutes  
 off a "ONE-HOUR"  
 TV servicing job?



READ THE "Capacitor"

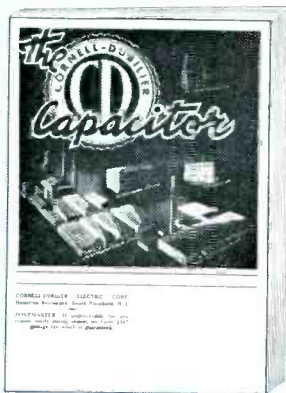

C-D's FREE MONTHLY MAGAZINE OF NEW SERVICE TECHNIQUES!

Every month some smart cookie somewhere figures out a way to do a "one-hour" servicing job in 45 minutes or so. As soon as we hear about it, we pop it right into The Capacitor, diagrams and all. For instance, here are just a few of the thousands of articles that have appeared in the C-D Capacitor in recent months:

- "TV Interference . . . Causes and Remedies"
- "TV Picture-Tube Voltage and Signal Systems"
- "Simple Methods of Measuring Inductance of Air-Core and Powdered-Iron-Core Coils"
- "Taking Complete Receiver Performance Data"

A few typical articles to appear in coming months are:

- "Testing AC Capacitors"
- "General-Purpose Impedance Bridge"
- "The Meaning of Distortion"
- "AC Bridges"

Clip the coupon today. We'll put you on the list to receive the next 12 issues of The Capacitor, free!

*Cornell-Dubilier Electric Corporation, South Plainfield, New Jersey. Other plants in New Bedford, Brookline and Worcester, Mass.; Providence, R. I.; Indianapolis, Ind., and Cleveland, Ohio.*

THIS COUPON ENTITLES YOU TO  
 RECEIVE THE CAPACITOR FOR  
 ONE YEAR, FREE OF CHARGE

MAIL IT TODAY!

CORNELL-DUBILIER ELECTRIC CORP., DEPT. S-10  
 SOUTH PLAINFIELD, N. J.

GENTLEMEN:

*Time's a-wasting. Let's see how many hours The Capacitor can save for me. Send the next 12 issues free of charge.*

NAME . . . . .

ADDRESS . . . . .

CITY . . . . . ZONE . . . . . STATE . . . . .

**CORNELL-DUBILIER**  
 CONSISTENTLY DEPENDABLE

- ★ CAPACITORS
- ★ VIBRATORS
- ★ ANTENNAS
- ★ CONVERTERS



1910 1950  
 Reg. U. S. Pat. Off.

world's  
 largest manufacturer  
 of Capacitors

# PARTNER?

**"I'm looking at  
a good one!"**



"Like having someone to run interference for me on every sale!" Radio-TV servicemen feel that way about the General Electric trademark because experience has shown how highly their customers respect the symbol "G-E".

This is only the start of the G-E dealer-profit story. For General Electric helps you with an unexcelled group of tube promotion aids—income-builders every one! G.E.'s complete line of tubes includes newest types made possible only by superior resources in research, development, and manufacture ... meaning that you can go after *all the tube business, all the time!*

Unwrap this G-E dealer success-package! Give *your* skill and efforts as serviceman a rich reward! Your G-E tube distributor gladly will cooperate in every way. Phone or write him today! *Electronics Department, General Electric Co., Schenectady 5, N. Y.*

*You can put your confidence in—*

**GENERAL  ELECTRIC**

161-JA2

**ONE SOURCE FOR  
ALL YOUR TUBE  
REQUIREMENTS!**



TV PICTURE TUBES

METAL TUBES

GLASS TYPES

MINIATURES

—also GERMANIUM DIODES and SELENIUM RECTIFIERS. Stock G-E 100-percent to save time and routine in ordering—to have the benefit of bulk deliveries from your distributor—to profit from General Electric tube quality and product popularity.

RADIO · TELEVISION · ELECTRONIC  
**SERVICE**

**LEWIS WINNER**  
Editorial Director

**F. WALEN**  
Assistant Editor

**ALFRED A. GHIRARDI**  
Advisory Editor

	Page
Association News	32
Connecting TV Receivers to Master Antenna Systems. By Ira Kamen	10
Phono Installation and Service (Toy Type Phonos and Recorders). By Kenneth Stewart	18
Use of Tube Curves to Diagnose Circuit Performance. By Edward M. Noll	28
Ser-Cuits (Westinghouse and G.E. TV Models)	14
Servicing Helps. By M. A. Maxwell	12
Ten Years Ago in Associations	32
Tube News (New TV and FM Types). By L. M. Allen	26
TV Cross-Hatch Generator (Cover). By Allan Lytel	16
TV Receiver Production Changes. By Donald Phillips	23
Wire Recorder Servicing (Sears, Roebuck Models). By Max Alth	24
News and Views. By Lewis Winner	9
<b>CIRCUITS</b>	
Cross-Over Network	20
Circuit to Reduce Vertical Sweep Radiation in Philco Sets	13
G.E. 4SJ3A1	18
G.E. 186-3A	19
G.E. 4SJ2A1	19
G.E. 4SJ4A1	19
Hickok 620 (Cover)	16
Phase Inverter	30
RCA ST270 (Front End)	10
RCA Master Antenna Outlet	10
6BN6 Circuit	26
Wave-Trap Hookup for Philco TV Models	13
Westinghouse H-223	15
Westinghouse H-242 HV Supply	23
<b>COVER</b>	
TV Cross-Hatch Generator (Hickok 620)	16
<b>SERVICING HELPS</b>	
Eliminating Parasitic Oscillation in Horizontal Output Circuit	12
Germanium Diode Markings	12
How to Provide Series-Filament Continuity When Picture Tubes are Removed	12
Identifying and Eliminating Various Types of TV Interference	13
<b>TV RECEIVER PRODUCTION CHANGES</b>	
Buzz Modulation Correction (G.E.)	23
Improved HV Power Supply (Westinghouse)	23
Picture-Tube Circuit Alterations (Westinghouse)	23
Separate Picture-Tube Filament Winding Addition (G.E.)	23
Vertical-Size Modification (G.E.)	23
<b>Index to Advertisers</b>	48
<b>Manufacturers</b>	
Jots and Flashes	48
News	41
New Parts . . . Accessories	43
TV Parts . . . Antennas . . . Accessories	38

Entire contents Copyright 1950, Bryan Davis Publishing Co., Inc.



Published monthly by Bryan Davis Publishing Co., Inc.  
52 Vanderbilt Avenue, New York 17, N. Y. Telephone MUrray Hill 4-0170

Bryan S. Davis, President      Paul S. Weil, Vice-Pres., Gen. Mgr.      F. Walen, Secretary      A. Goebel, Circulation Manager

East-Central Representative: James C. Munn, 2253 Delaware Dr., Cleveland 6, Ohio. Telephone: Erievlew 1726  
Pacific Coast Representative: Brand & Brand, 1052 W. Sixth St., Los Angeles 14, Calif. Telephone: Michigan 1732  
Suite 1204, Russ Building, San Francisco 4, Calif. Telephone: SUTter 1-2251

Entered as second-class matter June 14, 1932, at the Post Office at New York, N. Y., under the Act of March 3, 1879. Subscription price: \$2.00 per year in the United States of America and Canada; 25 cents per copy. \$3.00 per year in foreign countries; 35 cents per copy.

**KESTER  
SOLDER**

## Give top quality TV service with Kester "Resin-Five" Core Solder

**MADE ONLY FROM NEWLY MINED  
GRADE A TIN AND VIRGIN LEAD**

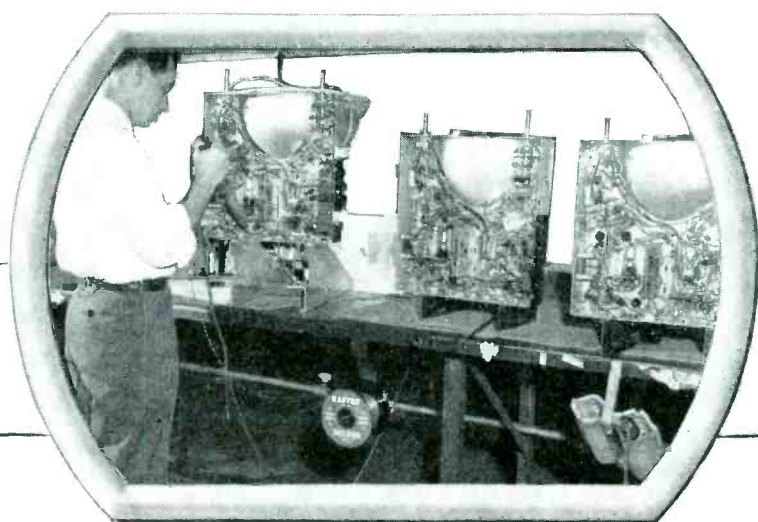
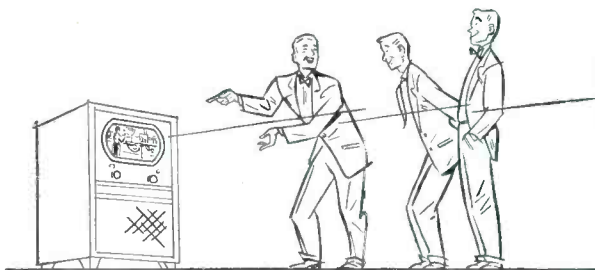

# 'Resin-Five' Core Solder

*non-corrosive . . . non-conductive*

Kester... Standard for the TV and Radio Fields

TV—the nation's fastest growing business demands the nation's number 1 solder. Kester "Resin-Five" Core Solder, formulated especially for TV, will out perform any solder of the rosin-core type. It easily solders such metals as brass, zinc, nickel-plate, copper, and ferrous alloys.

"Resin-Five" flux is more active and stable than any other rosin-type flux. Yet it is absolutely non-corrosive and non-conductive.

**FREE SOLDERING BOOKLET**—Send for Your  
Copy of — *Soldering Simplified*

**Kester Solder Company**  
4248 Wrightwood Avenue • Chicago 39, Illinois  
Newark, New Jersey • Brantford, Canada



Used by leading television manufacturers

## ...RCA Test Equipment

Normal sync pulses in a video amplifier presented accurately by use of the low-capacitance probe.



**NOW — at \$249.50**

**... the RCA WO-58A Television Oscilloscope has no equal**

Unquestionably the finest instrument of its type, the WO-58A is a splendid investment for any service shop. Expressly designed for observation of voltages in TV receivers, this oscilloscope affords accurate presentation of sync pulses, deflection waveforms, and composite video signals. Defective waveforms can be traced step-by-step to their sources.

Peak-to-peak voltages of TV-receiver waveforms can be read at all times during operation. The frequency-compensated vertical range control is graduated in five voltage steps of 3-to-1 ratio which, together with a built-in calibrating voltage source, facilitates voltage measurements over any extended range.

A crystal probe is supplied which can be connected to the kinescope socket of the receiver under test. When so used, it presents the same capacitance as the kinescope grid and, therefore, provides faithful reproduction of video-amplifier response curves.

The vertical amplifier of the WO-58A has a useful range from 1 cycle to 4 megacycles. Its characteristics of tilt, overshoot, and rise time are excellent. As a result of its unusual transient-response performance, the WO-58A provides accurate traces of sync pulses and other steep wave forms. *Supplied complete with crystal probe, direct probe, and low-capacitance probe. See your RCA Test Equipment Distributor today for full details.*

AVAILABLE FROM YOUR RCA TEST EQUIPMENT DISTRIBUTOR



**RADIO CORPORATION of AMERICA**  
TEST EQUIPMENT

HARRISON, N. J.

# ATV 225

**THE TESTED LEAD-IN LINE**

*Means More  
Set Sales*



● Since late in 1947 Anaconda ATV\* 225 Shielded Lead-In Lines\*\* have been in operation in various sections of the United States.

Comparative results are now conclusive. ATV 225 means no more weather interference, no more moisture, or dirt troubles, no "snow," no "ghosts," no re-radiation from nearby installations, auto, truck or airplane ignition.

In a word, pictures are clear and clean as never before. And because service call-backs are negligible, (instead of ruinous) there's more time for selling sets. And there's lots of replacement business on out-of-date, unshielded lead-in lines . . . with scientific, time-tested ATV 225. It's now generally available. Order today.

**Specifically, ATV 225 offers:**

1. High impedance—matches receiver input circuit.
2. Extremely high signal to noise ratio.
3. Low attenuation—full signal strength.
4. Stable performance and long life under all weather conditions.
5. Fire resistant—meets Underwriters' requirements.
6. Operates in conduit without change in electrical properties.

49447

**ANACONDA**  
from mine to consumer

\*Reg. U. S. Pat. Off.  
\*\*Patent Applied for.

**ANACONDA WIRE & CABLE COMPANY**

25 BROADWAY, NEW YORK 4, N. Y.

Unit switch construction houses precision resistors in insulated recesses.

Easy-to-change standard batteries. Double spiral springs give permanent connection.

Direct connections—no harness cabling—no shorts.

Molded selector switch fully enclosed. Spiral spring index control—over 150,000 cycles without breaking.

## Here's why top engineers and technicians use Model 630

Features like those shown above are what make this popular V.O.M. so outstandingly dependable in the field. The enclosed switch, for instance, keeps the silvered contacts *permanently clean*. That's rugged construction that means stronger performance, longer life. And tests show that the spiral spring index control, after more than 150,000 cycles of switch rotation, has no disruption or appreciable wear! Investigate this history-making Volt-Ohm-Mil-Ammeter today: 33 ranges, large 5½" meter.

ONLY  
\$37.50  
AT YOUR DISTRIBUTOR

FOR THE MAN WHO TAKES PRIDE IN HIS WORK

# Triplett

TRIPLETT ELECTRICAL INSTRUMENT COMPANY • BLUFFTON, OHIO, U.S.A.

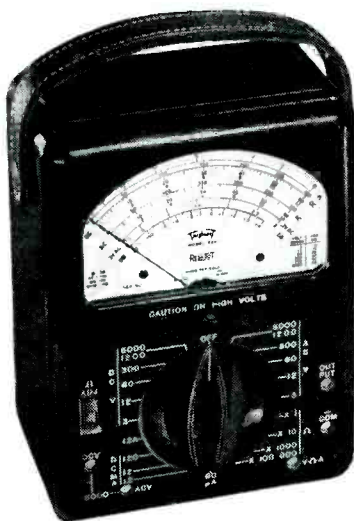



# Profits climb when you use G-E SPEAKERS

## ...WITH MOUNTING BRACKETS AT NO EXTRA COST!

**H**ERE'S the answer to a serviceman's prayer! Time-saving mounting brackets that solve dozens of awkward replacement problems are now available at no extra cost with

every General Electric small-size speaker you get from your distributor or jobber! Adjustable up, down, or sideways, these brackets save your time and simplify tough jobs.



Here's a G-E 4" unit in high mount position. Note how bracket eliminates an awkward blocking job, helps turn out neater, cleaner work.



Bracket can be adjusted up or down to fit the cabinet problem. This G-E 5" Round speaker is especially designed for service replacement.



Lateral mounting feature of bracket saves fingers, time and temper. Screws hold bracket arms and speaker securely and permanently in place.

### How To Build Customer Goodwill

Your customer gains confidence in you when you replace with components of the best quality. When you install a G-E speaker in his set, tell him about its advantages—

- ★ Aluminum Base Voice Coil—a famous G-E feature! High humidity won't warp it! Extremes of temperature won't affect it!
- ★ Much higher power handling capacity... Tough, all-weld construction... G-E Alnico 5 Magnet, securely and efficiently mounted, steady as a rock.
- ★ Power, sensitivity, fidelity! More of everything for his money!

Call your G-E distributor  
or jobber today!

Mail coupon for  
Free Sample Bracket!

This offer open only to radio and TV servicemen!

General Electric Company, Bldg. 1, Section 310  
Electronics Park, Syracuse, New York

Send me free sample bracket and all the facts on G-E Small-Size Speakers.

NAME \_\_\_\_\_

FIRM \_\_\_\_\_

ADDRESS \_\_\_\_\_

CITY \_\_\_\_\_ STATE \_\_\_\_\_

You can put your confidence in—  
**GENERAL**  **ELECTRIC**

SYLVANIA'S EXTENSIVE NATIONAL ADVERTISING IS

# Building business for *you* every minute!



LOOK FOR THIS SIGN OF DEPENDABLE RADIO SERVICE

If your television becomes a terrible vision, call the expert who displays the Sylvania service sign. He knows these complex sets inside out... has the "savvy" to make the delicate adjustments and repairs they sometimes need. He relies on super-keen Sylvania testing devices to detect and diagnose troubles accurately... Sylvania radio tubes, the proper television picture tubes and other custom parts to restore perfect sight and sound. Stop at the shop showing the Sylvania sign for top television and radio repairs.

**SYLVANIA RADIO TUBES**  
PRODUCT OF SYLVANIA ELECTRIC PRODUCTS INC.



LOOK FOR THIS SIGN OF DEPENDABLE RADIO SERVICE

Whistling sounds in your set really give reception a black eye. Get rid of unwanted noises now by calling the radio serviceman who displays the Sylvania sign. He'll make you



LOOK FOR THIS SIGN OF DEPENDABLE RADIO SERVICE

Does your radio give out with squeals and grunts? Then call the serviceman who displays the Sylvania sign. Because your radio needs expert care, the kind this fellow is trained

Sylvania ads especially prepared to boost your service are telling 15,500,000 people from coast to coast all about the valuable service and parts you're offering them. Readers of these magazines are attracted to the lively cartoon-type ads, three of which are reproduced above. They tell them to stop at the Sylvania sign

of dependable service... for the best radio and television repairs at the fairest prices!

Hundreds of these readers are your potential customers. These humorous ads, running in the cream of the nation's publications, help assure you a steady stream of new customers and greater profit.

There's Still Time To Cash In On The First 1950 Sylvania Service Dealer Campaign - Write Sylvania Electric Products Inc., Advertising Dept. R-1701, Emporium, Pa.

# SYLVANIA ELECTRIC

RADIO TUBES; CATHODE RAY TUBES; ELECTRONIC DEVICES; FLUORESCENT LAMPS, FIXTURES, WIRING DEVICES, SIGN TUBING; ELECTRIC LIGHT BULBS; PHOTOLAMPS.

RADIO TELEVISION ELECTRONIC  
**SERVICE**

### The Healthy Road Ahead

THAT LUSTY WORK-SCHEDULE, earmarked for every Service Man in the months to come, and probed in these columns last month, received quite a helping hand from a TV broadcaster in New York a few weeks ago, via a full page ad, which bluntly admitted the important function of the Service Man.

Said this broadcaster in an appeal to viewers: "Are you getting every television station that your receiver is supposed to bring to you. . . . Remember your TV set is made to show you everything on all channels *clearly, vividly and faithfully*. . . . Right now all the television stations allowed to New York are on the air, so don't risk missing any one of them. . . . If you are missing any of the attractive programs that are on the air, you're not getting all the stations that your set was made to give you—what it was *guaranteed* to give you. . . . So why not get in line with our channel and every other channel, today. . . . Here's how—it's simple and economical; it's going to make home an even nicer place to go to. It's going to bring you hours and hours of greater fun, relaxation and enjoyment. It's going to get you *everything* your TV set was made to bring you. . . . All you have to do is call your local Service Man—hundreds of accredited and highly-trained experts are listed in your telephone directory. . . . Remember—a slight adjustment to your *antenna or tuning controls* may be all that's needed to bring you everything your set was made to bring you, including the wonderful show on our station."

Quite a tribute to the Service Man broadcasters feel the boys can do for them!

Additional evidence of the growing TV market appeared in an RMA receiver production report, issued a short while ago, which showed that nearly 2,500,000 receivers were produced during '49, bringing total production since the war to 3,500,000 units. The report also revealed an interesting trend; most of the receivers coming off the line from now on will be with the larger-type picture tubes. More than 58 per cent of the sets produced in November alone used the 12½-inch type and almost 19 per

cent used the 16-inch size and larger.

Here are important figures . . . figures which should prove quite valuable in planning for the days to come.

#### Installation-Service Charges

RATES for the installation and service of TV models, a controversial subject for years, appear to be well on their way to reaching a standardized level.

Thanks to a detailed study by a leading manufacturer, a program has been evolved covering, in particular, three types of installations which have been found to be most prevalent.

In one plan provision has been made for a complete installation, instruction of the customer, parts and tube protection including the picture tube for a year and unlimited service for ninety days, for which two types of charges can prevail: \$22.95 for a built-in antenna model and \$39.95 for an outdoor antenna model of the 10-inch variety. After this period there's a preferred flat-rate charge of \$5.75 per call for service-as-needed. For receivers with 12½-inch tubes the charges have been set up as \$24.95 and \$44.95, respectively, and for the 16-inch models, \$29.95 and \$49.95, respectively. For those who want one year's parts and tube protection and unlimited service, a charge of \$45.00 for a built-in antenna receiver has been prescribed, with the outdoor antenna installation being charged at \$65.00 for 10-inch models.

The survey conducted by this company indicated that the flat-rate for each service-call approach was one which most television set owners seemed to prefer.

Everyone is indeed grateful for this practical plan, which provides an effective pricing pattern.

#### Does TV Damage the Eyes?

THE ALL-IMPORTANT QUESTION of TV and the eyes, long a debated topic, has received one of its most thorough analysis in a booklet recently prepared by Benjamin Roness, a physician, for the National Society for the Prevention of Blindness.

Dr. Roness notes that for ocular comfort . . . "It is important to have steadiness of the picture and a minimization of light bands and other interferences." He suggests proper ad-

justment of the fine-tuning and focus controls as one solution.

Room lighting is also quite important, according to this expert. He points out that the constant shifting of the eye from a bright to a dark background causes considerably more work of the eye muscle, and therefore quicker fatigue. This, he says, can be avoided by indirect lighting of the room. Describing the type of screen which is preferable for best viewing Dr. Roness says that P4 screen, generally used, has been found to be most suitable, since it has a color composition which appears white to the eye, producing a minimum of fatigue. In addition it is so balanced as to minimize flicker effects.

The clarity of the image is, of course, extremely important. Commenting on this point Dr. Roness says: "Since the strength of the received signal is generally universally proportional to the distance of the receiver from the transmitter, it naturally follows that receiving sets placed beyond the normal service area will not receive a good signal and consequently the picture will be *rainy* and indistinct and conducive to eye fatigue."

This point accents the importance of the antenna, which when properly installed, with perhaps the aid of a booster, can be usually the solution to the location problem, even in those areas beyond the normal service range.

#### Standard Brands

WITH THE GROWTH OF TV and the increased demand for servicing, involving quantities of components and accessories, it has become more essential than ever to use only quality parts and allied equipment to secure those all-important guaranteed results. This practice, in the shop and in the field, is a vital responsibility of every Service Man to the millions of set owners throughout the country.

You'll find such quality parts and accessories advertised in the columns of SERVICE every month by manufacturers with outstanding technical-progress reputations. You'll find these standard-brand producers always cooperative, willing to help out with those installation and servicing problems.

In talking or writing to these folks, it will help them and you, too, and we'll be quite grateful, if you'll note that you saw their advertisement in SERVICE.—L. W.

# Connecting MASTER



Fig. 1. Rooftop of multiple dwelling cluttered with TV antennas.  
(Courtesy National Antenna Corporation)

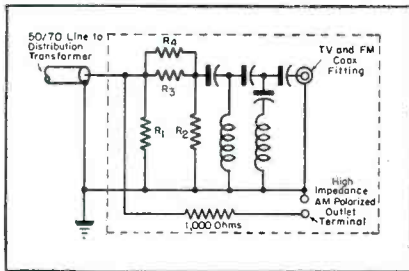

Fig. 2. Circuit of master antenna outlet unit.

Fig. 4. Front end of the RCA 8T270 series which provides for a 72-ohm and 300 ohm line input.

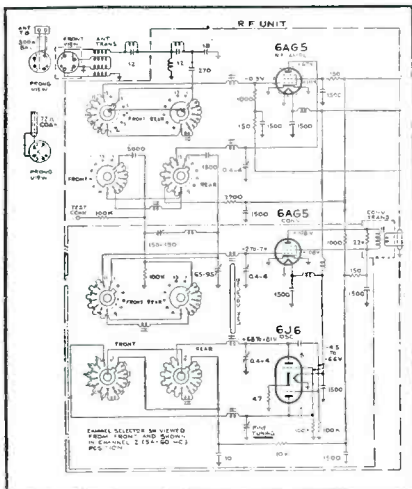
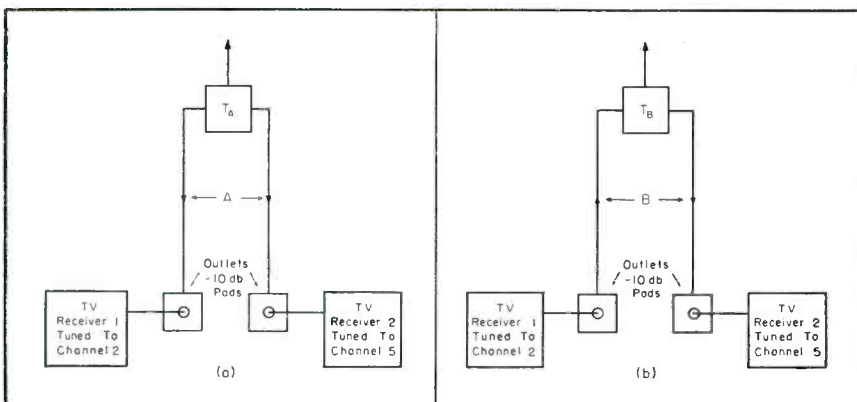

Fig. 3. Signal path conditions. In *a* appears an illustration of the paths of direct signals. The transformer sees only a 10 db outlet attenuation to the receiver. There is no attenuation on the secondary side of the transformer  $T_A$  for direct signals. The drawing in *b* illustrates the path of signals reradiating into the master antenna system from the local oscillator of receiver No. 1. The attenuation between outlets for the reradiated signals is 40 db plus the attenuation of the coax cable used to connect outlets to the transformer. The transformer has a -20 db isolation to the reradiated signal and each outlet has a 10 db attenuation. Arrows indicate the path of reradiated oscillator signal from receiver No. 1 tuned to Channel 2.



EXPERIENCE HAS shown that indoor TV antennas, whether they are of the portable or built-in type, will normally provide satisfactory results only in those locations where there are strong signals from nearby television stations which have an unobstructed path to the indoor antenna.

Actually, in multiple dwellings such as apartment houses and hotels, the clear path and strong-signal advantages have been found to be of little value to the indoor affairs. For in these dwellings there are steel girders used for structural supports and metal lath in the walls to form a base for plaster work, which serve as wave obstructors. Fundamentally, television waves are like light (quasi-optical) which will not bend or penetrate through metal structures and will also be attenuated by dielectric materials such as brick, plaster, etc. This condition represents a fundamental law, like the law of gravity or Huygen's astronomical principles, and are not subject to changes as long as we employ the present standards of TV transmission. Generally, therefore, external TV antennas will be a permanent necessity for most multiple dwellings where tenants desire to view a majority of the TV channels in the area. However, the use of external antennas by all tenants of multiple dwellings has its problems. As shown in Fig. 1, a maze of antennas on the rooftop of a multiple dwelling can make the loca-

tion a hazardous area in the event of a fire, ruin the appearance of the building and in addition, prompt complaints from tenants because of *rf* interference on channels 5, 11 and 13 in the New York City, Chicago, Los Angeles and Baltimore-Washington, D. C. areas, or on channel 6 in such areas as Philadelphia where channels 3 and 6 are in operation. The proximity of antennas may also produce undesirable loading effects which upset antenna adjustment.

The reason for the *rf* interference becomes obvious when the video and audio carrier, and local oscillator frequencies for channels 2 to 13 are considered. We find that when the local oscillators of the TV receiver are tuned to channels 2, 3, 7 and 9, *rf* signals are radiated on channels 5, 6, 11 and 13, respectively, which couple to other TV receivers through proximity of open transmission lines or antennas.

The foregoing illustration indicates that, for interference-free reception in most multiple dwellings, another approach to antenna installations is necessary. The amplified type of master antenna system has been found to provide the solution to the problem.

The majority of the realtors in the New York City areas have begun to realize that a master antenna system offers a practical means of assuring tenant satisfaction and increasing the appeal and value of their properties.

In N. Y. City architectural circles,

Fig. 5. Three methods used to connect receivers to master antenna systems. The *ac/dc* type of TV, FM or AM receivers cannot be connected to the system unless the power line is isolated from the receiver with an *ac* isolation transformer.

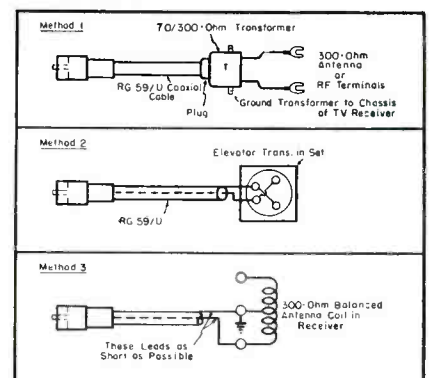

# TV Receivers to ANTENNA SYSTEMS

## Practical Methods Used in Variety of Multiple-Dwelling Installations Involving 72 and 300-Ohm Input Systems.

television master antenna outlet facilities are being given the same consideration as provision for heat, light, plumbing and other necessary services.

From building plans now being processed it appears as if the master-antenna idea is destined to spread nationally. Coupled with programs to provide national distribution for the streamlined-rooftop installations, Service Men will soon find themselves involved in a new profitable antenna-installation business.

Of particular importance in the master-antenna system installation is the connection between the receiver and the outlet device. Familiarity with the circuits of these units have been found very helpful.

The outlets, which are fed from coaxial lines emanating from distribution transformers of one system<sup>2</sup>, terminate the coaxial lines in their own impedance (50 or 72 ohms) by virtue of a pi pad in the outlet.

In addition to properly terminating the coaxial lines, whether or not a set is connected to the outlet, the pad attenuates the received signal ten decibels. When further attenuation is required, a resistor,  $R_2$  (Fig. 2) may be removed from the outlet circuit and the outlet attenuation increases to 15 db.

The importance of this outlet at-

by **IRA KAMEN**

*Manager, TV Dept.  
Commercial Radio Sound Corp.*

tenuation is apparent when one considers that it is necessary to isolate the TV receivers from each other to preclude *rf* interference and interaction.

In Fig. 3 appears two figures detailing the interference and interaction problem and cures.

In (a) of this drawing we note how the desired direct TV signals are attenuated only 10 db from the final distribution transformer to the outlet devices which supply signals to receivers 1 and 2.

In (b) we find the case of a receiver (1) which is tuned to channel 2 and its local oscillator is reradiating an

interference signal on channel 5. The interfering signal (from receiver 1) sees the 10-db attenuation of its own outlet, 20-db attenuation due to a circuit action of a transformer<sup>1</sup> ( $T_A$ ) and another 10 db of attenuation due to the outlet device which feeds TV receiver 2, plus the attenuation of the cable between the outlets.

Since there is at least 40 db of attenuation between any two outlets, and let us say TV receiver 1 is radiating 10,000 microvolts of interfering channel-5 signal into its outlet, less than 100 microvolts ( $10,000/100 = 100:1$  voltage ratio or 40 db) will appear at the antenna terminals of TV receiver 2.

It is a fact that the 100 microvolts of interfering signal will not appear on the TV receiver 2 screen, since it will be swamped by 3,000 microvolts of direct signal for all TV channels provided at the antenna terminals of all TV receivers connected to this type of

(Continued on page 33)

<sup>1</sup>The master antenna system referred to in this paper is described in detail in the Ira Kamen-Lewis Winner book, *TV... FM Antenna Installation*. This system has been installed in many New York City buildings, including the Hampshire House, Hotel McAlpin and Hotel Shelton.

<sup>2</sup>RCA MI 6875    <sup>3</sup>RCA Antenaplex.

At the signing of contracts providing for the installation of master-antenna system outlets for 1,000 apartments in the Schwab House, 40 and 715 Park Avenue, New York City. Standing, left to right: Alexander Fisher, president of Commercial Radio Sound Corp.; Ira Kamen, and Samuel A. Seaver, realtor. Seated, left to right: Frank Folsom, president of RCA; Francis Kleban, realtor, and Julian Roth, architect, of Emery Roth and Sons.

Fig. 6. Master-antenna outlet installed in the Park Lane Hotel, New York, on a surface mounted wiremold box above the molding. (Courtesy RCA)

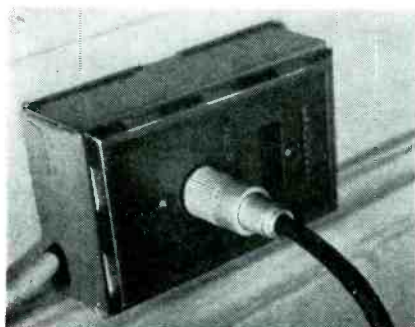

# Servicing Helps

## How to Provide Series-Filament Continuity When Picture Tube Is Removed . . . Germanium Diode Application . . . Eliminating Parasitic Oscillation in Horizontal Output Circuit . . . Identifying and Eliminating Various Types of TV Interference.

INSUFFICIENT HORIZONTAL sweep width in the G. E. models 805, 806, 807, 809, 817, 818 and 821, which has been found due to a parasitic oscillation in the type 19BG6 horizontal sweep output tube, can be corrected by connecting a 47-mmfd 500-v mica capacitor<sup>1</sup> from pin 7 of the 19BG6 tube to a ground lug of an existing terminal board on the adjacent side apron.

### Series Filament Continuity on Removal of Pix Tube

When it is necessary to perform alignment, measure socket voltages, or trouble shoot a TV receiver, it is desirable to remove the picture tube for convenience as well as a personal safety precaution. In receivers with series lighting of the filaments, the removal of the picture tube breaks the continuity of the heater circuit for all tubes and a substitute resistor or suitable filament element must be used to restore continuity. A defective 6SN7GT tube, with a good heater, has been found suitable for this purpose.

To prepare the 6SN7GT, all base pins are sawed or clipped off, except 7 and 8. These are the filament pins and it will be found that they will insert readily into the *crt* socket pin openings 1 and 12. This will reestablish the continuity and provide proper voltage division on the filament strings.

The keyway on the altered 6SN7GT will not line up with the keyway slot in the *crt* socket; however, it will not interfere with the insertion of the tube into the socket.

### Germanium Diode Symbol and Marking

The germanium crystal diode is used in many of the current TV receivers

by **M. A. MARWELL**

for two different circuit applications: (1), video detection and (2), *dc* restoration at the picture tube grid. This diode is symbolized by a polarity marking on the case, the plus mark corresponding in function to the plate of the rectifier tube. The other terminal is equivalent to the cathode.

### TV Sources of Interference<sup>2</sup>

Television reception is subject to interference from various sources. Short-wave, FM and amateur stations, diathermy equipment, and other television stations in the area are possible sources of interference to good reception. Either the fundamental frequency or a harmonic of the fundamental frequency may cause trouble in either the video or sound channel.

The video-*if* response of Philco TV models covers the range of frequencies between 22 and 29 mc, these being the extreme limits. The sound-*if* amplifiers will pass a signal as low as 21 mc; therefore, the interference limits can be said to be 21 and 29 mc.

There are seven conditions which may cause interference:

(1) Any signal which will beat with the local oscillator to produce a beat frequency between 21 and 29 mc can cause interference. For example, the frequency of the local oscillator for channel 3 is 87.85 mc. This frequency

minus 21 mc is 66.85 mc, and the oscillator frequency minus 29 mc is 58.85 mc. Thus, any signal with a frequency between 58.85 and 66.85 mc will beat with 87.85 mc to produce a beat frequency between 21 mc and 29 mc and may interfere with reception of channel 3.

(2) Any *rf* signal whose harmonic will beat with the local oscillator to produce a beat frequency between 21 and 29 mc may also cause interference. For example, the frequencies which have second harmonics that interfere with channel 3 lie between 58.85 mc over 2 and 66.85 mc over 2. In areas where a strong local transmitter is operating, harmonics up to the eighth harmonic may be troublesome. For channel 3, 58.85 and 66.85 mc may be divided by any whole number up to eight to find the interfering frequency limits.

(3) Any extremely strong signal with a fundamental frequency or harmonic frequency that falls in the range of 21 to 29 mc may find its way into the *if* amplifiers and cause interference.

(4) Any image-frequency signal may produce interference. The limits of image frequencies for any channel fall between 21 mc plus the local-oscillator frequency and 29 mc plus the local oscillator frequency. For example, the local-oscillator frequency for channel 3 is 87.85 mc. This frequency plus 21 mc is 108.85 mc; the oscillator frequency plus 29 mc is 116.85 mc. Thus, any frequency between 108.85 and 116.85 mc is an image for channel 3, and may beat with the local oscillator to produce an interfering signal between 21 and 29 mc.

(5) Any signal with such a frequency that the harmonic falls in the

<sup>1</sup> Stock No. UCU-1020.

<sup>2</sup> Based on data supplied by Philco.

image-frequency range is also a possible source of interference.

(6) Any signal with a frequency within  $\pm 8$  mc of the local-oscillator frequency will beat with the desired signal, and may produce an interfering beat signal between 21 and 29 mc. For example, such frequencies for channel 3 would be between 79.85 (87.85 minus 8 mc) and 95.85 mc (87.85 plus 8 mc).

(7) Any signal which will beat with the second harmonic of the local oscillator to produce a beat frequency between 21 and 29 mc is also a possible source of interference. For instance, the second harmonic of the local oscillator for channel 3 is 175.7 mc (87.85 mc times 2). Any frequency between 146.7 mc (175.7 minus 21 mc) and 154.7 mc (175.7 minus 29 mc) will beat with the second harmonic of the local oscillator to produce a beat frequency between 21 and 29 mc, and may interfere with reception on Channel 3.

#### Identification of Interference

If the interference falls in the video channel and appears on the picture-tube screen, the local oscillator may be tuned higher in frequency, so that the video *if* signal is passed through the sound channel. If the source of interference is a radio station, it may be identified when it announces its call letters.

#### Signal-Generator Use

An accurately calibrated signal generator may be used to produce an audible beat with the interfering signal. The frequency of the signal generator when zero beat is obtained will be the frequency of the interference.

#### Elimination of Interference

In most cases, interference can be greatly reduced or completely eliminated without seriously affecting the television signal. This may be accomplished by installing a wave trap across the antenna terminals of the receiver. The wave trap should have an extremely low impedance to a signal of the interfering frequency, and a high impedance to the frequency of the desired television signal. With such a circuit the unwanted signal is effectively shorted across the transmission line before it reaches the receiver, but the

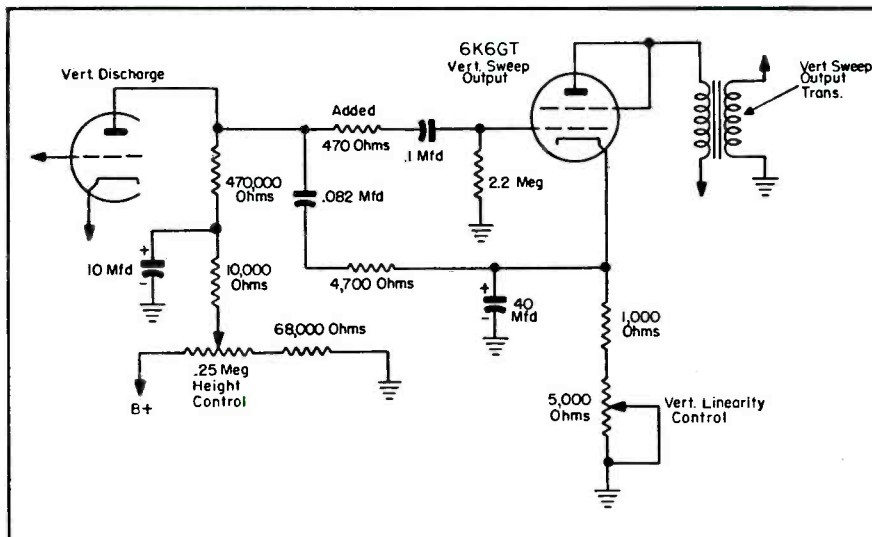

Fig. 1. Circuit which can be used to reduce vertical sweep radiation in Philco receivers.

desired signal is practically unaffected by the presence of the wave trap.

#### Half-Wave Lines

A half wavelength of transmission line, shorted at one end, offers a low impedance at the other end of the frequency at which it is resonant. This half wave section makes an effective wave trap. However, at the lower television frequencies, a half wavelength of line may prove to be too long to be practical. In this case, a similar

effect may be produced by using a quarter wavelength of line with an open end.

#### Series-Resonant Circuits

For interference at the sound *if* or video *if* frequencies, a series-resonant circuit of lumped reactances is recommended for shorting out the unwanted signal. The  $Q$  of such a wave trap should be high, so that the desired signal is attenuated as little as possible.

Fig. 2. Wave-trap connections for eliminating interference at the *if* frequencies in Philco models. *A* and *B* represent high  $Q$  coils with a tuning core and 56-mmfid fixed-ceramic-type capacitors; item *A* is Philco part No. 62-056409001 and item *B* is Philco part No. 32-4302. The dotted line components indicate the series-resonant circuits which are connected to the leads farthest from the *rf* grid, while the solid-line components indicate the series-resonant circuits which are connected to the leads closest to the *rf* grid.

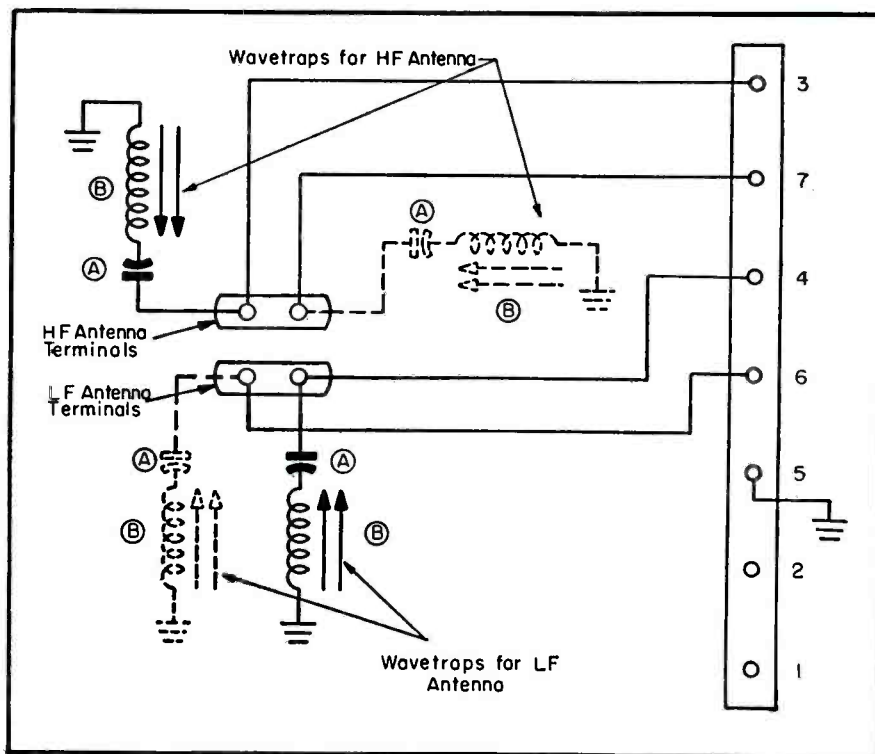



## Circuit Features of Westinghouse H-223 TV Receiver. Analysis of the Sync-Separation System in the G. E. 817 and 821 Models.

TV MODELS, with unconventional circuits, have become quite prevalent during the past few weeks. In one model, for instance, produced by Westinghouse (H-223), the *if* system is quite different in that it uses a *common if* setup.

In the conventional type TV receiver, the video and audio *rf* carriers are converted into their respective *if* frequencies in the mixer stage of the *rf* tuner. They are then separated, usually at the plate of the mixer or the first *if* stage, and the audio and video components are amplified and detected in separate channels. Every effort is made to keep the audio component from appearing on the grid of the picture tube. This is usually accomplished by the use of traps in the video *if* system, and, in some cases, the video amplifier.

With the *common if* system, the audio and video carriers are converted to their respective *if* frequencies in the same manner as in the conventional system. However, the two *if* signals are not separated into different *if* channels at this point. Instead, they are amplified in a *common if* amplifier, and both signals appear at the video detector. Since audio and video carriers are originally transmitted 4.5 mc apart and this separation is accurately maintained by temperature-controlled crystal oscillators in the transmitter, the two *if* signals appearing at the video detector are separated by exactly 4.5 mc. In addition to the function for which it is named, the video detector serves as a mixer for the two *if* signals. The mixing of the audio *if* carrier with the video *if* carrier produces a 4.5-mc beat signal that is frequency modulated in accordance with the audio *if* carrier.

The manner in which the 4.5 mc beat signal is obtained can be likened to the mixer action in the superhet receiver. The incoming video *if* signal serves in lieu of a local oscillator and beats against the incoming audio *if* signal to produce the sum and dif-

ference frequencies at the output of the video detector. Since the sum frequency will fall far outside the pass-band of the video amplifier, it can be disregarded. This leaves only the difference frequency of 4.5 mc to be considered.

After passing through the video amplifier, the 4.5 mc signal is fed to a 4.5 mc audio *if* amplifier, which amplifies the signal sufficiently to drive the ratio detector. An audio amplifier raises the output of the ratio detector to a level suitable for exciting the speaker.

### RF Tuner

The *rf* tuner, consisting of the *rf* amplifier, mixer, and a *hf* oscillator assembled as a complete unit, amplifies the received signals and converts the audio and video carriers to the correct intermediate frequencies.

Transformer coupling between the antenna terminals and the *rf* amplifier provides a correct impedance match. In addition to providing the correct impedance match between the transmission line and the grid of the *rf* amplifier, the transformer presents a high impedance at low frequencies, thereby tending to eliminate interfering, low-frequency signals such as broadcast, etc.

The *rf* amplifier grid and plate circuit, along with the mixer grid circuit, are tuned by incremental inductances. As the channel selector switch is rotated toward the higher frequency channel positions, the inductances are progressively shorted and the circuits are resonated to the desired frequency.

The oscillator tuning circuit consists of separate inductances that are switched in and out of the circuit as the channel selector switch is rotated.

A 6C4, operating in a modified Colpitts circuit, serves as the *hf* oscillator. Its output is injected into the mixer grid circuit through a 1.5-mmfd capacitor. Rectification of the circuit provides part of the bias for the mixer

tube, and the remainder of the bias is supplied by contact potential.

*Agc* voltage is applied to the grid of the *rf* amplifier tube. This voltage controls the gain of the tube and keeps the picture contrast relatively constant under variations in signal strength. In addition, it tends to prevent blocking on very strong signals.

### The IF Amplifier

The *if* amplifier unit is a stagger-tuned impedance-coupled affair, stagger-tuning providing the required pass-band without resorting to complicated over-coupled transformers or *M-derived* and other types of filters. The plate load impedances are peaking coils, each of which is tuned to a different frequency. Interstage coupling is obtained through capacitors in a manner similar to that used in resistance-coupled audio amplifier. Since there are only four tuned circuits in the system—there are no traps—alignment has been found to be relatively simple. To maintain relatively constant video and audio output under varying signal strengths *agc* voltage is applied to the first two stages.

In early production of this chassis, a trap ( $L_{210}$  and  $C_{211}$ ) was inserted between the mixer plate and the grid of the first *if* amplifier. This trap was provided to prevent the *hf* oscillator voltage from *leaking through* to the grid of the *if* tube. In later production, however, the same result was accomplished by changing the length and dress of the mixer plate lead, and the trap was deleted.

All stages of the *if* amplifier have *LC* isolation networks in their heater circuits. These traps prevent interaction between stages and coupling of the *if* voltages into other stages of the receiver through the heater—cathode capacitance of the tubes and the common heater line.

The *if* amplifier has been so designed that the video *if* carrier appears at

(Continued on page 35)



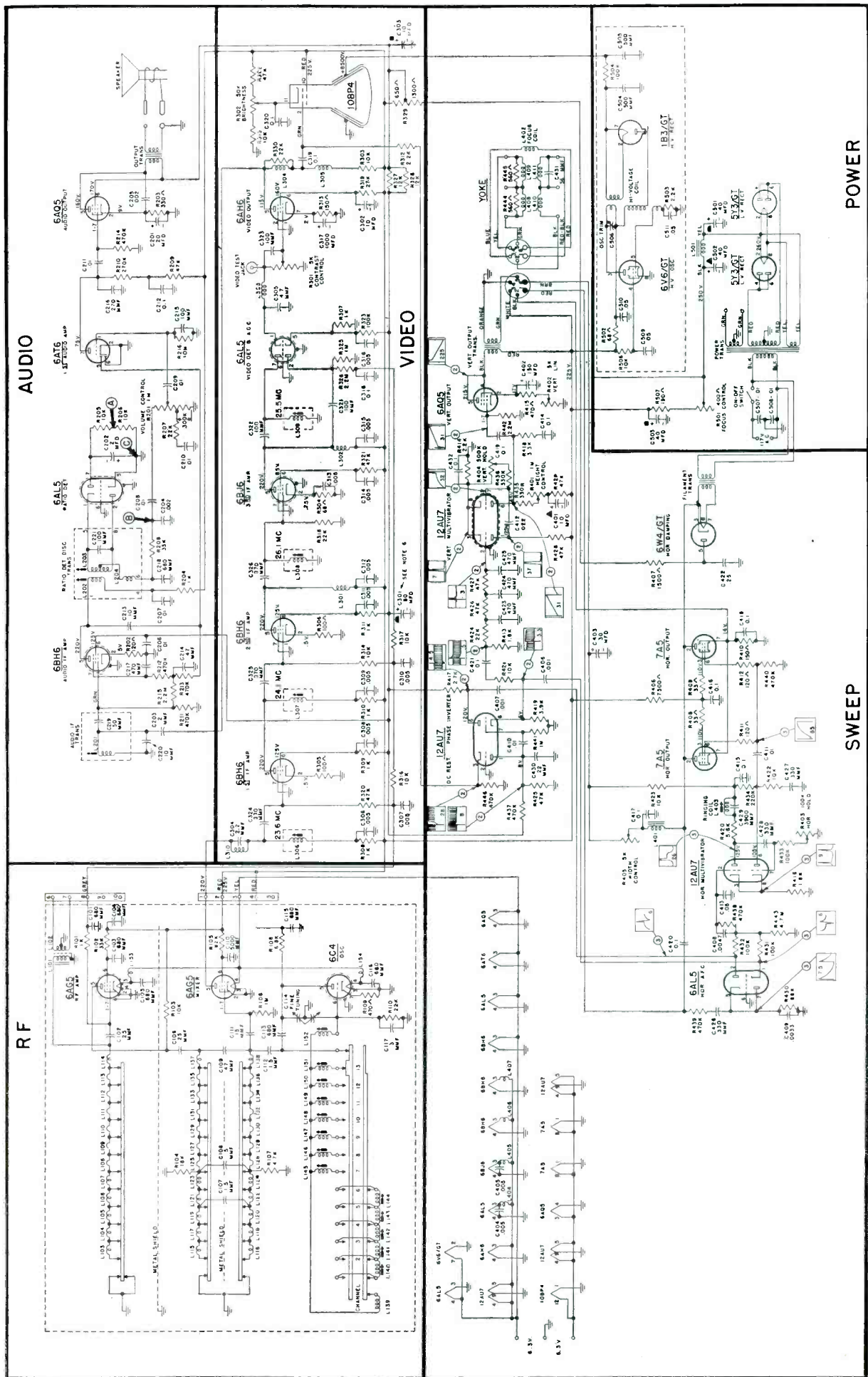
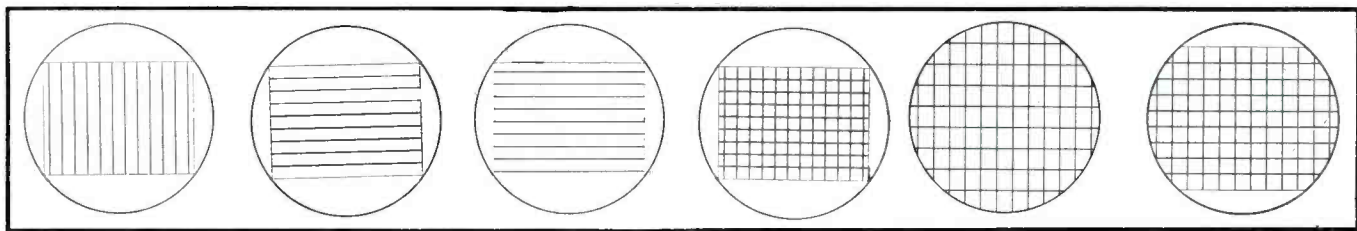

Fig. 1. Circuit of the Westinghouse H-223 twenty-one tube TV model which features a common *if* chain.

Fig. 2. Patterns obtainable with generator, left to right: Vertical-line arrangement; horizontal-line results indicating how the pattern may differ in position, depending on how the receiver locks in with the applied signal; cross-hatch output for a 3:4 aspect ratio; cross-hatch result for a 3:1 aspect ratio (full screen or circular type of picture), and cross-hatch pattern of a truncated circle type of picture.



# TV Cross-Hatch Generator

IN TV receiver alignment, the TV tube pattern is very important. Unfortunately, transmitters are not always on the air when the patterns are required and some alternate means of creating a pattern for the alignment job becomes necessary. From the labs of one manufacturer has come a generator<sup>1</sup> affording a pattern of cross-hatch characteristics which can be utilized effectively for alignment. Provision has been made for the application of a signal to the picture tube which may be either horizontal line or vertical line in structure, or a combination of the two, resulting in the cross-hatch pattern.

There are 12 vertical lines and either 8 or 9 horizontal lines for the standard

<sup>1</sup>Hickok 620.

[See Front Cover]

by **ALLAN LYTEL\***  
*Temple University Technical Institute*

4:3 ratio picture size. Either of these signals or both is available via an *output selector switch*. Output voltage from a cable connector is variable between 50 and 5000 microvolts, with the modulating frequencies of the *rf* signal being crystal controlled.

The screen of the television receiver is provided with the cross hatch pattern when the output signal from the generator is applied to the receiver's antenna terminals.

The pattern may be used to check receiver sensitivity, 60-cycle hum in the horizontal deflection circuits, and particularly the alignment of such controls as horizontal and vertical linearity, drive, horizontal and vertical width, height, hold and horizontal *afc*.

The circuit features two fundamental oscillators, one of which is crystal controlled operating at 219.24 and a Colpitts *rf* oscillator. The *rf* oscillator is tunable for any channel between 2 through 5 inclusive, or between frequencies of 50 and 90 mc. By means of two multivibrators and a blocking oscillator, the crystal output frequency is divided and provides the previously mentioned 12 vertical bars and 9 horizontal bars.

\*Author of *TV Projection and Enlargement*.

Fig. 1. Complete circuit of Hickok model 620 cross-hatch generator illustrated in part on the cover of this issue.

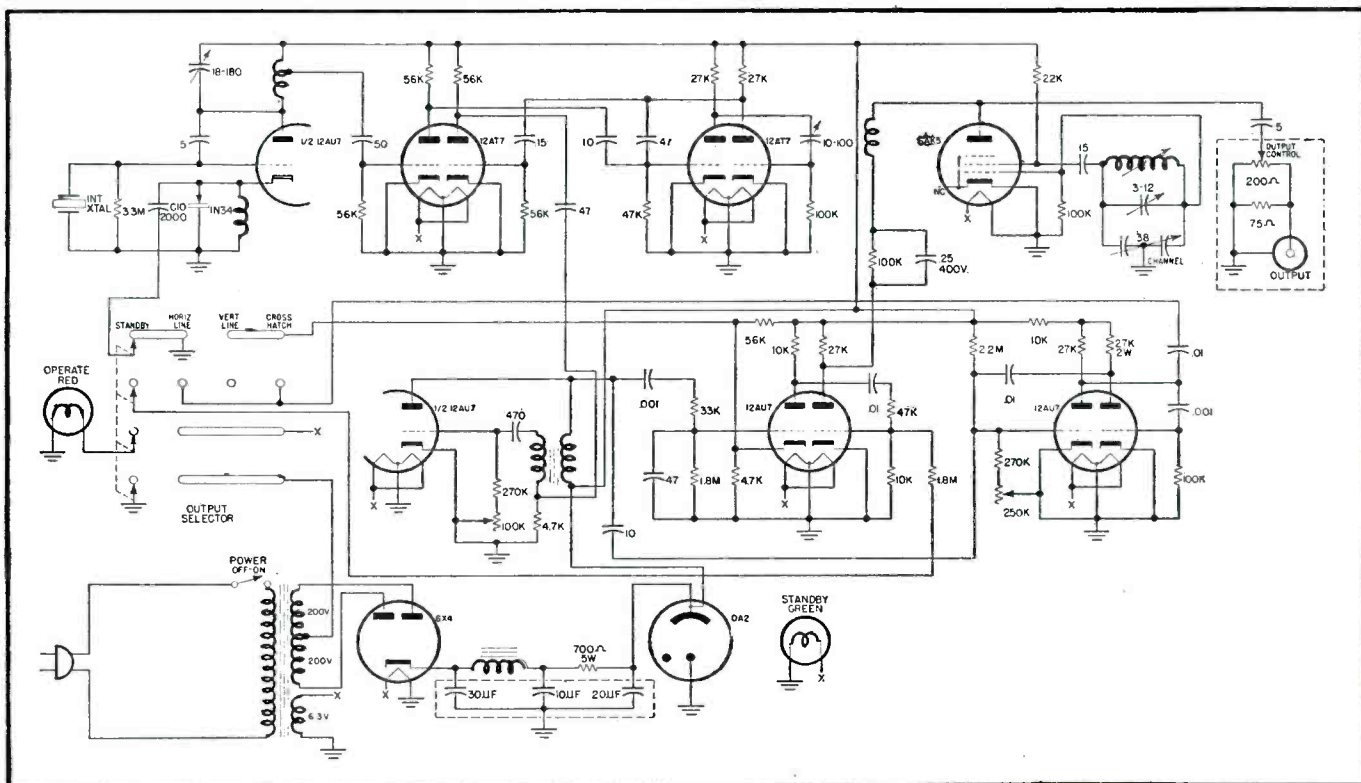

# THE EYE IS QUICKER THAN THE EAR



IF you service TV, you know this. Customers are quick to *see* imperfections. Much slower to *hear* them. Therefore *premium-quality* Hytron receiving tubes for the tougher TV jobs. *At no extra cost!* You gain also: Through fewer expensive service call-backs. Better customer satisfaction and confidence. More profits.

How does Hytron do it? By working closely with leading TV set manufacturers. By endless striving to better already superior performance. By improved design . . . processing . . . inspection . . . testing.

Try Hytron TV receiving tubes: 1X2, 6AG5, 6AL5, 6AU6, 6BG6G, 6BQ6GT, 6J6, 6SN7GT, 12SN7GT, etc. You pay no more for Hytron. But *see* the difference yourself . . . on the TV screen . . . on your cash register.

OLDEST MANUFACTURER SPECIALIZING IN RECEIVING TUBES



MAIN OFFICE: SALEM, MASSACHUSETTS



49c net

**OUR APOLOGIES!** We knew these Hytron shop tools would be popular . . .

*because they are designed "by servicemen, for servicemen." But we didn't dream they would be so popular. That you needed them so badly. First production runs of both Soldering Aids and Tube Lifters melted away like snow in the red hot demand. New, more adequate production facilities had to be rushed into action.*

**NOW YOU CAN HAVE THEM**

*Sorry, if you were one of the unlucky ones who had to wait. Your Hytron jobber should now have both Soldering Aids and Tube Lifters in stock. If he hasn't, please drop us a line.*



15c net

**ALSO AT YOUR HYTRON JOBBER'S . . .**

TUBE TAPER 5c net



9-PIN MINIATURE STRAIGHTENER 55c net



7-PIN MINIATURE STRAIGHTENER . . . 55c net



AUTO RADIO TOOL 24c net



# PHONO *installation and service*

THE RECENT holiday season saw the wide distribution of uniquely designed toy-type radio-phonos as well as play-talk type units for the juvenile audience.

Because of the particularly constant use this equipment is expected to be subjected to, there will undoubtedly be quite a demand for servicing, soon.

In view of these possibilities the circuits of these models have been secured and are presented on this page, this month.

In Fig. 1 appears the radio-phonos setup (G. E. 4SJ3A1) which is a four-tube affair with a 12SA7 converter, 12SQ7 first audio, 50L6GT power output and a 35Z5GT rectifier. Using a 5¼" pm speaker, the output is about ½ watt.

Two types of toy record players are illustrated in Figs. 2 and 3. The Fig. 2 system (G.E. 186-3A) uses a 50L6 amplifier and a 35Z5 rectifier, while in the Fig. 3 arrangement (G.E. 4SJ2A1) a 25L6 is used as an amplifier with a 65-ma selenium rectifier. The 50L6 unit, a table-model, has a 4" pm speaker, and the 25L6 unit, a console

arrangement employs a 5¼" pm speaker.

High-impedance crystal pickups are used in each of the three models.

In Fig. 4 appears the circuit of the playtalk device (G.E. 4SJ4A1) which has a 25L6 power amplifier, 6SC7 voltage amplifier and a selenium rectifier. Recording on a paper disc is provided via a magnetic head and a 3½" speaker.

## Cobra Pickups

Pickup repair, normally not too complex a procedure where dynamic or crystal types are involved, can be quite difficult when the cobra models come on the scene.

The operation of the cobra pickup is considerably different from the crystals and dynamics. These pickups generate audio power, while the cobra controls power generated by an *rf* oscillator, detector and audio amplifier. The oscillator operates at a frequency of 2.5 mc. Modulation is accomplished

by changing the energy losses in a tuned circuit. These losses may be represented by an equivalent resistance in series with the reactance of the coil. The ratio of the resistance to the reactance determines the efficiency of *Q* of the coil. The amplitude of the *rf* voltage developed across this coil by an oscillator will vary with changes in *Q*.

## Oscillator-Preamp Chassis

The grid coil and other components of the oscillator are mounted on an oscillator-preamp chassis, while the plate coil is in the needle cartridge with a vane and needle assembly. The coil is fixed and has 40 turns of No. 40 wire (approximate *dc* resistance 2½ ohms). The vane, stainless steel, in the field of the coil, is spot welded to an osmium-iridium tipped stylus.

## Stylus-Vane Operation

Any movement of the stylus will cause a corresponding movement of the vane. As the stylus and vane follow the modulations in the record, changes in the mutual inductance between the vane and coil occur. When the vane is at rest, a constant *rf* voltage appears across the plate coil. As the vane is set in motion and reaches its greatest outward swing from the coil, the result is a low mutual inductance, low reflected resistance, higher *Q*, and a higher *rf* voltage across the coil. In the vane's greatest inward swing the result is a high mutual inductance, high reflected resistance, lower *Q* and a lower *rf* voltage. Thus we find that the amplitude of the *rf* voltage which appears across the coil will vary with changes in *Q*, satisfying the condition for amplitude modulation. The position of the vane changes both the *Q* and *L* of the coil. Changes in *L* shift the frequency slightly, and a certain amount of frequency modulation is

Fig. 1. Circuit of G. E. 4SJ3A1 toy radio-phonos consolette.

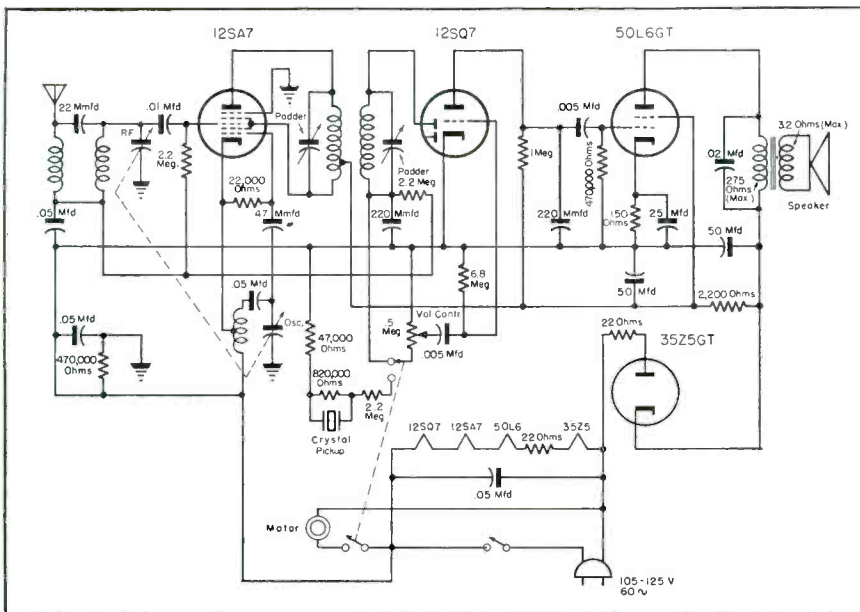



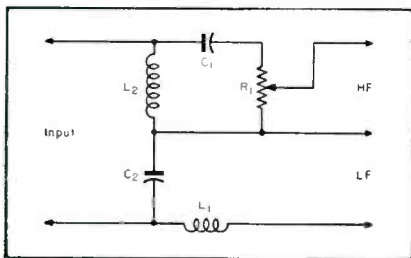
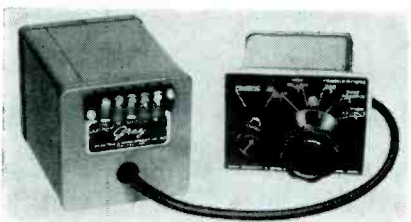
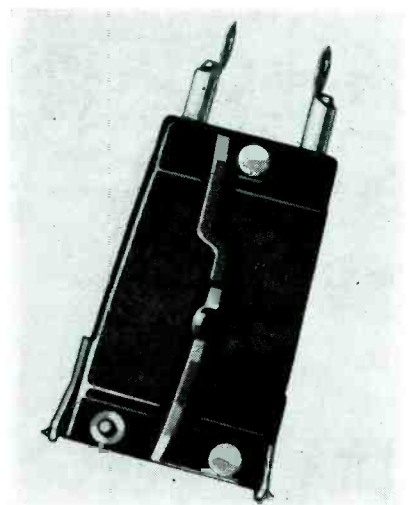

Fig. 5. Circuit of crossover network.

Five-step equalizer which compensates for *hf* deficiencies in records providing flat response to a heavy roll-off for worn records. Selection of 150 or 250 ohms' output impedance afforded. (Courtesy Gray Research and Development Co., Inc.)



Miniature-type cartridge (19/32" wide by 1" long) with a tracking pressure of 7 grams, developed for use with 33 1/3, 45 and 78 rpm records. (Courtesy Webster Electric Company)



cle range. The circuit design of the network is such that all these frequencies should be reproduced by the tweeter only. The other purpose of the network is a protective one. Usually the very fine diaphragm and featherweight voice coil suspension of the tweeters are unable to withstand the extreme excursions caused by the frequencies below 1,000 cycles. Although the driver unit used in some tweeters<sup>2</sup> are capable of response to 250 cycles, it would be overloaded by frequencies below 1,000 cycles due to insufficient horn loading. The acoustical cutoff of the tweeter itself lies below 700 cycles thereby avoiding undesirable phase shifts through the crossover range.

#### Dividing Network Circuits

The circuit of a dividing network appears in Fig. 5. It consists of a low-pass and a high-pass filter. Various values for  $L_1$ ,  $L_2$ ,  $C_1$ ,  $C_2$ , and  $R_1$  are tabulated in table 1. The most popular impedance speakers (4, 6, 8, 10, 12 and 16 ohms) have been accounted for in the values. The crossover frequency will vary in individual cases from 990 to 1,085 cycles. The adjustment in crossover frequency eliminates fractional values of capacitors, so that no difficulty in purchase should be entailed.

#### Balancing Potentiometer

The values for the balancing potentiometer  $R_1$  were determined for the condition where the tweeter is approximately 6 db more efficient than the cone speaker, which is about normal for average cones. Since the division of power into the cone and tweeter will vary as a function of the impedance of the cone speaker,  $R_1$  provides an effective method of proper balance. A resistor of the semi-variable 10-watt type has been found ideal for this application since it may be pre-set and set at the optimum operating position. Impedance changes resulting

<sup>2</sup>Racon models.

Table 1: Values of dividing network components as a function of cone impedance and a nominal crossover of 1000 cycles.

Output and Cone Impedance	$C_1$ (mfd)	$C_2$ (mfd)	$L_1$		$L_2$		$R_1$
			(mh)	turns	(mh)	turns	
4 ohms	32	50	.5	112	.3	90	6 ohms
6 ohms	22	35	.8	140	.5	112	10 ohms
8 ohms	16	25	1.0	160	.65	130	12 ohms
10 ohms	13	21	1.3	175	.8	140	15 ohms
12 ohms	11	18	1.5	200	.97	155	20 ohms
16 ohms	8	13	2.0	212	1.3	170	25 ohms

from this adjustment will not effect any noticeable difference in performance.

#### Coil Turns

The number of turns required for  $L_1$  and  $L_2$  in table 1 have been predicated on a winding form 1/4" in diameter with a winding space 3/4" long. Using No. 16 enameled wire, it will be found that 13 turns per layer will be required. The 1/4" winding form should be non-metallic and can be purchased in the form of a dowel stick. The sides of the winding form can be three inches square or circular pieces of 3/8" masonite, wood or stiff bristol board. The sides should be nailed to the winding form with brass brads. To simplify the winding process, a 3/16" or 1/4" hole may be drilled through the completed winding form and a 2" round head bolt inserted. It should be screwed firmly in place with a lock-washer and nut, and inserted in the chuck of a hand drill. The hand drill should then be set firmly in a vise and each inductance wound. The bolt, nut and lock washer should be removed. One pound of wire will be found sufficient for both coils of any combination shown in table 1, with the exception of the last one, which will require 1 1/2 pounds.

#### Need for Paper Capacitors

Paper capacitors must be used for  $C_1$  and  $C_2$ . Electrolytics must not be used nor any type bearing positive or negative markings at its terminal. Since there will never be more than 25 volts across them even at 30 watt levels, their cost becomes relatively low and they may be purchased with voltage ratings from 50 volts up.

#### Phasing Requirements

Phasing of the cone speaker and tweeter is necessary so that sound waves emanating from the two sources will reinforce rather than cancel each other. The equipment should be turned on and using radio or recorded musical programs, careful listening tests should be made. Sit across the room from the loudspeakers and have a second person alternately switch the two leads to the tweeter. Maximum output will be obtained when the speakers are in proper phase. It is also advisable to make listening tests across the arc of sound projection to make sure no hollow patterns exist, which is an indication of out-of-phase operation.

# THE REDSKINS ARE HERE!



## SANGAMO'S NEW MOLDED PAPER TUBULARS

Sangamo presents the REDSKIN . . . a new molded paper tubular capacitor that gives *long life* under severe operating conditions. The REDSKIN is an 85° C tubular that is easy to work with, on production line or bench, because the flexible leads resist breakage and can't pull out! It offers greater mechanical strength because of its plastic construction. It is molded under *low* pressure, assuring elements undamaged in fabrication, greater dependability, and the absence of "hot spots."

A trial of these new molded tubulars will convince you! See your jobber—if he can't supply you, write us.

### BIG CHIEF SANGAMO SAYS:

PLENTY PROUD OF NEW PAPOOSES!  
REDSKINS HEAP TOUGH...STAND TESTS  
THAT MAKE OTHER BRAVES FLINCH.  
REDSKINS LIVE LONG TIME...WORK  
HARD...HELP YOU MAKE WAMPUM TOO!



#### IMMERSION and HUMIDITY RESISTANCE

Test Result: **EXCELLENT!**

Far surpasses normal specification requirements . . . Insulation resistance practically unchanged under severe conditions of immersion or humidity.



#### 85° C PERFORMANCE

Test Result: **EXCELLENT!**

Long life operation under high temperature conditions make it a "natural" for applications where high temperatures cause trouble.



#### MECHANICAL STRENGTH

Test Result: **EXCELLENT!**

Especially designed flexible leads resist breaking or pulling out even when handling is extremely rough.



**SANGAMO ELECTRIC COMPANY**  
**SPRINGFIELD, ILLINOIS**

In Canada: Sangamo Electric Company Limited, Leaside, Ont.



8C491E



# FIELD TESTED

Installation Information on

# TV and FM

RECEIVING ANTENNAS

## TV . . . FM Antenna Installation

by IRA KAMEN

*Manager, Antenaplex and TV Dept., Commercial Radio Sound Corp.*

and LEWIS WINNER

*Editorial Director, Bryan Davis Pub. Co., Inc.; Editor, SERVICE and TELEVISION ENGINEERING*

The only practical book on the all-important item in TV and FM reception . . . based entirely on actual experiences in the most active TV and FM areas in the country. . . . Over 35,000 words of vital data with over 130 photos and drawings.

### TEN CHAPTERS COVERING:

*Installation Tools  
Antenna Installation Procedures  
Securing 12-Channel Coverage  
HF Antenna Installations  
TV Interference*

*Fringe Reception  
Master Antenna Systems  
FM Antennas  
Installation Business Practices  
Tricks of the Trade*

The first book in which you'll find complete design and installation information on every type of TV and FM receiving antenna. . . . Contains detailed illustration and subject index for rapid reference.

✓✓ "The best book on the market at this time dealing with the problem of television antennas and antenna installation . . . If more Service Men would read this book, it would help them considerably in making better installations and providing better television reception for their customers."—*M. J. Shapp, President, Jerrold Electronics Corp.*

✓✓ "Will recommend it to all the Service Men and technical people I meet."—*Charles Cahn, Field Service Engineer, Bendix Radio.*

✓✓ "Well organized and illustrated, very complete and up-to-date, carefully detailed. It will definitely improve the ability of the man who studies it and therefore is mighty useful to a firm like ours."—*Hamilton Hoge, President, United States Television Mfg. Corp.*

✓✓ "Will certainly fill a long-felt need for some practical information . . . sincerest congratulations."—*George P. Adair, Former Chief Engineer, FCC, and now Consultant in Washington, D. C.*

✓✓ "A thorough-going compendium of the installing art . . . Going to recommend it highly to our Service Control Department and our service organizations."—*Ernest A. Marx, General Manager, Television Receiver Sales Div., Allen B. DuMont Laboratories, Inc.*

✓✓ "Informative and extremely well written."—*R. Morris Pierce, Vice President in charge of Engineering, WJR, WGAR, KMPC.*

**BRYAN DAVIS PUBLISHING CO., INC., Book Dept.  
52 Vanderbilt Avenue, New York 17, N. Y.**

Send me a copy of TV . . . FM Antenna Installation, post-paid, for which I am enclosing \$2.00.

(Please print)

NAME .....

ADDRESS .....

CITY AND STATE .....

AT YOUR JOBBER  
OR ORDER DIRECT



**Price \$2 Post Paid**



# T V Receiver Production Changes

## Vertical Size Modification, Separate Picture-Tube Filament Winding Addition and Buzz-Modulation Correction in G. E. Receivers. Improved HV Power Supply and Picture-Tube Circuit Alterations in Westinghouse Models.

by DONALD PHILLIPS

INSUFFICIENT PICTURE HEIGHT, experienced with the vertical size control on the G.E. 901 and 910, has been corrected, and the range extended about four inches by shunting  $R_{118}$  (2.2 megohm) with another 2.2-megohm resistor or replacing  $R_{118}$  by a 1-megohm resistor.  $R_{118}$  is one of the plate charging resistors in the vertical sweep generator tube circuit located at the rear of the chassis.

### Separate Filament Winding For Picture Tube

On the G.E. models 811 and 814, the picture tube is heated by a separate filament winding on the power transformer and a 1-megohm resistor is connected between filament and the cathode of the picture tube socket. This arrangement was used to provide a more conservative voltage relation between filament and cathode, since the resistor places these two elements at the same B+ potential. In the model 810, however, the picture-tube filament was provided by the same filament winding that supplied the low voltage rectifier tube, 5Y3GT. Thus, the filament of the picture tube was at a higher B+ voltage than the cathode. Although it was still within tolerance, this arrangement was believed to be a possible cause of trouble and therefore the circuit used in the 811 and 814 has been included in all 810 models.

### Buzz Modulation

In the G.E. models 802 and 803, a sharp low-frequency audio buzz, which

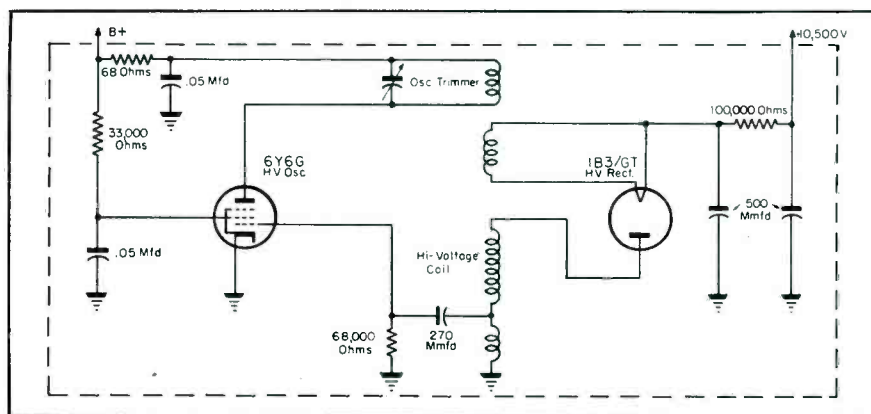

Circuit of high-voltage power supply included in late production models of the Westinghouse H-242, with a 6Y6G hv oscillator used in place of a 6V6GT.

sounds similar to 60 cycles sync pulse reproduction, and noted particularly on channel 13 reception, has been isolated to the filament lead that connects to the head-end switch wafer. The trouble, apparent only when tuned to the station, can be corrected by making the following alterations. The supply filament lead at the point where it connects the *rf* head and switch wafer (second from rear), must be disconnected. This filament lead runs between  $V_{20}$  and the *rf* head-end switch,  $S_1$ . Then a choke consisting of self-supporting No. 18 insulated wire must be made up, by close winding 8 turns around a  $\frac{1}{4}$ " rod. The choke is slipped off the rod and connected in series with the filament lead and the point of the switch where the lead was originally connected. A 5,000-mmfd ceramic capacitor is then connected between the junction of the choke and filament supply lead, to the lug on which  $C_{147}$  is grounded. The ground end of this capacitor is connected as close as pos-

sible to the ground end of the lug where it assembles to the switch back plate. The leads on the choke and capacitor must be short.

### Westinghouse HV Supply Changes

In late production of Westinghouse model H-242, a V-2150-31A chassis with a modified high-voltage power supply has been included. A 6Y6G high voltage oscillator tube has been used in this new setup instead of a 6V6GT, and the circuit changed accordingly; Fig. 1.

### Noise Effect Reduction

In the Westinghouse V-2150-31 and V-2150-31A chassis the third *if* amplifier screen dropping resistor ( $R_{348}$ ) was designated 100,000 ohms in the service notes. However, in early chassis a 47,000-ohm resistor was used. In chassis containing this 47,000 ohms re-

(Continued on page 31)

# Wire-Recorder Servicing

---

## Service Notes on Sears Roebuck Equipment: Speed Variation Control . . . Bias Voltages and Their Effect on Quality and Erasures.

---

b y M A X A L T H

IN SERVICING a wire recorder, there are many unusual problems to consider. For instance, the mechanism which controls constant speed of the wire over the recording head requires careful checking. A stroboscopic disc placed over the turntable that doubles as reel and record turntable, can be used for this purpose.

If there are any variations in speed, the cause must be checked back through a series of rubber drive pulleys through to the motor itself. This requires a disassembly of the pulley train and a check for freedom of rotation, oil and flat spots on the rubber drive wheels. The idler pulley tension must be checked carefully, too, as this is very critical. If the tension is too great, the pulley is too tight and there will be rumblings in the recording. Accordingly, the motor will only start with great difficulty, sometimes not at all. If there is insufficient tension, there'll be wows in the recording because of slippage.

### Piano as Note Standard

A piano will be found very handy for checking, a recorded note serving as an excellent guide for speed analysis.

Winding of the wire smoothly on the drum must also be considered in servicing. A guide activated by a heart shaped cam controls this operation. The head oscillates in a vertical plane. Its gyrations equal the width of the spool or drum upon which the wire is wound. If this action is not centered in relation to the drum, the wire will pile up on one side. The head can be centered by removing or adding shims beneath the toe of the upright upon which the head rides. This

upright is found beneath the panel of the recorder, and is in a vertical position.

This upright should also be checked for possible burrs or other obstructions, such as dirt. It should be cleaned and polished with 00 sandpaper. The entire upright should also be covered with a layer of light grease.

It is important to make certain that the long spring that pulls the head downward has sufficient tension to easily do so; the spring action must be positive, the spring tension should not be too great, and not bind the slider against the support.

If the layer of wire on the spool is too wide for the spool, or too narrow, the heart-shaped cam will be found to be malformed. The larger the cam the wider the winding, and vice versa. It is possible to file an overly large cam down to size, but it is better to replace this part.

The oscillating action of the head is also important. If it is not right the wire will not wind up properly and will snarl and possibly break. Also, minor speed changes will result as the wire slips around.

On the electrical side of the recorder we find that we have the problem of bias and erasure voltage to consider as well as the recording signal.

The bias voltage is a 25 to 40-ke signal impressed upon the wire by means of a coil wound around one-half of a horseshoe magnet. Its frequency is unimportant, but occasionally this frequency will heterodyne with that of the *if* frequency of the associated receiver. When this occurs a small, fixed mica capacitor can be soldered across the bias oscillator coil to lower its frequency.

There is little chance of there ever being too much bias voltage. How-

ever, there is good chance that the bias voltage may be too low, and there'll be erasure trouble. When the bias is too low, the recording will not be completely erased. The result is heard during the playback as background interference.

Also, if the bias voltage is below normal, the recording signal will be slightly distorted, and below normal volume.

Bias voltage can easily be measured with a *vtvm*. In cases when a meter is not available, there are some alternate test methods possible.

The wire should be erased completely by running it through the recorder, in record position, but with the recording mike input turned all the way down. This length of wire should be played back for a check on whether the erasure is clean; there shouldn't be a sound.

If after recording on this wire, taking care to keep the recording signal within the prescribed limits, the resultant record is low and distorted, the bias voltage can be considered below par. If the record is clear but low, the recording voltage is too low.

If the reel used has been used before and perhaps magnetized at too high a level, a normal bias voltage will not erase it completely with one pass over the head. The test results therefore may be deceptive, and should be watched carefully.

The output from a wire recorder is very low, on the order of one millivolt. It is important therefore that the amplifier is up to par, and have sufficient gain.

The recording head itself is not subject to any problems uncommon to ordinary coils. Opens and shorts which may occur can easily be located with an ordinary ohmmeter.

ADMIRAL • ARVIN • BELMONT • BENDIX • CAPEHART

# It's smart to use the Television Tubes

CROSLY • DEWALD • DUMONT • EMERSON • FADA

## TV Set Manufacturers choose...

FARNSWORTH • GAROD • HALLICRAFTER • MOTOROLA • OLYMPIC

PHILCO • PILOT • RAY

SENTINEL

SPARTON •

STROMBERG-

CARLSON •

TELE-TONE

TRAVELER

WESTINGHOUSE • ZENITH

**RAYTHEON**  
*Quality*  
**Television Tubes**

Television servicemen minimize their tube-to-tube variation bugaboo by using the same TV tubes leading set manufacturers use — *Raytheon Quality Television Tubes*. The wealth of experience Raytheon gained in the development and manufacture of tubes for video amplifiers in Radar applications, is proving invaluable in the production of high efficiency tubes for modern TV receivers. Raytheon instantly recognized that the normal industry test tolerances of many tubes being used in video applications were not close enough for perfect perform-

ance in today's television receivers. A new, stricter set of test tolerances and more rigid quality standards were introduced with the result that Raytheon Quality TV Tubes save many a headache for manufacturer and serviceman.

Save time and trouble — save money — safeguard customer goodwill — standardize on Raytheon Quality Television Tubes.

**RAYTHEON CATHODE RAY TUBES** come in all the most popular types. For peak video performance, specify Raytheon Television Picture Tubes as well as all other Raytheon Television Type Tubes.



**RAYTHEON**

**RAYTHEON MANUFACTURING COMPANY**

Radio Receiving Tube Division

Newton, Mass., Chicago, Ill., Atlanta, Ga., Los Angeles, Calif.

*Excellence in Electronics*

RADIO RECEIVING TUBES, TELEVISION TUBES, CATHODE RAY TUBES, SPECIAL PURPOSE TUBES, SUBMINIATURE TUBES, MICROWAVE TUBES

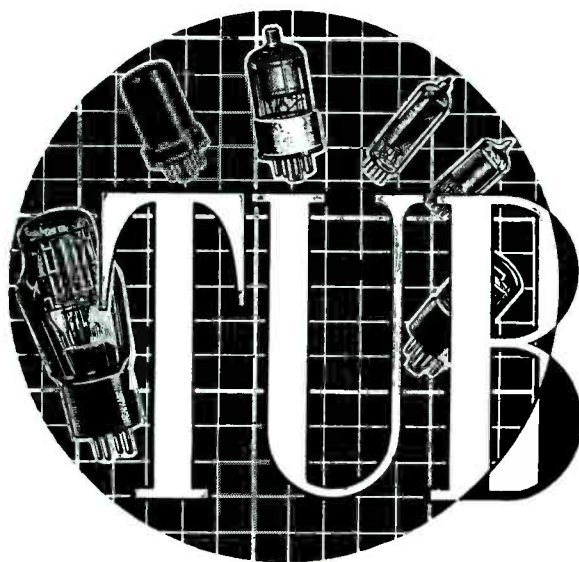

# TUBE News

## Application Characteristics of New TV and FM Tubes: 6BN6, 1V2, 6CB6 and 6AU5GT.

THE PAST WEEKS have seen the announcement of a variety of FM and TV type tubes with many unusual properties.

An interesting example of this production trend is the 6BN6,<sup>1</sup> the internal construction of which is shown in Fig. 1.

This tube, a miniature beam tube, was designed primarily to perform the combined operations of a limiter, discriminator, and audio-voltage amplifier in FM receivers.

### The 1V2

Another recently announced tube, with unusual characteristics, is the 1V2,<sup>2</sup> a half-wave rectifier of the single-ended type for use in compact, high-voltage, pulse-operated rectifying systems. In voltage-doubler circuits, it has been found particularly suitable as a rectifier of high-voltage pulses produced in the scanning system, for magnetically deflected 10- and 12-inch picture tubes.

The 1V2 has a filament operating at 0.625 volt and requires about 0.18 watt. The low filament power permits the use of a small size and lightweight rectifier transformer.

The base pins of the tube fit the noval 9-pin socket which may be mounted to hold the tube in any position. In providing the adequate low-leakage insulation required in 1V2

by L. M. ALLEN

sockets, designed with a cylindrical center shield, it is necessary to remove the center shield. In addition, the socket clips for pins 1, 6 and 7 are usually removed to reduce the possibility of arc-over and minimize leakage.

When the filament voltage is measured, it is recommended that a thermal *rms* voltmeter be used. The meter and its leads must be insulated to withstand 15000 volts and the stray capacitances to ground should be minimized.

The high voltages at which the 1V2 is operated are very dangerous. All circuit parts where this tube is used, which are at high potentials, are being enclosed on the chassis, and *interlock* switches used to break the primary

circuit of the high-voltage power supply when access to the equipment is required.

### The 6CB6

Another new type TV tube is the 6CB6,<sup>2</sup> a sharp-cutoff pentode of the 7-pin miniature type, designed especially for video *if*-amplifier service at about 40 mc. Its design also permits use as an *rf* amplifier in *vhf* television tuners.

Featured in the 6CB6 is a high transconductance combined with low interelectrode capacitances, and separate basepin terminals for grid No. 3 and cathode. The separate terminals permit the use of an unbypassed cathode resistor to minimize the effects of regeneration.

### The 6AU5GT

For horizontal-deflection amplifiers the 6AU5GT<sup>2</sup> has been developed.

The tube is a high-perveance, beam power amplifier of the single-ended type. It features a low  $\mu$ -factor, high plate current at low plate voltage, and a high operating ratio of plate current to grid-No. 2 current. A power supply of 250 volts, or less, is all that has been found necessary for receivers us-

(Continued on page 31)

Typical circuit and internal construction of 6BN6 miniature beam tube.

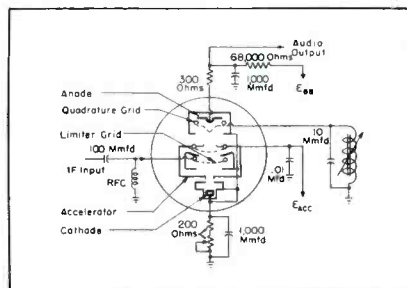

<sup>1</sup>G. E.

<sup>2</sup>RCA.

**NEW  
SUPERIOR**

**Hi-  
LO**

**TV ANTENNA**

by  **the Leader in The  
Antenna Field**

**\$9.95** .....with 2 section 8 ft.  
electro-galvanized steel mast

Another pace setting development by *Radiart!* Here is the popular HI-LO antenna streamlined to a price that you would pay for just an ordinary single bay style. This type, the HL 4 series covers all TV channels 2 through 13. Its unidirectional pick-up helps to eliminate ghosts and other unwanted signals. It permits separate orientation of the high and low bays, allowing each to be set in the most favorable direction.

**FEATURES INCLUDE:**

- Speedy installation with pivoted dipoles
- Rigid and sturdy to defy the wind and elements
- Bakelite insulators — cadmium plated hardware
- Electro-galvanized steel masts

**AVAILABLE IN THE FOLLOWING TYPES:**

- High and Low Bays, 2 section 8 ft. mast . . . model HL 45 . . . \$ 9.95
- HL 45 unit plus swivel base, guy ring, stand-off insulator and phasing line . . . . . model HL4 . . . . . 10.95
- High and Low Bays only . . . . . model HL 4L . . . . . 7.95
- High Bay only . . . . . model H4 . . . . . 2.75
- Low Bay only . . . . . model L4 . . . . . 5.75



**Topping the  
Nation in Sales**

**RADIART TV  
CONICAL TYPE ANTENNAS**

**Our "Lazy X" line is HOT  
... feature it for  
faster sales**



IT'S RIGHT WHEN IT'S RADIART

**THE RADIART CORPORATION**  
CLEVELAND 2, OHIO



- VIBRATORS
- TV ANTENNAS
- POWER SUPPLIES
- AUTO AERIALS

# Use of Tube Curves to

# Diagnose Circuit Performance

DIAGNOSIS OF CIRCUIT performance, when a limited amount of information is available, can often be performed by the construction of dynamic load lines on the characteristic curves of the tubes used in the circuit.

## Beam-Power Amplifier Problems

To diagnose performance of a stage which uses a pentode or tetrode, the effects of the screen grid must first be evaluated. Thus, in the amplifier of Fig. 1, not only is it necessary to consider the plate characteristic curve (Fig. 2), but curves of the same tube operating as a triode-connected system, Fig. 3.

To find the operating point it is first necessary to know the screen voltage, which can be found from the triode-connected curves. This information can be obtained in the following manner:

(1) The plate-current axis of the triode-connected curves of a pentode or tetrode represents total space or cathode current (sum of plate and screen grid) for a given plate voltage and grid bias. Therefore, if the ratio of screen-to-plate current is known, the plate-current axis can be very conveniently recalibrated in terms of screen current. The ratio of screen-to-plate current can be conveniently obtained from the tetrode curves of the same tube. It is preferable, for the very best accuracy, to find this ratio somewhere near the operating plate voltage, although approximate results can be obtained by finding the ratio at most any point, because variations in the ratio are very slight except at very low plate voltages. A ratio at 150 plate volts (Fig. 2) has been taken to illustrate this problem. This ratio was found by finding the zero bias plate current, point C, and zero bias screen, point D.

$$\text{Ratio } A = \frac{I_{sg}}{I_p} = \frac{12.5}{177.5} = .071$$

(2) The fractional part of the total cathode current, which is screen current, can be represented as

$$\frac{I_{sg}}{I_p + I_{sg}} \times I_k$$

This can be expanded to the form

$$\frac{I_{sg}}{I_p} \times \frac{I_k}{1 + \frac{I_{sg}}{I_p}}$$

How Tube Curves Can Serve to Predict Possible Circuit Problems and Solutions. Typical Cases Involving Beam-Power Amplifier and Phase Inverter Cited.

by EDWARD M. NOLL

Instructor in Television  
Temple University

Now if  $A$  represents the ratio of screen-to-plate current, screen current can be found by applying the formula,

$$I_{sg} = \frac{A}{1 + A} I_k$$

Thus the triode-connected curves can be recalibrated with a simple substitution. The 200-ma point on the total current (identified as plate current) axis of Fig. 3, therefore, also repre-

sents a screen current of

$$I_{sg} = \frac{.071}{1 + .071} \times 200 \text{ ma} = 13.2 \text{ ma}$$

This procedure recalibrates the entire scale for screen current.

(3) After the screen current calibration, a screen load line is drawn with a slope in accordance with the value of the screen resistor. One point, of course, is the supply-voltage point

Figs. 1 and 2. In Fig. 1 appears a 6L6 tetrode amplifier and in Fig. 2 the plate characteristics of the 6L6. In this plot the load line has been corrected to compensate for the effects of rectification with large signals.

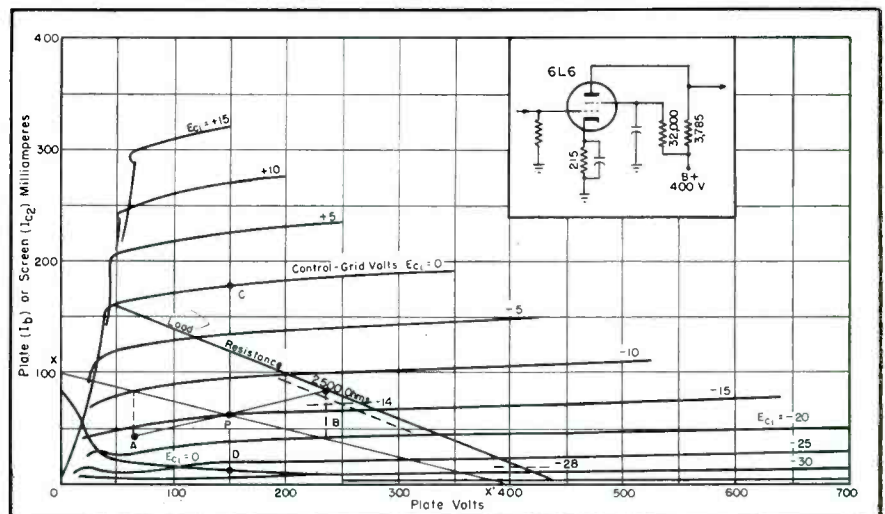

# "The Standard Booster"

A New High Gain **TV PREAMPLIFIER**  
For Studio-Clear Reception



Model B-50



**"The Standard Booster"** is attractively designed to blend with any TV set. One tube—single stage—trouble free operation—adaptable to either 300 or 75 ohm line.

*Plus Profits for You*

**Boost Your TV Set Sales  
in Fringe Areas**

"The Standard Booster" will give your TV set customers brighter, sharper pictures. Considerably higher gain... lower signal to noise ratio... 2 knob control... continuous tuning eliminates a switch from high to low channels... fully shielded... printed circuit for added stability.

*Standard* COIL PRODUCTS CO., INC.

CHICAGO • LOS ANGELES • BANGOR, MICHIGAN

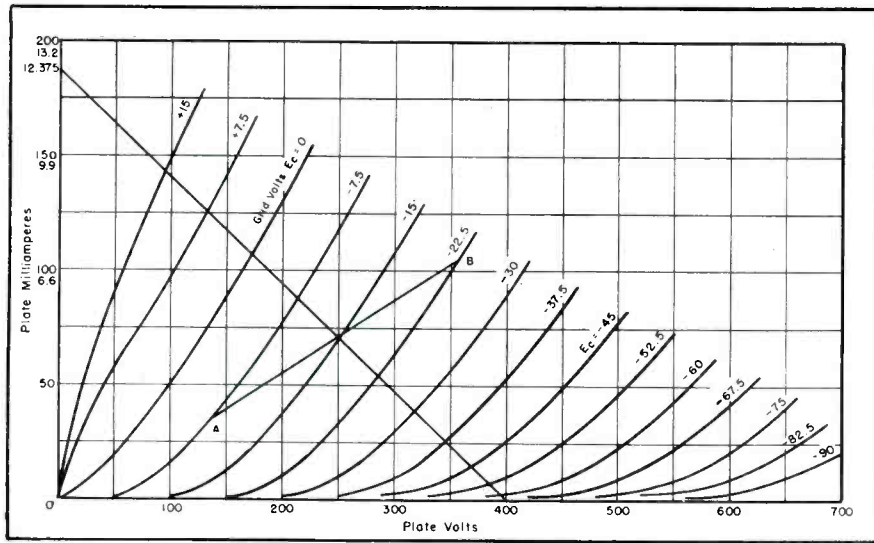

Fig. 3. Operating results obtained from a triode connected 6L6.

on the plate-voltage axis. A second point can be obtained by assuming a screen-voltage change (plate voltage on Fig. 3). However, screen and plate voltage are the same (under assumption of triode connection) and to find a corresponding change in screen current, the following equation is applied:

$$\Delta I_{sc} = \frac{\Delta E_{sg}}{R_{sc}} = \frac{400}{32,000} = 12.4 \text{ ma}$$

(4) The next step involves the drawing of a cathode line with a slope corresponding to a 215-ohm cathode resistor, or

$$\text{Point } A = \frac{7.5 \text{ v}}{215 \text{ ohms}} = 35 \text{ ma and}$$

$$\text{Point } B = \frac{22.5}{215} = 105 \text{ ma}$$

(5) The point of intersection of the screen and cathode lines represents the screen voltage which exists when the stage is tetrode connected with values as shown in Fig. 1. To find the operating characteristics of this stage, it is necessary to use tetrode

curves of the 6L6, with a screen voltage constant of 250.

It is important we realize that true operating conditions are only found when the correct screen-voltage constant is used. Up to this point of the procedure our calculations have served to find the operating screen voltage.

(6) After the correct screen voltage set of curves is obtained, the plate load line is drawn from the supply voltage point on Fig. 2. For the example under consideration this line (XX<sup>1</sup>) will have a slope corresponding to 4,000 ohms.

(7) A cathode line is then drawn on this curve. Inasmuch as screen and plate current flows in the cathode resistor, it has a higher effective value than if plate current flowed alone. The effective increase in cathode resistance is a function of the ratio of screen to plate current. In our example this ratio is 0.071 and the effective resistance must be 7.1% higher than actual value, or

$$\text{Effective cathode resistance} = R_k (1 + A) = 215 (1 + .071) = 230 \text{ ohms}$$

This value is used in calculating

points for the cathode line AB:

$$\text{Point } A = \frac{10 \text{ v}}{230 \text{ ohms}} = 43.5 \text{ ma and}$$

$$\text{point } B = \frac{22.5}{230 \text{ ohms}} = 87 \text{ ma}$$

(8) Intersection of the plate and cathode lines locates the operating point. Conditions of operation can be found with procedures discussed in previous installments.<sup>1</sup>

(9) The accuracy of the operating point can be traced by:

- (a) Noting the similar operating bias of -15 on both curves (Figs. 2 and 3).
- (b) A check of the voltage  $E_p$  equals  $E_{bb} - I_{sc} R_{sc} - E_c$  or  $E_p = 400 - (62.5 \text{ ma} \times 3785) - 15 = 149$ , which parallels the value indicated on the curve at the operating point.
- (c) Another check on the screen voltage  $E_{sg}$  which equals  $E_{bb} - I_{sc} R_{sg} - E_c$  or  $E_{sg} = 400 - (7.1 \text{ ma} \times 32000) - 15 =$  approximately 250 v

One difficulty arises in pentode and tetrode calculations after the operating screen voltage has been found by assuming triode conditions. Unfortunately no set of curves is available for this value of screen voltage. This is particularly the case for conventional *rc* amplifiers which operate with rather low screen voltages. The characteristic curves provided for most *rc* tubes have a screen voltage constant which is too high and are therefore useless. Approximate results, close enough for most practical design, can be found after recalibrating the given curves for a new value of screen voltage. This is permissible because plate current is a function of screen voltage and grid bias and not plate voltage.

To recalibrate, four steps should be followed:

- (a) First, we must find the ratio of the screen-voltage constant (of set of curves) to the calculated operating screen voltage.
- (b) Then the plate-current axis can be recalibrated by multi-

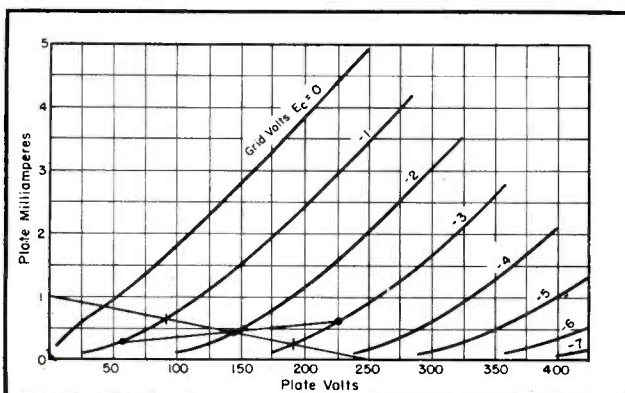

Fig. 4. Dynamic curves of a phase inverter.

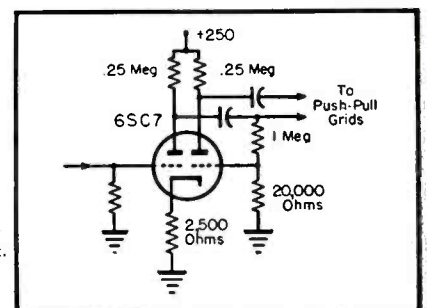

Fig. 5. A phase-inverter circuit.



plying values by the foregoing factor.

(c) Bias curves are now recalibrated by multiplying each one by the same factor.

(d) The plate voltage axis must not be altered.

#### Phase Inverter Constructions

Phase inverter plots can be made very simply by using plate load and cathode lines. The most important factor is to consider both tubes' currents, whenever they flow through a common part. In the circuit of Fig. 5 the cathode resistor is common to both sections of the phase inverter and therefore the cathode bias developed across it, is the result of two currents flowing through it.

To plot characteristics, four steps should be followed:

(1) First a load line of 250,000 ohms is drawn. When the plate resistor is so much higher in value than the cathode resistor the effects of the cathode resistance on the plate load is insignificant and need not be considered.

(2) Next a cathode line, with a slope of 5,000 is drawn. Although the cathode resistor is only 2,500 ohms, its effective resistance is twice as much because of the presence of both sections' plate current.

(3) Operating point will be found at  $-2E_c$ ,  $I_a$  4 ma, and  $E_p$  148 volts.

(4) If a 2 volt peak-to-peak signal is applied to the input of the phase inverter a 100-volt signal will appear at the plate of the first section according to the plate-load line plot. This signal, in addition to being applied to the grid of a succeeding stage, also excites the grid of the second section of the phase inverter. A voltage divider with a value of 1 megohm and 20,000 ohms divides this voltage down to 2 for a similar excitation of the second grid to produce equal amplitude but opposite polarity output at the plate of second section.

<sup>1</sup>SERVICE; November and December, 1949.

[To Be Continued]

## Tube News

(Continued from page 26)

ing this new tube type, only one 6AU5GT in a suitable circuit being required to deflect fully a 10BP4, a 12LP4, or any other similar picture tube having a deflection angle up to about 60° and operating at an anode voltage up to 12 kv.

For  
profitable  
TV  
servicing

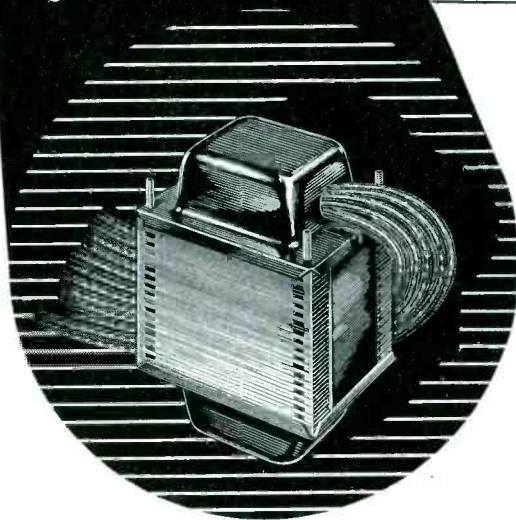

**JUST PUBLISHED**— Ask your Stancor distributor or write for your free copy of the New **STANCOR TV COMPONENTS REPLACEMENT GUIDE**, Bulletin 338C. Lists Stancor replacement components for two-hundred and fifteen models and chassis made by forty-three leading receiver manufacturers.



## STANDARD TRANSFORMER CORPORATION

3588 ELSTON AVENUE • CHICAGO 18, ILLINOIS

## Use STANCOR EXACT DUPLICATE TRANSFORMERS

Every call-back you make means lost time and profits. Why take a chance with transformers that "almost fit?" You're sure of a good job and a satisfied customer when you use Stancor *Exact Duplicate* transformers for TV servicing. These units meet the exact specifications, electrically and physically, of the original components. Representative types are listed below.

**Vertical Blocking - Oscillator Transformer.** Stancor Part Number A-8121. Exact duplicate of RCA type 208T2. For generation of 60 cps required to drive grids of vertical discharge tubes.

**Plate and Filament Transformer.** Stancor Part Number P-8156. Exact duplicate of RCA type 201T6 used in model 630TS receiver.

**Deflection Yoke.** Stancor Part Number DY-1. Exact duplicate of RCA type 201D1. For use with direct viewing kinescopes such as 7DP4 and 10BP4.

**Focus Coil.** Stancor Part Number FC-10. Exact Duplicate of RCA type 202D1. For use with magnetically focused kinescopes such as RCA type 10BP4.

**Horizontal Deflection Output and HV Transformer.** Stancor Part Number A-8117. Exact duplicate of RCA type 211T1. For use with direct viewing kinescopes, such as types 7DP4 and 10BP4.

For complete specifications and prices of these and other Stancor TV replacement components, see your Stancor distributor or write for Television Catalog 337.

## Production Changes

(Continued from page 23)

sistor, it may be possible to reduce noise at the *crt* grid by increasing the value to 100,000 ohms.

#### Horizontal Drift Correction

In late production models of the G. E. 810 and 811 the blocking oscillator coil ( $T_{10}$ ) was mounted below the chassis rather than on top of the chassis to reduce the amount of horizontal oscillator drift.

## RADIART SERVICE PLAQUE AWARDS



Distributors and the service plaques they received from Radiart jobber sales manager Milton S. Roth, at the recent Minnesota Gopher conference. Left to right: Roth, Ward Jensen of Lew Boun Co., Ray Daly of Power City Radio, Leonard Tesdell of Iowa Radio Corp., each of whom are fifteen-year distributors, and May Kirkeby, Radiart rep.

**WHAT LEGAL TEXTS  
ARE TO THE ATTORNEY  
RIDER BOOKS  
ARE TO THE  
ELECTRONIC TECHNICIAN**

**The New CATHODE-RAY  
TUBE AT WORK** by RIDER et al

The greatest and most complete reference book ever written on the Cathode-ray tube! It is a practical, down-to-earth encyclopedia about five times the size of the old standard text. Starting with basic theory of cathode-ray tube operation, it proceeds through application in scopes and TV receivers...with full and clear explanations for uses in every field and research activity which employs a cathode-ray oscillograph. All scopes produced and sold during the last 10 years, more than 70 different models are described completely - with schematic wiring diagrams. Almost 500,000 words and about 3,000 illustrations are incorporated in more than 900 pages. It is a book which will enjoy years and years of daily use. 22 chapters. Page size 8 1/2 x 11" \$9.00

**THE THEORY AND PRACTICE OF  
30-1000 MC RECEIVING ANTENNAS**

by Arnold B. Bailey

This book is a rare combination of theory and practice that:

- 1.—Clearly explains and teaches
  - 2.—Can be used as a daily work reference
- Reflecting world-wide knowledge of the antenna art, it clearly explains the theory behind the performance of every type of 30-1000Mc receiving antenna on the commercial market, leaving the reader with a full understanding of why each behaves as it does. And since the author has resolved the mathematics of antenna problems into graphs, charts and tables - it can be put to good use by all. Designed to serve all men whose livelihood depends on getting the most out of an antenna system, it is equally important to the antenna design engineer, television technicians, electronics schools, students, radio amateurs . . . More than 500 pages, 6 x 9", cloth bound . . . \$4.50

**OTHER RIDER BOOKS**

- Radio Operator's License Q and A Manual.** The radio operator's license manual with the discussion follow-thru - It makes the answers more understandable and also teaches. 608 pages. \$6.00
- TV Picture Projection and Enlargement.** Explains TV receiver optics and removes the mystery from projection and enlargement processes. 192 pages \$3.30
- FM Transmission and Reception,** 416 pages . . . \$3.60
- The Oscillator at Work.** 254 pages. . . \$2.50
- Broadcast Operator's Handbook.** 278 pages . . . \$3.30
- Inside the Vacuum Tube.** 420 pages. . . \$4.50
- Servicing by Signal Tracing.** 370 pages. \$4.00
- Understanding Microwaves.** 396 pages. \$6.00
- A-C Calculation Charts.** 168 pages. . . \$7.50
- Vacuum Tube Voltmeters.** 188 pages. . . \$2.50
- Business Helper.** 144 pages. . . \$2.00
- Radio Amateur's Beam Pointer Guide.** 32 pages . . . \$1.00
- Automatic Frequency Control Systems.** 154 pages . . . \$1.75
- Installation and Servicing of Low Power Public Address Systems.** 208 pages. . . \$1.89
- Understanding Vectors and Phase.** 158 pages . . . Cloth Cover \$1.89  
Paper Cover \$1.00
- Radar - What it is.** 80 pages. . . \$1.00

**RIDER BOOKS**

JOHN F. RIDER PUBLISHER, INC.  
480 Canal Street, New York 13, N.Y.

**ASSOCIATIONS**



**PR SMA**

THE CROSS-HATCH generator, described in this issue by Allan Lytel, was the subject of a talk by John Stimson, sales and service manager of the Hickok Company, at a recent meeting of PRSMA held in the auditorium of KYW.

Stimson revealed how the pattern generator and auxiliary equipment can be employed in TV alignment and trouble shooting.

PRSMA's efforts to assist Service Men and dealers in coordinating their activities in television servicing, were described by David Krantz, president of the association, recently. Krantz pointed out that the PRSMA program accents the importance of using the services of competent, fully-equipped TV service organizations. He indicated that accredited lists of qualified video Service Men have been compiled and are being supplied upon request.

Krantz also stated that a drive is on to improve the technical standards of TV service groups to assure maximum satisfaction not only to the dealer, but to the consumer and manufacturer.

**ARTSNY**

MAX LEIBOWITZ was reelected president of the Associated Radio-Television Servicemen of New York, at a recent election meeting held in New York.

At a subsequent meeting, Leibowitz announced that a special series of radio and TV courses have been programmed by the N. Y. City Board of Education in conjunction with the association. These courses, which were expected to begin during the early weeks of January, will cover all aspects of radio and television, from the rudiments of the art to the most advanced stages. Lectures will be given by members of the N. Y. City school system staff, who are thoroughly familiar with the type of information Service Men require. A small fee is being charged to cover the cost of equipment and other incidental expenses.

Advance registration for the courses indicates that there'll be a record turnout at each session.

The special series of television lectures being co-sponsored by ARTSNY and ESFETA, have been well received by the members of the association. Leibowitz believes that the com-

bined TV lecture program and school series will provide association members with an exceptionally thorough training in modern television servicing.

**TEN YEARS AGO**

From the Association News Page of SERVICE, January, 1940

RTG OF BOSTON held its annual meeting. George Feldman, past secretary of the association, left the group to join the U. S. Army. . . . The Texas Radio Service Association held a dinner-demonstration-floor show at the Chapparral, Dallas, Texas, which featured a talk by E. G. Perkins of the Supreme Instrument Corporation, covering *New Service Procedure For Today and Tomorrow*. . . . H. A. Fillman was elected president of the Lehigh Valley Radio Service Association. Other elected officers included: S. P. Gruit, vice president; R. P. Abbott, secretary; Russell Buss, financial secretary and J. A. Muthart, treasurer. R. P. Abbott, association secretary, announced plans for the Third Annual banquet, which was to be held at the Hotel Allen.

**STANDARD COIL PRODUCTS  
1,000,000 TV TUNER**



Glen E. Swanson, president of Standard Coil Products Company, Inc., of Chicago, Los Angeles, and Bangor, Michigan (right), receiving the millionth 12-channel TV tuner recently produced, from John R. Johnson, plant superintendent of the Los Angeles factory.

A substantial portion of the TV sets made in '50 are expected to include the Standard tuner, according to Standard Coil officials.

The company which began as a coil manufacturer in '35 in a loft over a store in Chicago, now have over 3,000 employees and five manufacturing plants.

President G. E. Swanson; vice president R. E. Peterson, and secretary-treasurer J. O. Burke originated the business.

## Master Antennas

(Continued from page 11)

master antenna system. Should further isolation be necessary, an extra 5 db of isolation can be obtained by removing  $R_0$  from the outlet feeding a high-level reradiating receiver. More attenuation in the outlet device feeding a TV set whose oscillator reradiation does not offend other receivers is not recommended as it reduces equally the desirable direct TV signals and the undesirable reradiated TV signals from other receivers. Therefore, nothing is gained.

Isolation between TV receivers connected to outlets fed from separate transformers is considerably more than 40 db and therefore little or no interference can be expected between TV receivers connected to outlets or separate transformers.

The filter in the outlet device is of the high-pass type which rejects any signals induced into the system which are in the *if* band of 21.25-27.25 mc. The capacitors in the outlet filter all prevent an *ac/dc* type of television set from pumping back any power voltages into the coaxial line.

A 1,000-ohm resistor in the outlet circuit, which taps the coaxial line end of the outlet ahead of the high-pass filter enables AM signals to be taken from the system to a separate polarized outlet receptacle.

FM signals also pass through the high-pass filter and are available from the same coaxial fitting which is employed for connecting television receivers.

### Connecting TV, FM and AM Sets to System

TV receivers on the market today have either 75 or 300-ohm input impedances or both, as in the case of the 1949-1950 model RCA front end shown in Fig. 4

In Fig. 5 appears a composite drawing which shows the various circuit arrangements for connecting both 75 and 300-ohm TV and FM receivers

(Continued on page 34)

Fig. 7. Pattern illustrating marred reception due to direct pickup, first image being received via the air and second by way of coax cable.

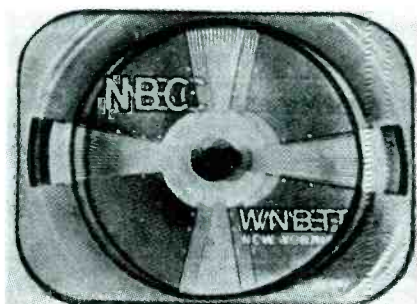

WHAT A BASIC, LEGAL REFERENCE LIBRARY IS TO THE ATTORNEY...

# RIDER MANUALS ARE TO THE ELECTRONIC TECHNICIAN



## to the ATTORNEY

...the field of legalisms is exacting and highly detailed. There are complex problems to be untangled, narrow paths to travel. The lawyer's BASIC library provides COMPLETE, ACCURATE and AUTHENTIC DATA on laws...with interpretations and decisions, both old and new. His library gives him the information he needs to bring his own case to a successful conclusion.



## to the ELECTRONIC TECHNICIAN

...the science of electronics is more exacting, more highly detailed. AM-FM-TV and allied equipment all have their different servicing problems. The Electronic Technician's BASIC Library of RIDER MANUALS gives him the COMPLETE, ACCURATE, FACTORY-AUTHORIZED DATA that he needs to bring each servicing problem to a successful, speedy and profitable conclusion.

--- YOUR JOBBER HAS THEM NOW! ---

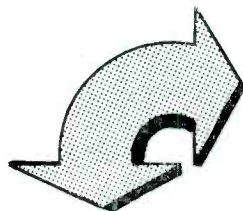

## RIDER TV MANUAL VOL. 3

Larger page size, 12" x 15". All pages in place, with diagrams and related text more closely positioned. Giant pages are retained, but now have only one fold for greater convenience and durability. Complete, Accurate, Factory-Authorized Data from 74 manufacturers. 441 models. 243 chassis. An absolute "must" for every Serviceman in every TV area.

Equivalent of 2032 pages (8 1/2" x 11") Plus Cumulative Index Volumes 1, 2 and 3, Plus the famous RIDER "HOW IT WORKS" Book... \$21 00

## RIDER MANUAL VOLUME XX

What a Manual this is! Complete, Authentic, Reliable, Factory-Authorized Data from 74 manufacturers. 1776 pages, with every page filed in its proper place...Easier to read and use than ever before. Covers AM, FM, Auto Receivers, Record Changers and Tuners...Covers receivers to November, 1949. RIDER...and RIDER ALONE...gives you the information you need WHEN AND HOW YOU NEED IT! Get Volume XX today!

\$18.00 Including Cumulative Index, Volumes XVI through XX, Plus the Famous RIDER "HOW IT WORKS" Book.

### RIDER MANUALS

Television Manual Volume 3 (Plus "How It Works" Book and Index).....	\$21.00
Television Manual Volume 2 (Plus "How It Works" Book and Index).....	\$18.00
Television Manual Volume 1 (Plus "How It Works" Book and Index).....	\$18.00
Volume XX .....	\$18.00
Volume XIX .....	\$19.80
Volume XVIII .....	\$19.80
Volume XVII .....	\$16.50
Volume XVI .....	\$ 8.40
Volume XV .....	\$19.80
Volume XIV to VII (each volume).....	\$16.50
Volume VI .....	\$12.50
Abridged Manuals I to V (one volume).....	\$19.80
Master Index, Covering Manuals, Vols. I to XV.....	\$ 1.50
PA Equipment Manual, Vol. I.....	\$18.00

NOTE: Are you receiving your copy of "Successful Servicing"? It's Rider's own publication of interest to every Serviceman. Write for it...it's FREE!

JOHN F. RIDER PUBLISHER, Inc., 480 Canal Street, New York 13, N. Y.  
Export Agents: Rocke International Corp., 13 E. 40th St., N. Y. C. Cable ARLAB.

## RIDER MANUALS mean SUCCESSFUL SERVICING

NOTE: The Mallory TV Service Encyclopedia, 1st TV Edition, makes reference to only one source of TV receiver schematics - Rider TV Manuals.  
NOTE: The Mallory Radio Service Encyclopedia, 6th Edition, makes reference to only one source of radio receiver schematics - Rider Manuals.  
NOTE: The C-D Capacitor Manual for Radio Servicing, 1948 Edition No. 4, makes reference to only one source of receiver schematics - Rider Manuals.

# Presenting DURANITE

## the SUPERIOR CAPACITOR



● An entirely new tubular capacitor—featuring Aerolene, the new impregnant; new processing methods; new DURANITE casing.

Such is DURANITE—the toughest tubular yet offered for use in stay-put assemblies. Therefore don't confuse DURANITES with conventional molded tubulars. DURANITES are different.

Drop, bang, scratch—no damage to the permanent, non-varying, rock-hard DURANITE casing. Unaffected by high temperatures—nothing to melt or burn. Thoroughly moistureproof. No shelf deterioration. Pigtailed won't pull out. And so on.

Order DURANITES from your Aerovox jobber. Popular capacities. 200 to 1600 v. D.C.W. Try them. You'll be amazed!



FOR RADIO-ELECTRONIC AND  
INDUSTRIAL APPLICATIONS

AEROVOX CORP., NEW BEDFORD, MASS., U.S.A.  
Export: 13 E. 40th St., New York 16, N.Y. • Cable: 'ARLAB'  
In Canada: AEROVOX CANADA LTD., Hamilton, Ont.

## Master Antennas

(Continued from page 33)

to the coax fitting and the recommended method of connecting AM standard broadcast receivers to the polarized fitting on the master-antenna system outlet plate.

A photo of an installed outlet is shown in Fig. 6.

In developing the master-antenna system<sup>2</sup>, illustrated in part, in Fig. 6, engineers selected an output outlet impedance of 50/75 ohms. This impedance was selected because of the leading ghost and FM interference problems which occur in urban strong-signal areas.

In the leading ghost problems we must consider the basic fact that in any coax transmission system the TV signals have a slower speed of propagation than in air. This means that if the TV receiver picks up an appreciable signal directly from a TV station, with respect to the amount of indirect delayed signal received from the antenna or antenna system, the direct (via air) signal pickup may cause a leading ghost problem which may mar the picture as shown in Fig. 7.

Therefore, it is obvious that if a master antenna system in a strong signal area is to be completely free of direct pickup, the 300-ohm open transmission line which acts as an indoor antenna, must be removed from the TV receiver antenna input circuit.

Fig. 8 shows a typical receiver in which a 70/300-ohm trifilar matching transformer<sup>3</sup> has been installed on the TV receiver chassis where the 300-ohm transmission line has been removed, and the coax line from the outlet run directly into the transformer. The installation of this transformer further precludes local oscillator interference from radiating into the antenna system. Tests have shown that, radiation from TV receiver local oscillators, to

<sup>2</sup>RCA Antenaplex. <sup>3</sup>RCA MI 6876-2.

Fig. 8. TV receiver with a 300-ohm input and trifilar matching transformer installed to eliminate direct pickup from 300-ohm twin lead.

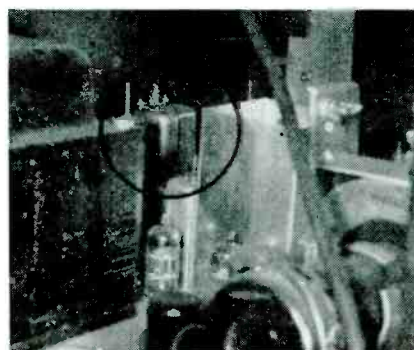

a great extent, is of push-push nature, so that they balance out when connected to the coax line through a trifilar transformer.

Another type of 70/300-matching transformer connected to a television receiver is illustrated in Fig. 10.

Removing the 300-ohm so-called balanced line between the rf and external-antenna terminals also reduces the possibility of FM interference pickup due to lack of image rejection in the TV receiver, since only the controlled FM signals from the master antenna system are available at the outlet and none will appear on the antenna terminals due to direct pickup in the TV receiver.

A typical hookup of a 75-ohm TV receiver to a master antenna system appears in Fig. 11.

Incidentally, the connection of the coaxial cable to one side and ground of a 300-ohm TV receiver input, as shown in Fig. 5, is not recommended unless the antenna coil is easily accessible for direct connection.

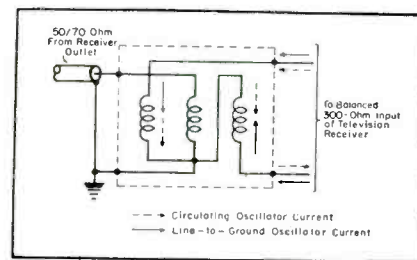

Fig. 9. Circuit of coax line connection to 300-ohm trifilar transformer, which illustrates why oscillator currents are cancelled in this system.

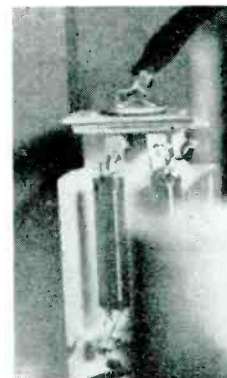
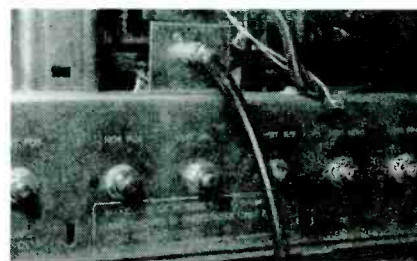

Fig. 10. A TV receiver with another type of impedance-matching transformer.

Fig. 11. Connection of a 75-ohm receiver (DuMont) to a coax cable coming from a master-antenna system outlet.



## Ser-Cuits

(Continued from page 14)

the 50% (6 db) point on the *if* response curve, while the audio *if* carrier appears at a point 26 db below the video *if* carrier or at the 2.5% point. As a result, the amplitude of the audio *if* carrier is much less than that of the video *if* carrier at the video detector. This condition is essential for two reasons: First, the audio *if* signal must be of very low amplitude at the grid of the *crt* to prevent picture distortion; and second the audio *if* amplitude must be low in comparison with the video *if* amplitude in order that the characteristics of the 4.5 mc beat response from the two signals will be determined chiefly by the audio *if* signals and fluctuations in the video *if* signal will have less effect upon the 4.5 mc beat response.

### Video Detector and AGC

The video detector is a diode type similar to those used in AM receivers. The *if* signal is applied to one plate of a 6AL5 twin-diode. On the positive portions of the video *if* signal, the diode conducts and current flows up through a contrast control to the cathode of the diode. This current develops a voltage across the contrast control, and the voltage varies with the modulation on the signal. The setting of the contrast control determines the amount of the signal that is applied to the grid of the video amplifier which, in turn, determines the voltage amplitude applied to the picture-tube grid.

At the same time as the video detector is performing the foregoing function, it serves as a mixer for the video *if* and audio *if* signals. The resultant 4.5 mc frequency-modulated beat signal appears across the contrast control along with the video component.

The other diode section of the 6AL5 serves as an *agc* rectifier. The *if* signal is also applied to the plate of this section. On the positive portions of the signal the diode conducts, and current flows down through a 3,000-ohm resistor developing a negative voltage at the junction of this resistor and a 2,200-ohm unit. This voltage is applied to the tubes under *agc* through a delay network composed of the 2,200-ohm resistor and a .1-mfd capacitor. Each stage under *agc* is decoupled from the *agc* line by resistor-capacitor networks to prevent interaction between stages.

A delay bias of approximately one volt is applied to the cathode of the

(Continued on page 36)

# Applications Unlimited!

## University POWRMIKE

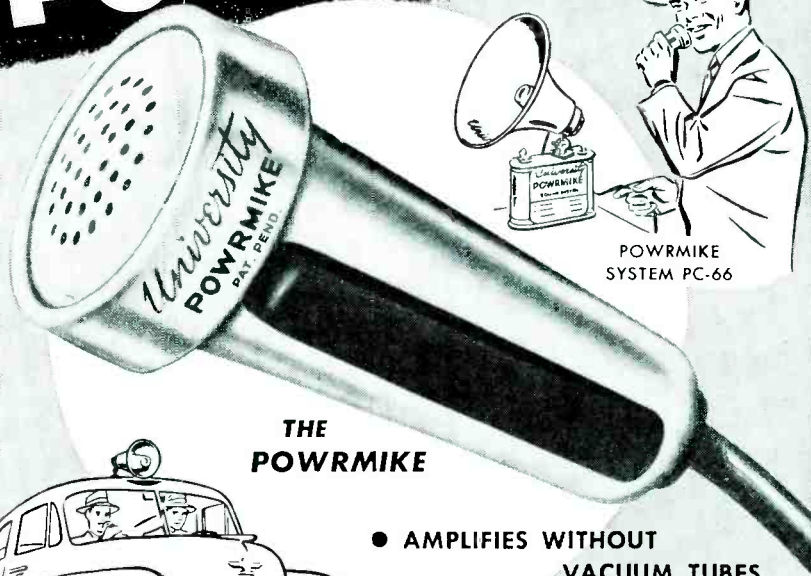

POWRMIKE  
SYSTEM PC-66

### THE POWRMIKE

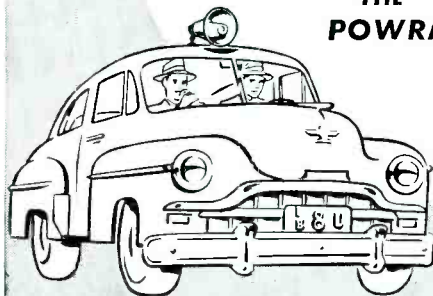

ALSO FOR MOBILE AND  
SPECIAL INSTALLATIONS

- AMPLIFIES WITHOUT  
VACUUM TUBES
- OPERATES FROM ANY  
6 VOLT D.C. SOURCE
- INSTANTANEOUS OPERATION
- DEPENDABLE, FOOL-PROOF,  
ECONOMICAL

The new UNIVERSITY POWRMIKE opens a new field for sound distribution. Low in cost, requiring no amplifier, completely portable, POWRMIKE can be used in thousands of applications where power supply or high cost rule out sound amplification. POWRMIKE has a maximum output of 1.5 watts, reproduces speech with excellent fidelity and is instantaneously operated by handy press-to-talk switch. Additional speakers may be added for broader coverage and special switching arrangements.

POWRMIKE is the perfect answer for voice amplification in stores, carnivals, rallies, waiting rooms, auctions, outdoor markets, sight seeing buses and boats, school group activities, police and fire department work, etc. Get the complete story on sensational POWRMIKE, today.

**MODEL PC-66** — For applications requiring portability. Includes: POWRMIKE microphone wired to loudspeaker, "Hot-Shot" type battery mounting bracket with volume control, and automobile current adapter.

**MODEL PC-60** — For mobile operation and special installations. POWRMIKE microphone, loudspeaker, and automobile cigarette lighter adapter, supplied unwired.

WRITE DEPT. C FOR ILLUSTRATED CATALOG



## University LOUDSPEAKERS INC

80 SO. KENSICO AVE., WHITE PLAINS, N. Y.

Famous World-Wide for LOUDSPEAKERS • DRIVER UNITS • TWEETERS • PORTABLE POWRMIKES

# PHOTOFACT Users Write Our Best ADS!

Hundreds of unsolicited letters tell what the world's finest Radio Data means to Service Technicians



Kenneth C. Zentz  
1105 E. 4th St.  
Pueblo  
Colorado

"Now a word about your service—your PHOTOFACTS. They spell the difference between success and failure for most any radio shop... they just can't be beat."

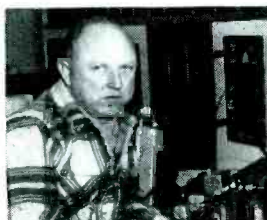

Donald A. Dewey  
5649 Cahuenga  
North Hollywood  
California

"Imagine my surprise and pleasure when I find a Folder in SAMS covering the very set I need. Your manuals have saved my life in the past on late models... Keep up the good work and some day all servicemen will realize the fine job you are doing."

## NOW! GET THE PROOF FOR YOURSELF!

**FREE**

We'll Send You a FREE Photo-fact Folder on any postwar set

Learn for yourself—at our expense—how PHOTOFACT pays for itself by earning bigger repair profits for you! Ask for a FREE Folder covering any postwar AM, FM or TV receiver listed in the PHOTOFACT Cumulative Index. Examine it. Put it to work at your bench—then judge for yourself!

WRITE FOR FREE FOLDER TODAY!

### HOWARD W. SAMS & CO., INC.

Howard W. Sams & Co., Inc.  
2201 E. 46th St., Indianapolis 5, Ind.

- Send FREE PHOTOFACT Folder covering following receiver.....
- Send FREE Cumulative Index
- Send complete PHOTOFACT details

Name.....

Address.....

City..... Zone..... State.....

## Ser-Cuits

(Continued from page 35)

*agc* rectifier by a pair of 1,000 and 100,000-ohm series-dropping resistors. The purpose of this delay bias is to prevent the *agc* from becoming operative until the signal strength has reached a predetermined amplitude. This assures maximum sensitivity of the receiver on weak signals.

### Video Amplifier

The video amplifier in this model is a single-stage amplifier utilizing direct coupling between the video detector and the control grid of the amplifier. If capacitive coupling were used, the coupling capacitor would have to be large to pass the 60-cycle vertical sync pulses. If the capacitor were large enough to pass the sync pulses, the time constant of the *rc* network, formed by the coupling capacitor and the contrast control, would be too long, and the amplifier would be highly susceptible to noise pulses. The direct coupling method is therefore used to provide better low-frequency response and, at the same time, to make the system more immune to noise.

High-frequency response is improved by the use of two series peaking coils. These coils tend to isolate the output capacity of the 6AL5 video detector from the input capacity of the 6AH6 amplifier, and the output capacity of the 6AH6 amplifier from the input capacity of the picture tube, so that the capacities are effectively in series rather than in parallel. Since the high-frequency response is a function of the shunt capacity in the circuit, effectively placing the tube capacities in series—thus lowering the shunt capacity—we have an increase in high frequency response. A further improvement of high-frequency response has been affected by the use of a shunt peaking coil and a 100-mmf coupling capacitor. The shunt-peaking coil is self resonant at a frequency higher than the highest frequency desired to be passed. As the frequency increases, the load impedance increases, and this tends to compensate for the attenuation caused by the tube and stray shunt capacities. The coupling capacitor provides a low-impedance path around the contrast control for the high frequencies and also a form of high frequency *boost*, especially at the lower settings of the contrast control. A series peaking coil, in the plate of the amplifier, is dampened by a 22,000-ohm resistor to prevent the development of trans-

*Be Sure...*  
Rely on these  
**ERIE RESISTOR**  
components



If your distributor cannot supply you, write us for information. New catalog on request.

Electronics Division  
**ERIE RESISTOR CORP., ERIE, PA.**  
LONDON, ENGLAND TORONTO, CANADA

ients that would adversely affect the picture.

The video amplifier is designed to have a sharp cutoff in the vicinity of 3.5 to 4 mc to attenuate the 4.5 mc beat frequency, so that it will have no visible effect on the picture. Although the 4.5 mc beat is 26 to 32 db down on the video-amplifier response curve and its amplitude is not great enough to have any appreciable effect on the grid of the picture tube, the signal is still strong enough to excite the grid of the audio *if* amplifier. The attenuation of the 4.5 mc beat is further increased by the action of the audio *if* transformer, which is effectively a series-tuned circuit shunting the plate of the video amplifier. This series-tuned circuit provides a low impedance path from the plate of the video amplifier to ground for the 4.5 mc signal, and at the same time sufficient voltage is developed across the audio *if* transformer winding to excite the grid of the audio *if* amplifier tube.

[To Be Continued]

G.E. 817 and 821

In our analysis of this 12" type TV set last month<sup>1</sup>, the *rf* amplifier, con-

<sup>1</sup>SERVICE; December, 1949.

verter and oscillator; video and audio *if* amplifiers; and the video detector and amplifier were discussed. Another section of the receiver which merits comment is the sync separation circuit. In the *T* version illustrated last month, amplification and shaping of the sync pulses and their separation (clipping) from the composite video signal have been accomplished by two clippers. Partial clipping of the sync pulse from the video signal is performed by a 6AL5 diode. This tube also performs the function of the *dc* restorer for the video amplifier output to the picture tube. With the polarity of the sync pulses of the composite video signal being negative-going, as applied through a capacitor, the diode conducts on negative peaks of the composite video signal resulting in negative polarity sync pulses developed across a 47,000-ohm resistor. When this signal is applied to one half of a 12SN7GT phase inverter, the signal is amplified, limited in amplitude so as to reduce any noise riding above the sync pulse amplitude and, the phase of the signal inverted so that a positive-going signal can be applied to the second half of the 12SN7GT which functions as a second clipper.

#### Clipper-Tube Plate Voltage

The clipper tube is operated at a low plate voltage with its bias derived by grid rectification of the positive polarity signal applied to the grid. Thus, conduction occurs only during the sync pulse intervals which are the most positive component of the signal applied, resulting in clipping action. The horizontal and vertical synchronizing pulses are developed across a 6,800-ohm resistor in the cathode of the clipper and are positive-going.

#### DU MONT APPOINTS PICTURE-TUBE DISTRIBUTORS

Twenty-four picture-tube distributors have been named by the cathode-ray tube division of the Allen B. Du Mont Laboratories, Inc.:

Chief Electronics, Inc., Poughkeepsie, N. Y.; Wm. Dandreta & Co., Providence, R. I.; Davis Radio Distributing Co., Mt. Vernon, N. Y.; Edwin E. Taylor Company, Albany, N. Y.; Electronic Supply Corp., Columbus, O.; Louis M. Herman Co., Boston, Mass.; Holub & Hogg, Cincinnati, O.; Hunter Electronics, Rochester, N. Y.; Island Radio Distributors, Hempstead, L. I.; Marsh Radio Supply, Milwaukee, Wis.; Mattson's, Inc., Richmond, Va.; A. W. Mayer Co., Boston, Mass.; Northwest Radio & Electronic Supply, Minneapolis, Minn.; P. A. Burks & Co., Louisville, Ky.; Peerless Electronic Equipment, Louisville, Ky.; Pilgrim Distributing Co., Chicago, Ill.; Pioneer Radio Supply Co., Cleveland, O.; R-K Distributing Co., Louisville 3, Ky.; Radio Distributing Co., South Bend, Ind.; Radio & Electronic Parts Corp., Cleveland, O.; Radio Distributing Co., Indianapolis, Ind.; Radio Electronic Sales, Worcester, Mass.; Radonics (Harry's Radio Parts Corp.), St. Louis, Mo., and Srepeco, Inc., Dayton, Ohio.

**You Get  
OVERALL  
Test  
Performance  
With...**

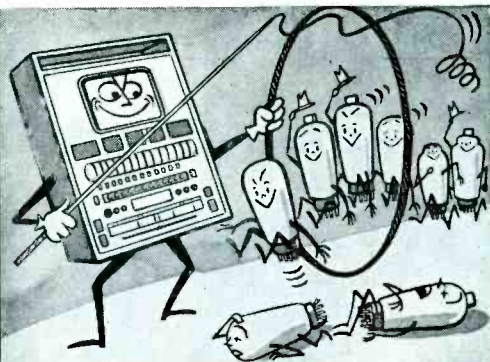

## **PRECISION** SERIES 10-12 *Electronamic*\* TUBE PERFORMANCE TESTER

\*Reg. U.S. Patent Office

**with 12 ELEMENT free-point Master Lever Selector System**

★ To test modern tubes for only one characteristic will not necessarily reveal overall performance capabilities. Tube circuits look for more than just Mutual Conductance or other single factor.

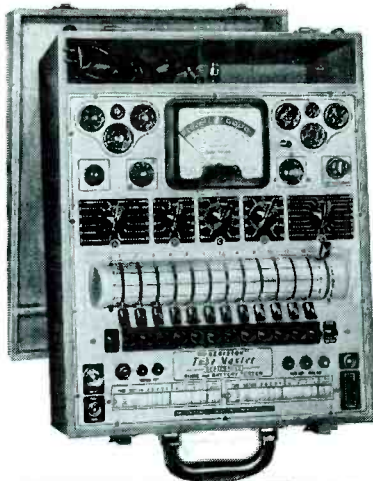

MODEL 10-12-P (illustrated): in sloping, portable hardwood case with tool compartment and hinged removable cover. Size 13 3/4" x 17 1/4" x 6 3/4".....\$96.10  
MODEL 10-12-C (Counter Type).....\$99.40  
MODEL 10-12-PM (Panel Mount).....\$99.40

★ In the Precision Electronamic Circuit, the tube PERFORMS under appropriately phased and selected individual element potentials, encompassing a wide range of plate family characteristic curves. This complete Path of Operation is integrated by the indicating meter in the positive PERFORMANCE terms of Replace-Weak-Good.

- ★ Facilities to 12 element prongs.
- ★ Filament voltages from 3/4 to 117 volts.
- ★ Tests Noval 9 pins; 5 and 7 pin acorns; double-capped H.F. amplifiers; low power transmitting tubes; etc. REGARDLESS OF FILAMENT OR ANY OTHER ELEMENT PIN POSITIONS.
- ★ ISOLATES EACH TUBE ELEMENT REGARDLESS OF MULTIPLE PIN POSITIONS.
- ★ DUAL short check sensitivity for special purpose tube selection.
- ★ Battery Tests under dynamic load conditions.
- ★ 4 1/2" Full Vision Meter.
- ★ Built-in Dual-Window, brass-g geared roller chart.
- ★ FREE Replacement Roll Charts and supplementary tube test data service.

See

the "Precision" Master Electronamic Tube Testers at leading radio equipment distributors. Write for catalog describing Precision Test Equipment for all phases of modern A.M., F.M., and TV.

## **PRECISION APPARATUS CO., INC.**

92-27 Horace Harding Boulevard, Elmhurst 6, New York  
Export Division: 458 Broadway, New York, U.S.A. • Cables—Marhanex

#### CHANNEL MASTER EXHIBIT AT AIEE MEETING

A special exhibit, including an active TV camera chain, *dynamic demonstrator* receiver, transparent plastic model receiver, model transmitter, various types of receiving antennas, typical commercial receivers, a coax and radio relay TV network display, 'scope and tubes used in TV, was displayed by Channel Master Corporation, Ellenville, N. Y., during the recent AIEE-AAAS annual convention at the Hotel McAlpin in New York City. Joseph Resnick, general manager and Harold Harris, sales manager, were present at the exhibition.

#### SAMS MOVES TO NEW PLANT

Howard W. Sams & Co., Inc., have moved to a new plant at 2201 East 46th Street, Indianapolis 5, Indiana. The new building, comprising 30,000 square feet of air-conditioned floor space will house sales and administrative offices, engineering laboratories, photographic and drafting departments, presses and binderies.



*Nation-wide*  
**ACCEPTANCE**  
on Proven Superiority



**ANCHOR**  
**TV PRE-AMPLIFIER**  
Here's Proof of Distributor Acceptance

SOUTH BEND, IND.—"We have found Anchor TV Pre-Amplifier to be superior in performance to anything else on the market. It has been a profitable item on which we have built up dealer good will."

COMMERCIAL SOUND & RADIO CO.—A. E. Kester, Pres.

PHILADELPHIA, PA.—"Anchor Booster's consistency, its high gain and its performance in outer fringe areas have built for it a reputation which cannot be beat in our area. The excellency of this product has opened up many television areas and many additional sales in Television Receivers, their component parts and accessories."

RADIO ELECTRIC SERVICE COMPANY OF PENNSYLVANIA  
Albert N. Kass, Sales Manager

**ANCHOR** has established general acceptance and good will for all good boosters through its own top-notch performance!

Unanimous proven verdict of users. Anchor's engineering is not approached—nor will it ever be.

The ANCHOR BOOSTER is built to help you make the best TV installations possible for your customers.

Why then be satisfied with the ordinary? Anchor builds demand for reliable boosters—making more sales—adding good will. Tie Anchor Booster into every television sale.

Here is dependability with instant sales appeal—2½ times average gain (Voltage Ratio), guaranteed coverage of low and high band—precision with beauty—pride in having the best!

Get in touch with your jobber—or write **ANCHOR ANCHOR ENGINEERING ALWAYS A YEAR AHEAD**



**RIDER MANUAL TV VOLUME 3 NOW AVAILABLE**

TV Manual Volume 3 has been published by John F. Rider Publisher, Inc., 480 Canal Street, New York 13, N. Y.

Manual includes schematics, chassis views, parts, lists, alignment tables, adjustment of traps, trimmers, transformers, voltages and resistance readings, test patterns, waveforms.

Volume has an enlarged page size, 12"x15". Has a cumulative index for the three TV manuals and a *How It Works* book.

Priced at \$21.00.

**New TV Parts . . . Accessories**

**TRICRAFT INDOOR TV ANTENNA**

An electrically-tuned indoor TV antenna, the Vidiette model 700 has been announced by Tricraft Products Company, 1535 North Ashland Avenue, Chicago, 22.



\*\*\*

**INSULINE TV SERVICING TOOL KIT**

A TV *Handi-Kit*, furnished in a pocket-size leatherette carrying case including tools which will fit the adjusting screws of all types of *rf* and *if* transformers, padding and trimmer capacitors, etc., has been announced by the Insuline Corporation of America, 36-02 35th Ave., Long Island City, 1, N. Y.

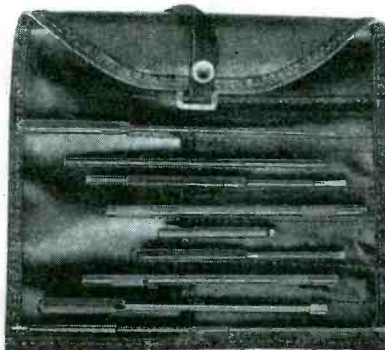

\*\*\*

**STAMFORD CASTING LADDER RACK FOR PANEL TRUCKS**

A rack for carrying ladders and other bulky equipment on panel trucks has been produced by Stamford Casting Company, 820 Atlantic St., Stamford, Conn.

Brackets are polished aluminum castings, and crossbars are heavy wall aluminum tubing. Load carrying capacity is said to be well over 350 pounds. Rack, installed, weighs less than 10 pounds.

In installation, four holes are drilled in the roof, and brackets are fastened with toggle bolts. A felt pad distributes the load over 70 square inches of support area.

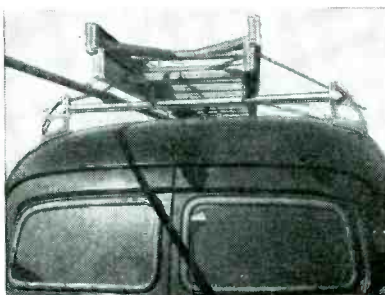

**DRAKE**

*insta-heat*  
**SOLDERING GUN**

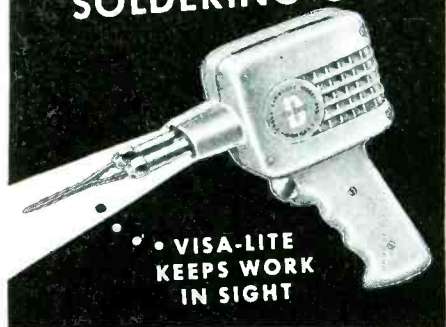

• VISA-LITE  
KEEPS WORK  
IN SIGHT

Perfectly balanced, functional in design, the DRAKE "insta-heat" Soldering Gun gives you all the features you've wanted: A full 135 watts, this gun has the perfectly located VISA-LITE, that keeps work always in full view—even in dark difficult corners. The soldering tip is easily - instantly - removable, using only a screwdriver. See your distributor.

**DRAKE ELECTRIC WORKS, INC.**  
3656 LINCOLN AVENUE CHICAGO 13

**NOW! Everything you want to know about . . .**



400 PAGES OF VITAL NEW FACTS

315 Illustrations, many in Full Color

BIG MASTER INDEX

**New! Illustrated! Authoritative! Includes COLOR TELEVISION**

Just off the press; a GOLD MINE OF INFORMATION about television servicing and trouble-shooting, fully illustrated, clearly explained. It's a complete, up-to-the-minute explanation of television, including UHF, Color TV, new adapters, converters and practical applications. Shows you step-by-step, how to repair, adjust, align, service all makes . . . how to locate and correct troubles in a hurry. Edited by COYNE television experts. Easy-to-follow instructions. The perfect reference book and practical working guide for radio and TV servicemen and retailers, broadcasters, instructors, students, industrial libraries . . . for everyone interested in keeping up with the swift advance of modern television. At your book dealer or get your copy today on 7-Day Trial Offer.

**SEND NO MONEY INSPECT 7 DAYS AT OUR RISK**

Send no money. Just fill out handy coupon below. Pay postman only \$4.25 plus C.G.D. postage. After 7 full days, you must be satisfied or return for prompt refund. No risk! Mail coupon TODAY!

**ORDER TODAY—TRIAL OFFER COUPON**

Educational Book Publishing Division  
**COYNE ELECTRICAL & RADIO SCHOOL**  
500 S. Paulina St., Dept. 10-E4, Chicago 12, Ill.  
YES! Rush your new PRACTICAL TELEVISION SERVICING and Trouble-Shooting Manual on trial offer. I will pay postman \$4.25 plus postage. Book may be returned in 7 days for prompt refund.

Name \_\_\_\_\_  
Address \_\_\_\_\_  
City \_\_\_\_\_ Zone \_\_\_\_\_ State \_\_\_\_\_  
(I am enclosing \$4.25. You pay postage. Same Money-Back Guarantee.)



**SHELDON RECTANGULAR TUBE**

A rectangular screen all-glass gray-black picture tube, type has been announced by Sheldon Electric Division of Allied Electric Products, Inc., Irvington, N. J.

Tube measures 10 $\frac{7}{8}$ "x13 $\frac{1}{2}$ "x18 $\frac{3}{4}$ ".

Magnetic focus and deflection are employed in tube.

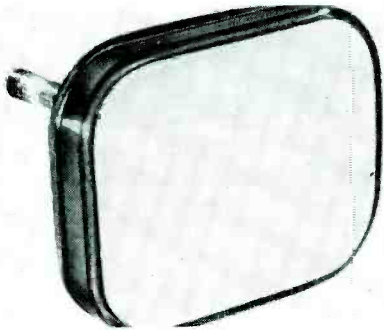

\* \* \*

**MARVIN CHIMNEY ANTENNA MOUNT**

A chimney antenna mount, *Unimac* model UCH-4, with a single bolt which is said not only to lock-clamp a 12' steel strapping in place, but take up the slack in the retaining band at the same time, has been announced by the Unimac Division, Department B, Marvin Radio-Television, Buckeye at 89 St., Cleveland, Ohio.

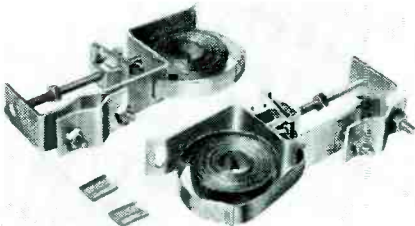

\* \* \*

**DECIMETER TVI TRAPS**

A series of three TVI wave traps has been developed by Decimeter, Inc., Denver, Colorado. Designed to be applied to the 300 ohm leadin to alleviate interference in the three ranges: *A*, 20 to 26 mc; *B*, 25 to 35 mc; and *C*, 88 to 103 mc. Wave trap cases of polystyrene plastic come in three colors; green for the *A* range, red for *B*, and ivory for the *C* range.

Traps operate on induction principle. They slide around the antenna leadin.

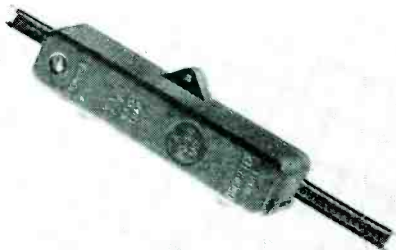

**TV SERVICE DEALERS! RIDE THE ALLIANCE TENNA-ROTOR**

*"CASH IN ON TV ADVERTISING"* **Gravy Train!**

**NEW!**  
Direction Indicator Control Model Now Available!

**Eye-Compelling TV Demonstrations Sell!... 6,000,000 Viewers Around 50 TV Stations... SEE TENNA-ROTOR IN ACTION!**

*Here's why it pays to stock Alliance Tenna-Rotor!*

- Every week your customers see the Alliance TV film!
- Alliance Tenna-Rotor is the only TV antenna rotator backed by national television advertising!
- Proved in the field by thousands of users!
- Laboratory tested to operate in rain, snow or icy weather!
- Guaranteed for one year!

Special Alliance 4 conductor cable with "ZIP" feature makes for faster, easier installations!

Tenna-Rotor eliminates antenna service complaints and expensive call-backs!

**SERVICE DEALERS!... Climb on the gravy train now! Write for the Alliance Merchandiser—"Fastest Profit Maker in Television Today".**

**Underwriters' Laboratories Approved.**

**Alliance Manufacturing Company • Alliance, Ohio**

**JFD ALUMINUM TV CONICALS**

All aluminum conical TV antennas have been announced by the JFD Manufacturing Co., Inc., 6101 Sixteenth Ave., Brooklyn 4, New York.

Conicals, known as the Commandair type, feature elements of heavy-wall aluminum tubing and dipole insulators made of bakelite.

Available in standard conical, conical with high-frequency element and conical with three-element dipole types. Supplied in either single bay or  $\frac{1}{4}$  wavelength stacked arrays.

(Right)  
JFD aluminum conical.

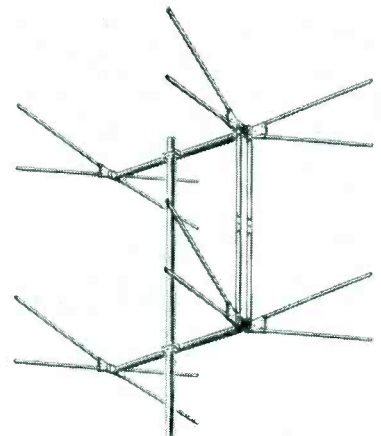



# SPRAGUE DISC

## CERAMIC BYPASS AND COUPLING CAPACITORS

These new ceramic units—no bigger than a dime—find dozens of bypass and coupling uses in both standard and FM as well as television equipment. They have higher self-resonant frequencies than conventional capacitors and fit neatly across miniature tube sockets. They're covered with a tough, protective coating which guards against moisture and heat. Sprague Disc ceramics are available in both single and money-saving dual capacitors.

Use Sprague Disc ceramics whenever circuits call for ultra-compact, bypass or coupling capacitors. Each unit is clearly stamped with capacitance. All capacitors are rated at 1000 v. test, 500 w.v.d.c.

See these remarkable new capacitors at your Sprague distributor today! Write for bulletin M 431.

### SPRAGUE PRODUCTS COMPANY

Distributors' Division  
of the Sprague Electric Company  
61 Marshall St.  
NORTH ADAMS, MASS.

### WORKSHOP ASSOCIATES 6-ELEMENT ARRAY

A 6-element array, consisting of two basic 3-element antennas aligned in the same direction, and spaced  $\frac{1}{2}$  wavelength apart, has been announced by The Workshop Associates, Inc., Newton Highlands, Mass.

Array referred to as a version of the *broadside array*, is said to be capable of furnishing high gain (7.8 db) and sharp directional pattern to bring weak TV signals up out of the *snow*. Said to have a front to back ratio of 18 db which can reduce by 98% any interfering signal from the rear.

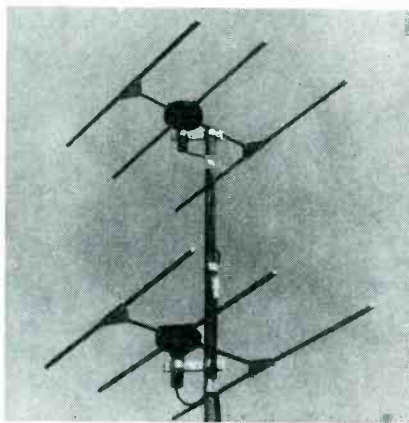

\*\*\*

### DELSON CONICAL WINDOW-TENNA

A *conical window-tenna*, model B63, has been produced by the Delson Manufacturing Co., 126 Eleventh Avenue, N. Y. 11.

Antenna accommodates windows from 32" to 42". Extension bars available for use on windows from 32" to 54", type X61; X62 for windows from 32" to 66", and X63 for others up to 78".

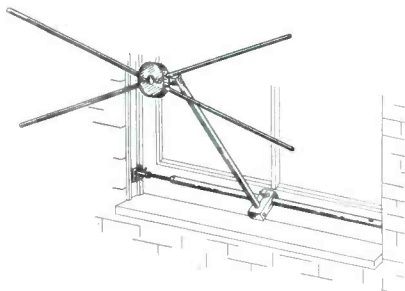

\*\*\*

### SIMPSON TV SIGNAL BOOSTER

A TV booster, model IMB-13, featuring a swivel-based antenna, which can be plugged into the booster, has been announced by Mark Simpson Manufacturing Co., Inc., 32-28 Forty-ninth St., L. I. C. 3, N. Y.

Uses two 6AK5s.

\*\*\*

### CLEVELAND AIRCRAFT REMOTE-CONTROL ANTENNA ROTATOR

A remote-control antenna rotator, Tune Vue, has been announced by the Cleveland Aircraft Products Co., 113 St. Clair Ave., N. E., Cleveland, Ohio.

Rotator is powered by an induction-type motor operating off a 110-volt 60-cycle power source.

(See page 42 for additional *New Product News*)

Servicemen - Dealers

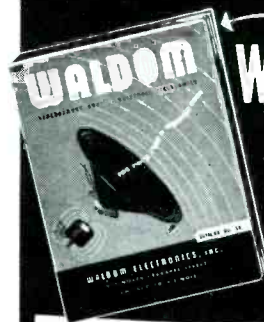

**WALDOM**  
Replacement  
Cone  
Manual  
Catalog No. 50

Write for your FREE copy Today!

Waldom's Free New 24-Page Replacement Cone Manual lists specific replacement data for over 75 different TV, FM, and AM Sets. This handy reference speeds-up your repair time — means more profit to You! Write today for your Free Copy. Just send your name and address to Dept. S.

For Finer Tone a Waldom Cone



Check these features:

- Hawley diaphragms — with the patented thin, tapering edge that assures maximum speaker efficiency and true low frequency response.
- The finest voice coils and spiders made with precision craftsmanship to exacting specifications.
- Unconditionally Guaranteed as to construction and performance.
- Carries the full R.M.A. Warranty.

**WALDOM ELECTRONICS, INC.**  
911 N. Larrabee St., Chicago 10, Ill.

**PHOENIX**  
*Speed - Tennas*  
**DO A BETTER JOB!**

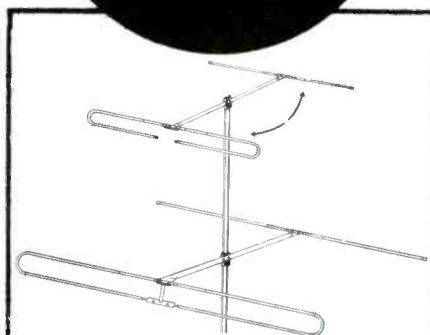

Strong—light in weight—fast, easy installation. Engineered to give highest quality electrical performance... and designed to withstand the toughest weather conditions. Pre-assembled—no loose hardware.

**PHOENIX**  
ELECTRONICS, INC.  
Lawrence, Mass.

AT LEADING  
JOBBER'S  
Write for  
folder V of  
complete line  
of television  
accessories.

**ONTARIO RESEARCH NAMED SOLE AGENT FOR WALKER DUALCOTED STEEL SNYDER TV MASTS**

Ontario Research Corp., 2218 W. Ontario Street, Philadelphia, Pa., has been appointed sole selling agent for the Snyder Manufacturing Company's TV masts of Walker dualcoted steel.

Richard Morris has been named sales manager of Ontario.

According to Mr. Morris, the Walker-dualcoting process offers protection against corrosion through a double safety coating on both the inner and outer tube walls. Non-cracking or chipping if bent during installation, the process is said to prevent corrosion from salt, acids and caustics.



Richard Morris

\* \* \*

**SUNBERG NOW OXFORD ELECTRIC V-P**

Hugo Sundberg has been named vice president and manager of the Oxford Electric Corp., 3911 South Michigan Ave., Chicago, Ill. Sundberg was formerly with Utah Radio Products.



Hugo Sundberg

\* \* \*

**HYTRON TO BUILD PICTURE-TUBE PLANT**

The cornerstone of a television picture tube plant at Newburyport, Mass., was laid recently by Bruce A. Coffin, president, and Lloyd H. Coffin, treasurer, of Hytron Radio & Electronics Corp.

The new plant is expected to provide a daily production of 3,000 picture tubes, ranging in size up to 20".

The plant is located next to Hytron's present factory at Newburyport.

\* \* \*

**SUN RADIO AUDIO EQUIPMENT HANDBOOK**

A pocket manual entitled *1950 Audio Equipment*, has been published by Sun Radio & Electronics Co., Inc., 122-124 Duane St., New York 7, N. Y.

Written by Irving Greene, manager of Sun Radio's audio engineering department, the handbook deals not only with radio AM and FM tuners, phonograph pickups, records, amplifiers and speakers, but also with the installation of such equipment in cabinets and again as built-in home features.

*Announcing*

FOR FIELD OR BENCH WORK ...

*Easier, Faster  
More Profitable TV-FM  
Servicing at Lowest Cost!*

**NEW OAK RIDGE miniatures**

work like **GIANTS** for you!

**OAK RIDGE 10-in-1 MINIATURE TV-FM SIGNAL GENERATOR**

Pinpoints any signal failure from antenna to CRT or speaker in 2 minutes flat! Incorporates 3 separate tuning bands and modulation output and attenuator for TV & FM. Generates a signal to perform as complete . . .

- RF, OSC, and Mixer (1st Det.) Tester
- Video IF Tester • Audio IF Tester • Video & Audio 2nd Detector Tester • Video & Audio Amplifier Tester • Sound Trap Aligner or Tester • Adjacent Picture Trap Aligner or Tester • Marker Generator • Antenna Orientation Tester • Antenna Sensitivity Tester.

You get **ALL TEN IN ONE** with this extremely adaptable, precision-made Model 103! Size: 5 3/4 x 4 x 2 1/4". Dealer's Net \$29.95.

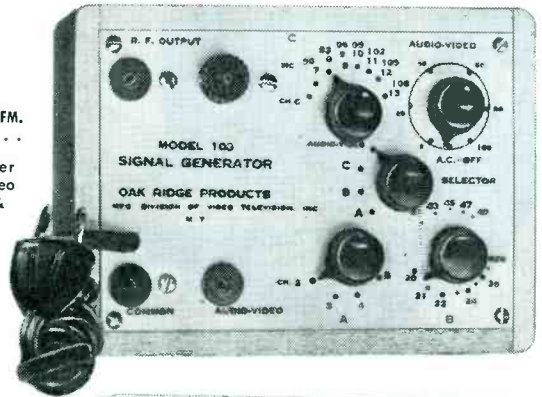

**OAK RIDGE 7-in-1 MINIATURE TV-FM-AM SUBSTITUTION TESTER**

*Which Servicing Aids do You Need Most?*

- Test Speaker Without Transformer • Test Speaker With Transformer • Paper Condenser Substitutor • Electrolytic Condenser Substitutor • Fixed Resistor Substitutor • Variable Potentiometer Substitutor • Audio Signal Tracer for Video, Audio & Sweep Circuits in TV, FM, AM, Audio Amplifiers, etc.

You get **ALL SEVEN IN ONE** with the versatile, precision-made Model 101! Size 5 3/4 x 4 x 2 1/4". Dealer's Net \$16.25.

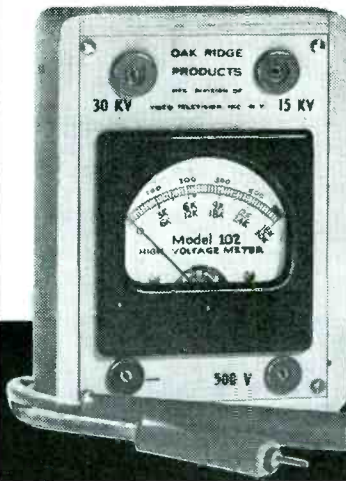
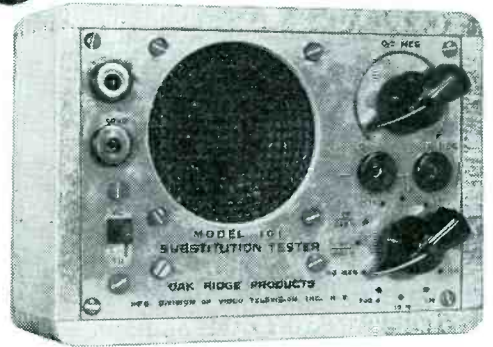

**OAK RIDGE 3-in-1 MINIATURE TV HIGH VOLTAGE TESTER**

Accurately checks all high voltages in any direct-view or projection TV set. Has precision 10,000 ohm/volt movement, three scales: 0-500V, 0-15KV, 0-30KV. Complete with special high voltage test lead. Size: 5 3/4 x 4 x 2 1/4". Dealer's Net \$14.95.

Boost your efficiency and earnings! Ask your parts jobber for these amazing new **MINIATURES** today! Write for free Catalog **T-S**

**OAK RIDGE PRODUCTS**

239 EAST 127th STREET NEW YORK 35, N. Y.  
Manufacturing Division of VIDEO TELEVISION, INC.

Makers of the famous OAK RIDGE Patented SNAP-LOCK TV-FM Antennas and Accessories.

**TACO ANTENNA STACKING BULLETIN**

Explanation and detailed drawings of the procedure to follow in stacking high-band antennas appear in an engineering bulletin, No. 58, released by Technical Appliance Corporation, Sherburne, N. Y. Dimensions and proper phasing of antennas are given for both the two-stacked and four-stacked arrays.

\* \* \*

**G-C TO MAKE WINDSOR ELECTRONIC MIRROR**

General Cement will manufacture the Windsor Electronics, Chicago, *Third Eye Miro-Pix Mirror*.

Miro-Pix is a portable telescoping television service 10" x 12" mirror.

**STANCOR TV PARTS GUIDE**

A 20-page booklet, No. DD338C, listing replacement transformers for 215 TV receivers and chassis made by forty-three manufacturers has been published by the Standard Transformer Corporation, Elston, Kedzie and Addison Sts., Chicago 18, Illinois. Stancor replacement part numbers are listed together with manufacturers' part numbers for positive identification.

\* \* \*

**FEDERATED PURCHASER TO MOVE**

Federated Purchaser, Inc., will move to new quarters at 66-68 Dey Street, New York City on or about March 15. Federated's present New York address is at 80 Park Place.

## PROFIT MAKING MUSTS!

### NEW DYNATRACER

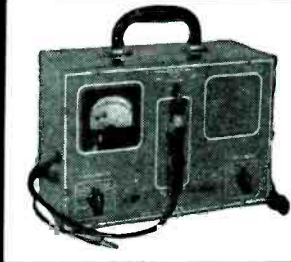

MODEL 777A

\$41.50

NET PRICE

#### —The One Outstanding Signal Tracer—

The answer to speedy accurate Trouble Shooting New Model 777A dynatracer is such a masterpiece in engineering design that it is sweeping the nation in enthusiastic acceptance.

New design ultra sensitive instrument permits detecting signal and any distortion or variation with either or both meter and speaker at any point in any receiver or electronic circuit. Traces what happens at any and every point from a tenna, through each stage of r-f-i-f-a-f to speaker. No switching or changing channels.

The best and simplest way to solve problems of INTERMITTANTS — NOISE — OPENS — SHORTS — LEAKS — DISTORTION, ETC.

Frequency Range—Up to 160 Megacycles.

Gain measurements made by accurate meter indications instead of uncalibrated magic eye indicators. Negligible outside pick up of noise and hum negligible disturbance to circuit—input capacity only 3 micromicrofarads.

Attenuation—10,000 to 1 with ladder attenuator and a vernier control.

Sensitivity—10,000 microvolts for full scale deflection of meter or 200 microvolts per division.

Tubes—6AU6—6AT6—6AQ5—6X4 and 1N34 crystal rectifier.

Ainico 5 magnet speaker.

MICROPHONES and PICKUPS tested through special jack provided.

Automatic control switch—either speaker or meter—both or standby.

Beautiful hammerstone grey steel panel and case with new design probe. A high quality instrument in every detail. For 105-135 volts operation 50-60 cycles. Size 6 7/8" x 8 7/8" x 1 1/2". Weight 9 1/2 lbs.

### TELEVISION MARKER



MODEL TV 50

\$49.95

NET PRICE

Designed for use in marking television sweep generators. The large planetary driven dial is calibrated to an accuracy of 1%. Uses 4 frequency bands covering frequency of 5 to 130 mc and 96 mc to 260 mc. A self contained crystal oscillator is available for simultaneous marking or may be used alone with the variable frequency marker turned off. Due to the type of oscillator any crystal from 100 KC up may be used in the crystal socket. An internal mixing arrangement is provided so that the output of a sweep generator may be connected to the TV 50 and the output lead will carry both the sweep frequency and the marker frequency.

Buy it from your jobber.  
Write for Catalog ISV

**RADIO CITY PRODUCTS CO., INC.**

152 West 25th Street,  New York 1, N. Y.

### ALLIANCE TENNA-ROTOR WITH DIRECTIONAL INDICATOR

A new model *Tenna-Rotor*, model DIR, which features a directional indicator control case, has been announced by the Alliance Manufacturing Co., Alliance, Ohio. Indicator dial on control case panel enables the viewer to select and know the actual compass direction to which the antenna is pointed.

Model has stainless steel bearing inserts, and is said to be designed to operate in any weather.

Models supplied with special Alliance 4-conductor cables which are said to have a special *zip* feature to facilitate installation.



\*\*\*

### G. E. 12-INCH DARK-FACE GLASS PICTURE TUBES

Two 12-inch TV picture tubes, incorporating a *filterglass* face plate, have been announced by G. E.

Designated as the 12KP4A (aluminized) and 12LP4A (non-aluminized).

\*\*\*

### EASY-UP TV TOWERS

A tower which is said to elevate a TV antenna approximately 30' above roof-top, the 300 *Roat-Tower*, has been introduced by the Easy-Up Tower Co., Racine, Wisc. Incorporated is a rotating feature, permitting the antenna to be oriented after the tower is installed. Horizontal cross-bars form a ladder for climbing. Tower is of electrically-welded steel tube and rod construction, dip-galvanized after fabrication.

Basic model has two 10-foot pre-assembled tower sections and a 10-foot top pole which mounts the antenna and its pole. Sections are joined together at site of installation by three bolts. A four-way hinged base permits *walking* the tower up along the peak of the roof, or tipping it up from either side.

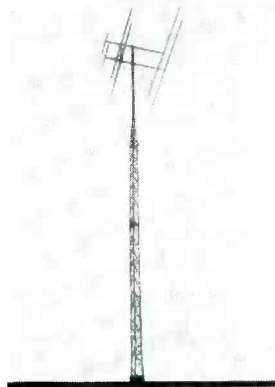

### BLACKBURN ADJUSTABLE GROUND CLAMP

An adjustable ground clamp to fit 3/8" to 1 1/4" pipe, and 3/8" to 3" pipe, has been announced by Blackburn Specialty Co., 6541 Euclid Ave., Cleveland 3, Ohio. Features a tightening screw which is said to chafe the pipe, draw up slack, cut through rust and dirt and at the same time contract band around the pipe surface.

Clamp consists of a flexible, perforated copper band which encircles the pipe. A boss raised on the flat end of a removable copper alloy terminal lug fits into band holes. Tightening screw with a lock nut is threaded through the boss.

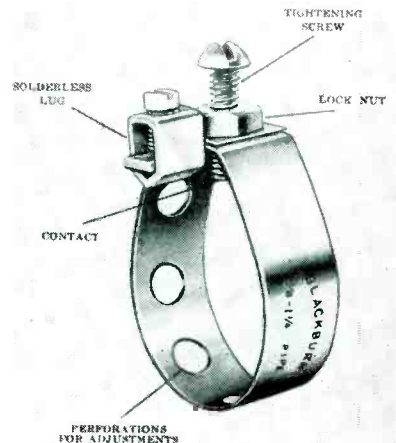

\*\*\*

### DU MONT FOUR-SECTION SPIRAL-TYPE INPUTUNER

A four-section inputuner incorporating a spiral-type inductor has been announced by the Electronic Parts Division of Allen B. Du Mont Laboratories, Inc., 35 Market St., East Paterson, N. J. Tuning range is continuous from 54 to 216 mc. Inputuner requires 5.9 turns of tuning motion as against 10 turns for previous models. Can be used on either 300 or 72 ohm antenna systems, by means of an input transformer.

# HOT

nails



**SAVES YOU DOLLARS ON TV INSTALLATIONS**

Easily pierces brick, mortar between brick, most concrete. Acts as a mast coupler and stand-off insulator!

Write for FREE sample today!

**HOT NAILS, INC.**  
40 WEST 4TH STREET, NEW YORK 12, N. Y.

## New Parts, Accessories

### MALLORY 6-VOLT BENCH POWER SUPPLY

A 6-volt portable *dc* power supply, type 6RS10, has been announced by P. R. Mallory & Co., Inc., 3029 E. Washington St., Indianapolis 6, Indiana.

Unit has been designed for use in the testing and demonstrating of auto radios and electrical equipment, solenoids, relays, motors, clutches, brakes, chucks, etc.

Voltage is continuously variable from 0 to 8. The unit is said to permit continuous operation at 10 amperes and intermittent at 20 amperes. It has a filtered *dc* output with less than 1 volt ripple at 6 volts, 10-ampere output.

Supply is equipped with a 0-20 ampere *dc* ammeter, 0-10 volt *dc* voltmeter, self-resetting circuit breaker in the *dc* line, and a switch and fuse in the *ac* line.

\* \* \*

### AEROVOX PLASTIC-SEALED PAPER-CASE TUBULARS

Paper tubulars, type P85, featuring Aerolene-impregnation and a Duranite seal, have been announced by Aerovox Corp., New Bedford, Conn.

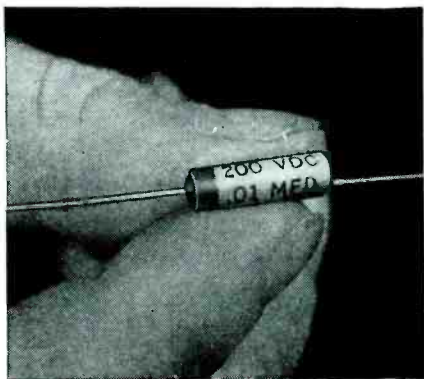

\* \* \*

### TRIPLETT VOLT-OHM-MIL-AMMETER

A 5½" laboratory-type volt-ohm-mil-ammeter, type 630A, with mirrored, hand-drawn scales has been developed by The Triplett Electrical Instrument Co., Bluffton 2, O.

Six *dc* volt ranges from 0 to 6,000 at 20,000 ohms/volt; six *ac* volt ranges from 0 to 6,000, at 5,000 ohms/volt; and five *dc* current ranges. Resistance ranges from 0 to 100 megohms.

Features a precalibrated rectifier unit.

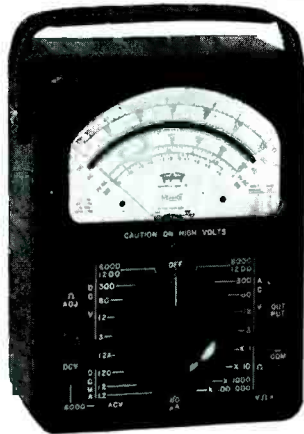

This model for manual operation. Many variations are available to record-changer manufacturers.



## MODEL TS (ALL THREE SPEEDS)

Here's the turntable that puts you right in the middle of the profitable market for consoles, table models and portable phonographs that will play all three types of records. Simple and fool-proof in operation, the Model TS incorporates all of the advanced engineering features which have long distinguished GI's *complete* line of Smooth Power phonomotors, recorders and record-changer recorders.

Quantity price quotations, specifications and blueprints mailed immediately upon request. Write today to:



**The GENERAL INDUSTRIES Co.**

DEPARTMENT O • ELYRIA, OHIO

### SYLVANIA SEALED IN GLASS GERMANIUM DIODES

Germanium crystal diodes that are enclosed in hermetically sealed glass cartridges have been announced by the electronics division of Sylvania Electric Products, Inc. Crystals are available in two types; IN34A, a general purpose diode, and IN58A, a 100-volt diode.

Electrical features are said to include small interelectrode capacitance; small shunt capacitance; low forward resistance; high back resistance and ability to work into a low resistive load with good efficiency.

### IRC MINIATURE RESISTORS

Two miniature BT type insulated resistors, type BTR and BTB, have been developed by the International Resistance Co., 401 N. Broad St., Philadelphia, Penna.

Type BTR, a ⅓-watt unit, has a body length of 13/32" and a diameter of 3/32", while BTB, a 2-watt unit, has a body length of 1¼" and a diameter of ¼".

Minimum resistance of each is 470 ohms, and maximum resistance 22 megohms. Available in ± 5% and ± 10% tolerances in RMA ranges.

## Three Good Reasons Why Astatic Holds Its Position As The NATION'S LEADING MANUFACTURER OF PHONOGRAPH PICKUP CARTRIDGES

GC  
CERAMIC  
CARTRIDGE

• The first Ceramic Cartridge with replaceable needle. Takes the special new Astatic "Type G" needle — with either one or three-mil tip radius, precious metal or sapphire — which slips from its rubber chuck with a quarter turn sideways. Resistance to high temperatures and humidity is not the only additional advantage of this cartridge. Output has been increased over that of any ceramic cartridge available. Its light weight and low minimum needle pressure make it ideal for a great variety of modern applications.

CQ  
CRYSTAL  
CARTRIDGE

• An entirely new Astatic design, featuring miniature size and five-gram weight. Model CQ-J fits standard 1/2" mounting and RCA 45 RPM record changers. Model CQ-IJ fits RMA No. 2 Specifications for top mounting .453" mounting centers. Needle pressure five grams. Output 0.7 volts at 1,000 c.p.s. Employs one-mil tip radius, Q-33 needle. Cast aluminum housing.

LQD  
DOUBLE-NEEDLE  
CRYSTAL  
CARTRIDGE

• The LQD Cartridge — for 45, 33-1/3 and 78 RPM Records — is outstanding for excellence of frequency response, particularly at low frequencies, among all turnover types. A gentle pry with penknife removes ONE needle for replacement . . . without disturbing the other needle, without removing cartridge from tone arm. Gentle pressure snaps new needle into place. Model LQD-1, with needle guards, illustrated. Available without. Stamped aluminum housing.

Astatic Crystal Devices manufactured  
under Brush Development Co. patents



### SUPERIOR INSTRUMENT UTILITY TESTER

A pocket size utility tester that is said to be capable of measuring the actual current consumption of any appliance or utility either *ac* or *dc*, while the unit under test is in operation, has been announced by Superior Instruments Co., 227 Fulton St., New York City.

Appliance registers a reading in amperes. A special pair of insulated clip-ends are supplied for motors. Incorporates a direct-reading resistance range for measuring resistances commonly used in electrical appliances, motors, etc.

\* \* \*

### UNIVERSITY LOUDSPEAKER CROSSOVER NETWORK

A filter network, model 4410, of the LC type for use with coaxial or duplex loudspeaker systems, which is said to provide a proper attenuation rate at a crossover of 600 cycles has been announced by University Loudspeakers, Inc., 80 South Kensico Ave., White Plains, N. Y.

Filter was designed primarily for use with high-frequency tweeters and is particularly efficient when used with University tweeter models 4408 and 4409.

\* \* \*

### G. E. SWEEP GENERATOR OUTPUT ADAPTOR

A balanced output adaptor, type ST-8A, for use with the G. E. model ST-4A sweep generator has been announced by General Electric.

The sweep generator presently has a single-ended output and with the addition of this adaptor, balanced output is available.

\* \* \*

### INDUSTRIAL DEVICES VOLT-AMP TESTER

A general-purpose volt-ampere checker, type 900, that plugs in between line and connection cord, and is said to provide simultaneous voltage and amperage readings directly off two dials, has been announced by Industrial Devices, Inc., Edgewater, N. J.

Employs two neon indicators which extinguish at the voltage and amperage readings indicated by the adjustable knobs. A multiplying switch provides for the expansion of the range indicated on the ammeter scale. Tester distinguishes between *ac* and *dc*.

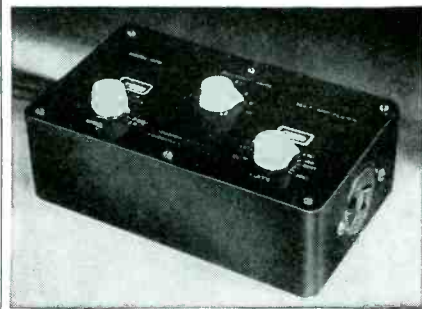

\* \* \*

### C-D AUTO ANTENNAS

Two models of auto antennas for installation on any contour at any angle have been announced by Cornell-Dubilier Electric Corp., South Plainfield, N. J.

One model, Skyhawk 4-B, is a two-section mast that extends to 43", with a 36" lead-in. Another model, Skyhawk 8-B, chrome plated in three sections, extends to 60". Has a 36" polyethylene lead-in.

## Heathkit

# TEST EQUIPMENT

Build YOUR OWN

**Heathkit**  
AUDIO GEN.  
KIT \$34.50

**Heathkit**  
TELEVISION  
GENERATOR  
KIT \$39.50

**Heathkit**  
CONDENSER  
CHECKER KIT \$19.50

**NEW Heathkit**  
IMPEDANCE  
BRIDGE SET \$69.50

**NEW Heathkit**  
HANDITESTER  
KIT \$13.50

**Heathkit**  
TUBE CHECKER  
KIT \$29.50

**Heathkit**  
SIGNAL  
TRACER KIT \$19.50

**Heathkit**  
R.F. SIGNAL  
GEN. KIT \$19.50

**Heathkit**  
5" OSCILLOSCOPE  
KIT \$39.50

**Heathkit**  
BATTERY  
ELIMINATOR  
KIT \$22.50

**Heathkit**  
ELECTRONIC  
SWITCH KIT \$34.50

**Heathkit**  
VACUUM TUBE  
VOLTMETER KIT \$24.50

Heathkits are beautiful factory engineered quality service instruments supplied unassembled. The builder not only saves the assembly labor cost but learns a great deal about the construction and features of the instrument. This knowledge aids materially in the use and maintenance of the equipment. Heathkits are ideal for and used by leading universities and schools throughout the United States. Each kit is complete with cabinet, 110V 60 cycle transformer (except Handi-Tester), all tubes, coils assembled and calibrated, panel already printed, chassis all punched, formed and plated, every part supplied. Each kit is provided with detailed instruction manual for assembly and use. Heathkits provide the perfect solution to the problem of affording complete service equipment on a limited budget. Write for complete catalog.

## HEATH COMPANY

BENTON HARBOR, MI  
MICHIGAN

EXPORT DEPARTMENT  
12 EAST 40th STREET  
NEW YORK 16, N. Y.  
CABLE - ARLAB - N. Y.

## HI-VOLT

THE ALL-IN-ONE TELEVISION TESTER

Goes right to work  
No accessory attachments

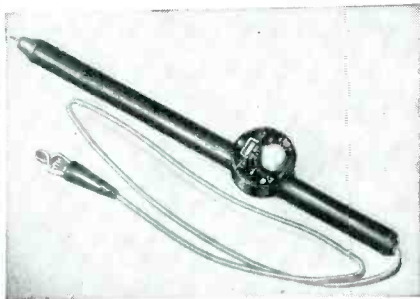

### High Voltage Readings to 30,000 Volts

Save time and trouble on servicing with a simple check on voltages first!—and here's the up-to-the-minute meter that will put speed into your servicing. It's economical, practical—easy to handle, simple to use. Inexpensive, yet built for rugged duty—requires no kid-glove handling and is virtually burn out proof!

#### Here's All You Do:

- Connect the flexible lead test-clip to chassis or similar ground.
- Touch the heavily insulated test prod to high voltage supply.
- Turn meter dial until the glow lamp abruptly extinguishes. *This is your voltage—read directly off the dial.*

#### Draws Minimum Current, Too!

Multi-megohm multiplier in the 7 inch long prod enables Model 520 to draw less than 0.1 milliamperes per 10,000 volts.

For television, oscillograph and other high voltage electronic d-c supplies

**HI-VOLT MODEL 520 — 3.2 to 30 KV**  
List Price \$11.00

Supplied by your dealer —  
or write manufacturer direct.  
FREE CATALOG ON REQUEST

## INDUSTRIAL DEVICES, INC.

22 STATE ROAD EDGEWATER, NEW JERSEY

### CB AUTOMATIC AUDIO SWEEP GENERATOR

An automatic audio sweep generator which is said to have a frequency of from 25 to 32,000 cycles in one continuous range has been announced by the Clough Brengle Company, 6014 Broadway, Chicago, 40, Ill. Sweep may be adjusted to any spread from 500 to 10,000 cycles, or the instrument may be operated manually.

Wave form distortion is stated to be less than 1/2 of 1%, and the sweep calibration is linear, sweep frequency being adjustable from 2 to 10 sweeps per second.

Complete construction and operational data appear in bulletin 18A.

### C-D TV ANTENNA ROTATOR

A TV-antenna rotator, the Tele-rotor has been announced by Cornell-Dubilier Electric Corp., South Plainfield, N. J. Unit is said to take load stress up to 300 pounds. Motor is said to be weather sealed and lubricated for life. It is instantly reversible, and is operated by directional push buttons.

The housing of the rotator is die cast, designed for mast or platform mounting and equipped with three heavy-duty guy-wire lugs. It will accommodate 7/8" to 2" upper and lower masts.

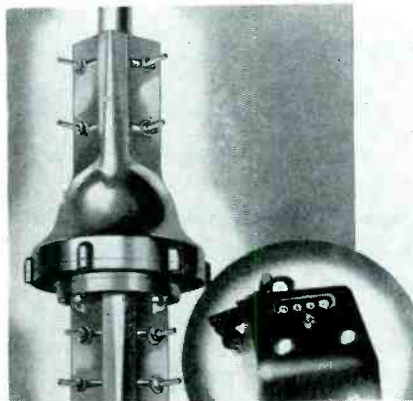

\* \* \*

### EICO 5" 'SCOPE

A 5" 'scope, model 400, has been announced by Electronic Instrument Co., Inc., 276 Newport St., Brooklyn 12, N. Y. Available both as a kit and a fully wired unit.

The 'scope has a horizontal sweep circuit of 15 to 30,000 cps. Frequency response of horizontal and vertical amplifiers is said to be 50 cps to 50 kc. Input impedance: 1 megohm and 50 mmfd. Tubes: two 6SJ7s, two 5Y3s, and 884, and a 5BP1. Provides for external synchronization, test voltage, and intensity modulation. Deflection sensitivity: .30 volts-per-inch, full gain.

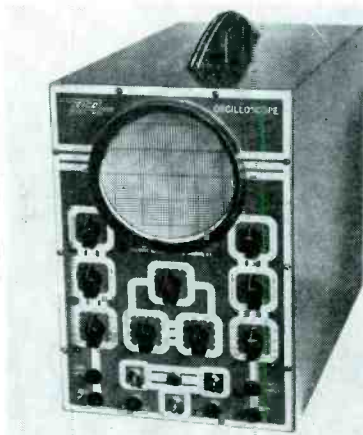

\* \* \*

### MARKWELL TV TACKER

A TV tacker (L4) designed for tacking round coaxial cable to wood or plaster using 1/2" leg staples (LAD), has been announced by Markwell Mfg. Co., Inc., 200 Hudson St., New York 13, N. Y.

Tacker can also be used for tacking twin-lead in using a 3/8" leg staple (LAC) driven parallel and between the two outside wires.

# MERIT

SINCE 1924—FINE RADIO PARTS

## News

### FREE!

#### MERIT TV "REPL" GUIDE

January 1950 Issue

60 MANUFACTURERS  
—400 MODELS—MOST  
COMPLETE, UP-TO-  
DATE LISTING

Get this easy-to-use, time-saving guide to exact replacements for all popular television receivers. Simplifies servicing, cuts repair-bench time. Write us today for your free copy!

### USE MERIT TV!

ONE SOURCE FOR  
TV Tape-Marked Components:  
Power, Blocking Oscillators,  
Vertical Outputs, Focus Coils,  
Deflection Yokes, Flybacks.

WATCH FOR  
Merit's future  
issues of the TV  
"Repl" Guide.

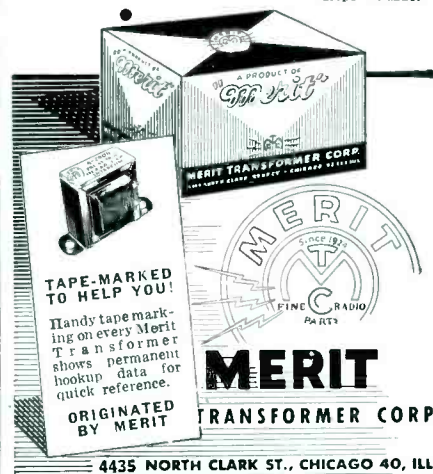

TAPE-MARKED  
TO HELP YOU!

Handy tape marking on every Merit Transformer shows permanent hookup data for quick reference.

ORIGINATED  
BY MERIT

# MERIT

TRANSFORMER CORP.

4435 NORTH CLARK ST., CHICAGO 40, ILL.

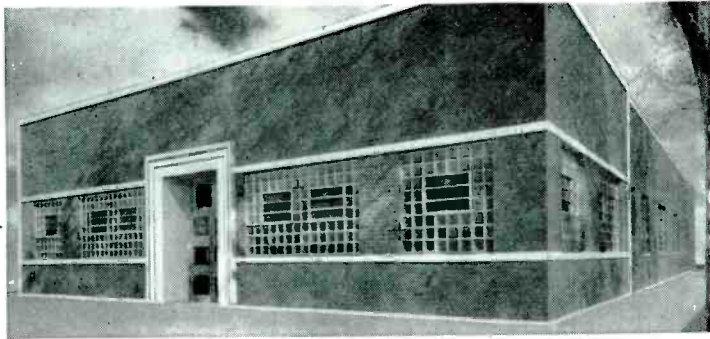

## KEEPING PACE with SERVICE-DEALER NEEDS

Expanded manufacturing and technical facilities enable us to serve you better . . . faster. A modern equipped plant and laboratory; latest production methods and trained technicians producing dependable electronic products help you save time and increase your operating profits. Our staff engineers are constantly developing and testing new products to offer you the latest and best in equipment.

### NEW! Model "B" Supplies 1 to 20 Amps 6 Volts DC, Continuous Duty



Patent Pending

Send for Folder on Complete Line

Test auto radios, relays, telephone circuits, instruments and other low voltage needs.

Conduction cooling increases rectifier power rating 1½ times . . . dissipates over 3 times the heat . . . costs no more! Proved best, the Electro "B" offers ample power to test or operate up to two receivers simultaneously. Peak instantaneous current rating of 35 amperes (from 50 to 60 cycle 115 volt power source).



Pioneer Manufacturers

of Battery Eliminators

ELECTRO PRODUCTS LABORATORIES, INC., 4501 N. Ravenswood Ave., Chicago 40, Ill.

## three decades of radio-television "know-how"

### TELEVISION and FM ACCESSORIES

LIGHTNING ARRESTER

NO 6112



TURNBUCKLES

NO 6150



GUY WIRE CLAMP

NO 6144



INSULATED MAST STAND-OFFS

3½" and 7" lengths for twin-lead or coaxial cable.



ANTENNA MAST SUPPORTS

NO. 6131 for wall

NO. 6130 for chimney

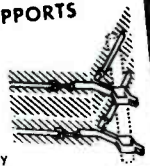
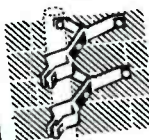

### TELEVISION SERVICING TOOLS "Handi-Kit"

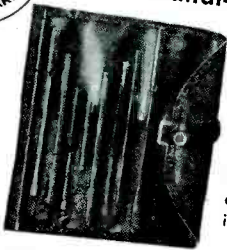

Nine specially designed television servicing tools in a durable pocket-size leatherette case. All the tools needed for a complete servicing job.

### "KILOVOLTER" MULTIPLIER PROBE

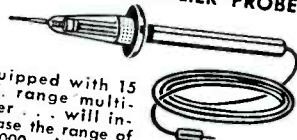

Equipped with 15 K.V. range multiplier . . . will increase the range of a 5,000 volt range voltmeter to 20,000 volts per scale. Available in 5,000, 10,000 and 20,000 ohms per volt.

Illustrated are only a few of ICA's extensive line. Write Dept. S for complete catalog.



## insuline CORPORATION OF AMERICA

INSULINE BUILDING • 36-02 35th AVENUE • LONG ISLAND CITY, N. Y.  
West Coast Branch and Warehouse: 1335 South Flower Street, Los Angeles, Calif.  
Exclusive Canadian Sales Agents: CANADIAN MARCONI COMPANY, Montreal

## SYLVANIA SUBMINIATURE AMPLIFIER TUBES

Two subminiature tubes, a triode and pentode, designed for use as class A of amplifiers or resistance coupled of amplifiers have been announced by Sylvania Electric Products, Inc.

The triode, type 6AD4, has a mutual conductance of 2700 micromhos, and the pentode, type 6BA5, a rating of 3300 micromhos.

Both tubes are enclosed in T-3 envelopes and supplied with 6.3 volt, 150 milliamper heaters.

\* \* \*

## CALIRI SOLDERING GUN

A soldering gun with a single-pole electrode, the Cal-88, has been produced by the Caliri Manufacturing Co., Inc., 45 Washington St., West Orange, N. J.

Gun is said to have a long duty cycle. Entire gun weighs one and one-half pounds.

Pistol-grip, three-finger trigger controls a dual-heat feature providing 150 and 100 watts heat.

Electrodes are said to be corrosion resistant.



\* \* \*

## HICKOK MICROVOLT SIGNAL GENERATOR

A microvolt generator, model 292X, to cover both upper channel TV and mobile band frequencies on fundamentals, has been announced by The Hickok Electrical Instrument Co., 10529 Dupont Avenue, Cleveland 8, Ohio.

Measures both input and output of units under test. Modulated and unmodulated output from 1 to 100,000 microvolts. May be externally modulated from 15 to 10,000 cps. Has a db meter. Self-contained crystal oscillator circuit.

For complete information write to H. D. Johnson.

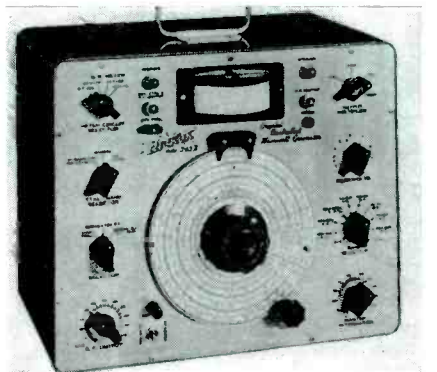

\* \* \*

## WELLER HEAVY-DUTY SOLDERING GUN

A soldering gun, model WD-250, that is said to be capable of handling 250 watts has been announced by Weller Manufacturing Co., 808 Packer St., Easton, Pa. Features a five-second dual heat, prefocused spotlight and a rigid-tip. Tip design is said to provide more copper in chisel-shaped head.



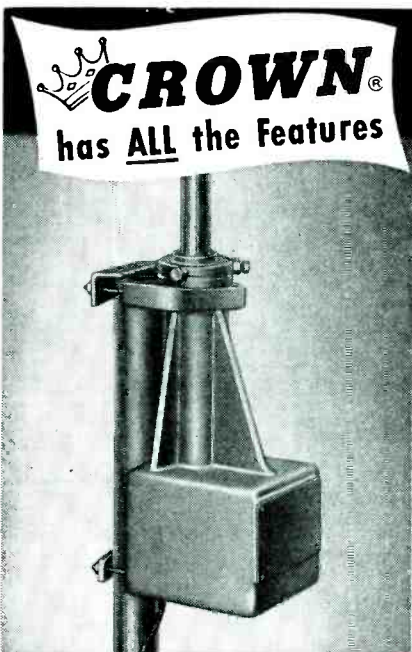

Directional Indicator  
 Electrical Stops  
 Easy Installation  
 Life-Time Lubrication  
 One-Year Guarantee  
 Electrically Safe  
 Non-Warp Castings  
 Ball Bearing Equipped  
 Machine Cut Gears



List \$59.50

**CROWN**  
 Antenna Rotator

Write for details  
 CROWN CONTROLS Co., Inc.  
 New Bremen, Ohio

**APPROVED ELECTRONIC MARKER GENERATOR**

A marker generator, type A-450, has been announced by Approved Electronic Instrument Corp., 142 Liberty St., N. Y. C.

Frequency range is 19.5 to 40 mc, said to be accurate to .5%.



**SUPERIOR INSTRUMENTS TV SIGNAL GENERATOR**

A TV signal generator, model TV-30, has been produced by the Superior Instruments Co., 227 Fulton St., N. Y. 4.

Frequency ranges are 18-32, 35-65, 54-98 and 150-250 mc, without switching. Audio modulating frequency 400 cycles (sine wave).

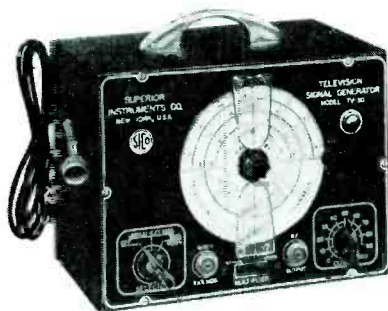

\*\*\*

**CLAROSTAT VERTICAL POWER RESISTOR**

A vertical power resistor, the *Standee*, for above-chassis mounting, has been announced by Clarostat Mfg. Co., Inc., Dover, New Hampshire.

Resistor consists of a wire-winding on fibre-glass core, bent in hairpin form with mica separator between the legs, placed in a ceramic tube filled with cold-setting inorganic cement and provided with bottom terminals and mounting bracket. The lugs are locked into the tube wall in addition to being sealed in cement. Can be mounted above the chassis with a large hole to clear the terminals and a small hole to take a self-tapping screw or rivet for the mounting bracket.

*Standees* are available in the standard 19/32" diameter, and in heights of 1 1/2", 2", 2 1/2" and 3", with respective power ratings of 10, 15, 20 and 25 watts. Maximum resistance values are 6,000, 9,000, 12,000 and 15,000 ohms, respectively.

\*\*\*

**TRICRAFT CONICAL TV ANTENNA**

A hi-lo conical type X antenna series, type 3000, has been announced by the Tricraft Products Co., 1535 W. Ashland Ave., Chicago, Ill.

Constructed of aluminum. Furnished in single, double or quad element assembly, with or without mast.

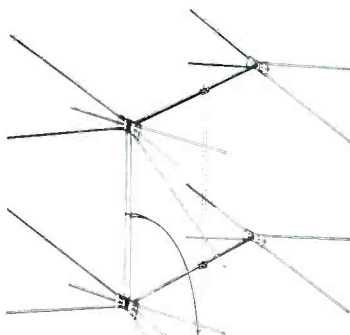

**Cash in on TV SERVICE PROFITS**



**PRACTICAL TELEVISION SERVICING**

by J. R. JOHNSON and J. H. NEWITT

334 pages, 6x9, over 230 illustrations, \$4.00

All about TV components—construction—operation—trouble-shooting—servicing.

Here's the book that helps you get where the big servicing money is—in television! As a complete working manual, it teaches you to understand television fully. Tells you what to do . . . what mistakes to avoid . . . what tools, parts, and equipment to use in performing all details of troubleshooting, diagnosing, and remedying television receiver troubles. No complicated mathematics. The authors actually operated a television shop to get this vast amount of down-to-earth data that will pave your way for greater profits. Read it 10 days at our risk! Use coupon.

**DON'T LET OSCILLOSCOPES STUMP YOU!**

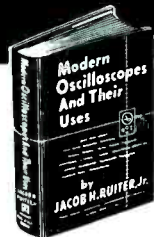

**MODERN OSCILLOSCOPES AND THEIR USES**

by JACOB H. RUITER, Jr.

of Allen B. Du Mont Laboratories, Inc.

326 pages, 370 illustrations, \$6.00

This new book by an expert gets right down to earth in explaining oscilloscopes (cathode ray oscillographs)—how they work and how to apply them to AM-FM-TV service jobs. For the first time, it gives you the collection of practical oscilloscope data you need to improve efficiency and boost your earnings. In easily understood terms, the author tells how to use oscilloscopes—from locating receiver troubles to aligning and adjusting the most complicated circuits. Each operation of the oscilloscope is clearly explained from making connections, to adjusting circuit components, setting controls and analyzing patterns. Many teaching and industrial uses are also discussed. 10-day money-back guarantee! Mail coupon now!

**MAKES AUTO RADIO REPAIRS TWICE AS EASY**



**SERVICING THE MODERN CAR RADIO**

by A. L. HURLBUT

2nd Edition, 702 pages, 8 1/2 x 11, 222 Illustrations and over 500 car radio circuit diagrams. \$7.50

Here is everything to help the beginner or experienced service man repair auto radios faster, easier and more profitably. Tells all about testing, installation, and modern servicing methods. Gives needed facts of car radio circuits, special servicing problems, shop set-up, business-getting ideas, etc. Best of all are over 500 detailed circuit diagrams covering a large percentage of all car receivers.

**10 DAY MONEY-BACK GUARANTEE**

Dept. S-10, MURRAY HILL BOOKS, Inc. 232 Madison Ave., New York 16, N. Y.

Enclosed find \$..... for books checked; or  send C.O.D. (in U.S.A. only) for this amount plus postage and I will pay postman.

If books are not satisfactory, it is understood I may return them in 10 days and you guarantee to refund the purchase price.

- PRACTICAL TELEVISION SERVICING, \$4
- MODERN OSCILLOSCOPES AND THEIR USES, \$6
- SERVICING THE MODERN CAR RADIO, \$7.50

Name .....

Address .....

City, Zone, State .....

## JOTS AND FLASHES

THE TV PICTURE TUBE of '50, particularly the 16" type, has begun to display many variables, especially its face radius. To date there are about sixteen types of 16" tubes available with face radius variations from 27" to 60" with the 27" radius the most popular. The situation appears to have confused many Service Men and accordingly it was decided to probe these variables and other features of the larger picture tubes. The results of this study have been compiled into an extremely helpful table, which will be published exclusively in SERVICE in the February issue. . . . Samuel Olchak is now advertising and sales promotion manager of Air King Products Company, Inc. . . . Dr. H. Giuliani has been named chief mechanical and chemical engineer of Telrex, Inc. . . . Irvin Guttman has been appointed chief electronics project engineer and sales engineer of Telrex, and Joseph P. Stephanie has become an associate electronics engineer at Telrex. . . . Alignment and general test techniques will be discussed in a series of twelve lectures programed by G. E. Three basic pieces of equipment will be featured during the lectures; a 5" scope, marker generator and sweep generator with a balanced output adaptor. Cities to be visited include Oklahoma City, Tulsa, New Orleans, Houston, San Antonio, Fort Worth, Dallas, Albuquerque, Salt Lake City, Los Angeles, San Francisco and Seattle. . . . The fortieth anniversary of Webster Electric Company, Racine, Wisconsin, was celebrated recently with an open-house party. . . . Sam Stroum, 2229 22 Avenue, North, Seattle, Wash., is now a Clarostat sales rep covering Washington, Oregon, Idaho and Montana. Stroum will also represent Insuline in the same area. . . . Jeff Wilson has been named general sales manager of Columbia Records, Inc. . . . Tydings Company have opened a new store at 5647 Penn Avenue, Pittsburgh, Penn. . . . The Radio Parts and Electronic Equipment Conference and Show scheduled for the Stevens Hotel in Chicago, May 22 to May 25, will be an all-distributor event featuring a series of conferences, clinics and talks covering such problems as turnover, sales promotion, cycle inventory methods of control, etc. . . . H. P. Balderson is now chairman of WCEMA, Los Angeles Council. C. A. Swanson has been named vice chairman and Fred W. Falck, Jr., renamed to his position as secretary-treasurer. . . . Ray T. Schottenberg has become a rep for Vec-D-X covering southern New Jersey, eastern Pennsylvania, Maryland, Delaware and the District of Columbia. . . . Radio Merchandise Sales, Inc., have moved their factory and offices to 1165 Southern Boulevard, New York 59. . . . J. J. Clancy, 3611 Webster Street, Fort Wayne, Indiana, is now representing the sound division of the Webster Electric Company in northeastern Indiana and southern Michigan. . . . The second volume of the RCA TV Pict-O-Guide containing troubleshooting photographs, has been announced by the RCA tube department. The book, authored by John Meagher, contains eighty-four photos and about 25,000 words of practical trouble shooting data. . . . Larry F. Hardy is now president of sales of the radio and television division of Philco. F. D. Ogilby has been named vice president of the division.

## ADVERTISERS IN THIS ISSUE

### SERVICE INDEX—JANUARY, 1950

AEROVOX CORP. . . . .	34
Agency: Austin C. Lescarboura & Staff	
ALLIANCE MFG. CO. . . . .	39
Agency: Foster & Davies, Inc.	
ANACONDA WIRE & CABLE CO. . . . .	5
Agency: Kenyon & Eckhardt, Inc.	
ANCHOR RADIO CORP. . . . .	38
Agency: Symonds, MacKenzie & Co.	
THE ASTATIC CORPORATION . . . . .	44
Agency: Wearstler Advertising, Inc.	
CORNELL-DUBILIER ELECTRIC CORP. . . . .	Inside Front Cover
Agency: Reiss Advertising	
COYNE ELECTRICAL SCHOOL . . . . .	38
Agency: The Phil Gordon Agency, Inc.	
CROWN CONTROLS CO., INC. . . . .	47
Agency: Don Kemmer Co., Inc.	
DRAKE ELECTRIC WORKS, INC. . . . .	38
Agency: William Hoffman & Associates	
ELECTRO PRODUCTS LABORATORIES, INC. . . . .	46
Agency: Gorsch and DeVille, Advertising	
ERIE RESISTOR CORP. . . . .	36
Agency: W. S. Hill Co.	
GENERAL ELECTRIC COMPANY . . . . .	1, 7
Agency: Maxon, Inc.	
GENERAL INDUSTRIES CO. . . . .	43
Agency: Meldrum & Fewsmith, Inc.	
THE HEATH COMPANY . . . . .	44
Agency: G. Jean Arend, Advertising	
HOT NAILS, INC. . . . .	42
Agency: A. D. Adams, Advertising	
HYTRON RADIO & ELECTRONICS CORP. . . . .	17
Agency: Bennett, Walther & Menadier, Inc.	
INDUSTRIAL DEVICES, INC. . . . .	45
Agency: RAF Advertising, Inc.	
INSULINE CORPORATION OF AMERICA . . . . .	46
Agency: Bass & Co., Inc.	
KESTER SOLDER CO. . . . .	3
Agency: Frank C. Nahser, Inc.	
P. R. MALLORY & COMPANY, INC. . . . .	Inside Back Cover
Agency: The Aitkin-Kynett Co.	
MERIT COIL & TRANSFORMER CORP. . . . .	45
Agency: Symonds, MacKenzie & Co.	
MURRAY HILL BOOKS, INC. . . . .	47
Agency: The Harry P. Bridge Co.	
OAK RIDGE ANTENNAS . . . . .	41
Agency: H. W. Hauptman Co.	
ONTARIO RESEARCH CORP. . . . .	34
Agency: Brooks and London	
PHOENIX ELECTRONICS, INC. . . . .	40
Agency: Milron Richards	
PRECISION APPARATUS COMPANY, INC. . . . .	37
Agency: Shappe-Wilkes Inc.	
RADIART CORP. . . . .	27
Agency: Stern and Warren	
RADIO CITY PRODUCTS CO. . . . .	42
Agency: Jaman Advertising, Inc.	
RADIO CORPORATION OF AMERICA . . . . .	4, Back Cover
Agency: J. Walter Thompson Co.	
RAYTHEON MFG. CO. . . . .	25
Agency: Walter B. Snow & Staff	
JOHN F. RIDER PUBLISHER, INC. . . . .	32, 33
Agency: Shappe-Wilkes Inc.	
SANGAMO ELECTRIC CO. . . . .	21
Agency: Arthur H. Mogge, Inc.	
HOWARD W. SAMS & CO., INC. . . . .	36
Agency: George Brodsky, Advertising	
SPRAGUE PRODUCTS COMPANY . . . . .	40
Agency: The Harry P. Bridge Co.	
STANDARD COIL PRODUCTS CO., INC. . . . .	29
Agency: Frank C. Nahser, Inc.	
STANDARD TRANSFORMER CORP. . . . .	31
Agency: Burnett-Kuhn Adv. Co.	
SYLVANIA ELECTRIC PRODUCTS, INC. . . . .	8
Agency: Newell-Emmert Co.	
TRIPLETT ELECTRICAL INSTRUMENT CO. . . . .	6
Agency: Western Adv. Agency, Inc.	
UNIVERSITY LOUDSPEAKERS, INC. . . . .	35
Agency: George Homer Martin Associates	
WALDOM ELECTRONICS, INC. . . . .	40
Agency: Sandler-Rodkin Adv. Agency	

**CORROSION-  
PROOF!**

**Snyder**  
PHILADELPHIA

**TV**

**MASTS**

OF

**walker**  
Conshohocken

**DUALCOTED  
STEEL**

DEVELOPED AND ENGINEERED ESPECIALLY FOR TELEVISION AERIALS.

Tough flexible coating on inner and outer tube wall.

Prevents corrosion from salt, acids, caustics.

Will not crack or chip.

SOLE SELLING AGENT

**ONTARIO  
RESEARCH CORP.**

An Affiliate of  
SNYDER MFG. CO.

2218 W. ONTARIO ST.  
PHILA. 40, PA.

**Heat is no  
Problem,  
when you know  
your stuff . . .**



## **MALLORY CAPACITORS Can Take It!**

Mallory FP Capacitors are built to withstand continuous high temperatures. Tests show they perform consistently during 2000 hours of operation at a temperature of 185°F. At lower temperatures, even longer!

Proof of this performance is found in the experience of one television manufacturer, who kept records of field failures for six months. *Of 385,000 Mallory FP Capacitors in service only six failed!* Special design and meticulous production care make such records possible . . . by eliminating the major source of internal corrosion.

Mallory Capacitors have set new long-life standards for the industry, yet cost no more. You will find it pays to rely on the complete Mallory Capacitor line—paper—ceramics—FP Electrolytics.

*See Your Distributor for Mallory Precision Quality Parts at Regular Prices*



P. R. MALLORY & CO., Inc.  
**MALLORY**

CAPACITORS • CONTROLS • VIBRATORS • SWITCHES • RESISTORS  
• RECTIFIERS • VIBRAPACK\* POWER SUPPLIES • FILTERS

\*Reg. U.S. Pat. Off.

**APPROVED PRECISION PRODUCTS**

**P. R. MALLORY & CO., Inc., INDIANAPOLIS 6, INDIANA**

*Built for Service...* **SINCE 1915**

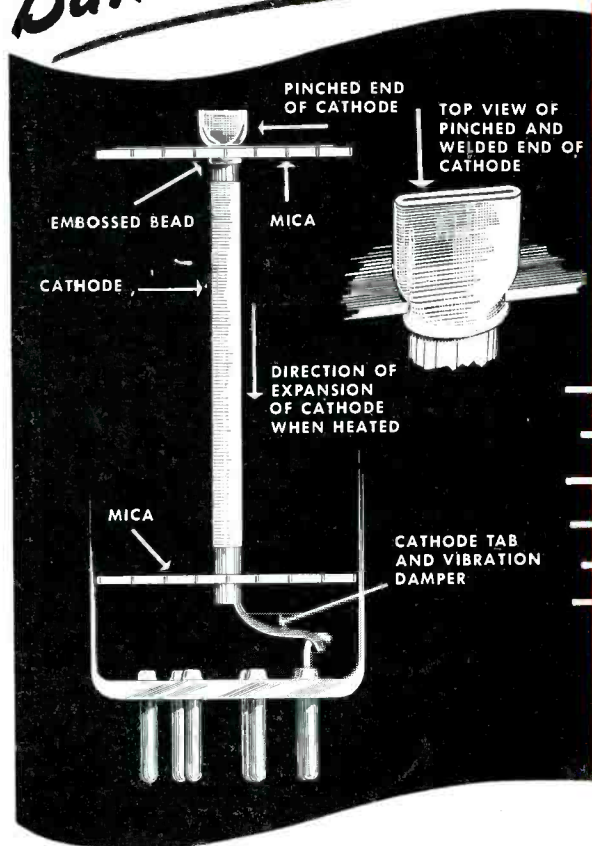

## The inside story of

# Cunningham quality

### 1. How Cunningham "Inverted" Pinched Cathodes Minimize Microphonics

Engineering progress is part and parcel of Cunningham quality. For instance . . . unlike most tubes Cunninghams use "inverted" pinched cathodes to minimize microphonics by preventing cathode vibration or displacement.

These important features are achieved by clamping the mica firmly between the embossed bead and the pinched top end of the cathode. This arrangement holds the upper end of the

cathode rigidly, but permits the heated cathode to expand freely downward through the bottom mica without producing cathode strain. The lower end of the cathode is prevented from vibrating by means of the damping tab connected between the cathode and a stem lead.

The "inverted" pinched cathode is only one of the many improvements which account for the *first-line* quality of Cunningham tubes. It serves to explain why experienced servicemen use Cunninghams consistently.

ALWAYS KEEP IN TOUCH WITH YOUR CUNNINGHAM DISTRIBUTOR



**RADIO CORPORATION of AMERICA**  
ELECTRON TUBES  
HARRISON, N. J.