

SERVICE

October
1949

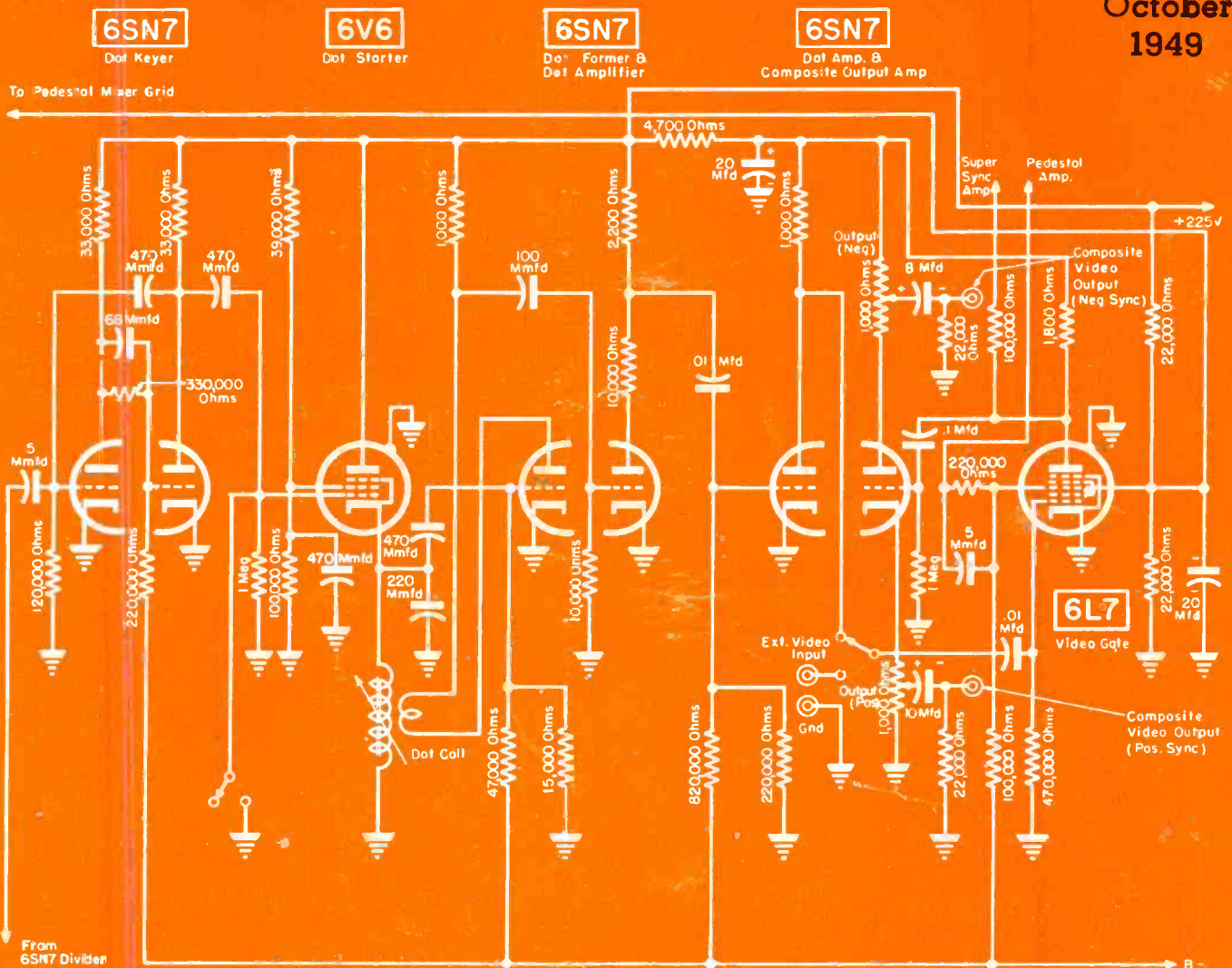

Circuitry of composite video generator which provides horizontal and vertical blanking pulses, horizontal and vertical synchronizing pulses and equalizing pulses.

[See page 2]

Cub Sized...



STURDY AS A GRIZZLY

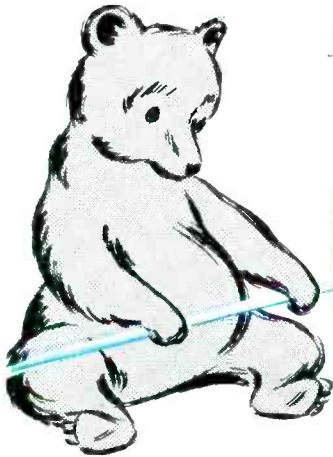

CORNELL-DUBILIER "BLUE CUB"*

FIVE EXCLUSIVE "LIFE-PRESERVING" FEATURES:

LEADWELD terminals:



The only tubular with leads welded to section. Welding eliminates possibility of opens and intermittents.

STYRICAST molded:



The only tubular cast in plastic after Vikane impregnation. No heat or pressure to injure unit. Rockhard coating for permanent eye-appeal and durability.

FIXEDRESIN case:



Will withstand temperatures up to 300°F without softening.

VIKANE* impregnation:



Results in superior capacitor section that will withstand higher break-down test and have the lowest power-factor of any tubular.

GRIPSEAL impregnated:



Additional impregnation after final assembly as a permanent double humidity seal.

the new plastic paper tubulars

One sure thing about these C-D "BLUE CUBS"—you can install them and forget about them. No shock, no vibration is too much for these pint-sized "giants"; they're fortified with solid mold construction and "cushioning" features. They take temperatures from -70°F to $+212^{\circ}\text{F}$ in their stride. Capacity remains constant within 5% under most severe conditions of temperature and humidity. Get acquainted with these job-insuring "BLUE CUBS" now.

Your jobber has a supply in all popular capacity ranges at 400, 600 and 1,600 V.D.C.

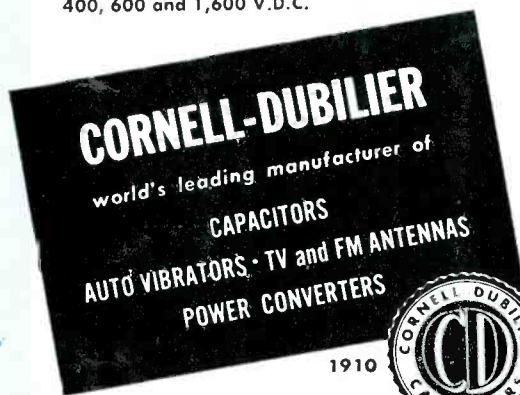

1910 1949



* T. M. Reg. U. S. Pat. Off.

For further details on this and other units in C-D's complete line of quality capacitors see your jobber or write for catalog, Cornell-Dubilier Electric Corp., Dept. S109, South Plainfield, N. J. Other plants in New Bedford, Worcester and Brookline, Mass.; Indianapolis, Ind.; Providence, R. I. and subsidiary, The Radiart Corp., Cleveland, Ohio.

See yellow pages of your Classified Telephone Directory for nearest C-D authorized distributor.

"MY SALES PROVE KEN-RAD TUBES HAVE WHAT IT TAKES!"

"I tell you, businesses aren't built on promises, They're built on performance—performance that brings customers back for more.

"And it takes good quality to guarantee good performance!

"Take Ken-Rad tubes. Why, they've been the quality leader for years—backed by one of the country's biggest, finest companies with plenty of engineering know-how.

"Result is, Ken-Rad tubes have paid me a steady dividend of increased business. For turnover and profit, they have what it takes!"



HOWARD L. BOLIN,
Omaha, Nebraska,
with thousands of dealers
like him, sells the tubes
that sell fast and stay
sold—Ken-Rad tubes.

RALPH L. CLARK, Foreman, Miniature Mounting Section, is one of the many experts who carefully supervise the manufacture of Ken-Rad tubes. These men build quality into the tubes at the very beginning; test out trouble at every stage of production.



"MY TESTS PROVE KEN-RAD TUBES HAVE WHAT IT TAKES!"

"Here at the plant we put Ken-Rad tubes through one test after another to prove their quality is unsurpassed.

"The 'short' test, shown on the left, is given tubes before the characteristics test. It enables us to spot tubes that are not up to Ken-Rad standards.

"Ken-Rad tubes also are tested for noise, microphonics, life, appearance, gas, air and hum.

"We don't guess. The Ken-Rad tubes we make and ship have proved themselves over and over again!"

KEN-RAD *Radio Tubes*

PRODUCT OF GENERAL ELECTRIC COMPANY

Schenectady 5, New York

THE SERVICEMAN'S TUBE
... backed by profit-making sales aids which your Ken-Rad distributor gladly will show you. Phone or write him!



102-H-6

RADIO · TELEVISION · ELECTRONIC
SERVICE

LEWIS WINNER
Editorial Director

F. WALEN
Assistant Editor

ALFRED A. GHIRARDI
Advisory Editor

	Page
Aligning the Westinghouse H-196. By Irving Silberg	14
Association News	30
Coax-Line Installation Practices. By Ira Kamen	20
Composite Video Signal Generator. By Allan Lytel	10
Phono Installation and Service. By Kenneth Stewart	34
Ser-Cuits (Bendix 2,000-3,000 Series)	22
Servicing Helps. By M. A. Marwell	18
Ten Years Ago in Associations	33
TV Receiver Production Changes. By Donald Phillips	26
Views and News. By Lewis Winner	9
 CIRCUITS	
Bendix 2,000-3,000 Series	24
G. E. Table Model Clock Mechanism	18
Supreme 665 (Cover)	10
Supreme 665 (Dot Signal Channel Circuit)	55
Supreme 665 (Timer Section)	55
TV Alignment Bias-Box System	16
UHF Antenna Installation Layout	52
Westinghouse H-196	15
Westinghouse 223, 242, 251, 231 and 226 (Circuit to Eliminate Blooming)	26
Westinghouse 242 (Improved Horizontal Multivibrator Circuit)	26
Westinghouse 242 (Improved Vertical Multivibrator Circuit)	28
 COVER	
Composite Video Signal Generator (Supreme 665)	10
 SERVICING HELPS	
Admiral 20 and 30 Series Service Notes	37
Avoiding Picture-Tube Damage Caused by Incorrect Adjustment of Ion Trap	38
Eliminating Picture Distortion in Metal Tubes Due to Magnetism	37
How to Disconnect Dynamic Limiter in Belmont TV Sets	18
Installation of Sleep Receiver (G. E.) Clock Booster Spring	18
Ratio-Detector Alignment Notes	38
Use of Detent Index Button for G. E. 805	18
 TV RECEIVER PRODUCTION CHANGES	
Addition of Power Transformer Fuse to Admiral TV Sets	26
Improvement of Picture Definition; Eliminating Blooming, Vertical Bars and Horizontal Line Bumps in Westinghouse TV Models	26
Installation of AGC and Improved Horizontal Oscillator in Admiral Receivers	28
 Index to Advertisers	56
 Manufacturers	
Jots and Flashes	56
News	29
New Parts . . . Accessories	48
TV Antennas . . . Accessories	45

Entire contents Copyright 1949, Bryan Davis Publishing Co., Inc.



Published monthly by Bryan Davis Publishing Co., Inc.
52 Vanderbilt Avenue, New York 17, N. Y. Telephone MUrray Hill 4-0170



Bryan S. Davis, President Paul S. Weil, Vice-Pres., Gen. Mgr. F. Walen, Secretary A. Goebel, Circulation Manager

East-Central Representative: James C. Munn, 2253 Delaware Dr., Cleveland 6, Ohio. Telephone: Erievlew 1726

Pacific Coast Representative: Brand & Brand, 1052 W. Sixth St., Los Angeles 14, Calif. Telephone: Michigan 1732
Suite 1204, Russ Building, San Francisco 4, Calif. Telephone: SUTter 1-2251

Entered as second-class matter June 14, 1932, at the Post Office at New York, N. Y., under the Act of March 3, 1879. Subscription price: \$2.00 per year in the United States of America and Canada; 25 cents per copy. \$3.00 per year in foreign countries; 35 cents per copy.

The Offer Still Stands!

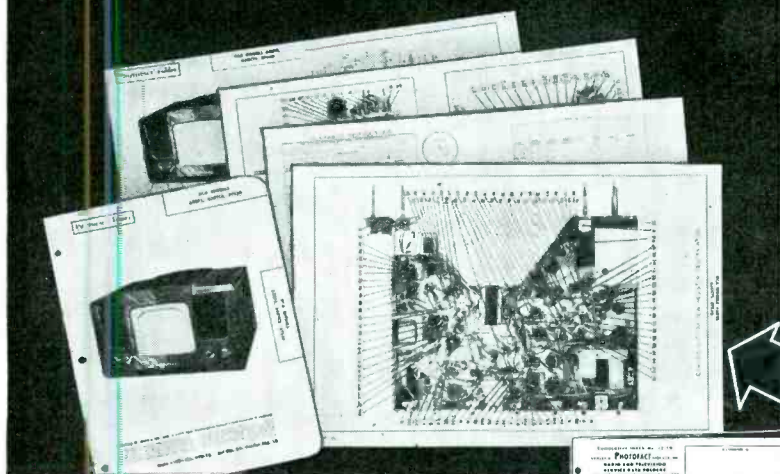

Only \$18.73 Down Puts the Complete Photofact Library in Your Shop Today...

NCW—the new “Pay-as-you-Profit” Plan brings the famous PHOTOFAC Library within the reach of every Serviceman! Now you can easily own the world’s finest radio service data—seven complete volumes, plus continuous PHOTOFAC Folder Set service—full coverage of all post-war AM, FM and TV models! Everything you’ll ever need for quicker, more profitable servicing! You pay only \$18.73 down—the remainder in small monthly payments. *Absolutely no carrying charges and no interest!* Make the down payment—and you get the complete Library immediately. Your Jobber has all the details of this amazing new purchase plan. See him today, or write us direct for full information.

Get the Easy-Pay Details Now!

FREE PHOTOFAC Cumulative Index

Select your FREE PHOTOFAC Folder (covering any AM, FM or TV model) from the PHOTOFAC Cumulative Index. Get the FREE Index today. Covers all post-war receivers right up to the present. Helps you find the Folders you want in a jiffy—Folders that make your work quicker, easier, more profitable. Get this FREE Index at your Jobber or write direct for it now.

SERVICEMEN: We'll Prove You'll Save Time, and Earn More with PHOTOFAC!

We'll Send You Absolutely

FREE

Any PHOTOFAC Folder Listed in the PHOTOFAC Cumulative Index!

NOW—learn for yourself—at our expense—how PHOTOFAC will make your service work quicker, easier, more profitable! Examine an actual PHOTOFAC Folder. Use it. You'll learn first-hand why this indispensable service data is used daily by over 25,000 successful service technicians. You'll discover quickly that no other service gives you PHOTOFAC'S outstanding advantages: *completeness, accuracy, uniformity and ease-of-use.* PHOTOFAC alone, is the *only* radio service data prepared from laboratory analysis of the actual equipment. Nothing in the field equals PHOTOFAC. Know the facts—get your FREE Folder now. Examine it—use it—compare it—and you will understand why no modern service shop can afford to be without PHOTOFAC.

NOTE: This FREE offer is limited to Service Technicians. Attach coupon below to your letterhead and mention the name of your jobber. If you have no letterhead, send coupon to your jobber. Experimenters and others may obtain the Photofact Folder by remitting 50c.

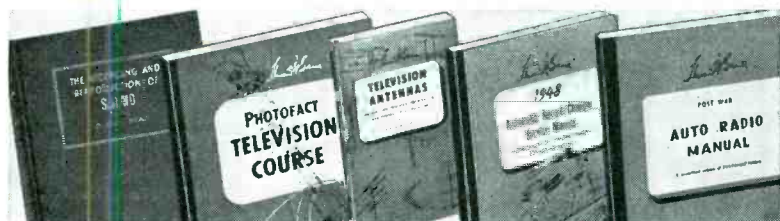

CURRENT PHOTOFAC BEST-SELLERS

The Recording and Reproduction of SOUND, by Oliver Read. The complete, authoritative treatment of the entire subject of Sound, written by the editor of *Radio & Television News*. **\$5.00**

Photofact Television Course. The book used by thousands; gives you a clear understanding of TV principles, operation and practice. **\$3.00**

Television Antennas. Shows you how to select and install the proper antenna, and how to overcome antenna problems. **\$1.25**

1948 Record Changer Manual. Covers 45 models made in 1948, including new LP and dual-speed changers, plus leading wire recorders. Based on actual analysis of the equipment. **\$6.75**

Auto Radio Manual. Complete Photofact service data on more than 100 post-war auto radio models—a time-and-money-saver. . . **\$4.95**

HOWARD W. SAMS & CO., INC. INDIANAPOLIS 1, IND.

**HOWARD W. SAMS & CO., INC.
955 N. Rural St., Indianapolis 1, Ind.**

Send FREE Photofact Cumulative Index

Send Full Easy-Pay Details

I am a Service Technician:

Send FREE Photofact Folder for set model

I am an Experimenter:

Send Photofact Folder for set model
(50c enclosed)

Name

Address

City Zone State

"An inferior set with a good antenna will always outperform a better set with a poor antenna." From FM-TV Magazine, June 1949.



SELL A TV PICTURE

... for Customer Satisfaction!

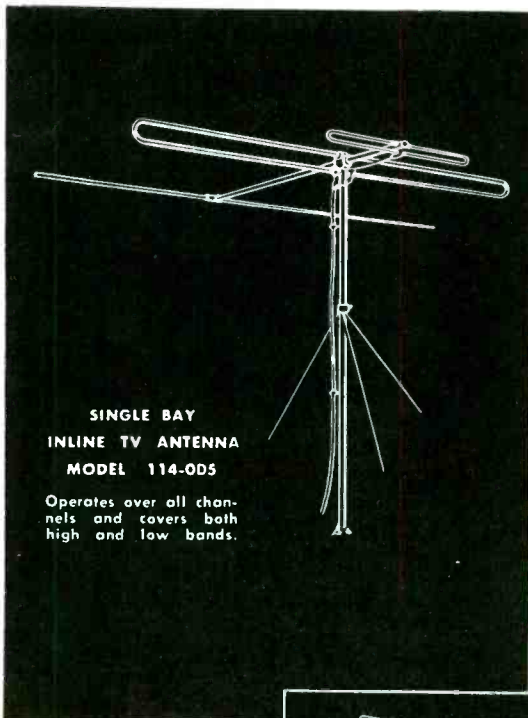

**SINGLE BAY
INLINE TV ANTENNA
MODEL 114-0D5**

Operates over all channels and covers both high and low bands.

FOR CUSTOMERS.....

An inadequate antenna sacrifices more than 10% of the TV picture quality. The customer wants the best TV picture reception. He depends on the TV dealer for a TV set at the price he can afford and for an antenna that is the best on the market.

FOR SALES.....

SEE-ABILITY IS SELL-ABILITY and the better the TV picture, the more satisfied the set owner will be. "When you sell a picture, you build customer satisfaction." And customer satisfaction sells more TV sets.

FOR INFORMATION.....

It takes selling punch and selling knowledge to put the most into a selling talk that will sell the potential TV viewer. American Phenolic Corporation has prepared "Sell a TV PICTURE", a comprehensive 16 page sales manual to help you sell TV.

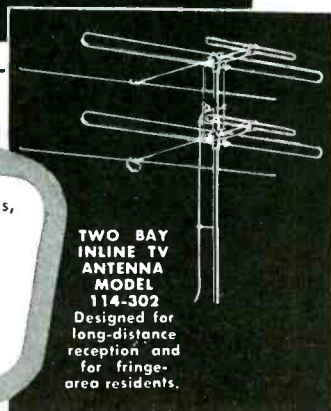

**TWO BAY
INLINE TV ANTENNA
MODEL 114-302**
Designed for long distance reception and for fringe-area residents.

--- THIS BOOK IS FOR YOU

"Sell a TV PICTURE" gives exact, scientific TV data in carefully chosen terms that are easily understood. Write today and ask for your free copy of "Sell a TV PICTURE". AMERICAN PHENOLIC CORPORATION, 1830 SO. 54TH AVENUE, CHICAGO 50, ILL.



For proved effectiveness, specify

**AMPHENOL
INLINE
ANTENNAS**

**AMPHENOL
-INLINE-
ANTENNAS**

AMERICAN PHENOLIC CORPORATION 1830 SO. 54TH AVENUE • CHICAGO 50, ILLINOIS

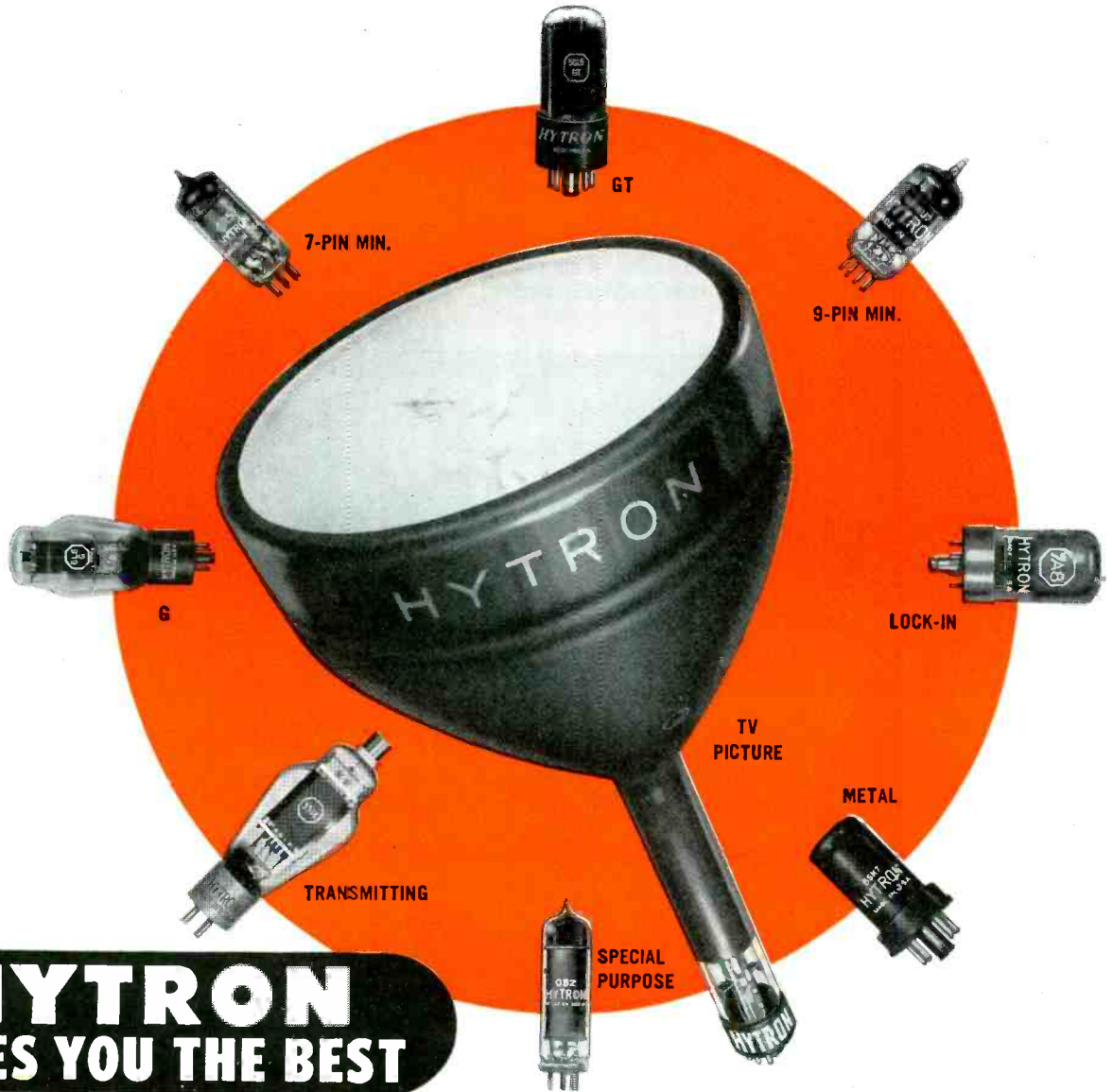

HYTRON GIVES YOU THE BEST

... OF ALL KINDS OF TUBES

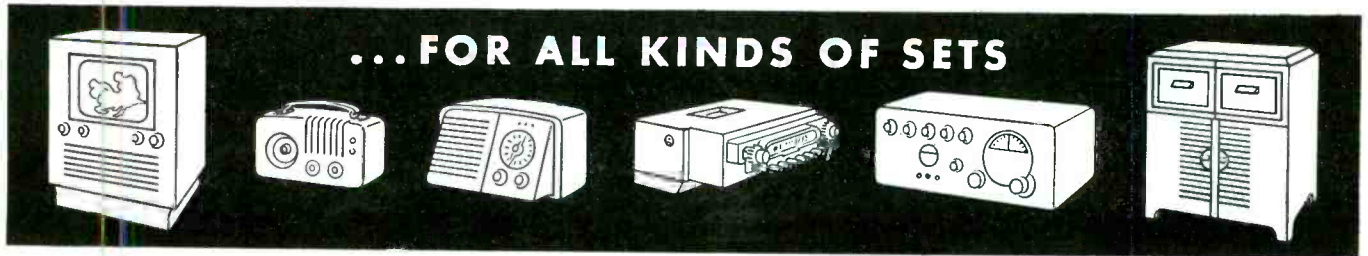

... FOR ALL KINDS OF SETS



OLDEST MANUFACTURER OF RECEIVING TUBES.

HYTRON

RADIO AND ELECTRONICS CORP.

MAIN OFFICE: SALEM, MASSACHUSETTS



HYTRON SERVES THE SERVICEMAN



TUBE TAPPER 5¢



7-PIN MINIATURE STRAIGHTENER 55¢



9-PIN MINIATURE STRAIGHTENER 55¢

SOLDERING AID 49¢



TUBE LIFTER 15¢

AUTO RADIO TOOL 24¢

Already Six Tools Available From Hytron Jobbers. Watch For More!

"Of Vital Importance to Every Progressive Servicing Establishment"

"Here in Mt. Vernon we have, what we sincerely believe to be, one of the finest servicing organizations of its kind. Our equipment and facilities are the most modern to be found anywhere. Rider Manuals are an integral part of our equipment. We have a complete library on hand, and we find them to be essential to tracing the trouble and correcting faulty receivers of all makes and models. In our opinion, Rider Manuals are of vital importance to every progressive servicing establishment."

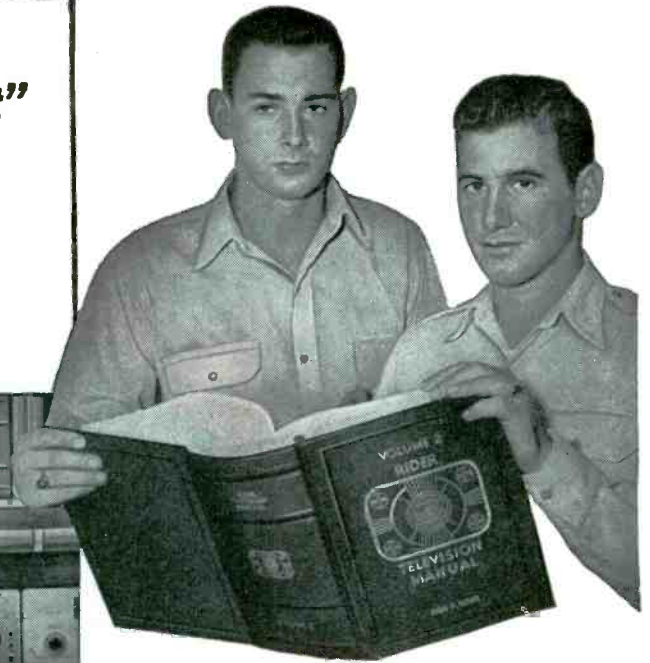
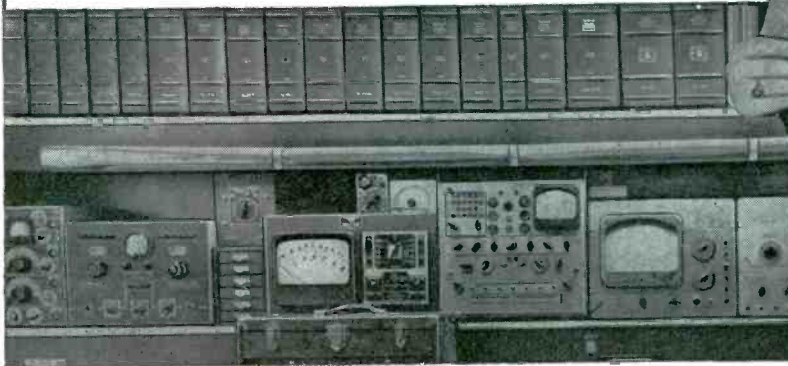

Frank R. Frasca — David R. Petrie
Television Laboratories
11 West Prospect Avenue
Mt. Vernon, New York

Build a Library of RIDER MANUALS *And watch the difference it makes in your business!*
World's Greatest Compilation of Authentic, Reliable, Factory-Authorized Servicing Information!

On the way! **NEW RIDER TV-3**



GREATER IN SIZE! ALL PAGES IN PLACE! EASIER TO USE!

Rider again points the way to successful TV servicing. The Rider TV Manual Volume 3 is bigger and better in every way. New and enlarged page size, 12 x 15 inches. All pages are collated in position. Double spreads, triple spreads and giant pages have been retained to assure clarity and ease of reading...but triple spreads and giant pages now have only ONE fold for greater durability. Easier to use because there are fewer pages to turn. Easier to read because diagrams and related text are more closely positioned. TV-3 is more compact, more complete...fully covering everything you should know about each receiver. More than 60 manufacturers are listed in the equivalent of approximately 2000 pages (8 1/2 x 11), PLUS Cumulative Index Volumes 1, 2 and 3, PLUS "How It Works" Book. Reserve Your Copy Today.

Coming Soon!



NEW RIDER MANUAL VOL. XX

Covering the latest AM, FM and Auto Receivers. Complete in every respect, this volume will have the added advantage of text and double spreads assembled in position.

A New Book...A Helpful, Profitable Book for Your BUSINESS HELPER

by Leslie C. Rucker
(Rucker Radio Wholesalers)

You can't afford to miss the valuable pointers offered in this person-to-person talk by a successful business man who started from scratch and worked his way up to a chain of 3 stores. Any one of his many worthwhile ideas can mean fifty times the cost of the book in your pocket. This authoritative guide will show you how to avoid losses and turn ideas into profits.

144 pages,
22 chapters. \$2.00

RADIO OPERATOR'S LICENSE Q AND A MANUAL

Lists all the questions and answers for the FCC exams. But the outstanding feature of this Manual is its thorough FOLLOW-THROUGH...a carefully simplified discussion of the answer to the technical question...so necessary for an absolute understanding of the answer.
Approx. 750 pages, profusely illus. \$6.00

RIDER MANUALS

Television Manual, Vol. 2.....	\$18.00
(plus "How It Works" and Index)	
Television Manual, Vol. 1.....	18.00
(plus "How It Works" and Index)	
Volume XIX.....	19.80
Volume XVIII.....	19.80
Volume XVII.....	16.50
Volume XVI.....	8.40
Volume XV.....	19.80
Volume XIV to VII (each vol.).....	16.50
Volume VI.....	12.50
Abridged Manuals I to V (one volume).....	19.80
Record Changers and Recorders.....	9.00
Master Index, covering Manuals, Vols. 1 to XV.....	1.50
PA Equipment Manual, Vol. 1.....	18.00

FREE! Eye-Stopper for Service Shop Windows

A new Display, 14x17 inches, captioned "Which One is the Phony". It shows two greatly enlarged photos of stamps, one genuine, one a known counterfeit, with identifying characteristics and means of recognizing the forgery. Over 10,000,000 people in the U.S.A. are stamp collectors. This display will be of interest to young and old, and will attract attention to your windows and, consequently, business to your shop. 2 displays will be issued each month, and you can get them FREE of CHARGE from your Jobber.

NOTE: Are you receiving your copy of "Successful Servicing"? It's Rider's own publication of interest to every Serviceman. Write for it...it's FREE!

RIDER MANUALS mean SUCCESSFUL SERVICING

ANOTHER NOTE: The C-D Capacitor Manual for Radio Servicing, 1948 edition No. 4, makes reference to only one source of receiver schematics — Rider Manuals.

JOHN F. RIDER PUBLISHER, Inc.,

480 Canal Street, New York 13, N. Y.
Export Agent: Rocke International Corp., 13 E. 40th St., N.Y.C.
Cables, ARLAB.

NOTE: The Mallory Radio Service Encyclopedia, 6th edition makes reference to only one source of radio receiver schematics — Rider Manuals.

Simpson

INSTRUMENTS THAT STAY ACCURATE

Presents

the

New!

MODEL 303

VACUUM TUBE VOLT-OHMMETER

... A Worthy Companion
of the 260

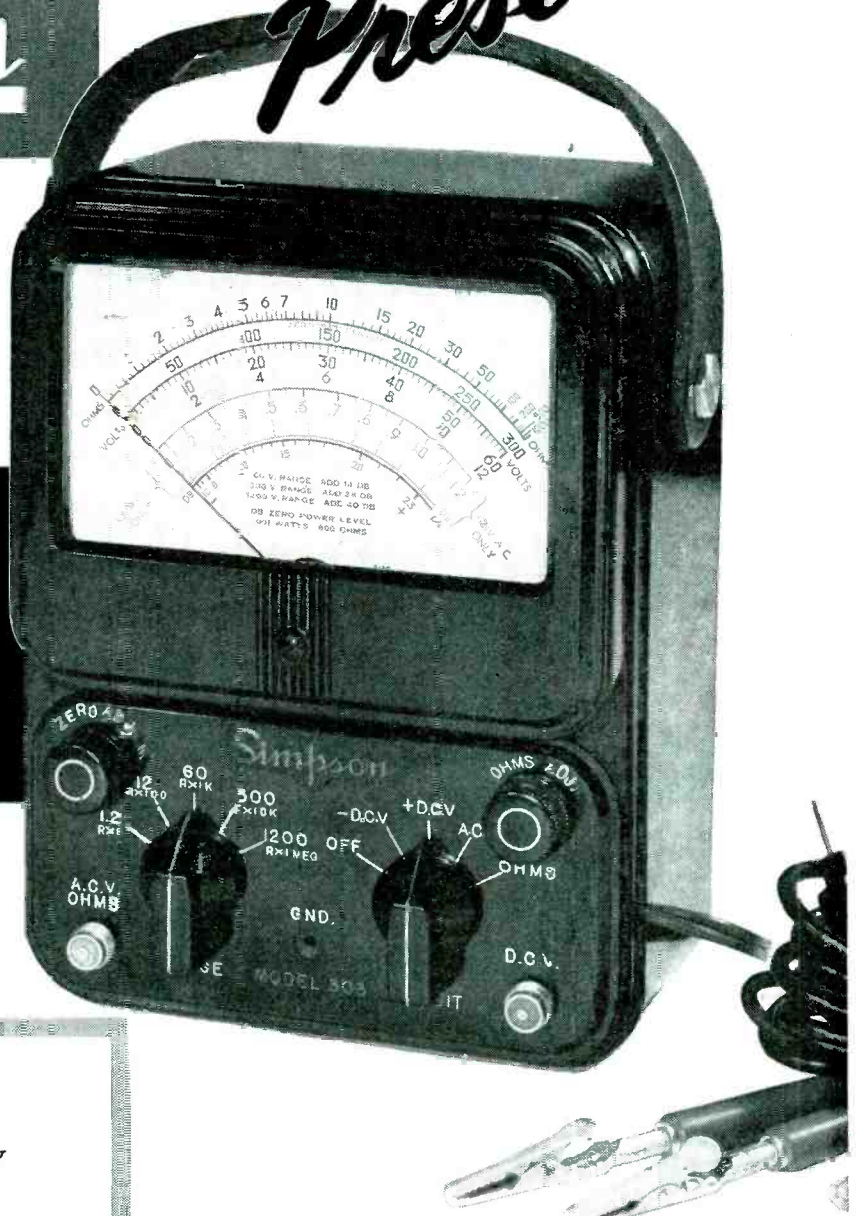

SPECIFICATIONS

DC Voltage
Ranges—1.2, 12, 60, 300, 1200 (30,000 with Accessory High Voltage Probe)
Input Resistance—10 megohms for all ranges
DC Probe—with one megohm isolating resistor
Polarity reversing switch

Ohms
Ranges—1000 (10 ohms center)
100,000 (1000 ohms center)
1 megohm (10,000 ohms center)
10 megohms (100,000 ohms center)
1000 megohms (10 megohms center)

AC Voltage
Ranges—1.2, 12, 60, 300, 1200
Impedance (with cable) approx. 200 mmf shunted by 275,000 ohms

AF Voltage
Ranges—1.2, 12, 60
Frequency Response—Flat to 100,000 cycles

Decibels
Ranges—-20 to +3, -10 to +23, +4 to +37,
+18 to +51, +30 to +63
Zero Power Level—1 M. W., 600 ohms

Galvanometer
Zero center for EM discriminator alignment and other galvanometer applications

R. F. Voltage
(Signal tracing with Accessory High Frequency Crystal Probe)
Range—20 volts maximum
Frequency—Flat 20 KC to 100 M.C.
105-125 V. 60 cycles
Size 5 1/4" x 7" x 3 1/8" (bakelite case). Weight: 4 lbs.
Shipping Wt.: 6 1/2 lbs.

Dealer's Net Price Model 303, including DCV Probe, ACV—Ohms probe and Ground Lead—\$58.75; Accessory High Frequency Probe, \$7.50
Accessory High Voltage Probe, \$14.85
Also available with roll top case, Model 303RT—\$64.75

Smaller and Handier for Greater Portability

A worthy companion of the world-famous Model 260 is this brand new addition to the Simpson line—the Model 303!

Skilled Simpson engineers spent months of painstaking research in the laboratory to produce the Model 303, which is one of the most versatile instruments ever made for TV servicing. This ruggedly constructed instrument offers the maximum in portability because it is approximately 60% smaller than other vacuum tube volt-ohmmeters. However, no sacrifice has been made in readability. The 303 has a large 4 1/2" meter, despite its handy compactness.

One of the many features of the 303 is its low current consumption. The AC voltage range is wider than on any other similar instrument—from 1.2 volts minimum to 1,200 maximum. Like all other instruments bearing the Simpson name, the Model 303 is an instrument of highest quality at an amazingly low price.

SIMPSON ELECTRIC COMPANY

5200-5218 West Kinzie Street, Chicago 44, Illinois
In Canada: Bach-Simpson, Ltd., London, Ontario

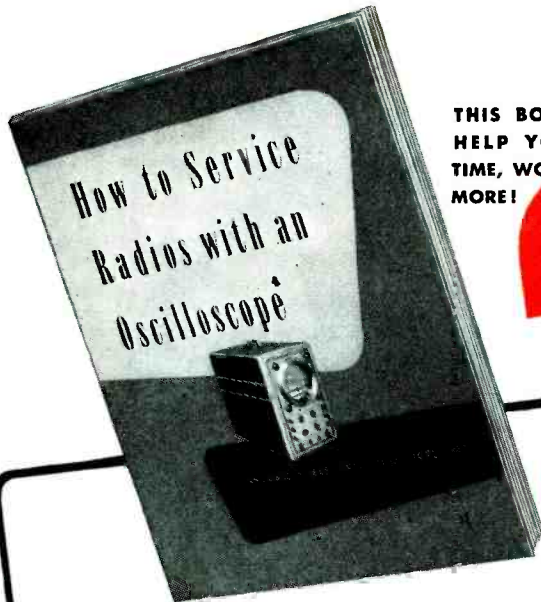

**THIS BOOK WILL
HELP YOU SAVE
TIME, WORK, EARN
MORE!**

2nd

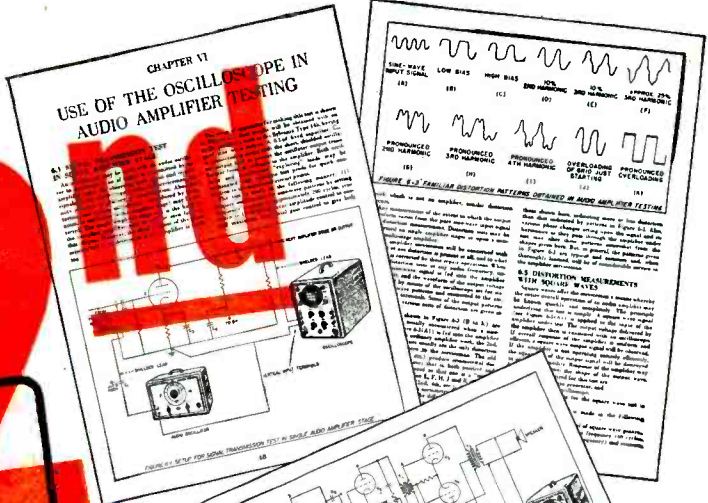

SYLVANIA SHOWS YOU

**"HOW TO
SERVICE RADIOS
WITH AN
OSCILLOSCOPE"**

Here's a big, complete book that gives you step-by-step instructions for using the oscilloscope in testing and servicing radio receivers, audio amplifiers and transmitters.

The more than 90 illustrations of circuits, 'scope patterns, and set-up arrangements for circuit testing explain over 50 separate oscilloscope applications.

PRINTING OFF PRESS!

Only
\$1.00

**EXPLAINS THESE AND
MANY MORE**

1. AM and FM receiver alignment
2. Locating hum
3. Signal tracing and trouble shooting
4. Finding receiver faults from oscilloscope patterns
5. Checking AVC action
6. Voltage gain measurement
7. Auto radio vibrator tests
8. Checking peak current in rectifiers
9. Impedance measurement
10. Checking filter capacitors — and many others!

**SYLVANIA
ELECTRIC**

FLUORESCENT LAMPS, FIXTURES, WIRING DEVICES, SIGN TUBING; LIGHT BULBS; PHOTOLAMPS; RADIO TUBES; CATHODE RAY TUBES; ELECTRONIC DEVICES

- ★ **Get this big 72-page book!**
- ★ **More than 90 pictures and diagrams!**
- ★ **Written in easy-to-follow servicemen's language!**

Sylvania Electric Products Inc.
Advertising Dept. R-1910
Emporium, Pa.

Gentlemen:
Send me "How To Service Radios with an Oscilloscope." Enclosed is \$1.00.

Name

Address

City Zone

State

RADIO - TELEVISION - ELECTRONIC
SERVICE

**Preventive Maintenance Now A
Headliner**

PREVENTIVE MAINTENANCE, just an interesting idea a short while ago, has now become an item of national importance, not only to Service associations, but parts and set manufacturers, who have inaugurated lavish campaigns.

Philco, one of the receiver makers intrigued with the possibilities of preventive maintenance, has initiated quite a program with mailing pieces, handbills, envelope inserts, window banners and shop signs proclaiming the importance of rejuvenation. To sharpen the interests of Service Men, they've sent out a letter which really hits hard.

Says this letter . . . "Get the *lead* out! . . . Fall months are radio months. Millions all over the country will be listening to the finest radio programs ever scheduled. Many of these, however, will enjoy only a portion of the quality built into each production because their radios are not giving peak performance. This is the ideal time for a campaign to encourage your customers to have *all the* radios in their home reconditioned. . . . Wake up the *sleepers*. . . . Restore the *gold brick*. . . . Rejuvenate the *work horse*!"

"Every family has a *sleepers*," the letter continues. "That's the almost forgotten set that was stuck into the attic during the war because the parts were so hard to get. . . . Ask your customer to let you wake up that *sleepers*. . . . The *gold brick* is the set that stands in the corner and looks so nice. It doesn't play, but the cabinet looks so well, that it is just kept about the house. That *gold brick* should be restored. . . . The *work horse* is the set that does double duty. From as far back as they can remember the entire family has used it constantly. Yes, they even got used to the squawks it sometimes lets out as if it were hurting. They got used to the *tinny* tone on some stations and they never used a certain portion of the dial at all because the set just didn't play on those stations. . . . Rejuvenate that *work horse*. . . . Sharpen up all your tools. . . . Polish up that test equipment. . . . Heat up that soldering iron. . . . Get the lead

out. . . . Yes, you'll need that lead to mend those tired joints in restoring your customer's receivers to peak performance!"

Another manufacturer, RCA, has set up a *tune-up* program as their contribution to preventive maintenance, stressing the fact that . . . "Over 10,000,000 radios need service!"

They, too, are offering a variety of displays, mailing pieces and even spot-announcement scripts, which tell quite a story.

One spot script says, in part . . . "Remember how good your radio once sounded? Then one day you realized the volume was too weak . . . then your favorite stations became hard to get, and finally the radio got noisy. . . . Whatever the trouble your Service Man will tune up your radio for better tone, less noise and more volume. . . . He'll test all tubes, realign circuits, solder loose connections, check volume and tone controls, clean chassis, check speaker, touch up scratches and polish your cabinet."

Another script points out that . . . "If you have a dead radio, a noisy radio, a weak radio or just a no-good radio, your Service Man's radio repair tune-up special will save you real money!"

In another script, the conversational approach is used. . . . "Hello (Service Man's name). I can't hear you very well. Yes I'll wait until you shut off your radio. Did you say noisy radio and you can't get your favorite stations very good? . . . Yes, ma'am, we'll be glad to pick up your set today and give it our radio repair tune-up special."

Noise is stressed in still another type of script with the commentary. . . . "Is your radio too weak? Is it annoyingly noisy? Is the tone getting so you can't stand it?" And this theme is carried on to another script which asks the listener. . . . "Is your radio home peaceful? You sure buy a lot of peace and happiness at home by keeping your *extra radios* in *good working order*. The kids listen to their programs. Mother and dad do theirs. . . . For only \$. . . your Service Man will give your set a tune-up special. . . . Now you can really afford to get those extra radios working again. . . . and enjoy a peaceful radio home."

There's some mighty sound advice in these spot plugs!

Other manufacturers are also driving home the benefits of preventive maintenance with lively campaigns. Sylvania, for instance, not only has prepared a complete kit of direct mail and window pieces, but a national magazine schedule, extolling the Service Man and citing what he can do for Mr. and Mrs. Set Owner.

Here are striking programs which are going to help you, if you'll let them. Pitch in. Set up your preventive maintenance and general Servicing plans now. Dress up your window with the attractive material available. Send out those blotters, cards, teasers, and letters. Get on the air, if possible. Hammer away at that preventive maintenance theme. You'll never regret that effort!

AM and TV Circuitry

WITH TV developments romping ahead at an unparalleled pace and the corresponding need for TV information at a new high, it has become essential to feature TV circuits and allied data extensively in SERVICE. As a result some of the boys currently involved only in standard broadcast or FM service work have reported that we seem to be neglecting them.

While TV receivers and instruments do contain many special types of circuits akin to video systems only, there are also a variety of circuits in every TV receiver, with multiple application features found in all AM and FM models.

It must be remembered that the TV set is just as much a receiver of sound as sight, featuring the requirements of a broadcast model. While it is true that the sound section does use FM, there are still many AM items in the sight portion, which incidentally actually operates on AM.

Familiarity with TV circuitry expands the ability to service any type of receiver. It may be tagged TV, but the set is still a receiver with circuitry typical of modern radio chassis construction, with which every alert Service Man should be conversant.—L. W.

Fig. 1. The video signal generator.

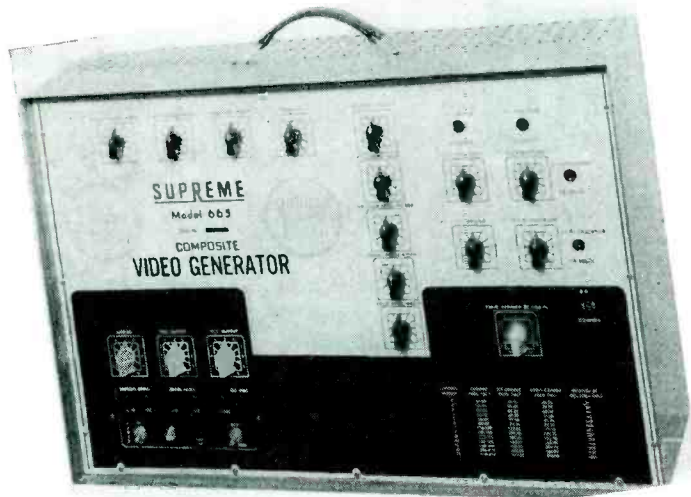

Composite

Video

SIGNAL GENERATOR

Test Instrument Provides Dot Modulation Pattern Which Can Be Used to Check for Horizontal and Vertical Sync, Horizontal and Vertical Size, and Proper Positioning of Raster on Picture Tube Face.

IN TV receiver alignment and servicing, a test pattern plays a vital role, providing a means of checking for synchronization (both horizontal and vertical), size (horizontal and vertical) as well as the proper positioning of the raster upon the picture tube face. And where an electromagnetically deflected and focused picture tube is used, the pattern aids in the proper adjustment of the deflection yoke, ion trap and the focus coil. With an electrostatically deflected tube, the proper positioning voltages may be applied to produce the correctly positioned raster.

Unfortunately many TV stations are not on the air during the average service day and as a result the receiver probe becomes increasingly difficult. In a study of the problem, one manufacturer¹ found it possible to provide the required test-pattern signal with a video generator² which produces horizontal and vertical blanking pulses, horizontal and vertical sync and equalizing pulses.

There are six functional sections in the generator: (1) Timer; (2) pedestal; (3) super-sync; (4) video; (5)

by **ALLAN LYTEL***

Temple University Technical Institute

gating and output, and (6) power supply.

The timer section has a self-excited sine wave oscillator which produces a 31,500-cps signal which is $\frac{1}{2} H$.** This oscillator has both coarse and fine frequency adjustments. One of the outputs from this oscillator uses the positive peak of the sine wave signal to operate a 6SN7 pulse former (V_{23B}) which provides a negative pulse output. This 31,500-pulse output is known as the *advanced signal*. The original output from the sine wave oscillator is fed also to a phase shifter (10 mmfd-180,000-ohms; C_{67} and R_{110}) which advances the phase approximately 60° . This phase shifted output is fed to an additional phase shifter (33 mmfd-22,000 ohms; C_{68} and R_{118}) which retards the phase about 15° in relation to the first phase shifter. The output of this second phase shifter passes through a 6SN7 inverter amplifier (V_{24B}) which simultaneously amplifies and inverts the sine wave 180° . The

output of this amplifier is retarded 15° or approximately $.02H$.

The output of the first phase shifter also passes through a 6SN7 inverter amplifier (V_{24A}) which in turn amplifies and inverts to provide a sine wave signal retarded 120° . This results from the positive 60° phase shift in the rc network (C_{67} and R_{110}) and a negative 180° phase shift in the vacuum-tube amplifier. Thus the sine wave is retarded 120° or $1/6$ of H .

There are two pulse formers one of which follows each inverter amplifier. One, a 6SN7 (B_{25A}), is known as the *normal* pulse former because of its greater importance than the *advanced* pulse, and since it operates on the peak of the sine wave output of the 6SN7 amplifier (V_{24A}). This produces a negative pulse output delayed approximately $1/6 H$ from the output of the advanced pulse former. The second, a *delayed* pulse former, operates on the peak of the sine wave output from the second 6SN7 amplifier (V_{24B}). It has a negative pulse output which is delayed about $.02 H$ from the normal pulse.

The *timer* section has a divider chain having four units: (1) A 7:1 divider

*Author of *TV Projection and Enlargement*.

** H is 63.5 microseconds; the time of a single horizontal line.

¹Supreme. ²Model 665; see front cover.

Fig. 2. Dct modulation pattern of a Magnavox MV-10E receiver, provided by generator.

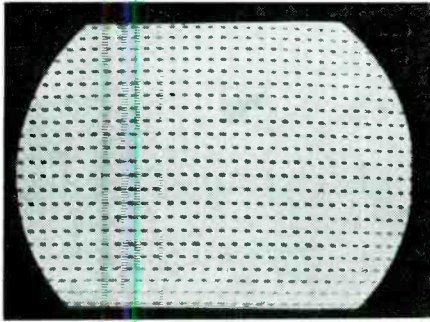

with a 6SN7 (V_{28}) which operates on the advanced pulse which takes the 31,500 pulse and produces a 4,500 pps signal. (2) A 3:1 divider with a 6SN7 (V_{27}), which operates on the output of the 7:1 divider. This produces a 1,500 pps signal from the 4,500 output of the first divider. (3) A 5:1 divider with a 6SN7 (V_{28}) which operates on the output of the 3:1 divider and produces a 300 pps signal from the 1,500 pps output. (4) An additional 5:1 divider with a 6SN7 (V_{29}) which operates on the output of the first 5:1 divider, and produces a 60 pps signal from the 300 pps signal.

Timer Section

The timer section starting with a self-excited sine-wave oscillator with a 31,500 cps signal produces five outputs: (1) 31,500 pps or the advanced pulse; (2) normal pulse of 31,500 pps; (3) delayed pulse of 31,500 pps; (4) 60 cps negative-going step, in sync with the advanced pulse which is the output from the last divider; (5) 15,000-cps negative-going step which comes from the second divider. This is also in synchronism with the advanced pulse.

The *field pedestal* section has a multivibrator which uses the 60-cps multivibrator. This oscillator which has one stable state only is fired by the 60-cps timer signal and is cut off by the advanced pulse from the timer. By means of the *field pedestal width control* the width of this pedestal is adjustable in steps of $\frac{1}{2} H$. Its normal width is $18 H$; a separate auxiliary output is available at the *field driving pulse terminal*. This is a 2-volt negative signal and has an impedance of 1,000 ohms.

The *line pedestal* is formed by an additional multivibrator, which is unbiased and would be normally free-running without the application of a sync signal; it is synchronized by the normal pulse from the timer section. By means of the *line pedestal width control*, the width of this line pedestal is variable continuously and is nor-

mally set at $0.16 H$. There is also a frequency adjustment, the *interlace control*, which is set at a sub-multiple of the 31,500-cycle sync. The frequency of this multivibrator is normally set at 15,750 cps, the line frequency. An additional output is available at the *line driving pulse terminal*, which is a 15,750-cps signal, 2-volts negative, with a 5,000-ohm impedance.

The negative pulse outputs from the line pedestal multivibrator and the field-pedestal multivibrator are each applied to a different grid of the *pedestal mixer*. The output of the tube is a combination pedestal of positive polarity, since a negative pulse on either grid cuts off the plate current of the tube. (The line pulse, however, has no effect during the period of the field pulse which is much longer.) A pedestal *inverter clipper tube* amplifies and inverts the polarity of the positive pedestal produced by the pedestal mixer; this output signal is used for blanking.

Keying Multivibrators

The *super-sync* section features two keying multivibrators. One is a bias multivibrator synchronized by a 60-cps pulse from the timing circuit and is desynchronized or cutoff by the advanced pulse. This multivibrator has a frequency of 60 cps and its outputs are negative and positive pulses of equal width which are adjustable in width in steps of $\frac{1}{2} H$.

A 6SN7 is used as a keying delay multivibrator which is synchronized by the 60 cps timer signal and desynchronized by the advanced pulse. Its frequency is 60 pps and its pulse width is adjustable in steps of $\frac{1}{2} H$. A *field sync delay control* is used for this purpose and the normal width is $3H$. The useful output of this multivibrator is the trailing edge step which occurs at a time determined by the width of the

Fig. 3. Dot pattern of G. E. 801.

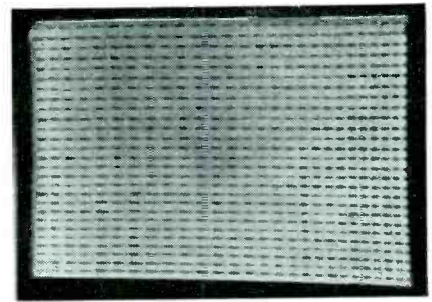

pulse. This time is normally $3 H$ after the beginning of the pulse.

The second keying multivibrator is operated at 60 cps and synchronized by the negative-going step from the delay multivibrator. It is desynchronized by the normal pulse from the timer circuit; width of the positive and negative pulse outputs is adjustable by means of the number of field sync pulses control in steps of $\frac{1}{2} H$. The width is normally $3 H$ plus $\frac{1}{6}$ of H because the multivibrator is fired in sync with the timer advanced pulse and the timer normal pulse is used for desynchronization.

Line Sync Multivibrator

A 6SN7, serving as a *line sync multivibrator*, is synchronized by the delayed pulse from the timer; this frequency is 15,750 pps since the multivibrator is also acted on by the line pedestal multivibrator. This circuit is inoperative during the $9 H$ period; by means of the *line sync width control* the width of the output pulses is continuously variable. Its normal width is $.08 H$ and the useful outputs are the leading and trailing edge of the negative step. Another 6SN7 serves as an *equalizing pulse multivibrator* and is synchronized by the *timer delay* pulse with a frequency of 31,500 pps. By means of separate squelch and unsquelch volt-

Fig. 4. Standard RMA TV composite signal; this is the output of the signal generator.

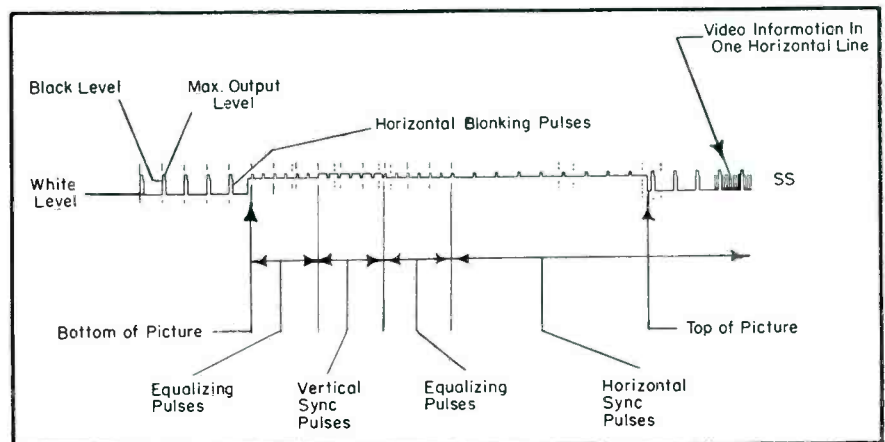

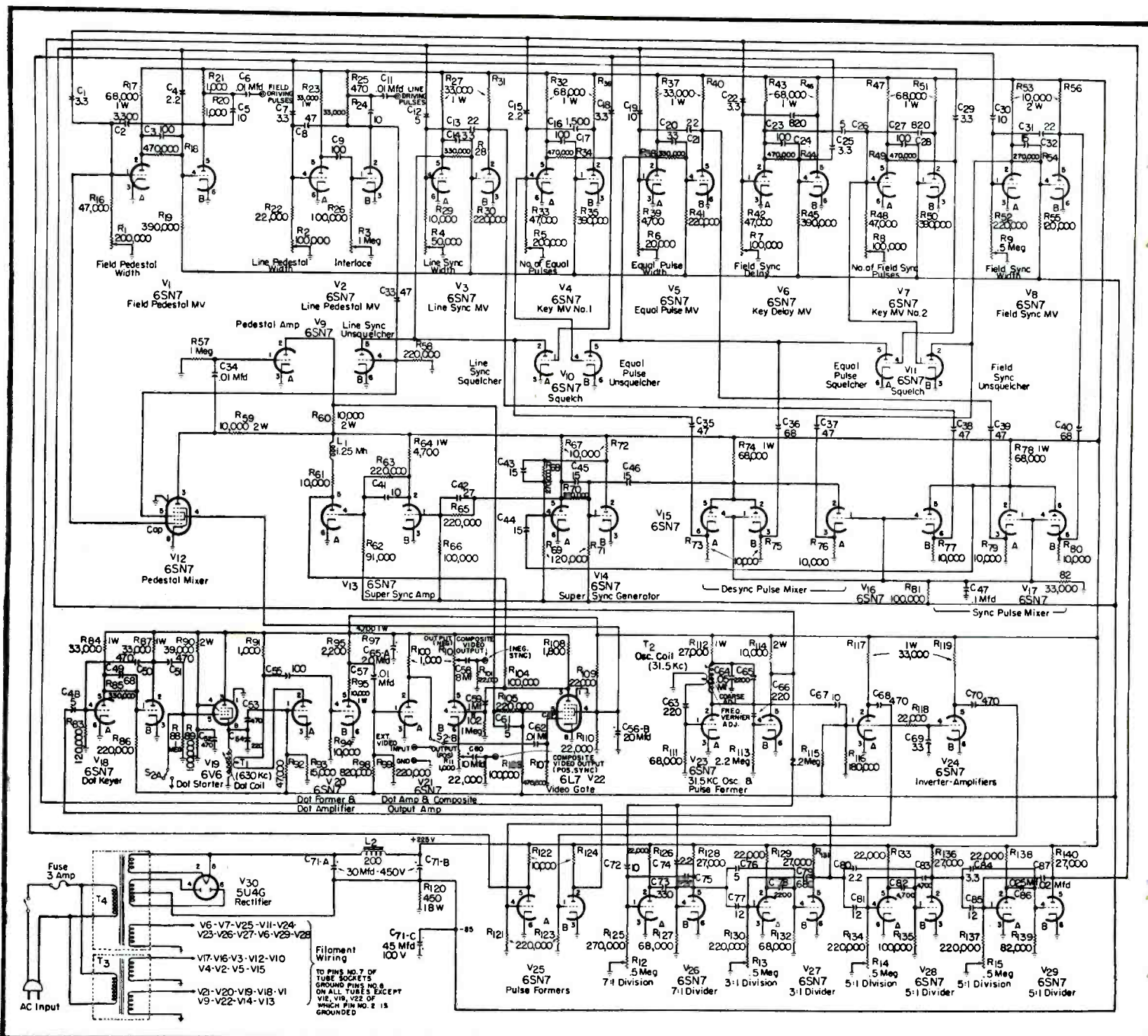

Fig. 5. Circuit of the video generator.

ages this multivibrator oscillator operates only during the first and third thirds of the $9H$ period in which it produces equalizing pulses. By means of the *equalizing pulse width* control the output is variable with a normal adjustment of width of $.04H$. The leading and trailing edges of the negative step portions are the useful outputs which are applied to differentiators.

The unit also has a *field sync multivibrator* which has a frequency of 31,500 pps and is synchronized by the timer delayed pulse. This circuit operates during the $3H$ period only; the normal width of the output is $.42H$ and is continuously adjustable by means of the *field sync width* control.

In a *super-sync generator* circuit, so

named because it produces a signal which is *blacker than black* in the composite television signal output, is a triggered multi-vibrator type of oscillator which is synchronized by means of the output of the mixer circuits leading from the equalizing pulse differentiators. This is triggered by the leading edge mixer and desynchronized or cut off by the trailing edge mixer. This signal output from the super-sync generator passes through a 2-stage amplifier where it is squared up.

The *video section* which produces the *dot modulation* includes a *dot keying multivibrator* which has a frequency of 1,500 pps synchronized by the 1,500-

cps signal from the second divider of the timer section. The output of the 6SN7 in this circuit is a negative pulse with a width of $2H$. A 6V6 *dot starter* acts as a current switching tube receiving the negative pulses from the 6SN7 dot keyer, which cuts off the current initially flowing through the tube and the inductance of the LC circuit in its cathode. Oscillation occurs at the resonant frequency of this tuned circuit which is 630 kc (or 40 times 15,750). These damped oscillations are killed at the end of the negative input pulse.

One section of a 6SN7, which serves as a *dot former* is connected as an oscillator to the LC tank. This tube has a separate source of bias and the oscil-

(Continued on page 54)



**HEAD-LINE
TV
AERIALS**

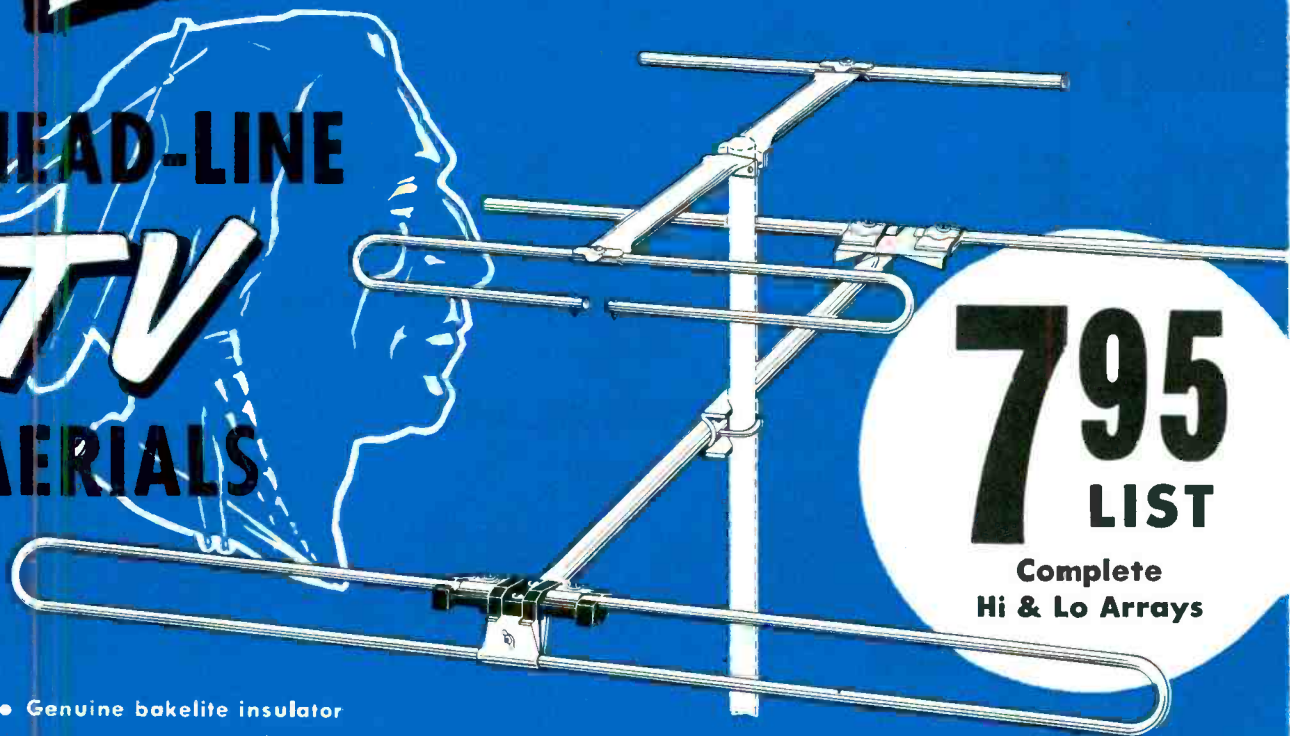

**795
LIST**
Complete
Hi & Lo Arrays

- Genuine bakelite insulator
- 1/2-inch aluminum elements
- Cadmium plated hardware
- Universal mast bracket

Quick and Easy Installation

Insert and Tighten!

ATTENTION
Jobbers • Distributors
Write for '50 catalog and
protected territories plan.

SNYDER MFG. CO.

ANTENN-GINEERS®
PHILADELPHIA 40, PA., U. S. A.

Export: Roburn Agencies, Inc., N. Y.
New York Area Distributor: H. L. Dalis, Inc.
Phila. Area Distributor: Almo Radio Co.

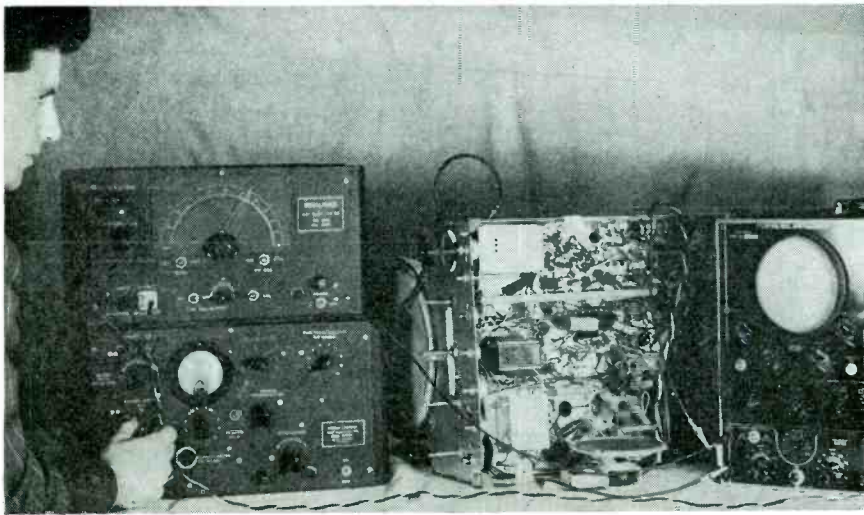

Fig. 1. Alignment setup for Westinghouse H-196 TV receiver.

Aligning the Westinghouse H-196

Alignment Procedure for the Sound and Video IF Sections.

IN TV ALIGNMENT, circuit familiarity is extremely important, such knowledge disclosing what technique variables it may be necessary to follow. For instance, in the Teletone¹ and Bendix² analyses presented earlier, there were quite a few alternate procedures required to affect proper alignment. In the Westinghouse H-196³ receiver, selected for this month's discussion, there are still other factors to consider. The *if* carriers of these models (Table 1) all of which are different point up, in part, the variable characteristics one must evaluate.

In considering the circuits of these receivers, those most relevant to alignment are of course the *rf* and the *if*, both sound and video. The *rf* units of all three sets are designed to cover channels 2 to 13 and utilize a 300-ohm balanced input. In checking for the overall response, the instrument setup for each would consist of a sweeping oscillator, twelve-channel crystal controlled marker and 50 to 300-ohm resistive pad mentioned previously.⁴ The front end of the Bendix is different in that it permits channel selection by

by **IRVING SILBERG**

Kay Electric Co.

means of a mechanical push button arrangement rather than the more common turret switch. In this model the *rf* tuning is accomplished by means of movable slugs which are set to their proper position by the action of a push-button mechanism. Oscillator trimming here consists of a setscrew adjustment for each channel position, setting a stop on the movable slug to its proper operating point.

The *if* systems of the receivers vary

considerably. In the Teletone, for example, the intercarrier system is used on video and sound *if* with the *if* string stagger-tuned to two frequencies. Both the picture and sound carriers are sent through a single *if* string and are separated after the second detector. The sound carrier is taken off the plate of the video amplifier by a 4.5-mc trap and fed through a 4.5-mc amplifier to the ratio detector, and then to the audio amplifier, audio output stage and speaker. For alignment of this receiver, therefore, it becomes important to have available, in addition to the *if* frequency marker, a highly precise source of 4.5-mc signal.

The Bendix model employs its first three *if* stages as a common amplifier chain for both the sound and picture signals. The sound *if* carrier is selected from the plate circuit of the third *if* amplifier and is fed through a stage of sound *if* amplification and a limiter stage before being demodulated in a conventional FM discriminator circuit. The fourth *if* stage serves only as a video *if* amplifier, feeding directly into the video detector. Trapping action is provided for the adjacent channel sound *if* carrier and a video trap is included in series with the video lead to the cathode of the picture tube to reject the 4.5-mc intercarrier beat. Again, signal frequen-

Receiver	Sound Carrier IF	Picture Carrier IF
Teletone TV-149..	32.8 mc	37.3 mc
Bendix 235.....	31.625 mc	36.125 mc
Westinghouse H-196	21.6 mc	26.1 mc

Table 1

These data reveal the wide *if* variations which exist in TV receivers. And wider differences may prevail if the RMA proposed *if* frequencies of 42.8 mc (sound *if*) and 47.3 mc (picture *if*) aimed at reducing the possible occurrence of spurious and interfering signals, are accepted. Adoption by the industry of these frequencies would mean that the TV Service Man would have to be able to check *ifs* of 20 to 30 mc of the earlier receivers to the more recent 30 to 40 mc and quite possibly to a near-future 40 to 50 mc.

¹SERVICE; October, November, 1948.

²SERVICE; January, March, April, 1949.

³A detailed description of the circuits employed in this model appeared in SERVICE, April and May, 1949.

⁴SERVICE; January, 1949.

⁵SERVICE; October, 1948.

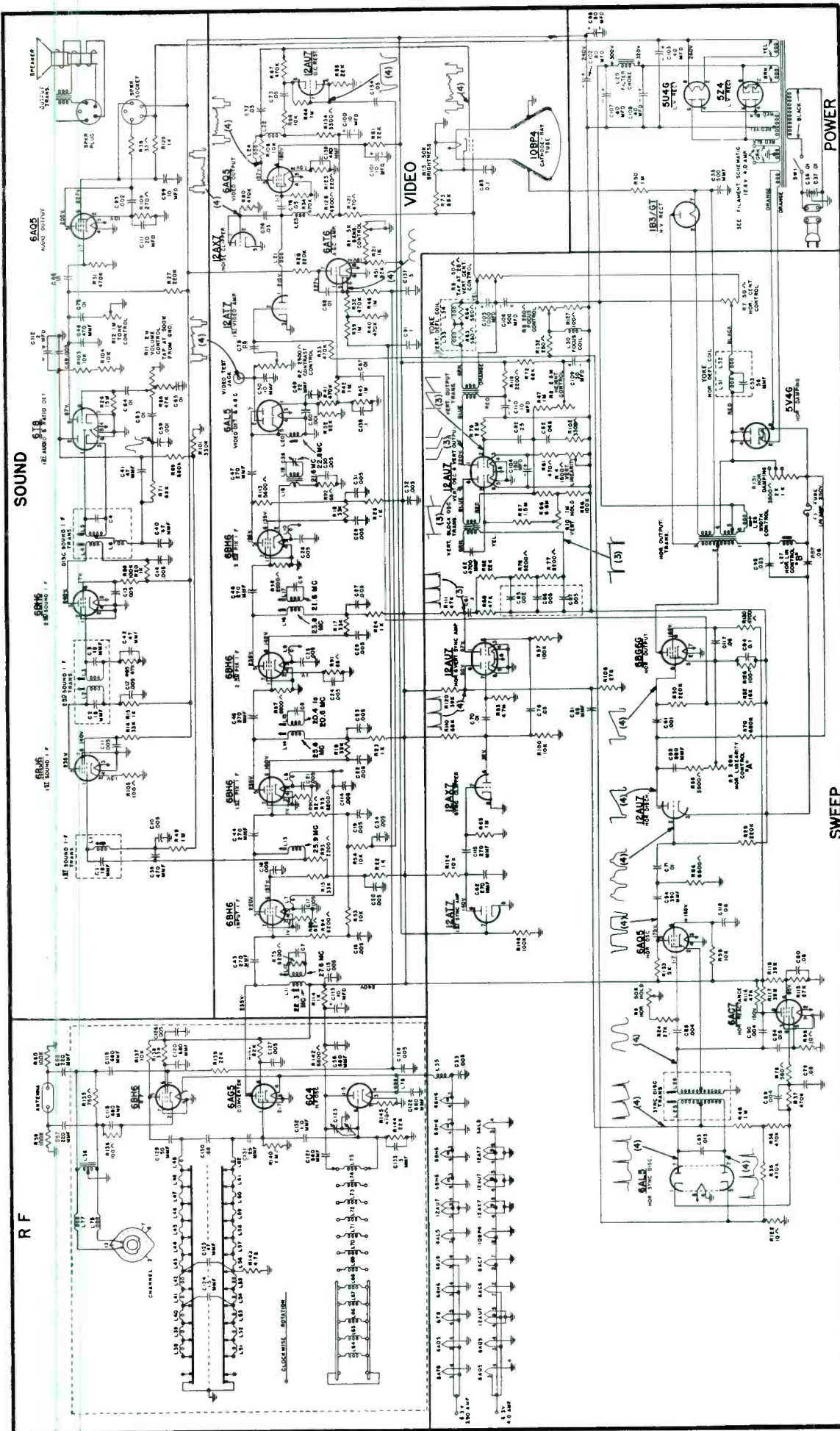

Fig. 2. Circuit of the Westinghouse H-196.

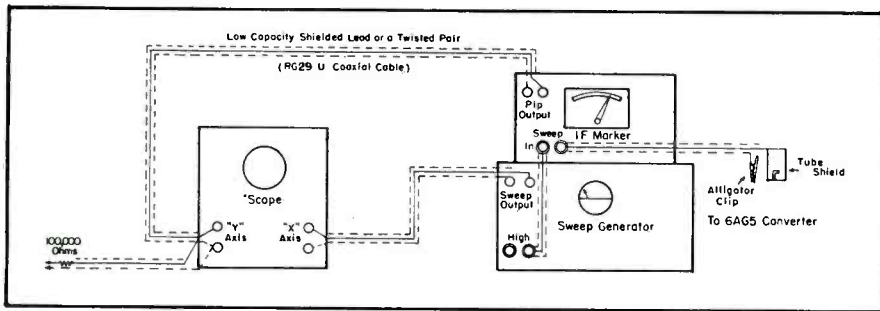
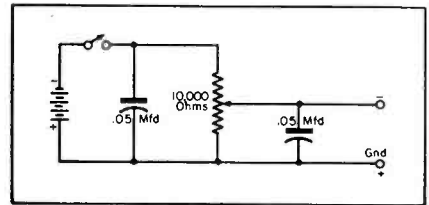

Fig. 3. Equipment layout for TV receiver alignment.

Fig. 4. Circuit of the bias box.



cies which cover the *if* band and include a 4.5-mc source are required.

In the Westinghouse set, the picture and sound carriers are separated immediately after the first (input) *if* amplifier. The sound *if* carrier is selected from the plate circuit of the input *if* stage and fed through two stages of sound *if* amplification, a ratio detector and first *af* amplifier to an audio output stage driving an electrodynamic speaker. The second stage of sound *if* amplification is arranged so as to provide a limiting action on strong signals and thus prevent overload of the ratio detector. The video *if* carrier is fed through three stagger-tuned stages of *if* amplification to the video detector. Trapping action is provided for the adjacent channel and accompanying sound *if* carriers.

The *if* systems of the three receivers exhibit a similarity in that all employ stagger-tuned amplifiers in their *if* circuits. This type of circuit lends itself most easily to speedy alignment practice since the complete amplifier string may be aligned with but one connection of the sweeping oscillator and frequency marker generator to the television chassis under test. As mentioned earlier,⁵ perhaps the cost convenient method of feeding signal through the *if* circuits is by means of a

tube shield placed over the mixer tube. Care should be exercised to keep the tube shield from being grounded. In obtaining the proper *if* response curve using a sweeping oscillator and frequency marker, adjustments at a particular frequency should always be made with reference to the base line. That is, in tuning for a maximum at a particular frequency, measurement should be made in terms of deflection from the base line and not with regard to the temporary shape of the response curve.

To insure efficient and accurate alignment the following precautions have been found quite helpful:

- (1) Secure ground connections must be made between all units included in the TV alignment test setup.
- (2) The *agc* circuit must be disabled before any alignment is attempted.
- (3) All interconnecting leads must be properly chosen and properly terminated.
- (4) Presence of hum must be checked (and eliminated) before making alignment adjustments.
- (5) A low-pass filter (e.g., a 10,000-ohm resistor) must be connected between the video detector and

the vertical amplifier input posts of the 'scope.

- (6) The lowest possible sweeping oscillator output signal must be used to avoid overload conditions.

H-196 Alignment Procedure

The instruments required for the H-196 alignment include a 'scope, sweeping oscillator and a variable-frequency, marker *pip* generator.⁸ As usual, the time-base reference voltage for the 'scope display is obtained from the sawtooth voltage generated within the sweeping oscillator (and used to frequency-modulate its variable frequency oscillator). The *rf* output of the sweeping oscillator is fed through a coupling network in the *if* marker and then by means of a tube shield (as described earlier) to the 6AG5 converter of the receiver. The *pip* output of the *if* marker is fed directly to the vertical amplifier input posts of the 'scope (without passing through the TV set) and is unaffected by the *if* amplifier characteristics.

For the *if* alignment procedure, the channel selector switch is turned to channel 3.

Sound IF: In aligning the sound *if*, the sweep generator output is at first off, and the variable *pip* marker is set up to provide *cw* output. A vacuum-tube voltmeter, connected across 10,000-ohm resistors in series (R_{103} and R_{104}), is switched to the 10-volt scale and the amplitude control associated with the *cw* output is adjusted until the meter reads approximately 5 volts. With the signal generator set at 21.6 mc, the first sound *if* transformer (L_1), the second sound *if* transformer (L_2 and L_3), and the primary of the sound discriminator transformer (L_4) are adjusted for maximum reading on the meter. As the circuits come into alignment, the signal generator output should be attenuated to keep the meter at about half scale.

The *vtrm* is then connected between the junction of the .0001-mfd, .01-mfd and 68,000-ohm units (C_{59} , C_{68} , and R_{71})

(Continued on page 36)

Fig. 5. Response characteristic plot of the video *if*.

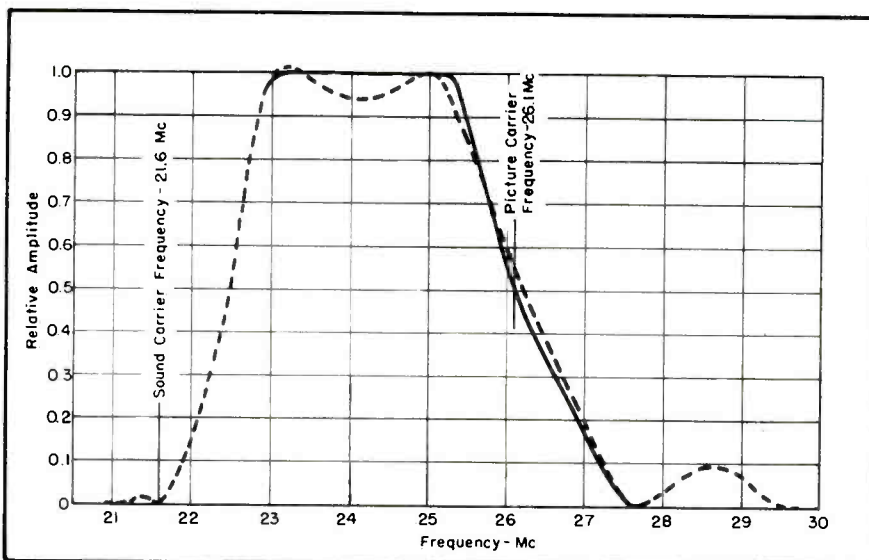

ONLY THE NEW TYPE Q CONTROL

Gives You these Advanced Features for Modern AM, FM and TV Servicing

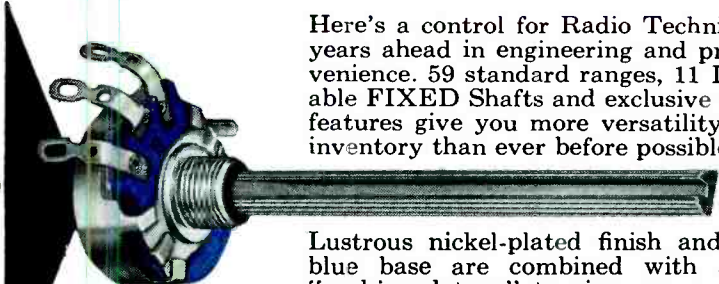

Here's a control for Radio Technicians that's years ahead in engineering and practical convenience. 59 standard ranges, 11 Interchangeable **FIXED** Shafts and exclusive convenience features give you more versatility with lower inventory than ever before possible.

Lustrous nickel-plated finish and distinctive blue base are combined with a smoother "cushioned turn" to give you a control that looks, "feels" and performs better than any you've ever used.



KNOB MASTER FIXED SHAFT

This 3" long *fixed* shaft is standard on the Q Control. 90% of all AM, FM and TV $\frac{1}{4}$ " knobs can be accommodated without alteration, except cutting to length. It is knurled, flatted and slotted, and ends spread easily for worn or oversize knobs. Shaft inserts are no longer needed.



enlarged cross-section

The Knob Master Fixed Shaft combines with compact $\frac{1}{16}$ " design and $\frac{1}{4}$ " long bushing to provide the industry's most adaptable small control.

11 INTERCHANGEABLE FIXED SHAFTS

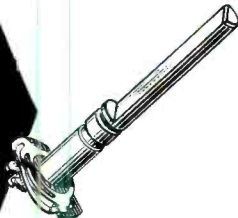

Now it's easy to adapt standard controls to "specials". Resilient Retainer Ring, an outstanding control design advancement, permits ready adaptability to any of 11 special **FIXED** shafts in less than a minute—using only a knife or screwdriver. Shafts are **FIXED** and permanent! They will not wobble.

Interchangeable Fixed Shafts are sealed in cellophane and individually packaged. Simple instructions are included in each carton.

**REVOLUTIONARY
TYPE Q CONTROL
LEADS THE FIELD IN
CONVENIENCE FEATURES**

OUTSTANDING APPEARANCE VERSATILE KNOB MASTER SHAFT INTERCHANGEABLE FIXED SHAFTS MODERN SMALL SIZE SMOOTHER ROTATION

Resilient Retainer Ring provides cushioned turn—a new sensation in operation

PRE-EMINENT ELECTRICAL FEATURES

$\frac{1}{2}$ watt rating—wider coverage
Famous IRC resistance element
Identical electrical rotation with or without switch
Wider range—500 ohms to 10 megohms

OUTSTANDING MECHANICAL FEATURES

Molded base accurately aligns parts
Salt spray materials and finishes
Two locating lugs provided

EASILY ATTACHED IRC SWITCHES

WIDE REPLACEMENT COVERAGE

59 values
Stock list shows Radio and TV uses
Type Q IRC Volume Control Kit available
Basic stock numbers unchanged

MECHANIZED PRODUCTION

Complete mechanization of production and testing eliminates hand operations and assures maximum uniformity

ATTRACTIVE NEW PACKAGING

Controls, shafts and switches individually packaged
Complete instruction sheet with each item

For complete details, ask your IRC Distributor or use the handy coupon to obtain your **FREE** copy of new Catalog DC-1.



**INTERNATIONAL
RESISTANCE CO.**

401 N. Broad St., Phila. 8, Pa.

In Canada: International Resistance Company, Ltd., Toronto, Licensee

Wherever the Circuit Says 

INTERNATIONAL RESISTANCE CO.

401 N. Broad St., Phila. 8, Pa.

Please send my free copy of Q Control Catalog DC-1.

Name

Address

City.....Zone.....State.....

Servicing Helps

Installation of Sleep-Receiver (G. E.) Clock-Booster Springs . . . Use of Detent Index Button for G. E. 805 . . . How to Disconnect Dynamic Limiters in Belmont Chassis . . . Admiral 20 and 30 Series Service Notes . . . Avoiding Picture-Tube Damage Caused by Incorrect Adjustment of Ion Trap . . . Ratio-Detector Alignment Notes . . . Eliminating Picture Distortion in Metal Tubes Due to Magnetism.

G.E. 64 and 65 Sleep Control Improvement

IN THE first models of the G.E. receivers using a clock the trip action on the switch often was not too positive. This has been cured by the addition of a helical booster spring.¹

Failure of switch contacts in the early sets was found due to the incomplete travel of the sleep control gear segment and cam assembly, after its release by the segment gear's drive pinion. Normally, the spring action of the switch contacts through the sleep control switch lever should be sufficient to allow the sleep control cam and gear segment to spring outward completely after it becomes disengaged from its pinion drive gear. However, binding or position control parts has resulted in failure of segment gear and cam to swing completely outward properly releasing switch control lever and contacts. The addition of the booster spring provides the additional

by M. A. MARWELL

tension to correct segment gear and cam operation.

Installation of the booster spring requires only the movement of the radio chassis sufficiently within the cabinet to gain access to the clock back cover mounting case. Then the case is removed. The clock mechanism may then be drawn forward from the front of the cabinet, just far enough to permit installation of the booster spring.

Fig. 1 shows the position of the booster spring as viewed from the rear of the clock mechanism. One end of the spring is fastened to the cam stud, the other end to the brass front plate stud.

Detent Index Button for G.E. 805

Popping out of the detent ball in the channel switch assembly of the earlier G.E. sets has been corrected in production by the use of a detent index

button² to take place of the ball. This button is a half ball with a shoulder to fit into the index pressure spring assuring a firm seat for the button.

In replacement the original ball may be removed by slightly lifting the index pressure spring. With a pair of tweezers, the pressure spring is lifted and the new index button slid into position so that its shoulder fits into the hole of the pressure spring.

The entire surface of the detent disc should be covered with a thin coat of lubriplate.

Disconnecting Belmont Dynamic Limiters

The dynamic limiter circuit used in the Belmont BRC chassis 18DX21A and 7DX21 was designed to reduce noise, external interference, and other objectionable effects expected in television reception.

It was later discovered that the noise and other effects were not as noticeable as expected and the dynamic limiter circuit could be eliminated. Since the dynamic limiter introduces a loss, an increase of audio sensitivity of approximately three times is now obtained.

All that is necessary to make this change is to remove the 1000-mmfd capacitor (C_{116}) connected from terminal 2 of transformer T_8 to pin 6 of the 19T8 (tube 4).

If not convenient to realign the transformer T_8 , then a 10-mmfd capacitor can be added from terminal 1 to terminal 2 of transformer T_8 .

Addition of the 10-mmfd capacitor will compensate for disturbing of the

(Continued on page 37)

Fig. 1. Rear view of G.E. clock mechanism showing position of a booster spring which provides a more positive trip action.

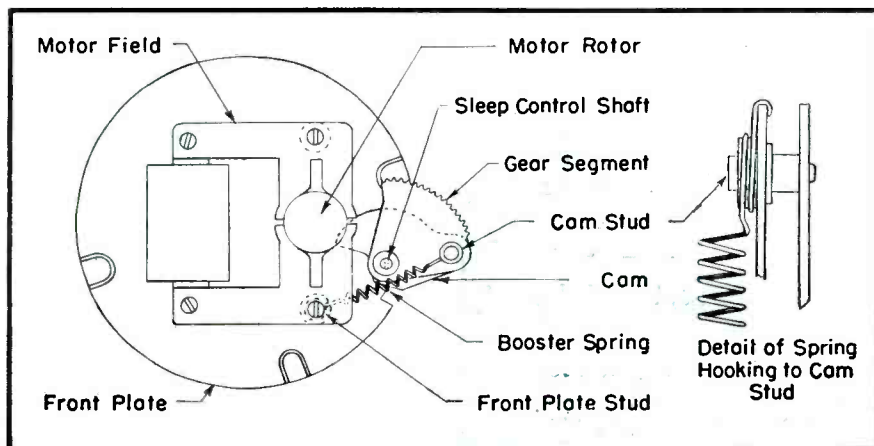

¹G.E. RMS-203. ²G.E. RDB-021.

NEW G-E *Triple-Play* CARTRIDGE PLAYS ALL 3 SPEEDS

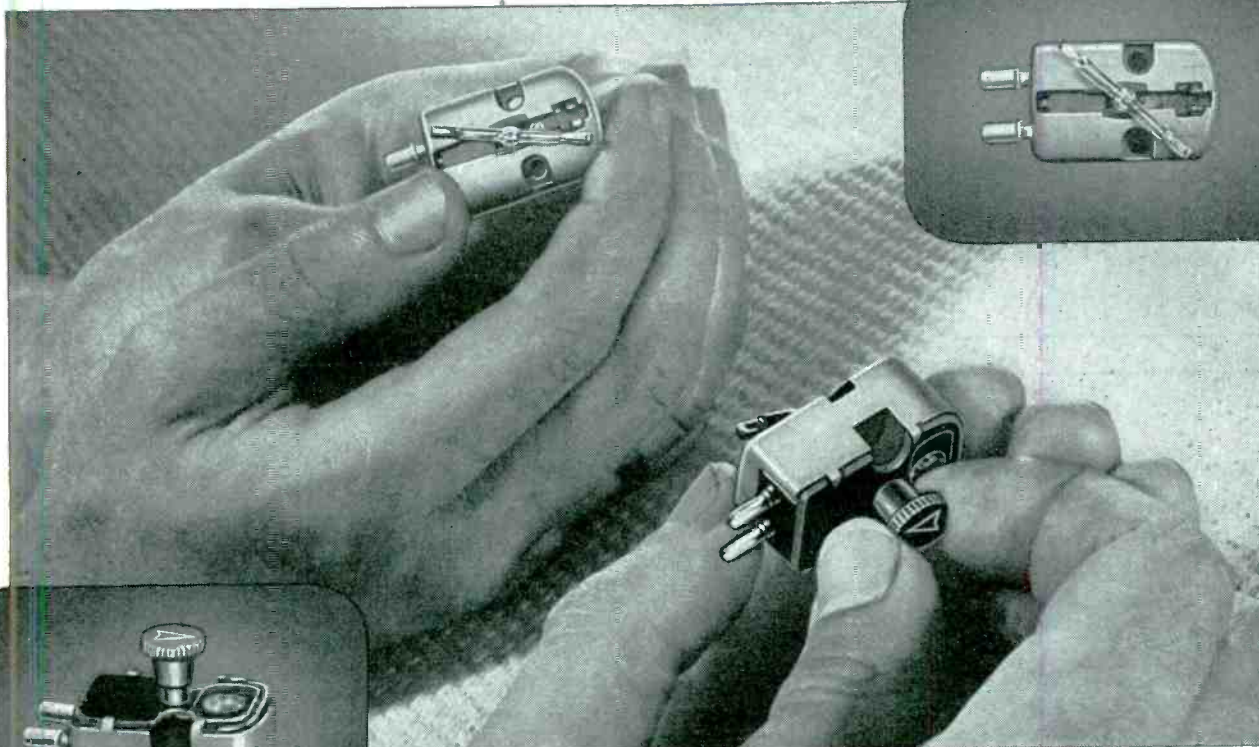

Latest Dual Stylus Unit Tracks 33-1/3, 45, and 78 rpm Records at Constant Pressure

Costs 25% less than Pickups it Replaces

A new General Electric "Triple Play" Cartridge that tracks any commercial record is now available to manufacturers, distributors, and dealers.

Simplicity is the key feature of this notable electronic advancement. Once installed in a tone arm, the cartridge will play all types of popular narrow groove and standard groove records *without replacement or even a change in position!*

ONLY ONE PRESSURE

The new cartridge retains the unsurpassed frequency response characteristics of the famous G-E Variable Reluctance unit and in addition, tracks the three types of records at 6 to 8 grams. Thus the pressure is constant regardless of the stylus you're using. The special design of the "Triple Play" permits precise adjustment of tone arm pressure. Weight changing and pressure compromise problems are eliminated. High compliance and low moving mass reduce record wear to a minimum.

TWO STYLI IN ONE CARTRIDGE

A single twist of a built-in knob turns either end of a dual stylus to playing position. A 1-mil stylus, mounted at one end, plays 33 1/3 and 45 rpm records, and a 3-mil stylus, at the opposite end, tracks standard 78 rpm records.

MANUFACTURERS NOTE LOW COST

Although it plays records that formerly required the use of two cartridges, the price of the "Triple Play" is 25% less than the price of two individual cartridges. It is adaptable to many types of tone arms and *its use as an initial component will effectively reduce set manufacturing costs.*

UNAFFECTED BY TEMPERATURE

The G-E "Triple Play" is unaffected by normal climatic changes in humidity and extreme variations in temperature. Needle talk and needle scratch are reduced to a minimum. Record reproduction—as always with G-E Cartridges—is superb. Mail coupon below for complete information.

You can put your confidence in—
GENERAL  ELECTRIC

General Electric Company, Parts Section 1E
Electronics Park, Syracuse, New York
Send me full particulars on the new G-E "Triple Play" Cartridge.

NAME _____

ADDRESS _____

CITY _____ STATE _____

COAX LINE Installation

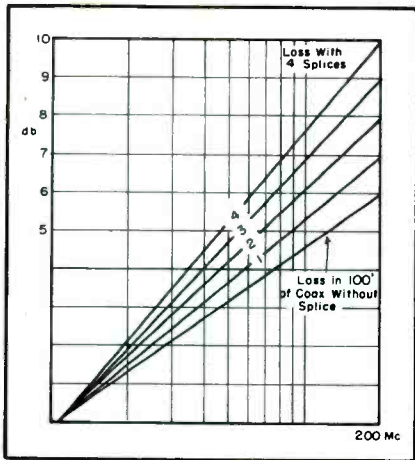

Fig. 1. Plot illustrating the average effect of a tap-on splice.

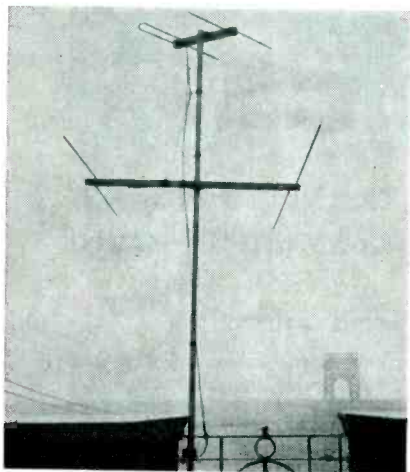
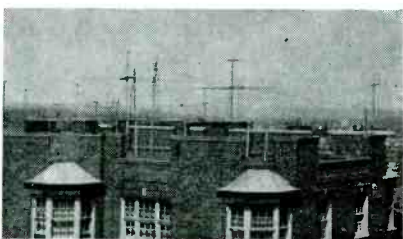

Fig. 2. View of antenna installation with a 300-ohm line taped with friction tape to a metal mast and railing, a procedure which would normally cause noise in the picture.

(Courtesy National Antenna Corp.)

Fig. 3. Roof top with typical TV antenna installations.

(Courtesy National Antenna Corp.)



IN MAKING dealer multiple-receiver installations from a single TV antenna system¹ and for video repeater or slave unit installations it is necessary to tap into coaxial cable without the affecting the impedance of the coaxial cable.

To provide such a connection, a resistance *tap-on splice* must be made on the coax cable line without breaking the center conductor, and thus maintaining the size of the center conductor. A technique which provides such a splice was illustrated in a series of step-by-step views last month.²

The *tap-on splice* has an average insertion loss of 1 db per splice; Fig. 1. Therefore, the last outlet on a coax line, with, for example, four receptacles,¹ would have 4 db more loss due to the insertions of the *tap-on splices*. Where necessary this additional loss can be compensated for by adjusting the value of the resistor in the coax outlet lines.³

The 300-ohm *through* and *tap-on splices* are simple to make. Short connections are also the rule with 300-ohm lines, but the insertion of small impedances due to lead lengths have a lesser effect on high-impedance transmission lines.

The feeding of 300-ohm transmission line, however, is important if the transmission line is not to act as a medium of noise pickup. Balanced cable will only function as such if the capacity of each side of the transmission to ground is the same. To meet this specification the 300-ohm line should be twisted one turn per foot from the antenna terminals to the TV receiver input terminals. Installations of the type illustrated in Fig. 2, in which the 300-ohm line is taped with friction tape to the metal mast and metal railing will normally be noisy as the *rf* balance of the transmission line is upset by these poor mechanical arrangements.

On multiple dwelling roofs where building management does not restrict TV antenna installations the safest procedure for installation is:

(1) The TV antenna should be installed as high as possible and as far away from other TV antennas as can be arranged.

(2) Coaxial cable should be used, for poorly installed 300-ohm open

¹As described and illustrated in chapter X of *TV-FM Antenna Installation* by Ira Kamen and Lewis Winner.

²SERVICE, September, 1949.

³Anaconda ATV-225.

transmission lines run nearby will radiate interference which can be picked up by other open transmission line, but not by coax cable.

There are some new multiple dwellings where the builder provides TV conduits for each apartment line, often one conduit for six apartments. Usually after three coax cables are run down the conduit the cable becomes hard to pull, especially if the run is from the sixth to the first floor. Powdering or waxing the coax cable eliminates the friction of the other cables and facilitates pulling of the cable between floors.

Sharp bends in coax cable cannot, of course, be tolerated. Manufacturers' specifications detail the maximum amount of bend that can be made without impairing the impedance of the cable. Where sharp right-angle coax runs must be made with the larger cables, it is best to use right-angle coax fittings, rather than ruin the cable by physical distortion.

Shielded Line Variables

Shielded lines with a 225-ohm impedance,³ which approximates the average impedance of 300-ohm tuners over the 54 to 216-mc range, also have been found quite acceptable in installation work.

The unusually high impedance inherent in shielded lines is achieved by in-

Fig. 4. Effective soldering and taping procedures which can be used with 300 ohm lead-in. Illustration in (a) shows how a 4" pigtail of No. 18 wire is soldered to the braid and 1" of the polyethylene is stripped. The taping procedure is illustrated in (b). Each end of the cable is taped with Scotch insulating tape to prevent water or moisture from entering or condensing under jacket. An alternative method would be to apply a coat of waterproof plastic seal over the exposed ends. (Courtesy Federal Telephone and Radio Corporation.)

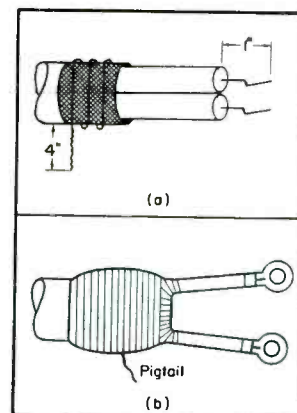

Practices

Part II ... The Tap-On Splice Technique ... Multiple Installation Procedures ... Shielded-Line Variables ... Coax Fittings.

by **IRA KAMEN**

Manager, Antenaplex and TV Dept.
Commercial Radio Sound Corp.

creasing inductance or decreasing capacitance. This can be accomplished by changes in geometry or by increasing magnetic permeability and decreasing dielectric constant. In the 225-ohm line, the latter method was selected since geometry changes would necessitate greatly increased cable size. Effective permeability has been increased by use of copper clad steel cored conductors and effective dielectric constant reduced by use of a polyethylene-air dielectric structure.

With given size conductor, the higher the impedance of a line the lower its attenuation. Low attenuation is very desirable since the signal available at the antenna is in many cases not very large and any energy loss sustained in the line during transmission to the receiver terminals becomes unavailable. The attenuation of the line is a measure of this unavailable energy loss in signal.

The 225-ohm shielded line has an attenuation of a little over 3 db per 100' at a frequency of 100 mc. Thus the signal voltage available at the receiver is approximately 71% of that at the antenna (for the line length and frequency indicated).

Since the line is a typical coax design, completely shielded and jacketed, its electrical characteristics are unaf-

ected by external influences such as rain, snow, ice, fog, dirt and other contaminating deposits.

Shielded lines also are unaffected by the presence of grounded or ungrounded conducting surfaces such as pipes, flashings, gutters, etc., and thus can be run through large or small steel pipe or conduit where desired, since their electrical properties are unaffected.

This ability, to be used in conduit, is becoming increasingly important since more and more custom installations, new home constructions and

(Continued on page 52)

Fig. 5. Views illustrating detailed procedures followed in stripping high frequency cable and assembling to connectors. In the first step a cut is made through the vinyl jacket, copper shielding and dielectric body. Then the dielectric material, shielding and outer jacket are removed. A cut is then made around the cable through the outer jacket only. A vertical cut is then made through this same material. The outer cover is then removed from this area and the cable becomes ready for pretinning of the shielding. Then the connector is put on the cable preparatory to holding it in an air vise. In the next step, the connector is fitted onto the outer jacket of the cable with a wrench made by soldering a mating serrated-edge receptacle to any kind of handle. A work sheet, with cutback measurements indicated, can be used to facilitate stripping.

Fig. 6 (below and left): In the final steps we have the soldering operations, first the shielding being soldered and then the tip being solder filled. Rapid contact with a hot iron is recommended as the dielectric, being thermoplastic, softens with heat applications above 180° F.

(Courtesy Amphenol)

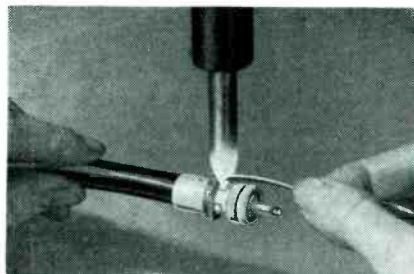
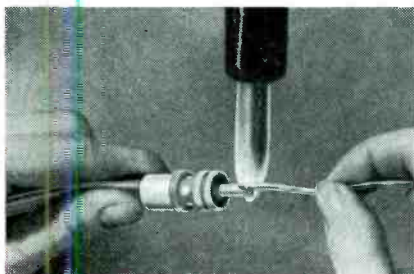
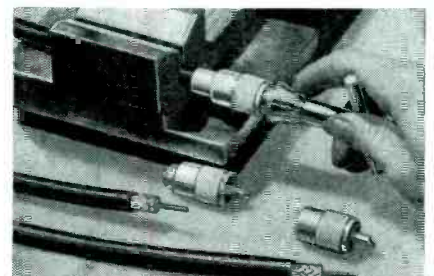
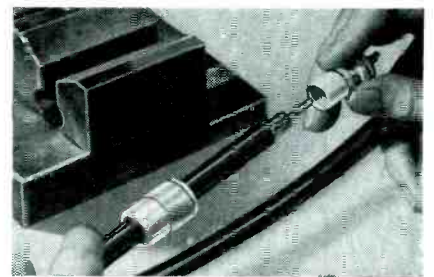
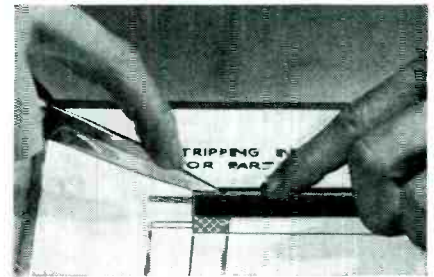
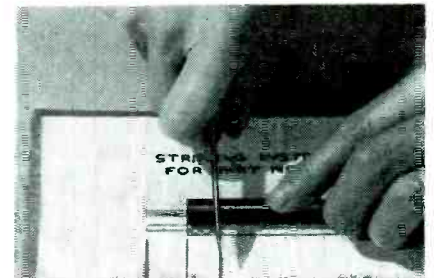
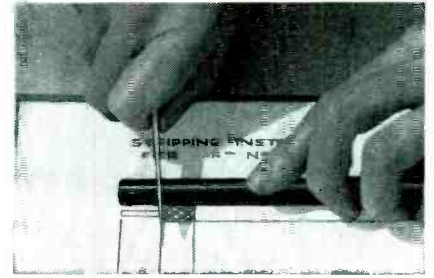



Circuit Analysis of Bendix 16-Tube TV Chassis.

TV RECEIVERS, with almost one-half the number of tubes employed in the pioneering models of two years ago, are now coming into wide use. The Bendix 2000 and 3000 series are an excellent example of this trend. In these receivers, only 16 tubes are used and but three controls are provided for operating the receiver: Volume; contrast; and station selector combined with a fine tuning control. Like many other sets, recently introduced, these also have a built-in antenna; a simple dipole with open triangular shaped end sections mounted on the sides of the cabinet. These sections are used as end-loading for the dipole. When an external antenna is used, the built-in antenna must be disconnected from the antenna terminals.

RF System

The *rf* system in these models, which incidentally are available for 10" and 12½" picture tubes, consists of a rotary turret-type tuner. This tuner is made up of a series of strips on which are mounted the coils for each channel. In the event that coils must be replaced, it is only necessary to remove a strip and snap in a new one. The tuner can be rotated in sequence in either direction. All coils are pre-adjusted, and final overall tuning adjustments are made at the factory with a sweep generator. Adjustment of the tuner in the field is difficult unless a sweep generator is used.

The circuit configuration of the tuner is relatively conventional. A balanced input (nominally 300 ohms impedance) is fed to a center-tapped coil which is coupled to the grid coil of the *rf* amplifier. The secondary circuit resonant frequency can be changed slightly by adjusting C_{101} . All coils have been matched to a standard, and the correct adjustment of C_{101} for one channel (after changing *rf* tubes for example) automatically brings all other channels into tune. C_{101} can be adjusted most easily on one of the higher frequency channels such as channel 12.

A 6AG5 pentode *rf* amplifier is used. Two overcoupled tuned circuits couple

the plate of the *rf* amplifier to the grid of the mixer. Alignment of these circuits is accomplished by adjustment of C_{104} and C_{106} . Both circuits are so loaded that the overall response of the *rf* system is flat over a bandwidth of 11 mc, to within 6 db of the peak response. The secondary load is primarily due to the input loading of the mixer. The mixer grid lead resistance is made up by two resistors (R_{104} and R_{105}) in series. The junction between these resistors provides a convenient test point for checking the *dc* voltage developed by the oscillator injection voltage, and for connecting a 'scope to examine the response characteristic of the *rf* system with a sweep generator.* A 10,000-ohm resistor should be connected in series with the 'scope to avoid adding excessive capacity to the mixer grid circuit.

The mixer tube is half of a 6J6; the other section of which is used as the local oscillator, which is a Colpitts type. The coils used for the oscillator are provided with an adjustable core which can be set for the correct frequency in each channel from the front of the set. Inductive coupling is used to inject oscillator voltage into the mixer circuit. The *dc* voltage developed by the injected oscillator signal must be measured at the test point in the mixer grid circuit, and should equal 3 volts minimum in the low channels, and 2.5 volts minimum in the high channels. Vernier tuning provides a frequency coverage ranging from 600

ke on channel 2, to 2.15 mc on channel 13.

Output voltage of the mixer is developed across coil, L_{103} . A sound trap, T_{100} , is inductively coupled to L_{103} , and reduces the mixer stage gain approximately 32 db at the sound carrier frequency. At this reduced level there will be produced a 4.5-mc beat note for intercarrier sound, when mixed with the picture carrier in the video detector crystal. The output voltage of the mixer is fed to the first *if* amplifier through a series-tuned circuit consisting of L_{102} , C_{111} , and associated circuit capacities. The series circuit is tuned to 22.5 mc and is used to prevent the oscillator signal from entering into the *if* amplifier.

IF System

A quadruple stagger-tuned, three-stage amplifier with crystal detector output comprises the *if* system. Quadruple stagger tuning is used to achieve the maximum possible gain for the desired bandwidth of 3.6 mc within 6 db.

A unique feature of the *if* is the design of the *if* transformers. The coils are bifilar wound (two windings, interwound) with triple Formex insulated wire. This type of winding is said to approximate unity coupling and give the effect of a single tuned coil. This arrangement has been found to afford many advantages. Improved filtering of all plate and grid returns can be achieved as the bypass capacitors can be returned to the same ground as the associated cathode. With the bifilar winding it is possible to keep the time constant in the grid circuit of each amplifier down to a low value. As a result there is no charging of the grid circuit by heavy noise pulses, and picture information is transmitted continuously through the *if* system.

Three 6AU6 *if* amplifier stages are employed. Unbypassed cathode resistors (R_3 and R_6) are used in the first

(Continued on page 40;
circuit on page 24)

*Note: This receiver is like all other high frequency receivers in that its performance can be greatly impaired by altering the lead dress or the location of the grounding points of the component. Therefore, the receiver should not be changed an appreciable amount from its original design in making service replacements.

Two test points are provided for *if* checks. One is on the *agc* string after the 1.5-megohm filter resistor (R_9). This point is used for checking developed *agc* voltage and for applying bias potentials when making sweep tests on the *rf* and *if* channels or aligning the *if* system. The other test point, at the video detector output, can be used for several tests: (1) high impedance *dc* meter can be used here for checking the voltage developed by the detector; (2) a 'scope can be tied to this point for checking the response characteristics of the overall *rf* and *if* systems with a sweep generator; (3) a 4.5-mc signal can be applied for aligning the inter-carrier sound channel.

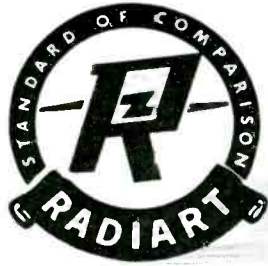

Radiart *features*

THE Lowest Priced Quality Line

OF TV CONICAL ANTENNAS

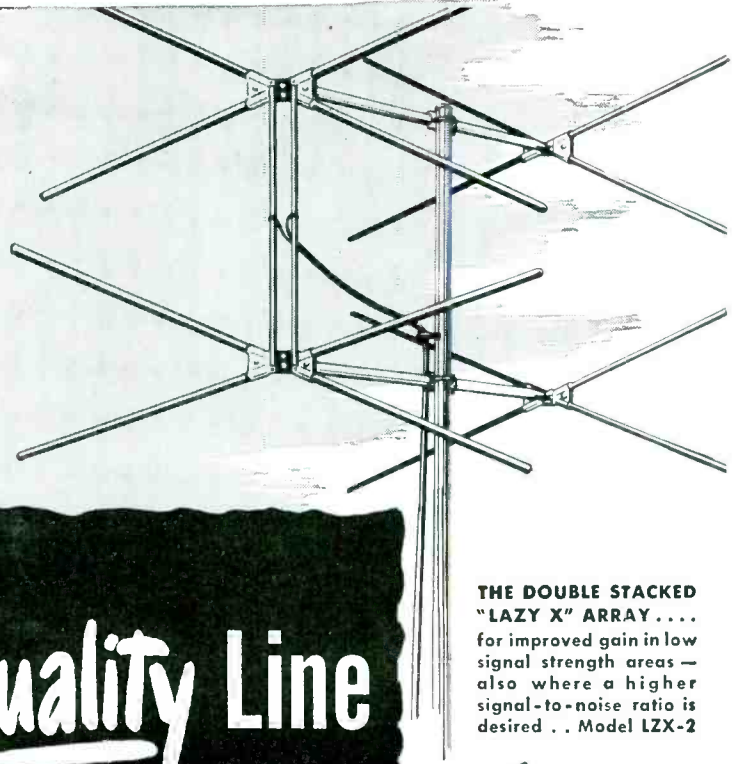

THE DOUBLE STACKED "LAZY X" ARRAY . . . for improved gain in low signal strength areas — also where a higher signal-to-noise ratio is desired . . . Model LZX-2

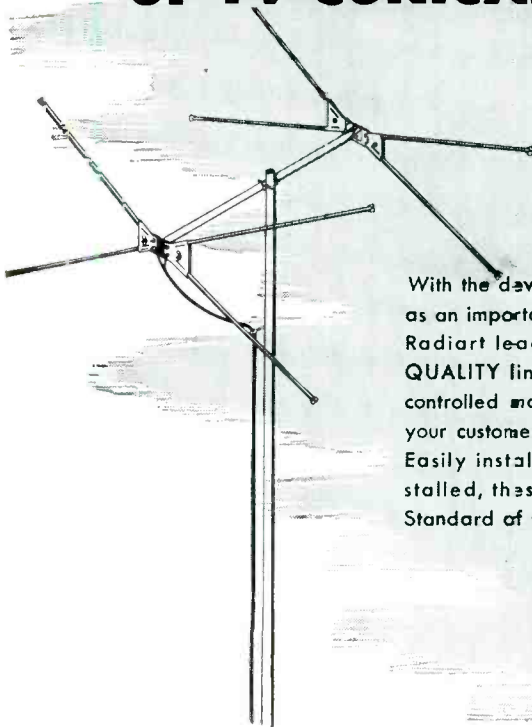

THE SINGLE BAY "LAZY X" . . . for primary service areas Model LZ

With the development of the conical type antenna as an important factor in television reception . . . Radiart leads the way with the lowest priced QUALITY line. Precision engineering . . . quality controlled manufacture combine to give you and your customers the greatest value for the dollar! Easily installed . . . and rigidly sturdy when installed, these Radiart products truly are "The Standard of Comparison."

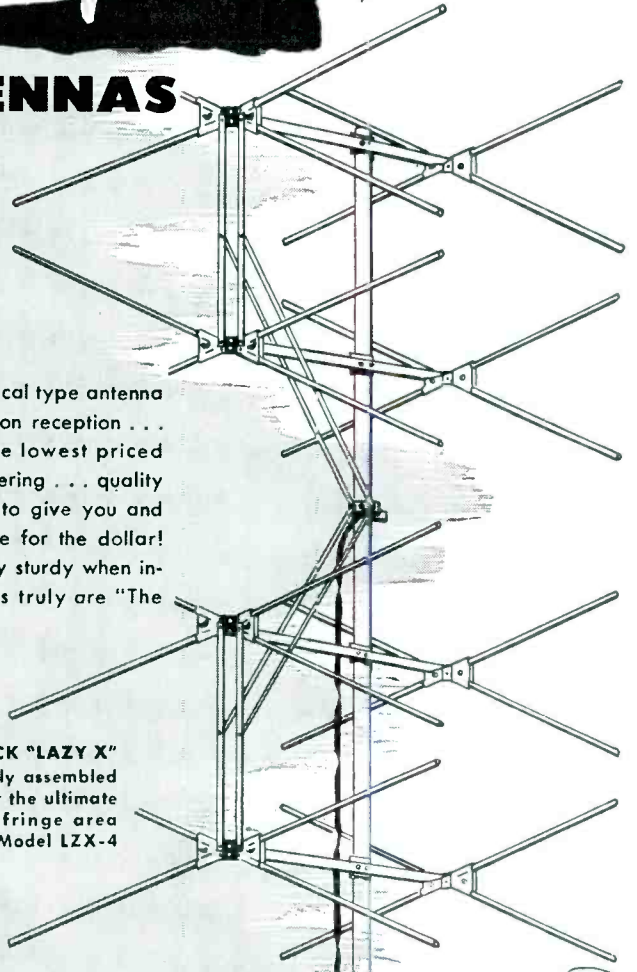

The QUAD-STACK "LAZY X" Array . . . easily assembled and installed for the ultimate in all channel fringe area reception Model LZX-4



IT'S RIGHT WHEN IT'S RADIART!

THE RADIART CORPORATION
CLEVELAND 2, OHIO



Manufacturers of the Famous Red Seal Vibrators

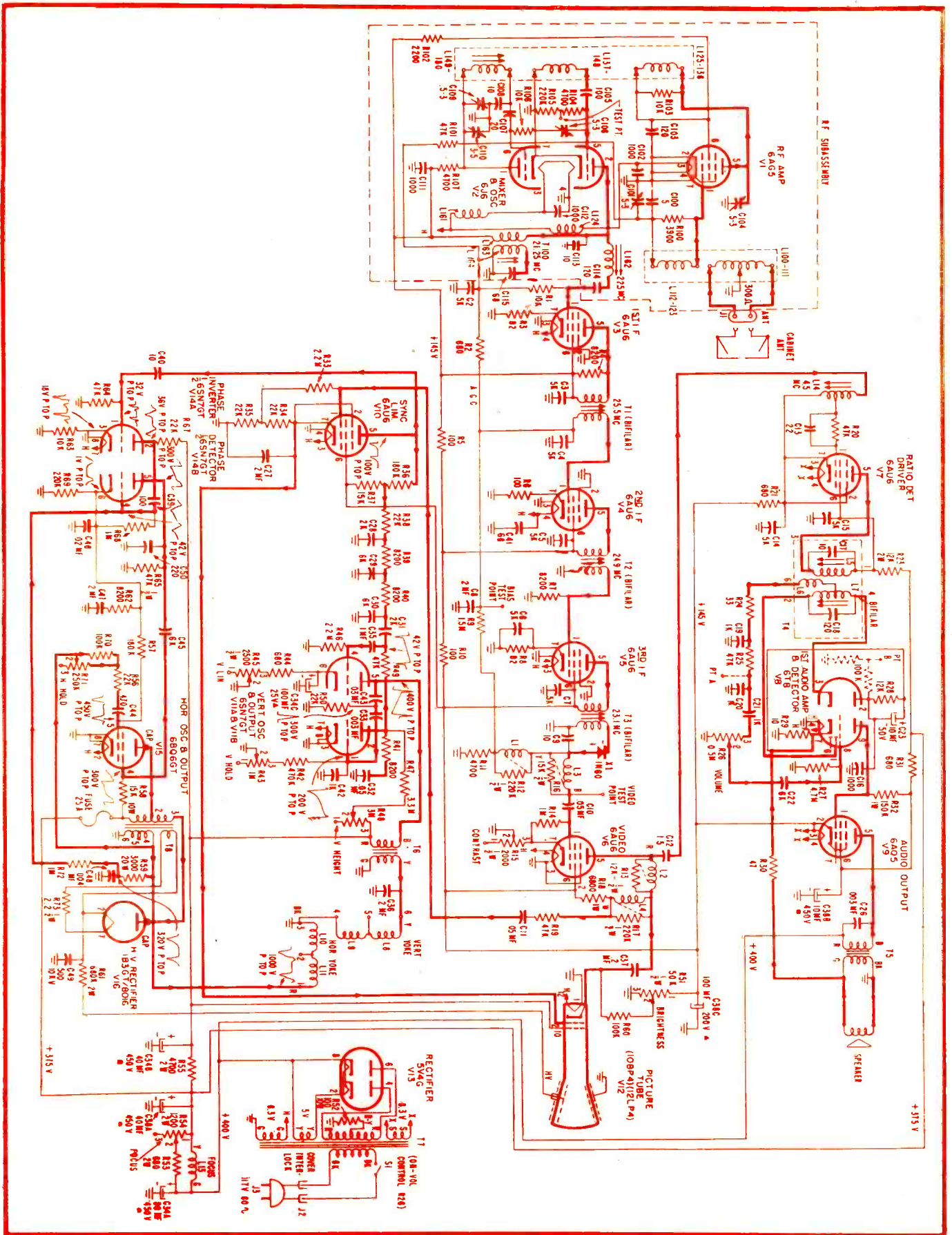

Fig. 1. Schematic of the Bendix 16-tube TV receiver; models 2000 and 3000 series.

WARD TELEVISION ANTENNAS MADE STRONGER, LONGER-LASTING, EASIER TO INSTALL with J&L STEEL PERMA-TUBE

J&L STEEL

The vertical mast and cross-arms of the Ward "Minute Man" antenna are made of J&L PERMA-TUBE. It takes just 60 seconds to remove the preassembled antenna from its box and swing all arms into position as shown here. PERMA-TUBE antennas combine strength, rigidity and rust-resistance—give longer trouble-free service—and better television reception.

PERMA-TUBE may be used for many applications where strength, rigidity, rust-resistance, and attractive appearance are necessary.

By using the new exclusive rust-resisting J&L PERMA-TUBE for the vertical mast and cross-arms in the "Minute-Man" series of television antennas, Ward Products Corporation, Division of the Gabriel Company, Cleveland, Ohio, builds in the following advantages:

1. Greater structural rigidity with smooth, attractive appearance. Greater strength to resist ice loads.
2. Clearer, steadier, television reception. Less vibration from wind.
3. No mechanical seam in Perma-tube to invite rust which would

reduce the torsional strength.

4. Ease and speed of installation . . . at less cost.

J&L PERMA-TUBE is a light-wall, electricweld steel tubing, coated inside and out with an exclusive plastic-type, weather-resistant finish. PERMA-TUBE can be furnished: bent . . . expanded . . . flanged . . . swaged or fluted.

J&L PERMA-TUBE for television antennas, costs less than any other tubing with comparable strength, rigidity and rust-resistance.

J&L PERMA-TUBE is not only

applicable to television antennas, but also wherever strength, rigidity and rust-resistance are important. It is available in all regular sizes and shapes of J&L Electricweld Tubing and in lengths up to 10 feet. Return the coupon TODAY for complete information on this new J&L product.

JONES & LAUGHLIN STEEL CORPORATION

From its own raw materials, J&L manufactures a full line of carbon steel products, as well as certain products in OTISCOLOY and JALLOY (hi-tensile steels).

PRINCIPAL PRODUCTS: HOT ROLLED AND COLD FINISHED BARS AND SHAPES • STRUCTURAL SHAPES • HOT AND COLD ROLLED STRIP AND SHEETS • TUBULAR, WIRE AND TIN MILL PRODUCTS • "PRECISIONBILT" WIRE ROPE • COAL CHEMICALS

Jones & Laughlin Steel Corporation
467 Jones & Laughlin Building
Pittsburgh 19, Pa.

Please send me complete information on the new J&L STEEL PERMA-TUBE mechanical tubing.

Do you recommend PERMA-TUBE for _____?

NAME _____
COMPANY _____
ADDRESS _____

TV

Receiver Production Changes

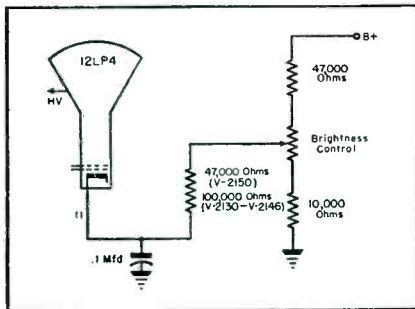

Fig. 1. Circuit modified to eliminate blooming in Westinghouse TV receivers; models 223, 242, 251, 231 and 226.

Fig. 2. Circuit developed for improvement of picture definition in Westinghouse model 242.

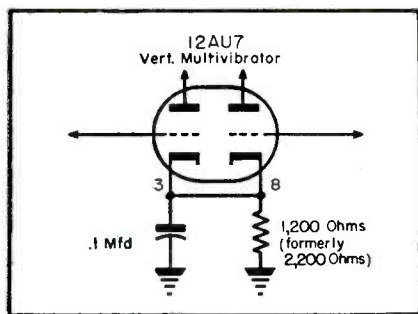
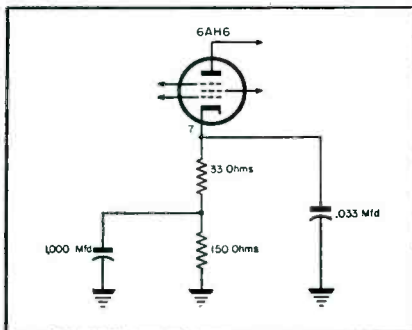
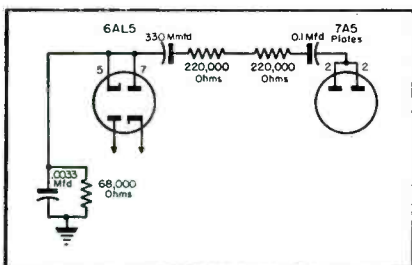

Fig. 3. Under some transmitter conditions a few retrace lines may not be blanked out at the top of the picture. If this condition is experienced the 2,200-ohm resistor, formerly installed in the cathode of the vertical multivibrator in Westinghouse receivers, should be changed to 1200 ohms as illustrated.



Addition of Power Transformer Fuse to Admiral TV Sets . . . Improvement of Picture Definition; Eliminating Blooming, Vertical Bars and Horizontal Line Humps in Westinghouse TV Models . . . Installation of AGC and Improved Horizontal Oscillator in Admiral Receivers.

by DONALD PHILLIPS

Admiral 20A1, 20B1, 21A1 TV Chassis

Power Transformer Fuse Addition:

To protect the power transformer in the 20 series¹ power supply from damage due to the failure of either the 6X5GT or 5U4G rectifiers, a 3-ampere, 250-volt fuse has been wired in the primary of the power transformer. The fuse is located in the second-anode-supply housing in a double fuse holder in the same location as used for the second anode power supply fuse. Therefore both fuses are in the second anode power supply housing.

If desired, a primary fuse can be added to early sets by clipping off the line cord plug and replacing it with a fused plug. The primary fuse will not blow out if the B+ becomes shorted but will blow if either rectifier becomes shorted.

If the tubes fail to light up, the 6X5GT and 5U4G should be checked for shorts and the primary fuse replaced.

¹These sets can be identified by the run number 16 (or higher) rubber stamped at rear of chassis.

Westinghouse H-217, H-217A and H-226

Increasing Picture Width: In early production versions of these receivers, some difficulty has been experienced

in obtaining sufficient picture width. If this condition occurs, the voltage divider (R_{501} , R_{502} , R_{503} and R_{504}) in the voltage-doubler circuit of the high voltage supply must be checked. In original production, the plate of the 1B3GT doubler tube was connected to the junction of R_{501} and R_{502} . To increase the picture width, the plate connection has been moved down to the junction of R_{502} and R_{503} .

Westinghouse H-223

Minimizing Picture Interference:

In early models, one side of the audio output transformer secondary winding was connected to the chassis near the transformer, and one of the speaker socket terminals was connected to the chassis near the socket. With these connections, the audio output currents were carried through the chassis for some distance, and under certain conditions disjointed or random sound bars appeared on the picture.

To remedy, the transformer secondary wire at the point where it connects to the chassis has been disconnected and connected to the grounded terminal of the speaker socket through an additional length of wire.

Westinghouse H-223

Use of EM Type Focus Coil: Permanent-magnet type focus coils were employed on some of the early models; coils can be identified by the part number V-6456 stamped on the coil. When these are used care must be executed

(Continued on page 28)

announcing . . .
The Greatest Advent in Speaker Development!

The New
PERMOFLUX
High-Fidelity
SPEAKERS

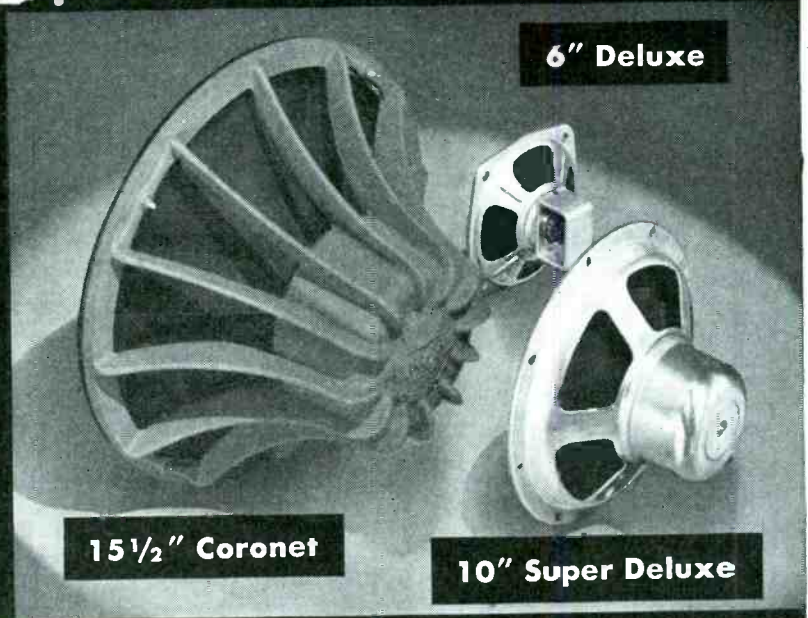

15 1/2" Coronet

6" Deluxe

10" Super Deluxe

A Special Treatment in Design that Eliminates Distortion!

These outstanding, new, deluxe high-fidelity speakers make PERMOFLUX, the most complete speaker line in the world!

SERVICEMEN — DEALERS

- Insist on the best!
- Buy PERMOFLUX Speakers!
- See your jobber today!

PERMOFLUX speakers will outperform, model for model, any speaker on the market.

PERMOFLUX HIGH-FIDELITY SPEAKERS						
<i>Deluxe High Fidelity Models—Heavy Magnets—No Pot Covers</i>						
SIZE	MODEL NO. OR CODE	MAGNET DATA FLUX GAUSS	VOICE COIL DATA DIA-METER	IMPE-DANCE	WATTS	
6"	6L-1	10000	3/4"	3.2	5	
8"	8T-8-1	10000	1"	8.0	8	
10"	10T-8-1	10000	1"	8.0	9	
12"	12T-8-1	10000	1"	8.0	10	
<i>Super Deluxe High Fidelity Models — Extra Heavy Magnets — With Pot Covers</i>						
8"	8WP-8-1	10000	1 1/4"	8.0	10	
10"	10WP-8-1	10000	1 1/4"	8.0	11	
12"	12WP-8-1	10000	1 1/4"	8.0	12	
15"	15WP-8-1	10000	1 1/4"	8.0	15	
<i>"Coronet" Supreme High Fidelity</i>						
12 1/2"	125Z-16	15000	2"	16 ohms	20	
15 1/2"	155Z-16	15000	2"	16 ohms	35	

NEW catalog available upon request. Write for your FREE copy!



PERMOFLUX CORPORATION

Two Factories to Serve You

Chicago 39, Illinois 4900 West Grand Avenue
 Glendale 5, California 236 South Verdugo Road

"I got
a **NEW DEAL**
thru **N.U.**



Says

MICHAEL S. COLAIANNI,
Globe Radio and Electronic Co.



"I got a New Deal when I modernize my service shop through the N.U. Dealer Equipment Plan . . . best of all AT NO COST TO ME. My new equipment helped increase radio and TV service earnings and brought in new business too. Now that I know about the N.U. Plan, I'll get all my equipment this easy way."

Sure! Mr. Colaianni is enthusiastic about the N.U. Dealer Equipment Plan . . . just as enthusiastic as thousands of other service technicians throughout the U.S.A. who were awarded equipment . . . at no cost.

Now! Any Serviceman Can Get New Equipment Thru the N.U. Dealer Equipment Plan

All YOU need do is tell your N.U. Distributor, "I want to go on the N.U. Dealer Equipment Plan." Select the equipment you want from your N.U. Distributor's stock . . . get on-the-spot delivery . . . and your day-by-day purchases of N.U. Tubes automatically make it yours.

N.U. has household, sports and travel gifts for you too . . . under the same plan.

National Union takes the money that ordinarily goes for extravagant consumer magazine advertising and gives it to you in the form of vital service equipment and valuable luxury gifts.

Use Premium Quality N.U. Tubes and Build a Bigger-Better Business

ONLY YOUR N.U. DISTRIBUTOR CAN OFFER YOU THE N.U. PLAN

See Him or write us today

NATIONAL UNION RADIO CORPORATION
ORANGE, NEW JERSEY

TV Production Changes

(Continued from page 26)

to avoid bringing another magnet into contact with the coil, because prolonged contact will alter the magnetization and affect the amount of current required for correct focusing. The focus control range will then be insufficient.

With the *pm* focus coils, the centering range is also less than that afforded by *em* type.² In view of these problems, the *em* coils were used in later production models. The connections are the same for both coil types.

²Range may adequate when a G.E. 10BP4 is used with a *pm* type coil.

Westinghouse H-223, 231, 242, 252, 216, 217, 226

Correction for Blooming: In some models, the picture was found to expand in all directions excessively as the brightness control was advanced. To correct a resistor was inserted in series with the brightness control. The correct value for the V-2150 series chassis is 47,000-ohm ½ watt and for the V-2130 and V-2146 chassis, a 100,000-ohm ½ watt resistor. This change went into effect in the H-223 at chassis No. D11635, H-242 No. A013681, H-251 No. D008727, H-231 all and H-226 No. H00847.

Picture Definition Improvement: Picture definition in the early 242 models has been improved somewhat by adding a 33-ohm ½ watt resistor in the cathode circuit of the 6AH6. In addition, a .033 mfd bypass has been added; part number on the capacitor is V-6023-4333M (the change went into effect at chassis number A013985).

Vertical Bars: Differences in tube characteristics of the 12AU7 horizontal multivibrator have resulted in a bright vertical bar appearing on the screen just before the set is locked-in horizontal sync. This has been cured by changing the value of the resistors in the voltage feed-back circuit to 220,000 ohms 1 watt each. This change was effective on the H-242 number A0152210.

Horizontal Line Hump: Some H-242's had a 4700-ohm waveform correction resistor in the plate circuit of the 12AU7 vertical multivibrator. Under certain transmitter conditions this may cause a wide separation of the top horizontal lines causing a *hump* which cannot be taken out with the vertical linearity control, to appear at the top of the picture. If this is the

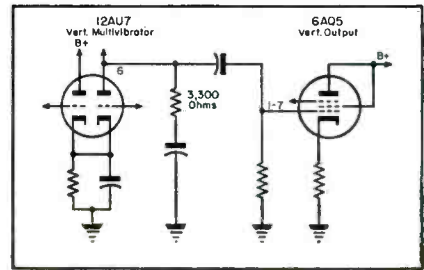

Fig. 5. Installation of a 3300-ohm ½-watt resistor in the vertical multivibrator circuit of Westinghouse receiver to remove the hump in top horizontal lines of picture.

case, the 4700-ohm resistor should be replaced by a 3300-ohm ½-watt resistor.

Admiral 20 and 30 Models

Automatic Gain Control: This feature was not included in the 30 series but is used in the 20 series for five reasons:

- (1) It automatically compensates for variations in signal strength and enables the operator to switch to various channels without frequent adjustments of the contrast control.
- (2) It acts as an automatic volume control on TV sound.
- (3) Eliminates picture flutter caused by airplanes.
- (4) Helps to eliminate picture changes caused by a swaying antenna leadin, or other causes of fluctuating signal strength.
- (5) It stabilizes the pulse voltages fed to the synchronizing circuits.

Horizontal Oscillator Circuit: In the 30 series receivers, the vertical oscillator is connected to *boot-strap* B+ circuit but the horizontal oscillator is not.

In the 20 series receivers, both vertical and horizontal oscillators obtain B+ from the *boot-strap* circuit and a fault in the *boot-strap* circuit can effect both height and width of the picture.

TENNA-ROTOR STORY ON TV



Sales and ad executives discussing series of six sound films, describing installation and operation of the Alliance Tenna-Rotor, which will be telecast over many TV stations throughout the country.

Standing from left to right: Miles C. McKearney, Alliance account executive, Foster & Davies, Inc.; J. Treacy, N.B.C. division manager of spot sales. Sitting from left to right: John Bentia, Alliance sales manager; Harold Gallagher, sales manager, WNBK, Cleveland; Hal Sweitzer, Alliance sales department.

SYLVANIA RECEIVING TUBE DATA BOOK

A revised 418-page edition of a manual containing basic application data for 637 receiving and cathode-ray tubes has been announced by the radio division of Sylvania Electric Products, Inc., Emporium, Pa.

Data supplied includes characteristic curves for tube types in common use; resistance coupled amplifier data; interchangeable tube charts; dictionary of tube, circuit, FM and television terms; and instruction on the use of characteristic curves.

Individual tube characteristics are arranged according to types.

Bound with ring type plastic spine; priced at eighty-five cents per copy. Available from Sylvania distributors or directly from Sylvania Electric, Emporium Pa.

* * *

ALLIED RADIO CATALOG

A 156-page catalog (No. 120), with listings of radio, television and electronic parts, test equipment, public address systems, television and radio sets and accessories, recording equipment and accessories (including wire, tape and disc recorders), 3-speed record players and changers, high-fidelity amplifiers, speakers, tuners and other components for custom installations has been published by Allied Radio Corp., 833 West Jackson Boulevard, Chicago 7, Illinois.

* * *

F. H. GARCELON NOW WITH HYTRON

Frederick H. Garcelon has joined the sales force of the Hytron Radio & Electronics Corp., and will operate out of New York to contact equipment manufacturers.

Garcelon was formerly president of UVX Industries, Inc., a sales agency which established distribution outlets for the Hytron sunlamp and other similar products.

* * *

STANCOR TV REPLACEMENT GUIDE

The third edition of the Stancor TV components replacement guide has been announced by Standard Transformer Corporation, 3580 Elston Avenue, Chicago 18, Illinois.

Replacement components, including transformers, chokes, deflection yokes and focus coils, for use in 108 TV receiver models are listed in this 4-page reference bulletin DD338B.

* * *

PLANET MFG. CORP. FORMED TO PRODUCE CAPACITORS

A new company, the Planet Mfg. Corp., 225 Belleville Ave., Bloomfield, N. J., has been organized to manufacture dry electrolytics.

Officers include Philip Greenspan, president; George F. Jephson, vice president in charge of sales; Irving A. Greenfield, treasurer, and Josef Unger, secretary, all of whom were formerly with Solar Manufacturing Corporation.

(Continued on page 44)

The little **SHURE** cartridges

that fill the Big need

for High Fidelity

Phonograph Reproduction . .

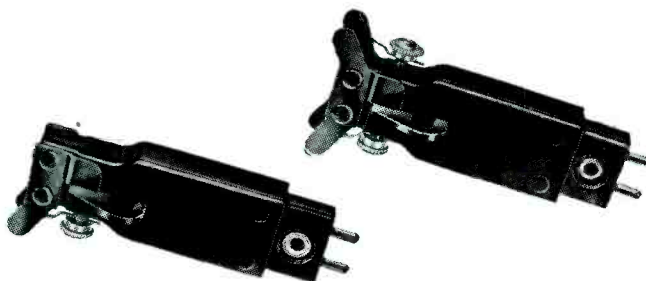

THE NEW SHURE "VERTICAL DRIVE"

CRYSTAL PICKUP CARTRIDGES

Big things often come in little packages . . . So it is with the superlative new Shure "Vertical Drive" Crystal Cartridges. They reproduce *all* the recorded music on the new fine-groove recordings—a reproduction that meets the strict requirements of high compliance and full fidelity. The "Vertical Drive" cartridges are requisite for the critical listener—the lover of fine music. They are especially recommended for those applications where *true fidelity* is essential.

SINGLE MODELS:

W 23 A for standard width-groove records.

W 21 A for fine-groove records.

TURNOVER MODEL:

W 22 A for both standard and fine-groove recordings.

Unusually highly compliant, these "Vertical Drive" Cartridges will faithfully track standard records with a force of only 7 grams—micro-groove records with a force of only 5 grams (an added protection for treasured recordings). Will fit standard or special mountings. Have more than adequate output for the average audio stage.

SHURE

SHURE BROTHERS, INC.

Microphones and Acoustic Devices

225 WEST HURON STREET, CHICAGO 10, ILL. • CABLE ADDRESS: SHUREMICRO

ASSOCIATIONS

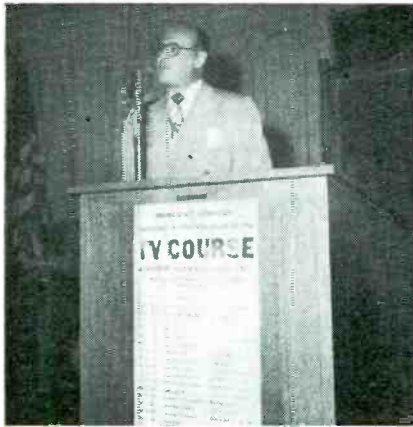

John F. Rider presenting the first TV Course lecture at ARTSNY in New York City.

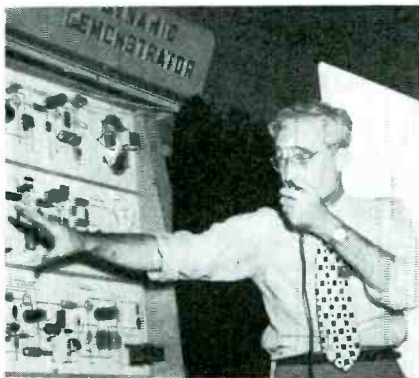

John Meagher describing the RCA TV dynamic demonstrator board at the recent PRSMA preventive maintenance meeting in Philadelphia.

Dave Krantz, PRSMA prexy, delivering the welcoming address at the Radio and TV Service Convention and Exhibit.



PRSMA

A STRIKING ATTENDANCE of nearly three thousand was recorded at the recent three-day Radio and TV Service Convention and Exhibit, sponsored by the Philadelphia Radio Service Men's Association at Town Hall in Philadelphia. This unique affair, designed to spiral interest in preventive maintenance, featured exhibits by approximately fifty representatives, distributors, manufacturers and publishers, and talks by such outstanding authorities as John F. Rider; A. T. Alexander, Motorola; Lou Calamaras, NEDA; George Devine, G. E.; Milt Shapp, Jerrold; Harold Harris, Channel Master; Carl Quirk, Du Mont; John Meagher, RCA; W. Hensler, Howard Sams; Caywood Cooley, Philco, and Ira Kamen.

Dave Krantz, PRSMA prexy, presented the address of welcome.

John F. Rider addressed a subsequent special session of PRSMA on the propagation of TV waves, the meeting being held at a studio of KYW in Philadelphia.

RETA, Ontario

IN AN EXTREMELY COMPREHENSIVE report to the *Round Robin Service* of Howard W. Sams on the organizational and operational program now in use by the Radio Electronic Technicians Association of Canada, appears a host of invaluable association activity information. A discussion of the aims and objectives of the association dis-

Lou Calamaras, executive secretary of NEDA, presenting the keynote address at the PRSMA meeting.



closes that the group was organized . . . to raise the prestige of the radio service profession in the eyes of the general public and the radio industry at large; eliminate unfair trade practices including price cutting, misleading advertising, charging for work not done, and material not used; offer reasonable and fair guarantees according to terms agreed upon; establish a code of ethics governing conduct and trade practices and set up a scale of suggested service charges.

An operational manual is also described in the report. The manual, planned to hold those responsible for the operation of RETA and its local districts, covers the activities of the officers and details all procedures to be followed. In a section on the duties of district officers, the manual covers the activities of the chairman, vice chairman and committee personnel. The information on committee personnel is particularly interesting, detailing that . . . the first function of a committee is to bring several minds to bear on a problem or a group of problems in order to arrive at a mature and comprehensive decision. A committee chairman, according to this manual, should attempt, insofar as he is able, to delegate the work of the committee to its members.

Examination procedures are also analyzed in the report and a suggested examination is presented. According to RETA the objective type of exam has been found very fruitful, with several types being used: *True-False*,
(Continued on page 33)

Carl Quirk of Du Mont presenting his talk on 'scopes at the Philadelphia gathering.



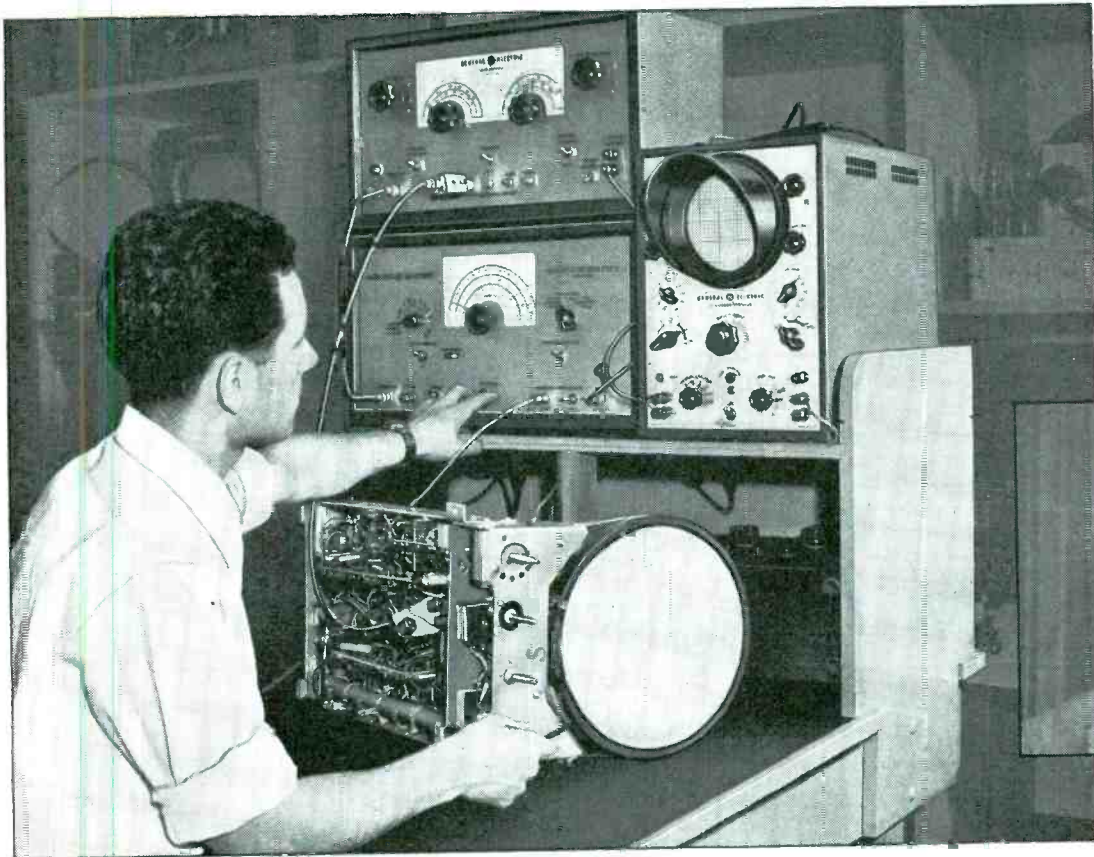

Says GENE ANTHONY
 Manager, Service Department
 General Electric Supply Corp.
 New York City



"MAKES TV SET ALIGNMENT EASY"

IN the biggest, fastest, toughest TV market in the world, TV set alignment is no longer a difficult, time-consuming job. Three new coordinated G-E test equipments now assure ease, speed, and accuracy in this work.

Says Gene Anthony, one of the best known service managers in New York: "The new G-E Test Equipment Package has improved our operation tremendously. Alignment work that used to require all the time of specialists

in our shop is now performed with full confidence by any one of our men. Operation and controls of the three instruments—Variable Permeability Sweep Generator, Crystal Controlled Marker Generator, and Cathode Ray Oscilloscope—are simple and easy to understand and can be taught quickly.

"With this equipment we do all kinds of TV service work—including mass alignments and the servicing of head ends as separate units."



You can put your confidence in—

GENERAL  ELECTRIC

General Electric Company
 Building 1, Room 1
 Electronics Park
 Syracuse, New York

Send me complete data on the new G-E Television Test Package.

NAME _____

ADDRESS _____

CITY _____ STATE _____



FIELD TESTED

Installation Information on

TV and FM

RECEIVING ANTENNAS

TV . . . FM Antenna Installation

by IRA KAMEN

Manager, Antenaplex and TV Dept., Commercial Radio Sound Corp.

and LEWIS WINNER

Editorial Director, Bryan Davis Pub. Co., Inc.; Editor, SERVICE and COMMUNICATIONS

The only practical book on the all-important item in TV and FM reception . . . based entirely on actual experiences in the most active TV and FM areas in the country. . . . Over 35,000 words of vital data with over 130 photos and drawings.

TEN CHAPTERS COVERING:

Installation Tools
Antenna Installation Procedures
Securing 12-Channel Coverage
HF Antenna Installations
TV Interference

Fringe Reception
Master Antenna Systems
FM Antennas
Installation Business Practices
Tricks of the Trade

The first book in which you'll find complete design and installation information on every type of TV and FM receiving antenna. . . . Contains detailed illustration and subject index for rapid reference.

✓✓ "The best book on the market at this time dealing with the problem of television antennas and antenna installation . . . If more Service Men would read this book, it would help them considerably in making better installations and providing better television reception for their customers."—*M. J. Shapp, President, Jerrold Electronics Corp.*

✓✓ "Will recommend it to all the Service Men and technical people I meet."—*Charles Cahn, Field Service Engineer, Bendix Radio.*

✓✓ "Well organized and illustrated, very complete and up-to-date, carefully detailed. It will definitely improve the ability of the man who studies it and therefore is mighty useful to a firm like ours."—*Hamilton Hoge, President, United States Television Mfg. Corp.*

✓✓ "Will certainly fill a long-felt need for some practical information . . . sincerest congratulations."—*George P. Adair, Former Chief Engineer, FCC, and now Consultant in Washington, D. C.*

✓✓ "A thorough-going compendium of the installing art . . . Going to recommend it highly to our Service Control Department and our service organizations."—*Ernest A. Marx, General Manager, Television Receiver Sales Div Allen B. DuMont Laboratories, Inc.*

✓✓ "Informative and extremely well written."—*R. Morris Pierce, Vice President in charge of Engineering, WJR, WGAR, KMPC.*

BRYAN DAVIS PUBLISHING CO., INC., Book Dept.
52 Vanderbilt Avenue, New York 17, N. Y.

Send me a copy of TV . . . FM Antenna Installation, post-paid, for which I am enclosing \$2.00.

(Please print)

NAME

ADDRESS

CITY AND STATE

AT YOUR JOBBER
 OR ORDER DIRECT



Price \$2 Post Paid

Association News

(Continued from page 30)

Multiple Choice, Matching Type, etc. There appears to be several advantages to this type of procedure. For example, these examinations do not, as a rule, require as much of the applicant's time. They are also much easier to mark. This can be done very quickly even by an inexperienced person providing he or she has the key. This type of examination also eliminates the possibility of the examiner's judgment entering into the marking, as the answer can only be right or wrong.

Typical *True-False* examinations have included thirty statements covering a variety of circuit, servicing, maintenance and installation problems.

In the *Best Answer Type* category, a score of questions have been used on all problems which might be met in the field.

ARTS'NY

TV COURSE sessions were recently inaugurated by the Associated Radio-Television Service Men of New York, in the grand auditorium of the Central Commercial High School in New York.

At the first session, John F. Rider appeared and offered a talk on TV transmission and reception.

Members of Philco offered the second course with a lecture on television front ends.

TEN YEARS AGO

(From the Association News Page of Service, October-November, 1939)

JOHN F. RIDER appeared at a session of the Boston chapter of RSA, held in the crystal ballroom of the Hotel Kenmore. . . . William Fuller was elected chairman of the Jersey City chapter and L. Coon was named vice chairman. Frank Johnson was renamed secretary; George Kuhn, Sr., was elected treasurer and William Iannuzzi was appointed sergeant-at-arms. . . . At the meeting of the Jersey City chapter, the service supervisor of Philco, Mr. Studeman, spoke. . . . NAB entered into a cooperative agreement with RSA to present spot announcements urging listeners to keep their receivers in repair at all times. Twenty-five chapters participated in the program. . . . W. Frank Cook of NRI appeared at a Washington chapter meeting and presented a talk entitled *Know Your Own Television Equipment*.



1. SAVE INSTALLATION TIME. Actually save enough for additional installations each week. Simplicity of Brach Antenna design, together with maximum pre-assembly at the factory, take whole hours of "time-on-the-roof" off your installation costs. And, for easier, quicker, on-the-job handling, Brach TV Antenna Kits are individually packaged, complete with all necessary hardware. Brach Universal Base Mount is a real time saver.

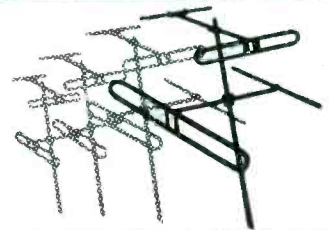

2. ELIMINATE EXPENSIVE CALL-BACKS. Brach quality engineering and bulldog ruggedness combine to help make your initial installation completely satisfactory. Developed by a name as old as radio itself, Brach TV Antennas are products of the manufacturer's own laboratory. From the rugged structural steel base mount to the tip of the sturdy mast, they're designed to stand up and shrug off the worst the weather has to offer—and deliver superior reception—longer. Factory pre-tuned and matched for 300-ohm transmission line, all Brach Antennas feature large-diameter aluminum elements for better signal pick-up.

3. MAKE PURCHASERS YOUR BEST SALES-MEN. The future success of your television line depends upon the success of your past installations. There's a Brach TV Antenna to meet every television problem better. Each Brach array you install puts you further ahead of your competition performance-wise.

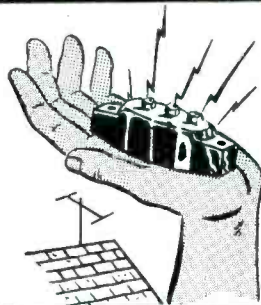
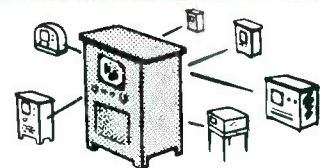

A NECESSARY EXTRA BRACH LIGHTNING & STATIC ARRESTER #4004

Helps keep the buck and jump out of the image when due to static discharge. Protects certain delicate receiver parts. Complete with all necessary hardware, the Brach Rare Gas Arrester is easily attached to any downlead. Constructed of porcelain and non-corrosive metal parts. Tested and listed by Underwriters' Laboratories.

SEND FOR BRACH CATALOG NO. S-1304



L. S. BRACH MFG. CORP.

200 CENTRAL AVENUE, NEWARK, N. J.

WORLD'S OLDEST AND LARGEST MANUFACTURERS OF RADIO ANTENNAS AND ACCESSORIES

PHONO *installation and service*

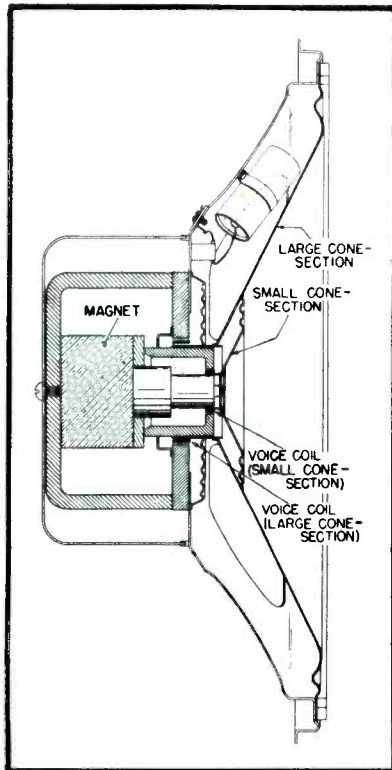

THE DEVELOPMENT of the microgroove record and its accompanying high-fidelity properties, has propelled interest in high-fidelity accessories, particularly speakers, an interesting example of which appears at left. This model, a duo-cone type¹, is a 15" permanent-magnet unit, capable of handling 25 watts input.

Developed by Dr. H. F. Olson of the RCA Laboratories Division, the speaker employs a unique magnet structure and vibrating system consisting of a dual cone, each section of which is driven by its own voice coil operating in its own air gap. Both air gaps are excited by a single 2-pound, Alnico V magnet. The two cone-sections are mounted in a single housing in such a way that the sound pressure from each cone emanates from approximately the same conical surface. A $\frac{3}{4}$ " voice coil drives the small cone-section to produce the high frequencies, and a 2" voice coil drives the

large cone-section to produce the lower frequencies. The small cone-section does not vibrate at the lower audio frequencies because its inner suspension is very stiff and its outer suspension to the large cone-section is very flexible. Over the range of cross-over frequencies, which centers at approximately 2000 cps, the two cone-sections vibrate as a single cone. Thus, the speaker has been found to avoid the cross-over interference characteristics of conventional high-low speaker combinations, and a multi-element cross-over network has been found unnecessary. Only an isolating capacitor is required to prevent excessive low-frequency power from damaging the high-frequency voice coil.

The magnetic structure consists of a single magnet arranged with pole pieces and yoke so that the magnetic paths form a bridge network to provide each air gap with equal flux density. The directivity is said to be approximately uniform over the entire frequency range within a total angle of approximately 60°.

Cut-away view of the duo-cone loudspeaker with the isolating capacitor installed.

Output Transformers

Two output transformers have been designed especially to operate with the speaker; for line to voice coil², and from tube to voice coil³. These units are multi-tapped for several input impedances.

Mounting

For highest operating efficiency, the speaker should be flange-mounted with the front edge of the large cone-section flush with the front of the baffle. The baffle should be part of an enclosure made of $\frac{3}{4}$ " plywood lined with a sound-absorbent material $\frac{1}{2}$ " to 1" thick. The enclosure should have an inside volume of approximately 5 to 10 cubic feet with a port-hole opening of approximately 30 to 100 square inches placed below the speaker mounting hole. An extension of the low-frequency response is obtained by the use of the larger cabinet.

Speaker can be used as a direct replacement for existing rim-mounted

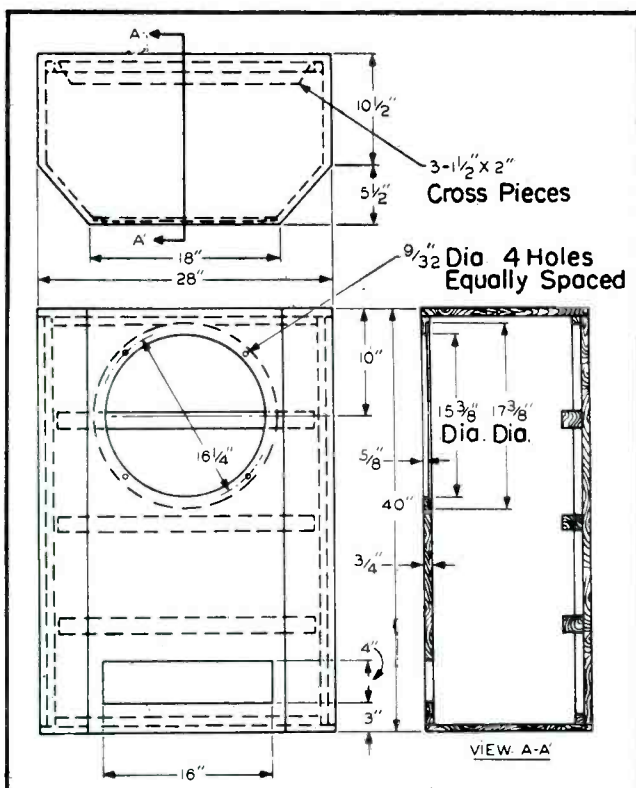

Dimensional outline of a typical bass reflex cabinet designed for the duo-cone speaker.

¹RCA 515S1.

Duo-Cone Hi-Fi Speaker Design . . . Two-Speed Record Changers for 7" Records . . . Use of Gram Scale to Check Tone Arm Needle Pressure and Vertical Friction.

by **KENNETH STEWART**

15" speakers, and can also be mounted in a flat baffle.

Admiral Two-Speed Record Changer

The microgroove trend has also prompted the design and production of a variety of changers for either the 33 $\frac{1}{3}$ or 45 rpm records or both. One manufacturer⁴ has introduced a changer to automatically play a series of ten 7" 33 $\frac{1}{3}$ rpm records or ten 7" 45 rpm records. A wide-diameter, plastic centerpost is used for playing 45 rpm records and a conventional, metal centerpost is used for playing 33 $\frac{1}{3}$ rpm records.

To play 45 rpm records, the large diameter centerpost is inserted into the hole in the center of the turntable. While holding the turntable with one hand, the centerpost is turned counter-clockwise until the lock-in-lugs fall into and lock in three slots in the turntable. To remove this centerpost, the turntable is held with one hand and the centerpost turned clockwise. Then it is lifted up.

To play 33 $\frac{1}{3}$ rpm records, the small diameter centerpost is inserted into the center of the turntable and pressed down until it locks in place. To remove this centerpost, it is lifted straight up and out.

45 RPM Operation

The turntable is driven by the smaller of the two rubber tires on a compound idler wheel, riding against the outer rim of the turntable.

The speed of the turntable is determined by the setting of a speed change knob. When the knob is in the 45 position, the larger rubber tire on the compound idler wheel rides against the 45 rpm section (larger diameter) of the motor drive shaft. When the knob is moved to 33, the compound idler wheel moves so that the larger tire rides against the 33 $\frac{1}{3}$ rpm section

(smaller diameter) of the motor drive shaft.

The changer mechanism is driven through a change cycle by a knurled hub of the turntable rotating the rubber tire drive wheel. During normal playing, the drive wheel does not touch the knurled hub of the turntable. As the needle enters the record spiral grooves and moves towards the centerpost, the pickup arm lever and stud move simultaneously, and rotate the trip bracket counter-clockwise. Since the trip bracket and drive wheel are on the same shaft, the drive wheel is pivoted approximately 10° counter-clockwise. The rubber tire contacts the knurled hub of the turntable, and is rotated in a counter-clockwise direction.

33 $\frac{1}{3}$ RPM Operation

The change cycle for 33 $\frac{1}{3}$ rpm operation is exactly the same as for 45 rpm operation, except for change cycle time and the fact that the 33 $\frac{1}{3}$ rpm records are supported by an offset on the 33 $\frac{1}{3}$ rpm centerpost and the 33 $\frac{1}{3}$ rpm record support, and are pushed off by a pushoff plate.

Trip Adjustment

This record changer employs the position-type trip; that is, it trips into change cycle when the needle in the pickup arm reaches a given distance from the center of the record. If the trip is properly adjusted, the record changer will trip into change cycle when the needle is between 2" to 2 $\frac{3}{16}$ " from the center of the hole in the turntable or approximately half way in on the spiral groove in the center of the record.

If the record changer does not trip at the proper position, it is then necessary to adjust a trip adjusting screw. Turning this screw in (clockwise) moves the trip point away from the



Dr. H. F. Olson of RCA Labs with the duo-cone loudspeaker he developed.

centerpost. Turning it out, moves the trip point nearer to the centerpost.

If the screw is turned all the way out, the changer may not trip. If it is turned in too far, the changer may trip before the record finishes playing.

This record changer does not have a conventional set-down screw adjustment. The pickup arm sets down properly unless the Allen set screw on the pivot collar is loosened, or excessive pressure has been applied to the pickup arm.

When properly adjusted for correct set-down, the needle point will set-down between 2 $\frac{9}{16}$ " and 2 $\frac{10}{16}$ " from the near side of the 45 rpm centerpost; between 3 $\frac{5}{16}$ " and 3 $\frac{6}{16}$ " from center of the hole in the turntable. Making this adjustment for 45 rpm records, automatically provides correct set-down for 33 $\frac{1}{3}$ rpm records.

The changer is designed so that when the needle rests 1/16" above the changer pan, the pickup arm will automatically lift high enough during change cycle to clear the top record of a stack of ten 33 $\frac{1}{3}$ rpm records on

(Continued on page 43)

Mrs. Tincie Dyer, chief telephone operator at the Texas Engineering and Manufacturing Co., Inc., plant in Dallas, Texas, operating a recently-installed 45-rpm system which is connected into the plant's sound system.



²RCA 21-T1.
³RCA 21-T1.

⁴Admiral.

UTAH IS OUT IN FRONT
 AGAIN... AN AMAZING SPEAKER
 Now Aluminum Voice Coils



FEATURES

ALUMINUM VOICE COILS
 All speakers thru 1" dia. V.C.
VULCANIZED CONES, SPIDERS
 Permanent, won't flutter.
POT & FRAME STAKED
 together. No spot welds.
BEAUTIFULLY FINISHED
 Bright cadmium plating.

A COMPLETE LINE OF NEW SPEAKERS READY FOR DELIVERY

JOBBERS! Here's good news—the re-engineered Utah Speaker line is better than ever. Write today for new catalog and prices. Ask for sample.



SPEAKERS
 Utah, Incorporated
 Huntington, Indiana

Aligning the H-196

(Continued from page 16)

and the junction of R_{103} and R_{104}); and the secondary of the sound discriminator transformer (L_5) is adjusted for zero voltage on the meter. The voltage will change polarity as the secondary is tuned through resonance and care must be exercised to determine exact zero. A medium strength signal should be used.

The sweep generator output is then turned on and adjusted for a center frequency of about 21.6 mc and a deviation of approximately 1 mc. The

output from the sweep generator should be attenuated to a low value. With the 'scope connected between the junction of C_{10} , C_{13} , and R_{11} and ground, the *cw* output of the variable *pip* marker should then be turned off and the *pip* amplitude control increased until a clear marker appears on the pattern. The marker should appear at the crossover point, and the discriminator pattern distributed symmetrically about the crossover point. The pattern should be linear for at least 75 kc on each side of the crossover point. This can be checked by moving the marker frequency 75 kc on each side of 21.6 mc. If the correct pattern is

not obtained, it may be necessary to slightly readjust L_6 or L_7 , L_2 , L_3 , and L_4 . The peak-to-peak response of the discriminator characteristic varies in different chassis but should be at least 500 kc.

The sound *if* pattern can be checked by disconnecting C_{112} and connecting the 'scope between the junction of R_{103} and C_{112} and ground. If L_1 , L_2 , L_3 , and L_4 are peaked too sharply, the band-pass may be insufficient.

Video IF: The 'scope is connected between the video test jack and ground, and a bias box (Fig. 4) connected between the *agc* line and the chassis. The sweep generator should then be set up for a center frequency of about 26.1 mc and a deviation of about 12 mc and attenuated to a low level. Using the *pip* output of the variable *pip* marker as a frequency indication, the trap adjustments C_{28} , L_{17} , and L_{12} must then be tuned for minimum voltage at 21.6 mc for L_{38} and L_{17} , 20.4 and 27.6 mc. L_{16} , L_{14} , L_{13} , and L_{11} must then be tuned at 23.8, 25.6, 25.9, and 22.3 mc, respectively, for maximum deflection of the marker *pip* from the base line. If it is necessary to adjust L_{13} , L_{14} , or L_{16} , their respective trap adjustments must be checked. The 'scope pattern obtained should be similar to that shown in Fig. 5, the solid line representing an ideal curve and the dotted line a typical response. If the pattern is not similar, corrections can usually be made by readjusting L_{16} and L_{20} . Adjustments to correct the response curve should not be made on any trap except L_{16} .

RF Alignment: The adjustment of the *rf* circuits on this model is a factory procedure. If misalignment of these circuits is encountered, it is advisable to contact the receiver manufacturer's service manager to determine the procedure which should be followed.

*Variable-frequency marker *pip* generator (Megaligner) covers a range of from 19 to 49 mc. Its output is available either as a marker *pip* (fed to a 'scope independent of the circuit under test), as a tunable *cw* signal source, or as a 4.5 mc crystal oscillator *cw* source. Instrument consists of an *rf* buffer amplifier, variable frequency oscillator and detector, an *af* amplifier, and a crystal oscillator. A switching arrangement permits the activation of either oscillator separately or of both (for purposes of calibration).

In developing a *pip*, sweeping oscillator signal from the Mega-Sweep is fed through the buffer amplifier to the variable oscillator and detector stage. The resultant beat note obtained from the variable oscillator and the incoming sweeping oscillator signal is passed on through a tuned (10 kc) network to the *af* amplifier and thence to the *pip* output terminals of the unit.

Servicing Helps

(Continued from page 18)

alignment of the ratio detector transformer (T₂) caused by removing C₁₁₉.

Admiral 20 and 30 Service Notes

Raster But No Sound or Picture:

In the 30 series this trouble is usually located in the rf tuner if the B+ and filament voltages are normal.

However, in the 20 series, since the sound is taken off at the first video if amplifier stage, (first production, the sound was taken off at the second video if) loss of the sound or picture could be caused by trouble in the tuner, audio channel or the first or second video if stages.

In the 20 series a fault in the 6AC7 (V₃₀₀) video amplifier plate circuit, such as an open circuit peaking coil, will cause the agc tube to draw excessive plate current and develop a high voltage across the (6AU6) agc tube plate resistors (approximately 15 volts) and cut off the rf and first and second video amplifier tubes. This fault may also be caused by a defective 6AC7.

Raster But No Picture: No picture in the 30 series usually indicates a trouble in the tuner or the video if channel, if there are no other troubles, such as a faulty power supply, etc.

In the 20 series, since the agc circuit controls the rf stage in the tuner and the video if channel, a defect in the agc circuit may cause a loss of picture.

If the agc circuit becomes inoperative, lack of control bias will cause the picture signal to develop a negative voltage across the video-detector load resistor which may be high enough to cut off the video amplifier tube. A defect of this nature may be checked by reducing the input to the receiver by removing the antenna from the set, since a picture will appear with a weak signal, under these conditions.

Sync Circuits: The sync circuits in the 20 series are similar to those in the 30 series but the agc circuit can cause trouble which may not be readily recognized.

If the agc circuit is only partly operative due to a weak agc tube or a defective component, the video amplifier may operate near cut-off due to the high negative voltage developed across the video detector load resistor. Under these conditions a picture may be received, but the sync pulses at video amplifier plate circuit may not

(Continued on page 38)

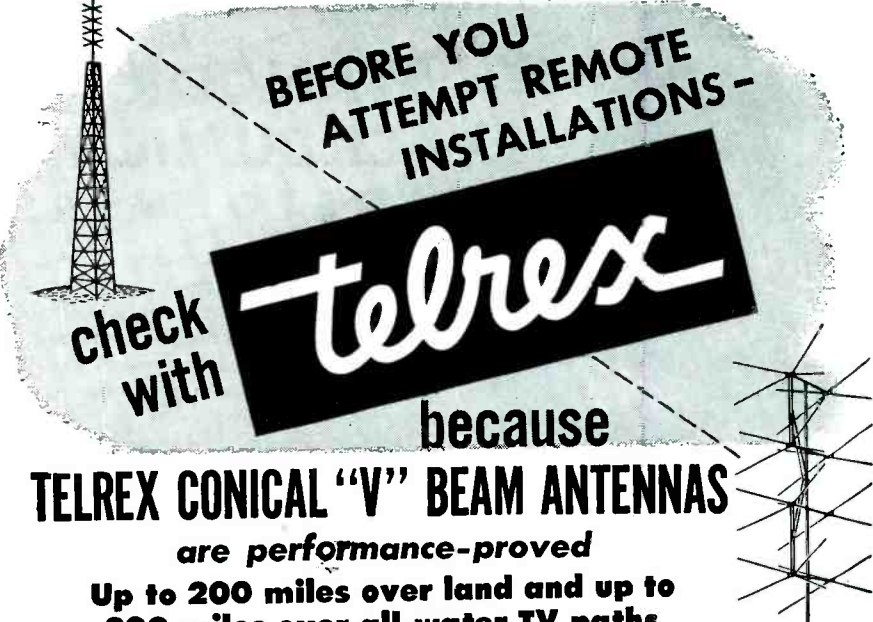

BEFORE YOU ATTEMPT REMOTE INSTALLATIONS -

check with **telrex** because

TELREX CONICAL "V" BEAM ANTENNAS

are performance-proved

Up to 200 miles over land and up to 300 miles over all-water TV paths

For both remote or high signal areas, Telrex Conical Window Mounts, Stacked Bi-Directionals and Stacked Arrays are the antennas dealers and service men can depend upon for consistently good results. Each type is thoroughly engineered in the laboratory, service-tested in the field and built for long service life. Using Telrex Conical Antennas on every installation is one sure way to better, brighter pictures and a minimum of service call backs. Ask your distributor for catalog or write direct outlining your antenna problems.

TELREX ANTENNAS COVER CHANNELS 2 TO 13 AND FM—NO HIGH FREQUENCY HEAD NEEDED

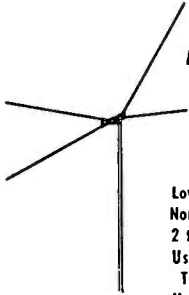

TELREX MODEL 1X-BD

Bi-Directional Hi-Gain Conical "V" Beam
Broad Band Full Audio and Video Band Pass
Low Vertical Angle
Non-Varying Center Impedance 2 to 1 Front to Back Ratio
Uses 72, 150 or 300 Ohm Transmission Lines
Universal Mounting Clamp

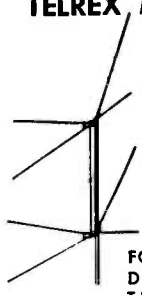

TELREX MODEL 2X-BD

Bi-Directional Stacked Conical "V" Beam
Low Vertical Angle
Extremely High Signal to Noise Ratio
Constant Center Impedance Uses 72, 150 or 300 Ohm Transmission Lines
Universal Mounting Clamp

FOR THE ULTIMATE IN BI-DIRECTIONAL GAIN, USE TELREX MODEL 4X BD.

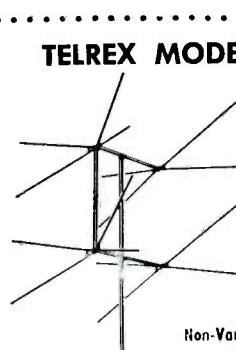

TELREX MODEL 4X-TV

2 Bay Uni-Directional Conical "V" Beam
Broad Band—Full Audio and Video Band Pass
Low Vertical Angle, Minimum Reflections
Maximum Signal to Noise Ratio 4 to 1 Front to Back Ratio All Frequencies
Non-Varying Center Impedance
Universal Mounting Clamp

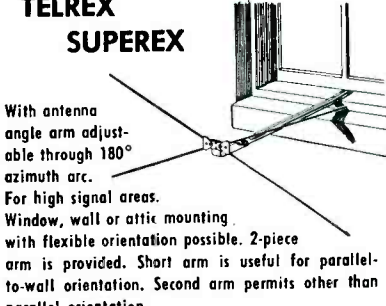

TELREX SUPEREX

With antenna angle arm adjustable through 180° azimuth arc.
For high signal areas. Window, wall or attic mounting with flexible orientation possible. 2-piece arm is provided. Short arm is useful for parallel-to-wall orientation. Second arm permits other than parallel orientation.

ALL TELREX ELEMENTS ARE MADE OF LASTING DURAL

telrex INC

ASBURY PARK 4, NEW JERSEY

AMERICA'S OUTSTANDING TELEVISION BEAM

For
profitable
TV
servicing

Use STANCOR EXACT DUPLICATE TRANSFORMERS

Every call-back you make means lost time and profits. Why take a chance with transformers that "almost fit?" You're sure of a good job and a satisfied customer when you use Stancor Exact Duplicate transformers for TV servicing. These units meet the exact specifications, electrically and physically, of the original components. Representative types are listed below.

Vertical Blocking - Oscillator Transformer. Stancor Part Number A-8121. Exact duplicate of RCA type 208T2. For generation of 60 cps required to drive grids of vertical discharge tubes.

Plate and Filament Transformer. Stancor Part Number P-8156. Exact duplicate of RCA type 201T6 used in model 630TS receiver.

Deflection Yoke. Stancor Part Number DY-1. Exact duplicate of RCA type 201D1. For use with direct viewing kinescopes such as 7DP4 and 10BP4.

Focus Coil. Stancor Part Number FC-10. Exact Duplicate of RCA type 202D1. For use with magnetically focused kinescopes such as RCA type 10BP4.

Horizontal Deflection Output and HV Transformer. Stancor Part Number A-8117. Exact duplicate of RCA type 211T1. For use with direct viewing kinescopes, such as types 7DP4 and 10BP4.

For complete specifications and prices of these and other Stancor TV replacement components, see your Stancor distributor or write for Television Catalog 337.

NEW—Ask your Stancor distributor for your copy of the latest edition of Stancor's TV Components Replacement Guide, Bulletin 338B. Lists Stancor replacement parts for 108 TV receivers made by 37 manufacturers. Or write us today.



STANDARD TRANSFORMER CORPORATION
3588 ELSTON AVENUE • CHICAGO 18, ILLINOIS

(Continued from page 37)

have sufficient amplitude to synchronize the sweep circuits.

If the foregoing faults are encountered, the negative *agc* voltage must be measured at the junction of R_{301} and C_{305} and chassis. This voltage should read approximately $-.05$ with no signal and approximately $-.5$ with an average to high signal.

Picture-Tube Damage Caused by Incorrect Adjustment of Ion Trap Magnet³

It is extremely important that the

ion trap magnet be correctly adjusted immediately after the set is first turned on during the installation. Improper positioning of the magnet may result in the development of circular areas of discoloration on the face of the tube. This is true even though the ions developed in the tube are being properly deflected. When the magnet is not correctly oriented, the electron beam strikes the edge of the aperture in the anode top disc instead of moving cleanly through the hole. The heat produced by the action vaporizes the metal of the disk, thus releasing gas which has a harmful effect on the tube.

Some of the vaporized material may be deposited on the screen of the tube and be apparent as darkened areas on the screen.

To adjust correctly the ion trap magnet, it must be positioned over the neck of the picture tube with the arrow on the magnet pointing toward the face of the tube. Then the set should be turned on, and with the brightness control adjusted for a *low* intensity, the magnet rotated around the neck of the tube and moved forward and backward until the raster is brightest on the screen. If, in obtaining the brightest raster, it is necessary to move the magnet more than $\frac{1}{4}$ " from the pole pieces in the tube, or if the magnet is pushed against the focus coil, the magnet may be weak and a new one should be tried. As a final check on the adjustment, the brightness should be adjusted for a clear line structure, and the ion trap magnet should again be adjusted for the brightest raster.

The ion trap magnet should never be moved to remove a shadow from the raster if the brightness is decreased by so doing. Shadows should be removed by adjusting the focus coil.

It is essential that the brightness control be kept at a low setting until the magnet has been initially adjusted. Furthermore, the magnet must be adjusted immediately after the set is first turned on. Picture tubes have been ruined in fifteen seconds by operating the brightness control too high when the ion trap magnet was incorrectly adjusted. However, in some cases it may take much longer for the darkened areas to appear on the screen, and the adjustment procedure should not be omitted merely because the set appears to be operating satisfactorily.

Ratio-Detector Alignment³

Although the television chassis and all test equipment should, in general, be bonded to a common ground, difficulty will be experienced during the ratio-detector zero adjustment if the common terminal of the *v_{trm}* is bonded (either directly or through the instrument case) to the television chassis. Both connection points for the *v_{trm}* during this adjustment are above ground in the TV chassis, and both *v_{trm}* terminals must therefore be isolated from ground.

Westinghouse H-216

Metal Tube Picture Distortion Due to Magnetism: If a strong magnetic field is brought near the 16AP4 picture tube, the metal cone of the tube can

³From data prepared by Westinghouse.

be magnetized sufficiently to cause objectionable distortion of the picture. The primary indication of this type of distortion is a kink in the edge of the raster.

Close contact of the tube's metal cone with any strong magnetic field must be avoided. The most likely cause of cone magnetization is contact of the metal cone with the frame of a *pm* speaker. Magnetized sections near the middle and small end of the cone produce the most disturbance. The magnetism is usually localized and can be detected with a pocket compass.

A magnetized cone can be demagnetized by the use of the *ac* magnetic field produced by a simple coil. A suitable coil consists of approximately 1,250 turns of No. 24 insulated copper wire wound on a form that is seven inches in diameter. Because such a coil will draw about 1 ampere at 117 volts *ac*, it will overheat if energized continuously; therefore, it should be used only intermittently. To demagnetize the cone, the coil should be energized and its flat side moved over the magnetized area. The coil should not be deenergized until after it has been moved away from the cone.

Westinghouse H-198, H-199 and H-203

Oscillation and Poor Sensitivity on FM Band: In later production models of this series, a resistor has been added and a capacitor deleted to minimize effects caused by production variances in 6AV6s. A resistor (470,000 ohms, ¼ watt) has been inserted in the lead between terminal 2 of the first 455 kc *if* transformer and the selector switch. The deleted capacitor has been connected between the *avc* line and ground; this capacitor is shown as C₃₅ on the H-198 schematic and as C₃₇ on the H-199 and H-203 schematics.

In case of oscillation and poor sensitivity on the FM band, a check should be made to determine that the capacitor is not present in any chassis in which the resistor has been inserted. If both the resistor and capacitor are present, the capacitor should be removed and the receiver realigned.

Westinghouse H-214 and H-214A

Critical Lead Dress: To prevent *if* oscillation, the green lead from the first *if* transformer to the 6SF7 grid should be dressed close to the chassis. The blue and green leads from the second *if* transformer should be separated as far as possible.

As a heat precaution, all leads must be dressed well away from the ballast resistor (R₁).



BUILD BETTER SERVICE BUSINESS
with this new booklet!

- Give customers a new appreciation of your service facilities
- Get the better, more profitable service calls

Every radio service magazine raved about this latest business builder from the makers and distributors of:

SPRAGUE CAPACITORS

Here is just the kind of advertising for your service business that you've been looking for! "Your Money's Worth in Good Radio and Television Service" is a handsomely 2-color lithographed 16-page booklet that tells customers a lot about service they probably never realized before. It shows why good service is worth good money. It explains the large amount of

costly equipment needed to repair complicated modern receivers properly. And it demonstrates to set owners exactly why and how the best service is cheapest in the long run. Each copy can be prominently imprinted with your name and address. Fill in and mail the coupon for sample copies and details—or see your Sprague distributor.

Write for FREE SAMPLE

Dept. S-109, Sprague Products Company
North Adams, Mass.

Please rush me a free copy of your new booklet "Your Money's Worth in Good Radio and Television Service" and explain how I can obtain additional copies for distribution to my customers.

Name _____
Address _____
City, Zone _____ State _____

Let GI's *Smooth Power* Line-up solve your record speed problems

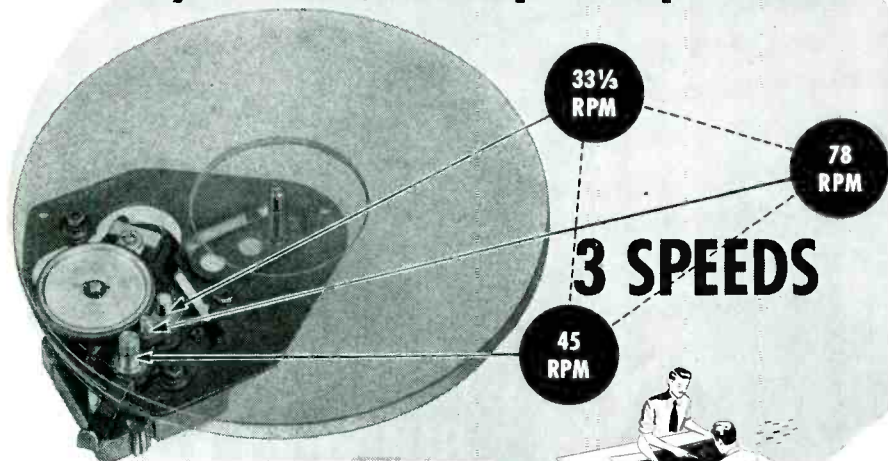

MODEL TS—45-78-33 1/2 R. P. M. General Industries' newest rim-drive phonomotor, designed to accommodate all types of records now on the market. Features include standard narrow flange turntable for compact installation, and ingenious speed-change mechanism which is both simple and positive in operation.

Single-speed phonomotor for 78, 45 or 33 1/2 R.P.M. operation . . . dual-speed motors for any two-speed combination of the above . . . and a low-cost rim-drive motor for all three speeds . . . that's the *complete* General Industries line-up which gives your designers and engineers the solution to their "which speed to use" problems.

And no matter what the choice, you get the same dependable *Smooth Power* motors which have made General Industries a leading name, as well as the oldest name in the phonomotor field. GI *Smooth Power* motors are engineered to meet exacting performance standards, and to provide trouble-free long life for the ultimate user. Every one of the GI motors is dynamically balanced to the degree necessary for excellent reproduction of records.

For full details, specifications and dimensions of General Industries' *complete* Smooth Power line of phonomotor motors, recorders and record changer-recorders, write *today* for a copy of the latest GI catalog.

TWO-SPEED MOTORS

General Industries offers you a choice of six different dual-speed combinations to take any two of the standard 2-pole rim-drive models, or a 4-pole rim-drive model for use in instruments in which the ultimate in performance standards is desired.

SINGLE-SPEED MOTORS

All five of the famous GI *Smooth Power* single-speed phonomotor motors now are available in your choice of 78, 45 and 33 1/2 R.P.M. speeds. Both 2-pole and 4-pole motors afford a complete range of selection to meet every operating requirement.

a maximum of about 3.5 volts peak-to-peak, when signals up to 1.0 volt are applied to the antenna terminals. For signal strengths greater than 1.0 volt at the antenna, it is necessary to remove the antenna coil section on that channel from the tuner to prevent overloading. Satisfactory reception has been found possible with as much as 10 volts antenna input signal.

Video System

The video system consists of a 6AU6 amplifier with associated wide band low-pass filters. The output of the detector is applied to a filter (L_3 wound on R_{16}) with sufficient bandwidth to pass 4.5 mc. As a result, the load resistor (R_{11}) must be small to minimize attenuation of the higher video frequencies.

Contrast is controlled by varying the amount of degeneration in the video amplifier stage. This is done by varying the resistance (R_{15}) in the cathode circuit. A control that has a multiple finger wiper on the resistor element is used to avoid producing a picture with noise streaks when the contrast is adjusted.

All of the coils in the video system are shunted with damping resistors. The series coils are loaded rather heavily to damp out transients which tend to accentuate picture sharpness, but affect contrast adversely. The design of the video system with the rest of the receiver provides a response characteristic which is fairly flat to 1 mc, is down 3 db at about 2 mc, and is down 6 db at 3.2 mc.

The video stage gain is 27 db measured at 100 kc with the contrast control set at maximum. Both the inter-carrier sound *if* (4.5 mc) and the synchronizing information are taken off the plate circuit of the video amplifier.

The video signal is applied to the cathode of the picture tube through a .2-mfd capacitor (C_{57}) at black positive polarity. The cathode is returned to the brightness control (R_{51}) through a 100,000-ohm resistor (R_{50}). The *dc* restoration for holding black level is accomplished in a rather unusual manner. Two variables are involved; the voltages on both cathode and grid of the picture tube. When a signal is applied to the cathode it tends to hold white level constant with respect to ground. Examination of the signal voltage on the cathode, as observed on a *dc*-connected 'scope, will show the white level holding constant and the sync and black level increasing as contrast is increased. Simultaneously, the output of the video amplifier is applied to the sync limiter tube which is biased



The GENERAL INDUSTRIES Co.
DEPARTMENT O • ELYRIA, OHIO

Ser-Cuits

(Continued from page 22)

two stages to minimize the variation of input capacity with *agc* voltage changes. With the values used at 4 volts bias, there is only .5 db variation from peak response in picture carrier location.

A 1N60 crystal is used as the video detector. It is similar to the 1N34, except that it has been tested dynamically and thus has been found to provide improved efficiency. The detector load resistor (R_{11}) is rather small be-

cause of the requirements of the video system.

Design of the *if* system provides for an overall response curve which is flat-topped with a bandwidth of at least 3.6 mc within 6 db. The picture carrier, 25.75 mc, is 6 db down from the peak response and the band center is approximately 23.95 mc. The sound carrier, 21.25 mc, is attenuated 32 db by the sound *if* trap, coil (L_{104}), the secondary of T_{100} .

AGC System

The *agc* action is designed to hold the signal at the video amplifier grid to

at approximately 4 volts under no signal conditions. Increases in signal level on the grid of the sync limiter tube will cause the average plate current to increase, with a resultant *dc* cathode voltage increase equal in magnitude to about 75% of the applied peak-signal voltage. A total of 44,000 ohms (R_{34} and R_{35}) is in the sync limiter cathode circuit to produce a *dc* voltage variation that will be sufficient to approximate the required amount. The cathode resistance is tapped at the center point to give the proper bias to the tube. The 75% ratio was selected so that the net voltage between the grid and cathode of the picture tube would be representative of the black level voltage at the peak of the blanking pulses. The *dc* is applied to the picture-tube grid simultaneously with the video signal on the cathode. The grid cathode voltage will maintain black level for a wide range of signals. This can be observed by placing a *dc*-connected 'scope between grid and cathode.

Sound System

As mentioned previously, intercarrier sound reproduction is used. By this method the 4.5-mc beat note between the picture and sound carriers is utilized. The sound carrier has been attenuated 32 db from the peak video level, which is a very satisfactory level for obtaining in the output of the video detector, a 4.5-mc beat frequency, which is frequency modulated at the sound frequency rate and thus contains no appreciable amplitude-modulation components.

The sound system consists of a 6AU6 driver amplifier, 6T8 ratio detector and first audio amplifier, and a 6AQ5 audio-output amplifier. The 4.5-mc signal is applied to the driver tube from the tap on an adjustable coil (L_{14}) which is in series with 1.5-mmfd capacitor (C_{12}) connected to the plate of the video amplifier. The series-tuned circuit serves as a trap for attenuating 4.5 mc in the video channel. The small C_{12} coupling capacitor minimizes the addition of capacity across the video filter. The grid of the driver tube is fed from a tap on a coil (L_{14}) to keep the impedance in the grid circuit low enough to eliminate instability due to plate-grid feedback. In addition, loading of the video circuit is also avoided when the driver tube draws grid current upon application of the 4.5-mc signal. Limiting action is obtained in the grid as well as the plate, which with the screen, operates at a low *dc* potential.

The driver-amplifier tube is con-
(Continued on page 42)

The good little lamp that's seen but not heard

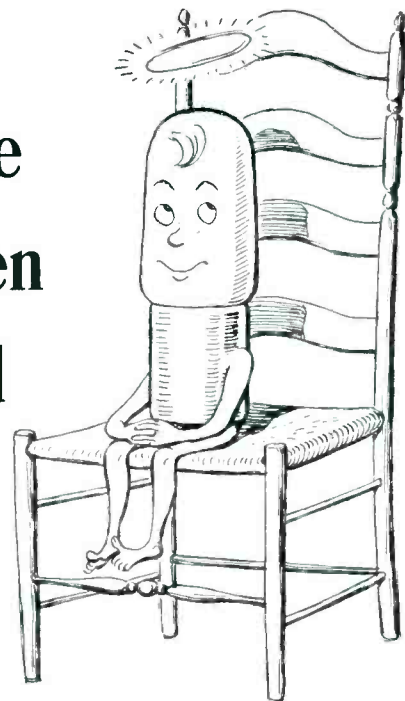

INTERFERENCE with radio reception is not part of the job of a properly designed radio dial lamp. Yet some lamps *do* interfere, when vibration and poor contact between the filament and lead-in wires cause tiny arcs and minute changes in resistance.

That can't happen in G-E radio dial lamps because the tungsten fila-

ment legs are pressed firmly right into the softer metal of the lead-in wires—a vibration-proof joint.

Features like this assure customer satisfaction. For information on prices and types of G-E miniature lamps, see your nearby G-E Lamp Office. Or write to General Electric Company, Div. 166S-10, Nela Park, Cleveland 12, Ohio.

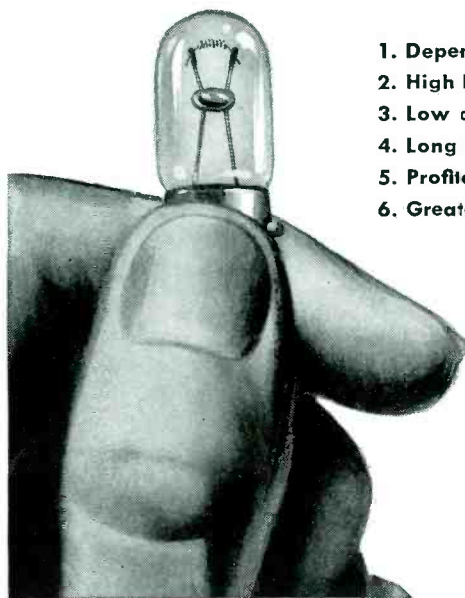

1. Dependable, trouble-free performance.
2. High level of maintained light output.
3. Low current consumption.
4. Long life.
5. Profitable to handle.
6. Greater dealer acceptance.



You can put your confidence in—

GENERAL  **ELECTRIC**

Compare...

CIRCLE-X TV ANTENNA TO ANY OTHER TV ANTENNA

The mechanical and electrical construction of Circle-X antenna is unsurpassed. No other type of antenna combines all the features that are engineered into the Circle-X.

	One Type Antenna for all jobs	Low Installation Cost	Light Weight	Rigidity	One Wire Lead in	High Gain	Wide Angle Reception	No High Frequency Head	Eliminates Ghosts	Eliminates Service Recalls
Circle X	X	X	X	X	X	X	X	X	X	X
Brand A		X		X		X				
Brand B				X	X	X	X			X
Brand C				X	X					
Brand D				X				X		
Brand E				X		X				
Brand F		X	X	X		X				

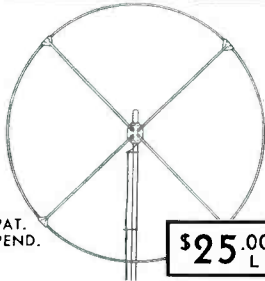

PAT. PEND.

\$25.00 LIST

DEALERS: Air Express or Parcel Post Special Delivery direct from factory to you through your jobber, if he cannot supply you with the Circle-X from his stock.

CIRCLE-X ANTENNA CORP.
503 MARKET ST., PERTH AMBOY, N. J.

The high gain of the Circle-X is equal to stacked arrays. It is made of the light weight corrosion resistant aluminum alloys that have been used for many years, exposed to salt spray and other adverse atmospheric conditions.

The Circle-X gives clearer, sharper pictures on all channels (no high frequency head needed). It eliminates the necessity of having a rotor or reflectors. It is perfectly matched to 72,150 and 300 ohm receiver input circuits.

CIRCLE X

ANTENNA CORPORATION

Sync Separation

Video signals are applied to the grid of a sync limiter tube from the plate of the video amplifier tube through an isolating resistor of 47,000 ohms (R_{10}) and 0.05-mfd capacitor (C_{11}). Isolation between the video amplifier plate circuit and the grid of the sync limiter is required to avoid adding excessive capacity to the video plate circuit which would reduce video bandwidth.

Clipping and limiting are accomplished in both the grid and plate of the sync limiter. The grid develops its own bias and the plate is operated at very low *dc* potential. Approximately one-tenth of this amplitude is fed through an integrating network and a 2,000-mmfd coupling capacitor (C_{31}) to the vertical oscillator tube. The full signal amplitude is applied to the horizontal deflection system through a differentiating circuit consisting of C_{10} and R_{14} .

Vertical Deflection System

The vertical-deflection system consists of a free-running multivibrator which is locked into synchronism by vertical triggering pulses. The output of the multivibrator (V_{11}) is fed into the vertical deflection coils (L_8 and L_9) without the use of further amplification. The multivibrator employs both halves of a 6SN7 tube.

Horizontal Sweep System

The horizontal sweep system consists of a *beam relaxer* oscillator which is connected directly to horizontal de-

Build YOUR OWN Heathkit TEST EQUIPMENT

Heathkit AUDIO GEN. KIT \$34.50

Heathkit TELEVISION GENERATOR KIT \$39.50

Heathkit SIGNAL TRACER KIT \$19.50

Heathkit CONDENSER CHECKER KIT \$19.50

NEW Heathkit IMPEDANCE BRIDGE SET \$69.50

NEW Heathkit HANDITESTER KIT \$13.50

Heathkit TUBE CHECKER KIT \$29.50

Heathkit 5" OSCILLOSCOPE KIT \$39.50

Heathkit BATTERY ELIMINATOR KIT \$22.50

Heathkit ELECTRONIC SWITCH KIT \$34.50

Heathkit R.F. SIGNAL GEN. KIT \$19.50

Heathkit VACUUM TUBE VOLTMETER KIT \$24.50

Heathkits are beautiful factory engineered quality service instruments supplied unassembled. The builder not only saves the assembly labor cost but learns a great deal about the construction and features of the instrument. This knowledge aids materially in the use and maintenance of the equipment. Heathkits are ideal for and used by leading universities and schools throughout the United States. Each kit is complete with cabinet, 110V 60 cycle transformer (except Handi-Tester), all tubes, coils assembled and calibrated, panel already printed, chassis all punched, formed and plated, every part supplied. Each kit is provided with detailed instruction manual for assembly and use. Heathkits provide the perfect solution to the problem of affording complete service equipment on a limited budget. Write for complete catalog.

HEATH COMPANY

BENTON HARBOR, 11 MICHIGAN

EXPORT DEPARTMENT
12 EAST 40TH STREET
NEW YORK 18, N.Y.
CABLE - ARLAB - N.Y.

deflection coils (L_{10} and L_{11}) and a phase detector tube which is used to synchronize the *beam relaxer* oscillator tube.

The horizontal oscillator employs a 6BQ6GT in a *free running oscillator* circuit to supply a linear sweep current through the horizontal deflection coils.

The synchronizing system used to lock the oscillator in step with the synchronizing pulses employs a 6SN7, in which one section of the 6SN7 is used as a sync clipper and phase inverter, and the other portion as a phase detector.

Phono Service

(Continued from page 35)

the turntable and will not lift high enough to strike the bottom record of a stack of $33\frac{1}{3}$ rpm records to be played.

Gram Scales⁶

In previous discussions, it has been pointed out that the gram scale is an extremely important item in record-player trouble shooting. The mechanism provides a means of measuring tone-arm needle pressure and vertical friction.

In applying one type, the Philco gram scale⁶, for needle-pressure evaluation, it is first held on its side and the pointer set to the center line of the scale. This is the 0 point, and each small division on either side of the 0 is equal to one gram on the turntable. After the scale has been set to 0, it is placed on the turntable with the guard on the scale in an open position, at right angles to the scale. Now the needle of the tone arm is set into the hole at the end of the pointer and the reading on the scale observed. This reading is the needle pressure; the correct needle pressure for the Philco arm is 6 to $7\frac{1}{2}$ grams.

To determine vertical friction the head of the pickup is pressed down and then allowed to return to its normal position, and the reading noted. The pickup is then raised slightly, and then gently lowered to the normal position, with the reading again noted. The vertical friction is the difference between the two readings obtained. For example, if the scale reading is $7\frac{1}{4}$ grams after the pickup is depressed and released, and is $6\frac{3}{4}$ grams after the pickup is raised and lowered, the vertical friction is $7\frac{1}{4} - 6\frac{3}{4}$ or $\frac{1}{2}$ gram. The vertical friction should not exceed 2 grams.

⁶From Philco service notes.
⁷Philco part No. 45-9531.

RACON LOUDSPEAKERS . . . America's Finest Since 1922



QUALITY

"There is hardly anything in the world that some man cannot make a little worse and sell a little cheaper . . . and the people who consider price only are this man's lawful prey."

—RUSKIN

Pretty smart chap, this Ruskin.

Styles may have changed since his time, but basic thinking remains the same. There are still many of us who believe the best is the least expensive in the long run and will not accept any shortcuts to quality.

Racon Electric Co., Inc., was founded twenty-seven years ago with the clear conviction of the kind of products to make . . . the best public address loudspeakers it was in their power to produce, without any compromise to accepted acoustical theory or craftsman's honor.

Today, Racon has not only a national but an international reputation for quality. Users of Racon loudspeakers range from industrial, marine and railroad companies to educational institutions and U.S. and foreign government agencies.

Where specifications call for the finest loudspeaker, you will find that sooner or later, they gravitate to Racon.

All Racon products are guaranteed for 18 months.

SOUND TECHNICIANS AND SERVICEMEN — For full details on our complete line of Public Address and Wide Range Loudspeakers, see your favorite parts jobber, or write for Catalog S.

Sound
Equipment
Manufacturers

Racon Electric Co., inc.

52 East 19 St.
New York 3,
N. Y.



Symbol of Acoustical Excellence Since 1922

NOW—A SENSATIONAL, LOW-COST JACKSON *Dynamic** TUBE TESTER

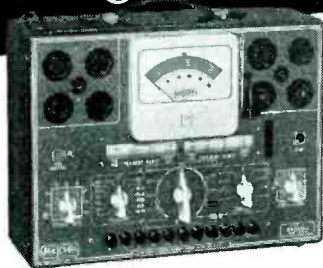

the NEW JACKSON CHALLENGER model 103—only \$49.50

Now you can buy a genuine Jackson Dynamic Tube Tester at an amazing low price. It's ideal for the serviceman who needs an extra tester, for the man just starting in business, or the ham or experimenter. Look at these specifications.

Dynamic* Test Method—First used by Jackson test tubes under actual load conditions.

Tests Over 700 Types—Including TV rectifiers and sweep tubes.

*TM Reg. U. S. Patent Office

**JACKSON ELECTRICAL
INSTRUMENT COMPANY**
Dayton 1, Ohio

Built-In Roll Chart—With free 1 year replacement.

Quick Set-Up—Combination Push-Button and rotary switch selectors.

Tests For Shorts—With neon indicator. Many other famous Jackson features!

Two More Low-Cost Jackson Instruments!—A new Jackson Challenger VTVM, and a new Jackson Challenger RF Oscillator are on the way. Only \$49.50 each!

Makers of Jackson "Service-Engineered" Test Equipment • Tube Testers • VTVM's • Condenser Checkers • Audio Generators • RF Generators • FM-AM Sweep Generators • Television Sweep Generators • Oscilloscopes.

ASK YOUR DISTRIBUTOR FOR FULL INFORMATION

SNYDER TV ANTENNA FREE TRIAL OFFER

A ten-day free-trial offer on the Redi-Mount line of TV antennas, either conical or hi-lo type, has been announced by the Snyder Mfg. Co., 22nd and Ontario Sts., Philadelphia 40, Pa.

The free-trial offer will prevail in selected areas, through jobbers and distributors.

Commenting on this move, Snyder sales manager Dick Morris said: "This offer is absolutely unqualified. Any Service Man can get a Snyder TV antenna without obligation. He can install it and test it in every way he wishes.

"If, after ten days, he is not fully satisfied, he may return it and the company will pay all shipping charges both ways. If the Service Man is fully satisfied, he may keep it and he will be billed through the jobber or distributor."



Snyder Lazy X

SHELDON ELECTRIC NOW MAKING TV PICTURE TUBES

Sheldon Electric Co., Irvington, N. J., has announced its entry into the television field with a line of 10", 12½" and 16" flat-face, all-glass picture tubes. The company has been merged with and is now operated as a division of Allied Electric Products, Inc.

Nathan Chirelstein, president of the corporation, in 1925 organized and became president of the Sonatron Tube Co. In 1929, Sonatron Tube became part of the National Union Radio Corp., and Chirelstein became president and a director. He resigned after one year's service. In 1935 he organized Allied Electric Products, Inc., Sheldon Electric Co. and an affiliated corporation.

* * *

G. E. DEVELOPS HIGH-SPEED TUBE TESTER

A machine which automatically tests a new tube every 30 seconds has been developed by the tube divisions of G. E. and is now used in the production of mercury and gas-filled thyratrons. Previously it took four minutes for each tube to be tested.

Operated by one person, the machine puts each tube through tests on grid emission, peak arc drop (cathode emission) filament resistance (current), anode breakdown voltage, and grid bias to control breakdown. The latter test is made under two voltage conditions.

ALEXANDER NORDEN, JR. APPOINTED BY CORNISH WIRE

Alexander Norden, Jr., has joined Cornish Wire Co., Inc., 15 Park Row, New York, N. Y. He will develop a new division, the wired assemblies division, which will concentrate upon the designing, engineering and manufacturing of staple and specialized electrical wire assemblies for manufacturers of radio and TV equipment.

Norden was formerly executive vice president of L. S. Brach Mfg. Co., Newark, N. J. He was also founder and president of Interstate Mfg. Corp., Newark, N. J.



A. Norden, Jr.

* * *

VOLUME THREE OF RIDER TV MANUAL COMING OFF PRESS

The third volume of the Rider TV manual will be published in November in a new size, with pages approximately 12" x 15".

* * *

HARPER NAMED HEAD OF MECK SPECIAL PRODUCTS DIV.

Sam M. Harper has been appointed director of the special products division of John Meck Industries, Inc.

WARD LEONARD CATALOG

A relay catalog, D-20A, has been released by Ward Leonard Electric Co., Electronic Distributor Division, 53 W. Jackson Blvd., Chicago 4, Ill.

Catalog illustrates and describes various types of relays, (sensitive, midget metal base, heavy duty midget, midget magnetic, heavy duty power, thermal time delay and motor driven time delay). Offered are data on contact ratings, coil specifications, sizes, and other helpful data on *ac* and *dc* units.

* * *

BEN JOSEPH NAMED N. Y. REP. BY COLUMBIA WIRE

Ben Joseph has been appointed New York rep for the Columbia Wire and Supply Co., Chicago, Illinois, national distributors and warehouse for Anaconda Densheath TV and radio wire and cables.

* * *

HATRY REELECTED NEDA PREXY

Louis W. Hatry has been reelected NEDA president. Other reelected officers include: Arthur C. Stallman, first vice president; A. W. Greeson, Jr., second vice president; Aaron Lippman, treasurer, and Lealis L. Hale, secretary.

* * *

J. F. BOZELLI JOINS BRACH

Joseph F. Bozzelli has been appointed assistant sales manager of the L. S. Brach Manufacturing Corp., Newark, N. J.

Bozzelli was formerly a sales engineer at JFD Mfg. Co.

New TV Parts . . . Accessories

CHANNEL MASTER TV FAN FLECTOR ANTENNA

A *Fan Flector* TV antenna has been announced by Channel Master Corp., Ellenville, N. Y. Combines fan type elements which are said to provide uniform high impedance, and *vee*-type alignment of these elements for narrow lobe, high-gain characteristics on the high band.

Three models are available: single bay, the BM 312, with gains from 2 to 4 db on the low band and 5 to 6½ db on the high band; stacked, the BM 312X2, with gains of 5 to 7 db on the low band and 8 to 11 db on the high band; double stacked, the BM 312X4, with gains of 7½ to 9 db on the low band and 10½ to 11¾ on the high band.

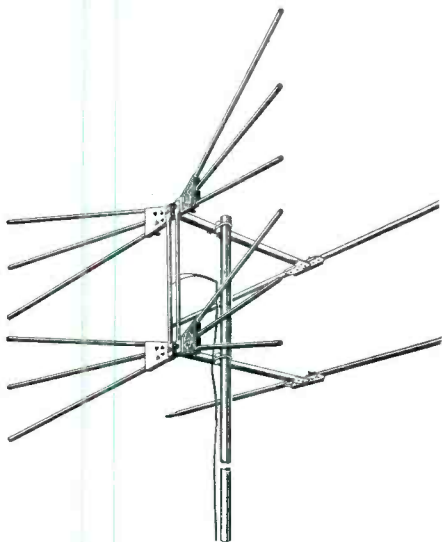

* * *

DECIMETER TV BOOSTER

A 2-stage TV preamp featuring a balanced triode amplifier and three tuned circuits on each channel, has been announced by Decimeter, Inc., Denver, Colo. Gain of over 30 db said to be available.

Channel-switch mechanism projects channel number upon a two-inch screen.

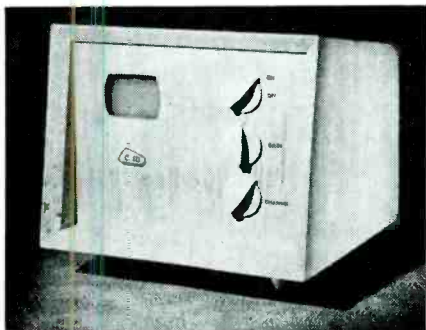

* * *

UNIVERSAL TV TOWER TRIPOD

An adjustable portable tripod to hold a TV tower for temporary installations, has been developed by The Universal Products Company, Racine, Wisc.



The TURNER 87

One look at the Turner Model 87 and you sense immediately here's a microphone masterpiece. Every detail of its attractive gunmetal case and polished chrome screen reflects the precision and care behind its manufacture. The Turner Model 87 is a single ribbon velocity type microphone with the Figure 8 Polar Pickup pattern so desirable in highest quality recording, public address and studio broadcast work. List price **\$47.50**

POLAR PICKUP PATTERN

The figure 8 pattern illustrated by the diagram shows the attenuation of sound arriving from sources at 90° from front or rear of microphone.

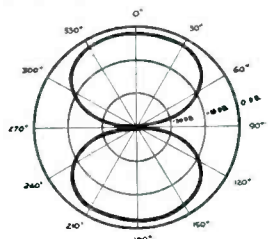

Write for Bulletin giving complete details

TURNER

The shorter way of saying "Sound Microphone Performance"

THE TURNER COMPANY

930 17th Street N. E., Cedar Rapids, Iowa

IN CANADA:

Canadian Marconi Co., Ltd.
Montreal, P. Q., and Branches

EXPORT:

Ad. Auriema, Inc.
89 Broad Street, New York 3, N. Y.



Licensed under U. S. patents of the American Telephone and Telegraph Company, and Western Electric Company, Incorporated. Crystals licensed under patents of the Brush Development Company.

...Help end spark plug INTERFERENCE



Spark Plugs are miniature broadcasting stations, send signals that interfere with radio reception, distort television. The New Auto-Lite "Resistor" Spark Plug reduces this interference.*



Recommend NEW AUTO-LITE Resistor SPARK PLUG

Here's How It Works to End Interference

The "Resistor" acts to dampen the spark plug radio signal to an acceptable level* while still delivering the full high voltage discharge required to ignite the fuel.

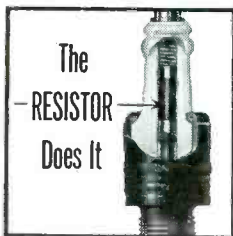

Auto-Lite Ignition Engineers, working with leading automotive manufacturers, have developed the new Auto-Lite "Resistor" Spark Plug with this built-in resistor that reduces spark plug interference.* Remember, the "Resistor" also helps deliver smoother idling, improved economy, longer electrode life. Dealers are being supplied as rapidly as possible. Write for Booklet M-1186 for full information.

THE ELECTRIC AUTO-LITE COMPANY
Toronto, Ontario Toledo 1, Ohio

*Under 35mv/m from 540 k.c. to 150 m.c. at 50 ft.

Tune in "Suspense," Thursdays, 9:00 P. M., E. T., CBS

TACO LAZY H ANTENNA

An improved version of the lazy H type 912, has been announced by Technical Appliance Corporation, Sherburne, N. Y.

High-frequency whiskers have been added to the dipoles to give a single lobe of greater gain in the high frequencies. An additional reflector is so spaced to serve these higher channels. Antenna features jiffy-rig factory pre-assembly, all-aluminum construction.

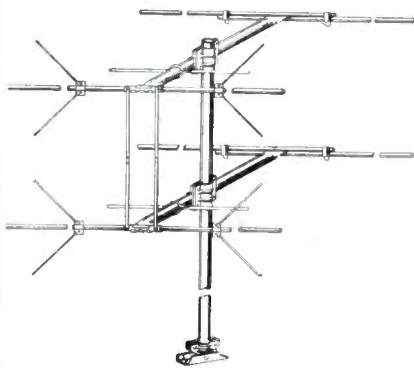

* * *

WALCO TV TOWER

A triangular-constructed TV tower made of aircraft tempered aluminum and said to weigh less than one pound per foot, has been announced by Walco Products, Inc., East Orange, N. J.

The tower is fitted with a hinged base plate which makes it possible to mount on a pitched roof, as well as on a flat surface. Top of the tower is fitted with an adjustable clamp.

* * *

RAYTHEON TV TUBES

Two new tube types, 1X2 and 6BQ6GT, for TV receiver use, have been announced by Raytheon Manufacturing Co., Newton, Mass.

The 1X2 is a filament type rectifier of miniature construction designed for use as a high voltage rectifier.

The 6BQ6GT with a T-9 bulb is a beam pentode for use as a horizontal deflection amplifier. Plate connection on this tube is made through a top cap which is said to allow for better isolation of the high plate voltage.

Raytheon has also announced an 8½" picture tube, type 8BP4. While having characteristics similar to the 7JP4 and being interchangeable with it, the 8BP4 is said to offer an increase in useful screen area of approximately 50%.

* * *

WALSCO TV-FM ALIGNMENT TOOL KIT

A line of TV-FM alignment tools has been announced by Walter L. Schott Co., 9306 Santa Monica Blvd., Beverly Hills, Calif.

Tools are flexible and made of a plastic that is said to be unbreakable. Inserts are made of tempered steel and are chemically welded to the shafts.

Tools may be purchased individually or in sets; either in pocket-sized leatherette kit or on a masonite wall rack for shop use.

Mueller TENNA-CLAMP COMPLETELY NEW AND DIFFERENT

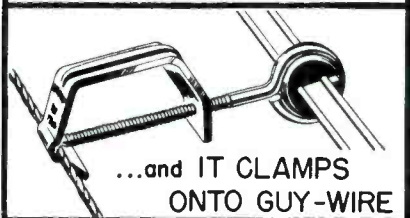
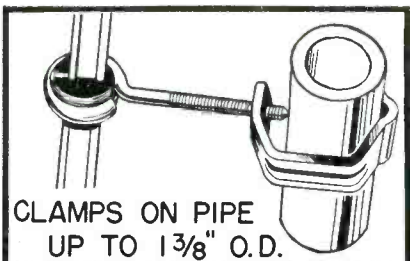

SUPPORTS TV LEAD-INS ON MASTS, PIPES, CROSS-ARMS, GUTTERS AND GUY-WIRES

- ONE STANDARD SIZE solves all sorts of lead-in problems.
- BRINGS LEAD-IN TO EDGE OF ROOF—right where you want it—holds lead-in away from gutters.
- DULL POINTED SCREW—solid grip on mast.
- ON MASTS TOO BIG for clamp—use the guy-wire.
- AVAILABLE FOR COAX and double lead-ins.

LOW PRICES!
9c net—only \$7.80 per 100
SEND FOR FREE SAMPLE AND CATALOG 810

Mueller Electric Co.
1565 E. 31st St., CLEVELAND 14, OHIO

Pat.

Pend.

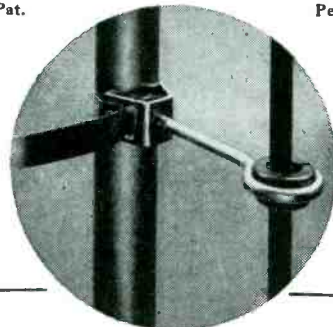

NOW! NEW LOW PRICE FOR PHOENIX PAM-11

.. Fastest, Strongest Antenna
Mast Stand-Off Insulator

- Attaches to any size mast in 10 seconds!
- Genuine Polyethylene parts.

19c list

PHOENIX
ELECTRONICS, INC.
Lawrence, Mass.

AT LEADING JOBBERS
Write for folder M of complete line of television accessories.

**EAGLE ELECTRONICS TV
CONVERSION KITS**

Teleramic conversion kits for conversion of 10" TV sets to 15" glass or 16" metal tubes, have been announced by Eagle Electronics, Inc., 88 Walker St., New York 13, N. Y.

Kits contain all components including front and rear mounting brackets plus an insulation ring and sleeve, horizontal output transformer and tube.

* * *

**CLAROSTAT HIGH-VOLTAGE-
COUPLER CONTROLS**

A high-voltage-coupler, type 56-125, which uses a plastic straight-through shaft in place of the previous insulating strip joining separate sections of the metal shaft, has been announced by Clarostat Mfg. Co., Inc., Dover, N. H. Insulating tube isolates the control proper from its mounting bushing and protects the elongated plastic shaft. The control-to-ground breakdown rating is said to be better than 10,000 volts.

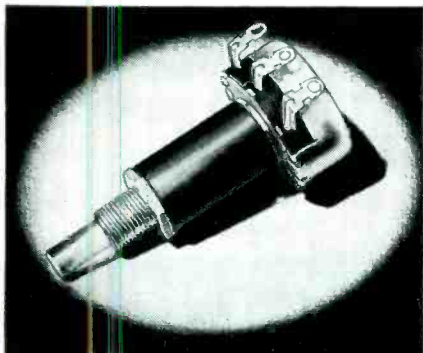

**APPROVED ELECTRONIC TV FIELD
STRENGTH METER**

A portable television field strength meter, model A-460, has been introduced by Approved Electronic Instrument Corp., 142 Liberty St., New York City.

The meter is calibrated from 50 to 30,000 microvolts. An all-channel selector on the panel has a final tuning control.



* * *

JFD LEADIN INSULATOR

Snap On insulators, for anchoring lead-in lines to antenna masts, have been announced by the JFD Manufacturing Co., Inc., 6101 Sixteenth Ave., Brooklyn 4, New York.

Constructed of cadmium plated steel, with a tempered spring steel clamp. Made with polyethylene inserts, and available in two types: SPT100 for 1" masts and SPT125 for 1 1/4" masts to fit either twin or coax cable leadins.

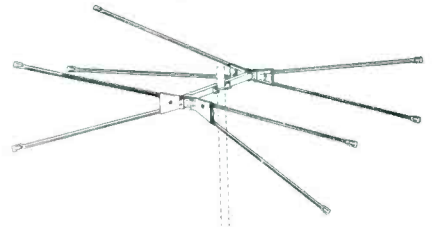

**PRECISION ELECTRONICS
TV CLARIFIER**

A TV Clarifier which is said to eliminate herringbone patterns, tears, waves and other picture effects and distortions produced by interference from FM, amateurs, shortwave, diathermy, etc., has been announced by Precision Electronics, Inc., 643 Milwaukee Ave., Chicago 22, Ill.

Consists of two variable capacitors in parallel with a fixed inductance, and inserted between the antenna and the receiver.

Clarifier may also be installed between the ac outlet and receiver to trap interference which might be present in the power line.

* * *

PHILSON CONICAL ANTENNAS

A conical antenna featuring a center clamp which is insulated by 3/8" thick bakelite, has been developed by Philson Mfg. Co., Inc., 156 Chambers Street, New York City. Single wing nut holds all elements.

Antennas are manufactured with a metal or wooden crossbar, and are pre-assembled.

FOR EASY AND FAST TV TEST AND ALIGNMENT..

USE THE NEW SUPREME

COMPLETE TELEVISION GENERATOR AND THE COMPOSITE VIDEO GENERATOR



Model 675



Model 665

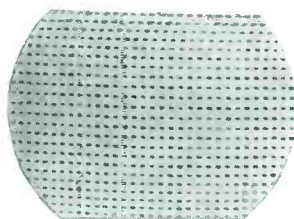

TEST PATTERN produced by Models 665 and 675 as seen on TV Receiver.

SUPREME, INC.

Greenwood, Mississippi, U. S. A.

FEATURES:

- Complete frequency coverage.
- Trombone attenuation.
- Self contained markers, variable.
- All frequencies on fundamentals, no confusing harmonics.
- External crystal markers.
- Enables you to use 665 Video Generator and completely test TV Receiver from antenna post to picture tube without station operation.

FEATURES:

- The only portable composite Generator.
- Provides standard RMA Video signal.
- Provides test pattern when you need it, as you need it.
- Internal modulation by dot pattern.
- Make TV receiver adjustments without station operation.

Please send me full details on the new Supreme Television Test System.

Name

Street and No.

City Zone State

2 NEW BOOKS

Now you'll really
know **HOW TO USE**
AN OSCILLOSCOPE



Don't let the oscilloscope "stump" you! Learn to use it fully—and watch your efficiency soar. This easy-to-understand book by an expert gives you the facts and how-to-use-it data you've been wanting.

MODERN OSCILLOSCOPES AND THEIR USES

by JACOB H. RUTTER, Jr.,
of Allen B. Du Mont Laboratories, Inc.
350 pages, 400 illustrations, \$6.00

This big book gets right down to earth in explaining oscilloscopes (cathode ray oscillographs) and showing exactly how to apply them to specific AM-FM-TV service jobs. No involved mathematics! First the author explains oscilloscopes fully. Then in easily understood terms he tells exactly how to employ them on specific jobs—from locating receiver troubles to aligning and adjusting the most complicated circuits.

HOW THEY WORK—HOW TO USE THEM ON THE JOB

Each oscilloscope operation is carefully explained including the making of connections, adjustment of circuit components, setting controls and analyzing patterns. About 400 illustrations including literally dozens of pattern photos make things doubly clear. Many industrial and teaching uses of the oscilloscope are likewise discussed. 10-day money-back guarantee. Use coupon.

FACSIMILE

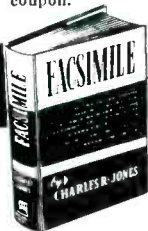

All about modern systems and how to service them

by CHARLES R. JONES

Coordinating Engineer, Finch Communications, Inc.
380 pages, 225 illustrations, \$6.00

Of course you're familiar with the marvels of facsimile in a general way—but how much do you really know about modern facsimile equipment, how it is made, how it works, and how to maintain it? And are you aware of the rapidly growing uses of facsimile in telegraphy, publishing, banking, railroading, mining, manufacturing, law enforcement and dozens of other places?

FACSIMILE, a new book by an expert in this field, covers the entire subject. Included are dozens of tips and detailed notes on servicing facsimile equipment. You learn about the latest developments, their present and potential uses, and exactly what makes them "tick." Throughout, FACSIMILE is invaluable for all radio men who know it pays to have specialized data such as this at their fingertips.

10 DAY MONEY-BACK GUARANTEE

Dept. S-109, MURRAY HILL BOOKS, Inc.,
232 Madison Ave., New York 16, N. Y.

Enclosed find \$_____ for books checked; or send C.O.D. (in U.S.A. only) for this amount plus postage and I will pay postman. If books are not satisfactory, I may return them in 10 days and you guarantee to refund the purchase price.

Rutter's MODERN OSCILLOSCOPES, \$6
 Jones' FACSIMILE, \$6
(\$6.50 each, cash, outside U.S.A.)

Name _____
Address _____
City, Zone, State _____

New Parts, Accessories

HEATH VOLTOHMMETER KIT

A Handitester volt ohmmeter kit featuring a 3" built-in meter, thumb-type ohms adjust control, ceramic divider resistors, and Bradley instrument rectifier, chosen for linear scales on *ac*, has been announced by the Heath Company, Benton Harbor, Mich. The *ac* and *dc* ranges are: 10-30-300-1000-5000 volts. Ohm ranges of 0-3000 and 300,000 ohms. Milliampere ranges of 10 and 100, meter movement is 400-microampere type.

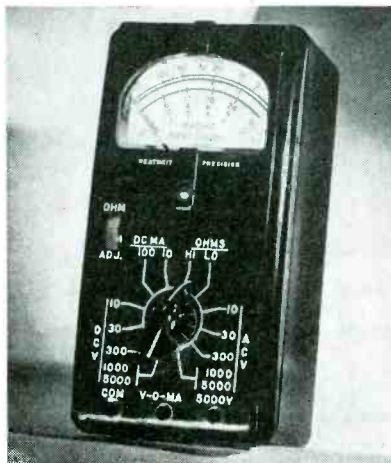

* * *

STACKPOLE VARIABLE RESISTOR DOUBLE-POLE LINE SWITCH

A double-pole line switch for volume, tone and other variable resistor controls has been announced by the Stackpole Carbon Company, St. Marys, Penna. Unit, type A-10, rated 1 ampere at 250 volts *ac-dc* or 3 amperes at 125 volts *ac-dc*.

Switch is .888" in diameter by .312" thick. Other features include stationary contacts mounted on fibre surface phenolic material to reduce arc tracing.

* * *

DU MONT 'SCOPES

Two 'scopes, types 304 and 304-H, developed as replacements for the famous 208-B have been announced by Allen B. Du Mont Laboratories, Inc., Clifton, New Jersey.

High-gain *ac* and *dc* amplifiers are provided for both X and Y axes.

Recurrent and driven sweeps are variable from 2 to 30,000 cps. Through an arrangement of switches, extremely slow sweeps, of 10 seconds or more, are available by the connection of external capacitors between the X-input terminals on the front panel.

Vertical deflections may be expanded to four times full-screen diameter; horizontal deflections, to five times full-screen diameter.

Stabilized synchronization of the pattern is said to be maintained by a synchronizing circuit.

The *crt* is operated at an overall accelerating potential of 1780 and an additional intensifier power supply increases this potential to 3000 volts.

Be Sure...
Rely on these
ERIE RESISTOR
components



Watch for
ERIE CERAMICON listings
in Howard W. Sams
Photofact Folders

Electronics Division
ERIE RESISTOR CORP., ERIE, PA.
LONDON, ENGLAND TORONTO, CANADA.

**SHOOTS TROUBLE
FASTER!** Makes more money
for you on job or
at service bench!



PRICE
\$9.95
at distributor
or postpaid,
direct. Sorry,
no C.O.D.'s.
O.K. adds
3% State Sales
Tax.

Signalette

MULTI-FREQUENCY GENERATOR

In radio service work, time means money. Locate trouble faster, handle a much greater volume of work with the SIGNALETTE. As a trouble shooting tool, SIGNALETTE has no equal. Merely plug in any 110V. AC-DC line, start at speaker end of circuit and trace back, stage by stage, listening in set's speaker. Generates RF, IF and AUDIO Frequencies, 2500 cycles to 20 Megacycles. Also used for checks on Sensitivity, Gain, Peaking, Shielding, Tube Testing. Wt. 13 oz. Fits pocket or tool kit. See at your distributor or order direct.

Clippard INSTRUMENT
LABORATORY
Inc.

DEPT. S, 1125 BANK STREET
CINCINNATI 14, OHIO
QUALIFIED JOBBERS WRITE,
WIRE FOR DETAILS.

C-D FEED-THRU CAPACITORS

A series of feed-through mica capacitors, type 742, that are said to be particularly adapted for auto receivers for noise bypassing, has been announced by Cornell-Dubilier Electric Corp., South Plainfield, N. J.

Over-all dimensions including mounting foot are 1 1/4" x 7/8". Have short, wide path terminals which are said to result in extremely low inductance. Supplied in a rigid metal clamp casing with mounting or soldering tab. Feed-through construction said to provide low impedance at high frequencies.

When used in an auto radio, capacitor is generally installed with a small inductance coil in the battery supply lead to the receiver.

* * *

JENSEN OPTICAL-LENS PRINCIPLE SPEAKER

A speaker, type H-510, which applies optical lens principles, has been developed by the Jensen Manufacturing Company, 6601 South Laramie Avenue, Chicago.

Employs a direct radiator low end with a separate high-frequency horn and compression driver for the high channel. Presence is said to have been enhanced by attaining a wider angle polar pattern in the extreme high-frequency region.

As in optics, the acoustic lens with its off-set circumferential slots and central opening, is said to permit a controlled time delay by progressively increasing the acoustic ray path from the center to the edge of the lens. The result is a spherical wavefront maintained out to very high frequencies.

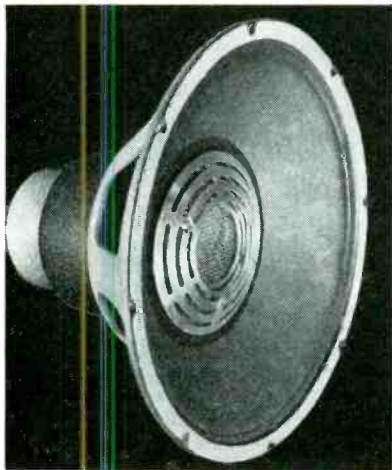

* * *

EMC SIGNAL GENERATOR KIT

An rf signal generator kit, model 500K, has been produced by Electronic Measurements Corp., 423 Broome Street, New York 13, N. Y.

Generator covers a range from 150 kc to 30 mc on fundamentals, and 100 mc on harmonics.

* * *

INSTANT TOOL SOLDERING IRON

An instant heating iron, employing a quick-heating element, to bring the tip to soldering temperature, and a bucking coil to maintain this temperature and prevent over-heating and scaling, has been announced by the Instant Tool Corporation, 231 West 29th St., New York City 1, N. Y.

For TELEVISION, F.M. and A.M.

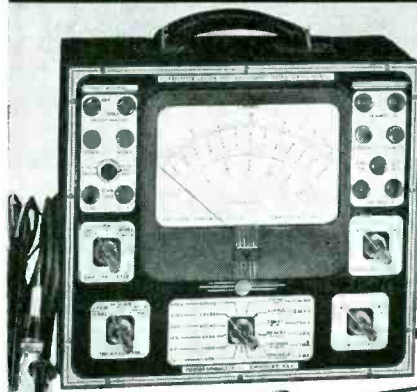

demand a
MODERN
VTVM—Megohmmeter
PRECISION
SERIES EV-10

Zero Center
on ALL
VTVM ranges
Large 7" meter

Self-contained to 6000 volts
-2000 Megs. - 12 Amps - +70DB.
D.C. Voltage ranges to 60,000 V.
when used with Series TV Super
High Voltage Television Test Probe.

PLUS complete
standard sensitivity
1000 ohms per volt
functions

EV-10 is a WIDE-RANGE ZERO-CENTER ELECTRONIC INSTRUMENT, stressing the utmost in performance and ease of manipulation. Application Engineered for rapid check of modern A.M., F.M., and TV networks.

IMPORTANT FEATURES

- ★ VOLTAGE REGULATED—BRIDGE TYPE CIRCUIT
- ★ ZERO-CENTER VTVM—no polarity switching or reversal of test prods.
- ★ SHIELDED COAXIAL TEST PROBES.
- ★ 1% wire and metallized resistors.
- ★ MOISTURE RESISTANT, plastic insulated wiring assures performance under adverse conditions.
- ★ DUO-BALANCED ELECTRONIC-BRIDGE OHMMETER
- ★ 7" RECTANGULAR METER

RANGE SPECIFICATIONS

- ★ Eight Zero-Center VTVM Ranges, from ±3 to ±6000 V.D.C.
- ★ Input Resistance—13 1/2 megs. constant to 600 volts. 133 1/2 megs. at 6000 volts.
- ★ Seven D.C. Current Ranges: from 0-600 microamperes to 12 amps.
- ★ Six Ohmmeter-Megohmmeter Ranges: self-contained to 2000 megohms.
- ★ Eight A.C.-D.C. and Output Voltage Ranges at 1000 ohms per volt: from 0-3 to 6000 volts
- ★ Six Circuit Probing, Zero-Center, VTVM Ranges: from ±3 to ±600 volts D.C.
- ★ Eight DB Ranges: —26 to +70 DB.
- ★ VTVM Ranges to 60,000 volts available via use of Series TV Test Probe.

ASK TO SEE Series E-400 Wide Range Sweep Signal Generator • Series ES-500 High Sensitivity 5" Oscilloscope.
WRITE FOR THE new 1949 catalog (JUST OFF THE PRESS) describing the complete "Precision" line of quality test instruments for all phases of AM-FM-TV service and test.

SERIES RF-10 HIGH FREQUENCY PROBE
An accessory item to Series EV-10, the RF-10 Probe provides direct voltage test facility to approx. 200 MC. Connects directly to EV-10 panel. Employs type 9002 tube. Net Price \$14.40

EV-10 MCP (illustrated) In open lace portable steel case. Complete with tubes, battery, and test probes \$89.95
EV-10-P In closed portable case \$92.70
EV-10-PM For standard rack mount \$92.70

PRECISION APPARATUS CO., INC.
92-27 Horace Harding Boulevard, Elmhurst 6, New York
Export Division: 458 Broadway, New York, U.S.A. • Cables—Morhenez

SYLVANIA TUBES

A series of miniature tubes have been announced by the Radio Division of Sylvania Electric Products Inc., 500 Fifth Ave., N. Y. 18. Included in the group are double diode-triode types 6BT6 and 12BT6 with operating voltages identical with older types 6AT6 and 12AT6; 6BK6 and 12BK6 to replace types 6AV6 and 12AV6; 6BU6 and 12BU6 to replace 6BF6 and 12BF6; and a new miniature, 26BK6, having no complementary type but operated at the same voltages as others in the group with the exception of its 26.5 volt, 70-milliamper heater.

Other new miniatures include a T 5 1/2 pentode power amplifier type 1W4 and a

T 5 1/2 triode amplifier or oscillator type 1C3.

These tubes are designed for battery operation and have 1.4 volt dc filaments requiring 50 milliamperes. Rated power output of the 1W4 pentode is 35 milliwatts with 45 volts on the plate and 200 milliwatts with 90 volts. The 1C3 general purpose triode is designed for 90-volt operation. This tube has an amplification factor of 14.5.

Also available is a miniature pentagrid converter tube, designed especially for lightweight portable receivers. The tube, 1L6, is supplied with a 1.4 volt dc filament cathode rated at 50 milliamperes. Operated from a 90-volt B supply, its plate current is 0.50 milliamperes.

TELEVISION SCOPE

SUPERIORITY AT A GLANCE!

The vertical response of this economy TV scope is usable to 5000 kc, not 50 kc. Response is flat to 750 kc, down 3 db at 1000 kc. Amplifier supplies a voltage gain of 20 at 5000 kc.

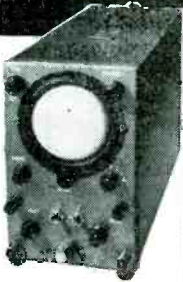

AR-3

Check this necessary feature before you buy any scope for TV use.

The R.S.E., AR-3 Scope has been built by Ross Armstrong to our rigid specifications. It's a complete unit that embodies standard horizontal amplifier and sweep circuits with normal sensitivity.

The case is 8" high x 5" wide x 14" long, attractively finished in "hammered" opalescent blue enamel. Operates on standard 110 volts—60 cycles—40 watts. Tubes, 3BP1-6AC7-6SJ7-6X5-5Y3-884. Instructions included. Complete specifications upon request. Satisfaction or your money back.

PRICE
\$49.95

AVAILABLE TO JOBBERS
IN QUANTITY

F. O. B.
DETROIT

CRYSTALS

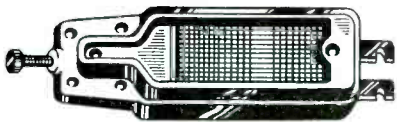

UP TO 77% OFF

Your choice of:
ASTATIC L72 Hi Output
SHURE P30 Lever Type
All Less Needle
BUY AN ASSORTMENT

\$1.49
EACH
NO LIMIT

A
SPEAKER
STEAL!



5" 450 ohm
DYNAMICS
Perfect—clean—
Where else but
at RSE?

Limit of 5 to
customer

99¢
EACH

ORDER INSTRUCTIONS



Minimum order—\$2.00. 25% deposit with order required for all C.O.D. shipments. Be sure to include sufficient postage—excess will be refunded. Orders received without postage will be shipped express collect. All prices F.O.B. Detroit.

Quantity and Export
Orders Solicited
RADIO SUPPLY & ENGINEERING CO., Inc.
86 SELDEN AVE. DETROIT 1, MICH.

STERLING HEARING-AID BATTERY TESTER

A hearing-aid battery tester, the No. 10, which can be plugged into any type or size of hearing-aid battery, pocket or desk model, for instant reading, has been developed by the Sterling Manufacturing Co., 9205 Detroit Ave., Cleveland, Ohio.

Meter reads either side of the scale, from zero to center. Tester is designed for use on 1½ v and 1.2 v A batteries and 15 v, 22½ v and 45 v B batteries.



GITS CIRCUIT TESTER

A circuit tester, the *Cord Visual Circuit Tester*, has been introduced by the Gits Molding Corp., 4600 West Huron St., Chicago 44. Instrument is designed for use on all low resistance circuits of 50 ohms and under.

Uses two penlight battery cells. A test clamp is fastened to the rubber covered wire which connects with the battery through the screw button at the back end. At the other end, next to the bulb, is a test prod about one-inch long. When the button is screwed down tight, and clip and prod are properly applied to the circuit in question, the bulb lights up if the circuit is good.



HICKOK MUTUAL CONDUCTANCE TUBE TESTER

A portable tube tester, model 600, built with dynamic mutual conductance circuits, has been announced by The Hickok Electrical Instrument Co., 10521 Dupont Ave., Cleveland 8, Ohio.

Scale readings are directly in micromhos: ranges are 0-3000-6000-15000 micromhos.

Case, 7½" x 11¾" x 16¾".

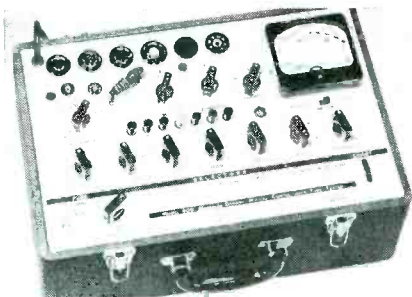

SPECIAL—10-DAY FREE TRIAL

Electronically Rotated Antenna

DEALERS— List Price **\$27.50**
SERVICE MEN

Prove for yourself that the Quad-Loop roof top antenna is the equal of mechanically rotated antennas costing up to four times as much installed. Test Quad-Loop, a sensation at the R.M.A. Parts Show, in your own service department for ten days.

Send no money. Write today on your business letterhead. We will ship C.O.D. a complete Quad-Loop roof top antenna. You pay only \$16.50. Jobbers protected.

If you are not satisfied that the Quad-Loop will substantially increase your sales and profits, return the antenna. Your money plus the freight charges will be sent by return mail. Write today.

No antennas will be shipped unless you include the name and address of your local jobber.

FIRST WITH ELECTRONIC ROTATION
GREATEST PRODUCER OF BUILT-IN TV ANTENNAS IN THE WORLD

SQUARE ROOT MANUFACTURING CORPORATION

900 Nepperhan Avenue, Yonkers 3, N. Y.

JACKSON 'SCOPE

A 'scope, type CRO-1, featuring a vertical-amplifier deflection sensitivity of .018 volt per inch on the narrow band has been announced by the Jackson Electrical Instrument Co., Dayton 1, Ohio.

Has a wide-band amplifier (4.5 mc) for the observation and measurement of pulse wave forms. Narrow band available for alignment of single stages of TV receivers. Horizontal amplifier deflection sensitivity, .55 volt per inch.

Input impedance is direct balanced, 6 megohms shunted by 11 mmfd; unbalanced 3 megohms shunted by 22 mmfd. Horizontal amplifier, 1.5 megohms.

Saw tooth sweep frequency, 20 cycles to 50 kc in 5 steps.



Approved



MODEL A-460

TV Field Strength Meter
\$79.50

Field Strength Meter; television 12 channel tuner; video if channel; large 6" directly calibrated meter; calibrated in microvolts; hammer-tone finished panel; ideal for locating antenna systems; testing transmission lines; testing efficiency of indoor antennas; checking booster efficiency, etc.

The Model A-460, Television Field Strength Meter is housed in a heavy gauge steel cabinet, battleship grey finish with 6 tubes (standard brands) IN34 Crystal operating instructions, circuit diagram and guarantee. Shpg. weight 25 lbs. Size: D—8" x H—10" x W—12".

MODEL A-400

TF & MF Sweep Signal Generator

\$79.50

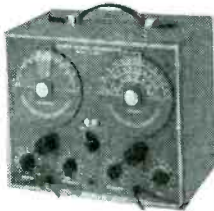

Television and FM Sweep Signal Generator; wide range all television and FM channels; 12 MC sweep width; built in RF marker 19.5-40 MC; crystal marker oscillator built in; phasing control; precision calibrated, direct reading; large, easy to read 5" dials; heavy hammer-tone finished panel; completely shielded.

The Model A-400 Sweep Signal Generator is housed in a heavy 16 gauge steel cabinet, battleship grey crackle finish. Complete with 7 (standard brand) tubes, connecting cables operating instructions, circuit diagram and guarantee. Shpg. weight 25 lbs. Size: 8"x10"x12".

WRITE for our NEW 1950 Edition 12-Page Catalogue

APPROVED ELECTRONIC INST., CORP.
142 Liberty St. BA. 7-9830 N.Y.C.

HYTRON DEFLECTION AMPLIFIER TUBES

Two horizontal deflection amplifier tubes, types 6BQ6GT and 25BQ6GT, have been announced by Hytron. Their construction and processing is said to make them suitable for the high peak inter-electrode voltages common in this service. The 6BQ6GT has a 6.3-volt heater for use in transformer-operated sets, while the 25BQ6GT with its 25-volt heater is suitable for use in sets employing series heater connections.

RADIO KITS CO SWEEP GENERATOR KIT

A sweep generator kit, model SW-5, covering a range of 2 to 226 mc, and featuring a variable phasing control, variable sweep width, and sweep out for 'scope, has been announced by the Radio Kits Company, 120 Cedar St., New York 6, N. Y. Comes with prewound coils, miniature tubes, and calibrated dial.

HOLUB TV-FM WIRE STRIPPER

A stripping tool, type Hi, that is said to remove the insulation from 300 ohm twin lead in *one* operation, has been announced by Holub Industries, Inc., Sycamore, Ill.

Stripper is also said to strip wires such as 16-18-20-22 without changing blades; one side of the blade strips twin lead, the other strips single conductors. Blades are replaceable, made of hardened and ground tool steel.

* * *

CHICAGO TRANSFORMER EXACT REPLACEMENT VIBRATOR TRANSFORMERS

A line of replacement vibrator transformers has been announced by Chicago Transformer Division, Essex Wire Corp., 3501 West Addison St., Chicago 18, Ill. Units are said to be exact duplicates of the original transformers in a wide range of makes and models of auto radios. Transformers are sealed in drawn steel cases.

Four-page, illustrated folder gives the characteristics and dimensions of the transformers and includes a replacement guide.

* * *

MALLORY 6-VOLT BENCH POWER SUPPLY

A 6-volt bench power supply, 6RS10, which can also be used as a source of *dc* wherever 110-115 volt *ac* is available, has been announced by P. R. Mallory & Co., Inc., 3029 E. Washington St., Indianapolis 6, Ind.

The voltage is continuously variable from 0 to 8. Unit may be safely operated continuously at 10 amperes and intermittently at 20 amperes. It has a filtered *dc* output with less than .9 volt ripple at 6 volt, 10-ampere output.

Equipped with a 0-20 ampere *dc* ammeter, a 0-10 volt *dc* voltmeter, a self-resetting circuit breaker in the *dc* line, a switch and fuse in the *ac* line, and a six-foot *ac* cord.

TUNE-UP CAMPAIGN



Window display material prepared by the RCA Tube Department for a *Radio Repair and Tune-Up* merchandising program for Service Men.

Campaign, aimed directly at the consumer, is strongly slanted to emphasize the fact that, for relatively low cost, the average noisy or inoperative receiver can be restored to first-class condition.

Campaign lists eight definite services and advertises the total price. To meet the requirements of individual dealers, provision is made for imprinting prices on the advertising material to order.

Available is a five-piece display kit; three-piece direct-mail campaign, a window streamer, newspaper ad mats, and several spot announcements.

RCA

TV ANTENNA STACKING KITS

MORE gain
EASY to attach
SIMPLE to adjust

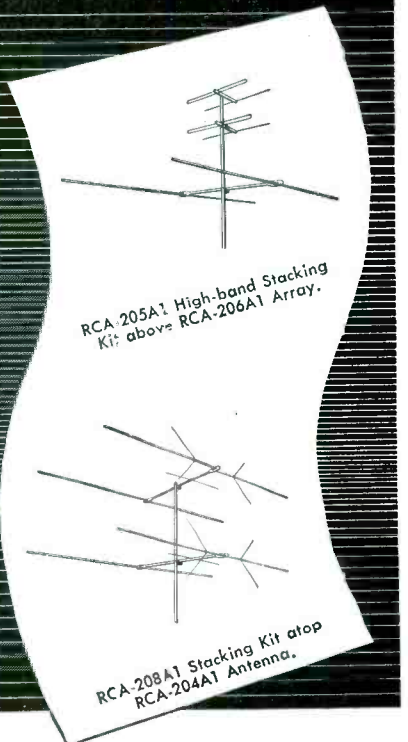

• Now . . . with new RCA stacking kits, you can "tailor" the basic RCA TV antennas to fit local receiving conditions.

RCA-205A1, when stacked above RCA-206A1 array, increases gain on channels 7 to 13.

For improved fringe-area uni-directional reception on all 12 channels, use RCA-208A1 in conjunction with RCA-204A1.

When you use the new RCA stacking kits, you are assured of lasting, dependable performance and increased customer satisfaction. RCA offers you the best in TV antennas to ensure the best in TV reception.

Always keep in touch with your RCA Distributor

TURN TO NEXT PAGE



ELECTRONIC COMPONENTS RADIO CORPORATION OF AMERICA
HARRISON, N. J.

SERVICE, OCTOBER, 1949 • 51

TV-FM MARKER

SWEEP TEE VEE MODEL TV 75



TV 75 is a sweep generator covering frequencies from 5 to 110 mc and from 150 mc to 270 mc in 4 bands. The sweep width may be varied from 100 KC to 10 mc with adequate linearity in band pass scope checks, etc. An accurate marker generator is provided with frequencies from 5 to 250 mc. The marker calibration is read directly on a large colored planetary driven dial and calibrated to an accuracy of 1%. Provisions for using crystal oscillator marker with a switch selecting either of two internal crystals or one external. Blanking enables removal of retrace generally found bothersome in the use of an electro magnetic type of sweep generator. Finished in attractive hammertone grey.

Buy It at Your Local Jobber

\$89.50
NET PRICE

RADIO CITY PRODUCTS CO., INC.

152 WEST 25th ST



NEW YORK 1, N. Y.

Coming Soon . . .

TELEVISION engineering

Watch for
Announcement!

WHEN YOU CHANGE YOUR ADDRESS

Be sure to notify the Subscription Department of SERVICE at 52 Vanderbilt Avenue, New York 17, N. Y., giving the old as well as the new address, and do this at least four weeks in advance. The Post Office Department does not forward magazines unless you pay additional postage, and we cannot duplicate copies mailed to the old address. We ask your cooperation.

Coax-Line Installation

(Continued from page 21)

commercial applications require a conduit run lead-in line.

Connections to the shield of the cable must be made only at the receiver. Normally the foil shield or

Fig. 7. A master-antenna installation, with a uhf converter added.
(Courtesy Commercial Radio Sound.)

Fig. 8. How an uhf converter can be placed in a vhf installation.

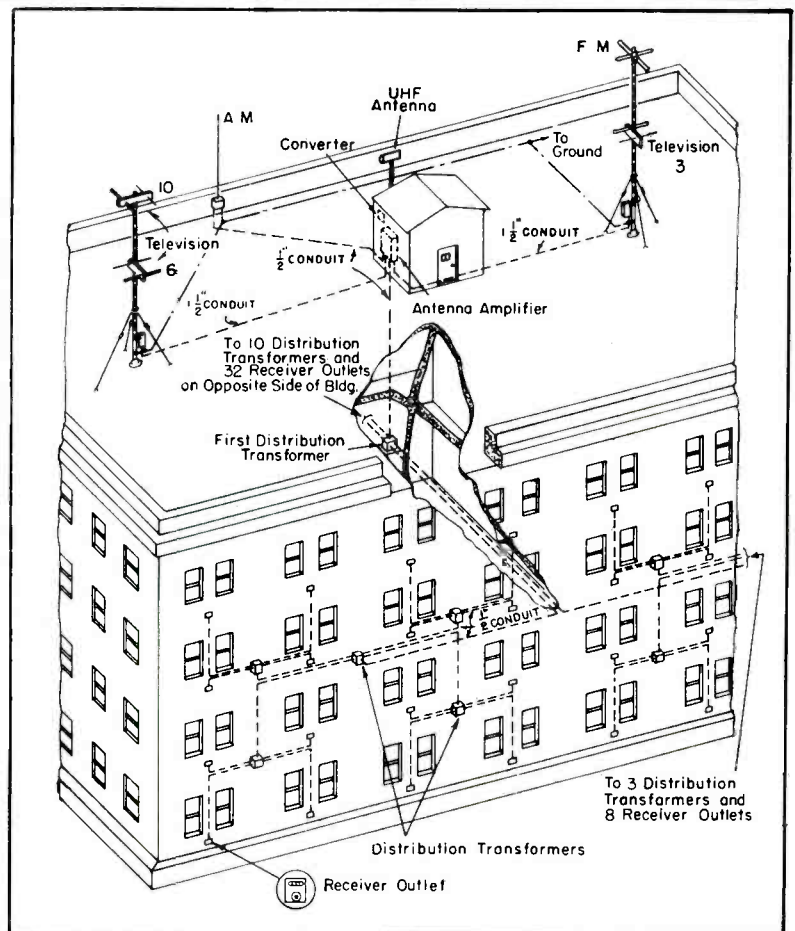
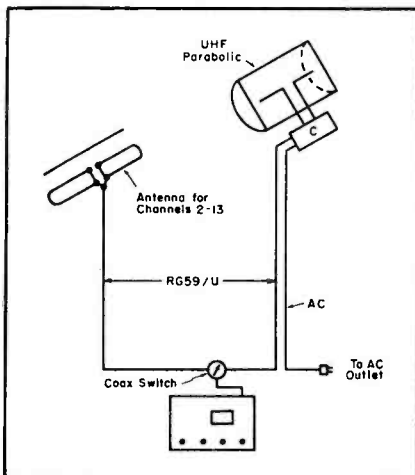

ISOLATION BENCH TRANSFORMER

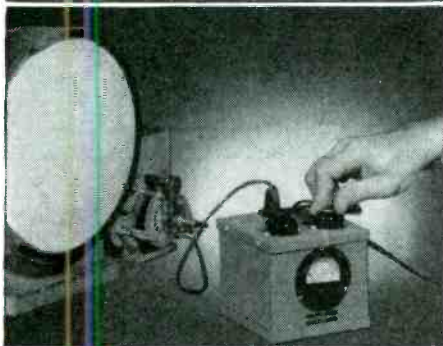

**REGULATE YOUR LINE VOLTAGE
TO FIT YOUR REQUIREMENTS**

N-303 VARI-VOLT JUNIOR \$15.00 DEALER NET

A voltage regulating isolation transformer to make your bench test voltage exactly what you want...on 117V line, variable from 95 to 145 volts...if line drops to 90, variable from 75 to 115V...output adjustable in 1½ volt steps...metered output voltage...capacity up to 250 Watts intermittent, 50-60 cycles...for radio and television receiver testing at under or over voltage...to isolate "hash" and live ground from AC-DC equipment...controlled voltage for meter calibration...speed up or retard heating of light soldering iron...and for many other similar uses.

See your local Halldorson distributor for complete line of replacement transformers...exact duplicates television and auto Vibrator transformer replacements, or write direct to us for complete information. THE HALL-DORSON COMPANY, 4500 Ravenswood Avenue, Chicago 40, Ill.

Halldorson

Vacuum Sealed Transformers

(Continued from page 52)

braided shield is connected to the receiver chassis. Under certain conditions it may be found that when this connection is made through a .05 or .1 mfd capacitor the shielding effect is enhanced.

The advent of ultrahigh TV in the 400-900 mc band which threatens to be with us soon will make the use of coax fittings mandatory.

At these new frequencies even the failure to make a perfectly symmetrical coax fitting connection will produce antenna circuit losses. Due to the

high losses of coax cable in this band the larger coax cables will become more popular in application; RG 8/U, 11/U, 17/U, etc.

[To Be Concluded in November, SERVICE]

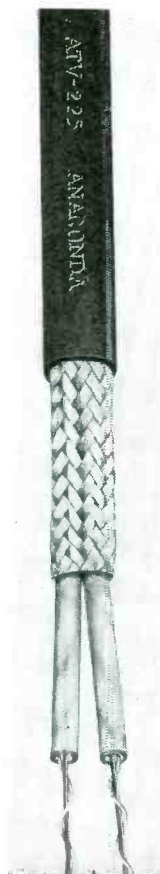
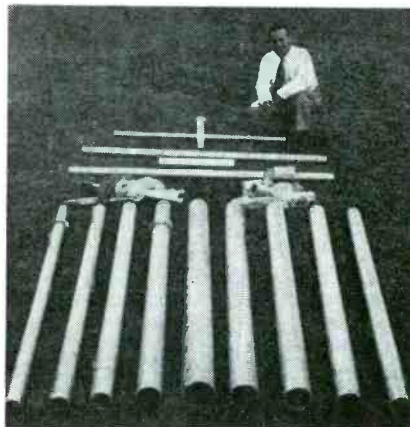

Fig. 9. View of 225-ohm coax cable. (Courtesy Anaconda Wire and Cable Company.)

PLYWOOD TUBING TV MASTS



Plywood tubing, bonded with phenolformaldehyde resins, available in six-foot sections for TV antenna mast installations. (Courtesy Special Purpose Products Co.)

RCA

TELEVISION ANTENNAS

**NEW DESIGNS
EASILY ASSEMBLED**

**IMPROVED
PERFORMANCE**

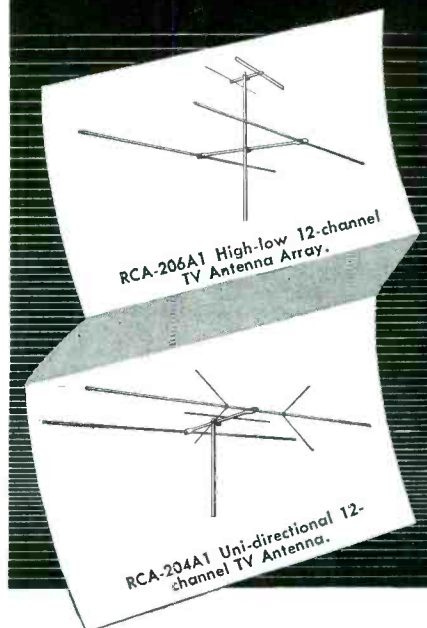

• Completely new in design—these sturdy, quickly assembled aluminum antennas answer your TV installation problems. Additional elements may easily be combined with either 12-channel antenna for improved reception.

RCA-206A1 is a 12-channel antenna array designed especially for locations where the high and the low channel stations are widely separated in direction.

RCA-204A1, a 12-channel uni-directional antenna which utilizes the unique RCA-developed "V" attachments to provide improved reception on channels 7 to 13, is an unusually simple and efficient antenna for all-channel reception.

Designed for use with 300-ohm balanced transmission line, they require no external line-matching transformers.

**Always keep in touch
with your RCA Distributor**

TURN TO NEXT PAGE



**ELECTRONIC COMPONENTS
RADIO CORPORATION of AMERICA
HARRISON, N. J.**

Like peas



in a pod

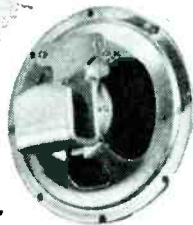

except for

QUAM

Only Quam offers more! The U-Shaped Coil Pot, providing an unbroken path for the magnetic lines of force, thus producing a stronger magnetic field with higher efficiency and improved performance, is an exclusive Quam feature.

The Quam Adjustable Voice Coil, permitting accurate centering after assembly and virtually eliminating rubbing voice coils, is also found *only* on Quam Speakers.

No other speaker offers such outstanding extra features—such extra value. For all your replacements, specify Quam.

Mail This Coupon
for Free Catalog



QUAM-NICHOLS CO.
526 E. 33rd Place
Chicago 16, Illinois

Please send me Quam catalog.

Name

Address

City..... State.....

You'll be
interested in



Coming Soon!

Fig. 6. Complete composite signal.

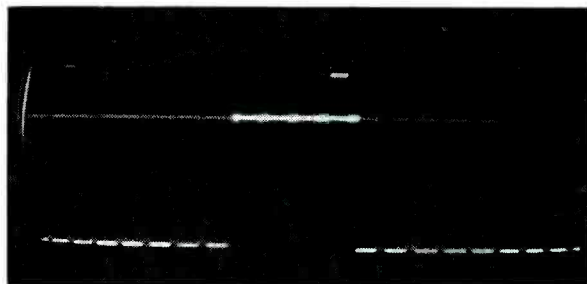

Video Signal Generator

(Continued from page 12)

lation initiated by the starter tube is kept alive by means of the energy supplied by the oscillator. Thus the amplitude stays relatively constant until the starter tube kills the oscillations. One portion of this tube forms negative pulses on a 1,000-ohm resistor (R_{91}) in its plate circuit, because of the plate current flow on peaks of the sine wave. This plate current occurs when the bias on the grid of the tube is overcome. By means of a 2-stage *dot amplifier*, using the second section of the 6SN7 and one section of the 6SN7 in the subsequent stage, these pulses are squared up to produce negative pulses at a frequency of 630 kc occurring in chains approximately 2 H in length (approximately 80 pulses) at 1,500 chains per second.

A *video gate tube*, a 6L7, receives the negative pedestal on one grid and the negative dots on the other grid. If the *dots-external video switch* is thrown in the other position, the external video is applied to this grid rather than the negative dots. Plate current can be cut off, by either the pedestal on one grid or the dots on the other; therefore, the output of this tube is a pedestal and dot signal in which positive is equal to black.

A 100,000-ohm and 1,800-ohm resistor (R_{104} and R_{108}) serve as the *mixer network* which mixes the pedestal-dot output from the video gate and the output from the super-sync amplifier to produce a composite video signal. The *output amplifier*, which uses the other triode section of the 6SN7, serving as the *dot amplifier*, is a balanced load inverter receiving the signal from the mixer network and developing a composite output with negative sync across its plate load. Both the cathode and plate load resistors are potentiometers which are able to control the amplitude of each of the two output signals independently. At the *composite output* terminals are available both a positive and negative complete standard RMA television signal. The output voltage may be varied from

0 to 5 and the impedance of each output is 1,000 ohms maximum in series with an 8-mfd capacitor.

With a 'scope³ a complete output of this *video generator* may be made visible.

It should be remembered that the primary function of this *video signal generator* is to provide a *dot modulation pattern*; the auxiliary outputs include the *video output* and the line and field driving pulses which may be used for synchronizing a monoscope or TV camera.

³Supreme 660.

FREE! Send for it NOW!

**ALLIED'S NEW
1950 CATALOG!**

**196 PAGES—
Everything in
Radio and
Electronics**

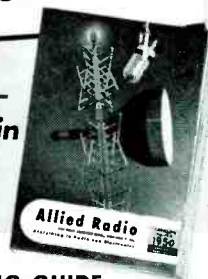

**GET RADIO'S
LEADING BUYING GUIDE**

Service Technicians and Engineers: ALLIED'S 1950 Buying Guide brings you all the new releases and money-saving values—from the world's largest stocks of test instruments, amplifiers, P.A. systems and equipment, tubes, parts, tools, books and accessories—ready for instant expert shipment. Send today for your FREE new 196-page ALLIED Catalog.

ALLIED RADIO CORP., DEPT. 23-K-9
833 W. Jackson Blvd., Chicago 7, Ill.

Send FREE New ALLIED Catalog.

FREE

Name.....

Address.....

ALLIED RADIO

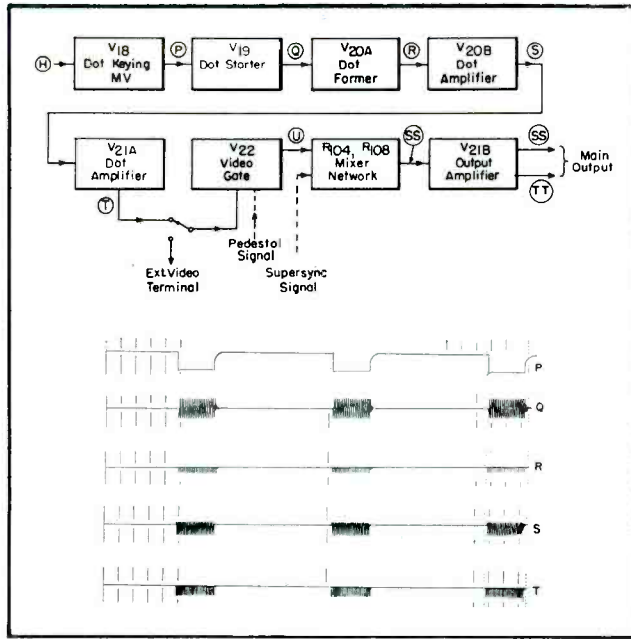
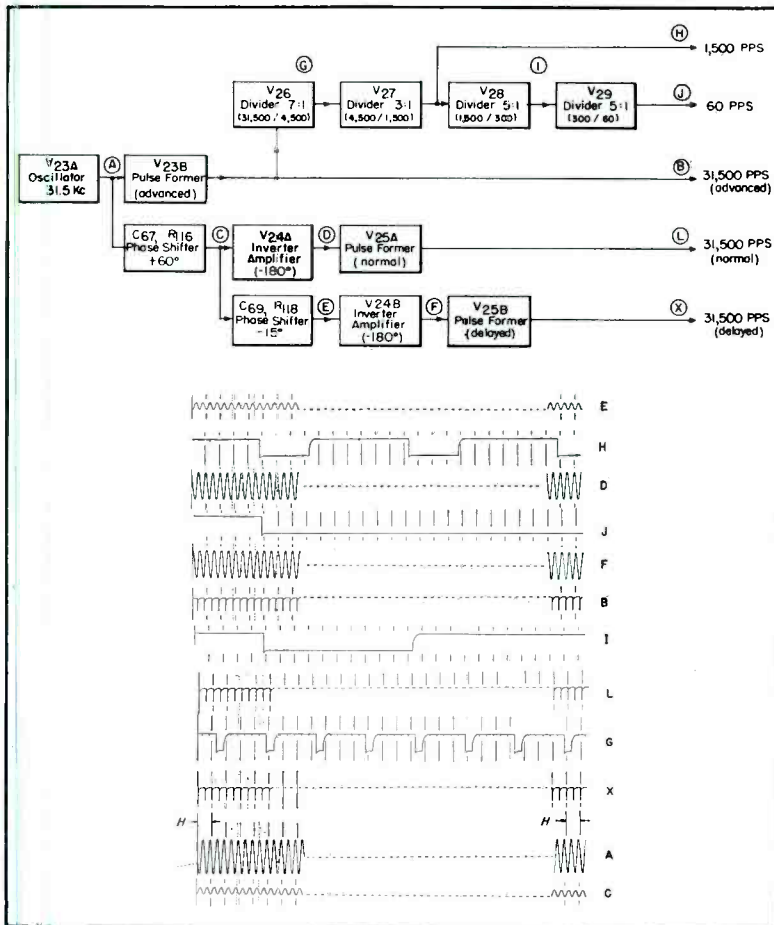

Fig. 7. Dot signal channel circuit.

Video Generator Circuit Sections

Fig. 8. Timer section of the generator. Spacing between adjacent vertical dimension lines is equal to H or approximately 63.5 microseconds; this is the period of one cycle of horizontal scan (one line period).



RCA

REVERSIBLE-BEAM TV ANTENNA ARRAY

Eliminates co-channel and adjacent-channel interference

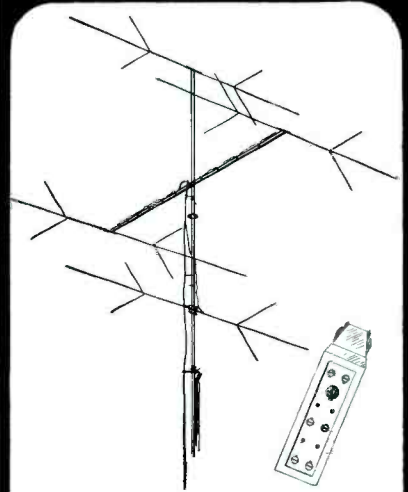

RCA 212A1 Antenna Array and Diplexer. A flick of a switch reverses the beam.

Now, you can offer your customers in fringe areas a *beam* antenna with high voltage gain, over-all front-to-back ratio, and *instant* reversal of direction right at the receiver!

The RCA-212A1 Reversible-Beam TV Antenna Array eliminates co-channel interference from stations in opposite directions . . . adjacent-channel interference produced by opposite stations in receivers having poor selectivity . . . and "ghosts" caused by line mismatches. The high over-all front-to-back ratio is achieved through the use of driven elements.

The RCA-212A1 is uniformly directional on all 12 channels and is easily orientated for maximum directional gain. Constructed of high-quality aluminum, the RCA-212A1 is lightweight and easy to install.

Ask your RCA Distributor for Bulletin 3F619 for details.

Always keep in touch with your RCA Distributor





MERIT HAS COMPLETE-EXACT TV REPLACEMENTS

When MERIT says it, it's News!

Merit jobbers can now offer exact replacements for RCA and other popular makes. All independent servicemen will welcome this news. Merit's TV Replacements fully maintain Merit's famous standards of quality. Buy them with complete confidence.

New MERIT CATALOG No. 4911 is now ready. Shows all TV Replacements in regular line. Write for your copy. All catalog items in stock.

Power Transformers					
Type No.	List Price	Volts	M.A.	Volts	Amp.
P-3061	\$25.00	362-362	295	5	6
P-3063	\$20.00	360-360	250	5	3

File No.	Wdgs. Amp.	Mfg. Center
6.3	5	3-3/16x4-1/16
6.3	5	
5	2	
6.3	9	3-3/16x4-1/16
6.3	8	
5	2	

Type No.	H	W	D	Mfg. Type
P-3061	6-13/16	3-27/32	4-23/32	C
P-3063	5-11/16	3-27/32	4-23/32	C

Vertical Output Transformer					
Type No.	List Price	Turns Ratio	Pri. to Sec.	Mtg. Centers	Mtg. Type
A-3035	\$5.25	10:1	1-19/32x2	EV	

Type No.	H	W	D
A-3035	3-1/8	2-11/16	2-1/2

Vertical Blocking Oscillator Transformer

(A highly popular unit of outstanding efficiency)

Type No.	List Price	Turns Ratio	Pri. to Sec.	Mtg. Centers	Mtg. Type
C-4000	\$2.75	1:4.2	1-15/16	J	

Type No.	H	W	D
C-4000	1-3/4	2-5/16	1-1/2

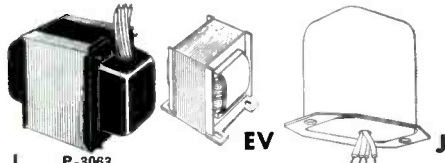

PRODUCTS OF MERIT



MERIT
COIL & TRANSFORMER CORP.

4435 NORTH CLARK ST., CHICAGO 40, ILL.

JOTS AND FLASHES

A New cycle in circuit nomenclature has appeared on the scene, with the announcements of the 1950 TV receivers. We now have such terms as *gyromatic picture lock* which is an *afc* circuit which automatically stabilizes the TV picture by locking the horizontal movement that would otherwise occur under weak signal or strong interference conditions; *gated afc* which has been found to practically eliminate readjustment of picture controls when switching from station to station, and *picture line suppressor* which makes it possible to turn up full picture brightness without the annoyance of having retrace or diagonal white lines appear on the screen. . . . A room designed to accommodate four custom-type audio systems has been opened by Altec Lansing at their New York offices, 161 Sixth Avenue. Speakers are located in a false corner, a wall behind a bookshelf, a closet door and a built-in bookcase. . . . James M. Blackledge, of Standard Transformer Corp., Chicago, has been elected chairman of the Association of Electronic Parts and Equipment Manufacturers. A. L. Tuttle of Centralab, Milwaukee, has been selected as vice chairman; Helen Staniland Quam, of Quam Nichols Company, Chicago, has been reelected treasurer for the fourteenth consecutive term and Kenneth C. Prince, Chicago, has been renamed executive secretary for the fifteenth year. . . . Dr. Ralph L. Power is now press agent for the Los Angeles chapter of the Reps. . . . Olson Radio Warehouse, Akron, Ohio, are offering a drinking glass decorated with twenty-five popular circuit symbols as a premium to Service Men. . . . The Triad Transformer Manufacturing Co., 2254 Sepulveda Boulevard, Los Angeles 64, Calif., have released a sixteen-page catalog, TR-49, illustrating the entire line of Triad transformers. . . . The Dial Corporation, 2323 West Devon, Chicago, has been formed to manufacture instrument dials in luminescent materials. Russ Diethert is general manager. . . . Ben Joseph, 551 Fifth Avenue, New York, has been named metropolitan New York rep for the Wire Corporation, 19 Jackson Street, Worcester, Massachusetts. . . . John J. Kopple is now president of the New York chapter of the Reps. Joseph Sprung is vice president and F. X. Brennan, secretary-treasurer. The board of directors now includes Dan Bitton, Robert E. Brewer, William Gold, Perry Saffler and Dave Sonkin. . . . Ralph Mueller, sales manager of Mueller Electric Company, Cleveland, Ohio, returned recently from a business and pleasure trip to the Pacific Coast and Hawaii. . . . Leonard C. Truesdell is now sales manager of the household radio and television division of Zenith Radio Corp. . . . Leslie C. Rucker's book *The Business Helper* will be published by John F. Rider, Inc., 480 Canal Street, New York 13, New York. . . . Gerald Wilson, 403 Second Street, Jackson, Michigan, and R. W. Farris Co., 406 West 34th Street, Kansas City 2, Missouri, have been appointed reps for the Circle X Antenna Corp., 500 Market St., Perth Amboy, N. J. The Lawrence Elliott Co., 17409 Glendale Ave., Cleveland, Ohio, and Le Roy Schenck, 9 West Park St., Newark, N. J., have been appointed Circle X Antenna reps for Kentucky and New York State including New York City and Northern New Jersey, respectively.

ADVERTISERS IN THIS ISSUE

SERVICE INDEX—OCTOBER, 1949

ALLIED RADIO CORPORATION	54
Agency: George Brodsky, Advertising	
AMERICAN PHENOLIC CORP.	4
Agency: Burton Browne, Advertising	
APPROVED ELECTRONIC INSTRUMENT CORP.	51
Agency: Sternfield-Godley, Inc.	
L. S. BRACH MFG. CORP.	33
Agency: A. W. Lewin Co.	
CIRCLE-X ANTENNA CORP.	42
Agency: Homer Harding	
CLIPPARD INSTRUMENT LABORATORY	48
Agency: The S. C. Baer Co.	
CORNELL-DUBILIER ELECTRIC CORP.	Inside Front Cover
Agency: Reiss Advertising	
THE ELECTRIC AUTO-LITE CO.	46
Agency: Ruthrauff & Ryan, Inc.	
ERIE RESISTOR CORP.	48
Agency: W. S. Hill Co.	
GENERAL ELECTRIC CO.	19, 31
Agency: Maxon, Inc.	
GENERAL ELECTRIC LAMP DEPT.	41
Agency: Batten, Barton, Durstine & Osborn, Inc.	
THE GENERAL INDUSTRIES CO.	40
Agency: Meldrum & Fewsmith, Inc.	
HALLDORSON CO.	53
Agency: Western Adv. Agency, Inc.	
THE HEALTH CO.	42
Agency: G. Dean Arend, Advertising	
HYTRON RADIO & ELECTRONICS CORP.	5
Agency: Henry A. Loudon Advertising, Inc.	
INTERNATIONAL RESISTANCE CO.	17
Agency: John Falkner Arndt & Co., Inc.	
JACKSON ELECTRICAL INSTRUMENT CO.	44
JONES & LAUGHLIN STEEL CORP.	25
Agency: Ketchum, MacLeod & Grove, Inc.	
KEN-RAD DIV. GENERAL ELECTRIC	1
Agency: Maxon, Inc.	
P. R. MALLORY & CO., INC.	Inside Back Cover
Agency: The Aitkin-Kynett Co.	
MERIT COIL & TRANSFORMER CORP.	56
Agency: Symonds, MacKenzie & Co.	
MUELLER ELECTRIC CO.	46
MURRAY HILL BOOKS, INC.	48
Agency: The Harry P. Bridge Co.	
NATIONAL UNION RADIO CORP.	28
Agency: VanDine Adv. Agency	
PERMOFLUX CORP.	27
Agency: Sander Rodkin Adv. Agency	
PHOENIX ELECTRONICS INC.	46
Agency: Milton Richards	
PRECISION APPARATUS CO., INC.	49
Agency: Shappe-Wilkes Inc.	
QUAM-NICHOLS CO.	54
Agency: Triangle Adv. Agency, Inc.	
RACON ELECTRIC CO., INC.	43
Agency: H. W. Hauptman Co.	
THE RADIART CORP.	23
Agency: Stern and Warren	
RADIO CITY PRODUCTS CO.	52
Agency: Jaman Advertising, Inc.	
RADIO CORPORATION OF AMERICA	51, 53, 55, Back Cover
Agency: J. Walter Thompson Co.	
RADIO SUPPLY & ENGINEERING CO., INC.	50
Agency: Claude E. Whipple	
JOHN F. RIDER PUBLISHER, INC.	6
Agency: Shappe-Wilkes Inc.	
HOWARD W. SAMS & CO., INC.	8
Agency: George Brodsky, Advertising	
SHURE BROTHERS, INC.	29
Agency: Casler, Hempstead & Hanford, Inc.	
SIMPSON ELECTRIC CO.	7
Agency: Burton Browne, Advertising	
SNYDER MFG. CO.	13
Agency: Brooks and London	
SPRAGUE PRODUCTS CO.	39
Agency: The Harry P. Bridge Co.	
SQUARE ROOT MFG. CORP.	50
Agency: Thomas & Delehanty, Inc.	
STANDARD TRANSFORMER CORP.	38
Agency: Burnet-Kuhn Adv. Co.	
SUPREME, INC.	47
Agency: Getz Crenshaw Adv. Agency	
SYLVANIA ELECTRIC PRODUCTS, INC.	8
Agency: Newell-Emmett Co.	
TELREX, INC.	37
Agency: George Homer Martin Associates	
THE TURNER CO.	45
Agency: W. D. Lyon Co.	
UTAH INC.	36
Agency: Bonsib Adv. Agency	

High Temperature is Tough
On Long Life . . .



But

Mallory Capacitors Can Take It!

It's one thing for a capacitor to have long life. But it takes a MALLORY CAPACITOR to sustain its long life at high temperatures. Tests prove that the characteristics of Mallory FP Capacitors are practically unchanged after 2000 hours at a temperature of 185° F.

Rigid manufacturing controls guard MALLORY CAPACITORS against contamination—the enemy of long life. Mallory Capacitors are untouched by human hands; production workers wear rubber gloves. And Mallory specifications on chloride content of the gauze are even more rigid than on hospital gauze, for gauze is the base on which aluminum is sprayed to create the anode plate.

You can depend on Mallory Capacitors for longer shelf life—longer life in an inactive set—lower

RF impedance—ability to withstand higher ripple current.

Mallory Capacitors cost no more than ordinary capacitors. They're easy to install, and when they're installed they're *dependable* . . . and that means the kind of service that satisfies customers. Order from your Mallory distributor.

NEW IMPROVEMENTS IN MALLORY FP CAPACITORS . . . Feature stronger anode tabs—withstand higher discharge currents—improved high surge separators—still greater heat resistance—extra heavy rubber seal—heavy cathode tab—special etched cathode.

*Don't Miss the Mallory Television Service Encyclopedia.
Get Your Copy From Your Mallory Distributor . . . Only 35c!*

P. R. MALLORY & CO. Inc.
MALLORY

CAPACITORS . . . CONTROLS . . . VIBRATORS . . .
SWITCHES . . . RESISTORS . . . RECTIFIERS . . .
VIBRAPACK* POWER SUPPLIES . . . FILTERS

*Reg. U. S. Pat. Off.

APPROVED PRECISION PRODUCTS

P. R. MALLORY & CO., Inc., INDIANAPOLIS 6, INDIANA



Get the "Tune-Up" flier from your Cunningham Distributor for the full story on the new "Tune-Up" campaign.

10 Million Radios Need Repair!

Now...Cunningham's new "Tune-Up" campaign helps you tap this rich business

Now...Cunningham offers you an effective way to overcome the public's reluctance to have faulty radios checked... a year-round *personalized* promotion campaign that tells your customers just what they will get for their money... and you name the price.

You can go after this *extra* business with professional posters, dis-

plays, mailing pieces, advertisements and spot radio announcements... supplied by your Cunningham Tube Distributor.

Here's *your* chance to cash in on one of the greatest service promotion campaigns ever launched! Lose no time in getting the special flier that gives the whole story from your Cunningham Distributor.



Now—The CUNNINGHAM Pricing Kit! Price your merchandise and make more sales! Use this Kit in the window, on counters, and in the store. Learn how to get your Kit today... see your CUNNINGHAM Tube Distributor while the supply lasts!



ALWAYS KEEP IN TOUCH WITH YOUR CUNNINGHAM DISTRIBUTOR

**A QUALITY PRODUCT OF THE
RADIO CORPORATION OF AMERICA**