

# SERVICE

September  
1949

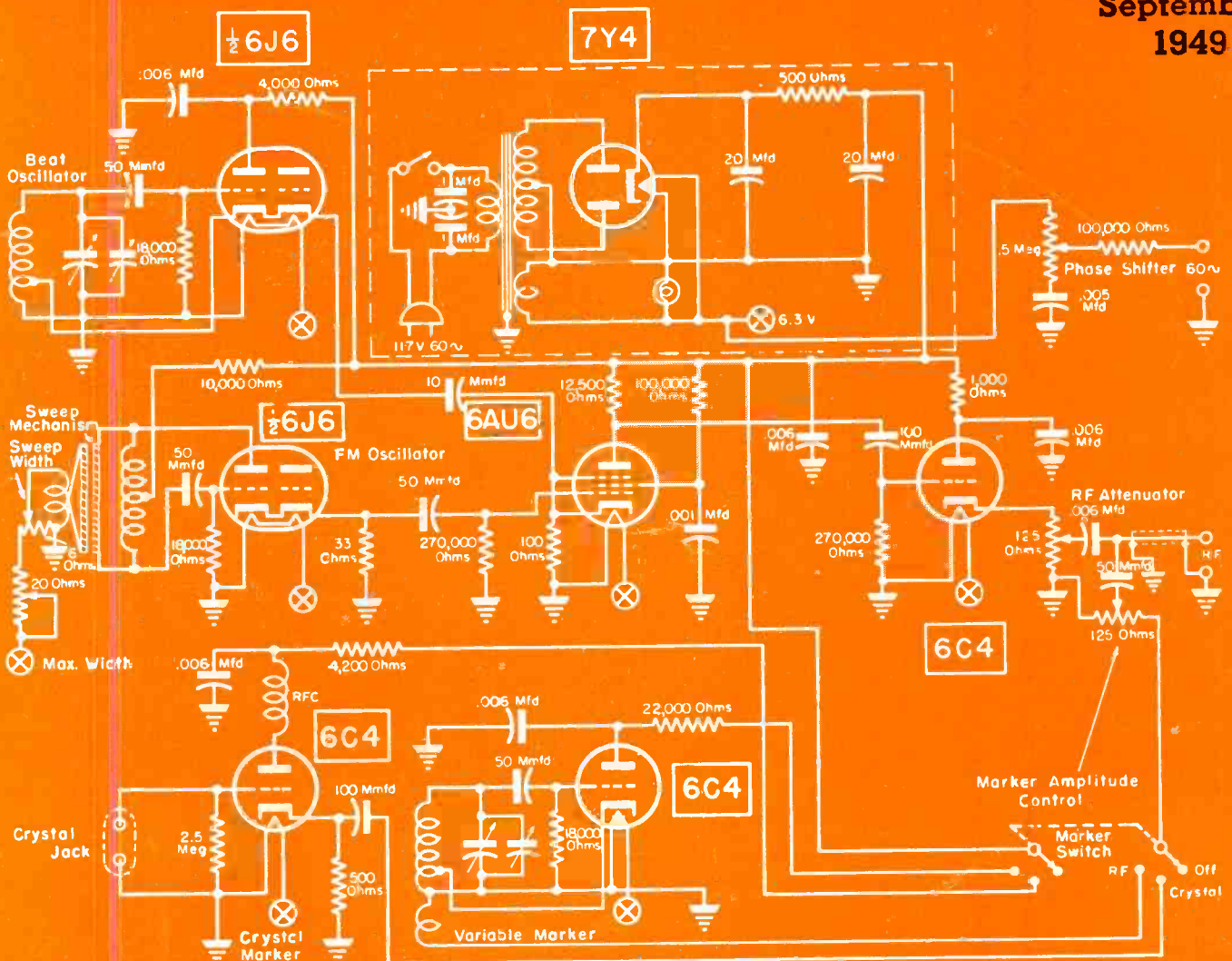

Frequency-modulated signal generator featuring four oscillators, one of which is a constant-amplitude FM fixed type operating at 114 mc.  
[See page 2]

THE TECHNICAL JOURNAL OF THE RADIO TRADE

**This sign belongs on your door...**



Customers "call again" for two reasons: they are either pleased with your service or displeased. Because the workings of an auto radio are quite intricate, no car owner can figure out for himself just who is at fault when a vibrator kicks up.

**not on the Vibrators you use**

Nevertheless, call backs on installations are costly affairs to you—both in time and reputation. The parts you choose must be as dependable as your own service. So stick with a name you know you can trust:

# CORNELL-DUBILIER

**Here's why C-D Vibrators are** *reliable, quiet and last longer*



1. Exclusive C-D pole piece design and armature weight result in a perfectly-balanced unit with less vibration, minimum mechanical hum and maximum life.

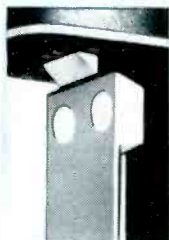

2. Exclusive C-D base mounting results in a full floating unit.



3. New stack design utilizing pure india ruby mica will take peak voltages of even 4,200 volts with no damage to vibrator.

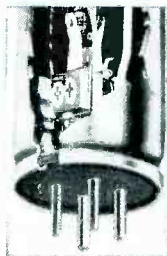

5. C-D designed electronic micro-metric equipment removes guesswork in contact point setting and assures consistent high quality.

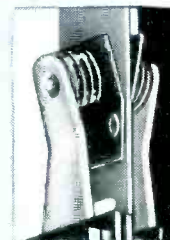

4. Unit completely enclosed in new, exclusive C-D super-soft, pure sponge rubber floating sock. Eliminates usual difficulties found in other vibrators.



For the best in Vibrators insist on C-D's. Now at your local C-D distributor. Or write for full details to Cornell-Dubilier Electric Corporation, Dept. S 99, South Plainfield, N. J. Other plants in New Bedford, Worcester and Brookline, Mass.; Providence, R. I.; Indianapolis, Ind., and subsidiary, The Radiart Corp., Cleveland, Ohio.

For your nearest C-D distributor, consult your local Classified Telephone Directory.



**A GREAT NAME IN CAPACITORS - A GREAT NAME IN VIBRATORS**



IN RADIO AND TELEVISION TUBE SALES

# 1949 IS A G-E YEAR

Now . . . help toward streamlining your service calls! The brand-new **POCKET OFFICE** (a General Electric "first" for more sales and profits) organizes your cards, prices, order blanks, job records in a handy 5" by 8" wallet.

**Y**ou have only so many working hours. And an hour lasts but sixty minutes. How can you make your time more productive?

One answer is the new G-E Pocket Office. All the papers you need on the job, are tucked away neatly in this flat binder that slips conveniently into your coat pocket. When you want a business card, a tube price, a job ticket, it's *there* . . . no searching for a form left back at your headquarters, no calling on your memory to record data best jotted down in pencil.

Handsome in rich brown simulated leather with gold lettering . . . strongly made, durable . . . the G-E Pocket Office is an accessory you'll be proud to own. It holds:

- Your business cards.
- New, cleverly designed "out" cards.
- Tube price list, beneath a clear acetate protective cover.
- Resistor-condenser color code card.
- Job tickets, repair stickers, tube-test stickers.
- Large memo pad.

Ask your General Electric tube distributor to show you the Pocket Office, and give you the details on how to secure this up-to-date aid to efficiency. Then use it to convert every minute of your working time into profits! *Electronics Department, General Electric Company, Schenectady 5, New York.*



You can put your confidence in—  
**GENERAL ELECTRIC**

101-MA6

RADIO · TELEVISION · ELECTRONIC  
**SERVICE**

**LEWIS WINNER**  
Editorial Director

**F. WALEN**  
Assistant Editor

**ALFRED A. GHIRARDI**  
Advisory Editor

	Page
Association News .....	41
Auto Radio Service Aids. By P. M. Randolph .....	40
Coax Line Installation Practices. By Ira Kamen .....	14
Phono Installation and Service. By Kenneth Stewart .....	22
Ser-Cuits (Videola TV Models) .....	18
Servicing Helps. By M. A. Marwelll .....	30
Sweep Generator Operating Hints. By Victor I. Robinson .....	36
Ten Years Ago in Associations .....	49
The Philco Built-In TV Antenna System .....	16
Tube News. By L. M. Allen .....	34
TV and FM Sweep Signal Generator (Cover) .....	21
TV Receiver Servicing. By Carl Quirk .....	26
Views and News. By Lewis Winner .....	13

**CIRCUITS**

Approved Electronic A-400 (Cover) .....	21
DuMont RA 105 Power Supply .....	26
DuMont RA 105 TV Receiver .....	27
Philco Built-In TV Antenna System .....	16
Philco 50-T1630 (Input) .....	16
Picture-Tube Conversion Circuit .....	30
'Scope Using 3RPI .....	34
Voltage-Doubler Picture-Tube Conversion Circuit .....	30
Videola VS 160, 165 .....	18
TV Antenna Insertion Circuits .....	14

**COVER**

TV and FM Sweep Signal Generator (Approved Electronic A-400) .....	21
--------------------------------------------------------------------	----

**SERVICING HELPS**

Adjusting RF Transformers in G.E. TV Sets .....	32
Basic Cures for Dead Auto Receivers .....	40
Converting 630 TS Chassis for 12 1/2, 15, 16 and 20-Inch Picture Tubes .....	30
Eliminating Tube Failures in AC/DC Chassis .....	30
Eliminating Noise Rattles, Pickup Noise and Wheel Static in Auto Installations .....	40
Reducing Hum Level in Bendix Models .....	30
Remedying Pushbutton Sticking .....	40
Improving Auto-Set Control-Shaft Fitting .....	40
Minimizing Bass Response in Westinghouse Receivers .....	30

<b>Index to Advertisers</b> .....	56
-----------------------------------	----

**Manufacturers**

Jots and Flashes .....	56
News .....	50
TV Antennas . . . Accessories .....	53

*Entire contents Copyright 1949, Bryan Davis Publishing Co., Inc.*



Published monthly by Bryan Davis Publishing Co., Inc.  
52 Vanderbilt Avenue, New York 17, N. Y. Telephone MURray Hill 4-0170



Bryan S. Davis, President      Paul S. Weil, Vice-Pres., Gen. Mgr.      F. Walen, Secretary      A. Goebel, Circulation Manager

Cleveland Representative: James C. Munn, 2253 Delaware Dr., Cleveland 6, Ohio. Telephone: Erleview 1726

Pacific Coast Representative: Brand & Brand, 1052 W. Sixth St., Los Angeles 14, Calif. Telephone: Michigan 1732  
Suite 1204, Russ Building, San Francisco 4, Calif. Telephone: SUTter 1-2251

Entered as second-class matter June 14, 1932, at the Post Office at New York, N. Y., under the Act of March 3, 1879. Subscription price: \$2.00 per year in the United States of America and Canada; 25 cents per copy. \$3.00 per year in foreign countries; 35 cents per copy.



# The Offer Still Stands!

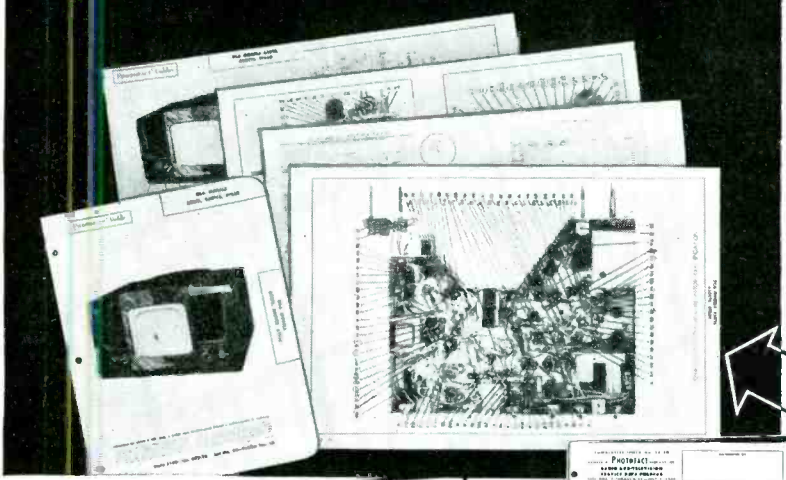

**Only \$18.73 Down Puts the Complete Photofact Library in Your Shop Today...**

NOW—the new “Pay-as-you-Profit” Plan brings the famous PHOTOFAC Library within the reach of every Serviceman! Now you can easily own the world’s finest radio service data—seven complete volumes, *plus* continuous PHOTOFAC Folder Set service—full coverage of *all* post-war AM, FM and TV models! Everything you’ll ever need for quicker, more profitable servicing! You pay only \$18.73 down—the remainder in small monthly payments. *Absolutely no carrying charges and no interest!* Make the down payment—and you get the complete Library immediately. Your Jobber has all the details of this amazing new purchase plan. See him today, or write us direct for full information.

**Get the Easy-Pay Details Now!**

## FREE PHOTOFAC Cumulative Index

Select your FREE PHOTOFAC Folder (covering any AM, FM or TV model) from the PHOTOFAC Cumulative Index. Get the FREE Index today. Covers all post-war receivers right up to the present. Helps you find the Folders you want in a jiffy—Folders that make your work quicker, easier, more profitable. Get this FREE Index at your Jobber or write direct for it now.

# SERVICEMEN: We'll Prove You'll Save Time, and Earn More with PHOTOFAC!

We'll Send You Absolutely

# FREE

**Any PHOTOFAC Folder Listed in the PHOTOFAC Cumulative Index!**

NOW—learn for yourself—at our expense—how PHOTOFAC will make your service work quicker, easier, more profitable! Examine an actual PHOTOFAC Folder. Use it. You'll learn first-hand why this indispensable service data is used daily by over 25,000 successful service technicians. You'll discover quickly that no other service gives you PHOTOFAC'S outstanding advantages: *completeness, accuracy, uniformity and ease-of-use.* PHOTOFAC *alone*, is the *only* radio service data prepared from laboratory analysis of the actual equipment. Nothing in the field equals PHOTOFAC. Know the facts—get your FREE Folder now. Examine it—use it—compare it—and you will understand why no modern service shop can afford to be without PHOTOFAC.



### CURRENT PHOTOFAC BEST-SELLERS

**The Recording and Reproduction of SOUND**, by Oliver Read. The complete, authoritative treatment of the entire subject of Sound, written by the editor of *Radio & Television News*. . . . . **\$5.00**

**Photofact Television Course**. The book used by thousands; gives you a clear understanding of TV principles, operation and practice. **\$3.00**

**Television Antennas**. Shows you how to select and install the proper antenna, and how to overcome antenna problems. . . . . **\$1.25**

**1948 Record Changer Manual**. Covers 45 models made in 1948, including new LP and dual-speed changers, plus leading wire recorders. Based on actual analysis of the equipment. . . . . **\$6.75**

**Auto Radio Manual**. Complete Photofact service data on more than 100 post-war auto radio models—a time-and-money-saver. **\$4.95**

**HOWARD W. SAMS & CO., INC. INDIANAPOLIS 1, IND.**

**NOTE:** This FREE offer is limited to Service Technicians. Attach coupon below to your letterhead and mention the name of your jobber. If you have no letterhead, send coupon to your jobber. Experimenters and others may obtain the Photofact Folder by remitting 50c.

**HOWARD W. SAMS & CO., INC.**  
955 N. Rural St., Indianapolis 1, Ind.

Send FREE Photofact Cumulative Index

Send Full Easy-Pay Details

I am a Service Technician:

Send FREE Photofact Folder for set model . . . . .

I am an Experimenter:

Send Photofact Folder for set model . . . . . (50c enclosed)

Name . . . . .

Address . . . . .

City . . . . . Zone . . . . . State . . . . .

# Your Best Buy!

## DU MONT Type 16FP4

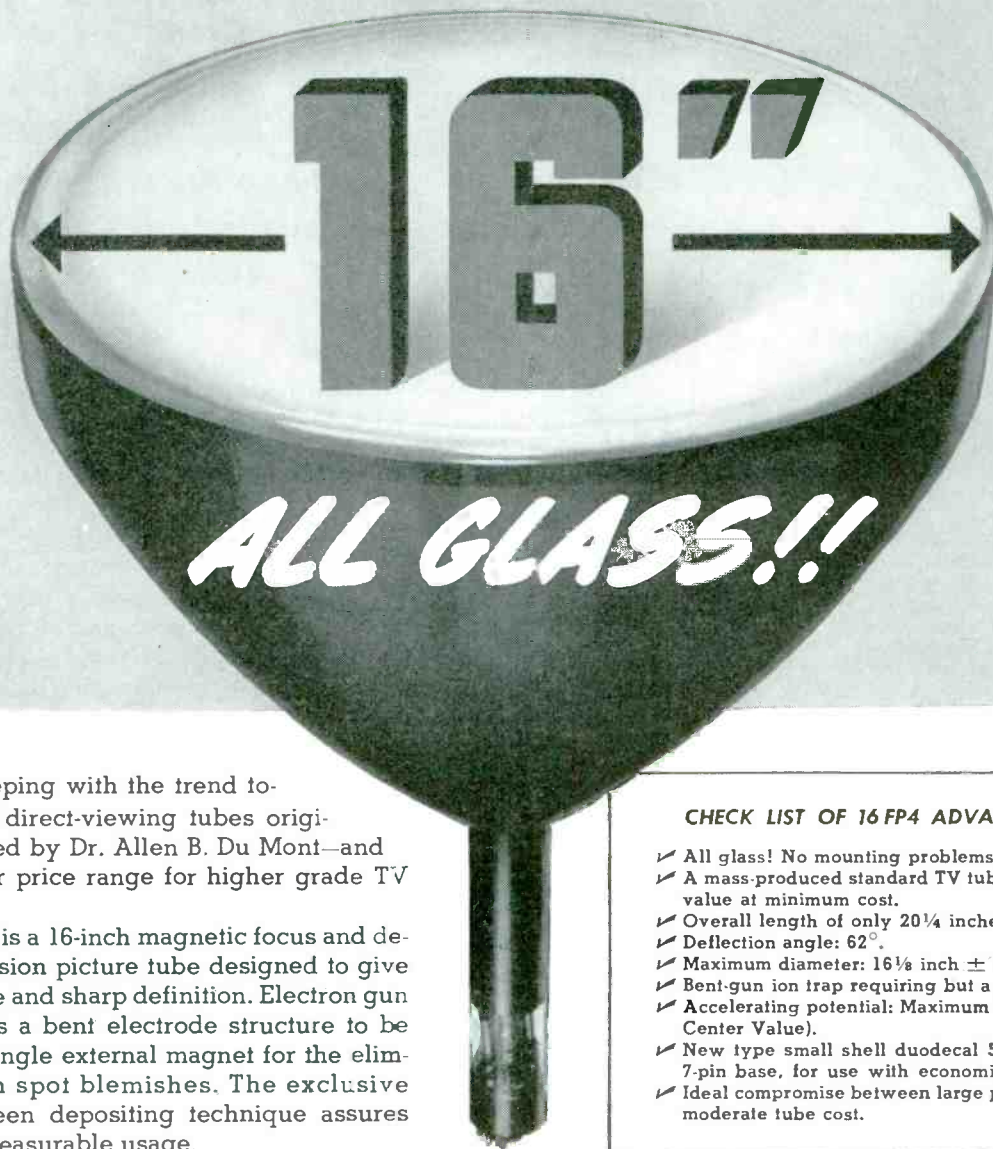

Fully in keeping with the trend towards larger, direct-viewing tubes originally pioneered by Dr. Allen B. Du Mont—and also the lower price range for higher grade TV offerings.

Type 16FP4 is a 16-inch magnetic focus and deflection television picture tube designed to give high brilliance and sharp definition. Electron gun design utilizes a bent electrode structure to be used with a single external magnet for the elimination of ion spot blemishes. The exclusive Du Mont screen depositing technique assures the longest pleasurable usage.

#### CHECK LIST OF 16FP4 ADVANTAGES...

- ✓ All glass! No mounting problems.
- ✓ A mass-produced standard TV tube for maximum value at minimum cost.
- ✓ Overall length of only 20¼ inches.
- ✓ Deflection angle: 62°.
- ✓ Maximum diameter: 16⅛ inch ± ⅛ inch.
- ✓ Bent-gun ion trap requiring but a single magnet.
- ✓ Accelerating potential: Maximum 16 KV: (Design Center Value).
- ✓ New type small shell duodecal 5-pin instead of 7-pin base, for use with economical half-socket.
- ✓ Ideal compromise between large picture size and moderate tube cost.

► Detailed Specifications on request. Let us quote on quantity requirements.

© ALLEN B. DU MONT LABORATORIES, INC.

FIRST WITH THE FINEST  
IN TELEVISION TUBES

# DU MONT Teletrons

ALLEN B. DU MONT LABORATORIES, INC., TUBE DIVISION, PASSAIC, N. J.



# YOU JUST CAN'T SERVICE F.M. and T.V. BY EAR!

Or any Quality A.M. radio  
— for that matter

2 Minutes . . . Reading Time  
Benefits . . . for a Life Time

**TODAY**, modern time and labor-saving Test Equipment is a **MUST** to do the servicing job that brings satisfied customers *back* to you . . . and eliminates costly "callbacks" . . . in short, to be profitable, jobs must be done *right* the first time.

**The days of "Servicing-by-Ear"** are gone . . . only the alert, aggressive and properly-equipped technician can thrive and make money. Any Radio Serviceman, anywhere in the U.S.A., can now own new, up-to-date Test Equipment . . . *plus* many luxury items for his home, office, or hobby . . . *At No Cost* . . . through the famous N.U. DEALER EQUIPMENT PLAN . . . the only Plan that gives you this opportunity!

**Since 1933**, successful servicemen from every state in the Union have built their businesses around the 84,000 pieces of Equipment awarded them through the N.U. Dealer Equipment Plan . . . they earned them without any special effort . . . simply through their usual day-by-day purchases of N.U. Radio Tubes.

**ONLY YOUR N.U. DISTRIBUTOR  
CAN OFFER YOU THE N.U. PLAN**

**TEST EQUIPMENT:** Ask him *today* to tell you how you can equip your shop, store or office.



**LUXURY GIFTS:** Mail the coupon below for the **FREE** 16-page fully-illustrated catalog.

**Select the Test Equipment** of your own choice from your N.U. Distributor's large, diversified stock . . . tell him you want to go on the N.U. Dealer Equipment Plan . . . get on-the-spot delivery of the Equipment . . . now you're on your way to a sounder, more profitable career in FM-TV and AM servicing.

**Remember too** National Union's help to the Service Engineer does not stop with Equipment. Each N.U. Tube, like the thoroughbred it is, best displays its 20 years of fine laboratory breeding, under the most severe operating conditions. No wonder N.U. Tubes are known throughout the industry as the Premium Quality Tube.

**Free!** Fully Illustrated  
Luxury Gifts Catalog

NATIONAL UNION RADIO CORP.  
354 Scotland Road, Orange, N. J.  
Send me the FREE Luxury Gift Catalog and tell  
me more about the N.U. Dealer Equipment Plan.

Name \_\_\_\_\_

Street Address \_\_\_\_\_

City \_\_\_\_\_ Zone \_\_\_\_\_ State \_\_\_\_\_

My Parts Distributor is: \_\_\_\_\_

**For Prompt Action . . . Mail Today!**

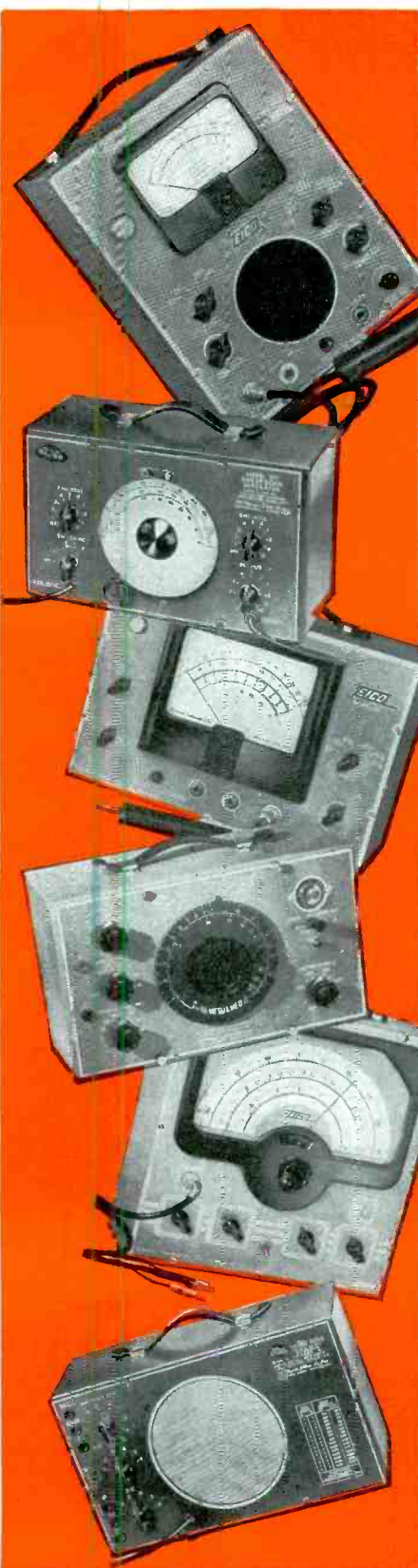

## NATIONAL UNION RADIO CORPORATION

ORANGE, NEW JERSEY

RECEIVING TUBES • TRANSMITTING TUBES • CATHODE RAY TUBES • TELEVISION TUBES • SPECIAL PURPOSE TUBES  
PHOTOTUBES • BALLASTS • BATTERIES • CAPACITORS • PANEL LAMPS • VIBRATORS • VOLUME CONTROL

**⑤ MORE FOR YOUR MONEY ⑤**

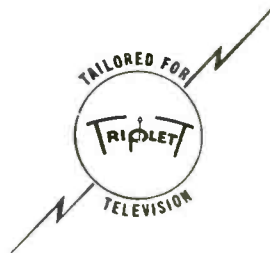

# NEW TV SWEEP GENERATOR-MARKER

**Covers All TV Picture and Sound I.F. and F.M. Ranges**

**MIRROR-SCALED for ACCURACY!**

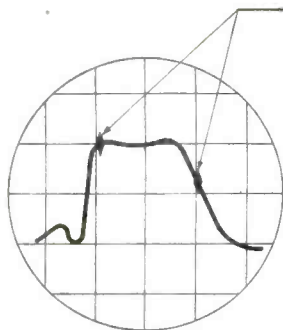
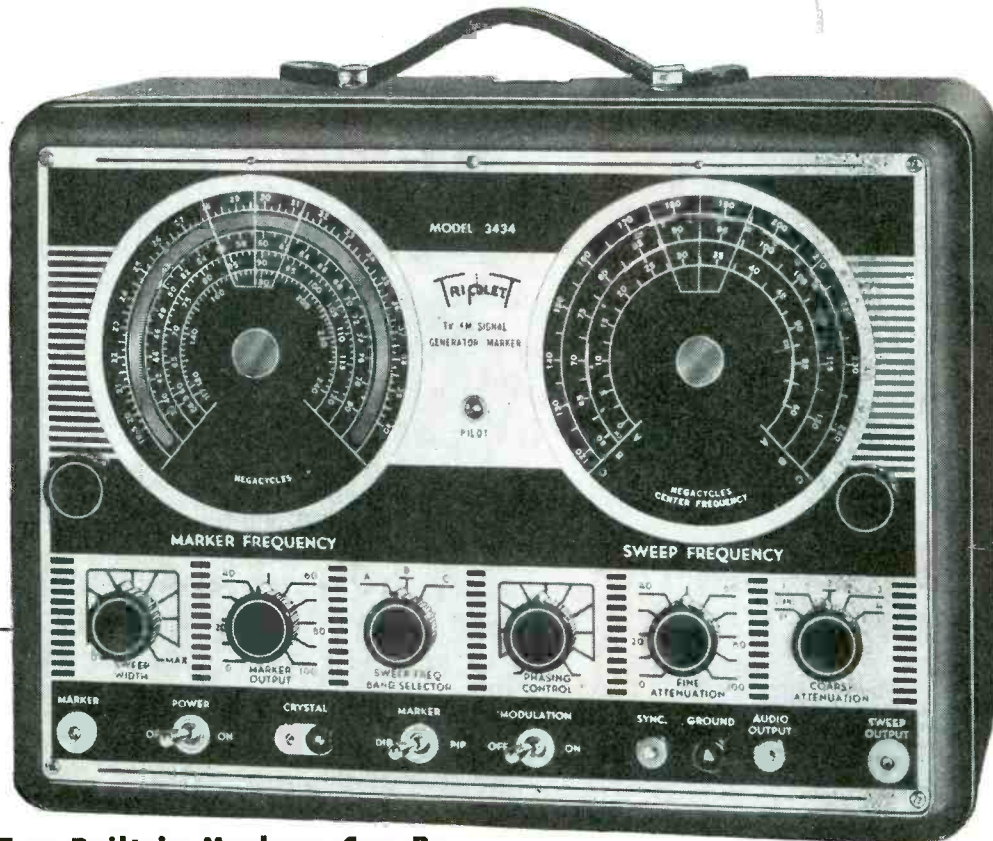

**Two Built-in Markers Can Be Used Simultaneously Giving Facilities for Faster Identification of Bandpass of Curves Without Constant Tuning of Marker**

**Model 3434 Only \$149<sup>50</sup>**

Suggested USA Dealer Net (crystals not supplied)

### TECH DATA

#### Frequency Coverage:

- SWEEP CENTER FREQUENCY
  - Range 1— 0-60 MC
  - Range 2— 60-120 MC
  - Range 3— 120-240 MC
- SWEEP WIDTH: 0-12 MC (Continuously Variable)
- MARKER FREQUENCY 19.5 to 40 MC (fundamental), 39 MC to 240 MC (harmonic)
- CRYSTAL FREQUENCIES To 20 MC on Fundamentals. Harmonics up to 216 MC. (Crystals Not Furnished)
- MODULATION 400 Cycle on both Crystal and Marker Frequencies
- AUDIO: 400 cycles

The new Triplet TV-FM Sweep Generator-Marker, with two built-in Markers and large mirrored dial, was "Tailored For Television" with YOU in mind! The two Markers can be used simultaneously . . . gives you the facilities for faster identification of bandpass of curves without constant tuning of Marker. Marker has both pip and absorption dip control.

The large Marker dial is mirrored for easy reading and greater reset accuracy. Straight line frequency tuning condensers used to provide linear scale markings.

No gaps in frequency . . . continuously variable Sweep width control. Audio output for quick check on video and sound amplifiers. Expertly-engineered shielding . . . all critical circuits enclosed. Copper plated steel construction.

Contained in attractive black suede finish steel case, size 15-11/32" x 11-1/32" x 8 1/4" . . . leather handle . . . copper-plated feet for grounding when working on metal work bench top . . . panel is black, white and red etched on aluminum.

*For Detailed Information*

*See your Radio Parts Distributor or write . . .*

**TRIPLET ELECTRICAL INSTRUMENT COMPANY • BLUFFTON, OHIO, U.S.A.**

*In Canada: Triplet Instruments of Canada, Georgetown, Ontario*

*Prices slightly higher west of Rockies*

Above also furnished in separate units . . . Sweep Generator . . . Variable Marker . . . Crystal Marker.

*Precision first... to Last*





**"Nothing like the factory-authorized data of RIDER MANUALS"**

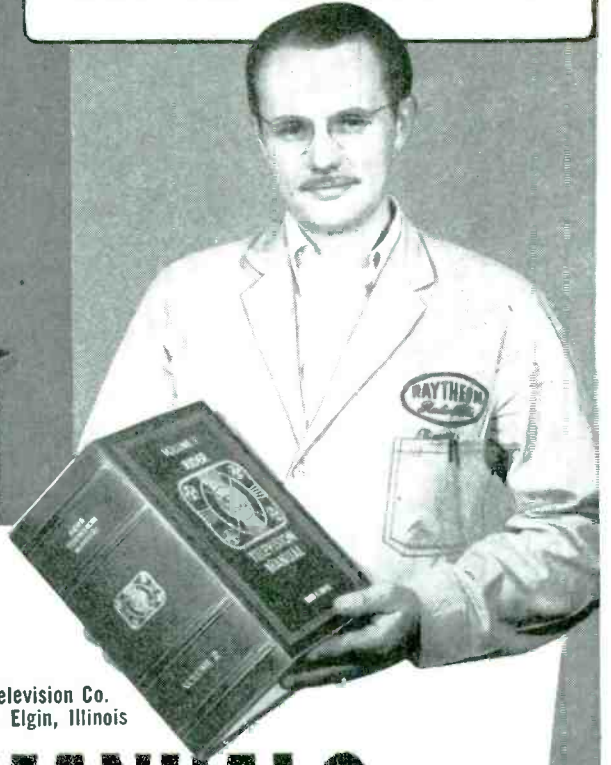
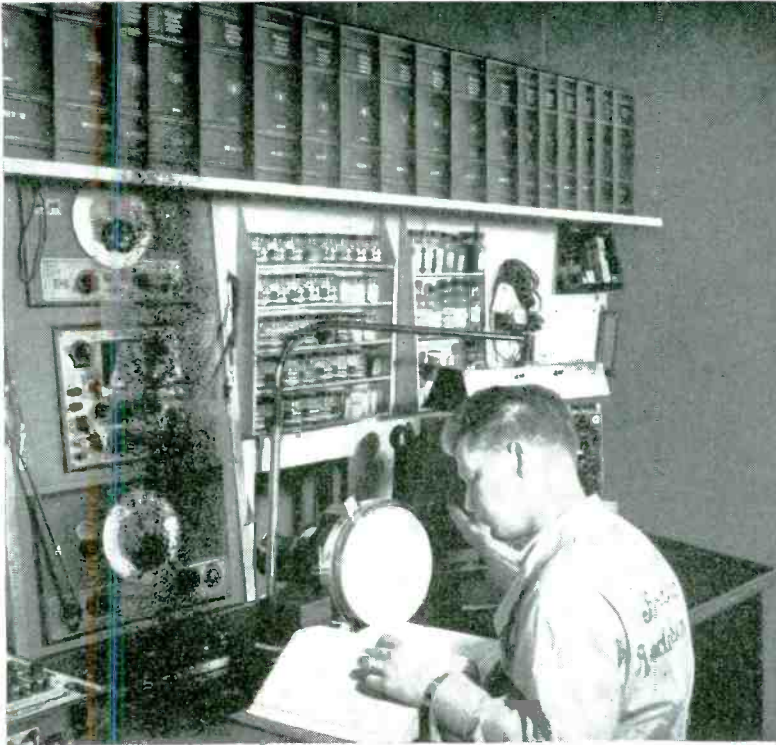

"Nothing like having servicing data direct from the factory when it comes to 'fixing' any kind of radio, TV or public address system. John F. Rider's Manuals have these facts, and I am glad to say that I'm making use of them constantly. Rider Manuals give me the greatest possible coverage, too. And with so many models and makes in existence today that coverage is an absolute necessity."

Charles R. Price  
L.S.K. Radio and Television Co.  
104 N. Spring St., Elgin, Illinois

**For 20 Years, RIDER MANUALS have been "money-makers" for Servicemen!**

Charles R. Price is only one of the thousands of servicemen who use Rider Manuals as a daily guide to better servicing... with resultant greater profits. For 20 years, RIDER MANUALS have been the most complete source of AUTHENTIC, OFFICIAL, RELIABLE Servicing Data, direct from the manufacturers themselves. As Servicing grows more complex, you'll find RIDER MANUALS all the more time-saving and profitable.

**How Available!**  
**RIDER MANUAL**  
**Volume XIX**



The biggest and best yet! 2122 pages. More than 100 manufacturers, including AM-FM, Amateur Receivers, Auto Radio and Record Changers. Crammed full of schematics, "Clari-Skematix", and voltage and resistance tables, and parts lists. Only RIDER gives you such a wealth of information at the lowest dollar-per-dollar cost in the industry.

Only **\$19<sup>80</sup>**

Including Cumulative Index Volumes XVI, XVII, XVIII, XIX... PLUS the Famous "HOW IT WORKS" Book.

**NOTE:**  
Are you receiving your copy of "Successful Servicing"? It's Rider's own publication of interest to every Serviceman. In it you will find all of the circuit changes in sets... as soon as they are released. It's FREE!

**And a PA "MUST"! RIDER PA MANUAL**

Covers amplifier production of 147 manufacturers from 1938 to 1948.  
2024 Pages PLUS "HOW IT WORKS" Book. Complete..... **\$18<sup>00</sup>**

**RIDER MANUALS**

- Television Manual, Vol. 2 \$18.00 (plus "How It Works" and Index)
- Television Manual, Vol. 1 18.00 (plus "How It Works" and Index)
- Volume XIX..... 19.80
- Volume XVIII..... 19.80
- Volume XVII..... 16.50
- Volume XVI..... 8.40
- Volume XV..... 19.80
- Volume XIV to VII (each vol.)..... \$16.50
- Volume VI..... 12.50
- Abridged Manuals I to V (one volume)..... 19.80
- Record Changers and Recorders..... 9.00
- Master Index, Covering Manuals, Vols. I to XV 1.50
- PA Equipment Manual, Vol. I..... 18.00

**JOHN F. RIDER PUBLISHER, Inc.**  
480 Canal Street, New York 13, N. Y.  
Export Agent: Rocke International Corp., 13 E. 40th St., N.Y.C.  
Cable, ARLAB.

**RIDER MANUALS**  
**Mean Successful Servicing**

**It's a TV "MUST"!**  
**RIDER TELEVISION MANUAL**  
**Volume 2**



RIDER TELEVISION MANUALS present the information needed to properly service all television receivers and kits manufactured to date. 67 manufacturers are represented in Volume 2. Equivalent of 2300 pages, including Giant, Triple and Double Spread pages.

Only **\$18<sup>00</sup>**

Including Cumulative Index Volumes 1 and 2... PLUS the Famous RIDER "HOW IT WORKS" Book.

**NOTE:**  
The Mallory Radio Service Encyclopedia, 6th edition, makes reference to only one source of radio receiver schematics—Rider Manuals. ANOTHER NOTE: The C-D Capacitor Manual for Radio Servicing, 1948 edition No. 4, makes reference to only one source of receiver schematics—Rider Manuals.



★ **Build Your Service-  
Sales Future on a Firm  
Foundation with . . . .**

**PRECISION**  
TEST EQUIPMENT  
*Standard of Accuracy...*

**...These 5 Matched "Precision"  
Instruments provide a Complete  
MODERN SERVICE LABORATORY for  
TV-FM-AM at only moderate cost.**

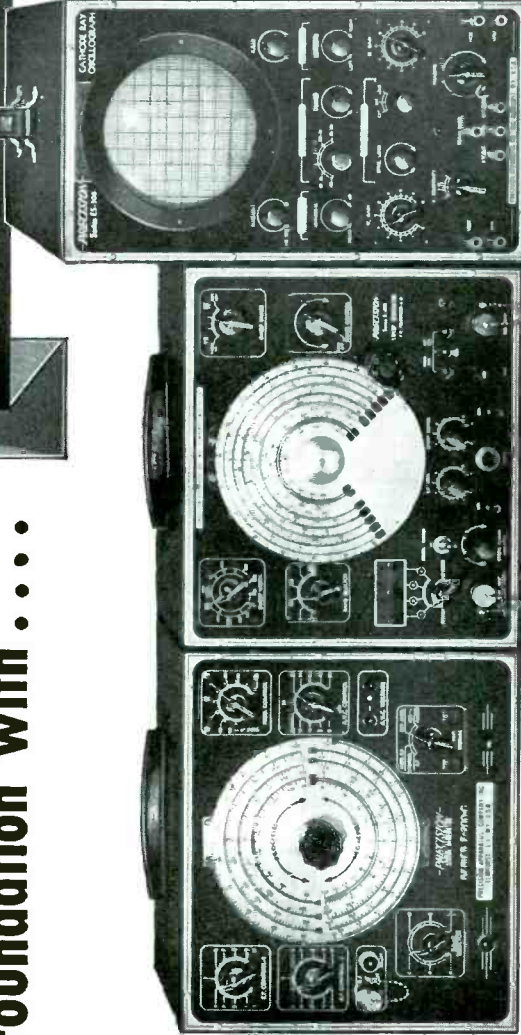

**SERIES E-200-C**—Modern Multi-band SIGNAL and MARKER GENERATOR for A.M., F.M., and TV alignment.

Exceptional Accuracy and Stability! 1000 pt. vernier calibrating scale! 0-100% Modulation! A.V.C. substitution network! Direct reading 88KC to 120 MC! Complete with output cable and tech. manual. In matched, heavy gauge case 10½ x 12 x 6".

Net Price:—\$67.25

**SERIES E-400**—Wide Range H.F. SWEEP SIGNAL GENERATOR Direct Reading from 2 to 480 MC.

Narrow and Wide Band Sweep for F.M. and TV • 1500 pt. vernier calibrating scale • Multiple Crystal Marker • 8 tubes including V.R. and rectifier • RG/62U Coaxial Terminated Output. Complete with 2 crystals. In heavy copper-plated case 10½ x 12 x 6".

Net Price:—\$124.70

**SERIES ES-500**—20 MV. High Sensitivity, Wide Range 5 inch C.R. OSCILLOGRAPH.

V. Amp. Response to 1 MCI Low Z, High R input Step Attenuator! X axis modulation terminals! 9 tubes incl. V.R. and 2 rectifiers! Complete with light shield and mask. Heavy steel case 8¼ x 14½ x 18".

Net Price:—\$149.50

**SERIES EV-10**—True Zero-Center VTVM —MEGOhmmETER with large 7" meter — plus complete 1000 Ω/V. functions.

59 ranges to 6000 Volts, 2000 Megs, ±70DB, 12 Amps • Voltage Regulated bridge type circuit • Constant 13½ Megs input resistance to 600 V. 133½ Megs at 6000 V • Optional RF probe. Complete with test cables. Matched heavy gauge steel cabinet 10½ x 12 x 6".

Net Price:—\$89.95

**SERIES 612**—Modern Free-point Cathode Conductance TUBE TESTER, and dynamic A-B-C Battery Tester.

Incorporates RMA recommended circuit principles! 10 lever free-point element selection! Built-in roller chart! Dual short-check sensitivity! Noise, Ballast and Pilot Test! Complete, ready to operate in matched heavy gauge steel cabinet 10½ x 12 x 6".

Net Price:—\$66.65

**BUY PERFORMANCE—NOT SPECIFICATIONS**

For over 15 years, "Precision" PERFORMANCE, ACCURACY, WORKMANSHIP and VALUE have set a standard of comparison...products of an organization whose sole efforts are concentrated exclusively in the design, development and production of the FINEST TEST EQUIPMENT...nothing else!

"Precision" Performance Engineered Instruments are on display at leading radio parts and equipment distributors.

**PANEL MOUNTS, PORTABLES, COUNTER TYPES**

Most "Precision" instruments are available in various enclosure styles to suit your individual application, field or shop. WRITE FOR OUR LATEST ILLUSTRATED CATALOG describing the full line of Precision quality test equipment for all phases of modern radio, television and communications.

**PRECISION APPARATUS CO., INC.**  
92-27 Horace Harding Boulevard, Elmhurst 6, New York

Export Division: 458 Broadway, New York, U.S.A. • Cables—Morhenes

**SERIES TV—Super-High Voltage Safety Test Probes.**

Extends range of Series EV-10 (above) up to 30 KV or 60 KV direct reading, with full safety to operator and equipment. Multiplier cartridges available to match most VTVM's and 20,000 ohms/v. test sets. Complete with 30 KV multiplier cartridge for EV-10.

Net Price:—\$15.45



Convenient "Precision" Purchase Terms can be arranged with your favorite authorized Precision Distributor.

TV • AM • FM • TV • AM • FM • TV • TV • AM • FM • TV • AM • FM • TV • TV

TV • AM • FM • TV • AM • FM • TV • TV





## Sales Stimulators Like These Are Pulling in Profits for RAYTHEON *Bonded* ELECTRONIC TECHNICIANS



ASK YOUR RAYTHEON TUBE DISTRIBUTOR for this presentation. It gives you the complete "Bonded" story and shows you why you can't afford to pass up this free Raytheon "dividend".

Wherever Service Dealers are riding the Raytheon "Bond" Wagon, volume and profit are riding high, too. The bigger and better RAYTHEON *Bonded* ELECTRONIC TECHNICIAN Program has a complete line of brand new displays, decals, mats, mailing pieces, shop and sales aids specially designed to create customer confidence and stimulate sales. Most of these hard-hitting sales tools are yours for the asking — if you can qualify as a RAYTHEON *Bonded* Technician. The Bond costs you nothing — but it pays big dividends.

Better ask your RAYTHEON TUBE DISTRIBUTOR whether you can ride the "BOND" Wagon to bigger business.



The Raytheon Bantall Tube simplifies your tube stock without loss of sales. Eight fast-moving Bantalls replace sixteen equivalent GT and metal types. A new and better tube at no extra cost! Ask your Raytheon Distributor for Raytheon Bantall Tubes.

**RAYTHEON**  
MANUFACTURING COMPANY  
Radio Receiving Tube Division

NEWTON, MASS. • CHICAGO, ILL. • ATLANTA, GA. • LOS ANGELES, CAL.

RADIO RECEIVING TUBES • CATHODE RAY TUBES • SPECIAL PURPOSE TUBES • SUBMINIATURE TUBES • MICROWAVE TUBES



SIZE: 16 3/4" Wide x 12 1/2" High x 6" Deep  
Dealer's Net Price, with Operator's Manual . . . \$79.50



Checks all

# TELEVISION and Radio types

## SIMPSON 555 Tube Tester

- Basic RMA recommended circuit. Tests any tube regardless of base connections or internal connections of elements.
- Simpson designed 3-position lever operated toggle switches with molded rotor carrying silver plated contacts, self-cleaning through wiping action.
- Sockets for all receiving tubes on the market.
- Provision for future tube developments.
- No adapters or special sockets required.
- Properly fused, provides for line adjustment from 100 to 130 volts; smooth vernier control.
- Beautiful modern panel of shining, silver and black anodized enduring aluminum.
- Large illuminated meter for easy readings.
- Unique jewel-like molded lucite housing encloses Neon bulb indicating shorts and inter-element leakages.
- Line adjustment control below dial opening. Easy to operate.
- Case of sturdy plywood with heavy fabricoid covering, slip hinges.
- Simpson patented "No-Backlash" Roll Chart.



See the 555 at your parts jobber or write for descriptive literature.

**Simpson**  
INSTRUMENTS THAT STAY ACCURATE

**SIMPSON ELECTRIC COMPANY** 5200-18 W. Kinzie Street, Chicago 44, Illinois In Canada: Bach-Simpson Ltd., London, Ontario



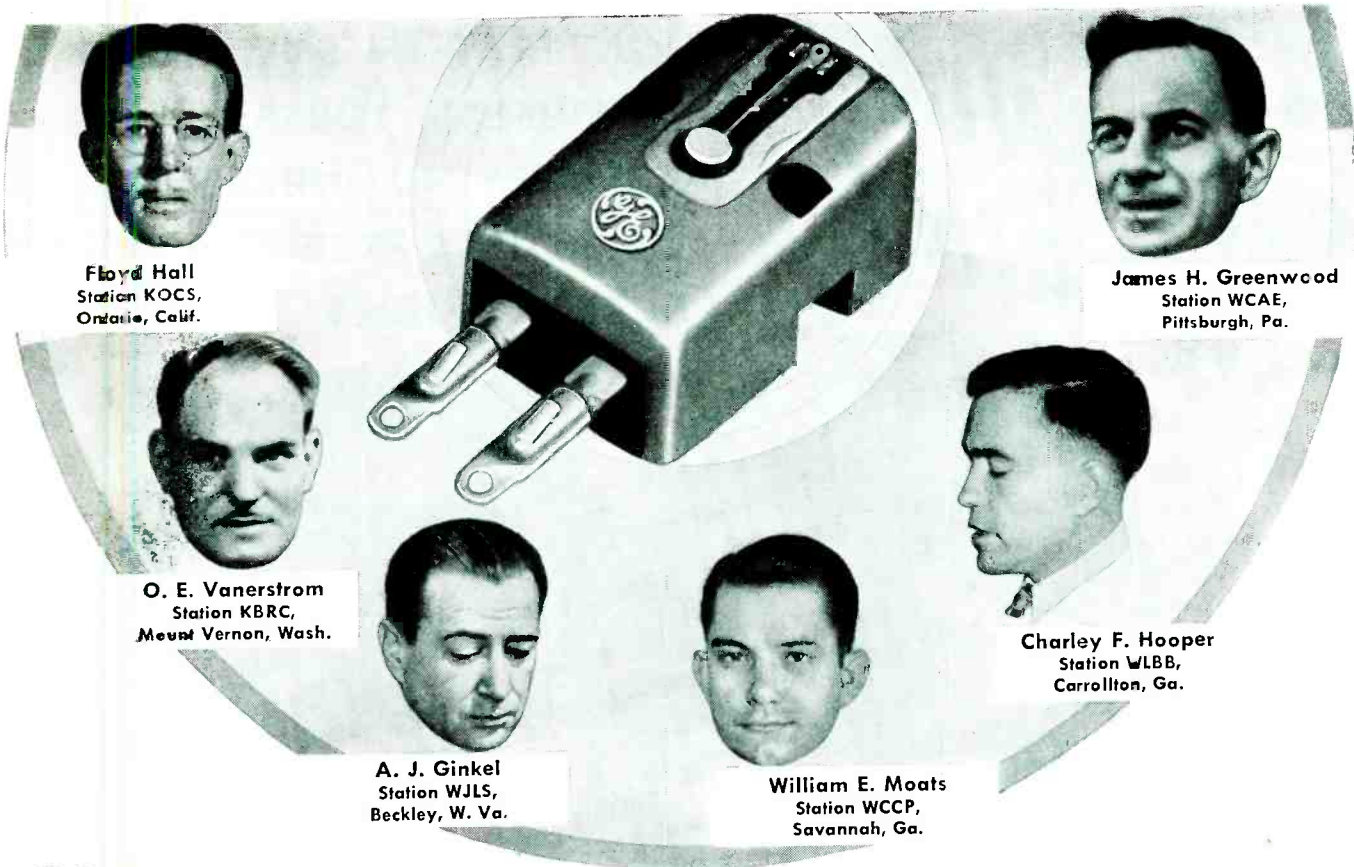

Floyd Hall  
Station KOCS,  
Ontario, Calif.

James H. Greenwood  
Station WCAE,  
Pittsburgh, Pa.

O. E. Vanerstrom  
Station KBRC,  
Mount Vernon, Wash.

Charley F. Hooper  
Station WLBB,  
Carrollton, Ga.

A. J. Ginkel  
Station WJLS,  
Beckley, W. Va.

William E. Moats  
Station WCCP,  
Savannah, Ga.

# Sell the cartridge studios prefer!



## VARIABLE RELUCTANCE CARTRIDGE

**Brings your customers professional record performance!**

Performance—not words, sells cartridges to broadcast stations. Day in and day out playing thousands of records on studio turntables G-E Variable Reluctance Cartridges deliver countless hours of enjoyment to listeners.

Station engineers are shrewd judges of the value of audio equipment. What stronger proof could you want than the opinion of these men on the G-E Cartridge!

And don't forget—every phonograph user, too—is a prospect for a G-E Cartridge. Your customer is entitled to the finest record reproduction his money will buy. Tell him about the cartridge the professionals prefer!

See your distributor and stock up today. Write to us for a new and important bulletin, "The Cartridge Story": *Parts Section, General Electric Company, Electronics Park, Syracuse, New York.*

*You can put your confidence in—*

**GENERAL  ELECTRIC**

**IT'S  
SYLVANIA  
AGAIN!**

**ION TRAP IN SYLVANIA  
TELEVISION TUBES  
ASSURES HUNDREDS  
OF HOURS FREE FROM  
SCREEN BURNS**

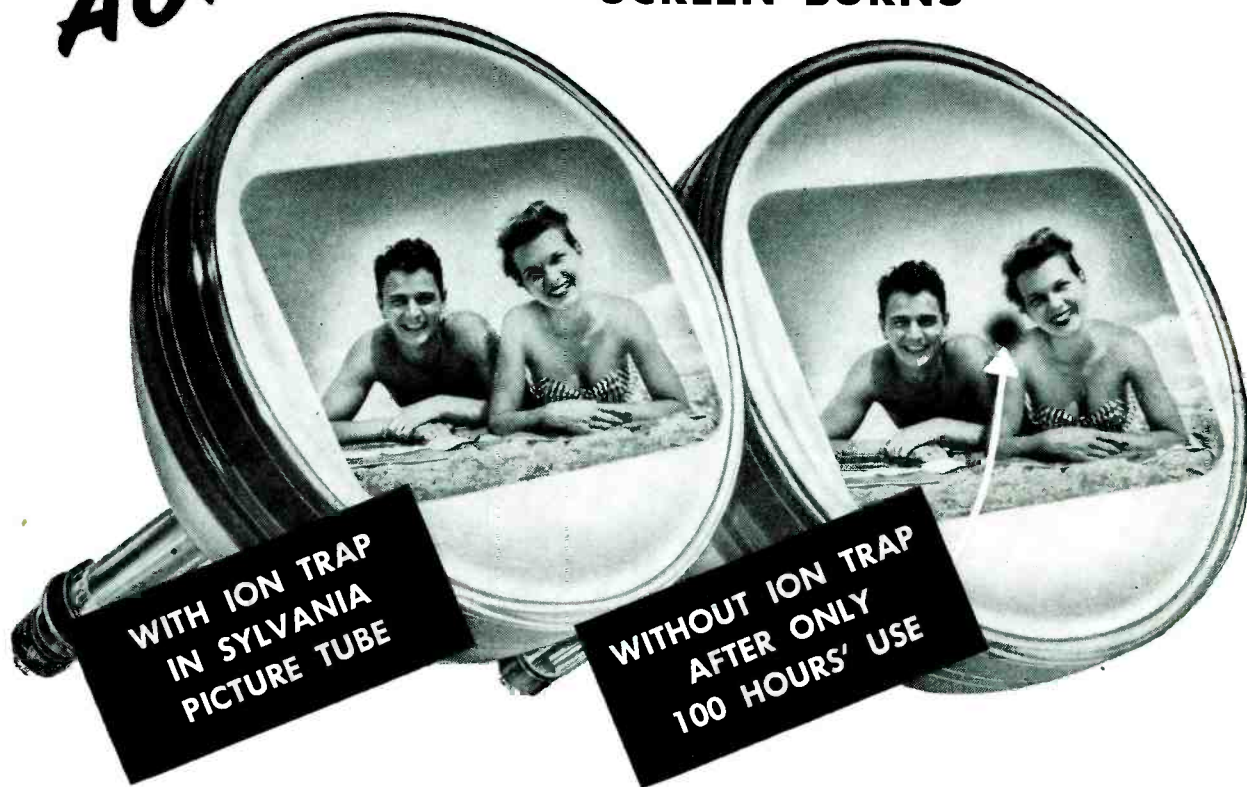

**HERE'S HOW IT WORKS...**

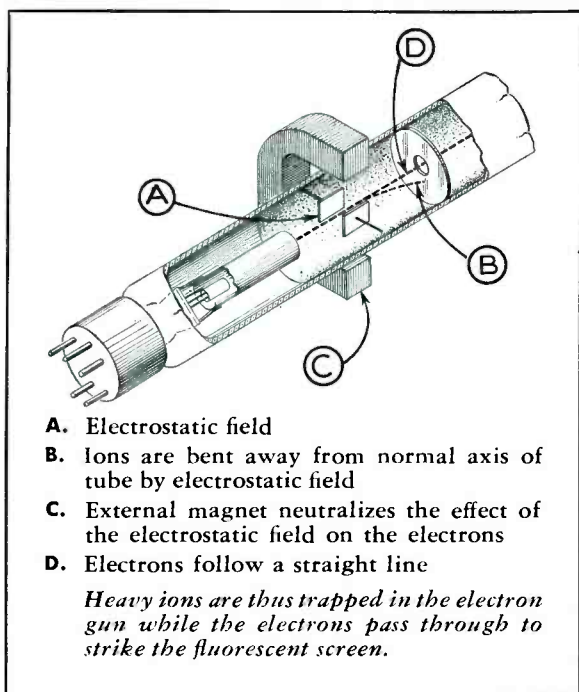

Owners of television sets equipped with Sylvania Television Picture Tubes report their screens still bright and unblemished after more than 1000 hours' use. Much credit for this top quality performance belongs to Sylvania scientists who hold the basic patents on the magic "ion trap." With this device these scientists prevented destruction of the fluorescent screen by heavy ion bombardment. So successful is this ion trap that now many other major TV tube makers are using it under agreements with Sylvania.

These same Sylvania Television Tube scientists are now developing shorter large-screen picture tubes and special tubes for uhf television. Their continued research makes the Sylvania label your guarantee of the newest and finest in television picture tubes. Sylvania has a complete line of all-glass and glass-metal types for television and general purpose cathode ray applications. They are available now from your Sylvania Distributor.

Write for free characteristics and TV set complement chart. Advertising Department, Box R-1909, Emporium, Pa.

**SYLVANIA  
ELECTRIC**

RADIO TUBES; CATHODE RAY TUBES; ELECTRONIC DEVICES; FLUORESCENT LAMPS, FIXTURES, WIRING DEVICES, SIGN TUBING; LIGHT BULBS; PHOTOLAMPS



# RADIO TELEVISION ELECTRONIC SERVICE

## The TV Swing

THE SPIRALLING PACE of TV has become a sizzling topic of national interest, prompting ecstatic statements by even the most conservative. Citing the striking rise as a boom, Paul V. Galvir of Motorola said that TV is an . . . "economic and social phenomenon. . . . In 1947 sales totaled 178,000 sets. The 1948 figures rose to 922,000 and we in the industry confidently predict sales of 2,000,000 for the current year."

Galvir felt that TV will have more far-reaching effects than radio, and will establish itself during our lifetime as one of America's top industries. This does not mean that radio will die, he said, but rather a shift in emphasis with radio becoming a supplementary medium.

Commenting on the accelerated accent on TV, Galvir reported that . . . "TV definitely has not been oversold. Only two million receivers have been sold thus far, while nearly seventeen-million families now live in TV areas. By the end of this year, it is anticipated that over sixty per cent of the nation's population will be served by TV stations."

This pronounced swing should be studied carefully by every Service Man, for it not only reemphasizes the mounting status of this giant infant, but the significant possibilities which are here and will be even greater in the years to come.

## The Eyes and TV

ALARMING VERSIONS of TV eyestrain have been found to be completely out of bounds by scores of leading ophthalmologists and optometric and medical associations.

Studies have revealed that TV in itself does not produce eyestrain. The Philadelphia Committee for the Prevention of Blindness reported that . . . "if looking at television hurts your eyes, perhaps there was something wrong with your eyes before the TV set was acquired. In other words, TV is not dangerous to vision."

In all reports the viewing distance was cited as the key factor in avoid-

ing any possible type of eye fatigue. A general rule for finding this distance is to multiply the width of the viewing tube by 10. On this basis, the approximate spacing for the most popular sizes of screens would be:

20" tube . . . 16'; 16" tube . . . 13';  
15" tube . . . 12'; 12" tube . . . 10';  
10" tube . . . 8'; 7" tube . . . 5';  
and 3" tube . . . 2'.

This all-important news, gathered through the facilities of the information research committee of the Television Broadcasters Association, should be memorized by all Service Men and applied diligently in the form of personal advice by letter, cards, etc.

Those you serve and might serve will be grateful for this guidance.

## Preventive Maintenance Control

PREVENTIVE MAINTENANCE, which through the driving efforts of the Service associations in Pennsylvania, has revitalized Servicing on many fronts and become a standard of practice in countless Service Shops, has prompted the adoption of many effective control systems.

In one extremely comprehensive maintenance-control set-up, described recently to ye editor by Jack Darr of Ouachita Radio Service, a detailed check list is used and followed religiously during every service call. The check list includes a general probe of tubes, then the voltages, the speaker, components, contacts, and alignment.

In the Darr approach, after the tubes are checked, the plate and screen voltages are surveyed, with particular attention being paid to low screen voltages which may be caused by leaky bypasses and short out early. The speaker test, next in line, includes a check on torn cone, dragging voice coil, loose rim on spider or cone. There is also the suggestion in this test that the Service Man listen carefully for ripping or popping noises. This may indicate corroded, noisy windings in the output transformer primary, if primaries, oscillator plate coils or rf plate coils. To quick check, the suspected plate can be shorted to ground momentarily. Good windings will not be damaged, and corroded windings will usually open entirely.

In checking capacitors, Darr first reads the bias voltage at the grid and then at the other end of the grid resistor with a *vtrm*. A difference in the reading indicates a leaky coupling capacitor. If the voltage is over one-half, Darr has found it wise to change the capacitor.

Darr's voltage checks are novel. When the oscillator stage is tested for output, the dial is first tuned to the low end and then the grid voltage is analyzed with a *vtrm* or a signal tracer. A voltage of 20 to 30 at the proper frequency indicates that the oscillator is operating properly. Checking the voltage at the second detector and first *af* plate is an important step, too. If this tube is a pentode, reports Darr, the two or three-megohm screen resistor requires careful attention, since they often increase or open up, causing a loss of volume and distortion.

After conducting a streamline series of tests on the receiver, Darr then proceeds to add the finishing touches by checking all controls for binding, and the dial pointer for calibration, seeing that it travels its full distance without dragging on the cabinet or dial scale. He brushes out the cabinet, cleans the dial glass and scale, and polishes the cabinet with furniture polish removing as many scratches and nicks as possible, a step that always brings a smile from the lady of the house. "And how important it is to keep her happy," says Darr!

While these tests sound involved, they are quite simple and when patterned properly take comparatively little time. Darr says that when he delivers a traced receiver, he reports: "We've checked your receiver carefully, and to the best of our knowledge, it's in tip-top shape. But if anything goes wrong, just let us know. We guarantee everything we did to the set!"

To simplify call back problems, a detailed record is kept of every job. Darr has found that preventive maintenance has been an answer to the seasonable lulls in business and the spark for new business.

Thanks, Jack Darr, for your refreshing report on a subject of such vital importance to every Service Men.—  
L. W.

Fig. 2. Views illustrating the *through-splice* coax-cable technique. In (1) is illustrated the proper way to pare a cable. Also shown here are the two center conductors butted together and soldered. View in (2) shows a thin double layer of high frequency tape wrapped over the splice. The view in (3) illustrates the position of an overlapping piece of tin braid or copper foil and in (4), the final operation, we have the polyvinyl outer sheaths pushed back and tightly taped with multi-layers of high frequency tape.

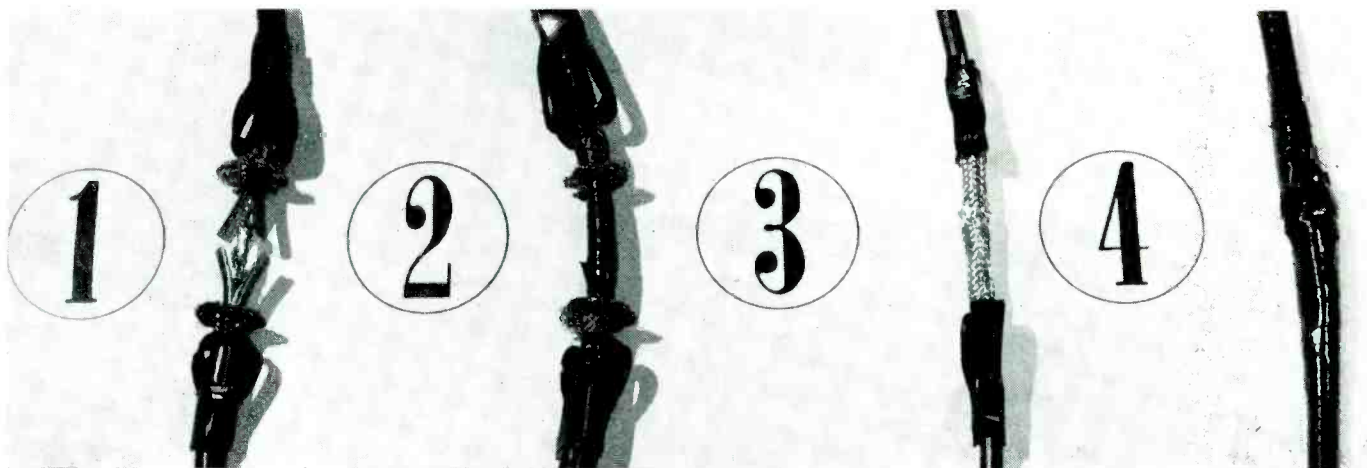

# COAX LINE Installation Practices

IN THE INSTALLATION of TV antennas, the transmission line plays a vital role, serving as a signal path which must be a comparatively *through lane* to provide those ideal results everyone wants. In those areas where noise and distance are factors, the maintenance of such a clear signal path is, of course, even more urgent. In such locations, where coax lines are widely used, there are many installation factors to consider, particularly when operating in the regions of 200 mc and higher. At these frequencies, for instance, we have to avoid such conditions as *distributed component* losses.

At 200 mc a piece of normal connection wire,  $\frac{1}{2}$ " long, may have an inductive reactance,  $X_L$ , of approximately 15 ohms, will form a capacity with respect to ground and have *rf* resistance due to *skin effect*. Thus, we find that

when the ends of coax cable are pared back,  $L$ ,  $C$  and  $R$  values exist. It is important therefore to visualize and approximate the value and importance of these *distributed components* in the same way that we evaluate *lump components* or normal inductances, capacitors and resistors furnished as manufactured parts.

In view of this condition, it is therefore extremely important that coax cable ends be prepared with care before they are connected to the antenna and receiver. In an investigation of the losses which can be incurred when the terminal connections are improperly made, losses of 6 and 10 db were found on channels 7 to 13 (174 to 216 mc). Fig. 1 illustrates the type of connection which had been made in these instances. Although the connections were mechanically good, they

were very bad for the 200-mc *rf* signals.

Unfortunately this type of terminal contact has been found to be the rule rather than the exception. The two-inch lengths of exposed dielectric material surrounding the center conductor may have an inductive reactance of more than 100 ohms at 200 mc. It is obvious that this inductive reactance is effectively in series with the coaxial cable and will add to the mis-match presented at the antenna terminals. It is also possible that the capacity of these leads may resonate with the inductance in the channels, 7 to 13, which will produce further insertion losses.

At the receiver end a poor makeup of the coaxial cable ends seriously increases the standing-wave ratio. This increase in standing-wave ratio seriously dissipates the power transferred from the antenna to the receiver and under certain conditions these standing waves will manifest themselves as re-

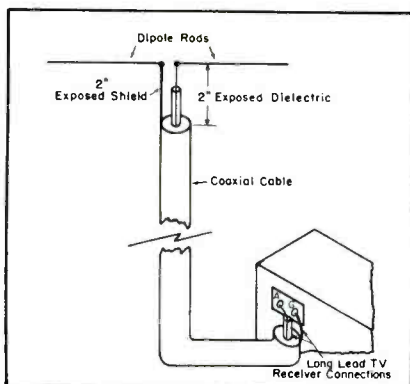
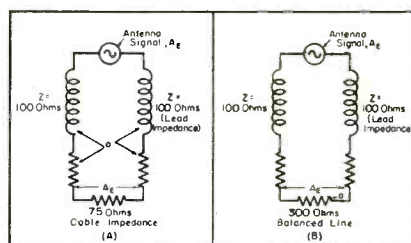

Fig. 1. A typical coax-cable installation which, while mechanically satisfactory is electrically deficient at 200 mc. The exposed shields, exposed dielectric and long leads in the receiver all contribute to a signal loss at the higher frequencies.

(Right)

The effective insertion circuits caused by long leads at 200 mc. These circuits illustrate why lead lengths are not so critical on 300-ohm lines. At *A*, for a 75-ohm impedance, we find that the greater percentage of antenna signal is across the high-impedance leads, while at *B* the greater percentage of antenna signal is across the high impedance balanced line.





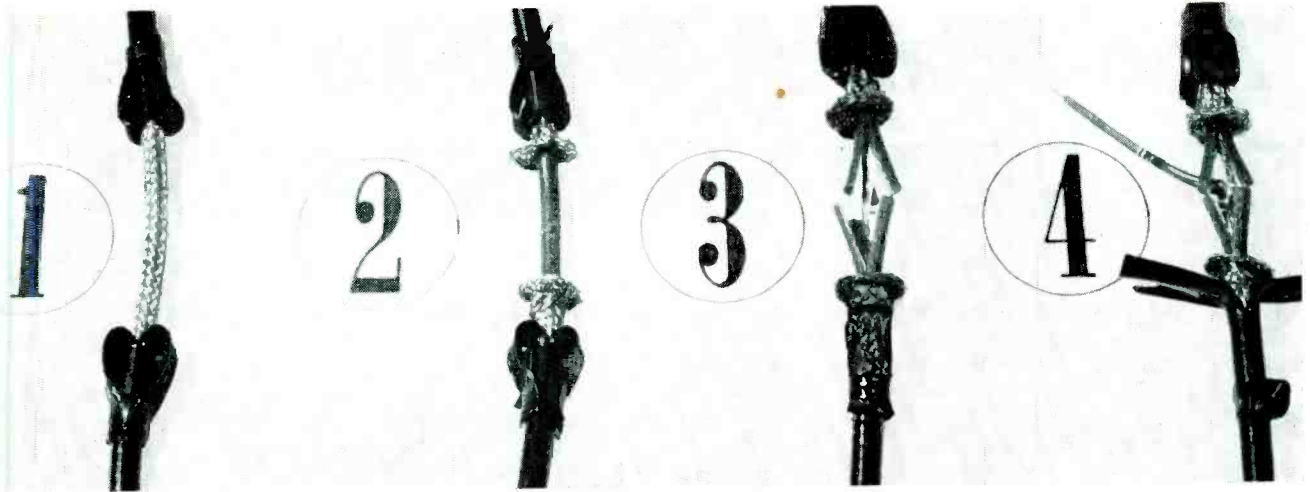
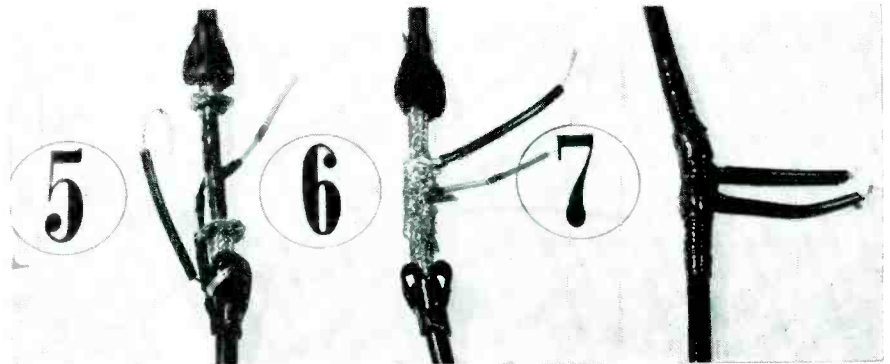

Fig. 3 (top and bottom<sup>1</sup>): tap-on splice technique applied when it is necessary to make a resistance tap on a coaxial cable without breaking the center conductor, thereby maintaining the size of the center conductor. In views (1), (2) and (3) we have the same peel back operations employed for the *through-splice* procedure except that the center conductor is not broken. The view in (4) illustrates the connection of a tap-on resistor used to isolate TV receivers from the coaxial line. The side of the resistor connecting to the center conductor of the coax cable has a tight polyvinyl or polyethylene spaghetti insulation. The resistor connection taped in place with high-frequency tape is shown in illustration (5). In views (6) and (7) we have the shield connection and final taping operations which are similar to those described in the *through-splice analysis*.



## Procedures, Which Must Be Followed To Provide Lowest Loss Transmission Line Feeds, Particularly at 200 Mc and Above Where Conditions are Critical. Methods Provide for Proper Termination of Lines at Both Ends and Use of Novel Splicing Techniques\* Designed to Meet Acute Higher Frequency Electrical and Mechanical Requirements.

reflections or ghosts. Because the reflections must travel up and down the transmission line they may be attenuated to the extent that they will not be visible on the picture or perhaps only as very light ghosts displaced to the right of the direct signal. These reflections, when visible, do not necessarily mar the pictures to an objectionable degree. There are, however, a great number of installations over ten miles from the transmitter where this high standing-wave ratio drops the signal to a level where *snow* begins to appear on channels 7 to 13. In strong signal areas, within 10 miles from the transmitter, these losses just *pad down* the signal strength and therefore these serious losses produce no visible defect; even a loss of 20 db (1/10 the voltage) has little effect on a 10-milli-

<sup>1</sup>Complete details of this splicing operation will appear in the October issue of *SERVICE*.

by **IRA KAMEN**

Manager, Antenaplex and TV Dept.  
Commercial Radio Sound Corp.

volt signal, as there still will be one millivolt available at the TV receiver input. One millivolt is a husky signal and with the average set using *agc* the Service Man cannot visually detect that he has lost signal due to poor *rf* coaxial connections. These results have hidden the *coax loss problem* from TV installers who have *successfully* made *long lead* connections in strong signal areas.

In fringe-area installations where coaxial cable is normally used for high signal-to-noise ratio results, an increase in power could be realized in many installations if the coaxial-end connections were made properly. In one instance it was possible to secure

a greater power gain by the proper makeup of coaxial cable ends, than was previously available with a booster amplifier connected in the antenna circuit with long lead connections.

To make coaxial-cable installations with a minimum of loss the antenna connection must be made as short as possible without kinks or fancy bends. On these short parebacks the end of the cable can be taped with non-hygroscopic high-frequency tape. This will prevent shorts and reduce the effect of cable contamination because the end of the cable will be sealed.

At the receiver end the leads from the coaxial cable should be made as short as possible for minimum loss. Taping at this end is also important to prevent shorts which might occur

(Continued on page 42)

\*The splicing procedures described in this paper were developed by the author.

# The Philco Built-In TV ANTENNA SYSTEM\*

MANY TV receivers now coming off the line are scheduled to include built-in type antenna systems. One line, exhibited a few weeks ago, featured a built-in system consisting essentially of two parts: an antenna that covers both bands and a tunable circuit for matching the antenna to the standard 300-ohm input line to the tuner.

The antenna in this system, which was developed by Philco, is a half-wave dipole consisting of two tapered sections of aluminum foil 0.005" thick. The narrow ends of these aluminum arms of the dipole are attached to a tunable matching circuit consisting of a variable capacitor connected across the terminals of a hairpin coil, which has two shorter loops attached to it at the antenna end. The 300-ohm line is taken off at the halfway point of the hairpin. A long bakelite rod with a control knob at one end is attached to the tuning capacitor.

When mounted in the cabinet of a receiver, this antenna is attached to the under side of the top of the cabinet. The aluminum foil extends across the width of the cabinet, near the back and is folded at the wide ends not only to follow the contours of the inside of the cabinet but also to provide augmented capacity between the ends of the dipole. The rod carrying the tuning knob extends from the rear to the front, and

the knob itself appears in a special slot at the top front of the cabinet.

In most of the new Philco television receivers, it is possible to remove the chassis from the cabinet without disturbing the antenna. In the case of two smaller table models, the 1104 and 1105, the built-in system can be removed by taking out two screws holding the capacitor assembly and a single set screw at the front holding the tuning knob.

## How the Built-In Antenna Works

The principles behind the Philco built-in antenna are detailed in Fig. 4 (a). At the extreme right is the circuit of the antenna, or of the two aluminum foil sections. It will be noted that it consists of both a reactance,  $X_A$ , and the radiation resistance of the antenna,  $R_A$ . Connected to this antenna circuit is the tunable matching circuit, consisting of the variable capacitor with reactance,  $X_C$ , the two smaller side loops which are inductive with reactances labeled  $X_1$  and  $X_2$ , and the long inductive loop with reactance,  $X_L$ . At the left, it will be noted that the 300-ohm transmission line, which leads to the tuner and is labeled  $T_L$ , is tapped off the long coil at a point which corresponds to an im-

pedance of about 300 ohms. This obviously results in a good match between the antenna (foil) and the lead-in to the tuner and input circuit, and hence a minimum standing-wave ratio.

This point is graphically shown in Fig. 4 (b), which indicates that the matching circuit connected to the antenna is tuned for each channel to an impedance of about 1,500 ohms. By choosing the right point on the long loop at which to tap off the 300-ohm line, it is possible to match the line's 300-ohm impedance. The actual tap-off point is approximately halfway along the length of the long loop.

Now let us consider the matching circuit and equivalent antenna circuit again, to see how they behave for the low and high bands. Over the low band, 54-88 mc, the radiation resistance,  $R_A$ , of the antenna is fairly uniform and low in value, while the antenna's reactance,  $X_A$ , is capacitive as shown in Fig. 4 (c). Hence to bring this antenna circuit to resonance for television channels 2 to 6, the matching circuit must be inductive. The relatively large inductance of the loop or hairpin loop is the principal factor in achieving this, whereas the effect of the smaller loops on this band is of lesser importance. The tuning capacitor serves to vary the inductive reactance of the long loop over the low

\*From notes prepared by John Pell, Manager of TV Service, Philco Corp.

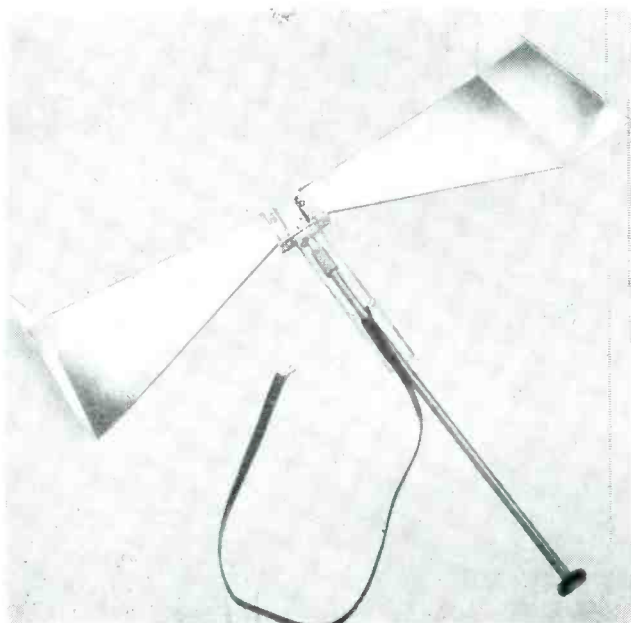
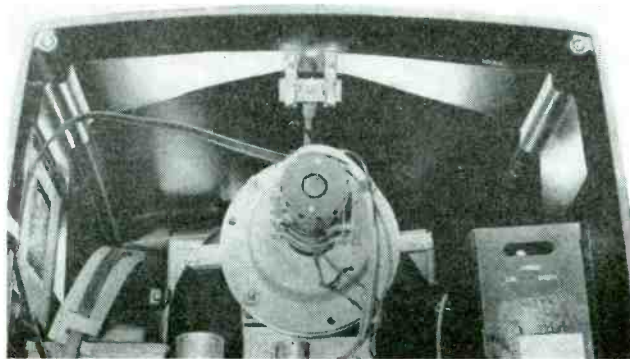

Fig. 1. The built-in antenna, which consists of two sections of aluminum foil which are attached on the underside of the top of the cabinet. Three loops of wire, two smaller ones like ears, on each side of a variable capacitor and a long hairpin loop extending along the rod between the capacitor and the tuning knob, together with the variable capacitor, provide a tunable circuit affording match of the 300-ohm lead-in to the set input.

Fig. 2. A view of the built-in antenna installed in a television receiver cabinet.





# Detailed Analyses of Circuitry, Operation and Maintenance of Tunable, Aluminum-Foil, Folded-Dipole Type Antenna.

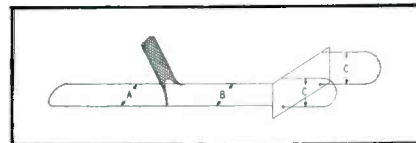

Fig. 3. Diagram of the coils used in the built-in TV antenna.

band for the purpose of matching the  $X_A$  (capacitive) of the antenna.

A similar analysis of the system's operation on high-band channels is illustrated in Fig. 4 (d). It will be noted that now the antenna's reactance,  $X_A$ , is inductive. Since the radiation resistance of the antenna is higher on channels 7 through 13, the circuit is tuned to resonance by means of the variable capacitor, and the inductance of the two smaller loops,  $X_1$  and  $X_2$ , is a substantial factor.

### Servicing Information

By turning the tuning knob, mounted at the top front of the cabinet, it is possible to tune the antenna system to resonance with the video carrier frequency of each channel.

The system is adjusted at the factory so as to resonate on each of the 12 channels at the correct tuning position. These tuning positions are shown on Fig. 5, which indicates the fraction of a full turn counter-clockwise from the completely clockwise position of the tuning control needed to reach the correct resonance position for each channel.

In preparing the antenna for a check, one point must be watched carefully. In the presence of very strong signals, the tuning of the antenna will not appear to be sharp because of the *agc* action. In such cases, the receiver must be tuned by means of the antenna tuning control for minimum background noise on each station.

### Alignment Procedure

A dipole<sup>1</sup> should be first connected through a 72-ohm coaxial cable to the

Fig. 5. The input circuit of the Philco Model 50-T1630 featuring the built-in antenna system.

Fig. 5 (below). Tuning positions of antenna system.

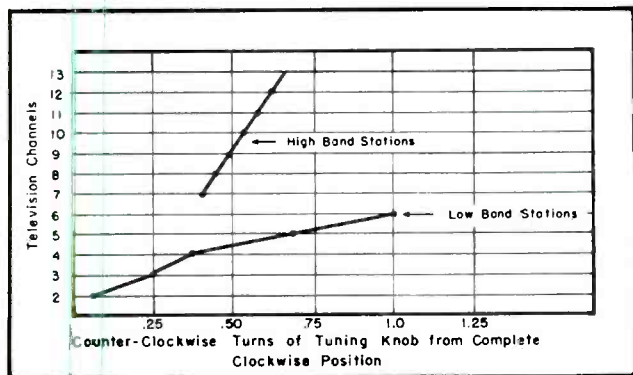

output of a suitable AM signal generator<sup>2</sup> having a band range covering the television channels.

A 20,000-ohm-per-volt voltmeter should then be connected to the *agc* bus, pin 2, of the *align test jack* of the receiver. (In some early production models, pin 1 is the *agc* bus.)

The *contrast control* of the receiver should then be turned fully counter-clockwise to remove delay voltage from the *agc* circuit.

The *channel selector* can then be set to channel 2 and the *fine tuning control* to the middle of its range. Then the receiver's local oscillator should be tuned on the sound carrier of the channel (tune for maximum sound).

The dipole should then be placed near the back of the receiver, and the signal generator set for a modulated output at the video carrier frequency of channel 2. The signal generator attenuator should then be adjusted for an output that will just give an indication on the meter; keep the meter reading less than 1 volt *dc*.

The antenna tuning control should now be tuned for a maximum reading on the voltmeter. For channel 2, this maximum reading should occur less than one-quarter turn counter-clockwise from the fully clockwise position of the tuning knob.

These steps should be repeated for channels 3 through 13. In each case,

(Continued on page 44)

<sup>1</sup>The dipole used for this purpose may be merely two clip-leads of appropriate length.  
<sup>2</sup>Such as the Philco model 7008 Precision Visual Alignment Generator.

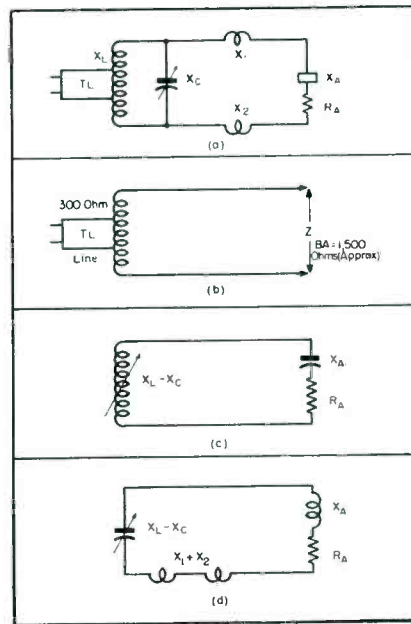
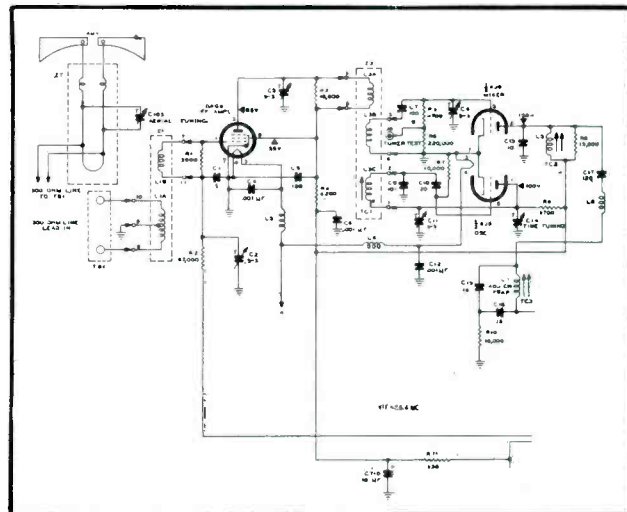

Fig. 4. In A appears a complete circuit of the built-in antenna system.  $X_A$  = antenna reactance;  $R_A$  = radiation resistance of antenna;  $X_1$  and  $X_2$  = inductive reactance of small loops;  $X_C$  = variable (tuning) capacitor;  $X_L$  = inductive reactance of large loop and  $T_L = 300$  ohm transmission line from antenna to tuner. In B appears an equivalent matching circuit for both TV bands.  $Z_{BA}$  = the tuned impedance of the antenna's matching circuit (approximately 1500 ohms) and  $T_L = 300$ -ohm transmission line tapped off  $Z_{BA}$  at 300-ohm point. In C appears the equivalent circuit for low-band operation.  $X_A$  = antenna reactance (capacitive on low band);  $R_A$  = antenna radiation resistance;  $X_L - X_C$  = variable reactance of matching circuit (tuned by  $X_C$  to be inductive over a low-band to resonance). An equivalent circuit for the high-band appears in D.  $X_A$  = antenna reactance (inductive on high-band);  $R_A$  = antenna radiation resistance;  $X_1 + X_2$  = two smaller loops; and  $X_L - X_C$  = variable reactance of matching circuit (tuned by  $X_C$  to be capacitive over a high-band to resonance).





## Highlights of Videola TV Models

THE CURRENT trend to the larger screen direct-view TV receiver has introduced circuits with quite a few innovations.

An interesting example of such design appears in Fig. 1; the Videola VS-120 and VS-120-J/VS-160 and VS-165, the former being used with a 12LP5 (91 square inches) and the latter with either a 15CP4 or 16CP4 (135 square inches).

### RF Tuner

The *rf* tuner consists of a high-gain unit with two tuned traps for eliminating FM interference. They are connected to the antenna input terminal strip on the tuner. Dual triode 6J6s are used for greatest signal-to-noise ratio. Internal tube noise is less than if pentodes were used.

### IF Amplifier

The *if* amplifier consists of three 6AU6s in a simple but highly sensitive circuit. Alignment is also simple since only two frequencies are utilized. The tubes are operated at a slightly higher voltage than is usually found in regular *if* amplifiers. Automatic gain control voltage is applied through suitable filter networks at each stage to the grid of each tube. There are *rf* chokes in the filaments of the *if* tubes to prevent regeneration through mutual coupling.

### Automatic Gain Control

A portion of the signal is removed through a 120-mmfd capacitor and applied to the plate of a 6AL5 *agc* diode. The *agc* voltage is filtered by a 2-megohm resistor and an .05-mfd capacitor and applied to the grids of the first and second *if* stages.

The *agc* delay bias varies from 2.5 volts with the contrast control at maximum, to zero with the control at minimum. Thus the range of the contrast control is increased since the *agc* volt-

age varies with the control setting in order to decrease detector output, and at the same time the video amplifier gain is decreased. In turn, the range is increased as the video amplifier gain is increased.

This type of circuit affords an additional feature. Since delay is present on weak signals and maximum sensitivity is not reduced by the *agc* bias, while little or no delay is present on strong signals, overload is less likely to be experienced in the last *if* stage.

### Video Amplifier

A 6AC7 is used in a *dc*-coupled video amplifier and its output is capacitively coupled to the picture-tube grid. It has high gain (40-50) and adequate output swing with a noise clipping action that is independent of picture content.

A video stage bias of 2.5 volts is developed across an 8-ohm resistor in the *B—* circuit. A low-impedance filter capacitor is across this bias resistor so as not to charge up in the presence of noise pulses that draw grid current in the 6AC7.

The screen voltage is taken from a bleeder connected between 360 volts and ground; two 220,000-ohm resistors. The internal impedance is low enough to maintain screen voltage at approximately 140 volts over a normal operating range, yet high enough to keep screen dissipation within limits should the set be improperly operated.

The video amplifier plate load consists of two resistors, a 5,600-ohm unit connected from plate to 140 volts and a 51,000-ohm resistor from plate to 360 volts. They are effectively in parallel for *ac* but are connected in this manner to give a plate supply of 190 volts, increasing the available video output swing.

In order that the clipping level and maximum output remain constant from the weakest to the strongest signals,

the contrast control provides variable *ac* degeneration and bias for the video amplifier. It controls the gain of the video stage and at the same time provides the proper cathode bias to offset the positive voltage developed across the diode load resistor which would otherwise be applied to the control grid of the 6AC7.

### Plakron Compensator

The engineers, who designed the Videola circuit, report that tests and experience have shown that a crisper picture results if the overall video circuit response is not flat but rises with frequency. Partly this is so because the output of commonly used camera tubes fall off with frequency and in addition even a perfect picture may appear better when viewed from the normal viewing distance if the high frequencies are boosted. The result is a transient which sharpens up all video detail.

However, boosting the frequencies would increase apparent picture noise but in this case, the boost is varied with the contrast control setting so that it is present when signals are strong and absent when signals are weak.

To afford this control, a 750-ohm contrast control is tapped with a 680-mmfd capacitor from the tap to the 6AC7 cathode and a 470 mmfd capacitor from the tap to ground. As the contrast control is varied to full gain (zero resistance) as in the case of a weaker signal, no boost is obtained. On a stronger signal, the gain is reduced and the high frequencies are boosted. Thus there is a constant boost of high frequencies for signals above the level where receiver noise enters the picture and decreasing to zero boost for weaker signals.

Both circuits utilize one triode section of a 12AU7. The triode acts as

(Continued on page 38)



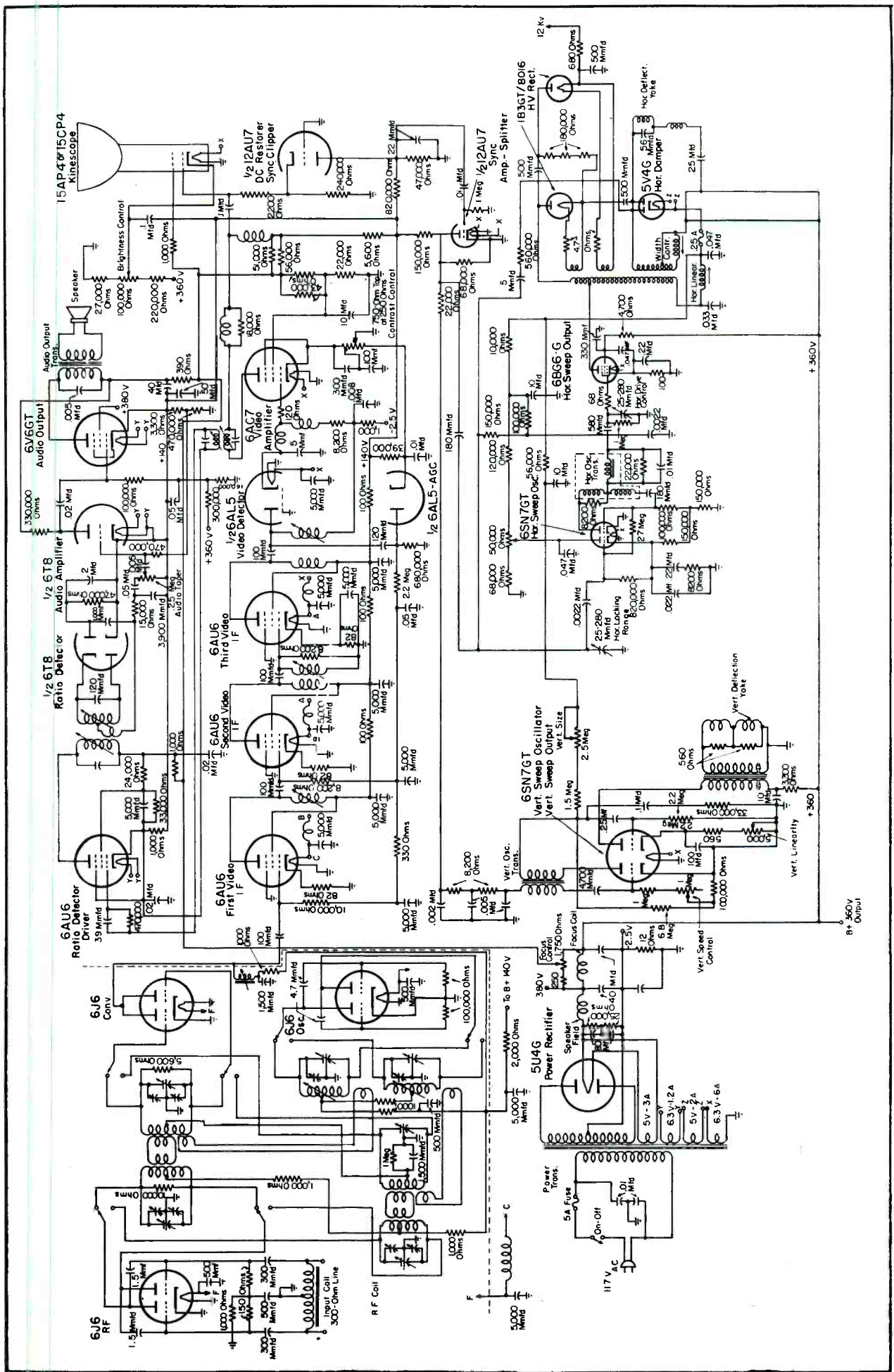
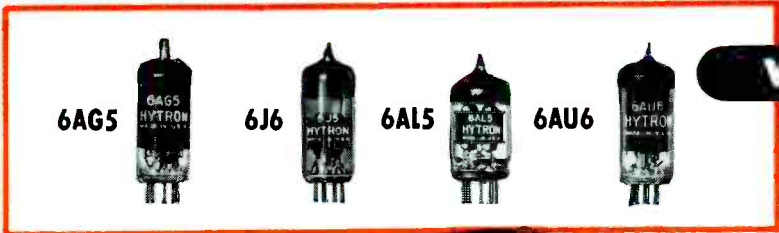
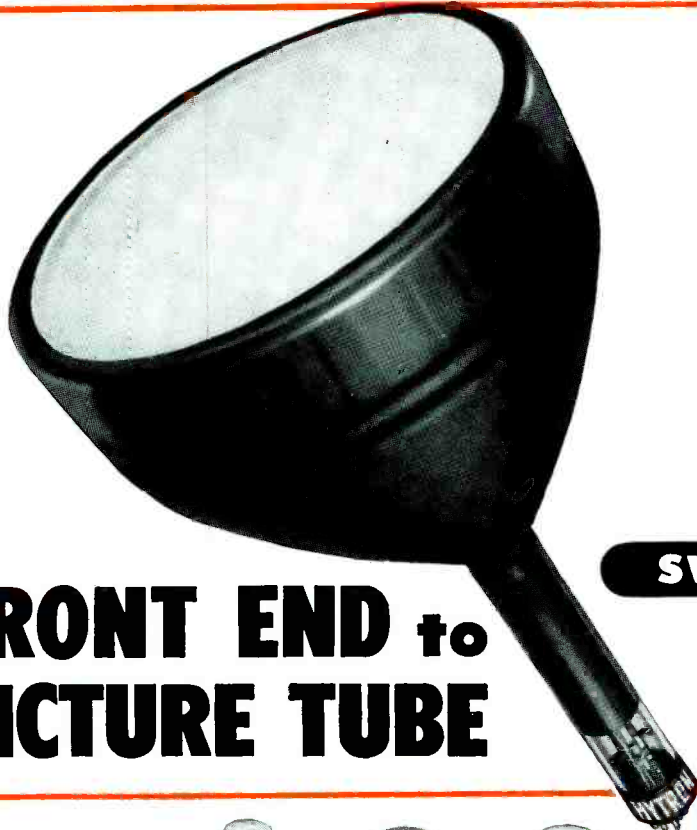

Fig. 1. Circuit of the Video Corp. of America VS 160, 165, TV receiver.



**VIDEO**



**FRONT END to PICTURE TUBE**

**AUDIO**



6BA6



6AU6



6AL5



6K6GT



6SN7GT

6V6GT

6BQ6GT

**SWEEP**



6W4GT

**POWER**

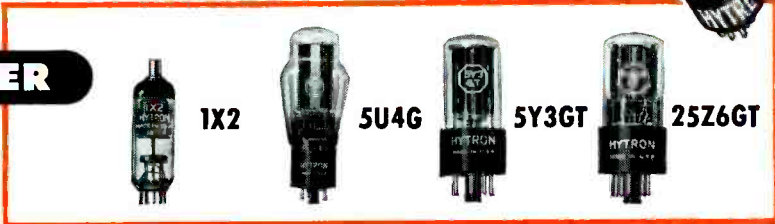

1X2

5U4G

5Y3GT

25Z6GT

**HYTRON GIVES YOU!**

- ★ All the popular TV types.
- ★ Premium TV quality—at no extra cost.
- ★ The same Hytron quality bought by 25 leading TV set manufacturers.



"MAKING TUBES IS EASY—IF YOU KNOW HOW!"



MAIN OFFICE: SALEM, MASSACHUSETTS

**HYTRON SERVES THE SERVICEMAN**



TUBE TAPPER  
5¢



7-PIN MINIATURE STRAIGHTENER  
55¢



9-PIN MINIATURE STRAIGHTENER  
55¢

SOLDERING AID  
49¢



TUBE LIFTER  
15¢

AUTO RADIO TOOL 24¢

Already Six Tools Available From Hytron Jobbers. Watch For More!



# TV and FM Sweep Signal Generator\*

[See Front Cover]

PERHAPS one of the most important pieces of test equipment for broad-band alignment is a frequency-modulated signal generator with sufficient sweep width and frequency coverage. On the cover this month appears the circuit of such a generator; Approved Electronic Instrument type A-400.

The unit provides coverage from 2 to 60, 10-120, and 168-227 mc, *rf* or FM. Marker frequencies from the *rf* oscillator are from 20 to 40 mc, and the crystal-controlled marker frequencies from 2.5 to 225 mc.

## Theory of Operation

Since TV receivers employ extremely wide-band amplifiers, it is necessary to be able to observe a visual response curve of the amplifier for proper stage alignment.

The visual trace as seen on the screen of a 'scope is a stationary pattern of two voltages applied to the vertical and horizontal input of the 'scope.

The sweep frequency of this model generator is sixty cycles. Therefore, if the horizontal deflection voltage is taken from the same source and is of the same phase as the sweep voltage, a stationary pattern representing the amplifier's response or selectivity characteristic can be observed. Due to small circuit constant differences a double line trace may be displayed. However, this can be corrected by adjustment of the phasing control incorporated in the generator.

Four oscillators are employed in the generator. To obtain the wide frequency coverage without bandswitching, it was found necessary to design a circuit using the beat-frequency method. The variable or beat oscillator to which the sweep dial is at-

tached, covers the frequency range from 57 to 114 mc.

A constant amplitude, frequency-modulated fixed oscillator operates at exactly 114 mc. The novel feature of this oscillator is the manner in which frequency modulation is accomplished. The tank coil is resonated by shunting it with a split-stator capacitor which is varied by means of an electromechanical driving mechanism. Two stator plates are mounted upon a lucite square, fastened to the driving mechanism and so positioned as to form a split-stator capacitor in conjunction with a light metal cup attached to the driving mechanism's diaphragm. The driving mechanism, when excited by a 60-cycle voltage, causes the metal cup to vibrate back and forth in respect to the fixed capacitor plates, thus causing a change of capacity across the tank circuit, with consequent frequency change. Due to the construction of the driving mechanism, the change in capacity is such that the change in frequency is practically linear for a frequency deviation from 50 kc to 12 mc.

It is well known that when two oscillators are operating at different frequencies, and their outputs are mixed, a third frequency of either the sum or the difference of their harmonics will be obtained. This principle is used in this generator.

Cathode coupling from the fixed oscillator and beat oscillator to the mixer grid and cathode, respectively, is used in order to load as lightly as possible the oscillator circuits.

The output of the mixer is fed to a 6C4 in a cathode-follower circuit. While the use of a cathode-follower

\*From data prepared by Fred Berhley, chief engineer of Approved Electronic Instrument Corp.

stage provides no additional amplification, the relatively low output impedance tends to reduce loading and provide a more uniform output.

As previously stated, the fixed oscillator operates at 114 mc. The variable oscillator to which the sweep dial is attached generates frequencies from 57 to 114 mc. Calibration of the sweep dial is in three bands, of which the 2 to 60-mc band represents the difference frequency between the fixed oscillator (114 mc) and any one frequency setting of the variable oscillator (57 to 114 mc). Band 2, from 10 to 120 mc, represents a harmonic calibration of band 1 (from 20 to 77 mc). Band 3, from 168 to 227 mc, represents the sum of the fixed oscillator (114 mc) and any one frequency setting of the variable oscillator (57 to 114 mc).

The crystal oscillator may be used to adjust the receiver's oscillator or to provide marker pips for *if* alignment. A simple Pierce circuit with external crystal holder, panel mounted, completes the crystal oscillator's requirements. The output of the crystal oscillator is coupled to the cathode follower output through a selector switch and amplitude control.

Provisions for marker frequencies from 20 to 40 mc have been made, the marker dial being directly calibrated.

## Alignment Procedure

The alignment procedure of all wide-band amplifiers follows basically the same pattern. However, TV receiver manufacturers normally furnish complete and detailed alignment information that should be followed closely for best results. The usual routine is: (1) Alignment of sound traps; (2) followed by adjacent channel traps; (Continued on page 44)

# PHONO *installation and service*

## **Design and Installation Data\* on Philco Three-Speed Unit Which Employs a Six-Gram High-Compliance Crystal Pickup With a Folded Mechanical Lever System. Features of Three-Speed Changer and Amplifier . . . 45 RPM Replacement Cartridges . . . Vinylite Record Static-Discharge Liquid.**

WITH THE interest in three-speed phonos mounting, most set manufacturers have begun to include players, which will accommodate all three types of records, the 78, 33 $\frac{1}{3}$  and 45.

In designing this type of changer, where smaller size, closer spacing and slow speed must be considered, the reproducer, tone arm and motor must meet quite a rigid set of requirements.

A good reproducer, for playing all types of records, must have: (1) Adequate output; (2) high effective compliance of needle and driving system; (3) reproduction free from distortion; (4) minimum needle pressure so as to reduce needle and record wear; (5) a stable system, preferably one with retractibility; and (6) provision for operation under adverse humidity conditions.

In addition to these reproducer requirements it is also necessary that the record changer be satisfactory for: (1) *Wow* and flutter (speed deviation); (2) rumble (undesirable low frequency sound); (3) uniform turntable speed (to maintain true pitch); (4) practically zero horizontal and vertical friction in the tone arm bearing; and (5) very sensitive trip mechanism for cycling the changer. In the *lp* and 45 rpm records, because of the narrower groove spacing, the available lateral amplitude which determines the driving force is reduced to less than one-half that obtainable on standard play records.

\*From notes, prepared by B. P. Haines of Philco, presented at a recent Service Managers' meeting in Philadelphia.

### by KENNETH STEWART

The standard record spacing is approximately 100 lines per inch, where the microgroove spacing is as high as 300 lines per inch. However, with the greater number of lines per inch, obtaining satisfactory output becomes a greater problem, as well as making the tracking more difficult. In addition, when the displacement is small, the grooves are likewise small and it is necessary to have a very small and sharp point on the needle. Hence, the force that can be exerted by the needle has to be reduced in order not to increase the force per unit area on the record, thereby reducing the record and needle life. The needle force selected by Philco was 6 grams which corresponds approximately to the force per unit area of a .003 radius needle at a one ounce pressure.

The spacing between the grooves on the *lp* and 45 records is only .0018" and it is in this spacing that the undulation or the modulation must take place. Each groove must use only one-half this space if over-cutting or breaking through of the grooves is to be avoided. Thus, it can be seen that the displacement from rest due to the motion of the needle point as it follows the groove will be only .0009". This extremely slight motion of the needle must, therefore, generate a voltage sufficient to drive an amplifier.

In the Philco sets, pickups use a crystal of the bimorph twister type, 1/32" thick, so that each wafer is,

therefore, only .016" thick, with a common terminal made of graphite cemented between the two sides. Generally, in reproducer design, the crystal is clamped on only one side. However, in the Philco system, the crystal is rigidly clamped on two adjacent sides. With the clamping along the adjacent sides, the voltage is increased. The driving of the crystal blank takes place through a folded, mechanical lever system. The use of a folded mechanical lever system not only provided the mechanical advantage required to drive the crystal, but also permitted passing of the motion from the needle through the system to the crystal on the inside without having an opening in the case; thereby, permitting the sealing of the entire unit against moisture.

The high compliance coupled with low stylus force affords low needle talk, low scratch and low distortion. Incidentally, the folded lever system, did not provide all the required needle compliance and therefore additional compliance was built into the tone arm bearing assembly and the stylus.

The problem of stress on the pickup was solved by Philco in the development of a new chuck, needle and tone arm system. A one piece, lightweight, small cross-section, spring phosphor bronze chuck was developed to decrease the force required at the needle to flex the crystal to give satisfactory tracking and meet the compliance requirements.

The chuck is cemented to one corner of the crystal and is supported by a new low durometer or softer rubber



fulcrum which also adds to the compliance of the system. This bearing is held in place by the two halves of the cartridge and two semi-circular rings that supply the right amount of clamping at the most optimum point. This type of construction permits, transfer of the motion of the needle from the outside to the inside through a hole in the rubber bearing that provides the seal without having an opening in the case. In addition to a seal created by the rubber under compression, silicone has been placed around the chuck at the corner where it clamps onto the crystal, and around the end of the rubber bushing inside the housing, to prevent any moisture leaking through the case.

The needle used in the New Philco sets is said to be so rugged that scrubbing or dragging on a turntable has shown no effect or damage whatever on the point shape or angle of the needle. The needle is made of a special .013 diameter wire, and will withstand a force of 100 grams or 15 times the playing force. As an added safety factor or precaution, a dual needle guard has been added. This is a snap on arrangement that prevents the needle from being misaligned or bent. The dual needle is inserted into the chuck exactly similar to the method used in previous *lp* pickups so that the needle is replaceable in the field as well as the complete reproducer assembly.

## PHONO ACCESSORIES

### Three-Speed Changers

Three-speed changers have proved so popular that they are now being included in complete phono units. In one such unit\* recently announced, there's a two-tube amplifier and rectifier, a *duo-needle* reversible cartridge, and three-speed motor. The cartridge control lever is on the tip of the tone arm.

### Replacement Cartridges

Replacement-type cartridges for 45-rpm changers have begun to come off the line. One model\*\*, an *orthogonal (vertical-type) torque drive* crystal cartridge, with  $\frac{3}{8}$ " and  $\frac{1}{2}$ " hole spacing, tracks at 5 grams pressure. Output of this unit has been reported to be

\*V-M 100.

\*\*Electro-Voice series 34.

1.1 volts on an RCA 12-5-31V record at 1,000 cps.

### Static Discharge Liquid

The tendency of vinylite records to accumulate dust particles, through static discharges†, has prompted many to seek solutions in the form of mechanical, electrical or chemical control. One manufacturer\*\*\* recently announced that it had developed a liquid which, when applied to record surfaces, creates a condition in the record which causes it to discharge any inherent static electricity so that it will no longer attract dust particles.

In application, a few drops of the liquid are spread on a soft cloth and rubbed over the surface of both sides of a record. Then a follow-up rub is made with a dry cloth to further spread out thin film (of a thickness of one to ten molecules) over the entire record surface. According to the manufacturer, the record may be played 50 to 100 times (depending upon needle pressure) before the invisible film wears through and another application of the neutralizing agent becomes necessary.

### LP Player Attachment

A *lp* record player attachment\*\*\* which is said to fit all types of existing record players, manual or automatic, without requiring installation, has been announced.

Unit consists of a microweight crystal pickup attached to a double disk turntable which is placed on the record player turntable spindle. A ball-bearing friction-drive between the two disks reduces the speed of the converter turntable to the  $33\frac{1}{3}$  rpm speed. The pickup tone arm is adjustable to any turntable height and contains a switch which automatically starts the record when the pickup is placed in playing position.

### Hi-Fi Amplifier

An all-triode\*\*\*\*, 10-watt, 7-tube high-fidelity amplifier kit, based on a design recently published by Consumers' Research, Inc., Washington, N. J., is now being marketed. Unit is said to have a frequency response ( $\pm 1$  db) from 20 to 15,000 cycles. Distortion is reported as less than 2.5%, gain as 75 db on radio and 97 db on phono.

Amplifier kit, model CR-10, comes with a punched chassis.

†Vinylite is a natural conductor of static electricity from the atmosphere, the static also being induced by handling records and created merely by the action of the needle playing the grooves of the record. Therefore, the charge which is built up acts as a magnet, and any dust or grit in the air which comes near the record surface is held fast and is difficult to remove from the record surface merely by brushing, as this action in itself increases the static charge in the record.

\*\*\*Walco Products, Inc.

\*\*\*\*American Microphone Co.

\*\*\*\*\*Sun Radio and Electronics Co., Inc.



(Above)

A three-way player with amplifier.

(Courtesy V-M)



(Above)

Plug-in preamp, featuring frequency compensation, which can be supplied with 15 db of bass compensation for use with magnetic pickups.

(Courtesy Thordarson)

(Below)

Orthogonal crystal cartridge.

(Courtesy Electro-Voice)

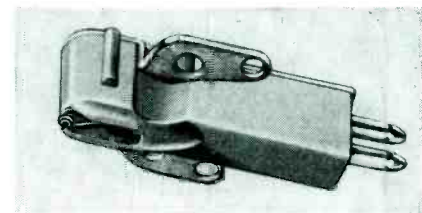

# NOW

## A SMALL SIZE VOLUME CONTROL

TO MEET THE REQUIREMENTS OF  
MODERN AM, FM AND TV SERVICING

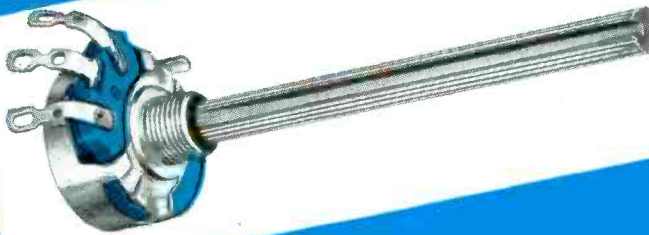

COMPACT  $\frac{1}{16}$ " DESIGN and  $\frac{1}{4}$ " long bushing permit easy installation in the most crowded chassis. Type Q Controls fit many smaller sets which will not take usual  $\frac{3}{8}$ " long bushing, yet are fully capable of handling larger set requirements.



### KNOB MASTER FIXED SHAFT

fits 90% of AM, FM and TV  $\frac{1}{4}$ " shaft knobs. No alteration except cutting to length. Knurled, flatted and slotted to accommodate knurled push-on knobs, spring-type push-on knobs or set screw knobs. Ends spread for fitting oversize or worn knobs. 3" length meets television requirements. No shaft inserts needed.



### RESILIENT RETAINER RING

permits removal of Knob Master Shaft and replacement with any of 11 special fixed shafts, in less than a minute, using only a pocket knife or screwdriver.



### INTERCHANGEABLE FIXED SHAFT FEATURE

Gives widest coverage of replacement with nominal stock of controls. Eleven types of shafts let the technician meet many special requirements without expanding control stock. These shafts are sealed in cellophane and individually packaged.

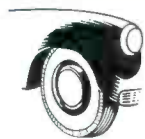

### CUSHIONED TURN.

New Resilient Retainer Ring contributes unusually smooth rotation. Your customers will notice the quality "feel" at once. Cushioned Turn does for IRC Q Controls what low-pressure balloon tires do for automobiles.



### NEW TYPE 76 SWITCHES

designed and manufactured by IRC. Easily and quickly attached to any IRC Q Control.

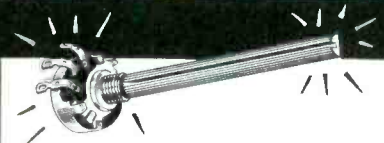

### STURDIER AND MORE BEAUTIFUL.

Rugged, molded control base and switch enclosure are colored distinctive IRC blue. All metal parts are non-ferrous material nickel-plated for lustrous finish and resistance to corrosion. Customers will like the Type Q's rich precision appearance.

IRC now offers Radio Technicians a new volume control carefully engineered to meet the needs of modern television and radio replacement. The new Type Q Control leads the field in practical convenience. It embodies outstanding constructional, electrical and mechanical features. Absolute uniformity is assured through the elimination of hand operations in manufacture, and by complete production testing.

### SEEING IS BELIEVING

In an actual field test, IRC Q Controls and Interchangeable Shafts were demonstrated to a large cross-section of radio and television technicians. All were enthusiastic over the unique features of these revolutionary new controls. Because of their versatility, ease of use, and dependability, we believe they will become the most widely used controls in the industry.



# A COMPLETE LINE OF 59 TYPE Q CONTROLS

*and 11 Special Shafts*

## GIVES YOU WIDEST SERVICE COVERAGE

Now, with IRC's versatile Q Control Line and Special Fixed Shafts, you can service virtually every type of small control requirement—in a minimum of time. Ease of installation—even in crowded chassis; one-minute replacement of shafts for specials; shaft and bushing lengths to meet current radio and TV conditions—all mean faster, easier servicing.

### PLUS THESE EXTRA CONSTRUCTION ADVANTAGES

Every IRC Q Control, Knob Master Shaft, Interchangeable Fixed Shaft or Switch is simply designed, ruggedly constructed, safeguarded by complete production testing. Control base is precision molded of high strength, low moisture absorption bakelite. Contractor is IRC patented one-piece dual unit of thin high-stress alloy. One-piece collector ring and center terminal are silver-plated brass. And the resistance element is the best IRC ever manufactured!

### FREE CATALOG GIVES FULL INFORMATION

For complete details of IRC's revolutionary new Type Q Controls and Interchangeable Fixed Shafts, write us today. IRC Q Controls mean easier AM, FM and TV servicing for you—more convenience for you. Get the full story. Mail coupon for our new Catalog DC-1.



The IRC Type Q Control comes to you in a newly designed blue and yellow carton. There is also a new matching carton for the Interchangeable Fixed Shafts. Complete easy-to-use instructions are included. Look for them at your distributor's.

*Wherever the Circuit Says* 



**INTERNATIONAL  
RESISTANCE COMPANY**

401 N. Broad St., Phila. 8, Pa.

In Canada: International Resistance Co., Ltd., Toronto, Licensee

**INTERNATIONAL RESISTANCE CO.**  
401 N. Broad St., Phila. 8, Pa.

Please send me Catalog DC-1 giving full information on new IRC Type Q Control.

Name \_\_\_\_\_

Address \_\_\_\_\_

City \_\_\_\_\_ Zone \_\_\_\_\_ State \_\_\_\_\_

# TV Receiver SERVICING

## Part II . . . Additional Data on Analyzing A TV Circuit, Covering the Composite Sync, Vertical Sync, Vertical Saw, Horizontal Sync, Horizontal Sweep, High-Voltage and Low-Voltage Power Supply Sections of Du Mont RA 105.

IN ANALYZING the procedures to be used in diagnosing TV receiver troubles last month four typical sections of the receiver were studied: picture and sound, sound *if*, audio, and picture and sync.

It was pointed out that the picture and sync section was so identified because a tube going bad in this section will not only affect the picture but the sync signal too, in one way or another. The review revealed that the point in the circuit where the sync is taken off is in the plate circuit of the first *video amplifier*, and from here it is fed to the sync clipper stage where the composite sync is removed and then applied to the sync circuits to perform the synchronization function.

If the indication on the *crt* is similar to that shown in Fig. 3 (p. 28) then the trouble would be in this section. It will be noted in this view that not only is there no picture, but the raster is not synchronized, as evidenced by the vertical retrace lines varying at random.

**Picture Section:** The second *video amplifier* along with the third *video amplifier* and *dc restorer*, are referred to as the picture section. If either the second or third *video amplifier* stages go dead completely then a

by **CARL QUIRK**

Head, Technical Service Section  
Teleset Service Control Dept.  
Allen B. Du Mont Labs, Inc.

sync raster (Fig. 4, p. 28) would appear on the face of the picture tube. Sync of the raster is evident because the vertical retrace lines are locked. Since the sync signals are taken from the plate of the first *video amplifier* and fed to the *sync clipper*, then the presence of the sync raster would indicate that this circuit is performing properly.

**Composite Sync Section:** Investigating the sync circuits we encounter a stage identified as the *composite sync section*. This is the stage where the video signal is fed to the grid and the composite sync is available at the plate. This composite synchronizing signal consists of the horizontal sync signals plus the sequence of pulses that occur at the end of a field (bottom of the picture) necessary for accurate synchronization of the vertical saw generator. If this stage becomes defective, both horizon-

tal and vertical sync are lost and the effect is as shown in Fig. 5, p. 28.

The composite sync signal is fed from the plate of the sync clipper into two different directions, into the horizontal circuits and into the vertical circuits.

**Vertical Sync Section:** The section designated as the *vertical sync section* consists of a triode (one-half of a 6SN7). If this stage becomes defective then the vertical sync would become very erratic. This may exhibit itself as a vertical jitter, or complete loss of vertical synchronization as seen in Fig. 6, p. 28.

However, it is also possible for a defective vertical saw generator to be responsible for defective synchronization.

The trouble may be that the free running frequency of the *vertical blocking oscillator* cannot be adjusted close enough to 60 cycles; Figs. 7 and 8, p. 28. If by adjustment of the vertical hold control, the indications on the *crt* approach this figure, and it is not possible to get one complete picture manually (Fig. 7), the free running frequency is too high. If by adjustment of the vertical hold control, the indications on the *crt* are similar to the view on Fig. 8, and it is not possible to get one complete picture manually, the free running frequency is too low. This figure indicates there are approximately one and one half frames in view at one time. A more extreme condition of this would be when two complete pictures one above the other are visible.

In either of the foregoing cases, the grid circuit of the vertical blocking oscillator should be investigated, checking C<sub>273</sub>, R<sub>307</sub> and R<sub>308</sub>.

If the free running frequency is too high and cannot be adjusted low enough, the value of the capacitor or

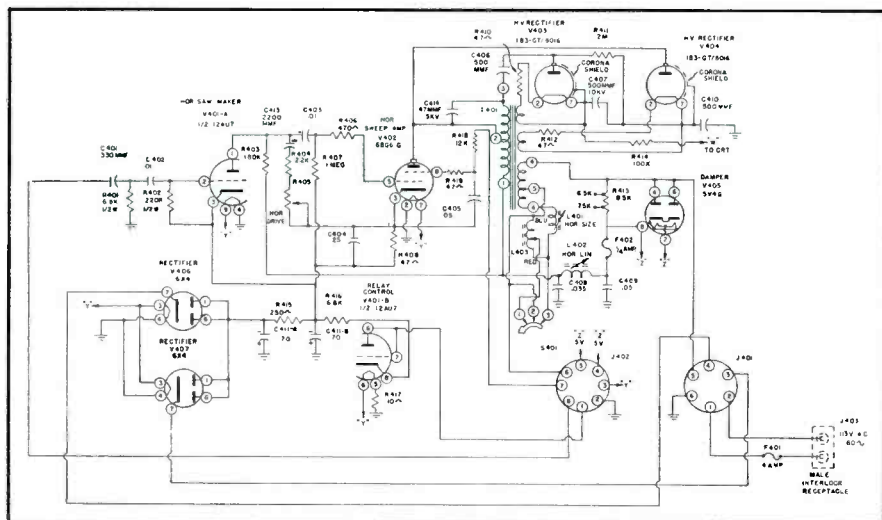

Fig. 2. Power supply schematic.



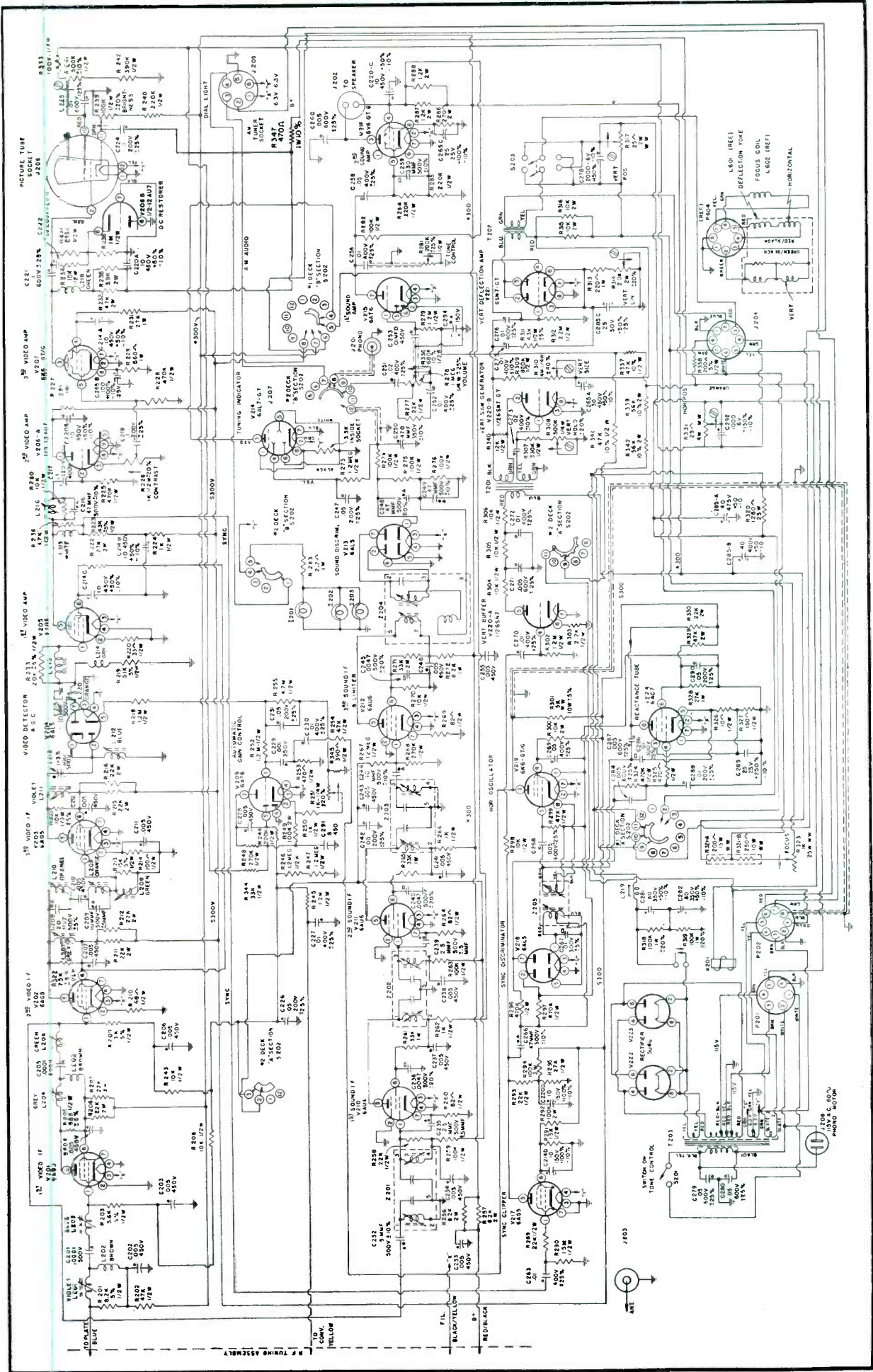

Fig. 1. Schematic of main chassis.

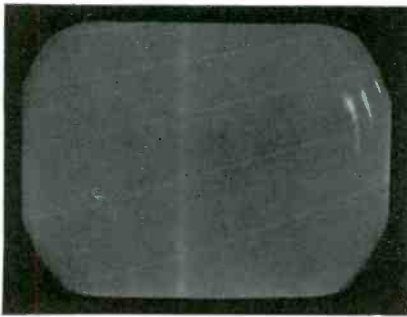

Fig. 3. View of unsynchronized raster.

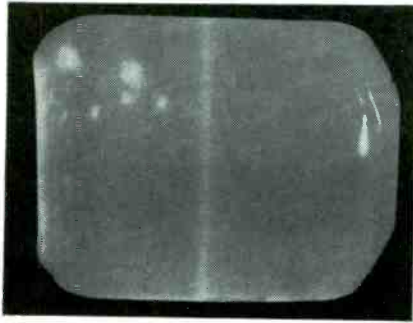

Fig. 4. A synchronized raster.

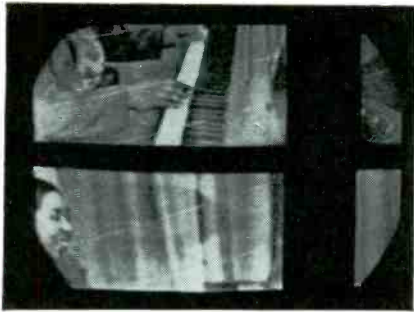

Fig. 5. Picture with no horizontal or vertical sync.

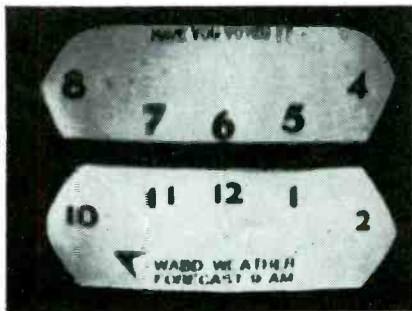

Fig. 6. Picture with no vertical sync.

Fig. 7. Picture with vertical free running frequency too high.



resistors must be much lower than normal.

If the frequency is too low, the defective component will have increased in value.

**Vertical Saw Section:** The vertical saw section, consisting of a vertical saw generator and vertical deflection amplifier is responsible for the production and amplification of the correct waveform to be applied to the deflection yoke. If there is no vertical deflection (only a horizontal line) or insufficient vertical deflection or poor vertical linearity the defect is in these stages. Also, as noted, it is possible for a defect in the vertical saw generator to cause faulty synchronization.

**Horizontal Sync Section:** This receiver uses an *afc* system for control of the horizontal oscillator frequency. In the diagram, this portion of the circuit has been broken down with the sync discriminator and the reactance tube designated as the horizontal sync section. Thus if one of these stages goes bad then it would be obvious that the picture is not syncing horizontally.

Fig. 9 shows the indications on the *crt* when the horizontal sync section fails.

In checking the horizontal sync section, four steps should be followed:

(1) The horizontal frequency control should be adjusted until a complete picture is seen on the screen. The entire picture will move sideways as shown at Fig. 10.

(2) The 6AC7 and then the 6AL5 should be replaced.

(3) Waveforms should be studied.

(4) Voltage and resistance measurements should be checked.

If step (4) reveals no discrepancy, then another check should be made. A high-impedance voltmeter should be connected from grid to ground at the 6AC7 reactance tube. An attempt should be made to synchronize manually the horizontal oscillator by carefully adjusting the horizontal frequency control. If the correction voltage is being applied to the grid of the reactance tube, the meter pointer will swing one way as the frequency shifts in one direction and the opposite way as the frequency shifts in the other direction. The magnitude of this variation in voltage will be at least three volts in each direction.

If this variation is present, then it is the reactance tube circuit that is defective.

If not, then the same check should be made at pin 7, of the sync discriminator. The results of the test at this point will reveal whether or not the defective circuit is the sync discrim-



Fig. 8. Picture with vertical free running frequency too low.

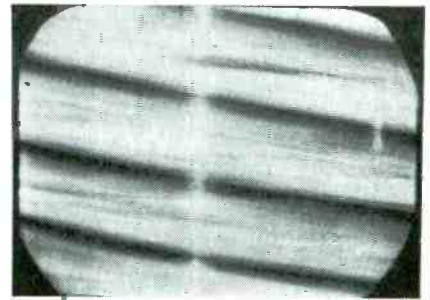

Fig. 9. Loss of horizontal sync picture.

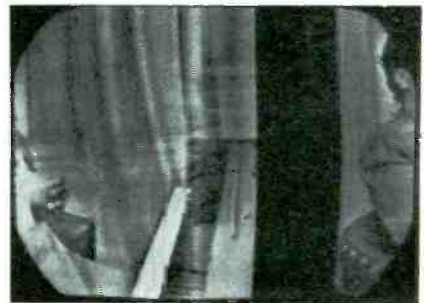

Fig. 10. Effect of lack of horizontal sync after the frequency control has been adjusted.

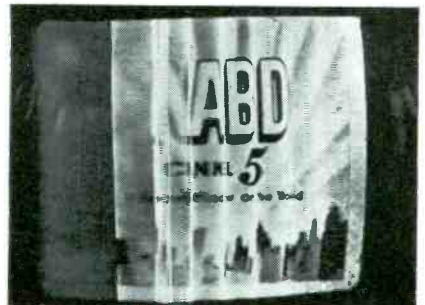

Fig. 11. Horizontal foldover picture result.

Fig. 12. Hum in horizontal sweep.





inator or the filter circuit between the discriminator and the reactance tube.

**Horizontal Sweep and High Voltage Section:** The largest section as far as number of tubes is concerned is designated as the horizontal sweep and high voltage section.

As in most current model TV sets, the high voltage is produced by the action of the horizontal sweep signal. Thus, both the horizontal sweep and high voltage circuits are included in this section. The indications for trouble in this section are: No raster (tuning indicator lights, indicates presence of B-); poor regulation (indicated by picture size changing with change in brightness control); horizontal fold-over (Fig. 11); and hum in horizontal sweep (Fig. 12).

**Low Voltage Power Supply Section:** The last section, the low voltage power supply, includes two 5U4G rectifiers and a relay control tube. The application of B+ to the input capacitor of the B+ filter is delayed by the action of the relay control circuit; if this stage is defective, no B+ will be available and thus all functions of the set will be inoperative.

Any TV receiver can be broken down in the same manner as the RA-105. It is not essential to make the breakdown in the form of an actual diagram. However, the Service Man should understand the operation of any television set to determine how such a breakdown should be made. Thus as he encounters a new receiver, by examining the schematic he can determine where a section ends and another begins. Obviously the smaller number of stages that constitute a section the closer to the actual trouble will his diagnosis lead.

In servicing a television receiver six basic steps can be followed:

(1) All indications of faulty operation should be observed.

(2) Based on the observations made, the trouble should be localized to one of the sections previously noted.

(3) The trouble should be further localized to the defective stage by means of signal tracing with a scope.

(4) The defective tube should be replaced with a tube that has been working in the same type circuit in another receiver.

(5) If the trouble is not remedied by step 4, then voltage and resistance measurements should be resorted to, to locate the defective part.

(6) If step 5 does not reveal any discrepancy then you should search for a defective component, whose defect will not noticeably affect the voltage and resistance readings; for example,

# HICKOK

610-A

*The complete*

## TELEVISION

Generator

*with*

## SELF-CONTAINED

## MARKERS

*makes your*

**TV SERVICING**

**RAPID**

**ACCURATE**

**PROFITABLE**



## Features

FOR TODAY AND THE FUTURE

1. Complete frequency coverage.
2. Variable, self-contained markers.
3. Crystal markers, any frequency, modulated or unmodulated.
4. Outstandingly stable.
5. High output.
6. Excellent attenuation.
7. Enables you to align any TV receiver independent of any local station. This generator is complete, and will remain up-to-date for a long time to come.

WITH THE HICKOK MODEL 610

*you can*

- ✓ Align I.F.
- ✓ Align R.F.
- ✓ Align Oscillators
- ✓ Align Traps
- ✓ Insert Markers (3 types)  
Oscillator, Absorption,  
Crystal
- ✓ Cover all TV channels

Thousands of the HICKOK Model 610 have been in use by leading technicians for over a year.



For over 39 years builders of the finest electrical and electronic test instruments.

**THE HICKOK ELECTRICAL INSTRUMENT CO.**

**10521 DUPONT AVE. CLEVELAND 8, OHIO**

Please send me full details on the complete new HICKOK 600 series Television test equipment, including the brand-new linearity Pattern Generator.

NAME \_\_\_\_\_

STREET & NO. \_\_\_\_\_

CITY \_\_\_\_\_ ZONE \_\_\_\_\_ STATE \_\_\_\_\_

an open bypass or a coil with shorted turns.

In following step 3, considerable care should be taken when observing waveforms. No only should the waveshape be noted, but the peak-to-peak amplitude should be measured. This is where a voltage calibrator becomes very handy.

It is possible for the waveshape to be correct but if the amplitude is not sufficient, then the circuit in question may not work properly.

An excellent argument in favor of a voltage calibrator can be demonstrated

by an actual fault that occurred in a RA-105 receiver.

The indications were that the set was being over driven by the stronger stations, and too much sync was available as indicated by the distortion in the picture.

From the strong signal present, the first thought was readjustment of the *agc* control and replacement of the 6AT6.

It was noted that readjustment of the *agc* control had no effect, regardless of the tube being used. The set

*(Continued on page 46)*

# Servicing Helps

**Converting 630TS Chassis for 12", 15", 16" and 20" Picture Tubes . . .  
Eliminating Tube Failures in AC/DC Chassis . . . Reducing Hum Level in  
Bendix Models . . . Minimizing Bass Response in Westinghouse Receivers  
. . . Adjusting RF Transformers in G. E. TV Sets.**

## Converting 630TS for Large Picture Tubes

THE RCA 630TS 30-tube chassis has become quite a standard among many TV manufacturers and custom builders, the chassis serving as a base unit for the regular 10" picture tube as well as the larger types.

To facilitate installation of the 12", 15", 16" or 20" tubes, one manufacturer<sup>1</sup> has developed a conversion kit with all the mechanical and electrical components necessary to make the changes.

Two types of conversion are possible. One, as illustrated in Fig. 1 (a) requires but a few parts and will provide up to 10 kv. Only resistors R<sub>1</sub> and R<sub>2</sub> are required additions to the original components. Two resistors, 18,000 ohms (R<sub>216</sub>) and 22,000 ohms (R<sub>207</sub>)

by M. A. MARWELL

must be completely eliminated from the original circuit.

While this method will provide results that will be satisfactory in most instances, a voltage doubler circuit shown in Fig. 1 (b) will be better since it will provide 12 kv at full rated load with the 15 and 16-inch picture tubes.

In most cases it will be necessary to lengthen the leads to the kinescope socket, yoke and the focus coil. In rare instances it may be advisable to lengthen the second anode lead. Where this has to be done, 15,000-volt tested insulated lead must be used. Usually, lengthening the second anode lead can

<sup>1</sup>Tech-Master Products Co.

be avoided merely by turning the picture tube so that the second anode connection faces down toward the chassis.

In making the change to a 12" or 12½" in the DuMont sets, the 1,800-ohm, 1-watt resistor (R<sub>188</sub>) in the focus circuit must be removed and a 680-ohm, 1-watt resistor added in series with the arm of the focus control.

When installing the 15" or 16" tubes a new focus coil will also be required in addition to the components shown in the diagram.

## Tube Failures in AC/DC Chassis

OFTEN in areas served by the REA or others a stable line voltage is difficult to maintain. Since the tube filaments of ac/dc receivers are connected in series directly across the 110-volt line, any great increase in line voltage may increase the voltage across the individual filament beyond the rated maximum. This may either burn out one or more tubes immediately, or, at least, seriously shorten the life of all the tubes.

Bendix reports that this hazard can be reduced by inserting a 75-ohm, 3 to 5-watt resistor in series with the filament string. A convenient location in the Bendix five-tube chassis for this resistor is between pin 7 of the 12SA7 and the 12SQ7. On the six-tube chassis, this resistor may be inserted between the 14A7 and the 14Q7 by removing the filament lead from pin 8 of the 14A7 rf tube and mounting the 75-ohm resistor directly on the tube socket lug.

## Hum Level Reduction (Bendix 75 Series)

It has been found possible to reduce the hum level in Bendix models 75M5, 75B5, 75W5, 75M8 and 75P6 by in-

Fig. 1 (a and b). In a appears the circuit which can be used to convert an existing high-voltage supply in a 630 type chassis to obtain 10 kv for the second anode of 12", 12½", 15" or 16" picture tubes. Only two new parts are required, R<sub>1</sub> and R<sub>2</sub>. In B appears a voltage-doubler conversion circuit which provides 12 kv at full rated load with 15" and 16" picture tubes. In both circuits the asterisk designates the connections brought to the same points as in the original circuit, while the diamond-shaped symbols indicate the additions required for the conversion. (L<sub>1</sub> is a width control; L<sub>2</sub> a horizontal linearity control and T<sub>1</sub> a replacement for the horizontal deflection output and high-voltage transformer).

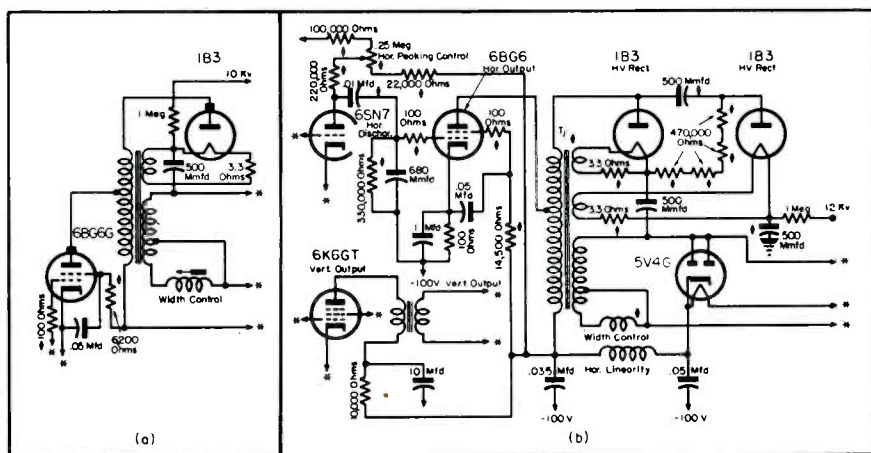



**This is it!**  
**"LITTLE GIANT"**



**RADIART**

# TELE-ROTOR

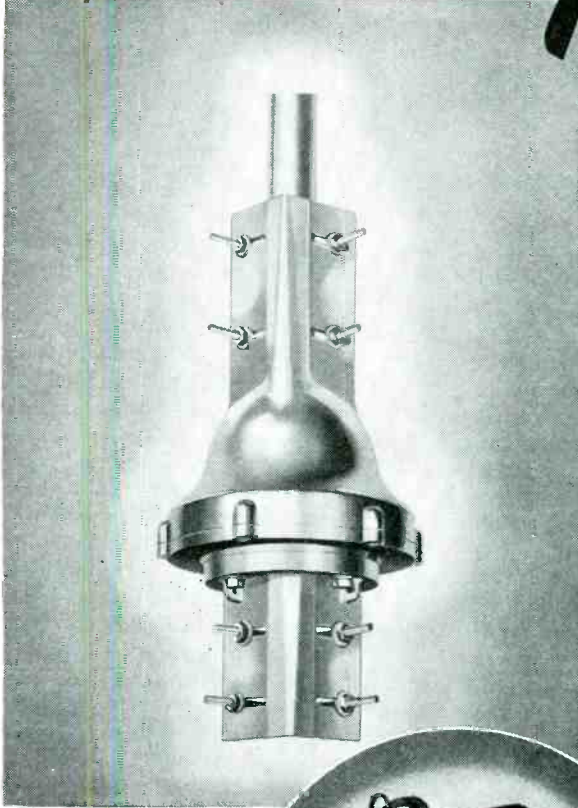
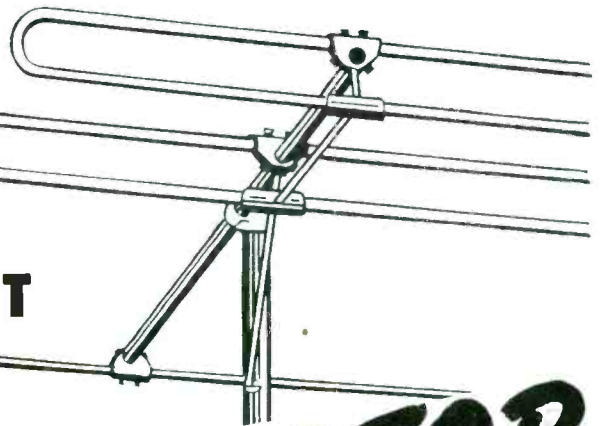

At last . . . the ultimate in rotators . . . a triumph in engineering skill. Months and months of patient research and development . . . now . . . we are proud to announce our latest triumph . . . the Radiart "Little Giant" TELE-ROTOR! Not a single factor has been overlooked to bring you the best . . . true to Radiart tradition that makes Radiart products . . . THE STANDARD OF COMPARISON! To you who have wanted a superior rotator that out-performs all others . . . **THIS IS IT!**

**Better Because:**

- Handles Heavier Loads . . . With Ease
- Remarkably Durable, Sturdy Design and Construction
- Absolutely Trouble-Free and Fool-Proof
- Available with "Compass Control" Directional Indicator

**Check These Features:**

- Heavily Reinforced Die-cast Housing
- Two 6½" Ball-Bearing Races
- Heavy-duty Precision Gears
- Positive Stop at End of Rotation
- Takes ¾" to 2" Upper and Lower Masts
- Motor Instantly Reversible
- Mast or Platform Mounting
- Three Heavy-duty Guy-Wire Lugs
- Completely Weather-Sealed
- Factory Lubricated for Life

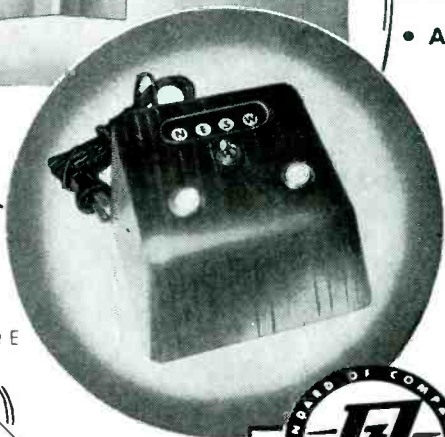

IT'S RIGHT WHEN IT'S RADIART!



**THE RADIART CORPORATION**  
 CLEVELAND 2, OHIO



**Manufacturers of the Famous Red Seal Vibrators**



Fig. 2. Assortment of parts supplied in converter kit.

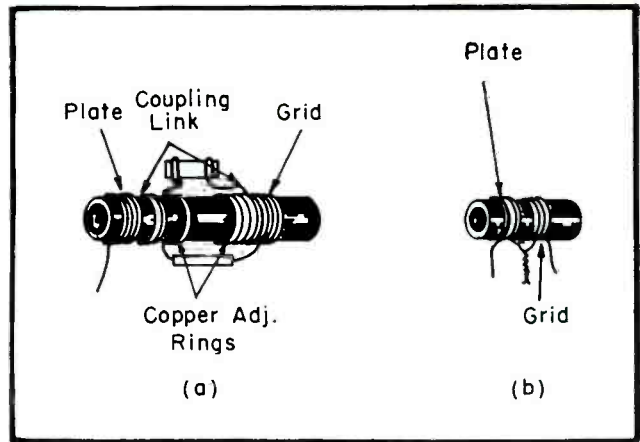

Fig. 3. Windings of 23a VT rf transformer.

stalling a choke in the output circuit to the speaker, in the following manner:

- (1) The .02-mfd capacitor ( $C_{35}$ ), connected from pin 3 of the 50L6 ( $V_a$ ) tube socket and terminal board, is first removed.
- (2) Then the red lead is removed from pin 4 of the 50L6 socket and the terminal of the 50-mfd electrolytic ( $C_{13c}$ ).
- (3) Next, the 470-ohm resistor ( $R_{55}$ ) is removed from pin 6 of the 50L6 socket and terminal board.
- (4) The pick-up point of the brown lead of the output transformer ( $T_c$ ) is now moved from the terminal board to pin 6 of the 50L6 socket.
- (5) The red lead from terminal of the 40-mfd capacitor ( $C_{13a}$ ) is then moved to a terminal of the 30-mfd electrolytic ( $C_{13b}$ ).
- (6) A hole must then be drilled through the chassis near the electrolytic capacitor for the leads of the added reactor<sup>2</sup> ( $L_{40}$ ).
- (7) In the next one ear of the reactor is bent and mounted on top of the chassis by soldering both ears to the chassis, or holes may be punched in each ear, and the reactor mounted with self-tapping screws. The reactor leads are then run through the hole drilled in step 6.
- (8) Since leads of the .02-mfd capacitor ( $C_{35}$ ) are too short, it will be necessary to install a new .02-mfd capacitor between pins 3 and 6 of the 50L6, with tubing over the positive lead, and the negative capacitor plate attached to pin 3.
- (9) The red lead of the added reactor is then connected to the 30-

mfd electrolytic ( $C_{13b}$ ).

- (10) In this, the final step, the black lead of the added reactor is connected to the other terminal of the 30-mfd electrolytic.

#### Excessive Bass Response (Westinghouse H-203)

Objectionable bass response in this model can be decreased by changing  $C_{20}$  from .05 to .005 mfd.

#### TV Receiver RF Amplifier Circuits\*

IN GROUNDED-GRID circuits, a feature of many TV receivers, particularly the G. E. series, the 6AU6 pentode is used as a triode with the suppressor and screen tied to the plate, which is connected to approximately 220 volts through a plate resistor.

A grounded-grid amplifier requires bias just as in the case of most other amplifiers and, therefore, a bias resistor properly bypassed is placed in series with the cathode and is on the order of 200 ohms. This bias resistor is not connected directly between cathode and ground since it would then shunt the dynamic cathode-to-ground impedance and the input impedance would be something less than 200 ohms instead of the desired 300 ohms. Therefore, the bias resistor is isolated from the cathode by connecting it in series with the cold end of the cathode inductance. A bypass capacitor in parallel with this resistor is essentially a short circuit at rf. For this reason the effect of the resistor is eliminated as far as rf is concerned. The dc plate current flows through the resistor and develops a bias voltage in the normal manner.

Although the grid is grounded and

the signal is applied between cathode and ground, the tube acts (as far as the output voltage is concerned) as though it were connected in the conventional manner, since the output circuit is connected in the customary way and the potential between cathode and control grid still varies according to the input signal. The varying signal in the plate of the rf amplifier is shunt-fed through a small capacitor to the primary or plate coil of a broadband transformer. A double-tuned, closely-coupled transformer is used between the plate of the rf amplifier and the converter grid. The pass-band of this tuned circuit is approximately 6 mc. The only exception to the double-tuned type of transformer is the transformer associated with channel 2, which is triple tuned so as to provide good selectivity and satisfactory image rejection for strong FM stations. The third tuned circuit is placed between the plate and grid windings of the channel 2 transformer and is inductively coupled to each of them. There is practically no direct coupling between the plate and grid coils.

The windings of each transformer are wound on the same form and inductively coupled to each other, as indicated in Fig. 3.

The plate and grid windings of each transformer are tuned to the mid-point of the particular channel for which it is to be used. The required bandwidth is then obtained by overcoupling and resistive loading of the secondary, if necessary to prevent excessive valley. When two circuits tuned to the same frequency are gradually coupled together, the bandwidth spreads out on either side of the frequency to which both circuits are tuned. With close coupling, the response curve broadens out on either side of the center fre-

(Continued on page 45)

<sup>2</sup>Bendix LFO102.

\*From copyrighted data prepared by K. Fowler and H. Lippert of the G.E. technical service section.



*announcing*

The Greatest Advent in Speaker Development!

*The New*  
**PERMOFLUX**  
**High-Fidelity**  
**SPEAKERS**

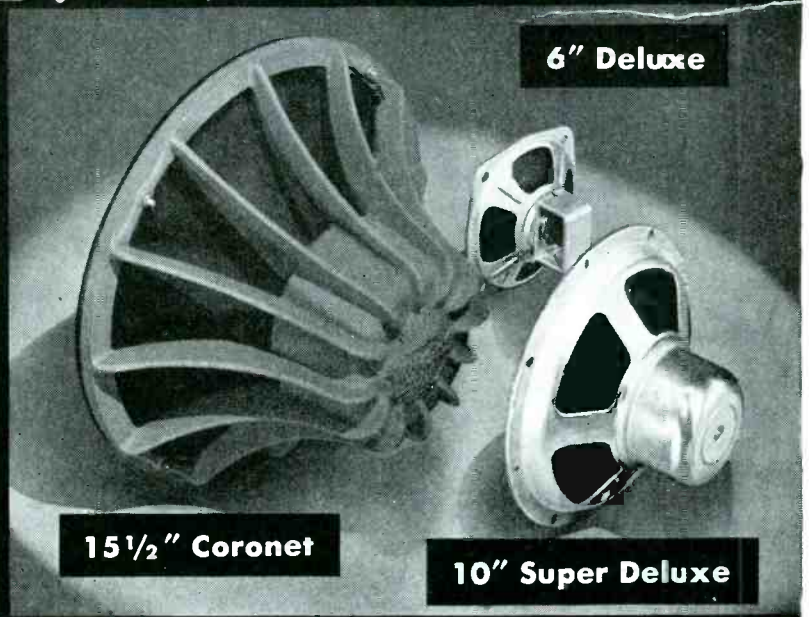

15 1/2" Coronet

6" Deluxe

10" Super Deluxe

A Special Treatment in Design that Eliminates Distortion!

These outstanding, new, deluxe high-fidelity speakers make PERMOFLUX, the most complete speaker line in the world!

**SERVICEMEN — DEALERS**

- Insist on the best!
- Buy PERMOFLUX Speakers!
- See your jobber today!

PERMOFLUX speakers will outperform, model for model, any speaker on the market.

**PERMOFLUX HIGH-FIDELITY SPEAKERS**

*Deluxe High Fidelity Models—Heavy Magnets—No Pot Covers*

SIZE	MODEL NO. OR CODE	MAGNET DATA FLUX GAUSS	VOICE COIL DATA DIA-METER	IMPE-DANCE	WATTS
6"	6L-1	10000	3/4"	3.2	5
8"	8T-8-1	10000	1"	8.0	8
10"	10T-8-1	10000	1"	8.0	9
12"	12T-8-1	10000	1"	8.0	10

*Super Deluxe High Fidelity Models — Extra Heavy Magnets — With Pot Covers*

8"	8WP-8-1	10000	1 1/4"	8.0	10
10"	10WP-8-1	10000	1 1/4"	8.0	11
12"	12WP-8-1	10000	1 1/4"	8.0	12
15"	15WP-8-1	10000	1 1/4"	8.0	15

*"Coronet" Supreme High Fidelity*

12 1/2"	125Z-16	15000	2"	16 ohms	20
15 1/2"	155Z-16	15000	2"	16 ohms	35

NEW catalog available upon request. Write for your FREE copy!

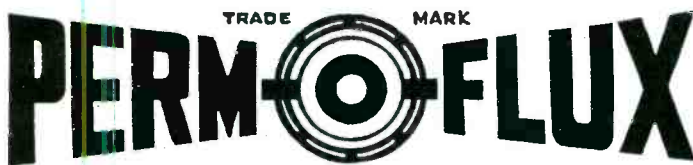

**PERMOFLUX CORPORATION**

Two Factories to Serve You

Chicago 39, Illinois 4900 West Grand Avenue

Glendale 5, California 236 South Verdugo Road

SERVICE, SEPTEMBER, 1949 • 33

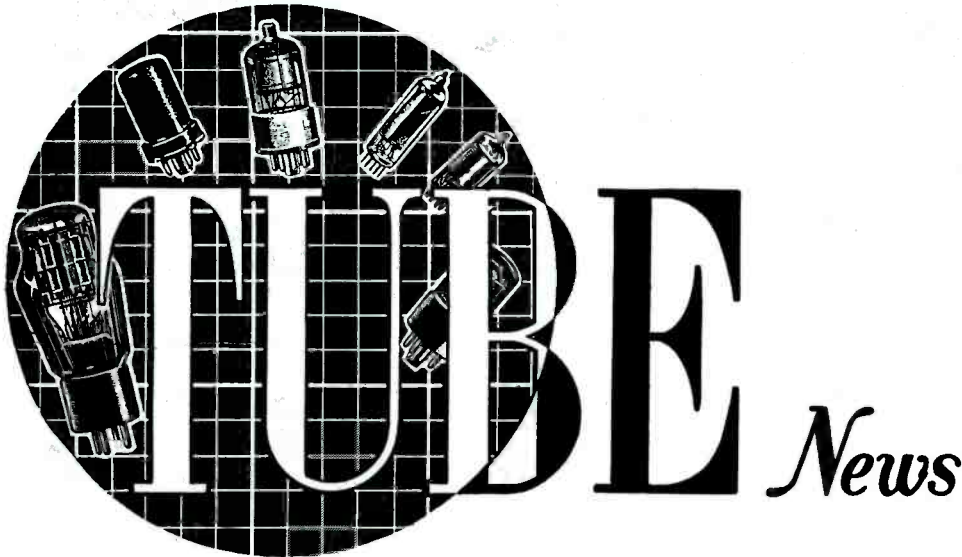

# TUBE News

## Design and Application Features of 3RP1 Three-Inch CRT

THE INCREASED use of 'scopes in shops and labs has prompted the development of many types of *crt's*, particularly the small units.

Recently, a 3" model, the 3RP1, an electrostatic focus, electrostatic deflec-

tion, high deflection sensitivity type was announced by RCA. The tube was designed to provide high bright-

ness when operated with an anode-No. 2 voltage near the maximum of 2,500, and good brightness at relatively low anode-No. 2 voltages.

Having a separate base-pin connection for each of the four deflecting electrodes, this *crt* is especially suitable for use in balanced electrostatic-deflection circuits, and when so used gives best definition. However, the tube may be used with unbalanced deflection.

The 3RP1 has the same electron gun, operating voltages, and basing arrangement as the 2BP1 and 2BP11, and are electrically interchangeable.

Line brightness<sup>1</sup> of the 3RP1 is amply high for operation without a light shield in a well-lighted room at anode-No. 2 voltages as low as 1,000.

### Tube Circuit

A typical oscillograph circuit for the 3RP1 is shown in Fig. 1. This circuit includes such features as balanced deflection, balanced spot centering, and provision for grid modulation. Balanced deflection is recommended to minimize spot and pattern distortion. Spot centering is obtained by adjustment of the .25-megohm ganged pairs of potentiometers.

Grid modulation is accomplished by introduction of the signal through a .0001-mfd capacitor to grid No. 1. A

(Continued on page 47)

<sup>1</sup>Line brightness is inversely proportional to the length of the scanned line and in grid-modulated service, is also directly proportional to the per cent of the time that the line is scanned.

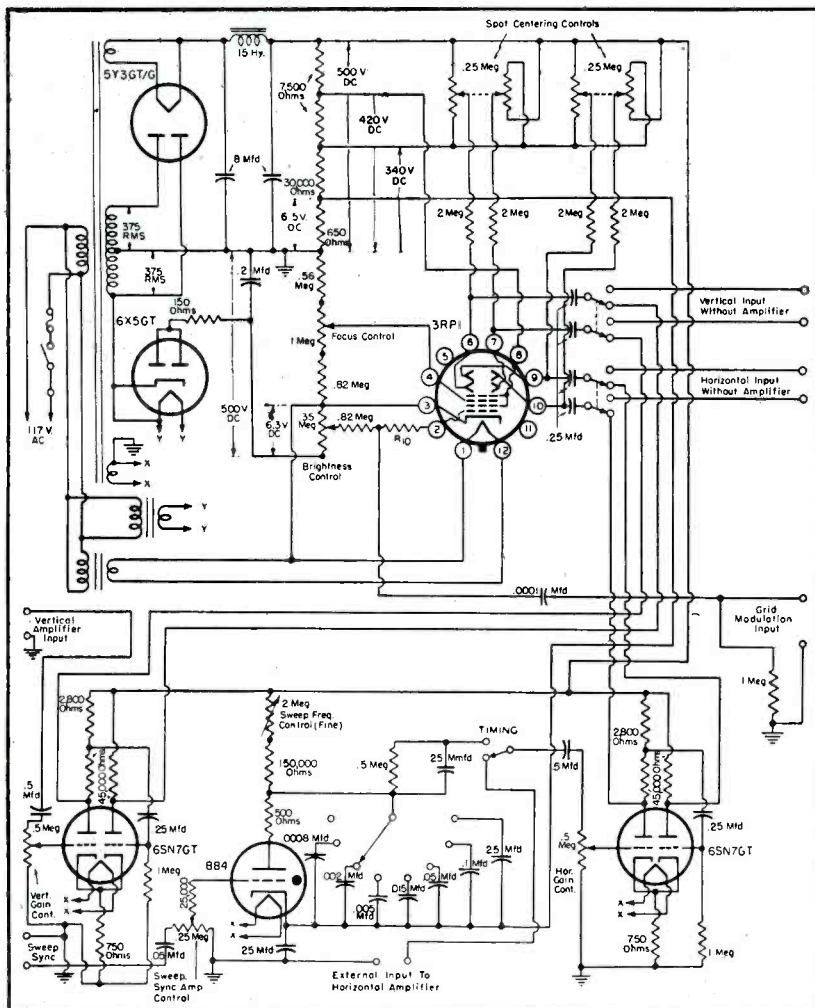

Fig. 1. A 'scope circuit, using the 3RP1, featuring balanced deflection and balanced-spot centering.





*3 New Time-Saving, Profit-Building*  
**G-E TELEVISION SERVICE INSTRUMENTS**



**Now — with this new G-E equipment — you can check TV receivers under conditions varying from fringe areas to "under the tower" and predict operation of the sets anywhere in the service area — at a glance!**

**V**ARIABLE Permeability Sweep Generator! Crystal Controlled Marker Generator! Cathode Ray Oscilloscope! Put them all together in one group and you have what manufacturers and servicing dealers have acclaimed the fastest, most accurate answer to television receiver testing problems ever offered!

Here's why—

- Variable Permeability Sweep Generator can be set quickly to any desired frequency, supplying high output and exceptionally wide linear sweep—

- Because of low leakage, complete over-all response from antenna terminals to picture detector can be viewed with contrast at maximum settings.
- All desired markers for complete alignment are obtained by one initial setting of the master dial on the marker generator.
- High quality general purpose oscilloscope presents accurate picture of wide range of phenomena from response curves to composite signal.



**GET THE FACTS TODAY!**

Specialty Division—Room 107  
 Electronics Park  
 Syracuse, New York

Send me specifications, pictures, and prices on the new G-E Television Test Equipment Package.

NAME \_\_\_\_\_  
 ADDRESS \_\_\_\_\_  
 CITY \_\_\_\_\_ STATE \_\_\_\_\_

*You can put your confidence in—*

**GENERAL  ELECTRIC**

Fig. 1. TV service bench layout at Highland Radio, Highland, Indiana. (Courtesy C. A. Usher, Highland Radio)

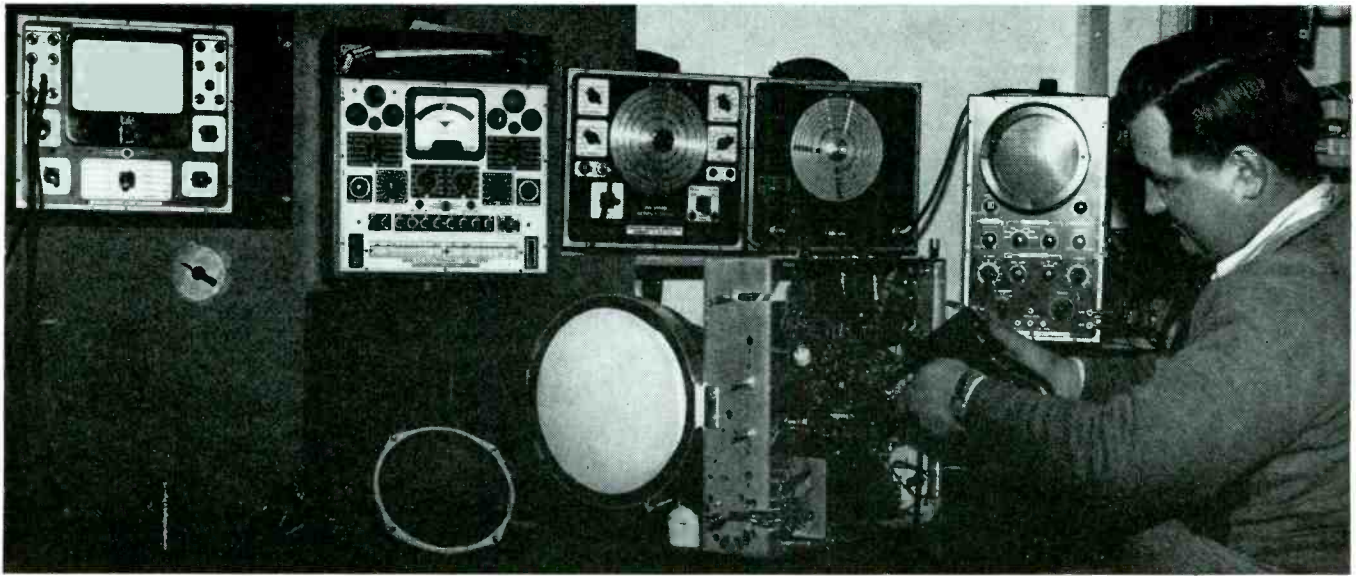

# SWEEP GENERATOR Operating Hints

**Solution to Problems Involving Interfering Patterns Which Cause Distortion of Desired IF Response Characteristics; Extraneous Marker Pips on Response Curve; Low Amplitude Crystal Marker Pips; Dual Scope Traces; Calibration Control, etc.**

THE SWEEP GENERATOR, rapidly growing in popularity in standard and particularly TV Service Shops, is accordingly receiving the close study of many Service Men, with the operational and application characteristics the focal point of attention.

Field and shop reports have disclosed that there are several TV set-generator operational problems which appear to be the most puzzling to the Service Man. One of these concerns the interfering patterns which cause distortion of the desired *if* response characteristic. The probable cause of this problem is in the TV set local oscillator producing an extraneous pattern as a result of beat action against the sweep generator. To cure, the receiver channel selector should be rotated to a non-interfering position, or as an alternative, the local oscillator should be temporarily disabled.

Extraneous marker pips on the response curve, are another difficulty often encountered. This condition

by **VICTOR I. ROBINSON**

Senior Engineer  
Precision Apparatus Co., Inc.

might be due to the marker signal beating against one of the sweep generator oscillators or against oscillators in the TV set. Familiarity with the expected frequency distribution over the particular response curve will assist in identifying the proper marker pip. If the receiver oscillators are the cause, the offending oscillator should be disabled.

Another problem involves pattern configuration changes due to hand-capacity effects or as connecting cables are moved. This is caused by insufficient grounding inter-connections. Metallic braid should be used to secure sufficient grounding contact between the TV set and all test instruments.

Often the amplitude of the crystal marker pip is not as large as desired. The crystal may be operating on a

relatively high harmonic for the desired marker frequency. Greater marker strength can be obtained by extracting the output of the built-in crystal oscillator and injecting it (in parallel with the sweep generator output) directly into the input of the circuit being analyzed.

After a badly misaligned video *if* system has been aligned, the response characteristic sometimes assumes a radically different shape when the contrast control setting is *reduced*. This is usually caused by setting of the output controls of the sweep generator too high and a high setting of the TV set contrast control, resulting in deceptive flattening of the response characteristics in the last alignment steps.

In another problem often met, we find a condition where one of the dual oscillograph traces persistently maintains a slightly *different configuration*. This peculiarity is due to the fact that half-wave power supply rectification in certain direct *ac* line-operated TV



sets produces a slight phase shift in the video if system. This phase shift can be disregarded insofar as satisfactory operation of the TV set is concerned. This difference in configuration should not be confused with a difference in the *width* (not *configuration*) of the two 'scope patterns. This condition is attributed to slight variations in the electromechanical reactance modulators in commercial sweep generators, and can be disregarded by the Service Man.

On occasion the dial calibration of sweep generator may be slightly off and cause some bewilderment. Practically all modern sweep generators utilize an internal beat-frequency system to provide the unusually wide band coverage required for both FM and TV applications. In actual practice the output of a variable frequency oscillator is mixed with a fixed frequency oscillator, obtaining beat output at both the sums and differences of the two oscillators. For example, the sweep generator dial calibration of 25 mc may be produced by a variable oscillator frequency at 100 mc beating against a fixed oscillator at 75 mc (100 mc — 75 mc = 25 mc). Now a 1% oscillator frequency shift at 100 mc would provide for example, 101 mc. A 1% frequency tolerance at 75 mc might result in 74.25 mc; 101 mc — 74.25 mc = 26.75 mc, or a potential overall frequency error of 7% at 25 mc.

#### HF Oscillator Calibration

It is therefore apparent that although the individual *hf* oscillators in a sweep generator may be calibrated to well within  $\pm 1\%$ , the actual beat output, particularly at the lower subtractive frequencies, can vary from the beat frequency dial calibration considerably more than  $\pm 1\%$ . The use of accurate marker pips, of course, renders this condition quite unimportant. It is important to remember that the dial calibration of a sweep generator is of secondary importance whenever marker pips are being used to check response curve configurations.

It is often desirable to first check the sweep generator dial calibration before using the generator at *low sweep widths* to check the frequency of a small sector of an overall broad response characteristic. To perform this operation, the overall response characteristic should be obtained on the 'scope, and a marker pip, corresponding to the generator dial frequency to be checked, injected. The sweep width or *deviation control* must be reduced gradually, the pip being kept in the center of the 'scope trace

(Continued on page 45)

## THE NEW SHURE TURNOVER PICKUP

# PLAYS ALL THREE!

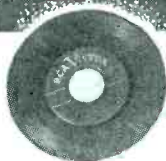

RCA 45 RPM



Columbia 33 1/3 RPM

**45 RPM**  
**33 1/3 RPM**  
**78 RPM**

with amazing  
fidelity of tone.

Standard  
78 RPM

Model: 901D

Code: RUZEL

List Price: \$16.25

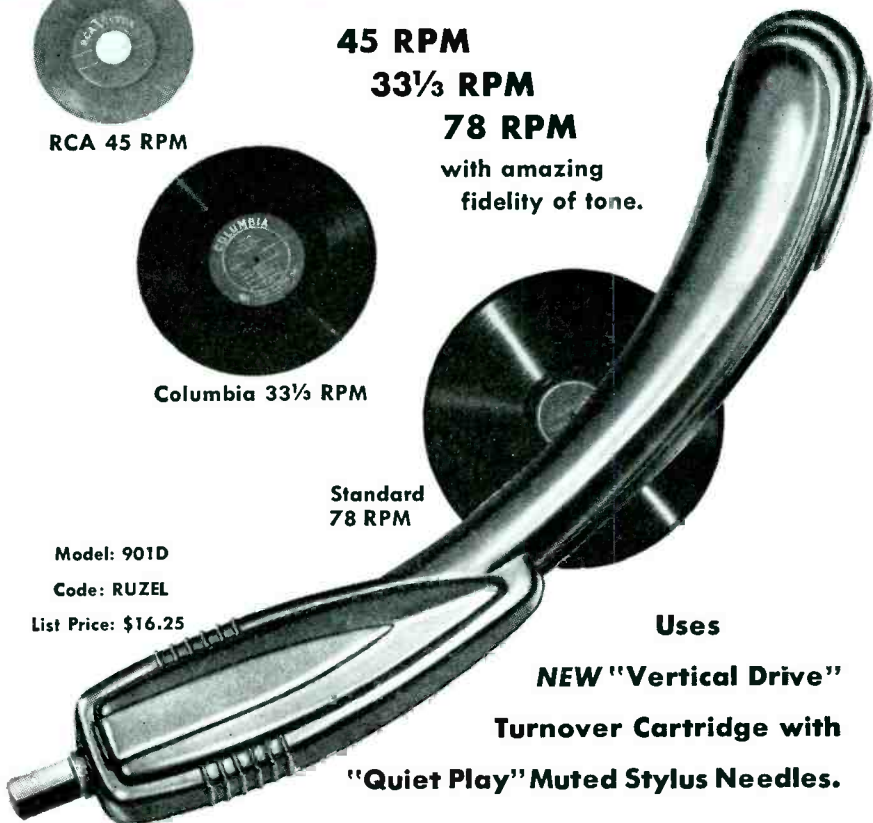

Uses

**NEW "Vertical Drive"**  
**Turnover Cartridge with**  
**"Quiet Play" Muted Stylus Needles.**

With the All-Purpose Turnover Pickup you can provide your customers with "studio quality," custom-made reproduction at moderate cost.

The Model 901D Crystal Turnover Pickup . . .

1. Eliminates costly, awkward, two arm arrangements.
2. Is highly compliant, eliminating the need for weight changes.
3. Tracks with but 1/4 oz. (7 grams) on all records.
4. Has extended record-matched frequency response—needs no equalization.
5. Has output of 1.1 volts on standard 78 RPM records and 1 volt on 33 1/3, 45 RPM test records.
6. Provided with fully guarded 3-mil Osmium and 1-mil Sapphire "Muted Stylus" needles, individually replaceable.

Licensed under Brush Pats. Shure Pats. Pending



## SHURE BROTHERS, INC.

Microphones and Acoustic Devices

225 WEST HURON STREET, CHICAGO 10, ILL.

CABLE ADDRESS: SHUREMICRO

# NATIONAL TELEVISION BOOSTER



## CLEAR BRIGHT PICTURES IN FRINGE AREAS

The new National Television Booster opens up whole new areas to television entertainment . . . makes excellent reception possible far beyond the normal receiving range. Also ideal for use in apartments or other locations where outdoor antennas are either not permitted or not practical. Greatly reduces noise in addition to increasing signal strength.

- A real working RF stage, using separate high-gain 6AK5 tubes for high and low bands.
- Covers all 12 channels.
- Easy to install and operate.
- Fine tuning control assures best possible definition.
- 300 ohm balanced or 72 ohm unbalanced inputs match any antenna.
- Electrostatic shielding.
- Self-contained power supply, 115 volts A.C., 60 cycles, 10 watts.

**\$39.95** (Suggested Retail Price)

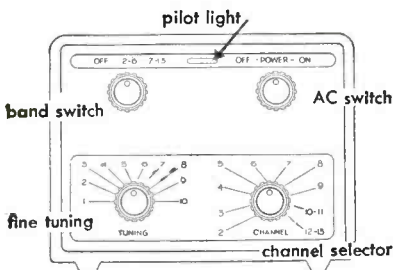

## Ser-Cuits

(Continued from page 18)

a dc restorer, by virtue of the bias voltage developed across a 270,000-ohm resistor, clips the sync from the composite signal and then clips the sync on the other side.

The diode, consisting of the grid and cathode develops a positive voltage across the 270,000-ohm resistor. The voltage across this resistor is a function of the average value of the applied signal and is applied to the picture-tube grid, thus providing dc restoration. A 22-mmfd capacitor, across the sync separator load resistor reduces any video which might be present in the sync signal.

### Horizontal Sweep Circuit Picture-Tube Anode Supply

The Videola circuit engineers state that they found multivibrators too sensitive, with a change of over 1,000 for a change in 1 volt of control voltage, while a sine wave oscillator was relatively insensitive to control, with the sawtooth developed in its output circuit being too long with respect to return time, for proper deflection and adequate high voltage.

Accordingly a circuit combining the best characteristics of both, was applied. This is essentially a sine wave oscillator with good stability, but a resistor in series with a tuned circuit adds an impulse providing rapid return time. Proper circuit constants provide the proper control sensitivity for the dc afc voltage applied to the first grid and for manual control by the changing resistance in the second grid.

The horizontal amplifier output is a sawtooth with a fast return time and a peak necessary for obtaining adequate high voltage. This peak is obtained by a pulse fed back from the horizontal output transformer secondary to the grid of the 6BG6G through a 15-mmfd capacitor. A capacity divider composed of a 270-mmfd fixed capacitor and a 25-280 mmfd trimmer varies the amount of drive applied to the 6BG6G. The trimmer is adjusted for best linearity and width.

### Vertical Deflection Circuit

One triode of a 6SN7 is used as a blocking oscillator and saw-tooth generator, while the other triode section is the vertical deflection amplifier. The Videola engineers report that they found that this type of circuit permits more reliable interlace than most other types of oscillators. The frequency is varied by a 1-megohm potentiometer. Vertical linearity is varied



A. J. GINKEL  
Station WJLS  
Beckley, W. Va.

# "Stands out above all others"



VARIABLE RELUCTANCE CARTRIDGE

SEE PAGE 11

Pat.

Pend.

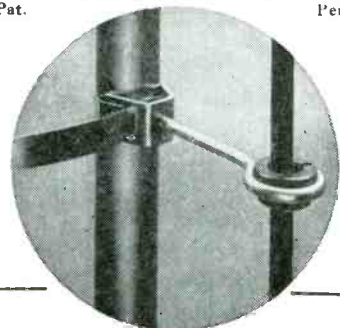

## NOW! NEW LOW PRICE FOR PHOENIX PAM-11

.. Fastest, Strongest Antenna Mast Stand-Off Insulator

- Attaches to any size mast in 10 seconds!

- Genuine Polyethylene parts.

**19c** list

PHOENIX ELECTRONICS, INC.  
Lawrence, Mass.

AT LEADING JOBBERS  
Write for folder M of complete line of television accessories.





with a 5,000-ohm potentiometer, while height is varied with a 2-5-megohm potentiometer.

### Intercarrier Sound System

The difference frequency between the sound and picture carrier is 4.5 mc and this beat component of the carriers is used in this system. Drift will not affect the sound to any great extent since even if the carrier drifts, the difference frequency remains relatively constant.

The 4.5 mc signal is removed after the 6AC7 video amplifier through a critically coupled transformer. One section of this transformer is in the plate of the 6AC7 and the other in the ratio-detector driver grid. This double-tuned circuit provides greater rejection at 4.5 mc in the video circuit and has more selectivity and sensitivity than single tuned traps. A 6AU6 is used as the ratio-detector driver and a 6T8 as a combination ratio detector and first sound amplifier stage.

### Power Supply

The power supply has been designed to eliminate high wattage bleeders. This has been accomplished by connecting the circuits operating at lower voltages in series, across the higher voltages necessary for the deflection system.

The deflection circuit operates at the higher voltage (360) while the *rf*, *if* and audio circuits are connected in series across the deflection circuits.

The *rf* and *if* plates and screens are at 140 volts while the cathodes return to ground. The audio cathodes are at the same 140 volts, while the audio plates are at 360 volts. Thus they operate on the difference between 140 and 360 volts, or 220 volts. A 390-ohm resistor, together with a 40-mfd capacitor act as a filter, preventing the current variations from modulating the *B* voltage.

Automatic voltage regulation of the 140 volts is accomplished by a 6V6 which acts as a series regulator. Current variations in the *rf* and *if* circuits changing the 140 volts, changes the effective grid-cathode voltage of the 6V6 since its grid is connected to the divider going from 360 volts to ground. Thus the change in the 140-volt system is only about 10 per cent with *acc* bias changes although the current change is much greater.

The 360 volts at 180 ma is obtained from a conventional transformer power supply circuit using a 5U4G full-wave rectifier. A 62-ohm speaker field coil, in conjunction with the focus coil, act as filter components.

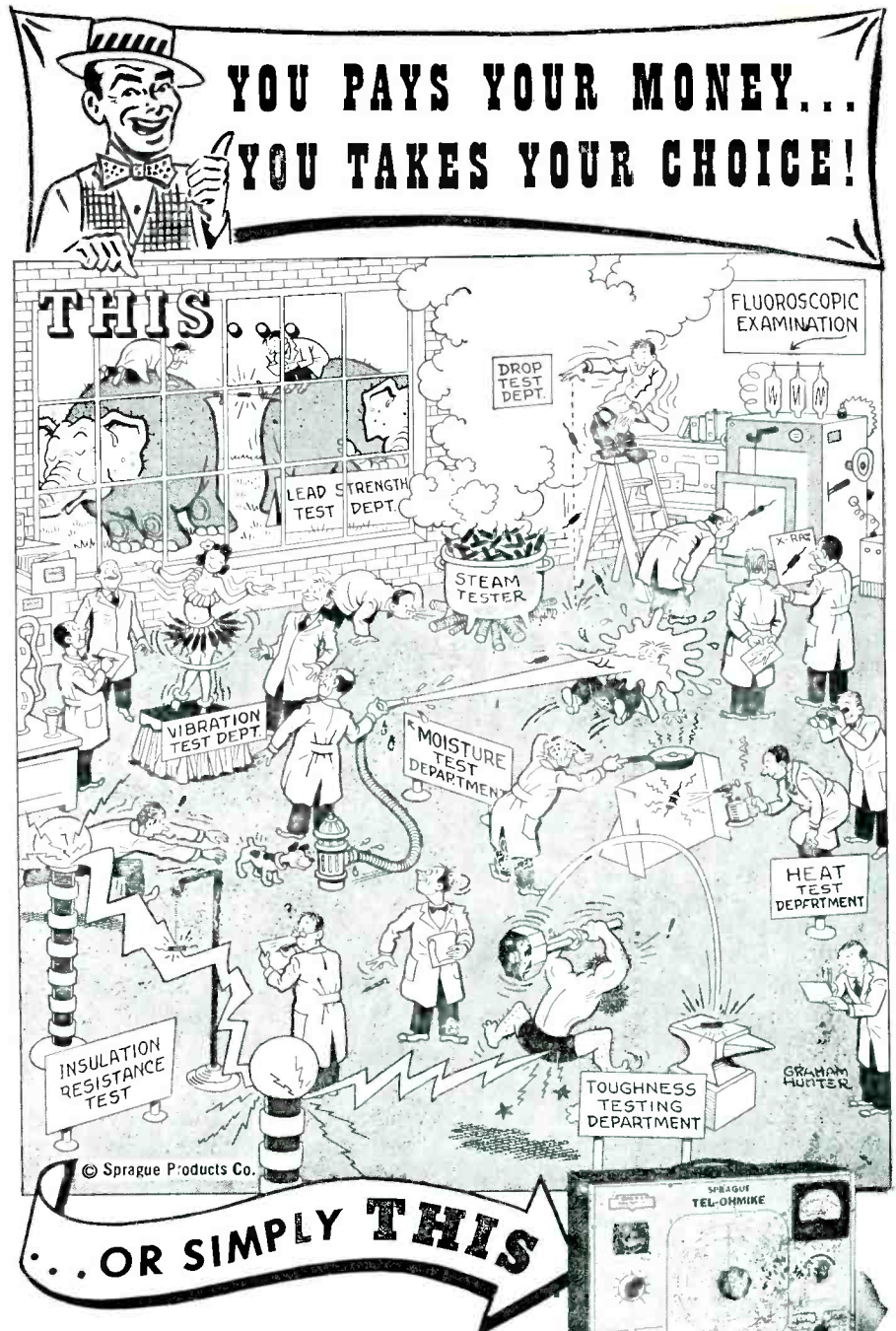

© Sprague Products Co.

...OR SIMPLY THIS

Exaggerated? Not by a jugful! So many claims are being made for the average capacitor these days, you'd almost need a test department like this to prove whether or not the manufacturers are telling the truth.

For everyday testing of essential capacitor characteristics in your own service shop, we recommend the Sprague Tel-Ohmike Analyzer. Measures capacitances from .00001 to 2000 mfd., electrolytic power factor to 50%, and electrolytic leakage under rated voltage from built-in power supply. Checks insulation resistance of ceramic, paper and mica capacitors. Measures resistors from 2.5 ohms to 25 megohms. Also is a 0-15-150-750 volt and 0-1.5-15-75 ma. volt-milliammeter.

Write for catalog M-414 today.

**FREE! LARGE REPRINTS OF THIS CARTOON**

Handsomely lithographed with advertising removed, size 11" x 14", suitable for framing. Send 10c to cover mailing and handling cost.

**SPRAGUE PRODUCTS CO., North Adams, Mass.**  
Distributors' Division of the Sprague Electric Company



**Sprague Tel-Ohmike** analyzer for fast, easy testing of all essential capacitor and resistor characteristics.



**Sprague Capacitors** for dependable service in any application.

**SPRAGUE**

# Auto Radio Service Aids

## Improving Control Shaft Fittings . . . Remediating Pushbutton Sticking . . . Basic Cures for Dead Receivers . . . Eliminating Noise Rattles, Pickup Noise and Wheel Static.

SERVICING HELPS, based on field experiences are always extremely handy. Recently the Kaiser-Frazer and G. E. field men compiled such an assortment of data, which have been found particularly interesting, not only insofar as the Kaiser-Frazer receivers<sup>1</sup> ('49 models) are concerned, but for general auto installations.

### Control Shaft Fitting

The field men reported that in cases where the volume and tuning control shafts appear too short to accommodate the shaft parts and knobs, a formed lip which is bent forward in the escutcheon opening of the instrument panel will be found to obstruct receiver installation. This lip may be removed by either filling or bending it back.

In instances where the hole for the receiver mounting bracket has not been accurately located, it is possible that the receiver is positioned a bit too far toward the front of the car to allow the receiver control shafts to come through instrument panel holes to the maximum extent. If the *knock out* hole for the mounting bracket screw must be drilled, the Service Man must make certain that it is accurately positioned.

### Pushbutton Sticking

In checking for this condition, any burrs must be removed from the bottom of the cast grille for pushbutton openings. A binding tuning shaft will also cause the pushbuttons to stick or fail to return to their normal positions. To clear shaft from binding, the tuning shaft opening should be enlarged, using a reamer, or a rattail file.

### Dead Receiver

There are four conditions which have been found to be the cause of most dead sets:

(1) Installation wiring is a promi-

<sup>1</sup>Receivers made by G. E.

by P. M. RANDOLPH

nent problem. This should be checked to make certain the correct lead is connected to the ignition and instrument light switch, respectively. If the receiver lead that should go to the instrument light control is connected to the ignition switch, the receiver will not operate, though the pilot lamps will light.

(2) The loudspeaker plug connection is another trouble spot. Though the plug pin receptacles in the speaker-lead connectors in the K-F sets are arranged in such a manner to be polarized, the operator often neglects to align the receptacles with respect to the male plug pins at the speaker. Forcing together of the incorrectly aligned parts is liable to cause the male pins to break through into the thin walls of the non-conducting adjacent holes of the speaker plug, resulting in open circuit wiring to the loudspeaker.

(3) Exposure of the receiver to such dampness as water drain-leaks upon the components and wiring, results in voltage breakdown at tube sockets (especially the 6V6 output tubes), or the shorting of capacitors and resistors, and is thus quite an important dead-receiver point to check. The *rf* trimmer strip at the center of the receiver will also be affected, causing the set to become weak or dead. Water leaks around the windshield, and screw head holding the set mounting bracket to the cowl should be well sealed against water draining upon the receiver. A thorough check for probable leaks and the necessary steps taken to prevent their occurrence should be taken at the time of the initial receiver installation.

(4) A lower than normal battery voltage can be the cause of the failure or weak signals. The receiver will not function properly if the battery

voltage measures less than 5.8 volts.

### Noise Rattle

Noise in the form of rattle can be attributed to mechanical insecurity of parts, loose fittings, and screw fastenings, etc. Some of these are:

(1) Loose tone control knobs, and loose tone and volume control shafts may rattle against the cast grille. The keyway in the tone control shaft may be spread slightly to provide a tighter fit to the control knob.

(2) If the shaft assembly seems loose or tends to rattle within the grille mounting hole, a  $\frac{3}{4}$ " length of #1 spaghetti (fabric or cambric tubing) may be slipped over the shaft assembly and into the bushing. This will displace the loose fitting and cushion against rattle.

(3) Vibration of the screen, which is set behind the cast instrument panel grille may cause a buzz sound when loose. The screen may be shimmed at its four corners to stabilize its mounting.

### Circuit and Pickup Noise

(1) Circuit noise can be minimized by antenna selection and careful peaking of the antenna trimmer to increase sensitivity and reduce noise. For metropolitan areas, a 62" antenna is quite adequate, while in outlying country areas the antenna length of 93" is recommended. Adjustment of the antenna trimmer is important, and should not be overlooked. Every receiver installation should be adjusted for normal operation after the receiver has been operating approximately 15 minutes to reach normal operating temperatures, and with antenna fully extended. The weakest stations near the higher frequency end of the dial scale should be tuned in for testing. Trimmers should be adjusted for minimum noise level and maximum clarity on stations used for test.

(2) Noise pickup may come from various sources, chiefly from ignition circuits of the car. The recommended  
(Continued on page 48)



# ASSOCIATIONS



## ESFETA

THE EMPIRE STATE FEDERATION of Electronic Technicians Associations will launch a state-wide TV course in the Fall which will extend into the Spring of 1950.

Lectures are scheduled in four areas: New York City, Poughkeepsie, Rochester, and Binghamton-Endicott. Sixteen meetings are being arranged for each area.

Subjects to be covered include: The nature of TV, transmission and reception, modulated waveforms, high frequency propagation and reception; antennas and transmission lines; front ends; video *if* circuits of all types including intercarrier systems; sound circuits and alignment; detector and video amplifiers; picture tubes (operation and control circuits); sync and sweep circuits (adjustments and controls, *afc*; high-voltage circuits; 'scopes; sweep generators; alignment of TV receivers; installation problems (midtown, suburban, fringe areas); servicing TV receivers.

Scheduled to present the lectures are John F. Rider; Ward Products; Philco; Westinghouse Electric; Emerson Radio; RCA; Allen B. DuMont Labs; Bendix Radio; Beta Electronics; Hickok; Coastwise Electronics Co.; Kay Electric Co.; and ye editor and Ira Kamen.

The talks will be presented in September, October, November and December, and January, February, March and April.

An examination will be conducted in May.

## ARTSNY

IN A RECENT issue of the *ARTSNY News*, the monthly journal of the Associated Radio-Television Servicemen of New York, appeared quite an open letter to the industry. Prepared by prexy Max Leibowitz, the letter scored those set manufacturers who "were instrumental in keeping the independent Service Man out of TV installation and Service."

Leibowitz said: "Since the advent of radio, and through the years, the independent Service Man has been keeping the sets of the listening public in operating condition and has contributed more than any other group



Robert E. White, general manager of KYW receiving a citation for KYW from PRSMA president Dave Krantz . . . "For Their Outstanding Work in Promoting Public Confidence in the Radio Technicians." Grouped from left to right are Stanley Waskiewicz of PRSMA; John Meagher, public relations director of KYW; Krantz; Richard G. Devaney, vice-president of PRSMA; Wm. Royal and Leonard Carr of the association, and James P. Begley, program manager of KYW.

toward the expansion of radio into the tremendous industry it is today, thereby benefiting the broadcaster, manufacturer, distributor, and the public.

"This same independent Service Man is well prepared in furnishing similar efficient service in the television field and the manufacturer needn't fear that the Service Man will defame the good name of their product if those technicians are given the co-operation promised them.

"We, in the association, fully realize that since location introduces a serious problem requiring specialized antenna installations in the metropolitan areas and since the quality of the merchandise offered to the viewing public needs more than the necessary amount of servicing, the only way the independent Service Man can remain in business is by charging for each installation and repair done on a television set on a time material basis.

"No one can pre-determine what constitutes a standard installation or servicing fee at the present time since each job constitutes an individual problem.

"There seems to be a trend toward stabilization occurring in the industry at present which may start sales and service rolling again unless there is a

continuation of irresponsible and premature statements about frequency changes and the introduction of color television.

"Let us hope that the television set manufacturers and others become conscious of their numerous errors and correct them before it is too late."

## ART, WESTERN CANADA

THE SECOND ANNUAL CONVENTION of the Associated Radio Technicians of Western Canada was held in the early summer in the Marlborough Hotel, Winnipeg, Canada. All of the radio technician associations in the four western provinces were represented at this meeting.

One year ago at a meeting in Calgary, Alberta, ART of Western Canada was formed. At that time the Associated Radio Technicians of B. C. and the Associated Radio Technicians of Alberta joined forces to form the nucleus of what is expected will become a Dominion-wide organization and embody all the radio technician associations in Canada. At the session in Winnipeg were the ART of Saskatchewan and the Manitoba Radio Service Association who have affiliated

(Continued on page 48)

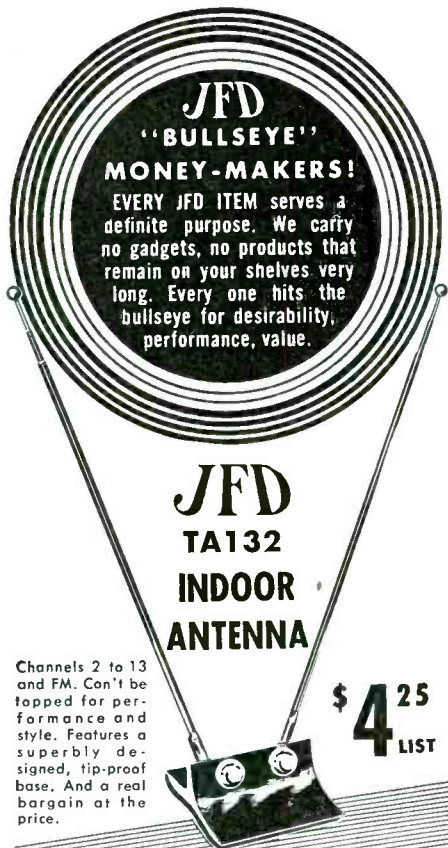

**JFD**  
"BULLSEYE"  
**MONEY-MAKERS!**  
EVERY JFD ITEM serves a definite purpose. We carry no gadgets, no products that remain on your shelves very long. Every one hits the bullseye for desirability, performance, value.

**JFD**  
**TA132**  
**INDOOR**  
**ANTENNA**

Channels 2 to 13 and FM. Can't be topped for performance and style. Features a superbly designed, tip-proof base. And a real bargain at the price.

**\$4<sup>25</sup>**  
**LIST**



**JFD**  
**TELEVISION**  
**BALLASTS**

Use the ballast the manufacturers use in their original equipment.

**\$2<sup>25</sup>**  
**LIST**

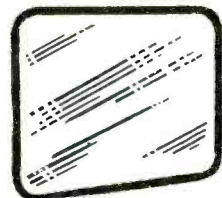

**JFD**  
**TELEVISION**  
**FILTERS**

Eliminate harmful glare. Even if you're willing to pay 10 times the price, you couldn't buy a better filter.

Available in sizes to fit standard and special tubes.

Write for **FREE JFD Catalog** of TV Accessories. No. TV100  
More than a catalog, it contains installation and servicing data of interest to every Serviceman.  
Also **FREE** for the asking... JFD Catalog of Radio Accessories. No. 438.



**JFD** MANUFACTURING CO., Inc.  
6109 16th Avenue.  
Brooklyn 4, N. Y.  
FIRST IN TELEVISION ANTENNAS AND ACCESSORIES

**Coax Line Installation**

(Continued from page 15)

when strain is placed on the cable by movement of the TV receiver.

In fringe areas where every db must be realized, the best solution for eliminating losses due to distributed inductance is the application of coaxial fittings. These coaxial fittings maintain the concentric character of coaxial cable so that 200-mc losses are negligible.

To assure a more perfect job in fringe installations it may be necessary to remove the manufacturer's connection between the antenna coil and the receiver antenna terminals and replace these terminals with a coaxial receptacle.

One manufacturer of TV antennas has realized the seriousness of coaxial-cable end losses and has designed his antenna so that the cable is connected to the antenna elements by means of a coaxial male and female plug and receptacle assembly. In this case the antenna gain from this array is available without further loss. Also the nearly perfect match at the antenna terminals to the coaxial cable means that any signals reflected back up the cable due to TV receiver mismatch will be absorbed at the antenna end and not be reflected back again to the TV receiver input.

**Coax Splicing**

Coaxial cable is expensive and efficient shops usually splice together 20, 30 and 50-foot sections of leftover coax so that it may be used as required for

Fig. 4. Fittings which are ideal for coax cable since they maintain the concentric character of the cable so that 200 mc losses are negligible. (Courtesy Amphenol)

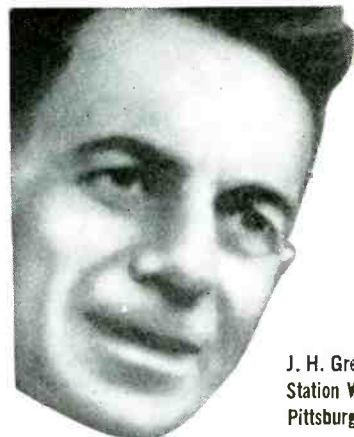
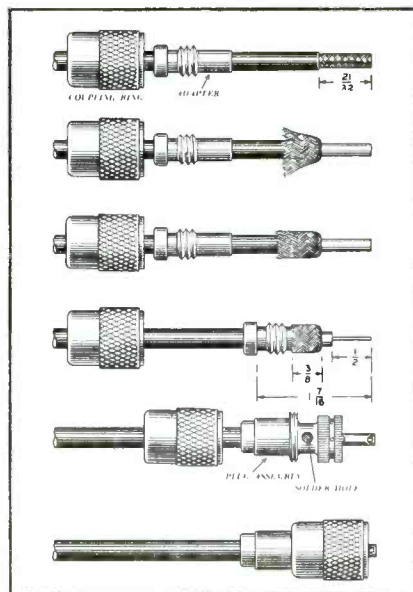

J. H. Greenwood  
Station WCAE  
Pittsburgh, Pa.

**"we consider it the best!"**



**VARIABLE**  
**RELUCTANCE**  
**CARTRIDGE**

**SEE PAGE 11**

**AMPERITE**  
**Studio Microphones**  
**at P.A. Prices**

Ideal for  
**BROADCASTING**  
**RECORDING**  
**PUBLIC ADDRESS**

"The ultimate in microphone quality," says Evan Rushing, sound engineer of the Hotel New Yorker.  
• Shout right into the new Amperite Microphone—or stand 2 feet away—reproduction is always perfect.  
• Not affected by any climatic conditions.  
• Guaranteed to withstand severe "knocking around."

Models  
RBLG—200 ohms  
RBHG—Hi-imp.  
List \$42.00



"Kontak" Mikes  
Model SKH, list \$12.00  
Model KKH, list \$18.00

**Special Offer:** Write for Special Introductory Offer, and 4-page illustrated folder.

**AMPERITE Company, Inc.**  
561 BROADWAY • NEW YORK 12, N. Y.  
Canada: Atlas Radio Corp., Ltd., 560 King St. W., Toronto



new installations. In this way what might be waste material can be utilized and a *hidden cost* removed from overhead.

It has been found that a *through-type* splice, in which the concentric characteristic of the coax is maintained provides the best results. The standard *pare back* splicing of coaxial cable has been found dangerous since it may insert a mismatch in the line and produce serious signal losses and reflections. The steps that should be followed in preparing a *through-splice* are illustrated in Fig. 1. In the first step of this procedure, the outer polyvinyl jacket, coaxial shield, and polyethylene dielectric material is cut in half and *beeled back*. Then the two center conductors are butted together for soldering. A solder gun and rosin core solder are recommended for this operation. By keeping the dielectric material peeled back during this soldering step, the heat is dissipated into the air and not into the dielectric material which softens when heated. In the third step the polyethylene dielectric material is pushed back over the center conductor and a thin double layer of high-frequency tape wrapped over the assembly. The taping begins at the center over the splice to reinforce the connection and the mating of the dielectric materials and tapers to a single layer of tape on both sides of the *through-splice*. In making the shield connection, the shields are pushed back and an overlapping piece of tinned braid or copper foil, which wraps completely around the two mating shields, is soldered in place (using a solder gun and rosin solder) to maintain the concentricity of the outer conductor. In the last step the polyvinyl outer sheaths are pushed back and tightly taped with multi-layers of high-frequency tape so that the splice point becomes as strong as any other section of the coaxial cable.

After experience is gained at making this type of connection it will take a competent Service Man about 15 minutes to make a perfectly good *through-splice*. Splice making can be assigned as a profit-making idle time or rainy-day job.

Using this type of splice there will be no noticeable difference in loss, as measured at 200 mc, between a new cable and a spliced cable. The insertion of a *through-splice* usually adds no more than 1 db of loss to the cable's attenuation characteristic at 200 mc; therefore in non-critical primary signal areas as many as six *through-splices* may be inserted with no more than 6 db additional loss added to the antenna circuit.

[To Be Continued]

# Now... OHMITE Little Devils

## IN 1/2-WATT OR 1-WATT ASSORTMENT

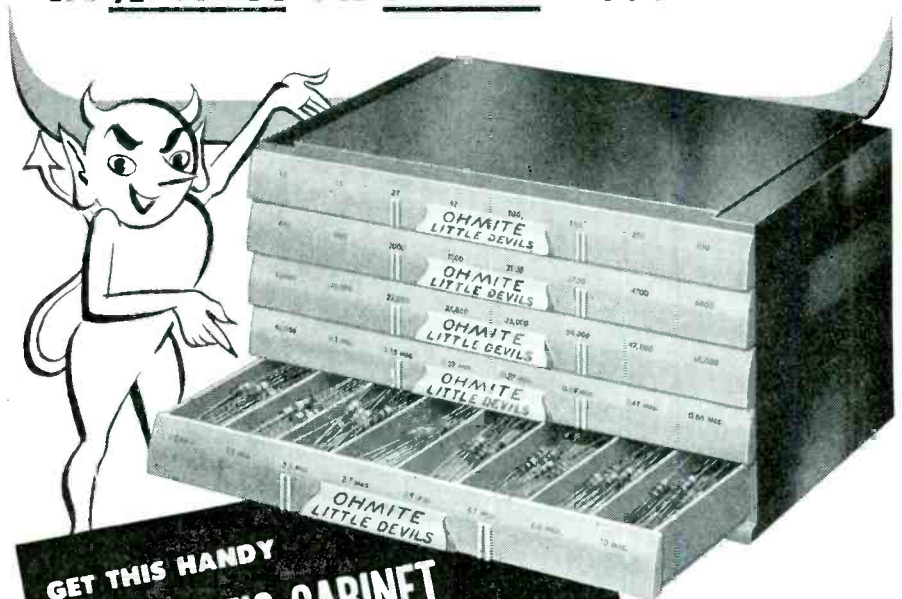

**GET THIS HANDY ALL-PLASTIC CABINET**  
Packed with 125 "Little Devil" Resistors  
—FOR COST OF RESISTORS ALONE!

1/2-WATT ASSORTMENT  
**\$12.50**

1-WATT ASSORTMENT  
**\$18.75**



### LITTLE DEVIL COMPOSITION RESISTORS

Guesswork's gone . . . when you use individually marked Ohmite "Little Devils." These tiny but rugged resistors are available in standard RMA values, 1/2, 1, and 2-watt sizes . . . 10 ohms to 22 megohms. Tol.  $\pm 10\%$  and  $\pm 5\%$ . Values to 2.7 ohms available in 1-watt size,  $\pm 10\%$  tol.

Each assortment, either 1/2-watt or 1-watt, is packed in its own rugged cabinet . . . and you pay only the regular price of the resistors, *nothing extra* for the cabinet!

Factory packed in each cabinet's 40 separate compartments are 125 carefully selected "Little Devils" (tol.  $\pm 10\%$ ) . . . in the 40 values from 10 ohms to 10 megohms most frequently used by servicemen. It's no trouble to find the resistor you need . . . *fast!*

Molded of strong, lustrous plastic, and extremely compact—only 9" x 4 3/4" x 5 1/4"—Ohmite cabinets protect your resistors, too, and help you check inventory at a glance. You'll want to order both assortments, today.

### SEE YOUR DISTRIBUTOR

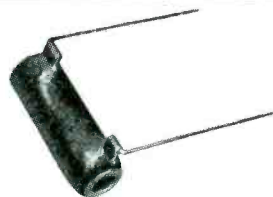

### BROWN DEVIL RESISTORS

A favorite with servicemen, these dependable, wire-wound, vitreous-enameled resistors are easily mounted by their tinned wire leads. Tol.  $\pm 10\%$ . In 5, 10, and 20-watt sizes.

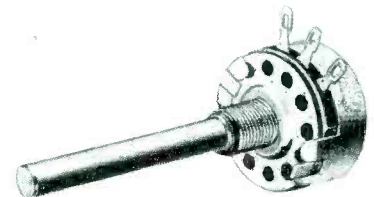

### MOLDED COMPOSITION POTENTIOMETER

Built to last, this Type AB Potentiometer has a heat-treated, solid-molded resistance element—not just a film—and provides unusually quiet operation. It has a 2-watt rating.

**OHMITE MANUFACTURING CO., 4878 FLOURNOY ST., CHICAGO 44**

Be Right with

**OHMITE**

Reg. U. S. Pat. Off.

**RHEOSTATS • RESISTORS • TAP SWITCHES**



**HALF AS LARGE... TWICE AS GOOD!**

**DUAL & TRIPLE  
DANDEES**  
with the **NEW**  
**INSULATED-  
STUD  
TERMINALS**

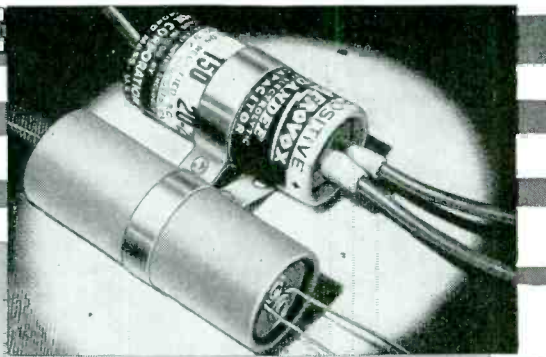

• Smaller — better. That's why the new Aerovox dual and triple midget-can electrolytics are a smash hit with servicemen.

Stud terminals replace usual riveted terminals. Reduce tubular diameter 40%. Advanced electrolytic capacitor art further reduces bulk. Note comparison between usual dual and new Dual Dandee.

To top it all, insulated wire leads in place of bare wires! Also insulating sleeves over stud terminals. No danger of "shorts" even in tight spots.

**GO AEROVOX!**

For faster, easier, more-money servicing, ask your Aerovox jobber for these Dandees. Ask for latest Aerovox catalog—or write us.



**FOR RADIO-ELECTRONIC AND  
INDUSTRIAL APPLICATIONS**

AEROVOX CORPORATION, NEW BEDFORD, MASS., U. S. A.

SALES OFFICES IN ALL PRINCIPAL CITIES • Export: 13 E. 40th St., NEW YORK 16, N. Y.

Cable: 'ARLAB' • In Canada: AEROVOX CANADA LTD., HAMILTON, ONT.

**Philco TV Antenna**

(Continued from page 17)

the peak reading on the voltmeter should come near the correct turn position of the tuning control.

In the event peaking cannot be obtained on channel 6, in early production sets of the smaller Philco table models 1104 and 1105, about 1½" of the aluminum antenna foil should be removed from the right-hand end of the foil, looking at the rear of the cabinet; just cut off the foil with a sharp knife and straight edge. This is the end of the foil nearest the high voltage power supply. The uncut dipole is level with the top of the high voltage cage. There will be a space of 1½" when the dipole has been cut.

If a peak reading cannot be obtained on each channel in the low-frequency band at approximately the correct turn position of the tuning knob, the long section of the loop assembly, to which the 300-ohm line is attached, may be pushed together or bowed out to obtain peaking. The legs of the loop sections can readily be squeezed together or pulled apart to achieve peaking in the correct turn position for each low-band channel from 2 to 6.

If a peak reading cannot be obtained on each channel in the high-frequency television band, the two small loops near the tuning capacitor may be elongated by squeezing the wires together or may be bowed out into more circular shape.

After these adjustments have been made, if it is still not possible to obtain maximum meter readings at the correct positions of the antenna tuning control, it is suggested that the variable capacitor be replaced. Incidentally, this capacitor has a range of from 2 to 30 mmfd.

**Build YOUR OWN Heathkit TEST EQUIPMENT**

**Heathkit AUDIO GEN. KIT \$34.50**

**Heathkit TUBE CHECKER KIT \$29.50**

**Heathkit 5" OSCILLOSCOPE KIT \$39.50**

**Heathkit BATTERY ELIMINATOR KIT \$22.50**

**Heathkit VACUUM TUBE VOLTMETER KIT \$24.50**

**Heathkit R.F. SIGNAL GEN. KIT \$19.50**

**Heathkit ELECTRONIC SWITCH KIT \$34.50**

**Heathkit SIGNAL TRACER KIT \$19.50**

**Heathkit CONDENSER CHECKER KIT \$19.50**

**NEW Heathkit IMPEDANCE BRIDGE SET \$69.50**

**NEW Heathkit HANDITESTER KIT \$13.50**

Heathkits are beautiful factory engineered quality service instruments supplied unassembled. The builder not only saves the assembly labor cost but learns a great deal about the construction and features of the instrument. This knowledge aids materially in the use and maintenance of the equipment. Heathkits are ideal for and used by leading universities and schools throughout the United States. Each kit is complete with cabinet, 110V 60 cycle transformer (except Hand-Tester), all tubes, caps assembled and calibrated, panel already printed, chassis all punched, formed and plated, every part supplied. Each kit is provided with detailed instruction manual for assembly and use. Heathkits provide the perfect solution to the problem of offering complete service equipment on a limited budget. The basic three instruments — an Oscilloscope, Vacuum Tube Voltmeter and Signal Generator can be purchased in Heathkits for \$63.50, about the cost of a factory built VTVM alone. Write for complete catalog.

**HEATH COMPANY**  
BENTON HARBOR, 11 MICHIGAN

EXPORT DEPARTMENT  
13 EAST 40th STREET  
NEW YORK 16, N. Y.  
CABLE — ARLAB — N. Y.

**TV-FM Sweep Generator**

(Continued from page 21)

(3) video if channel; (4) sound channel.

The receiver's oscillator adjustment is the most important adjustment and must be done most carefully. The rf amplifier adjustment can be made by using a local test pattern or using the generator if no pattern is available.

For the adjustment of sound traps, the output of the signal generator should be connected to the mixer grid so that the signal is into the amplifier ahead of all sound traps. Avc action, if any, will not be affected, because an insulating capacitor has been built into the signal generator. It is advisable that, for the alignment of all if channels, video, sound, and traps, the local



oscillator of the receiver should be rendered inoperative to avoid interaction between the local oscillator and the signal generator, which might result in distortion or spurious marker pips on the screen trace. For the alignment of sound traps it is only required to apply a signal of sound trap frequency and to adjust the traps for minimum response with an oscilloscope or sensitive meter connected across the video detector load resistor.

## Servicing Helps

(Continued from page 32)

quency until the desired bandwidth is obtained.

Tuning of the coils and adjustment of the bandwidth is made on each transformer at the factory before the head-end assembly is placed in the receiver chassis. In some post-war G. E. television receivers, the only capacity across the plate and grid windings is the distributed and tube capacities. Each winding is tuned by the distributed and tube capacities existing across it by varying the inductance of each coil by either spreading or squeezing turns. In other G. E. receivers, the model 810 for instance, a small trimmer is used in conjunction with the distributed and stray capacities to facilitate alignment and to compensate for differences in tube capacities when changing tubes.

In most post-war G. E. TV receivers a separate transformer is used for each of the twelve television channels. As the receiver is switched from channel to channel, a new primary and a new secondary winding, pretuned at the factory with the proper degree of coupling for the particular channel, is connected in the circuit. The ground connection of the transformers remain fixed.

It should be noted that these transformers between the plate of the *rf* amplifier and the converter grid provide a considerable amount of the necessary selectivity for good image rejection and adjacent channel attenuation. Since the tuned circuits for each channel are pretuned at the factory, no tuning of the *rf* circuits is required by the operator. The operator merely switches in the correct transformer for the desired channel. The only tuning done is in the local oscillator circuit.

## Sweep Generator Hints

(Continued from page 37)

by adjustment of the sweep generator's tuning dial. When the pip finally occupies the whole width of the 'scope trace, the tuning dial of the sweep generator is accurately set to the same frequency as the marker pip.

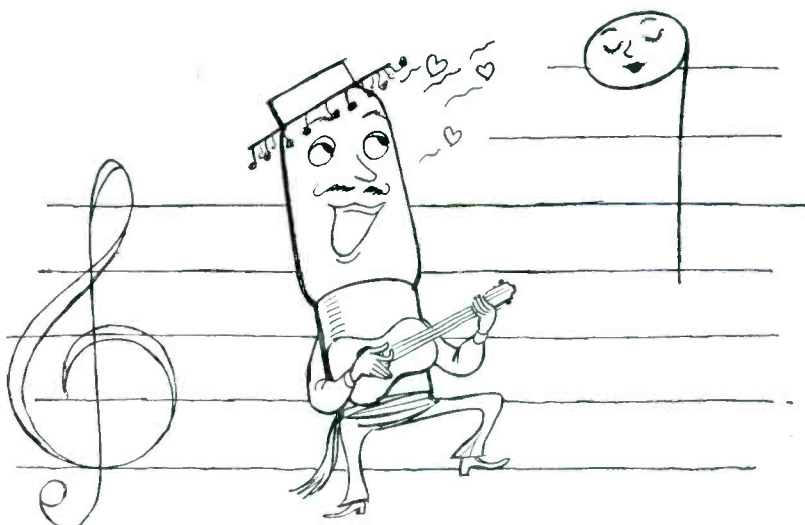

# The little lamp that learned to love "high C"

**A** SOPRANO'S "high C" can be just too much for many dial lamps. Severe vibrations caused by such high notes are often sufficient to tear an old-style lamp filament apart. General Electric engineers found a simple way to minimize this cause of early lamp failure. By making the filament supports longer and moving the bead closer to the coil, they greatly reduced the effects

of vibration.

That's why G-E dial lamps have actually learned to like "high C"... and to give long life in spite of the continuous vibration.

For information on prices and types of G-E miniature lamps, call your nearby G-E Lamp office. Or write to General Electric Company, Div. 166-S9, Nela Park, Cleveland 12, Ohio.

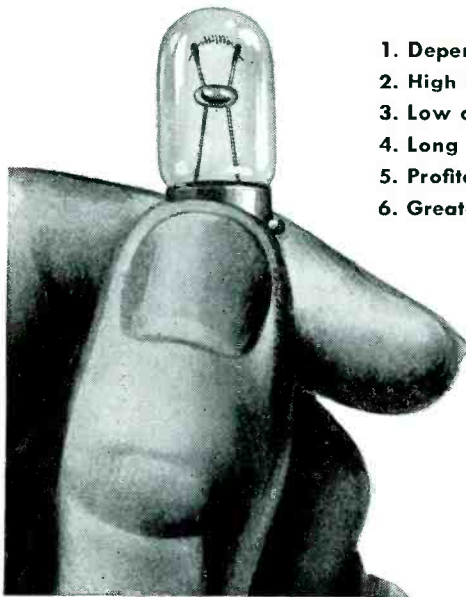

1. Dependable, trouble-free performance.
2. High level of maintained light output.
3. Low current consumption.
4. Long life.
5. Profitable to handle.
6. Greater dealer acceptance.



You can put your confidence in—

**GENERAL  ELECTRIC**



Patent Pending

**New!**  
**MODEL "B"**  
**DC POWER SUPPLY**

**HIGHEST EFFICIENCY KNOWN**  
**in the 3 to 9 Volt Range**

**New, Exclusive Design Increases Power 1½ Times** . . . yet costs no more than the conventional type. Completely different application of selenium rectifiers, aided by conduction cooling, dissipates over 3 times the heat. The Electro Model "B" has proved itself the most efficient direct current source of power known. Gives instant readings, and offers ample power to operate any receiver. Peak instantaneous current rating of 35 amperes (from 50 to 60 cycle 115 volt power source), permits operation of two receivers with push button solenoids. **Applications:** Test or operate auto radios, relays, telephone circuits, laboratory instruments and many other low voltage requirements.

**EXCLUSIVE FEATURES**

- ★ Heavy-duty selenium rectifiers
- ★ 8 Heavy-duty power tap adjustments
- ★ 1 to 20 amperes at 6 volts continuous duty
- ★ Less than 3% AC ripple or hum
- ★ Damped volt and ammeters (no wiggling) Voltmeter 3% accuracy
- ★ Heavy-duty transformer and choke
- ★ 6000 Mfd. filter condenser

**UNMATCHED PERFORMANCE, QUALITY AND PRICE!**

Send for Details **TODAY!**



Pioneer Manufacturers

of Battery Eliminators

**ELECTRO PRODUCTS LABORATORIES, INC.**  
549 WEST RANDOLPH STREET • CHICAGO 6, ILLINOIS

**TV Servicing**

(Continued from page 29)

was pulled from the cabinet and checked on the bench.

Waveforms were observed in the *agc* circuit and at pin 1 of the 6AT6 the waveform was correct as far as waveshape was concerned. However, the amplitude was measured and instead of being 2 volts peak-to-peak it was only .2 volt. Measurements were then taken back in the horizontal oscillator circuit where this signal originates.

At the plate of the 6K6GTG horizontal oscillator, the waveform was correct in shape but only 20 volts instead of a normal 200. A similar check at the grid revealed a signal whose amplitude was 10 volts instead of 100 volts.

Voltage readings were then taken and the screen grid of the 6AL5 sync discriminator was found to be 20 volts instead of 225 volts. The actual cause of this trouble was that the 10,000-ohm resistor, R<sub>300</sub>, had increased in value to several megohms.

This trouble would have caused many to check other circuits, but the calibrator used for determining the amplitude of the signal under observation, pin-pointed the trouble.

A recent case history illustrated quite effectively the importance of observing all indications of troubles, as outlined in step 1.

A receiver was brought into the shop with the complaint that the vertical sync would not hold. A thorough investigation of the vertical sync circuits disclosed no faulty components. At this stage, the Service Man was ready to give up. He called in another Service Man and disclosed all the details to him.

This man noted the indications very carefully and noticed that when the vertical frequency control was very carefully adjusted, the picture would stop rolling, but the vertical retrace lines were still present. Readjustment of the brightness and contrast controls would not eliminate these lines without detrimentally affecting the background illumination of the picture.

After discussing this symptom, it was decided that perhaps the low-frequency response of some part of the receiver was at fault. This possibility was suggested, since it was apparent that the vertical blanking was not functioning properly.

The next step was to observe the video waveform at the output of the video amplifier. The waveform observed indicated poor low frequency



O. E. Vanerstrom  
Station KBRC  
Mt. Vernon,  
Wash.

**"The finest instrument of its kind"**



**VARIABLE RELUCTANCE CARTRIDGE**

**SEE PAGE 11**



• BUILDERS OF QUALITY RADIO INDUCTANCES SINCE 1924 •  
**THE SENSATIONAL NEW MILLER BAND-PASS TRF TUNER USING A GERMANIUM DIODE DETECTOR**



- HIGH FIDELITY**
- NO TUBES!
  - NO POWER SUPPLY! • NO HUM!
- A SIMPLE 2 TUNED CIRCUIT NEGATIVE MUTUAL COUPLED BAND PASS TUNER
- EASY TO ASSEMBLE & WIRE!

In spite of its simplicity, low cost; #585 kit is not a toy; — it is a carefully designed High Fidelity Broadcast band tuner. Use it with your amplifier and speaker system for truly high quality reception. The audio output of the tuner is proportional to the input signal and will vary from .05V to .5V for stations within a 20-25 mile radius when used with a good antenna of from 75 to 100 feet in length. A good antenna is absolutely essential to the proper operation of the #585 tuner. The net price of the Miller #585 TRF tuner kit, including chassis, dial, and tuning condenser, is only \$11.40. The additional parts required make it possible to build the complete tuner at a net cost of less than \$15.00. Order yours now — ask for the new MILLER — Cat. No. 585 Crystal Detector Tuner — Net \$11.40



SEE YOUR LOCAL RADIO PARTS SUPPLIER FOR THE MILLER #585 KIT AND OTHER MILLER PRODUCTS

**J. W. MILLER COMPANY**  
5917 S. MAIN ST. LOS ANGELES, CALIF.



response, since the vertical blanking interval was not properly reproduced.

The video signal was next observed at the grid of the video amplifier and the waveform at that point was normal. Since this indicated trouble in the video amplifier stage, those components that affect the low frequency response were investigated and it was found that the 10-mfd screen bypass was open.

If the Service Man had noticed the presence of the retrace lines when he first observed the symptoms, he might have located the difficulty without any outside help.

This practice of observing all indications very carefully cannot be overemphasized.

### Recording of Troubles

One practice that is followed by some shops and which is recommended for general use, is the recording of various troubles encountered in specific receivers. For example, a chart could be made up to cover all troubles found in a particular model receiver. This chart could include several headings: *Indications, Defective Section, Defective Part, Frequency of Occurrence.*

Under indications would be included all noted symptoms.

Under frequency of occurrence, each time the same defect occurs, a figure with the date should be included.

Information of this type is a definite help to a new man providing rapid location of the trouble.

The subject of television receiver trouble-shooting cannot be adequately covered in less than a volume. However, it is hoped that the information presented will prove of some value in providing trouble-shooting abilities.

## Tube News

(Continued from page 34)

small capacitance is used since the modulating signal is usually a pulse having a steep wave front. Large values of capacitance for this capacitor may require better filtering of the high-voltage supply for the *crt* in view of the fact that the grid-No. 1 signal is referred to ground. The capacitor must have low leakage and must be able to withstand the anode-No. 2 voltage. The purpose of the series grid-No. 1 resistor,  $R_{10}$ , providing not less than 2,000 ohms per volt of signal voltage, is to keep the grid-No. 1 drive within the maximum positive rating, because the grid-No. 1 current of the *crt* increases rapidly above zero grid-No. 1 bias and sets up a counter voltage, the value of which is in proportion to the value of the grid-No. 1 current. (Continued on page 48)

# for TV Transformers

## insist on CHICAGO

### exact replacements!

**Available NOW — To Fit Today's Leading Television Circuits**

You'll save time, save trouble, and save money in Television servicing by using components that *exactly* fit the circuits and the chassis. For TV transformers, insist on the CHICAGO line—made by the foremost suppliers of original equipment transformers to the Television industry. The four units described below are representative of the complete CHICAGO TV Transformer line—offering exact replacement equipment to fit today's leading Television receivers.

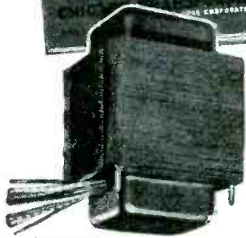

TP-365

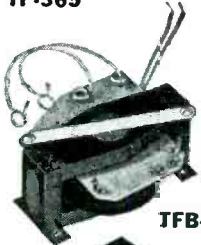

TFB-1



TSO-1

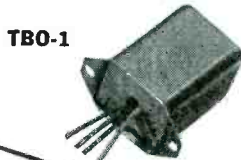

TBO-1

**TV Power Transformer No. TP-365.** Designed to supply 405 volts d-c with two 5U4G's to an 80 mfd condenser input. Copper shorting band around core reduces external magnetic field; cuts image distortion to a minimum.

Pri.: 115 v., 60 cycles      Fil. No. 1: 12.6 v., 5 amps, C-T  
H.V. Sec.: 362-0-352 v., a-c,      Fil. No. 2: 5 v., 2 amps  
                                                .295 amps d-c      Fil. No. 3: 5 v., 6 amps

Exact equivalent to R. C. A. Type No. 201T6. List Price, \$17.50

**Horizontal Scanning Output Transformer No. TFB-1.** Couples horizontal output circuits to horizontal deflection yoke. Provides high pulse voltage which, when rectified, supplies anode of picture tube. Also has rectifier filament winding.

Exact equivalent to R. C. A. Type No. 211T1. List Price, \$5.60

**Vertical Scanning Output Transformer No. TSO-1.** Couples vertical output tubes to picture tube deflection yoke.

Pri. Impedance: 19,000 ohms at 30 v., 60 cycles, 13 ma d-c  
Ratio, Primary to Secondary: 10 to 1

Exact equivalent to R. C. A. Type No. 204T2. List Price, \$4.15

**Vertical Blocking Oscillator Transformer No. TBO-1.** 60-cycle unit for creating the vertical sweep "saw-tooth" voltages required in conventional circuits.

Pri. Inductance: 1.15 hy  $\pm 20\%$  at 3 v., 1000 cycles  
Pri. Leakage Inductance: 8 mh  $\pm 25\%$ , -15%

Ratio, Primary to Secondary: 1 to 4.2  
Exact equivalent to R. C. A. Type No. 208T2. List Price, \$1.90

**See your Jobber for CHICAGO TV Transformers. GET CHICAGO'S COMPLETE TV TRANSFORMER CATALOG. Ask your jobber for it, or write us direct.**



# CHICAGO TRANSFORMER

DIVISION OF ESSEX WIRE CORPORATION

3501 ADDISON STREET • CHICAGO 18, ILLINOIS

# Cannon Plug

## FOR PUBLIC ADDRESS SYSTEMS



MICROPHONES

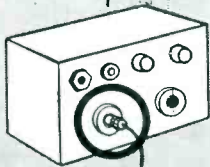

AMPLIFIERS

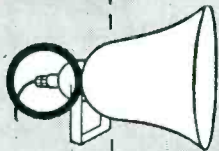

LOUD SPEAKERS

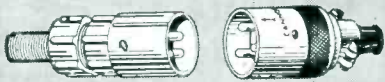

"XL" SERIES

"P" SERIES



"O" SERIES

Available at jobbers everywhere or write  
PA Plug Catalog. Address Dept. 1-268.

SINCE 1915

# CANNON ELECTRIC

*Development Company*

3209 HUMBOLDT ST., LOS ANGELES 31, CALIF.  
In Canada — CANNON ELECTRIC CO., LTD., TORONTO

(Continued from page 47)

portion to the magnitude of the grid-No. 1 current.

In this circuit, one side of the heater is connected directly to the cathode to prevent transformer or circuit leakage from developing any voltage between heater and cathode. A bypass capacitor of about 4 mfd may be used between the arm of the .35-megohm grid-No. 1-bias potentiometer and cathode in case hum is present in the grid-No. 1 circuit.

The power supply for the amplifiers and the sweep (timing) oscillator is combined with that for the 3RP1. This arrangement provides additional current for the centering potentiometers and makes possible the use of a supply having lower voltage and lower current than would be required with separate power supplies.

### Auto Radio Aids

(Continued from page 40)

noise suppressor and noise filter capacitor units should be checked. To eliminate wheel static about one-half ounce of powdered graphite should be inserted through the valve of all four tire tubes. This will provide a ground leakage path to efficiently dampen static radiation.

### Association News

(Continued from page 41)

themselves with ART of Western Canada.

Officers of the association are: Wilfred Munton, chairman; and J. R. Baird, secretary-treasurer. They were reelected at the meeting by acclamation to serve a second term. Delegates to the convention included: Eric Young, Victoria, B. C.; Sam Beyer, Vancouver, B. C.; Norman MacMillan, Calgary, Alberta; Fred Reid, Saskatoon, Saskatchewan; Alf Reimer, Steinback, Manitoba; Al Johnston and Bill Davis, Winnipeg, Manitoba. Bill Winter, president of Radio Electronic Technicians Association, Ontario, sat with the delegates at the conference table. While not an official delegate from Ontario, he presented the views of the Service Men from that province which proved to be of considerable value as plans were laid to include them in the association in the near future.

At the meeting it was decided that effective this fall, the association will be known as the Radio Electronic Technicians Association.

Groups wishing to affiliate with the association should direct their inquiries



W. E. MOATS  
Station WCCP  
Savannah, Ga.

**"The greatest  
advance in  
record-playing.."**



**SEE PAGE 11**

**FREE! Send for it NOW!**

**ALLIED'S NEW  
1950 CATALOG!**

**196 PAGES—  
Everything in  
Radio and  
Electronics**



**GET RADIO'S  
LEADING BUYING GUIDE**

Service Technicians and Engineers: ALLIED'S 1950 Buying Guide brings you all the new releases and money-saving values—from the world's largest stocks of test instruments, amplifiers, P.A. systems and equipment, tubes, parts, tools, books and accessories—ready for instant expert shipment. Send today for your FREE new 196-page ALLIED Catalog.

ALLIED RADIO CORP., DEPT. 24-J-9  
833 W. Jackson Blvd., Chicago 7, Ill.

Send FREE New ALLIED Catalog.

**FREE**

Name.....

Address.....

**ALLIED RADIO**



to J. R. Baird, 918 Rogers Bldg., Vancouver, B. C.

**TEN YEARS AGO**

*From the Association News Page of SERVICE, September, 1939*

BERTRAM L. LEWIS, correspondent for the Radio Technician's Guild of Rochester, reported that the boys visited the 50-kw transmitter of WHAM at Victor, New York. Al Bolling, operator of the station, conducted the tour for the members of the group. . . . Scholes of G. E. addressed a meeting of the association group of Oakland, California, on the Treasure Island shortwave station. At a subsequent meeting Homer Eldridge and Cliff Fox were elected to the executive board. William Appleton, secretary of the association, reported that the annual picnic at Tilden Park was very successful. . . . Robert Thompson of Meissner, addressed a meeting of the Chicago chapter of the RSA and discussed and demonstrated a television kit. At subsequent meetings in September, Leon Podolsky of Sprague Products appeared, and RCA sponsored John F. Rider, who spoke on test equipment. . . . At a meeting of the Ohio Valley Chapter, members voted to join in on the television course offered by RSA.

**ERIE RESISTOR CARTON FOR DISTRIBUTOR ITEMS**

A single carton, designed in a size which will package a convenient number of any given item, and containing cellophane envelopes holding the smaller items, and individual boxes for the larger item, has been announced by the Erie Resistor Corp.

Contents in this streamlined carton will be identified on the end of the carton as well as on the envelopes and individual containers.

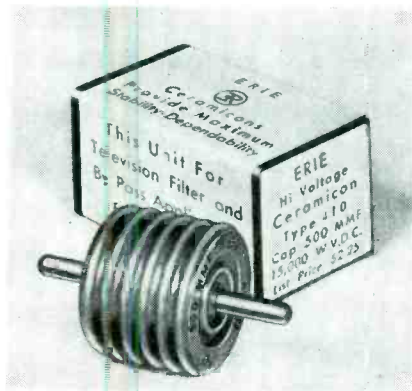

**NOW DU MONT OFFERS THE TYPE 274-A**

**CATHODE-RAY OSCILLOGRAPH FOR**

**RADIO and TELEVISION Servicing**



**AT REDUCED COST**  
Remember . . .

**DOUBLED BAND WIDTH**  
**TRIPLE SENSITIVITY**

★ Some time ago Du Mont announced a new oscilloscope — Type 274-A — featuring several notable improvements over Type 274. Since then the 274-A's popularity has been unparalleled by any other low-priced oscilloscope in the fields of radio and television servicing. Here's why:

The 274-A has an improved vertical amplifier with a sensitivity better than 0.2 rms volts/in., and a range (within 30%) of 20 cps to 100 kc in frequency response.

In your servicing of both radio and television receivers, you can look at more parts of more circuits with still

greater accuracy and therefore better results. For example, you can see lower level signals and you can handle more sections of the detector and i-f circuits. You can minimize "hum" troubles more easily, and you can do a better job on sync circuits as well as on other circuits in TV sets.

All in all, with the 274-A you can't miss doing an all-around, bang-up, more satisfactory and therefore more profitable job. You enjoy all the benefits of the big 5-inch cathode-ray tube (either medium-persistence Type 5BP1-A or short-persistence Type 5BP11-A).

Cat. No. 1420-A with 5BP1-A tube . . . . . \$124.50

Cat. No. 1422-A with 5BP11-A tube . . . . . \$124.50



**INSTRUMENT DIVISION • 1000 MAIN AVE., CLIFTON, N. J.**

SERVICE, SEPTEMBER, 1949 • 49

# TELEVISION SCOPE

## SUPERIORITY AT A GLANCE!

The vertical response of this economy TV scope is usable to 5000 kc, not 50 kc. Response is flat to 750 kc, down 3 db at 1000 kc. Amplifier supplies a voltage gain of 20 at 5000 kc.



AR-3

Check this necessary feature before you buy any scope for TV use.

The R.S.E., AR-3 Scope has been built by Ross Armstrong to our rigid specifications. It's a complete unit that embodies standard horizontal amplifier and sweep circuits with normal sensitivity.

The case is 8" high x 5" wide x 14" long, attractively finished in "hammered" opalescent blue enamel. Operates on standard 110 volts—60 cycles—40 watts. Tubes, 3BP1-6AC7-6SJ7-6X5-5Y3-884. Instructions included.

Complete specifications upon request. Satisfaction or your money back.

PRICE  
**\$4995**

AVAILABLE TO JOBBERS  
IN QUANTITY

F. O. B.  
DETROIT

## CRYSTALS

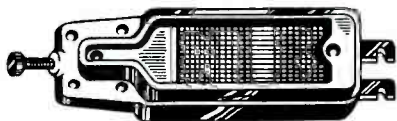

UP TO 77% OFF

Your choice of:  
ASTATIC L72 Hi Output  
SHURE P30 Lever Type  
All Less Needle  
BUY AN ASSORTMENT

**\$149**  
EACH  
NO LIMIT

**A  
SPEAKER  
STEAL!**



5" 450 ohm  
DYNAMICS

Perfect—clean—  
Where else but  
at RSE?

Limit of 5 to  
customer

**99¢**  
EACH

## ORDER INSTRUCTIONS



Minimum order—\$2.00. 25% deposit with order required for all C.O.D. shipments. Be sure to include sufficient postage—excess will be refunded. Orders received without postage will be shipped express collect. All prices F.O.B. Detroit.

Quantity and Export  
Orders Solicited

**RADIO SUPPLY & ENGINEERING CO., Inc.**  
86 SELDEN AVE. DETROIT 1, MICH.



## TV TECHNICIANS LECTURE BUREAU FORMED

A Television Technicians Lecture Bureau, which will sponsor a nationwide program of non-commercial lectures for radio and television Service Men, has been announced by Paul H. Wendel, 55 E. Washington St., Chicago.

The bureau's lecture staff will be headed by Walter R. Jones, associate professor of electrical engineering and research coordinator for the school of electrical engineering of Cornell University, and A. C. W. Saunders, director of the Saunders Radio and Electronics School, of Boston.

The first five lectures, which will be given at thirty intervals in cities throughout the nation, will cover practical applications of test equipment in AM, FM, sound and television servicing; TV antennas and the installation of television receivers; replacement parts and components in AM, FM, sound and TV servicing; practical servicing of today's TV receivers and setting up, financing and managing an independent radio and TV service business.

Service Men attending the lectures will receive a lecture notebook that will contain a synopsis of the highlights of the talks, together with space for the technician's own notes. An admission fee will be charged at each lecture, Wendel said, so that the lectures can be maintained on a totally impartial and unbiased basis, and to provide for visual aids and demonstration devices as well as to employ the best available lecturing talent.

\* \* \*

## ELECTRONICS ENGINEERING INDEX

The Electronics Engineering Master Index for 1947 and 1948, and the index for January-June 1949, have been scheduled for publication in November, 1949, by the Electronics Research Publishing Co., Inc., 480 Canal St., New York 13, N. Y.

Contents will cross reference published technical papers and related U. S. patents allowed during the period covered by the volume. Index will also contain a list of technical articles available from sources other than regularly published publications.

\* \* \*

## WELLER SOLDERING GUN CATALOG

A catalog covering soldering guns has been released by Weller Manufacturing Company, 808 Packer Street, Easton, Penna.

\* \* \*

## BLAKE NOW RADIART BOARD CHAIRMAN

Octave Blake, president of Cornell-Dubilier Electric Corporation, has been elected chairman of the board of Radiart Corporation of Cleveland, Ohio, a wholly owned subsidiary of Cornell-Dubilier. L. K. Wildberg, formerly vice president and general manager, has been advanced to the post of president of Radiart.

## FIELD TESTED Installation Information on



**TV  
and  
FM**

## RECEIVING ANTENNAS

TV... FM Antenna Installation

by Ira Kamen

Manager, Antenplex and TV Dept.  
Commercial Radio Sound Corp.

and Lewis Winner

Editorial Director,  
Bryan Davis Pub. Co., Inc.;  
Editor, Service and Communications

The only practical book on the all-important item in TV and FM reception... based entirely on actual experiences in the most active TV and FM areas in the country.

Over 35,000 words of vital data with over 130 photos and drawings.

Ten chapters covering:

Installation Tools  
Antenna Installation Procedures  
Securing 12-Channel Coverage  
HF Antenna Installations  
TV Interference  
Fringe Reception  
Master Antenna Systems  
FM Antennas  
Installation Business Practices  
Tricks of the Trade

The first book in which you'll find complete design and installation information on every type of TV and FM receiving antenna.

Contains detailed illustration and subject index for rapid reference.

Available direct or through your distributor **\$2.00**  
Postpaid

Send coupon below to your distributor or direct to:

Bryan Davis Publishing Co., Inc.  
(Book Dept.)  
52 Vanderbilt Avenue, N.Y. 17, N.Y.

Please send me a copy of "TV-FM Antenna Installation," postpaid, for which I am enclosing \$2.00.

(Please Print)

NAME .....

ADDRESS .....

CITY AND STATE .....



## E-V BULLETINS

A series of bulletins describing microphones, stands, phono cartridges and pickups, have been released by Electro-Voice, Inc., Buchanan, Mich.

One bulletin, a 4-page unit, No. 104, includes information and list prices on the E-V line of microphones and stands for all types of applications; broadcast dynamics, cardioid dynamic and crystal microphones, general-purpose dynamic and crystal, velocity microphones, dynamic and carbon mobil-mikes, desk stands and floor stands.

Another bulletin No. 150, describes a *break-in* touch-to-talk stand. Stand is said to fit any microphone with standard 5/8"-27 thread. Unit is available three ways: complete with switch and base, or switch only, or complete with switch, base and microphone.

Mercury model 911 crystal and model 611 dynamic microphones, are covered in another bulletin, No. 154.

Three bulletins have become available on phono cartridges and pickups: bulletin No. 153, with data on twist torque drive phono cartridges which plays 33 1/3, 45, and 78 rpm records with a single twin-tip replaceable needle; bulletin No. 152, with details on the E-V series 2200 (RCA type 45) phono pickup for manual operation with 45 rpm and 33 1/3 rpm 7" records; bulletin No. 151, with information on the E-V series 2000 and series 2100 phono pickups for 33 1/3, 45 and 78 rpm records.

\* \* \*

### OLSON NATIONWIDE SERVICE ADS

A national advertising campaign urging set owners to have their sets repaired at local service stores was initiated recently by the Olson Radio Warehouse, Akron, Ohio. Ads are being placed in monthly and weekly consumer magazines, reaching an estimated 86 million readers.

\* \* \*

### MALLORY VIBRATOR GUIDE

A 40-page *Vibrator Guide* which contains approximately 230 more listings than a previous edition, has been announced by P. R. Mallory & Co., Inc., 3029 E. Washington St., Indianapolis 6, Ind.

Guide features an alphabetical listing of receivers and vibrator power supplies, showing name of receiver, year and model number, and part number of the correct Mallory component for replacement; installation notes; buffer capacitor reference circuits; how to build and use a practical vibrator tester; auto radio service notes cross-reference by vibrator type and application; cross-reference by original equipment part number; cross-reference by vibrator manufacturer replacement part number; Mallory vibrator listings, specifications and base diagrams; Mallory auto radio capacitors and radio frequency choke coil specifications.

Available to the trade at 15c per copy.

\* \* \*

### MURRAY MENTZER DEAD

Murray Mentzer, president and co-founder of Precision Apparatus Co., Elmhurst, L. I., N. Y., died recently.

Precision was organized by Mr. Mentzer and Sol Weingast in 1933, after years of activity in the Service field and specialization in the modernization of old test equipment.

Surviving are his wife and son who will retain his interest at Precision. No change in management or policy is planned.

\* \* \*

## NOW Astatic Research AIDS TELEVISION PROGRESS WITH THE

# Channel Chief

## MODEL AT-1

# TELEVISION BOOSTER



LIST PRICE  
**\$49<sup>50</sup>**

**New Astatic Booster Has Gain Equivalent to Two Ordinary Boosters**

**... Covers All 12 Channels with**

**Very Uniform Gain ... Eliminates Sacrifice**

**of Good Sound for Good Picture, or Vice Versa, with Dual-Tuning.**

### ADDITIONAL IMPORTANT FEATURES

1. Self-contained power supply operating from 115 volt, 60 cycle AC power line.
2. On-off switch allows booster to be switched in or out of the circuit at will.
3. Recessed pilot light indicates when booster is on.
4. Beautiful, furniture-finish mahogany cabinet (8 1/2" wide x 6 1/2" high x 7 3/4" deep) to complement fine home furnishings.
5. Simple to install and operate—complete instructions with each unit.

**A**STATIC RESEARCH—which has led the march of progress in various sound reproduction fields since the company first pioneered in crystal microphones, phonograph pickups, cartridges, parts and accessories—now brings major new advantages in reception and tuning to the television field. The new Astatic device which makes it all possible is the Channel Chief, Model AT-1, a radically improved type of television booster. The common failing of many boosters—showing a "peak" on some channels and "fall-off" on others—has been eliminated. The Channel Chief provides extremely high gain—equivalent of two conventional boosters—uniform on all 12 television channels. Its dual controls allow separate tuning of picture and sound, with no sacrifice of one for the other. Or, if one signal is weak and the other adequate, both controls may be adjusted to the weaker to bring it in strong. A variable gain control permits reduction of signal strength to prevent picture distortion when the signal input is greater than that required for good definition. Altogether, the results are the considerable extension of fringe areas, good reception in areas previously rated as unsatisfactory, easier tuning and added selectivity on any receiver, elimination of the need for expensive outdoor antennas within service areas. The increased selectivity serves to reduce drastically, or eliminate, interference from adjacent channels, amateur and commercial fundamentals and harmonics in the receiver's I.F. range, FM stations and oscillators of nearby FM, TV and short wave receivers. No other booster can do so much... for your installation and service business, for the television receiver owner. Write for added details.



### RADEL APPOINTED AIRCO TELEVISION CO. GENERAL MANAGER

Herman T. Radel has been named general manager of Airco Television Co., Inc., Fifth and Luzerne Sts., Philadelphia 40, Pa. Radel was formerly area field service inspector for Motorola Philadelphia Co., and for 18 years was in charge of radio and electronics service for Trilling & Montague.

\* \* \*

### BOES IN REP BUSINESS

W. W. Boes, 120 W. Second Street, Dayton 2, Ohio, has entered the rep business and announced that he will be able to serve industrial, measuring and component parts manufacturers.

### L. M. HERSHEY JOINS G-I

Lloyd M. Hershey has become director of research for General Instrument Corp., Elizabeth, N. J.

Hershey previously was assistant to the chief engineer at the Hallicrafters Company and prior to that was in charge of development research for Hazeltine.

\* \* \*

### THORDARSON CATALOG

A 24-page catalog, No. 400H, has been released by the Thordarson Electric Mfg. Div. of Maguire Industries, Inc., 500 W. Huron St., Chicago 10, Ill.

Listed are audio transformers, auto transformers, chokes, *cut* transformers, isolation transformers, TV power transformers, expansion feed back control transformers, etc.



# CLICK!

★ For quick, correct, profitable control replacements, use **Pick-A-Shaft Clarostats.**

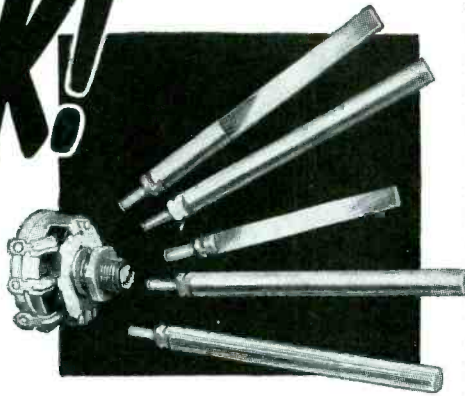

## THE RIGHT CONTROL & THE RIGHT SHAFT EVERYTIME!

Select the right control electrically — ohmage, taper, tap, etc. Then select the right shaft mechanically — ten types to choose from. Aluminum shafts for ready cutting to exact

length. Insert shaft in slot and bang it — CLICK! You've got a trouble-free job — no wiggle, no wobble, no trouble. A free shaft with each Pick-A-Shaft Control.

Ask our jobber for Pick-A-Shaft Clarostat controls. You'll like them. Catalog on request.



CLAROSTAT



*Controls and Resistors*

CLAROSTAT MFG. CO., INC. • DOVER, NEW HAMPSHIRE • In Canada: CANADIAN MARCONI CO., LTD. Montreal, P. Q. and branches

## SYLVANIA ELECTRIC NATIONAL SERVICE MAN PROMOTION

A series of national advertisements promoting the Service Man, has been scheduled by the radio division of Sylvania. The campaign, which will run from September to December, will be supplemented by new point of sale merchandising material supplied to service-dealers in kit form.

The national advertisements have been designed to attract set owners through cartoon type illustration and text directing them to their local radio Service Man.

Point of sale merchandising material was designed and produced under the direction of Terry P. Cunningham, director of advertising for Sylvania. It includes three-color direct-mail pieces, window displays, decals, window posters and mats for local newspaper use. With the exception of government postal cards the material is supplied gratis to Sylvania authorized dealers.

\* \* \*

## C-D CAPACITOR KIT CABINET

A three-drawer metal cabinet, which includes an assortment of twenty different capacitors, has been announced by Cornell-Dubilier Electric Corp., South Plainfield, New Jersey.

Drawers not only have compartments for the twenty different types of capacitors but for additional stock as well.



\* \* \*

## RAYTHEON TUBE DATA

A comprehensive summary of almost 200 Raytheon special purpose and power tubes with their essential characteristics, classified and indexed for easy reference, has been published by the Radio Receiving Tube Division, Raytheon Manufacturing Company, 55 Chapel Street, Newton 58, Mass.

Nearly 50 subminiatures with their complete technical data are listed together in chart form.

\* \* \*

## J. W. HEAD HONORED

J. W. Head, president and founder of Electronics Institute, Inc., of Detroit, recently received an honorary LLD degree from Piedmont College, Demorest, Georgia.

The degree was conferred for distinguished service as an educator, engineer, and practical scientist.

Head also directs the activities of Industrial Electronics, Inc., a professional consultant organization.

\* \* \*

## TACO TV ANTENNA PERFORMANCE DATA

A TV antenna catalog, No. 30, has been published by Technical Appliance Corporation, Sherburne, N. Y.

Performance curves as well as field patterns, compiled on the various Taco antenna types, have been included in the brochure.



FLOYD HALL  
Station KOCS  
Ontario, Calif.

**"Out-performs  
all other  
systems..."**



**VARIABLE  
RELUCTANCE  
CARTRIDGE**

**SEE PAGE 11**

## TELEVISION MARKER

MODEL  
TV 50

Net Price  
**\$49.95**

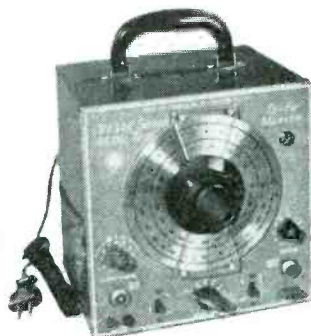

Designed for use in marking television sweep generators. The large planetary driven dial is calibrated to an accuracy of 1%. Uses 4 frequency bands covering frequency of 5 to 130 mc and 96 mc to 260 mc. A self contained crystal oscillator circuit is available for simultaneous marking or may be used alone with the variable frequency marker turned off. Due to the type of oscillator, any crystal from 100 KC up may be used in the crystal socket. An internal mixing arrangement is provided so that the output of a sweep generator may be connected to the TV 50 and the output lead will carry both the sweep frequency and the marker frequency. Buy it from your jobber.

**RADIO CITY PRODUCTS CO., INC.**

152 West 25th Street,  New York 1, N. Y.



## New TV Parts . . . Accessories

### TACO YAGI TV ANTENNA

A TV yagi hf antenna, type 957, has been announced by Technical Appliance Corporation, Sherburne, N. Y.

Antenna is said to be ideal for use with a rotator. Stacked arrays of antenna are also available.

Antenna is factory preassembled. Supplied peaked for channels 7, 8 and 9; 9, 10 and 11; and 11, 12 and 13.

Bulletin 53 contains full technical information, including performance curves.

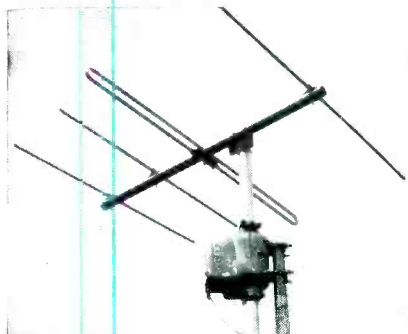

\* \* \*

### DIELECTRIC DUOBAND ANTENNAS

Duoband dipole antennas with reflectors, type DPC, have been announced by The Dielectric Products Company, Inc., Jersey City, New Jersey. Antennas feature a duo-antenna head which is said to permit the antenna to be used as a folded dipole. As such, the high frequency pickup is 30 to 50 degrees off the front. Antenna can be used as a V. Made completely of aluminum. Models D 72 and D 300 for impedance of 72 and 300 ohms. Front-to-back ratio said to be 5 to 1 on all channels.

Also available are a Duoband antenna with the adjustable high frequency unit (models DA 72 and DA 300), a two-stack array (models DD 72 and DD 300) with a reported voltage gain on the low channels of 1.8 to 1 and 2.4 to 1 on the high channels, and a four stack array (model 4 D 72 and 4 D 300) of four model D antennas stacked at 34 inches.

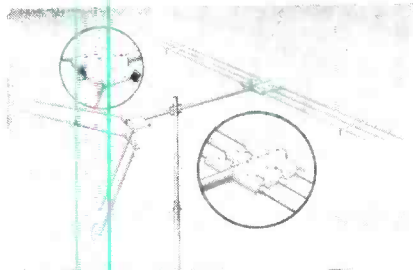

\* \* \*

### CROWN ANTENNA ROTATOR

An antenna rotator featuring a dial compass indicator, reversible motor, 30-watt input power, and a weight capacity of 175 pounds, has been announced by the Crown Controls Company, Inc., 124 S. Washington St., New Bremen, Ohio.

Entire weight of antenna and antenna mast rotates on radial end-thrust ball bearings. Fits antenna masts up to a maximum outside diameter of 1 1/4".

## A RELIABLE SOURCE OF 6-VOLT DC



## STANCOR MODEL 752 Power Pack

### Ideal for . . .

Servicing auto radios . . .  
demonstrating auto accessories . . .  
replacing storage batteries . . .  
testing push-button solenoids . . .  
testing 6-volt battery-type radios . . .  
electroplating and many other uses.

The Stancor Model 752 Power Pack is an efficient selenium rectifier type of power supply—indispensable for many uses around the modern service shop where a dependable source of 6-volt DC is required.

Low internal resistance provides high current capability with good voltage regulation, while heavy duty components are designed to withstand high over-loads. For demonstrating or testing auto radios, several sets with motor tuning can be operated simultaneously.

The Stancor Model 752 Pack plugs into the standard 115-volt, 50-60 cycle AC supply to provide a continuous output of 6-volts at 12.5 amperes DC, or 25.0 amperes intermittently. A built-in voltmeter permits visual checking of output voltage, and a seven-position switch provides variation of output voltages over a convenient range for various loads.

ONLY  
**\$43<sup>90</sup>**

SEE THE STANCOR MODEL 752 POWER PACK AT YOUR DISTRIBUTOR TODAY



Write or ask your Stancor distributor for the new Stancor catalog, listing complete specifications and prices of more than 400 Stancor transformers, chokes and related components for radio and television servicing.

**STANDARD TRANSFORMER CORPORATION**  
ELSTON, KEDZIE & ADDISON • CHICAGO 18, ILLINOIS

### BEST-VUE WINDOW TV ANTENNA

A conical window type antenna has been announced by Best-Vue Products, 247 Centre Street, New York City.

\* \* \*

### AMPHENOL INDOOR TV ANTENNA

An indoor TV antenna, number 114-024 (Telestar) has been announced by American Phenolic Corp., Chicago, Ill. Antenna is fabricated of aluminum rods, tipped with plastic. Base is molded of polystyrene. Base is weighted against tipping and is adjustable to conform to convex cabinet surfaces.

Right: Amphenol indoor TV antenna.

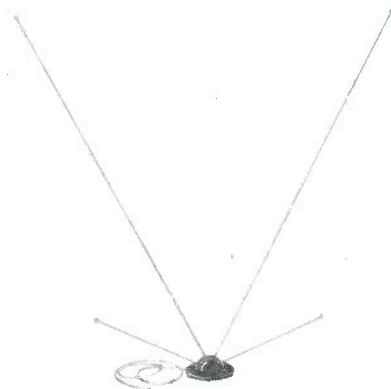

## COMPARE ACTUAL PERFORMANCE CURVES . . .



## OF THE ANCHOR TV-PRE-AMPLIFIER

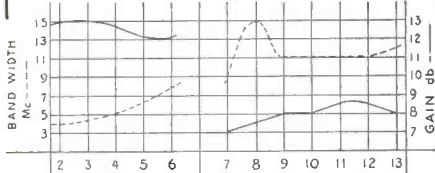

HAZELTINE REPORT No. 2801-17

The ANCHOR PRE-AMPLIFIER is engineered to *amplify the signal only*, not the noise. Furthermore, the inherent noise of this unit is not measurable.

The ANCHOR Booster provides maximum gains possible from the 6AK5 tube with excellent band widths.

It increases signal strength without loss of picture detail.

The outstanding acceptance of the ANCHOR TV-PRE-AMPLIFIER by Service Engineers and Dealers is the best testimonial to its quality.

Engineered for modern and the best TV reception. Priced right for profits. Get details now.

See your jobber or write us.

**ANCHOR**  
RADIO CORP.  
2215 S. St. Louis Ave.  
Chicago 23, Ill.

## RCA REVERSIBLE-BEAM TV ANTENNA

A TV antenna array, for use in fringe reception areas lying between stations occupying the same or adjacent channels, has been introduced by the RCA Tube Department.

Called the RCA reversible-beam TV antenna array, it is designed to prevent the signal of one station from interfering with the signal of a station lying in the opposite direction.

Developed at the RCA Laboratories, in Princeton, N. J., the antenna is said to have a high front-to-back ratio which provides maximum gain in one direction while *rejecting* signals arriving in the opposite direction. A diplexer is said to permit instantaneous reversal of the directivity of the antenna to provide reception from either station. Diplexer is said to also eliminate the adjacent-channel interference from stations in opposite directions, sometimes encountered in receivers having limited selectivity. Diplexer is a phasing network consisting of four one-quarter wavelength lines, an absorbing resistor, and a switch to permit choice of dipole combinations.

Array comes with four sets of dipole elements with V attachments, terminal-board assembly, 19' (4 sections) of 1 1/4-inch-diameter aluminum tubing, two section crossarms, two guy rings, 22 harness standoffs, 11 leadin standoffs, and diplexer.

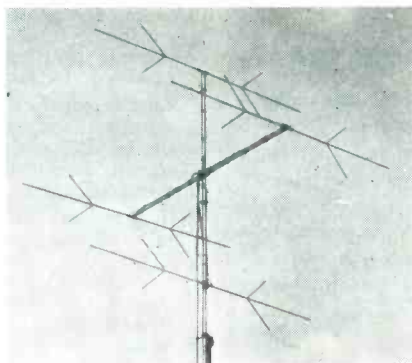

## G. E. SWEEP GENERATOR

An electronic sweep generator, using a variable permeability type sweep, has been developed by the specialty division of G. E.

Frequency of generator, type ST-4A, is continuously variable from 4 to 110 mc and from 170 to 220 mc with a linear sweep width of from 500 kc to greater than 15 mc.

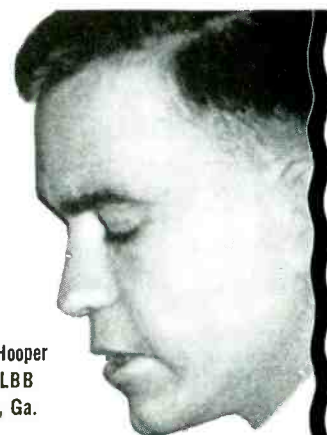

Charley F. Hooper  
Station WLBB  
Carrollton, Ga.

“... there's  
nothing else  
like it!”



VARIABLE  
RELUCTANCE  
CARTRIDGE

SEE PAGE 11

## TELEPHONES

DESK



MODEL

Now—Deluxe quality telephones incorporating latest improvements in design and technique. No scrap parts—but real honest to goodness first class material and finest workmanship. Lowered costs due to increased volume make possible this special low price.

WALL



MODEL

**\$17.95 Pair**

either type shown—*complete* with wire, power supply and instructions.

READY TO HOOK UP

ANYONE CAN INSTALL

25% deposit required on C.O.D. orders.

We can handle anything in the telephone line.

**DUNN-WRIGHT  
ELECTRIC COMPANY**

667-C 6th Avenue, Brooklyn, N. Y.

**FOR ORIGINALITY**

LOOK TO **XCELITE**

No Radio Man Should Be Without It!

It's A "Fistful" of  
Quick-Change Tools!

9 chrome-plated nut drivers, 3/16" through 1/2", 2 screwdriver sizes, one reamer and combination XCELITE handle that fits them all—in compact, good-looking metal container. ALL FOR **\$9.95 ONLY**

A lot cheaper than buying separate tools! Faster tool changing! And a "honey" of a gift idea. Ask your dealer or jobber! Or write us.

**PARK METALWARE CO., INC.**

Dept. V

Orchard Park, New York

Quality  
Tools  
PREFERRED BY  
EXPERTS



### ASTATIC TV BOOSTER

A TV booster, type AT-1, has been announced by The Astatic Corporation, Conneaut, Ohio.

Booster uses four tubes and features dual tuning controls.

Also has a variable gain control.



\* \* \*

### SPRAGUE VIDEO CAPACITORS

Television type 6000 volt-capacitors for 85°C high humidity operation, type TVQ, have been announced by Sprague Products Company, North Adams, Mass.

These units, made with Sprague's *vitamin Q*\* impregnant, are designed to minimize corona and have an internal humidity barrier and a heavy outer wax coating. The .01 mfd, 6000-volt is 1 1/8" in diameter by 2" long.

Complete description appears in bulletin M-433.

\* Reg. U. S. Patent Office.



\* \* \*

### HICKOK TV LINEARITY PATTERN GENERATOR

A portable linearity-pattern generator, model 620, to provide an independent video pattern at any time for TV receiver screen alignment and servicing, has been announced by The Hickok Electrical Instrument Company, 10521 Dupont Avenue, Cleveland 8, Ohio.

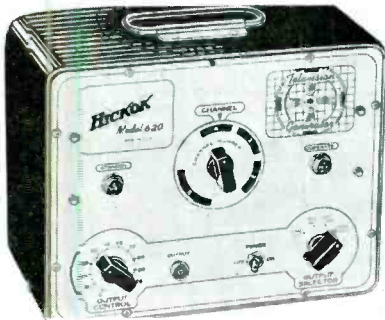

\* \* \*

### RCP TV MARKER

A TV marker, model TV50, calibrated from 5 to 250 mc in four bands, has been announced by Radio City Products Co., 152 W. 25th Street, New York 1, N. Y. Features a self-contained crystal oscillator circuit so that simultaneous marking can be utilized or it can be used alone with the variable frequency marker turned off. A phasing control circuit is said to enable adequate alteration of the dual trace found in sweep generators of the electro-mechanical type. The design of the oscillator is such that any crystal from 1 mc up may be used in the crystal socket, which accommodates any generally available crystals mounted in FT243 holders.

# TELEVISION Service Shops... End 'Fixed' Antenna Troubles!

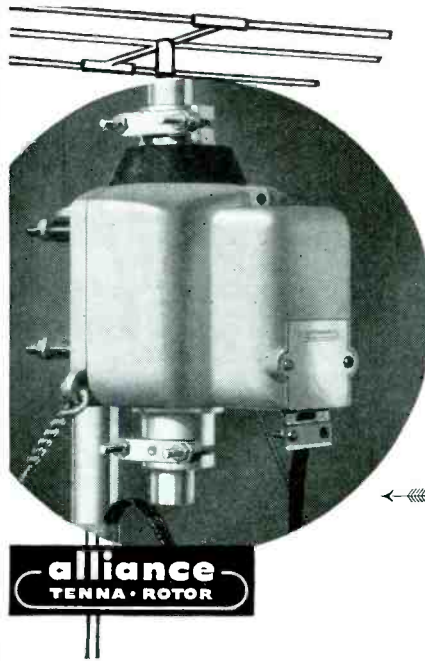

## alliance tenna-rotor

- Faster Installations!
- Fewer Call-Backs!
- Bigger Profits!
- Happier Customers!

Rotator unit—metal enclosed—moisture sealed. Size 7" x 8".

Plastic control case plugs into 110 volts. Size 5" x 5".



• Tenna-Rotor speeds TV installations—saves man-hours on the job because it eliminates critical antenna orientation! Now, *one man* does all the work—easily and quickly! In fringe or multi-station areas, your customers get "peak" reception, selectivity and wider range! And it overcomes "ghosts" and variable reflection factors!

Foolproof, weatherproof, built for long life, Tenna-Rotor comes individually boxed—complete assembly (rotator and control case)—weighs 12 lbs.—retails at \$39.95 (slightly higher west of Rockies). Be sure to ask for genuine **Alliance 4-conductor cable** with each unit! Join the trend to Tenna-Rotor! It pays off with **more sales and faster service!** Order from your jobber—**NOW!**

**ALLIANCE MANUFACTURING COMPANY**

**ALLIANCE, OHIO**

Export Department: 401 Broadway, New York, N. Y., U.S.A.

lator circuit so that simultaneous marking can be utilized or it can be used alone with the variable frequency marker turned off. A phasing control circuit is said to enable adequate alteration of the dual trace found in sweep generators of the electro-mechanical type. The design of the oscillator is such that any crystal from 1 mc up may be used in the crystal socket, which accommodates any generally available crystals mounted in FT243 holders.

An internal mixing circuit provides for receiving the output of any sweep generator so that the output leads carry both the sweep frequency and the marker frequency.

Tube complement: 12AT7, 6C4, VR105, 6X5GTG.



# American Beauty

## ELECTRIC SOLDERING IRONS

are sturdily built for the hard usage of industrial service. Have plug type tips and are constructed on the unit system with each vital part, such as heating element, easily removable and replaceable. In 5 sizes, from 50 watts to 550 watts.

### TEMPERATURE REGULATING STAND

This is a thermostatically controlled device for the regulation of the temperature of an electric soldering iron. When placed on and connected to this stand, iron may be maintained at working temperature or through adjustment on bottom of stand at low or warm temperatures.

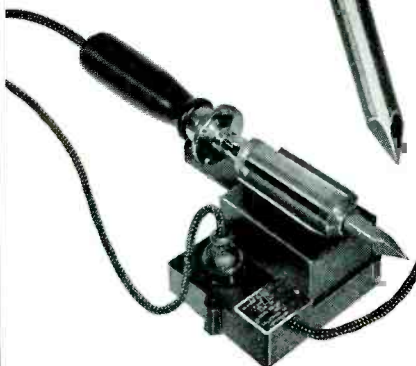

For descriptive literature write

110-1

**AMERICAN ELECTRICAL  
HEATER COMPANY**  
DETROIT 2, MICH., U. S. A.

## JOTS AND FLASHES

COLOR TV is still several years away, at least for general public use, according to the RMA. Filing a preliminary statement with the FCC prior to its appearance at the TV allocation session, RMA said that. . . "Even if the Commission should authorize commercial TV broadcasting (in color) it would be probably several years before initial production through the development, manufacture and sale of transmitters would begin. It would be even longer before wide public use would be possible." . . . The Parts and Distributors' Convention and Show is to be held in Chicago at the Hotel Stevens during the week of May 22, 1950. The show will be conducted on behalf of five co-sponsors: RMA, NEDA, AEP, WCEMA and the Sales Managers Club, Eastern Division. . . The Second Canadian Town Meeting of Radio Technicians will be held in Montreal on October 17, 18 and 19 in the auditorium of the Montreal Technical School. . . At the recent graduation exercises of the RCA Institutes, one hundred and twenty-nine received their diplomas in television transmission and maintenance, radio broadcasting and servicing, telegraph operating and advance technology. . . A new company, Gertsch Products, Inc., has been formed at 11846-48 Mississippi Avenue, Los Angeles, 25, California. E. P. Gertsch, formerly with Hoffman Radio, heads the group, and M. O. Kappler is chief engineer. . . David Krantz, PRSMA proxy, is now manager of The Philadelphia Television Service Corporation. . . Alfred H. Massallek has been named executive design engineer of Shure Brothers, Inc., 225 West Huron St., Chicago, Illinois. . . Glen W. Victory is now manager of purchasing for the TV picture tube division of Sylvania Electric. . . A regular semi-annual dividend of \$2.50 a share on preferred stock was declared recently by the board of directors of Howard W. Sams and Co., Inc. . . The NEDA board of directors will hold a meeting in Cleveland on October 8 and 9 at the Cleveland Hotel. . . Dante S. Perla has been appointed to teach TV in the night classes of the YMCA Trade and Technical School in New York City. Formally with Temco, Perla teaches TV at RCA Institutes during the day. . . Raytheon has announced a new TV line featuring a built-in antenna and syncroset tuner. . . George K. Konz is now assistant manager of advertising and sales promotion at National Union Corporation. . . Sol Tronick has joined the staff of LeRoy Schenck to contact jobbers. . . David H. Ross Company, 1355 Market Street, San Francisco 3, Calif., will represent TACO in northern California and northern Nevada. Ray Velliquette and Company, 1406 South Grand Avenue, Los Angeles 15, Calif., will cover southern California, southern Nevada and Arizona for TACO. . . Editors and Engineers, Ltd., 1300 Kenwood Road, Santa Barbara, Calif., have published a series of radio license exam booklets entitled *Radio and Television Questions and Answers* by Woodrow Smith. Copies list at \$1.00 each.

## ADVERTISERS IN THIS ISSUE

### SERVICE INDEX—SEPTEMBER, 1949

AEROVOX CORP. . . . .	44
Agency: Austin C. Lescarboura & Staff	
ALLIANCE MFG. CO. . . . .	55
Agency: Foster & Davies, Inc.	
ALLIED RADIO CORPORATION . . . . .	48
Agency: George Brodsky, Advertising	
AMERICAN ELECTRICAL HEATER CO. . . . .	56
Agency: Dudgeon, Taylor & Bruske, Inc.	
AMPERITE CO. . . . .	42
Agency: H. J. Gold Co.	
ANCHOR RADIO CORPORATION . . . . .	54
Agency: Symonds, MacKenzie & Co.	
THE ASTATIC CORPORATION . . . . .	51
Agency: Wearstler Advertising, Inc.	
CANNON ELECTRIC DEVELOPMENT CO. . . . .	48
Agency: Dana Jones Co.	
CHICAGO TRANSFORMER DIV. ESSEX WIRE CORP. . . . .	47
Agency: George Brodsky, Advertising	
CLAROSTAT MFG. CO., INC. . . . .	52
Agency: Austin C. Lescarboura & Staff	
CORNELL-DUBILIER ELECTRIC CORP. . . . .	Inside Front Cover
Agency: Reiss Advertising	
ALLEN B. DUMONT LABORATORIES, INC. . . . .	4. 49
Agency: Austin C. Lescarboura & Staff	
DUNN-WRIGHT ELECTRIC CO. . . . .	54
ELECTRO PRODUCTS LABORATORIES, INC. . . . .	46
Agency: Gotsch and DeVille, Advertising	
GENERAL ELECTRIC LAMP DEPT. . . . .	45
Agency: Batten, Durstine & Osborn, Inc.	
GENERAL ELECTRIC CO., I. 11, 35, 38, 42, 46, 48, 52, 54	
Agency: Maxon, Inc.	
HEATH COMPANY . . . . .	44
Agency: G. Dean Arend, Advertising	
THE HICKOK ELECTRICAL INSTRUMENT CO. . . . .	29
Agency: White Adv. Co.	
HYTRON RADIO & ELECTRONICS CORP. . . . .	20
Agency: Henry A. Loudon Advertising, Inc.	
INTERNATIONAL RESISTANCE CO. . . . .	24, 25
Agency: John Falkner Armit & Co., Inc.	
J. F. D. MFG. CO., INC. . . . .	42
Agency: Shappe-Wilkes, Inc.	
P. R. MALLORY & CO., INC. . . . .	Inside Back Cover
Agency: The Aitkin-Kynett Co.	
J. W. MILLER CO. . . . .	46
NATIONAL CO., INC. . . . .	38
Agency: John C. Dowd, Inc.	
NATIONAL UNION RADIO CORP. . . . .	5
Agency: VanDine Adv. Agency	
OHMITE MFG. CO. . . . .	43
Agency: The Fensholt Co.	
PARK METALWARE CO., INC. . . . .	54
Agency: Melvin E. Hall Agency, Inc.	
PERMOFLUX CORPORATION . . . . .	33
Agency: Sander Rodkin Adv. Agency	
PHOENIX ELECTRONICS, INC. . . . .	38
Agency: Milton Richards	
PRECISION APPARATUS CO., INC. . . . .	8
Agency: Shappe-Wilkes, Inc.	
THE RADIART CORP. . . . .	31
Agency: Stern and Warren	
RADIO CITY PRODUCTS CO. . . . .	52
Agency: Jaman Advertising, Inc.	
RADIO CORPORATION OF AMERICA . . . . .	Back Cover
Agency: J. Walter Thompson Co.	
RADIO SUPPLY & ENGINEERING CO. . . . .	50
Agency: Claude E. Whipple	
RAYTHEON MFG. CO. — RADIO RECEIVING TUBE DIV. . . . .	9
Agency: Walter B. Snow & Staff	
JOHN F. RIDER PUBLISHER, INC. . . . .	7
Agency: Shappe-Wilkes, Inc.	
HOWARD W. SAMS & CO., INC. . . . .	3
Agency: George Brodsky, Advertising	
SHURE BROTHERS, INC. . . . .	37
Agency: Casler, Hempstead & Hanford, Inc.	
SIMPSON ELECTRIC CO. . . . .	10
Agency: Burton Browne, Advertising	
SPRAGUE PRODUCTS CO. . . . .	39
Agency: The Barry P. Bridge Co.	
STANDARD TRANSFORMER CORP. . . . .	53
Agency: Burnett-Kuhl Adv. Co.	
SYLVANIA ELECTRIC PRODUCTS, INC. . . . .	12
Agency: Newell-Emmett Co.	
TRIPLETT ELECTRICAL INSTRUMENT CO. . . . .	6
Agency: Western Adv. Agency, Inc.	



**VERSATILITY...**  
**Another Big**  
**Feature of**



**The Mallory Midgetrol**



The first  $\frac{1}{16}$ " diameter Replacement Control Line

The tremendous nation-wide demand for the Mallory Midgetrol is a result of definite advantages this amazing control has over all others. And one of the most important of these advantages is the *remarkable versatility* of the Mallory Midgetrol!

Yes, here is a precision control that will replace  $\frac{1}{8}$ " controls in standard sets, as well as giving you a big new market in the popular smaller sets requiring a  $\frac{1}{16}$ " control. Think what this means in profits for you, and . . .

**LOOK WHAT THE MALLORY MIDGETROL OFFERS:**

**WIDER APPLICATION**—The small size allows you to service portables, auto radios and small AC-DC receivers requiring  $\frac{1}{16}$ " controls.

**SIMPLER INSTALLATION**—The new and unique flat shaft design of the Mallory Midgetrol saves installation time with *all* types of knobs.

**LESS INVENTORY**—Electrical characteristics allow you to use the Mallory Midgetrol to replace  $\frac{1}{8}$ " as well as  $\frac{1}{16}$ " controls. Since no special shafts are required, you carry fewer controls in stock.

- |                   |                                 |                    |                     |
|-------------------|---------------------------------|--------------------|---------------------|
| <b>NEW SIZE</b>   | <b>NEW SHAFT</b>                | <b>NEW SWITCH</b>  | <b>NEW CONTACT</b>  |
| <b>NEW DESIGN</b> | <b>NEW EXTENSION</b>            | <b>NEW ELEMENT</b> | <b>NEW TERMINAL</b> |
|                   | <b>NEW TWO-POINT SUSPENSION</b> |                    |                     |

*Don't Miss the Mallory Television Service Encyclopedia.  
 Get Your Copy From Your Mallory Distributor . . . Only 35c!*

**P. R. MALLORY & CO. Inc.**  
**MALLORY** CAPACITORS . . . CONTROLS . . . VIBRATORS . . .  
 SWITCHES . . . RESISTORS . . . RECTIFIERS  
 VIBRAPACK\* POWER SUPPLIES . . . FILTERS  
\*Reg. U. S. Pat. Off.

**APPROVED PRECISION PRODUCTS**

**P. R. MALLORY & CO., Inc., INDIANAPOLIS 6, INDIANA**

# Partners in Prestige



## Cunningham... the high mark in quality for over 33 years

As a product of the engineering and manufacturing resources of the Radio Corporation of America, Cunningham tubes have consistently occupied the forefront in tube quality and performance. That is why RCA and Cunningham stand side-by-side as two great names in radio.

Cunningham tubes have enjoyed customer acceptance for over 33 years. Whether it's metal, miniature, or glass, there's a Cunningham type to meet practically every service requirement. Your Cunningham Distributor keeps complete stocks on hand to meet your immediate needs.

### Now... TV Trouble Shooting by Picture Analysis!

The first of its kind—the Pict-O-Guide quickly tells how to locate the cause of trouble in a faulty TV receiver—and indicates how to cure it. To learn how you can get your copy, see your Cunningham Distributor without delay! The supply is limited.



SEE YOUR CUNNINGHAM DISTRIBUTOR TODAY

**A QUALITY PRODUCT OF THE  
RADIO CORPORATION OF AMERICA**