

SERVICE

Sound Issue

June
1949

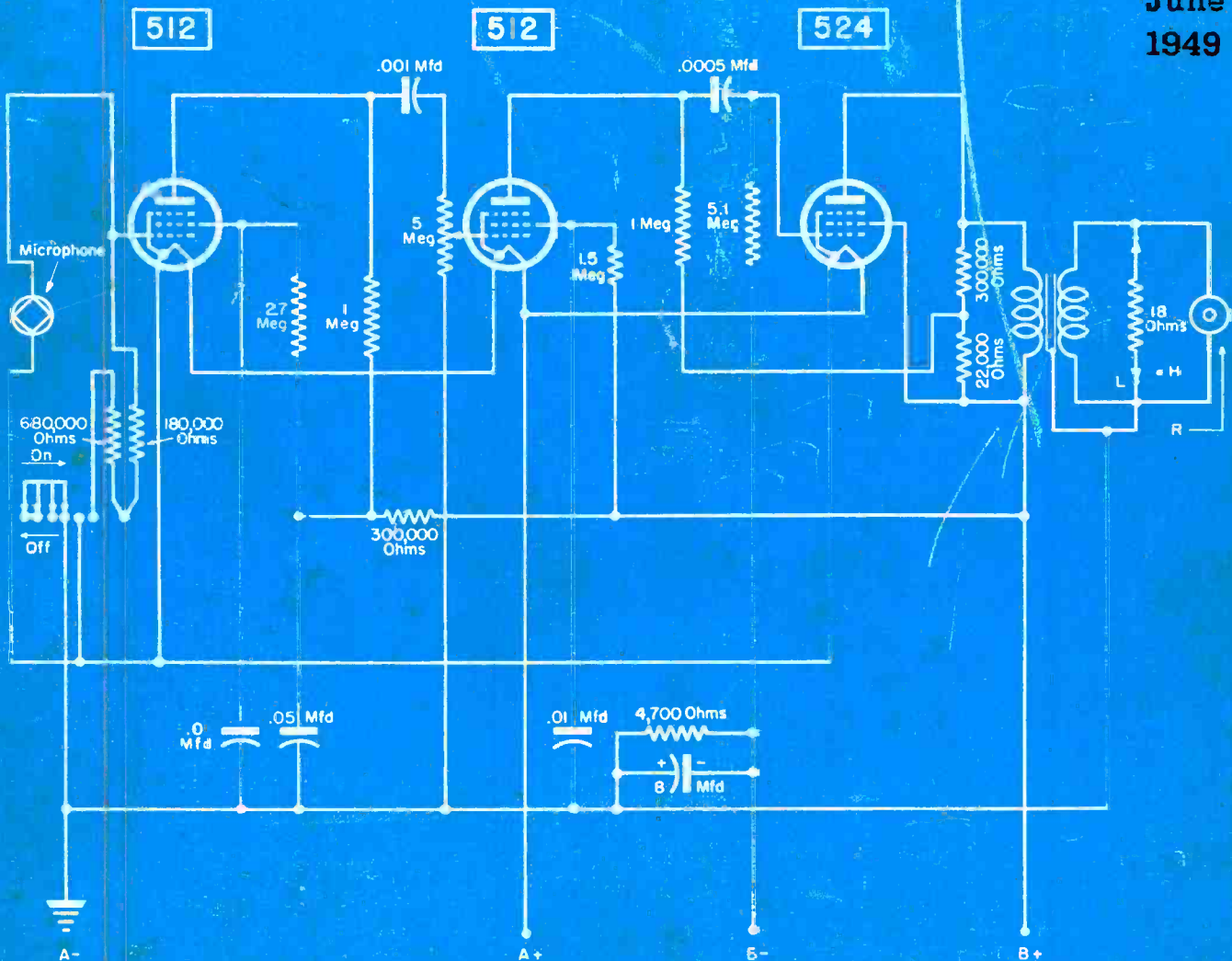

Three-tube hearing-aid analyzer which features a sound chamber to provide a definite sound pressure in the microphone plane.

[See page 3]

THE TECHNICAL JOURNAL OF THE RADIO TRADE

Cub Sized...



STURDY AS A GRIZZLY



CORNELL-DUBILIER "BLUE CUB"*

FIVE EXCLUSIVE "LIFE-PRESERVING" FEATURES:

LEADWELD terminals:



The only tubular with leads welded to section. Welding eliminates possibility of opens and intermittents.

STYRICAST molded:



The only tubular cast in plastic after Vikane impregnation. No heat or pressure to injure unit. Rockhard coating for permanent eye-appeal and durability.

FIXEDRESIN case:



Will withstand temperatures up to 300°F without softening.

VIKANE* impregnation:



Results in superior capacitor section that will withstand higher break-down test and have the lowest power-factor of any tubular.

GRIPSEAL impregnated:



Additional impregnation after final assembly as a permanent double humidity seal.

the new plastic paper tubulars

One sure thing about these C-D "BLUE CUBS"—you can install them and forget about them. No shock, no vibration is too much for these pint-sized "giants"; they're fortified with solid mold construction and "cushioning" features. They take temperatures from -70°F to $+212^{\circ}\text{F}$ in their stride. Capacity remains constant within 5% under most severe conditions of temperature and humidity. Get acquainted with these job-insuring "BLUE CUBS" now.

Your jobber has a supply in all popular capacity ranges at 400, 600 and 1,600 V.D.C.



1910



1949

* T. M. Reg. U. S. Pat. Off.

For further details on this and other units in C-D's complete line of quality capacitors see your jobber or write for catalog. Cornell-Dubilier Electric Corp., Dept. S6-9, South Plainfield, N. J. Other plants in New Bedford, Worcester and Brookline, Mass.; Indianapolis, Ind.; Providence, R. I. and subsidiary, The Radiart Corp., Cleveland, Ohio.

See yellow pages of your Classified Telephone Directory for nearest C-D authorized distributor.

"KEN-RAD TUBES MEAN SATISFIED CUSTOMERS— INCREASED BUSINESS!"



H. A. GEORGE, Car Radio & Appliance Store, 7604 South Cottage Grove, Chicago, Illinois, is another serviceman who knows by experience that Ken-Rad Tubes are fast, dependable sellers.

"We've sold a lot of Ken-Rad Tubes in our shop through the years, so I know what I'm talking about.

"Believe me, Ken-Rad Tubes have what it takes to keep customers satisfied. A satisfied customer is a steady customer—and steady customers mean faster turnover, more money in the till.

"There's no substitute for quality—that means there's no substitute for Ken-Rad Tubes!"

"KEN-RAD TUBES ARE TESTED OVER AND OVER AGAIN—TO GUARANTEE SATISFACTION!"



ROBERT W. FIELD, Circuit Engineer, is in charge of special stroboscopic vibration test (below). This helps to determine the numerous tests Ken-Rad Tubes must pass before being approved and shipped to dealers.

"From start to finish of production, Ken-Rad Tubes must pass one comprehensive test after another.

"These are based on work such as the special stroboscopic vibration check developed by General Electric engineers.

"Tubes are placed in a special spring-supported socket which is driven from a variable-frequency audio oscillator.

"A stroboscopic light then is used to illuminate the tube while it is studied for vibrating elements or loose parts under a high-power microscope.

"No wonder Ken-Rad Tubes satisfy customers!"

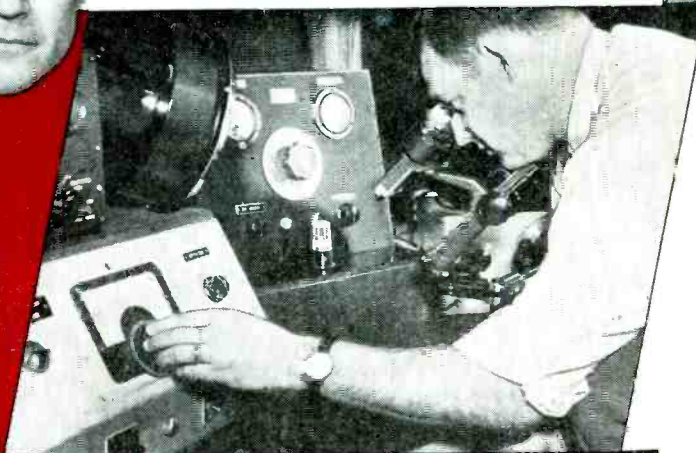

THE SERVICEMAN'S TUBE

... backed by profit-making sales aids which your Ken-Rad distributor gladly will show you. Phone or write him today!

KEN-RAD Radio Tubes

PRODUCT OF GENERAL ELECTRIC COMPANY

Schenectady 5, New York

62-MAA

RADIO · TELEVISION · ELECTRONIC
SERVICE

LEWIS WINNER
Editorial Director

F. WALEN
Assistant Editor

ALFRED A. GHIRARDI
Advisory Editor

	Page
Association News	28
Coin-Operated Automatic Phono Servicing. By Jack Darr	10
Constant Voltage Source for TV Receivers. By Hans U. Hjermsstad	16
Custom Audio Installations. By Irving Greene	30
Design and Construction of a Custom Cabinet. By Clifford Stubbs	32
Hearing Aid Servicing (Cover). By Clifford W. Carlson	27
Phono Installation and Service. By Kenneth Stewart	18
Servicing 45-RPM Changers. By Thomas Y. Flythe	12
Sound Installation Servicing Helps. By Ira Kamen	22
Stepping Up Your TV Servicing Income. By R. J. Guilfoyle	24
Ten Years Ago in Associations	28
Views and News. By Lewis Winner	9
 CIRCUITS	
Amplifier Which Can Be Adapted to TV Receivers to Improve Fidelity	30
Audio Peak Limiter Circuit	39
G. E. Variable Reluctance Phono Preamp	19
Inverse Feedback Circuit in a Single-Ended Amplifier	22
Otarion Hearing-Aid Analyzer (Cover)	27
RCA 9EY3 45-RPM Amplifier	14
Rock-Ola Crystal Pickup Adapter Circuit	10
Rock-Ola Input Circuit	10
Rock-Ola Quick-Heater Relay System	11
Sola Constant-Voltage Transformer Circuit	16
Speaker Transformer Primary Measurement System	22
 COVER	
Hearing Aid Analyzer (Otarion)	27
 SERVICING HELPS	
Sound Installation Formulas	22
Sound Installation Circuit Aids	22
Index to Advertisers	48
 Manufacturers	
Jots and Flashes	48
News	46
Sound Parts and Accessories	44

Entire contents Copyright 1949, Bryan Davis Publishing Co., Inc.



Published monthly by Bryan Davis Publishing Co., Inc.
52 Vanderbilt Avenue, New York 17, N. Y. Telephone Murray Hill 4-0170



Bryan S. Davis, President Paul S. Weil, Vice-Pres., Gen. Mgr. F. Walen, Secretary A. Goebel, Circulation Manager

Cleveland Representative: James C. Munn, 2253 Delaware Dr., Cleveland 6, Ohio. Telephone: Erieview 1726
Pacific Coast Representative: Brand & Brand, 1052 W. Sixth St., Los Angeles 14, Calif. Telephone: Michigan 1732
Suite 1204, Russ Building, San Francisco 4, Calif. Telephone: SUTter 1-2251

Entered as second-class matter June 14, 1932, at the Post Office at New York, N. Y., under the Act of March 3, 1879. Subscription price: \$2.00 per year in the United States of America and Canada; 25 cents per copy. \$3.00 per year in foreign countries; 35 cents per copy.

PHOTOFACT Publications

The Books that Help You

SAVE TIME

SAVE WORK

EARN MORE

LEARN MORE

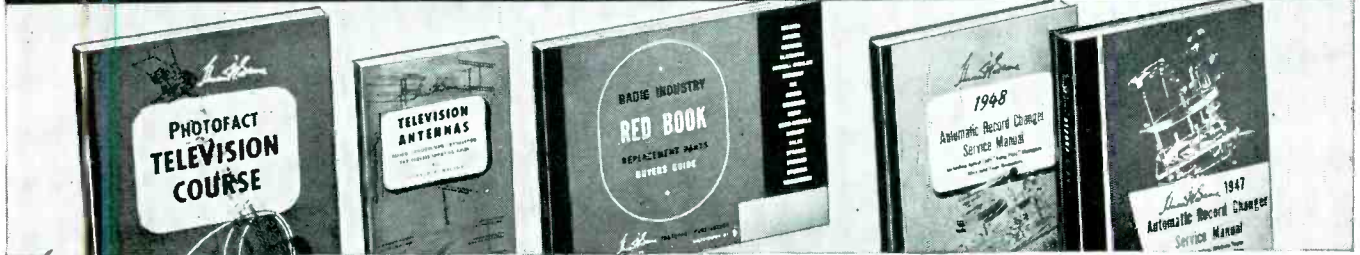

NEW TELEVISION BOOKS

TELEVISION COURSE

Gives you a clear, complete understanding of TV principles, operation and practice. Covers: Beam Formation and Control; Beam Deflection Systems; Beam Modulation and Synchronization. Full analysis of the Cathode Ray tube, voltage supplies, control functions, antenna circuits, RF and IF systems, AGC, video amplification, contrast, etc. 216 pages; 8½ x 11"; profusely illustrated; sturdily bound. **Only \$3.00**

TELEVISION ANTENNAS

All you need to know about TV antennas. Written by Donald A. Nelson; based on actual field experience. Shows you how to select antenna, how to install it, how to solve troubles. Many short-cuts help you save time and earn more. Chapters cover: antenna principles; construction; analysis of all types of commercial units; installation data; problems and trouble-shooting. 192 pages; 124 illustrations. **Only \$1.25**

THE RED BOOK

Tells you in *one* volume all you need to know about replacement parts for 17,000 receivers made from 1938 to 1948. Eliminates wasteful hunting through dozens of incomplete manuals. Includes full, accurate listings of all 9 major replacement components; lists correct replacement parts made by 17 leading manufacturers. Gives original parts numbers, proper replacements and valuable installation notes on: Capacitors, transformers, controls, I.F.'s, speakers, vibrators, phono-cartridges, tube and dial-light data, battery replacement data. 448 pages; 8½ x 11"; sewed binding. **Only \$3.95**

RECORD CHANGER MANUALS

Volume 2, 1948. Covers 45 models made in 1948, including new LP and dual-speed changers, plus leading wire and tape recorders. Complete accurate data—based on actual analysis of the equipment. Gives full change cycle data, adjustment information, needle landing data, hints and kinks, parts lists, exclusive "exploded" diagrams. A time-saving, money-making book. Over 400 pages; 8½ x 11"; deluxe bound. **\$6.75**

Volume 1, 1947. Covers over 40 different post-war models up to 1948. Includes full, hard-to-get data on leading wire, ribbon, tape and paper disc recorders. 400 pages; fully illustrated; 8½ x 11"; hard binding. **Only \$4.95**



SPECIALIZED SERVICE DATA VOLUMES

Post-War Auto Radios. Covers everything you need to know on over 100 post-war models (practically every auto radio made since 1946); represents the products of 24 different manufacturers. Makes auto radio servicing easy. Over 360 pages; profusely illustrated; each model treated uniformly, completely, accurately—based on actual study of the equipment. Sturdy binding; 8½ x 11". **Only \$4.95**

Post-War Audio Amplifiers. Invaluable data for custom-builders, audio men and sound engineers. Covers a wide variety of well-known audio amplifiers and FM and AM tuners, plus data on important wire and tape recorders. Presents a complete analysis of each unit. A "must" for all sound men and custom installers. 352 pages; 8½ x 11"; sturdily binding. **\$3.95**

Post-War Communications Receivers. Complete technical analysis of more than 50 of the most popular communications sets on the market. An invaluable service aid, a perfect buying guide for purchasers of communications receivers. All data is accurate and authoritative, based on actual examination and study of each unit. 264 pages; profusely illustrated; 8½ x 11"; durably bound. **Only \$3.00**

"MUSTS" FOR EVERY SERVICE BENCH

Radio Receiver Tube Placement Guide. Shows you exactly where to replace each tube in 5300 radio models, covering 1938 to 1947 receivers. Clear, accurate diagram for each tube layout. Saves time—eliminates risky hit-or-miss methods, especially where tubes have been removed from the set. Indispensable in the shop or on calls. 192 pages. **Only \$1.25**

Dial Cord Stringing Guide. The book that shows you the *one right way* to string a dial cord. Here, in one handy pocket-sized book, are all available dial cord diagrams covering over 2300 receivers; 1938 through 1946. Makes dial cord restringing jobs quick and easy. Nothing like it. Order copies today for your tool kit and shop bench. **Only \$1.00**



PHOTOFACT SERVICE MANUALS

Here's the radio service data that's invaluable—that saves you time and helps you earn more! Preferred and used daily by thousands of Radio Service Technicians. Complete, accurate—based on analysis of the actual equipment. Uniform treatment for each model: includes Standard Notation Schematics; full chassis photo coverage; alignment, stage gain, voltage and resistance analysis; parts numbers and proper replacements; disassembly notes; oscilloscope wave forms; record changer analysis—everything you need for quick, profitable servicing. Covers all post-war radios; in semi-annual deluxe bound volumes, over 1000 pages each. 7 volumes cover receivers made to Oct. 1, 1949.

Each Volume in Deluxe Binder **\$18.39**

"The Recording and Reproduction of Sound"

by Oliver Read

The first complete reference book that gives the right answers on all phases of SOUND. Written by the editor of Radio News. Authoritative, complete information on recording and reproduction. Nothing else like it. Order now.

320 Pages **\$5.00**
Deluxe Bound

Published by **HOWARD W. SAMS & CO., INC.** • INDIANAPOLIS 1, INDIANA

MORE FOR YOUR MONEY

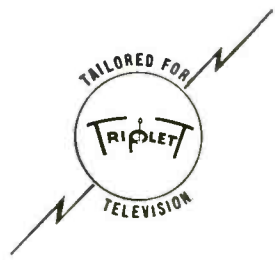

NEW TV SWEEP GENERATOR-MARKER

Covers All TV Picture and Sound I.F. and F.M. Ranges

MIRROR-SCALED for ACCURACY!

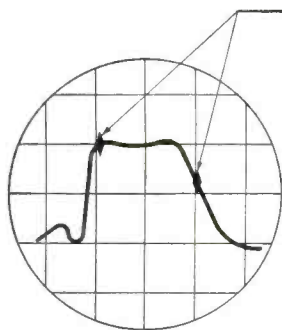
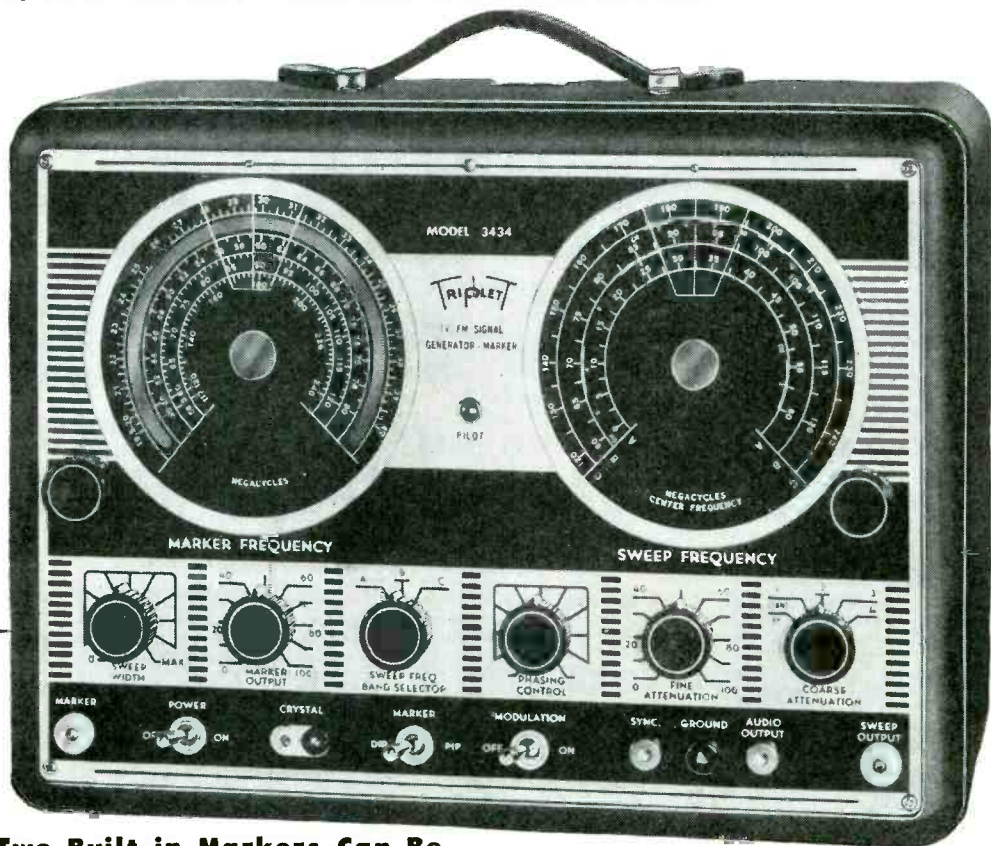

Two Built-in Markers Can Be Used Simultaneously Giving Facilities for Faster Identification of Bandpass of Curves Without Constant Tuning of Marker

Model 3434 Only \$149⁵⁰

Suggested USA Dealer Net (crystals not supplied)

TECH DATA

Frequency Coverage:

- SWEEP CENTER FREQUENCY
 - Range 1— 0-60 MC
 - Range 2— 60-120 MC
 - Range 3— 120-240 MC
- SWEEP WIDTH: 0-12 MC (Continuously Variable)
- MARKER FREQUENCY 19.5 to 40 MC (fundamental). 39 MC to 240 MC (harmonic)
- CRYSTAL FREQUENCIES To 20 MC on Fundamentals. Harmonics up to 216 MC. (Crystals Not Furnished)
- MODULATION 400 Cycle on both Crystal and Marker Frequencies
- AUDIO: 400 cycles

Above also furnished in separate units . . . Sweep Generator . . . Variable Marker . . . Crystal Marker.

Precision first...to Last

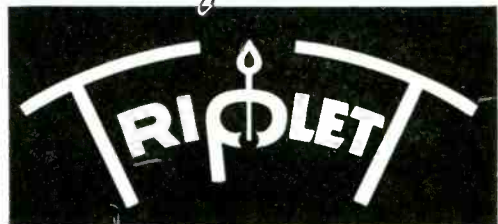

The new Triplet TV-FM Sweep Generator-Marker, with two built-in Markers and large mirrored dial, was "Tailored For Television" with YOU in mind! The two Markers can be used simultaneously . . . gives you the facilities for faster identification of bandpass of curves without constant tuning of Marker. Marker has both pip and absorption dip control.

The large Marker dial is mirrored for easy reading and greater reset accuracy. Straight line frequency tuning condensers used to provide linear scale markings.

No gaps in frequency . . . continuously variable Sweep width control. Audio output for quick check on video and sound amplifiers. Expertly-engineered shielding . . . all critical circuits enclosed. Copper plated steel construction.

Contained in attractive black suede finish steel case, size 15-11/32" x 11-1/32" x 8 1/4" . . . leather handle . . . copper-plated feet for grounding when working on metal work bench top . . . panel is black, white and red etched on aluminum.

For Detailed Information See your Radio Parts Distributor or write . . .

TRIPLET ELECTRICAL INSTRUMENT COMPANY • BLUFFTON, OHIO, U.S.A.

In Canada: Triplet Instruments of Canada, Georgetown, Ontario

Prices slightly higher west of Rockies

The Biggest and Best Yet!

READY NOW!

RIDER MANUAL VOLUME XIX

Newest, Most Comprehensive, Factory-Authorized Servicing Data From Over 100 Manufacturers!

Authentic! Official! Reliable!

Never before have we published such a Manual. More pages. More data — direct from the servicing departments of the manufacturers themselves. More of everything you need to help you do a bigger, better, more profitable volume in 1949. Here are the famous Rider "Clari-Skematix" that help simplify jobs. Here are alignment charts, voltage and resistance tables and parts lists. Everything easy to read . . . easy to follow. Rider . . . and only Rider . . . gives you all this invaluable information at the lowest dollar-for-dollar cost in the industry.

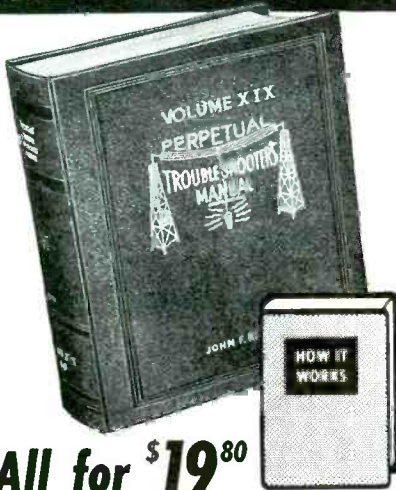

All for \$19⁸⁰

- ★ 2122 Pages
- ★ Over 100 Manufacturers
- ★ Including AM-FM, Amateur Receivers, Auto Radio and Record Changers
- ★ Cumulative Index Volumes XVI, XVII, XVIII, XIX
- ★ Plus
- Famous "How It Works" Book

. . . which gives you the "extra" knowledge so necessary for successful servicing.

"RIDER MANUALS

are my most profitable working tools!"

"Rider Manuals are necessary working tools that make our servicing operations easier and more profitable. In these days when you have to scratch for business, factory-authorized servicing information helps put us head and shoulders above competition, when it comes to doing a servicing job that stays sold."

Vere L. Henning—Henning Radio and Television Service
726 Armstrong Ave., St. Paul, Minn.



"TV MUST" . . . Rider TV Manual, Volume 2

Equivalent of 2300 pages, PLUS Cumulative Index Covering TV Volumes 1 and 2 . . . and "HOW IT WORKS" Book. Official, Authentic, Reliable Servicing data on complete receivers, tuners, kits and boosters from 67 mfrs. Complete.....\$18.00

"PA MUST"

Rider PA Manual

The first industry-wide public address equipment Manual, covering amplifier production of 147 manufacturers from 1938 to 1948. 2024 Pages PLUS "HOW IT WORKS" Book.

Complete \$18.00

RIDER MANUALS

Television Manual, Vol. 2...\$18.00	Volume XV	\$19.80
(plus "How It Works" and Index)	Volume XIV to VII (each vol.)	16.50
Television Manual, Vol. 1.... 18.00	Volume VI.....	12.50
(plus "How It Works" and Index)	Abridged Manuals I to V	
Volume XIX..... 19.80	(one volume).....	19.80
Volume XVIII..... 19.80	Record Changers and	
Volume XVII..... 16.50	Recorders	9.00
Volume XVI..... 8.40	Master Index, Covering	
	Manuals, Vols. 1 to XV....	1.50
	PA Equipment Manual, Vol. 1	18.00

RIDER MANUALS mean SUCCESSFUL SERVICING

NOTE: Are you receiving your copy of "Successful Servicing?" It's Rider's own publication of interest to every Serviceman. Write for it . . . it's FREE!

ANOTHER NOTE: The C-D Capacitor Manual for Radio Servicing, 1948 edition No. 4, makes reference to only one source of receiver schematics — Rider Manuals.

JOHN F. RIDER PUBLISHER, Inc.,

480 Canal Street, New York 13, N. Y.

Export Agent: Rocke International Corp., 13 E. 40th St., N.Y.C.
Cables, ARLAB.

NOTE: The Mallory Radio Service Encyclopedia, 6th edition makes reference to only one source of radio receiver schematics — Rider Manuals.

PERFORMANCE-ENGINEERED AT ELECTRONICS PARK



SMALL-SIZE SPEAKERS

**That Talk in Terms of
GREATER SERVICE SATISFACTION
To 65% of Your Trade!
Because they deliver more—**

**POWER
SENSITIVITY
FIDELITY**

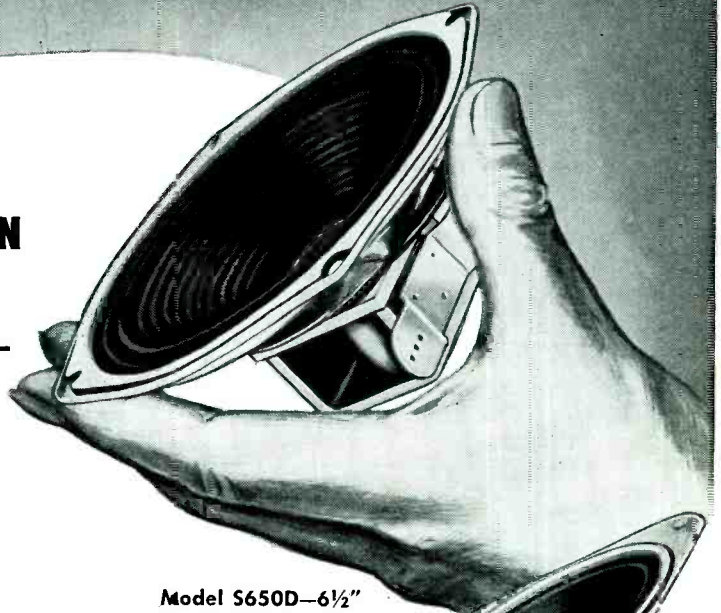

Model S650D-6 1/2"

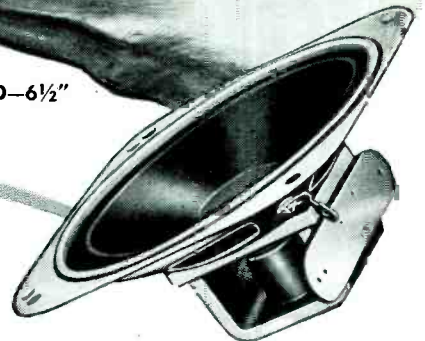

Model S525D-5 1/4"



Model S400D-4"

A RECENT SURVEY shows that 65% of all speaker service requirements are on sets using 4 to 6 inch speakers! Remember—even the smallest General Electric speaker is rated at 4 watts... General Electric speakers, with sturdy all-weld construction, give you higher sensitivity because each G-E Alnico 5 magnet is fixed so firmly in the yoke that hundreds of pounds of pressure cannot budge it!

It costs no more to give your customers the finest! The G-E Speaker family is headed by the famous 1201—grand-daddy of 'em all. Build your reputation on the General Electric Value Line! Send for FREE BULLETIN on G-E speakers:

General Electric Company,
Electronics Park,
Syracuse, New York.

**Yes—Even the Smallest G-E Speaker
Uses the Aluminum Foil Base Voice Coil**
—not subject to warping resulting from high humidity. Provides much higher wattage handling capacity.

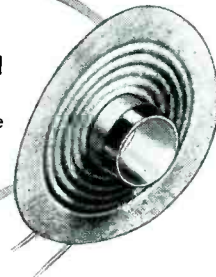

You can put your confidence in—

GENERAL ELECTRIC

Federal

SELENIUM RECTIFIERS

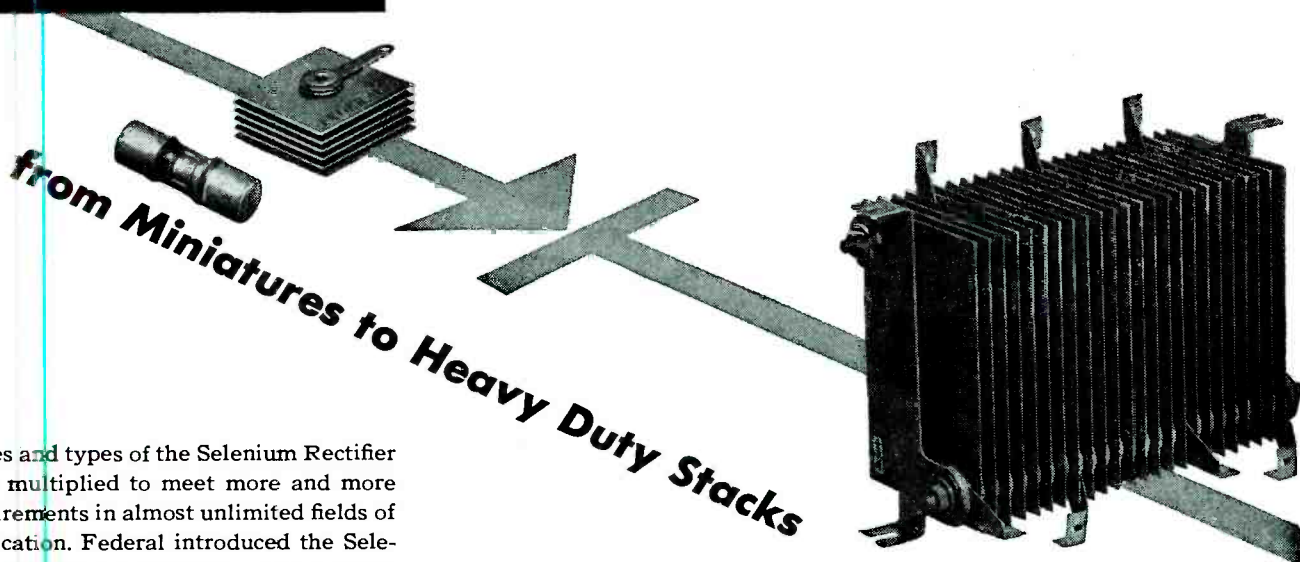

Sizes and types of the Selenium Rectifier have multiplied to meet more and more requirements in almost unlimited fields of application. Federal introduced the Selenium Rectifier in the U. S. and continues to lead in developing and manufacturing this versatile circuit element.

Federal has cooperated with a host of engineers and designers in the development of a complete line of Selenium Rectifiers, ranging from tiny Miniatures to huge Stacks. There is a Federal Selenium Rectifier which will meet practically any power conversion need.

Wherever used, Federal Selenium Rectifiers bring important advantages of dependable power handling . . . instant starting . . . silent, efficient operation . . . long service life.

These typical applications may suggest a new use in your own product. A Federal Selenium Rectifier could be the solution to your own power conversion problem. Bring any question to Federal—America's oldest and largest manufacturer of Selenium Rectifiers. Direct your inquiries to Department E-356.

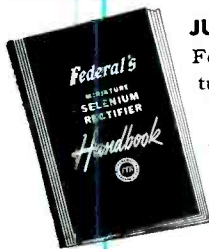

JUST OFF THE PRESS!
Federal's new Miniature Selenium Rectifier Handbook...48 pages of valuable design data. Available for 25 cents (coin only) from—

DO HUNDREDS OF POWER CONVERSION JOBS

more efficiently and economically than ever before!

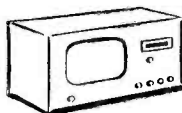

In television . . . radio . . . amplifiers and . . . intercommunication systems.

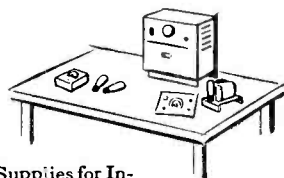

In Power Supplies for Industrial and Laboratory Use . . . Cathodic Protection . . . Electroplating.

In fans . . . sewing machines . . . electric shavers . . . electronic organs . . . motion picture projectors . . . photo-electric cells.

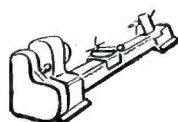

In machine tool controls . . . magnetic chucks . . . relay control systems . . . dial switching systems.



In High Power Communication . . . Broadcast Transmitters . . . Television Transmitters.

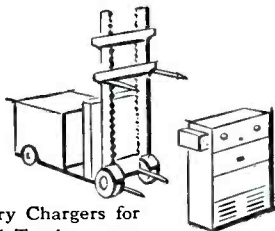

In Battery Chargers for Industrial Trucks . . . automobiles . . . telephone exchanges . . . and in Battery Eliminators.

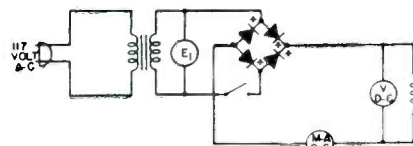

And In Many Specialized Electrical and Electronic Applications.

Federal Telephone and Radio Corporation

SELENIUM and INTELIN DIVISION, 900 Passaic Ave., East Newark, New Jersey

In Canada: Federal Electric Manufacturing Company, Ltd., Montreal, P. Q.
Export Distributors: International Standard Electric Corp., 67 Broad St., N.Y.



FEDERAL TELECOMMUNICATION LABORATORIES, Nutley, N. J. . . . a unit of I T & T's world-wide research and engineering organization.



An IT&T Associate

FOR EVERY RADIO SERVICEMAN!

The new Sylvania FM-AM Signal Generator Type 216

Supplies all signals necessary for complete stage-by-stage alignment of AM and FM receivers.

Frequency Coverage:

80 kc to 60 mc AM and 80 kc to 120 mc FM, continuously variable in seven bands on fundamental frequencies. Useful AM and FM harmonics to 240 mc.

For FM service:

±350 kc Sweep: up to 120 mc with 60 cps modulation.

±75 kc Sweep: up to 120 mc with 400 cps modulation.

In addition, sawtooth external modulation may be used.

For AM service:

±15 kc Sweep up to 61 mc with 60 cps modulation.

0 to 100% Modulated AM with 400 cps modulation.

In addition, external modulation may be used.

Check these Sylvania features! They're "musts" for complete FM and AM servicing:

AM modulation: 0 to 100%, continuously variable.

Accurate calibration: 1/2 of 1%.

High rf output: 1 volt on all ranges.

True rf meter for constant reference level.

Both step-by-step and smooth attenuator output controls.

Regulated power supply.

Oscilloscope synchronizing voltage output.

Crystal check point circuit.

Multiple shielding and filtered for minimum leakage.

Heterodyne detector for frequency comparison.

Mar-resistant, pearl-gray crackle finish baked on a treated steel case.

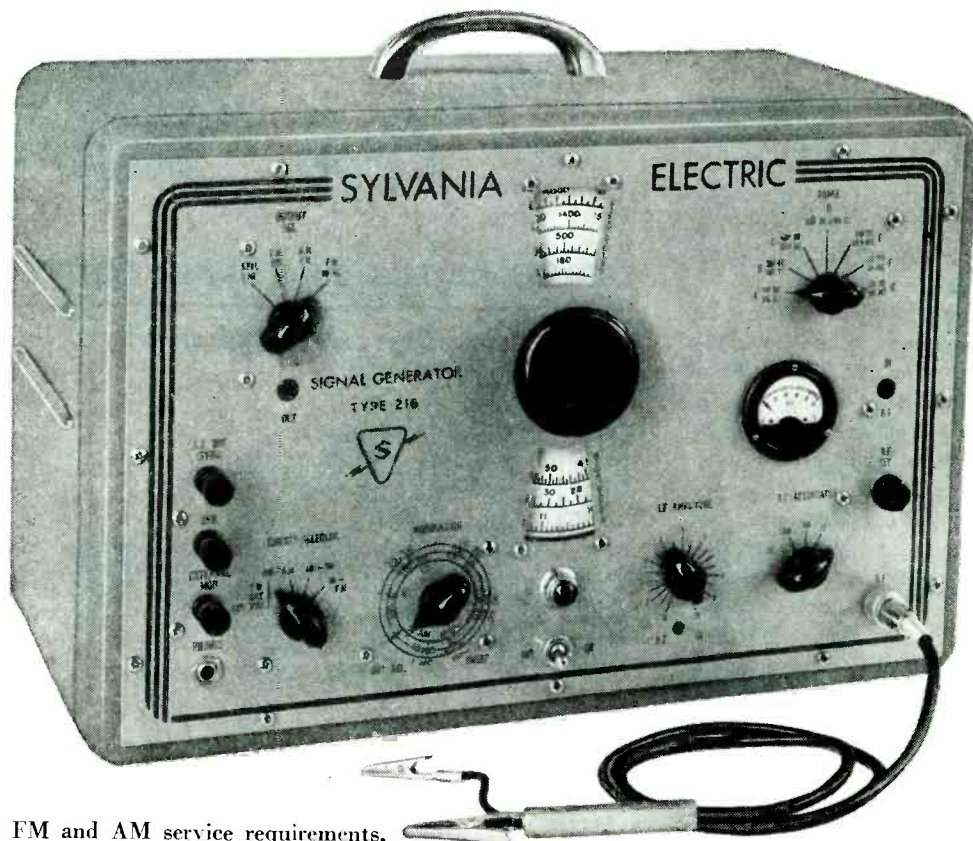

To meet your FM and AM service requirements, you'll want Sylvania's new Signal Generator Type 216! With it you can align the rf and if sections of all FM and AM receivers, adjust all types of FM detectors, and make overall receiver checks. Its high level output and accurate calibration make it also a valuable instrument for other service and laboratory uses requiring a high quality rf signal source. Beautiful styling in keeping with modern service shop environment. Dimensions: 11-3/8" x 17-1/16" x 10-5/8". Weight: 24½ lbs. Priced at \$189.50. Mail coupon for complete details!

SYLVANIA ELECTRIC

ELECTRONIC DEVICES; RADIO TUBES; CATHODE RAY TUBES; FLUORESCENT LAMPS, FIXTURES, WIRING DEVICES, SIGN TUBING; LIGHT BULBS; PHOTOLAMPS

Sylvania Electric Products Inc.
Advertising Dept. R-1906
500 Fifth Ave., New York 18, N. Y.

Gentlemen: Kindly forward full details on your new Sylvania FM-AM Signal Generator Type 216.

Name.....

Address.....

City..... State.....

RADIO • TELEVISION • ELECTRONIC
SERVICE

A Report on Sound

SOUND, always an excellent source of business and income for the Service Man, during the past twelve months has become an even more important factor as a medium of revenue.

With the introduction of the long-playing record system and the assortment of components of equipment required for installation and service, the Service Man received quite a strong stimulant for sound work. And the improvements in wire and tape recorders, speakers, amplifiers and phono equipment spiralled opportunities, too.

In this, our *annual sound issue*, appears a progress report on these and other unusual developments of the year, which are destined to create quite a boom for sound men. Prepared by a group of sound specialists and based in the main on actual experiences, the subjects covered include the design, application and servicing of two and three-speed systems, hearing-aid service instruments, juke-box servicing, custom audio installations, amplifiers for TV high-fidelity audio, *pa* installation hints, cabinets, changers, motors, etc.

Features of three-speed changers, for instance, are disclosed in a report by Kenneth Stewart, on page 18. Stewart also discusses the characteristics of needle-changer mechanisms used in long-players and also tells how to curb groove skipping and minimize hum-to-signal noise ratios on the microgroove record players.

The first complete discussion of the servicing of 45 rpm changers appears on page 12. This interesting analysis, prepared by Thomas Y. Flythe, details the tools required and how to make a variety of adjustments on the mechanism, cartridge and amplifier.

In introducing this unusual discussion Flythe states that . . . "Any combination of motors, gears, tubes and electrical circuits designed for operation by the lay public is bound to require some measure of servicing in its lifetime. The 45 rpm changer, with all its advantages of streamlined design and minimum of moving parts, is no exception and there will always be a degree of careless handling by

adults and exploring by youngsters."

How true!

On page 27 is an unusual sound report by Clifford W. Carlson, revealing for the first time the features of a hearing-aid servicing program for the independent Service Man. Described, too, are the special features of the equipment developed for this type of work. Incidentally, the circuit of the hearing-aid analyzer discussed appears on the front cover of this issue.

In a report on another field of servicing (juke-box amplifiers) which during the past year has become quite an independent Service Man's project, Jack Darr details the characteristics of amplifiers used in the Rock-Ola, Wurlitzer and Seeburg automatic phonos. In this discussion, which begins on page 10, appears data on pickups and preamps, input transformers and input circuits, power tubes and power supplies, the quick starting relays used, and the direct and wireless remote-control systems featured in these phono systems.

Custom audio installations, which today are at their peak of popularity, receive an extraordinarily complete analysis in a report by Irving Greene (page 30) who covers such all-important factors as demonstration room construction, the design features of portable home-demonstration high-fidelity systems and the circuits that can be used to convert amplifiers in TV receivers to provide improved audio performance.

In his analysis of the portable rig for home demonstration, Greene details the features of the unit and just how this can be used to stimulate the sale of a variety of audio accessories.

The custom-installation study is continued in a report by Clifford Stubbs, who on page 32 reveals how to build quite an interesting type of cabinet.

On page 22 appears an article which every Service Man will find extremely useful. Prepared by Ira Kamen, the discussion covers a review of the simple formulas which can be used to solve major installation problems and provides a roundup of some of the proven trick circuits which can be used to expedite installations and improve results.

Hope you like this series of sound features. Any comments will be sincerely appreciated.

TV Safety Rules

A SET of important precautionary picture-tube safety rules, prepared by a special committee of the RMA, has just been released.

Seven basic rules are featured: (1) Don't expose picture tube until you are ready to use it. . . . (2) Always wear goggles when handling a naked tube. . . . (3) Keep people away at a safe distance when the picture tube is exposed. . . . (4) Place the used tube in the carton which contained the new tube and *take it away*. . . . (5) Always keep the picture tube in the protective container whenever possible. Always place an exposed tube on some sort of clean soft padding when necessary to set it down. . . . (6) Don't leave any picture tubes lying around. There are two safe ways of disposing used tubes. (Place the old tube in a shipping carton properly sealed and then drive a crowbar or similar instrument through the closed top of the container: or, if more than one tube is to be disposed of, place them in a metal ashcan and use a plunger operated through the closed top). . . . (7) Don't use regular picture tubes for display purposes. Contact your supplier for special display tubes.

A complete analysis of this *vital* report will appear in the July issue. Watch for it!

Just What the Doctor Ordered

SERVICE MEN who are often beset with a barrage of time and material charge questions when they submit a bill, particularly for a TV or FM job, can now relax. A leading parts manufacturer has prepared a booklet which reveals, in the most lucid manner we have ever seen, for the benefit of the set owner, just what the Service Man must know and have in the way of equipment and books to service TV and FM receivers today. The booklet, available to all Service Men from this parts manufacturer's distributors, and which can carry the Service Man's imprint, can be used as a mailing or personal delivery piece. In either case, it will serve as a diplomatic agent and pave the way for calls with a smile.

A round of grateful applause to this manufacturer for so helpful an item.—L. W.

COIN-OPERATED Automatic

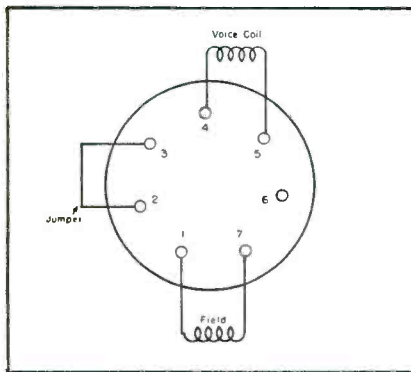

Fig. 1. Prong view of Wurlitzer speaker-plug connections.

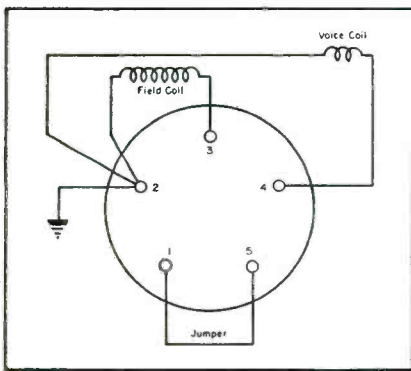

Fig. 2. Prong view of Rock-Ola speaker-plug connections.

Fig. 3. Circuit of the crystal pickup adapter used in Rock-Ola juke boxes.

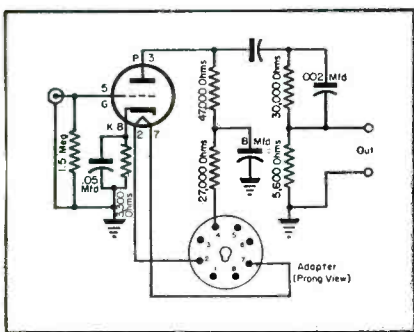
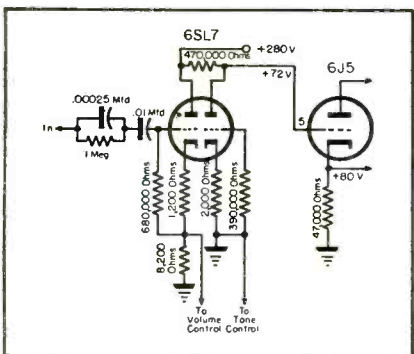

Fig. 4. Input circuit of the Rock-Ola automatic phono units.



THERE ARE thousands of coin-operated automatic phonos or *juke boxes* in operation throughout the country, affording a lucrative servicing opportunity for every Service Man. While it is true that many operators maintain their own staff, there are also many who call on the Service Man for help, and often on a retaining basis. This independent-type business can be had by the Service Man alert enough to prepare himself for the work.

Servicing these amplifiers offers little difficulty to the man already well-grounded in circuit and component design and application, as they are fundamentally conventional audio amplifiers with from 8 to 10 watts power output. Several manufacturers, however, do use a few special circuits and *trick* arrangements.

Component Servicing

Since these amplifiers must operate for long periods without attention, it is imperative that the components receive careful study during a service call. Special attention must be paid to those parts which show signs of weakness, and are likely to go out in the near future. Filters, tubes, bypass and coupling capacitors and high-resistance windings in audio transformers, etc., must be very carefully tested, with any parts which show the least sign of weakness replaced. Operators would much rather pay the cost of an extra part than have the machine idle, with consequent loss of revenue and probably a long trip to replace the defective amplifier.

The major part of the *juke-box* amplifiers in use today were built in the main by Rock-Ola, Wurlitzer and Seeburg. Fortunately for the Service Man, while these companies bring out new models periodically, the plug connections are not altered, thus simplifying servicing. For instance, almost all Rock-Ola and Wurlitzer models use the same speaker plugs (Figs. 1 and 2), with the connections the same, thus permitting the use of an old speaker on a new model amplifier. It will pay to check this point before connection, of course, but it will be found true in most cases.

Most of the older models used magnetic pickups, input impedances were low, and the amplifiers didn't have the necessary voltage gain to operate satisfactorily with a crystal pickup. Some manufacturers, therefore, built *crystal*

pickup adapters, with a 6J5 or similar triode as a preamplifier to raise the input to the level needed for satisfactory operation. These are usually built into a small separate chassis, and mounted on the cabinet wall. A socket adapter inserted under one of the power tubes supplies the necessary operating voltages; Fig. 3.

The Rock-Ola model P has an unusual direct-coupled circuit in the input stage; Fig. 4. The input from the pickup is connected to the pin 1 (grid) of a 6SL7, the plate of the triode being connected to the other plate through a 470,000-ohm resistor and pin 5 plate) connected directly to the grid of a 6J5 phase-inverter. This grid is 72 volts above chassis ground. The cathode of the 6J5 is raised 80 volts above ground by a large bias resistor. The grid of the No. 2 triode of the 6SL7 is connected to a tone control circuit, using a four-position tap-switch, and different sizes of capacitors.

Some of the older Wurlitzers used quite a complicated tone-compensation circuit in the input, which also served as a volume control. The volume control itself in this circuit is a dual, 15,000-150,000/100,000-150,000 ohms. Also incorporated in the same unit were tapped chokes and RC networks used for tone controls. Not very much trouble is experienced with these parts, except for an occasional cleaning job on the control.

In the older Seeburg amplifiers, the coupling capacitor between the '76 pre-amp tube and the driver was a part of the tone control, as it was used in series with the *bass* potentiometer. It is necessary to watch carefully for leakage here, which causes loss of bias of the driver tube, with consequent bad tone and low volume.

Both Seeburg and Rock-Ola units use tap-switches for tone control in several models, often with tapped chokes and capacitor, and sometime with RC networks alone.

Input Transformers and Input Circuits

Almost all of the amplifiers use push-pull output of some kind, with class A and AB being the most common. This type of amplification requires the use of some kind of input transformer with a center-tapped secondary, or a phase inverter. The earlier models used the transformers, or center-tapped chokes across the grid, capacitively fed. The windings of these transformers are

Phono SERVICING

Features of Special Circuits and Components Used in Juke-Box Amplifiers (Rock-Ola, Wurlitzer and Seeburg) With Which Service Men Should Be Familiar to Insure Profitable Servicing Calls.

subject to electrolysis, with unbalance resulting, and thus both halves of the chokes must be checked carefully. A minor difference in resistance (50 to 75 ohms) between the two halves of a center-tapped transformer is normal, due to difference in the physical distance of the two halves of the windings from the core. However, any large difference in resistance should be investigated. In the Seeburg models there are split-secondary input transformers and RC networks from the low ends to ground, for tone compensation. Small resistors, 330 ohms in this case, are in series with the grids, for suppression of parasitic *hf* oscillations in the power stage.

Wurlitzer uses what appears to be a conventional input transformer, but it is connected as a cathode-follower, from the '76 (driver) into the grids of the 6L6s in the power stage. This is an unusual circuit and warrants close attention.

Rock-Ola uses input transformers with the primary shunt fed. The plate voltage is applied through a 50,000-ohm resistor to the driver tube. In this case, it is necessary to look out for leaky coupling capacitors, as a high leakage will cause saturation of the core, with resultant loss of volume and distortion.

Power Tubes and Power Supplies

In the older amplifiers, tubes like the '45, '42, and 6B5 will be found, while in the later models the 6L6 is the most popular. Rectifiers used include the 5Z4, 5R4, 5U4 and the old reliable 5Z3. Wurlitzer used a '45 as a bias rectifier in their model P-400 to supply the high bias voltages required for the '45s. Seeburg used an '80 in a somewhat similar circuit.

In the older model Wurlitzers, a pair of two-volt tubes were used in the preamp and driver stages; two '30s, or a 1B5 and a 30, the usual arrangement. These filaments were supplied by a bleeder resistor in the last few volts of the high-voltage supply. The filament voltage must be watched closely on

by **JACK DARR**

Quachita Radio Service

these tubes, since shorts or leakage in the high-voltage will sometimes cause paralysis of the filaments. The 1B5s often have a tendency to be microphonic. Replacement is the only cure.

Power supplies are more or less conventional, with the exception of the separate bias supply just mentioned, and this will be found only in the older models. In almost all of these amplifiers, a jumper will be found in the speaker plug to open either the *ac* or the B-minus line, when the speaker plug is pulled; Fig. 1.

To have the amplifier warmed up sufficiently to operate by the time the record reaches the playing position after a coin is inserted, some form of *quick-starting* device is necessary. The two-volt tubes, together with the '45s in the output did the job in the older models. The 6L6s posed a different problem. Rock-Ola solved it a rather novel way; Fig. 5. They inserted a 200-ohm relay into the cathode of 6L6s. When the amplifier was off, the contacts of the relay (*spdt*), connected the 6L6 filaments to a ten-volt tap on the power transformer. When the amplifier was turned on, the high-filament voltage caused the power tubes to heat up quickly, and when sufficient current was being drawn to close the

Fig. 5. The quick-heater relay system used in the Rock-Ola instruments.

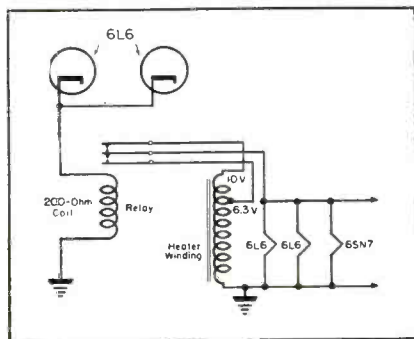

relay, the filaments were returned to their normal six volts.

In some Wurlitzer and Rock-Ola models, a .2 or .25-mfd capacitor (mostly 200-volt type) was connected across the filter choke. Replacement with 600-volt types has been found to provide best results. A disastrous failure was experienced recently because of the use of low-voltage units. New filters had been installed, and the amplifier in service only a few hours, when this capacitor blew. The consequent overload blew the rectifier tube, the filament fell over and shorted to the plate, applying the high-voltage *ac* to the filter capacitor. The results were spectacular, though somewhat exasperating!

Output Transformers and Circuits

Output transformers are more or less conventional. These are heavy-duty units, and failures are rare. Output connections for one speaker, with a winding tapped for two, are a common arrangement. When the extra speaker is connected by a plug, a dummy plug with appropriate jumpers is inserted in the extra-speaker socket; *Wurlitzer*. Inverse feedback seems to be rare in these amplifiers, especially where feedback voltage is taken off the voice coil. The speakers themselves are usually from 12" to 15" electro-dynamics, with field resistances ranging from 4,500 to 5,500 ohms. Extra or extension speakers are usually *pms* of whatever size is necessary, and 8-ohm voice coils seem to predominate.

Remote Controls, Direct and Wireless

There are numerous remote-control arrangements provided with these units, of the wired and wireless types. The wired type is merely an extension, through multi-conductor cables, of the various functions of the selector switches, etc., in the main cabinet. The wireless type consists of a small transmitter with a selector mechanism, usually of the *stepper* type, and the

(Continued on page 34)

SERVICING

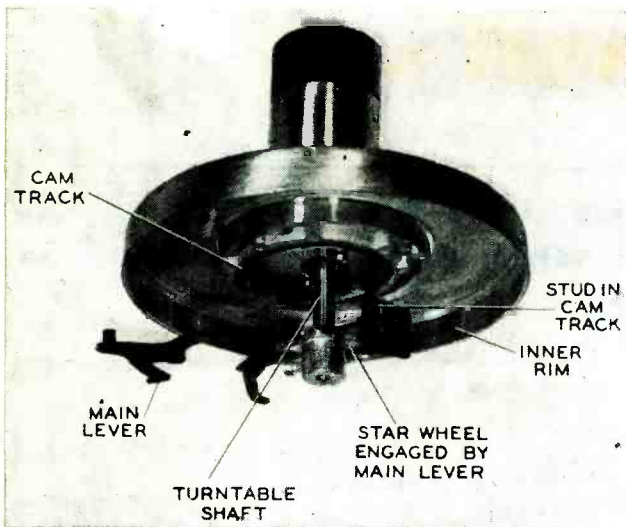

Locations of the turntable shaft, main lever and star wheel.

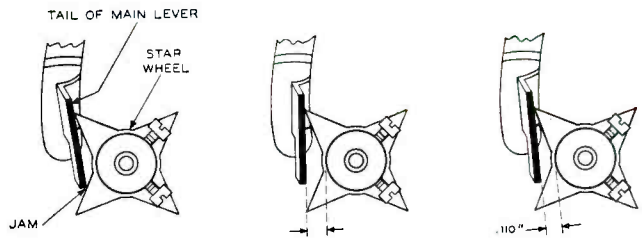

Setting the tail of the main lever in cycle: At extreme left, lever is too near the star wheel, causing jamming; at center, lever is too far away causing failure to drop records; at right, the correct setting is shown.

ANY COMBINATION of motors, gears, tubes and electrical circuits designed for operation by the lay public is bound to require some measure of servicing in its lifetime. The 45-rpm record changer,¹ with all its advantages of streamlined design, and a minimum of moving parts,² is no exception, for there will always be a degree of careless handling by adults and *exploring* by youngsters.

One of the questions most asked of Service Men by their customers today is how conventional 78-rpm instruments already in the home can be conveniently supplemented with the 45-rpm system. The answer is an automatic record player attachment, model 9JY.³ By means of a dual switch⁴ this attachment can be connected to almost any radio-phono that already has a record player. The switch permits the operator to select at will the 78-rpm changer in the cabinet or the new 45-rpm attachment. With this same switch, it is also possible to connect

by THOMAS Y. FLYTHE

Field Supervisor
RCA Service Company, Inc.

any two-record player attachments (a 45-rpm system, and a 78-rpm system, for example) so that they play through a standard radio. This switch is mounted on the rear of the cabinet, and the connections are simple.

¹Because the 45-rpm changer represents a new approach to the science of reproducing recorded music, the RCA Service Company has launched a training program designed to acquaint its distributors, their dealers, and the nation's independent radio and phonograph Service Men with its operation and mechanical features. The program, begun last month, will send company representatives on an instruction tour of 68 cities from coast to coast. Through talks, slide presentations, and actual demonstrations, they will offer practical service information and methods for connecting the 45-rpm record changer to conventional receivers and combinations. Invitations to independent Service Men will be extended locally by RCA Victor distributors sponsoring the meetings in their areas.

²The changer has 25% fewer parts than conventional changers.

For radios not equipped with a phono jack, there is a radio-phono switch⁵ which permits instant change-over from radio operation to the 45-rpm record player attachment.

The reduction of the turntable speed on the new changers to 45 rpm has made it possible to attach the changer cam directly to the turntable, thereby eliminating the speed reduction mechanism through which this cam is driven in conventional changers. Housing the drop mechanism in a 1½" turntable spindle has resulted in fewer parts. Many of the racks, cams, bearings, sleeves, shafts, screws, and other items normally required in post-type changers have been eliminated. Another factor influencing the simplicity of the 45 rpm changer is the common diameter trip. Many other record changers require complicated trip mechanisms to compensate for the variations in record dimensions. By making a record and changer of complementary design, it was possible to

Steps which should be followed in inserting the crystal in pickup. The loosening of the pivot screw is all that is required to remove the crystal.

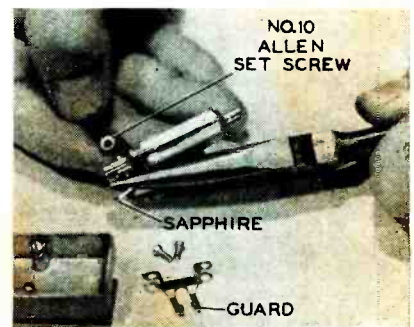
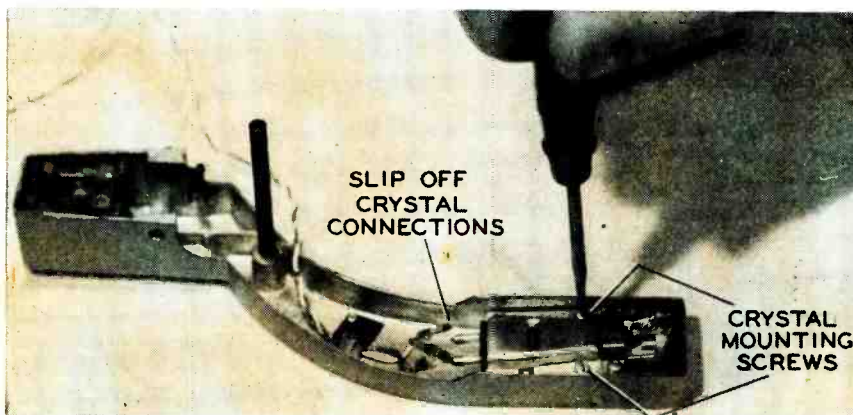

45-RPM Changers

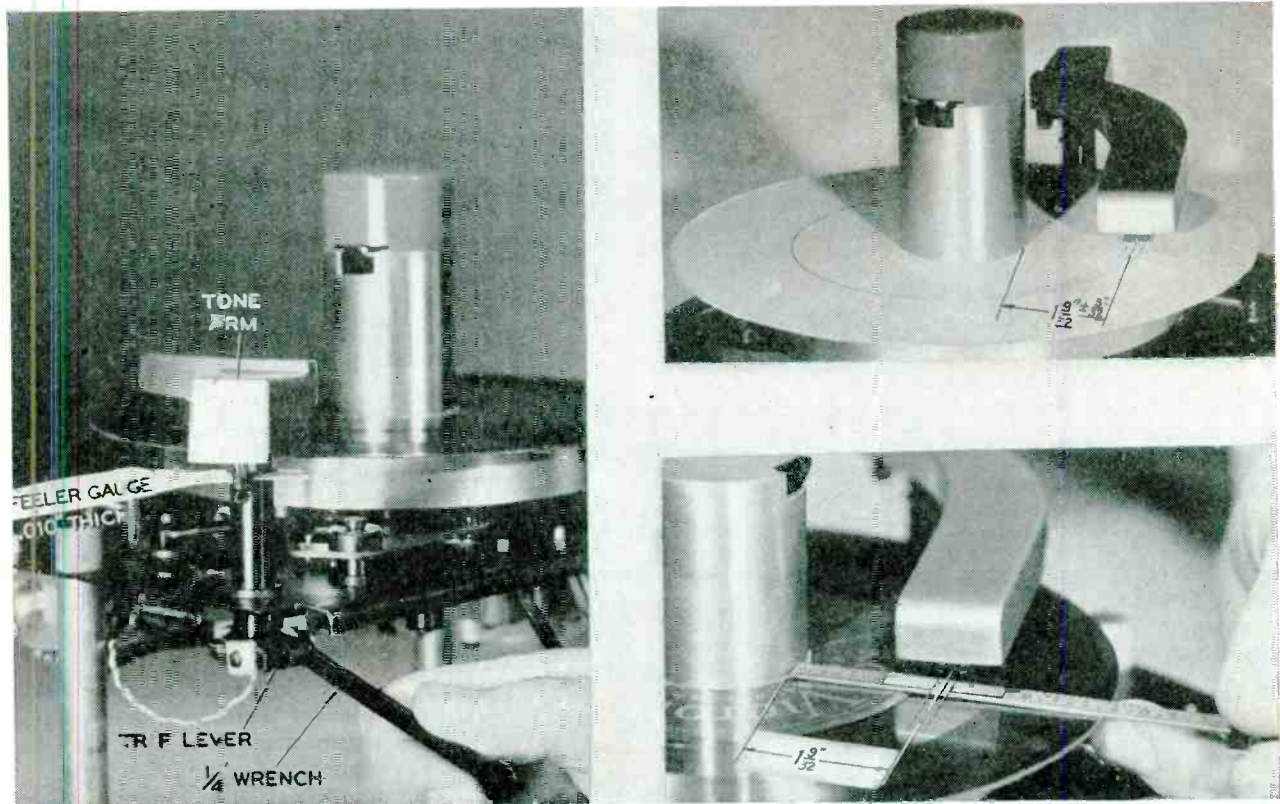

Tripping adjustments. View at left shows how a wrench is used to make an adjustment. Top, right, and bottom views illustrate measurement of distances between the needle in the cartridge and the spindle, with a feeler gauge.

eliminate the variations and employ a common trip.

However, while we stress the simplicity of the 45 rpm changer, Service Men know that servicing record changers is not an amateur's job. If we analyze the requirements of a good record changer Service Man, we find he must be a good mechanic and a good electrician, have proper tools, and be able to determine from observation what course he should pursue to make the necessary repairs.

From a knowledge standpoint, the

Service Man should be very familiar with the technical service data on the particular changer that he is going to service. Also, all supplementary information which has been issued since the original service data, should be studied closely. Knowledge achieved by studying and observing is a major key to servicing success. Common

sense is another definite requirement.

Proper servicing of the 45-rpm changer requires proper tools and lubricants. Oil⁶ should be used for slow-speed bearings and general lubrication, but not for oiling the motor. Singer household sewing machine oil should be used for the motor bearings. Grease⁶ should be used on the cam track. A quarter-inch wrench is useful for loosening and tightening certain cap screws, particularly the one which holds the trip lever to the vertical pivot shaft. In many locations a quarter-

⁶Available through RCA distributors.

⁷Type 202W1.

⁸Type 240X1.

Tools Required . . . How to make Adjustments On the Star Wheel for Timing . . . Setting of the Tail of the Main Lever . . . Pickup and Sapphire Replacement Procedures . . . Adjusting Tone Arm Pivot, Sapphire Height Above Motorboard, Tripping and Landing, Tone Arm Height In Cycle Muting Switch, Turntable and Spindle Separator Mechanism . . . Installing Record-Player Switches.

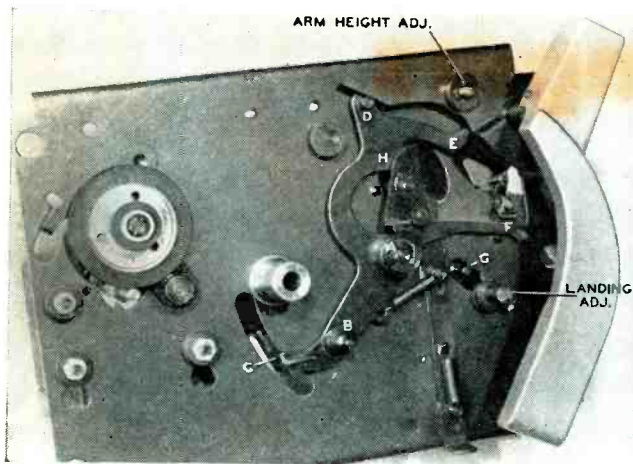

Arm height and land adjustment procedure. *B* is the height-adjustment screw which regulates the tone arm height during the cycle.

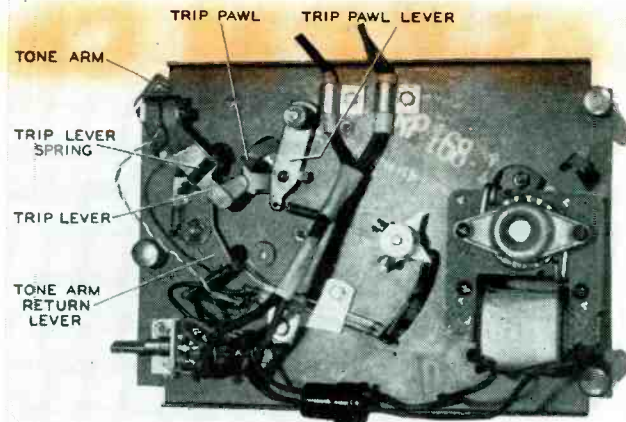

An underside view of the changer mechanism showing the trip pawl, trip pawl lever, tone arm, etc.

inch spin-tight can be used. A fine stone is the best means for smoothing off any rough edges on levers or other working parts.

To check the pickup pressure, a scale which will measure 5 grams is desirable. A good magnifying glass is necessary to examine sapphires. You cannot rub the .0009" diameter sapphire across your finger nail to test whether it is chipped. A feeler gauge or a .010" thick card should be used when adjusting the vertical play or clearance in the tone arm vertical pivot shaft. The standard shipping guard should be employed to protect the sapphire from damage when servicing or moving the changer. When such a guard is not available, tape may be used. A No. 10 Allen set-screw works nicely as a socket wrench for loosening or tightening the nut that holds the sapphire in the crystal cartridge. A No. 6 Bristo wrench is required on some changers to fit the Bristo screws which hold the star wheel in place.

One of the most necessary tools for servicing record changers is a complete set of records. You cannot test a record changer unless you play rec-

ords on it to be sure that everything is correct. A stroboscope is also very desirable to check speed. Another important tool needed is the soldering iron to unsolder and resolder the crystal pickup cable at the muting switch.

Other items which may be required include:

- (1) An audio amplifier or other suitable means of checking a crystal pickup.
- (2) Shielded cable to connect the changer to an amplifier.
- (3) Stand or frame to hold the changer while rendering service.
- (4) Fluorescent or neon lamp to use in conjunction with the stroboscope to determine speed.

While it would be impossible to anticipate all of the various service problems Service Men may encounter, a review of the changer's essential components and methods for adjusting or servicing them may prove helpful.

The sequence of making adjustments on any changer is important. The fol-

lowing adjustments are indicated in the sequence in which they should be made.

Star Wheel Timing

The star wheel must be fastened to the drive gear shaft so that it is properly related to the separator parts. To do this, the drive gear shaft must be rotated by hand (turntable assembled to motor board, of course) while your fingers are held against the separator shelves at the top, thus pressing them into the spindle. The shaft should be turned one way until the separator blade nose hits your finger. Then the shaft should be turned in the opposite direction until the separator blade heel hits your finger. You must determine the shaft position half way between these two positions. Then the star wheel must be placed on the shaft so that one tooth points to the center of the record shelf on that side of the spindle and the screws then tightened. You can point one tooth at a cam screw for the same results. Recheck after tightening screws on the star wheel.

Setting Tail of Main Lever

The tail of the main lever stops the star wheel. If this is set too close to the star wheel, it will jam; if too far away, it will cause erratic record dropping. At the ragged edge, every third record may fail to drop. The correct setting is .110" from the hub of the star wheel to the inside surface of the lever when in the center of the change cycle.

The diameter of a No. 4-40 machine screw (.112") makes a convenient gauge for determining the correct setting. If you are in doubt, and have no way to measure, the end should be moved toward the star wheel until most of the play is removed when you move

Circuit of the amplifier used in the 45-rpm, model 9EY3, unit. The prong-like ground shown at the motor board, plug and filter positions is the chassis ground. The standard ground symbol applies to the common ground or *B*.

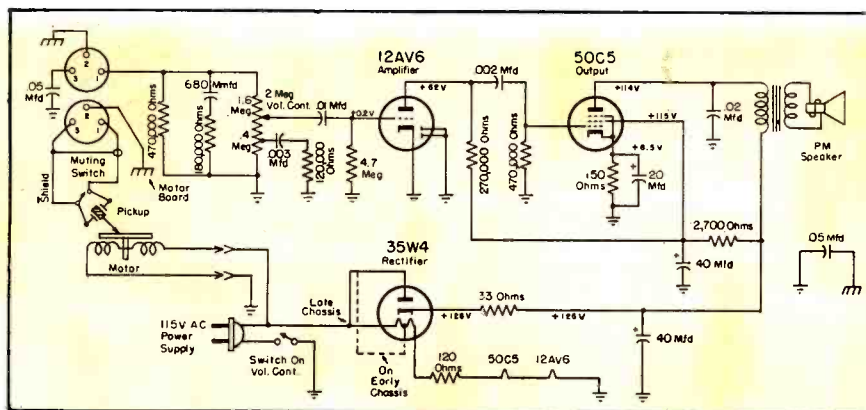

the star wheel back and forth at this setting.

Pickup and Sapphire Replacement

The crystal cartridge is very easy to change, requiring only the removal of two screws and the two slip-on terminals to detach it from the tone arm. By loosening the pivot screw, lifting the arm up, and turning it over, the crystal may be removed without unsoldering the leads. This eliminates removing the trip lever. You should make certain that you get the pivot screw adjustment correct if you do use this method of servicing. No soldering is required unless the arm is removed from the record changer.

Replacing the sapphire is equally easy. The crystal is removed from the tone arm. The sapphire guard is detached by removing its two screws. A pair of long nose pliers is very convenient for holding the assembly, and a No. 10 Allen set screw makes an excellent socket wrench for loosening and tightening the nut, on the crystal cartridge. The nut must not be over-tightened; this may break the shank or damage the crystal itself.

Adjusting Tone Arm Pivot

The tone arm is held on the vertical pivot shaft by means of two pointed pivots. One is permanently fastened to the inside of the tone arm; the other is a cone-pointed adjustable screw, locked in position by means of a separate screw. Correct adjustment requires just the slightest bit of play at the pivot point. If this adjustment is too loose, failure to trip, or intermittent tripping, as well as erratic landing, may result. If the pivot screw is too tight, the tone arm will bind. The adjustment must always be rechecked after tightening the locking screw, to make sure that this has not changed the pivot screw adjustment.

To test, the trip lever should be held and the pickup end of the tone arm gently moved back and forth. The movement at the pickup, due to play in the pivots, should not exceed about $\frac{1}{32}$ ". You should make sure that there is some play to prevent binding.

Sapphire Height Above Motorboard

The next adjustment is the tone arm height above the motorboard when in the *out-of-cycle* or playing position. The sapphire must not touch the motorboard, yet it must be low enough to properly play the first record. The adjustment is made without any records on the turntable. The distance between the sapphire and the motor-

board should be measured when the arm is positioned between its rest and the turntable's edge. There should be $\frac{1}{8}$ " clearance between the sapphire and the motorboard. If the distance is incorrect, the adjusting lug, located under the arm just forward of the tone arm shaft should be bent up or down, as the case requires, and the test repeated. This should be continued until the spacing is correct.

Tripping Adjustment

The tripping adjustment is made by proper angular positioning of the trip lever in relation to that of the tone arm. Before attempting to make this adjustment, you must make sure that the vertical pivot shaft on which the trip lever is mounted has some play to prevent binding. This play should not be excessive, otherwise trouble may be encountered. To establish proper clearance, a feeler gauge about .010" thick should be used. As a substitute you can use an ordinary business card with a U slot cut into one end. This slot should be just big enough to fit around the tone arm shaft. This card should be slid in just under the top washer. Then the trip lever should be slid in up on the bottom of the shaft until it just takes up play. You are now ready to proceed with the tripping adjustment.

One of the easiest ways of making the tripping adjustment is to place on the turntable a cardboard disc on which you have marked a line $1\frac{3}{8}$ " from the nearest point of the spindle. (This can also be done with a scale instead of the cardboard disc.) With the turntable revolving at its normal speed, the cardboard disc should be held so that it does not turn with the turntable. Then the tone arm should be moved inward very slowly until it trips, releasing your hand at this instant to permit normal cycling. Notice just where the sapphire is located when tripping occurs. If it occurs before the $1\frac{3}{8}$ " line is reached, the trip lever should be moved just a little counterclockwise, looking down from the top, to make up for this difference. This should be repeated, moving the lever whichever way is required until tripping is obtained exactly at the center marking. After this, the trip lever can be tightened and the test repeated to make certain the adjustment has not been changed by tightening the lever.

Landing Adjustment

After the tripping adjustment is correctly set, it is necessary to make the landing adjustment. A normal record should be placed on the turntable

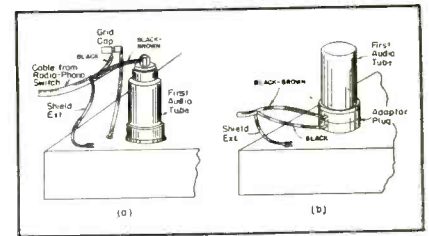

Hookups required when the 45-rpm system is used in a receiver using a first audio tube with a top grid cap (left), or a first audio tube of the 6SQ7, 6SR7, 12SQ7 or 12SR7 types (right).

and the changer run through its cycle until the arm is just ready to land.

In the correct adjustment, the sapphire lands halfway between the edge of the record and the first music groove or $2\frac{5}{8}$ " from the nearest side of the spindle. If it is not half way between these two, a screw adjustment is needed. To make the adjustment, the changer should be run to an *out-of-cycle* position and the tone arm placed on its rest. The landing adjustment screw should then be turned slightly in one direction and the changer tested to see whether the landing has improved. If it has improved, but not enough, the screw can be turned in the same direction until properly adjusted. If it has gotten worse, the screw must be turned the other way. This landing adjustment screw is shown in the customer's operation instructions as item A.

Tone Arm Height in Cycle

The next adjustment is for tone arm height during the change cycle. The object is to make certain that the arm raises high enough during the change cycle to land on the topmost record of a stack made up of the required number, but does not hit against the bot-

(Continued on page 36)

The 202W1 switch installed to permit use of a 45 rpm unit in a radio-phono combination.

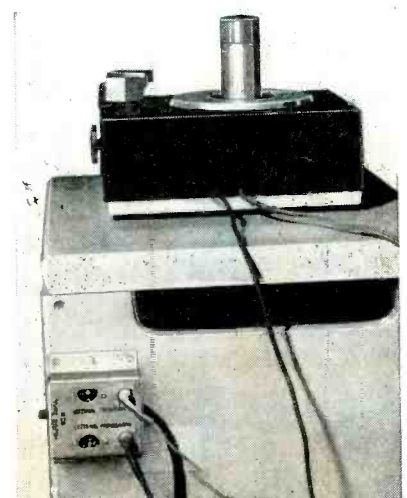

Constant Voltage Sources for TV Receivers



View of the constant-voltage transformer.

Characteristics of Line Voltages Which Affect Pictures and Equipment Which Can Be Used to Solve the Problem.

by **HANS U. HJERMSTAD**

Assistant to President

Sola Electric Company

LINE-VOLTAGE fluctuations often have a serious effect on television reception, particularly on the picture quality and tuning. There are two basic types of fluctuations which contribute to this problem:

(1) Line voltages that change over a long period of time, wherein the voltage will change from a low to a high value over a period of minutes or hours depending upon the load on the various circuits of the power distribution system.

(2) Voltage fluctuations which are rapid in nature. These voltage fluctuations are usually caused by the starting of motors, refrigerators or other household appliances which individually cause a line-voltage fluctuation. On some power circuits it has been observed that these collective fluctuations occur quite rapidly, frequently as often as six cycles per second. This effect literally constitutes a modulation of the line voltage. These observed line voltage fluctuations frequently have not been greater than one or two volts.

With a gradual change in line voltage the viewer will note that: (1) picture size will vary; (2) the horizontal and width controls will have to be altered; (3) brightness and the contrast controls will require readjustment;

(4) in some cases the vertical controls will be critical; and (5) there will be considerable change in the local oscillator frequency, requiring readjustment of tuning.

A rapid fluctuation in the line voltage results in an odd effect, the dimension of the picture appearing to change rapidly. On certain types of sets, it has been observed that a $1\frac{1}{2}$ -volt line modulation will cause as much as $\frac{1}{8}$ " to $\frac{1}{4}$ " deflection of the outer circle of the test pattern. This constant fluctuation of line voltage appears as though the subject literally had the jitters and the flicker becomes very annoying.

It has been found possible to eliminate these deficiencies due to line voltage fluctuation, with a constant-voltage type transformer,¹ as illustrated above. This unit, designed so as to take care of various *va* ratings of television receivers, is connected between the TV receiver and the wall receptacle.

How the Unit Works

In this transformer, the primary is arranged so that it can be connected

to the normal 117-volt line, and the secondary is loosely coupled to the primary by means of a magnetic shunt. The inductance of the secondary winding is tuned to resonance by means of a capacitance, C_1 . By having this circuit operating at resonance, a maximum amount of current is developed, resulting in that portion of the core becoming saturated. Because of this saturation, the secondary voltage is practically immune to primary changes over a wide range of voltage. This constant-voltage transformer is, therefore, also not affected by the type of load and the amount of load placed upon it up to its *va* rating; that is, it will regulate up to its total *va* rating and load does not affect its regulation to that point.

A portion of the voltage generated in the secondary of the *c-v* transformer is connected to the output receptacle to provide a nominal of 117 volts for the operation of the television receiver. This is so arranged that the TV set plug can be inserted at point, P_1 , in the circuit. Upon the closure of the receiver switch, SW_1 , the relay coil and set are energized over the normally-closed con-

(Continued on page 41)

¹Sola CVA 7202 (300 *va*).

Plot illustrating output voltages available at full and 60% load.

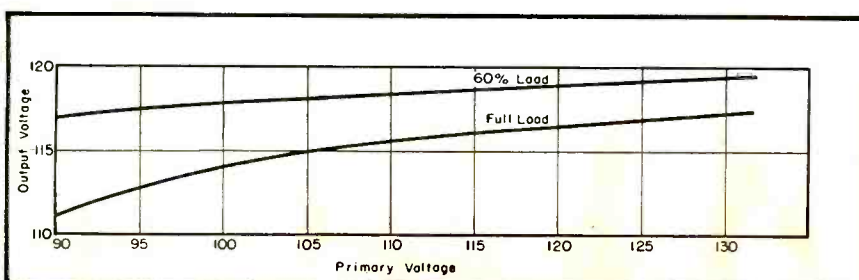

Wiring diagram of the transformer circuit.

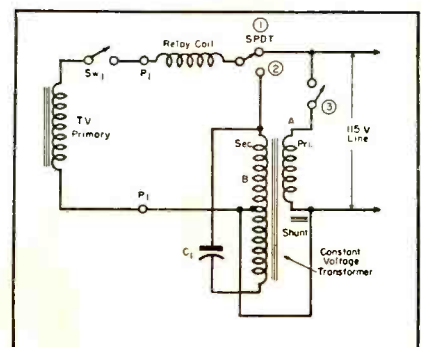

Relax!

LET NEW HYTRON TUBE LIFTER DO THE WORK



Give your nerves, sweat glands, and fried fingers a rest! *Lift* 'em all the e-a-s-y way from meanest sockets. Tubes - GT, G, standard, metal, lock-in. Also vibrators and plugs - Jones, Amphenol. And snap-in trimounts holding back covers of radios, etc. Handy knob puller too.

Stainless steel. Comfortable rolled edges. Another Hytron time-and-money saver by and for servicemen. *Only 15¢* from Hytron jobbers. Get your Hytron Tube Lifter today.



15¢ net

SIMPLE AS ABC - Disconnect set from line. Tip tube (vibrator or plug) slightly. Insert tapered end of Lifter under base with one hand. With other, guide tube vertically. Press Lifter handle backwards or sidewise. Effortlessly, out comes tube pronto!

Right-angle end of Lifter for compact auto radios. Pulls knobs when hocked around back of knob

with thumb and forefinger steadying sides of knob.

Slotted 45-degree-angle end reaches tubes from rear of cabinet. Slot fits around one pin of lock-in applying leverage near center of metal base - safely away from glass seals. This end lifts snap-in trimounts. And stubborn knobs, if cabinet is protected from heel of angle by cardboard.

NEW HYTRON ALL-WAYS CARTON

Has type number of tube imprinted *twice* on both ends. Half the dual imprint (generously large, easily read) of the type number is always right side up. Stack the *All-Ways* carton any way; you can't go wrong.

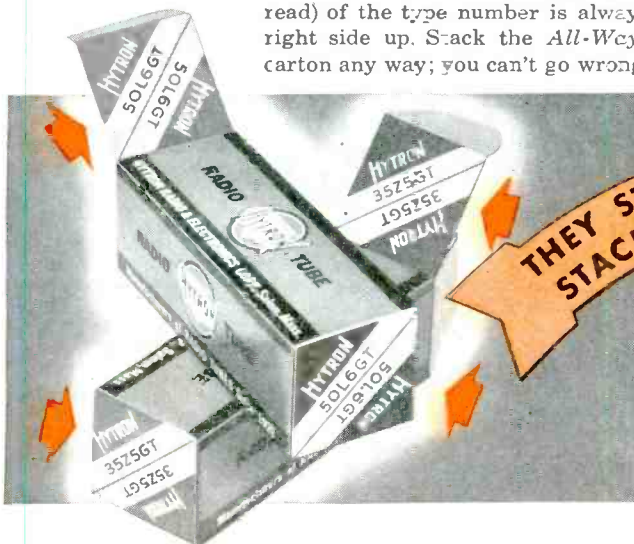

THEY STAY STACKED

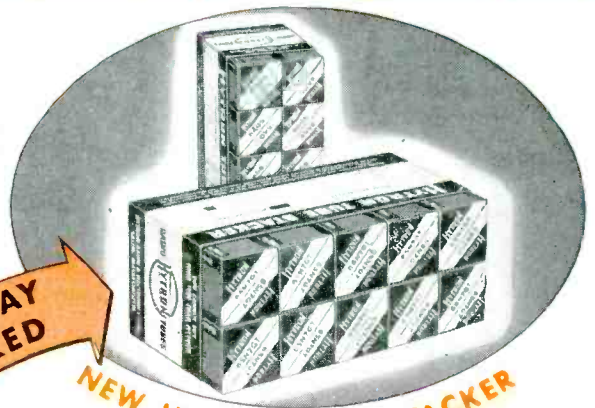

NEW HYTRON TUBE STACKER

Handy way to buy and stack tubes. Holds 10 cartons neatly - safely - compactly. Inventory where you can see it. Choice of horizontal or vertical stacking. Removal of cartons leaves shelves still neat; yet reminds you to re-order. Two Stackers: For miniatures; for GT, metal, lock-in. *Free* from your Hytron jobber.

SPECIALISTS IN RADIO RECEIVING TUBES SINCE 1921



HYTRON

RADIO AND ELECTRONICS CORP.



MAIN OFFICE: SALEM, MASSACHUSETTS

SERVICE, JUNE, 1949 • 17

PHONO *installation and service*



Three-speed automatic phono player. (Courtesy Markel Electric)



A three-speed player, with a 10 watt amplifier, for 78, 33 $\frac{1}{3}$ and 45 rpm home records and 33 $\frac{1}{3}$ rpm broadcast type recordings. (Courtesy Newcomb Audio)

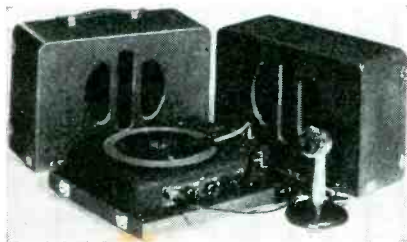

A three-speed transcription player. (Courtesy Califone)

A home-receiver type three-speed changer. (Courtesy V-M)



by KENNETH STEWART

THE NEEDLE-CHANGING mechanisms of the new long-playing¹ record changers have many unusual features.

In the system used in the Westinghouse model V-6267 changer, for example, there is a 2-position needle control. The dual tip needle extends through the crystal cartridge in such a manner that the standard tip is on one side of the cartridge and the fine tip is on the other side. By turning the needle control, the cartridge is rotated so that the desired needle tip is brought into play. At the same time a chain and spring arrangement in the pickup arm changes the needle pressure to correspond with the needle tip in use. When the needle control is turned to bring the fine tip into play (*slow* position), a chain winds around the hub on the cartridge swivel and applies tension to a wire spring which extends along the pickup arm to a bracket on the pickup arm hinge pin. The tension of the spring then lightens the needle pressure. If necessary, the spring tension can be varied by bending the metal bracket on the hinge pin

¹The 33 $\frac{1}{3}$ rpm records require the use of a finer needle tip than is used for the standard 78 rpm records. In addition, the needle pressure must be less (8 grams, ± 2 grams) for the long-playing records, than for the standard records (1 ounce $\pm \frac{1}{4}$ ounce).

Cross-sectional view of a three-speed record player which features a speed change spindle. In the *up* position, the changer is set for the long-playing records of 33 $\frac{1}{3}$ or 45 rpm type, and in the *down* position, the standard 78 rpm records can be used. (Courtesy Scott Radio Labs.)

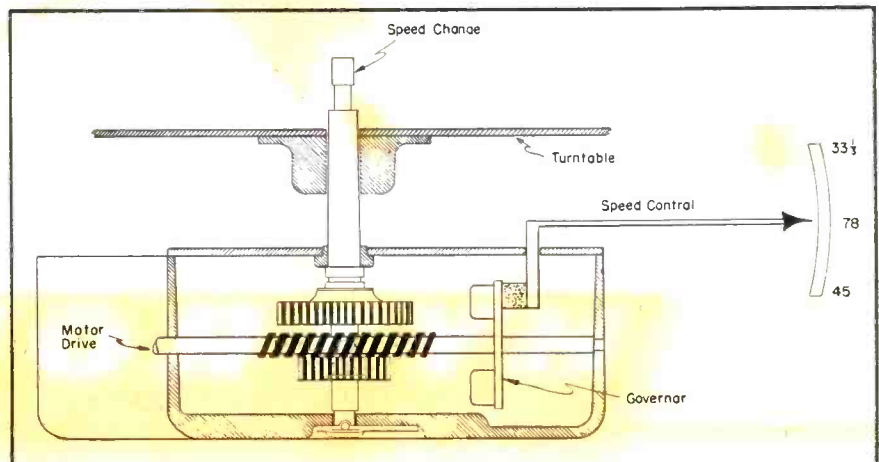

to obtain the required needle pressure of 8 grams. With the needle control in the standard position, the chain is not wound around the cartridge swivel hub, and there is no tension on the spring; thus, a 1-ounce needle pressure results.

Speed Changing Mechanisms

The speed control on the V-6267 changer provides a means of obtaining the two required turntable speeds, the control governing the position of the idler drive wheel through a link assembly. In one position, the drive wheel bears against the larger diameter portion of the motor armature shaft; this results in a turntable speed of 78 rpm. In the other position, the drive wheel is elevated so as to bear against the small diameter portion of the armature shaft, and a turntable speed of 33 $\frac{1}{3}$ rpm results.

Skipping Grooves on LP Operation²

The operation of long-playing records is much more critical than that of standard records. Because the pressure of the stylus is only a few grams, the danger of skipping grooves is increased and special precautions have to be taken to avoid it. In most cases, skipping is caused by binding of the pickup arm. Under no circumstances should an increase in stylus pressure be used as a cure. This will cause rapid wear of the stylus and the record

Characteristics of Needle-Changer Mechanisms of Long-Playing Combination Changers . . . How to Curb Groove Skipping and Minimize Hum-to-Signal Noise Ratios on Microgroove Record Players . . . Features of Three Speed Changers, Record Players and Assemblies.

alike. Recommended values of stylus pressure and pickup arm friction are:

Vertical friction...	1 gram
Lateral friction...	3 grams
Trip pressure....	4 grams
LP stylus pressure	6½ to 8½ grams
Maximum change in stylus pressure from one record to full stack	2 grams

The light stylus pressure makes it necessary that the disc must be absolutely level. This can be checked with a level or the improvement of operation noted by slightly lifting the record changer.

The lateral movement of the pickup arm should be checked for minimum friction. The pickup arm pivot shaft bracket which is riveted to the bottom base plate might have to be bent slightly to decrease the friction. The pivot should be free from dirt and well oiled at the bracket. The upturned end of the bracket should not rub against the tongue of the pickup arm raising disc.

Hum-To-Signal Noise Ratios

Due to the lower output of the pickup cartridge when playing microgroove records (caused by less lateral groove displacement), the hum-to-signal noise ratio is increased. This increase is caused by direct pickup of hum from the magnetic field of the phono motor and, also, by inadequate filtering in the audio amplifier which is apparent when the gain is raised to compensate for low signal input. Accordingly, a four-pole motor is often preferred, especially when there is no magnetic shielding as afforded by a record changer (such as found in plastic or wood cabinet manual record changers). Also, with the use of vinylite, the records must be cleaned regularly to prevent an accumulation of abrasive dust which might cause deterioration of the signal-to-noise ratio.

Three-Speed Changers

The past few weeks have seen the development of several three-speed record changers with many unusual features. In one model³ all three record sizes can be played in all three speeds automatically, and one or both sides of

10" and 12" records can be used continuously, in sequence, without turning the records over.

The changer handles twelve of the 12" 33½ rpm records automatically, playing one or both sides in sequence. The device will automatically play one or both sides of a stack of twelve 10" 33½, twelve 10" and ten 12" 78 rpm discs, or one side of fifteen 33½, ten 45 and twelve 78 rpm 7" records.

Another unusual type three-speed player,⁴ just announced, permits playing of not only the 45 and 33½ home-type records, but the 33½ broadcast-type transcriptions up to 17¼" in diameter and the regular 78 rpm recordings.

The unit incorporates a constant-speed rim-drive governor-controlled motor⁵ and a speed change lever. Featherweight crystal pickups with semi-permanent, replaceable needles are used.

The player is supplied with a 10-watt amplifier, using push-pull 6V6s and inverse feedback. Has an input for mike with separate mike and phono volume controls to permit mixing of

(Continued on page 42)

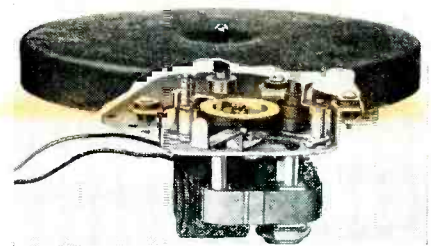

A three-speed phonomotor assembly. (Courtesy Alliance)



Above: Three-speed record player—which is available as a wireless-type player, a plug-in type for sets having a phono input connection and a complete unit with a speaker. (Courtesy John Meck Industries)

²C. E. models P8 and 810.

³Markel Electric Duo Playmaster.

⁴Newcomb Audio Products, model TR16B.

⁵General Industries.

Right: Views illustrating installation of a magnetic cartridge which is available for standard, 33½ or 45 rpm use. (Courtesy Pickering)

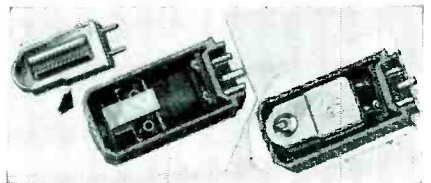

Circuit of a phono preamp designed for a variable reluctance cartridge. The unit has a gain of 35 db at 1,000 cps. (Courtesy G.E.)

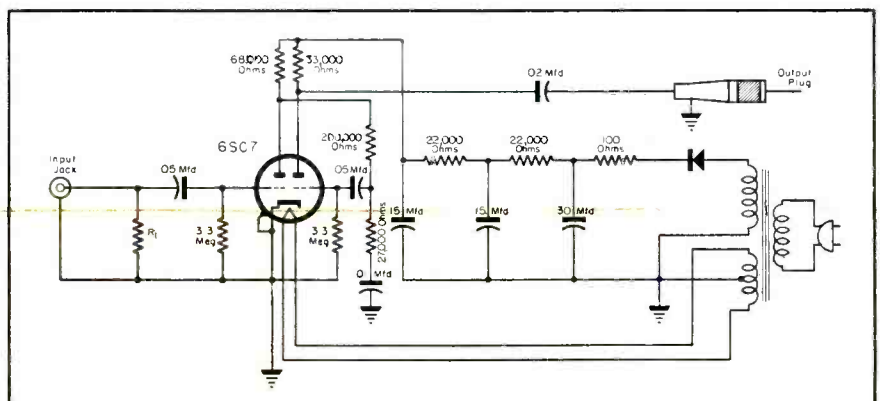

STOP TV JITTERS!

FLUCTUATING VOLTAGE FROM OVERLOADED CIRCUITS THE MAJOR CAUSE OF UNSATISFACTORY TV PERFORMANCE

NOMINAL LINE VOLTAGE
ESTABLISHED BY SET
MANUFACTURER

ACTUAL LINE VOLTAGE
FROM OVERLOADED CIRCUITS
MAY VARY 30% OR MORE

THIS NEW TRANSFORMER, OPERATING ON THE
PATENTED SOLA CONSTANT VOLTAGE PRINCIPLE,
STABILIZES VOLTAGE WITHIN PERMISSIBLE TOL-
ERANCE REGARDLESS OF LINE VOLTAGE FLUCTUA-
TIONS AS GREAT AS 30%.

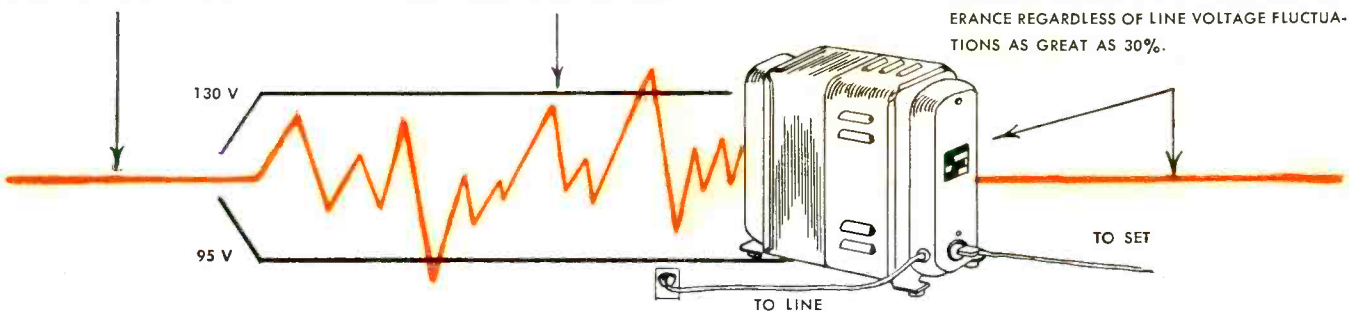

HERE ARE THE ADVANTAGES OF CONSTANT VOLTAGE PROTECTION

NO FLICKER. Most of the flicker in TV receivers is due to small line voltage changes. By eliminating these fluctuations a SOLA CVA eliminates flicker.

NO DISTORTION. The width or horizontal control varies with voltage changes. By eliminating these fluctuations a SOLA CVA eliminates image distortion.

ONLY ONE SETTING is required for vertical control — focus — contrast — brightness and sound. Once all of these controls are established to provide maximum quality in image and tone, no further adjustments due to voltage changes, are required. Constant voltage from a SOLA CVA

maintains the perfect balance necessary for complete, trouble-free enjoyment.

LONGER LIFE for tubes and other components. The danger of component failure is reduced to a minimum since the operating voltage is a fixed value and no dangerous surges can reach vital parts.

AUTOMATIC SWITCH cuts the transformer in and out when the set is turned on or off. The transformer carries no load when the set is not operating.

NO INSTALLATION PROBLEMS — just plug in a SOLA CVA to a regular service outlet — that's all there is to it.

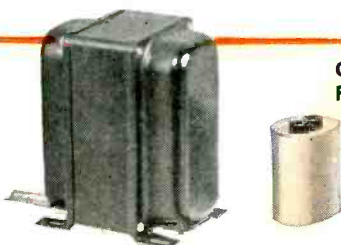

CHASSIS MOUNTED CONSTANT VOLTAGE PROTECTION WILL BE FEATURED IN MANY OF THE NEWER, IMPROVED TV RECEIVERS

After exhaustive field and laboratory tests, this specially designed SOLA Constant Voltage Transformer has been adopted as a "built-in" component for television receivers, and will be a featured improvement in the newer models soon to be released. Its use has established fixed performance values, and facilitated factory and field service adjustments. SOLA engineers invite inquiries from manufacturers who have not yet added this major improvement.

SENSATIONAL *New* SOLA CONSTANT VOLTAGE TRANSFORMER BANISHES FLICKER AND DISTORTION FROM TELEVISION SCREENS

Made under one or more of the following United States Patents Nos. 2,437,450, 2,212,198 - 2,542,211.

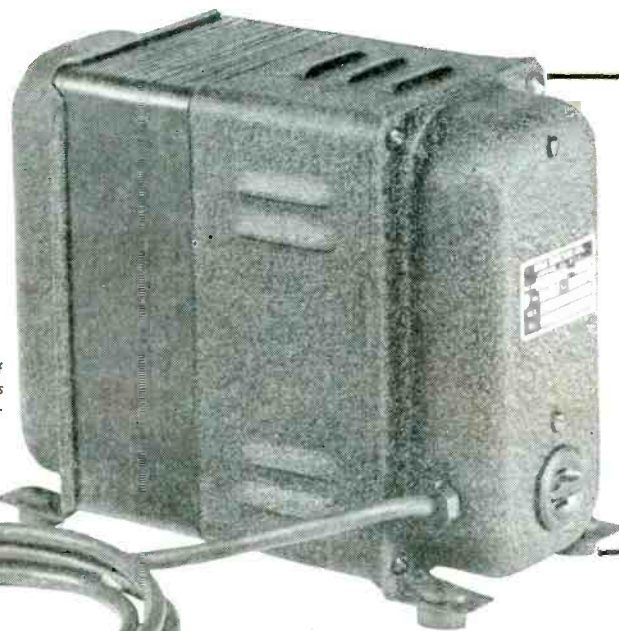

New **PLUG-IN TYPE
CVA SOLA CONSTANT
VOLTAGE TRANSFORMER**

ONLY \$37.50
LIST PRICE — F.O.B. CHICAGO

NEVER BEFORE SUCH FIDELITY

IN TV RECEPTION Watch *any* television set perform on the voltage available from any service outlet. A voltmeter would show you that with every variation on the supply line, something happens on the television screen. It may be flicker . . . it may be distortion . . . it may be a change in the clarity of the picture. Now, plug in a SOLA CVA. It's so easy to see and hear the difference.

This new triumph of SOLA engineering brings out all the fine qualities of television reception, simply by maintaining operating voltage at the manufacturers' rated requirements . . . and more than that . . . it protects costly components against violent voltage surges. The voltage may fluctuate all over the chart (and it usually does) but it reaches the receiver through a SOLA CVA stabilized within a permissible tolerance of less than 3% variation.

**AVAILABLE
NOW**
THROUGH YOUR
ELECTRONICS
WHOLESALE

SOLA *Constant Voltage* TRANSFORMERS

Order a SOLA CVA through your electronics wholesaler TODAY. Demonstrate it on your next service call. Let your customer see for himself what a whale of a difference constant voltage can make.

WRITE FOR BULLETIN 44 CVA-133.

SOLA ELECTRIC COMPANY • 4633 W. 16th STREET • CHICAGO 50, ILLINOIS

SERVICE, JUNE, 1949 • 21

SOUND INSTALLATION

Servicing Helps

SOUND INSTALLATIONS normally present many variables to probe, which can introduce delays and cut into profits. Tables and charts have been developed to simplify the problem and streamline the approach. The use of several simple formulas and some basic *trick* circuits have been found very effective, too, in providing rapid, accurate solutions to complex problems.

For example, there are *rule of thumb* formula data which are extremely handy during any sound assignment.

There are the voltage gain ratios which are very useful: 10:1 is a power gain of 20 db; 100:1 is a power gain of 40 db and 1,000:1 is a power gain of 60 db. Then we have the power gain values: 10:1 is 10 db; 100:1 is 20 db; 1,000:1 is 30 db; 10,000:1 is 40 db; 100,000:1 is 50 db; and 1,000,000:1 is 60 db.

From an understanding of these values and after a period of experience the sound man can evaluate quickly manufacturer's specifications.

The relation between the voltage and power gains are important, too. For instance, a voltage gain of 1.4:1 and a power gain of 2:1 is a 3 db increase in output level which is *smallest practical level increase that the human ear can detect*.

It becomes obvious from the foregoing that if the sound man has a choice of a 15 or a 10-watt amplifier, both of equal quality, he should choose his unit from an economy standpoint only, as the power ratio of 15/10 or 1.5:1 is less than 3 db and therefore of no practical importance.

In comparing the output ratings of any two amplifiers, it is necessary to evaluate the db output with respect to a given reference level; 20 db output from a 6-milliwatt reference level.

(The advent of the term *volume unit* or *vu* has brought about some con-

Simple Formulas Which Can Be Used to Solve Major Installation Problems... How to Use a Few Trick Circuits to Expedite Installations and Improve Results.

by IRA KAMEN

Commercial Radio Sound Corp.

fusion in reference levels, as amplifiers rated against the *vu* reference level have a different rated db output than one rated at the old 6-milliwatt level; a 10-watt amplifier at the 6-milliwatt level is 10/.006 or 32.2 db *rated output*. A 10-watt amplifier at the 1-milliwatt level is 10/.001 or 10,000:1, which according to the *power gain* table is 40-db rated output.)

Reference level information is important. Be sure it is on the amplifier specification.

Decibels can be accurately converted into *watts* without reference to logarithm tables by application of the following formula:

$$\text{Watts} = 2^{(\text{db}/3)} (.006) \text{ or } (.001)$$

To apply, let us suppose we want to find the exact wattage output of an amplifier rated at 30 db at the 6-milliwatt (.006) reference level. Therefore,

$$\text{Watts} = 2^{(30/3)} (.006)$$

$$\text{Watts} = 2^{(10/3)} (.006)$$

$$*\text{Watts} = 2^{10} (.006)$$

$$\text{Watts} = 1,024 (.006)$$

Watts = 6.144, exactly, as if taken from the logarithm tables.

Speakers and Speaker Circuits

The following facts should be known by sound men selecting and installing *speaker circuits and systems*:

Speaker Efficiency: A speaker which is rated as being 10% efficient will deliver 1 watt of sound power for every 10 watts of electrical power applied to its terminals. Actual tests have shown that often speaker efficiency is over rated, with hysteresis, diaphragm and eddy current losses being included in calculations. The RMA standards for loudspeaker measurements include tests which assure maximum speaker efficiency.

Speaker Impedance: The so-called speaker impedance of a packaged unit may be varied by the installation of a transformer whose secondary is connected to the voice coil.

The *impedance* of the primary side of the transformer is selected by determining the amount of power desired for the loudspeaker output level. If it is desirable to take one watt from a ten-watt 50-ohm output amplifier to

(Continued on page 39)

Fig. 1. Circuit used to measure the speaker transformer primary to determine if its X_L is at least four times its impedance rating when its secondary is unloaded.

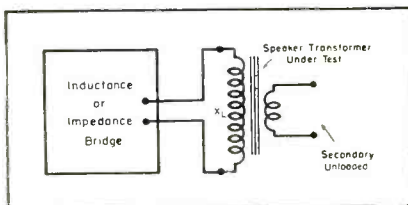
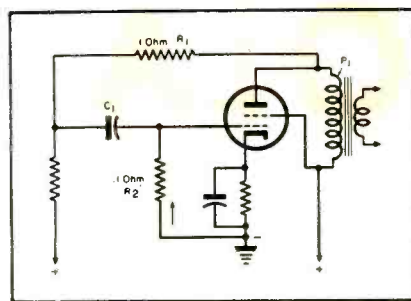
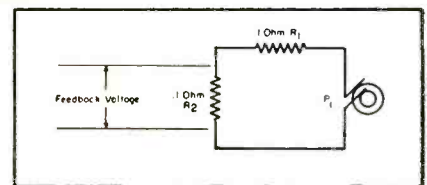

Fig. 2. A typical inverse-feedback circuit in a single-ended amplifier.



*Note 2^{10} is 2 multiplied by itself 10 times which is 1024.

Fig. 3. An effective inverse-feedback voltage-divider circuit.



The Vibrator that Wrote the Book!

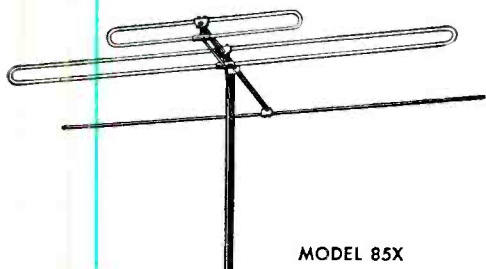
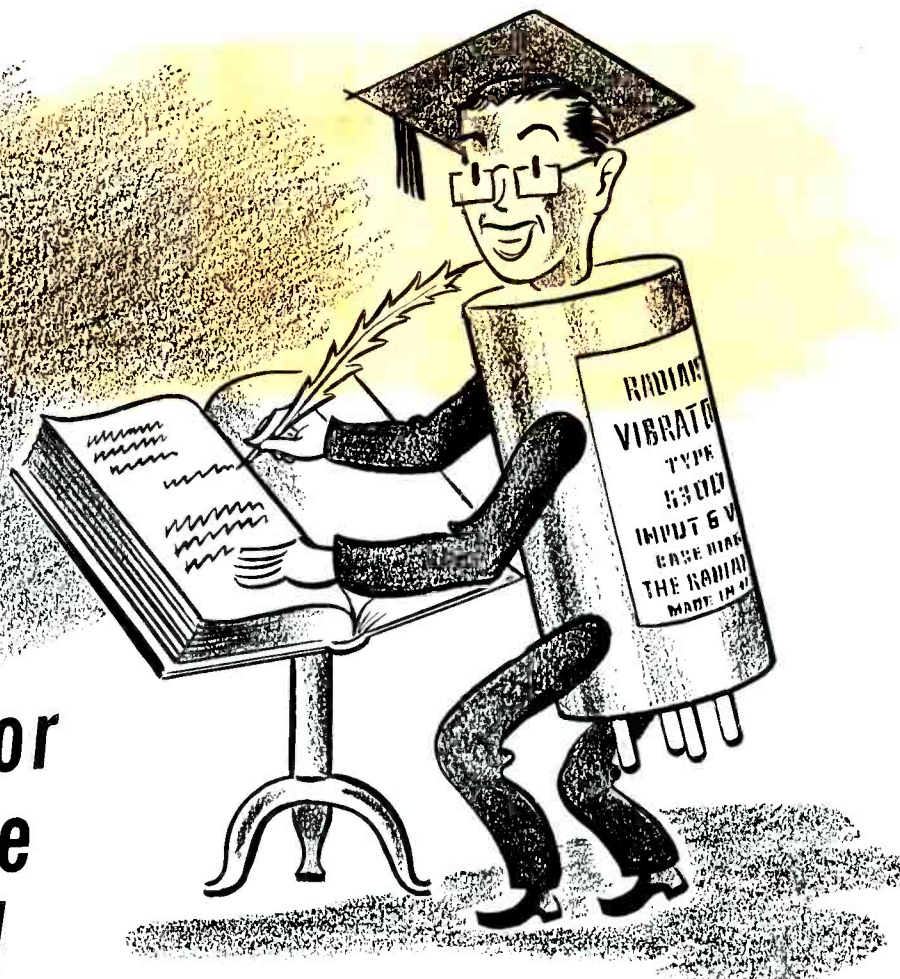

MODEL 85X

**RADIART TV AND FM
ANTENNAS ARE THE
FASTEST GROWING LINE
IN THE COUNTRY...
... MAKING GOOD
TELEVISION... BETTER**

When books are written on vibrator performance . . . and dependability — RADIART RED SEAL VIBRATORS are the ones that do the writing!

Radiart has established and maintained leadership because of its many points of superiority! QUIET • QUICK STARTING . . . DEPENDABLE . . . UNIFORM . . . precision manufacture plus the famous RED SEAL . . . these are a few of the factors that make Radiart Vibrators the preferred vibrator with servicemen and jobbers everywhere! And the "best seller" book in the vibrator field is the Radiart Replacement Guide — the catalog and manual that has become the "bible" of the industry!

For the best deal you can give your customers . . . and for trouble-free service always . . . the best buy always . . . RADIART!

IT'S RIGHT WHEN IT'S RADIART!



THE RADIART CORPORATION
CLEVELAND 2, OHIO

MANUFACTURERS OF THE RADIART TV-FM ANTENNAS AND AUTO AERIALS

First with the Finest in
TELEVISION TUBES!

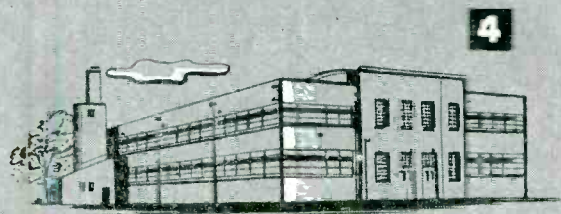
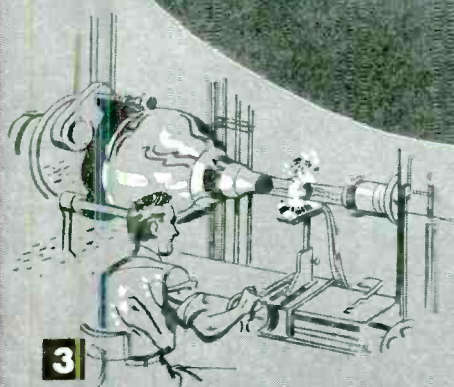
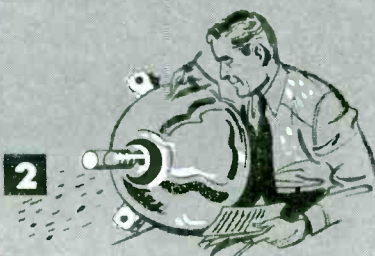
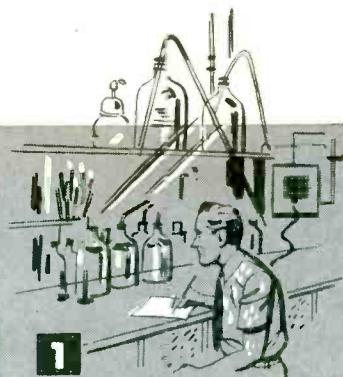
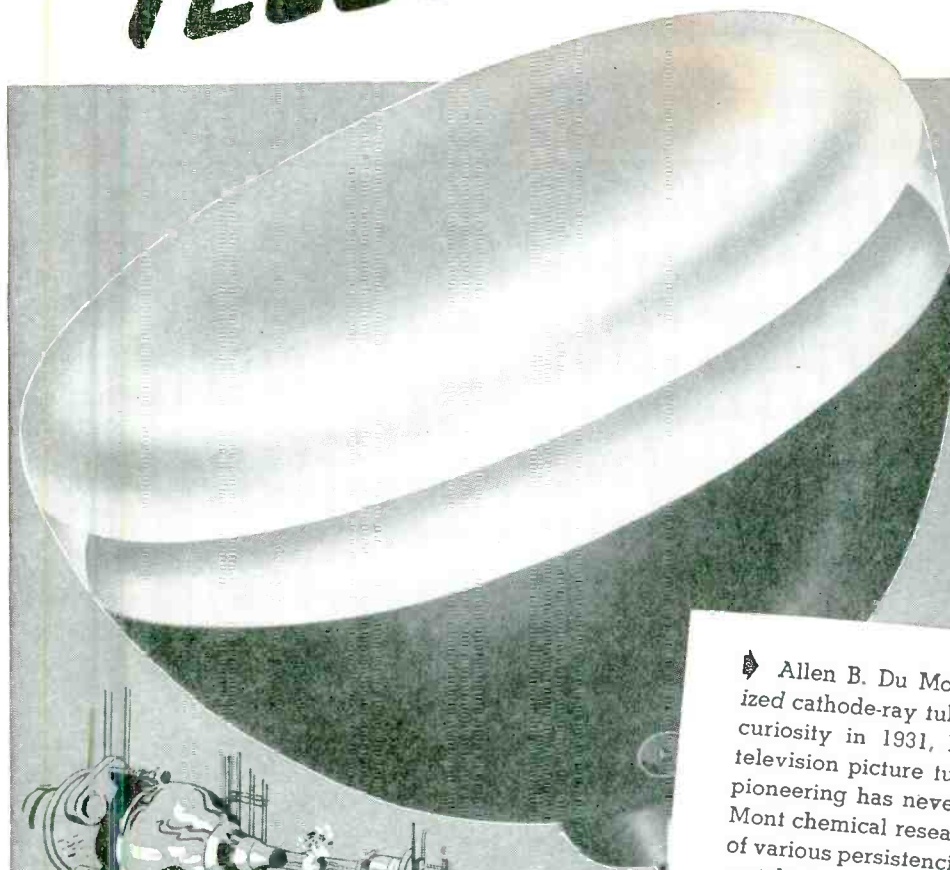

Allen B. Du Mont gave us the commercialized cathode-ray tube. Starting with a scientific curiosity in 1931, he pioneered the practical television picture tube of today. And Du Mont pioneering has never ceased. Examples? **1** Du Mont chemical research has led to tube screens of various persistencies and intensities precisely matched to any television requirements. **2** Du Mont research and development engineers have always led in large television tubes—those 12½", 15" and 20" Teletrons*—because Dr. Du Mont has insisted on "comfortable" viewing. **3** Du Mont craftsmen, provided with the finest glass-working equipment known, can translate advanced tube designs into greater tube values at lesser prices. **4** And to keep pace with the huge and still growing demands, Du Mont quantity-quality production has steadily stepped up, climaxed by the new Allwood plant. Yes, it's Du Mont Teletrons for the "First with the Finest in Television Tubes."

*Trade-mark

© ALLEN B. DU MONT LABORATORIES, INC.

FIRST WITH THE FINEST
 IN TELEVISION TUBES

DU MONT Teletrons

ALLEN B. DU MONT LABORATORIES, INC., TUBE DIVISION, PASSAIC, N. J.



Over 35,000 words of practical information, with more than 130 photographs and drawings covering every conceivable type of installation, based on actual experiences in the field. Topics covered include...

NOW AVAILABLE

THE FIRST PRACTICAL BOOK

ON THE INSTALLING OF TV and FM RECEIVER ANTENNAS

TV...FM ANTENNA INSTALLATION

by IRA KAMEN

Manager, Television Antenna Dept.
Commercial Radio Sound Corp.

and LEWIS WINNER

Editor, SERVICE and
COMMUNICATIONS

Antenna Tools

(Basic Tools Required . . . Application of the Correct Tools for Specific Types of Installations, Involving Flat-top Roofs, Slate Roofs, Tile Roofs, Chimneys, Etc.)

The TV Antenna Installation Problem

(Fundamentals of All TV Installations . . . Judging Specific Application Features of the Various Types of Antennas Which Can Be Used for TV Work . . . Solving Reflection Problems . . . Improving Signal-to-Noise Ratio.)

Solving the Problems of 12-Channel Reception

(Factors With Which Service Men Must Be Familiar to Accurately Install Antennas For Full-Band Coverage . . . Typical Problems Analyzed.)

High Frequency TV Antenna Installations

(Antennas and Installation Procedures Which Afford Best Results. Solving Major Installation Problems Involving Tuned Indoor and Outdoor Antennas. Application of Stub Filters.)

TV Interference

(Analysis of Nine Sources of Interference and Solutions Which Have Proved Effective.)

Fringe Reception

(Selecting and Installing Antennas for Maximum Reception in Areas Over 45 Miles From Stations . . . Tower Installations . . . Estimating Tower Costs.)

TV Master Antenna Systems

(Typical Multiple Dwelling Antenna Systems for Simultaneous Operation of Many Receivers From a Single Antenna Array and Amplifier Setup.)

FM Antennas

(Analysis of Practical FM Antennas . . . Selecting Proper Antenna for Rural and Urban Jobs.)

The Business of TV Antenna Installations

(How to Conduct Successfully TV Installation and Service Work Today . . . Proper Use of Correct Types of Installation and Servicing Agreements and Warranties.)

TV Antenna Tricks of the Trade

(Antenna Installation Devices Which Will Improve Picture Fidelity.)

(Indexed for Quick Reference)

BRYAN DAVIS PUBLISHING CO., INC., Book Dept.
52 Vanderbilt Avenue, New York 17, N. Y.

Send me a copy of TV . . . FM Antenna Installation, post-paid, for which I am enclosing \$2.00.

(Please Print)

NAME

ADDRESS

CITY AND STATE

AT YOUR JOBBER
OR ORDER DIRECT



Price \$2 Post Paid

HEARING-AID Servicing

FOR MANY years the servicing of hearing aids was a direct factory project. With the increased use of the aids, it became apparent that the factories would not be in a position to render too prompt a service to hearing-aid users, and thus localized service depots became prominent. In each instance, however, the service had been factory controlled. Now, it has become possible for the independent Service Man to play a major role in this hearing-aid work, through the establishment of a local service program.

Only a person who is hard-of-hearing can realize fully what it means to be without his hearing aid for even a short time. His world of sound is at an end until he is once again wearing his instrument. Because of this, the dealer and the local Service Men are in an especially advantageous situation. They find themselves in the position of being of real assistance to their fellow man and thus in constant demand because of the service they can offer. Their permanence and respect in the community will be even more assured.

Under the new plan, a Service Man makes an application for a service station where local dealer service is not available already. In the event the company is represented in an area by an authorized dealer, but no service department has been established, the Service Man may work in cooperation with that dealer. If the arrangement is approved, a complete set of test equipment is made available. Parts and accessories for the instruments would also be made available.

Special efforts to see that service information regarding methods of repair, *short cuts*, new types of parts, etc., is disseminated to all service stations is a feature of the program.

The Hearing-Aid Analyzer

Supplied to the Service Men, appointed for hearing-aid work, is an analyzer (*cover diagram*), which can be used to service all types of tube-type hearing-aids. This equipment consists of an *artificial ear*, audio oscillator (1,000 cycles), test probe, connecting cables, and analyzer with its sound chamber, selector switches, and gain meter.

The *artificial ear* is a device which, when placed in a sound field, will produce a voltage at its output proportional to the sound pressure. To provide a proper means of coupling the

Independent Service Man Program Now Affords Interesting Opportunities in a Rapidly Expanding Field. Special Test Equipment, Including Hearing-Aid Analyzer, Designed to Expedite Repairs. (See Front Cover).

by **CLIFFORD W. CARLSON**

Service Manager
Otarion, Inc.

sound pressure output of the hearing-aid receiver to the analyzer, the artificial ear is constructed with a two-cubic-centimeter cavity which provides an acoustical impedance equal to the accepted standard for the average ear.

When an energized hearing-aid receiver is attached to the artificial ear, the output of the receiver produces a sound pressure in the cavity which acts on the diaphragm of the dynamic microphone mounted in the artificial ear. This produces an electrical voltage at the terminals of the microphone which is proportional to the sound pressure level.

The *sound chamber*, contained within the analyzer, consists of the chamber and a permanent magnet speaker which provides a definite sound pressure in the microphone plane. The chamber is so arranged so that the upper section contains the permanent magnet speaker, and the lower section

has an opening and guide which assures correct placement of the hearing-aid in the sound field. The entire *sound chamber* is built into the analyzer and is lined with appropriate acoustic material.

The test probe is attached directly on the front of the analyzer. A varied voltage can be applied to the tip of the probe by means of the two selector switches. One switch is for a *coarse* setting and the other for a *fine* setting. This probe is used to check the individual stages in a hearing-aid. The tip may be replaced with a phonograph needle.

In the event that a source of 1,000 cps is not available, an audio oscillator is available with the equipment. The oscillator frequency is fixed at 1,000 cycles per second and has a variable voltage output. With this equipment

(Continued on page 38)

View of the analyzer and artificial ear used for hearing-aid servicing.



ASSOCIATIONS



RTG, Brookline, Mass.

ALFRED T. TURNER, secretary of the Boston Chapter of the Radio Technician's Guild, has notified us that James A. Stine is now president of the association. Melvin A. Shikes is vice president and Hyman Leve is treasurer.

There are four members on the board of directors: George Batt, Edmund E. Chebator, George I. Cutter and Herbert L. Gamer.

RTG, Rochester, New York

AT ELECTIONS recently held by the Radio Technician's Guild of Rochester, New York, T. Lawrence Raymo was reelected president. Robert A. Bryan, Sr., is now vice president; Donald Lissow is secretary and William A. J. Frenzel was renamed treasurer.

Larry Kline of Ward Products delivered a talk on antennas at a recent open session of RTG.

Ten members of RTG attended the recent first annual meeting of the Empire State Federation of Electronic Technicians' Associations, which was held in Binghamton in the Hotel Arlington: Ed Boyce, Bill Brewerton, Bob Bryan, Vin Craft, Bill Frenzel, Bert Lewis, Larry Raymo, Margaret Snyder, Dave Vialet and Ed Fisk. Larry Raymo requested that he be replaced as president of ESFETA because of the pressure of TV installation and service work in his area. He felt that he would not be able to devote enough time to the work required in the state organization.

The RTG television school is now underway and with a very substantial

attendance. Ed Yeaton is directing the classes at the TV school.

L. S. McLeod of the Sunbury, Pa., plant of the Westinghouse, addressed a recent open meeting of the Radio Technicians Guild of Rochester, and covered *Stratovision*.

ESFETA

IN THE May issue of SERVICE, in our report of the elections held during the first annual meeting of the Empire State Federation of Electronic Technicians' Associations, we inadvertently omitted the name of Arthur J. Blakely, president of the Corning Area Radio and Television Technicians' Guild, who was named sergeant-at-arms.

Four members were named to the board of directors: Richard Newcombe, of the Endicott Radio and Television Association, Endicott, New York; Warren Fribley of the Corning Area R-TTG; and John A. Wheaton of the RSA of A, Long Island.

Ed Fisk, of RTG, Rochester, was named publicity director, and will be assisted by the publicity committees of each of the local associations who are members of the state group.

ERTA

ELECTIONS were recently held by the Endicott Radio-Television Association at the Endicott American Legion Post

Officers of the Empire State Federation of Electronic Technicians' Associations (left to right): Warren Fribley, Richard Newcombe, Arthur J. Blakely, Ben De Young, Margaret Snyder, Max Leibowitz, Wayne Shaw and John A. Wheaton.



TEN YEARS AGO

From the Association News page of SERVICE, June, 1939

A TELEVISION DEMONSTRATION was held at a meeting of the Duluth Chapter of RSA. Also featured at the meeting was a talk by Al Zmeskal of Lucker Sales, Minneapolis, on antenna systems, *afc*, inverse feedback and general methods of manufacture. . . . The Pittsburgh Chapter held their *tenth anniversary dinner dance*. At a subsequent meeting of the Pittsburgh group a special plan involving the promotion of better reception was discussed. . . . The Washington, D. C., group prepared their local bylaws and regulations. Milt Shapiro of Radiart provided an interesting talk during a meeting of the association. . . . Irwin T. Higgins of Weston discussed the *Possibilities for Television Servicing* at a late June meeting of the Philadelphia Radio Servicemen's Association. . . . The ART of British Columbia held their annual elections and named Tom Brown, president; Art Houghton, vice president; Allen Johns, secretary; Fred Lewis, treasurer, and Wif Muntton, recording secretary. . . . Owen McArdle and Cal Stapp of the Danville Chapter delivered an address on *Overhead Expenses* during a meeting of the group. . . . John P. Sheridan, of the Eastern Co., presented an illustrated talk on the adjusting of phono and automatic devices at a meeting of the Boston Chapter.

82. Richard Wheet was named president; Ernie Marshall, vice president; Richard K. Newcombe, secretary, and Walter Porznick, treasurer.

CARTG

THE NAME of the Radio-Television Servicemen's Association of Corning has been changed to Corning Area Radio and Television Technician's Guild (New York).

Andrew M. Mertson is secretary of the association.

ART, British Columbia

THE ANNUAL DINNER-ELECTION meeting of the Associated Radio Technicians of British Columbia was held recently and J. Baird was named president to succeed retiring prexy F. Stucky. Other new officers elected were: W. Filtness, vice president; Al Clark, secretary; S. Beyer, treasurer; and F. Lewis, recording secretary.

Beanstalk? . . . No! But like the proverbial Beanstalk

RADIART SIMPLI-FLEX ANTENNA *Sales*
HAVE *Shot Up* **OVERNIGHT**

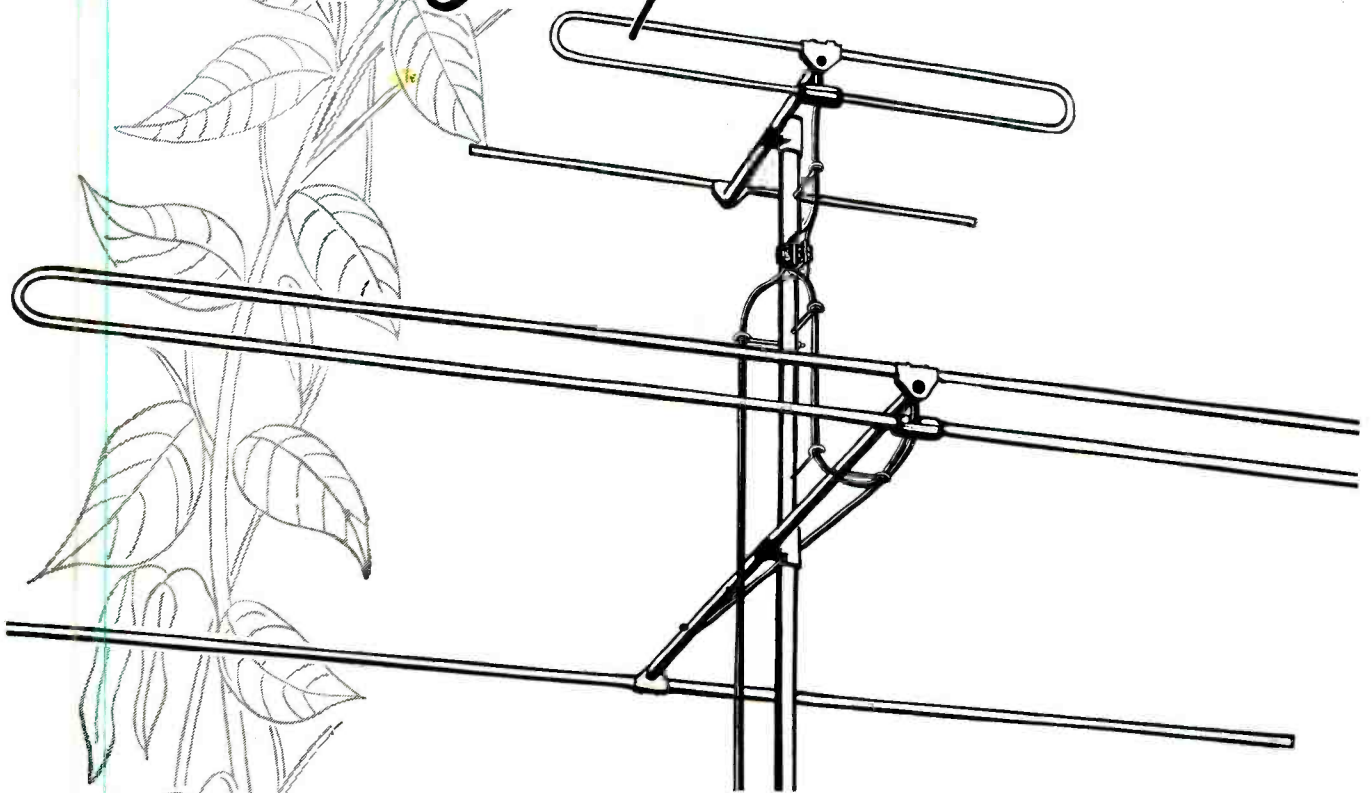

Wondering what all the excitement is all about? What is it that has shot up so quickly in demand? It's the RADIART line of SIMPLI-FLEX antennas! Practically overnight . . . *like the proverbial beanstalk . . . these antennas have grown and sky-rocketed in popularity and taken the country by storm!*

AND . . . the answer is simple enough . . . ELECTRICALLY . . . they out-perform all others—MECHANICALLY . . . they are easier to install, and more sturdy when installed!



IT'S RIGHT . . . WHEN IT'S RADIART

THE RADIART CORPORATION

CLEVELAND 2, OHIO

Manufacturers of the Famous Red Seal Vibrators

Custom Audio Installations

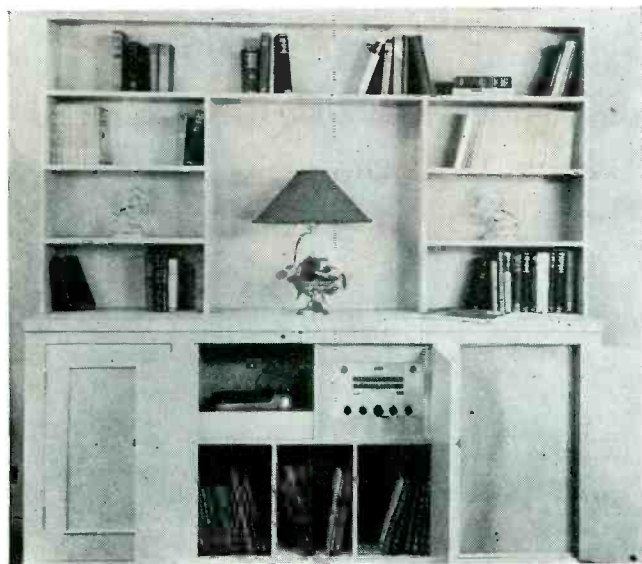

A typical custom *in-built* installation with the speaker installed in an 8 cubic foot area in the right compartment of the cabinet. (Courtesy Altec-Lansing)



Section of the sound demonstration studio, which illustrates the convenient layout of the tuners, amplifiers and record changers. (Courtesy Sun Radio and Langevin Mfg. Corp.)

IN LAST MONTH'S discussion the design and constructional features of a sound room were outlined. It was pointed out that simplicity of operation was a focal point in planning. Studies showed that from both the practical and merchandising points of view, this factor was extremely important. Accordingly our sound demonstration studio design was streamlined and avoided particularly the usual plug pulling, wire-raveling ceremonies which have been going hand in hand with the demonstration of sound equipment. Since high-fidelity music reproduction can *only* be demonstrated effectively by *instant comparison* with reproduction from conventional receivers, of the ready-made variety, this demonstration feature was also provided for in our setup.

Studio Construction

In considering the construction of the studio, the demonstration control panel received primary study. It was decided that the finished panel should be simple to operate, yet incorporate enough flexibility to almost completely control the components under demonstration from one central remote point.

Looking at the design situation from a consumer's as well as the dealer's standpoint, six factors were found to be particularly significant:

(1) For those with no experience in electronics and a limited knowledge of how the components affect each other,

the demonstration system had to be ultra simple; easy for mother, sister, or brother to know how to turn the set on, or set up a stack of records, $33\frac{1}{2}$. . . 45 . . . 78 rpm, or switch from AM to FM to TV or to phono.

(2) With the numerous makes of amplifiers, record changers, pickups, tuners and speakers on the market, we had to consider the problem which faces the inexperienced layman to choose and yet know that he will achieve the utmost for his investment. To assure our prospective buyer a fair selection which he could not only see, but hear and compare for himself under actual operation, provision then had to be made for a fair representation of the components on the market today for demonstration. It was found that provision should be made for at least eleven input sources to feed into eleven amplifiers which could drive any one of twenty speakers; this presents a total of over 2,400 different combinations of components. Then, too, consideration had to be given to the *high fidelity custom chassis* which is usually a two-piece affair. Thus providing for eleven of the *hi-fi* receivers chassis and feeding them into twenty speakers, added another 220 combinations, bringing the grand total to more than 2,600 combinations . . . plus TV tuners, really an adequate number of combinations to offer for demonstration.

(3) The layout of the studio was also found to revolve about the demonstration panel. For the room had to

be designed so that without twisting and hunting around the room, the components would be conveniently visible and easy to detect when in the circuit under demonstration. It was also found wise to concentrate the equipment to eliminate long runs of wire, avoiding unnecessary loss in power, which is also a loss in fidelity. Further, design considerations could extend to the inclusion of an indicating light system, so that the listener could also see which components are in the circuit, switching of components simultaneously turning on lights with one movement. This is important to achieve instant comparison. The time element in changing components in the circuit should be very short. Any time lag involved will tend to lessen the effect of the differences in tone quality, distortion as heard by the ear and frequency range, brilliance, efficiency and overall dynamic range as suited to the listener.

(4) The display of speakers in proper baffles, cabinetry and enclosures was another pertinent problem to consider. Baffles and enclosures can make all the difference in the world in the quality of speaker reproduction. After all the speaker is the final determining factor of what the other components can do. It is without any doubt the most integral part of the system, and proper enclosures and baffles will determine the resultant quality of reproduction. Individual speaker housing in most cases located some distance or

Part II . . . Demonstration Room Construction . . . Design Features of Portable Home Demonstration Hi-Fi System . . . Circuits for Conversion of Amplifiers in TV Receivers to Provide High Fidelity Performance.

adjacent to the pickup-tuner-amplifier housing is far more desirable than installing all of the components in one cabinet. This mode of installing high fidelity components is not new, but rapidly becoming the trend. One manufacturer has dubbed this idea, plus the installation of systems into bookcases and existing furniture, *Inbuilt Systems*. Others have called them *Built-In Systems*. But no matter what it is called, the customer has to be shown and the only method is demonstration in the proper type of baffles to bring out everything the speaker can offer. Actual demonstration of speakers in their respective cabinets and baffle housings will present the illusion of live performance.

(5) Probing the design of the demonstration room, it was found that it isn't essential to build a room with perfect acoustics, mainly because the average listener does not have the perfect acoustic condition in his home. It is best to try to design the room to avoid disturbance to the listener from other departments of your organization and to members of your organization from the demonstration being presented.

(6) Accessibility to wiring and outlets, our last point, was found quite

High fidelity demonstrator unit which contains a changer, amplifier and speaker, with provision for a tuner. (Courtesy David Bogen Company, Inc.)



by **IRVING GREENE**

Sound-TV Manager

Sun Radio and Electronics Co., Inc.

important to facilitate service and allow for changes in the design as new developments require additions or alterations of existing outlets, without breaking into walls and panels.

Portable Demonstration Rig

The portable home demonstration rig is a very handy item. It may not provide a selection of varied components to choose from but it will serve to demonstrate the illusion of live performance at home. Also, and very important, is the fact that the Service Man can see, during these demonstrations, what probability there may be to install *hi-fi* equipment in existing bookcases, furniture or closets and thus enlighten the prospect of the desirability and economy of such a plan.

Demonstration in the home will definitely sell the customer on the quality, and a little incentive on the part of a Service Man can sell the fact that the *inbuilt* version of a music reproducing system is the last word in convenience and low cost.

Initial investment and labor in setting up a portable rig is very small. First, it is necessary to choose a

¹Amphenol 86-RCP4.

speaker that will offer wide range reproduction and fit into a portable case that can be moved around with ease. For a case that would offer proper baffle and portability, a bass reflex cabinet, of the type covered with leathette fabric and fitted with a handle, would be suitable. It would be wise to also include a tweeter in the cabinet with provision for switching in and out of the circuit. It would fit nicely in the bass port of the cabinet. To avoid the usual tangle of wires, a connector¹ should be fitted in the rear of the cabinet. Second, a good tuner should be selected, preferably FM and a 10-watt amplifier plus a record changer of the two or three-speed variety. Housing of these components can easily be accomplished by using a portable record changer case for the phono and another record changer case for the amplifier and tuner. The interconnecting cables should be made at least 10' long so that the components can be separated in the room to demonstrate the benefits of an inbuilt system.

It would be wise to have more than one portable setup, one of an economically priced class and another of a more expensive priced class. It would also be wise to leave the equipment in the home for a short time, in order for the customer to really learn the difference in quality. The Service Man will learn that while many of the home demonstrations do not lead to sales in-

(Continued on page 43)

Circuit of amplifier which can be adapted to television receivers to provide high-fidelity reproduction.

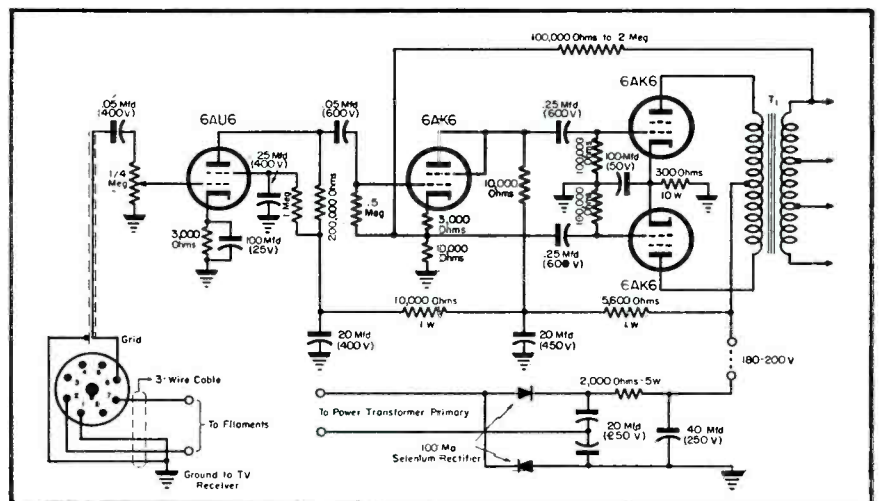

Design and Construction

Experience as Industrial Designer, General Knowledge of Woodworking and Familiarity with Basis of Acoustics Provides Ideal Background for the Building of a Radio-Phono Console with Hi-Fi Characteristics.

by CLIFFORD STUBBS

OUR PROBLEM was not new, we wanted a combination console and were confronted with the usual stumbling blocks: high prices, poor reception qualities, poor cabinet work, and cabinets that did not appeal or fit into our decorating scheme.

Custom Console Solution

It became obvious therefore that a custom-built console would be the answer. Having experience as an industrial designer, a general knowledge of woodworking, and the necessary hand tools and a circular power saw, construction at home was decided on, and standard equipment was selected. This included an AM/FM receiver¹

covering three short-wave bands, an automatic record changer² which plays mixed 10" and 12" records and shuts off when the last record has played and a 12" speaker.³ (A larger speaker doubtless would be superior, but would not fit our particular space requirements.)

Designs Considered

Dozens of cabinet sketches were made, and all possible locations were tried for each component. Chair-side designs seemed desirable for our own particular needs, but this so reduced the baffle area that this design was deemed impractical. Experimentation proved that the conventional console

arrangement was the most practical solution, with, however, record storage space eliminated to secure maximum allowable baffle area.

Size Problems

It was decided to make the cabinet 28" high (without legs) to match the modern sectional furniture in our living room. For others, the set would look equally well on legs about 3" high. Since the console was to be used in a small living room, swinging doors would be quite a nuisance and thus were not used. The console was to replace the space used by a table, so the next limitation was that the top must serve as a table; no hinged top allowed! Hence, the idea for a *bookcase* front, as the illustrations show.

Constructional details for the custom-built cabinet of modern design, which featured a *bookcase* type front composed of a piano hinge mounted board, sliding into open or closed position and eliminating the need for doors.

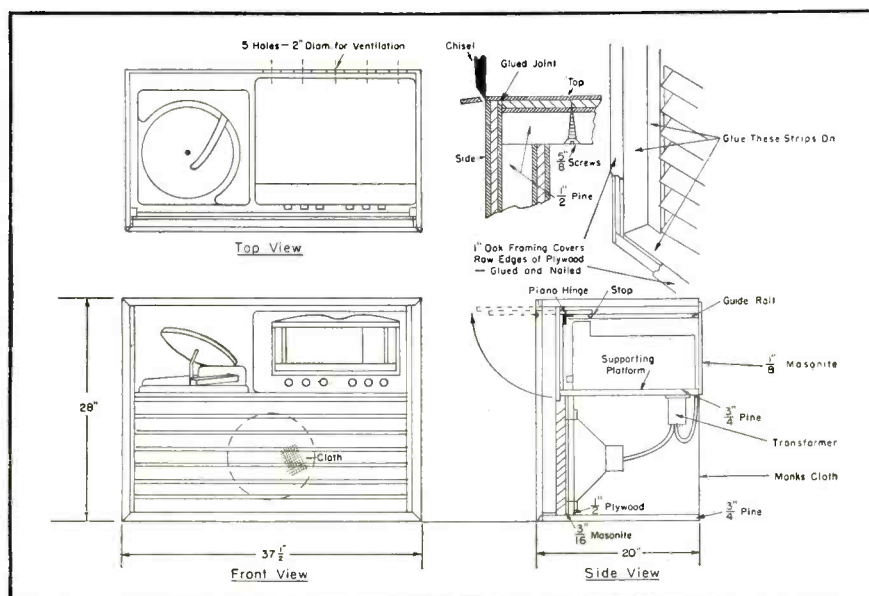

Cabinet Features

This front proved extremely practical from many angles. By making the front fit snugly, there is no need for a latch to hold it in, and even handles are eliminated. To open the front, it is only necessary to place one's hand under the cover which swings the front up and then push the cover on the guide rails into the cabinet. Fortunately, the phono spindle lifts out of the turntable. Thus, the records are loaded on the spindle outside of the cabinet, and then the loaded spindle is replaced in the turntable. It was *fortunate* that this arrangement worked out so well, because otherwise there would not have been depth enough for loading without

¹Hallcrafters S-47. ²Webster. ³Altec-Lansing.

of a CUSTOM CABINET



Left and right: Open and closed views of the custom-built phono combination cabinet.

putting the changer on a sliding track so that the whole unit could be pulled out of the cabinet.

Receiver Mount

The receiver merely rests on the supporting platform and was not secured in any way. Bolts did not seem necessary as the set is extremely heavy. Because of the heat generated by the receiver, the perforated metal cover was removed from the set and holes 2" in diameter drilled in a masonite back cover, as shown in the drawings. This completely eliminated any heating up.

Woods Used

Basically, the cabinet consisted of a pine box covered with $\frac{1}{4}$ " pickled oak *Weldwood* plywood. By planning it was possible to get all the plywood parts out of a standard 3' x 8' sheet.

The plywood was held to the pine with $\frac{5}{8}$ " screws, inserted through the pine and into the back of the plywood. This eliminated the display of any screw heads on the outside of the cabinet. Where the edges of the top and sides meet, a perfect joint was made. The sides were attached first, then the top was mortised on each end on a circular power saw. The top layer of plywood was intentionally left too long. After the top was screwed on and glued at the edges, the excess material was chiseled off, as shown. All other plywood edges are at the front of the cabinet. These were covered with 1" oak picture framing, glued with *Weldwood* glue and nailed in place.

Nail heads were sunk and then covered with plastic wood. The two narrow strips of plywood used at each side of the front, as well as the strip across the bottom, were glued in place so there would be no screw holes showing. All glued surfaces were held under clamps or other pressure while the glue dried.

Bookcase Front

The *bookcase* front was not difficult to make. A 10" wide pine board was attached to a 4" pine board with a piano hinge. Then a 12" plywood front was attached to the 10" board and hung below the supporting platform so a hand could be inserted underneath; this eliminated the need for handles. The 4" board not only supports the front, but acts as a guide to keep the front square in all positions. With the front closed, and perfectly lined up, a pin stop was driven in each guide rail so that the front would always stop in the same forward position. Guide rails were waxed so that the front would slide easily.

Use of Louvres

Seven louvre slats were set at 45° and fitted into supporting pieces at each end. The 45° grooves in the supporting pieces were cut with a power saw, but could easily be cut in a mitre box. Louvres 2" wide were backed up and glued to a piece of $\frac{3}{8}$ " masonite. The speaker was bolted to a piece of $\frac{1}{2}$ " plywood which was then riveted to the masonite. This was strictly an

economy measure, because the $\frac{1}{2}$ " plywood came with the speaker as a protector. It was not large enough to go across the full width of the cabinet. It was easier, too, to use the plywood because the bolt holes were all drilled and the bolts provided.

The Baffle

Fine grey cloth was mounted between the masonite and plywood as a dust protector for the speaker. The hole for the speaker was cut with a keyhole saw. Normally the masonite might be eliminated because a full width piece of $\frac{1}{2}$ " or $\frac{3}{4}$ " plywood would serve as well. The masonite panel (or plywood panel) should be painted grey before assembly in case it is seen through the louvres.

The back of the baffle area was covered with monks cloth to keep dust out of the speaker compartment.

Cabinet Finishes

Several coats of paste wax were all the finishing used on the plywood, although any stain or natural wood treatments would be completely satisfactory.

Effort and Results

Although many, many hours were spent in designing and constructing this console the results, both decorative and acoustic, have more than compensated for the effort.

American Beauty

ELECTRIC SOLDERING IRONS

are sturdily built for the hard usage of industrial service. Have plug type tips and are constructed on the unit system with each vital part, such as heating element, easily removable and replaceable. In 5 sizes, from 50 watts to 550 watts.

TEMPERATURE REGULATING STAND

This is a thermostatically controlled device for the regulation of the temperature of an electric soldering iron. When placed on and connected to this stand, iron may be maintained at working temperature or through adjustment on bottom of stand at low or warm temperatures.



For descriptive literature write

**AMERICAN ELECTRICAL
HEATER COMPANY**
DETROIT 2, MICH., U. S. A.

Coin Operated Phonos

(Continued from page 11)

associated power supply. The transmitter's output is impressed on the ac line through a capacitor or pickup loop, and picked off by a receiver in the main cabinet, where the rf pulses are used to operate a stepper relay, which causes the mechanism to select the proper record.

The transmitters are small using a 6V6GT or similar tube, keyed in the cathode circuit by points of the stepper, which is actuated by depositing coins. A 6X5 is used with a small power transformer to supply operating potentials. Operation of the transmitter may be checked by jumping the keying contacts of the stepper with a test-lead, and measuring the grid voltage with a *vacm*, or observing the rf pulses on a 'scope. Operation of the keying mechanism may be checked with the 'scope, by tripping the stepper and observing the rf pulses. These may even be counted, if necessary.

Receivers for these impulses are sometimes built into the main amplifier chassis (*Seeburg*), or on a separate chassis (*Wurlitzer*). In any case they are fundamentally the same. Wurlitzer uses a 6SK7 as an rf amplifier, 6SQ7 as a detector, and a 6SN7 as output, with a 4,500-ohm relay in its plate circuit. A 6U5/6G5 is used as a tuning indicator. Pickup for the rf is obtained through two .1-mfd capacitors, in series with a 50,000-ohm sensitivity control, connected as a rheostat, from the ac line. The relay is connected in parallel with a manually-operated selector in the main cabinet, so that selection of records may be made from either place. Some of the transmitters (*Wurlitzer 212*, etc.), use crystal control of the oscillator in the transmitter, to insure operation on the proper frequency, in locations where two or more machines must be placed in proximity to each other.

Servicing

Service and maintenance work on these amplifiers may be done with the same tools and instruments used on receivers. As mentioned earlier, it is important to watch out for parts which may fail immediately following a service job.

Setting up and *cooking* for at least an hour is recommended after each service job. Often, chassis will have to be cleaned as they become quite greasy, the result of oil drippings of the changer mechanism, which is just above the amplifier. A cloth dampened with kerosene will serve very well. Not only should the chassis be cleaned

Telrex INC.

CONICAL ANTENNAS

*America's Outstanding
Television Beam*

- ★ The ONE antenna for ALL channels (no high frequency head needed)
 - ★ Maximum efficiency on ALL channels
 - ★ 4 to 1 front to back ratio on all frequencies
- TELREX Conical Antennas provide the highest possible gain to the receiver—since the full strength of the signal (as received at the antenna) is carried to the set with negligible loss—and with a definite reduction in the strength of ghosts or reflections.

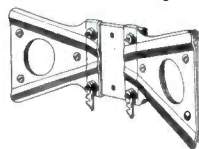

TELREX Conical Antennas are built better. Note this center clamp which provides such a strong grip over bet-

ter than 3" of each rod surface. It is both a mechanical support and electrical contact second to none. And is only one of the features which result in improved and steadier pictures—from a better antenna—a TELREX.

© 1949, Telrex, Inc.
AVAILABLE IN A VARIETY OF MODELS
TO MEET ANY NEED
At your distributor or write

TELREX, INC.
ASBURY PARK 5, NEW JERSEY

Music as the Masters played it!

THE Bogen RANGE MASTER



This new control permits your records to perform at their very best — an adjustable noise suppressor to correct for the particular condition of each record.

The Bogen PX15, fifteen watt high fidelity amplifier boasts eight other distinctive features, designed to multiply your listening pleasure. Write for complete new FREE High Fidelity Catalog.

David Bogen
CO., INC.

663 BROADWAY, NEW YORK 12, N. Y.

up but all sockets should be cleaned, too, with carbon-tetrachloride, to remove accumulations of dust, dirt, etc., that might provide a path for a possible high-voltage short. Filters should be checked very carefully for high power factor. Increasing power factor in electrolytics is an indication of increased leakage, and capacitors that read over about fifteen per cent should be changed. Amplifier tubes should be tested at rated settings, filament voltage decreased by one step; 6.3 to 5.0, etc. A decided drop in the test-reading will indicate deterioration of the filament, requiring replacement. High gas content in preamp and voltage-amplifier tubes must be watched for, too. Unequal readings on the two parts of dual tubes such as 6SC7, 6SN7, are also a warning of trouble. When used as phase-inverters, unbalance in these tubes will seriously affect the quality of the output.

If amplifier work becomes quite a factor in your shop, it will be pay to provide a *mock-up* similar to those used for testing aircraft or police radios. A test speaker or speakers, and a phono turntable, with a standard-frequency record and some musical selections will serve the purpose. It will also be helpful to have a wattmeter outlet, protected by not over a 5-ampere fuse. The primary wattage reading will enable you to spot easily any overload or high-leakage condition in the amplifier under test; the average drain is around 100 to 130 watts. Any deviation from this indicates an overload somewhere, which must be investigated. Experience will soon disclose how much each amplifier should normally draw.

As indicated earlier most servicing work will probably be limited to the three popular makes, and not very many different models of them. Only one test setup for each make will be required, as the phono can be used on all three. As the speaker plugs for each make will probably fit all models of that make, the problem is simplified there, too. The use of good amplifiers of each type is highly recommended. A set of voltage readings should be made on each, too, so that you will know what to expect from that model in the future, and thus permit more rapid checking of the equipment when it is to be serviced.

For test speakers, it is quite possible that the owner of the machines will have an extra speaker of each type that he will be glad to loan you. These may be mounted somewhere about the bench and the cables extended. A switch to disconnect the voice-coils

(Continued on page 36)

The little lamp that became the strong, silent type

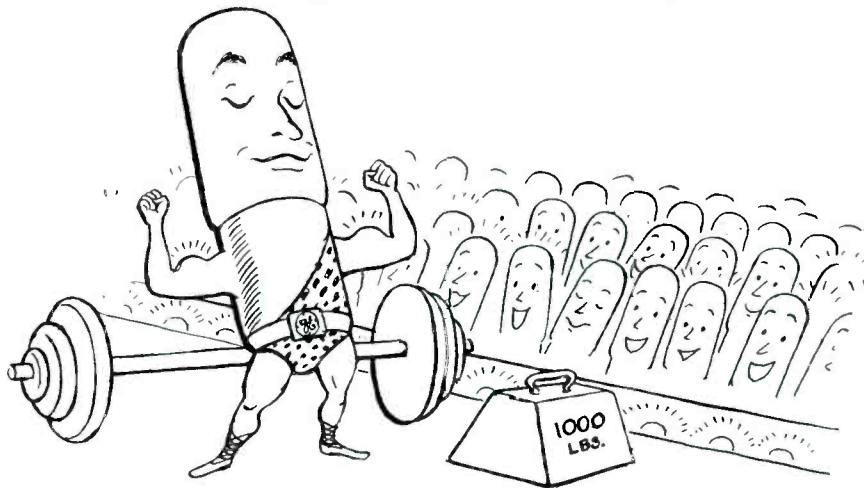

LIGHTING radio dials is no job for a "weaking" lamp. Testing many old style lamps, General Electric engineers found that certain frequencies caused severe vibration that often tore the filament apart. Poor contact between the filament legs and lead-in wires also resulted in tiny arcs or changes in resistance that caused radio interference.

That's why G-E dial lamps have been made "the strong, silent type." Improved design minimizes vibration, provides positive connection between the filament and lead-in wires.

For information on prices and types of G-E miniature lamps, call your nearby G-E Lamp office. Or write to General Electric Co., Division 166-S 6-49, Nela Park, Cleveland 12, Ohio.

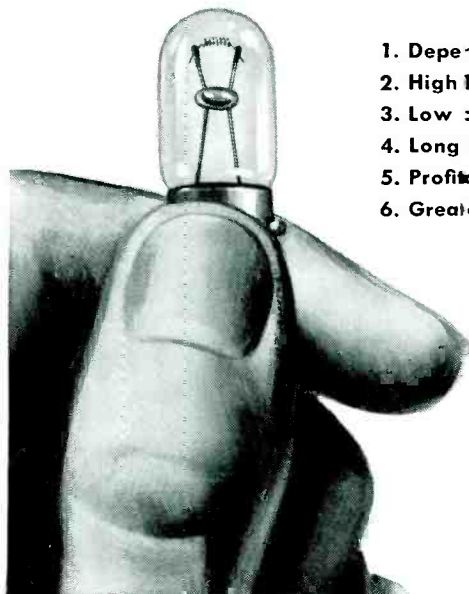

1. Dependable, trouble-free performance.
2. High level of maintained light output.
3. Low current consumption.
4. Long life.
5. Profitable to handle.
6. Greater dealer acceptance.



G-E LAMPS
GENERAL  ELECTRIC

PICKERING PICK-UP CARTRIDGES

- For the utmost in record playing pleasure
- For the greatest length of satisfactory service
- For those who want and demand the highest quality record reproduction, with all of the original modulation, realism and brilliance
- For minimum record wear
- For minimum extraneous and annoying sounds

120 SERIES for transcriptions and lacquer discs

MODEL R-150 for phonograph records

140 SERIES for microgroove records

All Pickering Pick-up Cartridges are available with either a Diamond or Sapphire Stylus... Diamond Styli are good for thousands of playings whereas Sapphire Styli require replacement after a few hundred playings.

Pickering also manufactures Pick-Up Arms, Preamplifiers, Equalizer-Amplifiers and Equalizers.

PICKERING & COMPANY

Oceanside, New York

45 RPM Servicing

(Continued from page 15)

tom record. The correct distance from the sapphire to the turntable is $\frac{3}{4}$ ". This adjustment is made by turning the adjusting screw *B*, located near the tone arm vertical pivot shaft. (Screw *B* is shown in the customer's operating instructions as the height adjustment.) To make the adjustment, the changer should be run far enough through its cycle for the arm to reach its highest point. Then screw *B* should be turned until this distance measures exactly $\frac{3}{4}$ ".

Muting Switch Adjustment

The muting switch is held open by the main lever while the record is playing, and short-circuits the pickup leads when the main lever moves toward the star wheel during cycling.

The muting switch contacts should be open by $\frac{1}{2}$ " during the playing time. When the contacts close, they should make firm contact. You can adjust the tension by moving the switch frame. The screws which hold the frame to the sub base are used for this adjustment.

The NEW EMC TV ANTENNA ORIENTER

- Eliminates Expensive Equipment!
- Eliminates Necessity of 2 Man Job!
- Results in Satisfactory Antenna Installation!

Clips to Video Input of Picture Tube

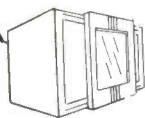

- ★ Faster, more accurate.
- ★ No soldered connections necessary.
- ★ Receiver does not have to be removed from cabinet.

★ Identifies "ghosts" and direction from which they originate.

Works in conjunction with any voltmeter having a sensitivity of 1,000 ohms per volt or higher. Converts your old voltmeter to a relative field strength meter.

LOOK AT THIS PRICE!

NO SERVICEMAN CAN AFFORD TO BE WITHOUT ONE. ONLY **\$7.95**

Ask for the EMC Model TVAO Antenna Orienter.

Write for Free Catalog S-6

EMC ELECTRONIC MEASUREMENTS CORP.
423 Broome St. New York 13, N. Y.

Coin-Operated Phonos

(Continued from page 35)

and substitute an 8-ohm, 20-watt resistor will be a great help for making maximum-output tests, as it'll take a big load off your ears.

Tests for final checks should be made with a frequency record, paying particular attention to the output at 1,000 cycles and at about 100 cycles. For gain tests, the output of the pickup may be adjusted to a convenient level, and the overall gain measured. A 'scope may be connected to the input and output of the amplifier for observation of *Lissajous*' figures to check distortion. Any departure from a straight, slanting line indicates the presence of distortion. The wave-form from the test record may also be observed, on the 'scope, for checking third harmonic distortion, etc. Flattening of peaks due to overload may be readily seen. It is important to be careful not to overload the input when making these tests. It has been found that the maximum voltage should be around 1 volt when using crystal pickup, and not over 2.5 to 3 volts for the older types made for the magnetic pickup. Overloading should not be experienced at these test values.

The turntable assembly is easily removed by first taking off the star wheel and then pulling off the two *C* washers from the turntable shafts. After this operation, the complete turntable assembly may be lifted from the changer. Caution is required to avoid losing the ball bearing assembly and the flat steel washers located on each side of it. To gain access to the separator assemblies after removing the turntable, it is then necessary to remove the turntable cam plate by releasing its two holding screws. Then the two screws, found inside the turntable spindle which hold the plastic cap in place, can be removed.

Separator Assemblies

The two separator assemblies may then be easily removed by lifting straight up. These units should be re-assembled in the reverse order, making sure that the compression spring is installed in the holes provided in each separator shelf. Timing of the separator assemblies is necessary to assure correct dropping of the records. To do this the shaft which drives the separator assemblies should be rotated until the front edge or nose of one assembly is just ready to protrude from

the edge of the spindle. The other separator blade should be in the exact corresponding position; that is, its nose should be also ready to protrude from the edge of the spindle. If the second separator blade is not in this position, it should be lifted gently until its gear is free to rotate and placed in the proper position. Then the blade should be pressed down on its shaft into proper mesh with the drive gear. When replacing the cap, do not tighten the screws beyond normal tightness; otherwise you may distort the cap, which will prevent records from dropping properly.

Lubrication Guide

Lubrication is vital to any moving part if friction is present. It is essential to know what parts should be lubricated and what parts should not be. Lubricating parts that should not be lubricated can be almost as detrimental to a changer as failure to lubricate the parts that require it.

Only three lubricants are required for the RP-168 and most other changers. One type^o should be used for the cam track and slides. Singer household sewing machine oil for motor bearings, and another type^o should be used for the turntable spindle shaft, drive gear shaft, main lever pivot and other similar items. Use the alternate lubricants for emergency only.

The tone arm pivot shaft and pivots or the record separator assemblies must not be lubricated. Make certain no oil or grease gets on the motor idler tire or the inner rim of the turntable.

Type 240X1 Record Player Switch

The type 240X1 switch was designed for switching from a record reproduction to radio reception when the receiver to which a record player is to be attached is not already equipped with a phono jack and switching arrangement.

The switch can be connected into the grid circuit of the first *af* tube or into the volume control circuit in a large majority of sets.

Type 202W1 Record Player Switch

To connect a 45-rpm or other attachment to a radio-phonograph combination so that either record player may be used at will, the type 202W1 switch can be used. Each of its two input-circuit assemblies includes a conventional two-conductor coaxial jack,

(Continued on page 38)

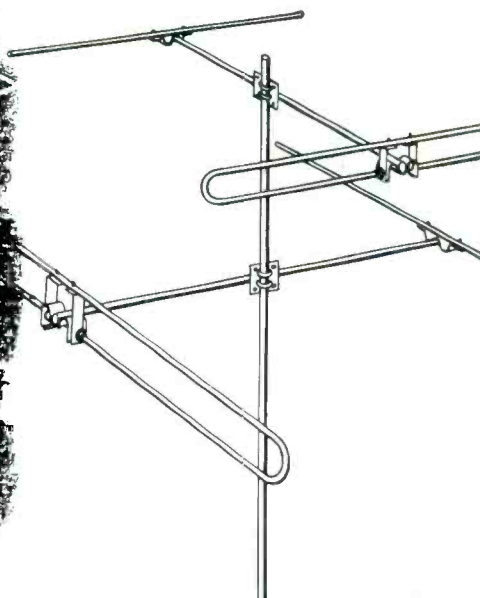

- 1. SAVE INSTALLATION TIME.** Actually save enough for additional installations each week. Simplicity of Brach Antenna design, together with maximum pre-assembly at the factory, take whole hours of "time-on-the-roof" off your installation costs. And, for easier, quicker, on-the-job handling, Brach TV Antenna Kits are individually packaged, complete with all necessary hardware. Brach Universal Base Mount is a real time saver.

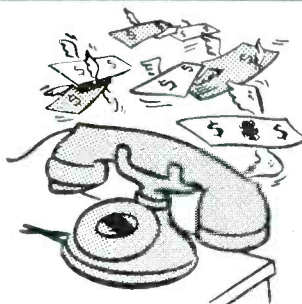
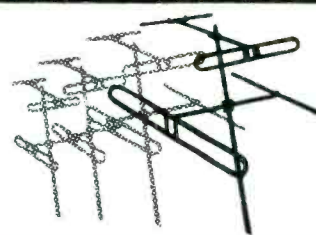

- 2. ELIMINATE EXPENSIVE CALL-BACKS.** Brach quality engineering and bulldog ruggedness combine to help make your initial installation completely satisfactory. Developed by a name as old as radio itself, Brach TV Antennas are products of the manufacturer's own laboratory. From the rugged structural steel base mount to the tip of the sturdy mast, they're designed to stand up and shrug off the worst the weather has to offer—and deliver superior reception—longer. Factory pre-tuned and matched for 300-ohm transmission line, all Brach Antennas feature large-diameter aluminum elements for better signal pick-up.

- 3. MAKE PURCHASERS YOUR BEST SALES-MEN.** The future success of your television line depends upon the success of your past installations. There's a Brach TV Antenna to meet every television problem better. Each Brach array you install puts you further ahead of your competition performance-wise.

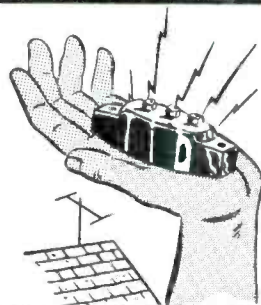
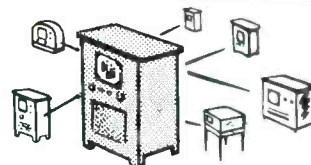

A NECESSARY EXTRA BRACH LIGHTNING & STATIC ARRESTER #4004

Helps keep the buck and jump out of the image when due to static discharge. Protects certain delicate receiver parts. Complete with all necessary hardware, the Brach Rare Gas Arrester is easily attached to any downlead. Constructed of porcelain and non-corrosive metal parts. Tested and listed by Underwriters' Laboratories.

SEND FOR BRACH CATALOG NO. S-1304



L. S. BRACH MFG. CORP.

200 CENTRAL AVENUE, NEWARK, N. J.

WORLD'S OLDEST AND LARGEST MANUFACTURERS OF RADIO ANTENNAS AND ACCESSORIES

it's new!

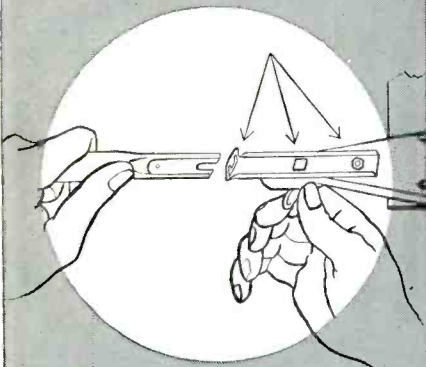

The **RMS** TV
ANTENNA LINE with the
 New, Exclusive feature

SPEE-D-LOK*

assembly

Dealers and service men across the country recognize these facts about the RMS Antenna Line:

1. GREATER EFFICIENCY — BETTER RESULTS
2. SPEEDIER INSTALLATION IN MATTER OF SECONDS
3. MODERATELY PRICED



THANKS, JOBBERS! For your tremendous interest in our Spee-D-Lok line, displayed at the Chicago Trade Show in May.

Send for the NEW Spring 1949 Catalog # 215.

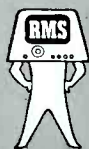

RADIO MERCHANDISE SALES, INC.
 550 Westchester Avenue, New York 55

Hearing Aids

(Continued from page 27)

the output is set at two volts under normal test conditions. A connecting cable is supplied with the oscillator to supply the necessary operating voltages which are obtained from the plug receptacle on the back of the analyzer chassis.

The gain meter readings, on the front of the analyzer panel, are the result of a conventional type vacuum-tube voltmeter circuit.

Hearing-Aid Testing

The procedure for testing a hearing-aid is relatively simple. The hearing-aid is placed in the sound chamber, microphone up, and to the rear of the sound chamber. The receiver, or ear-piece, of the hearing-aid is snapped onto the top of the *artificial ear*.

With the hearing-aid turned on (with no frequency suppression) and the volume control full on, the *A* and *B* selector switches are set to their proper positions. With the control switch set in the *chamber* position, a 1,000-cycle signal will be emitted from the permanent magnet speaker in the sound chamber, and a normal reading will be obtained on the meter for that instrument. If a normal reading is not obtained, the hearing-aid can be assumed to be defective and further checking will be necessary.

Under certain conditions of high room noise level, the gain meter will show considerable deflection. This cannot be avoided and the only solution is to find a quieter place in which to use the analyzer, although it will be found that considerable noise can be tolerated.

When a hearing-aid is found to be defective, it is advisable to check the accessories immediately. If the cord, batteries, and receiver are found to be operating properly, the instrument itself should be checked stage by stage. The accessories and final stage can be checked quickly by applying the test probe, after proper selector switch settings, to the grid of the final stage. If no meter reading is observed, the trouble lies either in this stage, the transformer, the receiver, or the receiver cord. If, on the other hand, the meter reading is normal at this point, it is necessary to continue to the next preceding stage. When the defective stage is discovered, the proper parts are replaced and the *over-all* gain test is given again to assure the instrument's working properly.

The hearing-aid servicing business is expected to grow to tremendous pro-

(Continued on page 39)

Mueller TENNA-CLAMP

COMPLETELY NEW AND DIFFERENT

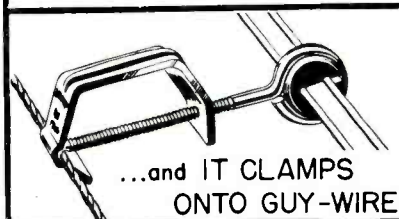
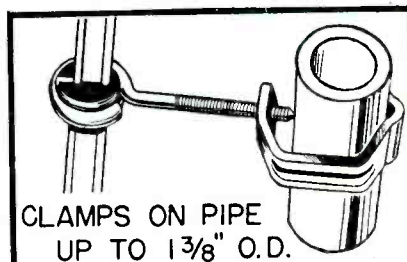

SUPPORTS TV LEAD-INS ON MASTS,
 PIPES, CROSS-ARMS, GUTTERS
 AND GUY-WIRES

- ONE STANDARD SIZE solves all sorts of lead-in problems.
- BRINGS LEAD-IN TO EDGE OF ROOF—right where you want it—holds lead-in away from gutters.
- DULL POINTED SCREW—solid grip on mast.
- ON MASTS TOO BIG for clamp—use the guy-wire.
- AVAILABLE FOR COAX and double lead-ins.

LOW PRICES!

9c net—only \$7.80 per 100

SEND FOR FREE SAMPLE AND CATALOG 810

Mueller Electric Co.

1565 E. 31st ST., CLEVELAND 14, OHIO

45 RPM Servicing

(Continued from page 37)

for use with record players, which is connected in parallel with a 3-contact jack for the three-pin plug found on certain other record players. The switch's output cable is fitted with a three-contact plug. There is also an adapter cable for sets having a two-contact input jack or receptacle. The switch itself mounts at any convenient location, preferably on the cabinet, within reach of the leads. The lead lengths may be extended by adding shielded leads.



Servicing Helps

(Continued from page 22)

drive the speaker, the speaker impedance should be:

$$\text{Speaker impedance} = \text{impedance of amplifier output} \left(\frac{\text{amplifier full output}}{\text{desired output}} \right)$$

$$\text{Speaker impedance} = 50 (10/1)$$

$$\text{Speaker impedance} = 500 \text{ ohms}$$

Speaker Transformers

Often a good loudspeaker is installed with a poor speaker transformer which seriously mars the overall response of the installed system. Four steps can be applied to determine whether or not a transformer has the desired frequency characteristics:

(A) The inductance of the speaker transformer should be measured with the secondary unloaded; Fig. 1, p. 22.

(B) Measurement should be made at the lowest frequency where flat response is required.

(C) The inductive reactance (X_L) should be four times the impedance; i.e., at the 500-ohm terminals the inductive reactance should measure 2,000 ohms at the lowest frequency.

(D) When the X_L of the primary is four times the impedance at the speaker terminals the formula $Z_p = N^2 Z_s$ is correct, where Z_p is the primary impedance, N^2 is the turn ratio squared, and Z_s is the secondary load impedance.

Inverse Feedback

Interpretation of an inverse feedback circuit, such as shown in Fig. 2 (p. 22), is not too involved, if an effective circuit is used for study; (Fig. 3 (p. 22)).

If we analyze this circuit as a voltage divider, it is obvious that the ratio of feedback voltage is: $R_o/R_i + R_o$. Substituting $100,000/1,100,000 = 1/11$ we find that slightly over 9% of the voltage is fed back from the plate to the grid circuit.

As a rule of thumb figure we can say that 10% feedback voltage reduces the tube distortion under proper load conditions to approximately 1/5 of its rated distortion level without inverse feedback.

Servicing of inverse feedback ampli-

Fig. 4. Audio peak-limiter circuit using a neon tube with an impedance-coupled voltage amplifier.

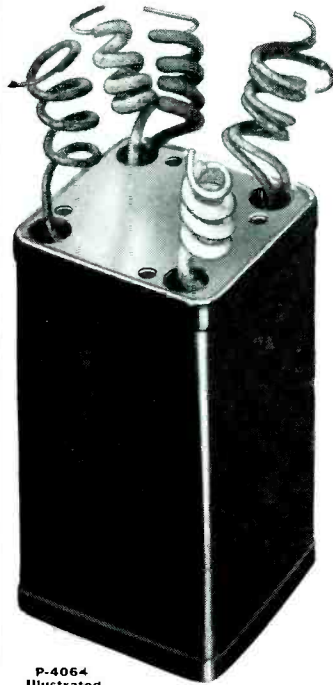
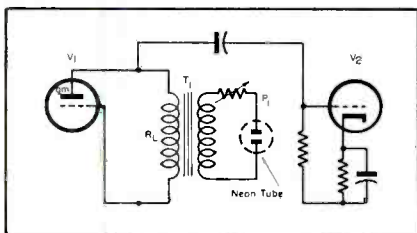

P-4064 Illustrated

JUST PUBLISHED!

Write For The New Stancor Transformer Catalog Listing Over 400 Replacement Items.

Stancor Part No.	Trade Name	Manufacturer's Part Number	Description	Year
P-4064	United Motors (Delco)	7240519	Buick	1946-47
P-4065	United Motors (Delco)	7255881	Cadillac, Chev., Olds., Pontiac	1946-47
P-6470	Regal (5-tube Univ. Series)	140-111	140 V. @ 50 Ma. 2-11/16" H x 2-11/16" W x 2-3/32" D	1946-47
P-6471	Motorola (408, 508, 608)	25B472533	6 tube Ford	1946-47
P-6472	Colonial-Detrola No. 8072 Colonial-Brendix MI Colonial-Motorola Motorola (405, 505, 605, 705)	D 71014	Ford 8A-18805-A	1947-48
		C 217020	Ford 8A-18805-A	1947-48
		C 71014	Ford-FD6, Nash Standard	1947-48
		25B70950	Standard	1947-48
P-6473	Zenith	95-1073	Ford, Mercury, Lincoln (8-tube)	1947-48
P-6474	Zenith	95-1066	Hudson	1947-48
P-6476	Colonial-Detrola No. 7070 Colonial-Motorola-Detrola No. 8030	D 70267	Ford No. 51A-18805-B2	1947-48
		C 70267	Willys No. 67977	1947-48



STANDARD TRANSFORMER CORPORATION
ELSTON, KEDZIE & ADDISON • CHICAGO 18, ILLINOIS

fiers is simple if the following two important facts are considered:

(1)—Some carbon resistors are affected by temperature and may change in value resulting in excessive feedback voltage ratio, which will decrease the amplifier's output, or conversely may decrease the feedback's voltage ratio, which will increase the amplifier's output of signal and percentage of distortion.

(2) If the dc insulation resistance of C_1 in Fig. 2 has weakened (reduced in value) dc will flow up through R_2 in the direction shown by the arrow (Fig. 2) and a positive grid bias will develop on the grid of the tube, which

will seriously distort the amplifier's quality.

Audio Peak Limiter

It has always been a problem to design an audio peak limiter which would

(Continued on page 40)

Hearing Aids

(Continued from page 38)

portions with the thousands of persons being added to the list of hearing-aid users every year. It presents a new opportunity for every Service Man.

Eliminate the Variables
in
Television Installation
with the



FIELD STRENGTH METER
Do not depend on pictures—
Use absolute measurements—
Direct Meter Readings



Improves Installation!!
Saves 1/2 the Work!!

Has numerous features and advantages, including— (1) Measures actual picture signal strength . . . (2) Permits actual picture signal measurements without the use of a complete television set . . . (3) Antenna orientation can be done exactly . . . (4) Measures losses or gain of various antenna and lead-in combinations . . . (5) Useful for checking receiver re-radiation (local oscillator) . . . (6) 12 CHANNEL SELECTOR . . . (7) Amplitudes of interfering signals can be checked . . . (8) Weighs only 5 lbs. . . (9) Individually calibrated . . . (10) Housed in attractive metal carrying case . . . (11) Initial cost of this unit is covered after only 3 or 4 installations . . . (12) Operates on 110V, 60 Cycles, A.C. Model FSM-1, complete with tubes . . . \$79.50 NET

Transvision offers a complete line:

- Television Kits and Cabinets
- Field Strength Meter
- Sweep Signal Generator
- All-Channel TV Booster
- Remote Control Units
- Tuners • Lenses • Antennas
- Accessories and Parts

All prices fair traded . . . 5% higher west of the Mississippi River.
See Your Local Transvision Outlet, or
Mail this coupon today to:—

TRANSVISION, INC.
NEW ROCHELLE, N. Y.

Please ship THROUGH YOUR NEAREST LOCAL OUTLET: S-6

- () Field Strength Meters
I am enclosing 10% DEPOSIT in the amount of \$. . . balance C.O.D.
() Send details of Dealer Plan.

Name
(please print)

Address

City & State

Servicing Helps

(Continued from page 39)

not seriously distort or load an audio circuit. Fig. 4 shows a novel audio peak limiter circuit which has no mal-effects on the quality of an amplifier. This limiter circuit functions in the following manner:

(1)—For all normal signals the circuit between V_1 and V_2 is an impedance-coupled amplifier in which the gain of the stage is equal to the mutual conductance (G_m) of the tube V_1 and the effective load of the primary winding of transformer, T_1 , which is at its highest value when its secondary is not drawing current.

(2)—On overload signals sufficient voltage is induced in the T_1 secondary so that the neon lamp is ionized. When the neon lamp is ionized the effective impedance of the primary, R_L , is reduced and therefore the gain of this stage is also reduced.

(3)—The potentiometer, P_1 , is adjusted to suit the level of signal where audio peak control is desired.

TV Income

(Continued from page 24)

the part's kit. This may be done as often as desired.

Now let us take the case where the Service Man decides to remove the set to the shop.

As before, when the complaint call is received, the original record card is pulled from the file, scheduled and promised. The Service Man in deciding to pull the chassis, fills out part 2 and detaches the small half of the stub, which serves as the customer's receipt. If an attempt has been made at the customer's home to repair the set and materials are used, the Service Man must show the parts used on part 2. This tag is then attached to the set and turned into the shop along with any defective parts. Part 1 and the original card are filled in to show that the set has been brought in. These are both returned to scheduling. The other half of the stub is placed in a tickler file in the shop. When a set is completed and ready to be returned this stub is sent to scheduling as notification that the set should be returned. The Service Man who brought the set in must get any materials used on the job in attempted repairs from the shop and not from the stock room. The shop also fills out part 2 showing materials used, this card also being used as a material requisition to replenish stock. Upon completion of the repair and notification to the schedul-

SHOOTS TROUBLE FASTER! Makes more money for you on job or at service bench!



PRICE
\$9.95
at distributor or postpaid, direct. Sorry, no C.O.D.'s. Oh loans add 3% State Sales Tax.

Signalette

MULTI-FREQUENCY GENERATOR

In radio service work, time means money. Locate trouble faster, handle a much greater volume of work with the SIGNALETTE. As a trouble shooting tool, SIGNALETTE has no equal. Merely plug in any 110V. AC-DC line, start at speaker end of circuit and trace back, stage by stage, listening in set's speaker. Generates RF, IF and AUDIO Frequencies, 2500 cycles to 20 Megacycles. Also used for checks on Sensitivity, Gain, Peaking, Shielding, Tube Testing. Wt. 13 oz. Fits pocket or tool kit. See at your distributor or order direct.

Clippard INSTRUMENT LABORATORY Inc.

DEPT. S, 1125 BANK STREET
CINCINNATI 14, OHIO
QUALIFIED JOBBERS WRITE,
WIRE FOR DETAILS.



PLAYS AUTOMATICALLY ALL RECORDS—ALL SPEEDS ALL SIZES!

V-M Tri-O-Matic Record Changers have simple, centralized controls; single Tone Arm; quick, quiet change cycle. Records are LOWERED—NOT DROPPED—on spindle shelf. All parts are riveted or pinned in adjustment at the factory, for years of trouble-free performance.

Ask your local distributor about V-M Models 406 and 407 Tri-O-Matic Replacement Units.

Immediate Delivery!

V-M Corporation

BENTON HARBOR, MICHIGAN

ing department, a return is scheduled. The customer is notified and an appointment made. The Service Man, who redelivers the set, takes with him part 1 and the original card which he fills in showing the satisfactory completion of the job. These are returned to scheduling, where parts 1, 3, and the original card are filed in the customer's folder. It should be noted that part 2 serves primarily as a return tag, but the eventual purpose of it is for a stock room record of material used. Here again the stock clerk has a record of all parts issued to the shop.

The original record card has only enough room to show five service calls. When this card is used up it is immediately indicative of a very troublesome set and should no longer be handled in a routine manner. A second card must then be filled out and be given to the most experienced man in the shop. When a customer is on the second card, every effort should be made to get to the bottom of the trouble and an attempt made to completely clear up this situation, for it is at this point where the servicing calls begin to absorb the profits.

If at any time the Service Man finds that he cannot complete his calls for the day, he should call those customers and inform them that he cannot service that day.

The foregoing plan has been placed into operation at several locations and served to accelerate the handling of both installation and service calls, minimize call backs and improve the overall tenor of service department and service shop operations.

Constant Line Voltages

(Continued from page 16)

tacts of the single-pole double throw switch. This causes the relay to close and the contacts are therefore changed from position 1 to position 2 and the contacts of the normally open switch, closed (position 3). The relay has sufficient delay action in it, so that the relay can throw from the normally open to the closed position and immediately upon so doing, the relay coil still being in series with the receiver primary stays closed, and energizes the primary of the *c-v* transformer. The output of the *c-v* transformer then is over contact 2 of the single-pole double-throw switch through the relay coil and stays in the energized position until such time as SW₁ is again opened. In this manner it becomes unnecessary to wire into the receiver, for the switch connections, to connect the *c-v* transformer in and out of the line. So that the relay may operate, it is necessary that a minimum load be applied to the

You've a record year ahead...

33 1/2 RPM

78 RPM

45 RPM

MODEL TS

...WITH THIS *3-Speed* PHONOMOTOR

Here's the motor that plays all three types of records without fuss or bother . . . the *one* motor designed, engineered and built to enable radio and phonograph manufacturers to offer their customers dependable, *complete* record entertainment. It's GENERAL INDUSTRIES' new Model TS three-speed phonomotor.

External speed change lever affords positive, accurate shifting to any of the three speeds without removing turntable. Ingenious, yet simple, shift mechanism is both trouble-free and fool-proof. Compact size of motor makes it ideally suited for portables as well as console models. Cost is surprisingly low.

For complete information—blueprints, performance specifications and quotations—write, wire or phone today.

The GENERAL INDUSTRIES Co.

DEPARTMENT O • ELYRIA, OHIO

transformer. This is approximately 1.3 amperes; the relay coil is capable of carrying over three amperes to provide for the maximum power out-

put of the transformer.

The *c-v* transformer can correct line voltage variation to better than 3%

(Continued on page 42)

View of the TV service laboratory of the Conlan Electric Corp., 1042 Atlantic Avenue, Brooklyn, N. Y., one of the first service organizations in New York City to establish a *Standard Register* type system for processing TV installations and service.

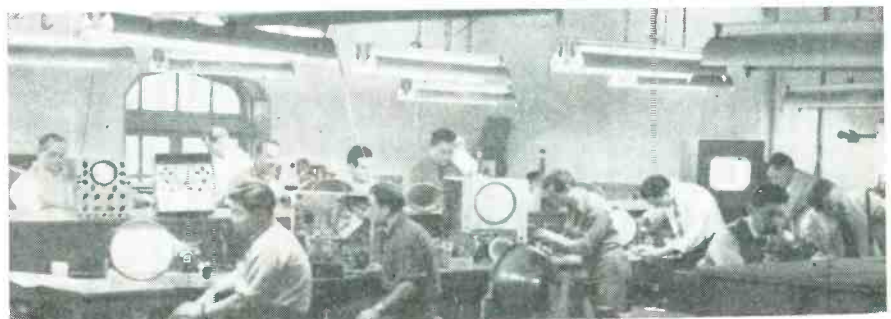

...Help end spark plug INTERFERENCE



Spark Plugs are miniature broadcasting stations, send signals that interfere with radio reception, distort television. The New Auto-Lite "Resistor" Spark Plug reduces this interference.*

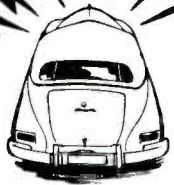

Recommend NEW AUTO-LITE Resistor SPARK PLUG

Here's How It Works to End Interference

The "Resistor" acts to dampen the spark plug radio signal to an acceptable level* while still delivering the full high voltage discharge required to ignite the fuel.

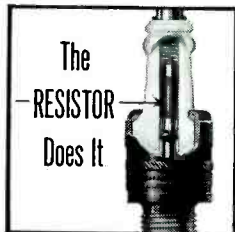

Auto-Lite Ignition Engineers, working with leading automotive manufacturers, have developed the new Auto-Lite "Resistor" Spark Plug with this built-in resistor that reduces spark plug interference.* Remember, the "Resistor" also helps deliver smoother idling, improved economy, longer electrode life. Dealers are being supplied as rapidly as possible. Write for Booklet M-1186 for full information.

THE ELECTRIC AUTO-LITE COMPANY
Toronto, Ontario Toledo 1, Ohio

*Under 35mv/m from 540 k.c. to 150 m.c. at 50 ft.

Tune In "Suspense," Thursdays, 9:00 P. M., E. T., CBS



with a 15% input voltage variation. The characteristics of the output voltage of the constant-voltage transformer with varying input voltage is shown in the plot on page 16.

This device, in addition to regulating voltages that change gradually, also has the ability to correct very rapid changes in line voltage. It will correct voltage fluctuations and transients up to six cps. These usually appear as line modulation voltages as mentioned previously. In correcting for these rapid fluctuations, much of the flicker, which is due to line voltage modulation, can be eliminated.

Phono Installation

(Continued from page 19)

speech with records or use of each independently.

Portable transcription players⁶ to handle three speeds of recordings and transcriptions have also become available.

The players feature a wrist-action pickup with a turn-over head, a triple-speed *micro-grip* turntable, a push-pull amplifier and one or two *pm* speakers, depending on model, with extension cord in a removable cover.

Another type of three-speed changer⁷ which has become available provides automatic playing of twelve 10" (33 $\frac{1}{3}$ or 78) records; ten 12" (33 $\frac{1}{3}$ or 78) records; any ten 12" or 10" of the same type intermixed; twelve 7" 33 $\frac{1}{3}$ or twelve 7" 45 type records.

Has a single tone arm with a dual needle and reversible cartridge.

Another recently announced three-speed record changer⁸ features a standard spindle, with a thin collar or spacer to center the 1 $\frac{1}{2}$ " center hole of the 45 rpm 7" records. The changer controls provide a speed selector switch, reject, and manual control for automatic or manual play. Tone-arm is equipped with a *Tandem-Tip* needle that provides microground tip for long-playing records, and a standard tip for standard records, both on one needle.

To accommodate the three types of records now available, a three-speed phonomotor assembly⁹ has also been produced. The assembly is furnished with either an 8" or 9" turntable. To convert from 78 or 33 $\frac{1}{3}$ rpm to 45 rpm, the three-speed unit utilizes an interchangeable disc. This is a reversible disc which will go on either

⁶Califone Corp. models 6U, 12MU and 18MU.

⁷V-M model 406.

⁸Webster-Chicago 356.

Use ERIE "CERAMICONS"[®]



... for capacitor replacements. TV and FM engineers know their superiority over mica or paper ... more efficient at high frequencies ... require less space.

If your distributor cannot supply you, write us for information. New catalog on request.

Electronics Division
ERIE RESISTOR CORP., ERIE, PA.
LONDON, ENGLAND TORONTO, CANADA

OTARION'S SERVICEMAN'S ANALYZER

SPELLS PROFIT for RADIO REPAIRMEN

Otarion's new Serviceman's Analyzer is designed for use for radio repairmen in the service of hearing aids.

The Hearing Aid Analyzer offers the radio repairman the additional equipment he needs to service hearing aids. It requires little space, is attractive and easy to operate. Hearing Aids may be tested for over-all gain and gain per stage. It may also be used for signal tracing in many audio devices, such as audio stages in radios, etc.

Here is an unusual opportunity to gain new business—and, to gain new profits by offering on-the-spot instrument service desired by all hearing aid users. For further information, write . . .

OTARION, INC.

159 NORTH DEARBORN STREET
CHICAGO, ILLINOIS

way, the height being adjusted for ease of record handling.

The three-speed phonomotor utilizes a motor¹⁰ which features a single lever shift. Advantages of the motor are said to be no rubber bands to slip, snap, distort or stretch; no needle shaft to indent tire under stalls, and unimpaired performance at all speeds, as either wheel is also in contact with turntable and driving shaft.

Magnetic cartridges, for installation in Webster automatic changers and use on standard and long-playing records, have been announced by the Pickering Co., Inc., Oceanside, N. Y.

Illustration on page 19 shows how the cartridge is installed, being slid on to the clip, and the cartridge then pressed down so that the stylus side is parallel to the edge of the cartridge holder. The terminals on the cartridge are then in a position to be bent over the contacts of the cartridge for soldering.

Models 120 and R150 are for standard records and 140 for 33 1/3 and 45 rpm use.

¹⁰Alliance. ²⁰Alliance model J.

Custom Audio

(Continued from page 31)

mediately, the demonstrations eventually will pay off in sales and often partial conversion of the customers present equipment to high fidelity standards. In any event, it will prove beneficial to your business, for the customer will be impressed with the difference and inevitably will do something to improve his equipment or replace it.

Adaptation of High Fidelity to TV

There are many prospects for high fidelity among those who have TV sets. Although many of the TV receivers on the market today provide very good FM circuits and excellent picture reproduction, they are very deficient in the reproduction of sound. Service Men have advertised and solicited business for conversions to large picture screens and have been very successful on that score, but many have overlooked the lucrative addition to these conversions, in the addition of a high fidelity audio circuit to existing receivers. With many concerts and operas that will eventually be televised, high fidelity sound reproduction will become a *must* in TV receivers.

A simple *hi-fi* amplifier can provide the required quality (circuit on p. 31). This audio system uses a selenium rectifier power supply for B+, the filament supply being taken from the receiver thus eliminating the need for any transformer in the circuit.

The unit can be built on a chassis, made from part of an old TV *if* strip, using the miniature 7 pin sockets, as the tubes in the amplifier are miniature

AMPHENOL ANTENNAS

for every
FM or TV Requirement

An efficient, high-gain antenna is imperative for TV reception, and Amphenol leads with the finest attainable. Highly trained and highly skilled Amphenol engineers have produced the most effective high and low band antennas and are continually making improvements as new ideas are developed. Constructed of aluminum tubing and aluminum alloy castings, Amphenol antennas have high forward gain combined with high front-to-back and front-to-side ratios, insuring maximum pickup and lasting enjoyment to the user.

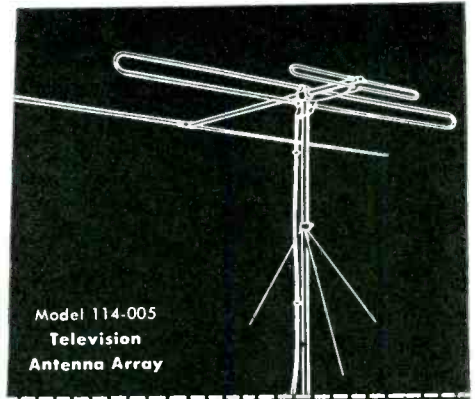

Model 114-005
Television
Antenna Array

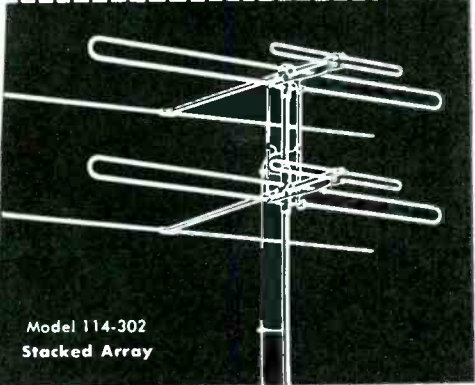

Model 114-302
Stacked Array



Model 114-008
Deluxe FM
Folded Dipole
With Reflector

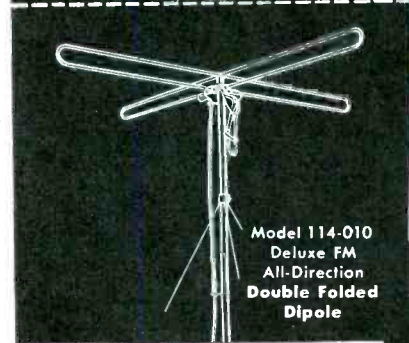

Model 114-010
Deluxe FM
All-Direction
Double Folded
Dipole

AMPHENOL

AMERICAN PHENOLIC CORPORATION

1830 SOUTH 54TH AVENUE
CHICAGO 50, ILLINOIS

Specifically engineered for finest FM performance, Amphenol FM antennas provide interference-free and general long distance reception which is unmatched in the FM antenna field. For rural, suburban or close-in installations, Amphenol FM antennas combine efficient operation with clean-cut, attractive design . . . antennas are entirely constructed of rust-proof aluminum. For consistent, top-quality service, Amphenol FM antennas are chosen again and again.

equivalents of conventional tubes such as 6V6 and 6SJ7. The chassis can be made small enough to fit into the TV cabinet above the receiver chassis. Point to point wiring is advised, though a resistor mounting board may be used. The output transformer is mounted on or near the speaker which, for best results, should be mounted in a bass reflex or acoustic labyrinth cabinet of at least 6 cubic feet inside area. This cabinet can be used as a table for the TV receiver. In the event the receiver cabinet does not provide enough room for the chassis, it can be mounted in the speaker cabinet if the space used is partitioned from the speaker and

adequate ventilation is provided. The *ac* line cord from the audio chassis should be connected to the primary of the power transformer of the receiver chassis, so that the switch of the receiver will automatically control the *ac* of both chassis. Volume control of the audio chassis (R_1) is a limiting control and should have a screwdriver shaft. This control is set to limit full volume of the receiver control below the distortion point. Incidentally, the audio section of the receiver will function, but will not in any way affect the operation or performance of the audio chassis.

[To Be Concluded in July]

ARE YOU RECTIFIER-WISE? WIN A VALUABLE PRIZE

With your Circuit Designs Using Federal's
Miniature Selenium Rectifiers

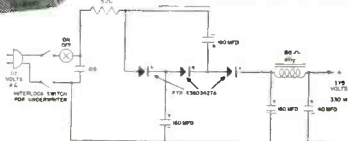

CONTEST DETAILS

1. All entries must be original circuits.
2. All entries become the property of Federal Telephone and Radio Corporation.
3. Federal engineers will judge entries on basis of novel and useful applications and select winning circuits.
4. Five winners will be selected from the entries received during each month of the contest. A grand prize will be awarded to the outstanding entry of the contest.
5. All entries must be received by the contest final closing date—July 31, 1949. Mail your entry to Contest Box C.
6. Winners will be announced.

FIVE MONTHLY PRIZES AND A GRAND PRIZE

The five monthly winners will each receive, FREE, a Federal FTR-1342-AS Selenium Rectifier Power Supply-Battery Charger. This compact unit, with its 6-volt, 6-ampere DC output, has many uses in home and shop. It comes equipped with a handy under-dash mounting socket for automobile battery charging.

The grand prize, a Federal FTR-3246-BS Radio Service Power Supply, is invaluable as a source of heavy duty, filtered DC power. Its 6-volt, 10-ampere DC output will handle auto radio testing and many other test and permanent power requirements. List price \$74.50.

MAIL YOUR ENTRY TO: MINIATURE RECTIFIER CONTEST

Federal Telephone and Radio Corporation

SELENIUM INTELIN DIV. • 900 PASSAIC AVENUE • EAST NEWARK, NEW JERSEY

Sound Parts, Accessories

SHURE BROS. CONTROLLED RELUCTANCE MICROPHONES

A controlled reluctance hand-held magnetic microphone, Hercules model 510, has been designed by Shure Brothers, Inc., Chicago, Illinois. Has a balanced-armature transducer, and thus can be used as a transmitter and a receiver.



* * *

RAULAND-BORG PHONO AMPLIFIER

A phono amplifier, (model 1825) which features a detachable remote control pre-amp (2 3/8" x 2 3/8" x 1 1/2") designed to mount in any position to meet the mechanical requirements of custom installations, has been announced by Rauland-Borg Corp., 3523 Addison St., Chicago, Illinois.

Amplifier is said to deliver a power output of 25 watts with not more than 5% total harmonic distortion; frequency response 1 db, 40 to 20,000 cps. Output impedances are 4, 8, 16, 250 and 500 ohms.

* * *

E-V CRYSTAL AND DYNAMIC MICROPHONES

General-purpose crystal and dynamic microphones (Mercury type) have been announced by Electro-Voice, Inc., Buchanan, Michigan.

Features a tiltable head for non-directional or semi-directional use.

Frequency response is said to be substantially flat, 50-8000 cps. Output level is -48 db for crystal (model 911) and -53 db for dynamic (model 611). The dynamic has an E-V *acoustalloy* diaphragm. Model 911 uses a high-capacity metal seal crystal.



CHECK!

- ★ Cold inorganic-cement coated
- ★ Won't blister, peel, flake, crack
- ★ Stands up under severe overloads
- ★ Fixed and adjustable, 5 to 200 watts
- ★ Wide selection of resistance values



YES INDEED, GREENOHMS ARE TOUGHER!

★ Those green power resistors you find in better-grade TV sets, oscilloscopes, test instruments, transmitters and industrial equipment, are GREENOHMS. Take a tip! For your "stay-put" jobs

— where you can't take a chance with component breakdowns — when you don't want to lose your profit by going back again — use GREENOHMS. They'll never let you down! And they cost less!

Ask our jobber for Greenohms.

Try them once!

Latest catalog on request.

CLAROSTAT



Controls and Resistors



CLAROSTAT MFG. CO., INC. • DOVER, NEW HAMPSHIRE • In Canada: CANADIAN MARCONI CO., LTD. Montreal, P. Q., and branches

TURNER MICROPHONES

Two microphones, 25X crystal and 25D dynamic, have been announced by the Turner Company, Cedar Rapids, Iowa. Crystal mike is equipped with a moisture-sealed crystal, and is said to have an effective output of 52 db below 1 volt/dyne/sq cm and flat response from 50-9000 cps. Dynamic features Alnico V magnets and is said to have an output level of 54 db below 1 volt/dyne/sq cm at high impedance, and flat response from 50-10,000 cps.

Turner has also re-designed their model 77 cardioid-type microphone, the model featuring a wide range pickup at the front and a sharply attenuated output at the rear, with approximately 15 db discrimination between front and rear at all frequencies.

Response is said to be substantially flat from 60 to 10,000 cps; output is rated at 62 db below 1 volt/dyne/sq cm at high impedance. Built-in switch gives choice of 50,200,500 ohms or high impedance.

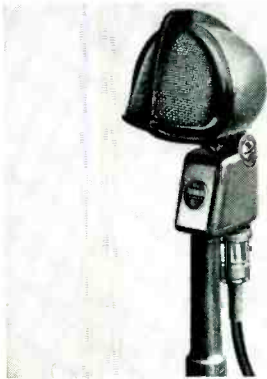

Model 25

PERMOFLUX TV REPLACEMENT SPEAKERS

An 8" speaker (model 7529) with an 87-ohm field, an exact replacement for Motorola TV sets, (models VT-107, VT-121, and 12VT-16) has been announced by PermoFlux Corp., 4900 W. Grand Ave., Chicago, Ill.

SPRAGLE RESONANT CAPACITORS

Resonant type paper tubular capacitors (type 72 P) are now available from the Sprague Products Company, North Adams, Mass.

Capacitors have a controlled inductive construction so that the combination of self-inductance and capacitance will series resonate at about 455 kc, the *if* frequency of most broadcast receivers.

Installed from B- to chassis ground in a high-gain ac/dc receiver, resonant capacitors are said to prevent degeneration at the *if* frequency and stop self-oscillation, permitting on-the-nose alignment. Their usual physical location is near the cathode return of the *if* amplifier.

Capacitors are said to have a very low impedance at the *if* frequency because of the nature of the series resonance curve. (Cannot be replaced by standard tubulars without exceeding the maximum safe B- to ground capacitance (.2 mfd) established as a shock hazard limit by the Underwriters' Labs).

Listings and application data are given in bulletin M-430.



PRICESTALK

at RADIO SUPPLY

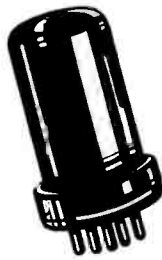

OZ 4's
(No Limit)

Fresh RK and RCA. Standard commercial grade, not JAN's.

BUY 12 **58c**
get 1 free EACH

EGG CRATE OF 100 **\$49⁰⁰**

VIBRATORS

MALLORY universal standard 4 prong, non-synchronous. Can size 1 1/2" x 3 1/8".

\$129
EACH

BUY 12 get 1 free

EGG CRATE **\$109⁰⁰**
of 100



AERIALS RADIART 363U1 (discontinued model) 3 section

63" top cowl, universal mount, 48" lead. Former list \$6.75.

\$241
EACH

BUY 10 get 1 free

\$215⁰⁰ per 100



GENERATOR CONDENSERS

By one of the big 3



15c .5 mfd 200 VDC, 6" lead
EACH

BUY 12 get one free **\$12.00** per 100

ORDER INSTRUCTIONS

Minimum order — \$2.00. 25% deposit with order required for all C.O.D. shipments. Be sure to include sufficient postage—excess will be refunded. Orders received without postage will be shipped express collect. All prices F.O.B. Detroit.



DON'T WAIT — ORDER TODAY

R. S. E. 3 inch TELEVISION SCOPE

Features:

WIDE BAND VERTICAL RESPONSE
FLAT TO 750kc
DOWN 3db
AT 1mc
VOLTAGE GAIN
OF 20 AT 5mc



AR-3

The R.S.E., AR-3 Scope has been built by Ross Armstrong to our rigid specifications. It's a complete unit that embodies standard horizontal amplifier and sweep circuits with normal sensitivity.

It's different because of the extreme vertical amplifier response. Check the featured specifications against others. For TV use wide band response if necessary.

The case is 8" high x 5" wide x 14" long, attractively finished in "hammered" opalescent blue enamel. Operates on standard 110 volts—60 cycles —40 watts. Tubes, 3BP1—6AC7 —6SJ7—6X5—5Y3—884. Instructions included. Complete specifications upon request. Satisfaction or your money back.

PRICE **\$49⁹⁵**
F. O. B. DETROIT

PUSHBACK

WIRE



BELOW MILL PRICES!

2,000,000 feet—tinned copper—all 1st class, double cotton serve, waxed finish.

Available solid or stranded

22 gauge (6 colors) per 1000 **\$3.98**

20 gauge (6 colors) per 1000 **\$4.98**

18 gauge (brown) per 1000 **\$6.49**

RADIO SUPPLY & ENGINEERING CO., Inc.
86 SELDEN AVE. DETROIT 1, MICH.

TRANVISION HOOK-CUT PLIERS

Hook-Cut pliers featuring both a sharp, tempered cutting edge and a long nose for probing into small places such as miniature sockets, etc., have been announced by Tranvision, Inc., New Rochelle, N. Y.

Pliers are made of hardened tool steel.

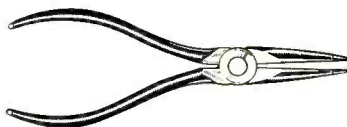

CORRECTIONS

IN THE REPORT on soldering corrosive standards and Government specifications

in the article entitled "Solder and the Service Man," which appeared in the May issue of SERVICE, the standard should have been described as follows: "As a protection the Government has set up standards, the last being QQ-S-571B, which not only establishes various standards which solder must have, but also establishes corrosion tests and other safeguards. Therefore, in purchasing solder, it may be assumed that any solder which passes this Government specification may be considered, in fact, to be non-corrosive."

The C-D TV capacitors, type DSTH, described in the *New Products* section of the March issue of SERVICE, are high-voltage paper type, with the capacitor element enclosed in two separate concentric wax-sealed cardboard cases.

**COMPARE
ACTUAL
PERFORMANCE
CURVES . . .**

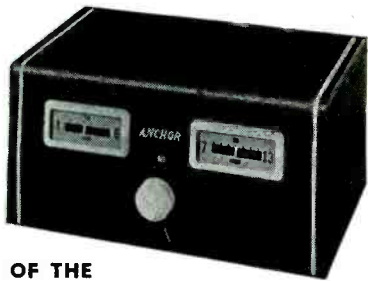

**OF THE
ANCHOR
TV-PRE-AMPLIFIER**

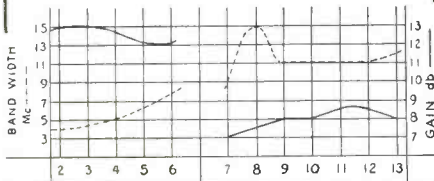

HAZELTEEN REPORT No 2801-17

The ANCHOR PRE-AMPLIFIER is engineered to amplify the signal only, not the noise. Furthermore, the inherent noise of this unit is not measurable.

The ANCHOR Booster provides maximum gains possible from the 6AK5 tube with excellent band widths.

It increases signal strength without loss of picture detail.

The outstanding acceptance of the ANCHOR TV-PRE-AMPLIFIER by Service Engineers and Dealers is the best testimonial to its quality.

Engineered for modern and the best TV reception. Priced right for profits. Get details now.

See your jobber or write us.

ANCHOR
RADIO CORP.
2215 S. St. Louis Ave.
Chicago 23, Ill.

FOR T-V SERVICING

Investigate the Mega-line of instruments:

- MEGA SWEEP
- MEGA PIPPER
- MEGA-MARKER
- MEGA-MARKER SR.

Request Catalog

Kay Electric Company

19 Maple Ave., Pine Brook, N. J.



**MAGINOT NAMED
N. U. DISTRIBUTOR DIV. S-M**

Emil J. Maginot has been appointed sales manager of the distributor division of the National Union Radio Corp.

Maginot came to National Union eight years ago and has served successively as director of sales engineering, and manager of advertising and sales promotion.



* * *

**HARRY ESTERSOHN NOW
JERROLD ELECTRONICS
SALES MANAGER**

Harry Estersohn, formerly sound sales engineer with the Lafayette-Concord Radio Corp., has been appointed sales manager of the Jerrold Electronics Corp., 121 N. Broad St., Philadelphia 7, Penna.



* * *

**NATIONAL VIDEO PRODUCING
PICTURE TUBES**

TV picture tubes are now being made by the National Video Corporation, 3019 West 47th St., Chicago, Ill.

A. Cole is president of National Video.

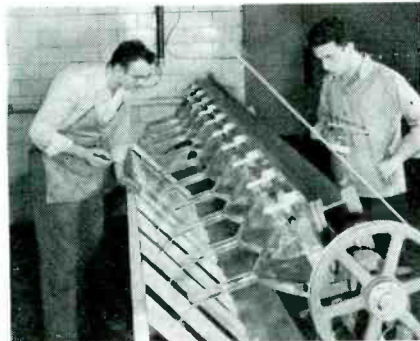

View in plant of National Video

* * *

STANCOR LITERATURE

An output transformer chart listing ninety tubes with corresponding Stancor output transformers has been published by the Standard Transformer Corp., 3580 Elston Ave., Chicago 18, Ill.

Stancor has also released a catalog which includes detailed electrical and physical specifications of more than 400 items. Included are audio and power transformers, chokes and related components for radio, television and other electronic applications.

SPECIAL TUBE SALE

AM, FM, TV Tubes 34 1/2¢ ea.

1B3	6AK5	6BH6	6Z7G
2C34	6AL5	6B16	12A U7
2E24	6AQ5	6S8GT	12A T7
4A6G	6A U6	6SN7GT	12A X7
616	6BD6	6SS7	12BA7
6AG5	6B6G6	6T8	12SB
			19T8

KEN RADS 49¢ ea.

1A5GT	6F5	7A4	24A
1P5GT	6F8G	7E7	30
1T5GT	6H6	7L7	35/51
1V	6I7	7T7	36
1C5GT	6K7G	12A7	56
2A5	6D6	12I5	57
2A7	6SF5	12Q7	58
5X4	6SG7	12SF7	77
6B8	6U7	12SG7	78
6C6	6T7G	20S0	89
6D8	6W7G	20S1	VR150

59¢ ea.

Summer Specials! 49¢ ea.

OZ4	1N5GT	7G7	7Q7
1A7GT	7A4	7H7	7S7
1G4GT	7A7	7J7	7W7
1H5GT	7F7	7N7	7X7

All American 5 Kit \$2.69

RCA, HYTRON, TUNGSOIL, SYLVANIA
50L6, 35Z5, 12SA7, 12SK7, 12SQ7

Minimum Order \$5.00. Add 5¢ per tube for orders of less than 100. Tubes may be assorted in mixed price categories. All ship. F.O.B. Chicago. 25% deposit with order, balance C.O.D. ALL MERCHANDISE BRAND NEW and individually boxed. Foreign inquiries invited.

Concert Master Radio Tube Company

1802 Winnemac Avenue
Chicago 40, Illinois

**SURPLUS HIGH SPEED DRILLS
MICROMETERS**

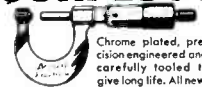

Chrome plated, precision engineered and carefully tooling to give long life. All new.
0-1" capacity . . . each \$2.25
1-2" capacity . . . each 3.50
2-3" capacity . . . each 5.50
3-4" capacity . . . each 6.50

All New Drills! Orig. value \$15.

30 assorted sizes and lengths \$3.50

SEND FOR FREE DESCRIPTIVE CATALOG
Send check, money order or cash. 25% deposit required on C.O.D. orders. All prices F.O.B. Culver City, Calif.

AIRBORNE SALES CO., INC. DEPT. SV. CULVER CITY, CALIF.

TEST EQUIPMENT CENTER

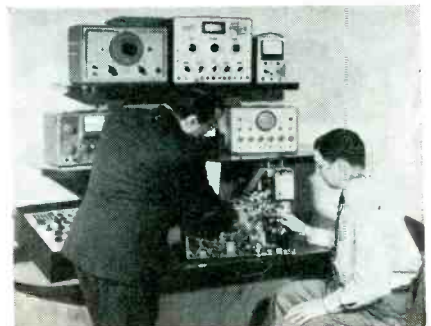

Burt L. Zimet (left) test equipment manager of Sun Radio and Electronics Co., Inc., 122-124 Duane St., New York 7, N. Y., detailing a test equipment application in the recently opened center in the store, which features two fully equipped test benches with live TV receivers.

**NEW! FASTER!
EASIER TO USE!**

**DRIVE-IT STAND-OFF
INSULATOR**

Pat. Pending

FAST—just a few hammer strokes and it's in, permanently secure. No tools . . . no bother . . . no effort. Made of cadmium plated steel—Lo-Loss Polyethylene insert. At better jobbers—order today! Send **9¢** list for catalog S.

Phoenix Electronics Inc.
Lawrence, Mass.

**ATTENTION
TELEVISION DEALERS**

WE MANUFACTURE AN ESPECIALLY DESIGNED OLIVE-DRAB TARP-COVERED

FOAMED LATEX PAD

24 INCHES SQUARE WHICH ABSORBS SHOCK TO THE T.V. SET WHILE BEING DELIVERED. COMPLETELY WATERPROOF.

CASH WITH ORDER **\$6.95**
PREPAID, OR C.O.D. PREPAID

HUDSON ELECTRIC CO.
HUDSON, OHIO

AT THE CHICAGO PARTS SHOW



Reps, distributors, manufacturers and members of the press at the NEDA cocktail party held during the recent Parts Show in Chicago.

**GUTHRIE APPOINTED RAULAND
CORP. S-M**

Frank W. Guthrie has been appointed sales manager of The Rauland Corp., 4245 No. Knox Ave., Chicago 41, Ill.

Guthrie joined Rauland in 1944, at which time he served as special assistant to Mr. Rauland in the coordination of government contract activities. He was later assigned the position of director of purchases, which post he held until his recent appointment.

Rauland is now producing TV picture tubes of the electromagnetic type for the replacement market, and aluminized tubes for receiver manufacturers. The 10", 12½" and 16" metal glass tubes are now being manufactured by Rauland.

**SUNDBERG NOW WITH
OXFORD ELECTRIC**

Hugo Sundberg, formerly sales manager of Cleveland Electronics, Inc., has been appointed assistant to the president of Oxford Electric Corporation, Chicago.

Sundberg was associated for more than twenty years with Utah Radio Products.



MALLORY DATA

A catalog, No. 549, covering the line of Mallory products has been announced by P. R. Mallory & Co., Inc., Indianapolis, Ind.

The catalog has been divided into sections according to major product classifications.

Among the new products listed are: metal tubular dry electrolytics; sizes FP (fabricated plate) twist prong type capacitors; ac motor-starting selector; continuous-duty oil impregnated ac capacitors; high-voltage OW types for TV; ceramic capacitors; Midgetrols; six-volt bench power supply, etc.

APPROVED ELECTRONICS CATALOG

A 12-page catalog describing a 15" TV custom built receiver, TV field strength meter, TV/FM sweep signal generator, marker generator, signal generator kits, FM tuner kit, TV tuners, audio amplifiers, etc., has been released by Approved Electronic Instrument Corp., 142 Liberty St., N. Y. 6, N. Y.

**TV CERTIFICATES AVAILABLE TO
THOSE WHO ATTENDED CHICAGO
TOWN MEETING**

Service Men, who were at the Town Meeting of Radio Technicians in Chicago and turned in their lapel tags to indicate they had earned Certificates of Leadership in Television, will receive their certificates if they will send their full names and addresses to Room 805, 21 East Van Buren Street, Chicago 5, Ill..

**HYTRON NOW MAKING TV
PICTURE TUBES**

Hytron Radio & Electronics Corp., is now producing TV picture tubes, which are being shipped to leading manufacturers as well as to Hytron distributors.

**FOR
DEMONSTRATING
& TESTING AUTO RADIOS
from AC LINES**

ATR

**"A" BATTERY
ELIMINATORS**

**for DEMONSTRATING AND
TESTING AUTO RADIOS**

New Models . . . Designed for testing D. C. Electrical Apparatus on Regular A. C. Lines. Equipped with Full-Wave Dry Disc Type Rectifier, Assuring Noiseless, Interference-Free Operation and Extreme Long Life and Reliability.

ATR

AUTO RADIO VIBRATORS

A Complete Line of Vibrators . . .
Designed for Use in Standard Vibrator-Operated Auto Radio Receivers. Built with Precision Construction, featuring Ceramic Stack Spacers for Longer Lasting Life.

NEW MODELS ✓ **NEW DESIGNS** ✓
NEW LITERATURE ✓

ATR "A" Battery Eliminator, DC-AC Inverters, Auto Radio Vibrators

See your jobber or write factory

AMERICAN TELEVISION & RADIO Co.
Quality Products Since 1931
SAINT PAUL 1, MINNESOTA-U.S.A.

SPRAGUE PHENOLIC-MOLDED TELECAP* TUBULARS



**THE MOST
TRULY
DEPENDABLE
PAPER
TUBULAR
CAPACITORS
EVER OFFERED
TO THE
SERVICE
PROFESSION**

- Extra Dependability at No. Extra Cost
- Withstand Heat and Humidity, Shock and Vibration
- High Insulation Resistance
- High Dielectric Strength
- Unequaled for Sizzling AC-DC Midgets, or "Hot" TV and Auto Sets.

See Your Jobber Today!

SPRAGUE PRODUCTS CO.
North Adams, Mass.

*Trademark

JOTS AND FLASHES

THE TWENTY-FIFTH ANNIVERSARY of RMA was applauded by President Truman and FCC chairman Wayne Coy in special letters to the association which were read during the recent all-industry banquet in Chicago. President Truman said: "The radio manufacturing industry during the past quarter of a century has become one of our foremost industries both in war and peace. . . . The industry is a potent force also in our free enterprise economy providing employment to thousands of technicians both in factories and in the service trades." . . . Coy declared: "This anniversary finds our radio communications systems, in the building of which you members have played such a notable role, at undreamed heights of progress." . . . Raymond C. Cosgrove is now president of RMA. This is his fourth term, having served for three consecutive years from 1944 to 1947. He succeeds Max F. Balcom, who declined to be a candidate for reelection. . . . Thomas Electronics, Inc., 118 Ninth Street, Passaic, N. J., are now producing 15" and 16" all-glass picture tubes. . . . Samuel Kessler, formerly with Royal Eastern Electrical Supply Co., is now general sales manager of the C & M Distributing Corp., 161 East 33rd Street, New York City. . . . A new type of eye-saver television tube has been developed by Dr. Lee de Forest, U. A. Sanabria and Warren C. Taylor of American Television, Inc., Chicago, Ill. The tube employs a screen which is so treated that light scattering is reduced to a minimum.

A *duplicording* wire recording process, permitting duplication on wire, has been developed by the Magnetic Recording Division, Air King Products Co., Inc., 170 53rd Street, Brooklyn 32, N. Y. . . . Columbia Wire and Supply Co. have moved to a new plant at 2850 Irving Park Road, Chicago 18, Ill. . . . Henry M. Josephs, chief engineer of Coastwise Electronics Co., Los Angeles, is now conducting a series of clinical meetings in twenty-one areas throughout the country: Salt Lake City, Denver, Kansas City, St. Louis, Indianapolis, Cincinnati, Pittsburgh, Cleveland, Detroit, Chicago, Buffalo, Syracuse, Albany, Boston, New York, Philadelphia, Baltimore, Washington, Atlanta, New Orleans and Dallas. Josephs' program includes a discussion and demonstration of all phases of alignment, repair and servicing. . . . A ten-page catalog describing the Jiffy-Tennas, Delson inverters, Del-Co line filters and Del-Co sound powered telephones, has been published by the Delson Manufacturing Co., 126 11th Avenue, New York 11, N. Y. . . . Telrex, Inc., Rutherford at Neptune Avenue, Asbury Park, N. J., has released a three-page report on conical antennas by M. D. Ercolino, chief engineer. The report covers the special requirements of all types of antennas, with special reference to bandwidths, gain, impedance matching, reactances at television frequencies, etc.

ADVERTISERS IN THIS ISSUE

SERVICE INDEX—JUNE, 1949

AIRBORNE SALES CO.	46
Agency: W. C. Jeffries Co.	
AMERICAN ELECTRICAL HEATER CO.	34
Agency: Dudgeon, Taylor & Bruske, Inc.	
AMERICAN PHENOLIC CORP.	43
Agency: Burton Browne, Advertising	
AMERICAN TELEVISION & RADIO CO.	47
Agency: Firestone-Goodman Adv. Agency	
ANCHOR RADIO CORP.	46
Agency: Symonds, Mackenzie & Co.	
DAVID BOGEN CO., INC.	34
Agency: George Homer Martin Associates	
L. S. BRACH MFG. CORP.	37
Agency: A. W. Lewin Co.	
CLAROSTAT MFG. CO., INC.	44
Agency: Austin C. Lescarboursa & Staff	
CLIPPARD INSTRUMENT LABORATORY	40
Agency: The S. C. Baer Co.	
CONCERT MASTER RADIO TUBE CO.	46
Agency: Sander Rodkin Adv. Agency	
CORNELL-DUBILIER ELECTRIC CORP.	Inside Front Cover
Agency: Reiss Advertising	
ALLEN B. DUMONT LABORATORIES, INC.	25
Agency: Austin C. Lescarboursa & Staff	
THE ELECTRIC AUTO-LITE CO.	42
Agency: Ruthrauff & Ryan, Inc.	
ELECTRONIC MEASUREMENTS CORP.	34
Agency: Altonari Adv. Agency	
ERIE RESISTOR CORP.	42
Agency: W. S. Hill Co.	
FEDERAL TELEPHONE & RADIO CORP.	7, 44
Agency: J. M. Matthes, Inc.	
GENERAL ELECTRIC CO.	6
Agency: Maxon, Inc.	
GENERAL ELECTRIC LAMP DEPT.	35
Agency: Batten, Barton, Durstine & Osborn, Inc.	
GENERAL INDUSTRIES, INC.	41
Agency: Meldrum & Fewsmith, Inc.	
HUDSON ELECTRIC CO.	47
HYTRON RADIO & ELECTRONICS CORP.	17
Agency: Henry A. Loudon Advertising, Inc.	
KAY ELECTRIC CO.	46
Agency: George G. Felt	
KEN-RAD DIV. GENERAL ELECTRIC CO.	1
Agency: Maxon, Inc.	
P. R. MALLORY & CO., INC.	Inside Back Cover
Agency: The Aitkin-Kynett Co.	
MUELLER ELECTRIC CO.	38
OTARION, INC.	42
PHOENIX ELECTRONICS, INC.	47
Agency: Milton Richards	
PICKERING CO.	36
Agency: Sam J. Gally	
THE RADIART CORP.	23, 29
Agency: Stern and Warren	
RADIO CORPORATION OF AMERICA.	Back Cover
Agency: J. Walter Thompson Co.	
RADIO SUPPLY & ENGINEERING CO., INC.	45
Agency: Claude E. Whipple	
RADIO MERCHANDISE SALES, INC.	38
JOHN F. RIDER PUBLISHER, INC.	5
Agency: Shappe-Wilkes Inc.	
HOWARD W. SAMS & CO., INC.	3
Agency: George Brodsky, Advertising	
SOLA ELECTRIC CO.	20, 21
Agency: Hardy Advertising	
SPRAGUE PRODUCTS CO.	48
Agency: The Harry P. Bridge Co.	
STANDARD TRANSFORMER CORP.	39
Agency: Burnet-Kuhn Adv. Co.	
SYLVANIA ELECTRIC PRODUCTS, INC.	8
Agency: Newell-Emmett Co.	
TELREX, INC.	34
Agency: Shappe-Wilkes Inc.	
TRANSVISION, INC.	40
Agency: H. J. Gold Co.	
TRIPLETT ELECTRICAL INSTRUMENT CO.	4
Agency: Western Adv. Agency, Inc.	
V-M CORPORATION	40
Agency: Mayard Advertising	

SHOOTING

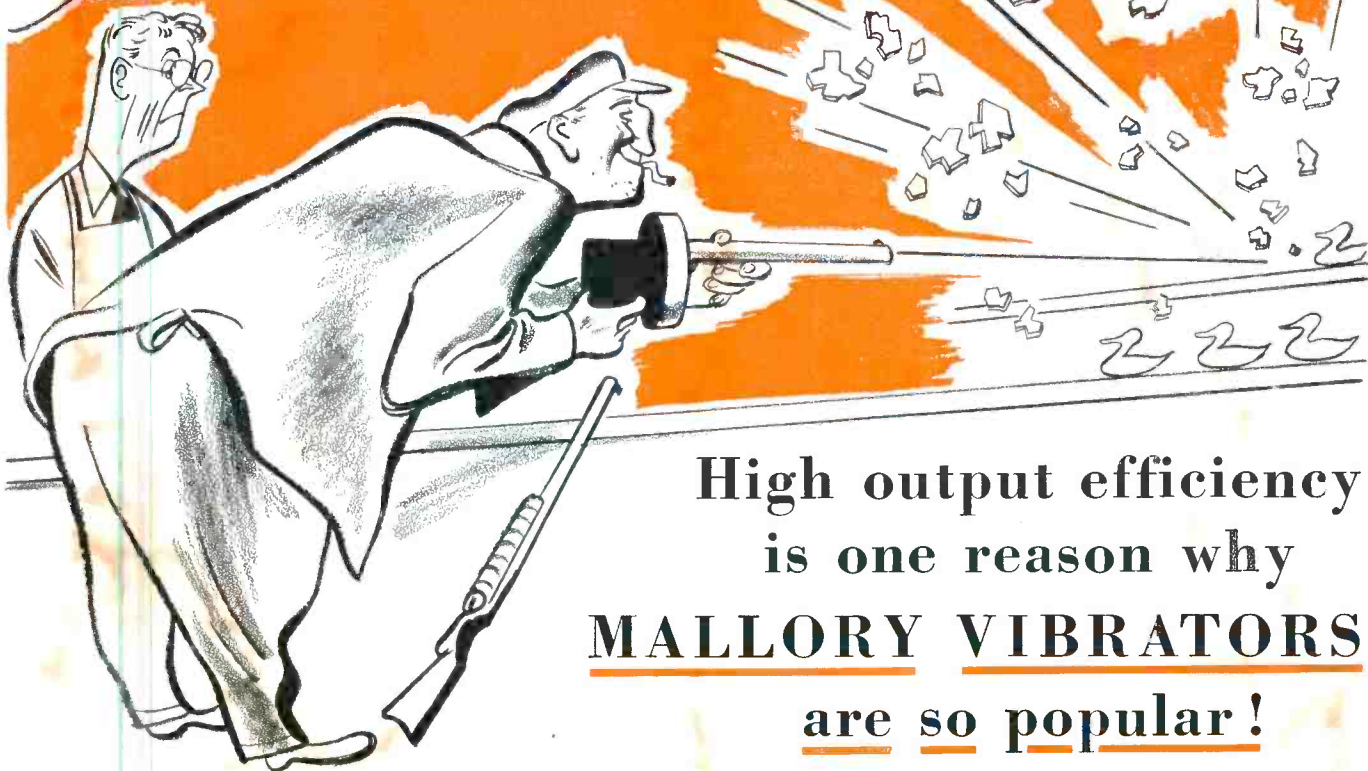

High output efficiency is one reason why **MALLORY VIBRATORS** are so popular!

High output efficiency! That's one of the vital reasons why more Mallory Vibrators are in use today than all other makes combined.

You get maximum efficiency from a Mallory Vibrator because its related parts are carefully

matched. Every part is carefully balanced with its counterpart by an exclusive Mallory method.

All working parts of Mallory Vibrators are Mallory-designed and Mallory-made. For Mallory focuses on Vibrator design an unusual combination of engineering talent and resources in electronics, electrochemistry and metallurgy.

The result is not only *high output efficiency* from Mallory Vibrators, but *long life* and *dependable starting*. No wonder more Mallory Vibrators are used in original equipment than all other makes combined. No wonder they make the best replacements. See your Mallory Distributor.

Mallory "2448" Vibrator Deal

This deal gives you a handsome storage and display cabinet for your stock of vibrators, together with a selection of vibrators and buffer capacitors that will answer 75% of your requirements.



You pay only the service man's net price for the six vibrators and twelve buffer capacitors. There is no charge for the attractive, convenient cabinet. Your Mallory distributor has them in stock for immediate delivery.

More Mallory Vibrators are used in original equipment than all other makes combined

P. R. MALLORY & CO. Inc. MALLORY

CAPACITORS • CONTROLS • VIBRATORS • SWITCHES • RESISTORS
• RECTIFIERS • VIBRAPACK* POWER SUPPLIES • FILTERS

*Reg. U. S. Pat. Off.

APPROVED - PRECISION PRODUCTS

P. R. MALLORY & CO., Inc., INDIANAPOLIS 6, INDIANA

*33 years
of service*

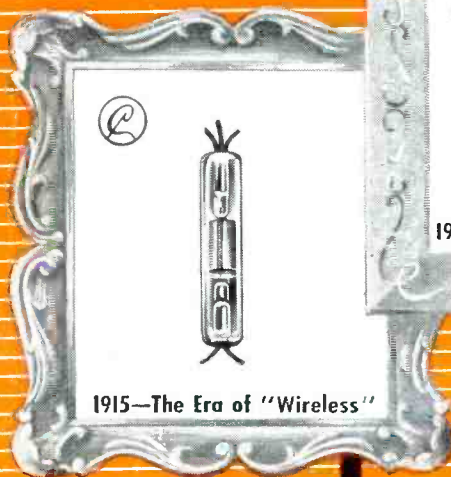

Cunningham-

**the symbol of quality and
performance since 1915**

DOWN THROUGH THE YEARS Cunningham tubes have enjoyed an enviable reputation for consistently high quality and top performance.

From the earliest receiving triodes to the modern high-gain receiving pentodes, the mark of a fine tube has been Cunningham.

Then, as now, Cunningham tubes have earned the confidence of professionals and set owners alike. That is why more and more experienced servicemen from coast to coast are turning to Cunningham tubes whenever renewals are required. It's a sure

way of building customer good will. Whether it's metal, miniature, or glass, there's a Cunningham type to meet practically every service requirement. Your Cunningham Distributor keeps complete stocks on hand to meet your immediate needs.

**RCA LABORATORIES
PRINCETON, N. J.**

Behind every Cunningham tube is the engineering leadership of the Radio Corporation of America.



SEE YOUR CUNNINGHAM DISTRIBUTOR TODAY

**A QUALITY PRODUCT OF THE
RADIO CORPORATION OF AMERICA**