

SERVICE

November
1948

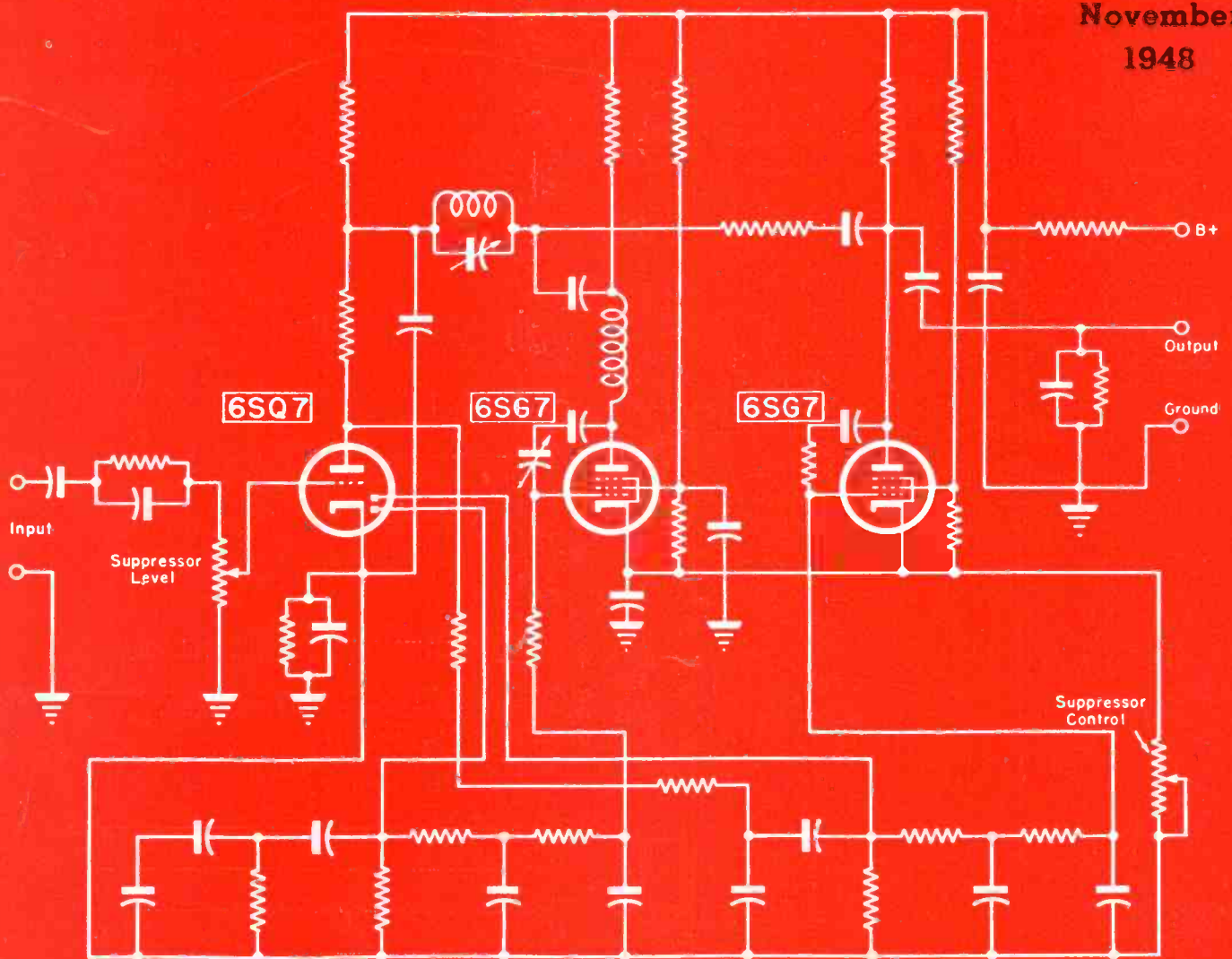

A three-tube dynamic noise suppressor used to curb noise levels in phono recordings.

[See page 26]

Profit-Building Ideas in Capsule Form

FREE
to SERVICEMEN

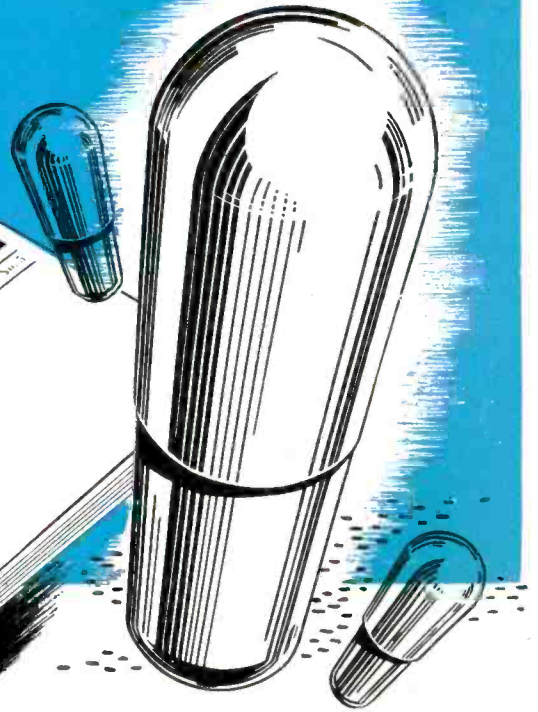

**GET ON
FREE MAILING
LIST NOW!**

"THE CAPACITOR" IS YOUR MAGAZINE—PUBLISHED SOLELY TO MAKE YOUR WORK EASIER—TO ADD DOLLARS TO YOUR INCOME!

With "Radio Service" signs sprouting on every corner, now is the time to establish *your* shop as *the* radio shop in your locality. How? By building a record of reliable work — fast, efficient service. That's why you need "The Capacitor".

This remarkable magazine makes servicing easier —helps you solve tough service problems—speeds up easy ones, by bringing to you every month a fresh supply of servicing hints and data.

Thousands of servicemen already are using "The Capacitor" to give them an edge on competition. Be the first in your territory to receive this valuable magazine — every month — absolutely FREE. **MAIL COUPON TODAY!** Cornell-Dubilier Electric Corporation, Dept. S-11, So. Plainfield, N. J.

YOU'LL READ ARTICLES LIKE THESE IN EVERY ISSUE OF "THE CAPACITOR". Here are some titles culled from recent issues: *How to Use Audio Oscillator and Signal Generator to Simplify Tests* — *Hum Elimination* — *New Requirements of FM and Television Servicing* — *Alignment of Superhets*. You'll find use for such articles as these in handling 9 out of 10 service jobs. Mail coupon NOW!

READ WHAT THIS SERVICEMAN SAYS. "I wish to thank you for mailing me 'The Capacitor'. The special items are of particular interest because of their easy reading and their simplification of complex circuits." This is typical of letters received every day.

SERVICEMEN'S ADS RUN FREE OF CHARGE. *The Trading Post* which appears in "The Capacitor" every month is your market place for buying, selling or swapping all types of electronic equipment. Use this C-D service to pick up that new signal generator you need — or to turn that spare tube tester into ready cash.

1910  1948

CORNELL-DUBILIER
WORLD'S LARGEST MANUFACTURER OF
CAPACITORS

MICA • DYKANOL • PAPER • ELECTROLYTIC

GET THIS COUPON IN THE MAIL TODAY

CORNELL-DUBILIER ELECTRIC CORPORATION,
South Plainfield, New Jersey
Please enter my name to start receiving "The Capacitor"
at once — absolutely free.

Name.....

Firm.....

Address.....

City..... Zone..... State.....

I own my own shop. I am employed. (Please check one)

MAKES FRIENDS...AND KEEPS THEM!



GENERAL  **ELECTRIC**

181-MA2-0050

FIRST AND GREATEST NAME IN ELECTRONICS



LEWIS WINNER
Editor

F. WALEN
Assistant Editor

ALFRED A. GHIRARDI
Advisory Editor

	Page
Association News	38
Practical FM Antenna Installations. By Ira Kamen	20
Ser-Cuits (25-Watt Amplifier, 1949 Auto Set, TV Receiver)	28
Servicing Helps. By P. M. Randolph	32
Ten Years Ago in Associations	39
The LP Microgroove Record System. By Ralph M. Baruch	14
Three-Tube Dynamic Noise Suppressor (Cover). By E. C. Dyett, Jr.	26
Tube News (Pulse-Operated TV Power Supplies)	36
TV Receiver Installation Pointers. By W. H. Buchsbaum	18
TV Receiver Visual Alignment Techniques. By Lester L. Libby	22
TV Sync and Inter-Sync Systems (Part III). By Edward M. Noll	34
Views and News. By Lewis Winner	13

CIRCUITS

Columbia LP Adapter	15
Farnsworth GV-260 TV Receiver	30
Horizontal Deflection Circuit and Pulse-Operated HV Supply	36
HV Power Supply for 12GP7 C-R-T	32
Kaiser-Frazer Auto Radio (1949 Model)	30
LP Adapter in Radio-Phono Using Dual Volume Control	16
LP Adapter in Dual I-F Circuit	16
LP Adapter in A-C/D-C Set	16
Philco LP Adapter	15
Plug-In and Wired-In LP Circuits	15
Receiver with Compensating Circuit and LP Adapter	15
Scott 110-A (Cover)	26
Simultaneous Operation of Two FM Receivers with One FM Antenna	20
Stromberg-Carlson AM-43	28
TV R-F Alignment Setup	22

COVER

Three-Tube Dynamic Noise Suppressor (Scott 110-A)	26
---	----

SERVICING HELPS

Admiral TV Interference Filter	32
Case Histories on Philco, Sonora, Spartan, Wilcox-Gay and Airline	46
Servicing Hints on Old Type Superhets	32
Surplus C-R-T as a TV Picture Tube	32

Index to Advertisers

.....	56
-------	----

Manufacturers

New TV Parts . . . Accessories	51
New Instruments . . . Components	53
News	48
Jots and Flashes	56

Entire contents Copyright 1948, Bryan Davis Publishing Co., Inc.



Published monthly by Bryan Davis Publishing Co., Inc.
52 Vanderbilt Avenue, New York 17, N. Y. Telephone MUrray Hill 4-0170



Bryan S. Davis, President Paul S. Weil, Vice Pres.-Gen. Mgr. F. Walen, Secretary A. Goebel, Circulation Manager

Cleveland Representative: James C. Munn, 2253 Delaware Dr., Cleveland 6, Ohio. Telephone: Erieview 1726

Pacific Coast Representative: Brand & Brand, 1052 W. Sixth St., Los Angeles 14, Calif. Telephone: Michigan 1732

Suite 1204, Russ Building, San Francisco 4, Calif. Telephone: SUTter 1-2251

Entered as second-class matter June 14, 1932, at the Post Office at New York, N. Y., under the Act of March 3, 1879. Subscription price: \$2.00 per year in the United States of America and Canada; 25 cents per copy. \$3.00 per year in foreign countries; 35 cents per copy.

Switch to PHOTOFACT— the Best Service Data Buy You'll Ever Make!

Thousands of Radio Service Technicians are *right!* They've found the way to quicker, easier, more profitable servicing. Join these thousands of successful money-making Servicemen who have switched to PHOTOFACT Service Data. Learn for yourself how this accurate, easy-to-use, practical data saves you time, makes your work easier, helps you earn more. PHOTOFACT gives you 100% useful service data—every photograph, every diagram, every bit of information helps you do a *complete job*. You owe it to yourself to switch to PHOTOFACT. There'll be a big difference in the time you save and the bigger profits you'll earn every single working day.



Subscribe Regularly to PHOTOFACT Folder Sets

Here's the most accurate and complete Radio Data ever compiled—issued regularly two sets per month. Keeps you right up-to-the-minute on all current receiver production. Your best buy in Service data—practical, useful information that makes money for you every day by saving you time on service jobs. Shows you everything you need to know about the sets you service—in clear, accurate, uniform style. Packed with extra help—full PHOTOFACT data on Automatic Record Changers—communications receivers—amplifiers—*plus* new PHOTOFACT Television Folders—exclusive, uniform coverage of popular Television Models, data proved best by actual service clinic experience. Subscribe at your Jobber today, for regular monthly issues. **\$1.50 PER SET ONLY**.....

PHOTOFACT VOLUMES The Preferred Service Data

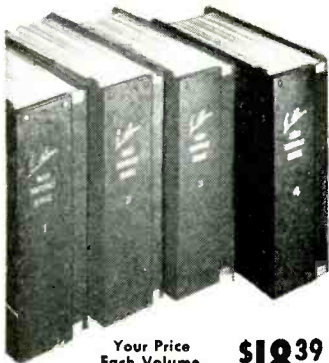

Your Price
Each Volume,
In DeLuxe Binder **\$18³⁹**

Bring your file of post-war receiver Service Data right up to July, 1948! Here's the most accurate and complete radio data ever compiled—preferred and used daily by thousands of Radio Service Technicians. Includes: Exclusive Standard Notation Schematics; photo views keyed to parts lists and alignment data; complete parts listings and proper replacements; alignment, stage gain, circuit voltage and resistance analysis; coil resistances; record changer service data, etc. Order Volume 4 today—keep your Photofact library up-to-date—it's the *only* Radio Service Data that meets your *actual* needs!

- Vol. 4.** Covers models from Jan. 1, 1948 to July 1, 1948
- Vol. 3.** Covers models from July 1, 1947 to Jan. 1, 1948
- Vol. 2.** Covers models from Jan. 1, 1947 to July 1, 1947
- Vol. 1.** Covers all post-war models up to Jan. 1, 1947

1947 Record Changer Manual

Nothing like it! Complete, accurate data on over 40 post-war models. Exclusive exploded views, photos from all angles. Gives full change cycle data, information on adjustments, service hints and kinks, complete parts lists. **PLUS**—for the first time—complete data on leading Wire, Ribbon, Tape and Paper Disc Recorders! 400 pages; hard cover; opens flat. Order now! **\$4.95 ONLY**.....



Receiver Tube Placement Guide

Shows you exactly where to replace each tube in 5500 radio models, covering 1938 to 1947 receivers. Each tube layout is illustrated by a clear, accurate diagram. Saves time—eliminates risky hit-and-miss methods. 192 pages, completely indexed. **\$1.25 ONLY**.....



Dial Cord Stringing Guide

The book that shows you the *one right* way to string a dial cord. Here, in one handy pocket-sized book, are all available dial cord diagrams covering over 2300 receivers, 1938 through 1946. Makes dial cord restringing jobs quick and simple. **ONLY.. \$1.00**

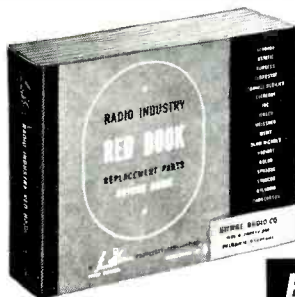

Radio Industry RED BOOK

The RED BOOK tells you in *one volume* all you need to know about replacement parts for approximately 17,000 sets made from 1938 to 1948. Includes complete, accurate listings of all 9 major replacement components—not just one. Lists correct replacement parts made by 17 leading manufacturers—not just one. Covers original parts numbers, proper replacement numbers and valuable installation notes on: Capacitors, Transformers, Controls, IF's, Speakers, Vibrators, Phono-Cartridges. *Plus*—Tube and Dial Light data, and Battery replacement data. 440 pages, 8½ x 11; sewed binding. **ONLY... \$3.95**

FREE Photofact Cumulative Index

Send for the FREE Cumulative Index to PHOTOFACT Folders covering *all* postwar receivers up to the present. You'll want this valuable reference guide to the Radio Service Data preferred and used by thousands. Helps you find the Folders you want quickly. Get this Index at your Jobber or write for it today.



BOOST YOUR EARNING POWER!

Mail This Order Form
to HOWARD W. SAMS & CO., INC.
2924 E. Washington St., Indianapolis 7, Indiana

My (check) (money order) for \$.....enclosed.

Send the RED BOOK. \$3.95 per copy.

Send PHOTOFACT Volumes in DeLuxe Binder:

Vol. 4. Vol. 3. Vol. 2. Vol. 1 (\$18.39 each).

Automatic Record Changer Manual, \$4.95.

Tube Placement Guide, \$1.25.

Dial Cord Stringing Guide, \$1.00.

Send FREE Photofact Cumulative Index.

Name.....

Address.....

City.....State.....

HOWARD W. SAMS & CO., INC.
INDIANAPOLIS 7, INDIANA

Build YOUR OWN TEST EQUIPMENT

Heathkit ELECTRONIC SWITCH KIT DOUBLES THE UTILITY OF ANY SCOPE



\$34.50

Has two separately controllable traces, individual inputs on any scope. See both the input and output traces, locate distortion, phase shift, etc., immediately. Individual gain controls and positioning control. Coarse and fine sweeping rate controls. Complete Heathkit matches others, with 5 tubes, All metal parts are punched, formed and cadmium plated. Complete with tubes, all parts, detailed blueprints and instructions. Shipping Wt. 13 lbs.
Nothing ELSE TO BUY

HEATHKIT CONDENSER CHECKER KIT

\$19.50

Nothing ELSE TO BUY

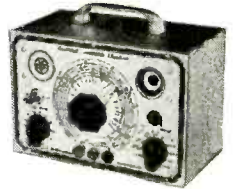

A condenser checker anyone can afford to own. Measures capacity and leakage from .00001 to 1000 MFD on calibrated scales with test voltage up to 500 volts. No need for tables or multipliers. Reads resistance 500 ohms to 2 megohms. 110V 60 cycle transformer operated complete with rectifier and magic eye indicator tubes. Easy quick assembly with clear detailed blueprints and instructions. Small convenient size 9" x 6" x 4 3/4". Wt. 4 lbs.

HEATHKIT SIGNAL GENERATOR KIT

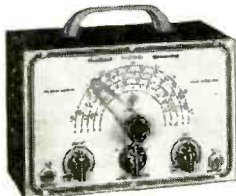

\$19.50
NOTHING ELSE TO BUY

Every shop needs a good signal generator. The Heathkit fulfills every servicing need, fundamentals from 150 Kc. to 30 megacycles with strong harmonics over 100 megacycles covering the new television and FM bands. 110V 60 cycle transformer operated power supply. 400 cycle audio available for 30% modulation or audio testing. Uses 6SN7 as RF oscillator and audio amplifier. Complete kit has every part necessary and detailed blueprints and instructions enable the builder to assemble it in a few hours. Large easy to read calibration. Convenient size 9" x 6" x 4 3/4". Wt. 4 1/2 lbs.

HEATHKIT SIGNAL TRACER KIT

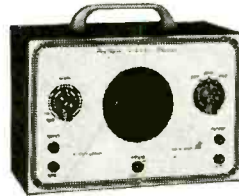

\$19.50
Nothing ELSE TO BUY

Reduces service time and greatly increases profits of any service shop. Uses crystal diode to follow signal from antenna to speaker. Locates faults immediately. Internal amplifier available for speaker testing and internal speaker available for amplifier testing. Connection for VTVM on panel allows visual tracing and gain measurements. Also tests phonograph pickups, microphones, PA systems, etc. Frequency range to 200 Mc. Complete ready to assemble. 110V 60 cycle transformer operated. Supplied with 3 tubes, diode probe, 2 color panel, all other parts. Easy to assemble, detailed blueprints and instructions. Small portable 9" x 6" x 4 3/4". Wt. 6 pounds. Ideal for taking on service calls. Complete your service shop with this instrument.

HEATHKIT SINE AND SQUARE WAVE AUDIO GENERATOR KIT

The ideal instrument for checking audio amplifiers, television response, distortion, etc. Supplies excellent sine wave 20 cycles to 20,000 cycles and in addition supplies square wave over same range. Extremely low distortion, less than 1%, large calibrated dial, beautiful 2 color panel, 1% precision calibrating resistors, 110 V 60 cycle power transformer, 5 tubes, detailed blueprints and instructions. R.C. type circuit with excellent stability. Shipping weight 15 pounds.

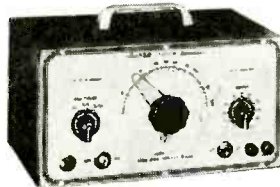

\$34.50
Nothing ELSE TO BUY

THE NEW HEATHKIT VACUUM TUBE VOLTMETER KIT

The most essential tool a radio man can have, now within the reach of his pocketbook. The Heathkit VTVM is equal in quality to instruments selling for \$75.00 or more. Features 500 microamp meter, transformer power supply, 1% glass enclosed divider resistors, ceramic selector switches, 11 megohms input resistance, linear AC and DC scale, electronic AC reading RMS. Circuit uses 6SN7 in balanced bridge circuit, a 6H6 as AC rectifier and 6 x 5 as transformer power supply rectifier. Included is means of calibrating without standards. Average assembly time less than four pleasant hours and you have the most useful test instrument you will ever own. Ranges 0-3, 30, 100, 300, 1000 volts AC and DC. Ohmmeter has ranges of scale times 1, 100, 1000, 10M and 1 megohm, giving range .1 ohm to 1000 megohms. Complete with detailed instructions. Add postage for 8 lbs.

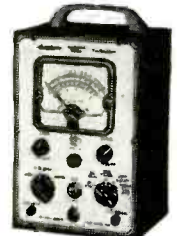

\$24.50
Nothing ELSE TO BUY

HEATHKIT FM AND TELEVISION SWEEP GENERATOR KIT

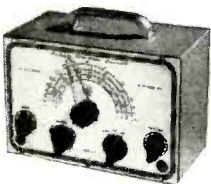

\$24.50
NOTHING ELSE TO BUY

THE BASIC FM AND TELEVISION SERVICE INSTRUMENT

At the lowest cost possible, anyone can now service FM and television receivers. The Heathkit sweep generator kit operates with oscilloscope and covers all necessary frequencies. A few pleasant hours assembling this kit puts any organization in position to share the profits of the FM and TV boom. Every part supplied — grey crackle cabinet, two color calibrated panel, all metal parts punched, formed and plated. 5 tubes, complete detailed instructions for assembly and use. Shipping weight 6 lbs.

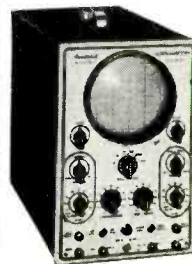

The NEW 1948 HEATHKIT 5 INCH OSCILLOSCOPE KIT

\$39.50

NOTHING ELSE TO BUY

New improved model of the famous Heathkit Oscilloscope. Building an oscilloscope is the finest training for television and newer servicing technique and you save two-thirds the cost. All the features and quality of instruments selling for \$100.00 or more. Supplied complete with cabinet, two color panel, 5B1 tube, 2 5Y3 tubes, 2 6SJ7 tubes and 884 sweep generator tube. Power transformer supplies 1000V negative and 350 volt positive. Sweep generator 15 cycles to 30 M. cycles. Has vertical and horizontal amplifiers. Oil filled filter condensers for long life. Complete blueprints and instructions included.



The **HEATH COMPANY**

... BENTON HARBOR 11, MICHIGAN

The ALL-AMERICAN FIVE

and HYTRON go together



Build a better mouse trap and the word gets around—but fast. Same with Hytron a-c/d-c tubes. Many years of experience. Many millions of tubes. Constant engineering co-operation with dozens of prominent radio set manufacturers. All help make Hytron a-c/d-c tubes better. Make it natural to think of Hytron when you think of the All-American Five.

The lowly a-c/d-c tubes must pack a heck of a lot of performance—at a price. Hytron tubes do. They offer the special advantage of being built to the strictest requirements of leaders in the small set field. GT or miniature—you, too, will find Hytron a-c/d-c tubes your best choice.



SPECIALISTS IN RADIO RECEIVING TUBES SINCE 1921.

HYTRON
RADIO AND ELECTRONICS CORP.

MAIN OFFICE: SALEM, MASSACHUSETTS



SERVICE, NOVEMBER, 1948 • 5

Why play "PENNY-ANTE"... when your business is at stake?

A good reputation, like good-will, is built by many deeds, but may be destroyed by a single dissatisfied customer. Your reputation is too valuable to risk for the few pennies "saved"

by buying inferior or unknown "bargains." That's why we keep repeating "Your Reputation and your customers deserve the best!" And the best means Sprague.

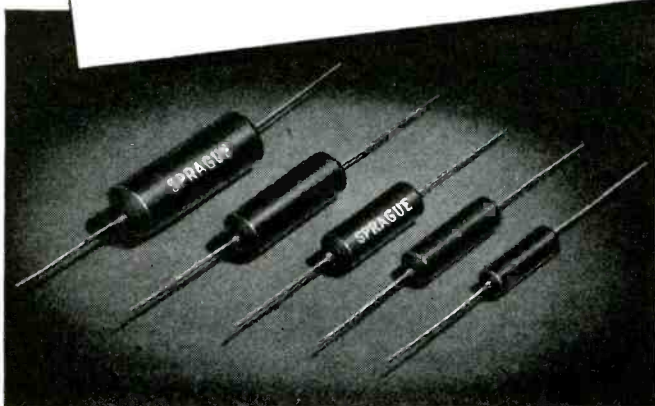
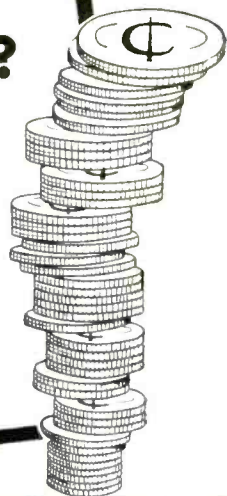

SPRAGUE TM TUBULARS—The first truly practical MOLDED Paper Tubular Capacitors!

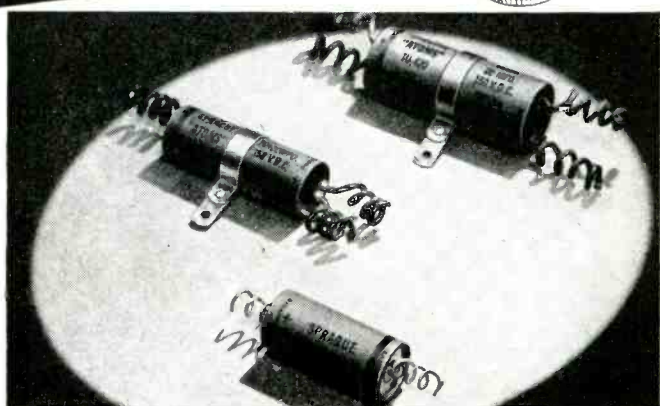

SPRAGUE ATOMS—Universal Midget Dry Electrolytics!

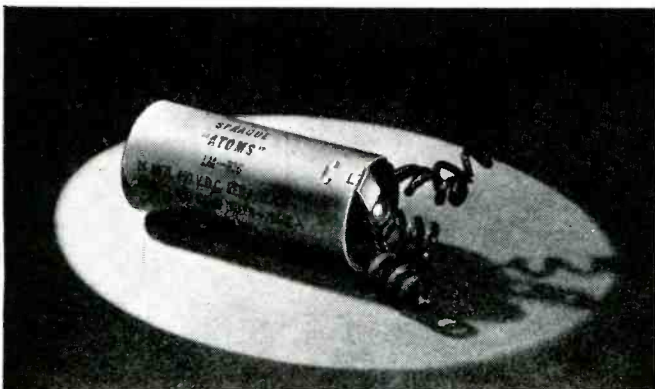

SPRAGUE LM—Universal Mounting Replacements!

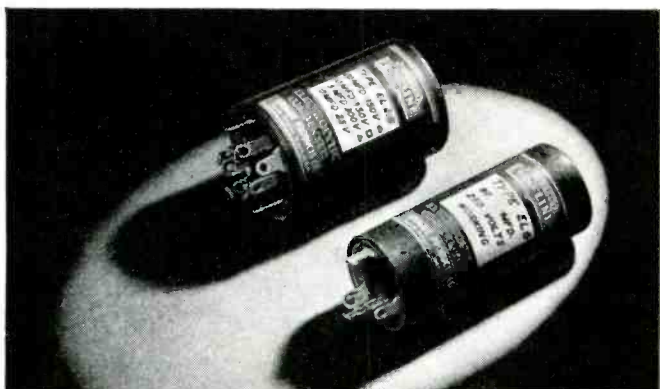

SPRAGUE EL—Self-Mounting Midget Can Type!



Reach for a **SPRAGUE**
and Know You're Right!

THESE SPRAGUE PRODUCTS ARE UNCONDITIONALLY GUARANTEED!

When used at their capacitance and voltage ratings, these Sprague Products are unconditionally guaranteed to render satisfactory performance.

CAPACITORS

*KOOLOHM
RESISTORS

SPRAGUE

*T.M. Reg.
U.S. Pat. Off.

SPRAGUE PRODUCTS COMPANY, North Adams, Mass.

(JOBGING AND DISTRIBUTING ORGANIZATION FOR THE PRODUCTS OF THE SPRAGUE ELECTRIC COMPANY)

WANTED
**Economical, Positive,
 Tube and Battery Tester**
 combined with
**complete 20,000 ohms per volt
 circuit testing facilities.**

Must handle all modern tubes with
 full anti-obsolescence features.
 Must test all up-to-date A.M., F.M.
 and TV. circuits.

Now Available!

THE NEW PRECISION SERIES 654

COMBINATION

**Cathode Conductance Tube Tester
 Dynamic (Under-Load) Battery Tester
 High Sensitivity A.C. and D.C. Circuit Tester
 (20,000 ohms per volt D.C.)**

**Ranges to 6000 Volts*, 120 Microamperes,
 12 amperes, 60 Megohms, + 70 DB**
 *(30,000 Volts with Series TV-2 Super
 High Voltage Television Test Probe.)

Series 654 is a rugged, complete, compact, high sensitivity Service Laboratory designed to meet the specific needs of the modern electronics service-maintenance technician, with utmost practical economy — conforming fully to the "Precision" high standards of quality, workmanship and performance!

TUBE AND BATTERY TESTING FEATURES

- Tests all modern tube types including Noval 9 pin, dual capped H.F. tubes, and TV amplifiers, via time-proven RMA-recommended, emission test parameters.
- Filament voltages — 3/4 to 117 V.
- Absolute Free-Point 10 element lever selection for both short and merit tests.
- Dual short-check sensitivity.
- Individual Tests of Multi-Section Tubes.
- Ballast Unit Tests.
- Micro-Line adjustment.
- Pilot and signal light tests.
- Noise and Condenser test jacks.
- Dynamic "under-load" test for all popular radio A, B, and C dry batteries.
- Built-in brass geared roll chart.
- Anodized, etched, easy reading, heavy gauge aluminum panel.
- Fuse Extractor Post.
- Telephone type cabled wiring using plastic-insulated, moisture resistant hook-up wire.

CIRCUIT TESTING FEATURES

- 5 D.C. Voltage Ranges: — 20,000 ohms per volt.
- 5 A.C. and Output Voltage Ranges: — 1000 ohms per volt
 0-12-60-300-1200-6000 volts
 also 0-30,000 volts via optional TV-2 Television Test Probe.
- 6 D.C. Current Ranges: — 0-120 microamperes.
 0-1.2-12-120 MA
 0-.2-12 Amperes
- 3 Wide Resistance Ranges: — 0-6000-600,000 ohms; 0-60 megohms.
 (No A.C. power required)
- 5 Decibel Ranges from —12 to +70 DB.

- ★ Fully Rotary Selective Ranges and Functions.
- ★ Only 2 pin jacks for all standard ranges.
- ★ 50 microampere, 4 1/8" Wide-Angle meter.
- ★ 1% Wirewound and film-type resistors.
- ★ All circuits isolated from power line.

SEE this new "Precision" Test Instrument on display at leading radio parts and equipment distributors. Write directly for the latest Precision catalog describing the full Precision line of quality Electronic Test Instruments for all phases of A.M., F.M. and TV.



Series 654 is available in 4 distinctive models to suit individual application requirements.

- ★ 654-P . . . PORTABLE . . . In hardwood portable case, with tool compartment and hinged removable cover. Size 12 x 13 x 6".
 Complete: — \$106.40
- ★ 654-MCP . . . LAB. PORTABLE . . . Open style Metal Case Portable. Fine dull black ripple finish on heavy gauge steel. Size 10 1/2 x 12 x 6".
 Complete: — \$103.55
- ★ 654-PM . . . PANEL MOUNT . . . In standard size panel mount, size 12 1/4 x 19", with dust cover. For rack, cabinet or wall mount.
 Complete: — \$106.40
- ★ 654-C . . . COUNTER . . . In modern, chrome-trimmed counter cabinet. Fine black ripple finish on heavy gauge steel. Size 16 x 13 1/2 x 7" slopes to 3" at front. Complete: — \$108.90

**Coming Soon—Watch for
 Official Announcement
 —Worth Waiting For:
 The New Series E-400
 WIDE RANGE SWEEP GENERATOR
 The New Series ES-500
 MULTI-PURPOSE 5" OSCILLOSCOPE**



PRECISION APPARATUS CO., INC.

92-27 HORACE HARDING BOULEVARD • ELMHURST 6, NEW YORK

Export Division: 458 BROADWAY, NEW YORK CITY, U. S. A. • Cables: MORHANEX

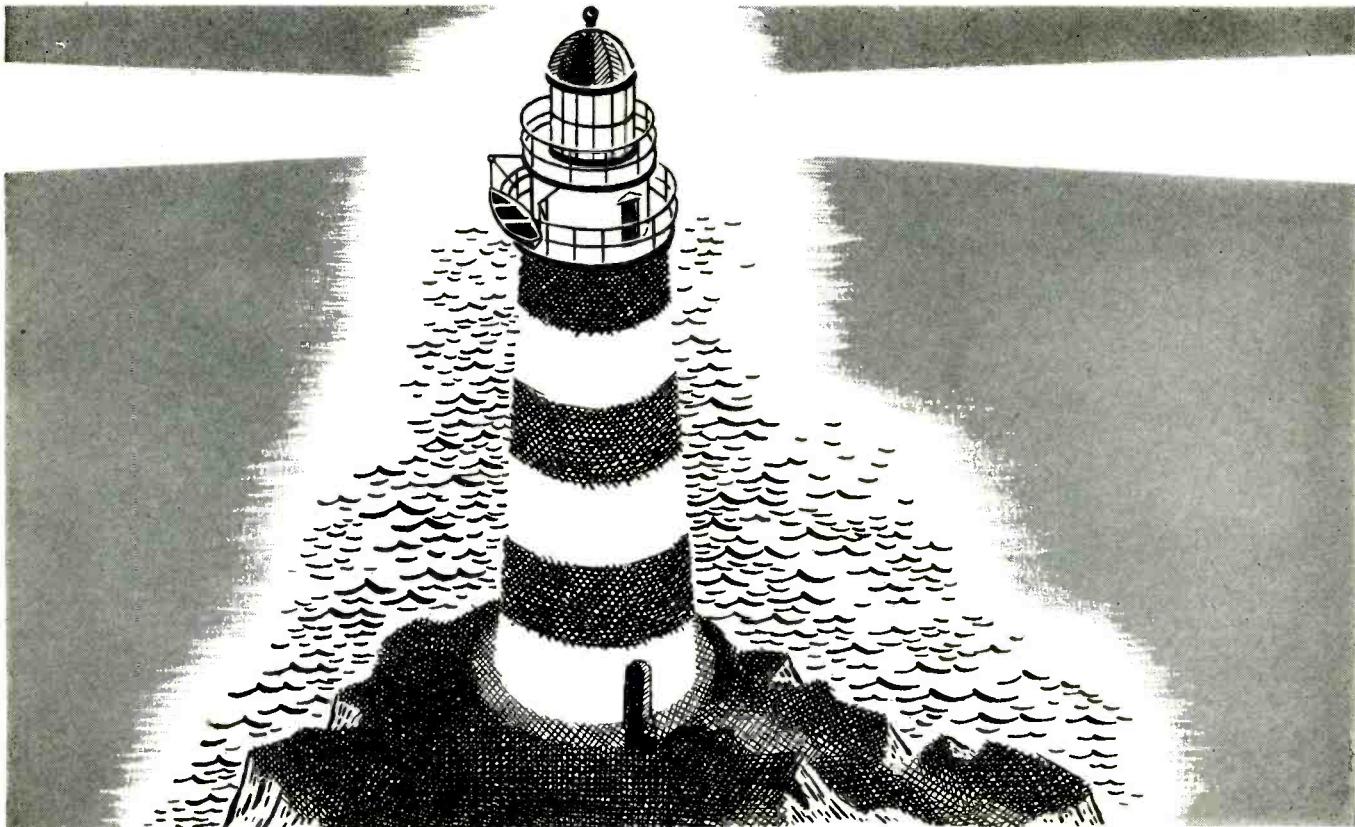

Guiding Light..

The beacon light that lends a guiding hand to ships at sea is the sailor's best friend. And so it has been true over the years of the RADIART VIBRATOR catalog! Carefully edited . . . skillfully planned . . . this catalog manual has been of infinite help to servicemen everywhere! For the invaluable technical data . . . the carefully cataloged listings . . . these have been the source of information that radio men depend upon. We are proud to help the trade in this manner, and will continue to print a catalog that will be regarded as "the bible of the industry".

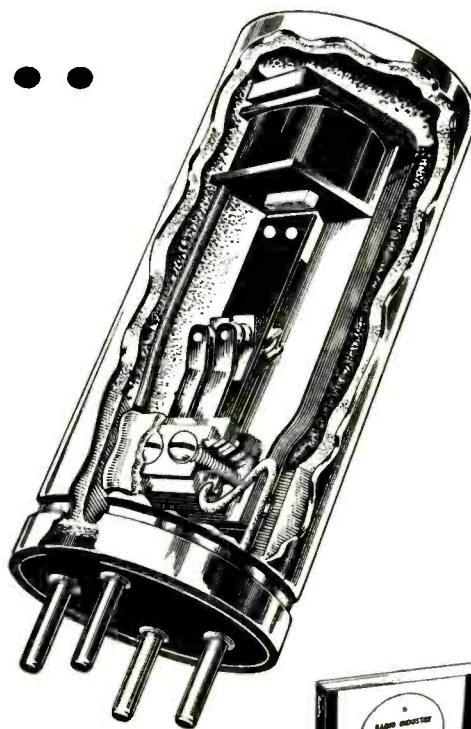

THE ONLY VIBRATOR LINE LISTED IN SAM'S RED BOOK



The Radiart Corp.

CLEVELAND 2, OHIO

Export-Scheel International Inc., 4237 N. Lincoln Ave., Chicago 18, Ill.

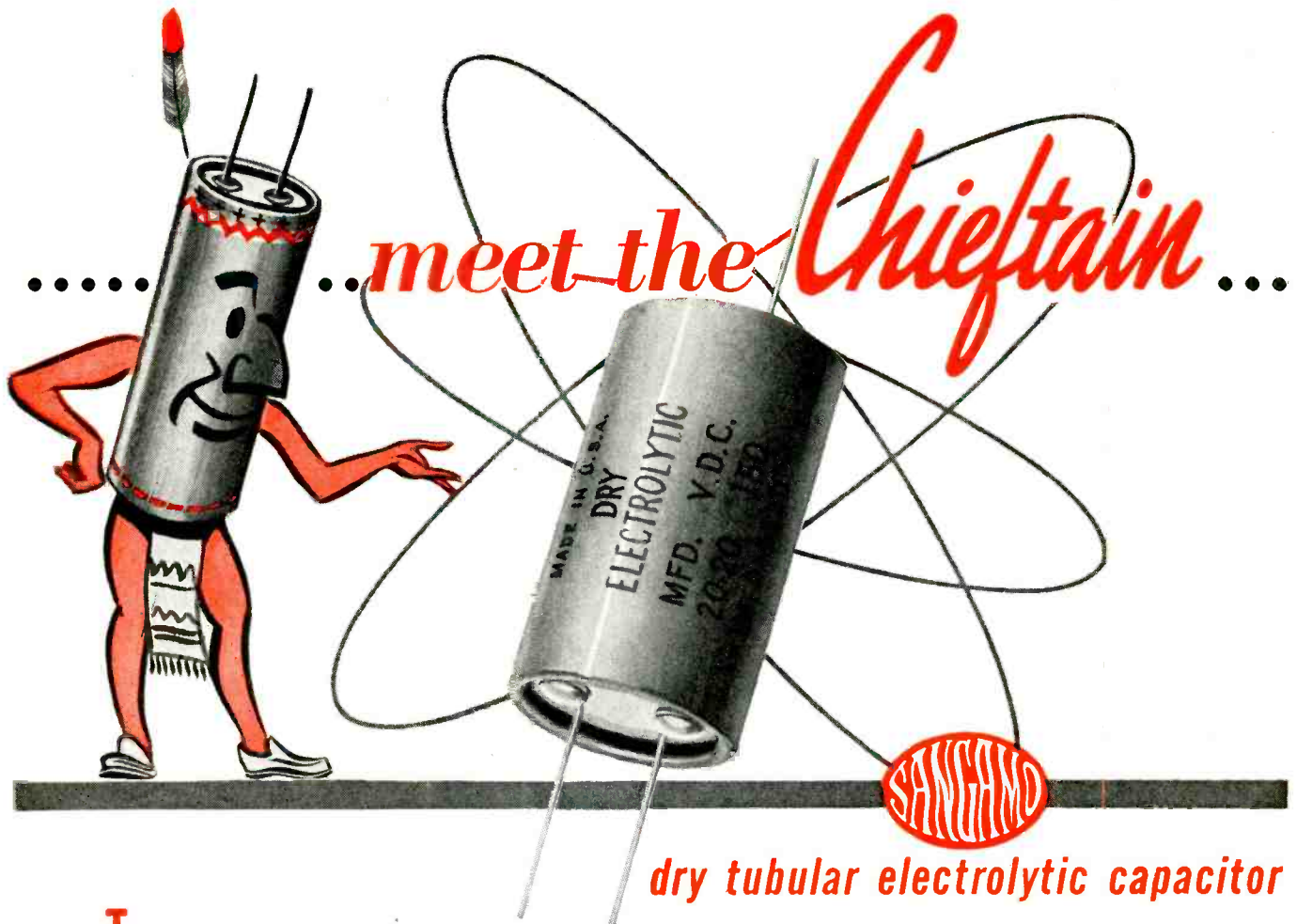

dry tubular electrolytic capacitor

Type MT and MTD electrolytic capacitors, "Chieftains" of the Sangamo line, are built to provide longer life, greater dependability, and better electrical characteristics. Ideal for replacements, they fit anywhere! Their small physical size makes them a "natural" for application in tight spots beneath a chassis, and the bare tinned-copper wire leads make them easy to mount.

Sangamo "Chieftains" are contained in hermetically-sealed round aluminum cans and are tightly encased in heavy cardboard sleeves on which polarity is clearly indicated. Double, pure paper spacers assure adequate

breakdown characteristics and all sections are tightly held in place within the container. Multiple staking connects the terminal tabs to the electrodes, providing permanent low resistance contact throughout the life of the capacitor. The low voltage units are supplied with etched cathodes to maintain uniform capacity when the capacitor is subjected to heat and high ripple currents.

"Chieftains" are manufactured under controlled conditions of almost surgical cleanliness, utilizing the very finest materials and production procedures available in the industry, for your assurance of quality in every respect.



Tomahawk



Warrior



Apache



Mohican

Your own trial-use will convince you that new standards of dependability and longevity have been built into Sangamo Electrolytics. Order from the new Sangamo Electrolytic Capacitor Catalog No. 825C, which is yours for the asking, and without obligation.

SC 4810



SANGAMO ELECTRIC COMPANY

SPRINGFIELD • ILLINOIS

Here's that Triplett F.M.-A.M.

Sig. Gen.

Frequency Ranges: Fundamentals—from 100 K.C. to 120 M.C. in ten bands. Added Frequency—(provided by built-in fixed 50 M.C. oscillator) from 120 M.C. to 170 M.C. Second harmonics can also be used to double the A.M. fundamental ranges.
 Dealer Net . . . \$173.25

MODEL 3433

**F.M. SWEEP FROM 0 TO 300 K.C.
 MODULATION FREQUENCY 60 OR
 400 CYCLES PER SECOND**

Stable frequency modulated signals give undistorted wave form. This permits easy and more precise alignment over all frequency ranges thus insuring maximum performance in a radio set that can in every way be comparable with original factory adjustments.

Other features include: constant deviation by using a fixed frequency reactance modulated oscillator, 110 Volt A.C. line filter to prevent leakage thru power supply, horizontal synchronized sweep voltage available thru jack on front panel.



For Ranges from 165 K.C. to 120 M.C. Select the Signal Generator with the *Illuminated Dial*

- Seven long scaled 330° arc.
- A big open, illuminated scale—easily read.
- 5 Fundamental Ranges 165 K.C. to 40 M.C.
- 2 Harmonic Ranges directly calibrated 36 M.C. to 120 M.C.
- 10 to 1 vernier tuning.

RANGES

A-165-525 KC	E-18-40 MC
B-500-1750 KC	Harmonics to 120 MC
C-1700-6200 KC	E2-36-80 MC
D-6-18.5 MC	E3-54-120 MC

Here is a very popular unit since everyone needs a stand by signal generator.

MODEL 3432 with its uniformly illuminated dial is the top value in signal generators for ranges to 120 MC. All R.F. and audio circuits are double shielded with copper plated steel . . . transformer is electrostatically shielded . . . the circuit selector provides for internally modulated signal (variable 0 to 100% at 400 cycles). Variable amplitude of external modulation 40 to 15,000 cycles, unmodulated signal or variable audio 0-10 volts at 400 cycles. The output attenuator provides fine control of R.F. Output to Co-axial output cable connector . . . Housed in Metal case, tan enamel finish. Leather strap handle for carrying.



MODEL 3432
 Illuminated Dial
\$69.50 Dealer Net

Precision first... to Last

SEE AT YOUR RADIO PARTS DISTRIBUTOR OR FOR MORE INFORMATION . . . WRITE

TRIPLETT ELECTRICAL INSTRUMENT COMPANY • BLUFFTON, OHIO, U.S.A.

In Canada: Triplett Instruments of Canada, Georgetown, Ontario



NEW!

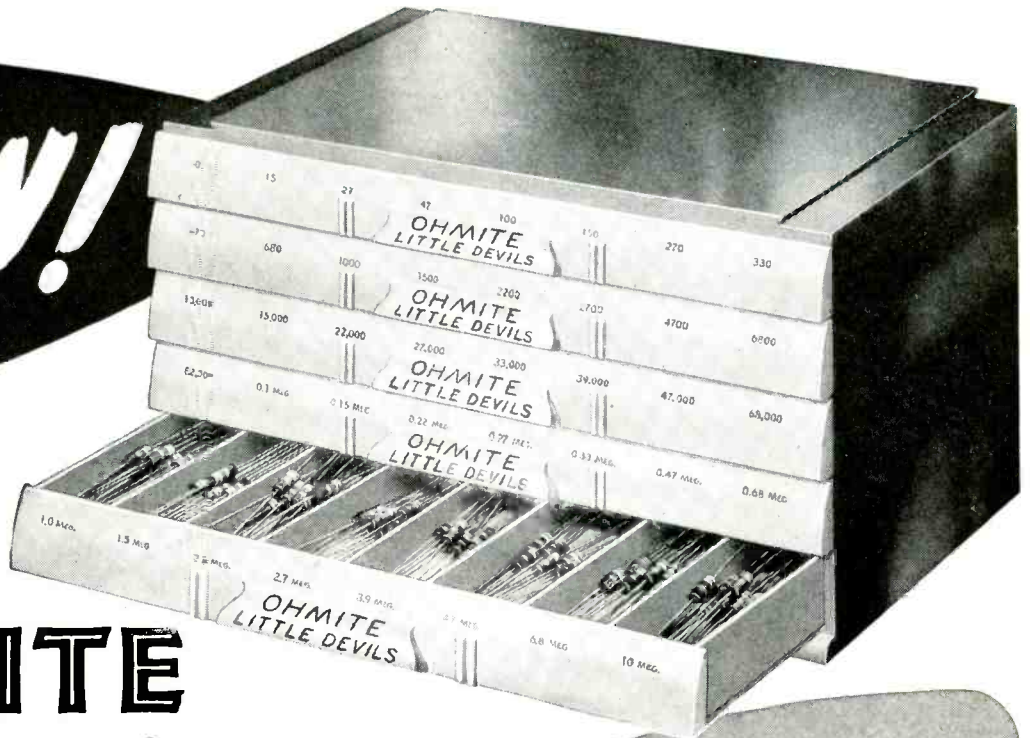

OHMITE *Little Devil* RESISTOR ASSORTMENT

IN RUGGED *All-Plastic* CABINET

REGULAR
PRICE FOR RESISTORS
\$10.00
NO CHARGE FOR
CABINET

**Servicemen's Assortment Contains 125 Selected 1/2-Watt
Little Devil Composition Resistors in 40 Separate Compartments**

Here's a handsome, sturdy, all-plastic resistor cabinet you'll be proud to have in your shop—and one that will save you hours of valuable time. The new cabinet is molded of solid plastic and has five drawers with eight compartments in each drawer. It is extremely compact—only 9" long, 4-3/4" high, and 5-1/4" deep. Factory-packed in the cabinet is a serviceman's assortment of 125 carefully selected Ohmite "Little Devil," 1/2-watt, individually marked, insulated composition resistors, in the 40 values (10 ohms to 10 megohms) most fre-

quently used by servicemen. The assortment is offered at the price of the resistors alone—the cabinet is furnished without extra cost!

You'll need one or several of these handy cabinets in your shop to protect your resistors and to help you find resistance values quickly. What's more, they provide visual stock control so you can avoid duplicate inventories or unnecessary trips to your distributor. Order your assortment and cabinet from your jobber, today!



**CAN BE
STACKED ON EACH OTHER**

A dovetail joint is provided on top and bottom of each cabinet so they can be stacked one on top of another.

QUANTITIES AND RESISTANCE VALUES IN THE SERVICEMAN'S ASSORTMENT							
Quantity	OHMS	Quantity	OHMS	Quantity	OHMS	Quantity	OHMS
1	10	3	1000	1	33000	10	0.47 meg.
1	15	1	1500	5	39000	1	0.68 meg.
1	27	1	2200	10	47000	10	1.0 meg.
1	47	3	2700	1	68000	1	1.5 meg.
1	100	5	4700	1	82000	1	2.2 meg.
1	150	1	6800	10	0.1 meg.	1	2.7 meg.
1	270	10	10000	5	0.15 meg.	1	3.9 meg.
1	330	3	15000	1	0.22 meg.	1	4.7 meg.
1	470	5	22000	10	0.27 meg.	1	6.8 meg.
1	680	10	27000	1	0.33 meg.	1	10 meg.

Stocked by Leading Distributors

OHMITE MANUFACTURING CO., 4879 FLOURNOY ST., CHICAGO 44

Be Right with **OHMITE**
RHEOSTATS • RESISTORS • TAP SWITCHES

Look for the distributor
who displays this sign!

**Authorized
Distributor**



**SYLVANIA RADIO TUBES
AND TEST EQUIPMENT**

AS a part of its 1948 program, Sylvania Electric will supply each of its authorized distributors with this new decal, printed in red, yellow, black and three shades of green. It's worth your while to look for this sign on

his windows, doors and trucks — it is your assurance that this distributor will supply you with genuine Sylvania radio tubes and top-quality test equipment — and that you can count on prompt, courteous service as well!

Sylvania Electric Products Inc., Radio Tube Division, Emporium, Pa.

SYLVANIA  **ELECTRIC**

MAKERS OF RADIO TUBES; CATHODE RAY TUBES; ELECTRONIC DEVICES; FLUORESCENT LAMPS, FIXTURES, WIRING DEVICES; ELECTRIC LIGHT BULBS

RADIO · TELEVISION · ELECTRONIC
SERVICE

Service Men Judge TV

TELECASTERS received some extremely helpful information from Service Men at the recent New York Town Meeting of Technicians on ten basic points which affect the consumer, Service Man, dealer and manufacturer.

In the form of ten questions, prepared by TBA prexy J. R. Poppele, the Service Man was asked: Is the presently designed test pattern adequate; is there enough resolution in the pattern for proper measuring; with some stations planning daytime program schedules, what would you suggest as the minimum number of hours of test pattern transmissions; are present audio tones satisfactory as an audio signal for testing equipment; are present transmission lines adequate; are you particularly inconvenienced by the varying input impedance on different types of receivers; have you found the re-radiation problem acute in your installations; what is the *biggest gripe* of TV set owners you have serviced; what problem do you encounter in orienting antennas for maximum signals from all stations; and have you noticed any particular problems related to high-frequency reception as compared with the lower channels.

The answers, which were extremely interesting, were compiled into a special report by Richard J. Guilfoyle¹ for submission to the TBA. According to the Guilfoyle report, the majority of the Service Men are satisfied with the present test pattern. The biggest objection was in the variation in size and aspect ratio of the patterns of different broadcasters, which appears to be due to a lack of standard.

Most Service Men agreed that there is sufficient resolution in the pattern for proper measuring. Incidentally, WNBT was cited as the station offering the best pattern. Commenting on program schedules, Service Men seemed to favor at least three hours in the morning and three hours in the afternoon with some kind of signal on the air from 9 A. M. to 10 P.M.

Present audio tones were cited as satisfactory as a signal for testing equipment. Those disagreeing said that test tones do not allow for a fidelity check and it is difficult to distinguish certain types of distortion. All

were in favor of transcribed music, preferably symphonies.

In the replies to the re-radiation problem query, many Service Men said that it did not bother them, but there were many others who found the problem quite acute, particularly in congested areas.

The *biggest gripe* query brought eight interesting answers: Interference, variation in definition between stations, poor sound with movies, over selling, too many failures, prices, not enough programs for women, and too much *sports*. In answering the question on problems encountered in orienting antennas for maximum signals from all stations, many Service men complained of having to sacrifice signal strength on certain stations to receive others or vice versa. The problem of reflections was also brought out by the Service Men. The high-frequency versus low-frequency question revealed that many Service Men found that TV receivers are more difficult to tune on the higher channels than on the low, a condition due to the fine tuning arrangement used in many sets.

Everyone is grateful to the Service Men who participated in this interesting survey.

High Quality

A REVEALING study of high fidelity was presented by John K. Hilliard of Altec-Lansing at the recent IRA-RMA Rochester Fall Meeting. Hilliard pointed out that there are several factors involved in conducting a listening test on the comparison of equipment:

"The listener should be enough of a scientist so that he will have an open mind and not be prejudiced. He must be enough of an artist not to be partial to any one particular type of equipment resulting from a knowledge of its technical features.

"It is necessary, in the case of a comparison test, to have as nearly as possible identical acoustical positions for the units to be compared.

"For judging *faithful reproduction*, the listener should be relaxed and in a frame of mind which is not distracting."

¹Sales Service Coordinator, Andrea Sales Corp.

Continuing, Hilliard said that small deviations in orientation of the speaker system may produce results which have a wider variation than the equipment itself. According to Hilliard, it is necessary to compensate for variations in amplifier equipment, absolute magnitude of generator impedance and relative efficiency of loudspeakers.

He said: "Variations of .5 to 1 db in certain specific portions of the frequency spectrum will completely change the listener's judgment of equality. Listening rooms or auditoriums below the optimum reverberation time generally yield a more critical analysis of equipment performance, but a less critical judgment of *pleasantness*. It is not desirable generally to use such an enclosure for normal reproduction. In most cases, on-axis listening should be conducted, supplemented by off-axis points in order to verify the distribution pattern."

Good Book For Service Men

WE HAVE just received a book which we believe to be one of the best ever published for the Service Man. Entitled *Radio Fundamentals* and authored by Arthur L. Albert, professor of communication engineering, Oregon State College, it is an extremely well-written text providing a thorough analysis of basic and advanced problems with which every Service Man is concerned.

The major topics covered are acoustics, circuits, tubes, amplifiers, oscillators, AM and FM receivers and transmitters, and antennas. An extremely helpful summary, review questions and problems accompany each chapter.

TV Sets At New High

NEARLY 90,000 TV receivers were made in September, according to RMA, bringing the total nine-month production very close to a half-million receivers.

There is certainly every indication that over three-quarter million television receivers will have been produced before the year is out, providing a total of nearly one million television receivers in the field . . . quite a healthy stride.—L. W.

The LP Microgroove

by RALPH M. BARUCH



An *lp* record player; Philco model M-15.



A microgroove record player. (Courtesy G. E.)



A dual-speed record player; Webster-Chicago model 256.

An *lp* pickup; Shure 900MG.



THE DEVELOPMENT of the long-playing microgroove records¹ has introduced an interesting new phase in sound for the Service Man, with many new components and accessories and circuit modifications to consider.

The *lp* record, which affords high-fidelity performance, requires a $33\frac{1}{3}$ rpm motor speed, since the cutting pitch is from 224 to 260 lines per inch, as compared to 88, 96 and, in some rare instances, 100 lines per inch.

These two factors multiply by nearly six times the amount that can be recorded on one side of the *lp record*; the standard 12" records can take between 4 minutes and 20 seconds and 5 minutes, while the microgroove record of the same size records up to $22\frac{1}{2}$ minutes depending, of course, upon the size of the particular selection on the side.

One of the reasons that such close groove spacing is possible is because recording is not continued to the center of the record, the minimum inside diameter of recording being $4\frac{3}{4}$ ". If recorded too far inside, at $33\frac{1}{3}$ particularly, records lose quality. Analyzing this factor, let us assume that at a certain frequency a complete wave occupies $\frac{1}{8}$ " of the circumference of the record. This wave will, on the inside, occupy only half or even less of this space and will therefore have to be squeezed in the space much smaller.

In developing the *lp* record, the overall recording level also had to be

taken into consideration. When cutting 224 to 260 lines per inch it is obvious that every groove is situated very close to the next and if loud modulation is recorded an overcut will result; one groove will run into the other and the pickup will not be able to track, skipping grooves and sliding across the record. Accordingly the level of the microgroove record was made about three to four db lower than the level on conventional records.

Due to the large number of grooves per inch each groove is correspondingly smaller by about $\frac{1}{3}$ or is about .0027". Therefore the needle of the *lp* pickup must not be larger than 1 mil at the tip, with the pressure of the arm approximately 5 to 6 grams. Although these pickups may seem very light it must be remembered that the pressure carried at the tip of the playing needle may exceed several hundred pounds to the square inch.

The reduced speed imposes several design factors which must be observed if faithful reproduction is desired. At $33\frac{1}{3}$ the turntable must be heavy because it has very little inertia at this reduced speed. The motor must consequently be a better one to drive a turntable at $33\frac{1}{3}$. The turntable must be also perfectly *on speed*. Any variation of speed can be noticed immediately if the variation is not constant causing *wow*. If this variation is constant the reproduction will be lower than the original if the turntable is slow and slightly higher if it is fast. The best way to check the turntable is with the aid of a stroboscope. The lines or dots on the *strobe* designed to check $33\frac{1}{3}$ rpm speeds will merge under a-c light and appear to be motionless. A neon lamp will give even better results. The speed test should

¹The Microgroove record was developed by Columbia Records by Dr. Peter Goldmark, CBS director of engineering and research. Assisting in the development were Rene Sneyvangers, CBS recording engineer and William S. Bachman, director of recording engineering and development for Columbia Records, Inc.

Below: Webster Electric microgroove pickup; F11 is a double needle type for *lp* and 78 rpm and F12 is a single needle *lp* type. Right: G.E. variable reluctance *lp* cartridge.

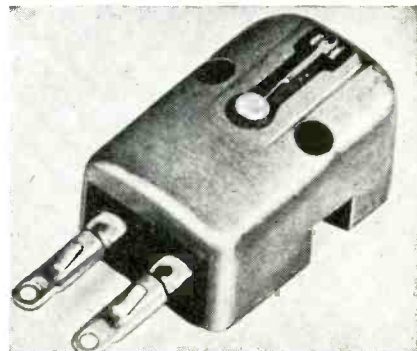
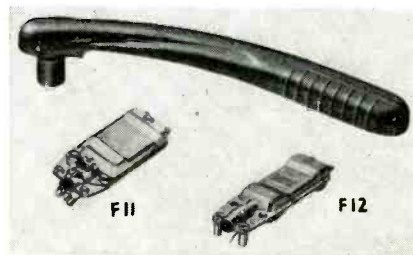

Record System

Characteristics of LP Records . . . Pickups and Motors Required for System . . . Changes Necessary in Receivers to Accommodate Philco and Columbia LP Adapters.

be made with the pickup playing the record as the arm will always slow the turntable down, if only slightly, but enough to make a difference. The turntable assembly must also be perfectly on level as the wall resistance of the grooves is less on the *lp* record. If necessary use a water scale to determine whether the turntable is leveled. If it is not the pickup will slide and scratch the record.

When changing existing equipment so that *lp* records can be played several facts must be taken into consideration. The existing amplification must be good to take full advantage of the high-fidelity recording of the micro-groove record. You will not get something from a record which the amplifier cannot amplify or which the speaker cannot reproduce. The motor which now plays 78 rpm records only, cannot be slowed down. It is practically impossible and will not give satisfaction. Consequently the shaft must be changed, a difficult and time-taking operation, or a new motor be installed. The latter will result in more satisfaction from your customers and for you.

The standard pickups are too heavy in most cases and the styli in the pickups too large at the tip. You cannot always lighten the counterweight, if it is not expressly manufactured for this purpose and you cannot change the stylus because it will then ride on the bottom of the groove of regular records and ruin them.

If a completely new installation proves too expensive the next best alternative is to change the existing equipment by installing a dual-speed turntable with two pickups, one for each type of record. There are also some regular players for the micro-groove record only.

LP Record Players

Several models of *lp* record players have been developed for use with standard receivers or phonos, provided

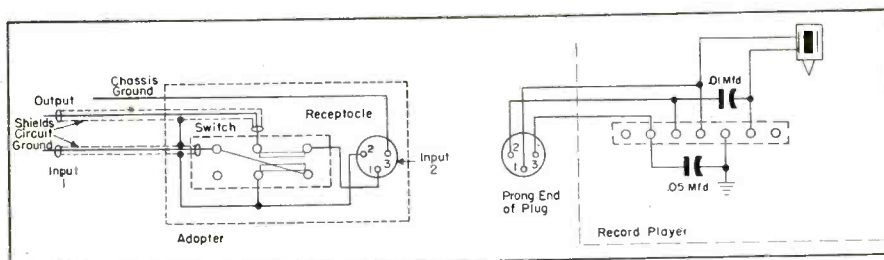

Figs. 1 and 2. Schematic of Philco and Columbia *lp* attachment and adapter.

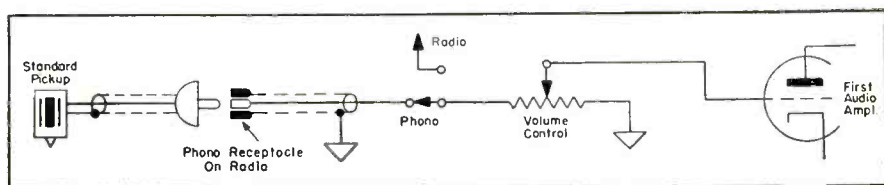

Figs. 3 and 4. In Fig. 3 we have a combination switch setup where a standard crystal pickup is used, and in Fig. 4 appears a plug-in or wired arrangement which can be used for the Fig. 3 setup.

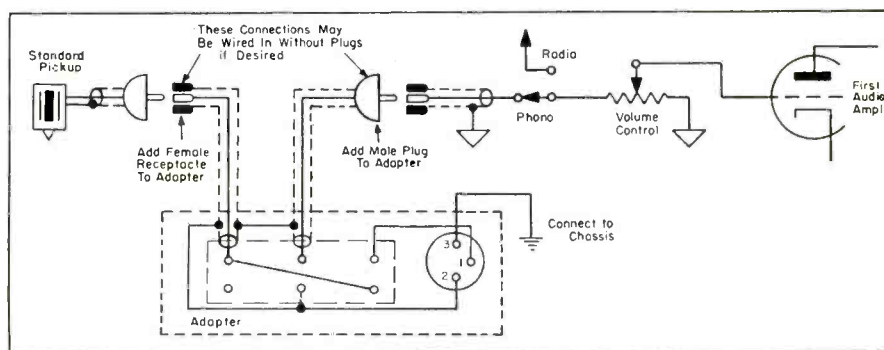

Fig. 5. Installation of an *lp* unit using a compensating network.

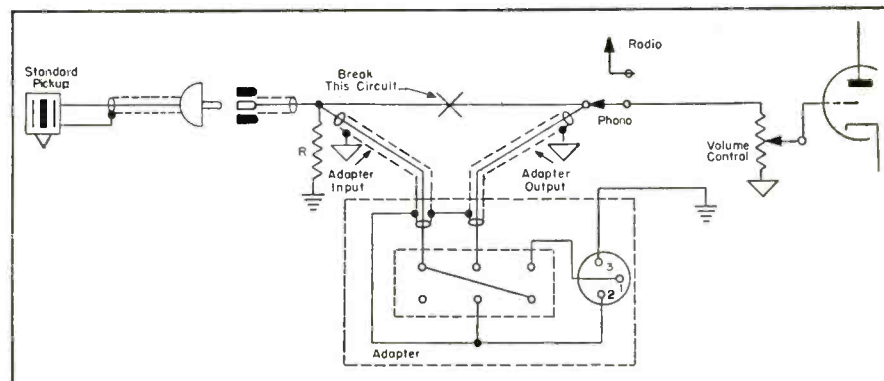
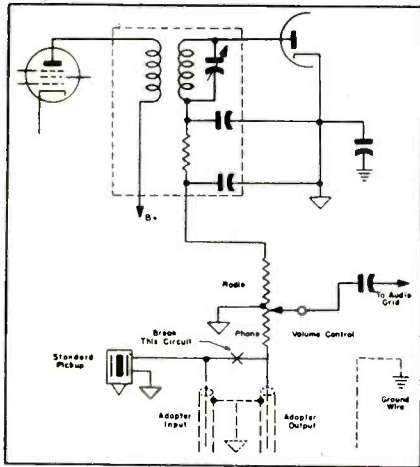

Fig. 6. Connecting of a *lp* adapter into a radio-phonograph circuit which has a dual-purpose volume control.



certain precautions are taken. With the Columbia 101 and Philco M15 models, for instance, the connection can be made to the volume control without changing the frequency characteristics of the player because this volume control remains within less than .5 megohm or more than 2 megohms. However, the length of shielded cable must be kept to a minimum so as not to reduce the output level through the value of shunt capacitance.

When connecting these *lp* players to Philco models 49-909 and 49-1101 it is necessary to remove the bracket located on the rear holding the switch to *radio*. The player should be plugged into place and then the switch made to *phono*.

With the Philco and Columbia installation kit comes an adapter (No. 76-4096) which consists of a bracket consisting of a three-prong receptacle, switch, shielded output lead, shielded input and ground leads. The receptacle serves as input for the attachment while the input lead (1) serves as input from the receiver detector or as input from the phono, depending upon the installation to which the attachment is being connected. Schem-

Fig. 7. A typical detector circuit used in an a-c/d-c receiver in which the *lp* attachment has been connected.

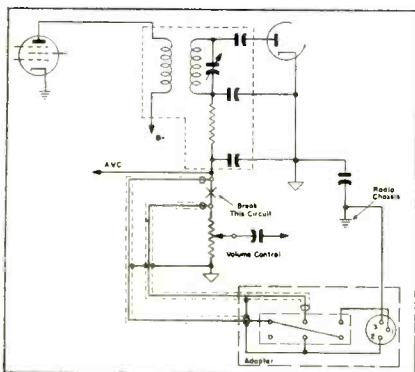

atic of the player attachment and the adapter appears in Fig. 2.

Two ground connections are used to operate the player attachment with various types of receiver and electric phonos. The chassis ground is connected through a .05-mfd capacitor, used for isolating to pin 3 of the plug and terminal 3 of the receptacle to which the black ground lead is connected. This ground lead is connected to all chassis. The other ground is the circuit ground connecting the low side of the attachment through a .01-mfd isolating capacitor to pin 2 of the plug and to point 2 of the receptacle and from there to the shields of the input and output cables.

The sliding contact terminal on the ground switching side of the switch is connected to the circuit ground and a jumper is connected from input terminal 1 of the switch to be shorted when the switch is in input position 2. This avoids leaking of any noise from the set into the player attachment and thereby marring the signal. Circuit ground must at all times be connected to the B- bus. This will then coincide with chassis ground in a-c installations. The connection should be made as closely as possible to the volume control B- connection. This avoids hum. When the adapter is used in installations where the negative side of the plate supply and the chassis are common the .05-mfd capacitor can be shorted by putting a jumper across this capacitor. Never jump this capacitor in a-c/d-c installations.

Combinations with Crystal Pickups

A standard combination switching circuit with a crystal pickup appears in Fig. 3, and in Fig. 4 we have a plug-in and wired-in arrangement for the *lp* unit. If wired in directly the input and output shields must go to the same point on the chassis as the regular phonograph input, namely, close to the low side of the volume control. Fig. 5 shows the installation for a phonograph input using a compensating network, represented by resistor *R*.

Fig. 6 shows a radio-phonograph system with a dual-purpose volume control: Clockwise it feeds the set into the

Astatic *lp* pickup, FL-33.

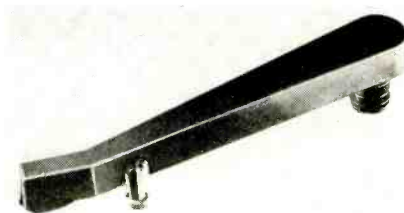
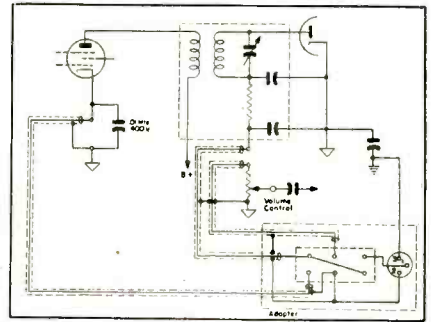

Fig. 8. Another way of connecting a *lp* unit into a receiver.



audio amplifier, counterclockwise it feeds the phono. In this case the adapter lead is connected to the phono side of the volume control.

When low output level pickups are used the adapter is connected preferably between the *radio-phonograph* switch and the output of the phono preamp.

Some receivers have no provisions at all for phono attachments. In this case the player must be connected into the circuit for best results. Fig. 7 shows a typical detector circuit used in a-c/d-c sets where the chassis ground and the receiver ground are isolated by a capacitor. In this case the volume control serves the detector diode load. The output of the *lp* adapter is connected to this volume control and the input lead to the point in the detector output circuit which was connected to the volume control. Disconnecting the detector circuit and shorting the detector output to the circuit ground silences the receiver.

Another method of silencing with amplifiers having a high i-f gain is illustrated in Fig. 8. The cathode circuit of the last i-f amplifier stage is opened. This however necessitates a shielded lead and a bypass. If dual i-f circuits are used (Fig. 9) silencing can be obtained by disconnecting the plate supply from the last i-f stage. If filter networks are used the point of disconnection must be made on the power supply side of the network.

[Circuit data courtesy Philco and Columbia.]

[To Be Continued]

Fig. 9. Dual i-f circuit where silencing is obtained by disconnecting plate supply from last i-f stage.

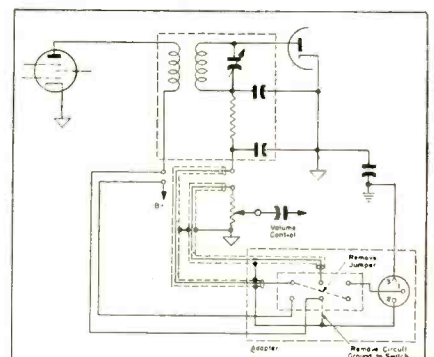



Have You Met the Little Fellow
with the
BIG
Advantages?

The All New
Mallory Midgetrol

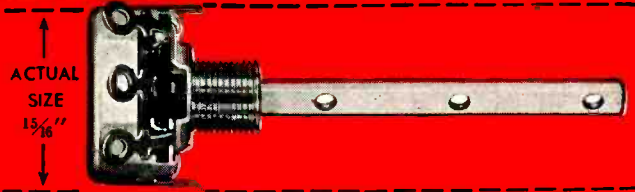

Offers These BIG Advantages...

**BIGGER
MARKET**

The small size of the Mallory Midgetrol lets you service portables, auto radios and small AC-DC receivers which require $15/16''$ controls.

**SIMPLER
INSTALLATION**

The unique shaft design of the Mallory Midgetrol saves installation time with *all* types of knobs.

**SIMPLER
STOCKING**

Electrical characteristics let you use the Mallory Midgetrol to replace $1 1/8''$ as well as $15/16''$ controls. Stocks are further reduced because no special shafts are needed.

The Mallory Midgetrol is unusually quiet, both mechanically and electrically—and tests prove it *stays* quiet. In addition, the Mallory Midgetrol has nine *all new* features.

- NEW SIZE
- NEW DESIGN
- NEW SHAFT
- NEW EXTENSION
- NEW SWITCH
- NEW ELEMENT
- NEW CONTACT
- NEW TERMINAL
- NEW TWO-POINT SUSPENSION

It's the NEW Standard in Carbon Controls. See your Mallory distributor.

P. R. MALLORY & CO. Inc.
MALLORY

CAPACITORS... CONTROLS... VIBRATORS...
SWITCHES... RESISTORS... RECTIFIERS...
VIBRAPACK* POWER SUPPLIES... FILTERS
*Reg. U. S. Pat. Off.

APPROVED PRECISION PRODUCTS

P. R. MALLORY & CO., Inc., INDIANAPOLIS 6, INDIANA

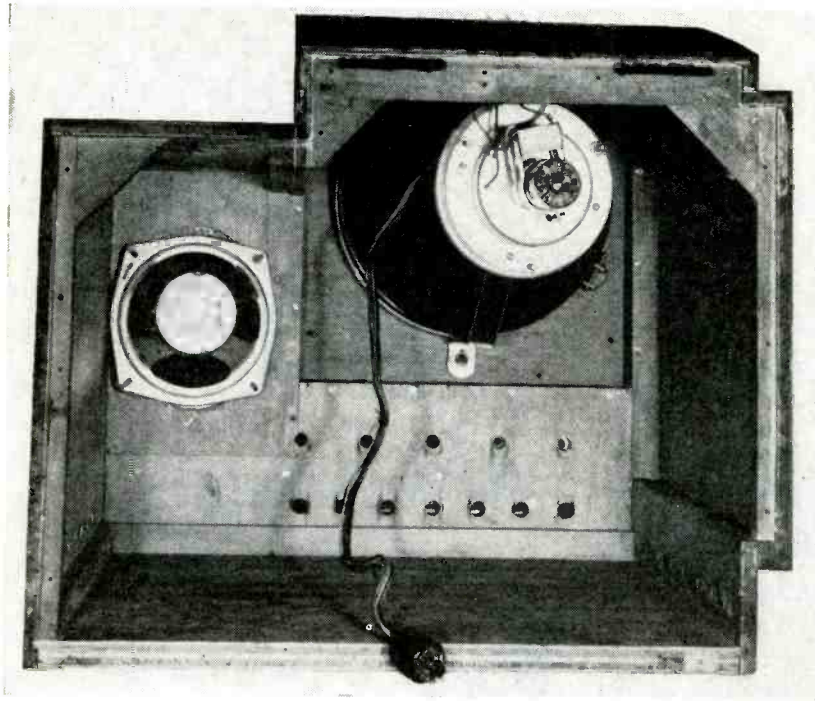
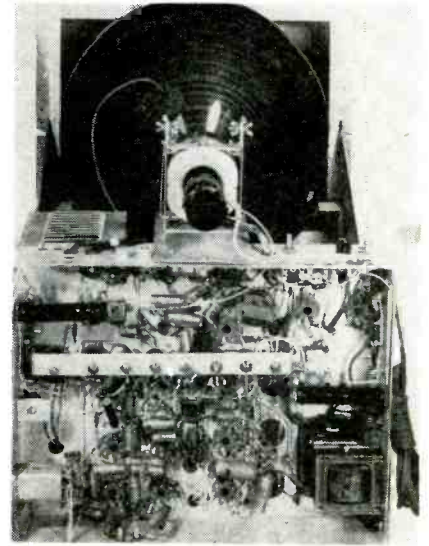

Fig. 1 (left). Picture tube housing in a Philco TV receiver.

Fig. 2. How the picture tube is mounted in a Bace type TV receiver.



TV Receiver Installation Pointers*

WHEN INSTALLING a TV receiver it is not possible to just plug it in, connect the antenna, and walk away. There are many items which must be checked carefully to assure complete customer satisfaction. Usually, for instance, the picture tube is transported separately or has been removed during the alignment procedure and must be inserted again in the home. With small 7" tubes this is no great problem, especially with electrostatic tubes which require only a single socket. But when a large diameter magnetic deflection tube is installed, a number of precautions must be taken. First, the tube must never be taken out of the carton before you have prepared a place for it, and an excellent example of the reason for this precaution appears in the Philco 48-1000 TV receiver. In this unit the picture tube is clamped on the front panel of the cabinet by means of a special harness. It is best to open all adjustments and prepare them before the tube is taken out of the carton. The mounting of the tube is really a two-man job, with one man holding the tube in place and the other tightening the clamps. Deflect-

ing yoke, focus coil and the ion trap assembly must be slipped on the neck of the tube before the socket plug is connected. The manufacturer suggests orienting the tube by the location of the socket key, before electrical connections are made, to avoid repeated rotating after the chassis is in the cabinet. All adjustments must then be tightened, the chassis slid in and all plugs connected, not forgetting the high voltage lead to the separate second anode terminal near the face of the tube.

In another TV receiver, the Bace model, the tube and chassis are mounted on a single assembly which can be

put into the cabinet without further adjustments. In this type of receiver the picture tube is mounted so that all alignments and adjustments can be made without disturbing the tube or any other component.

Adjusting the Ion Trap

Many receivers using magnetic deflection also use a magnetic ion trap to eliminate ion spots. These spots are caused by the effect of the ions, which are always present in the tube and become part of the electron beam. Since these ion spots are much heavier than electrons they do not bounce off the screen as easily and over a period of time inactivate the fluorescent material. For the same reason they are not deflected as much as the electrons and always hit near the center of the screen. To eliminate the ions from the electron beam, several methods are used. In one approach we have an external ion trap with a bent electron gun which directs ions and electrons to the second anode. The electron beam has to be bent back into the proper position so that it hits the screen and creates the image. This is done by placing two magnetic fields at

Fig. 3. View of a pattern with improper horizontal centering.

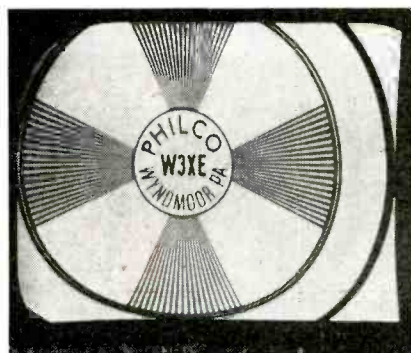

*From a forthcoming book.

Factors Involved in Final Check Up in Home to Assure Successful Operation of TV Receiver: Proper Installation of Picture Tube . . . Adjustment of Ion Trap . . . Centering . . . Focus . . . Linearity Control . . . Picture Quality Control.

the point where the electron beam turns away from the direct path to the screen. The magnetic fields are arranged so that the electron beam is bent back to hit the screen. Because the ions are so much heavier, the magnetic fields will have almost no effect on them, permitting the ions to go straight to the second anode, thus preventing them from reaching the screen and creating an ion spot. The magnetic field is generated by the ion trap, which is placed around the neck of the tube.

Two types of ion traps are in use, permanent magnets and electromagnets, where the magnetic field is due to a d-c current flowing through a coil. In Fig. 1 the ion trap can be seen mounted on the neck of the 10BP4 picture tube. Regardless of the type of ion trap used no light can appear on the screen unless it is in the proper location, since the electron beam cannot reach it. Usually the current through the ion trap is adjusted at the plant because it is not too critical. Permanent-magnet type ion traps are adjusted by a brass screw which varies the size of the airgap and, therefore, the strength of the field. The adjustment requiring the weakest magnetic field is usually the best one, when several different settings appear to work equally well. But the most critical adjustment is the positioning of the trap on the neck of the tube. All 10BP4 tubes now have two small blue

by **W. H. BUCHSBAUM**

Chief Engineer
Vision Research Labs., Inc.

flanges welded on the internal structure of the electron gun, and these two flanges serve to line up the ion trap position. The smaller magnet or coil goes towards the screen, and the ion trap is put on so that the two smaller magnets fit over the flanges. The final position is best reached with the set turned on. The trap is moved back and forth, and rotated in both directions until all four corners of the raster are visible. If a corner seems cut off, the trap must be rotated. If all four corners appear fuzzy or are missing, the trap must be moved back or forward. Before tightening the positioning clamps of the ion trap, you should be sure that the focus is even, i. e., all parts of the raster have good focus. Some interaction between magnetic focusing and the ion trap usually exists but should not materially affect the picture. The clamps should be tightened carefully, because the neck of the tube is quite fragile and too much force may cave it in, causing the tube to implode. The ion trap must never be clamped on the neck of the tube without rubber or felt pads between metal and glass. The ion trap is the last part fitting over the neck of the tube, but since no picture can be obtained without it, the focus coil or

deflecting yoke must not be clamped on tightly before the ion trap is adjusted.

Centering, Focus, and Linearity

Once the picture tube is in place the chassis connected and the ion trap clamped on, the set can be turned on and a station tuned in. Although it is possible to check just on a raster, the centering may be wrong when a station appears, because the upper and left edges of the raster are blanked out by the signal. The picture should be checked for proper centering first. To bring the edges of the picture parallel to the edges of the panel window, the deflecting yoke should be rotated slightly; in electrostatic deflection systems the tube should be rotated. Next the vertical and horizontal centering controls should be adjusted. If it appears in magnetic deflection systems that the centering control cannot quite center the picture correctly, that may indicate that the deflection yoke has to be twisted slightly. After proper centering is checked on several stations it may be found that centering on one station is not satisfactory to another. A compromise position should be achieved by repeated checking. Then the focus should be adjusted by varying the focus control, making sure that the picture is in focus on the edges as well as in the center. Any difficulty in this may be due to the position of the

(Continued on page 41)

Fig. 4. To prevent the picture from moving up or down as shown here, the vertical hold control must be adjusted until the picture stands still. (Courtesy DuMont).

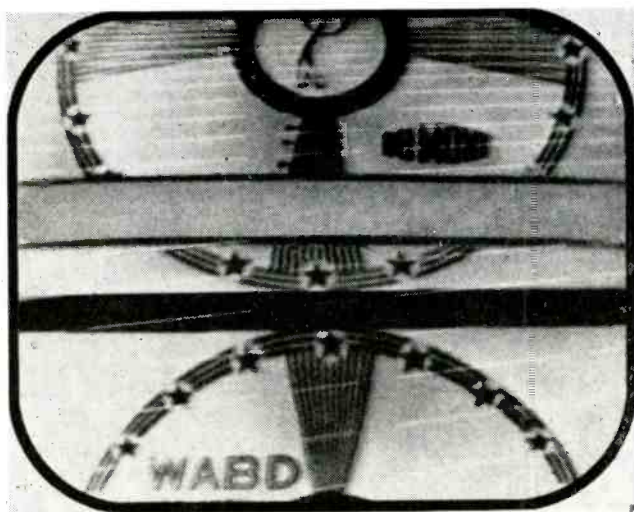
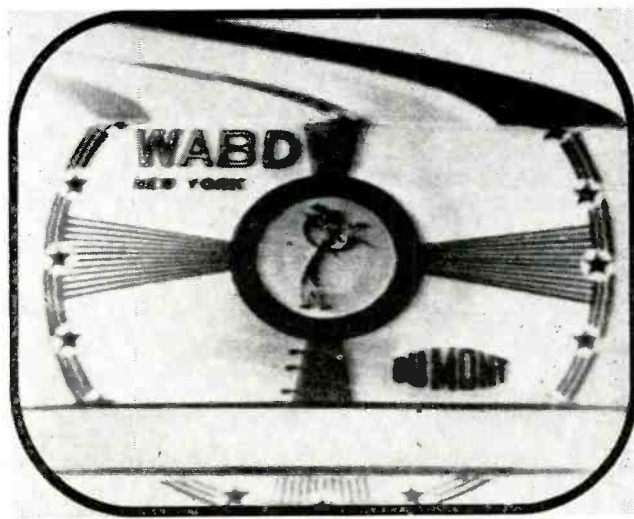

Fig. 5. Picture swaying back and forth for a moment before it locks in, is a normal action of *afc* used in most TV receivers and does not indicate set deficiency. (Courtesy DuMont).



Practical FM Antenna Installations

Selecting Proper Antennas Out of Six Standard Types for Rural and Urban Jobs . . . Checking Locations . . . Matching to 72- and 300-Ohm Lines . . . Directional Control . . . Multiple Antenna System Installations.

IN THE TRANSMISSION AND RECEPTION of FM broadcasts, there is no single most important element, for, like the proverbial chain, the system of transmission is no stronger and of no greater fidelity, than its weakest link.

Generally speaking, today's weak link in any FM receiving system, is the antenna. The advantages of FM (static-free reception, high fidelity and freedom from fading) cannot be realized unless all stations have adequate FM signal input to operate the noise limiter in the receiver. When the signal from the FM station is not adequate, the signals are lost in the background hiss and are pulsed by ignition systems of automobiles and other man-made devices which radiate interference fields. Public acceptance of FM has been phlegmatic, because of poor demonstrations of reception on antennas which did not pick up signals of adequate strength.

Many FM receivers have their weakest link built in as a loop, which are ineffective under the following conditions: (1) In multiple dwellings where the receiver is shielded from reception by adjacent buildings, or by the steel structural members in the wall against which the receiver is installed. (2) The bi-directional pattern of the loop makes it ineffective as a pickup medium for FM transmissions which are at right angles to the maximum pickup area of the loop's pickup pattern. This condition is common in urban locations where the FM stations are in all directions, with respect to the loop antenna. (3) Weak signal areas where the inefficiency of the built-in antenna does not provide sufficient signal strength to drive the receiver.

by IRA KAMEN

Manager, Television Antenna Dept.
Commercial Radio Sound Corp.
New York City

FM receiver manufacturers have pinned their hopes on the built-in loops, because they believe that the cost of installation of external antennas is a sales deterrent and that in a majority of cases the FM loop does a satisfactory job. Most manufacturers, however, provide terminals for external antennas, so that full realization of the FM receiver's capabilities can be obtained.

As a general statement, we may say that, perfect all-station FM reception is only possible with an outside antenna.

In multiple dwellings where rooftop antennas are not permitted, reception may be improved by installing window-mounted FM antenna assemblies. To justify the window-mount installation, you can check the noise reduction on the weakest FM station. The noise source may be pulses from ignition systems, elevators, razors, power

lines, etc., or from the series atmospheric pulses which produce a *rushing* noise in the background.

The multiple dwelling FM reception-problem is slowly being solved by the installation of master TV-FM and AM antenna systems. These antenna systems have a high-gain omnidirectional antenna installed on the rooftop level at some high point. The output of the FM antenna is fed into the input of an FM amplifier, the output of which is fed into a distribution network of transformers and cables, as shown below. These cables (which also carry the TV and AM signals) are then connected to all the outlets in the building. The FM receiver can be connected to this high level FM signal source by means of a simple flexible coaxial cable between the outlet and the FM receiver.

Rooftop FM antenna installations are sometimes as critical as TV installations. Often it is possible to move an FM antenna only a few feet on the roof and the new location will make the difference between good reception on all channels and good reception on only a few channels. With these facts in mind, let us see how to select and locate a rooftop FM antenna. There are six types of antennas which have been found most effective: (1) Overlapped dipoles, (2) overlapped dipoles and reflectors, (3) folded dipoles, (4) folded dipoles and reflectors, (5) turnstile dipoles and (6) turnstile folded dipoles.

The overlapped dipoles are purposely overlapped to obtain a broad-band response (88-108 mc). The dipole rods are made somewhat longer than a $\frac{1}{4}$ wavelength. This longer length makes the FM antenna induc-

Simultaneous operation of two FM receivers from a single FM antenna. The load impedance at points A and B is 300 ohms.

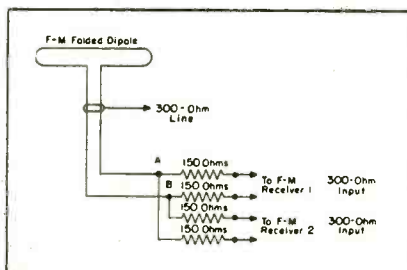

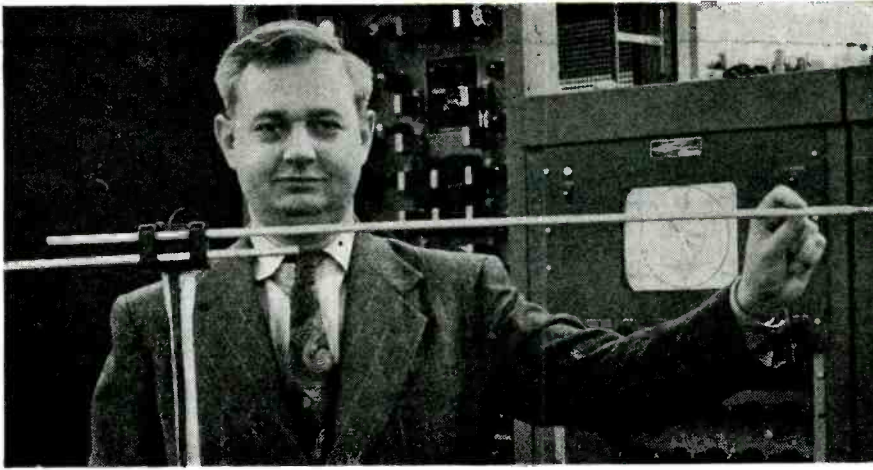

An overlapped type of FM dipole (Courtesy Bendix).

tive. The inductive effect however is compensated for by the capacitive reactance of the overlapping inner ends of the rods. This dipole antenna best matches a 72-ohm coaxial line and has a bidirectional pickup pattern. In low-signal high-noise areas, where all the FM stations are in one direction, a reflector may be added to this antenna to make it unidirectional. When the signal-to-noise ratio is very poor, a director may be added. Adding a director should be a *last resort*, as it narrows the bandwidth of the antenna to a point where full frequency coverage is not usually possible.

The folded dipoles are best matched to a 300-ohm transmission line. If the 300-ohm transmission line is to pick up a minimum of interference, two precautions must be taken: (1) The line should be installed clear of metal structures, and (2) line should be twisted at least one turn per foot. (Note: The foregoing considerations are also important in TV installations.)

The folded dipole also has a bidirectional pickup pattern which can be made unidirectional by the addition of a reflector element.

Turnstile antennas have an omnidirectional pattern and receive FM signals well from all directions. There are no *dead spots* with turnstile antennas as with straight dipoles which have two null points. The cross dipoles are connected together by a $\frac{1}{4}$ -wave matching section.

When installing rooftop FM antennas two men are required for fine adjustments. A man at the FM receiver will tune to the weak stations, while another man (on the roof) will raise and rotate the FM antenna until the weak stations are of sufficient signal strength to drive the FM receiver.

As a general rule, in urban locations where the FM stations are distributed

omnidirectional antennas offer the best all-channel FM frequency coverage, although simple less expensive dipoles are satisfactory in a majority of cases. In rural locations where signals are weaker and the stations are all in one direction, higher gain dipole antennas with reflectors are preferred.

When indoor antennas must be used, consideration should be given to the installation of a broadband FM booster amplifier which usually has a voltage gain of four or more. This additional gain may be enough to add several
(Continued on page 43)

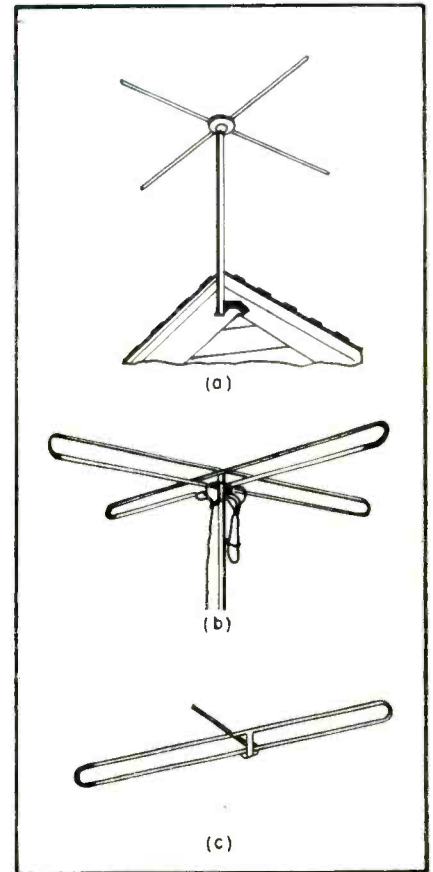

Three types of FM antennas. In a and b appear two types of omnidirectional antennas, the model in a being a turnstile dipole (*Hi-Par*) and in b, a turnstile folded dipole (*Amphenol*). In c is a folded dipole type.

Horizontal pattern of a FM non-directional antenna. The circularity remains fairly constant over the 88-108 mc band. (Courtesy Workshop Associates.)

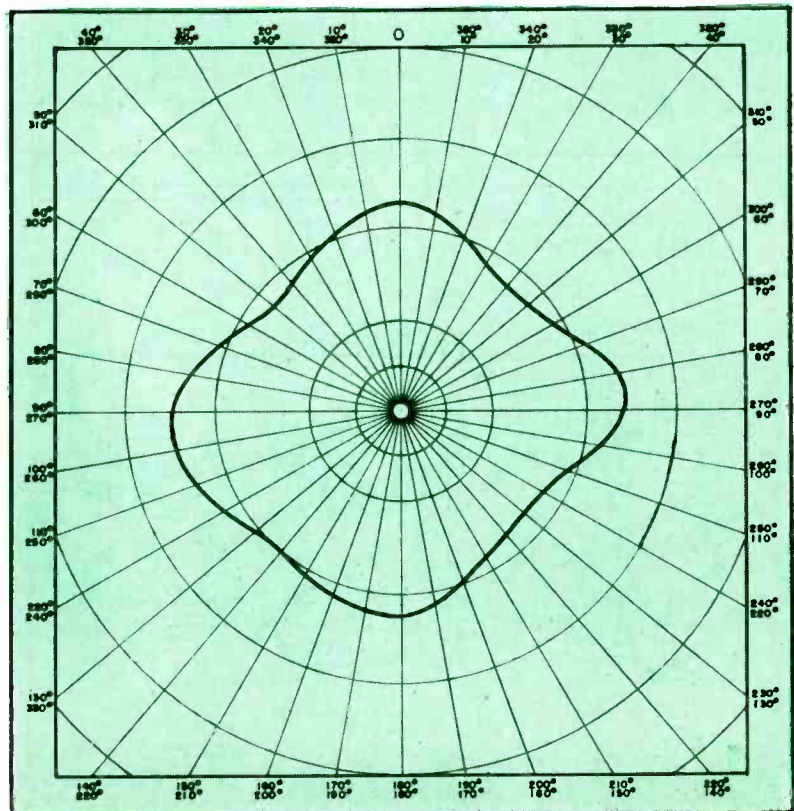

TV Receiver Visual Alignment Techniques

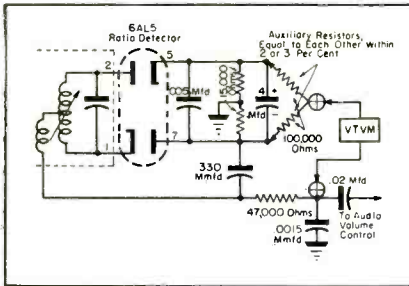
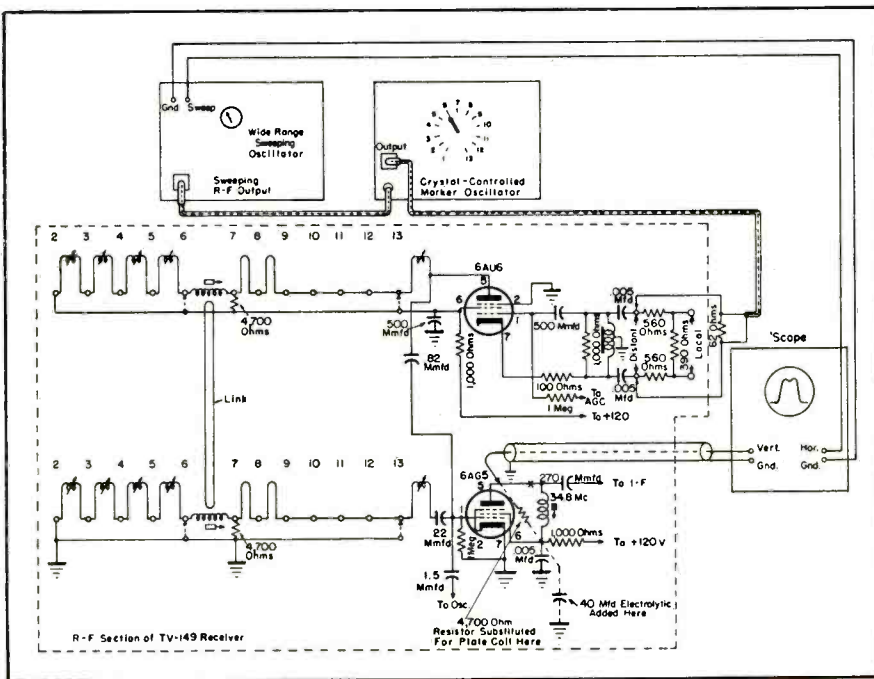

Fig. 1. A special setup used for alignment of the ratio detector in the Tele-Tone TV receiver.

CONTINUING WITH our Tele-Tone TV-149 receiver alignment procedure analysis, let us now consider the technique of adjusting the secondary circuit of the 4.5-mc ratio detector transformer which we discussed last month. To get a valid *zero* reading on the *vtvm* when connected as described, it is necessary that the 15,000 ohm ratio detector load resistors (connected from pins 5 and 7, respectively, to ground) should be equal to each other within 2 or 3 per cent. Since this equality is not generally attained with the normal production tolerances allowed these resistors, it is necessary to employ special procedures during the align-

Fig. 2. R-f alignment setup.



Second Installment With Additional Practical Alignment Procedure for the R-F and Oscillator Sections of the Tele-Tone TV-149

by **LESTER L. LIBBY**
 Chief Engineer
 Omega Laboratories and Kay
 Electric Co.

ment operation to assure equality. One such procedure consists of measuring carefully the value of each resistor with an accurate ohmmeter, and then shunting down the larger of the two with a suitable resistor whose value is such as to make the resultant resistance value equal in magnitude to that of the smaller of the two. The alignment procedure is then carried through as indicated previously, and after it is completed the auxiliary equalizing resistor is removed and the receiver operated in its normal fashion. An alternate procedure consists of choosing a pair of 100,000- or 120,000-ohm resistors, equal to each other within 2 or 3 per cent, and series

bridging these resistors across between pins 5 and 7 of the ratio detector, leaving their junction point ungrounded. The *vtvm* is then connected between the junction point of these auxiliary resistors and the top end of the .0015-mfd bypass which precedes the .02-mfd coupling capacitor to the audio volume control (Fig. 1), and the secondary of the ratio-detector transformer is adjusted for *zero* reading as before. The auxiliary resistors are then removed and the receiver is ready for normal operation of the sound system.

R-F Alignment

The adjustment of the r-f amplifier and mixer tuned circuits is normally a factory procedure. The circuit elements themselves are sufficiently stable so as not to change critically during the life of the set unless tampered with or accidentally damaged. Because the bandwidth of these stages is quite large, even replacement of the r-f amplifier tube or mixer tube will not adversely affect the overall response or impair the performance of the receiver. Hence readjustment of these coils will not generally be required in the field, and should not normally be attempted. If misalignment of these circuits is encountered, and if this misalignment is a result of other than the effects of capacitance differences caused by tube replacement, it is advisable to contact the receiver manufacturer's service manager to obtain his recommendation on what steps should be taken. If the misalignment is known to be the result of normal differences in replacement tube capacitances, the following procedure may be employed to touch up the key adjustments and restore the r-f pass band to its normal condition. First, the sweep generator is connected to the *distant* input terminals of the receiver by patching it through the

**"TV.....
and ALL
SEVENTEEN"**
Says R. K. Mosier

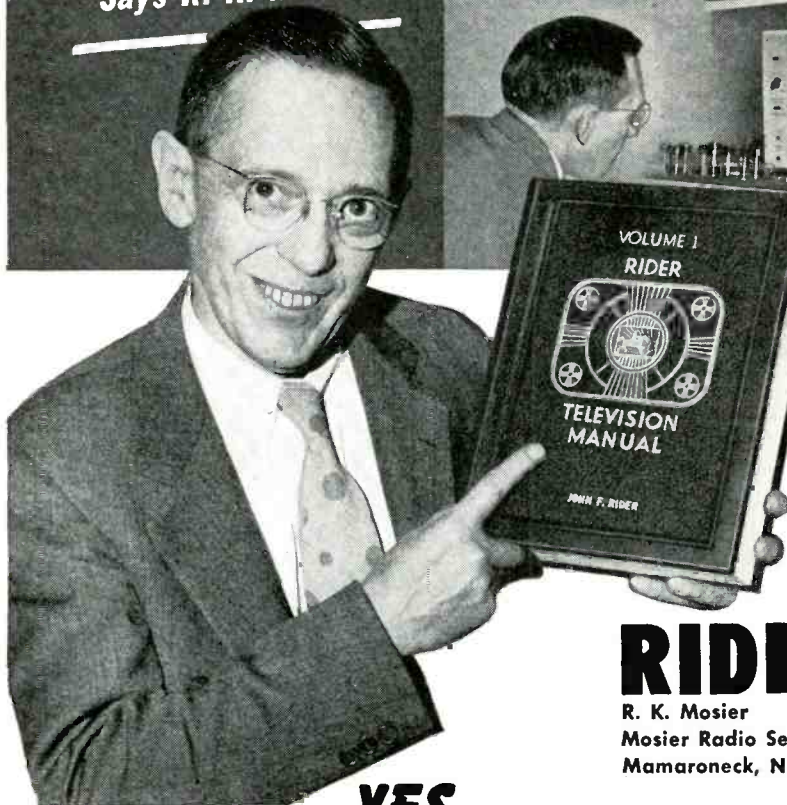

"We are fully aware of the importance of Television. It appears as the brightest spot for the future of all radio servicing. But TV, even with its surprisingly rapid growth, does not offer enough servicing volume to support our organization. We realize, as we prepare ourselves for the TV future, that we must continue to service AM radio as today's basic income of our business. That's why we now have a standing order with our wholesaler to keep us up to date with all the latest

RIDER MANUALS"

R. K. Mosier
Mosier Radio Service
Mamaroneck, N. Y.

YES... he has found, like thousands of other successful servicemen, that a complete set of Rider Manuals saves time, saves money, builds business. Each Manual, kept handy to the bench, is a source of ready reference for all sets from 1930 to 1948. Service data on 80% of the receivers now in American homes can be found only in the first fourteen volumes of Rider Manuals.

"Volume 1 RIDER TELEVISION MANUAL is up to the usual high standards of all the other Rider Manuals" —R. K. Mosier

Over 1400 Pages (equivalent of 2000 pages because of the 440 sq. inch GIANT SIZE schematics). PLUS 2 Separate Books... "HOW IT WORKS" and INDEX.....\$18.00
Includes everything needed on 1946-47 Television Receivers (complete and kit) of 34 leading manufacturers.

"We are equally pleased with the
RIDER PA MANUAL"

—R. K. Mosier

The first industry-wide service manual covering products of all leading manufacturers of PA amplifying systems, manufactured since 1938 to date. 2024 pages.....\$18.00

... and you, too,
should have all
Rider Manuals

Volume XVII\$16.50
Volume XVI\$ 8.40
Volume XV\$19.80
Volume XIV to VII
(each volume)\$16.50
Volume VI\$12.50
Abridged Manuals I to V
(one volume)\$19.80
Record Changers and
Recorders\$ 9.00
Master Index, covering
Manuals, Vols. I to XV. \$ 1.50

JOHN F. RIDER, PUBLISHER, Inc., 480 Canal Street, New York 13, N. Y.
Export Agent: Rocke International Corp., 13 E. 40th St., N.Y.C., Cable, ARLAB.

RIDER MANUALS *mean* **SUCCESSFUL
SERVICING**

On the Way...

VOLUME
18

At Your Jobber's Soon
2000 Pages PLUS Separate
"HOW IT WORKS" BOOK

Rider Manual data is RELIABLE, the OFFICIAL AUTHORIZED data right from the Service Departments of the set manufacturers themselves. They know the correct procedures for their sets, and have cooperated fully in getting this authoritative data to you through Rider Manuals. Successful servicemen know that they can turn to a Rider Manual for all the information they need on any set brought into the shop. They know that the Rider-Exclusive "Clarified Schematics" provide time-saving breakdowns of multi-band jobs; that with Volume XVIII even wire recorders are covered, along with FM and AM sets and record changers. ONLY RIDER GIVES YOU SUCH COVERAGE!

Both books, complete.....\$19.80

NOTE: The Mallory Radio Service Encyclopedia, 6th edition, makes reference to only one source of radio receiver schematics—Rider Manuals.
ANOTHER NOTE: The C-D Capacitor Manual for Radio Servicing, 1948 edition No. 4, makes reference to only one source of receiver schematics—Rider Manuals.

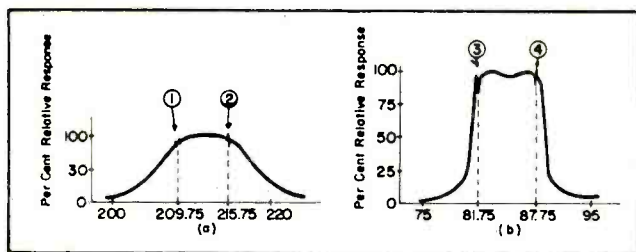

Fig. 3. Approximate r-f selectivity characteristics of the Tele-Tone. At point 1 we have the channel-12 sound-carrier crystal-marker birdie and at point 2 appears the channel-13 sound-carrier crystal-marker birdie. At point 3 we have the channel-5 sound-carrier crystal-marker birdie and at point 4 is the channel-6 sound-carrier crystal-marker birdie.

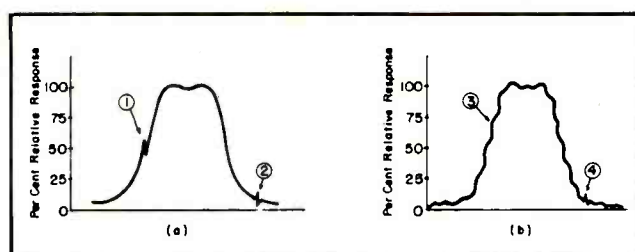

Fig. 4. Response curves for the local oscillator alignment setup. In a we have the audible beat-note method and in b the visual beat-note method illustrated. At point 1 appears the auxiliary 37.3-mc birdie from the marker generator and at point 2 we have the heterodyned r-f carrier birdie from the crystal-controlled marker oscillator. At point 3 appears the beat note on response curve and at point 4 we have both birdies (32.8 mc i-f).

sound carrier marker oscillator as diagrammed in Fig. 2. Then the scope is connected to the vertical amplifier, through a shielded cable, across an auxiliary 4,700-ohm resistor which has been substituted for the plate coil of the 6AG5 mixer tube, and a 40-mfd electrolytic is shunted across the .005-mfd screen bypass, as shown in Fig. 2. The sweeping oscillator output is then set up to a center frequency of approximately 213 mc, with a sweep excursion width of approximately 30 mc and with the attenuator set for maximum r-f output. The receiver is then tuned to channel 13 and the crystal-controlled r-f sound carrier marker oscillator is set to channel 13, its output control being adjusted for maximum. It will probably be necessary to use the maximum vertical gain on the scope to observe the r-f pass band characteristic, which should be approximately as shown in Fig. 3a. To adjust the observed characteristic to this shape it is necessary to use an insulated prod to manipulate the turns of the small self-supporting coils connected between the channel 13 switch contact points and the plate of the r-f amplifier and grid coupling capacitor of the mixer tube, respectively. After this procedure is completed, the test equipment and receiver should be adjusted for channel 6 and tuned up for the approximate curve shown in Fig. 3b. This is done by adjusting the tuning slugs of the two inductors connected between the channels 6 and 7 switch contact points of the r-f amplifier plate and mixer grid circuits, respectively. These inductor coils may be identified by the fact that they are coupled to each other by a link coupling circuit, as shown in Fig. 2.

Oscillator Alignment

The local oscillator on this receiver may depart $\pm \frac{1}{4}$ mc from its proper frequency on each channel without seriously affecting the performance of the set. This is a result of the use of the intercarrier system for extracting

the sound signal, and, as pointed out before, permits the elimination of the *fine tuning* control. The alignment of the local oscillator to the proper frequency on each channel should be made to an accuracy of better than ± 1 mc, however, so that there will remain as much margin as possible for subsequent oscillator frequency drift due to temperature and line voltage variations and due to aging of tubes and components. To align the local oscillator, the sweep generator and marker oscillator are connected in the same manner as for the r-f alignment (Fig. 2), but with their output voltages reduced to about one-tenth or one-twentieth of maximum. The auxiliary plate resistor and screen bypass electrolytic are removed from the mixer tube, as is also the scope cable, and the i-f plate coil connection is restored to normal. The scope cable is connected across the video amplifier grid and ground, as for the case of video i-f alignment. The marker oscillator i-f marker generator is set up to couple loosely (through a 0.25-mmfld capacitor) an i-f marker signal into the first video i-f amplifier grid. This i-f marker signal will be set accurately at either 37.3 mc (i-f picture carrier) or 32.8 mc (i-f sound carrier), as will be described in the following paragraph.

The receiver, sweep generator and the sound carrier marker oscillator are first all adjusted to operate on channel 2, and the marker i-f signal is tuned to 37.3 mc. The marker modulation switch is set to its *on* position. Under these conditions, when the receiver local oscillator is tuned to its proper frequency, the modulation tone of the marker will become audible in the receiver speaker. This occurs because the auxiliary 37.3 mc i-f signal supplied by the marker produces a 4.5-mc intercarrier signal in conjunction with the heterodyned signal from the sound carrier marker oscillator, provided this heterodyned signal is correctly located at 32.8 mc, by having the re-

ceiver local oscillator properly tuned with respect to the crystal-controlled r-f sound carrier frequency of the marker. The visually-displayed response curve on the scope screen will appear as shown in Fig. 4a. An alternate method of indicating proper adjustment of the receiver local oscillator is to set the marker auxiliary i-f carrier at 32.8 mc and tune the receiver local oscillator for the visual beat note which occurs when the heterodyned marker signal coincides with the auxiliary marker i-f signal. The beat note will be superimposed on the displayed response characteristic as shown in Fig. 4b.

After the channel 2 local oscillator alignment has been completed, the remaining channels may be aligned in any order thereafter. Since the channel 2 oscillator coil shunts each of the remaining coils in succession, any change of adjustment of this coil will in general necessitate a readjustment of most of the other coils, particularly those of the lower channels. Care should be taken that the alignment tool be of low-loss dielectric material no larger than $\frac{3}{16}$ " diameter. Serious damage to the oscillator coils may result if this precaution is not observed. When aligning the oscillator coil for any channel, it should be noted that as the slug is tuned through the oscillator coil there will be two points at which a proper setting may be obtained. Only the point at which the slug is nearest the front panel of the set should be used. Access to these oscillator coil adjustments is had by removing the escutcheon plate of the channel selector switch, as was illustrated in the setup illustration shown last month.

Appendix

In the discussion last month of the instruments used for visual alignment, we briefly described the *Mega-Pip*, which provides four simultaneous frequencies along the scope display and
(Continued on page 45)

Why Your RAYTHEON Tube Distributor* Recommends

The New RAYTHEON BANTAL TUBE



It's Easier to STOCK

At the same price as ordinary tubes one Raytheon *Bantal* takes the place of two—cuts your stock problem in half! The Bantal 12SK7GT, for example, replaces, without shielding, either the GT or metal equivalent. Fast turnover, less money tied up in stock, more profit on your investment.

*Your Raytheon Distributor sponsors the famous Bonded Dealer-Service Program. Ask him for full details on this business building plan.

It's Easier to SELL

All these advantages at
NO EXTRA COST

Rugged Eight-Pillar Construction — Short pillars direct to elements; low grid-plate capacitance—greater stability.

Completely Shielded Internally — No external shielding hardware or installation labor. Increases your service profit.

Glass Button Stem — Low Loss.

Glass-To-Glass Seal — Permanent Vacuum.

Wide Lead Spacing — No Electrical Leakage.

Strong Non-Flexible Leads — No Base Shorts.

Glass-To-Dumet Vacuum Seal — No Air Leaks.

EIGHT POPULAR TYPES — 6SA7GT — 6SJ7GT — 6SK7GT — 6SQ7GT — 12SA7GT — 12SJ7GT — 12SK7GT — 12SQ7GT.

SUPERIOR FOR HEAVY DUTY SERVICE — Recommend Raytheon Bantals particularly for replacements in sets or equipments requiring tubes of long life and greater dependability. Their superior performance assures customer satisfaction and repeat business.



RAYTHEON MANUFACTURING COMPANY

RADIO RECEIVING TUBE DIVISION

NEWTON, MASSACHUSETTS • CHICAGO, ILLINOIS • LOS ANGELES, CALIFORNIA

RADIO RECEIVING TUBES • SUBMINIATURE TUBES • SPECIAL PURPOSE TUBES • MICROWAVE TUBES

Three-Tube Dynamic

[See Front Cover]

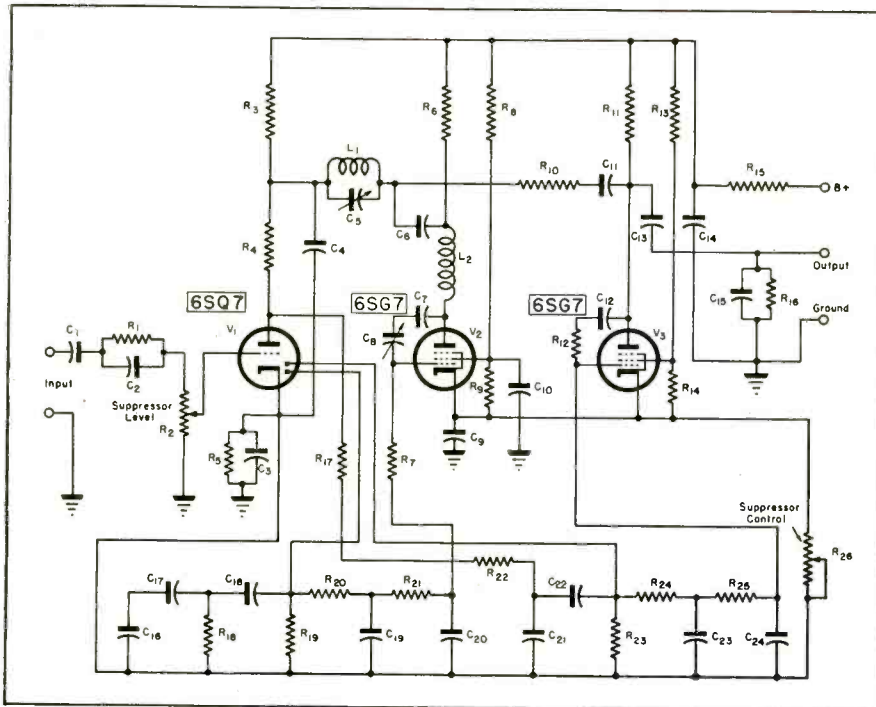

Fig. 2. Schematic of the dynamic noise suppressor, which also appears on the cover this month.

MOST RECORDS have a noticeable noise level. In wide-range amplifiers, used with many phono systems, the noise level becomes even more obvious and disturbing. Accordingly it is necessary to insert a suppressor to curb the fault and as cited in an earlier paper¹ the dynamic noise suppression principle offers a very effective means of accomplishing this control.

In this system the reactance tube is the key unit. It is simply a pentode amplifier with feedback, purposely out

of phase with the plate voltage, applied to the control grid. This causes the plate current to be out of phase with the plate voltage, and hence the plate impedance of the tube appears largely reactive.

This reactance is proportional to the transconductance of the tube and hence can be varied over a wide range by varying d-c bias voltages on the various grids. The reactance of such a tube can be made capacitive by using a capacitor between plate and control

grid and a resistor from grid to ground, or inductive by using a resistor between plate and grid and a capacitor from grid to ground. In the circuit² (shown on cover and in Fig. 2) V_2 is a capacitance tube (note C_8 and R_7), and V_3 is an inductance tube (note R_{12} and C_{24}). With these inductive and capacitive elements available, it is possible to design almost any type of band-pass filter system desired, and control the frequency characteristic over a wide range by varying one or several d-c.

Gate Action

In any dynamic noise suppressor, a band-pass filter with independently variable high- and low-frequency limits provides gate action on the incoming signal. When the music requires wide range, a control circuit operated by the signal itself opens the pass band of the filter system.

Fig. 3 shows the elements of the filter system used in the dynamic noise suppressor,² and Fig. 4 shows the response of the instrument. The effect of each circuit element on the response is quite interesting.

R_s , the source impedance into the filter circuit, controls the sharpness of the roll-off in the suppressed curve (Fig. 4) at point A; increasing R_s causes the roll-off to be more gradual. C_4 and C_6 are mainly to keep down the extreme high-frequency response in region B. C_5 and L_1 are adjusted to provide the fixed null at point C. L_2 and C_6 (actually V_2) give a dynamic null point D, which moves from the position shown to position C as the gates open. R_7 and L_2 (actually V_3) give the slope-off at low frequencies at E. Finally, RL , the load resistance of the filter system, controls the sharpness of the cut-off at F; as RL is increased, the cut-off becomes sharper.

D-C Bias

C_6 (or V_2) is controlled by a d-c bias proportional to the level of the incoming signal in the region between 1,000 and 3,000 cycles. L_2 (or V_3) is controlled by a bias proportional to the level of the signal in the 100-400 cycle region. These two control actions are entirely independent. Thus, as the signal in the 1,000-3,000 cycle

Fig. 4. Average response of the dynamic noise suppressor.

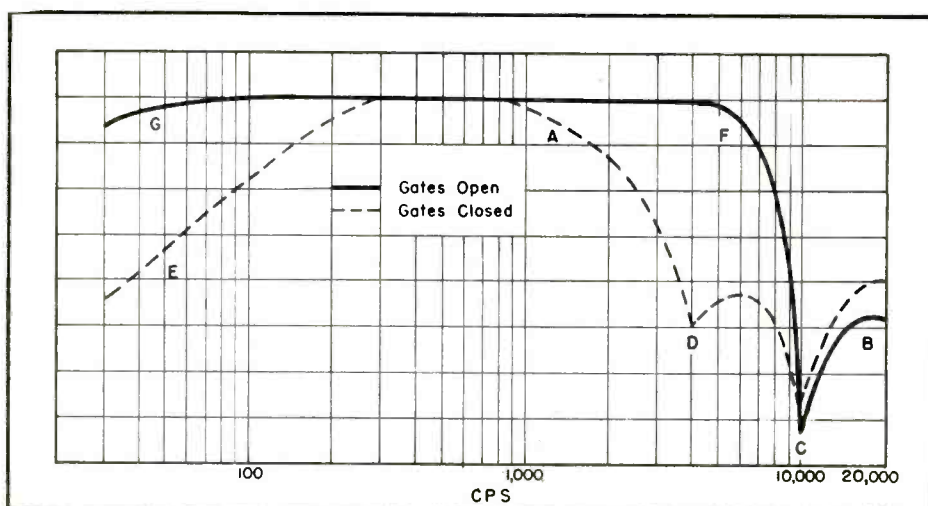

¹Dynamic Noise Suppressors, H. H. Scott; SERVICE; September, 1948.

²Circuit of the H. H. Scott 110-A dynamic noise suppressor.

Noise Suppressor

region increases in level, the response shifts automatically from the curve *A-D* to the curve *F-C*. As the low frequency (100-400 cycles) signal increases in level, the low frequency response shifts from *E* to *G*.

The speed of this action is controlled by the time constants of the bias filter networks: R_{20} , C_{18} , R_{21} , C_{20} , and R_{23} , C_{23} , R_{25} , C_{24} . It is adjusted to give quite rapid action and still filter out any low frequency *thumps* from the control biases. This control speed and the values for R_n and RL were determined on the basis of listening to a very large number and variety of records. It might be noted, at this point, that in order to produce the characteristic shown in Fig. 4, the signal is fed in at the junction of R_1 and R_2 , and C_{11} is shunted with a large electrolytic. These two steps remove the equalization and control action.

This *dynamic noise suppressor* is a three-tube unit (7" x 3 3/4" x 4 3/4") which can be added to any radio-phonograph or phono system. It is connected between the wide-range pickup (supplied with the suppressor) and the regular phono input jack on the receiver. The power for the suppressor is normally obtained with an adaptor plug which fits under the power output tube in the set. The *suppressor* requires 6.3 v at 0.8 ampere and 180 to 250 volts at 4.4 ma.

The input circuit contains specific equalization for the crystal pickup supplied. The output should work into a resistance of over 1/2 megohm and the average output voltage is about one volt.

The nominal frequency range is 30-8,000 cycles, which is quite adequate for most domestic recordings.

Installation

Let us assume that the radio-phonograph

Fig. 1. The H. H. Scott 110-A *dynamic noise suppressor*.



by E. G. DYETT, Jr.

Engineering Department
Herman Hosmer Scott, Inc.

in which the suppressor is to be installed has a 6L6, 6V6, 6K6, 6F6 (glass or metal).

It is fairly reasonable to assume that pin 4, the screen terminal (from which B+ for the *suppressor* is normally obtained), has between 180 and 250 volts d-c available. If the voltage is too low, the series screen resistor in the set may be shunted down to raise the screen voltage somewhat. If the voltage is too high, a resistor may be added in the *suppressor* in series with R_{15} . If the output tube (or tubes) is a pentode with the proper screen voltage but different base connections, the adaptor on the *suppressor* may be rewired. If the output tube is a triode, an adaptor *cannot* be used to supply the *suppressor* with power. In any case where voltages or connections are wrong, the *best* solution is to wire into the set a four-wire cable and an octal socket connector which will supply the following voltages: Pins 2 and 7, 6.3 volts a-c; pin 1, ground (B-); pin 4, B± 200-250 volts. The adaptor on the *suppressor* can then be plugged into this power socket instead of being inserted under an output tube. Any reasonably well filtered d-c supply point can be used. If hum is noticed, an extra electrolytic, either in the set or in the *suppressor*, will usually cure it. The *suppressor* contains a B+ filter (R_{15} and C_{14}) which is adequate for most installations. In a case where the receiver *cannot* supply the proper voltages (or will not safely stand the added current drain) a separate power supply can be constructed, which will furnish the required voltages. In any case you should *never* attempt to obtain B+ for the *suppressor* from the plate of the output tube. Installation of the *suppressor* on any a-c/d-c phonograph should not be attempted without complete special installation data.

Different Pickups

If the record changer arm will not permit the use of the pickup supplied, or if the customer desires to use a dif-

ferent pickup, two adjustments may be necessary. The sealed *Supp. Level* adjustment on the suppressor (R_3) will have to be reset to give the same output level into the set as the factory setting gives with the pickup supplied.

Use of Test Record

The best way to accomplish this is to temporarily use the cartridge supplied (hold on record or insert in some other arm) on a 1,000-cycle note of a test record (Columbia 10,004 or 10,003, etc.) and measure the voltage at the speaker terminals. Then, using the customer's pickup on the same test record, the *Supp. Level* control can be readjusted to give the same voltage at the speaker. The other change which may be desirable is a change in equalization. In general the equalization in the *suppressor* will be satisfactory for most crystal pickups, and if more brilliance is desired, it may even be left in with reluctance pickups. The equalizer in the unit (C_1 , R_1 , C_2) may be shorted out for use with reluctance pickups and their preamplifiers. Incidentally, if a variable reluctance pickup and preamplifier are to be used with the *suppressor* the separate power socket wired into the radio set or amplifier can provide power for the preamplifier as well as the *dynamic noise suppressor*. The preamplifier leads are simply wired to an octal plug using the same connections as for the power socket; this is then inserted in the back of the *suppressor* adaptor (where the tube normally goes). Be careful to find well filtered d-c in the set for this arrangement.

Radio Suppression

The *dynamic noise suppressor* can be inserted in the audio system after the phono-radio switch which would

(Continued on page 43)

Fig. 3. Basic filter circuit of the suppressor.

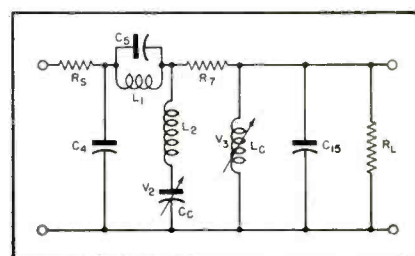

It's here!

The NEW General Electric Variable Reluctance Cartridge for Long Playing Records

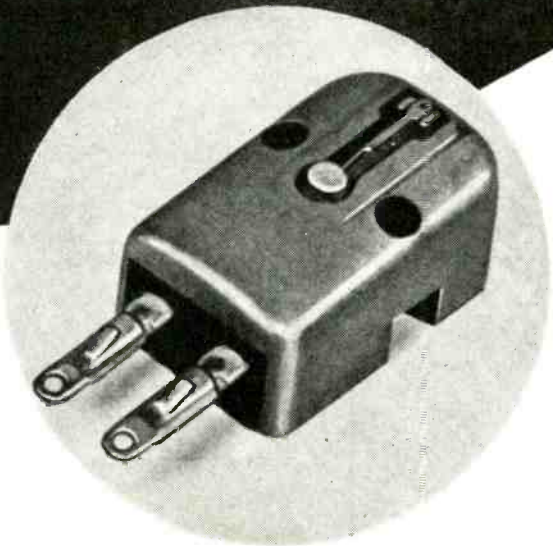

- Specifically designed for the new long playing records...high compliance...low mass stylus assembly
- Equipped with 1 mil tip radius sapphire stylus
- Can be used with standard G-E preamplifiers

Place your order today!

*General Electric Company, Electronics Park,
Syracuse, New York*

You can put your confidence in—

GENERAL  **ELECTRIC**

100-610

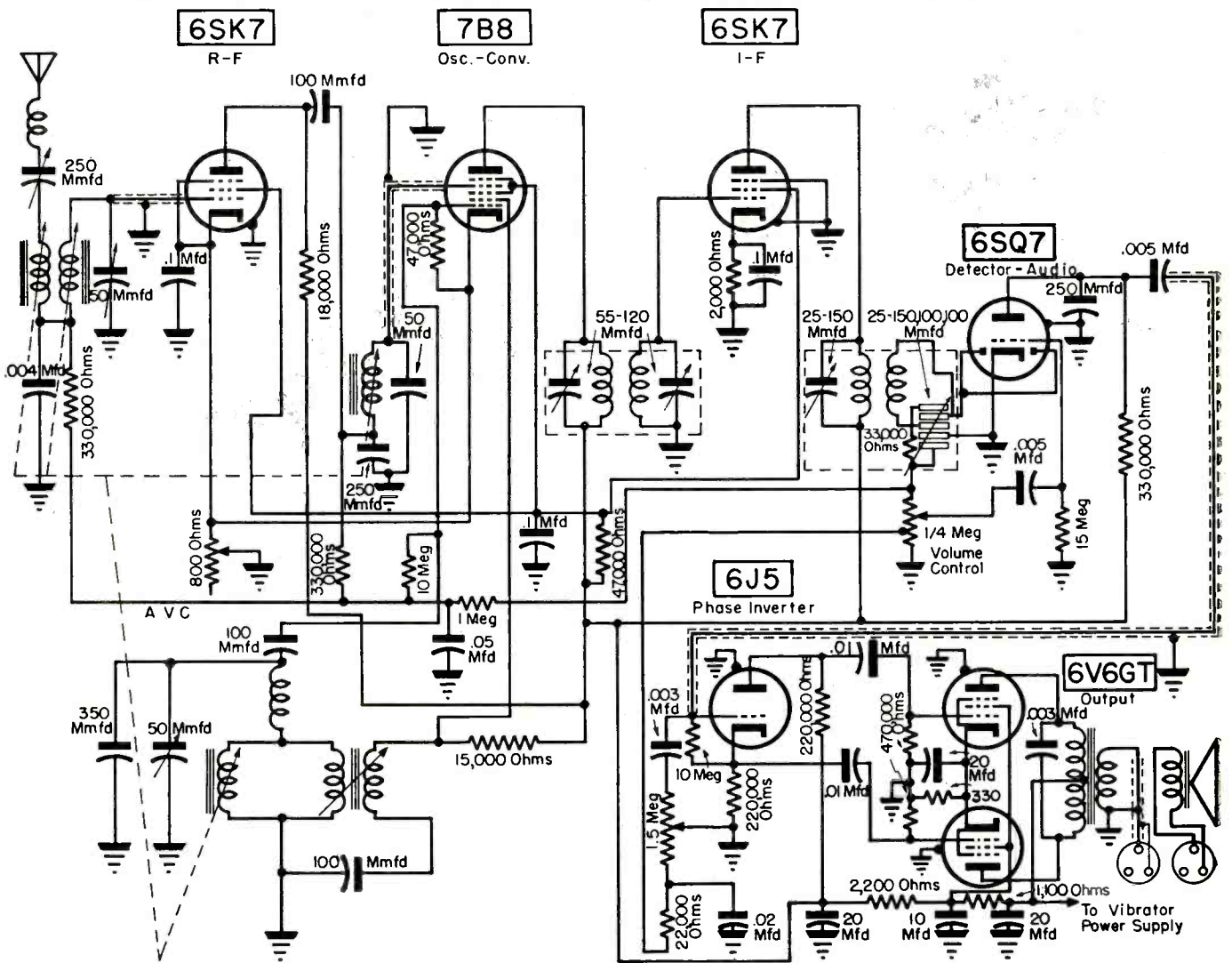

ured at 400 cps with a supply voltage of 117 volts, 60 cps, or 6 volts d-c. The combined noise and hum level is at least 50 db below rated output.

Fig. 3. Block diagram of the Farnsworth GV-260 television receiver.

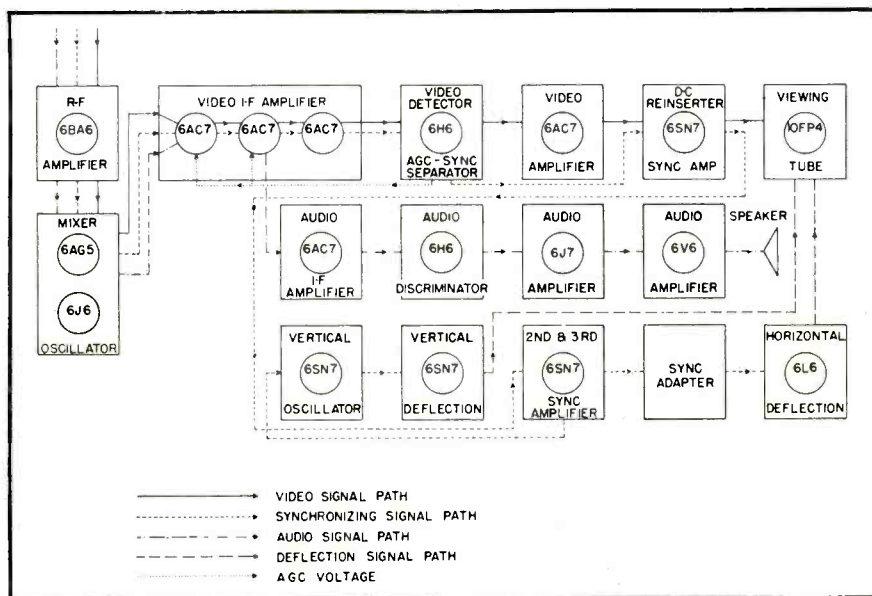

Output impedance taps have been provided at 4, 8, 15, 250 and 500 ohms.

Two parallel-connected octal sockets on the rear of the amplifier base provide connection to various taps of the output transformers.

In table A appears a listing of the amplifier output taps provided to accommodate various speaker loads. The audio voltages present when the amplifier is delivering rated output, are also indicated.

Terminal	Impedance	Output (at 25 watts)
8-1	4 ohms	10 volts
8-2	8 ohms	14 volts
8-3	15 ohms	20 volts
8-6	250 ohms	79 volts
7-2	385 ohms	98 volts
8-7	500 ohms	112 volts

Table A

To determine the power into any speaker, the impedance of the amplifier output tap is divided by the impedance of the speaker to be used (or

Servicing Helps

Surplus C-R-T as Picture Tubes . . . Admiral TV Interference Trap . . . Service Hints on Old Type Superhets . . . Case Histories on Philco, Sonora, Sparton, Wilcox-Gay and Airline Receivers.

Surplus C-R-T as Picture Tubes¹

THERE ARE MANY surplus cathode-ray tubes on the market which can be used as TV picture tubes.

The tubes are not recommended for custom built or conversion type jobs, since their blue color and long persistence characteristics may make prolonged viewing difficult.

However, for installation-test work, circuit and lab study, the tubes offer many interesting possibilities.

There are many varied types available; standard deflection and focusing (electrostatic and magnetic), and there are some tubes that use the former method of focusing and the latter for deflection.

Little difficulty will be experienced in converting a TV set for these tubes, but, because of the high-voltages involved the usual caution must be exercised.

If the socket of the new tube is different than the picture tube in the set it will be found advisable to construct an *extension cable* with a male socket used on the old c-r-t and female one to fit the new c-r-t. The wire used for this cable should be able to withstand high voltages with a reasonable safety factor.

Additional voltage may be obtained in several ways. A voltage doubler may be used as shown in Fig. 1, which will give almost 500 extra volts.

If the high voltage is increased by a considerable amount it will probably be necessary to change the filter and coupling capacitors in the sweep cir-

by P. M. RANDOLPH

cuits to break down voltage ratings above that of the new high voltages.

A very popular surplus c-r-t is the 12GP7, which has a 12" indicating diameter and a P7² screen with a long persistence (blue fluorescence and yellow trace). This tube has a 14-pin socket with three anodes.

Maximum rating for anodes are 6,600, 4,400, and 2,200 volts. In a comparison between this tube and a standard 7" picture tube, 7EP4, we find:

	12GP7	7EP4
Anode 1 (focusing)	857 v.	650 v.

Fig. 1. Conventional (A) and revamped (B) high-voltage TV-power supply which was used to accommodate the type 12GP7 surplus cathode-ray tube, as described in the Barbanel notes.

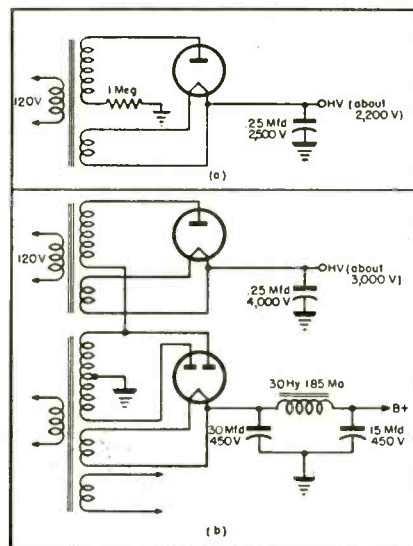

Anode 2 (h-v electrode)	3,000 v.	2,500 v.
Anode 3 (supplementary h-v electrode)	3,000 v.
Grid 1 (control grid)	-98 v.	-60 v.
Heater voltage	6.3 v.	6.3 v.
Heater current6 amp.	.6 amp.

In one changeover, using a home-made set which had a 7EP4, the 12GP7 was installed.

The 2.5-kv high-voltage supply was increased to 3 kv; Fig. 1. A separate high-voltage lead was connected from the h-v supply to anode 3 which is a cap (similar to a grid cap) on the tube, known as E₁₃ or intensifier anode.

It was found that a stronger signal was necessary to produce the same amount of contrast on the 12GP7 as on the 7EP4; the higher voltage provided a brighter picture, but the sweep circuits were unable to furnish sufficient amplitude to give the full 75 square inches of picture, and the picture had a bluish yellow color.

The 12GP7 may be directly substituted for the 7EP4 but greater brightness will result if the intensifier anode is connected to the high voltage.

It was found that the surplus tube produced a picture which was very satisfactory for testing purposes.

Admiral TV Interference Trap

DUE TO THE BROAD BANDWIDTH requirements, TV receivers are inherently susceptible to image and beat frequency interference³. Such interference is fre-

²The type used for television is designated as P4 which indicates white with a medium persistence.

³See Ira Kamen article on TV Interference in October, 1948, issue of SERVICE.

¹From notes submitted by Joseph Barbanel.

quently caused by FM and other radio services using the frequencies in the 109-mc band. To eliminate this interference, the Admiral Corp. service department has announced a 94-113 mc trap, type A1711, for their TV models.*

To install, two short pieces of tinned copper are soldered to the antenna lugs of the r-f tuner unit. The trap mounting position is just above the antenna lugs and so oriented that the 6J6 r-f tube is midway between the two coils in the trap. The trap is bolted to the chassis using the rear tuner mounting bolt. The front leg of the trap assembly is soldered to the chassis using a heavy soldering iron, and the two tinned leads, previously connected to the tuner terminal lugs, are soldered to the trap terminals.

If the sound or video interference is of unknown origin and frequency, the two slug adjustments on the trap must be alternately adjusted in small steps starting at the fully counter-clockwise setting of the slug adjust screws. This process is continued until the interference is completely eliminated or reduced as much as possible. If no change in the interference condition can be effected, the interference frequency must be outside of the trap tuning range. It cannot then be eliminated by the use of this trap.

The foregoing process can be used in an attempt to eliminate audio or video interference without test equipment. The following procedure may be used when the interfering signal can be identified and its frequency determined:

- (1) A signal generator (Measurements model 80) is set to the frequency of the interfering signal.
- (2) The generator is connected to the antenna terminals using a 150-ohm series resistor in each lead.
- (3) Tuning of the trap is adjusted so that it eliminates the interference caused by the generator signal.
- (4) The signal generator is disconnected from the television receiver antenna terminals.
- (5) Antenna is connected to the receiver.
- (6) A fine adjustment of the trap is made for maximum rejection of the interference signal. Little adjustment should now be necessary since the trap has been pre-set using the signal generator signal.

The good little lamp that's seen but not heard

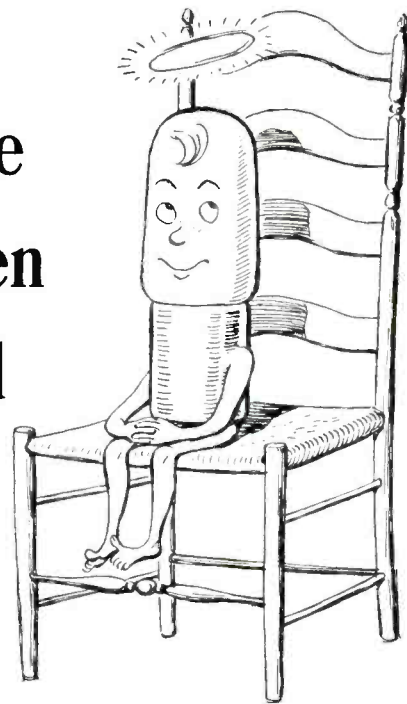

INTERFERENCE with radio reception is not part of the job of a properly designed radio dial lamp. Yet some lamps *do* interfere, when vibration and poor contact between the filament and lead-in wires cause tiny arcs and minute changes in resistance.

That can't happen in G-E radio dial lamps because the tungsten fila-

ment legs are pressed firmly right into the softer metal of the lead-in wires—a vibration-proof joint.

Features like this assure customer satisfaction. For information on prices and types of G-E miniature lamps, see your nearby G-E Lamp Office. Or write to General Electric Company, Div. 166S-11, Nela Park, Cleveland 12, Ohio.

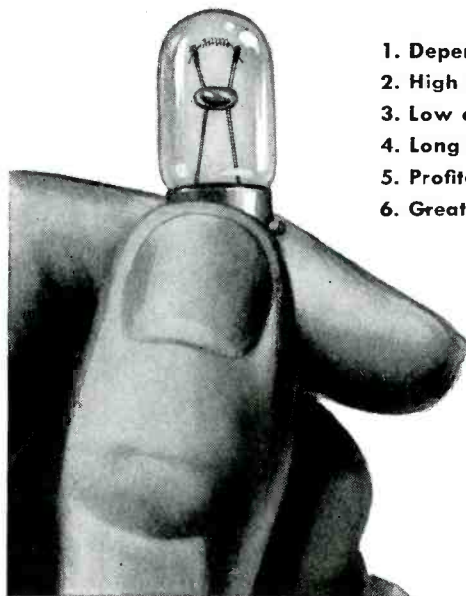

1. Dependable, trouble-free performance.
2. High level of maintained light output.
3. Low current consumption.
4. Long life.
5. Profitable to handle.
6. Greater dealer acceptance.



G-E LAMPS

GENERAL ELECTRIC

*Ser-cuits; October, 1948.

(Continued on page 46)

TV Sync And Inter-Sync Systems

Part III . . . Comparison of Sync Separator and D-C Restorer Operation. Differentiation and Integration Circuits In TV and How They Operate In Inter-Sync Separator Systems.

IN OUR ANALYSIS of diode separators, we indicated that it would be possible to operate a diode separator with external bias alone by making certain that the bias applied would not permit the diode to conduct until the amplitude of the blanking level was overcome. This means that a certain level signal would have to be applied at all times. Now, the advantage of the signal bias separator is that it is self-compensating over a limited range to changes in amplitude of the incoming signal. In this respect, it is again similar to a d-c restorer because the actual bias placed on capacitor *C* is again dependent on the peak amplitude of the sync tip and when the signal level decreases both the sync tip and the blanking level of the signal decrease in amplitude. If our signal has decreased in amplitude it means that the externally biased diode would not conduct until the signal amplitude is in excess of the blanking level and consequently a portion of our sync amplitude would be removed. However, with signal bias the decrease in initial amplitude of the sync tip causes less of a charge to appear on the capacitor *C*, consequently, less amplitude is neces-

by **EDWARD M. NOLL***

*Instructor in Television
Temple University*

sary to reach the conducting level of the diode. Once again, conduction of the diode will occur at the blanking level and the entire sync pulse will appear in the output.

A typical triode d-c restorer was shown last month in *B* of Fig. 5. This separator draws grid current during the peak of the sync tip and this current, passing through the grid resistance, charges capacitor *C* to a level which only permits conduction of the tube when the applied signal is higher in amplitude than the blanking level. Inasmuch as the tube only conducts on signal amplitudes greater than the blanking level only the composite sync signal will appear in the plate circuit. The remainder of the signal is removed by cut-off. Again it is the time constant of *R* and *C* which holds this bias level constant at the grid of the sync separator. Charge is established each line interval by the sync tip. If there is a change in signal level there is also a change in the peak grid current drawn and a change in the bias level. This change in bias level compensates for any change in signal amplitude and once more conduction level will appear at the blanking level of the signal for a wide range of signal amplitudes.

Again a better understanding of sync separator and d-c restorer operation can be obtained by comparing the two actions as presented in Fig. 1. In *A* we observe the grid draws sufficient current to set the average bias of the stage beyond cut-off, the proper amount to have cut-off bias level appears at the blanking level of the signal. When the signal amplitude is less the grid current drawn and the bias are corre-

spondingly lower and again the blanking level appears at cut-off. In the grid type d-c restorer, *B*, the average bias grid is at some point on the linear transfer of the tube. This places the picture content of the composite signal on the linear portion of the tube's characteristic and keeps the blanking level essentially constant near the zero bias level of the tube. With a change in signal level, peak grid current changes and the tube's bias changes the correct amount to set the blanking level at a point near zero bias again. Thus the major difference between sync separation and d-c restoration is the point at which the bias is set—in one case beyond cut-off and in the second case on the linear portion of the tube's characteristics. A number of factors decide what this bias level will be—signal amplitude, grid current characteristics of the tube, time constant, cut-off bias for the tube, and plate voltage on the tube. If a tube is to be used as a separator, it is necessary to have cut-off occur early and, consequently, the sync separator as compared to the d-c restorer operates with a lower plate voltage which means cut-off will occur at a lower bias and, in addition to that, substantial grid current flow is more readily obtained.

A signal-biased pentode, cathode grounded and low value screen and plate voltages, can also be used as a

Fig. 1. Triode sync separator and grid type restorer.

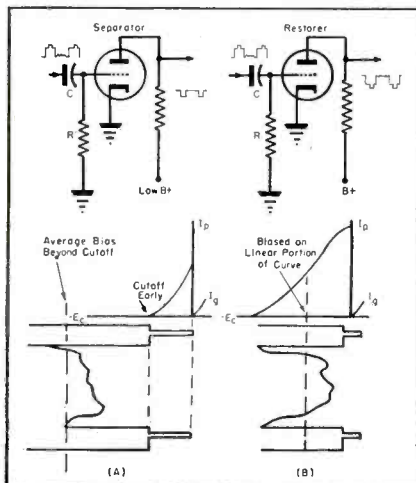
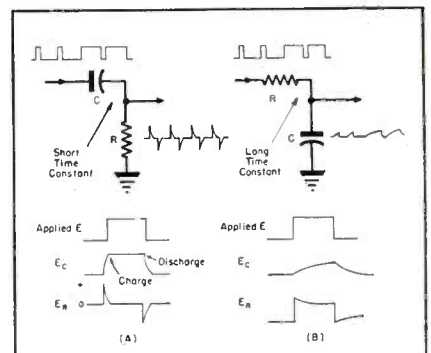

Fig. 2. Differentiating and integrating circuits.



*From a forthcoming book, *Television for Radiomen*, to be published by Macmillan.

sync separator. Again it is the grid current drawn during the sync tip which sets the bias of the tube at the proper level to have all portions of the signal below the blanking level beyond cut-off. An advantage of the pentode-type separator is that good clipping will occur over an appreciable signal amplitude range and the output of the pentode separator will be essentially constant in amplitude over this range of signal amplitudes. Actually, the sync pulses which appear in the plate circuit are a result of a grid voltage variation between cut-off and a positive grid voltage at which grid limiting occurs. Thus, if the plate voltage is held constant as it is with a bleeder network from *B* (*C* of Fig. 5; October installment), the sync signal amplitude in the plate circuit will be constant in spite of the variation in peak signal amplitude at the grid of the separator. Thus with appreciable change in signal amplitudes by fading or switching from one channel to another the amplitude of the sync at the output of the separator will remain essentially constant.

Composite signal for application to the sync separator can be taken off the video section of the receiver at a number of points. In the older receivers it was customary to take the portion of the composite signal to be applied to the sync separator off the video detector. The composite signal can also be taken off one of the video amplifiers or, as is most often done in the modern receiver, from the coupling circuit between the video output tube and the picture tube grid. At this point the composite signal is high in amplitude and much of the noise greater in amplitude than when the sync tip has been clipped off, improving the sync-to-noise ratio of the receiver. If the applied signal to the video amplifier is too great in amplitude, the sync pulse itself is severely limited and consequently sync stability is affected. However, if a signal of this amplitude is permitted to reach the grid of the picture tube the contrast range is destroyed and there is no particular significance to the loss of sync stability. If the contrast is properly adjusted a composite signal with the proper sync level is applied to the sync separator circuit.

Differentiation and Integration

The output of the sync separator, composite sync signal consisting of horizontal, equalizing and vertical sync pulses is diverted into two paths. One channel makes use of the leading edges of the pulses to synchronize the hori-

(Continued on page 47)

Everybody agrees
ATR AUTO RADIO VIBRATORS
are TOPS

ATR
AUTO RADIO VIBRATORS
have Ceramic Stack Spacers



A Complete Line of Vibrators . . .

Designed for Use in Standard Vibrator-Operated Auto Radio Receivers. Built with Precision Construction, featuring Ceramic Stack Spacers for Longer Lasting Life.

Backed by more than 17 years of experience in Vibrator Design, Development, and Manufacturing--

ATR PIONEERED IN THE VIBRATOR FIELD.

New 36 page
**VIBRATOR
 GUIDE
 FREE**

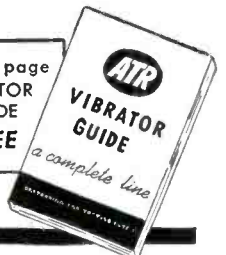

New Models



"A" BATTERY ELIMINATORS

For DEMONSTRATING AND TESTING AUTO RADIOS

New Models . . . Designed for Testing D. C. Electrical Apparatus on Regular A. C. Lines. Equipped with Full-Wave Dry Disc Type Rectifier, Assuring Noiseless, Interference-Free Operation and Extreme Long Life and Reliability.

New Models



STANDARD AND HEAVY DUTY INVERTERS

For Inverting D. C. to A. C. . . .

Specially Designed for operating A. C. Radios, Television Sets, Amplifiers, Address Systems, and Radio Test Equipment from D. C. Voltages in Vehicles, Ships, Trains, Planes and in D.C. Districts.

✓ NEW MODELS
 ✓ NEW DESIGNS
 ✓ NEW LITERATURE
*See your jobber
 or write factory*

AMERICAN TELEVISION & RADIO Co.
Quality Products Since 1931
 SAINT PAUL 1, MINNESOTA-U. S. A.

TUBE News

Analysis of Operation of Pulse-Operated TV Power Supply, Which Provides Both Horizontal-Deflection Power And High Voltage Required To Operate 10BP4 Picture Tube At Anode Potential of 9 KV.

by L. E. STEWART

PICTURE TUBES in tv circuits require high-voltage d-c power supplies that range in voltage from as low as 2 kv for directly viewed tubes to 30 kv and higher for projection tubes. The current requirements for these services are low, average values ranging from 100 to 200 microamperes.

In a tv circuit employing a magnetic deflection system, a high d-c voltage can be obtained by rectifying the high-voltage pulses that appear across the primary winding of the

horizontal-deflection output transformer, using the circuit shown in Fig. 1. This circuit supplies both horizontal-deflection power and the high voltage necessary to operate a 10BP4 at an anode voltage of 9 kv.

Design Considerations

In a 10BP4 horizontal-deflection circuit that is not also designed for

use with a pulse-operated power supply, voltage pulses of nearly 6 kv appear across the primary winding of the deflection transformer when the circuit is adjusted correctly. If these pulses are applied to a diode and rectified, a d-c output of approximately 5900 volts can be obtained from the anode. This voltage, however, is not of sufficient magnitude to operate the 10BP4 with good definition and brilliance. In order to increase the voltage available at the transformer primary, extra turns are added to the primary winding, as shown in Fig. 1, so that the primary of the transformer functions as an auto-transformer with a turns ratio of approximately 1.6:1. To avoid an appreciable reduction in the Q of the circuit, the distributed capacitance of the additional turns are kept low. Because of the additional primary turns, the high-voltage pulses are stepped up to approximately 9 kv. This voltage is rectified and applied to the anode of the 10BP4.

To utilize the negative excursion of the voltage pulse on the secondary side of the transformer and to obtain an additional few hundred volts, the return lead of the rectifier may be connected to the secondary. Although a negative pulse of approximately 1.5 kv appears across the transformer secondary, the d-c output is increased only by approximately 400 volts because of phase shift introduced by the leakage-reactance of the transformer.

The voltage across the primary

Fig. 1. Horizontal deflection circuit and pulse-operated high-voltage supply for the 10BP4 picture tube. L1 is a width control; L2, horizontal linearity control, Y deflection yoke; and R11, horizontal centering control.

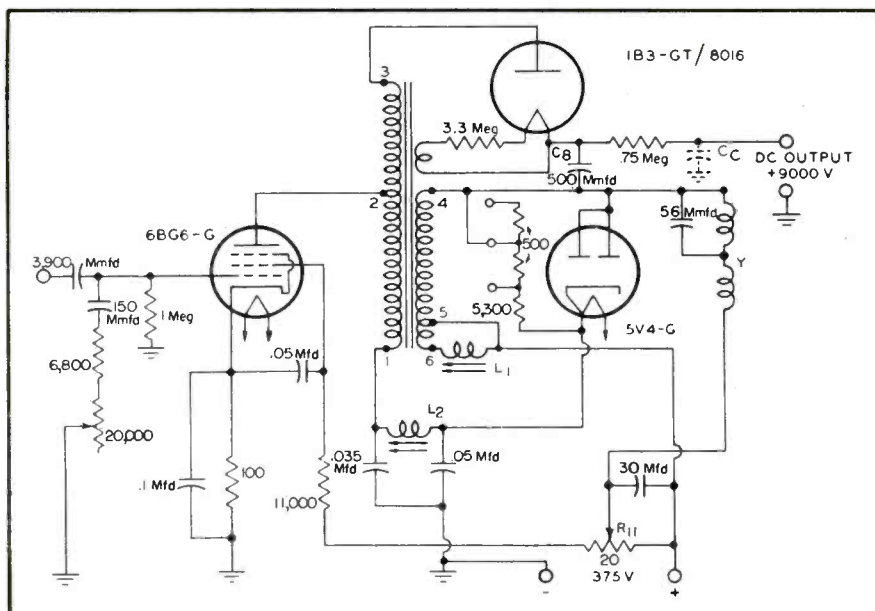

winding of the transformer has a negative oscillation of approximately 3,000 volts immediately following the positive 9000-volt pulse. This negative oscillation produces a pulse of negative voltage of approximately 1900 volts on the plate of the 6BG6G. This negative voltage will cause the 6BG6G to produce Barkhausen oscillations which may be radiated, thereby affecting the r-f section of the receiver. The oscillations will be carried through the circuit to modulate the picture-tube grid and will appear as vertical bars at the left edge of the picture. The effects of Barkhausen oscillations, however, will not be observed when the scanning circuit alone is tested. The effect is found only when the complete receiver is in operation and tuned to the higher-frequency channels, and when high intermediate-frequency gain is employed. In extreme cases, additional shielding of the horizontal-deflection circuit might help.

The filter circuit of the high-voltage supply consists of a 500-mmfd capacitor, a 750,000-ohm resistor, and a capacitor obtained by grounding the outer conductive coating of the 10BP4. The 750,000-ohm resistor not only acts as a filter element but also minimizes the possibility of severe electrical shock. A person coming in contact with the high voltage would not receive a serious shock from this voltage alone, because his body resistance would be low enough to virtually short-circuit the supply and, thus, reduce the high voltage to a safe value. Although the 375-volt *B* supply is connected directly to the 1B3GT/8016, it is not a source of high-voltage danger because its current is also limited by the 750,000-ohm filter resistor.

Since the filament of the 1B3GT/8016 is approximately 9 kv above ground, a filament-power supply insulated for this high voltage is required. And since the filament power required is only .25 watt, it may be obtained from the horizontal-deflection transformer without excessive loading of the scanning circuit. The filament winding consists of two turns of wire adequately insulated. A series resistor of 3.3 ohms is included to provide the proper value of filament current. Different circuits may require other values for this resistor to give the correct filament current.

The power supplied to the picture tube at 9 kv and 200 microamperes, the filament power of the 1B3GT/8016, and the dissipation of the 3.3-

(Continued on page 55)

NEW SHURE "900MG"

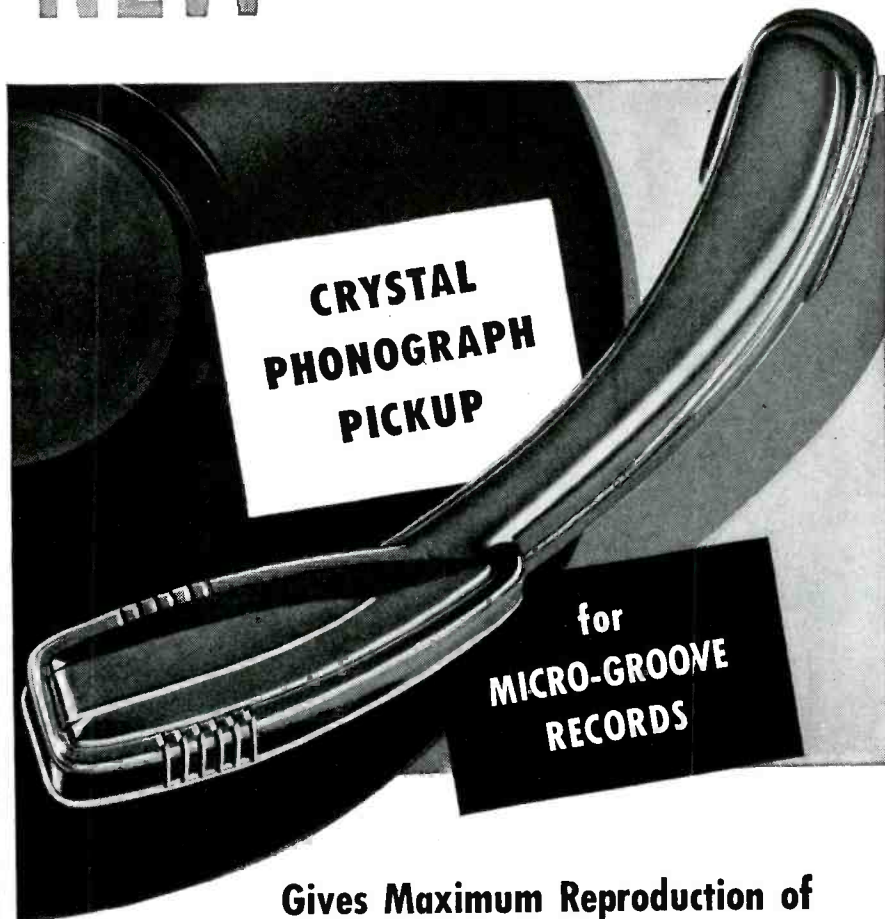

Gives Maximum Reproduction of Micro-Groove Record Fidelity

The Shure "900MG" Pickup is an ideal instrument for tracking on the new micro-groove records. It tracks at 6 grams . . . uses a special offset osmium-tipped needle with a point radius of only .001" . . . and has an output of 1 volt! The Shure lever system has been adapted in the development of this new pickup—providing a high needle compliance. Listen to it—you will be thrilled with the results!

Model "900MG"

Code: RUZUZ

Shure Patents Issued and Pending. Licensed under the Patents of the Brush Development Co.

SHURE

SHURE BROTHERS, Inc.

Microphones and Acoustic Devices

225 W. HURON ST., CHICAGO 10, ILL. • CABLE ADDRESS: SHUREMICRO

SERVICE, NOVEMBER, 1948 • 37

Left: Arthur Silverberg, secretary AR-TSNY and Max Liebowitz, the N. Y. association prexy, presenting ye editor with an honorary membership card in the AR-TSNY during the recent Town Meeting in N. Y. Right: At a monthly meeting of the Federation of Radio Servicemens Association of Pennsylvania, during which John F. Rider (extreme left) discussed his television lecture tour. Those at the meeting included John G. Rader (secretary-treasurer); A. R. Guild (secretary of FRSAF); Dave Krantz (Chairman of the State Federation); T. L. Clarkson of the Mid-State Radio Serviceman's Association; Larry Oebbecke, PRSMA president; Mark L. Hontz, PRSMA; Frederick J. Schmidt and Vance V. Beachley of the Harrisburg group; Ernest L. Courtemanche of the Scranton association; M. Ruggere and J. A. Renville, of Luzerne; Milan J. Knipa of Kingston; Stanley Winiarski, Jerry Kaufman and Dick Devaney of PRSMA and Max Leibowitz of AR-TSNY.



ASSOCIATIONS



PRSMA, Philadelphia, Pa.

LEONARD GROSS, manager of parts and service for Philco Distributors, Inc., Philadelphia branch, acted as master of ceremonies during a recent PRSMA meeting, which featured a presentation of Philco's offer to give TV service training to members of the association.¹

Speaker of the evening was Henry T. Paiste, Jr., special television sales representative for Philco, who was previously general manager of the Philco service division. He pointed out that Philco had not only learned to depend on the independent Service Man as far back as the days of the battery operated receivers, but that it could depend on the Service Man as long as the Service Man was supplied

with the necessary knowledge. He said that the fair treatment of the customer and good workmanship were the things which the Service Man contributed because of his good business sense and pride in his work.

Continuing, Paiste pointed out that Philco feels that the Service Man can become qualified to service television receivers if they are trained properly. To highlight this part of his talk, Paiste, with the help of service members of Philco Distributors, Inc., presented a skit which dramatized the difference in service rendered by an untrained and a trained man.

The skit related the plight of an untrained technician who was called in to service a TV receiver; In the

¹Details of the Philco plan appear in the news section of this issue; page 50.

first scene appeared the untrained fellow vainly trying to locate the trouble by the old hunt-and-peck system, and thrown out by the unhappy television set owner who has finally decided to try to save his receiver from total destruction. The untrained Service Man was then told of the Philco plan and how he could really service TV sets. The second scene showed our hero at a Philco school, securing a thorough servicing training.

Larry Oebbecke, PRSMA president, presided at this interesting meeting.

AR-TSNY, New York City

AT THE OCTOBER meeting of the Associated Radio-Television Servicemen of New York, the first of a series of lectures on TV was presented by John F. Rider, who covered antennas during an extremely informative two-hour talk.

Rider offered a lucid analysis of the basic points with which Service Men should be familiar to understand television antennas, pointing out how the principles of circuits, applied in stand-

(Continued on page 40)

At the recent PRSMA Philco meeting. At left: James M. Skinner, Jr., vice-president of the Parts and Service Division of Philco, and at right, a view of a comedy-playlet offered by Philco during the TV training talks.

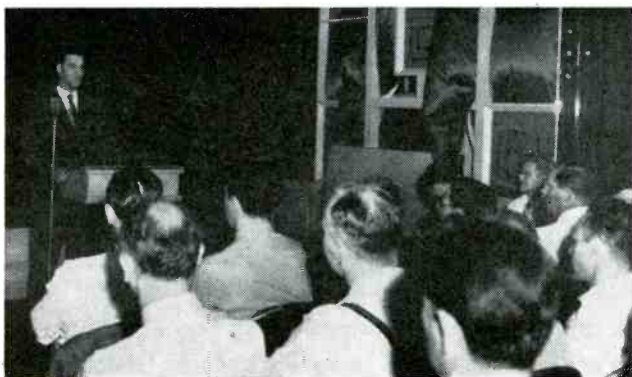

TEN YEARS AGO

From the Association News Page of **SERVICE**, November 1938

TWO MORE Service Men associations had become affiliated with RSA: Lehigh Valley Radio Service Association of Allentown, Pa., with T. W. Reichard, president; J. A. Muthart, treasurer; H. H. Fillman, secretary, and the Hartford Institute of Radio Technicians with Gerald Miller, chairman; James H. Smith, Jr., secretary, and Kenneth G. Anderson, treasurer. . . . The Washington, D. C., Chapter was established under the direction of J. B. Austin, Jr., chairman; Pat Hendrican, secretary, and Bill Carrick, treasurer. . . . The Buffalo Chapter of RSA had planned its annual November banquet. . . . The Danville Chapter received its RSA Chapter from Joe Marty, Jr., executive secretary. . . . An extended publicity and advertising program had been launched by the Decatur Chapter to acquaint the general public with the type of work being rendered by RSA members. . . . Bruce Burlingame spoke on the *Use of Meters in Service Work* at a meeting of the Metropolitan New York Chapter. At a subsequent meeting, J. J. Drummond of National Union conducted a forum on new tubes and their applications. John F. Rider was scheduled to give a talk before the New York group in December on the Chanalyst. . . . Harry Miller directed a membership drive for the Newark, N. J., Chapter. . . . The Peoria Chapter, in conjunction with the Klaus Radio Company, sponsored a talk by RCA Victor engineers on the RCA line. . . . Russ Lund of Clough-Brengle delivered a talk on dynamic testing before the Quincy Chapter. . . . The Staten Island Chapter held its annual picnic and were hosts to 177 persons.

John F. Rider and W. L. Parkinson of General Electric at the recent Town Meeting of Radio Technicians in New York City.



THE NEW DU MONT TYPE 274-A OSCILLOGRAPH IS EVEN BETTER FOR

**RADIO and
TELEVISION
Servicing**



**TWICE THE BAND WIDTH!
THREE TIMES THE
SENSITIVITY!**

★ With several notable improvements over its predecessor, the Du Mont Type 274, this new Du Mont Type 274-A is an even finer instrument for the job of radio and television servicing.

An improved vertical deflection amplifier offers a sensitivity of better than 0.2 rms volt/in., and a range (within 30%) of 20 cps to 100 kc in frequency response.

As a result, in your servicing of both radio and television receivers, you can now look at *more parts of more*

circuits with still greater accuracy and therefore better results.

For example, you can see *lower level* signals and you can handle *more parts* of the detector and i-f circuits. You can now minimize "hum" troubles more easily, and you can do a better job on syno circuits as well as on other circuits of television receivers.

In fact, with the new Type 274-A, you can't miss doing an all-around, bang-up, more satisfactory and therefore more profitable job. And remember, the new Type 274-A still has the big, 5-inch tube!

Cat. No. 1420-A with 5BP1-A \$136.50

Cat. No. 1422-A with 5BP11-A \$139.25

DU MONT *for Oscillography*
ALLEN B. DU MONT LABORATORIES, INC., PASSAIC, N. J.
CABLE ADDRESS: ALBEEDU, NEW YORK, N. Y., U. S. A.

CHECK!

A REAL CHOICE OF WIRE-WOUND CONTROLS...

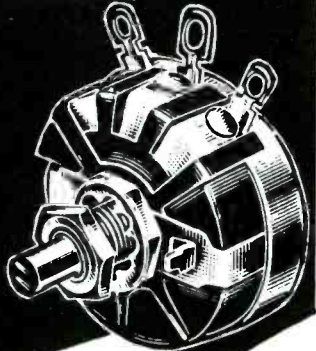

LARGE OR SMALL

In standard large Series 58 (1.21/32" dia.) and midjet Series 43 (1 1/8" dia.) Resistance values from 1 to 100,000 ohms.

POSITIVE CONTACT

Assured by careful electrical and mechanical design. Special alloy contact with wire winding. Low resistance path.

LONGEST WEARING

Minimum frictional drag and longer life because of special lubricant. Velvety rotation. Exceptionally low noise level throughout service life.

CLAROSTAT



Ask your Clarostat jobber for latest catalog. Or write us.

Controls and Resistors

CLAROSTAT MFG. CO., Inc., Dover, N. H.

* In Canada: CANADIAN MARCONI CO., Ltd
Montreal, P.Q., and branches

Officers of the recently formed Empire State Federation of Electronic Technicians. In front row (left to right): Wayne Shaw, secretary, and Max Liebowitz (president of ARTSNY), vice president. In the rear row (left to right): T. Laurence Raymo (president of RTG, Rochester, N. Y.), president, and Ben De Young, treasurer.



Association News

(Continued from page 38)

ard receivers, can be used to interpret the operation of television systems.

Max Liebowitz, association president, announced that he would appear at the special Binghamton meeting of the Empire State Federation of Radio Technician's Association, which was formed at a recent meeting at Rochester. Two delegates were named to accompany Liebowitz to the upstate meeting.*

RTG, Rochester, New York

Ed Fisk has sent us a bulletin commenting on the Empire State Federation. The bulletin discloses that the tentative plans for this new association will be organized by a group of delegates who have been elected or appointed representatives of the local groups in New York State. It is expected that the first concrete steps in forming the association will be the preparation of a constitution and a code of ethics.

Fisk also sent along a photograph of the elected officers which appears on this page.

RTG, Springfield, Mass.

LEWIS A. SHARRARD, corresponding secretary for the Radio Technicians Guild, Springfield, Massachusetts, has forwarded a report on the recent activities of RTG.

The group, which was re-formed in March, has officially become affiliated with the Massachusetts RTG under a state charter.

Television has been an important item in the association activities, serving as a basis of a series of lectures.

According to Sharrard, prompt action by F. M. Keefe, association

Al Saunders of Saunders Radio and Electronics School; Claude Maria, president of the Radio Service Dealers Association of Indianapolis, Indiana and Howard W. Sams of Howard W. Sams and Company, Inc., during a recent service meeting at which Saunders presented one of his lectures on television.



president, in collaboration with the Rochester RTG, was instrumental in preventing passage of a bill in the Massachusetts State Legislature which would have required licensed electricians to handle all television installations in Massachusetts.

FRSAP, Pennsylvania

THE OCTOBER MEETING of the Federation of Radio Servicemen's Association of Pennsylvania, which was held in Philadelphia, was highlighted by a statement declaring that the Federation is duly opposed to the formation of any national organization (which had been proposed at a recent meeting in Rochester) of Service Men without due consideration of all existing local and state groups. The Federation also went on record to say that it opposes any national organization which solicits individual membership.

John F. Rider, who was present at the meeting also indicated that he was opposed to the formation of a national group at this time, emphasizing that state federations should be formed first. Rider also discussed his forthcoming TV lecture tour and the first

(Continued on page 41)



* A full report on this meeting will appear next month on the Association News page.

talks to be presented before the six chapters of the State Federation covering TV antennas, 'scopes and sweep generators. It is expected that these talks will also be presented at other service association meetings throughout the country.

MSRSA, Harrisburg, Pennsylvania

A BULLETIN from the Mid-State Radio Serviceman's Association reveals that an election was held recently and T. L. Clarkson has been named chairman; Jay T. Sweeney, vice chairman; Paul W. Smith, secretary; and L. B. Smith, treasurer.

TV Installation

(Continued from page 19)

focus coil and the fact that there are sometimes several positions of the control which appear to give focus. The best one is the one requiring the least current through the coil or the lowest potential in electrostatic focusing.

The linearity of the picture can be adjusted by varying the proper controls and readjusting the vertical and horizontal size controls after each adjustment. It often appears that linearity at one station gives slight non-linearity at another, which is really due to a non-linearity in the sweep of one of the two stations. Usually these differences will be very slight and while they are apparent when a test pattern is transmitted, they do not become noticeable during a regular picture broadcast. Readjusting for proper horizontal and vertical synchronization by setting the respective hold controls may be necessary when the size controls are varied. All centering, focus, linearity, and size controls are considered secondary or non-operating controls, and are located either in the rear of the chassis or hidden under a panel. These controls are meant for use by the Service Man only and should not require adjustment by the customer.

Picture Quality

It frequently happens that, although the set is supposedly aligned properly, sound and picture are not correctly separated. While this is less frequent in receivers using the inter-carrier method for sound and picture, it is embarrassing when the customer complains about it after the installation has been completed. Therefore, each station in the area should be checked for sound and picture, making sure that no sound interference appears in

(Continued on page 42)

TRANSVISION



NEW Television Kits and Equipment

Important Advances in TV Reception and Servicing!

NEW 10" TV KIT at amazingly LOW PRICE!

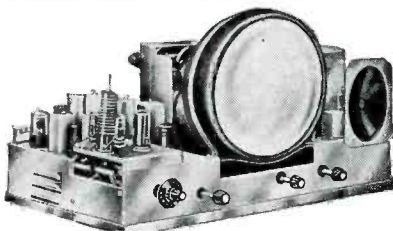

MODEL 10A TV KIT

The new Transvision Model 10A electromagnetic TV Kit gives a bright, stable 52 sq. in. picture. Has 10" picture tube, and CONTINUOUS TUNING on all 12 channels. Its high sensitivity makes for improved long distance reception; especially good on high channels. Complete with all-channel double-folded dipole antenna and 80 ft. of lead-in wire.
MODEL 10A TV KIT, less cabinet Net \$199.00
MODEL 12A TV KIT, same as above, but has a 12" picture tube..... Net \$263.00

NEW STREAMLINED CABINETS

for Transvision Model 10A or 12A TV Kit. Made of select grain walnut with beautiful rubbed finish. Fully drilled, ready for installation of assembled receiver.
Walnut Cabinet for 10A or 12A (Specify) ... Net \$44.95
Mahogany and blonde slightly higher.

TRANSVISION ALL-CHANNEL TELEVISION BOOSTER

To assure television reception in weak signal areas, or areas which are out of range of certain broadcast stations, Transvision engineers have designed this new booster. It increases signal strength on all television channels. Tunes all television channels continuously. Can be used with any type of television receiver. Unusually high gain in upper television channels.
Model B-1 LIST \$44.95

TRANSVISION REMOTE CONTROL UNIT KIT

Will operate any TV receiver from a distance. Turns set on, tunes in stations, controls contrast and brightness, turns set off. Ideal for installations where the television receiver is inaccessible. Tuner unit is a high gain, all-channel unit with about 50 micro-volt sensitivity. Easy to assemble in about an hour.
Model TRCU, with 25 feet of cable..... Net \$69.00
Without cabinet Net \$65.00

NEW TRANSVISION SWEEP SIGNAL GENERATOR FOR TELEVISION AND F.M.

Complete frequency coverage from 0-227 MC with no band switching. Sweep width from 0-12 MC completely variable. Accurately calibrated built-in marker generator.

OUTSTANDING FEATURES: (1) Frequency range from 0-227 MC. (2) Dial calibrated in frequency. (3) Sweep width from 0-12 MC completely variable. (4) Self-contained markers readable directly on the dial to .5% or better. (No external generator required to provide the marker signals.) (5) Crystal controlled output makes possible any crystal controlled frequency from 5-230 MC. (6) Plenty of voltage output—permits stage-by-stage alignment. (7) Output impedance 5-125 ohms. (8) Directly calibrated markers 20-30 MC for trap, sound and video IF alignment. (9) RF for alignment of traps for IF channels when a DC volt meter is used as the indicating medium. (10) Unmodulated RF signal to provide marker pips simultaneously with the main variable oscillator. (11) Markers can be controlled as to output strength in the pip oscillator. (12) Power supply completely shielded and filtered to prevent leakage. (13) All active tubes are the new modern miniature type. (14) Phasing control incorporated in the generator.
MODEL NO. SG..... Net \$99.50

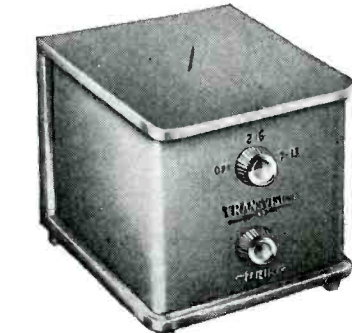

ALL-CHANNEL BOOSTER



REMOTE CONTROL UNIT KIT

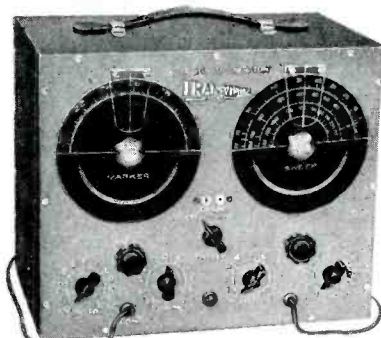

SWEEP SIGNAL GENERATOR

RADIOMEN . . . You Can GET INTO The TELEVISION BUSINESS
In a BIG WAY with the
TRANSVISION DEALER PLAN
WRITE FOR FOLDER D-1

NEW 8-PAGE CATALOG showing complete Transvision line now available at your distributor, or write to:

TRANSVISION, Inc. Dept. S New Rochelle, N. Y.

In Calif.: Transvision of California, 8572 Santa Monica Blvd., Hollywood 46

All prices 5% higher west of Mississippi; all prices fair traded. All prices subject to change without notice.

CAPACITORS and RESISTORS

JIFFY CHECKED

with the

AEROVOX MODEL 76 BRIDGE



DEALER'S NET
\$44.75

• A twist of the knob . . . the positive wink of the indicator eye . . . a glance at the big, easy-to-read dial through the precision pointer . . . another glance at the multiplier switch—and you've got your capacitance or resistance reading. Power factor and leakage readings also available with equal simplicity. Checks for shorts and opens. It's all done in a jiffy—yet with real accuracy. That's what you get in the Aerovox Model 76 Capacitance-Resistance Bridge just emerged from the Aerovox Engineering Laboratory in response to the demand for a simple, accurate, moderate-priced instrument for use in service shop, laboratory, or out in the field. You just can't afford to get along without it in this fast-moving postwar era!

• • • • •
Ask your Aerovox distributor or write us for the "Jiffy Checking" descriptive bulletin. Have your distributor show you this instrument and try it for yourself. You'll want to take one with you!



**FOR RADIO-ELECTRONIC AND
INDUSTRIAL APPLICATIONS**

AEROVOX CORP., NEW BEDFORD, MASS., U.S.A.
Export: 13 E. 40th St., New York 16, N.Y. • Cable: 'ARLAB'
In Canada: AEROVOX CANADA LTD., Hamilton, Ont.

(Continued from page 41)

the picture and no picture signal components can be heard. The only cure is realignment unless the fine tuning control can be adjusted to eliminate this defect. To obtain the best picture possible, brightness and contrast should be adjusted repeatedly for each station. The fine tuning should be adjusted for each station to make sure that the oscillator adjustment is correct. It should be possible to tune through the entire channel with the fine tuning control, obtaining sound without picture, both, and picture without sound. After all these adjustments have been checked and you are certain the receiver is operating properly on all stations, the TV set owner can be called in for a final demonstration.

Instructing the Owner

First, all stations should be tuned in to show that the receiver is functioning perfectly. Next, any shortcomings should be explained, such as ghosts, non-linearity at certain stations, etc. These factors must be analyzed in simple terms, making certain that they are well understood. In the next step the operation of all front panel controls should be demonstrated and explained, showing how the station selector is used, emphasizing that a definite click must be heard in a switch-type tuner. You should show how the fine tuning control brings in sound and picture and how it must be adjusted to obtain sound and picture separately. If a continuous-type tuning system is used, the tuning is like a fine tuning adjustment, once the desired channel is reached. The difference between contrast and brightness control and the effect they will have on each other should be explained carefully. You should then allow the owner to adjust the controls to suit himself, pointing out that the best brightness and contrast setting varies with the eyes of the individual. What is too bright for one may be too dull for another according to the sensitivity of their eyes. The only possible solution is a compromise setting of brightness and contrast control. Some Service Men show the effect of a light filter and explain its use. Customers often feel that such a filter helps reduce glare and is easier on the eyes. That is a matter of individual taste, but practice shows that many filter sales are made this way, at the final installation.

Enlarging lenses are sometimes desirable for the small screen table models.

If the set has the horizontal and

GREYLOCK A Dependable Name in RADIO TUBES

GT. Glass and Miniature Types
All Tubes in Individual Cartons

5Y3GT	12AT6	1R5
6AT6	12BA6	1T4
5BA6	12BE6	1U4
6BE6	12K7GT	1S5
6SA7GT	12Q7GT	3S4
6SL7GT	12SA7	3Q4
6SK7GT	12SK7	3V4
6SQ7GT	12SQ7	12AU6
6V6GT	25L6GT	12BF6
6X4	25Z6GT	35B5
6X5GT	35W4	35L6GT
12A8GT	50B5	35Z5GT
	50L6	117Z3

39¢
each

SPECIAL OFFER!

All 39¢ Tubes may be purchased in lots of 100 assorted, at \$35.00 per 100.

6A7	6AU6	6GG6
6AC5	6BH6	6SN7GT
6AK5	6B10	12AU7
6AQ5	6C6	25Z5
6AQ6	6D6	75
6AJ5	6SL7GT	6AL5

49¢
each

1H5GT	19T8	117L7
1N5GT	70L7	6L6GA
32L7	84	53

59¢
each

SPECIAL!! 6BG6G \$.89

Standard Replacement VOLUME CONTROLS.
all sizes, 1 1/2" shaft, less switch, each24
With SPST switch, each34
With DPST switch, each44

PM SPEAKERS Less Trans.
4" with Alnico V Magnet \$1.14
5" with Alnico V Magnet 1.14
6" with Alnico V Magnet 1.49
3" PM with plastic cone, and 8-oz. Alnico V Magnet 1.35
6"x4" PM with Alnico V Magnet 1.19
WEBSTER AJ1 Pickup, plastic arm 1.49

SELENIUM RECTIFIERS
100 Ma.59
75 Ma.49

TERMS: Net C.O.D., F.O.B. N.Y.C. 35¢ Handling Charge on all orders under \$5.00.

Write for Bargain Catalog S-11
GREYLOCK ELECTRONICS SUPPLY CO.
30 Church Street New York 7, N. Y.

vertical hold controls on the front control panel, their use must be carefully explained. To prevent the picture from moving up or down, the vertical hold control is slowly adjusted until the picture stands still. Then the control is adjusted just enough to make the picture move slowly upwards and "snap" into position. The vertical hold control should always be set in this manner, because this means that the synchronizing pulse will trip the vertical sawtooth generator just before the start of the next cycle.

Horizontal sweeps often use automatic frequency control. The characteristic of automatic frequency control is that it is not necessary to make an accurate adjustment because the *afc* action brings the picture into synchronism once the hold control is set close to the correct setting. This factor should be pointed out to the customer, explaining that the automatic frequency control needs a little time to work. If the picture appears to sway back and forth for a moment before it locks in, this is the normal action of the circuit and the set does not need adjustment or repair.

It seems that the largest number of service calls are not due to receiver defects but to incorrect adjustments

by the owner and the hold controls are the most frequent source of trouble.

The owner and family should be allowed to try the hold controls to be sure they really understand their function. After the operation of the front controls is explained, the existence of secondary controls can be mentioned, emphasizing the fact that their adjustment should not be necessary after the initial installation.

Customers should be cautioned against opening the back of the set, stressing the high voltage hazards and the fragility of the picture tube. With ordinary use a TV set is perfectly safe, but if the high voltage section is tampered with, it may become dangerous in spite of safety devices, such as interlock switches and shield cans.

FM Antennas

(Continued from page 21)

more good stations to the FM receiver's normal operation.

In many cases a flexible FM indoor antenna which can be moved around under a rug or in a closet is preferred to the inflexible built-in loop antenna which cannot be adjusted except by relocating the FM receiver itself.

The best way to predetermine the adequacy of an indoor antenna is to test the area in advance. This can be done with a portable receiver* which indicates the field strength of the FM signal in the prospective customer's home. This instrument takes the guesswork out of FM indoor antenna installations and saves the expense (delivery charges and time) of rejected FM receiver installations. Forcing the sale of FM receivers which operate satisfactorily on only one or two FM stations is a *bankrupt* policy, killing future sales of FM receivers for those laymen who hear the *noise* on the weak FM stations.

More than one FM receiver may be operated from a single antenna by proper loading adjustments. Care must be taken in this adjustment as some FM receiver local oscillators will produce interfering signals (beats) when the local oscillator of one FM receiver beats with the incoming signal on another FM receiver. For this reason unknown FM antennas should be located as far as possible from each other. The application of an FM booster amplifier as a preselector will usually prevent a radiating FM local

*Bendix Factometer, described in October, 1947, issue of SERVICE by Alvin A. Baer.



Inter-Comm REPLACEMENT SPEAKERS

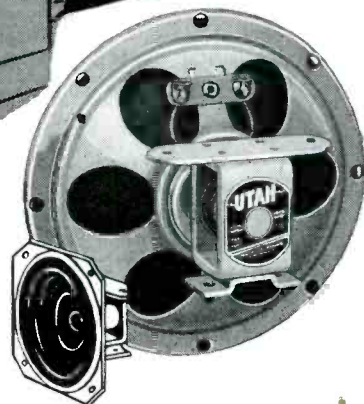

INTER-COMMS speak right up when the new Utah Inter-Comm Replacement Speakers are used. Your customers are pleased because voices are true and easily understood. Two new Utah Speakers are now available for inter-comm and similar sound applications. The SP4AI and SP5AI are built with 44 ohm voice coils and .68 oz. Alnico V Magnets. Dust covers are standard. Order from your jobber now.



UTAH RADIO PRODUCTS
HUNTINGTON, INDIANA
DIVISION OF INTERNATIONAL DETROLA CORPORATION
EXPORT DIVISION: MORHAN EXPORTING CORP., N.Y.C.

UTAH SPEAKERS SPEAK FOR THEMSELVES

oscillator from feeding its antenna with an interfering signal.

In many FM-TV console designs the FM input is *married* to the TV antenna and must take its FM signals from that source. Lack of image rejection in the TV receiver may have caused the TV installer to place an FM shorting stub across the TV input. This stub, while removing the interfering FM signals from the TV pattern, also short-circuits the FM signals from the FM receiver input. When FM stubs are installed, the FM input should be removed from the TV input and a separate indoor or outdoor antenna installed.

Noise Suppressor

(Continued from page 27)

give the advantage of *dynamic noise suppression* on recorded radio programs. The *important thing* in such an installation is to provide a means to keep the *input level* of the *radio signal* the same average level as that of the *pickup* for which the *Supp. Level* control is set, and to control the receiver *volume* after the 110-A. The *dynamic noise suppressor* will not work properly unless this input level is correct. Such an installation offers the added advantage of a very effective whistle filter at 10 kc (L_1 and C_5).

IRC Power Wire Wounds are better built every step of the way



Starting right from the winding form IRC Power Wire Wounds combine the best of materials, workmanship and resistor "know-how".

Highest grade alloy wire uniformly wound on sturdy ceramic tubes. Terminals spot welded for security; heavily tin dipped for easy soldering.

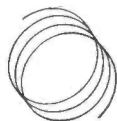

Climate-proof cement coating provides dark, rough surface—best for rapid heat dissipation, moisture protection and ability to withstand reasonable overloads.

Resistors cured at LOW temperature prevents damage to resistance windings, and loss of temper in terminals. Bands for adjustable types feature stainless steel springs and silver contacts. Cannot corrode to cause high resistance.

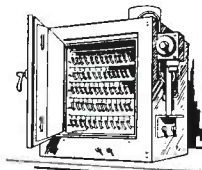

For exacting, heavy-duty requirements you can rely on IRC Power Wire Wounds for balanced performance in every characteristic. Being full-sized, they can operate continuously at full rating. Derating in high ranges is unnecessary.

IRC Power Wire Wounds are available in a full range of ratings, sizes and terminal types. 91 new ranges have just been added. Next time you step up to your distributor's counter—stock up on IRC Power Wire Wounds.

IRC INTERNATIONAL RESISTANCE CO.

401 N. Broad Street, Phila. 8, Pa.

In Canada: International Resistance Co., Ltd., Toronto, Licensee

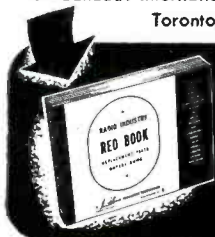

YES! We're listed in the RED BOOK. Looking for the correct IRC replacement controls for any receiver manufactured from 1938 to 1948? Just refer to the Radio Industry RED BOOK!

Ser-Cuits

(Continued from page 31)

plication; a 6SJ7 and a 6V6 power amplifier which drives a p-m dynamic speaker.

Following its final amplification in the third i-f stage, the video signal is impressed upon a 6H6 which performs three functions—video detection, synchronizing pulse separation and *agc* (automatic gain control).

Considering each of these functions in turn, the video signal is fed, after detection, to a 6AC7 wide-band video amplifier, then to the control-grid of the 10FP4 picture tube. Its average amplitude level is determined by the 6SN7 d-c reinserter to control the average brightness (background) of the reproduced image.

Sync pulses derived from the 6H6 sync separator are passed through one section of a 6SN7 amplifier. Horizontal pulses are then separated from the combined sync waveform in a differentiating circuit and applied to the horizontal *afc* circuit whose frequency they control.

In addition to providing scanning potentials, the 6L6 supplies high potentials which are rectified by a half-wave voltage-doubling circuit, filtered, and applied as operating potential (8,000 volts) to the picture tube.

Vertical sync pulses are separated in an integrating circuit, then impressed upon a 6SN7 vertical oscillator, to properly time its period of oscillation. These oscillations are then applied to the vertical scanning coil, after amplification by a 6SN7 amplifier, through an impedance matching transformer.

The third-mentioned function of the 6H6 sync separator provides *agc* to the first, second and third i-f amplifier stages, giving control to both picture and sound signals.

The R-F Chassis

The r-f section of the receiver is an assembly complete in itself except for plate and heater supplies, and includes r-f amplifier, local oscillator and mixer circuits.

The Colpitts circuit is used in the local oscillator for frequency stability, which is further enhanced by the use of negative temperature-coefficient capacitors. Shunt feeding is employed to reduce the number of switching contacts.

The Video I-F Amplifier

Departures from standard receiver practice in this TV model are: (1)

Presence of trap circuits and of loading resistors and (2) absence of variable tuning between stages. The 27.75-mc and 21.75-mc trap circuits tuned by 7.45 mfd capacitors are for purposes of adjacent television channel suppression. Additional traps are used to suppress the sound carrier in the television channel being received which would, if allowed to enter the detector, cause bars or herringbone patterns across the picture screen. The second departure from standard circuitry, the use of loading resistors, broaden the pass-band by lowering the Q of the tuned circuits. These resistors do cause a lowered amplification per stage which is characteristic of all wide-band amplifiers.

The absence of tuning adjustment in two of the coupling transformers, another departure, contributes to high gain, simplicity and ease of alignment. Resonance is afforded by the distributed coil capacity, the tube input capacity and the wiring capacity which simulate a lumped capacity in the untuned stages. For this reason the Service Man should carefully guard against the displacement of wires in the i-f stages, particularly in the stages not equipped for slug-tuning.

The remaining i-f circuit consideration which may be construed to differ

**FREE
ALLIED'S
NEW 1949
RADIO
CATALOG**



**Everything for the
Radio Service
Technician . . .**

**SEND FOR THIS
180-PAGE BUYING GUIDE NOW**

Radiomen! Here's the new 1949 ALLIED Buying Guide that brings you everything you need in radio and electronic equipment. Get everything that's newest and finest from the world's largest stocks—test instruments, sound systems and P.A. equipment, thousands of parts, tubes, tools, books—all at lowest money-saving prices, ready for instant expert shipment. Send for your FREE copy of the new 180-page ALLIED Catalog—today!

ALLIED RADIO

ALLIED RADIO CORP., DEPT. 23-L-8
833 W. Jackson Blvd., Chicago 7, Ill.

Send FREE New ALLIED Catalog.

Name.....

Address.....

from broadcast receiver practice is in unbypassed cathode resistors. It affords degeneration, which is encountered in audio amplifier work, resulting in improved frequency and amplitude response.

Video Detector

Video detection is quite normal in principle, differing but slightly from broadcast receiver practices. In the Farnsworth circuit a single tube is used to accomplish detection, sync separation and *agc*.

When the video intermediate frequency appears across section 2 of the 6H6 tube, rectification takes place, causing the demodulated signal to pass a contrast control. Signal path for the high intermediate frequencies (but not for the lower frequency demodulated video signal) back to the tube is afforded by 10-mmfd capacitor whose reactance is low at high frequencies, but high at low frequencies.

The composite video signal, which contains the picture producing variations in potential are blanking and the synchronizing pulses, is then fed to the video amplifier in variable magnitude, as determined by the contrast control.

An anti-resonant trap appears in the cathode circuit of the video demodulator which serves to reject a 4.5-mc beat-note from the control grid of the picture tube. This 4-5-mc signal arises from heterodyne action between the picture and sound carriers.

TV Alignment

(Continued from page 24)

pointed out that the signal from the sweep generator is fed into the *pipper* to a tap-off control and then out again to the receiver under test.

Now, this tapped-off signal is connected to the input of the broadly-tuned amplifier and thence to the mixer stage where it is heterodyned against the signal from the crystal-controlled local oscillator. The input amplifier is tuned broadly to permit it to pass signals within ± 4 mc of the RMA recommended i-f sound carrier frequency range of 21.25 to 21.9 mc, and acts primarily to isolate the crystal-controlled oscillator signal from the tv receiver circuit under test. The crystal-controlled local oscillator is set at a frequency midway between the i-f picture and sound carrier frequencies applicable to the particular type of tv receiver being aligned, and it hetero-

New DUAL SPEED PHONOMOTOR

FOR 78 R.P.M. OR 33 $\frac{1}{3}$ R.P.M.

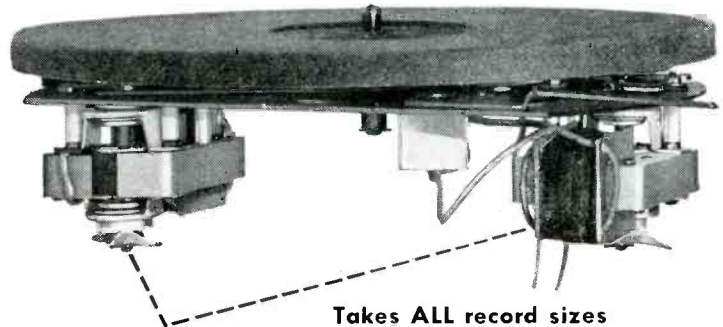

Takes ALL record sizes

TWO turntable speeds—78 or 33 $\frac{1}{3}$ r.p.m. are optional with the new Alliance Dual-Speed Phonomotor! With a simple "flick" of the control, you select either speed at will.

A dual version of the famous Model 80, this complete, new record player assembly gives the same kind of high quality "wow-free" performance required for commercial transcriptions!

Make the Alliance Dual-Speed your answer to the growing demand for slow-speed, long-play micro-groove records!

And remember—The new Alliance Dual-Speeds will be just as dependable as the millions of Model 80 Phonomotors now in use!

Radio service shops and retailers will find the new Alliance Dual-Speed Phonomotor is the ideal turntable drive for record players consoles, table models, combinations and portables. Each unit is individually boxed. Place your orders with your regular jobber now!

WHEN YOU DESIGN... KEEP
alliance motors
IN MIND

ALLIANCE MANUFACTURING COMPANY • ALLIANCE, OHIO

Export Department: 401 Broadway, New York 13, N. Y., U. S. A.

dynes in the mixer with the sweeping i-f signal derived from the sweep generator. The resultant sweeping signal is then passed on to a dual crystal bridge circuit wherein are contained two crystals at 2.25 and 3.75 mc, respectively, and two LC circuits, one each of which is tuned up to the frequency of its corresponding crystal. With this arrangement the *pipper* functions as a super-heterodyne receiver having two intermediate frequencies and having image responses equal in magnitude to the normal re-

sponses. As the frequency of the sweep generator passes through each of the four desired frequencies an impulse or *pip* is obtained from the bridge circuit. The pips are detected and amplified in the last stage and made available at panel posts for connection to the vertical amplifier of the display 'scope. Thus the pips are applied to the 'scope independent of the circuit under test, and hence are not lost in the trap points of the receiver i-f amplifier.

[To Be Continued in January]

JUST PUBLISHED!
2 NEW BOOKS
 to help you cash in
 on the industry's
**GREATEST SERVICING
 OPPORTUNITIES**

**PRACTICAL TELEVISION
 SERVICING**

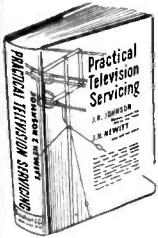

By **J. R. JOHNSON** and
J. H. NEWITT
 375 pages, 6x9, over 230
 illus., \$4.00

**NEW! DIFFERENT!
 DOWN-TO-EARTH**

At last you can get a book that really gives the lowdown on television servicing — one that tells you just what to do and guides you on precautions to take and mistakes to avoid. **PRACTICAL TELEVISION SERVICING** isn't a book of theory or mathematics. The authors — one a radio editor, the other a well-known engineer — actually operated a television service shop to get the low-to-do-it data they now pass along to you in easily understood form. Television components, construction and operation and how they differ from radio are clearly explained. Also, they show step by step how to handle every phase of television trouble diagnosing and servicing. You learn fast — and you learn right. Read it 10 days at our risk!

**PRACTICAL
 HELP ON**

- R-f, I-f, detector sections
- video amplifiers
- synchronizing and sweep circuits
- antennas; wave propagation
- installation
- test equipment; alignment
- wiring, repair techniques
- troubleshooting
- service hints; case histories etc.



**FREQUENCY
 MODULATION**

**FUNDAMENTALS
 APPARATUS
 SERVICING**

By **NATHAN MARCHAND**
 448 pages, 6x9, over 300
 illustrations, \$5.00

This new book by a well known radio consultant has been prepared first to help you understand FM clearly and, second, to explain fully just how to handle FM service work. Basic theory, circuits, transmitters, receivers and mobile equipment are covered — with special emphasis on modern methods of installing, adjusting and repairing FM receivers. From circuit peculiarities, tuning indicators, antennas, FM test units, receiver alignment to general servicing procedure and dozens of other subjects, this book is a practical guide to one of radio's fastest-growing developments. Use 10-day examination coupon.

**SIMPLIFIES
 SERVICE
 PROBLEMS!**

It takes more than ordinary radio knowledge to handle the complicated special problems of modern FM servicing. This book — replete with illustrations, schematics and on-the-job examples — will quickly help you understand each step of the work.

**10
 DAYS'
 TRIAL**

Dept. S-118, Murray Hill Books, Inc.,
 232 Madison Ave., New York, 16, N. Y.

Send me the books checked below for 10-days' examination on approval. In 10 days I will pay for the books plus a few cents postage or return them postpaid. (Postage paid on cash orders; same return privilege. Books sent on approval in U.S. only.)

Johnson & Newitt — **PRACTICAL TELEVISION SERVICING**, \$4.00

Marchand — **FREQUENCY MODULATION**, \$5.00

Name

Address

City..... Zone.....

State

Servicing Helps

(Continued from page 33)

Service Hints⁵

Handy Tool for Service Shops: A small eyeglass, of the kind a jeweler calls a *loupe*, is an extremely useful tool around a shop. One of about 4 or 6 powers may be used to check points on phono needles, to determine wear, locate loose ends of fine wires broken off on coils, etc.

Old Model Sets: Occasionally you'll run into a customer who is so attached to his '28 model or older radio that he insists on having it repaired, instead of trading it. A few chronic troubles which are characteristic of these older models are high-resistance, noisy windings on output and input transformers, causing loud, ripping noises, and produces a general weakness; leaky bypasses, especially the .25 and .5 mfd units used for plate and screen bypasses; leaky tone-control capacitors, and plate-load or bias resistors which have shifted in value. Proper bias voltages on power-tubes must also be watched. The 45, for instance, was commonly biased to around 50 volts negative. Defective bias resistors cause loss of bias and very bad tone, with low volume. If oscillator voltage is low on old superbets, the oscillator cathode resistor should be changed to larger value, measuring voltage and using size which gives best results.

Philco 48-150 and Other Battery Sets: Weakness and lack of sensitivity on these 5-tube battery sets may be traced to low screen voltage. The 47,000-ohm resistor used in the screen circuit of the 1L6G5 and 1LA6 tubes should be checked. This resistor is of the *match-stick* type, and has quite probably increased to around 2 megohms. Replace with ¼-watt size.

Case Histories⁶

Sonora Model WGFU 242—Weak, distorted reception and oscillation: If the set hasn't seen any use before the trouble occurs, it is probably an unsoldered white wire on the loop antenna. At least three new models have come in with the same trouble.

Sparton Model 5AM26—Intermittent reception, any slight disturbance cutting the set on and off: With the

⁵From notes submitted by Jack Darr.

⁶From notes submitted by John W. Findarlie.

**ERIE
 "CERAMICONS"**



- require less space
- are more efficient at high frequencies
- have greater dependability than any other type condenser

When repairs call for replacement —replace with ERIE "CERAMICONS." If your distributor cannot supply you, write us for information.

New catalog on request.

Electronics Division
ERIE RESISTOR CORP., ERIE, PA.
 LONDON, ENGLAND TORONTO, CANADA.

set in a dead condition, the oscillator section of the tuning capacitor should be shorted out with a screwdriver. If no noise is heard the trouble is due to a faulty oscillator coil. A factory replacement coil may cause the same condition in time, unless it is mounted on the end of the chassis, using *both* lugs to mount it to the chassis. Originally, only one lug was used and the coil was so mounted that as the tuning shaft was turned the coil would move too.

Wilcox-Gay Records —Cutter leaves blank spaces over an arc on the record: Check the height of the cutting arm from the surface of the record which should be ¼".

Poor reproduction on phono: This is often caused by loose connections at the reproducer cartridge terminals. Remove and squeeze the connecting clamps on the pickup wire leads with a pair of pliers and replace.

Airline Model 62-188 (Wells-Gardner) —Set fades and whistles: This was caused by defective capacitor C₄ connected from the low side of the antenna coil secondaries to ground opening. Replace with a .05-mfd/400-volt unit.

TV Sync

(Continued from page 35)

zontal deflection system, while the second channel uses the long duration vertical sync pulses to synchronize the vertical oscillator. So far as television application is concerned the circuit which utilizes the leading edges of the sync pulses is called a differentiating circuit and consists of a simple high-pass filter which readily passes on to the output the high frequency or leading and trailing edge components of the sync pulses. The integrating circuit is a simple low-pass filter which is not capable of following the leading edges of the pulses, but which builds up a charge on the capacitor in accordance with the duration of the pulse. The length of the flat top of the pulse or its duration is, of course, a low-frequency component. Thus by employing circuits which respond to the high or low frequency components of a pulse, we obtain a method of segregating horizontal and vertical synchronization components.

Differentiating circuits generally consist of a short time constant R-C combination, Fig. 2A. In this combination the time constant is short in comparison to the pulse duration and therefore the capacitor will charge hurriedly. At the instant the pulse is applied the voltage across the resistor will rise with it to maximum amplitude of the pulse. However, the capacitor will charge rapidly through the short time constant presented and will quickly charge to the peak pulse amplitude at which level no further current flows and the voltage across the resistor has dropped just as quickly to zero. Consequently the voltage across the resistor is a sharp spike of voltage, while the charge on the capacitor is the same level as the peak amplitude of the applied pulse. This distribution, maximum charge on C, and zero voltage across R, will continue for the duration of the pulse. At the termination of the pulse, the applied voltage quickly drops back to zero and the capacitor quickly discharges. At the termination, therefore, the voltage drops across the resistor will be maximum negative and exactly the same value as the full charge level of the capacitor (sum of voltage drops across the C and R will now equal zero). It is evident the voltage across R is now negative because the electron flow is now in the opposite direction because the charge is leaking off capacitor C. As this charge rapidly falls off C through the short time constant, the voltage across R becomes progressively less negative

db GAIN + + +

more signal strength for greater distance and the best picture

with **AMPHENOL**

STACKED ARRAY

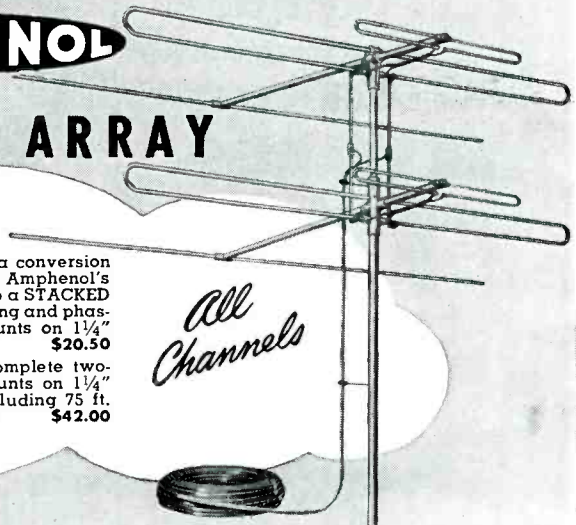

All Channels

MODEL NO. 114-301 is a conversion kit for use in building Amphenol's No. 114-005 Antenna into a STACKED ARRAY—mounting casting and phasing stub included. (Mounts on 1/4" mast—not included.) **\$20.50**

MODEL NO. 114-302 complete two-bay stacked array (mounts on 1/4" mast—not included) including 75 ft. of Amphenol twin-lead. **\$42.00**

Stacked Array multiplies the universally acknowledged features of the Amphenol All-Channel TV Antenna (No. 114-005). Stack to provide reception at greater distances—Stack for picture brilliance and clarity—Stack for controlled TV reception. Provide the TV Receiver with the Best Antenna to Produce the Best Picture. Amphenol's Stacked Array is your assurance of top TV picture quality.

Performance Charts Available

If you are not now receiving the monthly AMPHENOL ENGINEERING NEWS—you will want to request the September issue which included pattern and gain charts for the Stacked Array. We will be glad to mail it and to place your name on our list to receive future issues—write Dept. 13D.

AMERICAN PHENOLIC CORPORATION

1830 SOUTH 54TH AVENUE, CHICAGO 50, ILLINOIS
COAXIAL CABLES AND CONNECTORS · INDUSTRIAL CONNECTORS, FITTINGS AND CONDUIT · ANTENNAS · RADIO COMPONENTS · PLASTIC FOR ELECTRONICS

and falls toward zero at the same rate the capacitor charge is falling toward zero (always maintaining an algebraic sum of zero). Thus at the termination of the pulse, a sharp negative spike appears across the differentiating resistor. Inasmuch as the leading edge spike is the timing voltage of the horizontal oscillator the negative spike generated at the termination can be clipped off and removed. If for some applications a negative-going leading edge spike is necessary, it is only required that the applied pulse to the differentiating circuit be negative instead of positive-going.

The integrating circuit is a long time-constant R-C combination with the integrated vertical synchronization

taken off the integrating capacitor, B of Fig. 2. When a pulse is applied to an integrating circuit the capacitor charges very slowly during the entire duration of the pulse. Consequently, the time constant of the integrating combination is much longer than the duration of the pulse. In a typical television receiver, the differentiating circuit time-constant may be at some value between less than one and ten microseconds; the integrating circuit time-constant may be from 500 to thousands of microseconds. This is extremely long and only a charge equal to an extremely low percentage of the total pulse amplitude appears on the capacitor.

[To Be Continued]

ONLY

WALCO

OFFERS

these two micro-groove REPLACEMENT NEEDLES

for immediate delivery!

These new Walco needles complete your stocks. Now you can sell a Walco replacement on every phono service call you make! Build a reputation for thoroughness by replacing worn needles with a new dependable Walco jewel or precious metal needle. Customers will appreciate the service and you will profit by the extra sale. Remember, there's a Walco needle for every set and pickup.

WALCO MICRO-GROOVE FLOATING JEWEL SAPPHIRE

Highest quality genuine sapphire tipped needle for the new long playing micro-groove record players. Hand polished, microscopically inspected. List price \$2.50.



WALCO MICRO-GROOVE PRECIOUS METAL TIP

Bent spring action, special osmium alloy shank helps protect against excessive wear. Available in cartons or mounted display cards. List price \$1.50.

WALCO MUTED STYLUS FOR SHURE PICK-UP CARTRIDGE

The standard replacement needle for SHURE P-30 pickup cartridge. Walco—made under special Shure license. Lasting tip of osmium alloy. List price \$1.50.

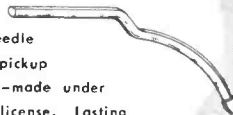

PLUS a complete retail line attractively packaged and cleverly displayed. A Walco needle for every purse and purpose. Ask your jobber or write direct for catalog.

ELECTROVOX CO., INC.

66 FRANKLIN STREET, EAST ORANGE, N. J.



O. F. JESTER NOW S-M OF ROSS MFG. CO.

Oden F. Jester has been appointed general sales manager of the Ross Manufacturing Co., 2241 S. Indiana Ave., Chicago, Ill.

Jester was formerly in charge of sales for the Maguire Electronic Division.



KAPLAN NOW HEADS SIGHTMASTER

Michael L. Kaplan has resigned as selling agent for Gloversville Knitting Co. of Gloversville, New York, and will devote his entire time to Sightmaster Corp., of which he is president.

RCA 1949 TUBE REFERENCE BOOK

The 1949 edition of the RCA Tube Department's Tube Reference and Calendar Notebook, is now on the presses and will shortly be channeled to RCA Tube distributors for issuance to Service Men.

Of special interest in the new edition is television data prepared by John Meagher; information and charts on television channels and carrier frequencies, television-signal data, test-pattern analysis, and air-path distance of reflected signals.

Revised sections on tubes and batteries include receiving-tubes characteristics chart and socket-connection diagrams, and condensed data on over 270 RCA tubes.

NEDA BOARD OF DIRECTORS AND OFFICERS CHICAGO MEETING

Seated, left to right: Thomas H. Brown, Southern New England Chapter; William A. Wilson, Ohio-Indiana-Kentucky Chapter; Dahl W. Mack, Keystone Chapter; John H. Brown, Iowa-Nebraska Chapter; H. H. Plunkett, Missouri Valley Chapter; Arthur W. Mayer, Yankee Chapter; Max I. Epstein, New York Metropolitan Chapter; Arthur W. Stallman, first vice president; Aaron Lippman, who was reelected treasurer at the meeting; Louis W. Hatry, newly-elected president; W. D. Jenkins, chairman of the board; Lealis L. Hale, secretary; Thomas A. Lynch, Southern California Chapter; A. D. Davis, Chicago Chapter; Hoyt C. Crabtree, North Texas Chapter; A. W. Creeson, Jr., Carolina Chapter; Harry Stark, Minnesota Chapter; L. B. Walker, Rocky Mountain Chapter; Sam Maehtinger, St. Louis Chapter; Gordon M. Fulton, Michigan Chapter; J. K. Featherman, Northwest Chapter; Guy B. Paine, retiring second vice president. Standing, left to right, L. B. Calamaras, executive secretary; Frank H. Lingnor, Wisconsin Chapter; R. C. Hall, South Texas Chapter; Helen C. Howley, Tri-State Chapter; M. E. Schifino, Empire State Chapter; Carl C. Brown, first vice president; W. L. Obenchain, Florida Chapter.



HOWARD SAMS HAM MANUAL

A 264-page postwar *Communications Receiver Manual*, CR1, has been announced by Howard W. Sams & Co., Inc., Indianapolis, Ind.

Manual covers more than 50 postwar communications receivers, including a number of units designed for aircraft and marine applications.

List price, \$3.00.

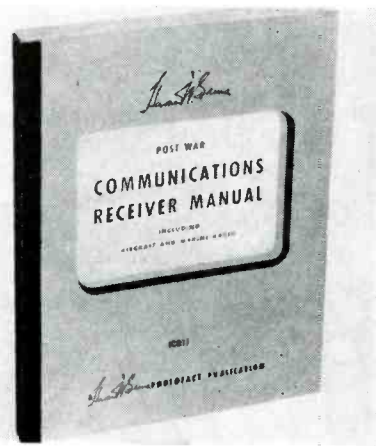

JFD 5TH TV-FM ANTENNA INSTALLATION FORUM

The 5th session of the JFD series of TV-FM antenna installation forums will be held in Rochester, on Tuesday evening, November 23, 1948, at the Sheraton Hotel. Fundamental installation and reception problems will be discussed.

Albert J. Friedman, JFD chief antenna development engineer, will conduct these meetings as previously.

STANCOR TV COMPONENTS CATALOG

A four-page catalog (DD337) describing a line of TV transformers and components has been released by Standard Transformer Corp., 3580 Elston Ave., Chicago 18, Ill.

Mauller

**(THE CLIPPER)
ANNOUNCES THE NEW
No. 22 "TWIN-CLIP"**

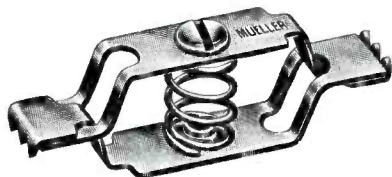

**HAS JAWS ON BOTH ENDS
Something New and Different!**

Both jaws may be opened at the same time by pressing the center of the clip, or either jaw may be opened separately without disturbing the grip of the other.

Two inches long, made of cadmium plated steel. Has screw connection.

The Twin-Clip is a real time-saver in many electrical and mechanical applications. May be used to make a quick splice, temporary repair hookup, hanging and racking various articles for display or industrial processing, holding identification and record cards, etc.

SEND FOR FREE SAMPLES
AND COMPLETE CATALOG 810

Mauller Electric Co.

1565 E. 31st St., Cleveland 14, Ohio

THIRD HYTRON CONTEST AWARD

Sidney C. Patrette, 125 Arroyo Way, San Jose, California, won the first prize award in the July Hytron Service Men's contest.

Patrette at present is employed as a radio technician for the National Advisory Council for Aeronautics at Moffett Field, Sunnyvale, California.



Sidney C. Patrette (left), California, receives the July prize in the Hytron Service Men's contest from Russ Hines, Hytron rep. (right), as Hytron jobber Frank Quement of Frank Quement, Inc., 161 West San Fernando Road, San Jose, Calif., looks on

**ROBINSON NAMED SYLVANIA
ELECTRIC L. I. CITY DISTRIBUTOR**

The Radio Tube Division of Sylvania Electric Products, Inc., has appointed the Robinson Television and Electronic Company, 23-05 45th Road, Long Island City, N. Y., as distributor for Sylvania radio and television tubes, test equipment and electronic products.

SYLVANIA APPOINTMENTS

J. T. Mallen has been appointed manager of equipment tube sales for the east central division, Radio Tube Division, Sylvania Electric Products, Inc. He was formerly east central division manager for renewal tube sales.

D. W. Gunn has been appointed assistant to the general sales manager for the Radio Tube Division, Sylvania Electric Products, Inc. He was formerly a special representative for the equipment tube sales department.



J. T. Mallen

D. W. Gunn

* * *

THOMPSON HEADS G. E. REPLACEMENT TUBE SALES

John T. Thompson has been appointed sales manager of replacement tubes for the G. E. Tube Divisions.

Formerly tube representative at the Atlanta, Ga., office, Thompson succeeds the late Russell W. Metzner, who died suddenly last July.



* * *

ALPHA METALS SOLDER BULLETIN

A four-page bulletin (201) with a solder selection guide, which lists the sixteen metals that are most frequently soldered, has been published by Alpha Metals, Inc., 363 Hudson Avenue, Brooklyn 1, New York. Information given about them includes their order of solderability together with recommendations for the best flux core solder or solder and flux suitable to soldering operations, and also for the flux type most desirable when an external flux is used.

* * *

TEST UNIT CARRYING CASE

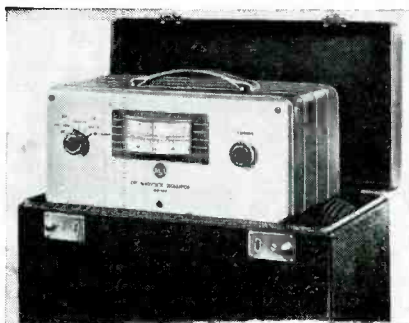

Lightweight plywood carrying case for test and measuring equipment recently designed by RCA. Has storage compartment which provides space for test leads, adaptors, probes, and other accessories.

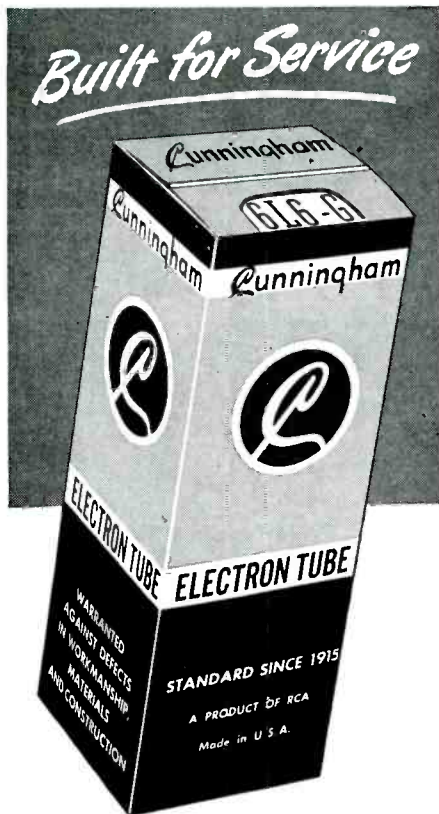

**Servicemen's choice!
in...**

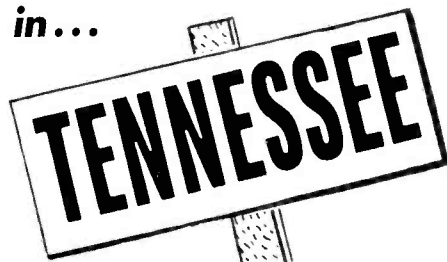

• Throughout Tennessee—experienced servicemen are casting their votes for Cunningham . . . the tube that's *built for service*. You can count on more customers if you make top-quality Cunninghams *your choice* whenever new tubes are called for.

See your
CUNNINGHAM DISTRIBUTOR

**Bomar Appliance Co., Inc., Knoxville
Curle Radio Supply & Sound Service
Chattanooga
Randolph & Cole, Inc., Nashville**



EXTRA Protection for EVERY Service Job!

**FIXED OR ADJUSTABLE
VITROHM RESISTORS**

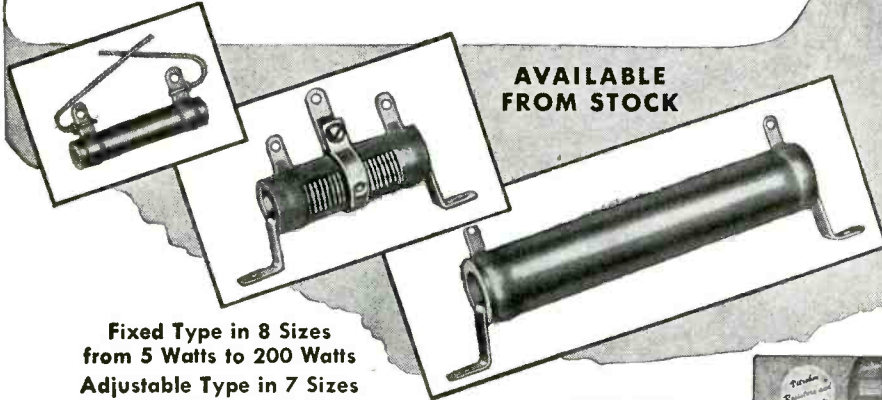

AVAILABLE FROM STOCK

**Fixed Type in 8 Sizes
from 5 Watts to 200 Watts**

**Adjustable Type in 7 Sizes
from 10 Watts to 200 Watts**

You can guarantee dependable, trouble-free performance when you install VITROHM wire-wound resistors. Windings are held in place and protected by a special WL vitreous enamel which is tough, crazeless, moisture and acid-resistant. They give long service, avoid call-backs, build satisfied customers and greater profits. Available in wide range of resistance values.

Authorized Distributors Everywhere

WARD LEONARD ELECTRIC CO., Radio and Electronic Distributor Division, 53-E W. Jackson, Chicago 4

SEND FOR FREE CATALOG

Write for Catalog No. D-130. Gives complete data and information.



**WARD LEONARD
RELAYS • RESISTORS • RHEOSTATS**

Electric control devices since 1892

SENSATIONALLY DIFFERENT...

SLIM JIM

A revolutionary development in soldering irons is the inter-changeable Thermo-Cel head. These heads not only simplify difficult operations but also are available in different wattages, thus giving the operator a flexibility of many irons in one. Our fifty-watt head will do the work of any ordinary 100-watt standard iron. **SAVE MONEY — SAVE TIME — LESSEN FATIGUE — INCREASE SPEED AND EFFICIENCY — try the SLIM JIM and you'll never go back to old, heavy, hot-handed antiques. THE SLIM JIM IS MADE TO STAND UP UNDER THE MOST EXACTING, CONTINUOUS 24-hour DUTY REQUIREMENTS.**

**WEIGHT OF IRON
3 1/2 oz**

**JOBBER: WRITE
DEPT. 511
FOR DETAILS**



**SLIM JIM with Transformer
A SOLDERING IRON OF SUPERIOR MERIT**

Note how specially developed sturdy Current Conductors are plugged into iron. Heat is thereby concentrated in Thermo-Cell. Air space minimizes back-flow of heat, thus assuring a cool handle at all times.

For: General Servicing Jewelry Instruments

SLIM JIM Thermo-Cel heads are equipped with the new "Filmized" tip—a special process developed by us—to prevent scale from oxidation, from "freezing" the tip in the head. This added feature also increases the life of the tip from 5 to 10 times longer. The SLIM JIM has never "broken down" either in the "field" or under the rigid test conditions in our laboratory.

The SLIM JIM is ideal for use in emergency. The iron can be purchased without the transformer, and with battery clips, for use on any 6-volt battery. Write for details to Dept. 511.

98% OF THE HEAT IN THE TIP

CHOOSE YOUR THERMO-CEL for the JOB — Easily Changed

- 1-RAMJET—1/4" or 3/16"**
- FOR: RADIO ASSEMBLY—SWITCHBOARDS—REPAIRS—METERS**
- 2-BULLET—1/4"—3/16"**
- FOR: HIGH SPEED ASSEMBLY—VOICE COILS—PICKUPS—METERS—HEARING AIDS**
- U—HEAVY OBLIQUE—3/16"—1/8"**
- FOR: TERMINAL BOARDS—RELAYS—CONTACTS**
- A—LIGHT OBLIQUE—1/4"—3/16"**
- FOR: PRECISION SOLDERING—OFF ANGLE JOBS—INSTRUMENTS**

JET THERMAL DEVICE CO.
2173 86th STREET BROOKLYN, N. Y.

PHILCO NATIONWIDE TV SERVICE MEN TRAINING PROGRAM

A long-term program to train Service Men in the technics of modern TV servicing has been announced by Philco Service Division. This new program includes three steps: Home instruction, a free course of home study; classroom and shop training, also provided free of charge in leading TV centers and in other cities where stations will soon be on the air; and finally, a third free course in how to do satisfactory and profitable service work, with free up-to-date manuals provided for all students who complete the entire course.

All Philco distributors in television cities are cooperating in this program.

The new course is available to all Service Men who have a sound basic technical knowledge of radio. These men include dealers, service managers and Service Men employed by dealers, and independent servicing contractors.

In the home program, a series of 10 lessons, *Television Trouble Shooting by Philco*, has been organized. At the end of each lesson is a series of examination questions.

In the second step, there'll be shop training in about 50 cities in the United States, where TV broadcasting is already available or stations will soon be on the air. Wholesale distributors of Philco television receivers and parts have already set up classrooms and model service shops.

Lectures will cover such subjects as antenna installation, pulse structures, development of picture, transmission of picture, circuit analysis, use of picture and sound signals, alignment of receivers, and projection television. Practical shop work will include experiments in trouble shooting and experience in solving everyday service problems with various models of receivers.

On completion of this course, the graduate receives a certificate signifying that he is trained to service modern TV receivers.

In the third phase the Service Man will be helped by the nearest Philco distributor with information regarding the expansion of television in his area, and the need for his services. As a further aid, to keep him abreast of the latest developments in television receivers, antennas and components, the Service Man will receive the regular technical manuals on television from Philco headquarters.

PHOTOFACT TV FOLDER PREPARATION



W. W. Hensler, analysis engineer on the staff of Howard W. Sams & Co., Inc., studying a TV receiver prior to preparing analysis copy for the Photofact TV service folders.

New TV Parts . . . Accessories

MASTERCRAFT ANTENNA MOUNT

An antenna mount with two aluminum castings (said to fit any chimney corner) with set bolts and lock nuts, accommodating all size masts up to 1 3/8" OD has been announced by Mastercraft Products, 60 South St., Boston 11, Mass.

Has 6 stamped and shaped aluminum corner sleeves which ride on cable, hold it in place and protect cable from chafing against chimney corners. Supplied with 25' of twisted double galvanized cable sufficient for any size chimney with tight gripping hammer-locks, and 2 hook bolts, 7" long, with washers and lock nuts.

Antenna mount is said to be protected by Product Liability Insurance with coverage for maximum personal injury \$10,000 per person or \$20,000 per accident; maximum \$1,000.00 product property damage.



* * *

RCA TV PICTURE MAGNIFIER

A television picture magnifier (type 205PI) designed specifically for smaller television receivers has been announced by the RCA Tube Department. The magnifier is said to enlarge the images on sets with seven-inch tubes to the approximate equivalent in size of those received on a 12-inch tube.

* * *

TRICRAFT TV-FM ANTENNA

An all-wave TV-FM antenna, model 500, which may be used out of the window and outside the porch, has been developed by Tricraft Products Co., 1535 N. Ashland Avenue, Chicago, Illinois.

Matches all sets with 300-ohm input. Net weight, 2 1/2 lbs.

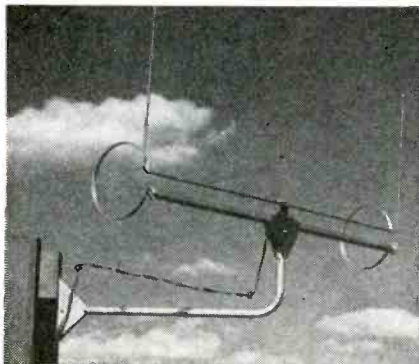

EASTERN TRANSFORMER TV ANTENNA

A Double U type TV antenna with three reflector elements, two director elements and two collector elements, has been announced by the Eastern Transformer Company, Inc., 147 West 22nd Street, New York City.

Can be used with either the coax or twinex leadin. Although it can be manually rotated for directional beaming, the assembly is said to be mechanically rigid.

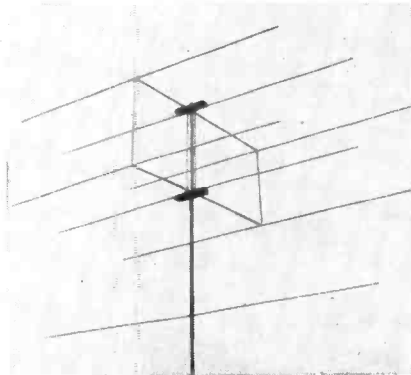

* * *

WALCO TELE-VUE FILTER

A TV glare filter, which is said to reduce excessive glare from direct view screens, is now being distributed by Walco Sales Company, 76 Franklin Street, East Orange, N. J.

The filter is attached to the screen with double sided adhesive dots.

* * *

VISION RESEARCH FM TELE TUNER

An FM tuner which can be connected between the TV receiver and antenna and tune in all FM stations, has been announced by Vision Research Laboratories, 87-50 Lefferts Blvd., Richmond Hill 18, New York.

Working on either channel 2 or 3, whichever is free in a given locality, the tuner amplifies and converts FM signals so that they are received through the television sound channel. A switch-through arrangement permits regular TV reception when the tuner is turned off, without disturbing any connections.



* * *

VERI-BEST U-BOLT ANTENNA ASSEMBLY

A U-bolt and aluminum block for antenna assembly has been announced by Veri-Best Television Products, Inc., 8-10 Forrest St., Brooklyn, N. Y.

Built for Service



Servicemen's choice!
in...



● Cunningham tubes continue to carry Washington because of their long-standing record of reliability. That's why—when you sell Cunningham tubes—more customers will come your way. Elect to use Cunninghams in *your* work.

See your
CUNNINGHAM DISTRIBUTOR

HERB E. ZOBRIST CO. . . . Seattle
HERB E. ZOBRIST CO. . . . Spokane

Cunningham Tubes

A product of
RADIO CORPORATION OF AMERICA
Harrison, N. J.

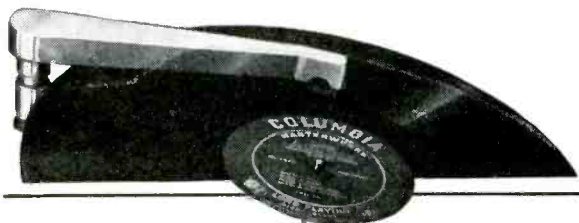

Astatic FL-33 PICKUP FOR COLUMBIA MICROGROOVE RECORDS

• Here is no mere version of what a pickup for use with Columbia Microgroove Records should be—but the actual playing arm designed to meet the precise requirements of Columbia's new recordings. This new Astatic Pickup is manufactured to meet the specifications by Columbia, to insure maximum quality performance of the Columbia LP Microgroove Record. Available, then, in the Astatic FL-33 Pickup and LP-33 Crystal Replacement Cartridge, is the ultimate of Microgroove companion equipment . . . alone capable of getting the most out of LP Records.

FL FILTER: For best performance with high quality speakers. Controls high frequency response.

FEATURES OF ASTATIC'S FL-33 PICKUP

1. Five-Gram Needle Pressure.
2. Permanent Sapphire Needle with .001" Tip Radius.
3. Approximately One-Half Volt Output.
4. Frequency Range 30 to 10,000 c.p.s.
5. Novel Design at Base Eliminates Tone Arm Resonances and Assures Perfect Tracking.
6. LP-33 Cartridge for Microgroove instantly replaceable in FL Arm with LP-78 Cartridge having .003" radius needle for playing 78 RPM Records. Both simply slip into position, no tools needed, **NO CHANGING OF NEEDLE PRESSURE.**

LISTED IN RADIO INDUSTRY RED BOOK

Astatic Crystal Devices Manufactured
Under Brush Development Co. Patents



SPELLMAN TV R-F FILAMENT TRANSFORMERS

A high-voltage, corona shielded, tuned transformer assembly which includes an octal socket for use with 1B3-8016 type tube has been developed by Spellman Television Co., Inc., 130 W. 24 Street, New York 11, N. Y.

The filament voltage is adjustable through a small access hole in bottom of a spun copper cup, allowing tube to be used for voltage from 1 to 20 kv.

Unit is designed to operate in conjunction with r-f step-up coils of approximately 200 kc frequency.

Coils are provided with diagrams giving dimensions, instructions, and all pertinent data. They are also available with a tested 1B3 with plate cap.



* * *

WORKSHOP ASSOCIATES SOLDERLESS COAX CONNECTORS

Silver-plated, solderless coax connectors are now being supplied on TV antennas made by Workshop Associates, Needham, Mass.

* * *

TECH-MASTER TV KITS

A TV kit, which is said to be a counterpart of the RCA 630TS, supplied with a factory-wired 12-channel front-end tuner and 10 BP4 picture tube, has been announced by Tech-Master, 123 Prince Street, New York, N. Y.

LARGE SCREEN TV



Top: Front view of custom-built projection receiver recently demonstrated by Television Assembly Company. Receiver which provides a 20 x 26 picture uses the Bausch and Lomb refractive arrangements with a F1.9 lens and 5" 5TP4 tube.

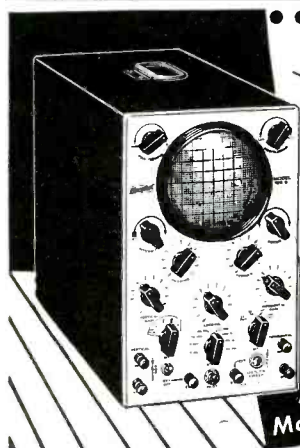

THE HICKOK CATHODE RAY OSCILLOGRAPH For Television

This 5" Oscillograph is SEVEN to TWENTY times more sensitive, for stage by stage alignment.

Features: Phasing control with HICKOK exclusive sinusoidal sweep. • Extra high gain vertical amplifiers—.03 V per inch. • Synchronized linear FM sweep. • Wide band amplifiers for FM and Television—better than 1 megacycle.

See Your Jobber or Write for Literature.

THE HICKOK ELECTRICAL INSTRUMENT CO.
10521 Dupont Avenue, Cleveland 8, Ohio

Ask for
Model 195 B

Permoflux SPEAKERS

YOUR JOBBER CAN SUPPLY YOU!

Permoflux quality and dependability—the same as supplied to the major set manufacturers—is your assurance of complete customer satisfaction. You'll find Permoflux Speakers easy to install and readily available in both PM and Electrodynamic types. You'll find too, that it pays to give your customers "tops in tone" with a Permoflux Replacement Speaker.

TWO COMPLETE
FACTORIES TO SERVE YOU



WRITE FOR
FREE BULLETIN

PIONEER MANUFACTURERS OF PERMANENT MAGNET DYNAMIC TRANSDUCERS

PERMOFLUX CORPORATION

4900 WEST GRAND AVE., CHICAGO 39, ILLINOIS
236 SOUTH VERDUGO ROAD, GLENDALE 5, CALIFORNIA

New Instruments . . . Components

CHICAGO TRANSFORMER REPLACEMENT TRANSFORMERS

A replacement transformer line has been announced by the Chicago Transformer Division, Essex Wire Corp., 3501 Addison Street, Chicago 18, Illinois.

Included in the line are power transformers and chokes, driver, speaker matching, interstage, and output transformers in a range of practical ratings.

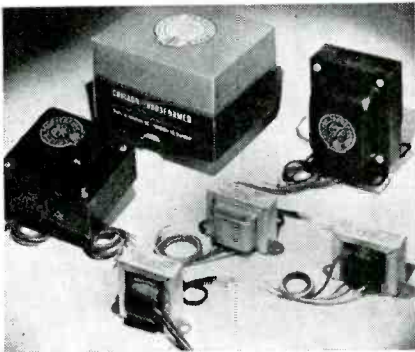

* * *

IRC POWER WIRE-WOUND RESISTORS

Ninety-one new ranges of power wire-wound resistors have been announced by International Resistance Co., 401 N. Broad St., Philadelphia 8, Pa.

Fixed and adjustable types in 10, 20, 50, 75, 100 and 200-watt sizes from 1 ohm to .1 megohm.

Supplemental catalog sheet listing all ranges in fixed and adjustable types, available terminals and tolerances are available.

free

1949

NEWARK

CATALOG



For EVERYONE interested in
TELEVISION • RADIO • ELECTRONICS
SOUND SYSTEMS • INDUSTRIAL EQUIPMENT
EVERYTHING in standard brand equipment!

Professionals! Radio Hams! Television Enthusiasts! Beginners! Oldtimers! Amateurs! Hobbyists! Here's one book that's a MUST for you! Our FREE 148 page catalog jammed with over 20,000 different items. The smallest part to the most complete industrial system from one dependable source!

24-HR. MAIL ORDER SERVICE • ONE YEAR TO PAY

3 GREAT STORES: Uptown at 115 West 45th St. and Downtown at 212 Fulton St. in NEW YORK 323 W. Madison St. in the heart of CHICAGO

MAIL ORDER DIVISIONS: 242 W. 55th St., N. Y. 19 and 323 West Madison St., Chicago 6, Illinois



MAIL COUPON NOW

Newark Electric Co.
Dept. K12, 242 W. 55th St.
New York 19, N. Y.

Please send me FREE the Newark 1949 Catalog

NAME _____
ADDRESS _____ CITY _____ STATE _____

REINER HI-VOLTAGE MULTIPLIER LEADS

High-voltage multiplier leads which convert a low voltage multimeter into a high voltage instrument, have been developed by Reiner Electronics Co., 152 West 25th Street, New York 1, N. Y.

Have special high-voltage type of resistors built into the prod handles.

Only the very lowest range such as 2.5-3-5-10-12-15 is used depending upon the scale range of the instrument.

Leads are available in voltage ranges of 5,000-10,000-12,000-15,000-25,000- and 30,000. Each range may be had in sensitivities of 20,000-10,000 and 5,000 ohms per volt.

* * *

RCA REPLACEMENT SPEAKERS

A line of speakers designed to meet most requirements for general radio receiver replacements and indoor sound-systems is now being marketed by the Renewal Sales Section of the RCA Tube Department.

Comprising 14 permanent-magnet and three field-coil type speakers, the line ranges from the miniature 2" by 3" elliptical speaker to the 12" size.

A feature of the p-m speakers is a clamping spring which locks the Alnico V magnet rigidly in position. This spring applies a locking pressure of 70 pounds for the 12" speaker and 40 pounds for the other sizes. The 2" x 3" and 4" shallow-pot-type speakers utilize a r-f heating process to solder-lock the magnet in position.

Another feature included in the 4", 4" by 6", and 5" p-m speakers is the universal transformer mounting bracket and adapter plate.

* * *

STANCOR HIGH-FIDELITY A-F TRANSFORMERS

A series of HF and WF high fidelity audio transformers with a complete range of commonly used ratings for amplifier circuits, speakers, microphones and pickups, including low impedance to grid, push-pull input, mixing, output and input, has been developed by Standard Transformer Corp., Elston, Kedzie & Addison Streets, Chicago 18, Illinois.

The HF series, except for the HF-65 output transformer, is said to have a frequency response of ± 1 db from 20-20,000 cps; HF-65 response is ± 1 db from 30-20,000 cps. The WF series, except for the WF-21, is said to have a frequency response characteristic of ± 2 db from 30-20,000 cps; WF-21 input transformer response is ± 2 db from 50-10,000 cps.

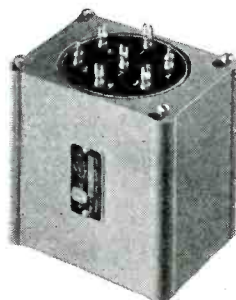

Built for Service

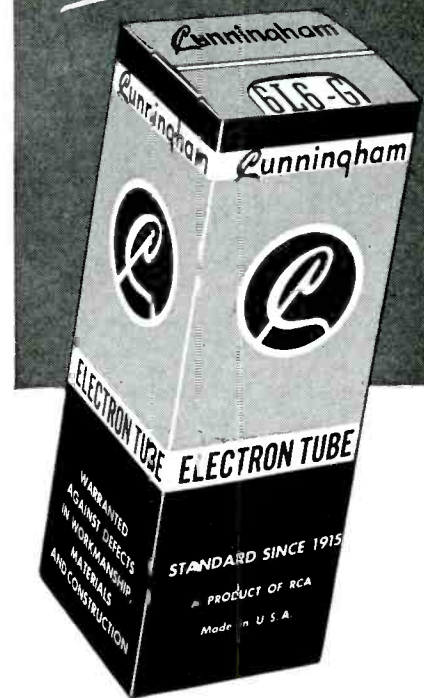

Servicemen's choice!
in...



• Cunningham tubes get more votes of confidence and receive more southern hospitality in Virginia . . . because Cunningham tubes have demonstrated their long life and top performance over a period of 32 years. That's why Cunninghams get more customers when renewal tubes are needed . . . and that's why you should make Cunningham tubes your leading brand.

See your
CUNNINGHAM DISTRIBUTOR
JOHNSTON-GASSER CO.
Richmond

Cunningham Tubes

A product of
RADIO CORPORATION OF AMERICA
Harrison, N. J.



It's MORE than Luck!

It's more than luck—that, for 23 years, Quam Speakers have been manufactured by the same management in a field that is noted for rapid, and sometimes sudden, changes.

It speaks well for the sound business policies of the company, its progressive engineering developments and the consistently high quality that has distinguished Quam Speakers.

It, also, explains the confidence in the stability of the company, and in its product, Quam Speakers, by service men and manufacturers alike.

Always specify Quam for Speaker replacements; you can depend on their quality, their performance and their guarantee!

Write for Catalog of Quam Adjust-O-Cone Speakers.

QUAM NICHOLS COMPANY

526 EAST 33rd PLACE
CHICAGO 16, ILLINOIS

Quam Speakers are listed in the Radio Industry Red Book.

PRECISION APPARATUS HIGH VOLTAGE TV TEST PROBES

TV high-voltage safety test probes, which afford direct measurement facilities up to 30,000 volts d-c, have been announced by Precision Apparatus Co., Inc., 92-27 Horace Harding Boulevard, Elmhurst, L. I., N. Y.

Probes provide direct kilovoltmeter facilities with present high sensitivity test sets and vacuum tube voltmeters.

Functional safety of the probes is said to be provided via extended high dielectric anti-leakage paths, a multi-channeled guard barrier, full handle length internal arc-back shield directly grounded and external arc-back barrier directly grounded. Fully shielded instrument connecting cable is said to further safeguard the user.

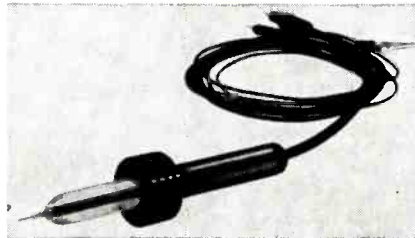

JET THERMAL SOLDERING IRON

A 3½-ounce soldering iron, *Slim Jim*, using a resistance wattage expanded principle, has been announced by the Jet Thermal Device Co., 2173 - 86th St., Brooklyn 14, N. Y. Said to provide quick-heating up to a working temperature in 90 seconds.

Iron features include replaceable thermo cartridges.

Has *Filmized copper tips* (special processing of copper which is said to make copper last from five to ten times longer than ordinary copper.)

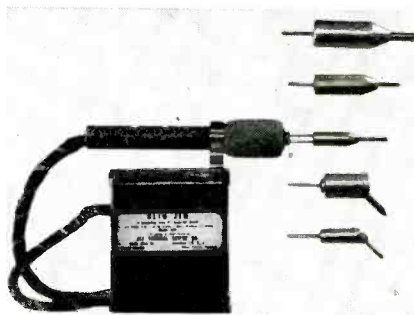

STERLING BATTERY CELL TESTER

A battery cell tester with three readings, *O* for okeh, *W* for weak, *D* for dead, has been announced by the Sterling Manufacturing Co., 9205-9223 Detroit Ave., Cleveland 2, Ohio.

Meter dial itself is brought into sharp focus by a background showing an actual battery divided into three colorful zones.

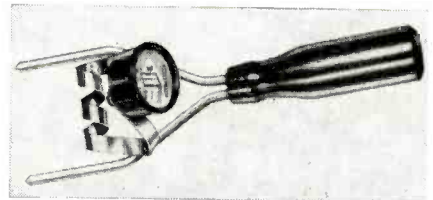

UTAH REPLACEMENT TRANSFORMERS

A line of replacement transformers (*universal output, universal line, and single output*) has been announced by Utah Radio Products, a Division of International Detrola Corp., 1123 East Franklin St., Huntington, Indiana.

Each transformer is said to be weather proofed and submitted to a steaming, dripping heat test.

Transformer types come in eight sizes.

STATEMENT OF THE OWNERSHIP, MANAGEMENT, CIRCULATION, ETC., REQUIRED BY THE ACTS OF CONGRESS OF AUGUST 24, 1912, AND MARCH 3, 1933.

Of SERVICE, published monthly at New York, N. Y., for October 1, 1948.

State of New York } ss:
County of New York }

Before me, a notary, in and for the State and county aforesaid, personally appeared B. S. Davis, who, having been duly sworn according to law, deposes and says that he is the Business Manager of SERVICE, and that the following is, to the best of his knowledge and belief, a true statement of the ownership, management, etc., of the aforesaid publication for the date shown in the above caption, required by the Act of August 24, 1912, as amended by the Act of March 3, 1933, embodied in section 537, Postal Laws and Regulations, to wit: 1. That the names and addresses of the publisher, editor, managing editor, and business manager are: Publisher, Bryan Davis Publishing Co., Inc., 52 Vanderbilt Avenue, New York 17, N. Y.; Editor, Lewis Winner, New York, N. Y.; Managing Editor, None; Business Manager, B. S. Davis, Ghent, N. Y.; 2. That the owners are: Bryan Davis Publishing Co., Inc., 52 Vanderbilt Avenue, New York 17, N. Y.; B. S. Davis, Ghent, N. Y.; J. C. Munn, Union City, Pa.; A. B. Goodenough, Port Chester, N. Y.; P. S. Weil, Great Neck, N. Y.; F. Walen, Union City, N. J.; G. Weil, Great Neck, N. Y.; L. Winner, New York, N. Y. 3. That the known bondholders, mortgagees, and other security holders owning or holding 1 per cent or more of total amount of bonds, mortgages, or other securities, are: None. 4. That the two paragraphs next above, giving the names of the owners, stockholders and security holders, if any, contain not only the list of stockholders and security holders as they appear upon the books of the company, but also, in cases where the stockholder or security holder appears upon the books of the company as trustee or in any other fiduciary relation, the name of the person or corporation for whom such trustee is acting is given; also that the said two paragraphs contain statements embracing affiant's full knowledge and belief as to the circumstances and conditions under which stockholders and security holders who do not appear upon the books of the company as trustees, hold stock, and securities in a capacity other than that of a bona fide owner; and this affiant has no reason to believe that any other person, association, or corporation has any interest direct or indirect in the said stock, bonds, or other securities than as so stated by him.

(Signed) B. S. DAVIS, Business Manager.
Sworn to and subscribed before me, this 25th day of September, 1948.

(Seal) EVELYN M. ROLLINS,
Notary Public.

Commission expires March 30, 1949.

For Originality

LOOK TO

XCELITE

Double-Bladed Bargain!

Change from Phillips to Standard screwdriving in a hurry! And what a bargain—the XCELITE "Combination-Detachable" 2-screwdrivers-in-one is yours for only \$1.60 in Regular size, just \$1.30 in Stubby! EXTRA BLADES only \$0.90 in Sizes No. 1, 2 and 3! For tool values like this, have your dealer show you the XCELITE line!



XCELITE

"Combination-Detachable" Screwdriver

*Originators—Not Imitators

PARK METALWARE CO., INC.

Dept. V Orchard Park, New York

Quality Tools PREFERRED BY EXPERTS

*FIRST TO USE PLASTIC FOR SCREWDRIVER HANDLES

A Remarkable NEW LINE

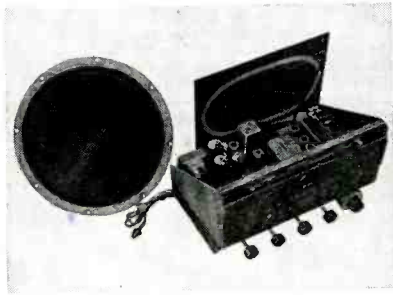

Espey Model 511

High QUALITY High POWER Custom-Built AM-FM CHASSIS

Like every other model in the complete ESPEY line of replacement receivers, and FM Tuners, the Model 511 AM-FM chassis (illustrated) is the last word in modern engineering in the electronics field. Featuring 12 tubes plus Rectifier and Tuning Indicator, it is Drift Compensated, and is supplied complete with all antennas, 25 watt speaker, and all hardware. Its low price assures high profits for you in the growing replacement field. Write today to Dept. N-11 for complete details of this expanding profitable market!

ESPEY MFG. CO., Inc.
528 EAST 72nd ST., NEW YORK 21, N. Y.
"Established 1928"

HARRISON PORTABLE WIRE RECORDER-PHONO

A portable wire recorder with a turntable suitable for either 10" or 12" records, which may be used as a phono, public address system or a musical instrument amplifier, has been announced by the Harrison Mfg. Co., 1446 N. St. Louis, Chicago 51, Illinois.

Will record from its own turntable or from the microphone which is furnished. External speaker leads are supplied for recording direct from radio as well as for using an external speaker when a larger speaker than that built-in is desired.

Other features include a tone control, automatic shut-off, roll-out control panel.

Tube News

(Continued from page 37)

ohm filament resistor place an additional load of approximately 2.3 watts on the scanning circuit. This additional load, as well as power losses in the transformer and rectifier, is well within the power capabilities of the circuit.

In horizontal-deflection circuits that do not utilize the pulse-operated power supply, the pattern width is controlled by varying the screen-grid voltage of the 6BG6G power tube. In the circuit of Fig. 1, however, this type of control is not practical because both output voltage and pattern width are affected by the value of the screen-grid voltage of the 6BG6G. As the screen voltage decreases, both horizontal-scanning power and picture-tube anode voltage decrease simultaneously and little change in picture width results. In order to control picture width, therefore, without appreciably affecting the d-c voltage, a variable inductor (L_1) connected across 15 turns of the secondary winding is used to shunt more or less current from the deflection yoke circuit. Variation of the inductance is adequate to change the picture width because the range required for adjustment is small.

Advantages

Pulse-operated power supplies have a number of desirable characteristics. The horizontal-deflection transformer simultaneously serves as a high-voltage transformer and filament transformer. The inverse-voltage rating of the rectifier tube need be, in general, only about 20 per cent higher than the d-c output voltage. Filtering is simplified because pulsing occurs only during retrace periods. If deflection fails, the high voltage also fails and, therefore, no damage to the picture-tube screen results. As the load on the power supply increases, both the tube anode voltage and the horizontal-deflection power decrease. As a result, the picture width remains essentially constant with change in load. High picture width remains essentially constant with change in load. High voltage for the vertical discharge tube also may be obtained from the pulse-operated power supply by the use of a suitable bleeder. With this arrangement, the amount of vertical deflection will depend upon the high-voltage output, and the picture height, therefore, will also remain essentially constant with change in picture-tube anode voltage.

[Data based on copyrighted material prepared by RCA.]



Servicemen's choice!
... for the last word
in TV service data



J. R. Meagher

• Now you can get the *practical* information you want on the servicing of television receivers! John R. Meagher, with his wealth of experience as Television Specialist for the RCA Tube Department, has prepared a series of articles exclusively for RCA SERVICE NEWS on the servicing of TV receivers. Here's valuable, authentic data you can't get elsewhere... so check with your Cunningham Distributor to make sure you get the entire series. The first article appeared in the May-June issue.



**INDISPENSABLE!
AN ESSENTIAL TOOL
FOR YOUR REPAIR KIT!**

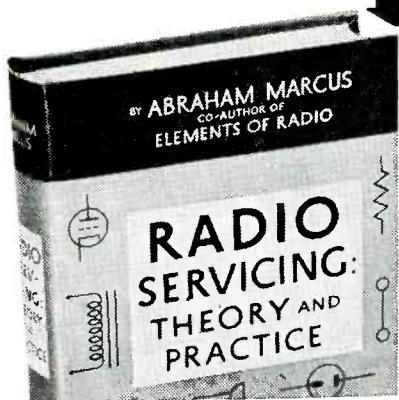

RADIO SERVICING: THEORY AND PRACTICE

By Abraham Marcus

author of *Elements of Radio*

• This book, the sequel to *Elements of Radio*, is essential equipment for all practical radio men—whether you are a service man, maintenance engineer or a manufacturing superintendent. Specific practices of radio repair and the more advanced problems of radio servicing are explained in clear language and over 575 drawings. It may be used by amateur craftsmen or students.

All Standard Servicing Instruments



ABRAHAM MARCUS' first book **ELEMENTS OF RADIO** sold over half a million copies!

For the first time in any book, an extensive section covers all standard servicing instruments—meters, electron-ray-tube indicators, tube checkers, etc.—their parts and their operation, graphically illustrated by 70 drawings in one chapter alone. It discusses electrical and radio theory, components and parts; the many uses of electron tubes, control circuits, power supplies, repair, replacement and readjustment. The sections on the latest developments in Frequency Modulation—FM—bring this practical book right up to the minute.

CHAPTERS include:

Electrical and Radio Theory • Components and Parts • The Electron Tube, as a Rectifier, as a Detector, as an Amplifier, as an Oscillator • Special Tubes • Circuits • Receivers • Instruments Used for Servicing, Procedures, Techniques • Repair, Readjustment, etc.

832 pages plus 16 pages of photographs, 575 drawings. Completely indexed and tabulated. No other reference materials are needed. Its clarity and completeness make it invaluable for the ham or professional.

Send for your copy now!
Mail check or money order for \$5.95 to

PRENTICE-HALL, INC.
Dept. 309-C

70 Fifth Avenue, New York 11, N. Y.

JOTS AND FLASHES

A TELEVISION RECEIVER industry-wide business in 1949 of \$330,000,000 and the sale of approximately 1,600,000 units was predicted recently by Ernest H. Vogel, manager of marketing, Electronics Department, General Electric. Walter M. Skillman, manager of sales for the receiver division of G. E., estimated that 70% of their dollar-volume business next year will come from television. . . . Eugene L. Berman has been named Alliance Manufacturing Co. sales rep for the Northern California territory. David L. Marshank, who formerly covered the entire state, will now concentrate his coverage in the southern half of the state. . . . C. H. Stratton Co., 2601 North Broad Street, Philadelphia, has become sales reps for Taco and will cover eastern Pennsylvania, southern New Jersey, Maryland, Virginia, and the District of Columbia. . . . In the five-week period ending October 1, RMA members produced over 170,000 FM receivers, an increase of close to 55% over August production. . . . Lafayette-Concord has been formed through the merger of Radio Wire Television and Concord Radio. . . . Donald B. Sinclair, General Radio assistant chief engineer, and Frank D. Lewis, G-R engineer, have received Presidential Certificates of Merit. . . . Arthur E. Akeroyd has opened an office at 419 Commonwealth Avenue, Boston. Akeroyd is now rep for Solar Capacitors, Ward Leonard, and Chicago Transformer. . . . William A. Sayre of Daytona Beach has been named Florida rep for the Sterling Manufacturing Company, 9205 Detroit Avenue, Cleveland, Ohio. The Corey Co., 81 Murray Street, New York City, has been named distributor for the Sterling Manufacturing Company. . . . Art J. Nelson, 1639 Blake Street, Denver, Colorado, is now representing P. R. Mallory & Co., Inc., in the Rocky Mountain territory. . . . Audio Equipment Sales, a division of F. Sumner Hall, Inc., is now located at 153 West 33 Street, New York 1. . . . Daniel R. Creato has been named vice president and general counsel for the RCA Service Company. . . . Capital Distributors, Inc., 15½ East Reno Street, Oklahoma City, Oklahoma, are now distributing Admiral receivers. . . . E. L. Berman Co. have been named reps for C. P. Clare & Company, covering northern California and Nevada. . . . Leslie J. Woods has been elected vice president of the Industrial Division of Philco Corporation. . . . Industrial Television, Inc., have announced plans for the manufacture of home television receivers. . . . David H. Ross, 104 9th Street, San Francisco, Calif., is now a manufacturers rep for Air King Products Company, Inc., Brooklyn, N. Y., and will represent them in northern California and the entire state of Nevada. . . . National Union Radio Corp. of Orange and Newark, N. J., are stepping up production on 7", 10" and 12" direct view and 4" projection type television tubes. . . . Jack Cherry has become sales manager of the Philco Service and Parts Division. Cherry has been with Philco for 14 years. . . . The Durst Mfg. Co., manufacturers of electric wiring and soldering pliers, have combined their office and plant facilities at a new location, 1110¼ Cumpston Street, North Hollywood, California.

ADVERTISERS IN THIS ISSUE

SERVICE INDEX—NOVEMBER, 1948

AEROVOX CORPORATION	42
Agency: Austin C. Lescarboursa & Staff	
ALLIANCE MFG. CO.	45
Agency: Foster & Davies, Inc.	
ALLIED RADIO CORPORATION	44
Agency: George Brodsky, Advertising	
AMERICAN ELECTRICAL HEATER CO.	35
Agency: Dudgeon, Taylor & Bruske, Inc.	
AMERICAN PHENOLIC CORP.	47
Agency: Burton Browne, Advertising	
AMERICAN TELEVISION & RADIO CO.	35
Agency: Prestone-Goodman Adv. Agency	
THE ASTATIC CORPORATION	52
Agency: Wearstler Advertising, Inc.	
CLAROSTAT MFG. CO., INC.	40
Agency: Austin C. Lescarboursa & Staff	
CORNELL-DUBILIER ELECTRIC CORP.	Inside Front Cover
Agency: Reiss Advertising	
ALLEN B. DUMONT LABS., INC.	39
Agency: Austin C. Lescarboursa & Staff	
ELECTRO-VOICE, INC.	31
Agency: Henry H. Teplitz, Advertising	
ELECTROVOX CORP.	48
Agency: George Homer Martin, Associates	
ERIE RESISTOR CORP.	46
Agency: W. S. Hill Co.	
ESPEY MFG. CO., INC.	—
Agency: Chas. R. Tighe Advertising, Inc.	
GENERAL ELECTRIC CO.	29
Agency: Maxon, Inc.	
GENERAL ELECTRIC LAMP DEPT.	33
Agency: Batten, Barton, Durstine & Osborn, Inc.	
GREYLOCK ELECTRONICS SUPPLY CO.	42
Agency: Bergman-Jarrett Co.	
THE HEATH COMPANY	4
Agency: Paxson Advertising	
THE HICKOK ELECTRICAL INSTRUMENT CO.	52
Agency: White Adv. Co.	
HYTRON RADIO & ELECTRONICS CORP.	5
Agency: Henry A. Loudon Advertising Agency	
INTERNATIONAL RESISTANCE CO.	44
Agency: John Falkner Arndt & Co., Inc.	
JET THERMAL DEVICES CO.	50
Agency: Adrian E. Clark, Jr.	
P. R. MALLORY & CO., INC.	17
Agency: The Altkin-Kynett Co.	
MUELLER ELECTRIC CO.	51
MURRAY HILL BOOKS, INC.	46
Agency: The Harry P. Bridge Co.	
NEWARK ELECTRIC CO., INC.	53
Agency: The Chernow Co., Inc.	
OHMITE MFG. CO.	11
Agency: Henry H. Teplitz, Advtg.	
PARK METALWARE CO., INC.	54
Agency: Melvin F. Hall Agency, Inc.	
PERMOFLUX CORPORATION	52
Agency: Turner Adv. Agency	
PRECISION APPARATUS CO., INC.	7
Agency: Shappe-Wilkes, Inc.	
PRENTICE-HALL, INC.	56
Agency: Franklin Spier, Inc.	
QUAM NICHOLS CO.	54
Agency: Triangle Adv. Agency, Inc.	
RADIART CORP.	8
Agency: Ohio Adv. Agency	
RADIO CORPORATION OF AMERICA	49, 51, 53, 55, Back Cover
Agency: J. Walter Thompson Co.	
RADIO MERCHANDISE SALES	55
RAYTHEON MFG. CO.	25
Agency: Walter B. Snow & Staff	
JOHN F. RIDER PUBLISHER, INC.	23
Agency: Shappe-Wilkes, Inc.	
HOWARD W. SAMS & CO., INC.	3
Agency: George Brodsky, Advertising	
SANGAMO ELECTRIC CO.	9
Agency: Arthur R. Mogge, Inc.	
SHURE BROTHERS, INC.	37
Agency: Casler, Hempstead & Banford, Inc.	
SOLAR CAPACITOR SALES CORP.	Inside Back Cover
Agency: O. S. Tyson & Co., Inc.	
SPRAGUE PRODUCTS CO.	6
Agency: The Harry P. Bridge Co.	
SYLVANIA ELECTRIC PRODUCTS, INC.	12
Agency: Newell-Emmett Co.	
TRANSVISION, INC.	41
Agency: H. J. Gold Co.	
TRIPLETT ELECTRICAL INSTRUMENT CO.	10
Agency: Western Adv. Agency, Inc.	
UTAH RADIO PRODUCTS DIV. INT'L DETROLA	43
Agency: Bonsib Adv. Agency	
WARD LEONARD ELECTRIC CO.	50
Agency: Henry H. Teplitz, Advtg.	



DRY ELECTROLYTICS FOR TELEVISION RECEIVERS



...stand up under 85°C operation

Solar's new Type DY-TV series of dry electrolytic capacitors assures dependable operation under the severest conditions found in television receivers.

An especially developed Solar processing technique makes possible small yet sturdy capacitors designed for high temperature operation with no sacrifice in long life or electrical characteristics.

Because of the remarkable film stability of Solar's DY-TV series of electrolytics, there is but an extremely small change in power factor and leakage current from room temperature to 85°C.

Type DY-TV capacitors, with their special film formation, do not "run away" when voltage is applied after idling under no-voltage conditions at 85°C. These characteristics are retained even after extended shelf life.

Investigate this remarkable achievement in capacitor design today! Write today for catalog.

SOLAR CAPACITOR SALES CORP.
NORTH BERGEN, NEW JERSEY

SOLAR CAPACITORS

"Quality Above All"



Concentrated Distribution

...in
the
Radio
Field



You can sell more RCA Batteries because—

1. RCA Batteries are sold primarily through radio dealers and servicemen—this means more *repeat* business for *you*.
2. RCA provides the greatest array of selling aids in battery history . . . all geared to the *radio trade!*
3. Eight warehouses are strategically located to assure you of quick delivery on fresh stocks of RCA batteries through your local RCA Distributor.
4. RCA's completely rounded line covers virtually all of the requirements of the radio and electronics field.
5. Smart packaging, competitive prices, and "the greatest name in radio" add up to overwhelming customer acceptance.
6. RCA batteries are *radio engineered* for extra listening hours.

See your RCA Distributor about RCA Batteries today.

SELL RCA BATTERIES—THE COMPLETE LINE FOR THE RADIO AND ELECTRONIC TRADE

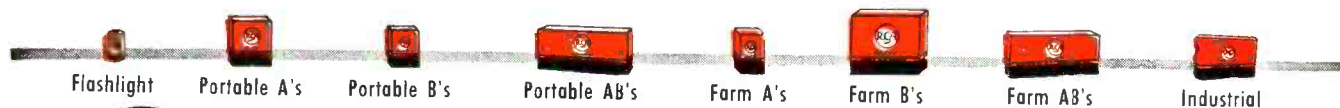

RADIO CORPORATION of AMERICA

HARRISON, N. J.